

Contents

Before driving

Introduction 2

Instrumentation 6

Controls and features 24

Seating and safety restraints 109

Starting and driving

Starting 149

Driving 156

Roadside emergencies 180

Servicing

Maintenance and care 202

Capacities and specifications 266

Customer assistance 272

Reporting safety defects (U. S. only) 284

Index 285

All rights reserved. Reproduction by any means, electronic or mechanical including photocopying, recording or by any information storage and retrieval system or translation in whole or part is not permitted without written authorization from Ford Motor Company. Ford may change the contents without notice and without incurring obligation.

Introduction

CALIFORNIA Proposition 65 Warning

 **Warning:** Engine exhaust, some of its constituents, and certain vehicle components contain or emit chemicals known to the State of California to cause cancer and birth defects or other reproductive harm. In addition, certain fluids contained in vehicles and certain products of component wear contain or emit chemicals known to the State of California to cause cancer and birth defects or other reproductive harm.



ICONS

Indicates a safety alert. Read the following section on *Warnings*.

Indicates that vehicle information related to recycling and other environmental concerns will follow.

Correct vehicle usage and the authorized disposal of waste, cleaning and lubrication materials are significant steps towards protecting the environment.



WARNINGS

Provide information which may reduce the risk of personal injury and prevent possible damage to others, your vehicle and its equipment.

BREAKING IN YOUR VEHICLE

There are no particular breaking-in rules for your vehicle. During the first 1 600 km (1 000 miles) of driving, vary speeds frequently.

This is necessary to give the moving parts a chance to break in.

If possible, you should avoid full use of the brakes for the first 1 600 km (1 000 miles).

INFORMATION ABOUT THIS GUIDE

The information found in this guide was in effect at the time of printing. Ford may change the contents without notice and without incurring obligation.

Introduction

















Vehicle symbol glossary

These are some of the symbols you may have on your vehicle.

Safety Alert		See Owner's Guide	
Fasten Safety Belt		Airbag – Front	
Airbag – Side		Child Seat	
Child Seat Installation Warning		Child Seat Tether Anchorage	
Brake System		Anti-Lock Brake System	
Brake Fluid – Non-Petroleum Based		Traction Control	
Master Lighting Switch		Hazard Warning Flasher	
Fog Lamps – Front		Fuse Compartment	
Fuel Pump Reset		Windshield Wash/Wipe	
Windshield Defrost/Demist		Rear Window Defrost/Demist	
Power Windows Front/Rear		Power Window Lockout	

Introduction

Vehicle symbol glossary

Child Safety Door Lock/Unlock		Panic Alarm	
Engine Oil		Engine Coolant	
Engine Coolant Temperature		Do Not Open When Hot	
Battery		Avoid Smoking, Flames, or Sparks	
Battery Acid		Explosive Gas	
Fan Warning		Power Steering Fluid	
Maintain Correct Fluid Level		Emission System	
Engine Air Filter		Passenger Compartment Air Filter	
Jack			

Instrumentation

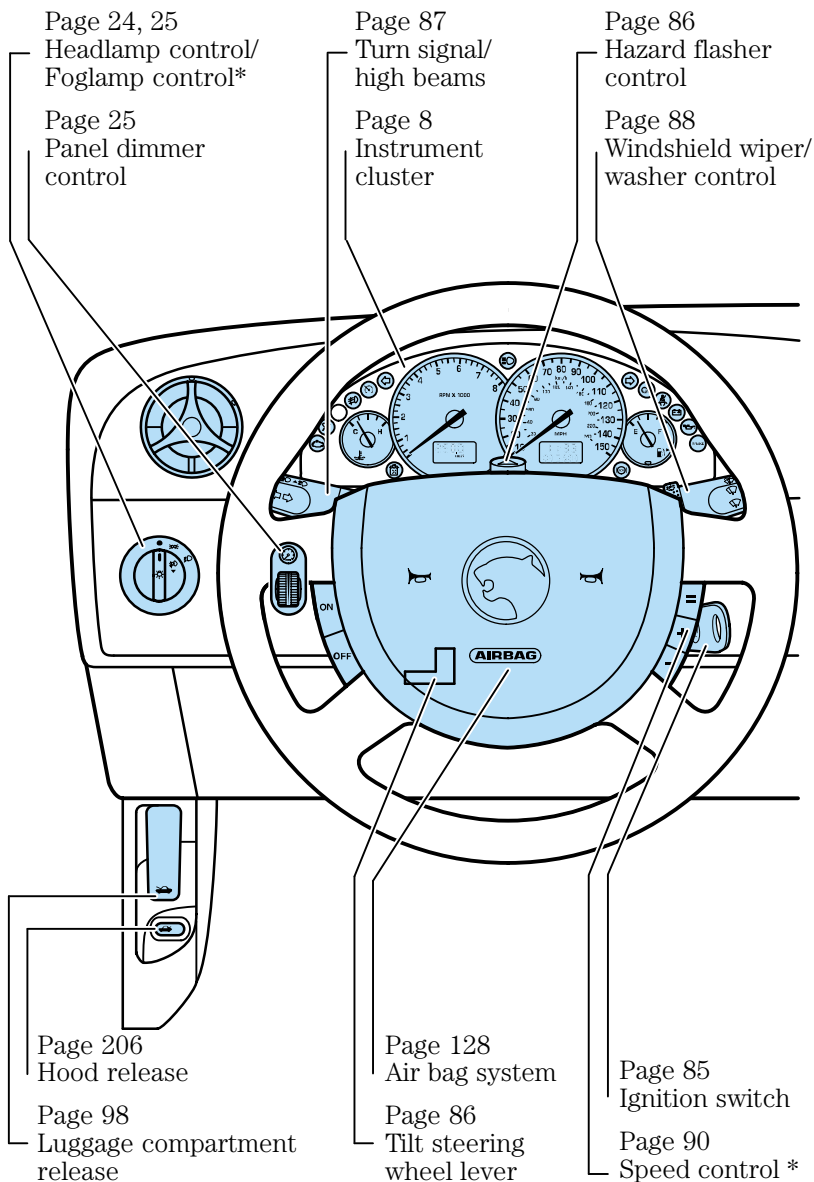

Instrumentation

Page 26

Trip computer

Page 106

Anti-theft system
status indicator

On various models the appearance and location of some items may differ from those shown here. However, the page references given still apply.

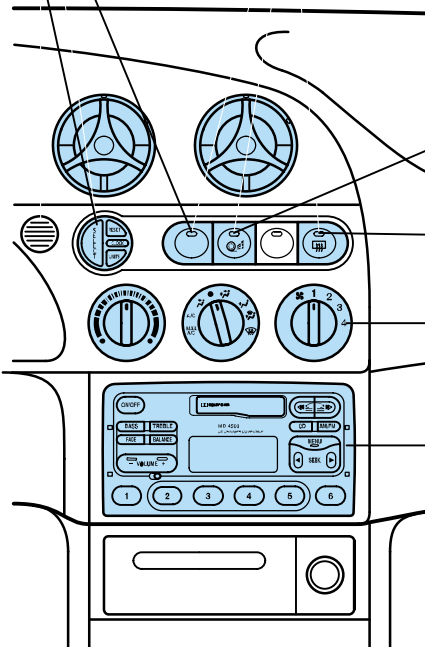

Page 12

Traction control system *

Page 28

Rear window defroster control

Page 29

Climate controls

Page 35

Audio system

Instrumentation

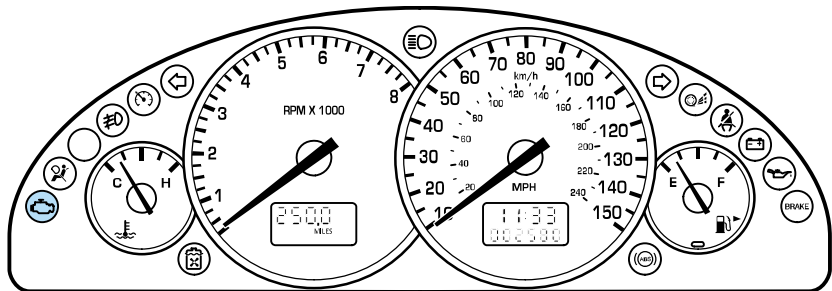

INSTRUMENT CLUSTER LIGHTS AND CHIMES

Check engine

Your vehicle is equipped with a computer that monitors the engine's emission control system. This system is commonly known as the On Board Diagnostics System (OBD II). This OBD II system protects the environment by ensuring that your vehicle continues to meet government emission standards. The OBD II system also assists the service technician in properly servicing your vehicle.

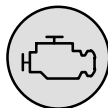

The “check engine” indicator light illuminates when the ignition is first turned to the **ON** position to check the bulb. If it comes on after the engine is started, one of the engine’s emission control systems may be malfunctioning. The light may illuminate without a driveability concern being noted. The vehicle will usually be drivable and will not require towing.

What you should do if the check engine light illuminates

Light turns on solid:

This means that the OBD II system has detected a malfunction.

Temporary malfunctions may cause your “check engine” light to illuminate. Examples are:

1. The vehicle has run out of fuel. (The engine may misfire or run poorly).
2. Poor fuel quality or water in the fuel.
3. The fuel cap may not have been properly installed and securely tightened.

These temporary malfunctions can be corrected by filling the fuel tank with good quality fuel and/or properly installing and securely tightening the gas cap. After three drive cycles without these or any other temporary malfunctions present, the “check engine” light should turn off. (A driving cycle consists of a cold engine startup followed by mixed city/highway driving). No additional vehicle service is required.

Instrumentation

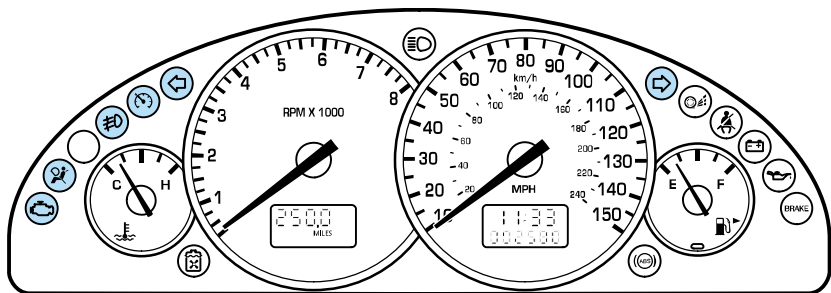

If the “check engine” light remains on, have your vehicle serviced at the first available opportunity.

Light is blinking:

Engine misfire is occurring which could damage your catalytic converter. You should drive in a moderate fashion (avoid heavy acceleration and deceleration) and have your vehicle serviced at the first available opportunity.



Under engine misfire conditions, excessive exhaust temperatures could damage the catalytic converter, the fuel system, interior floor coverings or other vehicle components, possibly causing a fire.

Instrumentation

Air bag readiness

Briefly illuminates when the ignition is turned on. If the light fails to illuminate, continues to flash or remains on, have the system serviced immediately.



Foglamps

Illuminates when foglamps are switched on.

Refer to *Foglamp control* in the *Controls and features* chapter for notes on use.



Speed control (if equipped)

Illuminates when the speed control system is switched on. Refer to *Speed control* in the *Controls and features* chapter.



Turn signals

Flashes when the left or right turn signal or hazard lights are activated.

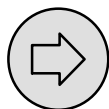
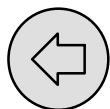

Instrumentation

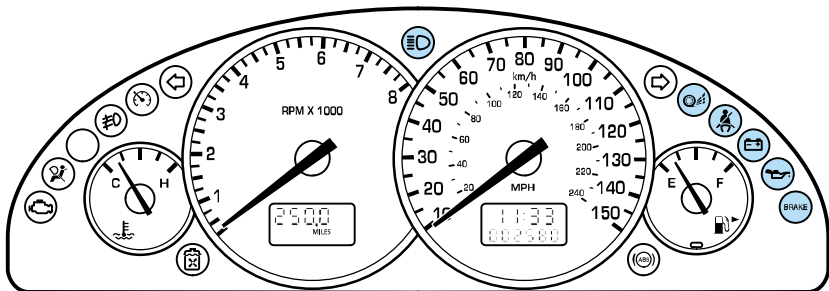

High beams

Illuminates when the headlamp high beams are on.

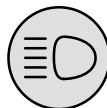

Traction control system (if equipped)

Illuminates to indicate the system is functioning to regulate tire traction. The control will toggle this feature on or off, but the feature defaults to on after each cycle of the ignition key. The light in the control illuminates when the system is switched off.



Safety belt

Illuminates when the ignition is switched on as a reminder to fasten the safety belts. For more information, refer to *Safety belt warning light and warning chime* in the *Seating and safety restraints* chapter.



Instrumentation

Charging system

Illuminates when the ignition is turned on and the engine is off. The light also illuminates when the battery is not charging properly and the vehicle may require electrical system service.

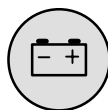

Engine oil pressure

Illuminates when the ignition is turned on and the engine is off. The light also illuminates when engine oil pressure falls below the normal range when the engine is running. Refer to the *Maintenance and care* chapter to check the engine oil level as soon as possible. If the engine oil level is correct and the light remains illuminated, do not start the engine. See your dealer or a qualified service technician.



Brake system warning

Extinguishes when the parking brake is released. Illuminates after releasing the parking brake to indicate low brake fluid level or that the Electronic Brake Distribution system (part of the ABS) requires service. The vehicle is equipped with one of two lights, depending on the market.

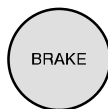

Instrumentation

O/D off indicator (automatic transaxle only)

Illuminates and remains illuminated when the transaxle control switch on the end of the gearshift lever is pressed and overdrive is turned off.

Indicates the status of the transaxle and will flash steadily if a malfunction is detected. If the flashing persists, have your transaxle serviced by your dealer or a qualified service technician as soon as possible.



Automatic transaxle warning (if equipped)

Illuminates when driving to indicate a possible malfunction with the transaxle. Have the system checked by your dealer or a qualified technician.



Instrumentation

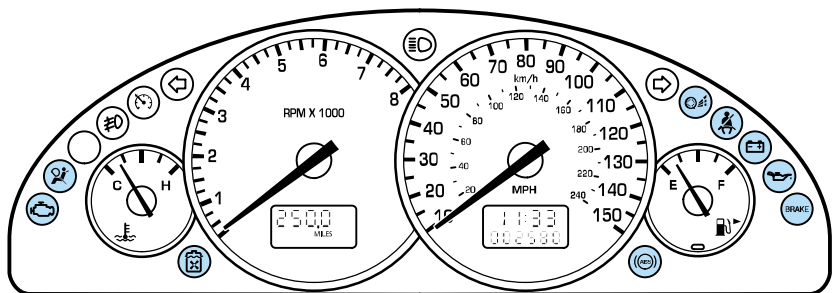

Testing the warning and indicator lights

Turn the ignition key to the on position without starting the engine. The following warning and indicator lights should illuminate: charging system, safety belt (does not illuminate, if the driver's safety belt is fastened), low coolant, engine oil pressure, check engine, air bag readiness, traction control, brake system and ABS. The overhead warning lights (if equipped) should also illuminate briefly.

If any of these lights do not illuminate, see your dealer or qualified service technician.

Headlamps on warning chime

Sounds when the headlamps are on, the ignition is off (and the key is not in the ignition) and the driver's door is open.

Key-in-ignition warning chime

Sounds when the key is left in the off/lock or accessory position and the driver's door is open.

Safety belt warning chime

For information on the safety belt warning chime, refer to the *Seating and safety restraints* chapter.

Liftgate ajar warning chime (if equipped)

Sounds when the ignition is in the on position and the liftgate is ajar or open. The interior dome lamp will also illuminate.

Instrumentation

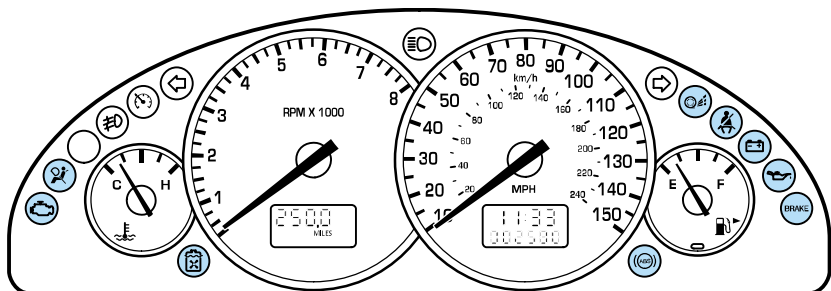

INSTRUMENT CLUSTER GAUGES

Engine coolant temperature gauge

Indicates the temperature of the engine coolant. At normal operating temperature, the needle remains within the normal area. If it enters the red section, the engine is overheating. Stop the vehicle, turn off the engine and let the engine cool. Refer to *Cooling system* in the *Maintenance and care* chapter.

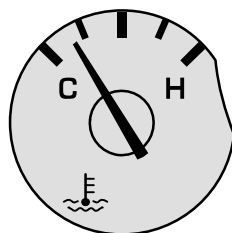

 Never remove the coolant reservoir cap while the engine is running or hot.

Instrumentation

Tachometer

Indicates the engine speed in revolutions per minute (rpm).

Trip odometer

Registers the distance traveled on individual journeys. Refer to *Trip computer* in the *Controls and features* chapter.

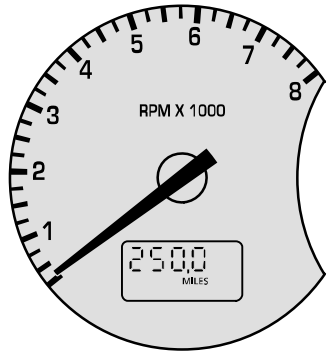

Speedometer

Indicates the current vehicle speed.

On Cougar S vehicles, the speedometer registers up to 160 mph.

Odometer

Registers the total distance traveled by the vehicle.

Speedometer



Odometer

Instrumentation

Fuel gauge

Displays approximately how much fuel is in the fuel tank (when the key is in the ON position). The fuel gauge may vary slightly when the vehicle is in motion. The ignition should be in the OFF position while the vehicle is being refueled. When the gauge first indicates empty, there is a small amount of reserve fuel in the tank. When refueling the vehicle from empty indication, the amount of fuel that can be added will be less than the advertised capacity due to the reserve fuel.

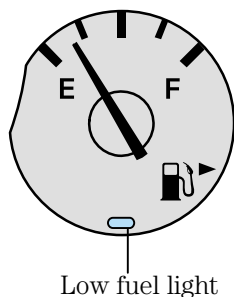

Low fuel reminder

Illuminates as an early reminder of a low fuel condition indicated on the fuel gauge. When refueling the vehicle after the light first comes on, the amount of fuel that can be added will be less than the advertised capacity since there is still fuel in the tank. The ignition must be in the ON position for this lamp to illuminate.

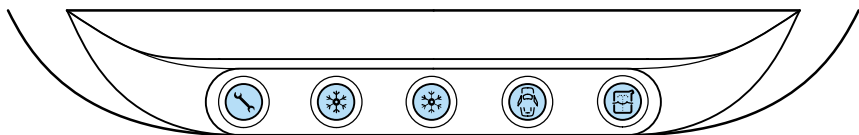

OVERHEAD WARNING LIGHTS (if equipped)

These lights illuminate briefly when the ignition key is turned to the on position.

Service intervals

Illuminates after approximately 7 700 km (4 800 miles) or 358 days to indicate that routine service should be performed. Check your maintenance schedule to determine the routine service to be completed. Routine service should be performed by an authorized Ford or Lincoln/Mercury Dealer. The light should be switched off by your Ford or Lincoln/Mercury Dealer after completing the service.

To reset the light, hold the SELECT and UNITS buttons on the trip computer for 5 seconds. The service interval light will be illuminated and then extinguish after approximately 4 seconds.



Instrumentation

Frost warning

Illuminates when ambient air temperatures are between 0°C (32°F) and 4°C (39°F). The yellow sign warns of possible ice on the roads.

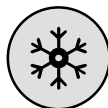

Danger of ice warning

Illuminates when 0°C (32°F) and below. The red sign warns of an increased danger of icy roads.

The absence of a light in cold temperatures does not necessarily mean that there is no risk of ice on the road. Caution should be exercised when weather conditions indicate that ice may be present. Even if the air temperature rises to above +4°C (39°F) it is no guarantee that the road is free of ice.

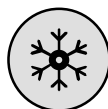

Instrumentation

Washer fluid warning

Indicates that the washer fluid reservoir is low. Refill as soon as possible. If a valid signal is received, the light will remain on until the ignition is cycled.



Door ajar

Illuminates when the ignition is switched on and any door or liftgate is open.



Controls and features

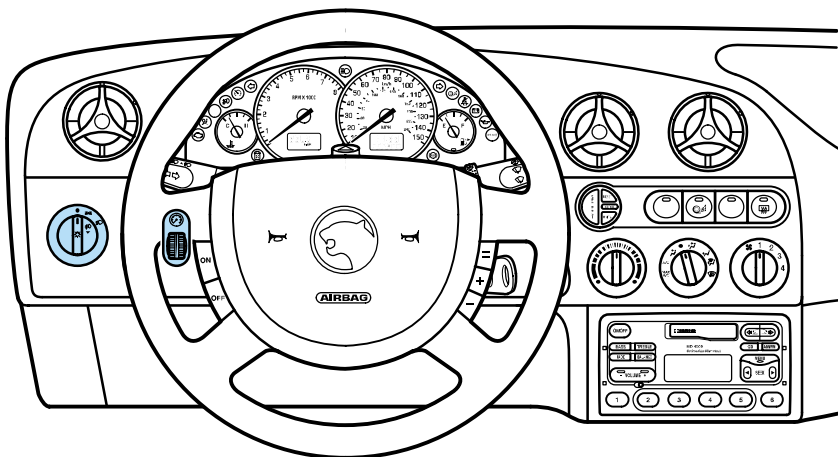

INSTRUMENT PANEL CONTROLS

Headlamp control

● Lamps off.

 Turn one position clockwise:
Parking lamps, instrument panel lamps, license plate lamps and tail lamps on.

 Turn two positions clockwise:
Headlamps on.

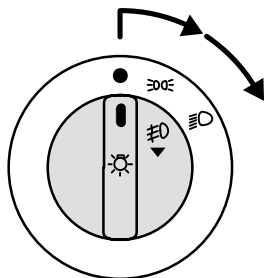

Controls and features

Foglamp control (if equipped)

Pull the control toward you while the headlamps are on to turn the foglamps on.

Push the control in to turn off the foglamps.

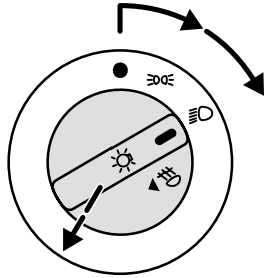

Daytime running lights (DRL) (Canadian vehicles only)

The DRL system turns the headlamps on, with a reduced light output, when:

- the ignition is in the on position and
- the headlamp is in the off position.

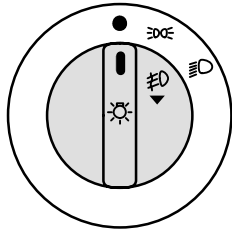

Always remember to turn on your headlamps at dusk or during inclement weather. The Daytime Running Lights (DRL) system may not provide adequate lighting output during these conditions. Failure to activate your headlamps under these conditions may result in a collision.

Panel dimmer control

Adjust the control to vary the intensity of the panel lighting. Operates only when the exterior lights are switched on.

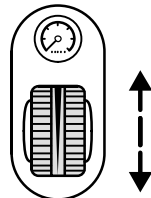

Controls and features

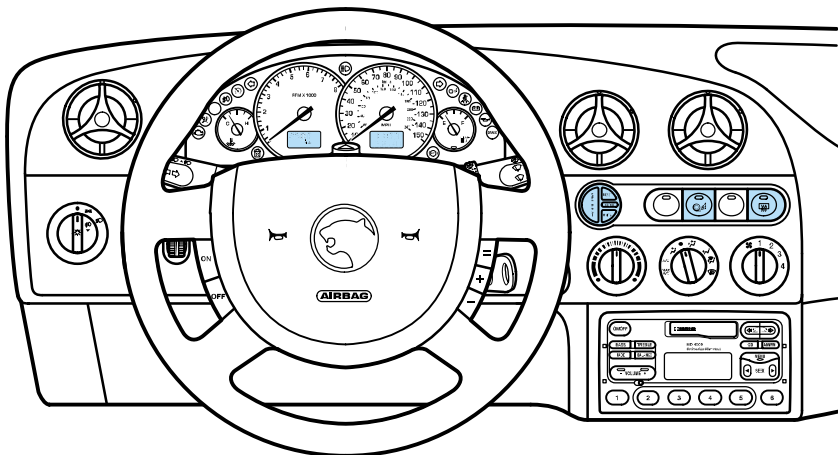

Trip computer

Press the SELECT button to change between temperature, average speed, tripmeter, distance to empty or fuel consumption.

Press the UNITS button to toggle between English or Metric units.

Press the RESET button to set the function to zero (if resettable).

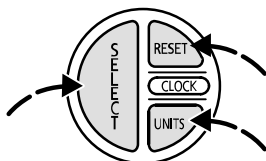

Temperature

Shows the outside air temperature. It may take several minutes of driving for the display to update the present temperature.



Average speed

Shows the average speed since last reset.



Controls and features

Tripmeter

Shows how far you have traveled since last reset.



Distance to empty

Shows the approximate distance you can drive with the fuel remaining in the tank.



Average fuel economy

Shows the average fuel economy since last reset.



Digital clock

Switch the ignition on: The clock can be set to either 12 or 24 hour format.

To toggle between 12 or 24 hour format, depress the CLOCK button. Then press the UNITS button until "HR" is in the display. Press the RESET button to toggle between 12 and 24 hours.

To advance the hours, press the UNITS button again until the hour flashes. Press the RESET button to advance the hours.

To advance the minutes, press the UNITS button again until the minutes flash. Press the RESET button to advance the minutes.

Press the CLOCK button to store the time. If the CLOCK button is not pressed, the new time setting will not be stored.

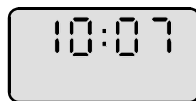
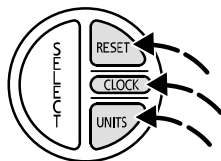

Controls and features

Traction control system (if equipped)

This system helps prevent wheel spin to improve tire traction. The control will toggle this feature on or off, but the feature defaults to on after each cycle of the ignition key. The light in the control illuminates when the system is switched off.

Refer to the *Traction Control* section in the *Driving* chapter.

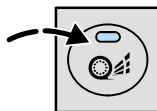

Rear window defroster

Press the defroster control to clear the rear window of thin ice and fog.

The ignition must be in the on position to operate the rear window defroster.

The defroster turns off automatically after 10 minutes or when the ignition is turned to the off position. To manually turn off the defroster, push the control again.

The light in the control illuminates when the system is switched on.

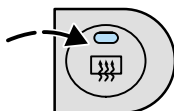

Front ashtray

The ashtray is located beneath the radio.

To open, press and the ashtray opens automatically. To empty, extract the ashtray.

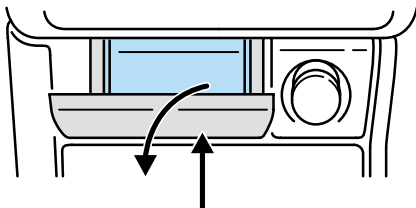

Controls and features

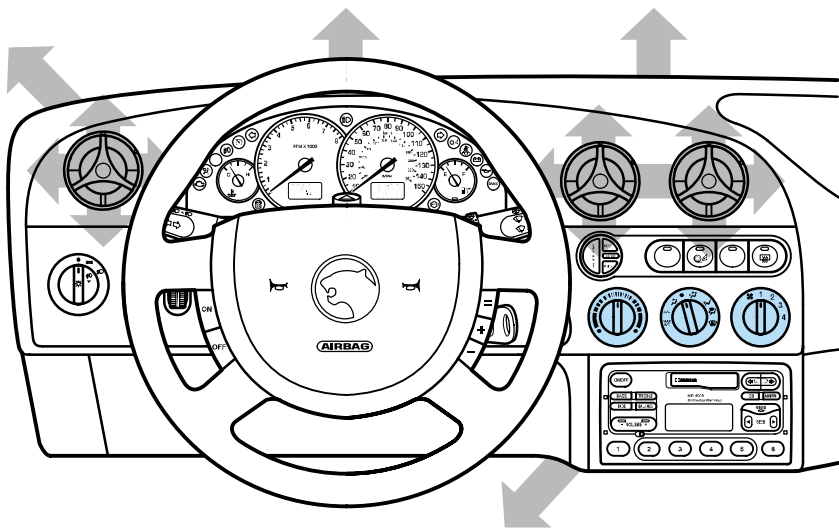

Climate controls

Your vehicle is equipped with a manual heating and air conditioning system.

Vents

Adjust as necessary.

Low airflow: rotate vent clockwise.

High airflow: rotate vent counterclockwise.

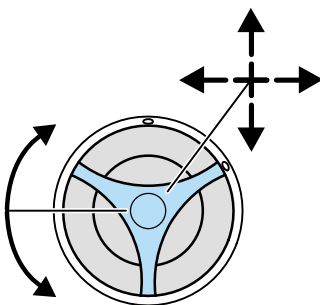

Controls and features

Temperature

Controls the temperature of the airflow inside the vehicle.

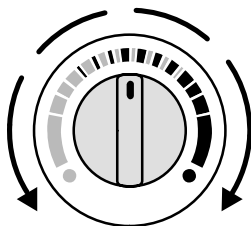



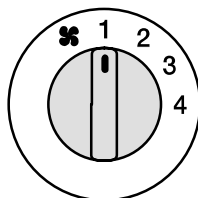

Fan speed

Controls the volume of air circulated in the vehicle.



Mode selector

Controls the direction of the airflow to the inside of the vehicle.

The air conditioning compressor (if equipped) will operate in all modes except , ,  and . However, the air conditioning will only function if the outside temperature is 4°C (39°F) or higher.

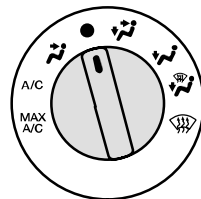

Since the air conditioner removes considerable moisture from the air during operation, it is normal if clear water drips on the ground under the air conditioner drain while the system is working and even after you have stopped the vehicle.

Under normal conditions, your vehicle's climate control system should be left in any position other than MAX A/C or off when the vehicle is parked. This allows the vehicle to "breathe" through the outside air inlet duct. In snowy or dirty conditions, leave the mode selector in the OFF position when the ignition is off.

Controls and features

- **MAX A/C** (if equipped): Uses recirculated air to cool the vehicle. MAX A/C is noisier than A/C but more economical and will cool the inside of the vehicle faster. Airflow will be from the instrument panel registers. Use this mode to prevent any undesirable odors from entering the vehicle.

- **A/C** (if equipped): Uses outside air to cool the vehicle. It is quieter than MAX A/C but not as economical. Airflow will be from the instrument panel registers.

- : Distributes outside air through the instrument panel registers. However, the air will not be cooled below the outside temperature because the air conditioning does not operate in this mode.

- : Outside air is shut out and the fan will not operate.

For short periods of time only, use this mode to prevent undesirable odors from entering the vehicle.



Controls and features

- : Distributes outside air through the instrument panel registers and the floor ducts. For added customer comfort, the air distributed through the floor ducts will be slightly warmer than the air sent to the instrument panel registers. If temperature is set to cool, the air will not be cooled below the outside temperature because the air conditioning does not operate in this mode.



- : Allows for maximum heating by distributing outside air through the floor ducts. If temperature is set to cool, the air will not be cooled below the outside temperature because the air conditioning does not operate in this mode.



- : Distributes outside air through the windshield defroster ducts and the floor ducts. For added customer comfort, the air distributed through the floor ducts will be slightly warmer than the air sent to the windshield defroster ducts.



Controls and features

- : Distributes outside air through the windshield defroster ducts. It can be used to clear ice or fog from the windshield when temperature is set to full hot and fan speed is set to 4. If the temperature is about 4°C (39°F) or higher, the air conditioner (if equipped) will automatically dehumidify the air to reduce fogging.



Operating Tips

- For best cooling performance, select MAX A/C (if equipped) to cool the vehicle quickly.
- In humid weather, select  before driving. This will reduce fogging on your windshield. After a few minutes, select any desired position.
- The outer vents can be used to defrost the side windows. This operates in all modes except defrost. To operate, the center vents must be closed and the outer vents positioned towards the windows.

Controls and features

- Don't put objects under the front seat that will interfere with airflow to the back seats.
- Remove any snow, ice or leaves from the air intake area (at the bottom of the windshield under the hood).
- Do not place objects over the defroster outlets. These objects can block the airflow and reduce your ability to see through the windshield. In addition, avoid placing small objects on top of your instrument panel. These objects can fall into the defroster outlets and block airflow and possibly damage your climate control system.

Cabin air filter

Your vehicle is equipped with an air filter that removes pollen and road dust from outside air before it is directed to the interior of the vehicle. Refer to the *Maintenance and care* chapter for maintenance of this filter.



Do not place objects on top of the instrument panel, as these objects may become projectiles in a collision or sudden stop.

AUDIO SYSTEM

Anti-theft protection panel (if equipped)

To deter would-be thieves, Ford audio units have a removable front panel without which the unit will not work.

Avoid touching the contacts on the back of the panel and do not use excessive force to refit it.

Slide the security release button to the left and remove the front panel. To reposition the panel, insert the right-hand edge first, then the left-hand side, until the retaining latch is engaged.

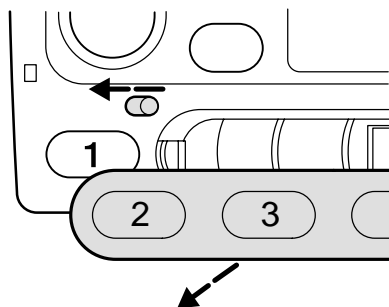

Replacement panels

Your Ford Dealer will require the following if you need to order a replacement panel:

1. Your name and address.
2. The Vehicle Identification Number (visible on a plate mounted in the engine compartment).
3. The audio unit type (e.g., 4600).
4. Proof of identification (e.g., driver's license, identity card).
5. A vehicle invoice (if the audio unit was installed in the vehicle prior to delivery) or a parts invoice if the audio unit was purchased separately from the vehicle, or an appropriate vehicle registration document.

Controls and features

Radio reception

To gain the best reception, always tune to the strongest station signal available.

The following tips will help you gain the best reception from your Ford audio system.

AM reception

Under most conditions, strong signals provide stable sound quality and little signal disturbance.

However, at night, atmospheric conditions may sometimes lead to interference from other stations.

FM reception

The FM waveband offers higher quality sound broadcasts, but signal strength can be subject to interference caused by:

- The limited range of some transmitters.
- Reception distortion as signals reflect off local buildings and other objects.
- Signal “dead spots” where reception is obstructed or restricted.

Controls and features

PREMIUM AM/FM STEREO/CASSETTE/SINGLE CD

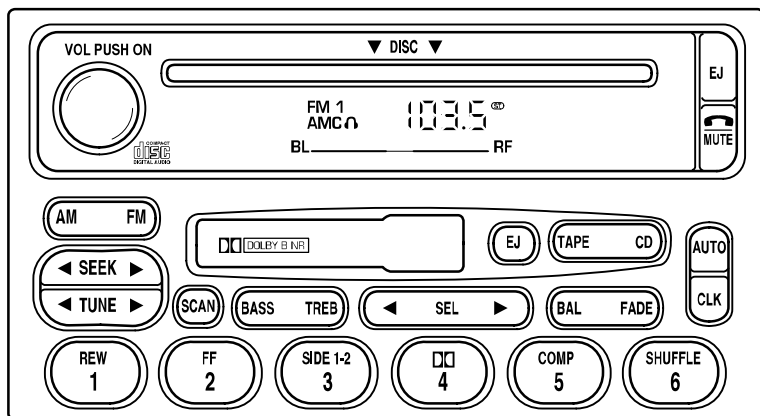

Volume/power control

Press for on/off. This button can also operate the unit for up to one hour with the ignition turned off. The radio automatically switches off after one hour.

Audio power can also be turned on by pressing the AM/FM select control or the tape/CD select control. Audio power is turned off by using the volume/power control.

Turn control to raise or lower volume.

If the volume is set above a certain level and the ignition is turned off, the volume will come back on at a “nominal” listening level when the ignition switch is turned back on.

VOL - PUSH ON

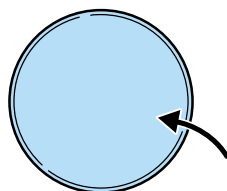

VOL - PUSH ON

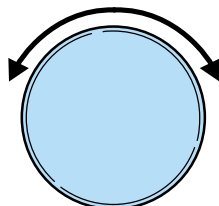

Controls and features

AM/FM select

The AM/FM select control works in radio, tape and CD modes.

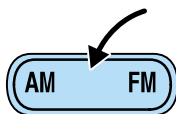

AM/FM select in radio mode

This control allows you to select AM or FM frequency bands. Press the control to switch between AM, FM1 or FM2 memory preset stations.

AM/FM select in tape mode

Press this control to stop tape play and begin radio play.

AM/FM select in CD mode

Press this control to stop CD play and begin radio play.

AM/FM select

The AM/FM select control works in radio, tape and CD modes.

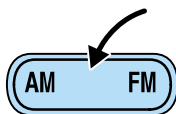

AM/FM select in radio mode

This control allows you to select AM or FM frequency bands. Press the control to switch between AM, FM1 or FM2 memory preset stations.

AM/FM select in tape mode

Press this control to stop tape play and begin radio play.

Controls and features

Tune adjust

Tune adjust in radio mode

- Press ◀ to move to the next frequency down the band (whether or not a listenable station is located there). Hold the control to move through the frequencies quickly.
- Press ▶ to move to the next frequency up the band (whether or not a listenable station is located there). Hold for quick movement.

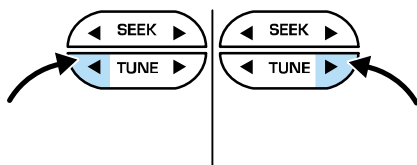

Tune adjust

The tune control works in radio mode.

Tune adjust in radio mode

- Press ◀ to move to the next frequency down the band (whether or not a listenable station is located there). Hold the control to move through the frequencies quickly.
- Press ▶ to move to the next frequency up the band (whether or not a listenable station is located there). Hold for quick movement.

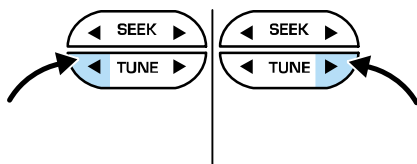

Controls and features

Seek function

The seek function control works in radio, tape or CD mode.

Seek function radio mode

Press ◀ to find the next listenable station down the frequency band.

Press ▶ to find the next listenable station up the frequency band.

Seek function in tape mode

Press ◀ to listen to the previous selection on the tape.

Press ▶ to listen to the next selection on the tape.

Seek function for CD

Press ◀ to seek the previous track of the current disc.

Press ▶ to seek forward to the next track of the current disc. After the last track has been completed, the first track of the current disc will automatically replay.

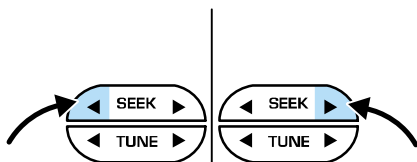
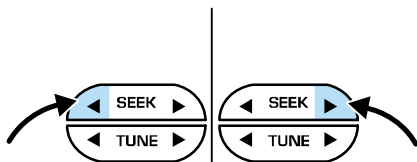

Controls and features

Seek function

The seek function control works in radio, tape or CD mode.

Seek function in radio mode

Press ◀ to find the next listenable station down the frequency band.

Press ▶ to find the next listenable station up the frequency band.

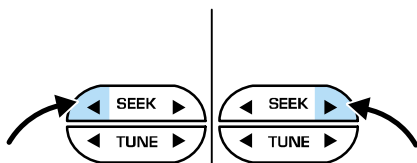

Seek function in tape mode

Press ◀ to listen to the previous selection on the tape.

Press ▶ to listen to the next selection on the tape.

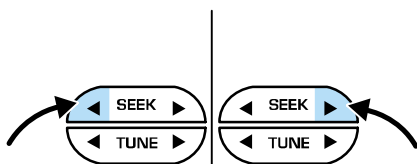

Seek function in CD mode

Press ◀ to seek the previous track of the current disc.

Press ▶ to seek forward to the next track of the current disc. After the last track has been completed, the first track of the current disc will automatically replay.

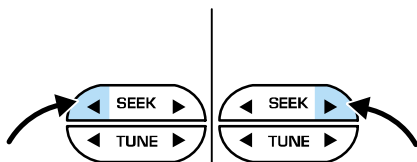

Controls and features

Scan function



The scan function works in radio, tape or CD mode.

Scan function in radio mode

Press the SCAN control to hear a brief sampling of all listenable stations on the frequency band. Press the control again to stop the scan mode.

Scan function in tape mode

Press the SCAN control to hear a short sampling of all selections on the tape. (The tape scans in a forward direction. At the end of the tape's first side, direction automatically reverses to the opposite side of the tape.) To stop on a particular selection, press the control again.

Scan function in CD mode

Press the SCAN control to hear a short sampling of all selections on the CD. (The CD scans in a forward direction, wrapping back to the first track at the end of the CD.) To stop on a particular selection, press the control again.

Controls and features

Scan function



The scan function works in radio, tape or CD mode.

Scan function in radio mode

Press the SCAN control to hear a brief sampling of all listenable stations on the frequency band. Press the control again to stop the scan mode.

Scan function in tape mode

Press the SCAN control to hear a short sampling of all selections on the tape. (The tape scans in a forward direction. At the end of the tape's first side, direction automatically reverses to the opposite side of the tape.) To stop on a particular selection, press the control again.

Scan function in CD mode

Press the SCAN control to hear a short sampling of all selections on the CD. (The CD scans in a forward direction, wrapping back to the first track at the end of the CD.) To stop on a particular selection, press the control again.

Radio station memory preset

The radio is equipped with six station memory preset controls. These controls can be used to select up to six preset AM stations and twelve FM stations (six in FM1 and six in FM2).

Controls and features

Setting memory preset stations

1. Select the frequency band with the AM/FM select control.
2. Select a station. Refer to *Tune adjust* or *Seek function* for more information on selecting a station.
3. Press and hold a memory preset control until the sound returns, indicating the station is held in memory on the control you selected.

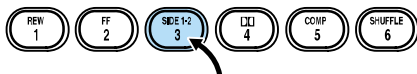
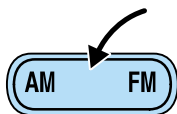

Autoset memory preset

Autoset allows you to set strong radio stations without losing your original manually set preset stations. This feature is helpful on trips when you travel between cities with with different radio stations.

Starting autoset memory preset

1. Select a frequency using the AM/FM select controls.
2. Press the AUTO control.
3. When the first six strong stations are filled, the station stored in memory preset control 1 will start playing.

If there are less than six strong stations available on the frequency band, the remaining memory preset controls will all store the last strong station available.

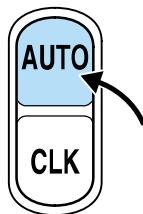

Controls and features

These stations are temporarily stored in the memory preset controls (until deactivated) and are accessed in the same manner of your original presets.

To deactivate autoset and return to your audio system's manually set memory stations, press the AUTO control again.

Bass adjust

The bass adjust control allows you to increase or decrease the audio system's bass output.

Press the BASS control then press:

- ◀ to decrease the bass output and
- ▶ to increase the bass output.



Treble adjust

The treble adjust control allows you to increase or decrease the audio system's treble output.

Press the TREB control then press:

- ◀ to decrease the treble output and
- ▶ to increase the treble output.



Speaker balance adjust

Speaker sound distribution can be adjusted between the right and left speakers.

Press the BAL control then press:

- ◀ to shift sound to the left and
- ▶ to shift sound to the right.



Controls and features

Speaker fade adjust

Speaker sound can be adjusted between the front and rear speakers.

Press the FADE control then press:

- ◀ to shift the sound to the front and
- ▶ to shift the sound to the rear.



Tape/CD select

- To begin tape play (with a tape loaded into the audio system) while in the radio or CD mode, press the TAPE control. Press the button during rewind or fast forward to stop the rewind or fast forward function.

- To begin CD play (if CD is loaded), press the CD control. The first track of the disc will begin playing. If returning from radio or tape mode, CD play will begin where it stopped last.

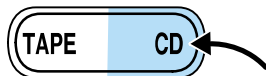

Tape select

- To begin tape play (with a tape loaded into the audio system) while in the radio or CD mode, press the TAPE control. Press the button during rewind or fast forward to stop the rewind or fast forward function.



Controls and features

Rewind

The rewind control works in tape and CD modes.

- In tape mode, radio play will continue until rewind is stopped (with the TAPE control) or the beginning of the tape is reached.
- In CD mode, pressing the REW control rewinds the CD within the current track.

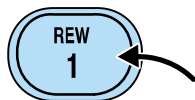

Fast forward

The fast forward control works in tape and CD modes.

- In the tape mode, tape direction will automatically reverse when the end of the tape is reached.
- In CD mode, pressing the control fast forwards the CD within the current track.

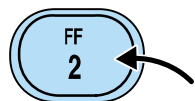

Tape direction select

Press SIDE 1-2 to play the alternate side of a tape.

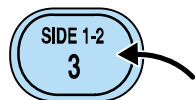

Eject function

Press the EJ control to stop and eject a tape.

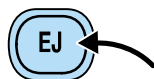

Press the EJ control to stop and eject a CD.

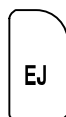

Controls and features

Dolby noise reduction

Dolby noise reduction reduces the amount of hiss and static during tape playback. Press the control to activate (and deactivate) the noise reduction.

Dolby noise reduction manufactured under license from Dolby Laboratories Licensing Corporation. “Dolby” and the double-D symbol  are trademarks of Dolby Laboratories Licensing Corporation.

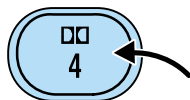

Compression adjust

Compression adjust brings soft and loud CD passages together for a more consistent listening level.

Press the COMP control to activate and deactivate compression adjust.



Shuffle feature

The shuffle feature operates in CD mode (if equipped) and plays all tracks on the current disc in random order.

Press the SHUFFLE control to start this feature. Random order play will continue until the SHUFFLE control is pressed again.



Controls and features

Shuffle feature

The shuffle feature operates in CD mode and plays all tracks on the current disc in random order.

Press the SHUFFLE control to start this feature. Random order play will continue until the SHUFFLE control is pressed again.



Mute button

Press the control to mute the playing media. Press the control again to return to the playing media.

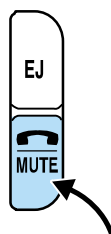

Controls and features

The AM/FM stereo/cassette with premium sound is compatible with a CD changer.

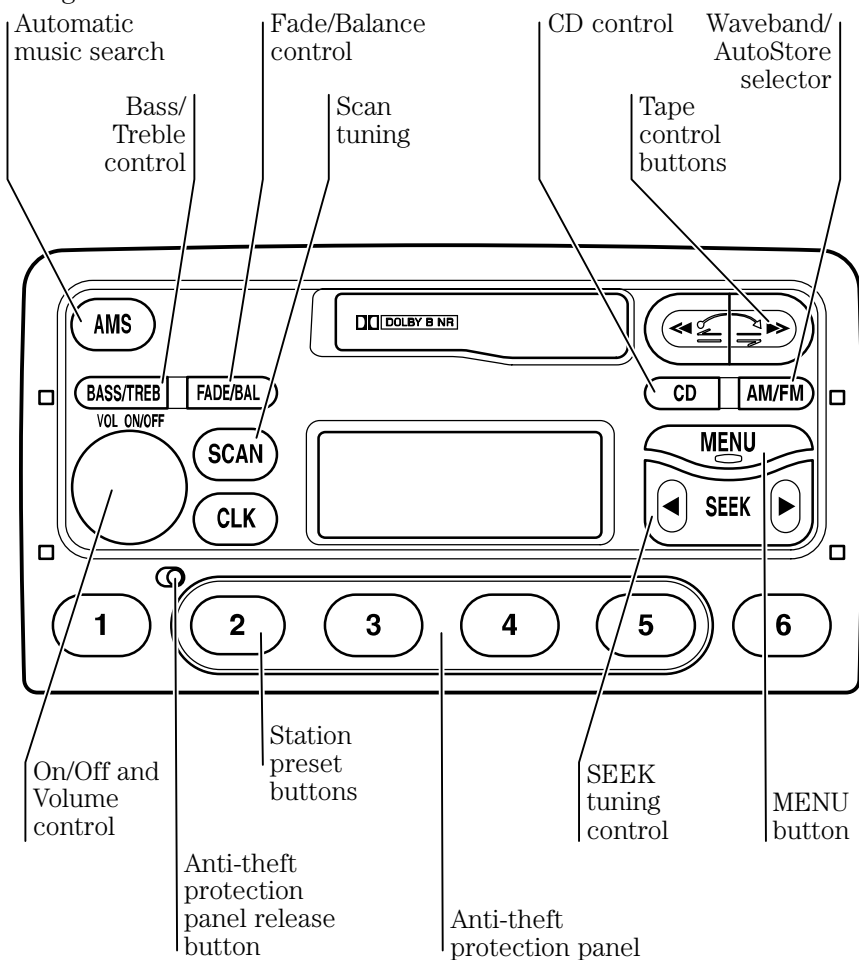

Controls and features

The AM/FM stereo/single CD player with premium sound is compatible with a CD changer.

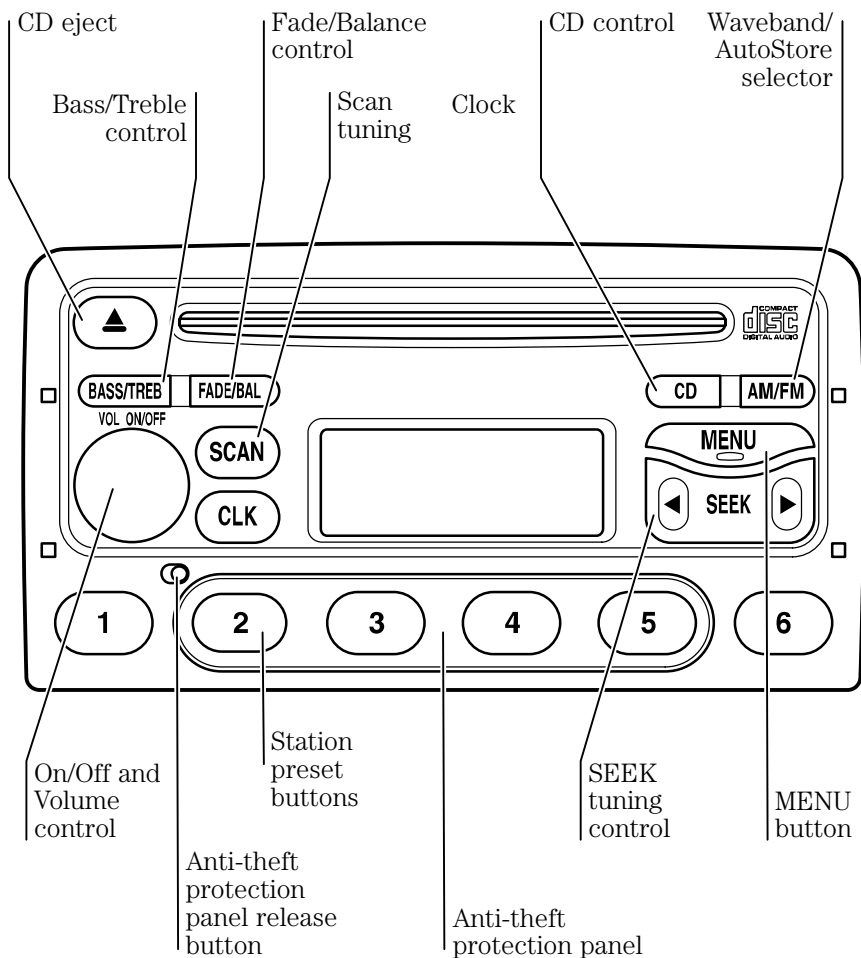

Controls and features

On/off

Press for on/off. This button can also operate the unit for up to one hour with the ignition turned off. The radio automatically switches off after one hour.

VOL ON/OFF

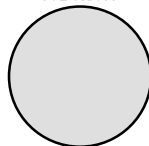

Volume control

The display indicates the level selected.

VOL ON/OFF

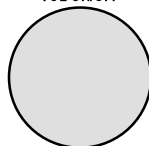

VOL 16

Bass/Treble control

Press "BASS/TREBLE" once for bass or twice for treble and use the volume control for adjustment. The display indicates the level selected.

BASS/TREB

BASS +7

TREB -2

Controls and features

Fade/Balance control

Press “FADE/BAL” once for fade (front to rear) or twice for balance (left to right), and use the volume control for sound system adjustment. The display indicates the level selected.

The fade function is applicable to vehicles with front and rear speakers only.

FADE/BAL

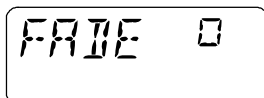
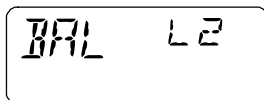

Seek tuning control (SEEK)

During radio reception, press ◀ or ▶ to locate the next station down or up the waveband selected.



Scan tuning control

Press the SCAN button. The radio tunes to and plays the next station on the waveband. After a short period it tunes to and plays the next station.

During this scan, “SCAN” appears in the display.

If you wish to continue listening to a station tuned to, press SCAN.

Pressing SCAN at any time will end the scan.

SCAN

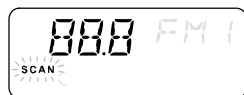

Controls and features

Band selector (AM/FM)

- Press repeatedly during radio reception to select AM, FM1, FM2 or AutoStore (see *AutoStore selector*). The display indicates the selection made.
- Press during tape or CD playback to return to radio reception.



AutoStore selector

AutoStore selects six strong FM station signals and stores them on the preset buttons.

- Press and hold the AM/FM button to activate AutoStore.



- “AST” flashes in the display while the unit searches through the FM frequencies.



- When the search is complete, sound is restored on preset button 1.

- Other stored stations can be selected using the other preset buttons.

- Alternatively, AutoStore can be used as an additional waveband to store other stations manually (see Station preset buttons).

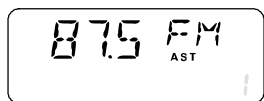

Controls and features

Station preset buttons

Select a waveband (FM or AM) and tune to the station required. Press and hold one of the preset buttons. When sound returns, the station has been stored.

24 preset frequencies can be stored – six on each of the AM, FM1, FM2 and AutoStore bands.

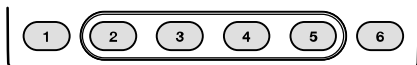

Stereo indicator

The **ST** symbol shows whenever a stereo signal is received.



MENU button (main features) – radio

Use the MENU button to access main menu features and the SEEK button for adjustment.

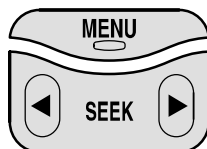

Manual tuning

Press the MENU button repeatedly until a display like the one shown opposite appears. Then use the SEEK button to make manual tuning adjustments. The FM waveband allows 200kHz tuning steps, and the AM band 10kHz steps.

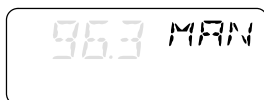
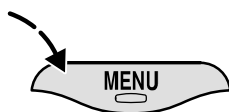

Controls and features

Automatic Volume Control (AVC)

Press the MENU button repeatedly until a display like the one shown opposite appears. Then use the SEEK button to turn this function on (“AVC + 1” to “AVC + 7”) or off (“AVC OFF”).

When selected, Automatic Volume Control increases or decreases the audio unit's volume level to compensate for engine and road speed noise.

This feature is not available on some vehicles and will not appear as a menu function.

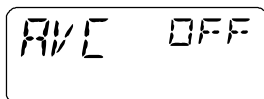
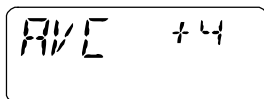
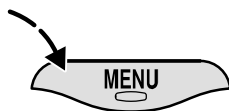

Cassette radio units only

Tape control buttons

Insert a tape and playback will automatically override radio or CD. “TAPE A” or “TAPE B” appears in the display to indicate which side of the tape is playing.

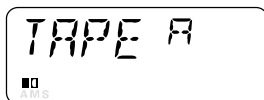

Controls and features

Fast forward/rewind

- Press ►► button fully in for fast forward.
- Press and release ◀◀ button to end fast forward and restart the tape.

- Press ◀◀ button fully in for rewind.
- Press and release ►► button to end rewind and restart the tape. If the beginning of the tape is reached, press both ◀◀ and ►► buttons part way in to restart playback.

If rewind is engaged during radio reception, tape playback will automatically restart when the beginning of the tape is reached.

During fast forward and rewind, radio transmission is automatically restored (with Automatic Music Search function turned off).

Auto reverse

If the end of the tape is reached, auto reverse operates with playback resuming at the start of the tape's other side.

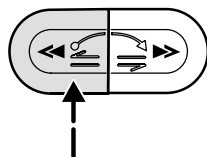
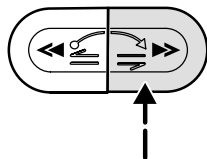

Controls and features

Tape side selection

During tape playback, press both ◀◀ and ▶▶ buttons partially in to change the tape side being played.

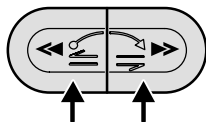

Tape eject

Press both ◀◀ and ▶▶ buttons fully in to eject the cassette and restore radio reception.

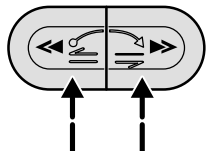

To pause tape playback

Press AM/FM to pause tape playback and restore radio reception, or the CD button for CD playback.



A square in the display indicates there is a tape inserted.



To restart tape playback

Press both tape buttons partially in or press AMS to resume tape playback.



Controls and features

Automatic Music Search (AMS)

Press AMS to turn this function on or off.

With this feature activated, press either ◀ or ▶ buttons (as appropriate), to obtain the previous or next track on the tape.

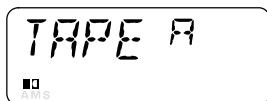

Cassette care and maintenance

For best possible sound quality, use tape cassettes that are clean and in good condition.

It is also recommended that the tape head in the audio unit is cleaned regularly with a wet cleaning cassette, which is available from your Lincoln/Mercury Dealer.

Controls and features

MENU button (main features) – tape

Use the MENU button to access main menu features, and the SEEK button for adjustment.

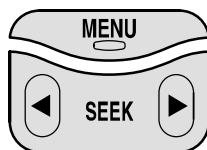

Dolby B® noise reduction

Press the MENU button repeatedly until a display like the one shown opposite appears. Then use the SEEK button to turn this function on (“NR ON”) or off (“NR OFF”). With the function on, background tape noise is reduced.

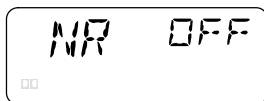
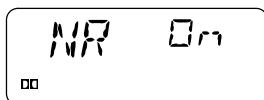

Automatic Volume Control (AVC)

Press the MENU button repeatedly until a display like the one shown opposite appears. Then use the SEEK button to turn this function on (“AVC + 1” to “AVC + 7”) or off (“AVC OFF”).

When selected, Automatic Volume Control increases or decreases the audio unit's volume level to compensate for engine and road speed noise.

This feature is not available on certain vehicles and will not appear as a menu function.

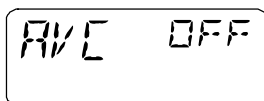
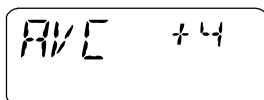
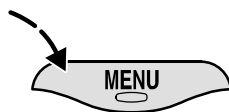

Controls and features

AM/FM stereo/single CD player with premium sound

CD Playback

(8cm and 12cm CDs can be played)

CD playback starts and radio reception is interrupted, when a CD is inserted into the entry slot.

“PLAY CD” appears in the display.

Press CD to start playback from a CD already in the audio unit. If no disc is inserted, “NO CD” appears in the display.

The display indicates elapsed track time up to 19:59. If the track is longer than twenty minutes, the first digit flashes while the rest of the numeral returns to zero and starts counting again.

Track selection

Press ◀ SEEK to return to the start of the track being played. If pressed within three seconds of the start of a track, the previous track will be selected. Press repeatedly to select previous tracks.

Press SEEK ▶ to select the next track or press repeatedly to access later tracks.

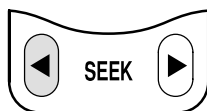
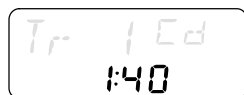

Controls and features

Fast forward/reverse

Press and hold ◀ SEEK or SEEK ▶ to search backwards or forwards across the tracks on the disc.



Scan mode

Press the SCAN button. Each track is played in turn for a short period.

During this scan, "SCAN" appears in the display. To continue listening to a track, press SCAN.

Pressing SCAN at any time will end the scan.



To end CD playback

Press the AM/FM button to restore radio reception without ejecting the disc. If reselected, the CD will start from wherever playback was last interrupted.

A square in the display indicates there is a disc inserted.



CD eject

During CD playback, press ▲.

When ejected, the disc is held ready for removal. If it is left as it is, the disc will be pulled back inside the audio unit automatically, and retained ready for playback.



Controls and features

CD care and maintenance

For best possible sound quality, use CDs that are clean and in good condition.

CD error codes

Codes may be shown in the audio unit display that indicate errors with the CD unit. These codes are as follows:

Display	Description/rectification
E11 or E15	Internal fault, see your dealer.
E12	Clean the disc and try again. If error still shows, see your dealer.
E14	Ambient temperature too hot – unit will not work until it has cooled down.
E16	There is an eject fault, see your dealer.

MENU button (main features) – CD

Use the MENU button to access main menu features, and the SEEK button for adjustment.

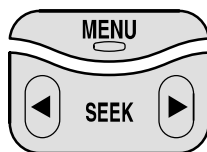

Controls and features

Random track playback (SHUF)

Press the MENU button repeatedly until a display like the one shown opposite appears. Then use the SEEK button to turn this function on (“SHUF-ON”) or off (“SHUF-OFF”).

With the function on, the elapsed time indicator is replaced by “SHUF” as a new track is selected.

If an optional CD changer is fitted, the audio unit plays all the tracks on the disc selected, then moves onto the next disc in the CD magazine and plays the tracks on that in random sequence.

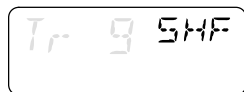
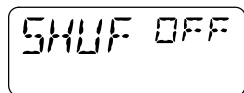
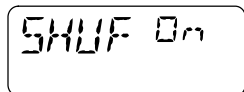
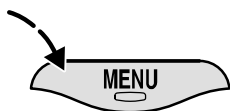

Track compression (COMP)

Press the MENU button repeatedly until a display like the one shown opposite appears. Then use the SEEK button to turn this function on or off.

With the function on, quieter music is boosted and louder music lowered to minimize repeated volume adjustments.

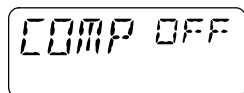
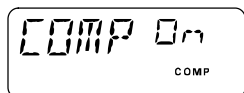
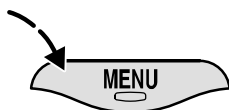

Controls and features

Automatic Volume Control

Press the MENU button repeatedly until a display like the one shown opposite appears. Then use the SEEK button to turn this function on (“AVC + 1” to “AVC + 7”) or off (“AVC OFF”).

- When selected, Automatic Volume Control increases or decreases the audio unit’s volume level to compensate for engine and road speed noise.

- The SEEK button provides a selection of settings between “AVC OFF” and “AVC +7”. The display shows the level selected.

This feature is not available on some vehicles and may not appear as a menu function.

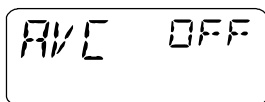
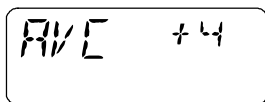
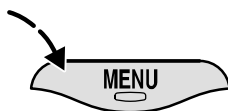

MENU button (main features) – CD

Use the MENU button to access main menu features, and the SEEK button for adjustment.

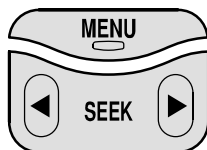

Controls and features

Random track playback (SHUF)

Cassette and CD radio units

Press the MENU button repeatedly until a display like the one shown opposite appears. Then use the SEEK button to turn this function on ("SHUF-ON") or off ("SHUF-OFF").

With the function on, the elapsed time indicator is replaced by "SHUF" as a new track is selected.

If an optional CD changer is fitted, the audio unit plays all the tracks on the disc selected then moves onto the next disc in the CD magazine and plays the tracks on that in random sequence.

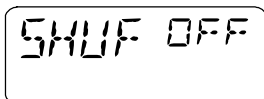
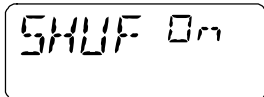
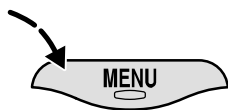

Track compression (COMP)

Press the MENU button repeatedly until a display like the one shown opposite appears. Then use the SEEK button to turn this function on or off.

With the function on, quieter music is boosted and louder music lowered to minimize repeated volume adjustments.

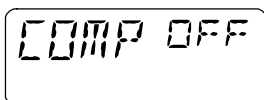
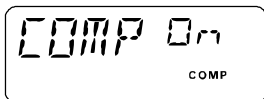
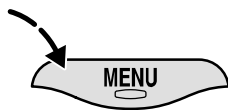

Controls and features

Automatic Volume Control (AVC)

Cassette and CD radio units

Press the MENU button repeatedly until a display like the one shown opposite appears. Then use the SEEK button to turn this function on (“AVC ON”) or off (“AVC OFF”).

- When selected, Automatic Volume Control increases or decreases the audio unit’s volume level to compensate for engine and road speed noise.
- The SEEK button provides a selection of settings between “AVC OFF” and “AVC +7”. The display shows the level selected.

This feature is not available on some vehicles and may not appear as a menu function.

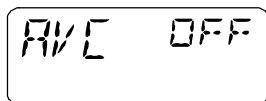
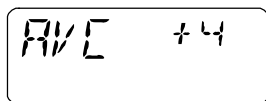
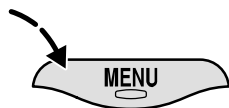

Controls and features

PREMIUM AM/FM STEREO IN DASH SIX CD RADIO

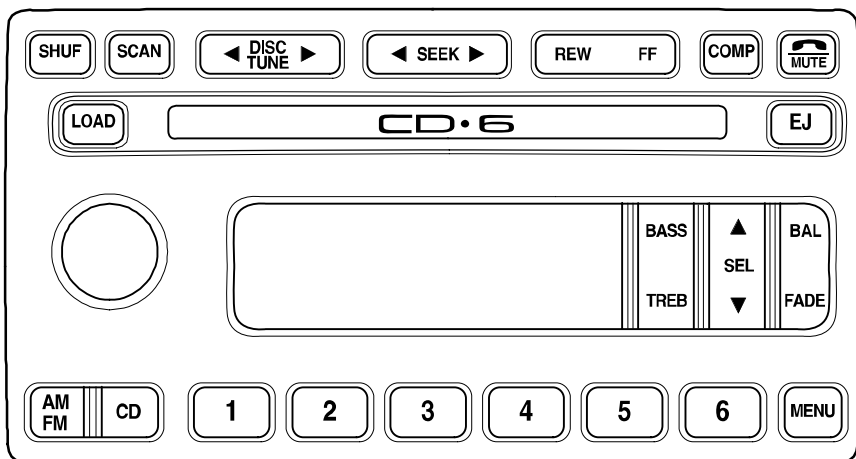

Volume/power control

Press the control to turn the audio system on or off.

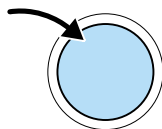

Push on

Turn the control to raise or lower volume.

If the volume is set above a certain level and the ignition is turned off, the volume will come back on at a "nominal" listening level when the ignition switch is turned back on.

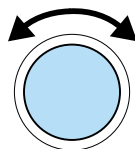

Push on

Controls and features

AM/FM select

The AM/FM select control works in radio and CD modes (if equipped).

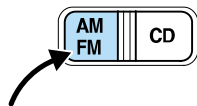

AM/FM select in radio mode

This control allows you to select AM or FM frequency bands. Press the control to switch between AM, FM1 or FM2 memory preset stations.

AM/FM select in CD mode

Press this control to stop CD play and begin radio play.

Tune adjust

The tune control works in radio or CD mode.

Tune adjust in radio mode

- Press ◀ to move to the next frequency down the band (whether or not a listenable station is located there). Hold the control to move through the frequencies quickly.
- Press ▶ to move to the next frequency up the band (whether or not a listenable station is located there). Hold for quick movement.



Controls and features

Tune adjust for CD mode

- Press ◀ to select the previous disc. (Play will begin on the first track of the disc unless shuffle mode is engaged.) Refer to *Shuffle feature* for more information. Hold the control to continue reversing through the disc.
- Press ▶ to select the next disc. Hold the control to fast-forward through the remaining discs.



Seek function

The seek function works in radio or CD mode.

Seek function in radio mode

- Press ◀ to find the next listenable station down the frequency band. SEEK DOWN will display.
- Press ▶ to find the next listenable station up the frequency band. SEEK UP will display.



Controls and features

Seek function in CD mode

- Press ◀ to seek to the previous track of the current disc. If the beginning of the disc is reached, the CD player seeks to the beginning of the last track on the current disc and begins playing.
- Press ▶ to seek forward to the next track of the current disc. After the last track has been completed, the first track of the current disc will automatically replay.



Scan function

The scan function works in radio or CD mode.



Scan function in radio mode

Press the SCAN control to hear a brief sampling of all listenable stations on the frequency band. Press the SCAN control again to stop the scan mode.

Scan function in CD mode

Press the SCAN control to hear a short sampling of all selections on the CD. (The CD scans in a forward direction, wrapping back to the first track at the end of the CD.). To stop on a particular selection, press the control again.

Controls and features

Radio station memory preset

The radio is equipped with six station memory preset controls. These controls can be used to select up to six preset AM stations and twelve FM stations (six in FM1 and six in FM2).

Setting memory preset stations

1. Select the frequency band with the AM/FM select control. Press the AM/FM control to toggle between AM, FM1, or FM2.
2. Press the SEEK control to access the next listenable station up or down the frequency band. Press the TUNE control to go up or down the listening band in individual increments.
3. Select a station. Refer to *Seek function* for more information on selecting a station.
4. Press and hold a memory preset control. The playing media will mute momentarily. When the sound returns, the station is held in memory on the control you selected. The display will read **SAVED**.

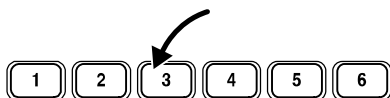

Controls and features

Autostore

Autostore allows you to set the strongest local radio stations without losing your original manually set preset stations. This feature is helpful on trips when you travel between cities with different radio stations.

Starting autostore

1. Press and momentarily hold the AM/FM control.
2. AUTOSTORE will flash in the display as the frequency band is scrolled through.
3. When the six strongest stations are filled, the station stored in memory preset control 1 will start playing.

If there are less than six strong stations available on the frequency band, the remaining memory preset controls will all store the last strong station available.

To deactivate autostore and return to your audio system's manually set memory stations, press the AM/FM control again.

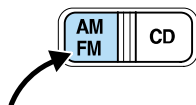

Controls and features

CD select

CD mode may be entered by pressing the CD control and the LOAD control. Load the CD into the audio system. The first track of the disc will begin playing. After that, CD play will begin where it stopped last.

If an alternative CD is desired, press the corresponding preset control (1–6) of a loaded CD, or press the TUNE control to access the other loaded CDs.

NO CD will display if the CD control is activated when there is not a CD present in the audio system. NO CD will illuminate in the display if the CD control and a present number (that is currently empty) are pressed. The system will play the next available disc.

If your vehicle is equipped with a CD changer, pressing the CD control again will allow you to toggle between accessing the multi disc system and the CD changer. The display will read CD or CDDJ.

Display description

Six circles are always lit in the digital display. These signify the six CD slots in the audio system. When a disc is loaded into a particular slot (1–6), the number inside that specific circle lights. If the circle is empty, there is no CD in that particular slot.

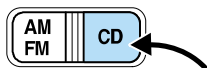

Controls and features

Load

The load feature allows you to load single CDs into the player internal to the radio.

This six disc CD player is equipped with a CD door. Compact discs should only be inserted into the player after the door has been opened by the player. Do not attempt to force the door open. Compact discs should only be loaded by pressing the LOAD control.

Press the LOAD control. (You can choose which slot will be loaded by pressing the desired preset number. If you do not choose a slot, the system will choose the next available one.) Wait until the CD door opens. Load the CD into the player. LOADING CD# is displayed. When the CD has been loaded, the door will close and the CD will begin to play. For example, to load a CD into slot #2, press the LOAD control and then press preset #2.



Controls and features

Auto load

This feature allows you to autoloading up to 6 discs into the multi disc CD player internal to the radio.

Press and hold the LOAD control until AUTOLOAD # is displayed. The CD door will open. Load the desired disc, one at a time. The CD is loaded into position and the audio system will display CD#. Each time the CD door opens, INSERT CD# is displayed. The door will close and the player will move to the next slot after each disc has been loaded. The process is repeated until all 6 slots are full. The audio system plays the last CD loaded and the display is updated. If some slots are already full and autoloading is activated, the system will fill all empty slots.



Eject

Press the EJ control to stop and eject a CD. You can choose which CD will be ejected by pressing the EJ control and the desired preset number (1–6). For example, to eject CD#2, press the EJ control and then press the present #2 control. If you do not choose a specific CD, the player will eject the current CD.

If a CD is ejected and not removed from the door of the CD player, the player will automatically reload the CD. This feature may be used when the ignition is ON or OFF.



Controls and features

Auto eject

Press and momentarily hold the EJ control to engage auto eject. All CDs which are present in the player will be ejected one at a time. If a CD is ejected and not removed from the door of the CD player, the player will automatically reload the CD. This feature may be used when the ignition is ON or OFF.



Rewind

The rewind control works in CD modes. Press and hold the REW control until the desired selection is reached. If the beginning of the disc is reached, the CD will begin play at the first track. Release the control to disengage rewind mode. When in rewind mode, your audio system will automatically lower the volume level of the playing media.



Fast forward

The fast forward control works in CD modes. Press and hold the FF control until the desired selection is reached. If the end of the disc is reached, the CD will return to the first track on the first disc. Release the control to disengage fast forward mode. When in fast forward mode, your audio system will automatically lower the volume level of the playing media.

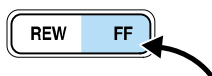

Controls and features

Shuffle feature

Press the SHUF control until the desired shuffle mode is displayed. The audio system will then engage the desired shuffle mode.

When engaged, the shuffle feature has two different modes:

SHUFFLE DISC and SHUFFLE TRK. SHUFFLE DISC randomly plays tracks from all the discs presently in the audio system.

SHUFFLE TRK plays all the tracks on the current disc in random order.



Compression feature

The compression feature operates in CD mode and brings soft and loud CD passages together for a more consistent listening level.

Press the COMP control until COMP ON is displayed.

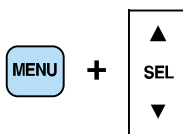

Bass adjust

The bass adjust control allows you to increase or decrease the audio system's bass output.

Press the BASS control. Use the SEL control to increase or decrease the amount of bass.



Controls and features

Treble adjust

The treble adjust control allows you to increase or decrease the audio system's treble output.

Press the TREB control. Use the SEL control to increase or decrease the amount of treble.



Speaker balance adjust

Speaker sound distribution can be adjusted between the right and left speakers.

Press the BAL control. Use the SEL control to adjust the sound between the speakers.

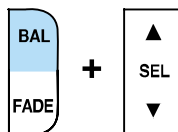

Speaker fade adjust

Speaker sound can be adjusted between the front and rear speakers.

Press the FADE control. Use the SEL control to adjust the sound between the front and rear speakers.

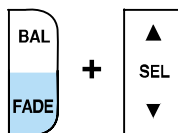

Controls and features

Menu mode

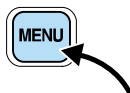

The MENU control allows you to access many different features within your audio system. There are three sets of menus available depending upon which mode or feature is activated.

While in FM mode, two menus are available. If RDS is turned off, you can access the following:

- SELECT HOURS — Refer to *Setting the clock*.
- SELECT MINUTES — Refer to *Setting the clock*.
- RDS OFF — Refer to *Radio data system*.
- If RDS is turned on, you can access the following:
 - SELECT HOURS — Refer to *Setting the clock*.
 - SELECT MINUTES — Refer to *Setting the clock*.
 - TRAFFIC ON/OFF—Refer to *Traffic announcements*.
 - FIND type—Refer to *Radio data system*.
 - SHOW (NAME, TYPE, NONE)—Refer to *Radio data system*.

Controls and features

When in CD mode, you can access:

SELECT HOURS, SELECT MINUTES or COMP ON/OFF.

SELECT HOURS, SELECT MINUTES— Allows you to adjust the hours and minutes. Refer to *Setting the clock*.

TRAFFIC ON/OFF— Traffic announcements can be programmed as local or distant. Refer to *Traffic announcements*.

RDS ON/OFF— This feature allows your audio system to receive text information from RDS-equipped FM radio stations. Refer to *RDS feature*.

FIND type — Allows you to select your desired FM program type and search for that selection.

SHOW — Allows you to select from NAME (displays the name of the radio station), TYPE (displays the RDS program type: rock, jazz, etc.), or NONE (deactivates the RDS display).

Radio data system (RDS) feature

This feature allows your audio system to receive text information from RDS-equipped FM radio stations.

To activate RDS:

- When in FM mode, press the MENU control until RDS OFF displays.
- Press the SEL control to engage this feature (RDS ON).

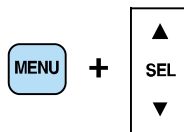

Controls and features

RDS features:

Once the RDS feature is on, press the RDS control to scroll through the following selections:

Traffic announcements

This feature allows you to hear traffic announcements while in CD mode. These announcements are broadcast by traffic capable RDS stations.

When in this mode, traffic announcements will interrupt radio and CD play.

- Press the MENU control until TRAFFIC is displayed.
- Press the SEL control to engage the feature. The display will read TRAFFIC ON.

This feature also allows you to control the volume of traffic announcements. With the display reading TRAFFIC ON, adjust the volume using the volume control to the desired level. The volume level will show at the bottom of the display. Interrupting traffic announcements will be at the selected volume level.

To disengage the feature, press the MENU control until TRAFFIC ON displays. Press the SEL control.

Controls and features

Program type

This feature allows you to search for RDS stations selectively by their program type.

Press the MENU control until FIND program type is displayed.

Use the SEL control to select the program type. With the feature on, use the SEEK or SCAN control to find the desired program type from the following selections:

- Classic
- Country
- Info
- Jazz
- Oldies
- R &B
- Religious
- Rock
- Soft
- Top 40

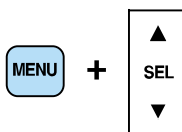

Show

This feature allows you to select the type of RDS broadcast information the radio will regularly show in the display.

With RDS activated, press the MENU control until SHOW is displayed.

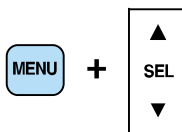

Controls and features

Use the SEL control to select TYPE (displays the RDS program type: rock, jazz, etc), NAME (displays the name of the radio station) or NONE (deactivates the RDS display).

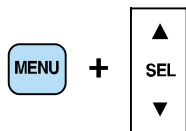

RDS clock feature

Refer to *Setting the clock* for information.

Mute mode

Press the control to mute the playing media. Press the control again to return to the playing media.



Setting the clock

Press the MENU control until SELECT HOUR or SELECT MINUTE is displayed.



Use the SEL control to manually set the time.

- Press ▲ to increase hours/minutes.
- Press ▼ to decrease hours/minutes.



Controls and features

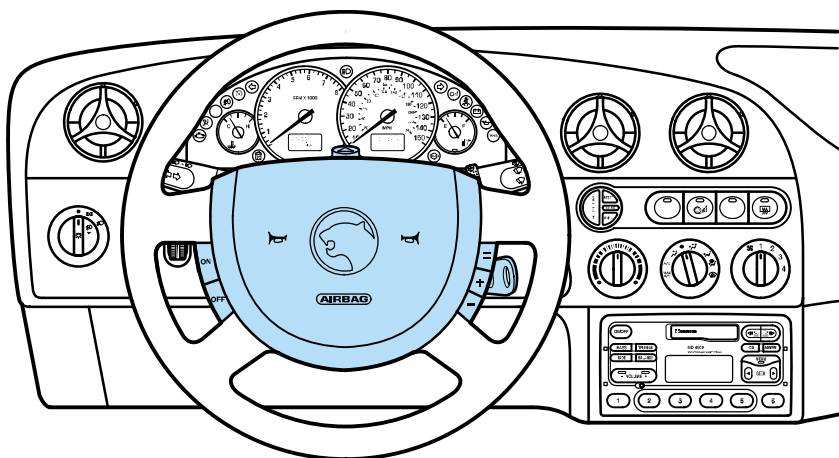

STEERING COLUMN CONTROLS

Ignition

1. Ignition off, steering wheel locked.

On vehicles with automatic transaxles, the ignition key can return to this position only if the gearshift lever is in P (Park).

2. The accessory position. Steering unlocked, radio operational. Ignition and all main electrical circuits are disabled.

The ignition key should not be left in this position for too long to avoid discharging the battery unnecessarily.

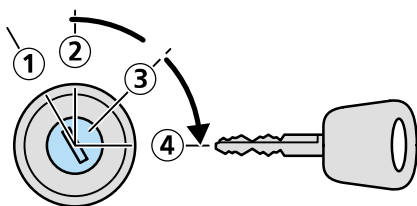

Controls and features

3. Ignition switched on, all electrical circuits operational. Warning and indicator lights illuminate. This key position is for normal driving.
4. Starter motor activated. Release the key as soon as the engine starts.

Tilt steering

Pull the locking lever on the steering column cover up to adjust the steering column position. Secure the wheel by releasing the locking lever.

 Never adjust the steering wheel while the vehicle is moving.

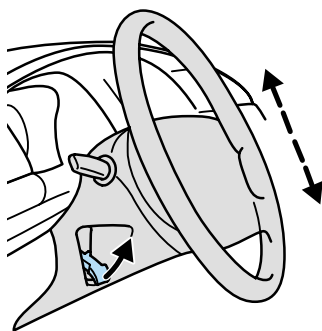

Hazard flasher control

Use only in an emergency to warn traffic of vehicle breakdown or approaching danger. Depress to activate. Depress again to switch off. The hazard lights can be operated when the ignition is off.

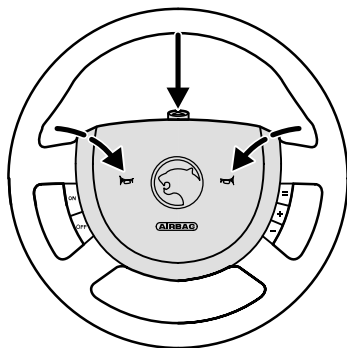

Horn

Press the pad in the middle of the steering wheel.

Controls and features

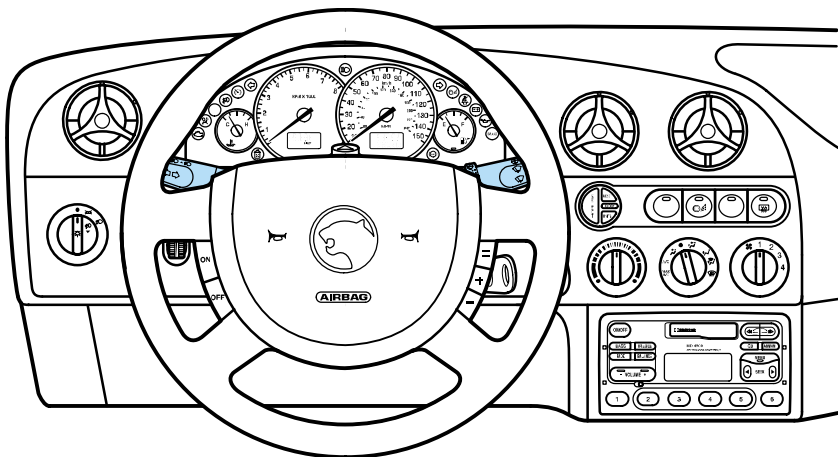

Multi-function switch

The turn signal functions are available only with the ignition switch on.

Right turn signal

Move the lever up.

Left turn signal

Move the lever down.

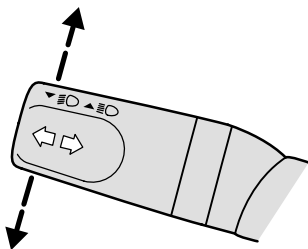

Controls and features

Flash-to-pass

Pull the lever toward you and release quickly for “flash-to-pass” operation.

High beam headlamps

Push the lever toward the instrument panel.

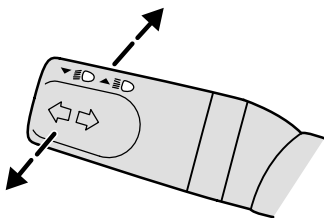

Windshield wipers and washer

Wipers

Lift the windshield wiper lever to the desired speed interval.

- Intermittent: push lever up to the first position.
- Low: push lever up to the second position.
- High: push lever up to the third position.

For a single wipe, push the lever downward.

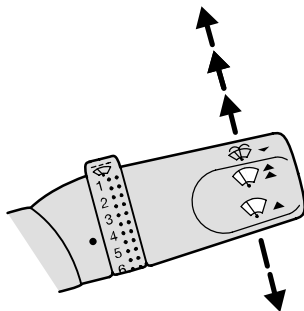

Controls and features

Intermittent wiper control

Rotate the variable intermittent wiper control to the desired speed.

1 = Short time interval

6 = Extended time interval

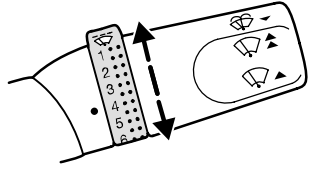

Washer

Pull the lever toward the steering wheel. The washer operates in conjunction with the windshield wipers.

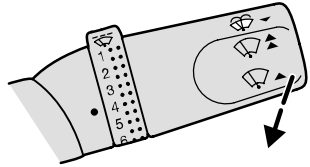

Rear window wipers and washer (if equipped)

Wiper

To turn it on, push the wiper control inward. Push the control in again to turn it off.

Washer

Push the lever away from the steering wheel.

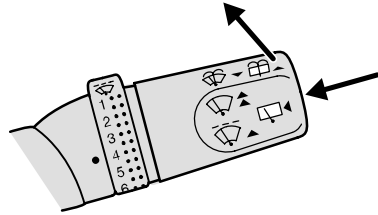

Controls and features

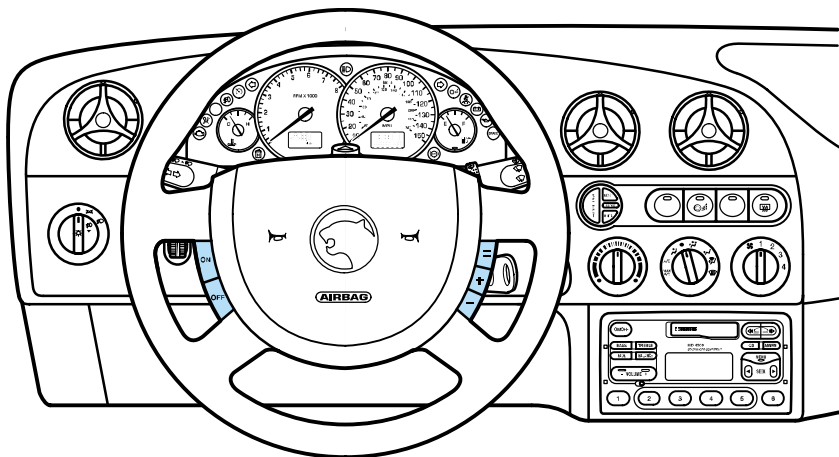

Speed control (if equipped)

 Do not use the speed control in heavy traffic or on roads that are winding, slippery, or unpaved.

To turn speed control on

- Press On.

Vehicle speed cannot be controlled until the vehicle is travelling at or above 48 km/h (30 mph).

 Do not shift the gearshift lever into N (Neutral) with the speed control on.

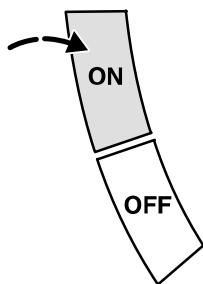

Controls and features

To turn speed control off

Press Off.

Once speed control is switched off, the previously programmed set speed will be erased.

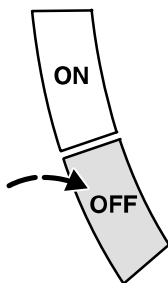

To set a speed

Press + and release. For speed control to operate, the speed control must be on and the vehicle speed must be greater than 48 km/h (30 mph).

The control light in the instrument panel will illuminate. If you drive up or down a steep hill, your vehicle speed may vary momentarily slower or faster than the set speed. This is normal.

Speed control cannot reduce the vehicle speed if it increases above the set speed on a downhill. If your vehicle speed is faster than the set speed while driving on a downhill in overdrive, you may want to shift to the next lower gear to reduce your vehicle speed.

If your vehicle slows down more than 16 km/h (10 mph) below your set speed on an uphill, your speed control will disengage. This is normal. Press = to re-engage it.

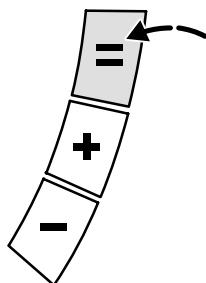
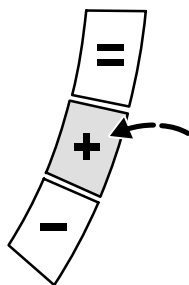

Controls and features

To set a higher speed

- Press and hold +. Release when the desired set speed is reached, or
- press and release +. Each press will increase the set speed by 1.6 km/h (1 mph) or
- accelerate with your accelerator pedal, then press +.

You may accelerate with the accelerator pedal at any time during speed control usage. Releasing the accelerator pedal will return your vehicle speed to the previously set speed.

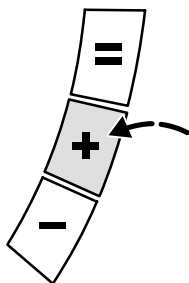

To set a lower speed

- Press and hold -. Release the control when the desired vehicle speed is reached, or
- press and release -. Each press will decrease the set speed by 1.6 km/h (1 mph), or
- depress the brake pedal. When the desired vehicle speed is reached, press +.

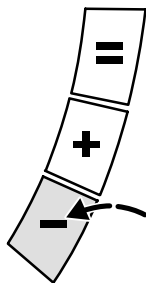

Controls and features

To disengage speed control

- Lightly depress the brake or clutch pedal.

Disengaging the speed control will not erase the previously programmed set speed.

To return to a set speed

- Press =. For = to operate, the vehicle speed must be faster than 48 km/h (30 mph).

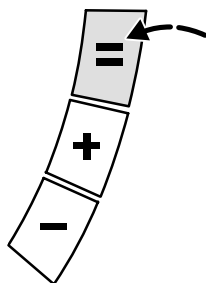

OVERHEAD CONTROLS

Interior lamps

The interior lamps have three switch positions: door delay, off and on.

When the control is switched to door delay (12 SEC), the interior light stays on for 12 seconds after the doors are closed with the ignition off.

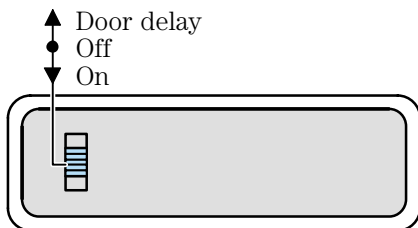

Controls and features

Reading lamps (if equipped)

The reading lamps are operated by separate on/off switches and can be adjusted to point in the desired direction.

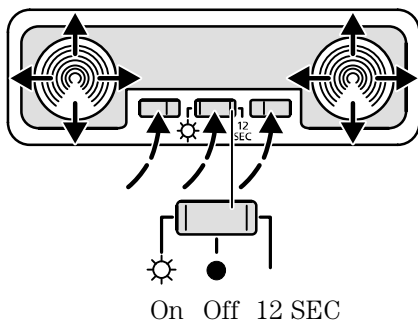

Sunroof (if equipped)

The electric sunroof can be operated only when the ignition is switched on.

To lift the rear of the sunroof

With the sunroof closed, press the rear part of the control. Press the front part of the control to lower the sunroof.

To open and close the sunroof

To open the sunroof, press the rear part of the control after the rear of the sunroof has been lifted. The sunroof is fully open when approximately $\frac{2}{3}$ of the opening is exposed. Press the front part of the control to close it.

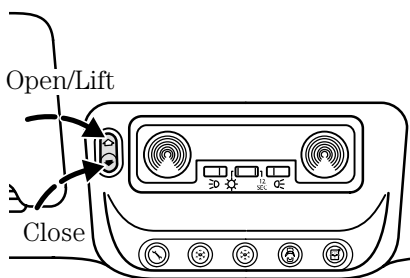

Controls and features

DOOR MOUNTED CONTROLS

Power mirrors

The control can be swiveled and turned.

Turn the control clockwise to adjust the driver's side mirror, counterclockwise to adjust the passenger side mirror. Adjust the selected mirror by moving the center control in the desired direction. Then turn the control back to the center position.

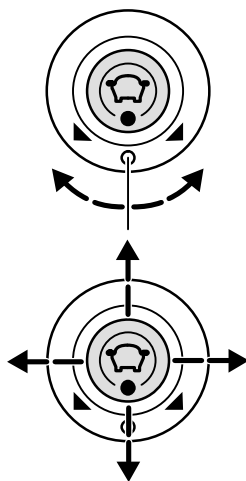

Heated mirrors (if equipped)

The heated mirrors are activated by turning on the rear window defroster.

Controls and features

Power windows

The windows will only operate when the ignition is switched on. Press the appropriate control to operate the power windows at each door position. Both windows can be controlled from the control on the driver's door. The passenger's door window can be operated individually with a separate door control.

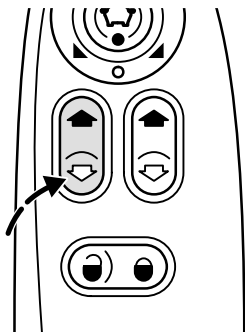

One touch down

The driver's door can be lowered automatically. Momentarily press the down button. The driver's window will open fully. Press the up button to interrupt one touch operation.

Power door locks

Push to lock or unlock both doors.

FLOOR MOUNTED CONTROLS

Parking brake

For information on the parking brake, refer to *Preparing to start the vehicle* in the *Starting* chapter.

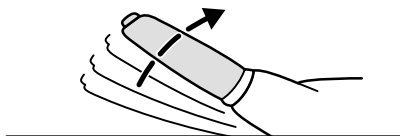

Controls and features

Positive retention floor mat (Driver's side only)

Position the floor mat in the footwell. Place the mat eyelet over the pointed end of the retention post from the rear and rotate forward to install. Adjust the floor mat position to allow proper operation of accelerator pedal, brake pedal and clutch pedal (if equipped).

To remove, lift the floor mat just forward of the retention post and rotate it rearward to disengage it from the retention post.

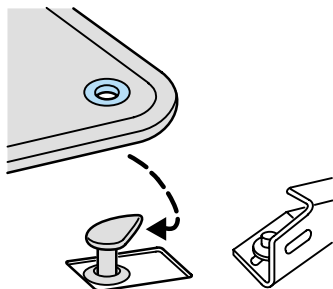

Fuel pump shut-off switch

For information on the fuel pump shut-off switch, refer to *Fuel pump shut-off switch* in the *Roadside emergencies* chapter.

Controls and features

LUGGAGE COMPARTMENT

The luggage compartment lock has one locking position.

Remote luggage compartment control

Push the control located under the instrument panel by the driver's door to open the luggage compartment.

To open the luggage compartment at least one door must be unlocked.

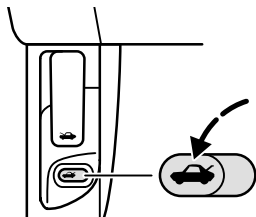

Interior luggage compartment release

Your vehicle is equipped with a mechanical interior luggage compartment release handle that provides a means of escape for children and adults in the event they become trapped inside the luggage compartment.

All drivers are advised to familiarize themselves with the operation and location of the release handle.

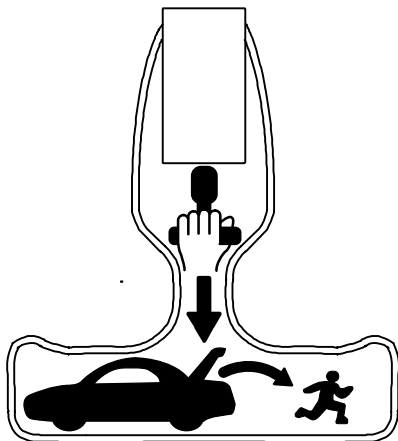

Controls and features

To open the luggage compartment door (lid) from the inside, pull the illuminated “T” shaped handle and push open the door (lid). The material that the handle is made of will glow in the darkness of the luggage compartment following brief exposure to ambient light.

The “T” shaped handle will be located either on the luggage compartment door (lid) or inside the luggage compartment near the tail lamps.

 Keep vehicle doors and luggage compartment locked and keep keys out of a child's reach. Unsupervised children could lock themselves in an open trunk and risk injury. Children should be taught not to play in vehicles.

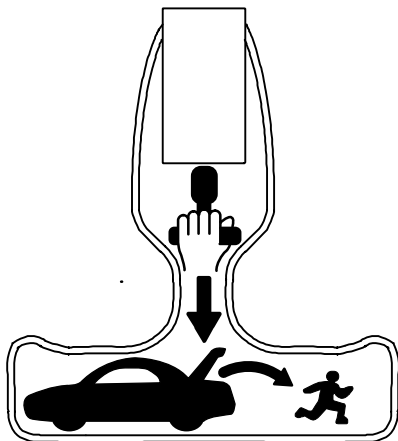

Controls and features

 On hot days, the temperature in the trunk can rise very quickly. Exposure of people or animals to these high temperatures for even a short time can cause death or serious heat-related injuries, including brain damage. Small children are particularly at risk.

Closing the liftgate

 To avoid injury to rear seat occupants when closing the liftgate, ensure that the head of any rear seat occupant is not in the path of the closing liftgate. Request that the occupants, especially taller occupants, lean forward and under the roof structure to avoid making contact with the closing liftgate. Close the liftgate carefully.

Controls and features

Cargo cover

Do not place objects on the cargo cover.

Removing the cargo cover

First, detach the lifting straps on the liftgate. Then pull it out horizontally without tilting it.

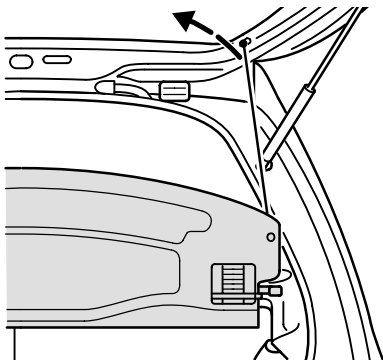

Replacing the cargo cover

Insert the cover horizontally, align it and push in as far as the stop. Attach the lifting straps to the liftgate.

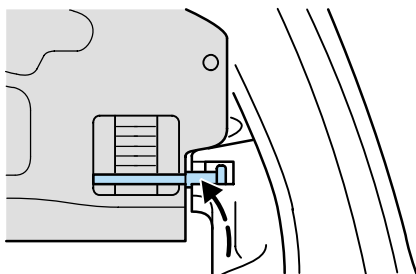

Controls and features

REMOTE KEYLESS ENTRY SYSTEM (if equipped)

If your vehicle has a remote entry system, you can lock and unlock the vehicle doors and open the luggage compartment without using a key. The remote also has a panic alarm feature.

The remote entry feature only operates with the ignition in the off position.

Locking the doors

Press the  control.

To signal that the doors are locked, the turn signal lamps will flash once. This signal will only occur if the doors, hood, and liftgate are closed.

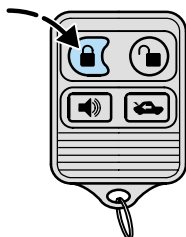

Unlocking the doors

Press the  control to unlock the driver's door.

To unlock the passenger's door, press the  control a second time within three seconds.

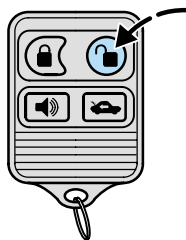

Controls and features

Opening the luggage compartment

Press the  control.

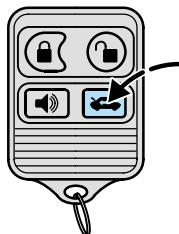

Sounding the panic alarm

Press the  control. The horn will sound and the direction indicators will flash for approximately two minutes.

To deactivate the alarm, press the  control again or turn the ignition key to the on position.

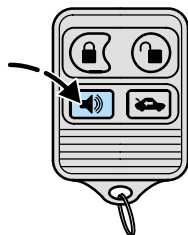

Replacing the battery

The transmitter is powered by one coin-type, three-volt lithium battery. A decrease in operating range can be caused by:

- battery failure,
- weather conditions, or
- structures around the vehicle.

Replacement batteries for the remote entry system transmitters may be purchased at pharmacies, watch stores or at authorized dealers.

Controls and features

To replace the battery:

1. Twist a thin coin between the two halves of the transmitter. Do not take the front part of the transmitter apart.
2. Remove the old battery.
3. Place the positive (+) side of the new battery down.
4. Snap the two halves of the transmitter back together.

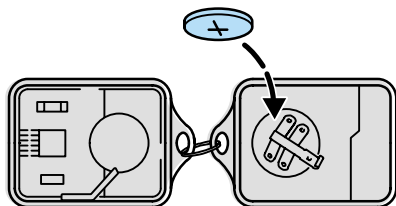

Replacing lost transmitters

Take your transmitters to the dealer for reprogramming if:

- a transmitter is lost or
- you want to purchase additional transmitters.

This device complies with part 15 of the FCC rules and with RS-210 of Industry Canada. Operation is subject to the following two conditions: (1) This device may not cause harmful interference, and (2) This device must accept any interference received, including interference that may cause undesired operation.

Changes or modifications not expressly approved by the party responsible for compliance could void the user's authority to operate the equipment.

Controls and features

ANTI-THEFT ALARM SYSTEM (if equipped)

The system is available with Remote Keyless Entry.

The system acts as a deterrent against unauthorized persons opening the doors, luggage compartment or hood.

Activation

The system is activated by pressing the  control once. The ignition key must be removed from the ignition and the doors, hood and liftgate fully closed, to allow activation.

The turn signal lamps will flash once to indicate the system is activated. If the lamps do not flash once, the system is not activated.

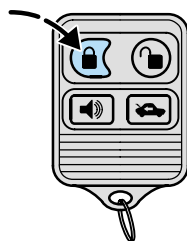

Alarm

Opening any door, the hood or liftgate will activate the alarm, when activated.

Once triggered, the system flashes the turn signal lamps and sounds the alarm system horn.

Disarming the system

The system can be disarmed by either:

1. Pressing the  button on the remote
2. Unlocking the door with a key

Either of these actions will disarm an Untriggered or Triggered Alarm system.

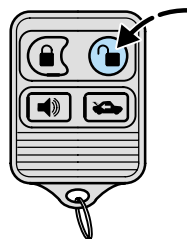

Controls and features

PASSIVE ANTI-THEFT SYSTEM

The Passive Anti-Theft System (PATS) is an engine immobilization system. It is an additional theft protection feature which prevents the engine from being started unless a coded key is used.

Automatic arming

The system is armed five seconds after switching off the ignition.

The armed status is indicated when the control light flashes every two seconds.

The light is located on the dashboard above the climate controls.

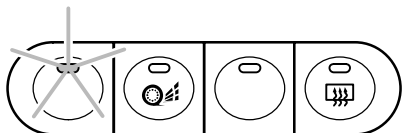

Automatic disarming

Switching on the ignition disarms the system if the correct code is recognized.

Keys

Your vehicle is supplied with two coded keys.

Only these keys can be used to start your vehicle.

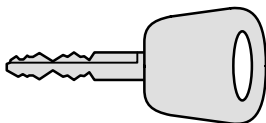

Controls and features

Functional check

When the ignition is switched on, the control light will illuminate for approximately three seconds to indicate that the system is operating correctly.

If the control light flashes rapidly for approximately one minute and then repeatedly at irregular intervals, the system did not recognize the key code. Remove the key and try again.

If the control light illuminates continuously for approximately one minute and then flashes repeatedly at irregular intervals, a system malfunction has occurred.

Have the malfunction repaired by your dealer or a qualified technician as soon as possible.

The system is not compatible with aftermarket remote start systems, which allow the vehicle to be started from outside the vehicle. Use of these systems may result in vehicle starting problems and a loss of vehicle security protection.

Metallic objects or electronic devices on the same key ring as the ignition key may cause vehicle starting problems if these objects are touching the ignition key during vehicle start. These objects and devices cannot damage the key. If a problem occurs, turn the ignition off and restart the engine with all other objects on the key ring held away from the ignition key.

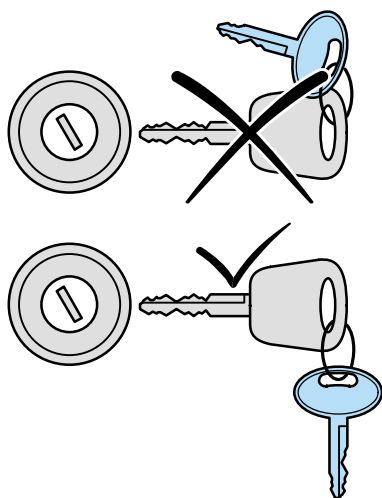

Controls and features

Key coding

A maximum of 7 keys in all can be coded with any two coded keys.

- Insert the first key in the ignition switch and turn to position 3.
- Turn the key back to position 1 and remove from the ignition switch within 5 seconds.
- Insert the second key in the ignition switch and turn to position 3 within 5 seconds.
- Turn the key back to position 1 and remove from the ignition switch within 5 seconds – the key coding mode is now activated.
- If an uncoded key is now inserted in the ignition switch and turned to position 3 within 10 seconds, this key is coded to the system.

If coding is not completed correctly, the control light flashes after the ignition is switched on with the newly coded key. Repeat the coding process.

This process can be repeated after waiting 20 seconds.

If keys become lost, you must have your dealer clear and reprogram the code for security reasons.

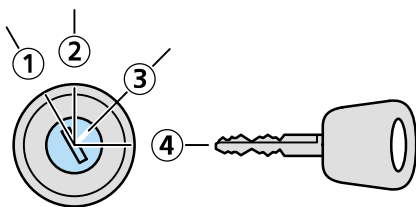

Seating and safety restraints

HEAD RESTRAINTS

Adjusting the head restraints

If your vehicle is equipped with adjustable head restraints, push or pull the head restraint to raise it to the desired height.

To lower, push the small catch in the collar around the stem and raise or lower the head restraint to the desired height.

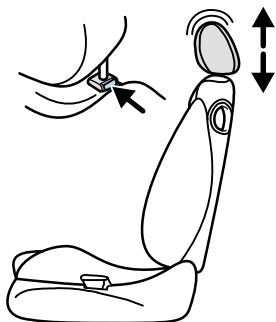

SEATING

Manually adjusting the seats

Pull the lever located under the front edge of the seat to move the seat forward or backward.

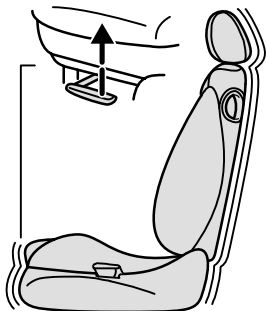

Seating and safety restraints

Pull the lever on the outside of the seat to recline the seat.

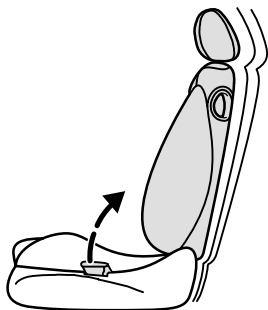

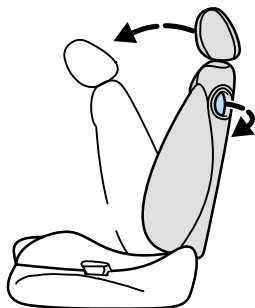

Pull the lever on the outside of the seatback to lean the seatback forward.

Fold back the seatback until it locks with a distinct 'click' and slide the seat backwards until it locks in position. Rock the seat to ensure that the catch is securely engaged.



 Do not place any objects behind the seat which could prevent the engagement of the seat lock.

 Never adjust the driver's seat or seatback when the vehicle is moving.

 Do not pile cargo higher than the seatbacks to reduce the risk of injuring people in a collision or sudden stop.

Seating and safety restraints

Power height adjustment (if equipped)

The controls are located on the left front corner of the seat.

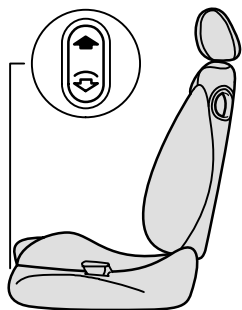

Adjusting the power seats (if equipped)

The controls are located on the left front corner of the seat. Move the relevant control in the respective direction to adjust the seat, seatback and lumbar as follows:

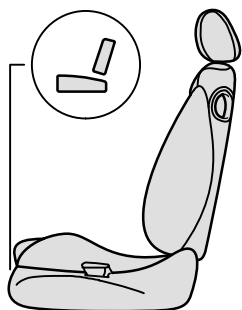

Seat

- (1) Forward and backward
- (2) Height of the entire seat

Seatback

- (3) Seatback inclination

Lumbar support

- (4) Lumbar support

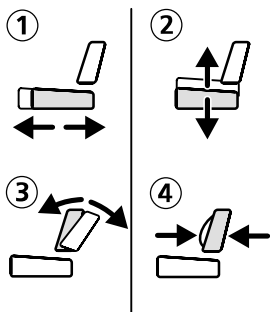

Seating and safety restraints

Closing the liftgate

 To avoid injury to rear seat occupants when closing the liftgate, ensure that the head of any rear seat occupant is not in the path of the closing liftgate. Request that the occupants, especially taller occupants, lean forward and under the roof structure to avoid making contact with the closing liftgate. Close the liftgate carefully.

Folding rear seats

Pull the release knob located in the luggage compartment. Fold down the seat.

To raise the rear seatback, push the seatback upward until it locks in place. Make sure it is firmly latched by pushing forward and back on it.

 Check to see that the seat and seatback are latched securely in position. Keep luggage area free of objects that would prevent proper engagement.

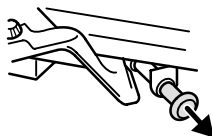



Seating and safety restraints

SAFETY RESTRAINTS

Important safety restraints precautions

 Always drive and ride with your seatback upright and the lap belt snug and low across the hips.

 To reduce the risk of injury, make sure children sit where they can be properly restrained.

 All occupants of the vehicle, including the driver, should always properly wear their safety belt, even when the air bag SRS is provided.

 It is extremely dangerous to ride in a cargo area, inside or outside of a vehicle. In a collision, people riding in these areas are more likely to be seriously injured or killed. Do not allow people to ride in any area of your vehicle that is not equipped with seats and safety belts. Be sure everyone in your vehicle is in a seat and using a safety belt properly.

 Reclining the seatback can reduce the effectiveness of the seat's safety belt in the event of a collision.

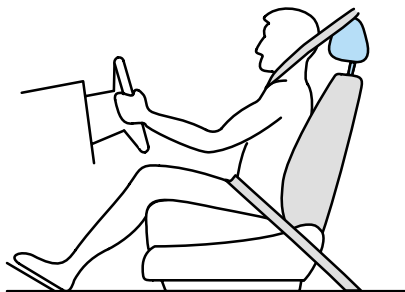

Seating and safety restraints

 Never let a passenger hold a child on his or her lap while the vehicle is moving. The passenger cannot protect the child from injury in a collision.

 In the event of a collision resulting in the deployment of the front air bags, the front safety belts must be replaced.

 Always transport children 12 years old and under in the back seat and always use appropriate child restraints.

 After any vehicle collision, the seat belt system at all outboard seating positions (except driver, which has no “automatic locking retractor” feature) must be checked by a qualified technician to verify that the “automatic locking retractor” feature for the child seats is still functioning properly, in addition to other checks for proper seat belt system function.

This vehicle has a seat belt system with an energy management feature at the front seating positions to help further reduce the risk of injury in the event of a head-on collision.

This seat belt system has a retractor assembly that is designed to pay out webbing in a controlled manner. This feature is designed to help reduce the belt force acting on the occupant’s chest.

Seating and safety restraints

 **BELT AND RETRACTOR ASSEMBLY MUST BE REPLACED** if the seat belt assembly “Tell-Tale Label” (if applicable, located on lap portion at outboard side of seat above anchorage point) is activated and states that the retractor assembly is required to be replaced, or the seat belt assembly “automatic locking retractor” feature or any other seat belt function is not operating properly when checked according to the procedures in the Service Manual.

Failure to replace the Belt and Retractor assembly could increase the risk of injury in collisions.

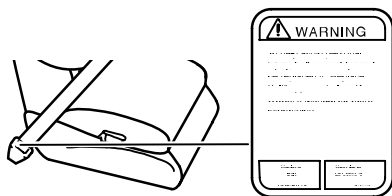

Using safety restraints properly

Combination lap and shoulder belt

To fasten, insert the tongue into the slot in the buckle until you hear it snap and feel it lock.

To unfasten, push the release button and remove the tongue from the slot.

The safety restraints in the vehicle are combination lap and shoulder belts. The front and rear seat passenger safety belts have two types of locking modes.

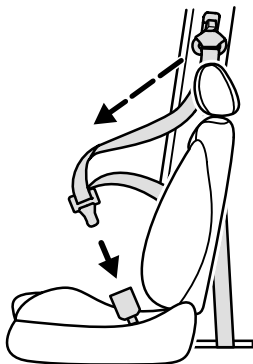

Seating and safety restraints

 Each seating position in your vehicle has a specific safety belt assembly which is made up of one buckle and one tongue that are designed to be used as a pair.

1. Use the shoulder belt on the outside shoulder only. Never wear the shoulder belt under the arm.
2. Never swing the safety belt around your neck over the inside shoulder.
3. Never use a single belt for more than one person.

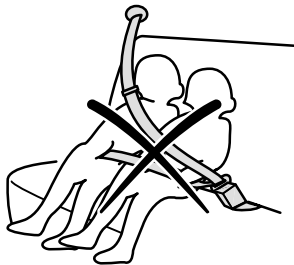
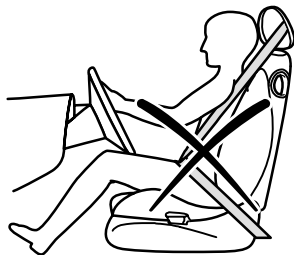

Vehicle sensitive (emergency) locking mode

The vehicle sensitive mode is the normal retractor mode which locks the belts in response to vehicle movement. For example, if the driver brakes suddenly, turns a corner sharply or your vehicle receives an impact of 8 km/h (5 mph) or more, the combination safety belts will lock to help reduce the forward movement of the driver and passengers.

Seating and safety restraints

Automatic locking mode

In this mode, the shoulder belt is automatically prelocked. The belt will still react to remove any slack in the shoulder belt.

The automatic locking mode is not available on the driver's safety belt.

When to use the automatic locking mode

- When a tight lap and shoulder belt fit is desired.
- **Any time** a child safety seat is installed in the vehicle. For information on the proper use of a child safety seat, refer to *Safety seats for children* later in this chapter.

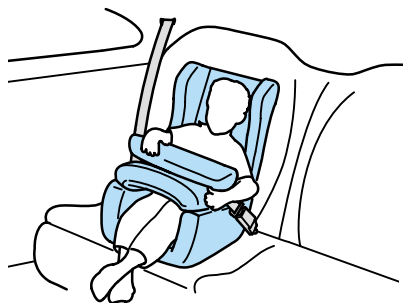

Using automatic locking mode

The automatic locking mode must be used when installing a child safety seat in any passenger seat.

1. Buckle the combination lap and shoulder belt until you hear it snap and feel it lock.
2. Grasp the shoulder belt portion and pull downward until the entire belt is extracted.
3. Allow the belt to retract. As the belt retracts, you will hear a clicking sound. This indicates that the safety belt is now in the automatic locking mode.

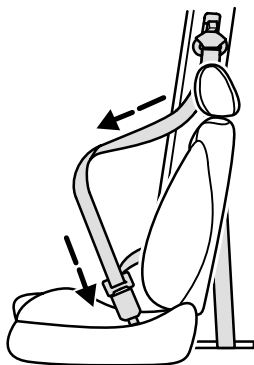

Seating and safety restraints

Canceling automatic locking mode

Unfasten the combination lap and shoulder belt and allow it to completely retract. This will cancel the automatic locking mode and activate the vehicle sensitive (emergency) locking mode.

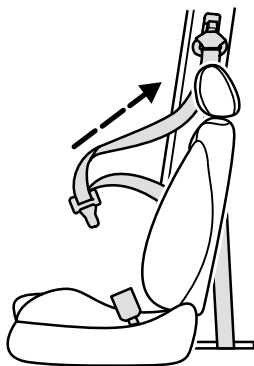

Front seat safety belt height adjustment

 Position the shoulder belt height adjusters so that the belt rests across the middle of your shoulder. Failure to adjust the safety belt properly could reduce the effectiveness of the seat belt and increase the risk of injury in a collision.



To lower the height of the shoulder belt:

1. Push the release control lever down.
2. Slide the seat belt loop down.

To raise the height of the shoulder belt:

1. Slide the seat belt loop upwards.
2. Pull down on the seat belt loop to make sure that it is locked in place.

Seating and safety restraints

Safety belt warning light and warning chime



Illuminates in the instrument cluster and a chime sounds to remind the driver to fasten his or her safety belt.

Conditions of operation

If...	Then...
If the driver's safety belt is not buckled before the ignition key is turned to on...	The safety belt warning light illuminates for one to two minutes and the warning chime sounds for four to eight seconds.
The driver's safety belt is buckled while the indicator light is illuminated and the reminder chime is sounding...	The safety belt warning light and warning chime turn off.
The driver's safety belt is buckled before the ignition key is turned to on...	The safety belt warning light and warning chime remain off.

Seating and safety restraints

Belt Minder

The Belt Minder feature is a supplemental warning to the safety belt warning function. This feature provides additional reminders to the driver that the driver's safety belt is unbuckled by intermittently sounding a chime and illuminating the *Safety belt* warning light in the instrument cluster once the vehicle speed has exceeded 5 km/h (3 mph).



If...	Then...
If the driver's safety belt is not buckled approximately 5 seconds after the safety belt warning light has turned off ...	The Belt Minder feature is activated – the <i>Safety belt</i> warning light illuminates and the warning chime sounds for 6 seconds every 30 seconds, repeating for approximately 5 minutes or until safety belt is buckled.
The driver's safety belt is buckled while the indicator light is illuminated and the warning chime is sounding...	The Belt Minder feature will not activate.
The driver's safety belt is buckled before the ignition switch is turned to the ON position ...	The Belt Minder feature will not activate.

Seating and safety restraints

The purpose of the Belt Minder is to remind occasional wearers to wear safety belts all of the time.

The following are reasons most often given for not wearing safety belts: (All statistics based on U.S. data)

Reasons given...	Consider...
"Crashes are rare events"	36 700 crashes occur every day. The more we drive, the more we are exposed to "rare" events, even for good drivers. <i>1 in 4 of us will be seriously injured in a crash during our lifetimes.</i>
"I'm not going far"	3 of 4 fatal crashes occur within 25 miles of home.
"Belts are uncomfortable"	Ford designs its safety belts to enhance comfort. If you are uncomfortable - try different positions for the safety belt upper anchorage and seatback which should be as upright as possible; this can improve comfort.
"I was in a hurry"	Prime time for an accident. Belt Minder reminds us to take a few seconds to buckle up.
"Seat belts don't work"	Safety belts , when used properly, reduce risk of death to front seat occupants by 45% in cars , and by 60% in light trucks .
"Traffic is light"	Nearly 1 of 2 deaths occur in single-vehicle crashes , many when no other vehicles are around.

Seating and safety restraints

Reasons given...	Consider...
“Belts wrinkle my clothes”	Possibly, but a serious crash can do much more than wrinkle your clothes, particularly if you are unbelted.
“The people I’m with don’t wear belts”	Set the example, teen deaths occur 4 times more often in vehicles with TWO or MORE people. Children and younger brothers/sisters imitate behavior they see.
“I have an air bag”	Air bags offer greater protection when used with safety belts. Frontal airbags are not designed to inflate in rear and side crashes or rollovers.
“I’d rather be thrown clear”	Not a good idea. People who are ejected are 40 times more likely to DIE. Safety belts help prevent ejection. WE CAN’T “PICK OUR CRASH”.

Seating and safety restraints



Do not sit on top of a buckled safety belt to avoid the Belt Minder chime. Sitting on the safety belt will increase the risk of injury in an accident. To disable (one time) or deactivate the Belt Minder feature please follow the directions stated below.

One time disable

Any time the safety belt is buckled and then unbuckled during an ignition ON cycle, Belt Minder will be disabled for that ignition cycle only.

Deactivating/activating the Belt Minder feature

Read steps 1-9 thoroughly before proceeding with the deactivation/activation programming procedure.

The Belt Minder feature can be deactivated/activated by performing the following procedure:

Before following the procedure, make sure that:

- the parking brake is set.
- the gearshift is in P (Park) (automatic transaxle) or the neutral position (manual transaxle).
- the ignition switch is in the OFF position.
- all vehicle doors are closed.

Seating and safety restraints

- the driver's safety belt is unbuckled.
- the parklamps/headlamps are in OFF position.



To reduce the risk of injury, do not deactivate/activate the Belt Minder feature while driving the vehicle.

1. Turn the ignition switch to the ON position (DO NOT START THE ENGINE).
2. Wait until the *Safety belt* warning light turns off (approximately 1-2 minutes).
 - Steps 3–5 must be completed within 60 seconds or the procedure will have to be repeated.
3. Buckle then unbuckle the safety belt three times, ending with the safety belt unbuckled. This can be done before or during Belt Minder warning activation.
4. Turn on the headlamps, turn off the headlamps.
5. Buckle then unbuckle the safety belt three times, ending with the safety belt unbuckled.
 - After step 5, the *Safety belt warning light* will be turned on for three seconds.

Seating and safety restraints

6. Within seven seconds of the *Safety belt* warning light turning off, buckle then unbuckle the safety belt.

- This will disable Belt Minder if it is currently enabled, or enable Belt Minder if it is currently disabled.

7. Confirmation of disabling Belt Minder is provided by flashing the *Safety belt* light four times per second for three seconds.

8. Confirmation of enabling Belt Minder is provided by flashing the *Safety belt* light four times per second for three seconds, followed by three seconds with the *Safety belt* light off, then followed by flashing the *Safety belt* light four times per second for three seconds again.

9. After receiving confirmation, the deactivation/activation procedure is complete.

Seating and safety restraints

Safety belt extension assembly

The safety belt may be too short even when fully extended. Approximately 20 cm (8 inches) may be added to the length of the belt with a safety belt extension (part number 611C22). Safety belt extensions are available at no cost from your dealer.

Only use extensions manufactured by the same supplier as the safety belt. Manufacturer identification is located on the label at the end of the webbing.

Do not use the extension to change the fit of the shoulder belt across the torso.

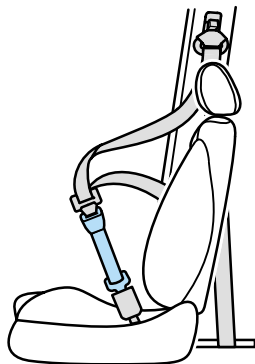

Safety belt maintenance

Inspect the safety belt systems periodically to make sure they work properly and are not damaged.

Inspect the safety belts to make sure there are no nicks, wears or cuts and replace if necessary. All safety belt assemblies, including retractors, buckles, front safety belt buckle assemblies slide bar, shoulder belt height adjusters, and attaching hardware, should be inspected after a collision.

Seating and safety restraints

Ford recommends that all safety belt assemblies used in vehicles involved in a collision be replaced. If the collision was minor and a qualified technician finds that the belts do not show damage and continue to operate properly, they do not need to be replaced. Safety belt assemblies not in use during a collision should also be inspected and replaced if either damage or improper operation is noted. Due to the energy management feature on the front safety belts, the safety belts **MUST** be replaced after any collision causing the deployment of the front air bags.



Failure to inspect and, if necessary, replace the safety belt assembly under the above conditions could result in severe personal injuries in the event of a collision.

Refer to *Cleaning and maintaining the safety belts* in the *Maintenance and care* chapter.

Seating and safety restraints

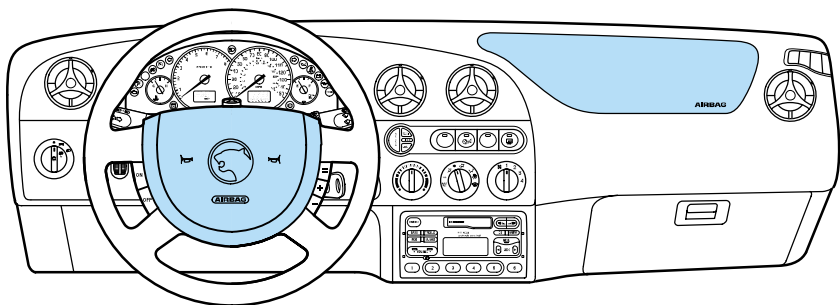



AIR BAG SUPPLEMENTAL RESTRAINT SYSTEM (SRS)

The supplemental restraint system is designed to work with the safety belt to help protect the driver and right front passenger from certain upper body injuries.

Air bags DO NOT inflate slowly or gently and the risk of injury from a deploying air bag is the greatest close to the trim covering and the air bag module.

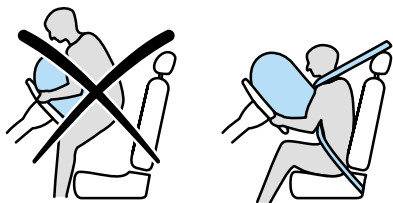
 All occupants of the vehicle including the driver should always properly wear their safety belts even when an air bag SRS is provided.



 Always transport children 12 years old and under in the back seat and always use appropriate child restraints.

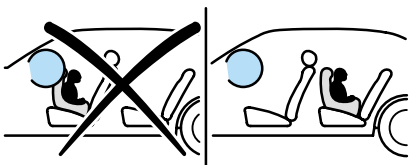

Seating and safety restraints

 NHTSA recommends a minimum distance of at least ten (10) inches between an occupant's chest and the driver air bag module.

 Never place your arm over the air bag module as a deploying air bag can result in serious arm fractures or other injuries.

Steps you can take to position yourself away from the air bag:

- Move your seat to the rear as far as you can while still reaching the pedals comfortably.
- Recline your seat one or two notches from the upright position.

 Do not put anything on or over the air bag module. Placing objects on or over the air bag inflation area may cause those objects to be propelled by the air bag into your face and torso causing serious injury.

 Do not attempt to service, repair, or modify the Air Bag Supplemental Restraint System or its fuses. See your Ford or Lincoln-Mercury dealer.

Seating and safety restraints

Children and air bags

For additional important safety information, read all information on safety restraints in this guide.

Children must always be properly restrained. Accident statistics suggest that children are safer when properly restrained in the rear seating positions than in the front seating positions. Failure to follow these instructions may increase the risk of injury in a collision.

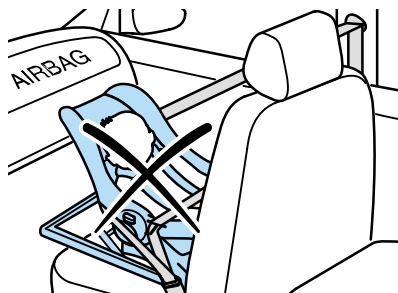

 Air bags can kill or injure a child in a child seat. **NEVER** place a rear-facing child seat in front of an active air bag. If you must use a forward-facing child seat in the front seat, move the seat all the way back.

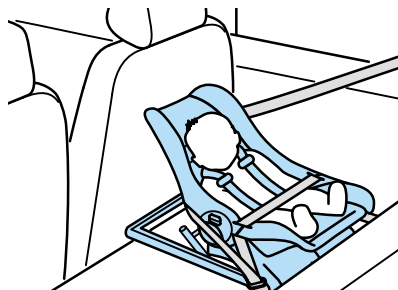

Seating and safety restraints

How does the front air bag system work?

The air bag SRS is designed to activate when the vehicle sustains sufficient longitudinal deceleration to cause the sensors to close an electrical circuit that initiates air bag inflation.

The fact that the air bags did not inflate in a collision does not mean that something is wrong with the system. Rather, it means the forces were not of the type sufficient to cause activation. Air bags are designed to inflate in frontal and near-frontal collisions, not rollover, side-impact, or rear impacts.

The air bags inflate and deflate rapidly upon activation. After air bag deployment, it is normal to notice a smoke-like, powdery residue or smell the burnt propellant. This may consist of cornstarch, talcum powder (to lubricate the bag) or sodium compounds (e.g., baking soda) that result from the combustion process that inflates the air bag. Small amounts of sodium hydroxide may be present which may irritate the skin and eyes, but none of the residue is toxic.

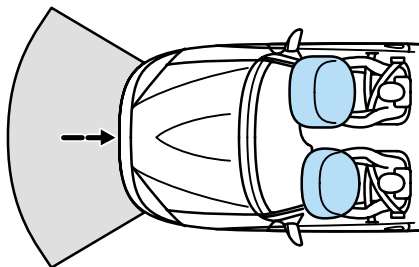

Seating and safety restraints

While the system is designed to help reduce serious injuries, it may also cause abrasions, swelling or temporary hearing loss. Because air bags must inflate rapidly and with considerable force, there is the risk of death or serious injuries such as fractures, facial and eye injuries or internal injuries, particularly to occupants who are not properly restrained or are otherwise out of position at the time of air bag deployment. Thus, it is extremely important that occupants be properly restrained as far away from the air bag module as possible while maintaining vehicle control.



Several air bag system components get hot after inflation. Do not touch them after inflation.



If the air bag is inflated, **the air bag will not function again and must be replaced immediately**. If the air bag is not replaced, the unrepaired area will increase the risk of injury in a collision.

The SRS consists of:

- driver and passenger air bag modules (which include the inflators and air bags),
- One or more impact and safing sensors
- and the electrical wiring which connects the components.

Seating and safety restraints

The diagnostic module monitors its own internal circuits and the supplemental air bag electrical system warning (including the impact sensors), the system wiring, the air bag system readiness light, the air bag back up power and the air bag ignitors.

Determining if the system is operational

The SRS uses a readiness light in the instrument cluster to indicate the condition of the system. Refer to the *Air bag readiness* section in the *Instrumentation* chapter.

Routine maintenance of the air bag is not required.

A difficulty with the system is indicated by one or more of the following:

- The readiness light will either flash or stay lit.
- The readiness light will not illuminate immediately after ignition is turned on.

If any of these indications happen, even intermittently, have the SRS serviced at your dealership or by a qualified technician immediately.

Unless serviced, the system may not function properly in the event of a collision.





Seating and safety restraints

Disposal of air bags and air bag equipped vehicles

For disposal of air bags or air bag equipped vehicles, see your local dealership or qualified technician. Air bags **MUST BE** disposed of by qualified personal.

Side air bag system (if equipped)

 Do not use accessory seat covers. The use of accessory seat covers may prevent the deployment of the side air bags and increase the risk of injury in an accident.

 Do not lean your head on the door; the side air bag could injure you as it deploys from the side of the seatback.

 Do not attempt to service, repair, or modify the air bag Supplemental Restraint System or its fuses. See your Ford or Lincoln-Mercury dealer.

 All occupants of the vehicle including the driver should always wear their safety belts even when an air bag SRS is provided.

Seating and safety restraints

How does the side air bag system work? (if equipped)

Side air bags, in combination with seat belts, can help reduce the risk of severe injuries in the event of a significant side impact collision.

The side air bags are fitted on the outboard side of the seatbacks of the front seats. In certain lateral collisions, the air bag on the side affected by the collision will be inflated, even if the respective seat is not occupied. The air bag was designed to inflate between the door panel and occupant to further enhance the protection provided occupants in side impact collisions.

The side air bags are not activated upon minor lateral, front or rear impact collisions.

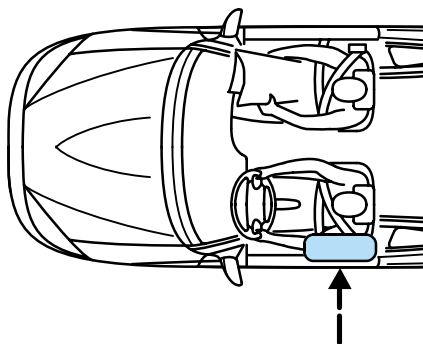

 Several air bag system components get hot after inflation. Do not touch them after inflation.

Seating and safety restraints

 If the air bag has deployed, **the air bag will not function again. The side air bag system (including the seat) must be inspected and serviced by a qualified technician in accordance with the vehicle service manual.** If the air bag is not replaced, the unrepaired area will increase the risk of injury in a collision.

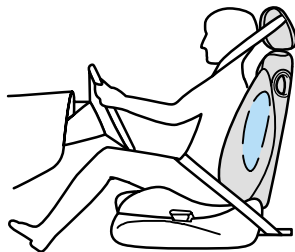

The side air bag system consists of the following:

- An inflatable nylon bag (air bag) with a gas generator concealed behind the outboard bolster of the driver and front passenger seatbacks.
- The same warning light, electronic control and diagnostic unit as used for the front air bags.
- Two crash sensors located under the outboard side of the seat, attached to the floor.

 Keep the sensors free from contact with water. If water has entered the floor area (i.e., due to flooding conditions) do not start the vehicle until the floor area is dry. Failure to do so may result in a malfunction of the side air bag or inadvertent side air bag deployment.

Seating and safety restraints

Determining if the system is operational

The SRS uses a readiness light in the instrument cluster to indicate the condition of the system. Refer to the *Air bag readiness* section in the *Instrumentation* chapter. Routine maintenance of the air bag is not required.

A difficulty with the system is indicated by one or more of the following:

- The readiness light will either flash or stay lit.
- The readiness light will not illuminate immediately after the ignition is turned on.

If either of these indications occur, even intermittently, have the SRS serviced at your dealership or by a qualified technician immediately. Unless serviced, the system may not function properly in the event of a collision.

Disposal of air bags and air bag equipped vehicles

For disposal of air bags or air bag equipped vehicles, see your local dealership or a qualified technician. Air bags **MUST BE** disposed of by qualified personnel.

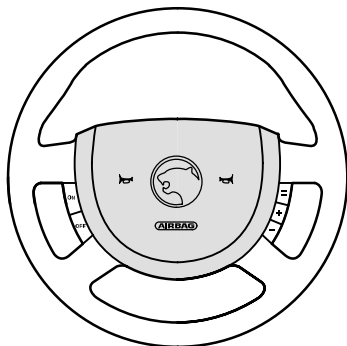
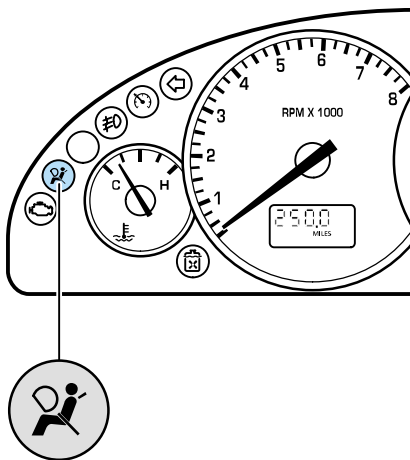

Seating and safety restraints

CHILDREN AND SAFETY RESTRAINTS

 Rear-facing child seats or infant carriers should never be placed in the front seats.

 To reduce the risk of injury, make sure children sit where they can be properly restrained.

 Always transport children 12 years old and under in the back seat and always use appropriate child restraints.

Accident statistics indicate that children are safer when properly restrained in the rear seats.

 Do not leave children, unreliable adults, or pets unattended in your vehicle.

 Safety belts and seats can become hot in a vehicle that has been closed up in sunny weather; they could burn a small child. Check seat covers and buckles before you place a child anywhere near them.

Seating and safety restraints

Important child restraint precautions

You are required by law to use safety restraints for children in the U.S. and Canada. If small children ride in your vehicle (generally children who are four years old or younger and who weigh 18 kg [40 lbs] or less), you must put them in safety seats made especially for children. Check your local and state or provincial laws for specific requirements regarding the safety of children in your vehicle.

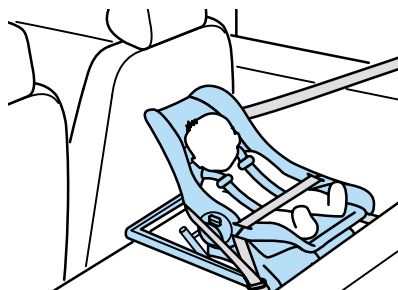

 Never let a passenger hold a child on his or her lap while the vehicle is moving. The passenger cannot protect the child from injury in a collision.

Always follow the instructions and warnings that come with any infant or child restraint you might use.

 Always transport children 12 years old and under in the back seat and always use appropriate child restraints.

Seating and safety restraints

Children and safety belts

Children who are too large for child safety seats (as specified by the child safety seat manufacturer) should always wear safety belts.

Follow all the important safety restraints and air bag precautions that apply to adult passengers in your vehicle.

If the shoulder belt portion of a combination lap and shoulder belt can be positioned so it does not cross or rest in front of the child's face or neck, the child should wear the lap and shoulder belt.

To improve the fit of lap and shoulder belts on children who have outgrown child safety seats, Ford recommends use of a belt-positioning booster seat that is labelled as conforming to all federal motor vehicle safety standards. Belt-positioning booster seats raise the child and provide a shorter, firmer seating cushion that encourages safer seating posture and better fit of lap and shoulder belts on the child. A belt-positioning booster seat should be used if the shoulder belt rests in front of the child's face or neck, or if the lap belt does not fit snugly on both thighs, or if the thighs are too short to let the child sit all the way back on the seat cushion when the lower legs hang over the edge of the seat cushion. You may wish to discuss the special needs of your child with your pediatrician.

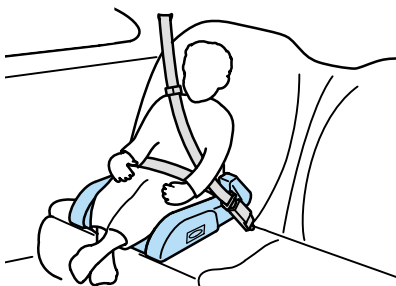

Seating and safety restraints

SAFETY SEATS FOR CHILDREN

 Rear-facing child seats or infant carriers should never be placed in the front seats.

 Carefully follow all of the manufacturer's instructions included with the safety seat you put in your vehicle. If you do not install and use the safety seat properly, the child may be injured in a sudden stop or collision.

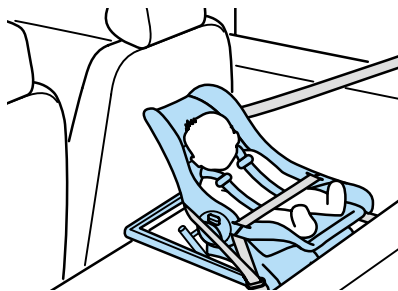

Child and infant or child safety seats

Use a safety seat that is recommended for the size and weight of the child. The best fit can be obtained with a child safety seat that has a base wide enough to span the depression of the rear seat so that it rests on the highest part of the seat cushion. Carefully follow all of the manufacturer's instructions with the safety seat you put in your vehicle. If you do not install and use the safety seat properly, the child may be injured in a sudden stop or collision.

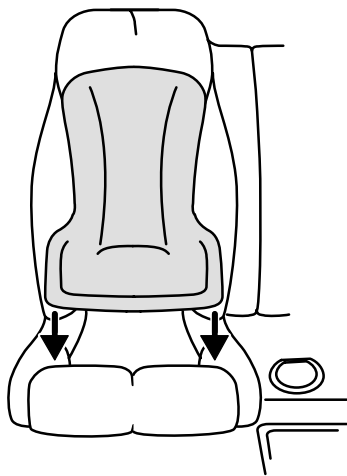

Seating and safety restraints

When installing a child safety seat:

- Use the correct safety belt buckle for that seating position.
- Make sure the tongue is securely fastened in the buckle.
- Keep the buckle release button pointing up and away from the safety seat, with the tongue between the child seat and the release button, to prevent accidental unbuckling.
- Put the safety belt in the automatic locking mode. Refer to *Using automatic locking mode* in this chapter.

Ford recommends the use of a child safety seat having a top tether strap. Install the child safety seat in a seating position which is capable of providing a tether anchorage.

For more information on top tether straps see *Attaching safety seats with tether straps* in this chapter.

Seating and safety restraints

Installing child safety seats in combination lap and shoulder belt seat positions

1. Position the child safety seat in a seat with a combination lap and shoulder belt.

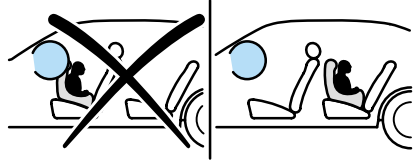

 Ford recommends that you properly secure children in the rear seat whenever possible. If you must use a forward-facing child seat in the front seat, move the passenger seat as far back from the instrument panel as possible. Never secure rear-facing infant seats in the front seat.

2. Pull down on the shoulder belt and then grasp the shoulder belt and lap belt together.

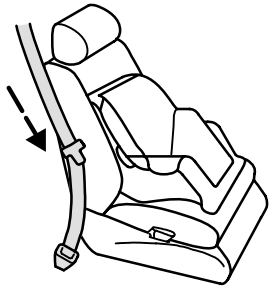

Seating and safety restraints

3. While holding the shoulder and lap belt portions together, route the tongue through the child seat according to the child seat manufacturer's instructions. Be sure the belt webbing is not twisted.

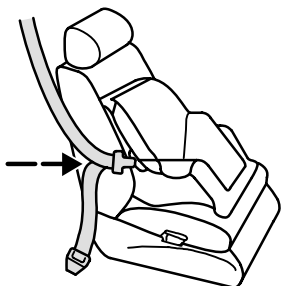

4. Insert the belt tongue into the proper buckle for that seating position until you hear and feel the latch engage. Make sure the tongue is latched securely by pulling on it.

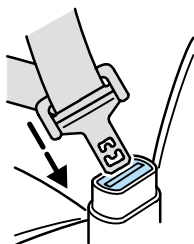

5. To put the retractor in the automatic locking mode, grasp the shoulder portion of the belt and pull downward until all of the belt is extracted and a click is heard.

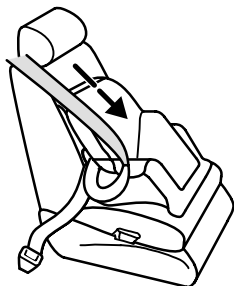

Seating and safety restraints

6. Allow the belt to retract. The belt will click as it retracts to indicate it is in the automatic locking mode.

7. Pull the lap belt portion across the child seat toward the buckle and pull up on the shoulder belt while pushing down with your knee on the child seat.

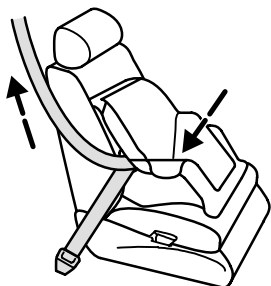

8. Allow the safety belt to retract to remove any slack in the belt.

9. Before placing the child in the seat, forcibly tilt the seat forward and back to make sure the seat is securely held in place.

10. Try to pull the belt out of the retractor to make sure the retractor is in automatic locking mode (you should not be able to pull more belt out). If the retractor is not locked, unbuckle the belt and repeat steps two through nine.

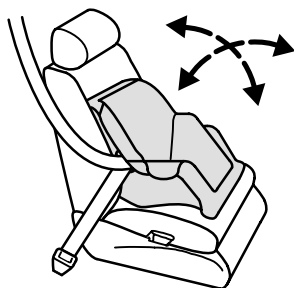

Check to make sure the child seat is properly secured before each use.

Seating and safety restraints

Attaching child safety seats with tether straps

Some child seat manufacturers make safety seats that include a tether strap which goes over the back of the vehicle seat and attaches to an anchoring point. Other manufacturers offer the tether strap as an accessory. Contact the manufacturer of the child seat for information about ordering a tether strap.

Your vehicle is equipped with built-in tether strap anchors located in the rear of the vehicle as described below.

The tether strap anchors in your vehicle are in the following positions (shown from top view, left is front of vehicle):



Attach the tether strap only to the appropriate tether anchor as shown in the drawings. The tether strap may not work properly if attached somewhere other than the correct tether anchor.

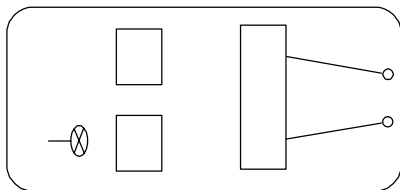

Seating and safety restraints

1. Position the child safety seat on the rear passenger seat cushion.
2. Route the child safety seat tether strap over the back of the seat.

For vehicles with moveable head restraints, route the tether strap under the head restraint and between the head restraint posts if you can. Otherwise, route the tether strap over the top of the seatback.

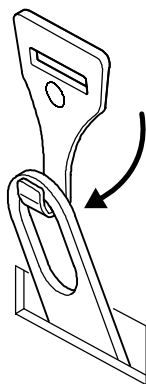

3. Locate the correct anchor for the selected seating position as shown previously.
4. Clip the tether strap to the anchor.
5. Refer to the *Installing child safety seats in the combination lap and shoulder belt seating position* section in this chapter for further instructions to secure the child safety seat.

Seating and safety restraints

6. Tighten the child safety seat tether strap according to the manufacturer's instructions.
7. Once you have installed the safety seat, assure that the tether strap is fastened securely. Also, test the safety seat before you place the child in it. Tilt the seat from side to side. Also try to tug the seat forward. Check to see if the belts hold the seat in place.





If the child safety seat is not anchored properly, the risk of a child being injured in a collision greatly increases.

IMPORTANT SAFETY PRECAUTIONS

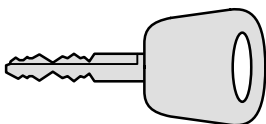
A computer system controls the engine's idle revolutions per minute (rpm). When the engine starts, the idle rpm runs faster to warm the engine. If the engine idle speed does not slow down automatically, have the vehicle checked by your dealer or a qualified service technician. Do not allow the vehicle to idle for more than ten minutes.



 Extended idling at high engine speeds can produce very high temperatures in the engine and exhaust system, creating the risk of fire or other damage.

 Do not park, idle, or drive your vehicle in dry grass or other dry ground cover. The emission system heats up the engine compartment and exhaust system, which can start a fire.

Starting

 Do not start your vehicle in a closed garage or in other enclosed areas. Exhaust fumes can be toxic. Always open the garage door before you start the engine. See *Guarding against exhaust fumes* in this chapter for more instructions.

IMPORTANT VENTILATION INFORMATION

If the engine is idling while the vehicle is stopped in an open area for long periods of time, open the windows at least 2.5 cm (1 inch).

Adjust the heating or air conditioning to bring in fresh air.

Refer to *climate controls* in the *Controls and Features* chapter.

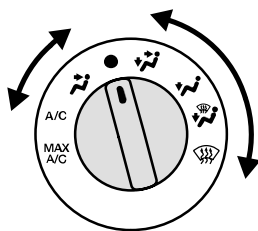

Improve vehicle ventilation by keeping all air inlet vents clear of snow, leaves and other debris.

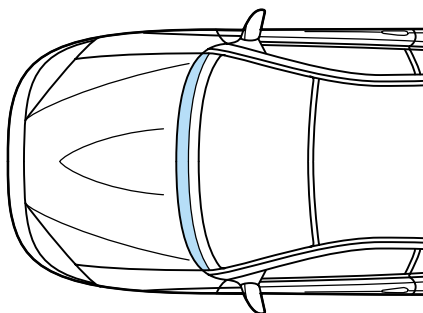

Guarding against exhaust fumes

Although odorless and colorless, carbon monoxide is present in exhaust fumes. Take precautions to avoid its dangerous effects.



If you ever smell exhaust fumes of any kind inside your vehicle, have your dealer inspect and fix your vehicle immediately. Do not drive if you smell exhaust fumes. These fumes are harmful and could kill you.

Have the exhaust and body ventilation system checked whenever:

- the vehicle is raised for service.
- the sound of the exhaust system changes.
- the vehicle has been damaged in a collision.

Starting

PREPARING TO START THE VEHICLE

Engine starting is controlled by the spark ignition system. This system meets all Canadian Interference-Causing Equipment standard requirements regulating the impulse electrical field strength of radio noise.

When starting the engine, avoid pressing the accelerator pedal before or during starting. Only use the accelerator pedal when you have difficulty starting the engine. For more information on starting the vehicle, refer to *Starting the engine* in this chapter.

Before starting the vehicle:

1. Make sure all vehicle occupants have buckled their safety belts. For more information on safety belts and their proper usage, refer to the *Seating and safety restraints* chapter.
2. Make sure the headlamps and vehicle accessories are off.

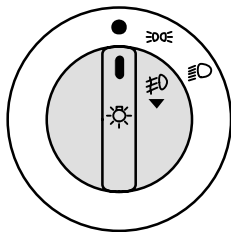

Starting

If starting a vehicle with an automatic transaxle:

- Make sure the parking brake is set.
- Make sure the gearshift is in P (Park).

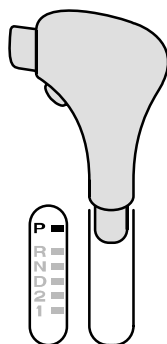

If starting a vehicle with a manual transaxle:

- Make sure the parking brake is set.
- Push the clutch pedal to the floor otherwise the engine will not crank (turn over).
- Put the gearshift into neutral.

3. Turn the key to the on position (without turning the key to start).

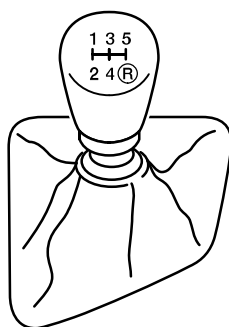

Make sure the following lights illuminate: charging system (if equipped), low coolant, engine oil pressure, check engine, air bag readiness, traction control, brake system, ABS, and safety belt. If a light fails to illuminate, have the vehicle serviced by your dealer or a qualified service technician.

- If the driver's safety belt is fastened the safety belt warning light does not illuminate.



Starting

STARTING THE ENGINE

1. Turn the key to the start position (4) without pressing the accelerator pedal and release as soon as the engine starts. The key will return to the on (3) position.

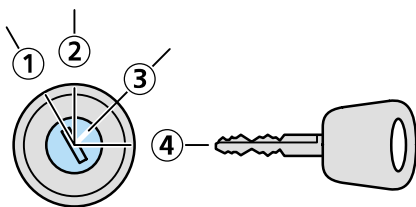

2. If the engine does not start within five seconds, wait ten seconds and try again.

3. If the engine does not start in two attempts OR the temperature is below -12°C (10°F), fully depress the accelerator pedal and start the engine while holding the accelerator pedal down to the floor. Release the accelerator pedal when the engine starts.

Vehicles equipped with the 2.0 l engine: If the engine fails to start, continue to crank with the accelerator depressed about 1/4 of the way down and hold that position until the engine starts. **DO NOT crank for more than 30 seconds** or you could damage the starter.

4. After idling for a few seconds, apply the brake and release the parking brake.

USING THE ENGINE BLOCK HEATER (IF EQUIPPED)

An engine block heater warms the engine coolant, which improves starting, warms up the engine faster and allows the heater-defroster system to respond quickly. It is strongly recommended if you live in a region where temperatures reach -23°C (-10°F) or below.

For best results, plug the heater in at least three hours before starting the vehicle. Using the heater for more than three hours will not harm the engine, so the heater can be plugged in the night before starting the vehicle.



To prevent electrical shock, do not use your heater with ungrounded electrical systems or two-pronged (cheater) adapters.

Driving

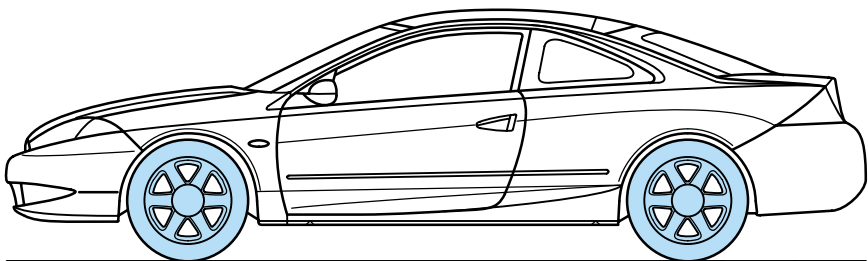

BRAKES

Your brakes are self-adjusting. Refer to the “Scheduled Maintenance Guide” for maintenance intervals.

Anti-lock braking system (ABS) (if equipped)

On vehicles equipped with an anti-lock braking system (ABS), a noise from the hydraulic pump motor and pulsation in the pedal may be observed during ABS braking events. Pedal pulsation coupled with noise while braking under panic conditions or on loose gravel, wet or snowy roads is normal and indicates proper functioning of the vehicle’s anti-lock brake system. If the vehicle has continuous vibration or shudder while braking, felt mainly in the steering wheel, the vehicle most likely needs service.

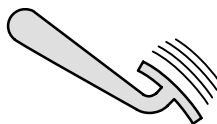

Operation of the anti-lock braking system

The ABS operates by detecting the onset of wheel lock up during brake applications and compensating for this tendency. The wheels are prevented from locking even when the brakes are firmly applied.

Braking with ABS

- In an emergency, apply full force on the brake. The ABS will be activated immediately, allowing you to retain full steering control of your vehicle and, providing there is sufficient space, will help you to avoid obstacles and bring the vehicle to a stop.
- We recommend that you familiarize yourself with this braking technique. However, avoid taking any unnecessary risks.

Two important rules when braking in emergencies with ABS:

1. Apply full force on both brake and clutch pedals (if equipped).

2. Steer around the obstacle. No matter how hard you brake, steering control is maintained.

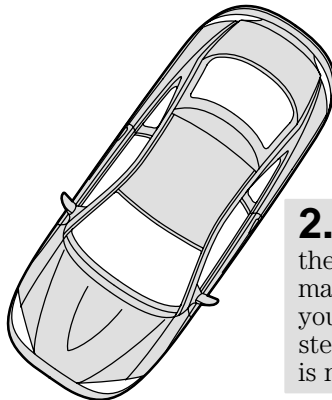

Driving

Parking brake

To engage the parking brake:

Pull the handle upward.

To release the parking brake:

1. Pull the handle up slightly.
2. Press and hold the release button.
3. Push handle downward to the off position.

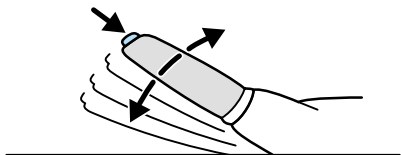
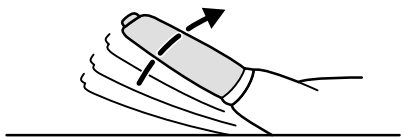

 Always set the parking brake fully and make sure that the gearshift is securely latched in P (Park) (automatic transaxle) or in 1 (first) (manual transaxle).

 To prevent personal injury, do not release the parking brake while outside the vehicle.

TRACTION CONTROL

This system prevents wheel spin at all speeds. The control will toggle this function on and off, but the feature defaults to on after each cycle of the ignition key.

The traction control system controls excessive wheel spin by automatically applying and releasing the brakes in conjunction with engine torque reductions.

This can occur when accelerating on a slippery road, a loose surface or when pulling away on a hill. The traction control lamp flashes when the system is functioning to regulate tire traction. The light illuminates continuously to indicate a fault in the system.

You should not take unnecessary driving risks because of the system's safety potential.

Switching off traction control

If you become stuck in snow or on a slippery road surface, try switching off the traction control system by pressing the switch. This may allow the excess wheel spin to “dig” the vehicle out or enable a successful “rocking” maneuver. Do not rock the vehicle for more than a few minutes, because it could damage the vehicle.

The light in the control illuminates continuously when the system has been switched off. To reactivate the system, depress the switch again or restart the engine.

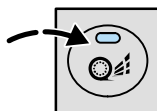

Driving

STEERING YOUR VEHICLE

Your vehicle comes with power steering. Power steering uses energy from the engine to help steer your vehicle.

If the amount of effort needed to steer your vehicle changes at a constant vehicle speed, have the power steering checked. If the power steering system breaks down (or if the engine is turned off), you can steer the vehicle manually but it takes more effort.

Never hold the steering wheel to the extreme right or left for more than five seconds if the engine is running. This can damage the power steering pump.

TRANSAXLE OPERATION

Automatic transaxle (if equipped)

Your 2.5 l V6 automatic transaxle electronically controls the shift feel by using an adaptive learning strategy. This feature is designed to optimize shift smoothness. It is normal for your transaxle to adjust during the first few hundred kilometers (miles) of operation until the adaptive strategy has been learned. The adaptive learning strategy is maintained by power from the battery. When the battery is disconnected or a new battery is installed, the transaxle must relearn its adaptive strategy. Optimal shifting will resume within a few hundred kilometers (miles) of operation.

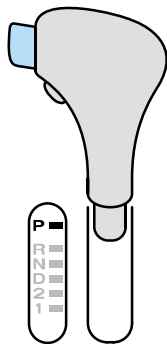

Vehicles equipped with an automatic transaxle are equipped with a brake-shift interlock feature that prevents the gearshift lever from being moved from the P (Park) position unless the brake pedal is depressed.

Putting your vehicle in gear

You must push the thumb button to move the gearshift to the position you choose.

To operate:

1. Start the engine.
2. Depress and hold the brake pedal.
3. Move the gearshift lever out of P (Park).

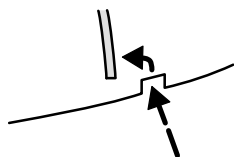
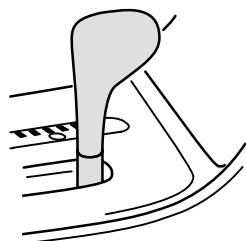

Overriding the brake-shift interlock feature

If you cannot move the gearshift lever from P (Park) with the brake pedal depressed:

1. Turn the ignition off and remove the ignition key.
2. Apply the parking brake and the brake pedal.
3. Insert a screwdriver or similar item about 5 cm (2 inches) into the square opening to the right of the gearshift at the base of the console.

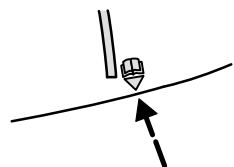
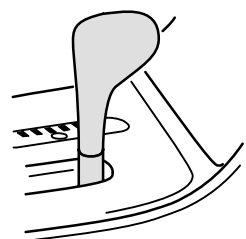



Driving

On vehicles without the opening, insert a screwdriver or similar item about 5 cm (2 inches) inward, directly below the arrow symbol located to the right of the gearshift at the base of the console.

4. Rotate the screwdriver point rearward.
5. Push and hold the thumb button and move the gearshift.
6. Remove the screwdriver when the gearshift moves from the P (Park) position.

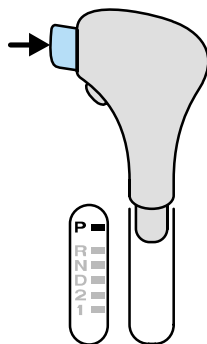
This procedure may have to be repeated each time the gearshift is placed in park until repairs are completed.



 The brake-shift interlock feature is designed to further enhance the safety of vehicle occupants when the vehicle is placed into gear. To preserve the benefits of this feature, have any repairs completed promptly.

The console-mounted gearshift will lock when you turn the key to the lock position. When the gearshift is in any position except P (Park), the ignition key cannot be turned to lock or removed from the steering column. To remove the key, the gearshift lever must be in P (Park).

Once the gearshift is secure in the desired position, release the brake pedal and use the accelerator as necessary.

- P** = Park **P** ■
- R** = Reverse **R** ■
- N** = Neutral **N** ■
- D** = Drive: Gear 1 to 4
with overdrive
Gear 1 to 3 with
overdrive cancelled **D** ■
- 2** = Gear 2 **2** ■
- 1** = Gear 1 **1** ■

Driving

Understanding gearshift positions

To account for customer driving habits and conditions, your 2.5 l V6 automatic transaxle electronically controls the shift feel by using an adaptive learning strategy. During the first few hundred kilometers (miles) of operation, it is normal for your transaxle to adjust. The adaptive learning strategy is maintained by power from the battery. When the battery is disconnected or a new battery is installed, the transaxle must relearn its adaptive strategy. Optimal shifting will resume within a few hundred kilometers (miles) of operation.



Hold the brake pedal down while you move the gearshift lever from P (Park) to another position. If you do not hold the brake pedal down, your vehicle may move unexpectedly and injure someone.

P (Park)

Always come to a complete stop before shifting into or out of P (Park). Make sure the gearshift is securely latched in P (Park). This locks the transaxle and prevents the front wheels from rotating.

Driving

R (Reverse)

With the gearshift in R (Reverse), the vehicle will move backward. Always come to a complete stop before shifting into and out of R (Reverse).

N (Neutral)

With the gearshift in N (Neutral), the vehicle can be started and is free to roll. Hold the brake pedal down while in this gear.

D (Overdrive)

The normal driving condition for the best fuel economy. Transaxle operates in gears one through four.

D (Overdrive) can be deactivated by pressing the transaxle control switch on the side of the gearshift lever. O/D OFF will illuminate in the instrument cluster.

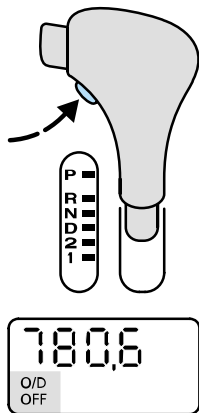

Drive (Drive) – O/D off illuminated

Activate by pressing the transaxle control switch on the underside of the gearshift lever. The transaxle operates in gears one through three. D (Drive) provides more engine braking than overdrive and is useful whenever driving conditions (i.e., city traffic, hilly terrain, etc.) cause the transaxle to excessively shift between D (Overdrive) and D (Drive).

Deactivate D (Overdrive) when:

- driving with a heavy load.
- towing a trailer up or down steep hills.
- additional engine braking is desired.

To return to D (Overdrive) mode, press the transaxle control switch. The O/D OFF message in the instrument cluster will extinguish.

Every time the vehicle is shut off and restarted, you must press the transaxle control switch to cancel overdrive operation if driving in overdrive is not desired.

2 (Second)

Use 2 (Second) to start-up on slippery roads or to provide additional engine braking on downgrades.

1 (First)

Use 1 (Low) to provide maximum engine braking on steep downgrades. Upshifts can be made by shifting to 2 (Second) or to D (Overdrive). Selecting 1 (Low) at higher speeds causes the transaxle to shift to a lower gear, and will shift to 1 (Low) after the vehicle decelerates to the proper speed.

Driving

Manual transaxle (if equipped)

Vehicles equipped with a manual transaxle have a starter interlock that prevents cranking the engine unless the clutch pedal is fully depressed.

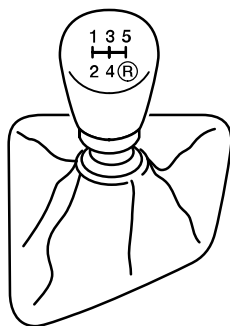

Using the clutch

When starting a vehicle with a manual transaxle:

1. Hold down the brake pedal.
2. Depress the clutch pedal.
3. Put the gearshift lever in neutral.
4. Start the vehicle.
5. Put the gearshift in 1 (First) or R (Reverse).
6. Release the clutch slowly while pressing gradually down on the accelerator pedal.

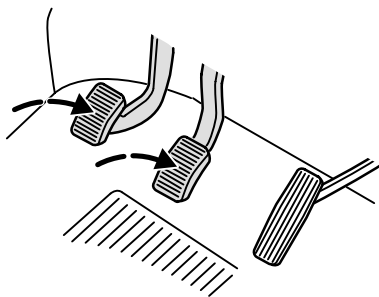

Do not drive with your foot resting on the clutch pedal. Do not use the clutch to hold your vehicle at a standstill while waiting on a hill. These actions may reduce the clutch life.

Recommended shift speeds

2.0 litre engine 5-speed transaxle shift speed schedules				
Recommended upshifts:	During acceleration:		During cruise*:	
	km/h	mph	km/h	mph
First to second	22	14	19	12
Second to third	40	25	32	20
Third to fourth	53	33	46	29
Fourth to fifth	77	48	64	40

2.5 litre engine 5-speed transaxle shift speed schedules				
Recommended upshifts:	During acceleration:		During cruise*:	
	km/h	mph	km/h	mph
First to second	22	14	16	10
Second to third	40	25	32	20
Third to fourth	53	33	50	31
Fourth to fifth	73	45	64	40

*The vehicle can be shifted at lower speeds to improve fuel economy.

Driving

Parking

1. Apply the brake and the clutch and shift into neutral.
2. Engage the parking brake.
3. Shift into 1 (First).
4. Turn the ignition off.

 Do not park your vehicle in neutral, it may move unexpectedly and injure someone. Use 1 (First) gear and set the parking brake.

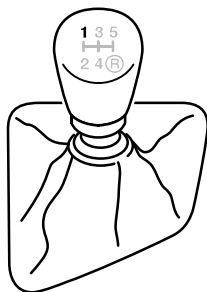
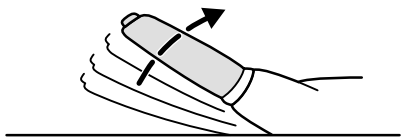

Reverse

To shift into R (Reverse):

1. Completely stop your vehicle.
2. Depress the clutch pedal to the floor and place the gearshift lever in the neutral position. Do not release the clutch pedal.
3. Push the gearshift lever completely to the right, pull up the ring on the stalk of the gearshift lever, and then pull rearward on the gearshift lever to engage the R (Reverse) gear.
4. When the R (Reverse) gear is engaged, slowly release the clutch pedal from the floor.

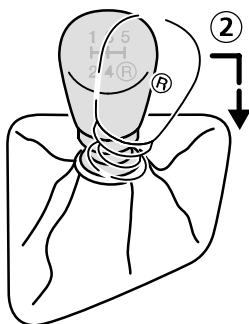
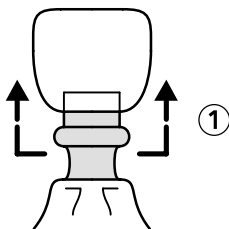

LOADING YOUR VEHICLE

Before loading your vehicle, familiarize yourself with these terms.

Base curb weight

Weight of the vehicle including any standard equipment, fluids and lubricants. It does not include passengers or aftermarket equipment.

Payload

Combined maximum allowable weight of passengers, cargo and optional equipment. The payload equals the gross vehicle weight rating minus base curb weight.

GVW (Gross Vehicle Weight)

Base curb weight plus the payload weight. The GVW is not a limit or a specification.

Driving

GVWR (Gross Vehicle Weight Rating)

Maximum total weight of the base vehicle, passengers, optional equipment and cargo. The GVWR is specific to each vehicle and is listed on the Safety Compliance Certification Label on the driver's door pillar.

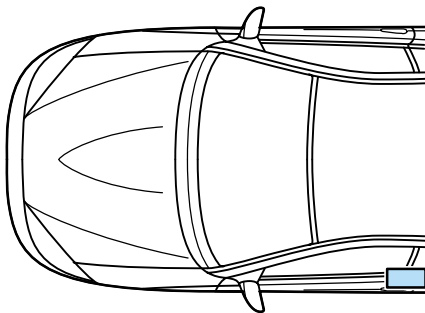

GAWR (Gross Axle Weight Rating)

Carrying capacity for each axle system (front and rear). The GAWR is specific to each vehicle and is listed on the Safety Compliance Certification Label on the driver's door pillar.

GCW (Gross Combined Weight)

The GCW is the maximum combined weight of the towing vehicle (including passengers and cargo) and the loaded trailer. The GCW is specified by the manufacturer to indicate the combined maximum loaded weight that the vehicle is designed to tow.

Payload = GVWR minus Base curb weight

To obtain the correct weight for your vehicle, take your vehicle to a shipping company or an inspection station for trucks.

Do not use replacement tires with lower weight capacities than the originals because they might lower the vehicle's GVWR and GAWR. (Replacement tires with a higher weight limit than the originals do not increase the GVWR and GAWR limitations.)

In high altitudes, engines will lose power at a rate of 3% power per 300 m (1 000 ft) increase in elevation. A reduction in GVW and GCW is recommended for maximum vehicle performance.



Do not exceed the GVWR or the GAWR specified on the Safety Compliance Certification Label.

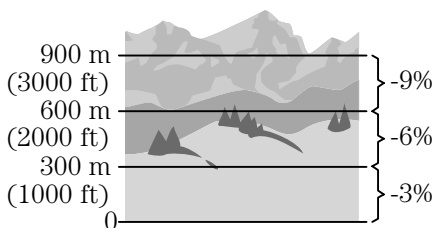

Driving



It is extremely dangerous to ride in a cargo area, inside or outside of a vehicle. In a collision, people riding in these areas are more likely to be seriously injured or killed. Do not allow people to ride in any area of your vehicle that is not equipped with seats and safety belts. Be sure everyone in your vehicle is in a seat and using a safety belt properly.

Driving with a heavy load

The total weight of the vehicle plus the total weight of passengers and cargo should never exceed the GVWR.

The weight that the vehicle carries over the front and rear axles should never exceed the GAWR for the respective axle.

The weight limits of your vehicle's tires affect the GVWR and GAWR limitations. Using tires with higher weight limits than the original tires will not increase the GVWR or GAWR of your vehicle; using tires with lower weight limits may lower the GVWR or GAWR of your vehicle.

Using a luggage rack

The sunroof opens to the outside. When placing a luggage rack or any load on the roof, ensure there is proper clearance before opening the sunroof.

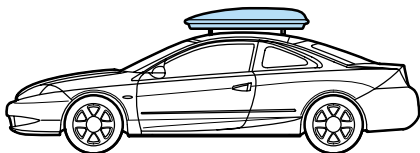

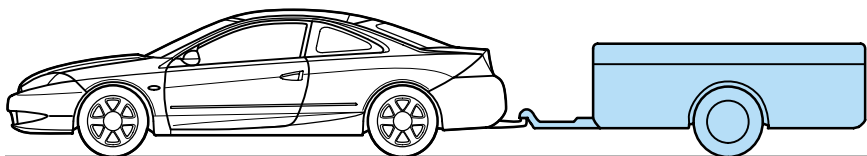

TRAILER TOWING

Your vehicle is capable of towing a trailer of up to a maximum of 454 kg (1 000 lbs) gross trailer weight with a maximum tongue load of 45 kg (100 lbs). Cougar S vehicles are not approved for trailer towing. It should also have 2.3 sq. meters (25 sq. feet) or less frontal area. Do not drive faster than 72 km/h (45 mph) while towing a 454 kg (1 000 lb) trailer.

Your vehicle does not come from the factory fully equipped to tow. No towing packages are available through Ford or Lincoln/Mercury dealers.

Trailer towing puts additional loads on your vehicle's engine, transaxle, axle, brakes, tires, and suspension. For your safety and to maximize vehicle performance, be sure to use the proper equipment while towing.

Driving

Follow these guidelines to ensure safe towing procedure:

- Stay within your vehicle's load limits.
- Thoroughly prepare your vehicle for towing. Refer to *Preparing to tow* in this chapter.
- Use extra caution when driving while trailer towing. Refer to *Driving while towing a trailer* in this chapter.
- Service your vehicle more frequently if you tow a trailer. Refer to the severe duty schedule in the "Scheduled Maintenance Guide".
- Do not tow a trailer until your vehicle has been driven at least 800 km (500 miles).
- Refer to the instructions included with towing accessories for the proper installation and adjustment specifications.
- Do not tow a trailer with a temporary spare tire in use on the vehicle.

Do not exceed the maximum loads listed on the Safety Compliance Certification Label. For load specification terms found on the label, refer to *Loading your vehicle* in this chapter. Remember to figure in the tongue load of your loaded vehicle when figuring the total weight.



Towing trailers beyond the maximum recommended gross trailer weight could result in engine damage, transaxle damage, structural damage, loss of control, and personal injury.

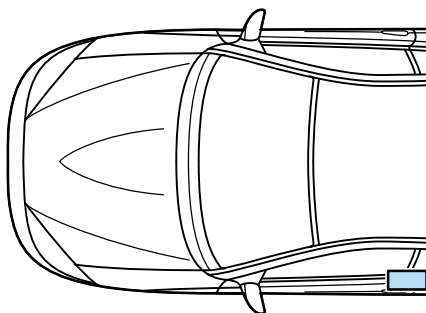

Preparing to tow

Use the proper equipment for towing a trailer and make sure that it is properly attached to your vehicle. See your dealer or a reliable trailer retailer if you require assistance.

Auxiliary coolers are recommended for the power steering system and automatic transaxle system if you are planning on:

- Traveling farther than 80 km (50 miles).
- Towing in hilly terrain.
- Towing frequently.

Driving

Using a hitch

Do not use hitches that:

- Clamp onto the vehicle bumper.
- Attach to the axle.

Distribute the load so that only 10 to 15% of the total weight of the trailer is on the tongue. Tie down the load so that it does not shift and change weight on the hitch. Follow the instructions of a reputable rental agency.

Using trailer lamps

Trailer lamps may be required on towed vehicles. Make sure your trailer lamps conform to any applicable regulation.

See your local trailer retailer or rental agency for proper instructions and equipment for hooking up trailer lamps.

Do not hook the trailer lamps directly into the vehicle's wiring system. If the trailer lamps are not working properly, the warning lights in the instrument cluster may not work properly.

Using trailer brakes

Use electric brakes or manual, automatic or surge type hydraulic brakes that meet federal and local regulations. Install and adjust brakes according to the manufacturer's instructions.



Do not connect a trailer's hydraulic brake system directly to your vehicle's brake system. Your vehicle may not have enough braking power and your chances of having a collision greatly increase.

Using safety chains

Always connect the trailer's safety chains to the vehicle. To connect the chains, cross the chains under the trailer tongue and attach to the vehicle frame or hook retainers (not the bumper). Make sure there is enough slack to allow the vehicle to turn corners.

Driving

Driving while towing a trailer

Do not drive faster than 72 km/h (45 mph) while towing a 454 kg (1 000 lb) trailer. Do not drive faster than 72 km/h (45 mph) with any weight trailer while towing in hilly terrain or on hot days.

Speed control (if equipped) may not work properly while towing on long, steep grades.

If driving with an automatic transaxle:

- Use D (Drive) or a low gear rather than D (Overdrive) while towing up or down steep inclines.
- Anticipate stops and brake gradually.

If driving with a manual transaxle:

- Select a gear that avoids jerking or excessive engine speed.
- Avoid driving excessively in first or second gear. If you need to drive excessively in first or second gear, the trailer may be too big or too heavily loaded for the vehicle drivetrain.
- Shift to a lower gear while towing up or down steep hills.
- Anticipate stops and brake gradually.

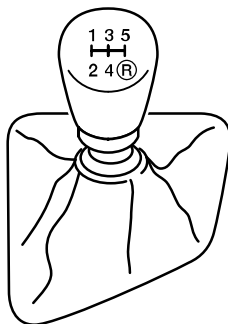
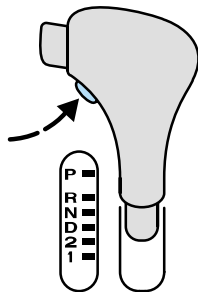

FUEL CONSUMPTION

Fuel economy can be improved by avoiding:

- lack of regular, scheduled maintenance,
- excessive speed,
- rapid acceleration,
- driving with the brake pedal depressed,
- sudden stops,
- extended engine idling,
- use of speed control in hilly terrain,
- extended use of the air conditioner, defroster, rear window defroster and other accessories,
- underinflated tires,
- heavy loads,
- aftermarket add-ons such as bike, ski or luggage racks, bug deflectors, etc.

Roadside emergencies

HAZARD FLASHER CONTROL

Use only in an emergency to warn traffic of vehicle breakdown or approaching danger. Depress to activate. Depress again to switch off. The hazard lights can be operated when the ignition is off.

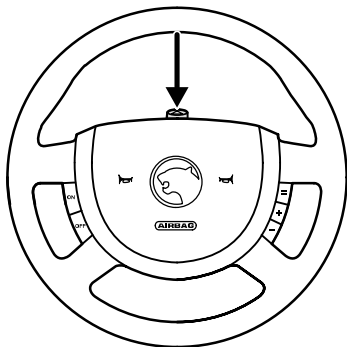

FUEL PUMP SHUT-OFF SWITCH

If the engine cranks, but does not start or does not start after a collision, the fuel pump shut-off switch may have been activated. The shut-off switch is a device intended to stop the electric fuel pump when your vehicle has been involved in a substantial jolt.

Once the shut-off switch is activated, you must reset the switch by hand before you can start your vehicle. The switch is located on the side panel in the driver's side footwell.

Roadside emergencies

 If you see or smell fuel, do not reset the switch or try to start your vehicle. Have all the passengers get out of the vehicle and call the local fire department or a towing service.

If your engine cranks but does not start after a collision or substantial jolt:

1. Turn the ignition key to the off position.
2. Check under the vehicle for leaking fuel.
3. If you do not see or smell fuel, push the red reset button down. If the button is already set, you may have a different mechanical problem.
4. Turn the ignition key to the on position for a few seconds, then turn it to the off position.
5. Check under the vehicle again for leaking fuel. If you see or smell fuel, do not start your vehicle again. If you do not see or smell fuel, you can try to start your vehicle again.

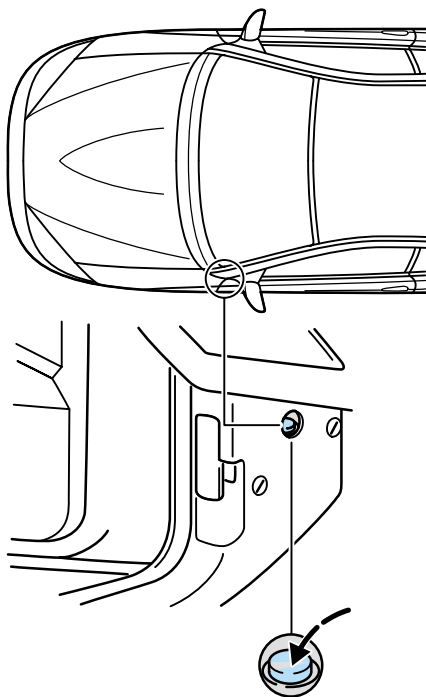

Roadside emergencies

FUSES AND RELAYS

If electrical components in the vehicle are not working, a fuse may have blown. Blown fuses are identified by a broken wire. Check the appropriate fuses before replacing any electrical components.

 Always replace a fuse with one that has the specified amperage rating. Using a fuse with higher amperage rating can cause severe wire damage and could start a fire.

Even after a fuse is replaced, it will continue to blow if the cause of the overload is not identified and corrected. If the fuse continues to blow, have the vehicle's electrical system checked by your dealer or a qualified service technician.

The passenger compartment fuse panel is located on the driver's side under the instrument panel. The power distribution box is located on the driver's side of the engine compartment.

They contain the main fuses and the main relays. The circuits protected are identified by numbers on the passenger compartment fuse panel and inside the cover on the power distribution box. Depending on country, the labels may not represent the fuses and relays in your vehicle. Refer to *Power distribution box* and *Passenger compartment fuse panel* in this chapter for information on fuse and relay assignment.

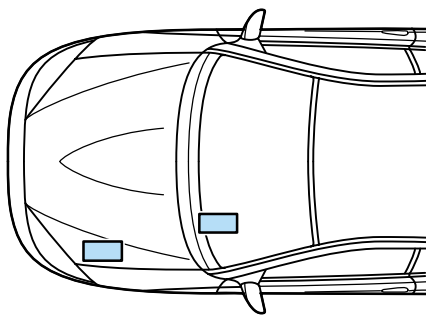
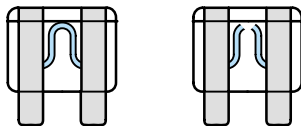

Roadside emergencies

Power distribution box

To check or replace a fuse or a relay, remove the cover of the fuse box in the engine compartment by releasing the latch (1) and lifting up.

A blown fuse can be identified by a break in the wire.

All fuses are a push fit.

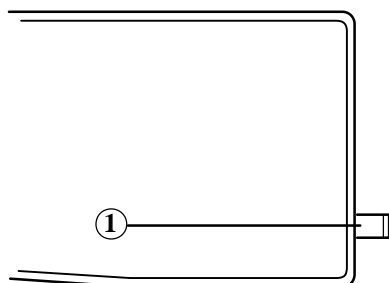

 Always replace the cover to the Power Distribution Box before reconnecting the battery or refilling fluid reservoirs.

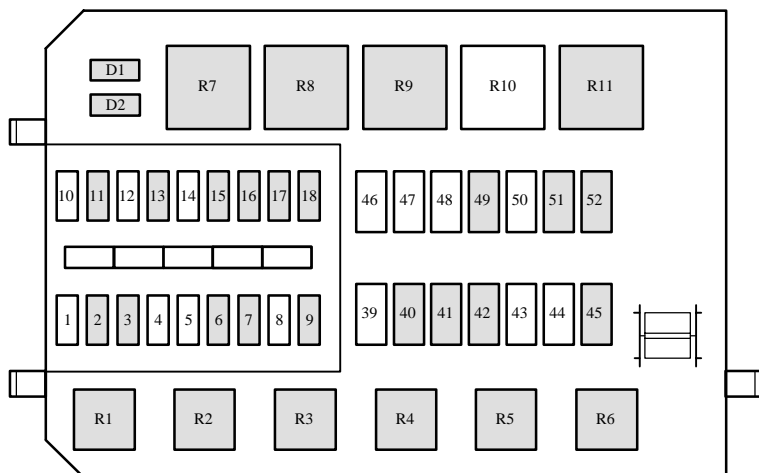

Roadside emergencies

Fuses in the power distribution box (engine compartment)

Fuse	Ampere rating	Color	Description
1	–	–	Not used
2	15	blue	Alternator
3	20	yellow	Fog lamps
4	–	–	Heated seats
5	–	–	Not used
6	3	violet	Engine management
7	20	yellow	Hazard lamps, horn, multifunction switch
8	–	–	Not used
9	15	blue	Fuel pump
10	–	–	Not used
11	20	yellow	Day time running light (Canada only)
12	–	–	Not used
13	20	yellow	HEGO sensors
14	–	–	Not used
15	7.5	brown	Right low beam
16	7.5	brown	Left low beam
17	7.5	brown	Right high beam
18	7.5	brown	Left high beam, instrument cluster, front fog lamps
39	–	–	Not used
40*	20	blue	Ignition, engine management
41*	20	blue	Engine management
42	40	green	Heater blower
43	–	–	Not used
44	–	–	Not used
45*	60	yellow	Main power supply to vehicle electrical supply (ignition relay)
46*	–	–	Not used
47*	–	–	Not used
48	–	–	Not used
49*	60	yellow	Engine cooling fan
50	–	–	Not used
51*	60	yellow	ABS
52*	60	yellow	Timer module, courtesy lamp, rear window defrost, fuses no. 25, 27, 28, 34, 36

*Have these fuses replaced by your dealer or qualified technician

Roadside emergencies

Relays in the power distribution box (engine compartment)

Relay	Color	Description
R1	black	Fuel pump
R2	black	Engine management
R3	black	Air conditioning
R4	black	Low beam
R5	black	High beam
R6	black	Horn
R7	green	Starter
R8	black	High speed engine cooling fan
R9	dark green	Engine cooling fan
R10	–	Not used
R11	green	Daytime running lights (Canada only)
D1	black	Starter relay
D2	black	Air conditioning

Passenger compartment fuse panel

To check or replace a fuse or a relay, open the fuse box by pulling down the lock release lever (1).

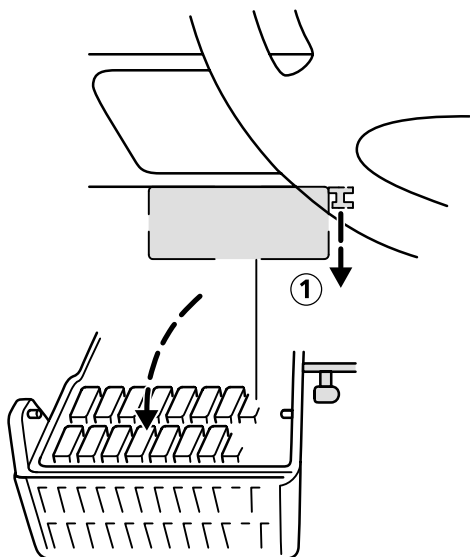

Roadside emergencies

A blown fuse can be identified by a break in the wire.

All fuses are a push fit.

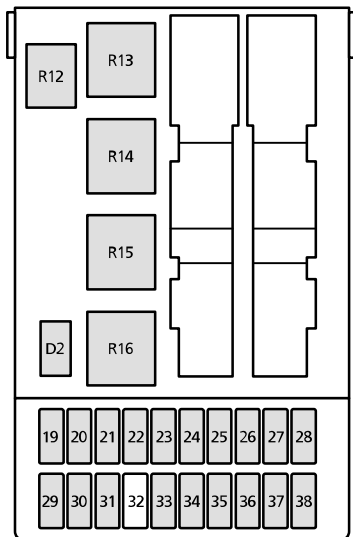

Relays in the passenger compartment fuse panel (below instrument panel)

Relay	Color	Description
R12	brown	Courtesy lamps
R13	green	Rear window defrost
R14	green	Blower motor
R15	green	Front wiper
R16	black	Ignition
D2	black	Reverse voltage protection

Roadside emergencies

Passenger compartment fuse panel (below instrument panel)

Fuse	Ampere rating	Color	Description
19	7.5	brown	Mirror heater
20*	10	black	Wipers
21	40	orange	Power roof, power windows
22	7.5	brown	ABS/TCS
23	15	blue	Turn signal lamps, backup lamps, speed control, gearshift lever, A/C clutch, blower motor
24	15	blue	Stop lamp, speed control
25	20	yellow	Alarm system, locking system
26	7.5	brown	High beam, low beam
27	15	blue	Cigar lighter
28	30	green	Power seats
29	30	green	Rear window defrost
30	7.5	brown	Engine management, locking system, instrument cluster
31	7.5	brown	Panel dimmer, license plate illumination, glove box lamp, belt minder module
32	–	–	Not used
33	7.5	brown	Left side lamps
34	7.5	brown	Power mirrors, clock, interior lamps
35	7.5	brown	Right side lamps
36	15	blue	Radio
37	30	green	Heater blower
38	7.5	brown	Air bags

*Have these fuses replaced by your dealer or qualified technician

Roadside emergencies

CHANGING TIRES

Park your vehicle in such a position where neither the traffic nor you are hindered or endangered when changing the tire. Ensure that the vehicle is on firm, level ground. Secure your vehicle further by blocking the wheels.

Activate the hazard lights.

Apply the parking brake and engage first or reverse gear or, if the vehicle has an automatic transaxle, select the P (Park) position.

If parking on a slope is unavoidable, block the wheels.

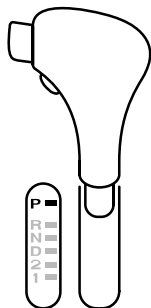
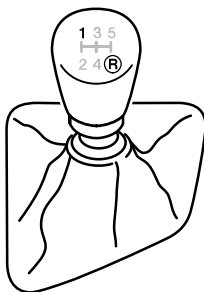
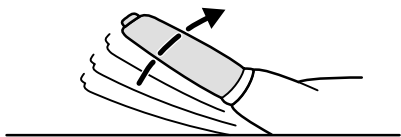

Roadside emergencies

The temporary spare tire

The vehicle may have a high pressure temporary spare tire. This spare is smaller than a regular tire and is designed for emergency use only. Vehicles with traction control (if equipped) may exhibit some unusual driving characteristics which can be avoided by switching the system off. Drive cautiously and replace the temporary spare tire as soon as possible.

 If you use the temporary spare tire continuously or do not follow these precautions, the tire could fail, causing you to lose control of the vehicle, possibly injuring yourself or others.

When driving with a temporary spare tire:

- Do not exceed the maximum speed of 80 km/h (50 mph) and only drive the shortest possible distance.
- Do not exceed the permissible gross weight of the vehicle.
- Do not install more than one spare wheel on your vehicle at any one time.
- Do not use snow chains on this type of wheel.
- Do not drive through an automatic car wash.



Roadside emergencies

Spare tire location

The spare tire and tools are located under the floor cover in the luggage compartment.

Removing the spare tire and tools

1. Raise the rear of the floor cover in the luggage compartment and fold it forward.
2. Completely unscrew the bolt.
3. Lift out the spare wheel.
4. Remove the jack which is located beneath the spare tire.

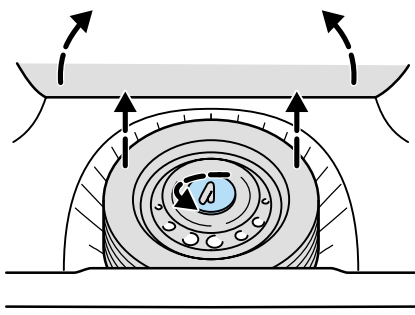

Roadside emergencies

Tire changing procedure

Removing a tire

1. Apply the parking brake and 1 (First) gear (manual transaxle) or the P (Park) position (automatic transaxle).
2. Activate the hazard flashers.
3. The driver and all passengers must leave the vehicle.
4. Secure the vehicle against rolling or sliding.
5. Insert the tapered end of the jack handle beneath the hub cover (if fitted) and push in. Twist off to remove the cover.
6. Loosen the wheel nuts slightly.

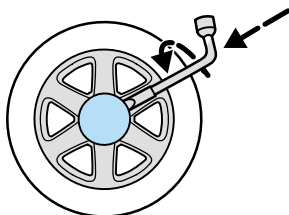

7. Place jack with complete support surface on the ground.
8. The jack must be applied exactly vertical to the jacking point of the vehicle. The jacking points are indicated by notches on the rocker panel flange.
9. Jack up the vehicle until the tire is clear of the ground. Unscrew and remove the wheel nuts and remove the wheel.

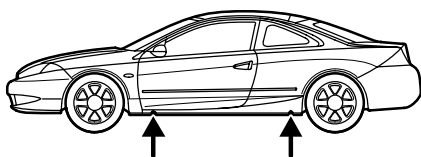

Roadside emergencies

Replacing a tire

1. Push the spare tire onto the wheel studs.
2. Screw on the wheel nuts, ensuring the tapered end of the wheel nuts are facing the wheel, and secure in a clockwise direction.
3. Lower the vehicle and remove the jack by turning the handle counterclockwise.
4. Fully tighten the wheel nuts in a crosswise pattern.
5. Align the hub cover and push firmly into position with the ball of the hand.
6. Stow the jack and damaged tire in the luggage compartment by reversing the spare tire removal instructions.

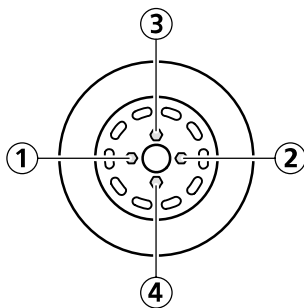
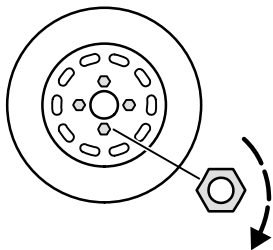

Roadside emergencies

JUMP STARTING YOUR VEHICLE



The gases around the battery can explode if exposed to flames, sparks, or lit cigarettes. An explosion could result in injury or vehicle damage.



Do not push start your vehicle. You could damage the catalytic converter.



Batteries contain sulfuric acid which burns skin, eyes, and clothing, if contacted.

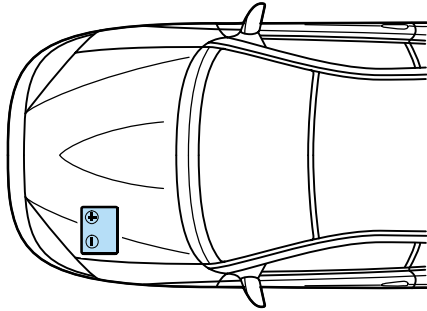

Do not attempt to push start your vehicle. Automatic transaxles do not have push-start capability.

Preparing your vehicle

1. **Use only a 12-volt supply to start your vehicle.**
2. Do not disconnect the battery of the disabled vehicle as this could damage the vehicles electrical system.

Roadside emergencies

3. Park the booster vehicle close to the hood of the disabled vehicle, making sure the two vehicles **do not** touch. Set the parking brake on both vehicles and stay clear of the engine cooling fan and other moving parts.

4. Check all battery terminals and remove any excessive corrosion before you attach the battery cables. Ensure that vent caps are tight and level.

5. Turn the heater fan on in both vehicles to protect from any electrical surges. Turn all other accessories off.

Connecting the jumper cables

1. Connect the positive (+) booster cable to the positive (+) terminal of the discharge battery.

Note: In the illustrations, “lightning bolts” are used to designate the assisting (boosting) battery.

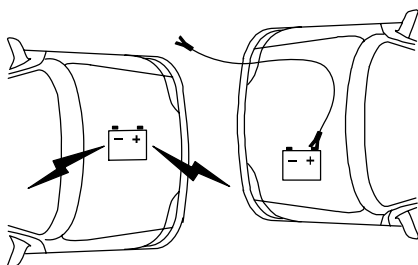

Roadside emergencies

2. Connect the other end of the positive (+) cable to the positive (+) terminal of the assisting battery.

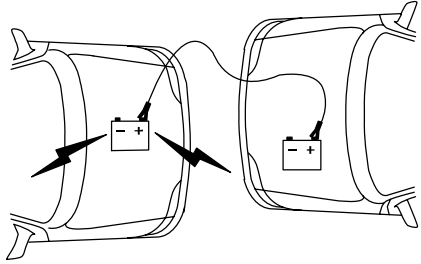

3. Connect the negative (-) cable to the negative (-) terminal of the assisting battery.

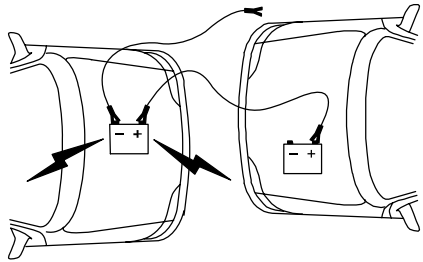

4. Make the final connection of the negative (-) cable to an exposed metal part of the stalled vehicle's engine, away from the battery and the carburetor.

The preferred locations of an exposed metal part (to “ground” the circuit) are the accessible engine mount studs or an engine lifting “eye”. **Do not** use fuel lines, engine rocker covers, or the intake manifold as “grounding” points.

Roadside emergencies

 Do not connect the end of the second cable to the negative (-) terminal of the battery to be jump. A spark may cause an explosion of the gases that surround the battery.

- 2.0 litre engine

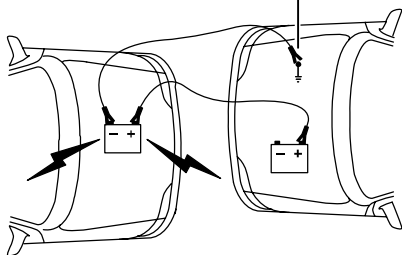
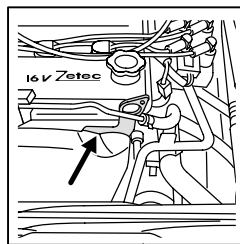

- 2.5 litre engine

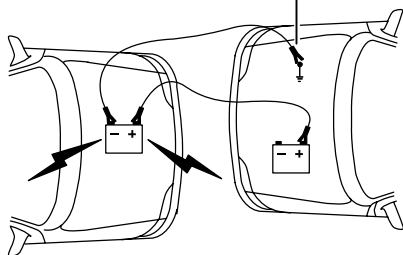
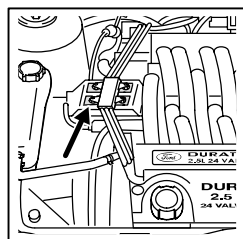

Roadside emergencies

5. Be sure that the cables are clear of fan blades, belts and other moving parts of both engines or any fuel delivery system parts.

Jump starting

1. Start the engine of the booster vehicle and run the engine at a moderately increased speed.
2. Start the engine of the disabled vehicle.
3. Once the disabled vehicle has been started, run both engines for a further three minutes before disconnecting the jumper cables.

Removing the jumper cables

Remove the jumper cables in the reverse order that they were connected.

1. Remove the jumper cable from the “ground” metal surface.

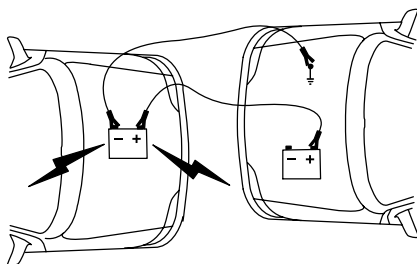

Roadside emergencies

2. Remove the jumper cable on the negative (-) connection of the booster vehicle's battery.

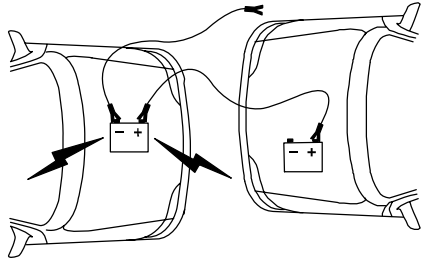

3. Remove the jumper cable from the positive (+) terminal of the booster vehicle's battery.

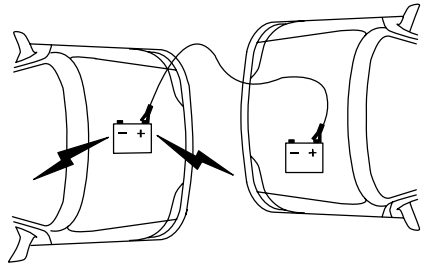

4. Remove the jumper cable from the positive (+) terminal of the disabled vehicle's battery.

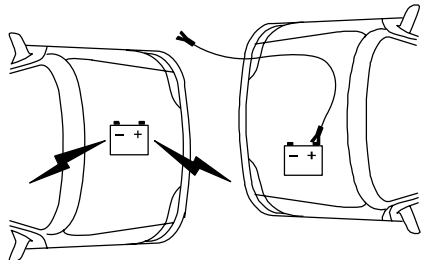

After the disabled vehicle has been started and the jumper cables removed, allow it to idle for several minutes so the engine computer can “relearn” its idle conditions.

Roadside emergencies

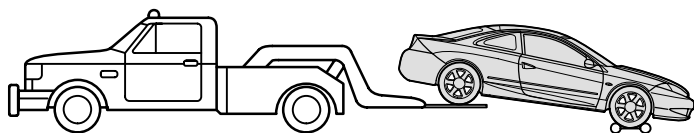
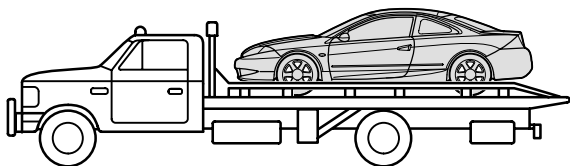
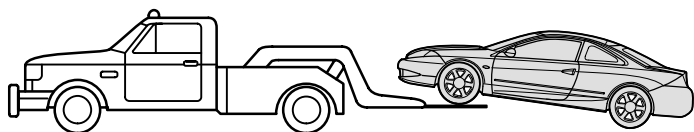

WRECKER TOWING

If you need to have your vehicle towed, contact a professional towing service or, if you are a member, your roadside assistance center. Recommended towing options include wheel lift towing or flat bed towing.

When calling for a tow truck, tell the operator what kind of vehicle you have. A towing manual is available from Ford Motor Company for all authorized tow truck operators. Have your tow truck driver refer to this manual for proper hook-up and towing procedures for your vehicle.

Roadside emergencies

TOWING YOUR VEHICLE BEHIND ANOTHER VEHICLE

At times you may want to tow your vehicle behind another vehicle.

Before you have your vehicle towed:

- Release the parking brake.
- Move the gearshift to N (Neutral).
- Turn the key in the ignition to off.
- Unlock the steering wheel.

Recreational towing

Follow these guidelines for your specific powertrain combination to tow your vehicle with all four wheels on the ground (such as behind a recreational vehicle).

These guidelines are designed to ensure that your transmission is not damaged due to insufficient lubrication.

All Front Wheel Drive (FWD) vehicles

An example of recreational towing is towing your vehicle behind a Motorhome. The following recreational towing guidelines are designed to ensure that your transmission is not damaged. It is not recommended to tow front wheel drive vehicles with the front drive wheels on the ground. It is recommended to tow your vehicle with the drive wheels on a dolly or two wheel car hauling trailer.

In case of a roadside emergency with a disabled vehicle (without access to wheel dollies, car hauling trailer or flatbed transport vehicle) your vehicle can be flat towed (all wheels on the ground) under the following conditions:

- Transmission is placed in N (Neutral).
- Maximum speed is 50 km/h (30 mph).
- Maximum distance is 50 km (30 miles).

For vehicles with manual transaxle, see section *Manual transaxle*.

Roadside emergencies

Automatic transaxle

In case of a roadside emergency with a disabled vehicle (without access to wheel dollies, car hauling trailer or flatbed transport vehicle) your vehicle can be flat towed (all wheels on the ground) under the following conditions.

- Transmission is placed in N (Neutral).
- Maximum speed is 50 km/h (30 mph).
- Maximum distance is 50 km (30 miles).

Manual transaxle

Do not tow your vehicle at a speed faster than 90 km/h (55 mph). Your maximum towing distance is unlimited.



Never use a tow bar that attaches to the bumper when you tow your vehicle. You could damage the bumper and cause an accident.

Maintenance and care

SERVICE RECOMMENDATIONS

- We highlight do-it-yourself items in the engine compartment for easy location.
- As possible, we design parts that can be replaced without tools.
- We provide you with a “Scheduled Maintenance Guide” which makes tracking routine service for your vehicle easy.

If your vehicle requires professional service, your Ford or Lincoln/Mercury dealership can provide necessary parts and service. Check your “Warranty Guide“ to find out which parts and services are covered.

Use only recommended fuels, lubricants, fluids and service parts conforming to specifications. Motorcraft parts are designed and built to provide the best performance in your vehicle.

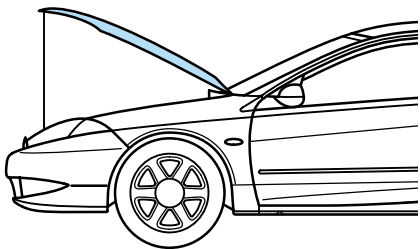

Precautions when servicing your vehicle

Be especially careful when inspecting or servicing your vehicle. Here are some general precautions for your safety:

- Do not work on a hot engine.



The cooling fan is automatic and may come on at any time. Always disconnect the negative terminal of the battery before working near the fan.

- If you must work with the engine running, avoid wearing loose clothing or jewelry that could get caught in moving parts. Take precautions with long hair.
- Do not work on a vehicle with the engine running in an enclosed space, unless you are sure you have enough ventilation.
- Keep all lit cigarettes, open flames and other lit material away from the battery and all fuel related parts.

If you disconnect the battery, the engine must “relearn” its idle conditions before your vehicle will drive properly, as explained under *Battery* in this chapter.

Maintenance and care

Working with engine off (automatic transaxle)

1. Set the parking brake fully and ensure the gearshift is securely latched in P (Park).
2. Turn off the engine and remove the key.
3. Block the wheels to prevent the vehicle from moving unexpectedly.

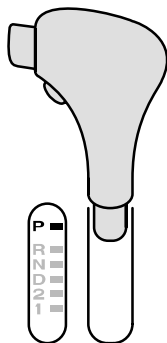

Working with engine off (manual transaxle)

1. Set the parking brake, depress the clutch and place the gearshift in 1 (First) or R (Reverse).
2. Turn off the engine and remove the key.
3. Block the wheels to prevent the vehicle from moving unexpectedly.

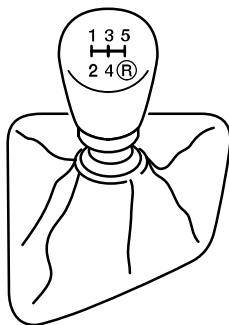

Maintenance and care

Working with engine on (automatic transaxle)

1. Set the parking brake fully and ensure the gearshift is securely latched in P (Park).
2. Block the wheels to prevent the vehicle from moving unexpectedly.

 Do not start your engine with the air cleaner removed and do not remove it while the engine is running.

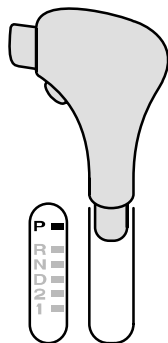

Working with engine on (manual transaxle)

1. Set the parking brake, depress the clutch and place the gearshift in neutral.
2. Block the wheels to prevent the vehicle from moving unexpectedly.

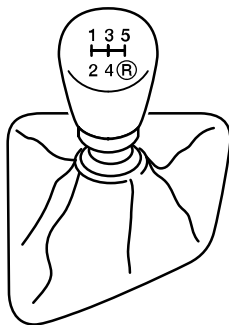

Maintenance and care

Opening the hood

- Pull the handle (1) located under the instrument panel.

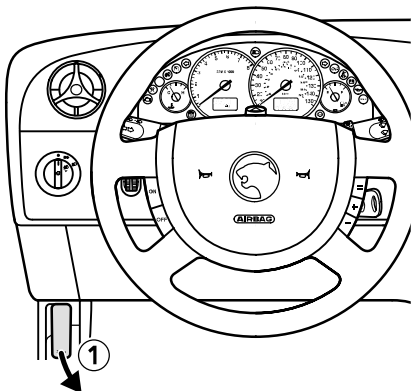

- Release the safety catch by reaching under the hood (2) and pushing it up.
- Raise the hood and support it with the strut (3) in the yellow colored retainer, ensuring it is secure. Hold the support at the yellow colored insulation section.

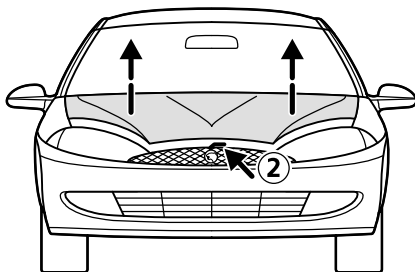

To close, replace the support strut in its retaining clip, lower the hood and allow it to drop into the catch for the last 20 – 30 cm (8 – 12 inches).

Always check to ensure that the hood lock is fully engaged.

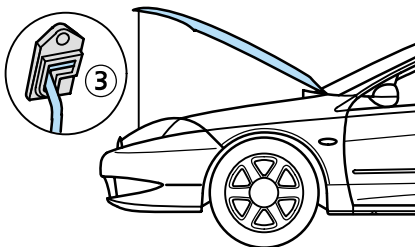

Maintenance and care

2.0 litre EFI-engine compartment

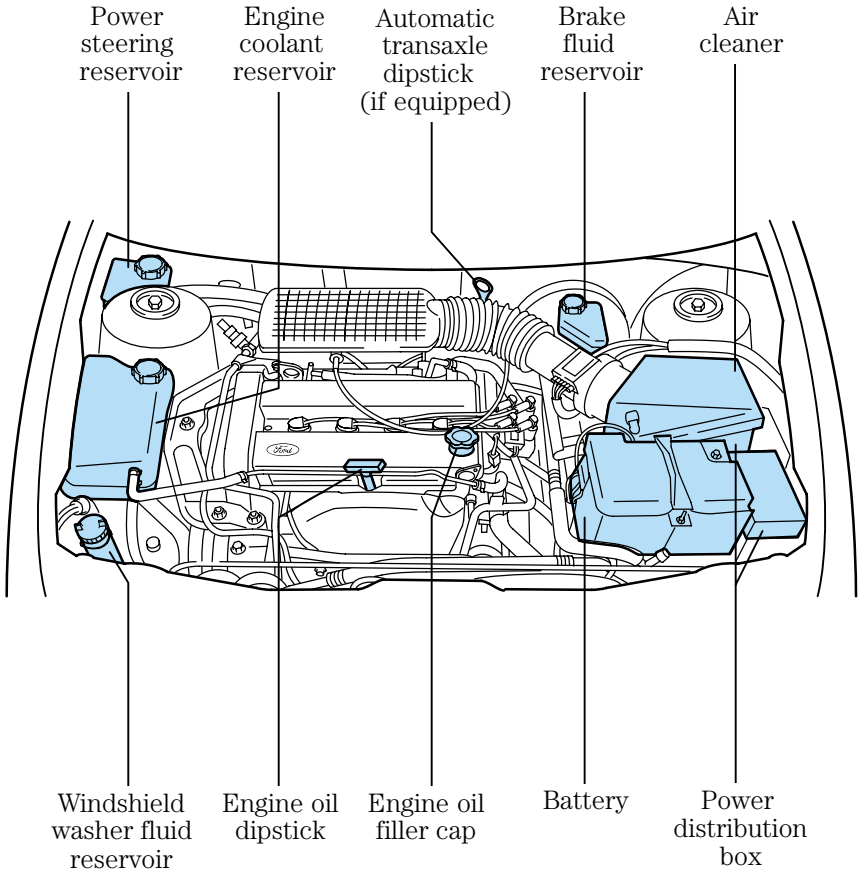

For ease of identification, all filler caps and the engine oil dipstick are marked yellow/black.

Maintenance and care

2.5 litre EFI-engine compartment

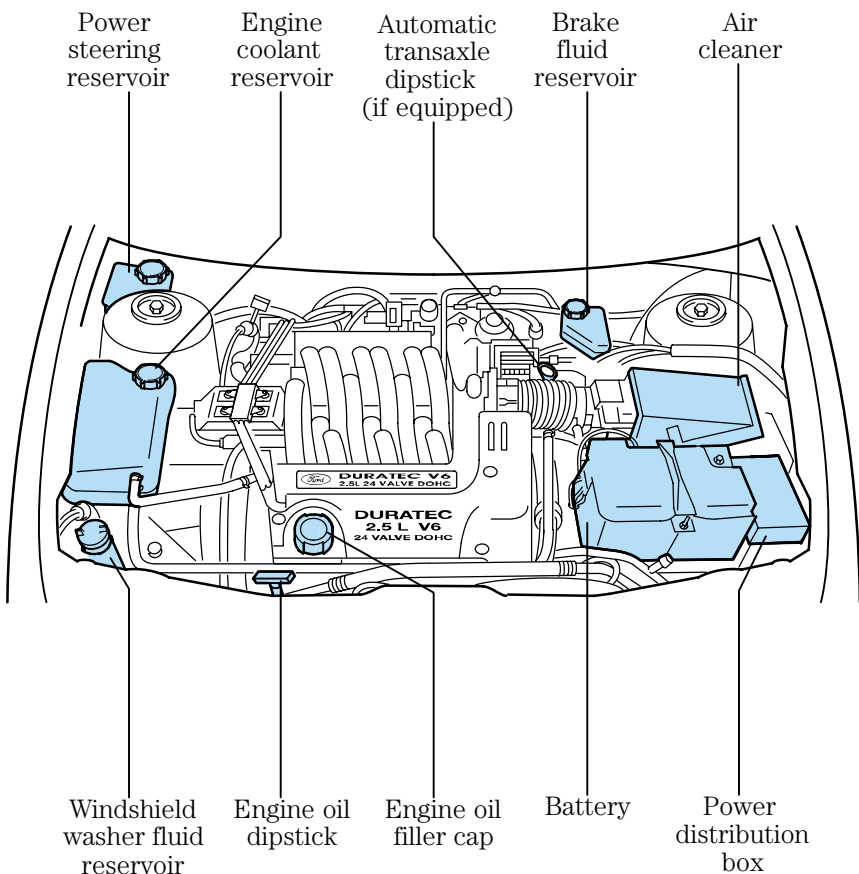

For ease of identification, all filler caps and the engine oil dipstick are marked yellow/black.

Maintenance and care

Engine oil and filter recommendations

Look for this certification trademark.

SAE 5W-20 engine oil is recommended

Use oils “Certified For Gasoline Engines” by the American Petroleum Institute (API).

Use Motorcraft or an equivalent oil meeting Ford specification WSS-M2C153-H.

SAE 5W-20 oil provides optimum fuel economy and durability performance meeting all requirements for your vehicle’s engine.

Do not use supplemental engine oil additives, oil treatments or engine treatments. They are unnecessary and could, under certain conditions, lead to engine damage which is not covered by your warranty.

Change your engine oil and filter according to the appropriate schedule listed in the “Scheduled maintenance guide”.

Ford production and aftermarket (Motorcraft) oil filters are designed for added engine protection and long life. If a replacement oil filter is used that does not meet Ford material and design specifications, start-up engine noises or knock may be experienced.

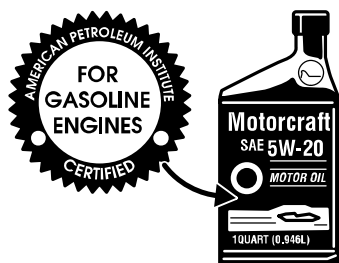

Maintenance and care

It is recommended you use the appropriate Motorcraft oil filter (or another brand meeting Ford specifications) for your engine application.

Checking the engine oil

Check the engine oil each time you fuel your vehicle.

To check the oil:

1. Make sure the vehicle is on level ground. If the engine is warm, turn the engine off and wait a few minutes for the oil to drain into the oil pan.
2. Set the parking brake and ensure the gearshift is securely latched in P (Park).
3. Open the hood. Protect yourself from engine heat.
4. Locate and carefully remove the engine oil dipstick.
5. Wipe the dipstick clean. Insert the dipstick fully, then remove it again. The oil level should be in the range shown on the dipstick (between the MIN and MAX areas).

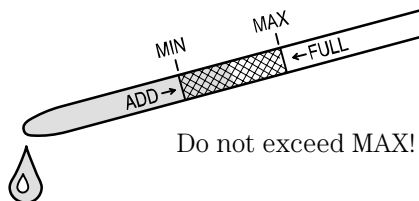

2.0 l DOHC

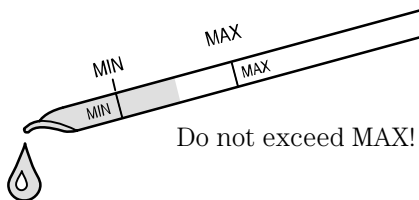

2.5 l DOHC

Maintenance and care

6. If the oil level is below the minimum line, add engine oil as necessary. If the oil level is beyond the maximum line, engine damage or high oil consumption may occur and some oil must be removed from the engine by a service technician.

7. Put the dipstick back in and ensure it is fully seated.



Continuous contact with used motor oil has caused cancer in laboratory mice.

Adding engine oil

1. Check the engine oil. For instructions, refer to *Checking the engine oil* in this chapter.
2. If the fluid level is not within the normal range, add only certified engine oil of the preferred viscosity. Add engine oil through the oil filler cap. Remove the filler cap and use a funnel to pour oil in the opening.
3. Recheck the oil level. **Make sure the oil level is not above the MAX mark on the dipstick.**

Change your engine oil and oil filter according to the scheduled mileage and time requirements, whichever occurs first.

Maintenance and care

Refer to the “Scheduled Maintenance Guide” for additional information.

It is recommended you use the appropriate Motorcraft oil filter (or another brand meeting Ford specifications) for your engine application.



Always dispose of used automotive fluids in a responsible manner. Follow your community’s standards for disposing of these types of fluids. Call your local recycling center to find out more about recycling automotive fluids.

Engine oil filler cap

The design of the filler cap varies by engine. To open, turn in the direction of the arrow and pull. Do not open the cap while the engine is running.



Empty and used oil containers must be disposed of at an authorized waste disposal facility.

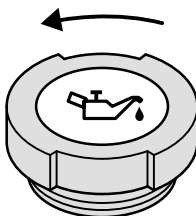
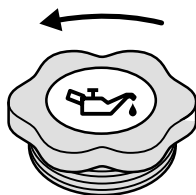



Maintenance and care

Brake/clutch fluid reservoir

Brake and clutch fluid systems are supplied from the same reservoir.

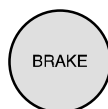
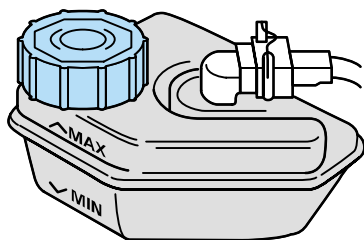
The level of the fluid must lie between the MIN and MAX marks on the side of the reservoir. If the level falls below the MIN mark, the brake fluid level warning light on the instrument panel will illuminate. Add only DOT 3 or DOT 4 brake fluid that meets the Ford specification (see the *Capacities and specifications* chapter).



 If you use DOT 5 or any other brake fluid that is not DOT 3 or DOT 4, you will cause permanent damage to your brakes.

 Brake fluid is toxic.

 Do not let the reservoir for the master cylinder run dry. This may cause the brakes to fail.

Windshield washer system

If necessary, add enough washer fluid to fill the reservoir. Follow the instructions on the washer fluid container.

 Do not put engine coolant in the container for the windshield washer fluid.

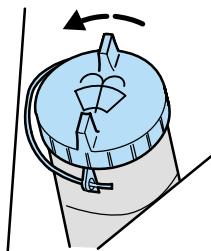

Maintenance and care

Cooling system – engine coolant

The importance of engine coolant

Engine coolant provides freeze protection, boil protection, cooling efficiency and corrosion protection to the engine and cooling components. In order to obtain these protections, the engine coolant must be maintained at the proper concentration and fluid level in the coolant reservoir.

Your vehicle was factory-filled with a 50/50 engine coolant and water concentration. If the concentration of coolant falls below 40 % or rises above 60 %, the engine parts could become damaged or not work properly. A 50/50 mixture of coolant and water provides the following:

- Boiling protection up to 265°F (129°C).
- Freeze protection down to -34°F (-36°C).
- Protection against rust and other forms of corrosion.
- Enables calibrated gauges to function properly.

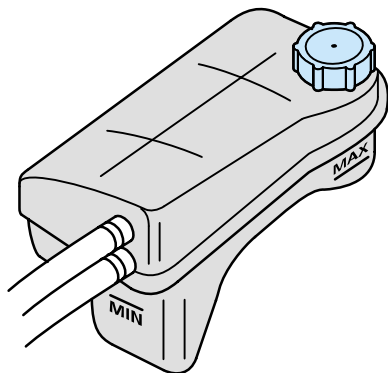

Checking engine coolant

The concentration and level of engine coolant should be checked at the mileage intervals listed in the “Scheduled Maintenance Guide”.

The coolant concentration should be maintained at 50/50 coolant and water, which equates to a freeze point of -34°F (-36°C). Coolant concentration testing is possible with a hydrometer or antifreeze tester (such as the Rotunda Battery and Antifreeze Tester, 014-RI060).

The level of coolant should be maintained at the MAX line on the coolant reservoir. If the level falls below, add coolant per the instructions in the *Adding engine coolant* section.

Adding engine coolant

When adding engine coolant, make sure it is a 50/50 mixture of engine coolant and distilled water. Add the mixture to the coolant reservoir when the engine is cool until the appropriate fill level is obtained.



Do not add engine coolant when the engine is hot.

Steam and scalding liquids released from a hot cooling system can burn you badly. Also, you can be burned if you spill coolant on hot engine parts.



Do not put engine coolant in the windshield washer fluid container. If sprayed on the windshield, engine coolant could make it difficult to see through the windshield.

Maintenance and care

The cooling system in your vehicle is filled with Ford Extended Life Engine Coolant F6AZ-19544-AA or equivalent meeting Ford specification WSS-M97B44-D.

To maintain the integrity of the coolant and the cooling system and maintain the warranty on the cooling system:

- **Add the type of coolant originally equipped in your vehicle.** If you are unsure which type of coolant your vehicle requires, contact your local dealer.
- **Do not mix the factory-filled coolant with a green-colored Premium Engine Coolant such as E2FZ-19549-AA, meeting Ford specification ESE-M97B44-A.** Mixing of Ford Extended Life Engine Coolant with a conventional green coolant can result in degraded corrosion protection.
- A large amount of water without engine coolant may be added, in case of emergency, to reach a vehicle service location. In this instance, the cooling system must be drained and refilled with a 50/50 mixture of engine coolant and distilled water as soon as possible. Water alone (without engine coolant) can cause engine damage from corrosion, overheating or freezing.

Maintenance and care

- **Do not use alcohol or methanol or any engine coolants mixed with alcohol or methanol antifreeze (coolant).**

Alcohol and other liquids can cause engine damage from overheating or freezing.

- **Do not add extra inhibitors or additives to the coolant.** These can be harmful and compromise the corrosion protection of the engine coolant.

- **Do not mix with recycled coolant.**



To avoid personal injury, make sure the engine is cool before unscrewing the coolant pressure relief cap. The cooling system is under pressure; steam and hot liquid can come out forcefully when the cap is loosened slightly.

Maintenance and care

1. Before you begin, turn the engine off and let it cool.
2. When the engine is cool, wrap a thick cloth around the coolant pressure relief cap on the coolant reservoir (an opaque plastic bottle). Slowly turn the cap counterclockwise (left) until the pressure begins to release.
3. Step back while the pressure releases (you may hear a hissing sound).
4. When you are sure that all the pressure has been released from the cooling system, use the cloth to turn the cap counterclockwise and remove it.
5. Fill the coolant reservoir slowly with the proper coolant mixture (see above) to the MAX line on the reservoir.
6. Replace the cap. Turn until tightly installed. (Cap must be tightly installed to prevent coolant loss.)

After any coolant has been added, check the coolant concentration (see *Checking engine coolant* section). If the concentration is not 50/50 (protection to -34°F / -36°C), drain some coolant and adjust the concentration. It may take several drains and additions to obtain a 50/50 coolant concentration.

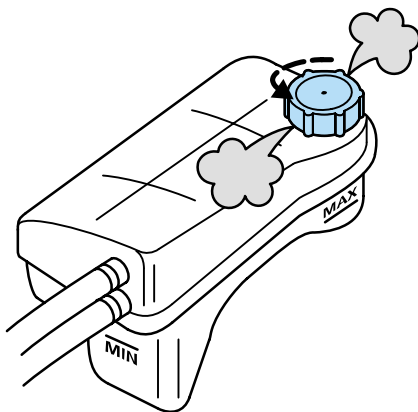

Whenever coolant has been added, the coolant level in the coolant reservoir should be checked the next few times you drive the vehicle. If necessary, add enough 50/50 concentration of engine coolant and distilled water to bring the liquid level to the proper level.

If you have to add more than 1.0 liter (1.0 quart) of engine coolant per month, have your dealer check the engine cooling system. Your cooling system may have a leak. Operating an engine with a low level of coolant can result in engine overheating and possible engine damage.

Changing engine coolant

Change your engine coolant according to the appropriate schedule listed in the “Scheduled Maintenance Guide”. It is important that the engine coolant be changed at the specified intervals. The corrosion protection of engine coolant is depleted with time and usage. Use of engine coolant with depleted corrosion protection may result in damage to the coolant system. Color, specific gravity and freeze point of the coolant are not indicators of depletion.

To find out how much fluid your vehicle’s cooling system can hold, refer to the *Refill capacities* in the *Capacities and Specifications* chapter. Fill your coolant reservoir following the directions given in the *Adding engine coolant* section.

Maintenance and care

Coolant usage in severe winter climate

If you drive in extremely cold climates less than -34°F (-36°C), it may be necessary to increase the coolant concentration above 50 %. Refer to the chart on the coolant container to ensure the coolant concentration in your vehicle will provide adequate freeze protection.

Never increase the engine coolant concentration above 60 % (protection to -60°F). At a level over 60 %, your engine could overheat and become damaged.

Coolant usage in hot climate

If you drive in hot climates, it is still necessary to maintain the coolant concentration at 50/50 coolant and water. **Do not allow the concentration to fall below 40 % coolant.** At a concentration less than 40 %, the corrosion protection to your engine and cooling components may be compromised and permanent damage may result.

Use of recycled engine coolant

Ford Motor Company does **not** recommend the use of recycled engine coolant in vehicles originally equipped with orange Extended Life coolant since a recycling process that produces orange coolant is not yet available.

Maintenance and care

Disposal of used engine coolant

Used engine coolant should be disposed of in an appropriate manner. Follow your community's regulations and standards for recycling and/or disposal of automotive fluids.

Checking and adding power steering fluid

Check the power steering fluid twice a year.

Switch off the engine. With the steering system at normal operating temperature, the fluid level should come up to the MAX mark.

If the fluid level drops below the MIN mark, add the specified fluid. Remove the cap and fill to proper level. Refer to the *Capacities and specifications* chapter.

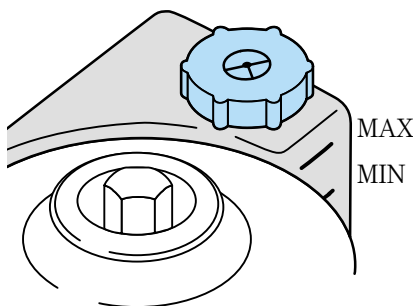

Maintenance and care

Checking and adding automatic transaxle fluid

Follow the scheduled service intervals outlined in the “Scheduled Maintenance Guide”.

Your transaxle does not consume fluid. However, it is recommended that you refer to your “Scheduled Maintenance Guide” for scheduled intervals for fluid checks and changes. The fluid level should be checked or changed by a qualified technician at the appropriate intervals or if the transaxle is not working properly, i. e., if the transaxle slips or shifts slowly or if you notice some sign of fluid leakage.

Note: Automatic transaxle fluid expands when warmed. To obtain an accurate fluid level check drive the vehicle until warmed, approximately 30 km (20 miles). If your vehicle has been operated for an extended period at high speeds, in city traffic during hot weather or pulling a trailer, the vehicle should be turned off for about 30 minutes to allow fluid to cool before checking.

1. Drive the vehicle 30 km (20 miles) or until the vehicle reaches normal operating temperatures.
2. Park the vehicle on a level surface and engage the parking brake.

Maintenance and care

3. With the parking brake engaged and your foot on the brake pedal, start the engine and move the gearshift lever through all of the gear ranges. Allow sufficient time for each gear to engage.
4. Latch the gearshift lever in P(Park) and leave the engine running.
5. Remove the dipstick, wiping it with a clean, dry lint free rag.
6. Install the dipstick making sure it is fully seated in the filler tube.
7. Remove the dipstick and inspect the fluid level. The fluid level should be in the designated areas for normal and room temperature.

Low fluid level

Do not drive the vehicle if the fluid level is below the hole at the bottom of the dipstick.

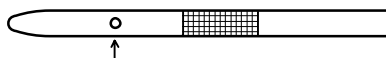

Do not drive if below this area

Correct fluid level

The transaxle fluid level should be checked at normal operating temperatures $66^{\circ}\text{C} - 77^{\circ}\text{C}$ ($150^{\circ}\text{F} - 170^{\circ}\text{F}$) on a level surface. The normal operating temperature can be reached after approximately 30 km (20 miles) of driving.

The transaxle fluid should be in this range if at normal operating temperature of $66^{\circ}\text{C} - 77^{\circ}\text{C}$ ($150^{\circ}\text{F} - 170^{\circ}\text{F}$).

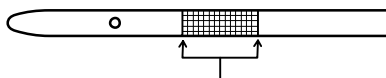

Normal operating temperature
 $66^{\circ}\text{C} - 77^{\circ}\text{C}$ ($150^{\circ}\text{F} - 170^{\circ}\text{F}$)

Maintenance and care

High fluid level

Fluid levels above the safe range may result in transaxle failure. An overfill condition of transaxle fluid may cause shift and/ or possible damage. High fluid levels can be caused by an overheating condition, see note.

Adjusting automatic transaxle fluid levels

Before adding any fluid, make sure the correct type is used. The type of fluid used is normally indicated on the dipstick and/or dipstick handle and also in the *Lubricant specifications* section in the *Capacities and Specifications* chapter.

Use of a non approved automatic transaxle fluid may cause internal transaxle component damage.

If necessary, add fluid in 250 ml (1/ 2 pint) increments through the filler tube until the level is correct.

If an overfill occurs, excess fluid should be removed by a qualified technician.

An overfill condition of transaxle fluid may cause shift and/or engagement concerns and/or possible damage.

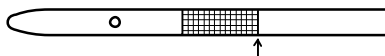

Do not add if above the crosshatched area

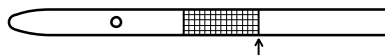

Do not add if above the crosshatched area

Maintenance and care

Battery

Your vehicle may be equipped with a Motorcraft maintenance-free battery. The Motorcraft maintenance-free battery normally does not require additional water during its life of service. However, for severe service usage or in high temperature climates, refer to the “Scheduled Maintenance Guide” for additional information. Keep the electrolyte in each cell up to the “level” indicator. Do not overfill the battery cell.

For longer, trouble-free operation, keep the top of the battery clean and dry. Also, make certain the battery cables are always tightly fastened to the battery terminals.

If you see any corrosion on the battery cables or terminals, remove the cables from the terminal(s) and clean with a wire brush. You can neutralize the acid with a solution of baking soda and water. Reinstall the cables when you are done cleaning them, and apply a small quantity of grease to the top of each battery terminal to help prevent corrosion.

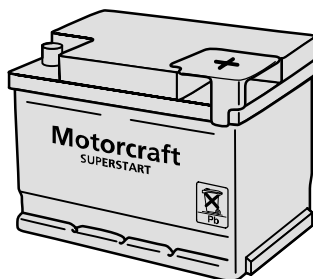

Maintenance and care

Battery replacement

If your original equipment battery requires replacement while under warranty, it will be replaced with a Motorcraft service battery, identical in design technology. Like the original equipment battery, it should not require water addition during its normal life of service; however, for severe service usage or in high temperature climates, refer to the “Scheduled Maintenance Guide” for additional information. Do not overfill the battery cell.

If the electrolyte level in your battery gets low, you can add plain tap water to the battery, as long as you do not use hard water (water with a high mineral or alkali content). If possible, however, try to only fill the battery cell with distilled water. If the battery needs water often, have the charging system checked.



Applying too much pressure on the ends when lifting a battery could cause acid to spill. Lift the battery with a carrier or with your hands on the opposite corners.

Maintenance and care

 Batteries normally produce explosive gases which can cause personal injury. Therefore, do not allow flames, sparks or lighted substances to come near the battery. When working near the battery, always shield your face and protect your eyes. Always provide proper ventilation.

 Follow these steps to minimize risk of personal injury.

 Battery posts, terminals and related accessories contain lead and lead compounds. **Wash hands after handling.**

 Always dispose of automotive batteries in a responsible manner. Follow your community's local standards for disposal. Call your local recycling center to find out more about recycling automotive batteries.

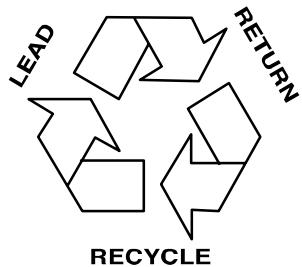

Maintenance and care

Relearning the idle function

Because your vehicle's engine is electronically controlled, some control conditions are maintained by power from the battery. When the battery is disconnected or a new battery is installed, the computer must "relearn" its idle conditions before your vehicle can drive properly. To begin this process:

1. Put the automatic transaxle gearshift in P (Park). Put the manual transaxle gearshift in neutral.
 2. Turn off all accessories and start the vehicle.
 3. Let the engine idle for at least one minute.
 4. The "relearning" process will automatically complete as you drive the vehicle.
- If you do not allow the engine to "relearn" its idle, the idle quality of your vehicle may be adversely affected until the idle is eventually "relearned".
 - If the battery has been disconnected or if a new battery has been installed, the clock and preset radio stations must be reset once the battery is reconnected.

Maintenance and care

Checking wiper blades

Check the wiper blades on your vehicle for roughness by running the tips of your fingers over the edge of the blade.

Traces of grease, silicone and fuel prevent wiper blades from functioning properly. We recommend Ford cleaning solutions or equivalent to clean wiper blades.

Change the wiper blades on your vehicle at least once a year.

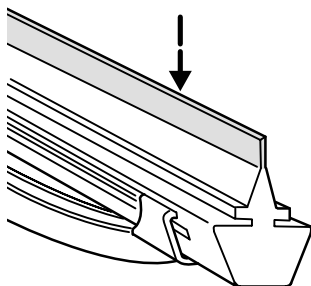

Cabin air filter replacement

In your climate control system, you have a filter that cleans the air before it enters the interior of the vehicle. This filter should be replaced at the intervals in the “Scheduled Maintenance Guide”.

To replace the cabin air filter:

1. Remove both windshield wiper arms. With the wiper arm in the horizontal position, lift the arm away from the windshield while pulling the retaining clip at the base toward the windshield.

Release the wiper arm, then lift it off the base.

Maintenance and care

2. Remove the plastic caps from the screws on the grille. Remove the screws.

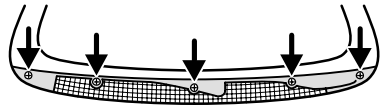

3. Open the hood. Pull off the rubber weatherstrip at the back of the engine compartment. Remove the screws that hold the grille, separate the two halves and remove the grille.

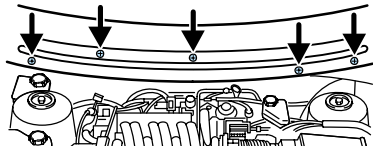

4. The filter is in a housing at the back of the engine compartment, on the left side. Pull off the two clips on the sides of the housing. Slide out the housing and filter.

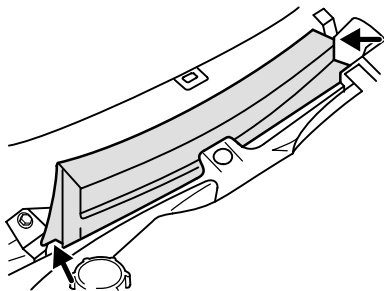

5. Slide the filter out of the housing, replace with the new filter and slide the housing and cabin air filter back into place. Reinstall the clips on the housing.

6. Replace the grille and wiper arms.

Maintenance and care

INFORMATION ABOUT UNIFORM TIRE QUALITY GRADING

New vehicles are fitted with tires that have a rating on them called Tire Quality Grades. The Quality grades can be found where applicable on the tire sidewall between tread shoulder and maximum section width. For example:

- **Treadwear 200 Traction AA Temperature A**

These Tire Quality Grades are determined by standards that the United States Department of Transportation has set.

Tire Quality Grades apply to new pneumatic tires for use on passenger cars. They do not apply to deep tread, winter-type snow tires, space-saver or temporary use spare tires, tires with nominal rim diameters of 10 to 12 inches or limited production tires as defined in Title 49 Code of Federal Regulation Part 575.104(c)(2).

U.S. Department of Transportation-Tire quality grades:

The U.S. Department of Transportation requires Ford to give you the following information about tire grades exactly as the government has written it.

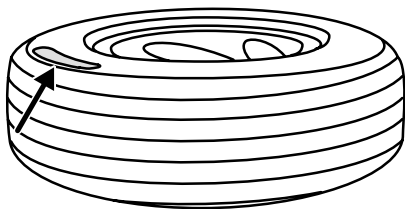

Maintenance and care

Treadwear

The treadwear grade is a comparative rating based on the wear rate of the tire when tested under controlled conditions on a specified government test course. For example, a tire graded 150 would wear one and one-half (1 1/2) times as well on the government course as a tire graded 100. The relative performance of tires depends upon the actual conditions of their use, however, and may depart significantly from the norm due to variations in driving habits, service practices, and differences in road characteristics and climate.

Traction AA A B C

The traction grades, from highest to lowest, are AA, A, B, and C. Those grades represent the tire's ability to stop on wet pavement as measured under controlled conditions on specified government test surfaces of asphalt and concrete. A tire marked C may have poor traction performance.



The traction grade assigned to this tire is based on straight-ahead braking traction tests, and does not include acceleration, cornering, hydroplaning or peak traction characteristics.

Temperature A B C

The temperature grades are A (the highest), B, and C, representing the tire's resistance to the generation of heat and its ability to dissipate heat when tested under controlled conditions on a specified indoor laboratory test wheel. Sustained high temperature can cause the material of the tire to degenerate and reduce tire life, and excessive temperature can lead to sudden tire failure. The grade C corresponds to a level of performance which all passenger car tires must meet under the Federal Motor Vehicle Safety Standard No. 109. Grades B and A represent higher levels of performance on the laboratory test wheel than the minimum required by law.



The temperature grade for this tire is established for a tire that is properly inflated and not overloaded. Excessive speed, underinflation, or excessive loading, either separately or in combination, can cause heat buildup and possible tire failure.

Maintenance and care

Checking tire pressure

Check the tire pressure periodically after the vehicle has been parked for at least one hour or has been driven less than 5 km (3 miles).

Inflate the tires as necessary. To check the tire pressure, insert the tire pressure gauge into the valve.

The cold pressure amount is listed on the tire instruction decal located on the passenger's door.

 Improperly inflated tires affect vehicle handling and can fail suddenly, possibly resulting in loss of vehicle control.

Rotating tires

Rotate your tires at regular intervals for even wear. Rotation intervals are listed in the "Scheduled Maintenance Guide".

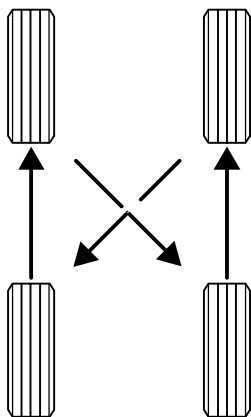



Maintenance and care

Replacing tires

Replace tires at the latest when the wear band is visible through the tire treads.

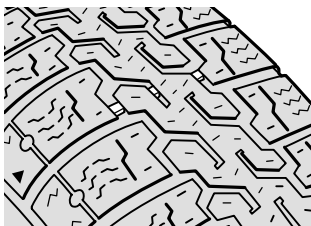
 A tread depth of 3 mm or less will deteriorate the rain and snow performance of the vehicle.





 Your vehicle might be equipped with a 17" tire. This tire has been tuned to match the vehicle driving performance. The only tire released is the Firestone Firehawk GTA02. The use of any other tire will lead to a deterioration of the vehicle functionality and performance.

 When replacing full size tires, never mix radial, bias-belted, or bias-type tires. Use only the tire sizes that are listed on the tire pressure decal. Make sure that all tires are the same size, speed rating, and load-carrying capacity. Use only the tire combinations recommended on the decal. If you do not follow these precautions, your vehicle may not drive properly and safely.

Maintenance and care

 Do not replace your tires with “high performance” tires or larger size tires.

 Failure to follow these precautions may adversely affect the handling of the vehicle and make it easier for the driver to lose control and roll over.

 Dispose of worn tires in accordance with local environmental regulations.

Refer to the tire instruction decal to determine the specific size tire and wheel Ford Motor Company recommends for use on this vehicle.

When purchasing replacement tires for your vehicle, consult your dealer or a qualified service technician to ensure that the correct tire type is used.

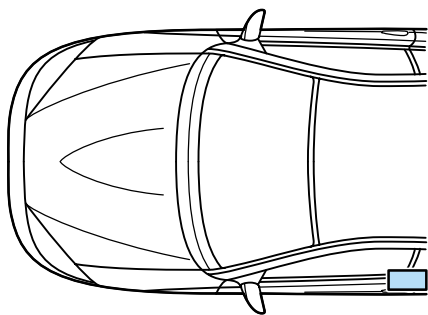

Using snow tires and chains



Snow tires must be the same size and grade as the tires you currently have on your vehicle.

The tires on your vehicle have all-weather treads to provide traction in rain and snow.

However, in some climates, you may need to use snow tires. If you need to use snow tires, you must use wheels of the same size and specifications as those originally installed.

Do not use any type of tire chains on this vehicle. This includes both conventional and cable type chains. Using chains on these tire sizes may cause damage to steering, suspension, and body components.

Follow these guidelines when using snow tires:

- If possible, avoid fully loading your vehicle.
- The suspension insulation and bumpers will help prevent vehicle damage. Do not remove these components from your vehicle when using snow tires.

Maintenance and care

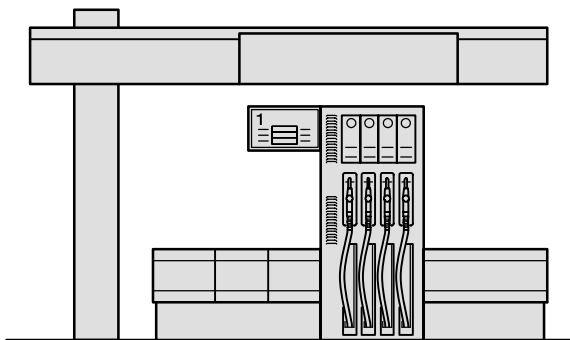



IMPORTANT FUEL INFORMATION

Important safety precautions

 Do not overfill the fuel tank. The pressure in an overfilled tank may cause leakage and lead to fuel spray and fire.

 If you do not use the proper fuel cap, the pressure in the fuel tank can damage the fuel system or cause it to work improperly in a collision.

 The fuel system may be under pressure. If the fuel cap is venting vapor or if you hear a hissing sound, wait until it stops before completely removing the cap.

 Automotive fuels can cause serious injury or death if misused or mishandled.

Maintenance and care

Observe the following guidelines when handling automotive fuel:

- Extinguish all smoking materials and any open flames before fueling your vehicle.
- Always turn off the vehicle before fueling.
- Make sure the fuel cap is correctly fitted after fueling. Failure to do so may cause the on board diagnostic system to illuminate the  light.
- Automotive fuels can be harmful or fatal if swallowed. If fuel is swallowed, call a physician immediately, even if no symptoms are immediately apparent. The toxic effects of fuel may not be visible for hours.
- Fuels can also be harmful if absorbed through the skin. If fuel is splashed on the skin, promptly remove contaminated clothing and wash skin thoroughly with soap and water.
- If fuel is splashed in the eyes, remove contact lenses (if worn), flush with water for 15 minutes and seek medical attention.
- Be particularly careful if you are taking “Antabuse” or other forms of disulfiram for the treatment of alcoholism. Breathing gasoline vapors or skin contact could cause an adverse reaction. Consult a physician immediately.

Maintenance and care

Choosing the right fuel

Use only unleaded fuel. The use of leaded fuel is prohibited by law and could damage your vehicle. The damage may not be covered by your warranty.

Your vehicle was not designed to use fuel containing manganese-based additives such as MMT. Additionally, vehicles certified to California emission standards (indicated on the underhood Vehicle Emission Control Information label) are designed to operate on California reformulated gasolines. If California reformulated gasoline is not available when you refuel, your vehicle can be operated on non-California fuels. However, even though your engine will perform adequately on other gasolines, the performance of the emission control devices and systems may be adversely affected. Repair of damage caused by a fuel that your vehicle was not designed for may not be covered by your warranty.

Maintenance and care

Octane recommendations

Your vehicle is designed to use regular gasoline with an (R+M)/2 octane rating of 87. We do not recommend gasolines labeled as “regular” in high altitude areas that are sold with octane ratings of 86 or even less.

For Cougar S vehicles, please use premium gasoline with an octane rating of 91.

Do not be concerned if your vehicle sometimes knocks lightly. However, if it knocks heavily under most driving conditions on the recommended octane, see your dealer or a qualified service technician to prevent any engine damage.



Maintenance and care

Fuel quality

If you are experiencing starting, rough idle or hesitation problems try a different brand of fuel. If the condition persists, see your dealer or qualified service technician.

It should not be necessary to add any aftermarket products to your fuel tank if you continue to use high quality fuel of the recommended octane rating. Aftermarket products could cause damage to the fuel system. Repairs to correct the effects of using an aftermarket product in your fuel may not be covered by your warranty.

Many of the world's automakers issued the World-wide Fuel Charter that recommends gasoline specifications to provide improved performance and emission control system protection for your vehicle. Gasolines that meet the World-wide Fuel Charter should be used when available. Ask your fuel supplier about gasolines that meet the World-wide Fuel Charter. In Canada, look for fuels that display the **Auto Makers' Choice**[™] logo.

Do not use gasolines containing methanol, which can damage critical fuel system components. Damage resulting from the use of methanol may not be covered by your warranty.



Fuel filler cap

Your fuel tank filler cap has an indexed design with a one-eighth turn on/off feature.

When fueling your vehicle:

1. Turn the engine off.
2. Carefully turn the filler cap counterclockwise $1/8$ of a turn until it stops.
3. Pull to remove the cap from the fuel filler pipe.
4. To install the cap, align the tabs on the cap with the notches on the filler pipe.
5. Turn the filler cap clockwise $1/8$ of a turn until it stops.

If the "check engine" indicator comes on and stays on when you start the engine, the fuel filler cap may not be properly installed. Turn off the engine, remove the fuel filler cap and reinstall it being careful to align the cap properly.

Maintenance and care

If you must replace the fuel filler cap, replace it with an authorized Motorcraft part. The customer warranty may be void for any damage to the fuel tank or fuel system if an authorized Motorcraft fuel filler cap is not used.



The fuel system may be under pressure. If the fuel filler cap is venting vapor or if you hear a hissing sound, wait until it stops before completely removing the fuel filler cap. Otherwise fuel may spray out and injure you or others.



If you do not use the proper fuel filler cap, excessive pressure or vacuum in the fuel tank may damage the fuel system or cause the fuel cap to disengage in a collision, which may result in possible personal injury.

Calculating fuel economy

To accurately calculate your vehicle's fuel economy:

1. Fill the tank completely and record the initial odometer reading.
2. Each time you fill the tank, record the amount of fuel added (in litres or gallons).
3. After at least three to five fill-ups, fill the fuel tank and record the current mileage reading.

4. Use one of the following equations to calculate fuel economy.

$\text{Litres used} \times 100 / \text{Total kilometres traveled}$

$\text{Total miles traveled} / \text{Total gallons used}$

Keep a record for at least one month. This will provide an accurate estimate of the vehicle's fuel economy.

EMISSION CONTROL SYSTEM

Your vehicle is equipped with various emission control components and a catalytic converter which will enable your vehicle to comply with applicable exhaust emission standards. To make sure that the catalytic converter and other emission control components continue to work properly:

- Use only unleaded fuels.
- Avoid running out of fuel.
- Do not turn off the ignition while your vehicle is moving, especially at high speeds.
- Have the items listed in the “Scheduled Maintenance Guide” performed according to the specified schedule.

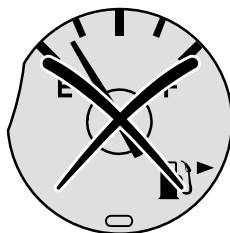

The scheduled maintenance services listed in the “Scheduled Maintenance Guide” are required because they are considered essential to the life and performance of your vehicle and to its emissions control system.

Maintenance and care

If other than Ford, Motorcraft or Ford authorized parts are used for maintenance replacements or for service of components affecting emissions control, such non-Ford parts should be equivalent to genuine Ford Motor Company parts in performance and durability.



Do not park, idle, or drive your vehicle in dry grass or other dry ground cover. The emission system heats up the engine compartment and exhaust system, which can start a fire.

Watch for fluid leaks, strange odors, smoke, loss of oil pressure, engine overheating, illumination of the “charging system” warning light or the “check engine” warning light. These events could indicate that the emission control system is not working properly.



Exhaust leaks may result in the entry of harmful and potentially lethal fumes into the passenger compartment.

Maintenance and care

Do not make any unauthorized changes to your vehicle or engine. By law, vehicle owners and anyone who manufactures, repairs, services, sells, leases, trades vehicles, or supervises a fleet of vehicles are not permitted to intentionally remove an emission control device or prevent it from working. Information about your vehicle's emission system is on the Vehicle Emission Control Information Decal located on or near the engine. This decal identifies engine displacement and gives some tune up specifications.

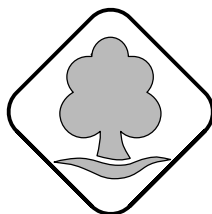

Please consult your “Warranty Guide” for complete emission warranty information.

Maintenance and care

Readiness for inspection/ maintenance (I/M) testing

In some localities, it may be a legal requirement to pass an I/M test of the on-board diagnostic (OBD-II) system. If your “check engine” light is on, refer to the description in the *Warning Lights and Chimes* section of the *Instrumentation* chapter. Your vehicle may not pass the I/M test with the “check engine” light on.

If the vehicle’s powertrain system or battery has just been serviced, the OBD-II system is reset to a “not ready for I/M test” condition. To ready the OBD-II system for I/M testing, a minimum of 30 minutes of city and highway driving is necessary as described below:

- First, at least 10 minutes of driving on an expressway or highway.
- Next, at least 20 minutes of driving in stop-and-go, city-type driving with at least four idle periods.

Allow the vehicle to sit for at least eight hours without starting the engine. Then, start the engine and complete the above driving cycle. The engine must warm up to its normal operating temperature. Once started, do not turn off the engine until the above driving cycle is complete.

BULB REPLACEMENT

Removing the headlamps assembly

 Handle a halogen headlamp bulb carefully and keep out of children's reach. Grasp the bulb only by its plastic base and do not touch the glass. The oil from your hand could cause the bulb to break the next time the headlamps are operated.

If the bulb is accidentally touched, it should be cleaned with rubbing alcohol before being used.

The bulbs for the low beam, high beam, turn signals and side lamps are housed in the lamp assembly. To replace a bulb, the complete lamp assembly has to be removed as follows:

1. Switch off the lamps.
2. Open the hood.
3. Remove the center cover.
4. Remove the screw (1) on both ends of the radiator grille and pull out the radiator grille.
5. Using a T30 Torx screwdriver, remove the two screws (2) and loosen the screw (3). The screws are not interchangeable and must be replaced to the appropriate location.
6. Carefully pull out the lamp assembly and disconnect the wiring connector.

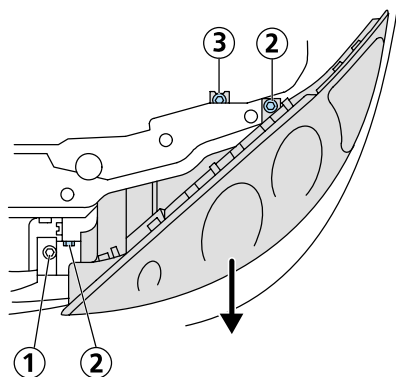

Maintenance and care

Front turn signal

Turn the bulb holder counterclockwise and pull it out. Pull the bulb out and replace it (1).

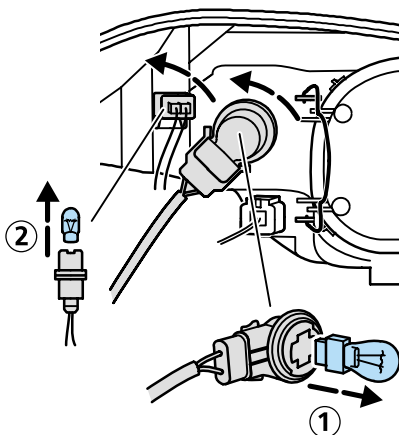

Turn the socket counterclockwise and pull it out. Pull the bulb out and replace it (2).

Opening the headlamp assembly

Release the wire clip on the rear of the headlamp assembly and remove the cover.

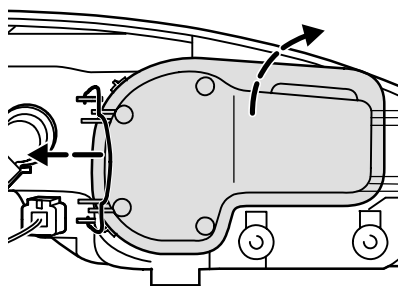

Maintenance and care

Headlamps – low beam

Disconnect the electrical connector, turn the bulb holder counterclockwise and replace it.

Do not touch the glass part of the bulb and pay attention to the tab guides when replacing.

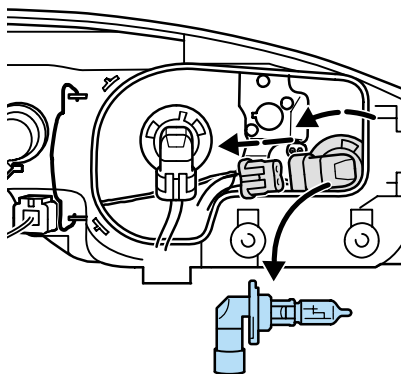

Headlamps – high beam

Replacement instructions are the same as for the low beam headlamp.

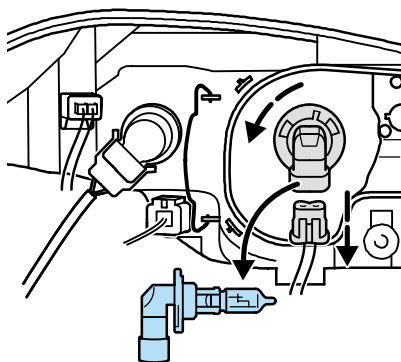

Parking lamps

Pull the bulb out and replace it.

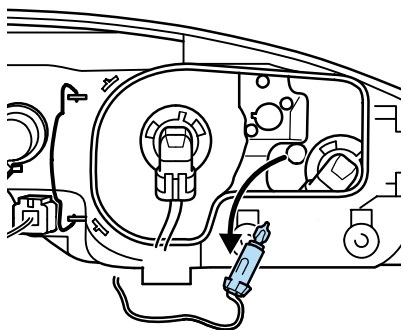

Maintenance and care

Headlamp alignment

Check the headlamp alignment after each replacement of a bulb. Refer to *Aiming the headlamps* in this chapter.

Reinstalling the headlamp assembly

Make sure the locator pin is aligned with the bushing in the fender.

All bulb connectors must be correctly connected.

Install in the reverse order of removal.

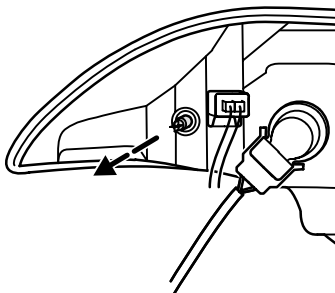

Foglamps (if equipped)

Have these lamps replaced by a Ford Dealer.

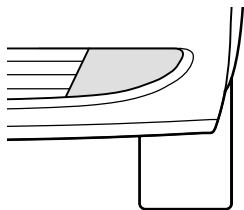

Maintenance and care

Side marker lamps

1. Push the complete light assembly to the front and pull it out.
2. Remove the socket from the assembly by turning it counterclockwise.
3. Pull the bulb out and replace it.

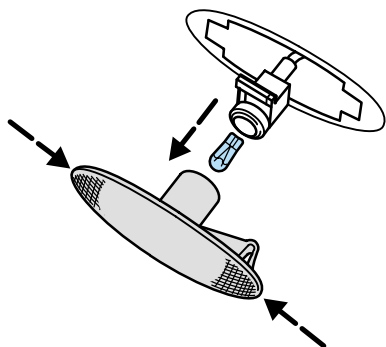

Brake/turn signal/tail/backup lamps

1. From the trunk, remove the carpet cover from the lamp assembly.
2. Remove the three retainer nuts and pull the lamp assembly out.
3. Turn the bulb counterclockwise and pull it out.
4. Replace the defective bulb.

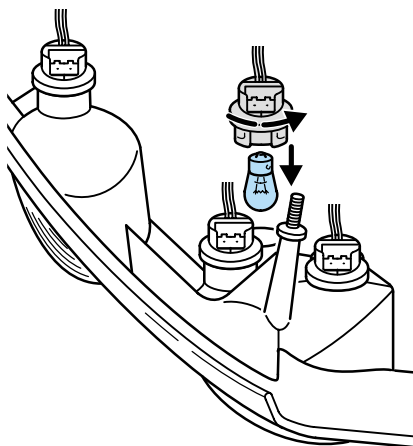

Parking lamps

Turn the socket counterclockwise and pull it out. Pull the bulb out and replace it.

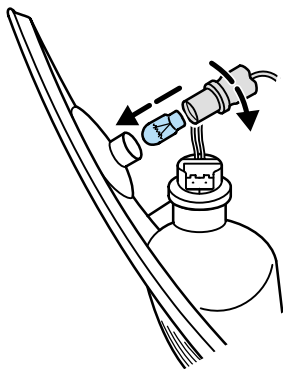

Maintenance and care

License plate lamp

Pry out the lamp with a flat blade screwdriver. Turn the socket counterclockwise and remove it. Pull the bulb out and replace it.

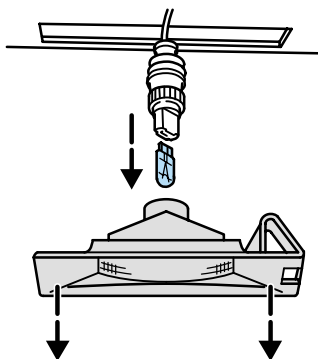

Luggage compartment lamp

Pry out the light assembly from the holder with a flat blade screwdriver. Turn the spherical bulb under slight pressure counterclockwise and remove.

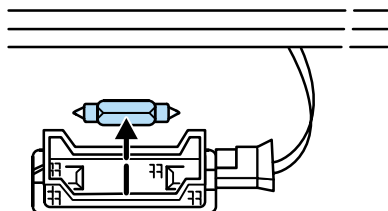

High mounted brake lamp

Remove the push pins and cover from the liftgate. To remove the push pins, gently pry them out with a flat-bladed screwdriver. Press the tabs of the push pin insert inward and pull them out.

Press the tabs on the brake lamp assembly, and pull it out. Pull the bulb out and replace it.

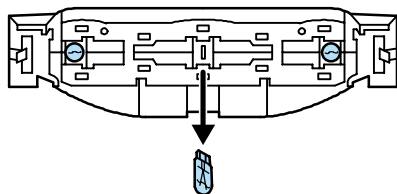

Maintenance and care

Interior lamps

Switch off the interior lamps (middle switch position). Pry out the lamp assembly with a flat screwdriver, release the reflector at the side and replace the bulb.

To install, fit the new bulb in reverse sequence.

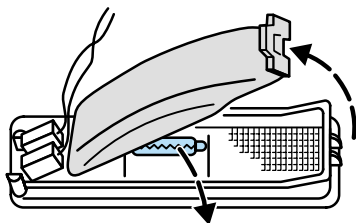

Reading lamps (if equipped)

Open the lamp assembly.

The bulbs can be replaced after the contact plate has been hinged back.

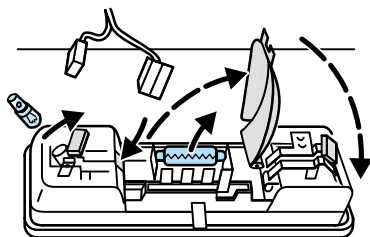

Bulb specifications

Function	Trade number
Front /turn lamp	3757 A
Headlamp (high)	9005
Headlamp (low)	9006
Side marker lamp	W5W
Parking lamp	W5W
Foglamp	9145
Rear tail/turn/brake lamp	1157
Backup lamp	1156
High-mounted brake lamp	2825/W5W
License plate lamp	168

Maintenance and care

Headlamp aiming

- Your vehicle is equipped with headlamps designed to meet Visual aim requirements according to FMVSS 108, table 17-2.
- Your headlamps are marked VOL [visual/optical (aiming) left]. This means that the left side of the light patterns for each low beam headlamp is used to aim the lamp (Fig. 1).
- Each headlamp may be properly aimed in the vertical (up/down) direction only. The horizontal (left/right) aim is preset by the headlamp manufacturer and does not need to be re-aimed.
- Turning the headlamp adjusting screws V1 and V2 in the directions indicated by the embedded arrows (Fig. 2) represents a change in vertical aim direction. Turn clockwise for up and counter-clockwise for down. It is important that both adjusting screws are turned by an equal number of revolutions or parts of revolutions and are turned as well in the same direction. Turn V1 before V2. Never V2 before V1. **Failing this requirement leads to improperly aimed headlamps and may cause glare light for oncoming drivers.** For example, if one of your low beam headlamps is aimed too low, you will turn V1 and V2 clockwise an equal number of revolutions until correct aim is achieved.

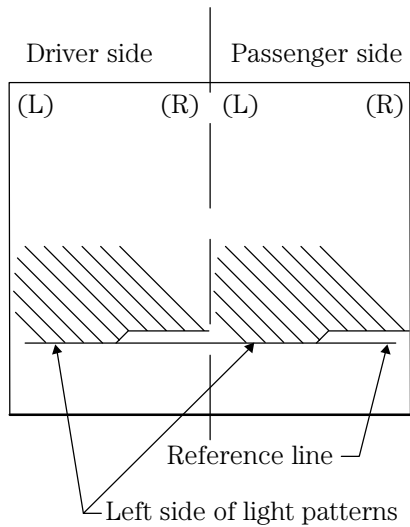

Fig. 1

Maintenance and care

- A screen or wall with a reference line (as described below) is needed in order to adjust the vertical position of each lamp's light pattern cut-off line. The cut-off line is the line formed between the bright lower portion and the dark upper portion of each lamp's light pattern. (Fig. 1).

Adjusting the vertical aim

1. The surrounding light level during the aiming process must be kept as low as possible (in a darkened enclosure or outside at night), as the light level has a major influence on the accuracy of the headlamp aim.

2. A flat vertical screen at least one meter wider than the vehicle is needed. A **level** surface on which to park the vehicle in front of the screen is also required.

3. Center the vehicle 7.6 meters in front of this screen (Figs. 3 and 4).

4. Measure the height of the low beam lamp center from the ground. Subtract 52 mm from this figure. Place a horizontal reference line on the wall at this height, masking tape works well for this. The line should be at least three meters long (Figs. 3 and 4).

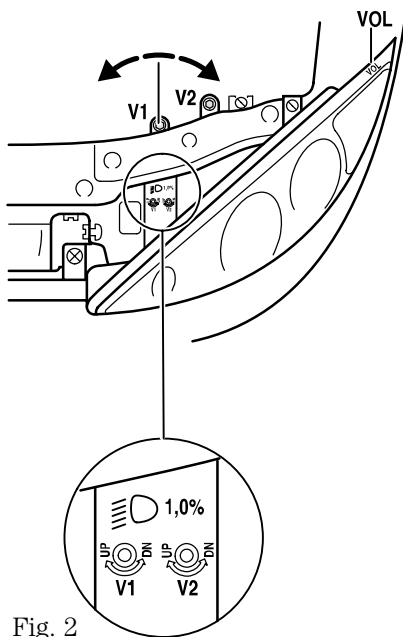
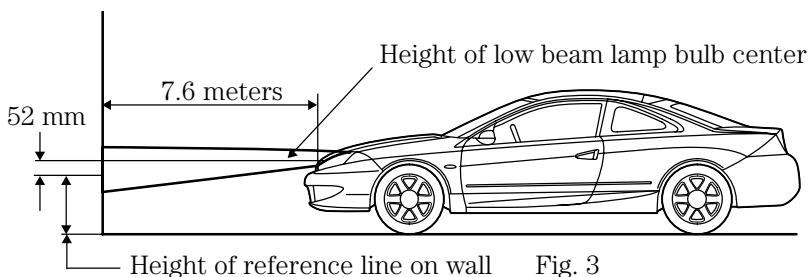

Fig. 2

Maintenance and care



5. Turn on the low beam headlamps. Notice that both the driver's side lamp and the passenger's side lamp create similar light patterns on the wall (see Fig. 1). If the left side of the cut-off line of either lamp is above or below the reference line on the wall, the vertical aim of that lamp requires adjusting.

6. On the lamp requiring adjustment, turn the adjusting screw marked with V1 in the desired direction (up or down). The vertical aim is correct when the horizontal cut-off line on the left side of the lamp's light pattern is vertically lined up with the horizontal reference line on the screen as shown in Fig. 1.

7. Turn the adjusting screw V2 in the same direction and by the same number of revolutions as V1.

Note: The adjusting screws V1 and V2 may be turned at the same time or V1 before V2. Never turn V2 before V1. Doing so will cause mis-aimed headlamps.

8. Repeat steps 6 and 7 above on the other headlamp if required.

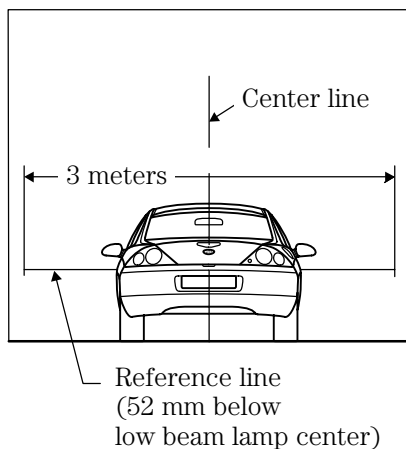

Maintenance and care

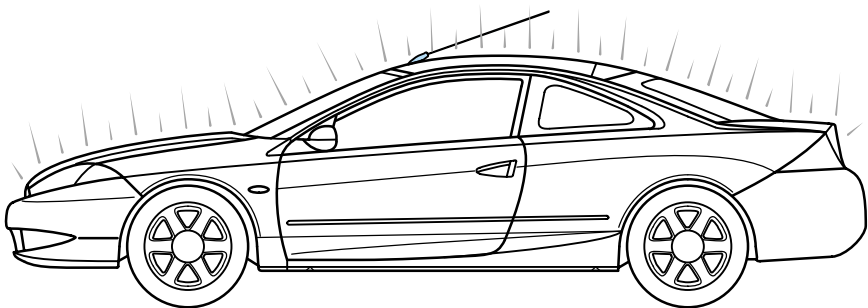

VEHICLE CARE

Washing your vehicle

 Only use car washing areas that have environmentally friendly drainage systems.

Wash your vehicle regularly with cold or lukewarm water. Never use strong detergents or soap. If your vehicle is particularly dirty, use a quality car wash detergent. Always use a clean sponge, washing glove or similar device and plenty of water for best results. To avoid spots, avoid washing when the hood is still warm, immediately after or during exposure to strong sunlight.

Maintenance and care

During winter months, it is especially important to wash the vehicle on a regular basis. Large quantities of dirt and road salt are difficult to remove, and they also cause damage to the vehicle.

Remove or lower any exterior accessories before entering a car wash.

Remove particles such as bird droppings, tree sap, insect remains, tar spots, road salt and industrial fallout immediately.

After washing, apply the brakes several times to dry them.

Waxing your vehicle

The best way to determine when the paintwork needs waxing is by noting when water stops beading on the surface. This could be every three or four months depending on operating conditions.

Use only carnauba or synthetic-based waxes. Remove any bugs and tar before waxing the vehicle. Use cleaning fluid or alcohol with a clean cloth to remove bugs. Use tar remover to remove any tar spots.

Maintenance and care

Repairing paint chips

Minor scratches or paint damage from road debris may be repaired with the Ultra Touch Prep and Finishing Kit (# F7AZ-19K507-BA).

Lacquer Touch-up Paint (# ALBZ-19500-XXXXA) or Exterior Acrylic Spray Lacquer (# ALAZ-19500-XXXXA) from the Ford Car Care Chemicals line.

Please note that the part numbers (shown as XXXX above) will vary with your vehicle's specific coloring. Observe the application instructions on the products.

Cleaning the wheels

Wash the wheels with the same detergent you use to clean the body of your vehicle. Do not use acid-based wheel cleaners, steel wool, fuel or strong detergents. Never use abrasives that will damage the finish of special wheel surfaces. Use a tar remover to remove grease and tar.

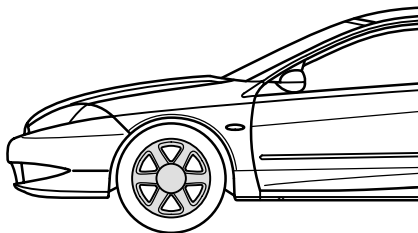

Maintenance and care

Cleaning the engine

Engines are more efficient when they are clean because grease and dirt buildup act as insulators and keep the engine warmer than normal. Follow these guidelines to clean your engine:

- Take care when using a power washer to clean the engine. The high pressure fluid could penetrate the sealed parts and cause damage.
- Do not spray with cold water as this may crack the engine block.
- Cover the alternator and battery to prevent water damage when cleaning the engine.
- Do not spray water directly on the ABS modulator.
- Never wash or rinse the engine while it is running; water in the running engine may cause internal damage.

Maintenance and care

Cleaning plastic exterior parts

Use a vinyl cleaner for routine cleaning of plastic. Clean with a tar remover if necessary. Do not clean plastic parts with thinners, solvents or petroleum-based cleaners.

Cleaning the exterior lamps

Wash the exterior lamps with the same detergent you use to wash the exterior of your vehicle. Use glass cleaner or tar remover if necessary.

To avoid scratching the lamps, do not use a dry paper towel, chemical solvents or abrasive cleaners to clean the lamps.

Cleaning the wiper blades

If the wiper blades do not wipe properly, clean both the windshield and wiper blades using undiluted windshield wiper solution or a mild detergent. Rinse thoroughly with clean water. To avoid damaging the blades, do not use fuel, kerosene, paint thinner or other solvents.

Cleaning the instrument panel

Clean the instrument panel with a damp cloth, then dry with a dry cloth.

Any cleaner or polish that increases the gloss of the upper portion of the instrument panel should be avoided. The dull finish in this area is to help protect the driver from undesirable windshield reflection.

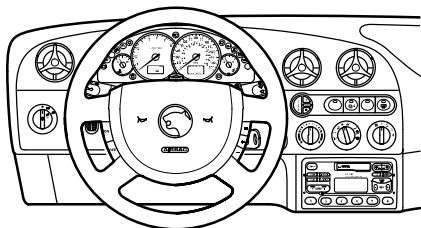

Maintenance and care

Cleaning the interior fabric

Remove dust and loose dirt with a whisk broom or a vacuum cleaner. Remove fresh spots immediately. Follow the directions that come with the cleaner.

Cleaning leather seats (if equipped)

For routine cleaning, wipe the surface with a soft, damp cloth. For more thorough cleaning, wipe the surface with a leather and vinyl cleaner or a mild soap.

Ford recommends using the Deluxe Leather Care Kit F8AZ-196253-AA, which is available from your Ford Dealer. This mild cleaner and special pad cleans the leather and maintains its natural beauty. Follow the instructions on the cleaner label. Regular cleaning of your leather upholstery helps maintain its resiliency and color.

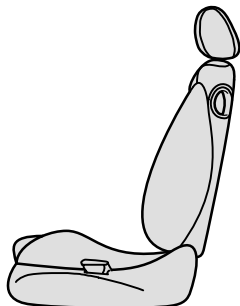

Cleaning seats equipped with side air bags

Remove dust and loose dirt with a whisk broom or a vacuum cleaner. Remove fresh spots immediately. Follow the directions that come with the cleaner. Do not saturate the seat cover with upholstery cleaner.



Do not use chemical solvents or strong detergents when cleaning the seat mounted side air bag. Such products could contaminate the side air bag system and affect performance of the side air bag in a collision.

Maintenance and care

Cleaning and maintaining the safety belts

Clean the safety belts with a mild soap solution recommended for cleaning upholstery or carpets and warm water. Do not bleach or dye the belts, because these actions may weaken the belt webbing.

Check the safety belt system periodically to make sure there are no nicks, wear or cuts.

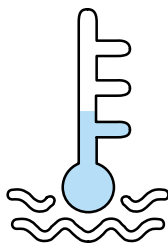
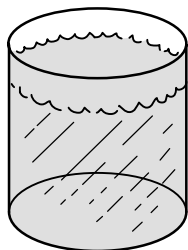

 Ford recommends that all safety belt assemblies and attaching hardware should be inspected by a qualified technician after any collision. Safety belt assemblies not in use during a collision should also be inspected and replaced if either damage or improper operation is noted.

Cleaning and caring for your vehicle

Refer to the “Customer Assistance Guide” for a list of Ford-approved cleaners, polishes and waxes.

Capacities and specifications

Motorcraft parts

Component	Part number		
	2.0 litre engine	2.5 litre engine	2.5 litre Cougar S
Spark plug*	AZFS-22F # 1+2** AZFS-22FE # 3+4	AWSF-32F	AWSF-22FS
Air filter	FA-1612	FA-1613	FA-1611
Cabin air filter	FP4	FP4	FP4
Fuel filter	FG-800A	FG-800A	FG-800A
Oil filter	FL-2005	FL-820	FL-820
Battery	BXT-40R	BXT-40R	BXT-40R
PCV valve	EV-224	EV-152	EV-152
Crankcase ventilation filter	FA-1621	—	—

* Refer to Vehicle Emission Control Information (VECI) decal for spark plug and gap specifications.

** If a spark plug is removed for examination, it must be reinstalled in the same cylinder.

If a spark plug needs to be replaced, use only spark plugs with the service part number suffix letter "FE" as shown on the engine decal.

Capacities and specifications

Capacities	2.0 litre engine	2.5 litre engine
Engine oil – with filter – without	4.25 l (4.5 qts) 3.75 l (4.0 qts)	5.5 l (5.8 qts) 5.0 l (5.3 qts)
Manual transaxle	2.6 l (2.7 qts)	
Automatic transaxle	NA	9.6 l (10.2 qts)
Power steering	Fill to MAX mark	
Cooling system with heating	6.6 l (7.0 qts)*	9.5 l (10.0 qts)* 9.7 l (10.2 qts)**
Windshield washer fluid	Fill to top of reservoir	
Fuel tank	58.5 litres (15.4 gallons)	
Braking system	Fill to MAX mark	

* Total capacity

** with automatic transaxle

Capacities and specifications

Lubricant specifications

Item	Ford part name or equivalent	Ford part number	Ford specification
Brake fluid	High Performance DOT 3 Brake Fluid (North America) or DOT 4 Brake Fluid (Europe)	C6AZ-19542-AB for DOT 3	ESA-M6C25-A (North America) or ESD-M6C57-A (Europe)
Engine coolant (orange)	Ford Extended Life Engine Coolant	F6AZ-19544-AA	WSS-M97B44-D or DEX-COOL® equivalent
Engine oil	Super Premium SAE 5W-20 GF3 Motor Oil	XO-5W20-QSP	API Certification Mark and WSS-M2C153-H
Power steering fluid	Motorcraft MERCON® ATF	XT-2-QDX	MERCON®
Transaxle fluid automatic	Motorcraft MERCON® ATF	XT-2-QDX	MERCON®
Transaxle fluid 5-speed manual	Motorcraft MERCON® ATF	XT-2-QDX	MERCON®
Windshield washer fluid	Ultra-Clear Windshield Washer Concentrate	C9AZ-19550-AC or C9AZ-19550-BC	ESR-M17P5-A

Capacities and specifications

Engine data

Engine		2.0 litre engine	2.5 litre engine	2.5 litre Cougar S
Cubic capacity	cm ³	1988	2495	2495
Power output	kW(HP) at rpm	96(125) 5500	125 (170) 6250	151 (195) 6600
Max torque	Nm (lb-ft.) at rpm	176 (130) 4000	220 (162) 4250	229 (169) 5500
Fuel grade		87 Octane		91 Octane
Continuous engine speed	rpm	6150	6700	6750
Max. intermittent engine speed	rpm	6375	6925	7000
Idle speed (manual transaxle)	rpm	(880±50)	725±50 (725±50)	725±50
Mixture preparation		Injection system		
Firing order		1-3-4-2	1-4-2-5-3-6	
Spark plug gap	mm	1.37		
Ignition system		Electronically controlled		
Valve clearance (cold)	Inlet mm Exhaust mm	0.11-0.18* 0.27-0.34*	Hydraulic valve adjusters	

* Mechanical valve adjuster

Capacities and specifications

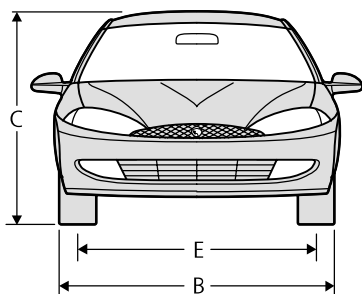
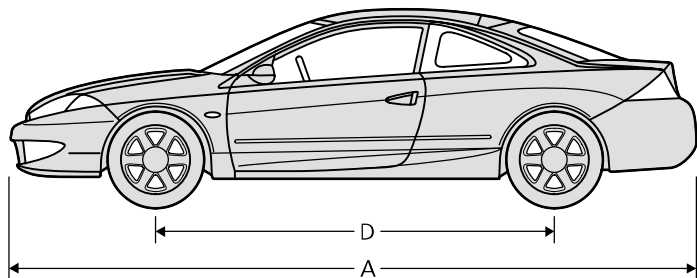

Dimensions		mm (inches)
A = Overall length		4720 (186)
B = Overall width (without mirrors)		1769 (69.6)
C = Overall height (curb weight)		1325 (52.2)
D = Wheelbase		2704 (106.5)
E = Track	front	1506 (59.3)
	rear	1491 (58.7)

Capacities and specifications

VEHICLE IDENTIFICATION NUMBER

The vehicle identification number (VIN) is attached to a metal tag and is located on the front driver's side of the instrument panel. The VIN tag may be seen by looking through the windshield from the outside of the vehicle.

Customer assistance

GETTING ROADSIDE ASSISTANCE

To fully assist you should you have a vehicle concern. Ford offers a complimentary roadside assistance program. This program is separate from the New Vehicle Limited Warranty . The service is available:

- 24-hours, seven days a week
- for the Basic warranty period (Canada) or New Vehicle Limited Warranty period (U.S.) of three years or 60,000 km (36,000 miles), whichever comes first on Ford and Mercury vehicles, and four years or 80,000 km (50,000 miles) on Lincoln vehicles.

In the United States, you may purchase additional roadside assistance coverage beyond this period through the Ford Auto Club by contacting your Ford or Lincoln-Mercury dealer.

Roadside assistance will cover

- changing a flat tire
- jump-starts
- lock-out assistance
- fuel delivery
- towing to the nearest Ford of Canada or Ford Motor Company dealership, or towing to your selling dealership if within 56 km (35 miles). Even non-warranty related tows, like accidents or getting stuck in the mud or snow, are covered (some exclusions apply, such as impound towing or repossession.

Using roadside assistance

Complete the roadside assistance identification card and place it in your wallet for quick reference. In the United States, this card is found in the Owner Guide portfolio in the glove compartment in Ford vehicles and is mailed to you if you own a Mercury or Lincoln. In Canada, it's found in the Roadside Assistance book in the glove compartment.

To receive roadside assistance in the United States for Ford or Mercury vehicles, call 1-800-241-3673 or if you own a Lincoln vehicle, call 1-800-521-4140. In Canada call 1-800-665-2006.

Should you need to arrange assistance for yourself, Ford will reimburse a reasonable amount. To obtain information about reimbursement, call 1-800-241-3673 in the United States for Ford or Mercury vehicles; or if you own a Lincoln vehicle, call 1-800-521-4140. Call 1-800-665-2006 in Canada.

Customer assistance

Ford extended service plan

You can get more protection for your new car or light truck by purchasing Ford Extended Service Plan (Ford ESP) coverage. Ford ESP is an optional service contract which is backed by Ford Motor Company or Ford Motor Service Company (in the U.S.) and Ford of Canada (in Canada). It provides:

- Protection against repair costs after your New Vehicle Limited Warranty period expires;

and

- other benefits during the warranty period (such as reimbursement for rentals and towing).

You may purchase Ford ESP from any participating Ford or Lincoln-Mercury or Ford of Canada dealer. There are several plans available in various time, distance and deductible combinations which can be tailored to fit your own driving needs. Ford ESP also offers reimbursement benefits for towing and rental coverage. (In Hawaii, rules vary. See your dealer for details.)

When you buy Ford ESP you receive Peace-of-Mind protection throughout the United States and Canada, provided by a network of more than 5,200 participating Ford, Lincoln-Mercury and Ford of Canada dealers.

If you did not take advantage of the Ford Extended Service Plan at the time of purchasing your vehicle, you may still be eligible. Please contact your dealer for further information. Since this information is subject to change, please ask your dealer for complete details about Ford Extended Service Plan coverage options.

Also, please be aware that some dealers offer service contracts that are not backed by Ford Motor Company or Ford of Canada. On the surface, many independent plans appear to be like Ford's. The problem is that they can often require the use of non-factory approved parts and have much more complex and restrictive claims coverage terms than Ford.

At Ford Motor Company and Ford of Canada, we are dedicated to providing Ford, Lincoln and Mercury vehicle owners with programs that will enhance your ownership experience and protect you from unexpected repair bills. Genuine Ford ESP is the only Extended Service Plan that enables us to provide that service.

Customer assistance

Getting the service you need

At home

Ford Motor Company and Ford of Canada have authorized dealerships to service your vehicle. When you need warranty repairs your selling dealer would like you to return to it for that service, but you may also take your vehicle to another Ford Motor Company dealership authorized for warranty repairs. Certain warranty repairs require special training though, so not all dealers are authorized to perform all warranty repairs. That means that depending on the warranty repair needed, the vehicle may need to be taken to another dealer. If a particular dealership can not assist you, then contact the Customer Assistance Center.

If you are not satisfied with the service you receive at the dealership, contact your Service Advisor for assistance. If the concern or inquiry remains unresolved, speak with the service manager. If you are still not satisfied, speak with the owner or general manager of the dealership. In most cases, your concern will be resolved at this level.

Ford Motor Company and Ford of Canada dealerships also carry genuine Ford parts and accessories, providing you with original equipment reliability.

Away from home

If you are away from home when your vehicle needs service, or if you need more help than the dealership could provide after following the steps described above, contact the Ford Customer Assistance Center to find an authorized dealership to help you in the United States

Ford Motor Company
Customer Assistance Center
16800 Executive Plaza Drive
P.O. Box 6248
Dearborn, Michigan 48121
1-800-392-3673 (FORD)
(TDD for the hearing impaired:
1-800-232-5952)

In Canada:
Customer Assistance Centre
Ford Motor Company of Canada,
Limited
P.O. Box 2000
Oakville, Ontario L6J 5E4
1-800-565-3673 (FORD)

Customer assistance

Please have the following information available when contacting Ford Customer Assistance:

- Your telephone number (home and business)
- The name of the dealer and the city where the dealership is located
- The year and make of your vehicle
- The date of vehicle purchase
- The current odometer reading
- The vehicle identification number (VIN)

If you still have a complaint involving a warranty dispute, you may wish to contact the Dispute Settlement Board (U.S.) or the Mediation/Arbitration Program (Canada).

In the United States, a warranty dispute must be submitted to the Dispute Settlement Board before taking action under the Magnuson-Moss Warranty Act, or to the extent allowed by state law, before pursuing replacement or repurchase remedies provided by certain state laws. This dispute handling procedure is not required prior to enforcing state created rights or other rights which are independent of the Magnuson-Moss Warranty Act or state replacement or repurchase laws.

THE DISPUTE SETTLEMENT BOARD (U.S. ONLY)

The Dispute Settlement Board is

- an independent, third-party arbitration program for warranty disputes
- available free to owners and lessees of qualifying Ford Motor Company vehicles

NOTE: The Dispute Settlement Board may not be available in all states: Ford Motor Company reserves the right to change eligibility limitations, modify procedures and/or to discontinue this service without notice and without incurring obligations per applicable state law.

What kinds of cases does the Board review?

Unresolved warranty repair concerns or vehicle performance as designed concerns on Ford, Mercury and Lincoln cars and Ford, Mercury and Lincoln light trucks which are within the terms of any applicable written new vehicle warranty are eligible for review, except those involving:

- a non-Ford product
- a non-Ford dealership

Customer assistance

- sales disputes between customer and dealer except those associated with warranty repairs or concerns with the vehicle's performance as designed
- a request for reimbursement of consequential expenses unless a service or product concern is being reviewed
- items not covered by the New Vehicle Limited Warranty (including maintenance and wear items)
- alleged personal injury/property damage claims
- cases currently in litigation
- vehicles not used primarily for family, personal or household purposes (except in states where the Dispute Settlement Board is required to review commercial vehicles).
- vehicles with non-U.S. warranties

Concerns are ineligible for review if the New Vehicle Limited Warranty has expired at receipt of your application and in certain states eligibility is dependent upon the customer's possession of the vehicle.

Eligibility may differ according to state law. For example see the unique brochures for California, West Virginia, Georgia and Wisconsin purchasers/ lessees.

Board membership

The Board consists of:

- three consumer representatives
- a Ford or Lincoln-Mercury dealership representative

Consumer candidates for Board membership are recruited and trained by an independent consulting firm. The dealership Board member is chosen from Ford and Lincoln-Mercury dealership management, recognized for their business leadership qualities.

What the Board needs

To have your case reviewed you must complete the application in the DSB brochure and mail it to the address provided on the application form.

Your application is reviewed and, if it is determined to be eligible, you will receive an acknowledgement indicating:

- the file number assigned to your application
- the toll-free phone number of the DSB's independent administrator

Your dealership and a Ford Motor Company representative will be asked to submit statements.

Customer assistance

To properly review your case, the Board needs the following information:

- legible copies of all documents and maintenance or repair orders relevant to the case
- the year, make, model, and Vehicle Identification Number (VIN) listed on your vehicle ownership license
- the date of repair(s) and mileage at the time of occurrence(s)
- the current mileage
- the name of the dealer(s) who sold or serviced the vehicle
- a brief description of your unresolved concern
- a brief summary of the action taken by the dealer(s) and Ford Motor Company
- the names (if known) of all the people you contacted at the dealership(s)
- a description of the action you expect to resolve your concern

You will receive a letter of explanation if your application does not qualify for Board review.

Oral presentations

If you would like to make an oral presentation indicate YES to question #6 on the application. While it is your right to make an oral presentation before the Board, this is not a requirement and the Board will decide the case whether or not an oral presentation is made. Oral presentation may be requested by the Board as well.

Making a decision

Board members review all available information related to each complaint, including oral presentations, and arrive at a fair and impartial decision.

Every effort is made to decide the case within 40 days of the date that all requested information is received by the Board. Since the Board generally meets once a month, it may take longer for the Board can consider some cases.

Customer assistance

After a case is reviewed, the Board mails you a decision letter and a form on which to accept or reject the Board's decision. The decisions of the Board are binding on Ford (and, in some cases, on the dealer) but not on consumers who are free to pursue other remedies available to them under state or federal law.

To request a DSB brochure/application

For a brochure/application, speak to your dealer or write/call to the Board at the following address/phone number:

Dispute Settlement Board
P.O. Box 5120
Southfield, MI 48086-5120
1-800-428-3718

You may also contact the North American Customer Assistance Center at 1-800-392-3673 (Ford). TDD for the hearing impaired: 1-800-232-5952 or by writing to the Center at the following address:

Ford Motor Company
Customer Assistance Center
16800 Executive Plaza Drive
P.O. Box 6248
Dearborn, Michigan 48121

UTILIZING THE MEDIATION/ARBITRATION PROGRAM (CANADA ONLY)

In those cases where you continue to feel that the efforts by Ford and the dealer to resolve a factory-related vehicle service concern have been unsatisfactory,

Ford of Canada participates in an impartial third party mediation/arbitration program administered by the Canadian Motor Vehicle Arbitration Plan (CAMVAP)

The CAMVAP program is a straight forward and relatively speedy alternative to resolve a disagreement when all other efforts to produce a settlement have failed. This procedure is without cost to you and is designed to eliminate the need for lengthy and expensive legal proceedings.

In the CAMVAP program, impartial third party arbitrators conduct hearings at mutually convenient times and places in an informal environment. These impartial arbitrators review the positions of the parties, make decisions and, when appropriate, render awards to resolve disputes. CAMVAP decisions are fast, fair, and final, the arbitrator's award is binding both to you and Ford of Canada.

CAMVAP services are available in all territories and provinces, except Quebec. For more information, without charge or obligation, call your CAMVAP Provincial Administrator directly at 1 800-207-0685.

Customer assistance

GETTING ASSISTANCE OUTSIDE THE U.S. AND CANADA

Before exporting your vehicle to a foreign country, contact the appropriate foreign embassy or consulate. These officials can inform you of local vehicle registration regulations and where to find unleaded fuel.

If you cannot find unleaded fuel or can only get fuel with an anti-knock index lower than is recommended for your vehicle, contact a district or owner relations/customer assistance office.

The use of leaded fuel in your vehicle without proper conversion may damage the effectiveness of your emission control system and may cause engine knocking or serious engine damage. Ford Motor Company/Ford of Canada is not responsible for any damage caused by use of improper fuel.

In the United States, using leaded fuel may also result in difficulty importing your vehicle back into the U.S.

If your vehicle must be serviced while you are traveling or living in Central or South America, the Caribbean, or the Middle East, contact the nearest Ford dealership. If the dealership cannot help you, write or call:

**FORD MOTOR COMPANY
WORLDWIDEDIRECTMARKET
OPERATIONS**
1555 Fairlane Drive

Fairlane Business Park #3
Allen Park, Michigan 48101
U.S.A.

Telephone: (313) 594-4857
FAX: (313) 390-9804

If you are in another foreign country, contact the nearest Ford dealership. If the dealership employees cannot help you, they can direct you to the nearest Ford affiliate office.

If you buy your vehicle in North America and then relocate outside of the U.S. or Canada, register your vehicle identification number (VIN) and new address with Ford Motor Company Worldwide Direct Market Operations.

Customer assistance

FORD CAR CARE PRODUCTS FOR YOUR VEHICLE

Ford has many quality products available from your dealer to clean your vehicle and protect its finishes. For best results, use the following or products of equivalent quality

Ford Custom Clearcoat Polish*

Ford Custom Silicone Gloss Polish

Ford Custom Vinyl Protectant*

Ford Deluxe Leather and Vinyl Cleaner

Ford Extra Strength Tar and Road Oil Remover*

Ford Extra Strength Upholstery Cleaner

Ford Metal Surface Cleaner

Ford Multi-Purpose Cleaner*

Motorcraft Car Wash Concentrate

Motorcraft Carlite Glass Cleaner

Ford Spot and Stain Remover*

Ford Super Premium Tire and Trim Dressing

Ford Triple Clean

Ford Ultra-Clear Spray Glass Cleaner

* May be sold with the Motorcraft name

FORD ACCESSORIES FOR YOUR VEHICLE

A wide selection of accessories is available through your local authorized Ford, Lincoln-Mercury or Ford of Canada dealer. These quality accessories have been specifically engineered to fulfill your automotive needs; they are custom designed to complement the style and aerodynamic appearance of your vehicle. In addition, each accessory is made from high quality materials and meets or exceeds Ford's rigid engineering and safety specifications. Ford accessories are warranted for up to 12 months or 20,000 km (12,000 miles) on all cars and light trucks and 12 months with unlimited distance on medium/heavy duty trucks unless the accessory is installed on a new vehicle, then the warranty becomes the balance of the new vehicle's warranty or the accessories warranty, whichever is greater. See your dealer for complete warranty information and availability.

Not all accessories are available for all models.

Vehicle Security

Remote keyless entry

Styled wheel protector locks

Vehicle security systems

Customer assistance

Comfort and convenience

Air conditioner
Air filtration systems
Cargo nets
Cargo organizers
Cargo shades
Cargo trays
Dash trim
Engine block heaters
Gear shift knob
Luggage presenter (Continental only)
Manual sliding rear window
Tire step

Travel equipment

Console
Console armrest
Daytime running lights
Factory luggage rack
Factory luggage rack adapters
Fog lights
Framed luggage covers
Heavy-duty battery
Neutral towing transfer case kit (Explorer 4.0L only)
Off road lights
Pickup box rails
Removable luggage rack
Removable luggage rack adapters
Retractable bed hooks and loops
Running boards
Snow traction cables
Soft luggage cover
Speed control
Towing mirrors
Trailer hitch
Trailer hitch bars and balls
Trailer hitch wiring adaptor

Customer assistance

Protection and appearance equipment

Air bag anti-theft locks
Bed mat/bedliner tailgate covers
Bed mats
Bedliners
Car/truck covers
Cargo liners, interior
Carpet floor mats
Cleaners, waxes and polishes
Flat splash guards
Front end covers (full and mini)
Hood deflectors
Locking gas cap
Lubricants and oils
Molded splash guards
Molded vinyl floor mats
Rallye bars
Rear air deflectors
Rear decklid spoilers
Side window air deflectors
Spare tire lock
Step bumpers
Step/sill plates
Tailgate covers
Tailgate lock
Tailgate protection
Tonneau covers
Touch-up paint
Universal floor mats

For maximum vehicle performance, keep the following information in mind when adding accessories or equipment to your vehicle:

- When adding accessories, equipment, passengers and luggage to your vehicle, do not exceed the total weight capacity of the vehicle or of the front or rear axle (GVWR or GAWR as indicated on the Safety compliance certification label). Consult your dealer for specific weight information.
- The Federal Communications Commission (FCC) and Canadian Radio Telecommunications Commission (CRTC) regulate the use of mobile communications systems – such as two-way radios, telephones and theft alarms – that are equipped with radio transmitters. Any such equipment installed in your vehicle should comply with FCC or CRTC regulations and should be installed only by a qualified service technician.

Customer assistance

- Mobile communications systems may harm the operation of your vehicle, particularly if they are not properly designed for automotive use or are not properly installed. When operated, such systems may cause the engine to stumble or stall. In addition, such systems may be damaged or their performance may be affected by operating your vehicle. (Citizens band [CB] transceivers, garage door openers and other transmitters with outputs of five watts or less will not ordinarily affect your vehicle's operation.)
- Ford cannot assume responsibility for any adverse effects or damage that may result from the use of such equipment.

ORDERING ADDITIONAL OWNER'S LITERATURE

To order the publications in this portfolio:

Make checks payable to:
HELM, INCORPORATED
P.O. Box 07150
Detroit, Michigan, 48207

For a free publication catalog, order toll free: 1-800-782-4356

Monday–Friday 8:00 a.m. – 6:00 p.m. EST,
for credit card holders only.

Reporting safety defects

REPORTING SAFETY DEFECTS (U.S. ONLY)

If you believe that your vehicle has a defect that could cause a crash, or could cause injury or death, you should immediately inform the National Highway Traffic Safety Administration (NHTSA) in addition to Ford Motor Company.

If NHTSA receives similar complaints, it may open an investigation, and if it finds that a safety defect exists in a group of vehicles, it may order a recall and remedy campaign. However, NHTSA cannot become involved in individual problems between you, your dealer or Ford Motor Company.

To contact NHTSA, you may either call the Auto Safety Hotline toll-free at 1-800-424-9393 (202-366-0123 in the Washington D.C. area) or write to:

NHTSA
U.S. Department of Transportation
400 Seventh Street
Washington D.C. 20590

You can also obtain other information about motor vehicle safety from the Hotline.

Index

A	Page	B	Page
Air bag disposal	137	Backup lamps	253
Air bag readiness light	11	Base curb weight	169
Air bag supplemental restraint system	128	Battery	193, 225, 266
Air bag system, side	134	Belt Minder	120
Air conditioning	31	Brake lamp, high mounted . . .	254
Air filter	266	Brake lamps	253
Alarm, activating panic	103	Brake system warning light . . .	13
Anti-lock brake system (ABS) light	14	Brake-shift interlock	160
Anti-lock braking system (ABS)	156	Brake/clutch fluid	213, 268
Anti-theft protection panel	35	Brakes	156
Anti-theft system	106	Break-in period	3
Antifreeze. <i>See</i> Engine coolant		Bulb replacement	249
Ashtray	28	Bulb specifications	255
Audio System	35	C	
Automatic transaxle	160	Cabin air filter	34, 229, 266
Automatic transaxle fluid	222	Capacities	267
		Car care products	280
		Carbon monoxide in exhaust . .	245
		Cargo cover	101
		Catalytic converter	10, 245
		Charging system warning light .	13
		Check engine light	8
		Child restraint precautions . . .	139
		Child safety seats	141
		Child safety seats, installing . .	143
		Child safety seats, tether straps	146

Index

C	Page	E	Page
Children and air bags	130	Electrical system	182
Children and safety belts	140	Emergencies, roadside	180
Children and safety restraints	138	Emission control system	8, 245
Chimes	17	Engine block heater	155
Climate controls	29	Engine compartment	207
Clock	27	Engine coolant	214, 268
Clutch fluid	213	Engine coolant temperature gauge	18
Clutch operation	166	Engine data	269
Controls and features	24	Engine oil	267, 268
Cruise control. <i>See</i> Speed control		Engine oil pressure warning light	13
Customer assistance	272	Engine, cleaning	262
D		Entry system, remote	102
Danger of ice warning light	22	Exhaust fumes	151
Daytime running lights (DRL)	25	F	
Defrost, windshield	33	Flash-to-pass	88
Digital clock	27	Flasher, hazard	86, 180
Dimensions	270	Flashing the lights	88
Dipstick, engine oil	207	Floor mat	97
Dispute settlement board	275	Floor mounted controls	96
Door ajar light	23	Foglamps	11, 25
Door locks	96, 102	Foglamps, replacing bulbs	252
Door mounted controls	95	Frost warning light	22
Driving	163	Fuel consumption	179
Driving with a heavy load	172	Fuel filler cap	243
Driving with a trailer	173	Fuel filter	266

Index

F	Page	H	Page
Fuel gauge	20	Hazard flasher control	86, 180
Fuel pump shut-off switch	97, 180	Head restraints	109
Fuel quality	242	Headlamp aiming	256
Fuel tank	267	Headlamp control	24
Fuel, calculating fuel economy	244	Headlamps on warning chime . .	17
Fuel, choosing	240	Headlamps, aiming	252
Fuel, octane recommendations	241	Headlamps, replacing bulbs . .	249
Fuel, safety information	238	High beams	12, 88
Fuse panels	183, 185, 187	High mounted brake lamp	254
Fuses and relays	182	Hood, opening	206
		Horn	86
G		I	
Gross axle weight rating (GAWR)	170	Icons	2
Gross combined weight (GCW)	170	Idle speed	269
Gross vehicle weight (GVW) . .	169	Idle, relearning	228
Gross vehicle weight rating (GVWR)	170	Ignition positions	85
		Instrument cluster	8
		Instrument cluster gauges	18
		Instrument panel controls	24
		Instrumentation	6
		Interior lamps	93
		Interior lamps, replacing bulbs	255
		Introduction	2

Index

J	Page	M	Page
Jack	190	Maintenance and care	202
Jack positioning	191	Manual transaxle	166
Jump starting	193	Mileage, calculating fuel economy	244
K		Mirrors	95
Key coding	108	Motorcraft parts	266
Key-in-ignition warning chime .	17	N	
Keys	106	National Highway Traffic Safety Administration	284
L		O	
License plate lamp	254	Octane rating	241
Liftgate	98	Odometer	19
Lights, warning and indicator	8, 16	Oil filter	266
Load limits	169	On board diagnostic (OBD-II) system	248
Loading your vehicle	169	On-board diagnostic	8
Low coolant warning light	14	Overdrive	15, 164
Lubricant specifications	268	Overhead controls	93
Luggage compartment	98, 103	Overhead warning lights	21
Luggage compartment lamp ..	254	Owner's literature	283

Index

P	Page	R	Page
Panel dimmer control	25	Reading lamps	94
Panic alarm	103	Reading lamps, replacing bulbs	255
Parking brake	96, 158	Rear seats	112
Parking lamps, replacing bulbs	251, 253	Rear window defroster	28
Parts	266	Rear window wipers and washer	89
Passenger compartment fuse panel	185	Recreational towing	200
Passive anti-theft system (PATS)	106	Refill capacities	267
Payload	169, 171	Relays	186
PCV valve	266	Remote keyless entry system	102
Power distribution box	183	Replacing the battery, remote entry system	103
Power door locks	96	Reporting safety defects	284
Power mirrors	95	Restraints, safety	113
Power seats	111	Roadside assistance	272
Power steering	160, 267, 268	Rotating the tires	234
Power windows	96		

S

Safety belt extension assembly	126
Safety belt height	118
Safety belt maintenance	126, 265
Safety belt warning chime	17, 119
Safety belt warning light	12, 119
Safety belts	12, 113
Safety Compliance Certification Label	175

Index

S	Page	T	Page
Safety defects, reporting	284	Tachometer	19
Safety restraint locking modes	116	Tail lamps	253
Safety restraints	12, 113	Temperature control	30
Safety restraints, cleaning	265	Testing the warning and indicator lights	16
Safety seats for children	141	Tilt steering wheel	86
Seating and safety restraints . .	109	Tires, changing	188
Seats	109	Tires, checking the pressure . .	234
Service intervals light	21	Tires, replacing	235
Service plan	273	Tires, rotating tires	234
Servicing your vehicle	202	Tires, snow tires and chains . .	237
Shift speeds	167	Tires, spare	189
Shift-lock system	161	Tires, tire grades	231
Side marker lamps	253	Tires, treadwear	232
Snow tires and chains	237	Towing your vehicle	199, 200
Spare tire	189	Traction control light	12
Spark plugs	266, 269	Traction control system	12, 28, 159
Specifications	266	Trailer towing	173
Speed control	11, 90	Transaxle	160
Speedometer	19	Transaxle, automatic	267, 268
Starting	149, 152	Transaxle, manual	267, 268
Steering column controls	85	Trip computer	26
Sunroof	94	Trip odometer	19
		Trunk. <i>See</i> Luggage compartment	
		Turn signal, replacing front bulbs	250
		Turn signals	11, 87
		Turn signals, replacing bulbs . .	253

U	Page
Used automotive fluids, disposal	212
V	
Vehicle care	259
Vehicle Emission Control Information (VECI)	245, 247
Vehicle identification number (VIN)	271
Vehicle symbol glossary	4
Ventilating your vehicle	150
Vents	29
W	
Washer fluid warning light	23
Washing your vehicle	259
Waxing your vehicle	260
Weight limits	169
Wheels, inspection and maintenance	234, 261
Windows	96
Windshield washer system ...	213
Windshield wipers and washer .	88
Wiper blades	229
Wrecker towing	199

Filling station information

Fuel	UNLEADED FUEL ONLY Octane 87 (Cougar S: Octane 91)
Fuel tank capacity	58.5 litres (15.4 gallons)
Engine oil	Use Super Premium SAE 5W-20 Motor Oil or equivalent meeting Ford specification WSS-M2C153-H
Tire size and pressure	Refer to the tire instruction decal on the passenger's door
Hood release location	Pull handle under the left side of the instrument panel
Fuel filler location	Right rear of vehicle