

## A Word to Mazda Owners

Thank you for choosing a Mazda. We at Mazda design and build vehicles with complete customer satisfaction in mind.

To help ensure enjoyable and trouble-free operation of your Mazda, read this manual carefully and follow its recommendations.

An Authorized Mazda Dealer knows your vehicle best. So when maintenance or service is necessary, that's the place to go.

Our nationwide network of Mazda professionals is dedicated to providing you with the best possible service.

We assure you that all of us at Mazda have an ongoing interest in your motoring pleasure and in your full satisfaction with your Mazda product.

**Mazda Motor Corporation**  
HIROSHIMA, JAPAN

### Important Notes About This Manual

Keep this manual in the glove box as a handy reference for the safe and enjoyable use of your Mazda. Should you resell the vehicle, leave this manual with it for the next owner.

Please be aware that this manual applies to all models, equipment and options. As a result, you may find some explanations for equipment not installed on your vehicle.

All specifications and descriptions are accurate at the time of printing. Because improvement is a constant goal at Mazda, we reserve the right to make changes in specifications at any time without notice and without obligation.

### Air Conditioning and the Environment

Your Mazda's genuine air conditioner is filled with R134a, a refrigerant that has been found not to damage the earth's ozone layer. If the air conditioner does not operate properly, consult an Authorized Mazda Dealer.

©2000 Mazda Motor Corporation  
Printed in Japan Jul. 2000 (Print2) ©

## How to Use This Manual

---

We want to help you get the most driving pleasure from your vehicle. Your owner's manual, when read from cover to cover, can do that in many ways.

Illustrations complement the words of the manual to best explain how to enjoy your Mazda. By reading your manual, you can find out about the features, important safety information, and driving under various road conditions.

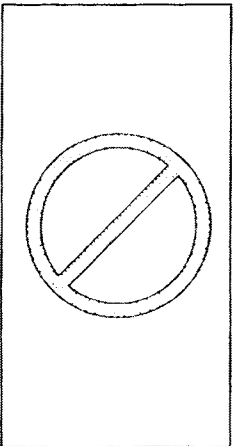

The above symbol in this manual means "Do not do this" or "Do not let this happen".

**Index:** A good place to start is the Index, an alphabetical listing of all information in your manual.

**Sections:** This manual has eleven sections. Sections 1 through 10 begin with a brief list of contents, so you can usually tell at a glance if that section has the information you want.

You'll find several **WARNINGS**, **CAUTIONS**, and **NOTES** in the manual.

### **WARNING**

*A **WARNING** indicates a situation in which serious injury or death could result if the warning is ignored.*

### **CAUTION**

A **CAUTION** indicates a situation in which bodily injury or damage to your vehicle, or both, could result if the caution is ignored.















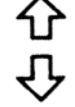



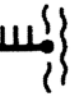





### **NOTE**

A **NOTE** provides information and sometimes suggests how to make better use of your vehicle.

## How to Use This Manual

### Graphic symbols:

Some of the following symbols are used to identify controls and displays on your vehicle.

	LIGHTS		HEADLIGHT HIGH BEAM		HEADLIGHT LOW BEAM		PARKING LIGHTS		ILLUMINATION CONTROL		TURN SIGNALS		HAZARD WARNING FLASHER
	HOOD RELEASE		TRUNK RELEASE		FUEL		ENGINE COOLANT TEMPERATURE		ENGINE OIL		BATTERY CHARGING SYSTEM		SEAT BELTS
	BRAKE SYSTEM		VENTILATION FAN		AIR RECIRCULATION		FRESH AIR		VENT		VENT-FLOOR		FLOOR
	FLOOR DEFROSTING		DEFROSTING		REAR WINDOW DEFROSTER		WINDSHIELD WIPER & WASHER		LIGHTER		HORN		WASHER FLUID



## **Table of Contents**

---

<b>Your Vehicle at a Glance</b>	<b>1</b>
<b>Essential Safety Equipment</b>	<b>2</b>
<b>Knowing Your Mazda</b>	<b>3</b>
<b>Protecting Your Mazda</b>	<b>4</b>
<b>Driving Your Mazda</b>	<b>5</b>
<b>In Case of an Emergency</b>	<b>6</b>
<b>Appearance Care</b>	<b>7</b>
<b>Maintenance</b>	<b>8</b>
<b>Customer Information</b> Including Information on How to Report Safety Defects (page 9-9)	<b>9</b>
<b>Specifications</b>	<b>10</b>
<b>Index</b>	<b>11</b>



# 1

## Your Vehicle at a Glance



*Your Mazda is a complex vehicle, but the design throughout considers your safety and comfort paramount. This requires many controls, locks, graphic symbols, mechanisms and amenities that need to be understood for proper operation.*

*Section 1 illustrates this information to familiarize you with what needs to be known to help make your motoring safer and easier, and lots more fun.*

Interior Overview	I-2
Instrument Panel Overview	I-3
Doors	I-4
Luggage Compartment	I-6

## Your Vehicle at a Glance

### Interior Overview

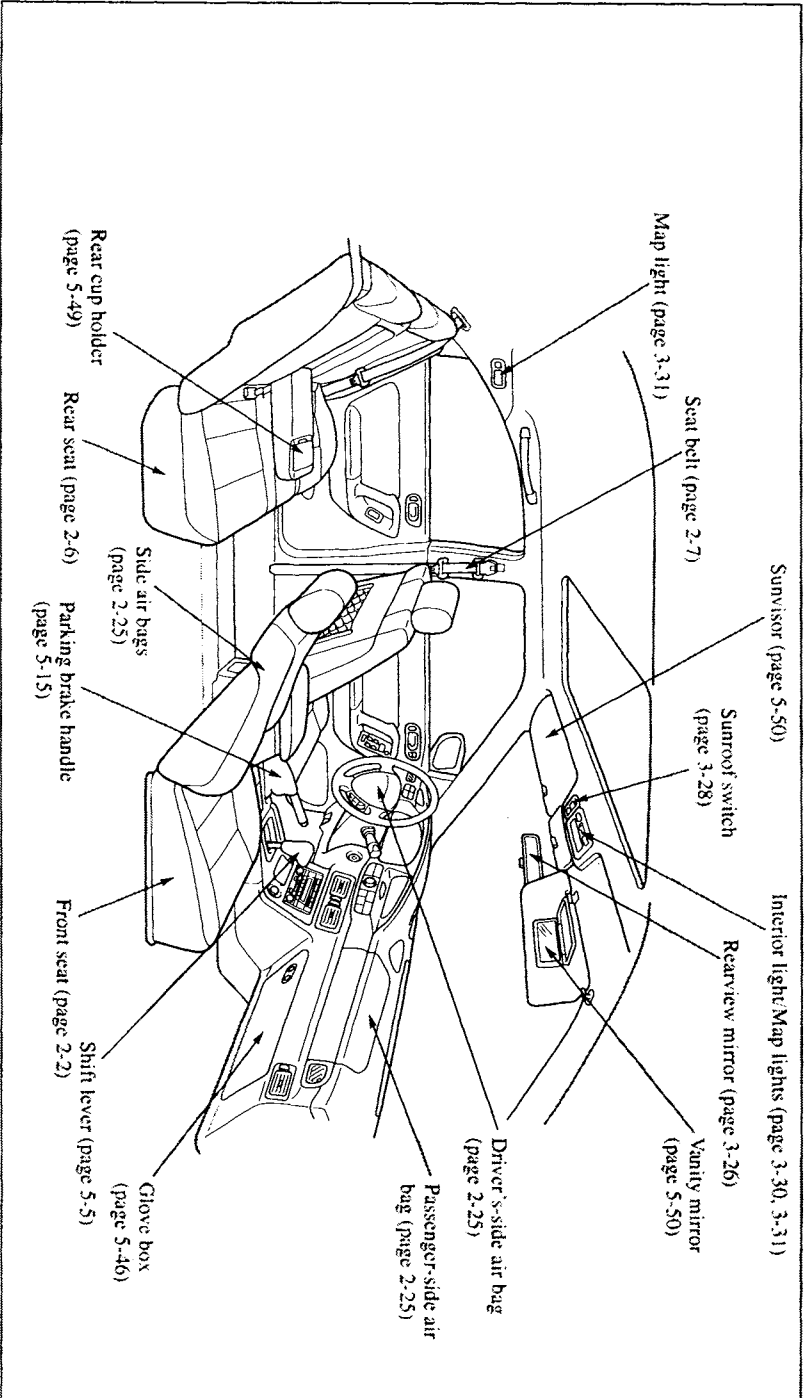



## Dashboard Overview

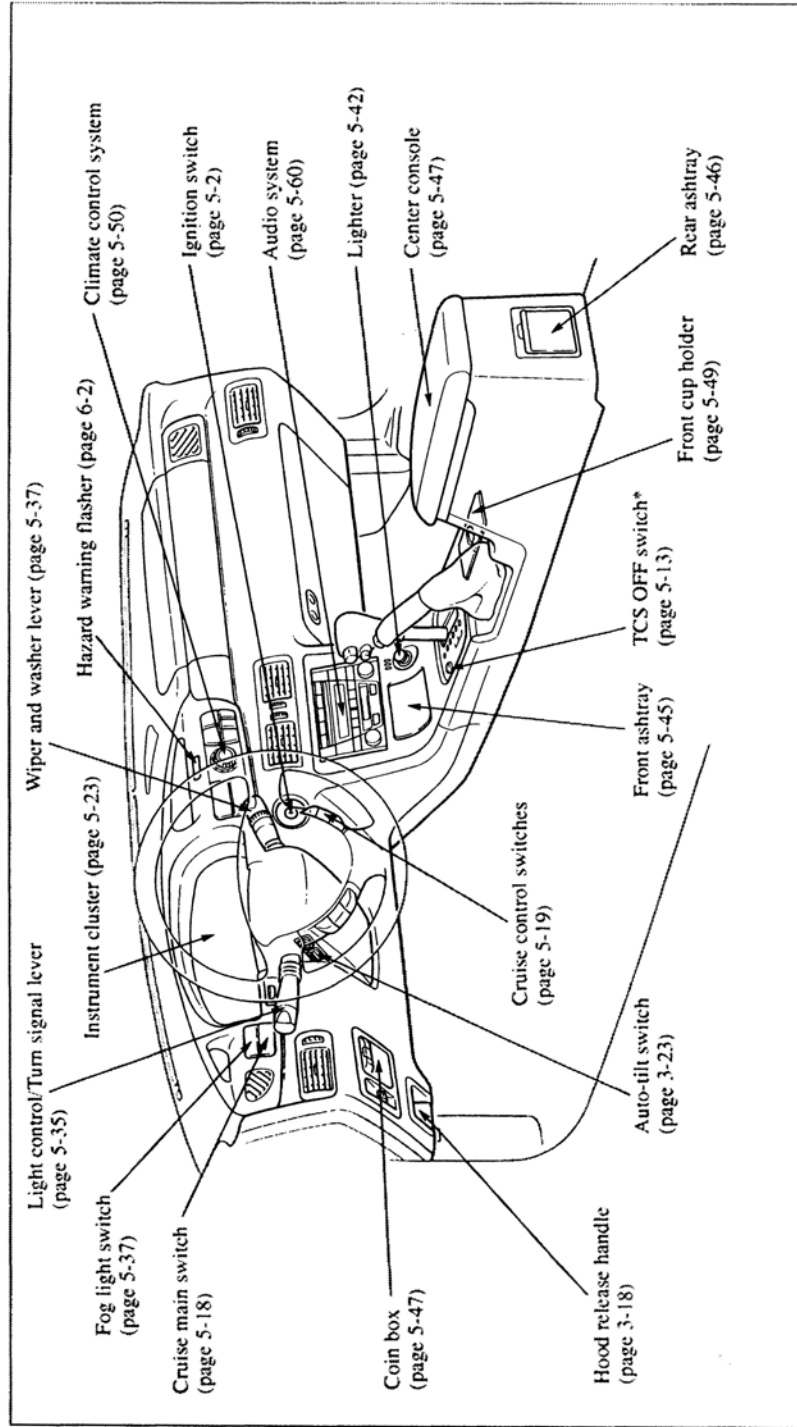

Your Vehicle at a Glance

DOORS

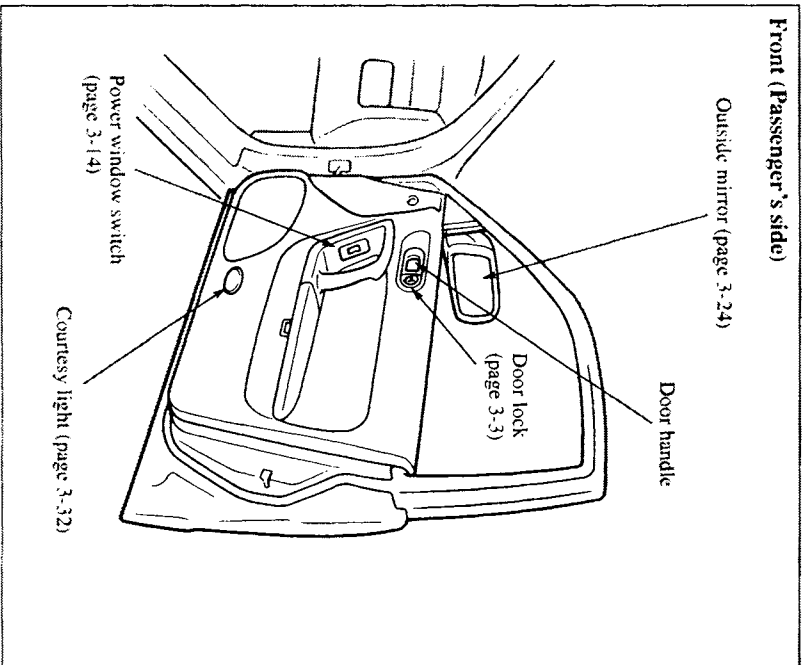
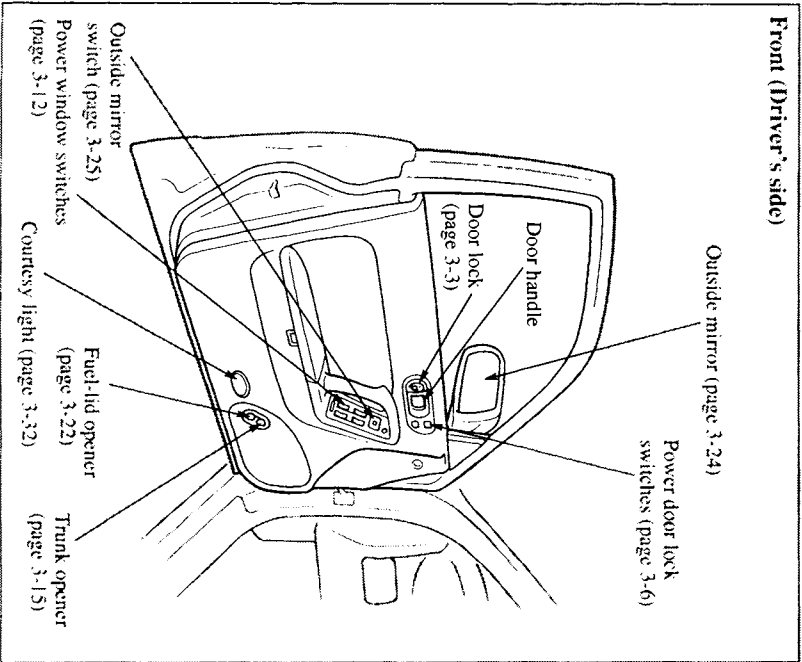

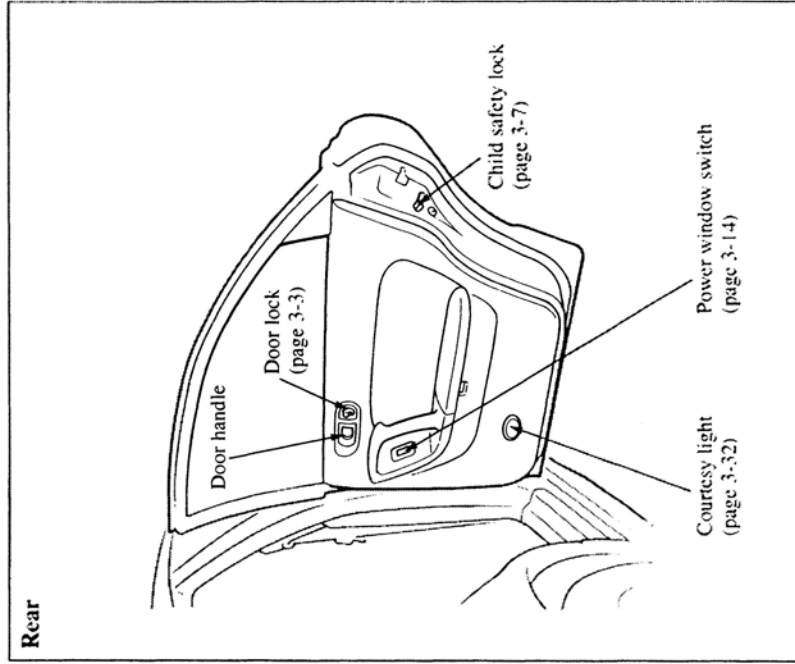

Your Vehicle at a Glance

### Luggage Compartment

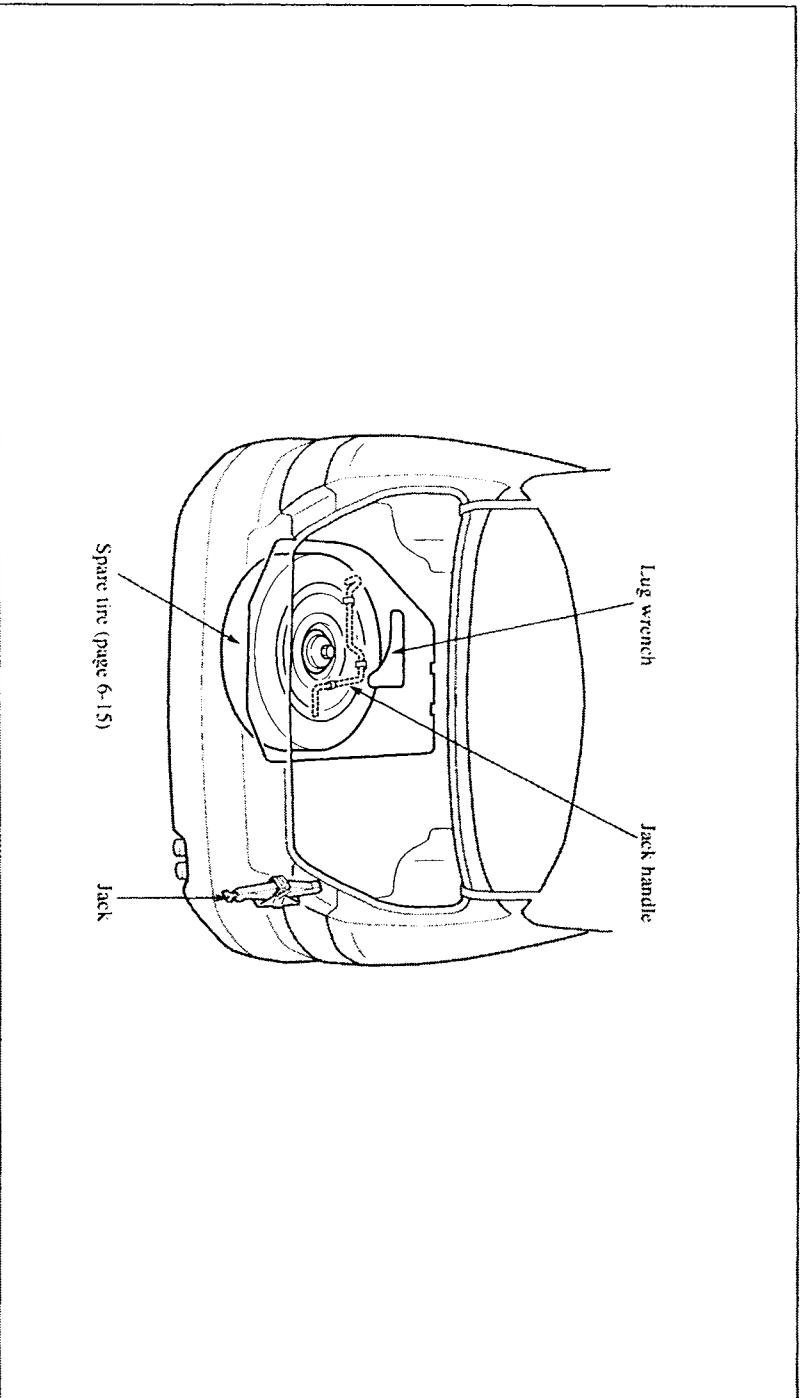

# 2

## Essential Safety Equipment

*Personal safety and comfort are what make driving your Mazda a pleasurable experience. Section 2 describes essential information for optimal safe driving including seats, seat belt systems and the supplemental restraint systems.*

Front Seats	2- 2
Seat Warmer	2- 5
Rear Seat	2- 6
Seat Belt Systems	2- 7
Child Restraint	2-16
Supplemental Restraint Systems	2-25

## Essential Safety Equipment

### Front Seats

The seat-bottom tilt, seat height, seat slide, and seat recline can be electrically adjusted. Move them to the desired positions by using the switch on the seat's lower side.

### CAUTION

- The seat-bottom power adjust is operated by a motor. Avoid extended operation because excessive use can damage the motor.
- To prevent the battery from running down, avoid using the power adjust when the engine is stopped. The adjuster uses a great amount of electric power.
- Don't use the switch to make more than one adjustment at a time.

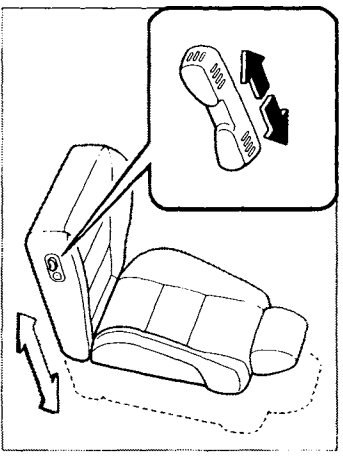

#### ■ Seat Slide

To slide the seat, move the slide lifter switch on the outside of the seat to the front or back and hold it. Release the switch when the seat is where you want it.

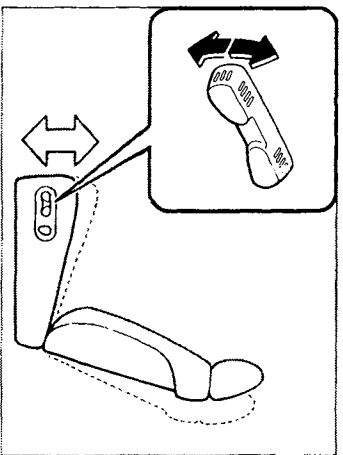

#### ■ Seat-Bottom Front Height Adjustment\*

To adjust the front height of the seat-bottom, raise or lower the front of the slide lifter switch on the left side of the seat.

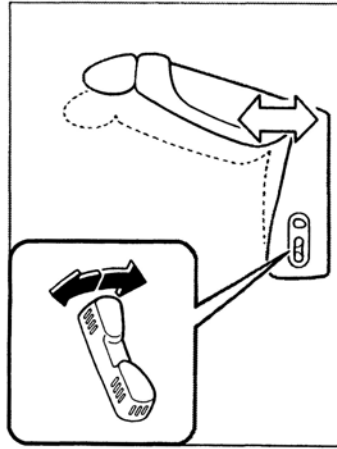

■ **Seat-Bottom Rear Height Adjustment\***

Raise or lower the back of the seat to adjust the rear height of the seat-bottom.

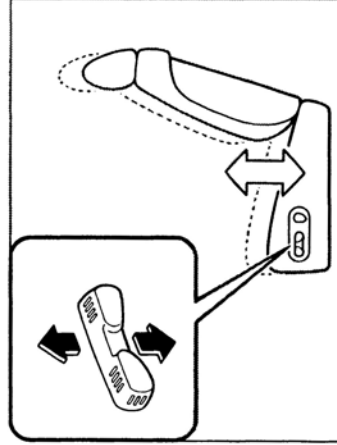

■ **Seat Height Adjustment\***

Raise the seat-bottom by pulling up on the center of the switch. Release the switch when the seat is where you want it.

Lower the seat-bottom by pressing down on the center and releasing it when the seat is where you want it.

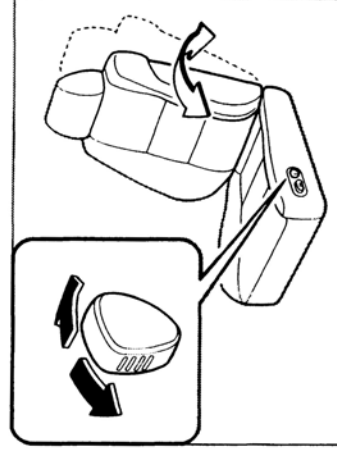

■ **Seat Recline**

Change the seatback angle by turning the reclining switch. When the seatback is at the angle you want, release the switch.

\*Some models.

**⚠ WARNING**

**Reclining:**  
*Sitting in a reclined position while the vehicle is moving is dangerous because you don't get the full protection from seat belts. During sudden braking or a collision, you can slide under the lap belt and suffer serious internal injuries. For maximum protection, sit well back and upright.*

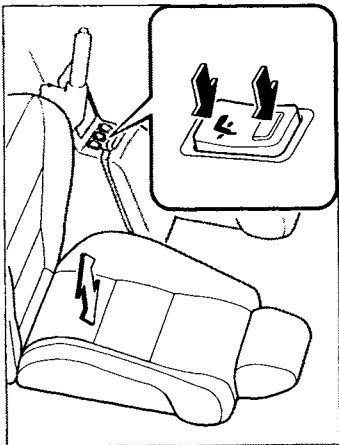

■ **Lumber Support Adjustment (Driver's Seat)**

The lumber support switch is located at the front of the center console. To increase seat firmness, press and hold the upper part of the switch to the desired position, then release the switch.

Press the lower part of the switch to increase softness.

■ **Head Restraint**

**⚠ WARNING**

**Head Restraints Adjustment:**  
*Driving with the head restraints adjusted too low or removed is dangerous. With no support behind your head, your neck could be seriously injured in a collision. Always drive with the head restraints inserted when seats are being used and make sure they are properly adjusted.*



## Essential Safety Equipment

### Seat Warmer\*

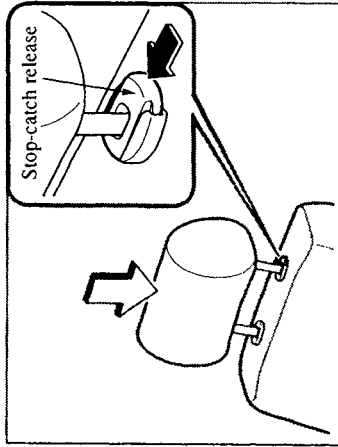

#### ▼ Height adjustment

To raise a head restraint, pull it up to the desired position.

To lower the head restraint, press the stop-catch release, then push the head restraint down.

Adjust the head restraint so that the top parallels the top of the passenger's ears, never the passenger's neck.

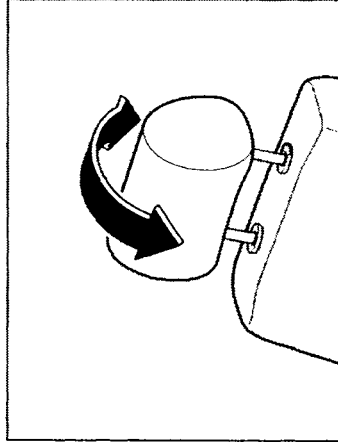

#### ▼ Angle adjustment (Driver's seat)

To adjust the head restraint angle apply pressure to the top of the head restraint and change the angle to the desired position.

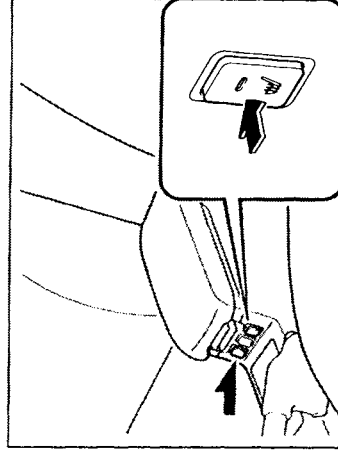

The front seats are electrically heated. The ignition switch must be in the ON position.

Press the switch to turn the seat warmer on or off. When the switch is in the ON position, the indicator light will come on.

#### NOTE

The thermostat regulates seat temperature by turning the current on and off.

\*Some models.

Essential Safety Equipment

Rear Seat

**⚠ WARNING**

Stacking Cargo:

*Stacking luggage or other cargo higher than the seatbacks or putting things on the rear package tray is dangerous. During sudden braking or a collision, objects can become projectiles that may hit and injure passengers. Don't stack things higher than the seatbacks or put things on the rear package tray.*

■ Head Restraint

**⚠ WARNING**

Head Restraints Adjustment:

*Driving with the head restraints adjusted too low or removed is dangerous. With no support behind your head, your neck could be seriously injured in a collision. Always drive with the head restraints inserted when seats are being used and make sure they are properly adjusted.*

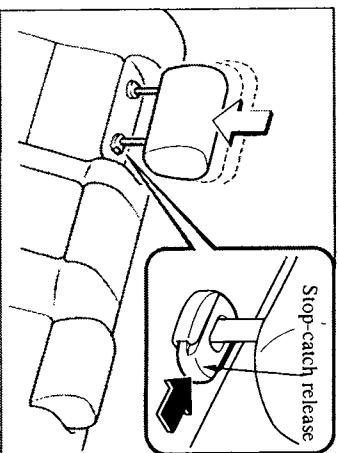

▼ Height adjustment\*

To raise the head restraint, pull it up to the desired position.

To lower the head restraint, press the stop-catch release, then push the head restraint down.

Adjust the head restraint so that the top parallels the top of the passenger's ears, never the passenger's neck.

## Seat Belt System

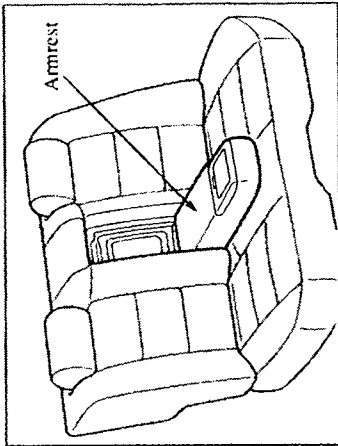

### ■ Armrest

The armrest can be used or placed upright.

Seat belts help to decrease the possibility of severe injury during accidents and sudden stops. Mazda recommends that the driver and all passengers always wear seat belts.

All of the door-side seat belt retractors are designed to keep the lap/shoulder belts out of the way when not in use.

The driver's seat belt has no provisions for child-restraint systems and has only an emergency locking mode. The driver may wear it comfortably, and it will lock during a collision.

However, the front passenger's seat and rear door-side lap/shoulder belt retractors operate in two modes, emergency locking mode and for child-restraint systems, automatic locking mode.

The rear center seat positions have a lap belt with manual adjustment.

### Emergency locking mode

If the belt has fully retracted, it will always be in the emergency locking mode until you move it into automatic locking mode by pulling the belt all the way out to its full length. In the emergency locking mode, the belt remains comfortable on the occupant and the retractor will lock in position during a collision.

If the belt feels tight and hinders comfortable movement while the vehicle is stopped or in motion, you may be in the automatic locking mode because you have pulled the belt too far out. To return to the more comfortable emergency locking mode, wait until you can stop the vehicle in a safe area, retract the belt fully to convert it back to emergency locking mode and then again extend it around you.

**Automatic locking mode**

Always use the automatic locking mode to keep the child-restraint system from shifting to an unsafe position in the event of an accident. To get the seat belt into the automatic locking mode, pull it all the way out and connect it as instructed on the child-restraint system. It will retract down to the child-restraint system and stay locked on it. See the section on child restraint (page 2-16).

 **WARNING**

***Not Wearing Seat Belts:***  
*Not wearing a seat belt is extremely dangerous. During a collision, occupants not wearing seat belts could hit someone or things inside the vehicle or even be thrown out of the vehicle. They could be seriously injured or even killed. In the same collision, occupants wearing seat belts would be much safer. Always wear your seat belt and make sure all occupants are properly restrained.*

 **WARNING**

***Seat Belt Damaged During an Accident:***  
*Using a damaged seat belt is dangerous. An accident could damage the belt webbing in use. A damaged seat belt cannot provide adequate protection in a collision. Have an Authorized Mazda Dealer inspect all seat belt systems in use during an accident before they are used again.*

**⚠ WARNING**

**Twisted Seat Belts:**  
*Twisted seat belts are dangerous. In a collision, the full width of the belt isn't available to absorb the impact. This puts more force on the bones beneath the belt, which could break them or cause other serious injury or death. Don't wear twisted seat belts.*

**⚠ WARNING**

**One Belt, One Passenger:**  
*Using one seat belt for more than one person at a time is dangerous. A seat belt used in this way can't spread the impact forces properly and the two passengers could be crushed together and seriously injured or even killed. Never use one belt for more than one person at a time.*

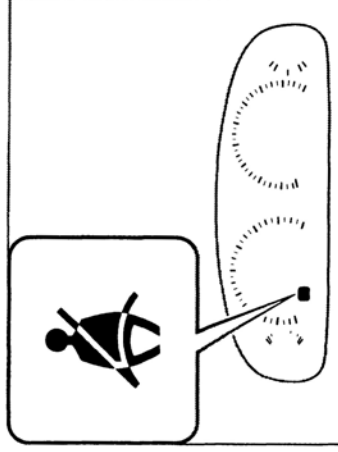

■ **Seat Belt Warning Light/Beep**

If the driver's seat belt is not fastened when the ignition switch is turned to the ON position, a beep will sound for about 6 seconds and the seat belt warning light will remain on until the belt is fastened.

If the system does not operate correctly, consult an Authorized Mazda Dealer.

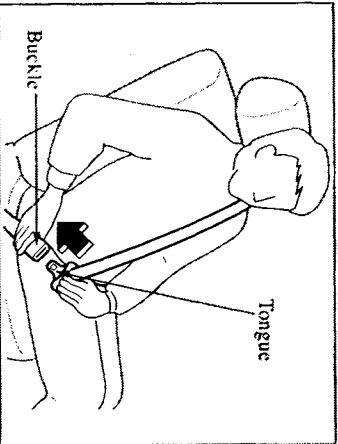

■ **Front Seat Belts**

To fasten:

1. Grasp the buckle and tongue.
2. Slowly pull out the lap/shoulder belt.
3. Insert the tongue into the buckle until you hear a click.
4. Make sure the shoulder belt is snugly fitted against your body.

**⚠ WARNING**

***Positioning the Shoulder Portion of the Seat Belt:***

***Improper positioning of the shoulder portion of the seat belt is dangerous. An improperly positioned belt will provide little or no protection in a collision. Always make sure the shoulder portion of the seat belt is positioned across your shoulder and near your neck, but never under your arm, on your neck, or on your upper arm.***

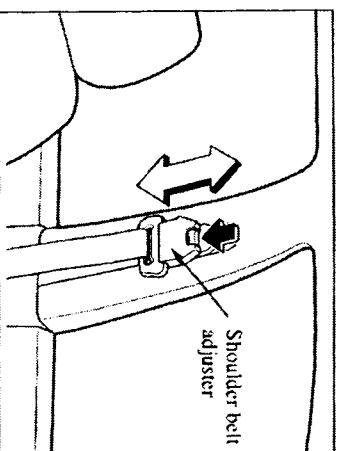

This adjuster the shoulder belt angle for a more comfortable fit. Simply push the button, move it to the desired position, and then release it. Make sure the adjuster is locked.

Essential Safety Equipment

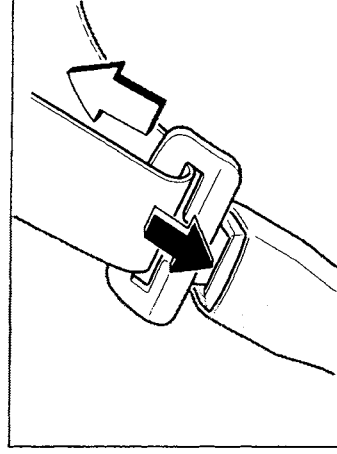
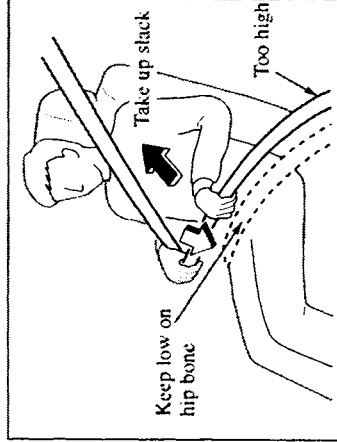
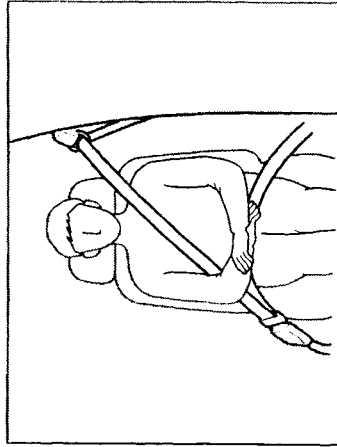

**⚠ WARNING**

***Positioning the Lap Portion of the Seat Belt:***

***The lap portion of the seat belt worn too high is dangerous. In a collision, this would concentrate the impact force directly on the abdominal area, causing serious injury. Wear the lap portion of the belt snugly and as low as possible.***

To unfasten:  
Depress the button on the buckle.

**NOTE**

If a belt does not fully retract, inspect it for kinks and twists.

The retractor will take up excess belt and maintain tension.

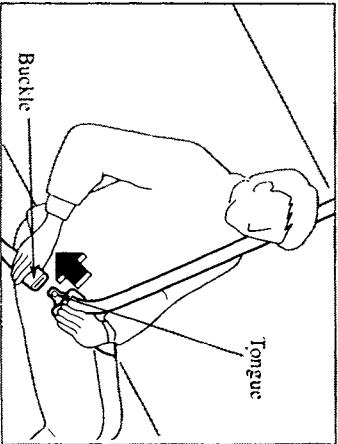

■ Rear Seat Belts

▼ Lap/shoulder belt

To fasten:

1. Grasp the tongue and pull it to the desired length.
2. Insert this tongue into the buckle until you hear a click.
3. Make sure the shoulder belt is snugly fitted against your body.

**⚠ WARNING**

***Positioning the Shoulder Portion of the Seat Belt:***

*Improper positioning of the shoulder portion of the seat belt is dangerous. An improperly positioned belt will provide little or no protection in a collision. Always make sure the shoulder portion of the seat belt is positioned across your shoulder and near your neck, but never under your arm, on your neck, or on your upper arm.*

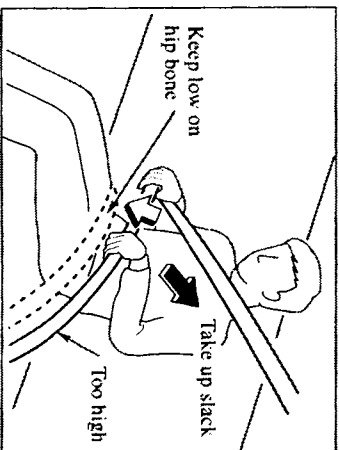

**⚠ WARNING**

***Positioning the Lap Portion of the Seat Belt:***

*The lap portion of the seat belt worn too high is dangerous. In a collision, this would concentrate the impact force directly on the abdominal area, causing serious injury. Wear the lap portion of the belt snugly and as low as possible.*



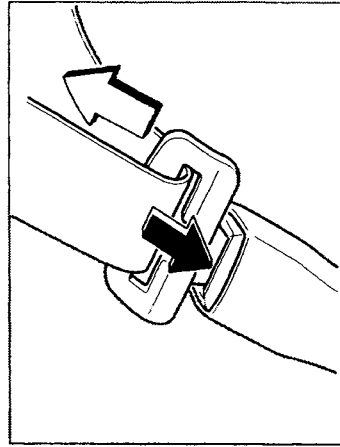

To unfasten:

Depress the button on the buckle.

**NOTE**

If a belt does not fully retract, inspect it for kinks and twists.

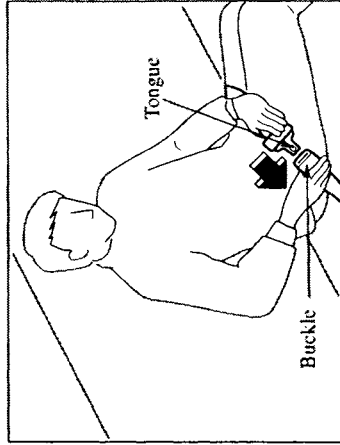

▼ **Lap belt**

To fasten:

1. Pull the tongue to the desired length.
2. Insert it into the buckle until you hear a click.

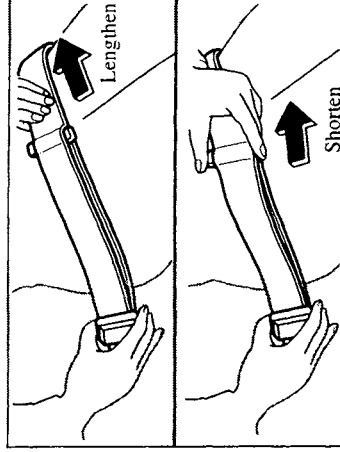

3. Adjust the belt length. To lengthen the belt, hold the tongue at a right angle to the webbing and pull. To shorten, pull the loose end of the webbing.

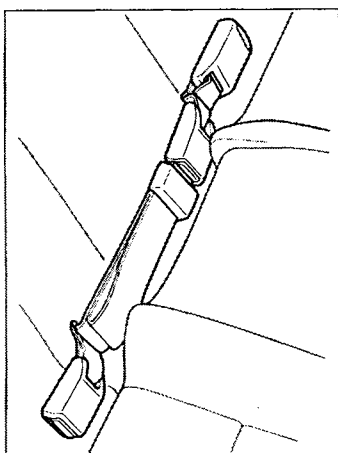
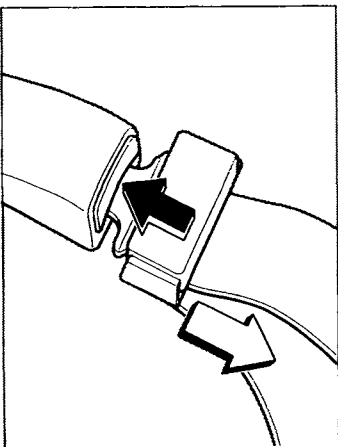
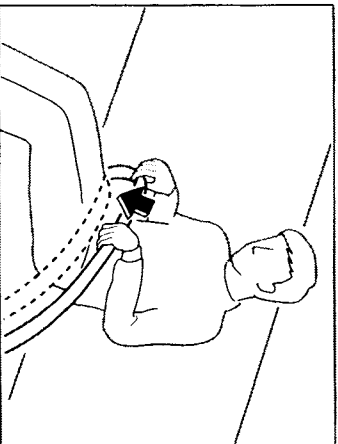

**⚠ WARNING**

**Wearing the Lap Belt:**

*A lap belt worn too high is dangerous. In a collision, this would concentrate the impact force directly on the abdominal area, causing serious injury. Wear the lap belt snugly and as low as possible.*

To unfasten:

Depress the button on the buckle.

**NOTE**

Secure the lap belt in the retainer on the seat when not in use.

■ **Seat Belt Extender**

If your seat belt is not long enough, even when fully extended, a seat belt extender may be available to you at no charge from your Authorized Mazda Dealer. This extender will be only for you and for the particular vehicle and seat. Even if it plugs into other seat belts, it may not hold in the critical moment of a crash. When ordering an extender, only order one that provides the necessary additional length to fasten the seat belt properly. Please contact your Authorized Mazda Dealer for more information.

**⚠ WARNING**

*Unnecessary Use of an Extender:  
Using a seat belt extender when not necessary is dangerous. The seat belt will be too long and not fit properly. In an accident, the seat belt will not provide adequate protection and you could be seriously injured. Only use the extender when it is required to fasten the seat belt properly.*

**⚠ WARNING**

*Using an Improper Extender:  
Using a seat belt extender that is for another person or a different vehicle or seat is dangerous. The seat belt will not provide adequate protection and the user could be seriously injured in an accident. Only use the extender provided for you and for the particular vehicle and seat. NEVER use the extender in a different vehicle or seat.*

## Child Restraint

### **WARNING**

*Using an Extender That is Too Long: Using an extender that is too long is dangerous. The seat belt will not fit properly. In an accident, the seat belt will not provide adequate protection and you could be seriously injured. Don't use the extender or choose one shorter in length if the distance between the extender's buckle and the center of the user's body is less than 15 cm (6 in).*

#### ■ Pregnant Women and Persons with Serious Medical Conditions

Pregnant women should wear seat belts. Ask your doctor for specific recommendations. The lap belt should be worn **SNUGLY AND AS LOW AS POSSIBLE OVER THE HIPS.**

Persons with serious medical conditions also should wear seat belts. Check with your doctor for any special instructions regarding specific medical conditions.

#### ■ Child Restraint Precautions

Statistics confirm that the rear seat is the best place for all children up to 12 years of age-the more so with a supplemental restraint system (air bags).

**⚠ WARNING**

Holding a Child While the Vehicle is Moving:  
*Holding a child in your arms while the vehicle is moving is extremely dangerous. No matter how strong the person may be, he or she cannot hold onto a child in a sudden stop or collision and it could result in serious injury or death to the child or other occupants. Always secure a child in a proper child-restraint system.*

**⚠ WARNING**

One Belt, One Passenger:  
*Using one seat belt for more than one person at a time is dangerous. A seat belt used in this way can't spread the impact forces properly and the two passengers could be crushed together and seriously injured or even killed. Never use one belt for more than one person at a time.*

**⚠ WARNING**

Proper Size of Child-Restraint System:  
*For effective protection in vehicle accidents and sudden stops, a child must be properly restrained using a seat belt or child-restraint system depending on age and size. If not, the child could be seriously injured or even killed in an accident.*

## ⚠ CAUTION

A seat belt or child-restraint system can become very hot in a closed vehicle during warm weather. To avoid burning yourself or a child, inspect either before using.

### ▼ Small children

You are required by law to use a child-restraint system for children in the U.S. and Canada. Small children, generally those who are four years old or younger and who weigh under 18 kg (40 lb), riding in your vehicle must be protected by child-restraint systems made especially for children. Check your local and state or provincial laws for specific requirements regarding the safety of children riding in your vehicle.

### ▼ Older children

A child who has outgrown child-restraint systems should sit in the rear and use seat belts, both lap and shoulder. If the shoulder belt crosses the neck or face, move the child closer to the center.

### ■ Child-Restraint Systems

Whatever child-restraint system you consider, please pick the appropriate one for the age and size of the child, obey state law and follow the instructions that come with the individual child-restraint system.

A rear-facing child-restraint system should never be used in the front seat because it would be too close to the air bag. The front passenger's seat is also the least preferred seat for other child-restraint systems.

**⚠ WARNING**

*Follow the Manufacturer's Instructions and Always Keep the Child-Restraint System Buckled Down.  
An unsecured child-restraint system is dangerous. In a sudden stop or a collision it could move causing serious injury or death to the child or other occupants.  
Make sure the child-restraint system is properly secured in place according to the manufacturer's instructions. When not in use, remove it from the vehicle or fasten it with a seat belt.*

**⚠ WARNING**

*Rear-Facing Child-Restraint Systems on the front seat are particularly dangerous. The child-restraint system can be hit by a deploying air bag and moved violently backward resulting in serious injury or death to the child. Never use a rear-facing child-restraint system in the front seat with an air bag that could deploy.*

■ **Installing Child-Restraint Systems**

Accident statistics reveal that a child is safer in the rear seat. The front passenger's seat is clearly the worst choice for any child under 12, and with rear-facing child-restraint systems it is clearly unsafe due to air bags.

Some child-restraint systems now come with tethers and therefore must be installed on the seats that take tethers to be effective. In your Mazda, tethered child-restraint systems can only be accommodated in the three positions on the rear seat.

**⚠ WARNING**

***Tethered Child-Restraint Systems  
Work Only on Rear Seat:***

*Installation of a tether equipped child-restraint system in the front passenger's seat defeats the safety design of the system and will result in an increased chance of serious injury if the seat goes forward without benefit of being tethered. Place tether equipped child-restraint systems where there are tether anchors.*

**⚠ WARNING**

***Seating Position with Side Air Bag:***

*Allowing a child to lean over or against the front door is dangerous. The impact of an inflating side air bag could cause serious injury or death to the child. Children are more likely to sleep in the vehicle, when they do, they are more at risk in the front passenger's seat that has a side air bag because they may slump over into the path of the seatback-mounted air bag. If a child can't be seated in the rear seat, do not allow the child to lean over or against the front door, even if the child is seated in a child-restraint system.*

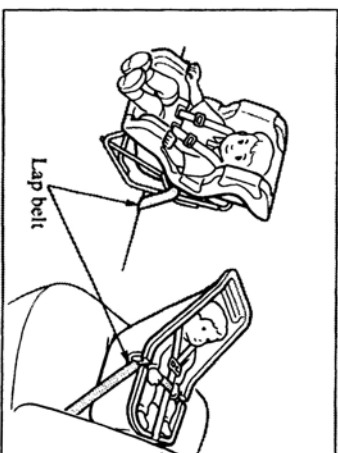

**▼ Rear center seat child-restraint system installation (Lap belt)**

Follow these instructions when using a child-restraint system.

1. Secure the child-restraint system with a lap belt. Adjust for a snug fit by pulling on the loose end of the belt webbing.



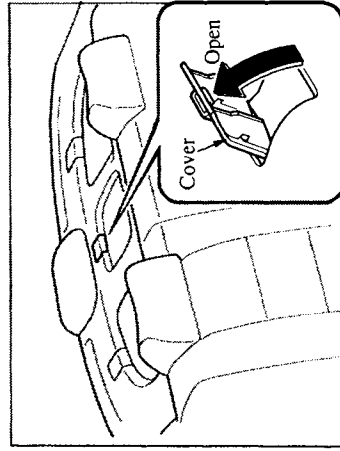

2. If your child-restraint system requires the use of a tether strap, hook the tether strap by following the child-restraint system manufacturer's instructions.

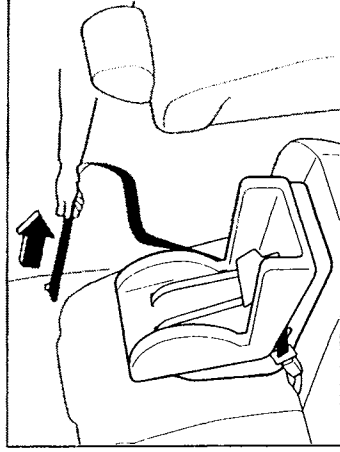
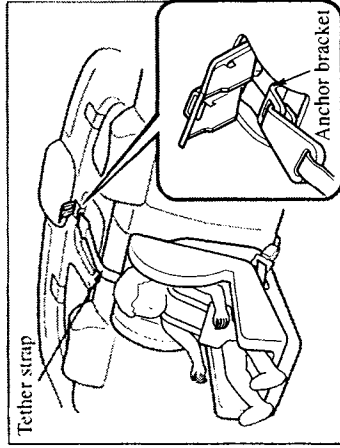

▼ **Rear outboard seat(s) child-restraint system installation (Lap/shoulder belt)**

Follow these instructions when using a child-restraint system.

- 1 Secure the child-restraint system with the lap portion of the lap/shoulder belt. See the instructions on the child-restraint system for belt routing instructions.

## Essential Safety Equipment

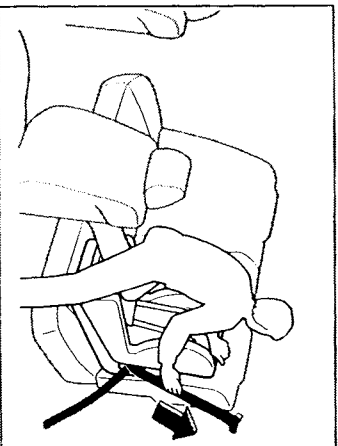

3. Inspect this function before each use of the child-restraint system. You should not be able to pull the shoulder belt out of the retractor while the system is in the automatic locking mode. When you remove the child-restraint system, be sure the belt fully retracts to return the system to emergency locking mode before occupants use the seat belts.

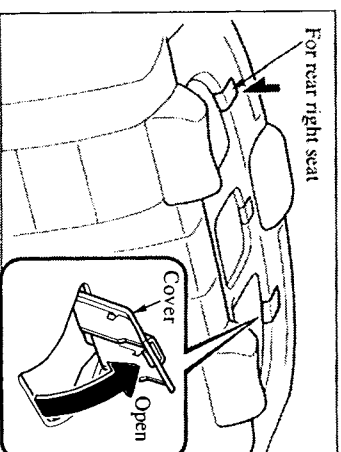

4. If your child-restraint system requires the use of a tether strap, hook the tether strap by following the manufacturer's instructions.

2. To get the retractor into the automatic locking mode, pull the shoulder belt portion of the seat belt until the entire length of the belt is out of the retractor. Push the child-restraint system firmly into the vehicle seat. Be sure the belt retracts as snugly as possible. Clicking from the retractor will be heard during retraction if the system is in the automatic locking mode. If the belt does not lock the seat down tight, repeat this step.

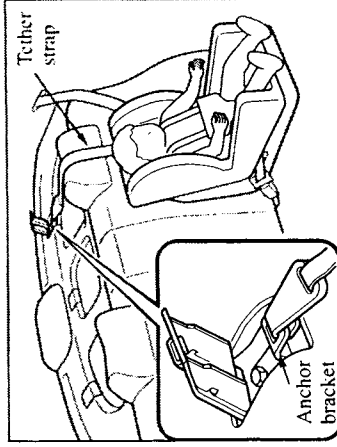

▼ **If you must use the front seat for children**

If you cannot put all children in the rear seat, at least put the smallest in the rear seat and be sure the largest child up front uses the shoulder belt over the shoulder. Do not put rear-facing child-restraint systems on the front passenger's seat. This seat is also not set up for tethered child-restraint systems, put them in one of the three rear seat positions set up with tether anchors.

Don't allow anyone to sleep against the right front door because you have a side air bag, it could cause serious injuries to an out of position occupant. As children more often sleep in cars, it is better to put them in the rear seat. If installing the child-restraint system on the front seat is unavoidable, follow these instructions when using a front-facing child-restraint system in the front passenger's seat.

**⚠ WARNING**

**Front Passenger's Seat Position:**  
*As your vehicle has front air bags and side air bags, a front-facing child-restraint system should be put on the front seat only when it is unavoidable. Always move the seat as far back as possible, because the force of a deploying air bag could cause serious injury or death to the child.*

**⚠ WARNING**

**Rear-Facing Child-Restraint System:**  
*Rear-facing child-restraint systems on the front seat are particularly dangerous. The child-restraint system can be hit by a deploying air bag and moved violently backward resulting in serious injury or death to the child. Never use a rear-facing child-restraint system in the front seat with an air bag that could deploy.*

**⚠ WARNING**

**Seating Position with Side Air Bag:**  
*Allowing a child to lean over or against the front door is dangerous. The impact of an inflating side air bag could cause serious injury or death to the child. Children are more likely to sleep in the vehicle, when they do, they are more at risk in the front passenger's seat that has a side air bag because they may slump over into the path of the seatback-mounted air bag. If a child can't be seated in the rear seat, do not allow the child to lean over or against the front door, even if the child is seated in a child-restraint system.*

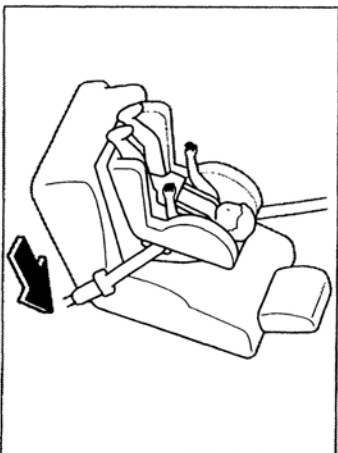

**▼ Front passenger's seat child-restraint system installation (Lap/shoulder belt)**

- 1 Slide the seat as far back as possible.
2. Secure the child-restraint system with the lap portion of the lap/shoulder belt. See the instructions on the child-restraint system for belt routing instructions.

## Supplemental Restraint Systems

3. To get the retractor into the automatic locking mode, pull the shoulder belt portion of the seat belt until the entire length of the belt is out of the retractor. Push the child-restraint system firmly into the vehicle seat. Be sure the belt retracts as snugly as possible. Clicking from the retractor will be heard during retraction if the system is in automatic locking mode. If the belt does not lock the seat down tight, repeat this step.

4. Inspect this function before each use of the child-restraint system. You should not be able to pull the shoulder belt out of the retractor while the system is in the automatic locking mode. When you remove the child-restraint system, be sure the belt fully retracts to return the system to emergency locking mode before occupants use the seat belts.

■ **The front and side supplemental restraint systems include 4 air bags. They are located in:**

- **The steering wheel**
- **The passenger side dashboard**
- **The outboard sides of the front seatbacks**

These systems operate independently depending on the type of accident encountered; both side air bags are not likely to deploy in the same accident because a vehicle is not often hit from both sides. The front and side air bag systems will not normally deploy during the same type of accident unless a combination of frontal and side impacts occur.

In a front-end or side impact, the air bag supplemental restraint systems are designed to provide only supplemental protection for the driver and front seat passenger. Seat belts must still be worn.

Without seat belt usage, the air bags cannot provide adequate protection during an accident. Seat belt usage is necessary to:

- Keep the passenger away from an inflating air bag.
- Reduce the possibility of injuries during an accident that is not designed for air bag inflation, such as roll-over or rear impact.
- Reduce the possibility of injuries in frontal or side collisions that are not severe enough to activate the air bags.
- Reduce the possibility of being thrown from your vehicle.
- Reduce the possibility of injuries to lower body and legs during an accident because the air bags allows no protection to these parts.
- Hold the driver in a position which allows better control of the vehicle.

 **WARNING**

Air Bags without Seat Belts:

*Depending only on the air bags for protection during an accident is dangerous. Alone, air bags may not prevent serious injuries. The appropriate air bags can be expected to inflate only during a frontal, side or rear-frontal collision of at least moderate force. Vehicle occupants should always wear seat belts.*

Small children, those under 18 kg (40 lb), should be protected by a child-restraint system (page 2-16).

 **WARNING**

Child in the Front Seat:

*Placing a child, 12 years or under, in the front seat is dangerous. The child could be hit by a deploying air bag and be seriously injured or even killed. A sleeping child is more likely to lean against the door and be hit by the side air bag in a moderate, right-side collision. Whenever possible, always secure a child 12 years and under on the rear seat with an appropriate child-restraint system for the child's age and size. Never use a rear-facing child-restraint system on the front seat with an air bag that could deploy.*

 **WARNING**

Child-Restraint System Positioning:

*Rear-facing child-restraint systems on the front seat are particularly dangerous. The child-restraint system can be hit by a deploying air bag and moved violently backward resulting in serious injury or death to the child. Never use a rear-facing child-restraint system in the front seat with an air bag that could deploy.*

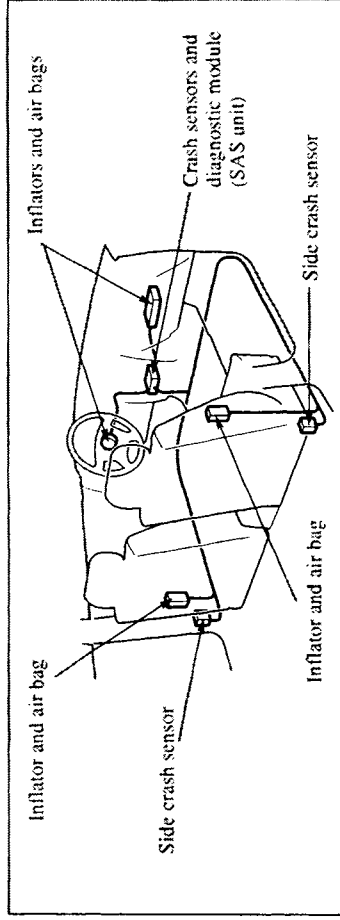

■ **System Description**

The supplemental restraint systems have two basic subsystems:

- The air bag system with inflators and air bags.
- The electric system with crash sensors and diagnostic module.

The air bags are mounted in the following locations:

the center of the steering wheel, the passenger side of the dashboard, and in the outboard sides of the front seatbacks. They are out of sight until activated.



■ **How the Air Bags Work**

When air bag crash sensors detect a frontal or side impact of greater than moderate force, an electrical current is sent to the inflators. Nitrogen and argon gases are produced to inflate the air bags. After the inflation, the air bags quickly deflate.

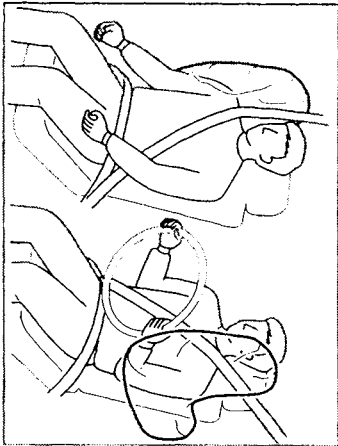

The air bags will function only once. After that, the air bags will not work again and must be replaced.

Only an Authorized Mazda Dealer can replace the systems.

**⚠ WARNING**

**Seating Position with Front Air**

**Bags:**

*Sitting too close to the air bag storage compartments or placing hands or feet on them is extremely dangerous. Front air bags inflate with great force and speed. Serious injuries could occur if someone is too close. The driver should always hold onto only the rim of the steering wheel. The front seat passenger should keep both feet on the floor. Front seat occupants should adjust their seats as far back as possible and always sit upright against the seatbacks with seat belts worn properly.*

**⚠ WARNING**

**Seating Position with Side Air Bags:**

*Sitting too close to the side air bag storage compartments or placing hands on them is extremely dangerous. A side air bag inflates with great force and speed directly out of the outboard shoulder of the front seat and expands along the front door on the side the car is hit. Serious injury could occur if someone is sitting too close to the door or leaning against a window in the front seats or if rear seat occupants grab the sides of the front seatbacks. Furthermore, sleeping up against the door or hanging out the driver's-side window while driving could block the side air bag and eliminate the advantages of supplemental protection. Give the side airbags room to work by sitting in the center of the seat while the vehicle is moving with seat belts worn properly.*



**NOTE**

When an air bag deploys, a loud inflation noise can be heard and some smoke will be released. Neither is likely to cause injury, however, the texture of the air bags may cause light skin injuries on body parts not covered with clothing through friction.



**WARNING**

**Hot Air Bag Inflators:**  
*Hot air bag inflators are dangerous. Immediately after inflation, the inflators in the steering wheel, dashboard or the seatbacks are very hot. You could get burned. Don't touch the internal components of the air bag storage areas after the bags have inflated.*



**WARNING**

**Modification of the Supplemental Restraint System:**  
*Modifying the components or wiring of the supplemental restraint system is dangerous. You could accidentally activate it or make it inoperable. Don't make any modifications to the supplemental restraint system. This includes installing trim, badges, or anything else over the air bag storage areas. It also includes installing extra electric equipment on or near system components or wiring.*  
*An Authorized Mazda Dealer can provide the special care needed in the removal and installation of front seats. It is important to protect the side air bag wiring and connections to assure that the bags do not accidentally deploy and that the seats retain an undamaged air bag connection.*

**⚠ WARNING**

Installation of Front-End

Equipment:

*Installation of front-end equipment, such as frontal protection bar (kangaroo bar, bull bar, push bar, etc.), snowplow, or winches, is dangerous. The air bag crash sensor system could be affected. This could cause air bags to inflate unexpectedly, or it could prevent the air bags from inflating during an accident. Front occupants could be seriously injured. Never install any front-end equipment to your vehicle.*

**⚠ WARNING**

Front Air Bag Storage Areas:

*Attaching an object to a front air bag storage area or placing something in front of it is dangerous. In an accident, the object could interfere with front air bag inflation and injure the occupants. Always keep the front air bag storage areas free of objects.*

**⚠ WARNING**

Side Air Bag Storage Areas:

*Attaching things to the seat in such a way as to cover the outboard side of the seat in any way is dangerous. In an accident the object could interfere with the side air bag, which inflates from the outboard side of the front seats, impeding the added protection of the side air bag system or redirecting the air bag in a way that is dangerous. Furthermore, the bag could be cut open spewing exhaust. Do not hang net bags, map pouches or back pads with side straps on the front seats. Always keep the side air bag storage areas in your front seats free to deploy in the event of a side collision.*

**⚠ WARNING**

Using Seat Covers:  
Using a seat cover on the front seats is dangerous. In a severe side collision, the seat covers could interfere with the side air bag inflation and serious injuries could result. Never use seat covers on the front seats.

**⚠ WARNING**

Damaged Air Bag Sensors:  
Driving with damaged air bag sensors is dangerous. A collision, even one not strong enough to inflate the air bags, could damage the sensors. If there was a subsequent collision, a damaged sensor would not inflate the air bags. Always have an Authorized Mazda Dealer inspect the supplemental restraint systems after a collision.

**⚠ WARNING**

Suspension Adjustment:  
Adjusting the vehicle suspension is dangerous. If the vehicle's height or the suspension is changed, the vehicle will be unable to accurately detect a collision resulting in incorrect or unexpected air bag deployment and the possibility of serious injuries.

**⚠ CAUTION**

To prevent damage to the side air bag wiring, don't place luggage or other objects under the front seats.

## Essential Safety Equipment

### ■ Front Air Bag Activation

A greater than moderate impact will cause the front air bags to inflate in the following cases:

- ① Hitting a solid wall straight on at greater than about 22 km/h (14 mph).
- ② Frontal impact within about a 30 degree range from head on to the vehicle.
- ③ Hitting a curb, pavement edge or hard object.
- ④ Driving into a big hole or hitting the far side of a hole.
- ⑤ Landing hard or the vehicle falling.

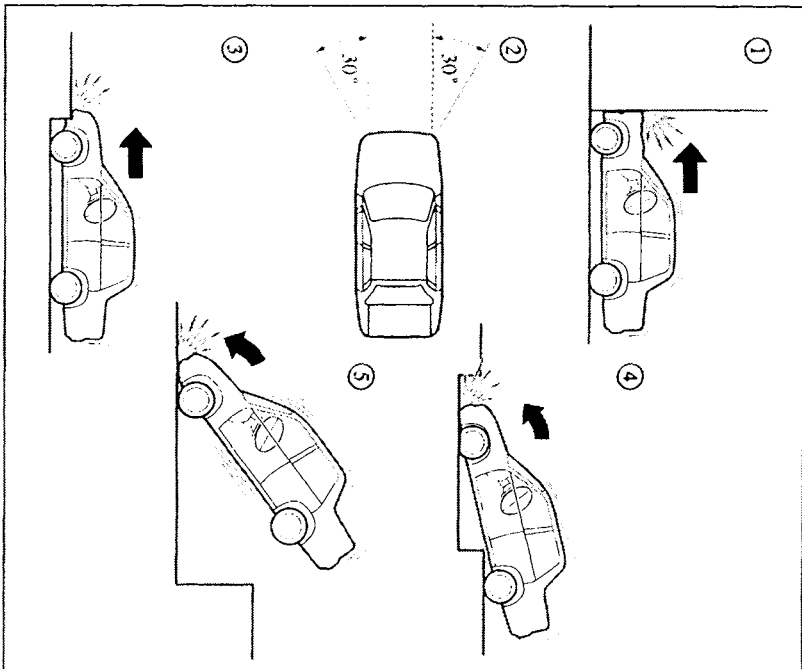

- **Limitations to Front Air Bag Activation**  
Depending on the severity of impact, the front air bags may not inflate in the following cases:
  - ① Impacts involving trees or poles cause severe cosmetic damage but may not have enough impact to activate the air bag.
  - ② Rear-ending or running under a truck's tail gate may not provide the stopping force necessary for air bag deployment.
  - ③ Frontal offset impact to the vehicle may not provide the stopping force necessary for air bag deployment.

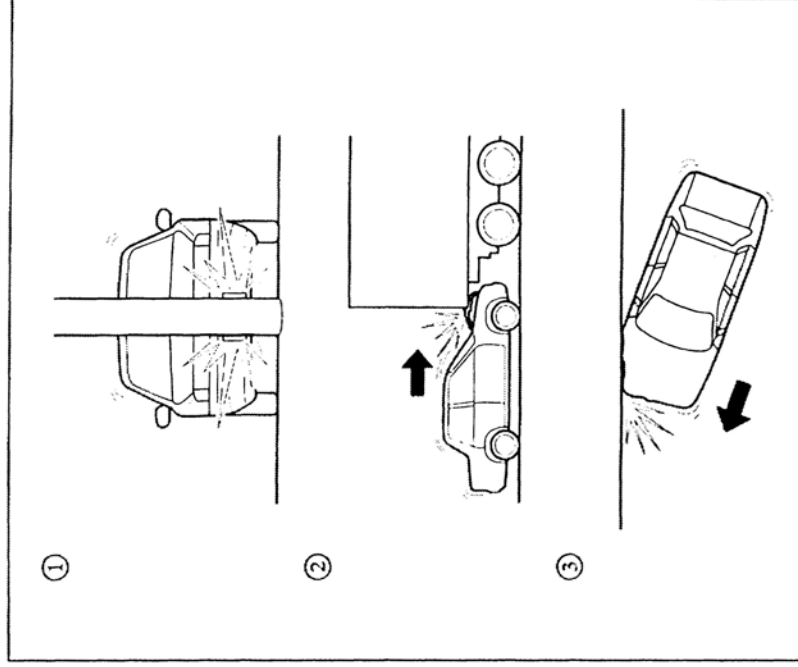

■ **Non-Activation of Front Air Bags**

Front air bags will not normally inflate in the following cases:

- ① Collision from the rear.
- ② Vehicle roll-over, may deploy the side air bag(s) but not the front air bags.
- ③ Impact to the side, but it may deploy a side air bag.

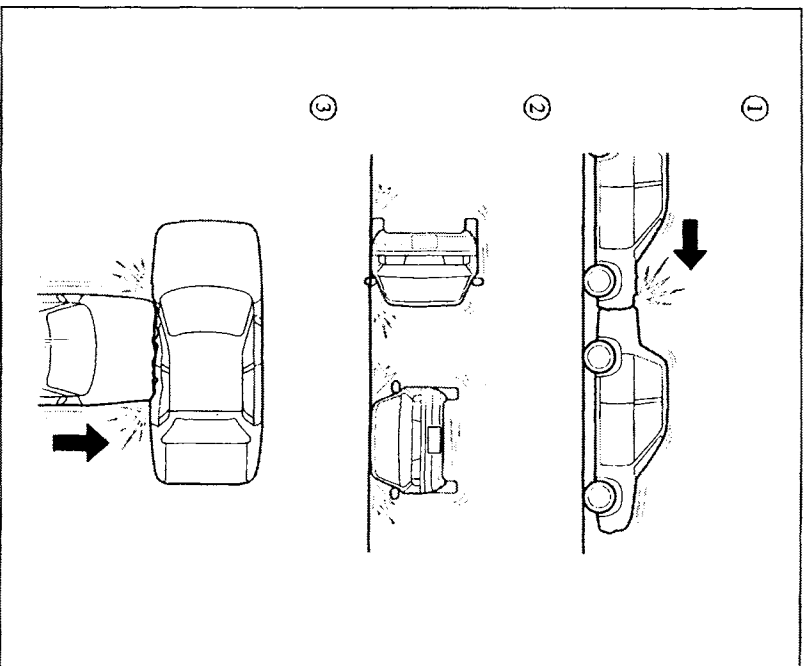

■ **Side Air-Bag Activation**

Greater than moderate impact to one side of the vehicle (driver or passenger side areas) will cause a side air bag to inflate, but it will not normally deploy the front air bags.

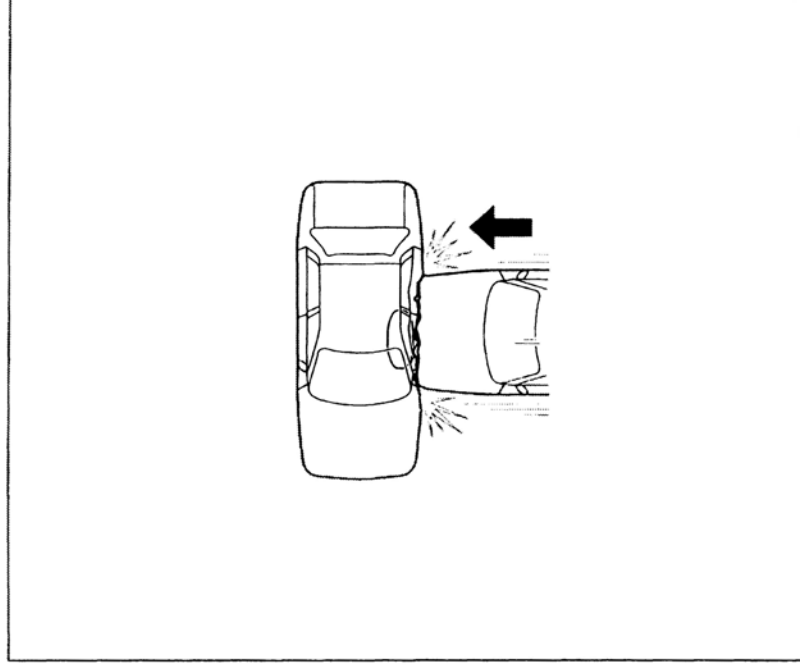

■ **Limitations to Side Air Bag Activation**

Depending on the severity of impact, a side air bag may not inflate in the following cases:

- ① Frontal offset impact may not provide enough side impact to deploy a side air bag.
- ② Side impacts involving trees or poles can cause severe cosmetic damage but may not have enough impact force to activate a air bag.
- ③ Vehicle roll-over may not provide enough side force to deploy the side air bags.
- ④ Side impacts with two-wheeled vehicles may not provide enough force to deploy a side air bag.

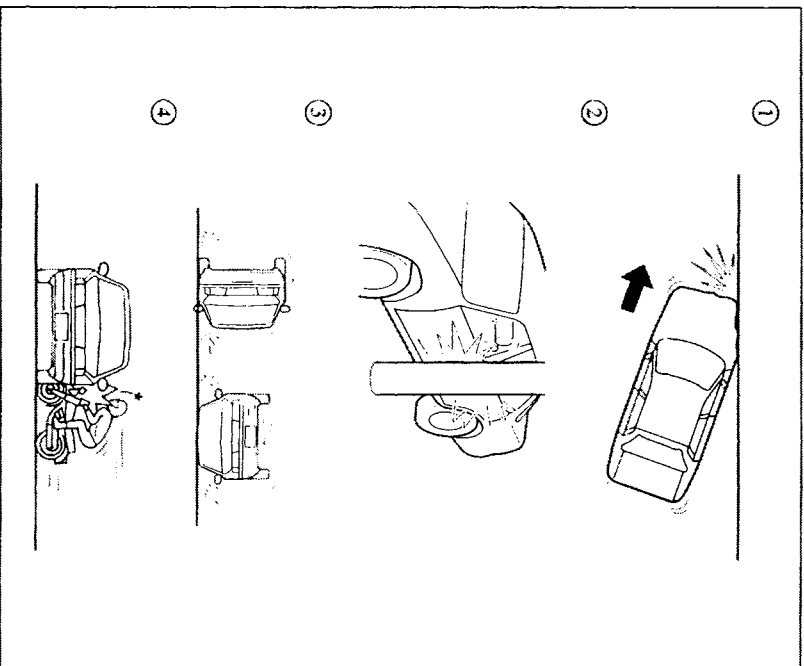



■ **Non-Activation of Side Air-Bags**

A side air bag will not normally inflate in the following cases:

- ① Collision from the rear.
- ② Collision from the front, but it may deploy the front air bags.

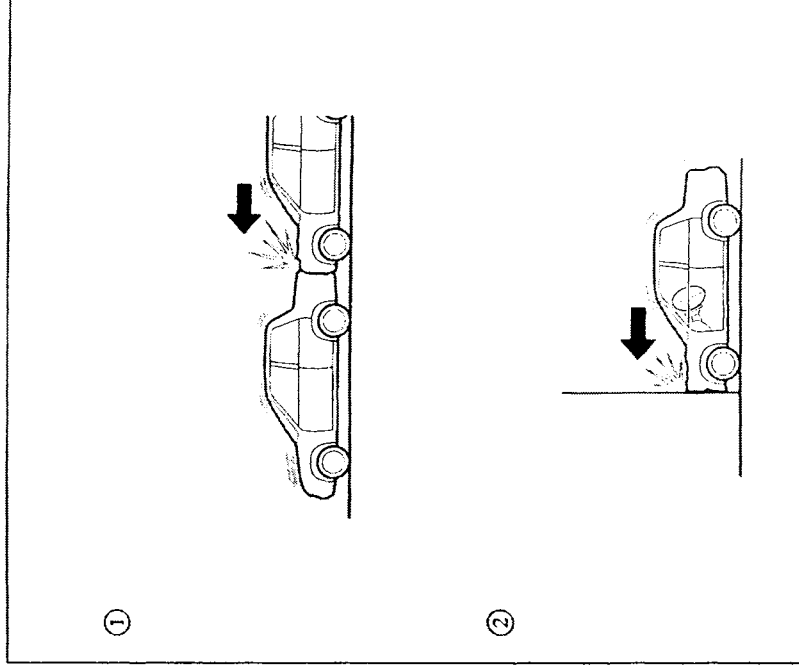

■ **Constant Monitoring**

The following components of the supplemental restraint systems are monitored by a diagnostic system:

- SAS unit
- Air bag modules
- Side air bag crash sensors
- Related wiring

A diagnostic module continuously monitors the system's readiness. This begins when the ignition switch is turned to the ON position and continues while the vehicle is being driven.

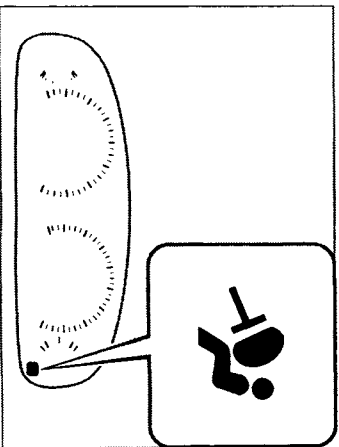

▼ **Supplemental restraint system warning light**

If the supplemental restraint system is OK, the SRS warning light comes on when the ignition switch is turned to the ON position or after the engine is cranked. After about 6 seconds it goes out.

A system malfunction is indicated when the SRS warning light constantly flashes, stays on or doesn't come on at all. If any of these occur, consult an Authorized Mazda Dealer as soon as possible. The system may not work in an accident.

**⚠ WARNING**

**Self-Servicing the Supplemental Restraint Systems:**

***Self-servicing or tampering with the supplemental restraint systems is dangerous. An air bag could accidentally activate or become disabled. This could cause serious injuries. Never tamper with the supplemental restraint systems and always have an Authorized Mazda Dealer perform all servicing and repairs.***

 **WARNING**

Removing Interior Parts:  
*Removing the front seat, front dashboard, the steering wheel or parts containing air bag sensors is dangerous. These parts contain essential air bag parts. The air bag could accidentally activate and cause serious injuries. Always have an Authorized Mazda Dealer remove these parts.*

 **WARNING**

Air Bag Disposal:  
*Improper disposal of an air bag or a vehicle with live air bags in it can be extremely dangerous. Unless all safety procedures are followed, injury can result. Ask an Authorized Mazda Dealer how to safely dispose of an air bag or how to scrap an air bag equipped vehicle.*

■ **Maintenance**

The supplemental restraint system is maintenance-free. But if any of the following occurs, take your vehicle to an Authorized Mazda Dealer as soon as possible:

- The supplemental restraint system warning light flashes.
- The supplemental restraint system warning light stays on.
- The supplemental restraint system warning light stays off when the ignition switch is turned to the ON position.
- The air bags inflate

**NOTE**

Should you sell your Mazda, we urge you to tell the new owner of its supplemental restraint systems and that familiarization with all instructions about them, from the Owner's Manual, is important.



# 3

## Knowing Your Mazda

*Security takes many forms and is very important to owner and occupant. Section 3 describes the safe way to use your Mazda; keys, locks, windows and interior fighting.*

Keys	3- 2
Door Locks	3- 3
Keyless Entry System	3- 8
Power Windows	3-12
Trunk Lid	3-14
Trunk Release Handle	3-16
Hood Release	3-18
Theft-Deterrent System	3-19
Fuel-Filler Lid	3-22
Fuel-Filler Cap	3-22
Steering Wheel	3-23
Mirrors	3-24
Sunroof	3-28
Interior Lights	3-30
Map Lights	3-31
Trunk Light	3-31
Courtesy Lights	3-32

**Keys**

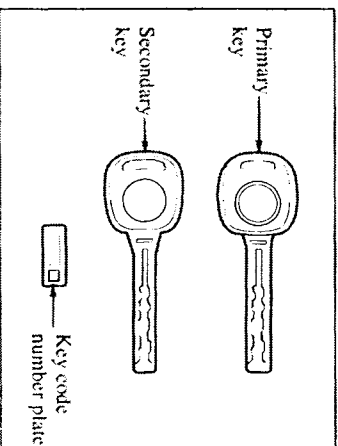

Your Mazda has two kinds of keys: primary and secondary.

Here's what the keys are used for:

Key	Primary	Secondary
Lock Operates	Yes	Yes
Ignition switch and steering column lock	Yes	Yes
Doors	Yes	Yes
Glove box	Yes	No
Trunk	Yes	No

If you must leave your vehicle with another person, such as a parking attendant, protect items by locking the glove box and trunk lid with the primary key. Keep that key and give the other person only the secondary key.

A code number is stamped on the plate attached to the key set; detach this plate and store it in a safe place (not in the vehicle) for use if you need to make a replacement key.

Also write down the code number and keep it in another safe and handy place, but not in the vehicle.

If your key is lost, consult your Authorized Mazda Dealer with the code number ready.

## Door Locks

**⚠ WARNING**  
**Keys and Children:**  
*Leaving children in a vehicle with the ignition key is dangerous. This could result in someone being badly injured or even killed. They could play with power windows or other controls, or even make the vehicle move. Don't leave the keys in your vehicle with children.*

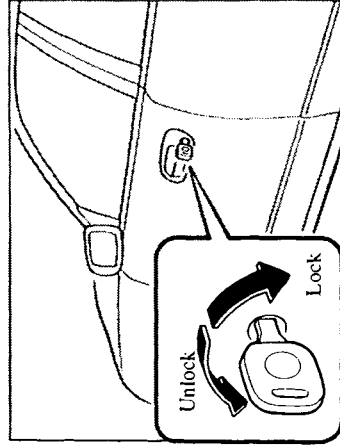

### ■ Outside Door Lock

#### ▼ Locking, unlocking with key

Either front door can be locked or unlocked with a key.

Turn the key toward the front to unlock, toward the back to lock.

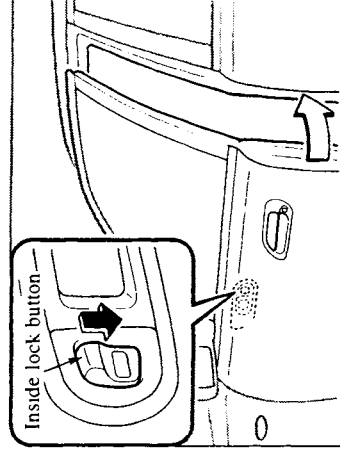

### ▼ Locking without key (Front doors)

To lock a front door without a key, push down the inside lock button and close the door.

#### NOTE

When locking the doors this way, be careful not to leave the key inside the vehicle.

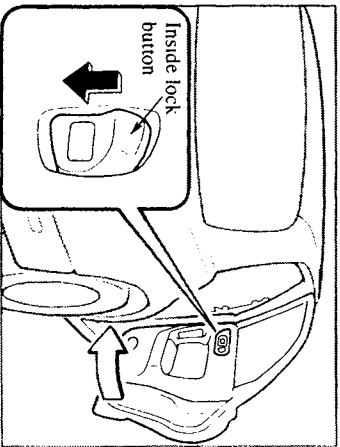

**(Rear doors)**  
To lock a rear door, push down the inside lock button and close the door.

**⚠ WARNING**

*Unattended Children and Pets:  
Leaving a child or an animal unattended in a parked vehicle is dangerous. In hot weather, temperatures inside a vehicle can become high enough to cause brain damage or even death. Always take all children and animals with you or leave a responsible person with them.*

**NOTE**

Always remove the key from the ignition switch, close all windows, and lock all doors when leaving your vehicle unattended. This discourages intruders and thieves.



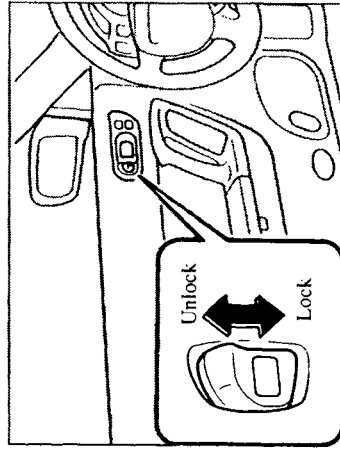

■ **Inside Door Lock**

To lock any door, push down the inside lock button.

To unlock, push it up.

**⚠ WARNING**

**Unlocked Doors:**  
*Unlocked doors in a moving vehicle are dangerous. Passengers can fall out if a door is accidentally opened and can more easily be thrown out in an accident. So keep all doors locked when driving.*

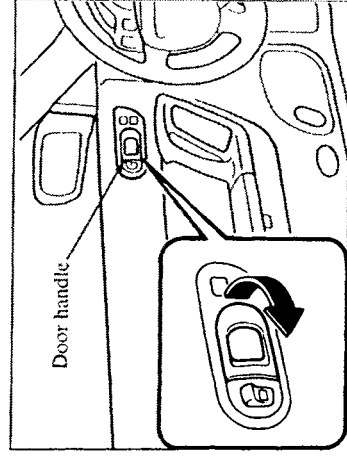

To open, pull the door handle.

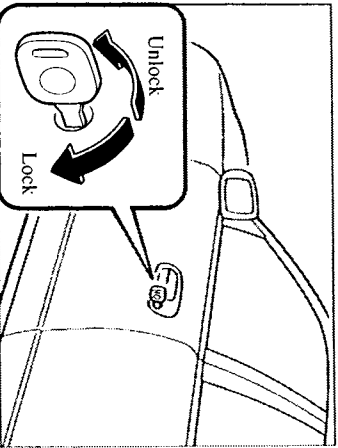

NOTE
Holding the key in the unlocked position in the driver's door lock for about a second unlocks all doors. To unlock only the driver's door, insert a key into the driver's door lock and turn the key briefly to the unlock position and then immediately return it to the center position.

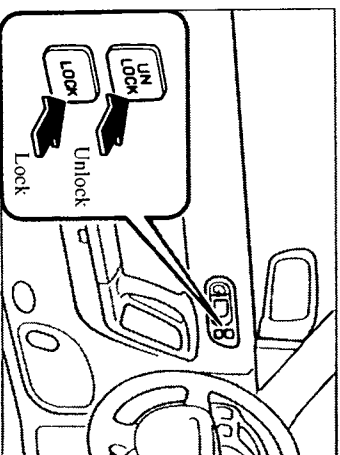

■ Power Door Locks

▼ Locking, unlocking with key

All doors lock automatically when either front door is locked with a key. All doors unlock when the driver's door is unlocked and the key is held in the unlock position. Also, all doors unlock when the front passenger's door is unlocked.

▼ Locking, unlocking with door-lock switch

All doors lock automatically when LOCK is pushed. They all unlock when UNLOCK is pushed.

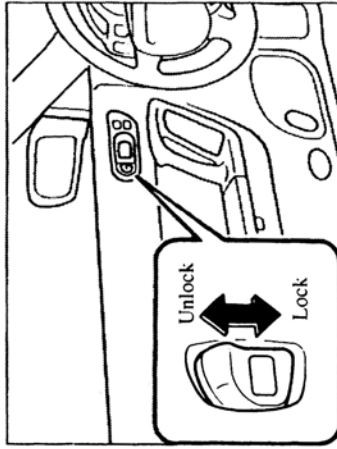

▼ Lockout prevention

Lockout prevention keeps you from locking the driver's door with the key in the ignition switch at ACC or LOCK. If you try to lock the driver's door when the key is in the ignition switch and the driver's door is open, the door lock immediately unlocks.

▼ Locking, unlocking with door-lock button

All doors lock automatically when the driver's door-lock button is pushed down. When it is pulled up, the driver's door unlocks.

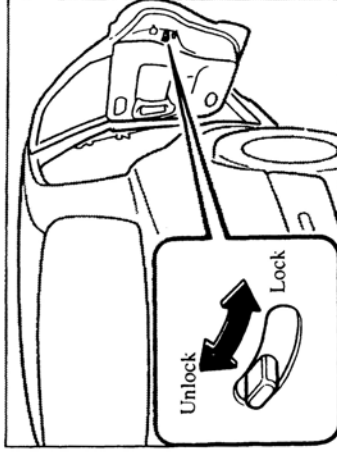

■ Rear Door Child Safety Lock

This lock is intended to help prevent children from accidentally opening the rear doors. Use it whenever a child rides in the vehicle.

If you slide the child safety lock to the lock position before closing that door, the door cannot be opened from the inside. The door can be opened only by lifting the outside handle.

**⚠ WARNING**

**Keys and Children:**

*Leaving children in a vehicle with the ignition key is dangerous. This could result in someone being badly injured or even killed. They could play with power windows or other controls, or even make the vehicle move. Don't leave the keys in your vehicle with children.*

## Knowing Your Mazda

### Keyless Entry System\*

This system locks and unlocks the doors and opens the trunk. It can also help you signal for attention in an emergency. Press the button slowly and accurately.

#### CAUTION

To avoid damage to the transmitter, do not drop it, get it wet, or expose it to heat or sunlight.

#### NOTE

- The keyless entry system is designed to operate up to about 2.5 m (8 ft) from the center of the vehicle, but this may vary because of local conditions.
- The system doesn't operate when the ignition switch is in the ON position.

(Continued)

- If the transmitter does not operate when pressing a button or the operation range becomes too small, the battery may be dead. To install a new battery, refer to Maintenance (page 3-10).
- Additional transmitters can be obtained at an Authorized Mazda Dealer. Up to 3 additional transmitters can be used with the keyless entry system per vehicle. Bring all transmitters to an Authorized Mazda Dealer when the electronic codes need to be reset.

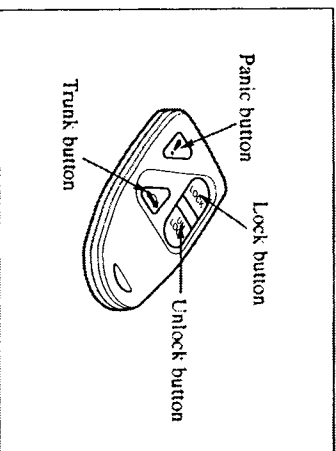

■ Transmitter

<p><b>NOTE</b></p> <p>This device complies with part 15 of the FCC Rules and with RSS-210 of Industry Canada. Operation is subject to the following two conditions: (1) This device may not cause harmful interference, and (2) this device must accept any interference received, including interference that may cause undesired operation. (Outside transmissions may momentarily interfere with the device's operation.)</p>
--

▼ **Lock button**

To lock the doors, press the LOCK button.

To confirm that all the doors have been locked, press the LOCK button again within 5 seconds. If they are closed and locked, the horn will sound.

**NOTE**

Confirm that all the doors are locked visually or aurally by use of the double click.

▼ **Unlock button**

To unlock the driver's door, press the UNLOCK button.

To unlock all the doors, press the UNLOCK button again within 5 seconds.

**NOTE**

After unlocking with the transmitter, all doors will automatically lock if one is not opened within about 30 seconds.

▼  **Trunk button**

To open the trunk, press the  button.

## Knowing Your Mazda

### ▼ ! Panic button

You can use the ! button to turn on the alarm, which allows you to signal for attention in an emergency.

#### NOTE

The alarm will work whether any door is open or closed.

### Turning on the alarm

Pressing the ! button once will sound the horn intermittently and flash the headlights and hazard warning lights for about 2 minutes and 30 seconds.

### Turning off the alarm

Press any button on the transmitter.

### ■ Maintenance

## ⚠ CAUTION

- Make sure the battery is installed with the correct pole facing upward. Battery leakage could occur if it is not installed correctly.
- When replacing the battery, be careful not to bend the electrical terminals or get oil on them. Also be careful not to get dirt in the transmitter as it could damage it.

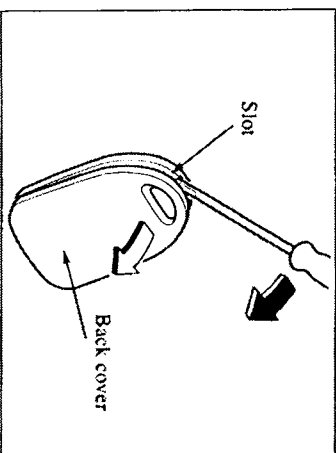

### ▼ Replacing the transmitter battery

1. Insert a small screwdriver into the slot and gently pry open the transmitter.

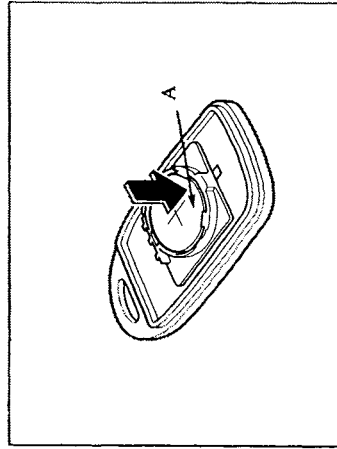

2. Press the portion of the battery indicated by A and remove the battery.

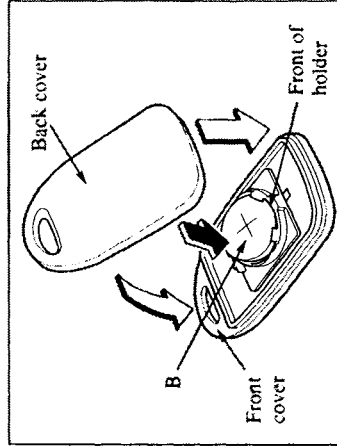

3. Install a new battery (CR2025 or the equivalent) into the front portion of the holder with the positive pole (+) facing up. Press on the B portion of the battery to set the battery.

<b>⚠ CAUTION</b>
Do not press any buttons when replacing the battery. The electronic code could be altered and cause the keyless entry system to malfunction. If the keyless entry system fails to operate, contact an Authorized Mazda Dealer.

4. Align the front and back covers and snap the transmitter shut.

## Power Windows

### ▼ Service

If you have a problem with the keyless entry system, consult an Authorized Mazda Dealer.

If your transmitter is lost or stolen, bring all remaining transmitters to an Authorized Mazda Dealer as soon as possible for a replacement and to make the lost or stolen transmitter inoperative.

### ⚠ CAUTION

- Changes or modifications could void your right to operate the keyless entry system.
- Damage to your keyless entry system will affect the vehicle warranty coverage.

### ⚠ WARNING

#### Closing Power Windows:

*Closing power windows are dangerous. A person's hands, head, or even neck could be caught by the window and result in serious injury or even death. This warning applies especially to children. Make sure the opening is clear before closing a window.*

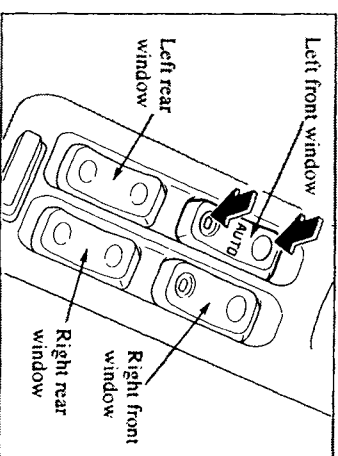

### ■ Driver's Door Power Window Switches

The ignition switch must be in the ON position for the power windows to operate.

All windows may be opened or closed by the power window master control switches on the driver's door.

To open the window, push the lower part of the switch.

To close, push the upper part of the switch.



▼ **Engine-off power window operation**

The power window can be operated about 45 seconds after the ignition switch is turned from the ON position to the ACC or LOCK position with all doors opened or closed. If any front door is opened, the power window will be inoperable.

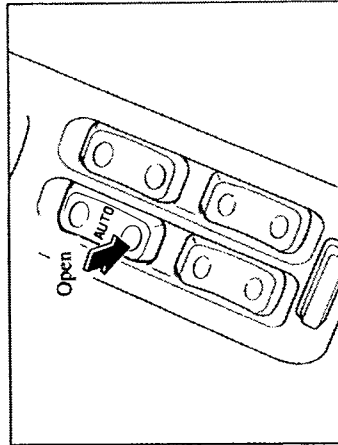

▼ **Auto-opening (Driver's window)**

To fully open the window automatically, push the lower part of the switch completely.

To stop the window partway, push the upper part of the switch and then release it.

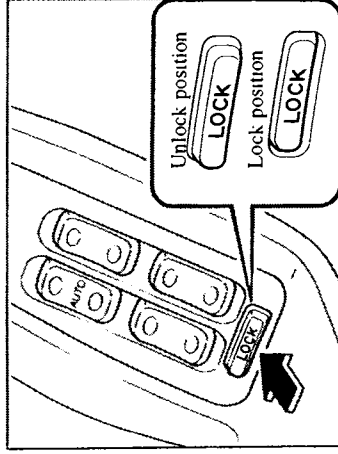

■ **Power Window Lock Switch**

With the lock switch in the unlocked position, all power windows on each door can be operated.

With the lock switch in the locked position, only the driver's door power window can be operated.

**Trunk Lid**

**⚠ WARNING**

*Unintentional Window Operation: dangerous. A person's hands, head, or neck could be caught by the window and result in serious injury. Unless a passenger needs to operate a window, keep the power window lock switch in the locked position.*

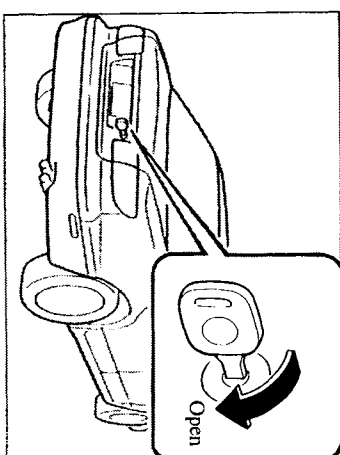
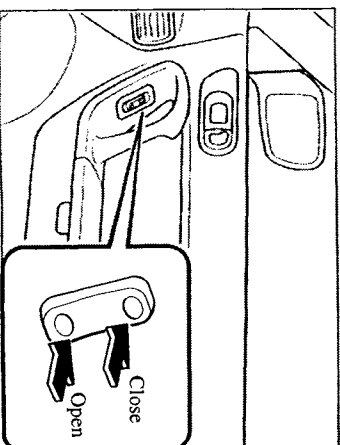

■ **Passenger-Door Power Window Switches**

The ignition switch must be in the ON position for the power windows to operate.

To open the window, push the lower part of the switch.

To close the window, push the upper part of the switch.

■ **Key-Operated Trunk**

To open the trunk lid, insert the primary key and turn it clockwise.

The secondary key will not operate this lock (page 3-2).

To close, use both hands to push the lid down until the lock snaps shut. Don't slam it.

Then pull up on it to make sure it's secure.

**⚠ CAUTION**

To prevent burning out the fuse and damaging the power window system, don't open or close more than two windows at once.

**⚠ WARNING**

*Open Trunk and Exhaust Gas: Exhaust gas in the cabin of a vehicle is dangerous. This gas contains CO (carbon monoxide), which is colorless, odorless, and highly poisonous. If inhaled, it can cause loss of consciousness and death. Because exhaust gas can get into the cabin through an open trunk, keep the trunk closed when driving.*

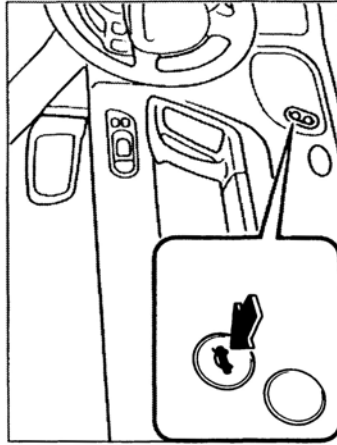

■ Remote Trunk Lid Release

To release the trunk lid from inside the vehicle, push the button.

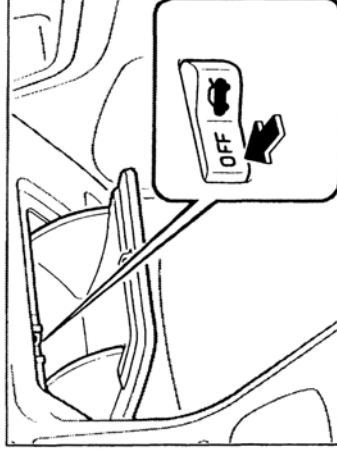

■ Remote Trunk Lid Release Lock-Out

As an added security feature, the remote release may be canceled to prevent anyone from opening the trunk without the primary key.

To activate the remote trunk lid release lock-out, push OFF

To reactivate the remote release, push 

## Trunk Release Handle

Your vehicle is equipped with a trunk release handle that provides a means of escape for children and adults in the event they become locked inside the trunk.

No matter how careful adults might be with keys and locking their cars, parents should be aware that children may be tempted to play around vehicles and use the trunk as a hiding place.

Adults are advised to familiarize themselves with the operation and location of the release handle so that all children can be told about it in an appropriate way, keeping in mind that most vehicles don't have such handles.

 <b>WARNING</b>
<p><b><i>Open Trunk Lid and Children:</i></b> <i>Leaving the trunk lid open or leaving children in the vehicle with the keys is dangerous. Children could open the trunk lid and climb inside resulting in possible injury or death from heat exposure. Close the trunk lid, lock the rear seatbacks and do not allow children to play inside the vehicle.</i></p>

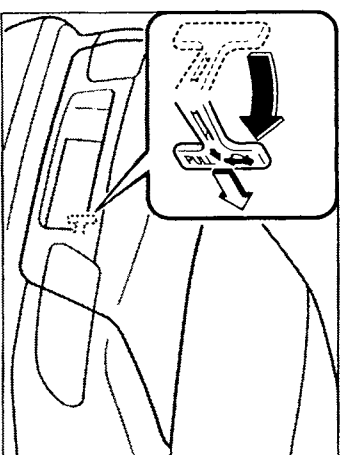

To open the trunk lid from the inside, pull the illuminated “T” shaped handle. The handle is made of material that will glow for hours in the darkness of the trunk following a brief exposure to ambient light.

The “T” shaped handle is located on the inside of the trunk lid.

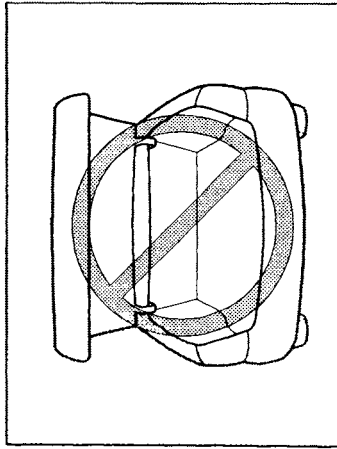

**⚠ WARNING**

*Unattended Children and Pets:  
Leaving children or animals unattended in a parked vehicle is dangerous. Babies left sleeping and kids who lock themselves in cars or trunks can die very quickly from heat prostration. Don't leave your children or pets alone in a car at any time. Don't leave the car, the rear folding seats or the trunk unlocked. Always keep the car from being a tempting place to play by locking doors, trunk and rear seats and keeping the keys where children won't play with them.*

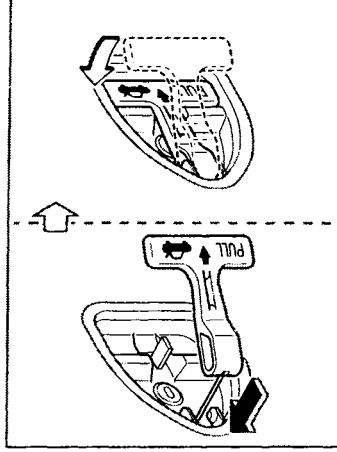

**⚠ CAUTION**

Always keep the handle firmly attached to the holder and in the recessed position. Not securing the handle this way could allow it to snag luggage in the trunk and open the trunk lid.

## Hood Release

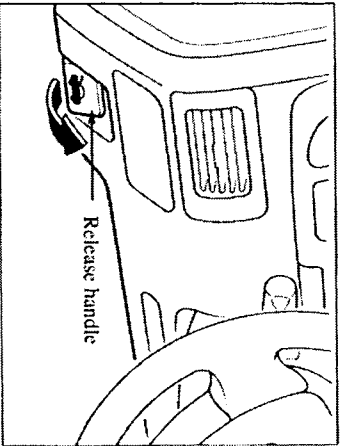

1 With the vehicle parked, pull the release handle to unlock the hood.

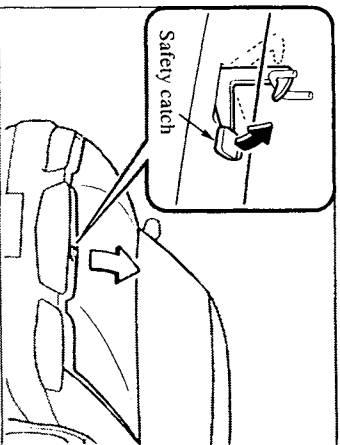

2. Pull the safety catch up and lift the hood.

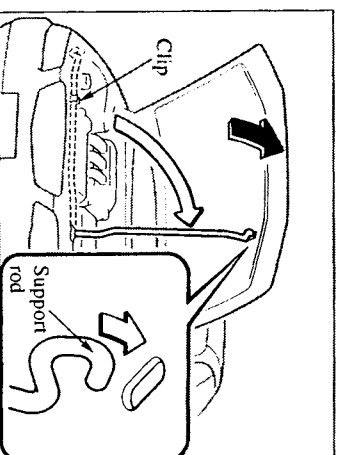

3. Use the support rod to hold the hood open.

Before closing the hood, secure the rod in its clip.

To close the hood:

- Check under the hood area to make certain all filler caps are in place and all loose items (e.g. tools, oil containers, etc.) have been removed.
- Close the hood so that it locks securely.

## Theft-Deterrent System

The optional theft-deterrent system is designed to prevent your vehicle or its contents from being stolen when all of the doors, hood, and trunk lid are locked.

If forcible entry is attempted, the system sounds the horn and flashes the hazard warning lights and headlights. It also makes the starter inoperable.

### NOTE

The theft-deterrent system operates without the keyless entry system transmitter\*, as well.

The system won't function unless it's properly armed. So when you leave the vehicle, lock all the doors, close all the windows, take your key, your transmitter\*, and make sure the security indicator light is flashing.

### ■ Operation

What turns it on:

- Forcing open a door, the hood, or the trunk lid.
- Opening the hood or the trunk lid by operating the hood release handle or remote trunk lid release button.
- Unlocking the driver's door with the door-lock button or the UNLOCK button.
- Opening a front or rear passenger's door after unlocking its door-lock button.

What it does:

- The horn sounds intermittently and the hazard warning lights and headlights flash.

- The starter is bypassed so that the engine can't be started.

The alarm continues for about 3 minutes, then stops.

If the system is triggered again, the lights and horn will activate and the starter will not work until a door or the trunk lid is unlocked with the key or with the transmitter\*

■ **How to Arm the System**

1. Remove the ignition key.
2. Close the hood and the trunk lid. Then close the doors and lock them from the outside using the key in the front door. If you have the keyless entry system, press the LOCK button on the transmitter.

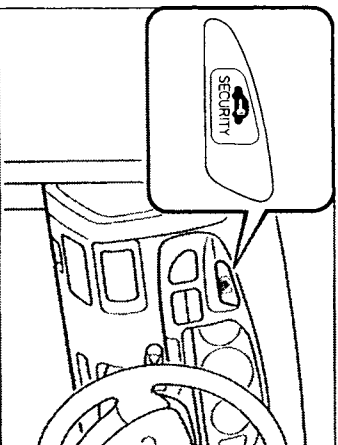

3. The indicator light comes on for about 10 seconds. Then it flashes every 3 seconds to indicate that the system is fully armed. It continues to flash until the theft-deterrent system is turned off.

■ **To Turn off an Armed System**

An armed system can be turned off by any one of the following methods:

- Unlock a door with the key.
- Press the UNLOCK button on the keyless entry system transmitter\*.
- Insert the key into the ignition and turn in to the ON position.

**NOTE**

The trunk lid can be opened with the key or the transmitter\* even when the system is armed. The alarm will not come on and the system will remain armed.



■ **To Stop an Alarm**

A triggered alarm can be turned off by any one of the following methods:

- Unlock a door with the key.
- Open the trunk lid with the key.
- Press the UNLOCK button or  button on the keyless entry system transmitter\*.

**NOTE**

If you have any problem with the theft-deterrent system, consult an Authorized Mazda Dealer.

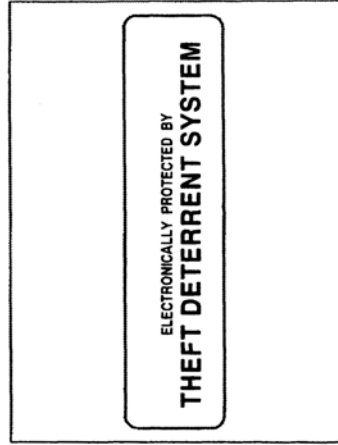

■ **Theft-Deterrent Labels**

Labels indicating that your vehicle is equipped with a Theft-Deterrent System are in the glove box.

Mazda recommends that you affix them to the lower rear corner of the front door windows.

### Fuel-Filler Lid

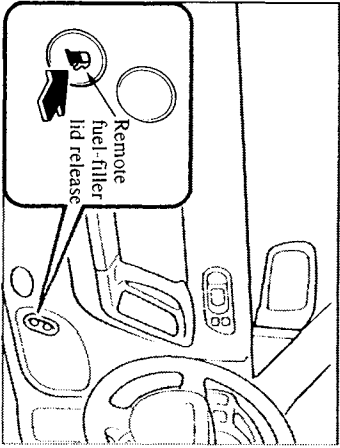

To open, push the remote fuel-filler lid release.

### Fuel-Filler Cap

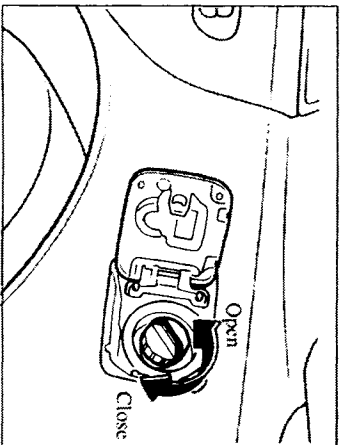

- To remove the filler cap, turn it counterclockwise.
- To replace the filler cap, turn it clockwise until it clicks.

## WARNING

Fuel Spray:

*Fuel spray is dangerous. Fuel can burn skin and eyes and cause illness when ingested. Fuel spray is released when there is pressure in the fuel tank and the fuel cap is removed too quickly. When removing the fuel cap, loosen the cap slightly and wait for any hissing to stop. Then remove it.*

## WARNING

Fuel Vapor:

*Fuel vapor is dangerous. It could be ignited by sparks or flames; causing serious burns and injuries. Before refueling, stop the engine. And always keep sparks and flames away from the filler neck.*

### Steering Wheel

**CAUTION**

Always use only a designated Mazda fuel cap or an approved equivalent, available at Authorized Mazda Dealers. The wrong cap can result in a serious malfunction of the fuel and emission control systems. It may also cause the check engine light in the instrument cluster to appear.

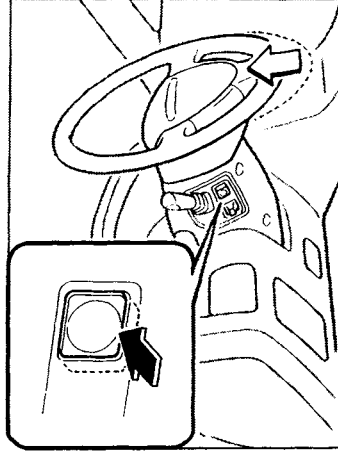
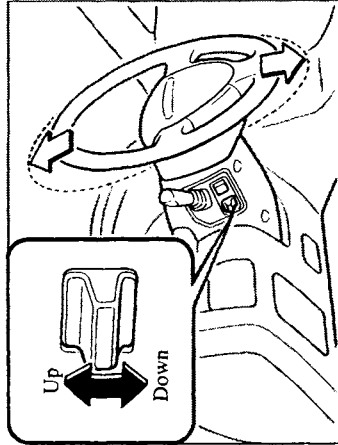

### ■ Auto-Tilt Steering Column

Push in the AUTO button to activate the auto-tilt function.

To change the angle of the steering wheel, stop the vehicle, put the ignition switch in the ON position and push the switch to adjust the steering column up or down.

**CAUTION**

Make sure the fuel-filler cap is tightened securely. The check engine light comes on when the cap isn't tightened securely. If the light remains on (even after you have tightened the cap securely, driven, and restarted the engine several times), it may indicate a different problem. Contact an Authorized Mazda Dealer as soon as possible.

When you remove the key from the ignition, the steering column will move up, away from the driver.

The steering column will move back to its position before the key was removed, when the key is returned to the ignition.

## Mirrors

### ■ Outside Mirrors

Check the mirrors' angles before driving.

## ⚠ WARNING

*Convex Mirror (Passenger Side*

*Type):*

*Changing lanes without taking into account the actual distance of the vehicle in the convex mirror is dangerous. You could have a serious accident. What you see in the convex mirror is closer than it appears. Be sure to look over your shoulder or to check your inside mirror before changing lanes.*

## ⚠ WARNING

*Adjusting the Steering Wheel:*

*Adjusting the steering wheel while the vehicle is moving is dangerous. Moving it can very easily cause the driver to abruptly turn to the left or right. This can lead to loss of control or an accident. Never adjust the steering wheel while the vehicle is moving.*

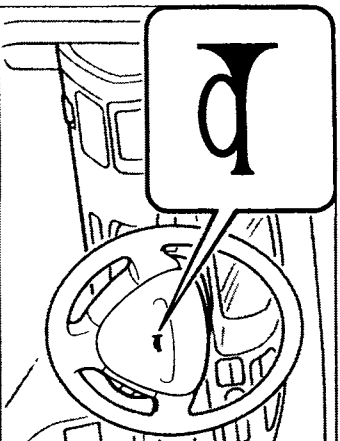

### ■ Horn

To sound the horn, press the center of the steering wheel.

Check the horn's operation regularly.

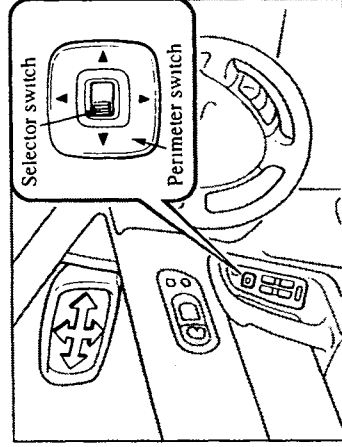

After adjusting the mirror, lock the control by moving the switch to the middle position.

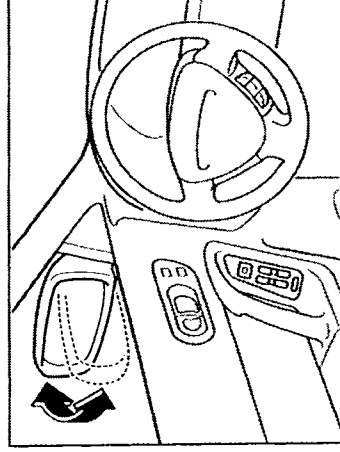

▼ **Power control mirror**

The ignition switch must be in the ON position.

To adjust:

- 1 Move the selector switch to the left or right to choose the mirror.
2. Depress the perimeter switch in the appropriate direction.

▼ **Folding the mirror**

Fold the outside mirror rearward until it is flush with the vehicle.

<b>⚠ WARNING</b>
<p><i>Driving with Mirrors Folded In: Driving with the outside mirrors folded in is dangerous. Your rear view will be restricted, and you could have an accident. Always return the outside mirrors to the driving position before you start driving.</i></p>

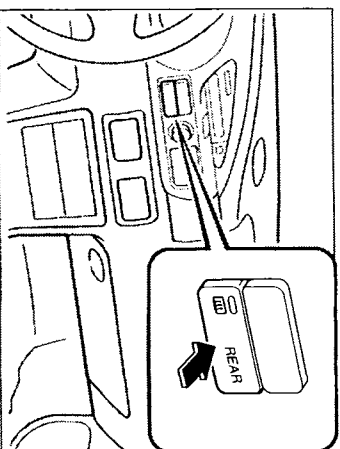

▼ **Mirror defroster\***

To turn on the mirror defroster, turn the ignition on and push the rear window defroster switch (page 5-40).

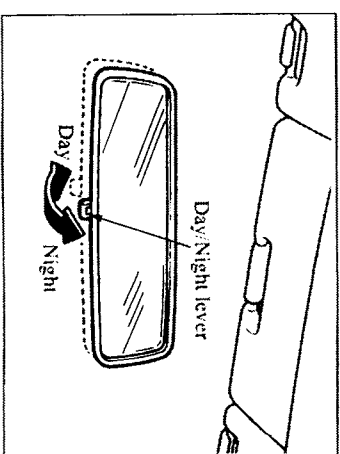

■ **Rearview Mirror (With Day/Night Function)**

Before driving, adjust the rearview mirror to center on the scene through the rear window. Do this with the day/night lever in the day position.

Push the lever forward for day driving. Pull it back to reduce glare from headlights.

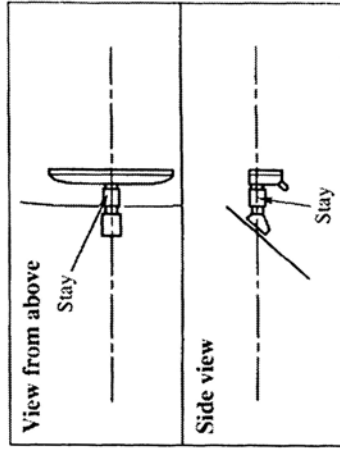

**⚠ WARNING**

***Blocked View:***  
*Cargo stacked higher than the seatbacks is dangerous. It can block your view in the rearview mirror, which might cause you to hit another car when changing lanes. Don't stack things higher than the seatbacks.*

**NOTE**

If your forward view is obstructed by the mirror or the sunvisor hits the mirror, adjust the mirror stay to the center-horizontal position.

## Sunroof

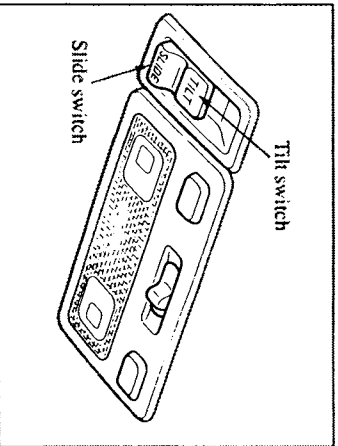

The rear of the sunroof can be tilted open to provide more ventilation.

To tilt, push the tilt switch.

To close, pull the tilt switch.

### WARNING

#### *Extending the Head or*

#### *Arms Through the Sunroof:*

*Extending the head, arms, or other parts of the body through the sunroof is dangerous. The head or arms could hit something while the vehicle is moving. This could cause death or serious injury. Don't let passengers stand up or extend anything through the open sunroof while the vehicle is moving.*

### WARNING

#### *Closing the Sunroof:*

*A closing sunroof is dangerous. The hands, head, or even neck of a person - especially a child - could be caught in it as it closes, causing serious injury or even death. Make sure the opening is clear before closing the sunroof.*

### ■ Sunroof Operation

The sunroof can be opened or closed electrically only when the ignition switch is in the ON position.

To open to any position, pull the slide switch towards the rear.

To close, push the slide switch forward.

### NOTE

After washing your Mazda or after a rain, wipe the water off the sunroof before operating it.



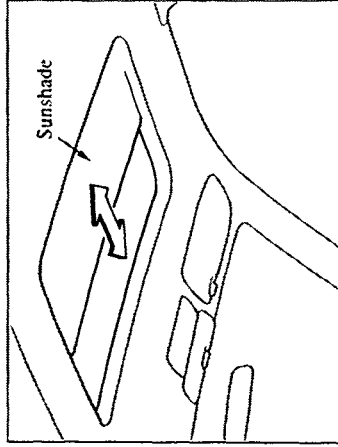

**⚠ CAUTION**

The sunshade doesn't tilt. To avoid damaging the sunshade, don't push up on it.

■ **Sunshade**

The sunshade can be opened and closed by hand when the sunroof is closed.

The sunshade opens automatically when the sunroof is opened, but must be closed by hand.

## Interior Light

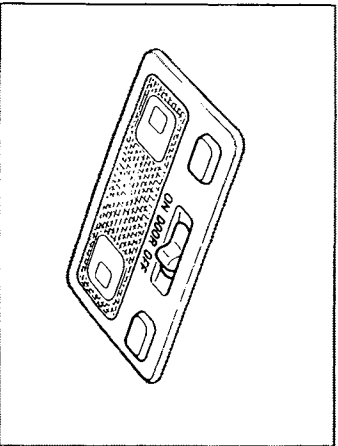

OFF — Light off  
DOOR — Light on when any door is open  
ON — Light on

### NOTE

When the switch is in the DOOR position, the interior light comes on for:

- about 30 seconds after the driver's door is unlocked and the ignition key is removed.
- about 15 seconds after the key is removed from the ignition.

The light also goes out when:

- the ignition switch is turned to the ON position.
- the driver's door is locked.

When the interior light comes on by opening a door, it goes out about 15 seconds after the door is closed.

(Continued)

Even if the door is not closed, the light goes out after about 5 minutes.

**Map Lights**

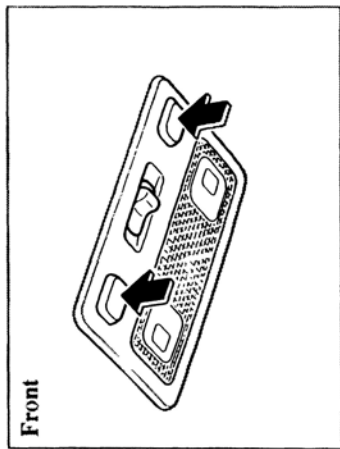

**Front**

The map lights are switched on or off by pressing the switches.

**Trunk Light**

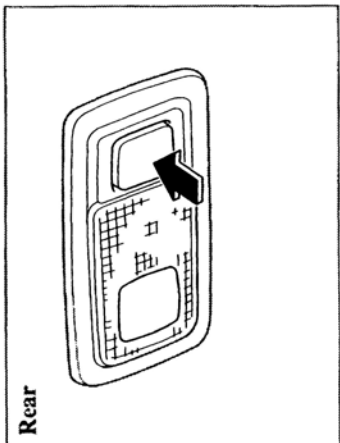

**Rear**

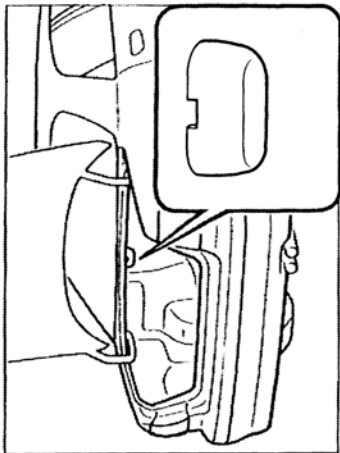

The trunk light is on when the lid is open and off when it's closed.

### Courtesy Lights

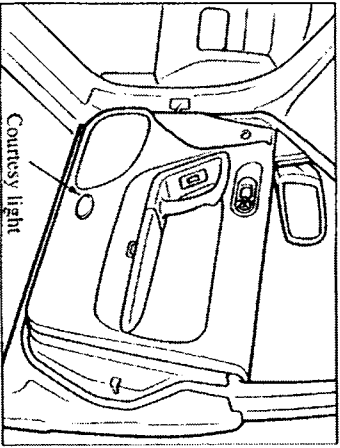

Lights on when any door is open.

# 4

## Protecting Your Mazda

*Most people like to save money. With an automobile vehicle, that can be done in several ways from its first day of operation. Probably tops on the list of cost-efficiency is using the right kind of fuel and using that fuel conservatively.*

*Section 4 explains how to do this. Further, it discusses proper loading and how to respond to unusual driving conditions. It also illustrates where important vehicle information labels may be found.*

Fuel Requirements	4- 2
Emission Control System	4- 3
Engine Exhaust	4- 4
Before Driving	4- 6
Break-In Period	4- 6
Money-Saving Suggestions	4- 7
Special Driving Conditions	4- 8
Vehicle Information Labels	4-12

## Protecting Your Mazda

### Fuel Requirements

#### (2.5 liter V6 DOHC)

Vehicles equipped with catalytic converters must use **ONLY UNLEADED FUEL**, which will reduce exhaust emissions and keep spark plug fouling to a minimum.

Your Mazda will perform best with premium unleaded fuel having an octane rating (antiknock index) of at least 91.

You may use a regular unleaded gasoline with a rating from 87 to 90; this will slightly reduce performance.

Also, fuel with a rating lower than 87 octane could cause the emission control system to lose effectiveness. It could also cause engine knocking and serious engine damage.

U.S. federal law requires that octane ratings be posted on gasoline station pumps.

#### (Miller Cycle Engine V6 DOHC)

Vehicles equipped with catalytic converters must use **ONLY UNLEADED FUEL**, which will reduce exhaust emissions and keep spark plug fouling to a minimum.

Your Mazda will perform best with premium unleaded fuel having an octane rating (antiknock index) of at least 91 [(R+M)/2 method].

Fuel with a lower rating could cause the emission control system to lose effectiveness. It could also cause engine knocking and serious engine damage.

## CAUTION

### NEVER USE LEADED FUEL

It is harmful to the catalytic converter. The lead will accumulate on the oxygen sensor and the catalyst inside the converter.

This will result in a malfunction of the emission control system, causing poor performance.

## Emission Control System

Gasoline blended with oxygenates such as alcohol or ether compounds are generally referred to as oxygenated fuels. The common gasoline blend that can be used with your vehicle is ethanol blended at no more than 10%. Gasoline containing alcohol, such as ethanol or methanol, may be marketed under the name "Gasohol"

### CAUTION

Never add fuel system additives. Never add cleaning agents other than those specified by Mazda. Other cleaning agents and additives may damage the system. Consult an Authorized Mazda Dealer.

Your vehicle is equipped with an emission control system (the catalytic converter is part of this system) that enables your vehicle to comply with U.S. exhaust emissions requirements.

Under U.S. federal law, any modification to the original-equipment emission control system before the first sale and registration of a vehicle is subject to penalties. In some states, such modification made on a used vehicle is also subject to penalties.

### CAUTION

Your vehicle can only use oxygenated fuels containing no more than 10% ethanol by volume. Damage to your vehicle may occur when ethanol exceeds this recommendation, or if the gasoline contains any methanol. Stop using gasohol of any kind if your vehicle engine is performing poorly.

Vehicle damage and drivability problems resulting from the use of the following may not be covered by the Mazda warranty.

- 1) Gasohol containing more than 10% ethanol
- 2) Gasoline or gasohol containing methanol
- 3) Leaded fuel or leaded gasohol

### WARNING

#### Parking Over Things That Burn:

*Parking over or near anything inflammable, such as dry grass, is dangerous. Even with the engine turned off, the exhaust system could ignite it because the exhaust system gets very hot during normal use. A resulting fire could cause serious injury or death. Never park over or near anything inflammable.*

**Engine Exhaust  
(Carbon Monoxide)**

**⚠ CAUTION**

Ignoring the following precautions could cause lead to accumulate on the catalyst inside the converter or cause the converter to get very hot. Either condition will damage the converter and cause poor performance.

- **USE ONLY UNLEADED FUEL.**
- Don't drive your Mazda with any sign of engine malfunction.
- Don't coast with the ignition switch turned off.
- Don't descend steep grades in gear with the ignition switch turned off.
- Don't operate the engine at high idle for more than 5 minutes.

(Continued)

- Don't tamper with the emission control system. All inspections and adjustments must be made by a qualified technician.

- Don't try to push-start or pull-start your vehicle.

**⚠ WARNING**

**Carbon Monoxide:**

*Engine exhaust is dangerous. This gas contains carbon monoxide (CO), which is colorless, odorless, and poisonous. When inhaled, it can cause loss of consciousness and death. If you smell exhaust gas inside your vehicle, keep all windows fully open and contact an Authorized Mazda Dealer immediately.*



**⚠ WARNING**

Exhaust Gas in Enclosed Area:  
*Running the engine inside an enclosed area, such as a garage, is dangerous. Exhaust gas, which contains poisonous carbon monoxide, could easily enter the cabin. Loss of consciousness or even death could occur. Don't run the engine when inside an enclosed area.*

**⚠ WARNING**

Idling with the Windows Closed:  
*Exhaust gas is dangerous. When your vehicle is stopped with the windows closed and the engine running for a long time in an open area, exhaust gas, which contains poisonous carbon monoxide, could enter the cabin. Loss of consciousness or even death could occur. Open the windows or adjust the heating or cooling system to draw fresh air.*

**⚠ WARNING**

Snow Blocking the Exhaust Gas:  
*Running the engine when a vehicle is stopped in deep snow is dangerous. The exhaust pipe could be blocked by the snow, allowing exhaust gas to enter the cabin. Because exhaust gas contains poisonous carbon monoxide, anyone in the cabin could be injured or killed. Clear the snow from underneath and around your vehicle before starting the engine.*

## Before Driving

### ■ Before Getting In

- Be sure the windows, outside mirror(s), and outside lights are clean.
- Inspect inflation pressures and condition of tires.
- Look under the vehicle for any sign of a leak.
- If you plan to back up, make sure nothing will be in your way.

#### NOTE

Engine oil, engine coolant, brake fluid, washer fluid, and other fluid levels should be inspected daily, weekly, or at refueling, depending on the fluid. See Maintenance, Section 8.

### ■ After Getting In

- Are all doors closed and locked?
  - Are the inside and outside mirrors adjusted?
  - Is everyone's seat belt fastened?
  - Do all the lights work?
  - Check all gauges.
  - Check all warning lights when the ignition switch is turned to the ON position.
  - Release the parking brake and make sure the brake warning light goes off.
- Always be thoroughly familiar with your Mazda.

## Break-In Period

No special break-in is necessary, but a few precautions in the first 1,000 km (600 miles) may add to the performance, economy, and life of your Mazda.

- Don't race the engine.
- Don't maintain one constant speed for long.
- Don't drive constantly at full-throttle or high engine rpm for extended periods of time.
- Avoid unnecessary hard stops.
- Avoid full-throttle starts.

## Money-Saving Suggestions

How you operate your Mazda determines how far it will travel on a tank of fuel. Use these suggestions to help save money on fuel and repairs.

- Avoid long warm-ups. Once the engine runs smoothly, begin driving.
- Avoid fast starts.
- Keep the engine tuned. Follow the maintenance schedule (page 8-3) and have an Authorized Mazda Dealer perform inspections and servicing.
- Use the air conditioner only when necessary.
- Slow down on rough roads.
- Keep the tires properly inflated.
- Don't carry unnecessary weight.
- Don't rest your foot on the brake pedal while driving.
- Keep the wheels in correct alignment.
- Keep windows closed at high speeds.
- Slow down when driving in crosswinds and headwinds.



## WARNING

### *Coasting:*

*Turning off the engine to coast down a hill is dangerous. This causes the loss of power steering and power brake control. Any loss of steering or braking control could cause an accident. Never turn off the engine and coast down a hill.*

## Special Driving Conditions

### ■ Hazardous Driving

When driving on ice or in water, snow, mud, sand, or similar hazard:

- Be cautious and allow extra distance for braking.
- Avoid sudden braking and quick steering.
- Brake with the pedal by using a light up-down motion. Don't hold the pedal down constantly.
- If you get stuck, shift to L or S and accelerate slowly. Don't spin the front wheels.
- For more traction in starting, use sand, rock salt, chains, carpeting, or other nonslip material under the front wheels.

### WARNING

*Downshifting on Slippery Surfaces: Downshifting into lower gear while driving on slippery surfaces is dangerous. The sudden change in tire speed could cause the tires to skid. This could lead to loss of vehicle control and an accident. If it is necessary to downshift on slippery surfaces, be very careful.*

### ■ Rocking the Vehicle

If you must rock the vehicle to free it from snow, sand, or mud, depress the accelerator slightly and slowly move the shift lever back and forth from D to R.

**⚠ WARNING**

Spinning the Wheels:  
*When the vehicle is stuck, spinning the wheels at high speed is dangerous. The spinning tire could overheat and explode. This could cause serious injuries. Don't spin the wheels at more than 56 km/h (35 mph), and don't allow anyone to stand behind a wheel when pushing the vehicle.*

■ **Winter Driving**

- Carry emergency gear, including tire chains, window scraper, flares, a small shovel, jumper cables, and a small bag of sand or salt.
- Ask a Mazda dealer to perform the following precautions.
- Have the proper ratio of antifreeze in the radiator.
- Inspect the battery and its cables. Cold reduces battery capacity.
- Use only cold-weather engine oil (page 8-12).
- Inspect the ignition system for damage and loose connections.
- Use washer fluid made with antifreeze—but don't use engine coolant antifreeze for washer fluid (page 8-24).
- Don't use the parking brake if it might freeze. Instead, shift to P. Block the rear wheels.

**⚠ CAUTION**

Too much rocking may cause engine overheating, transaxle failure, and tire damage.

## Protecting Your Mazda

### ▼ Snow tires

Your vehicle is originally equipped with all season radials designed to be used all year around. In some extreme climates you may find it necessary to replace them with snow tires during the winter months to further improve traction on snow and ice covered roads.

**Use snow tires on all four wheels.**

Don't go faster than 120 km/h (75 mph). Inflate snow tires 28 kPa (0.3 kgf/cm<sup>2</sup>, 4psi) more than recommended on the tire pressure label (driver's door), but never more than the maximum cold-tire pressure shown on the tires.

## WARNING

### *Mixing Tire Types:*

*Using tires different in size or type is dangerous. Your vehicle's handling could be greatly affected and result in an accident. Use only the same size and type tires (snow, radial, or non-radial) on all four wheels.*

### NOTE

Check local regulations before using studded tires.

### ▼ Tire chains

Check local regulations before using tire chains.

Install the chains on the front tires. Don't use chains on the rear tires. Use only SAE Class "S" chains, and make sure they fit.

To install the chains:

1. Remove the wheel covers, or the chain bands will scratch them.
2. Secure the chains on the front tires as tightly as possible. Always follow the chain manufacturer's instructions.
3. Retighten the chains after driving 1/2-1 km (1/4-1/2 mile).

### ⚠ CAUTION

- Chains may scratch or chip aluminum wheels. Install tire chains on steel wheels only.
- Chains may affect handling.
- Don't go faster than 50 km/h (30 mph) or the chain manufacturer's recommended limit, whichever is lower.
- Drive carefully and avoid bumps, holes, and sharp turns.
- Avoid locked-wheel braking.
- Don't use chains on the temporary tire; it may result in damage to the vehicle and to the tire.
- Don't use chains on roads that are free of snow or ice. The tires and chains could be damaged.

### ■ Driving in Flooded Areas

### ⚠ CAUTION

Make sure water does not enter the vehicle interior or the engine area. The vehicle interior could become wet or the engine could be damaged.

### ■ Trailer Towing

Never tow a trailer with your Mazda.

### ⚠ WARNING

Driving with Wet Brakes:  
*Driving with wet brakes is dangerous. Increased stopping distance or the vehicle pulling to one side when braking could result in a serious accident. Light braking will indicate whether the brakes have been affected. Dry the brakes by driving very slowly and applying the brakes tightly until brake performance returns to normal.*

Vehicle Information Labels

Overloading

 <b>WARNING</b>
<p><b>Vehicle Load Weight:</b> The gross axle weight rating (GAWR) and the gross vehicle weight rating (GVWR) of your vehicle are on the Motor Vehicle Safety Standard Label on the driver's door frame. Exceeding these ratings can cause an accident or vehicle damage. You can estimate the weight of your load by weighing the items (or people) before putting them in the vehicle. Be careful not to overload your vehicle.</p>

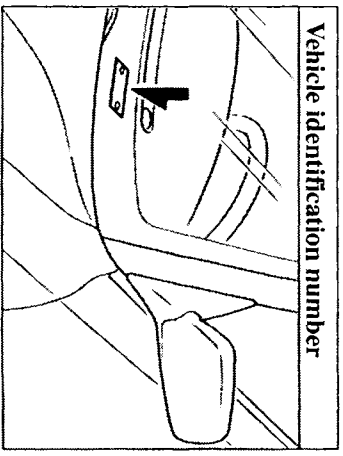

The vehicle identification number legally identifies your vehicle. The number is on a plate attached to the left top side of the dashboard. This plate can easily be seen through the windshield.

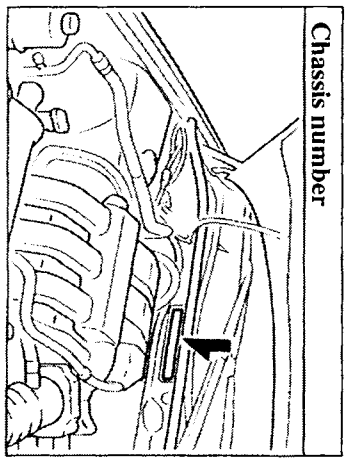
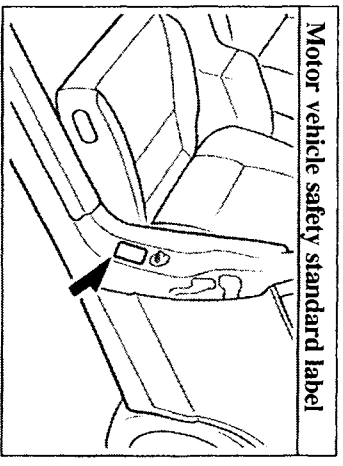



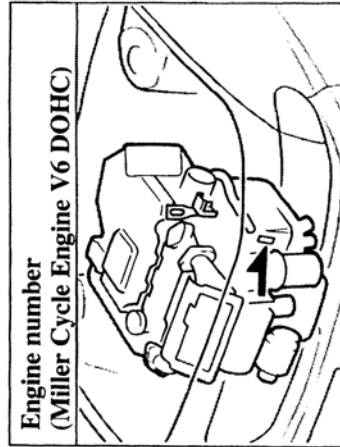
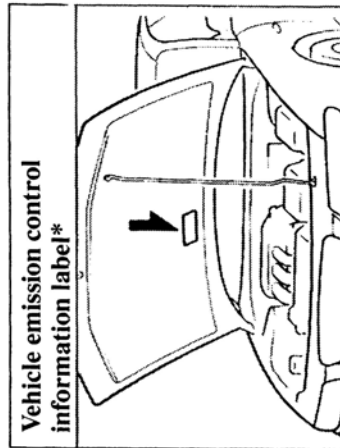
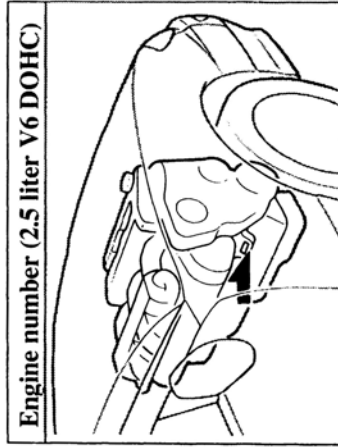
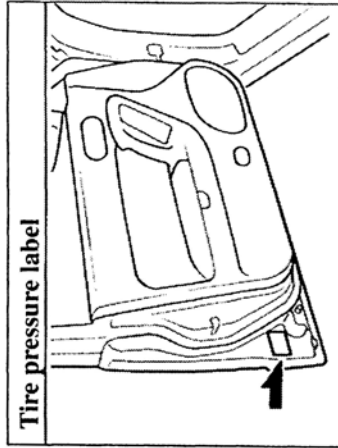



*Operating your vehicle requires a good understanding of the many controls you must know and use. Section 5 describes all this in step-by-step information from use of the ignition switch to cruise control and braking.*

*Also highlighted are the gearshift, power steering, instruments and gauges, warnings and indicators, windshield wipers, and interior features. You'll find complete details about the advanced audio system too.*

Ignition Switch Positions	5- 2
Starting the Engine	5- 3
Automatic Transaxle	5- 5
Traction Control System (TCS)	5-11
Brake System	5-13
Power Steering	5-17
Cruise Control	5-17
Instrument Cluster	5-23
Gauges	5-24
Dashboard Illumination	5-27
Warning Lights/Beeps	5-28
Lighting Control and Turn Signals	5-35
Windshield Wipers and Washer	5-37
Rear Window Defroster	5-40
Clock	5-41
Lighter	5-42
Accessory Socket	5-42
Ashtrays	5-45
Storage Compartments	5-46
Cup Holder	5-48
Sunvisors	5-50
Vanity Mirrors	5-50
Climate Control System	5-50
Radio Reception	5-60
Safety Certification	5-62
AM/FM Radio with Cassette Tape and Compact Disc Player/Changer (In-dash CD Changer)	5-64
Audio System Operation from the Steering Wheel	5-92
Antenna	5-92

## Ignition Switch Positions

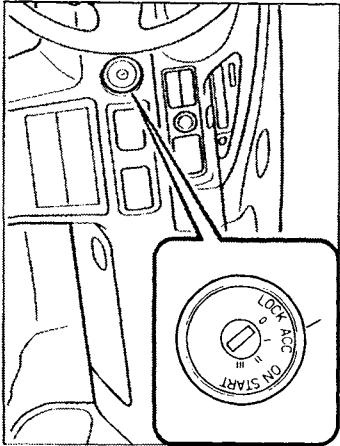

### ■ ON

This is the normal running position after the engine is started. The warning lights (except brakes) should be inspected before the engine is started (page 5-28).

### ■ START

The engine is started in this position. It will crank until you release the key; then it returns to the ON position. The brake warning light can be checked after the engine is started (page 5-28).

### ■ ACC (Accessory)

The steering wheel unlocks and some electrical accessories will operate.

### ■ LOCK

The steering wheel locks to protect against theft. Only in this position can the key be removed.

#### NOTE

If turning the key is difficult, jiggle the steering wheel from side to side.

## WARNING

### Removing the Key:

*It's dangerous to remove the key from the ignition switch while the vehicle is moving. Removing the key allows the steering wheel to lock. You will lose steering control and a serious accident could occur. Remove the key only when the vehicle is parked.*

### Starting the Engine

**⚠ WARNING**

*Not Setting the Parking Brake:*  
*Leaving the driver's seat without setting the parking brake is dangerous. Unexpected vehicle movement could occur if the parking brake is not set. This could cause an accident. Before leaving the driver's seat, always set the parking brake and make sure the shift lever is in P.*

1. Occupants should fasten their seat belts.
2. Make sure the parking brake is on.
3. Depress the brake pedal.
4. Put the vehicle in park (P). If you must restart the engine while the vehicle is moving, shift into neutral (N).

**NOTE**

The starter will not operate if the shift lever is **not** in P or N.

5. Turn the ignition switch to the START position and hold (up to 10 seconds at a time) until the engine starts.

**⚠ CAUTION**

Don't try the starter for more than 10 seconds at a time. If the engine stalls or fails to start, wait 10 seconds before trying again. Otherwise, you may damage the starter and drain the battery.

**NOTE**

If the ignition switch is in the LOCK or ACC position, a beep will sound when the driver's door is opened.

6. After starting the engine, let it idle for about 10 seconds.

<b>NOTE</b>
In extremely cold weather, below $-18^{\circ}\text{C}$ ( $0^{\circ}\text{F}$ ), or after the vehicle has stood idle several days, let the engine warm up without operating the accelerator.

<b>NOTE</b>
Whether cold or warm, the engine should be started without use of the accelerator.

If the engine fails to start, it may be flooded (excessive fuel in the engine).

Follow this procedure:

1. Depress the accelerator all the way and hold it there.

2. Turn the ignition switch to the START position and hold it there—for up to 10 seconds. If the engine starts, release the key and accelerator immediately because the engine will suddenly rev up.

3. If the engine fails to start, crank it without using the accelerator—for up to 10 seconds.

<b>NOTE</b>
<b>(2.5 liter V6 DOHC)</b> You may hear noise (from the valve tappets) if the engine has not been in use for a few days. At normal operating temperature, this should stop. If it doesn't, consult an Authorized Mazda Dealer.

**Automatic Transaxle**  
**Automatic Transaxle Controls**

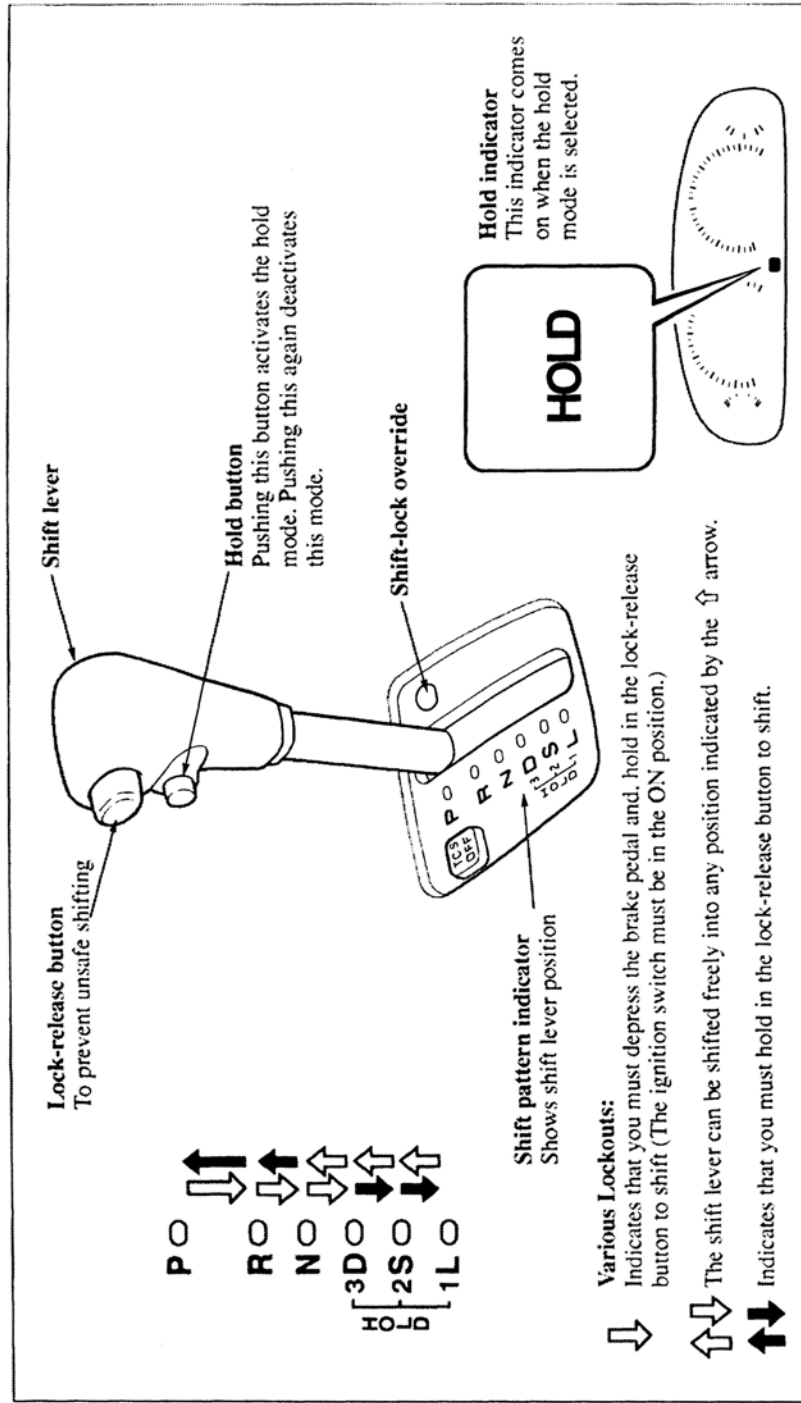

■ **Transaxle Ranges**

The shift lever must be in P or N to operate the starter.

▼ **P (Park)**

P locks the transaxle and prevents the front wheels from rotating.

 **WARNING**

Holding the Vehicle with P:

*Setting the shift lever to the P position without using the parking brake to hold the vehicle is dangerous. If P fails to hold, the vehicle could move and cause an accident. To hold the vehicle, set the shift lever to P AND set the parking brake.*

 **CAUTION**

- Shifting into P or R while the vehicle is moving can damage your transaxle.

- Shifting into a driving gear or reverse when the engine is running faster than idle can damage the transaxle.

▼ **R (Reverse)**

In position R, the vehicle moves only backward. You must be at a complete stop before shifting from R, except as explained under Rocking the Vehicle (page 4-8).

▼ **N (Neutral)**

In N, the wheels and transaxle are not locked. The vehicle will roll freely even on the slightest incline unless the parking brake or brakes are on.

 **WARNING**

Shifting from N or P:

*It's dangerous to shift from N or P into a driving gear when the engine is running faster than idle. If this is done, the vehicle could move suddenly, causing an accident or serious injury. If the engine is running faster than idle, don't shift from N or P into a driving gear.*



▼ **D (Drive)**

D is the normal driving position. From a stop, the transaxle will automatically shift through a 4-gear sequence.

▼ **S (Second)**

The S position is helpful when driving in slow-moving traffic and when climbing a hill.

▼ **L (Low)**

Use the L position when pulling heavy loads and climbing steep grades.

**Shift patterns without hold mode:**

**D = 1st, 2nd, 3rd, 4th**

**S = 1st, 2nd, 3rd**

**L = 1st, 2nd**

■ **Driving Tips**

▼ **Passing**

For extra power when passing another vehicle or climbing steep grades, depress the accelerator fully. The transaxle will shift to a lower gear, depending on vehicle speed.

▼ **Climbing steep grades from a stop**

To climb a steep grade from a stopped position:

1. Depress the brake pedal.
2. Shift to D, S, or L, depending on the load weight and grade steepness.
3. Release all brakes while gradually accelerating.

▼ **Descending steep grades**

When descending a steep grade, shift to S or L, depending on load weight and grade steepness. Descend slowly, using the brakes only occasionally to prevent them from overheating.

■ **Hold Mode**

The hold mode stops the automatic speed-change operation and has three positions: third (D), second (S), and first (L).

▼ **Hold operation**

Use the hold mode when starting from a stop on slippery surfaces, when driving up steep inclines, and for braking assistance on downgrades.

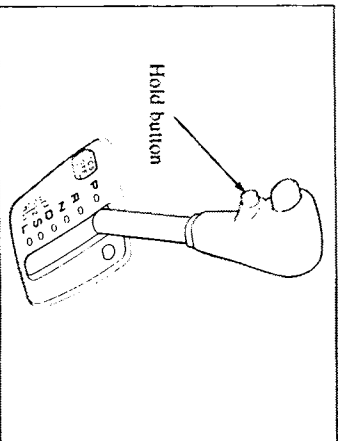

Push the hold button to activate the hold mode. Push it again to deactivate it.

▼ **When the hold mode is on:**  
**D (Drive)**

The transaxle is held in third. It automatically downshifts to a lower gear at a stop, however, and returns to third for smoother acceleration.

**S (Second)**

The transaxle is held in second. Don't drive faster than 102 km/h (64 mph)<sup>\*1</sup>, 96 km/h (60 mph)<sup>\*2</sup> in this position.

\*1 2.5 liter V6 DOHC

\*2 Miller Cycle Engine V6 DOHC

**L (Low)**

The transaxle is held in first. Don't drive faster than 46 km/h (28 mph) \*1 53 km/h (33 mph) \*2 in this position.

\*1 2.5 liter V6 DOHC

\*2 Miller Cycle Engine V6 DOHC

**Shift-up patterns with hold mode on:**

**D-Hold = 3rd (temporarily lowers gears for standing start)**

**S-Hold = 2nd (fixed)**

**L-Hold = 1st (fixed)**

**NOTE**

The hold mode is automatically canceled when the ignition is switched off.

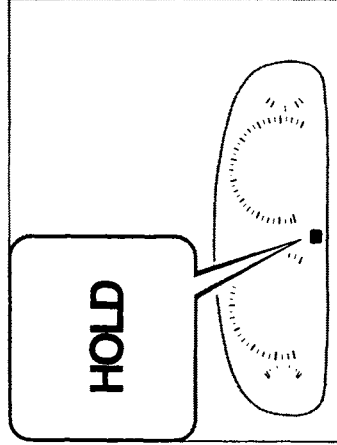

**▼ Hold indicator**

This light comes on when the hold mode is selected.

**⚠ CAUTION**

If the hold indicator light flashes, the transaxle has an electrical problem. Continuing to drive your Mazda in this condition could cause damage to your transaxle. Consult an Authorized Mazda Dealer as soon as possible.

**■ Shift-Lock System**

For your safety, the automatic transaxle has a **shift-lock, which prevents shifting out of P unless the brake pedal is depressed.**

To shift from P:

- 1 Depress and hold the brake pedal.
2. Start the engine.
3. Push and hold the lock-release button.
4. Move the shift lever.

**NOTE**

- When the ignition switch is in the ACC or LOCK position, the transaxle cannot be shifted from P
- If the brake is pumped with the shift lever in P, a chattering noise near the shift lever may be heard. Don't worry, this is a normal sound.
- To be sure the vehicle is in park, the ignition key cannot be removed unless the shift lever is in P.

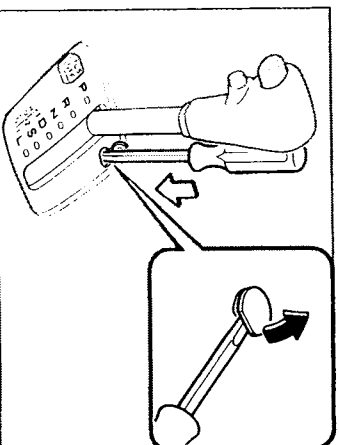

**■ Shift-Lock Override**

If the shift lever won't move from P with the brake pedal depressed, continue to hold down the pedal.

- 1 Remove the shift-lock override cover with a screwdriver.
- 2 Insert a screwdriver and push the lever down.
- 3 Push and hold the lock-release button.
- 4 Move the shift lever.

5. Take the vehicle to an Authorized Mazda Dealer to have the system checked.

### Traction Control System (TCS)\*

The Traction Control System (TCS) enhances traction and safety by regulating engine torque. When the TCS detects driving wheel slippage, it lowers engine torque to prevent loss of traction.

This means that on a slick surface, the engine adjusts automatically to provide optimum power to the drive wheels without causing them to spin and lose traction.

<b>⚠ WARNING</b>
<i>TCS and Snow and Ice: Driving without proper traction devices on snow- and ice-covered roads is dangerous. The traction control system (TCS) alone cannot provide adequate traction and you could still have an accident. Use snow tires or tires chains and drive at reduced speeds when roads are covered with ice and snow.</i>

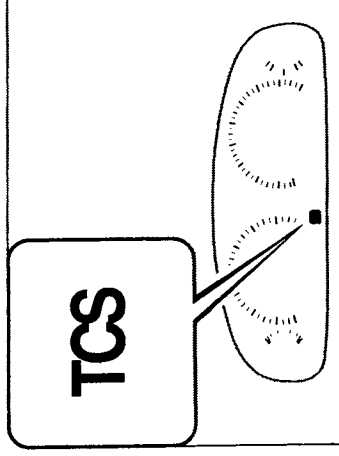

<b>⚠ WARNING</b>
<i>TCS and Unsafe Driving: The traction control system (TCS) cannot compensate for unsafe and reckless driving, excessive speed, tailgating (following another vehicle too closely), and hydroplaning (reduced tire friction and road contact because of water on the road surface). You can still have an accident. So don't rely on the traction control system as a substitute for safe driving.</i>

#### ■ Traction Control Indicators

#### ▼ Traction control system (TCS) warning light

This warning light stays on for a few seconds when the ignition switch is turned to the ON position.

It flashes when the system regulates engine torque. If the light stay on, take your vehicle to an Authorized Mazda Dealer. The traction control system may have a malfunction.

\*Some models.

<b>NOTE</b>
<ul style="list-style-type: none"><li>• In addition to the TCS warning light flashing, a slight lugging sound will come from the engine. This indicates that the traction control system is operating properly.</li><li>• On slippery surfaces, such as fresh snow, it will be impossible to achieve high rpm when the traction control system is on.</li></ul>

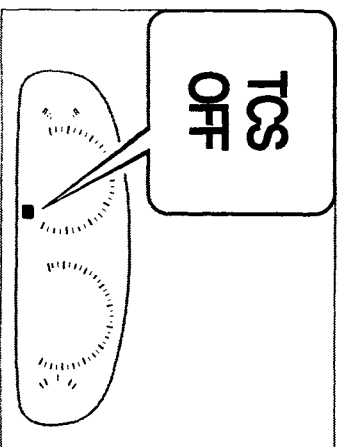

<b>NOTE</b>
After starting the engine on very cold days, the TCS OFF indicator will remain on and the system will not operate until the engine is warm.

▼ **TCS OFF indicator light**

This light comes on when the ignition switch is turned to the ON position. It goes off when the engine is started.

It also comes on when you switch off the traction control system or when the system has a malfunction.

## Brake System

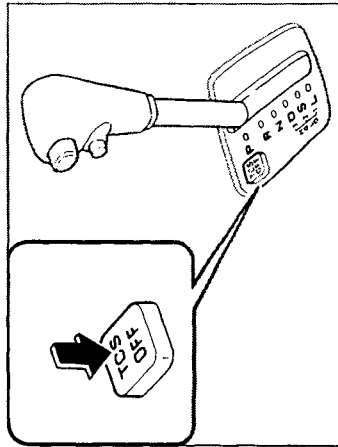

### ■ TCS OFF Switch

Push this switch once to turn off the TCS. Push it again to turn the TCS back on.

### NOTE

- If the TCS is off when the engine is turned off, it automatically activates when the ignition switch is turned on.
- Leaving the TCS on will provide the best traction.

### ■ Foot Brake

Your Mazda has power-assisted brakes that adjust automatically through normal use.

Should power assist fail, you can stop by applying greater force than normal to the brake pedal. But the distance required to stop will be greater than usual.

### ⚠ WARNING

*Driving with the Engine Off.*  
Continuing to drive when the engine is stalled or turned off is dangerous. Braking will require more effort, and the brake's power assist could be depleted if you pump the brake. This will cause longer stopping distances or even an accident. Don't continue driving when the engine is stalled or turned off, find a safe place to stop.

### ⚠ WARNING

*Riding the Brakes.*  
Driving with your foot continuously on the brake pedal or steadily applying the brakes for long distances is dangerous. This causes overheated brakes, resulting in longer stopping distances or even total brake failure. This could cause loss of vehicle control and a serious accident. Avoid continuous application of the brakes. Shift to a lower gear when going down steep hills.

**⚠ WARNING**

***Driving with Wet Brakes:***  
*Driving with wet brakes is dangerous. Increased stopping distance or the vehicle pulling to one side when braking could result in a serious accident. Light braking will indicate whether the brakes have been affected. Dry the brakes by driving very slowly and applying the brakes lightly until brake performance is normal.*

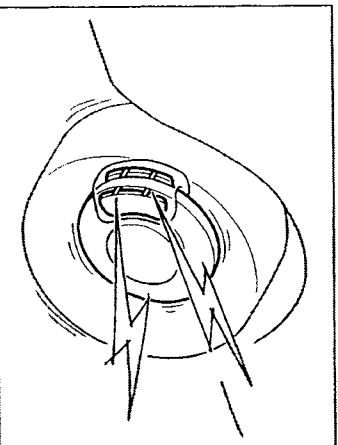

**⚠ WARNING**

***Driving with Worn Disc Pads:***  
*Driving with worn disc pads is dangerous. The brakes could fail and cause a serious accident. As soon as you hear a screeching noise consult an Authorized Mazda Dealer.*

■ **Brake Pad Wear Indicator**

When the disc brake pads become worn, the built-in wear indicators contact the disc plates. This causes a screeching noise to warn that the pads should be replaced.

When you hear this noise, consult an Authorized Mazda Dealer as soon as possible.



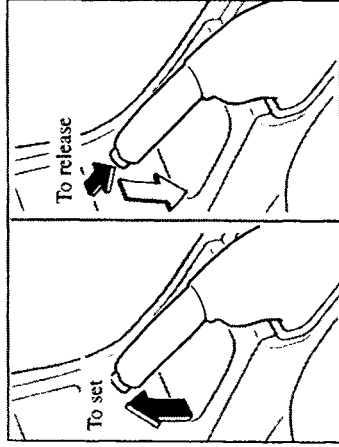

■ **Parking Brake**

To set the parking brake, depress the brake pedal; then pull the brake handle fully upward.

To release it, pull the handle up and press the button. Depress the brake pedal; then lower the handle to the release position while holding in the button. Release the pedal when it's safe to do so.

**NOTE**  
The drum-in disc parking brake system in your vehicle needs to be bedded down by an Authorized Mazda Dealer whenever the parking brake shoes or drums are changed, or there is a reduction in parking brake performance.

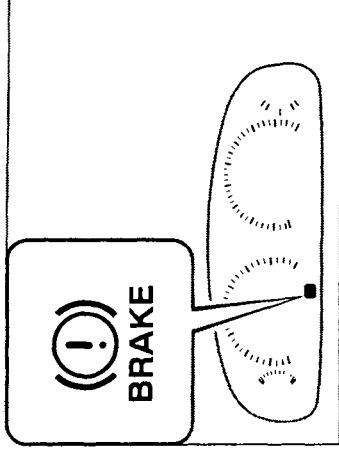

■ **Brake System Warning Light**

If the brake warning light stays on after the parking brake is fully released, the brake system has a malfunction. Refer to Warning Lights/Beeps (page 5-28).

**CAUTION**  
Driving with the parking brake on will cause excessive wear of the brake linings or pads.

■ Antilock Brake System (ABS)

The ABS control unit continuously monitors the speed of each wheel. If one is about to lock up, the ABS responds by automatically releasing and reapplying that wheel's brake.

The driver will feel a slight vibration in the brake pedal and may hear a chattering noise from the brake system. This is normal when the ABS operates. Don't pump the brakes, continue to press down on the brake pedal.

NOTE

- If the ABS warning light stays on while you're driving, the ABS control unit has detected a system malfunction. If this occurs, your brakes will function normally as if the vehicle had no ABS. Should this happen, consult an Authorized Mazda Dealer as soon as possible.
- Braking distances may be longer on loose surfaces (snow or gravel, for example) which usually have a hard foundation. A vehicle with a normal braking system may require less distance to stop under these conditions because the tires will build up a wedge of surface layer when the wheels skid.

 **WARNING**

**ABS:**  
*The ABS cannot compensate for unsafe and reckless driving, excessive speed, tailgating (following another vehicle too closely), and hydroplaning (reduced tire friction and road contact because of water on the road surface). You can still have an accident. So don't rely on ABS as a substitute for safe driving.*

NOTE

When the engine is jump-started, an unevenness of rpm occurs and the ABS warning light comes on. This is due to a lack of battery capacity and doesn't indicate a malfunction.

Have the battery recharged as soon as possible.

### Power Steering

Power steering is only operable when the engine is running. If the engine is off or if the power steering system is inoperable, you can still steer, but it requires more physical effort.

If the steering feels rigid during normal driving, consult an Authorized Mazda Dealer.

### CAUTION

Never hold the steering wheel to the extreme left or right for more than five seconds with the engine running. This could damage the power steering system.

### Cruise Control

With cruise control, you can set and automatically maintain any speed of more than about 40 km/h (25 mph).

### WARNING

#### Cruise Control Use:

*Using cruise control in the following conditions could cause you to lose control of the vehicle:*

- *Heavy or unsteady traffic*
- *Slippery or winding roads*
- *Similar restrictions that require inconsistent speed*

*Don't use cruise control in these situations.*

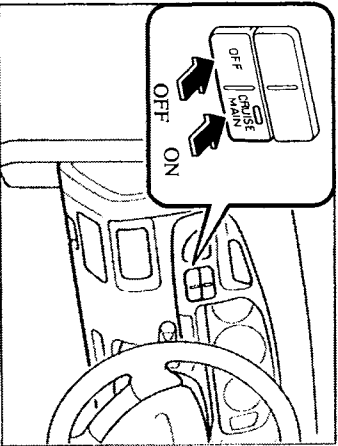

To activate the system, push the CRUISE MAIN switch. The indicator light comes on.

To deactivate the system, push the OFF switch.. The light goes off.

**⚠ WARNING**

***Cruise Main Switch:***  
*Leaving the CRUISE MAIN switch on when not using the cruise control is dangerous as it may be switched on accidentally. This could result in loss of vehicle control. Keep the CRUISE MAIN switch off when cruise control is not in use.*

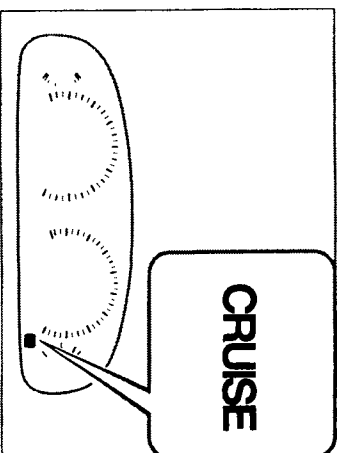

■ **Cruise Set Indicator Light**

The cruise set indicator comes on when a cruising speed is set.

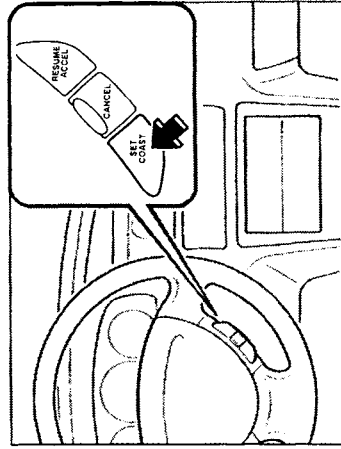

■ To Set Speed

- 1 Turn on the CRUISE MAIN switch.
2. Accelerate to the desired speed, which must be more than 40 km/h (25 mph).
3. Press the SET/COAST button and release it at the speed you want. Release the accelerator at the same time.

Don't continue to hold in the button. Until you release it, speed will drop (unless you continue to accelerate) and you'll miss the desired speed.

**NOTE**

- The SET function can't be activated until about 2 seconds after the CRUISE MAIN switch has been engaged.
- On a steep grade, the vehicle may momentarily slow down going up or speed up while going down.

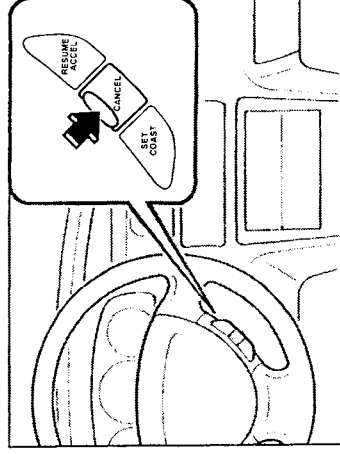

■ To Cancel

To turn off the system, use one of these methods:

- Push the CRUISE MAIN OFF switch.
- Slightly depress the brake pedal.
- Press the CANCEL switch.

The system is off when the ignition is off.

<b>NOTE</b>
Cruise control will cancel at about 15 km/h (9 mph) below the preset speed or below 40 km/h (25 mph).

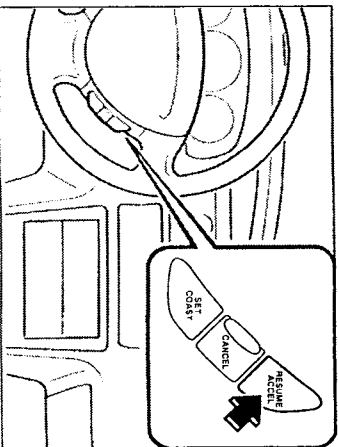

■ **To Increase Cruising Speed**

Follow either of these procedures.

- 1. Press **RESUME/ACCEL** and hold it. Your vehicle will accelerate.
  - 2. Release the switch at the speed you want.
- 1. Accelerate to the desired speed.
  - 2. Press **SET/COAST** and release it immediately.

Your vehicle has a tap-up feature that allows you to increase your current speed in increments of 1.6 km/h (1 mph) by a momentary tap of the **RESUME/ACCEL** switch.

Multiple taps will increase your vehicle speed 1.6 km/h (1 mph) for each tap. For example, if you are currently set at 96 km/h (60 mph) and tap the **RESUME/ACCEL** switch 5 times, your vehicle speed will increase and set at 104 km/h (65 mph).

■ **Accelerating with Cruise Control On**

Accelerate if you want to speed up temporarily when the cruise control is on. Greater speed will not interfere with it or change the set speed.

Take your foot off the accelerator to return to the set speed.

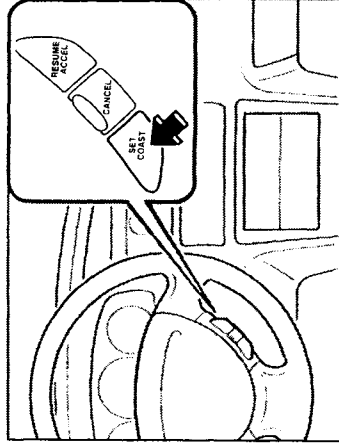

Your vehicle has a tap-down feature that allows you to decrease your current speed in decrements of 1.6 km/h (1 mph) by a momentary tap of the SET/COAST switch.

Multiple taps will decrease your vehicle speed 1.6 km/h (1 mph) for each tap. For example, if you are currently set at 104 km/h (65 mph) and tap the SET/COAST switch 5 times, your vehicle speed will decrease and set at 96 km/h (60 mph).

■ **To Decrease Cruising Speed**

1. Press SET/COAST and hold it. The vehicle will gradually slow.
2. Release the switch at the speed you want.

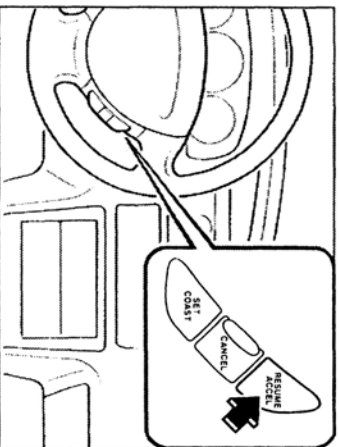

<b>NOTE</b>
With an automatic transaxle vehicle, the gear is automatically selected when going uphill.

■ **To Resume Cruising Speed at More Than 40 km/h (25 mph)**

If something besides the MAIN switch was used to cancel cruising speed and the system is still activated, the most recent set speed will automatically resume when the RESUME/ACCEL switch is pressed. If vehicle speed is below 40 km/h (25 mph), increase the vehicle speed up to 40 km/h (25 mph) and press the RESUME/ACCEL switch.



Instrument Cluster

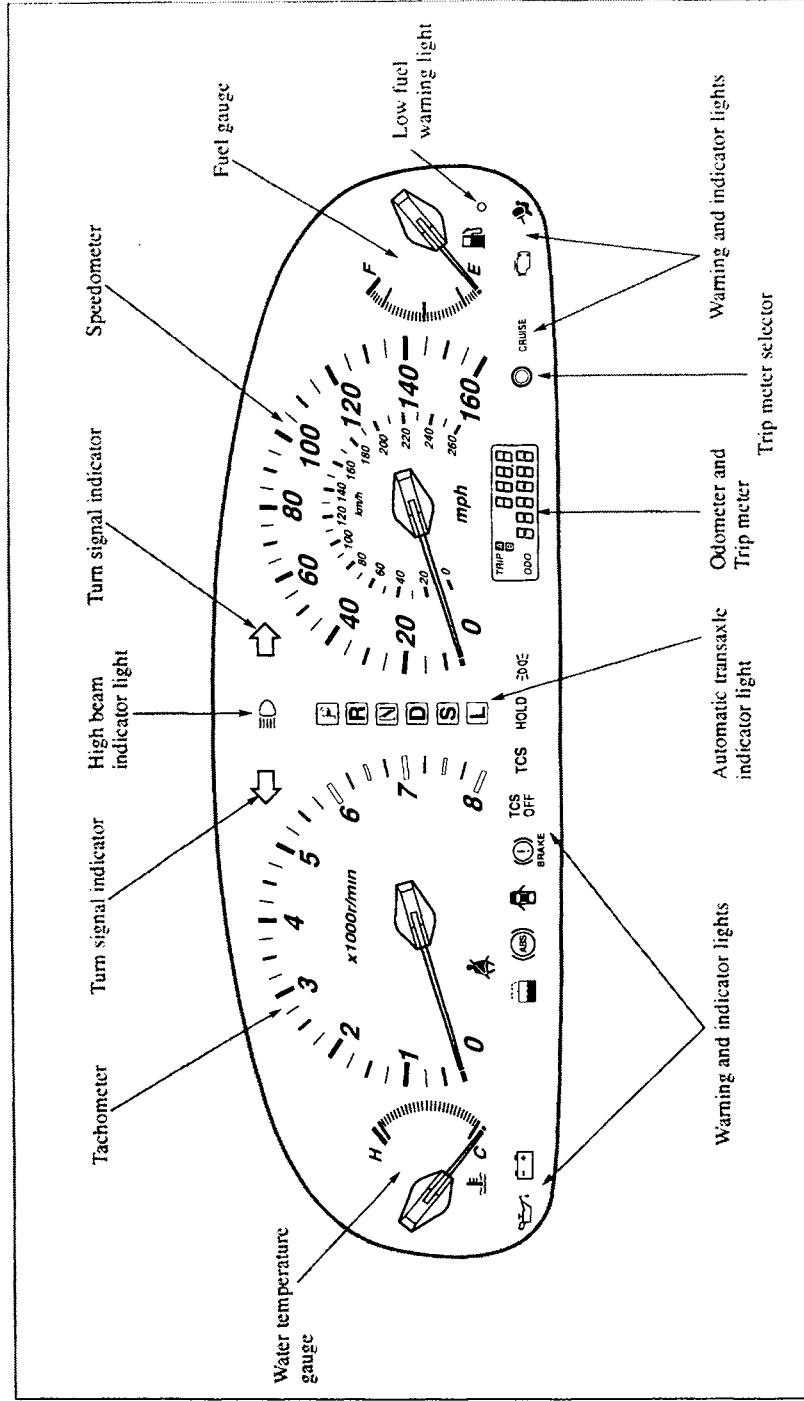

## Gauges

### ■ Speedometer

The speedometer indicates the speed of the vehicle.

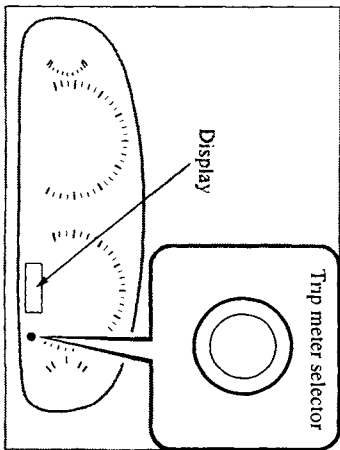

### ■ Odometer and Trip Meter

The odometer and trip meter are displayed when the ignition switch is turned to the ON position.

The display mode can be switched between trip meter A and trip meter B by pressing the selector. The selected mode will be displayed.

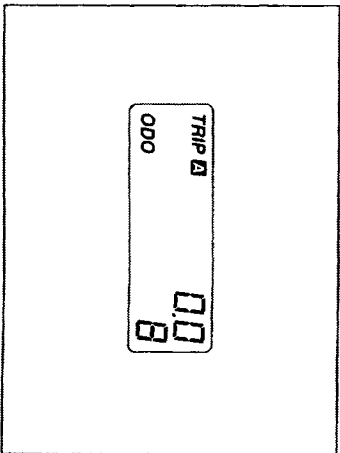

### ▼ Odometer

The odometer records the total distance the vehicle has been driven.

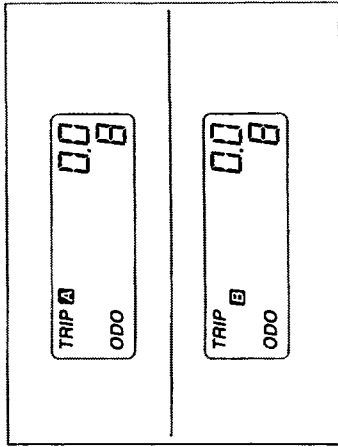

For instance, trip meter A can record the distance from the point of origin, and trip meter B can record the distance from where the fuel tank is filled.

When trip meter A is selected, pressing the selector again within one second will change the trip meter to B mode.

When trip meter A is selected, TRIP A will be displayed. When trip meter B is selected, TRIP B will be displayed.

The trip meter records the total distance the vehicle is driven until the meter is again reset. Return it to "0.0" by holding the selector depressed for more than 1 second.

Use this meter to measure trip distances and to compute fuel consumption.

▼ Trip meter

The trip meter can record the total distance of two trips. One is recorded in trip meter A, and the other is recorded in trip meter B.

<b>NOTE</b>	<ul style="list-style-type: none"> <li>• Only the trip meters record tenths of kilometers (miles).</li> <li>• The trip record will be erased when;             <ul style="list-style-type: none"> <li>• The power supply is interrupted (blown fuse or the battery is disconnected).</li> <li>• The vehicle is driven over 999.9 km (miles).</li> </ul> </li> </ul>
-------------	---

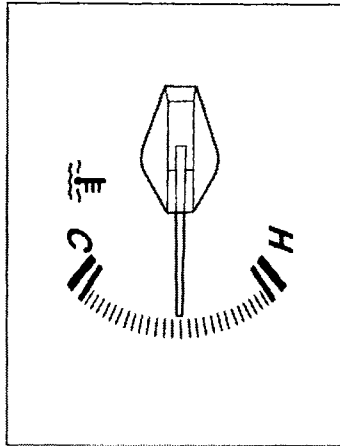

■ Water Temperature Gauge

The water temperature gauge shows the temperature of the engine coolant.

If the needle exceeds normal range toward H, it indicates overheating.

<b>CAUTION</b>
Driving with an overheated engine can cause serious engine damage (page 6-2).

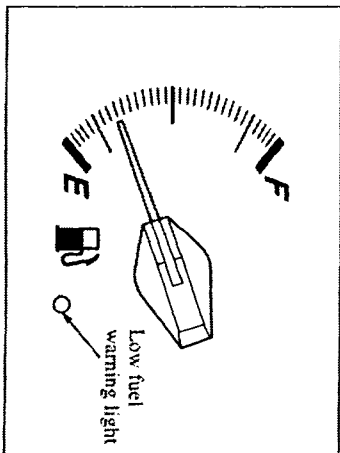

■ Fuel Gauge

The fuel gauge shows approximately how much fuel is in the tank. We recommend keeping the tank over 1/4 full. When the low fuel warning light illuminates or when the needle is near E, refuel as soon as possible.

### Dashboard Illumination

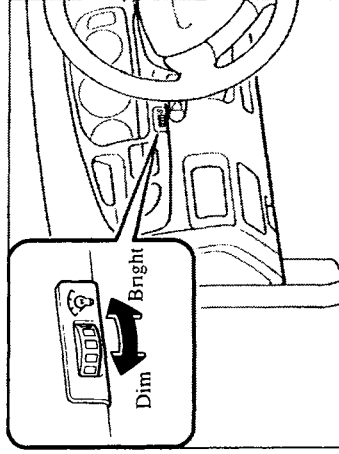

**CAUTION**

Don't run the engine with the tachometer needle in the RED ZONE. This may cause severe engine damage.

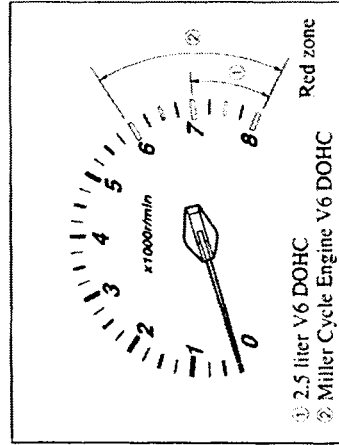

#### ■ Tachometer

The tachometer shows engine speed in thousands of revolutions per minute (rpm).

When the ignition switch is in the ON position, rotate the thumb-wheel to adjust the brightness of the dashboard lights.

## Warning Lights/Beeps

### ■ Warning Lights Inspection

Inspect the warning lights by turning the ignition switch to the ON position with the engine off and the parking brake on. Consult an Authorized Mazda Dealer about any light that doesn't come on.

If the brake system warning light is off when the ignition switch is in the START position, have the system inspected by an Authorized Mazda Dealer.

After starting the engine, make sure all warning lights are off. If one stays on, it's signaling for attention.

The brake system warning light should go off when the parking brake is released.

### ■ Brake System Warning Light



This warning light comes on when the ignition switch is turned to the ON position. When the parking brake is not applied, it goes out after about 2 seconds.

This warning has the following functions:

#### ▼ Parking brake warning

The light comes on when the parking brake is applied with the ignition switch in the START or ON position. It goes off when the parking brake is fully released.

#### ▼ Low brake fluid level warning/Electronic brake force distribution system warning

If the light stays on after the parking brake is fully released, you may have a brake problem.

Drive to the side of the road and park off the right-of-way.

### Low brake fluid level warning

You may notice that the pedal is harder to push or that it may go closer to the floor. In either case, it will take longer to stop the vehicle.

1. With the engine stopped, check the brake fluid level immediately and add fluid as required (page 8-19).
2. After adding fluid, check the light again.

If the warning light remains on, or if the brakes do not operate properly, do not drive the vehicle. Have it towed to an Authorized Mazda Dealer.

Even if the light goes off, have your brake system inspected as soon as possible.

**Electronic brake force distribution system warning**

If the electronic brake force distribution control unit determines that some components are operating incorrectly, the control unit may turn the brake system warning light on. In this case, the ABS warning light comes on at the same time. (page 5-32)

**⚠ WARNING**

**Brake Warning Light:**  
*Driving with the brake system warning light on is dangerous. It indicates that your brakes may not work at all or that they could completely fail at any time. If this light remains on, have the brakes inspected immediately. Don't drive with this light on, and contact an Authorized Mazda Dealer to have the brakes inspected as soon as possible.*

**⚠ WARNING**

**ABS Warning Light and Brake Warning Light on at the Same Time:**  
*Driving when the brake system warning light and ABS warning light are on at the same time is dangerous. When both lights are on, the rear emergency stop than under normal circumstances.  
Don't drive with both lights on, and contact an Authorized Mazda Dealer to have the brakes inspected as soon as possible.*

■ **Seat Belt Warning Light/Beep**



If the driver's seat belt is not fastened when the ignition switch is turned to the ON position, a beep will sound for about 6 seconds and the seat belt warning light will remain on until the belt is fastened.

If the system does not operate correctly, consult an Authorized Mazda Dealer.

■ **Charging System Warning Light**



This warning light indicates a malfunction of the alternator or of the charging system.

If the light comes on while driving:

1. Drive to the side of the road and park off the right-of-way.
2. Turn off the engine. Inspect the alternator drive belt for looseness and breakage.
3. If it's OK, the charging system has a problem. Consult an Authorized Mazda Dealer as soon as possible.

■ **Engine Oil Pressure Warning Light**



This warning light indicates low engine oil pressure.

If the light comes on while driving:

1. Drive to the side of the road and park off the right-of-way.
2. Turn off the engine and inspect the engine oil level (page 8-12). If it's low, add oil.
3. Check the light.  
  
If the light remains on even after you add oil, have your vehicle towed to the nearest service station or to an Authorized Mazda Dealer.

**CAUTION**

Don't run the engine if oil pressure is low. It could result in extensive engine damage.



■ **Traction Control System (TCS) Warning Light\***



This warning light stays on for a few seconds when the ignition switch is turned to the ON position.

The light flashes when the system regulates engine torque and will stay on if the system malfunctions. If it stays on while the system is operating, consult an Authorized Mazda Dealer.

■ **Low Fuel Warning Light**

This warning light in the fuel gauge signals that the fuel tank will soon be empty.

Get fuel as soon as possible.

■ **Check Engine Light**



If this light comes on while driving, the vehicle may have a problem. It is important to note the driving conditions when the light came on and consult an Authorized Mazda Dealer.

The check engine light may come on in the following cases:

- The fuel tank level being very low or approaching empty.
- The engine's electrical system has a problem.
- The emission control system has a problem.
- A ROOM fuse blows or is removed.
- The fuel-filler cap is missing or not tightened securely.

If the check engine light flashes continuously, decrease your speed and consult an Authorized Mazda Dealer as soon as possible.

■ **Low Washer Fluid Level Warning Light\***



This warning light reveals that little windshield washer fluid remains. Add fluid (page 8-24).

■ **Door-Ajar Warning Light**



This warning light comes on when any door isn't securely closed.

■ **Antilock Brake System (ABS) Warning Light**



The warning light stays on for a few seconds when the ignition switch is turned to the ON position.

If the ABS warning light stays on while you're driving, the ABS control unit has detected a system malfunction. If this occurs, your brakes will function normally as if the vehicle had no ABS. Should this happen, consult an Authorized Mazda Dealer as soon as possible.

**5-32**

\*Some models.

**⚠ WARNING**

***ABS Warning Light and Brake Warning Light on at the Same Time:***  
*Driving when the brake system warning light and ABS warning light are on at the same time is dangerous. When both lights are on, the rear wheels could lock more quickly in an emergency stop than under normal circumstances.*  
***Don't drive with both lights on, and contact an Authorized Mazda Dealer to have the brakes inspected as soon as possible.***

**NOTE**

When the engine is jump-started to charge the battery, uneven rpm occurs and the ABS warning light comes on. This is due to a weak battery, not a malfunction.  
 Recharge the battery.

■ **Supplemental Restraint System Warning Light**



If the supplemental restraint system is OK, the warning light comes on when the ignition switch is turned to the ON position or after the engine is cranked. After about 6 seconds it goes out.

A system malfunction is indicated when this light constantly flashes, stays on or doesn't come on at all. If one of these occur, consult an Authorized Mazda Dealer as soon as possible. The system may not work in an accident.

 **WARNING**

*Self-Servicing the Supplemental Restraint System.*  
*Self-servicing or tampering with the supplemental restraint system is dangerous. The air bags could accidentally activate or become disabled. This could cause serious injuries. Never tamper with the supplemental restraint system and always have an Authorized Mazda Dealer perform all servicing and repairs.*

■ **Ignition Key Reminder**

If the ignition switch is in the LOCK or ACC position, a beep will sound when the driver's door is opened.

■ **Lights-On Reminder**

If lights are on and the key is removed from the ignition switch, a beep will sound when the driver's door is opened.

## Driving Your Mazda

---

### ■ Headlight High-Beam Indicator Light



This light indicates one of two things:

- The high-beam headlights are on.
- The turn-signal lever is in the flash-to-pass position.

### ■ Lights-On Indicator Light



This indicator light comes on when the exterior lights are on.

### ■ Hold Indicator Light



This light comes on when the hold mode is selected.

## CAUTION

If the hold indicator light flashes, the transaxle has an electrical problem. Continuing to drive your Mazda in this condition could cause damage to your transaxle. Consult an Authorized Mazda Dealer as soon as possible.

### ■ Cruise Set Indicator Light



This light comes on when a cruising speed is set.

### ■ Traction Control System (TCS) OFF Indicator Light\*



This light comes on when the ignition switch is turned to the ON position. It goes off when the engine is started.

The light also comes on when you switch off the TCS. If the TCS has a malfunction, the TCS OFF indicator light will come on. If it comes on while you're driving, consult an Authorized Mazda Dealer.

### Lighting Control and Turn Signals

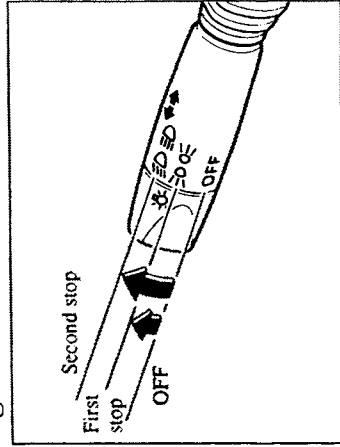

#### ■ Headlights

To turn on the lights, turn the knob on the end of the control lever.

The first stop turns on the taillights, dashboard lights, parking lights, license lights, and side-marker lights.

The second stop turns on the headlights, taillights, dashboard lights, parking lights, license lights, and side-marker lights.

If the light switch is left on, the lights will automatically switch off after 30 seconds of turning of the ignition switch (LOCK position) or removing the key.

The light will automatically switch on when the ignition switch is turned to the ACC or ON position.

#### ▼ Lights-on reminder

If lights are on and the key is removed from the ignition switch, a beep will sound when the driver's door is opened.

#### NOTE

To prevent discharging the battery, don't leave the lights on while the engine is off.

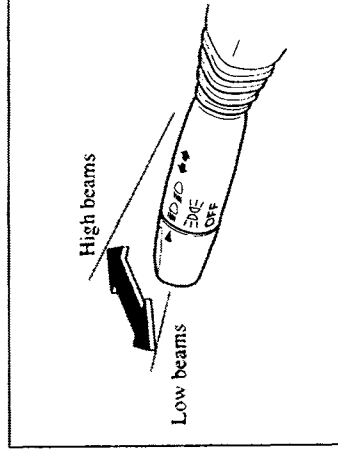

#### ▼ Headlight high-low beam

Push the lever forward for high beams. Pull it back for low.

The high-beam indicator light on the dashboard is blue.

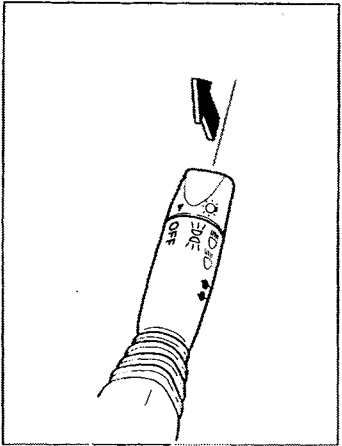

▼ Flashing the headlights

To flash the headlights, pull the lever fully toward you. The headlight switch need not be on, and the lever will return to the normal position when released.

The high-beam indicator light on the dashboard is blue.

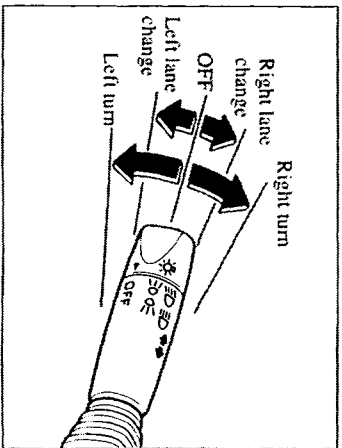

■ Turn and Lane-Change Signals

▼ Turn signal

Move the signal lever down (for a left turn) or up (for a right turn) to the stop position. The signal will self-cancel after the turn is completed.

Green indicators on the dashboard show which signal is working.

▼ Lane-change signals

Move the lever slightly toward the direction of the change—until the indicator flashes—and hold it there. It will return to the off position when released.

**NOTE**

If an indicator light stays on without flashing or if it flashes abnormally, the turn-signal bulb may be burned out.

## Windshield Wipers and Washer

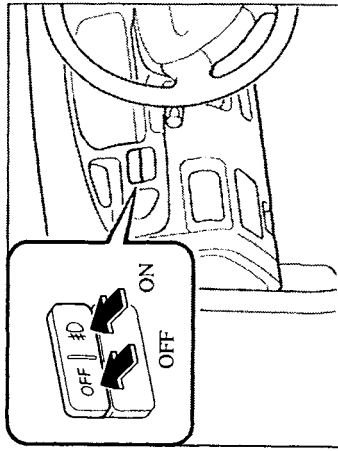

### ■ Fog Lights

Use this switch to turn on the fog lights. They help you to see as well as to be seen.

To turn on the fog lights, first turn on the headlight switch. Then press the fog light switch. To turn the fog lights off, press OFF or turn the headlight switch off.

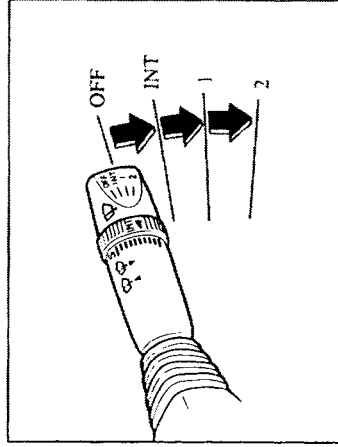

### ■ Windshield Wipers

The ignition switch must be in the ON position.

Turn the wipers on by pulling the lever down.

INT — Intermittent  
 1 — Normal  
 2 — Fast

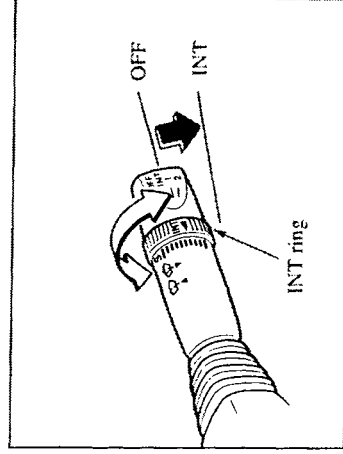

### ▼ Variable-speed intermittent wipers

Set the lever to INT and choose the interval timing by rotating the ring.

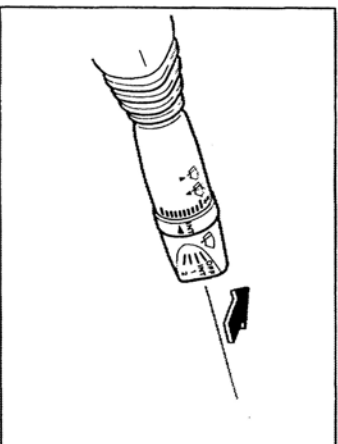

▼ **One-touch wipers**

For a single wiping cycle, push the lever forward and release it.

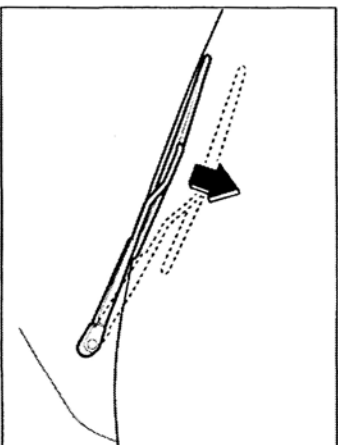

▼ **Cold-weather operation of concealed wipers\***

In cold areas, the wiper arms may trap heavy ice or snow. To prevent this, change the angle of the arm by pulling it up until it clicks. The wipers will then change to the partially concealed position.

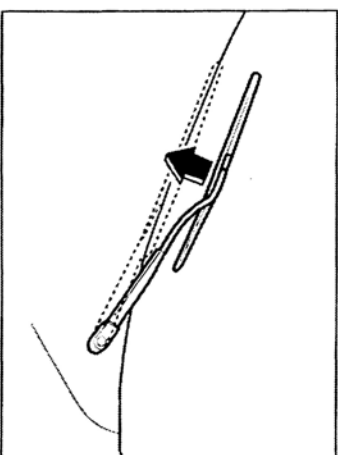

To return the arm to the fully concealed position, push it down until it clicks.

<b>⚠ CAUTION</b>
Do this only with the wiper switch off and when the wipers aren't moving.



**NOTE**

Because heavy ice and snow can jam the wiper blades, the wiper motor is protected by a circuit breaker. This mechanism will automatically stop operation of the blades, but only for about 5 minutes.

If this happens, turn off the wiper switch and park off the right-of-way. After 5 minutes, turn on the switch and the blades should operate normally. If they don't, consult an Authorized Mazda Dealer as soon as possible.

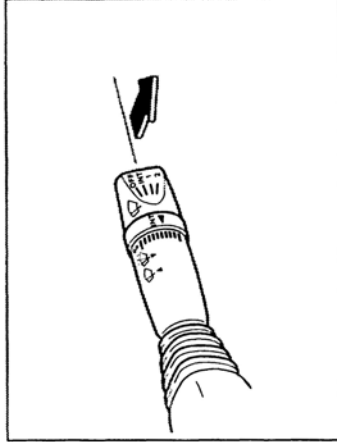

■ **Windshield Washer**

The ignition switch must be in the ON position.

Pull the lever toward you and hold it to spray washer fluid. In the OFF or INT position, the wipers will be activated until the lever is released.

If the washer doesn't work, inspect the fluid level (page 8-24). If it's OK, consult an Authorized Mazda Dealer.

**⚠ WARNING**

**Frozen Washer Fluid:**  
*Using windshield washer fluid in freezing temperatures is dangerous. The washer fluid could freeze on the windshield and block your vision. You could have an accident. Don't use the washer without first warming the windshield.*

## Rear Window Defroster

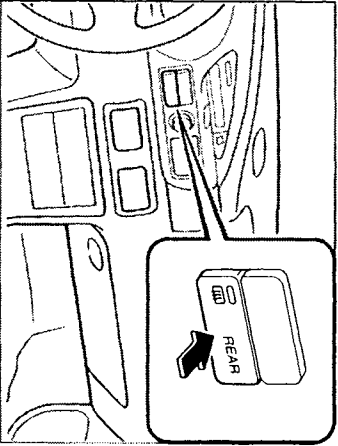

The rear defroster clears frost, fog, and thin ice from the rear window.

The ignition switch must be in the ON position.

Push the switch to turn on the rear window defroster; the indicator light will come on.

Push the switch again to turn it off.

### CAUTION

Don't use sharp instruments or window cleaners with abrasives to clean the inside of the rear window defroster grid inside the window.

### NOTE

This defroster is not designed for melting snow. If there is an accumulation of snow on the rear window, brush it off before using the defroster.

### NOTE

- When the switch is turned on, the defroster comes on for about 20 minutes. Then the defroster cycles — 2 minutes off, 3 minutes on — for as long as the switch remains on. The indicator light stays on constantly.

- The rear defroster shuts off when the ignition switch is turned off.

### NOTE

The FM radio antenna located in the rear window are not heated.

## Clock

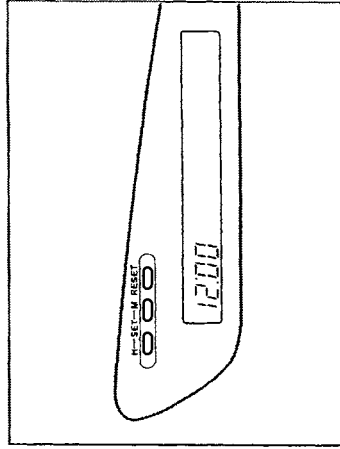

Press the RESET button to clear minutes. The clock will be set on the hour.

If the RESET button is pressed from 9:01 to 9:29, for example, the time will be reset to 9:00. If pressed from 9:30 to 9:59, the time will be reset to 10:00.

9:01—9:29 = 9:00  
9:30—9:59 = 10:00

### ■ Setting the Time

The ignition switch must be in the ACC or ON position.

### ▼ To set the hour

Press the H (hour) button to change hours.

### ▼ To set the minutes

Press the M (minute) button to change minutes.

### NOTE

When the power is disconnected, the time is automatically set at 1:00

### Lighter

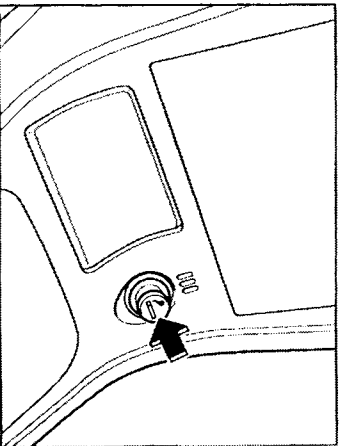

To operate the lighter, press it in and release it. When ready for use, it automatically pops out.

If the engine is off, the ignition switch must be in the ACC or ON position for the lighter to operate.

### CAUTION

- Don't hold the lighter in because it will overheat.
- Don't use the lighter socket for plug-in accessories such as shavers and coffee pots. They may damage it or cause electrical failure. Use only a genuine Mazda lighter or the equivalent.
- If the lighter doesn't pop out within 30 seconds, remove it to prevent overheating.

### Accessory Socket

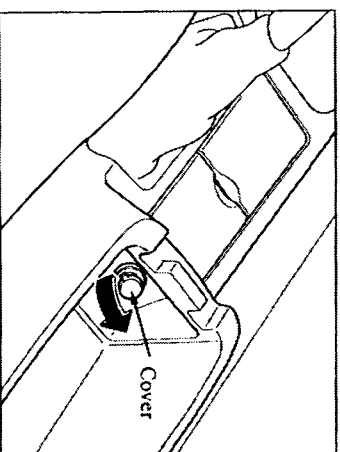

To use the accessory socket, the ignition switch must be in the ACC or ON position.

Only use genuine Mazda accessories or the equivalent requiring no greater than 12V—10A.

<b>⚠ CAUTION</b>
<p>To prevent accessory socket damage or electrical failure, pay attention to the following;</p> <ul style="list-style-type: none"><li>• Don't use accessories that require more than 12V—10A.</li><li>• Don't use accessories that are not genuine Mazda accessories or the equivalent.</li><li>• Close the cover when the accessory socket is not in use.</li><li>• Correctly insert the plug into the accessory socket.</li></ul>

<b>NOTE</b>
<p>To prevent discharging the battery, don't use the socket for long periods with the engine off or idling.</p>

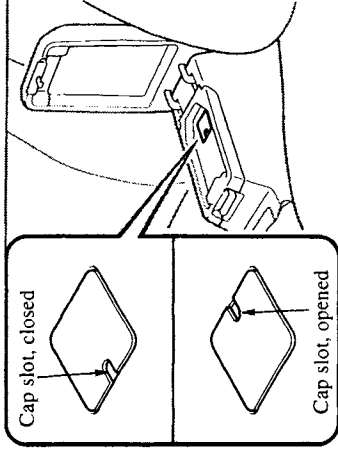

When placing an electrical device (e.g. cellular phone) in the tray which is connected with the accessory socket, pass the plug cord through the slot in the cap.

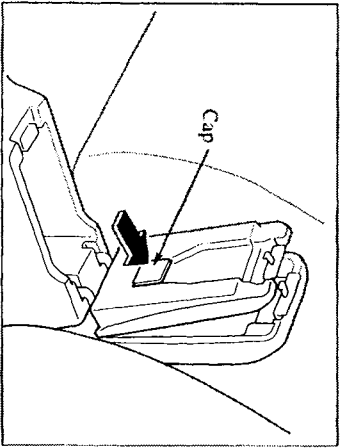

1. Open the tray by pulling the release catch.

2. Push the cap from the backside of the tray and remove it.

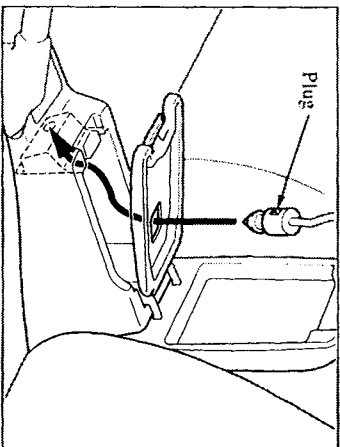

3. Pass the plug cord through the hole of the tray and insert the plug in the socket.

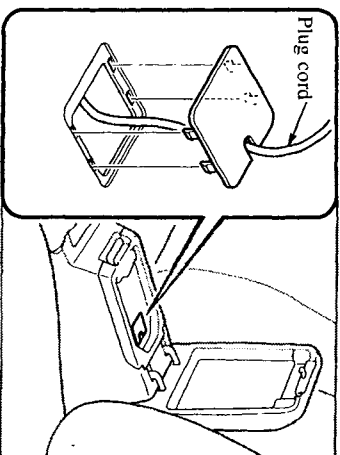

4. Make sure the plug cord is running through the cap slot; reinstall the cap.

Ashtrays

<b>⚠ CAUTION</b>
Don't use ashtrays for trash. You might start a fire.

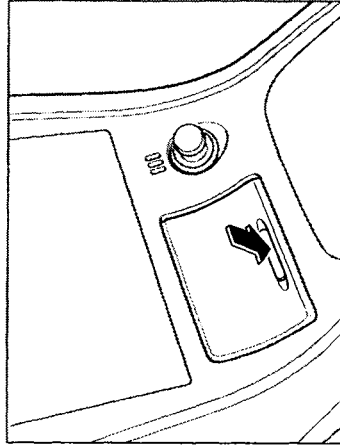

■ Front Ashtray

To open it, push the lower part of the cover.

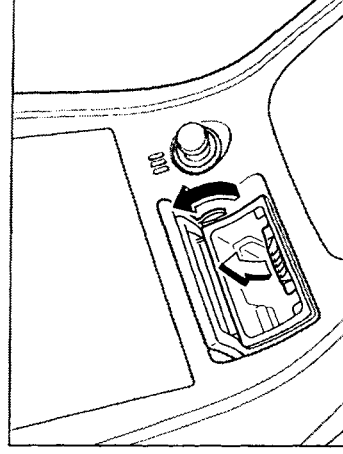

To remove it, push the cover forward and pull out the ashtray.

To reinstall the ashtray, set it completely back into its fixed position and close the cover.

Storage Compartments

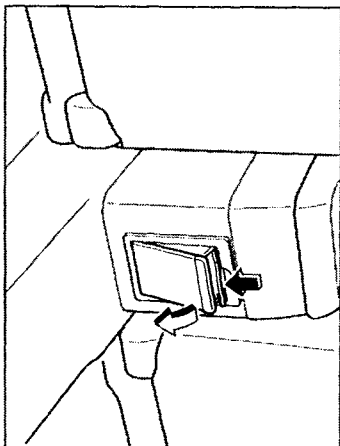

■ Rear Ashtray

To remove it, open and push down on the lock spring.

**⚠ WARNING**

**Open Storage Box:**  
*Driving with a storage box open is dangerous. To reduce the possibility of injury in an accident or a sudden stop, keep the storage boxes closed when driving.*

**⚠ CAUTION**

In hot weather, don't leave combustible materials or objects which will deform in extreme heat such as lighters and glasses in the vehicle.

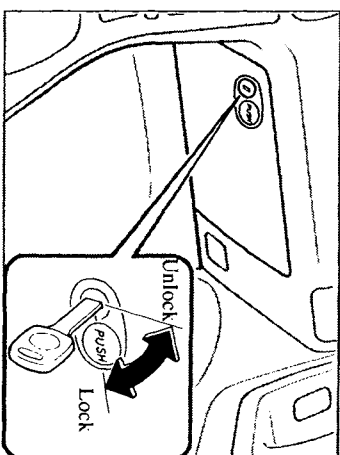

■ Glove Box

To open the glove box, press the button.

Insert the primary key and turn it clockwise to lock, counterclockwise to unlock.



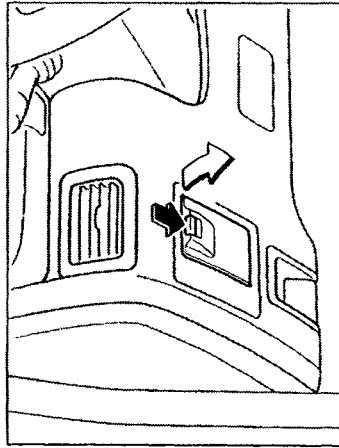

■ **Coin Box**

To open, press the release button.

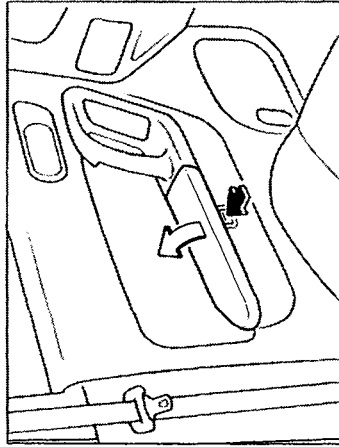

■ **Front-Door Storage Compartments**

To open, press the release button and lift the cover.

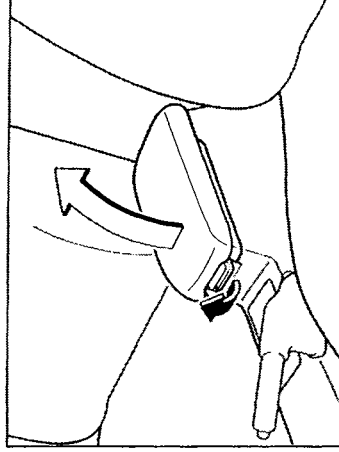

■ **Center Console**

To open, pull the lower release catch.

### Cup Holder

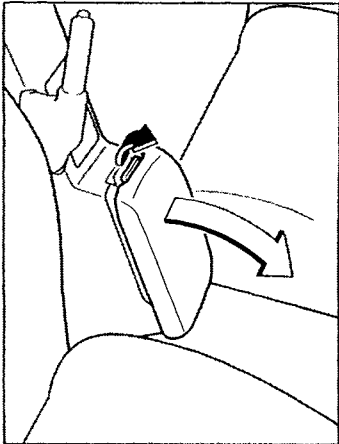

Small items can be placed in the tray of the center console lid.

To open it, pull the upper release catch.

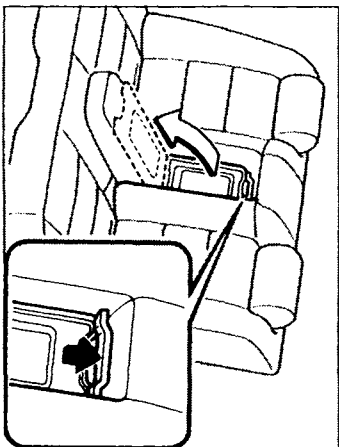

#### ■ Rear-Armrest Opening

This opening can be used when you need extra space for transporting long items (such as skis). You can also place things through it directly into the trunk.

## **WARNING**

*Using the Cup Holder:  
Using the cup holder to hold hot liquids while the vehicle is moving is dangerous. If the contents spill, you could be scalded. Never use the cup holder to hold hot liquids while the vehicle is moving.*

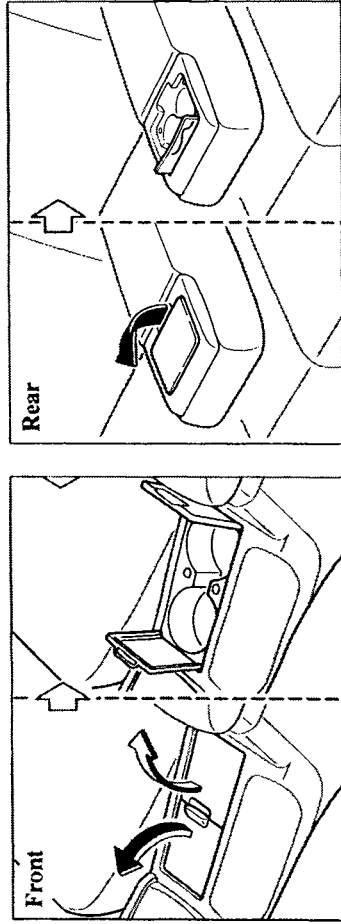

To use the cup holder, open the cover.

**Sunvisors**

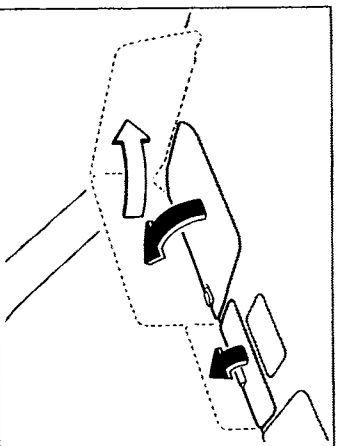

When you need a sunvisor, lower it for use in front or swing it to the side.

**Vanity Mirrors**

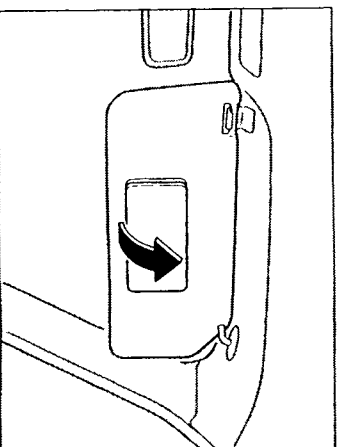

To use the vanity mirror, lower the sunvisor and pull the mirror cover up. The vanity mirror light will come on when you pull the cover up.

**Climate Control System**

- **Operating Tips**
- ▼ **Operating the climate control system**

Operate the climate control system with the engine running.

▼ **Clearing the air inlet**

Clear all obstructions like leaves, snow and ice from the hood and the air inlet in the cowl grille to improve the system efficiency.

▼ **Foggy windows**

The windows may fog up easily in humid weather. Use the climate control system to defrost the windows.

To help defrost the windows, operate the air conditioner to dehumidify the air.

▼ **Outside/Recirculated air position**  
Use the outside air position in normal conditions. The recirculated air position can be used temporarily when driving on dusty roads or for quick cooling of the interior.

▼ **Parking in direct sunlight**  
If the vehicle has been parked in direct sunlight during hot weather, open the windows to let warm air escape, then run the climate control system.

▼ **Not using for a long period**  
Run the air conditioner at least once a month to keep internal parts lubricated.

▼ **Check the refrigerant before weather gets hot**

Have the air conditioner checked before the weather gets hot. Lack of refrigerant may make the air conditioner less efficient. Consult an Authorized Mazda Dealer for refrigerant inspection.

The optional air conditioner is filled with R134a, a refrigerant that will not damage the ozone layer.











If the air conditioner is low on refrigerant or has a malfunction, consult an Authorized Mazda Dealer.

▼ **Replacement of the cabin air filter**

If your vehicle is equipped with an air filter for the air conditioner, it is necessary to change the filter periodically as indicated in scheduled maintenance (page 8-3). Consult an Authorized Mazda Dealer for replacement the cabin air filter.

**Driving Your Mazda**

■ **Selecting the Air-flow Mode**

Use	When you want air to the face:	When you want air to the face and the floor:	When you want air mainly to the floor:	When you want air to the floor and defrost the windshield:	When you want to defrost the windshield:
Mode					
AirFlow					

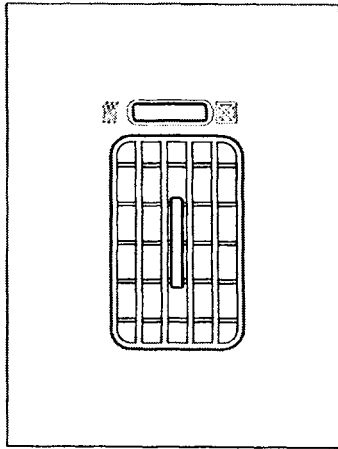

■ Vent Operation

▼ Directing airflow

You can direct air flow by moving the adjustment knob.

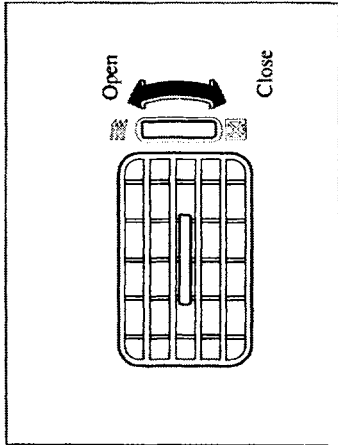

▼ Adjusting the amount of airflow

These vents can be opened by rotating the vertical wheels up or closed by rotating them down.

**NOTE**

When using the air conditioner, mist may come out from the vents. This is not a sign of trouble but a result of humid air being suddenly cooled.

## Driving Your Mazda

### Control Panel

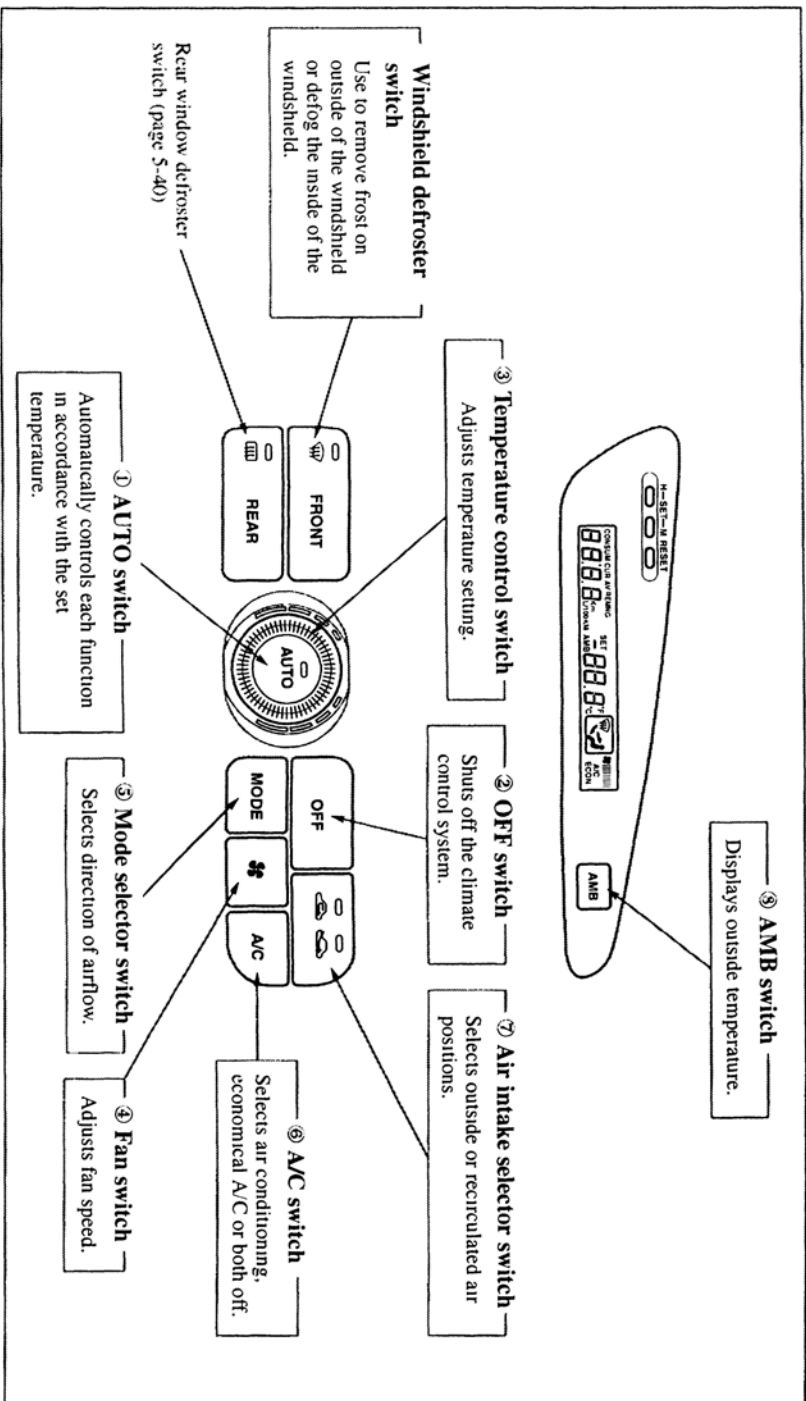



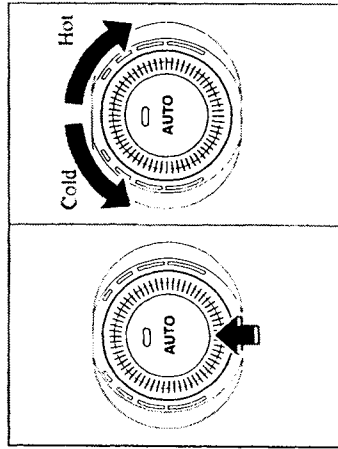

▼ **Standard use**

- 1 Press the AUTO switch. Selection of the airflow mode, air intake selector and amount of airflow will be automatically controlled.
2. Use the temperature control switch to select a desired temperature.

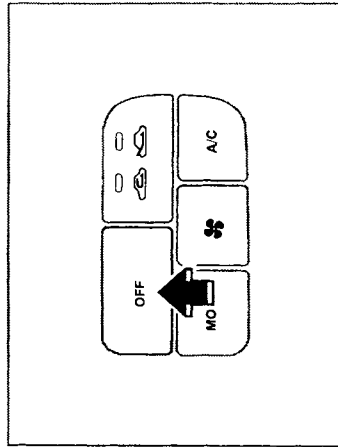

3. Press the OFF switch to turn off the system.

<p><b>NOTE</b></p> <ul style="list-style-type: none"><li>• First set the temperature to 77(°F), then adjust to the desired temperature.</li><li>• Setting the temperature to maximum high or low will not provide the desired temperature at a faster rate.</li><li>• To prevent cool air blowing from the vents when heating right after starting the engine, the amount of airflow is reduced until the air warms up.</li></ul>
---

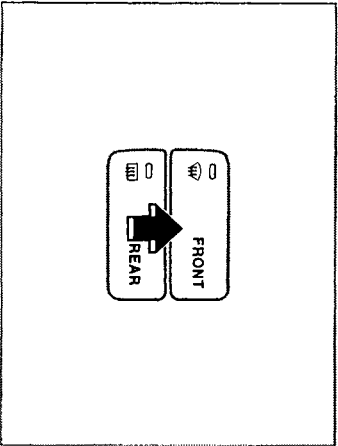



▼ Windshield defrosting and defogging

Press the windshield defroster switch. In this position, the outside air position is automatically selected, and the air conditioner automatically turned on. The air conditioner will direct dehumidified air to the front windshield and side windows. Airflow amount will be increased.  
To turn off the system press the windshield defroster switch again.

S-56

**⚠ WARNING**

Foggy Windshield:

*Using the  position with the temperature control set to the cold position will cause the outside of the glass to fog up. Your vision will be hampered, which could lead to a serious accident. Set the temperature control to hot or warm position when using the  position.*

**NOTE**

Use the temperature control switch to increase the air flow temperature and defog the glass more quickly.

▼ Control switches

① AUTO switch



By pressing the AUTO switch the following functions will be automatically controlled in accordance with the set temperature:

- Airflow temperature
- Amount of airflow
- Selection of airflow mode
- Outside/Recirculated air selection
- Air conditioner operation
- A/C or A/C ECON selection

**NOTE**

AUTO switch indicator light

- When on, indicates AUTO operation
- When off, indicates the operation of other switches such as the mode selector switch, fan switch, A/C switch and windshield defroster switch. Other functions will continue to operate automatically.

② OFF switch



Pressing the OFF switch shuts off the climate control system.

③ Temperature control switch



Controls air temperature between 65(°F) and 90(°F) in increments of 1(°F).

**NOTE**

Maximum low and high temperatures are fixed at 65(°F) and 90(°F).

④ Fan switch



The fan has four speeds. The selected speed will be displayed.

⑤ Mode selector switch



The desired airflow mode can be selected (page 5-52).

**NOTE**

With the airflow mode set to  position and the temperature control switch set at a medium temperature, heated air is directed to the feet and a comparably lower air temperature will flow through the central, left and right vents.

⑥ A/C switch



With the AUTO and fan switch ON, press the A/C switch to select the air conditioning (cooling/dehumidifying functions) on or off. Successively pressing the switch will display the following:  
A/C→A/C ECON→off (not displayed)

**NOTE**

- Although air conditioning and defogging ability is reduced, the A/C ECON function is designed to economize use of the air conditioning system.
- The air conditioner may not function when the outside temperature approaches 0°C (32°F). (Indicator remains on even when system is off.)

⑦ Air intake selector switch



Outside or recirculated air positions can be selected. Press the switch to select outside/recirculated air positions.

-  **Recirculated air position**

Use this position when going through tunnels, driving in congested traffic (high engine exhaust areas) or when quick cooling is desired.

-  **Outside air position**

Use this position for normal conditions and defogging.

 **WARNING**

*The Recirculated Air Position: Using the recirculated air position in cold weather will cause the glass to fog up. Your vision will be hampered, which could lead to a serious accident. Do not use the recirculated air position in cold weather.*

⑧ AMB (Ambient Temperature) switch



Press the AMB switch. The outside temperature will be displayed and the indicator light will be on. Press the switch again, the outside temperature will disappear and the indicator light will be off.

**NOTE**

When the air conditioner is operating and the temperature control is operated, the display will change to air conditioner setting temperature.

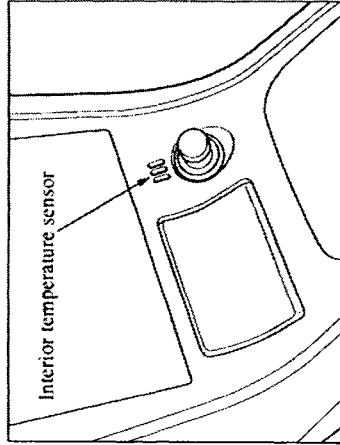
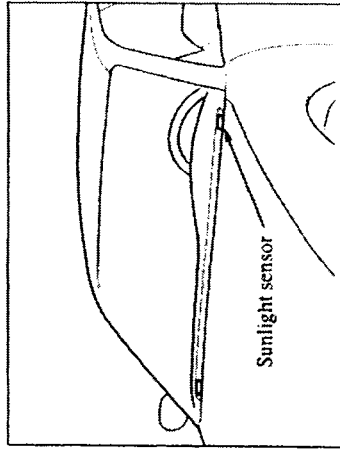

▼ Sunlight/Temperature Sensor

The full-automatic air conditioner function measures inside and outside temperatures, and sunlight. It then sets temperatures inside the passenger compartment accordingly. Don't obstruct the sensor.

## Radio Reception

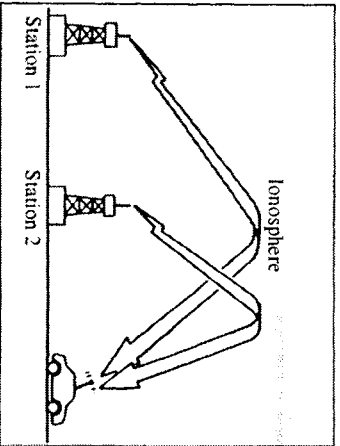

### ■ AM Characteristics

#### ▼ Station mixing

AM signals bend around such things as buildings or mountains and bounce off the ionosphere. Therefore, they can reach longer distances than FM signals. Because of this, two stations may sometimes be picked up on the same frequency at the same time.

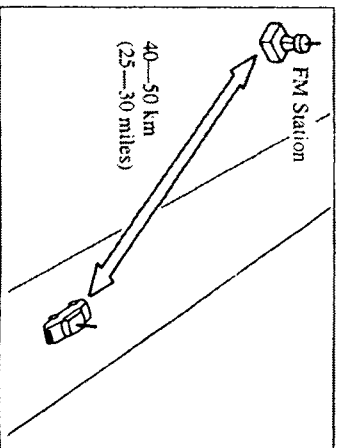

### ■ FM Characteristics

An FM broadcast range is usually about 40—50 km (25—30 miles) from the source. Because of extra coding needed to break the sound into two channels, stereo FM has even less range than monaural (non-stereo) FM.

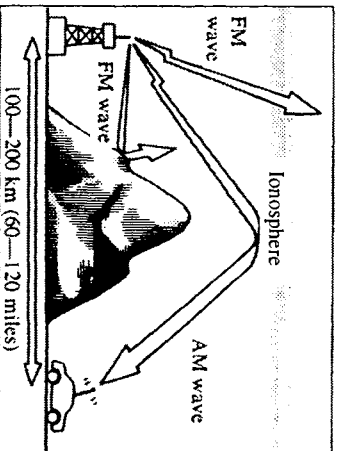

Signals from an FM transmitter are similar to beams of light because they do not bend around corners, but they do reflect. Unlike AM signals, FM signals cannot travel beyond the horizon. Therefore, FM stations cannot be received at the great distances possible with AM reception.

Atmospheric conditions can also affect FM reception. High humidity will cause poor reception. However, cloudy days may provide better reception than clear days.

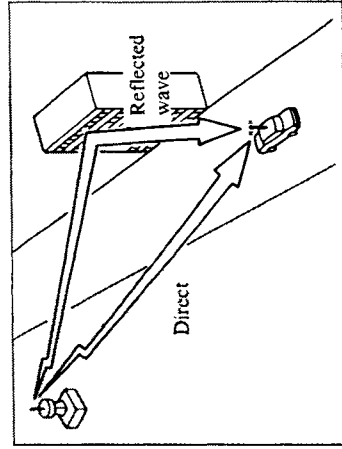

▼ **Multipath noise**

Since FM signals can be reflected by obstructions, it is possible to receive both the direct signal and the reflected signal at the same time. This causes a slight delay in reception and may be heard as a broken sound or a distortion. This problem may also be encountered when in close proximity to the transmitter.

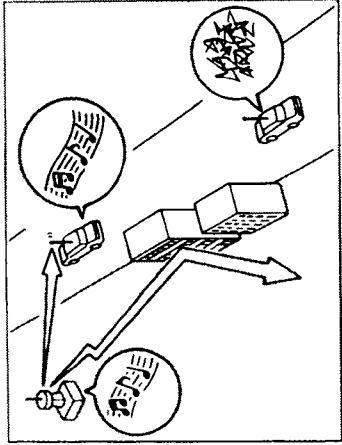

▼ **Flutter/Skip noise**

Signals from an FM transmitter move in straight lines and become weak in valleys between tall buildings, mountains, and other obstacles. When a vehicle passes through such an area, the reception conditions may change suddenly, resulting in annoying noise.

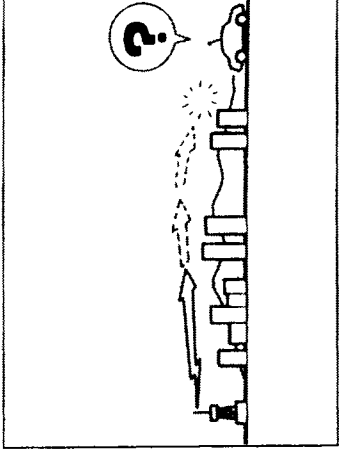

▼ **Weak signal noise**

In suburban areas, broadcast signals become weak because of distance from the transmitter. Reception in such fringe areas is characterized by sound breakup.

**Safety Certification**

This CD player is made and tested to meet exacting safety standards. It meets FCC requirements and complies with safety performance standards of the U.S. Department of Health and Human Services.

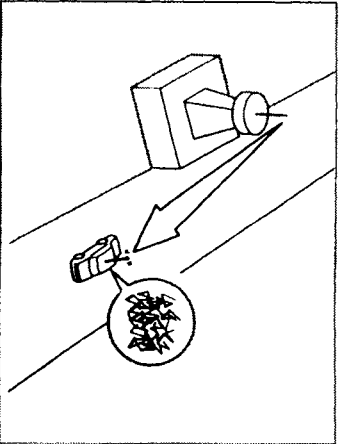

▼ Strong signal noise

This occurs very close to a transmitter tower. The broadcast signals are extremely strong, so the result is noise and sound breakup at the radio receiver.

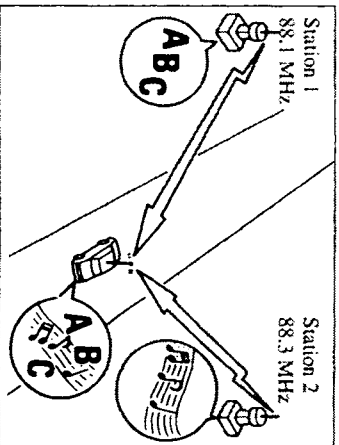

▼ Station drift noise

When a vehicle reaches the area of two strong stations broadcasting at similar frequencies, the original station may be temporarily lost and the second station picked up. At this time there will be some noise from this disturbance.



<b>⚠ CAUTION</b>
<ul style="list-style-type: none"><li>• This CD player should not be adjusted or repaired by anyone except qualified service personnel. If servicing required, contact an Authorized Mazda dealer.</li><li>• Use of controls or adjustments or performance of procedures other than those specified herein may result in hazardous radiation exposure. Never operate the CD player with the top case of the unit removed.</li><li>• Changes or modifications not expressly approved by Mazda may void the user's authority to operate this equipment.</li></ul>

<b>NOTE</b>
<p>For CD player section: This device complies with part 15 of the FCC Rules. Operation is subject to the following two conditions: (1) This device may not cause harmful interference, and (2) this device must accept any interference received, including interference that may cause undesired operation.</p>

<b>NOTE</b>
<p>This equipment has been tested and found to comply with the limits for a Class B digital device, pursuant to part 15 of the FCC Rules. These limits are designed to provide reasonable protection against harmful interference in a residential installation. This equipment generates, uses, and can radiate radio frequency energy and, if not installed and used in accordance with the instructions, may cause harmful interference to radio communications. However, there is no guarantee that interference will not occur in a particular installation.</p>

### AM/FM Radio with Cassette Tape and Compact Disc Player/Changer (In-dash CD Changer)

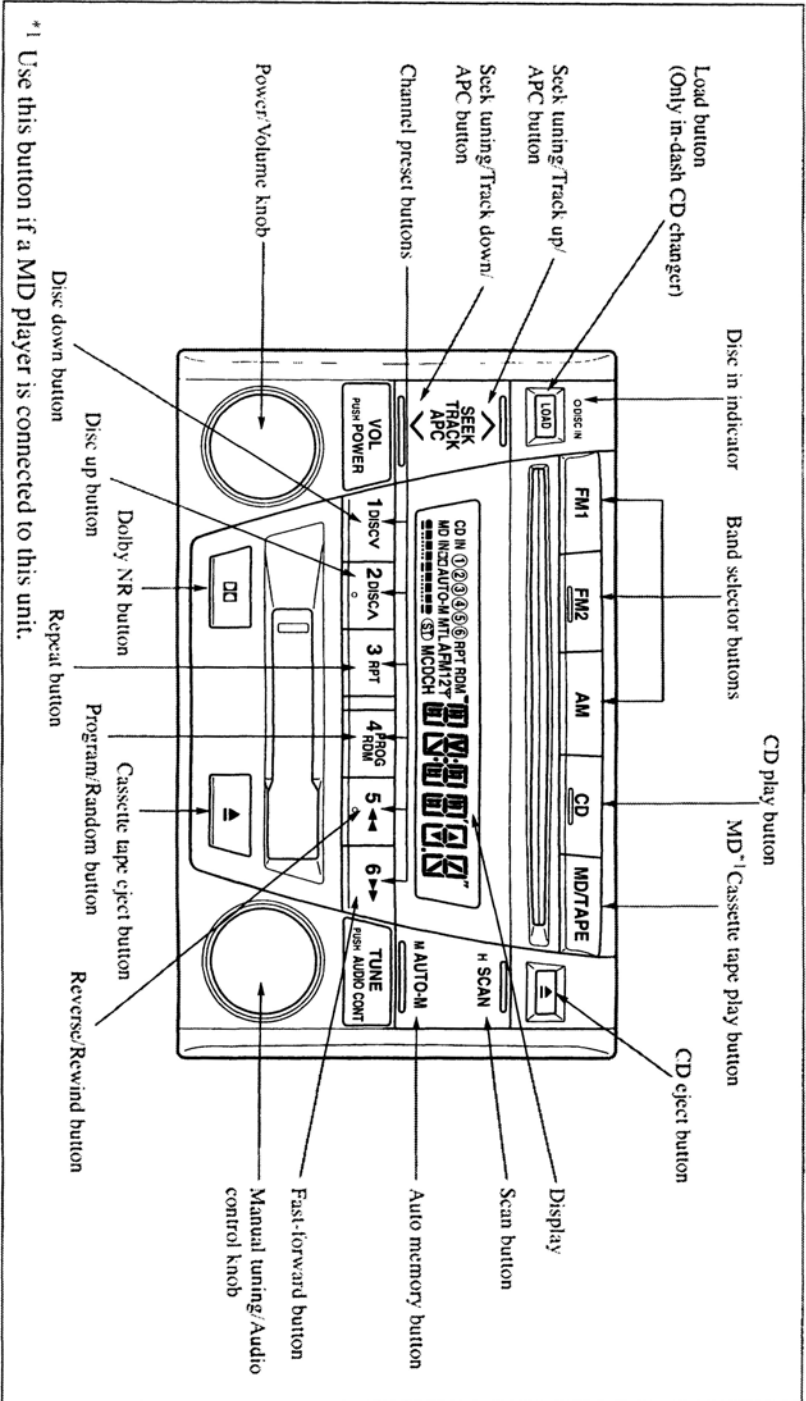

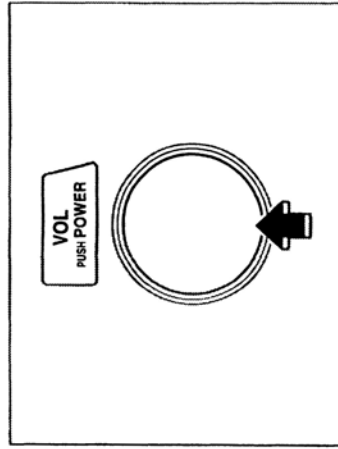

■ **Power ON/OFF**

Turn the ignition switch to the ACC or ON position.

Press the power/volume knob to turn the audio system on. Press the power/volume knob again to turn the audio system off.

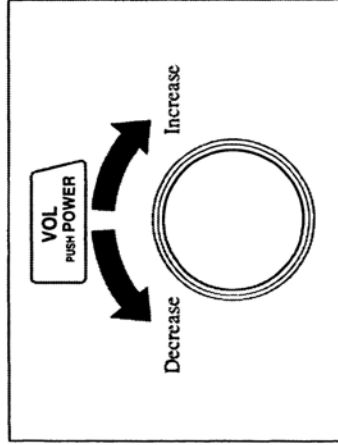

▼ **Volume adjustment**

Turn the power/volume knob to adjust the volume.

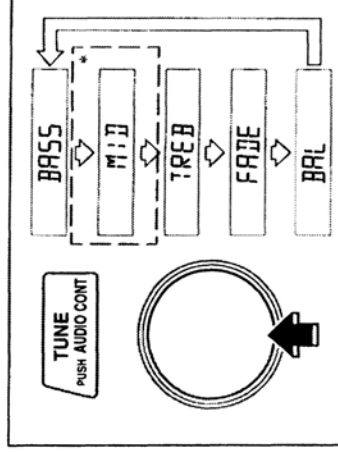

▼ **Audio sound adjustment**

1. Press the audio control knob to select bass, mid-range\*, treble, fade or balance control. The selected function will be indicated.

**NOTE**  
To prevent the battery from being discharged, do not leave the audio system on for a long period when the engine is not running.

\*Some models.

**NOTE**

About 5 seconds after selecting any mode, the volume function will be automatically selected. To reset bass, mid-range\*, treble, fade, and balance, press the audio control knob for 2 seconds. The unit will beep and "CL" will be displayed.

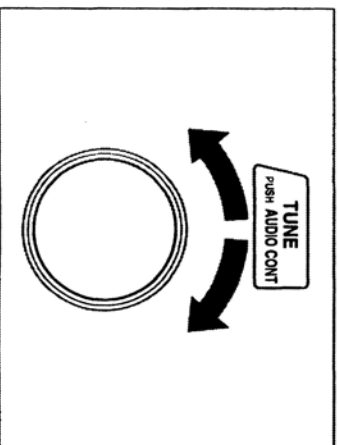

2. Turn the audio control knob to adjust the selected function; bass, mid-range\*, treble, fade or balance.

**Bass control**

To adjust the bass, select BASS by pressing the audio control knob. "BASS" will be displayed.

Turn the audio control knob to the right to increase bass, to the left to decrease it. The level will be displayed. Release the audio control knob when the desired level has been reached.

**Mid-range control\***

To adjust the mid-range, select MIDD by pressing the audio control knob. "MIDD" will be displayed.

Turn the audio control knob to the right to increase mid-range, to the left to decrease it. The level will be displayed. Release the audio control knob when the desired level has been reached.

### Treble control

To adjust the treble, select TREB by pressing the audio control knob. "TREB" will be displayed.

Turn the audio control knob to the right to increase treble, to the left to decrease it. The level will be displayed. Release the audio control knob when the desired level has been reached.

### Fader control

To adjust the sound distribution between front and rear speakers, select FADE by pressing the audio control knob. "FADE" will be displayed.

Turn the audio control knob to the right to shift the sound to the rear, to the left to shift the sound to the front. The level will be displayed. Release the audio control knob when the desired level has been reached.

### Balance control

To adjust the sound distribution between left and right speakers, select BAL by pressing the audio control knob. "BAL" will be displayed.

Turn the audio control knob to the right to shift the sound to the right, to the left to shift the sound to the left. The level will be displayed. Release the audio control knob when the desired level has been reached.

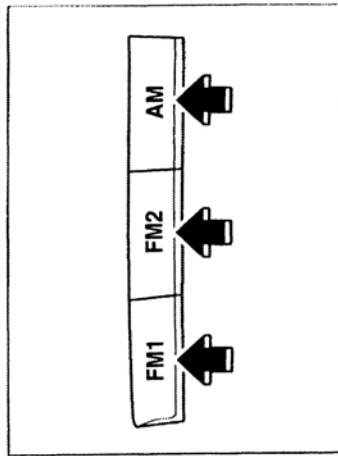

### ■ Operating the Radio

To operate the radio, turn the ignition switch to the ACC or ON position.

### ▼ Radio ON

Press the FM1, FM2 or AM button to turn the radio on.

## Driving Your Mazda

### ▼ Band selection

Select a band by pressing the FM1, FM2 or AM button.

The selected mode will be indicated. If FM stereo is being received, "ST" will be displayed.

#### NOTE

If the FM broadcast signal becomes weak, reception automatically changes from STEREO to MONO for reduced noise, and the "ST" indicator will go out.

### ▼ Tuning

The radio has the following tuning methods: Manual, Seek, Scan, Preset channel, and Auto memory tuning. The easiest way to tune stations is to set them on preset channels.

#### NOTE

If the power supply is interrupted (fuse blows or the battery is disconnected), the preset channels will be canceled.

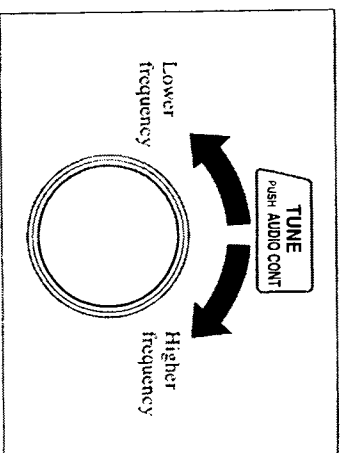

### Manual tuning

Turning the manual tuning knob will change to a higher or lower frequency.

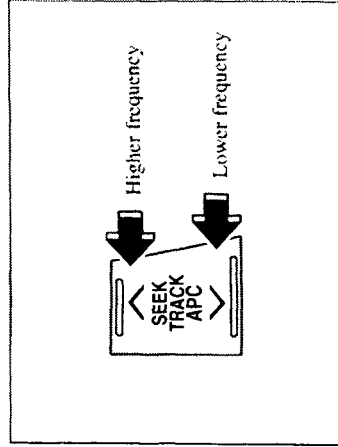

**Seek tuning**

Pressing the seek tuning button will cause the tuner to seek a higher or lower frequency automatically.

**NOTE**

If you continue to press and hold the button, the frequency will continue changing without stopping.

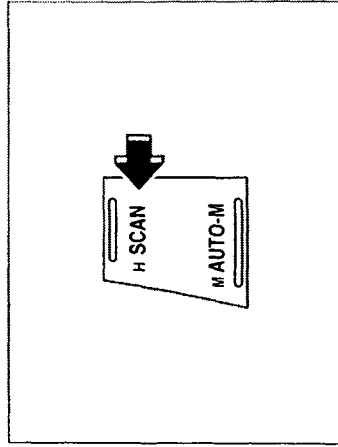

**Scan tuning**

Press the scan button to automatically sample strong stations. Scanning stops at each station for about 5 seconds. To hold a station, merely press the scan button again during this interval.

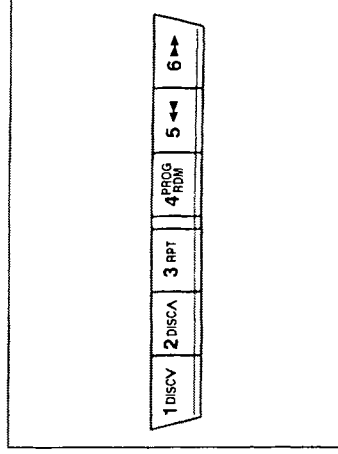

**Preset channel tuning**

The six preset channels can be used to store 6 AM and 12 FM stations.

To set a channel first select AM, FM1, or FM2. Tune to the station you want and depress a channel preset button for about 2 seconds until a beep is heard. The preset channel number and station frequency will be displayed. The station is now held in the memory. Repeat this operation for the other stations and bands you want to store.

## Driving Your Mazda

To tune one in the memory, select AM, FM1, or FM2 and then press its channel preset button. The station frequency and the channel number will be displayed.

### NOTE

If the power supply is interrupted (fuse blows or the battery is disconnected), the preset channels will be canceled.

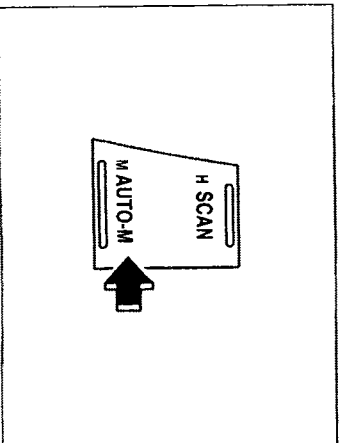

### Auto memory tuning

This is especially useful when driving in an area where the local stations are not known. Additional AM/FM stations can be stored without disturbing the previously set channels.

Press and hold the auto memory button for about 2 seconds until a beep is heard; the system will automatically scan and temporarily store the six strongest stations of each selected band in that area.

After scanning is completed, the strongest station will be tuned and its frequency displayed. Press and release the auto memory button to recall stations from the auto-stored stations. One stored station will be selected each time; its frequency and channel number will be displayed.

### NOTE

If no stations can be tuned after scanning operations, "A" will be displayed.



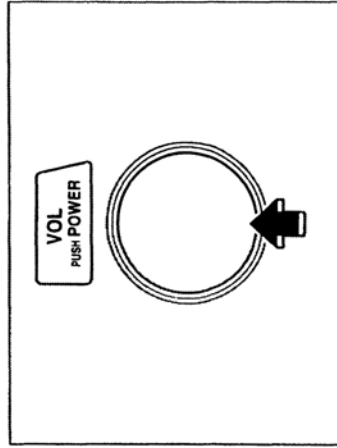

▼ **Radio OFF**

Press the power/volume knob to turn off the radio.

**NOTE**

Press the power/volume knob again to listen to the frequency last tuned to.

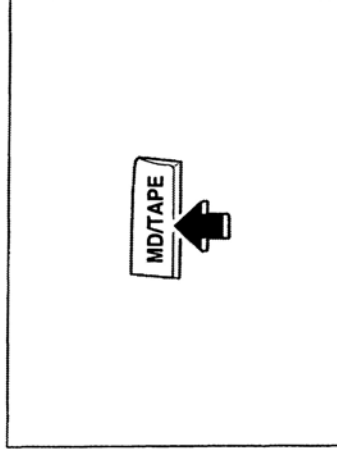

▼ **Playing**

Press the cassette tape play button to start playing when a cassette tape is in the unit. If there isn't a cassette tape in the unit when the cassette tape play button is pressed, "NO TAPE" will flash on and off in sequence.

■ **Operating the Cassette Tape Player**

To operate the cassette tape player, turn the ignition switch to the ACC or ON position.

▼ **Cassette tape insert**

Insert the cassette tape into the slot, open edge to the right and cassette tape will begin play and "TAPE" will be displayed. At the end of the cassette tape, the unit automatically reverses cassette tape play.

When ▲ is lit, the cassette tape's top side is playing. When ▼ is lit, the bottom side is on.

**NOTE**

When a metal tape is inserted, the player will automatically compensate for it and "MTL" will be displayed.

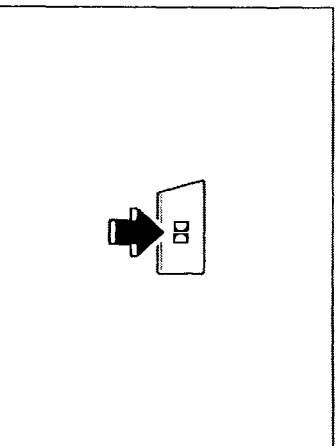

▼ **Dolby noise reduction**

When using a tape with Dolby NR\*, push the NR button. The NR symbol will be displayed. To play a tape without Dolby NR, push the button once again.

\* Noise reduction system manufactured under license from Dolby Laboratories Licensing Corporation.

Dolby and the double-D symbol DR are trademarks of Dolby Laboratories Licensing Corporation.

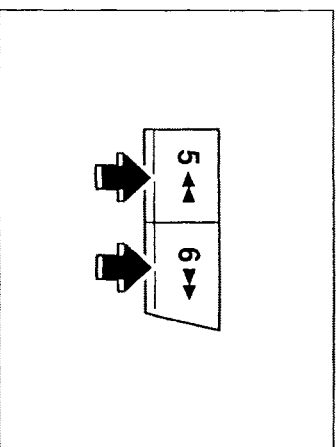

▼ **Fast forward/Rewind**

Press the fast-forward button to fast-forward.

Press the rewind button to rewind. To stop this operation and play the cassette tape, press the button again.

<b>NOTE</b>
When the cassette tape ends during fast forward or rewind, it automatically stops and starts playing.

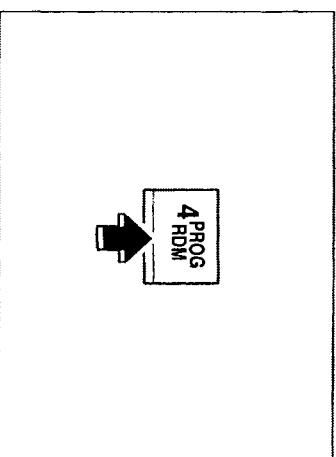

▼ **Reversing**

Press the program button to change cassette tape-playing direction.

<b>NOTE</b>
When the cassette tape ends, the unit automatically reverses play.

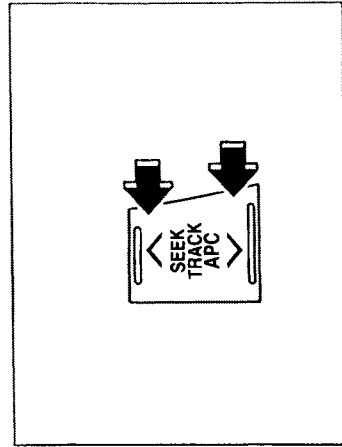

If APC detects 15 seconds of blank space it will automatically advance the tape to the next selection.

**NOTE**

APC may not operate properly if

- A tape was recorded at a low level.
- A tape has long, silent intervals.
- A tape is a live recording.
- A tape has very short intervals of less than 3 seconds.

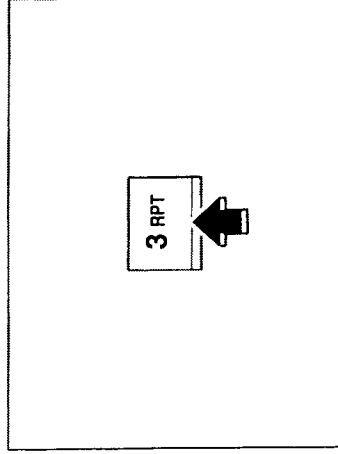

▼ **APC (Automatic Program Control)**

APC is used to find the beginning of either the next program or the one being played.

Press the APC button (  $\wedge$  ) to the beginning of the next selection.

Press the APC button (  $\vee$  ) to the beginning of the one being played.

To stop this operation and play the cassette tape, press the button again.

▼ **Repeat play**

This operation makes it possible to listen to a selection repeatedly.

Press the repeat button during play. The current selection playing will be repeated ("RPT" will be displayed).

Press the repeat button once again to cancel repeat play.

NOTE
RPT may not operate properly if
• A tape was recorded at a low level.
• A tape has long, silent intervals.
• A tape is a live recording.
• A tape has very short intervals of less than 3 seconds.

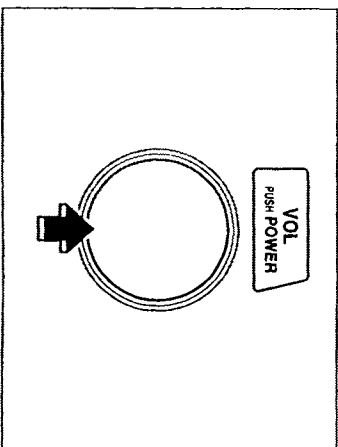

▼ Stopping

Press the power/volume knob to stop cassette tape play.

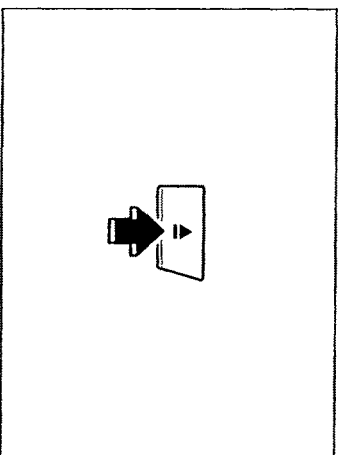

▼ Ejecting the cassette tape

Press the cassette tape eject button to eject the cassette tape.

NOTE
The cassette tape can be ejected when the ignition switch is in the OFF position.

■ **Operating Tips for Cassette Tape player**

▼ **Cleaning the cassette tape player**

The tape head, capstans, and pinch rollers will gather oxide residue from cassette tapes. This can cause weak or wavering sounds and damage to the cassette tapes and player. Use a good quality head-cleaning tape or a liquid cleaner cassette tape to remove it.

Should the unit not operate normally, consult an Authorized Mazda Dealer. Never attempt to repair it or insert a screwdriver or anything else.

▼ **Handing the cassette tape player**

The following precautions should be observed.

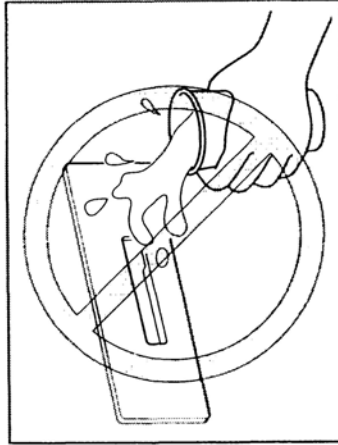

Do not spill any liquid on the audio system.

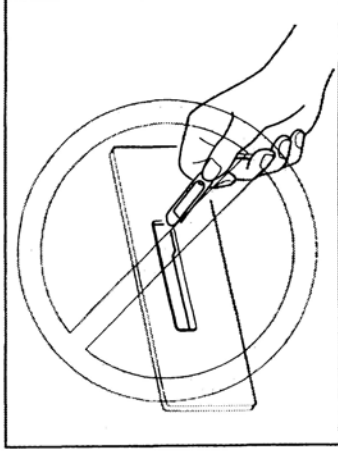

• Do not insert any objects, other than cassette tape, into the slot.

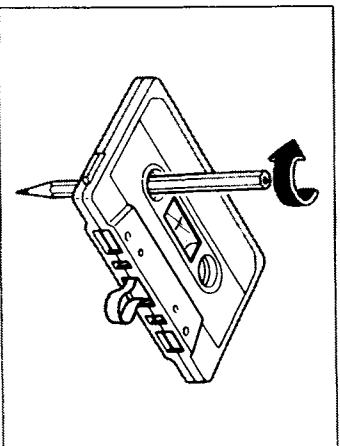

- Do not leave a cassette tape in the tape player slot when not in use. Remove it completely to permit the slot door to close and to protect the mechanism from dust.
- Store cassette tape away from extreme heat, magnetic fields, and direct sunlight. Protect the exposed cassette tape from dirt and damage. Store cassette tapes in their original cases or other protective cases.
- Insert only cassette tapes into the slot. If objects other than cassette tapes are inserted, they may damage the player.
- If the cassette tape is loose, it may produce poor sound or performance during playback. Use a pencil or something similar to remove any slack.
- Only cassette tapes that play no longer than 90 minutes should be used. Cassette tape exceeding 90 minutes are thin and may easily break.

■ **Operating the Mini Disc (MD) Player\***

To operate the MD player, turn the ignition switch to the ACC or ON position.

▼ **Inserting the MD**

Insert the MD, label-side up with the arrow pointed to the slot. The auto-loading mechanism will set the MD and begin play. There will be a short lapse before play begins while the player reads the digital signals on the MD.

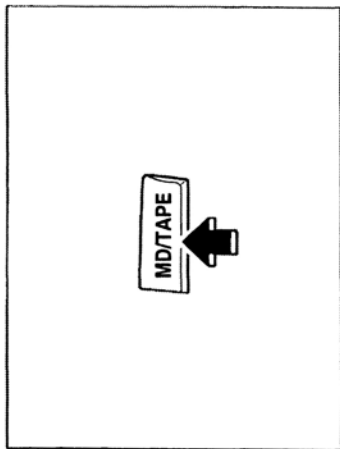

▼ **Playing**

Press the MD play button to start playing when a MD is in the unit.

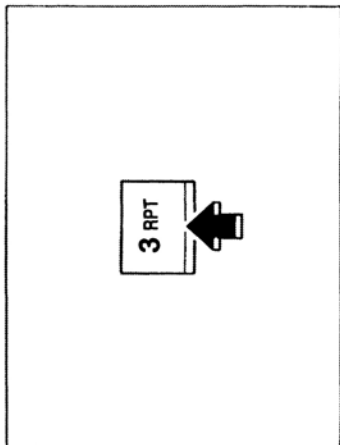

▼ **Repeat play**

This feature makes it possible to listen to a selection repeatedly.

Press the repeat button during play. The current selection will be repeated ("RPT" will be displayed).

Press the repeat button once again to cancel repeat play.

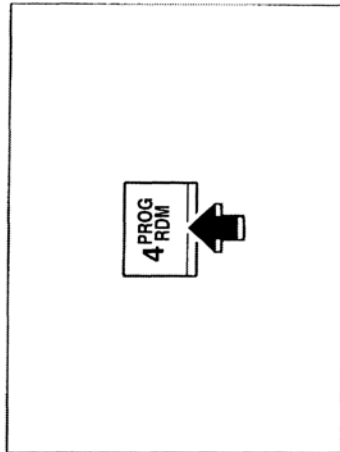

▼ **Random play**

This feature allows the MD player to randomly select the order of the songs.

Press the random button during play. The next selection will be randomly selected ("RDM" will be displayed).

Press the random button once again to cancel random play.

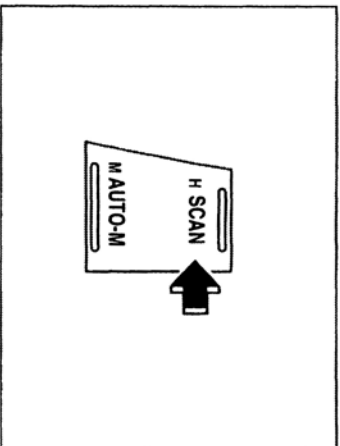

▼ Music scan

This feature helps to find a program by playing about the first 10 seconds of each track.  
Press the scan button during play to start scan play operation (the track number will flash).  
Press the scan button once again to cancel scan play.

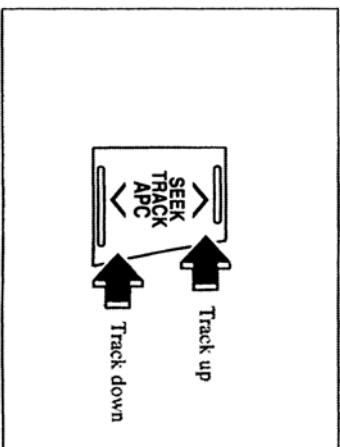

▼ Track search

Press the track up button once to skip forward to the beginning of the next track.  
Press the track down button once to skip back to the beginning of the current track.

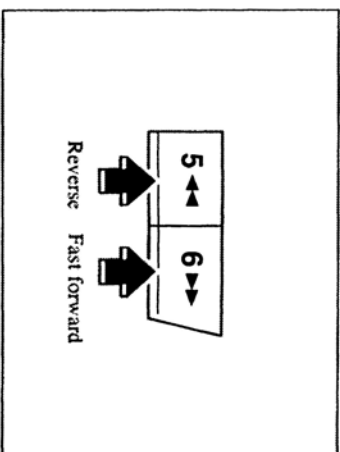

▼ Fast-forward/Reverse

Press and hold the fast-forward button to advance through a track at high speed.  
Press and hold the reverse button to reverse through a track at high speed.

**NOTE**

If the unit is left in scan, normal play will resume where scan was selected.



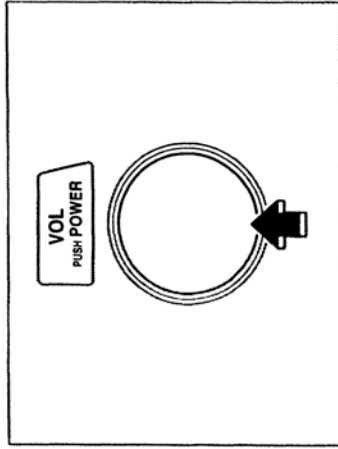

▼ **Stopping**

Press the power/volume knob to stop MD play.

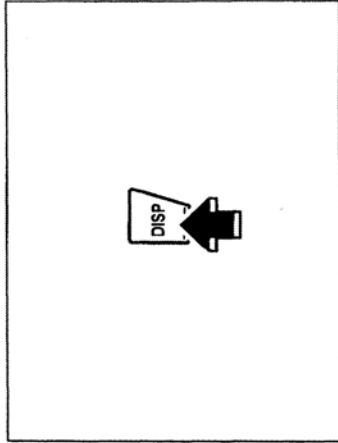

▼ **Long disc or song titles**

When disc or song titles exceed 10 letters or numerals, press the display button to display the remaining part of the title.

▼ **Changing the MD display**

To change the MD display during MD play, press and hold the display button for about half a second to advance through each of the following displays:

→ Song title → Disc title → No display →

NOTE
If there is no song or disc title recorded on the MD, "NO TITLE" will be displayed.

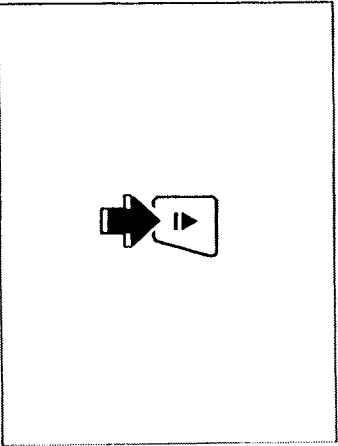

▼ Ejecting the MD

Press the MD eject button to eject the MD

■ Error Indications

If you see an error indication on the display, find the cause in the chart. If you cannot clear the error indication, take the vehicle to an Authorized Mazda Dealer.

Indication	Cause	Solution
CHECK MD	MD is inserted upside down	Insert the MD properly. If the code does not disappear, consult an Authorized Mazda Dealer
	MD is defective	Check the MD for scratches and/or soiling

■ **Operating the Compact Disc (CD) Player\*/In-Dash CD Changer\***

To operate the CD player/in-dash CD changer, turn the ignition switch to the ACC or ON position.

▼ **Inserting the CD (CD player)**

Insert the CD into the slot, label-side up. The auto-loading mechanism will set the CD and begin play. There will be a short lapse before play begins while the player reads the digital signals on the CD. The disc in indicator will illuminate and the track number will be displayed.

▼ **Inserting the CD (In-dash CD changer)**

The CD must be label-side up when inserting. The auto-loading mechanism will set the CD and begin play. There will be a short lapse before play begins while the player reads the digital signals on the CD.

The disc number and the track number will be displayed.

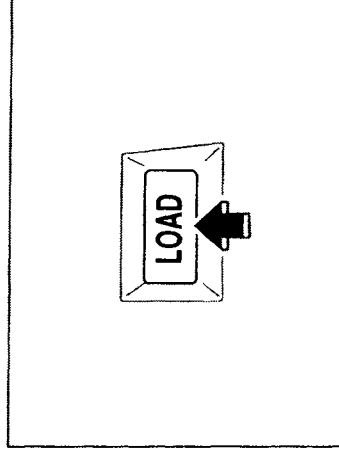

**Normal insertion**

1. Press the load button.
2. When "In" is displayed, insert the CD.

**NOTE**

A CD cannot be inserted while the display reads "WAIT." A beeping sound can be heard during this waiting time. Simultaneously pressing the power/volume knob and the load button for about 2 seconds will turn this beeping sound ON or OFF.

\*Some models.

**Multiple insertion**

1. Press and hold the load button for about 2 seconds until a beep is heard.
2. When "In" is displayed, insert the CD.
3. When "In" is displayed again, insert the next CD.

**NOTE**

The first-inserted CD will be played automatically when:

- No CD is inserted within 15 seconds after "In" is displayed.
- The CD trays are full.

**Inserting CDs into desired tray number**

1. Press and hold the load button for about 2 seconds until a beep is heard.
2. Press the channel preset button for the desired tray number within 5 seconds after the beep is heard.
3. When "In" is displayed, insert the CD.

**NOTE**

The CD can not be inserted to the desired tray number if the number is already occupied.

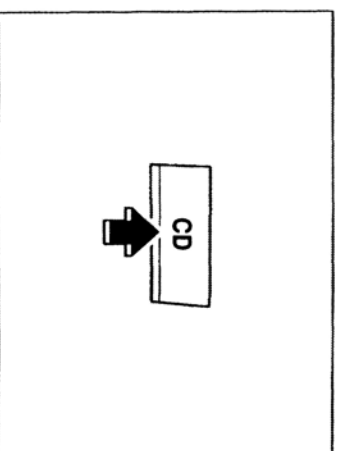

**▼ Playing**

Press the CD play button to start playing when a CD is in the unit.

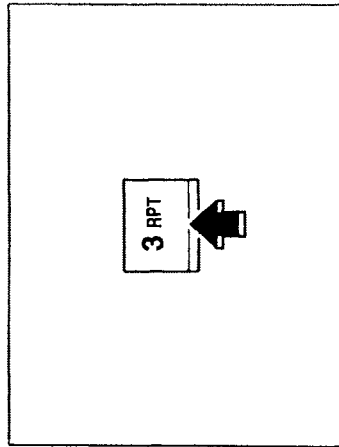

▼ Repeat play

This feature makes it possible to listen to a selection repeatedly.

Press the repeat button during play. The current selection will be repeated ("RPT" will be displayed).

Press the repeat button once again to cancel repeat play.

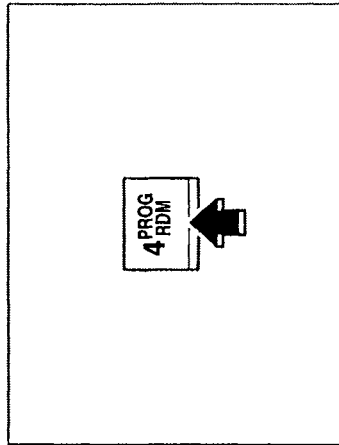

▼ Random play

This feature allows the CD player to randomly select the order of the songs.

Press the random button during play. The next selection will be randomly selected ("RDM" will be displayed).

Press the random button once again to cancel random play.

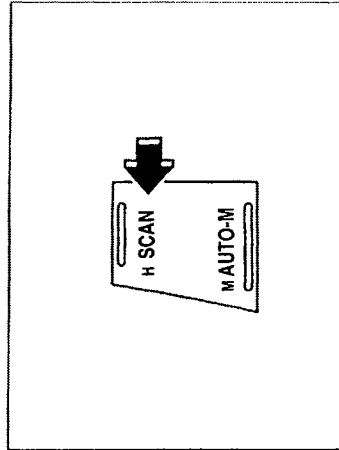

▼ Music scan

This feature helps to find a program by playing about the first 10 seconds of each track.

Press the scan button during play to start scan play operation (the track number will flash).

Press the scan button once again to cancel scan play.

**NOTE**

If the unit is left in scan, normal play will resume where scan was selected.

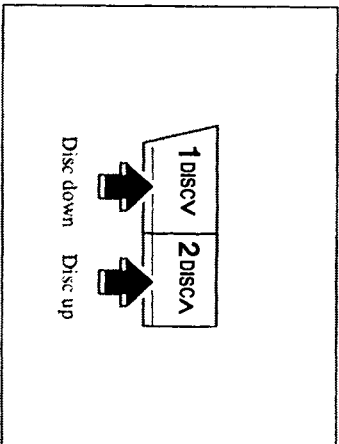

▼ Disc search (In-dash CD changer)

Press the disc up button (  $\wedge$  ) to skip forward to the beginning of the next CD. Press the disc down button (  $\vee$  ) to skip back to the beginning of the previous CD.

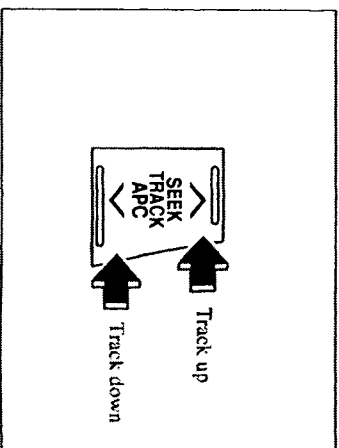

▼ Track search

Press the track up button once to skip forward to the beginning of the next track. Press the track down button once to skip back to the beginning of the current track.

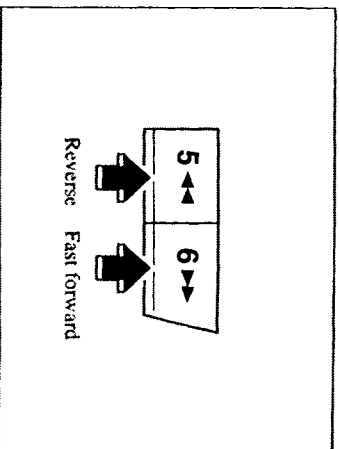

▼ Fast-forward/Reverse

Press and hold the fast-forward button to advance through a track at high speed. Press and hold the reverse button to reverse through a track at high speed.

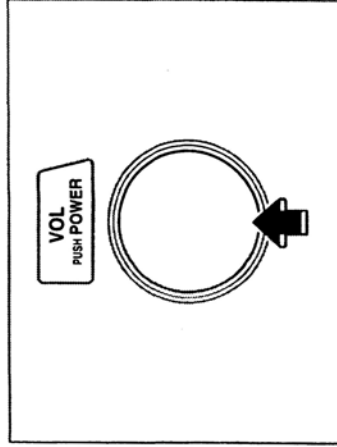

▼ **Stopping**

Press the power/volume knob to stop CD play.

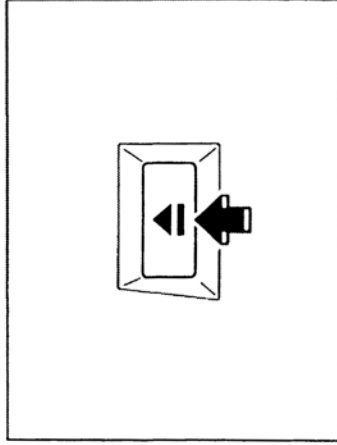

▼ **Ejecting the CD (CD player)**

Press the CD eject button to eject the CD.

▼ **Ejecting the CD (In-dash CD changer)**

**Normal ejection**

1. Press the CD eject button. The disc number and "OUT" will be displayed.
2. Pull out the CD.

**NOTE**

When the CD is ejected during play, the next CD will be played automatically.

**Ejecting CDs from desired tray number**

1. Press and hold the CD eject button for about 2 seconds until a beep is heard.
2. Press the channel preset button for the desired CD number within 5 seconds after the beep is heard.
3. Pull out the CD.

**Multiple ejection**

1. Press and hold the CD eject button for about 2 seconds until a beep is heard.
2. Wait 5 seconds or press the CD eject button again within 5 seconds after the beep is heard.
3. Pull out the CD, then the next CD will be ejected.

**■ Operating the CD Changer\*  
(Except In-Dash) with Controls on the Main Audio Unit**

The CD changer can be connected to the main audio unit and operated by the controls on the main unit. Regarding operation of the CD changer itself, please refer to the instructions attached to the changer.

**NOTE**

- CDs will be ejected starting with the one with the lowest number.
- All CDs in the tray will be ejected continuously.
- CDs can be ejected when the ignition switch is off. Press and hold the CD eject button for about 2 seconds and all CDs will eject.

**NOTE**

Operating the CD changer is generally the same as that of the CD player except for the insert and eject functions (pages 5-81—5-85).



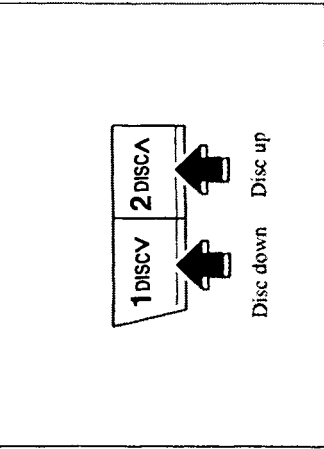

▼ Disc search

Press the disc up button ( ^ ) to skip forward to the beginning of the next CD.  
 Press the disc down button ( v ) to skip back to the beginning of the previous CD.

■ Error Indications

If you see an error indication on the display, find the cause in the chart. If you cannot clear the error indication, take the vehicle to an Authorized Mazda Dealer.

Indication	Cause	Solution
CHECK CD	CD is inserted upside down	Insert the CD properly. If the code does not disappear, consult an Authorized Mazda Dealer
	CD is defective	Check the CD for scratches and/or soiling

■ **Operating Tips for CD Player/  
In-dash CD Changer**

▼ **Condensation phenomenon**

Immediately after turning on the heater when the vehicle is cold, the CD or optical components (prism and lens) in the CD player/changer may become clouded with condensation. At this time, the CD will eject immediately when placed in the unit. A clouded CD can be corrected simply by wiping it with a soft cloth. Clouded optical components will clear naturally in about an hour. Wait for normal operation to return before attempting to use the unit.

▼ **Handling the CD player/in-dash CD  
changer**

The following precautions should be observed.

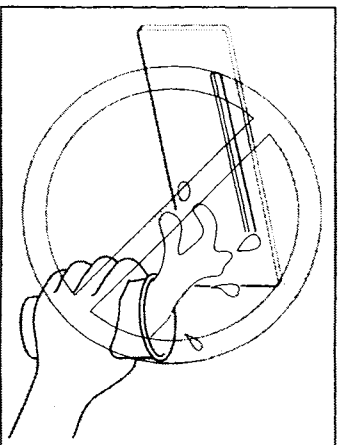

- Do not spill any liquid on the audio system.

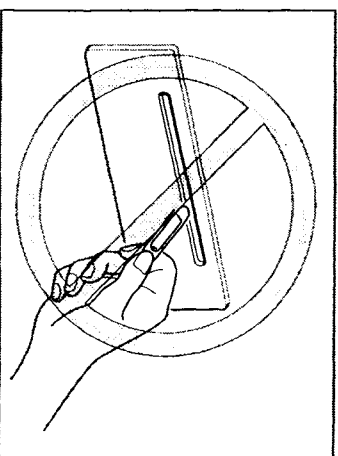

- Do not insert any objects, other than CDs, into the slot.

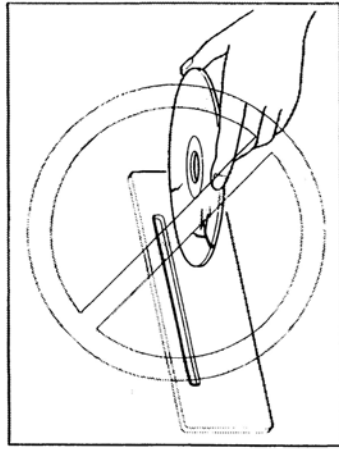

- The CD revolves at high speed within the unit. Defective (cracked or badly bent) CDs should never be used.

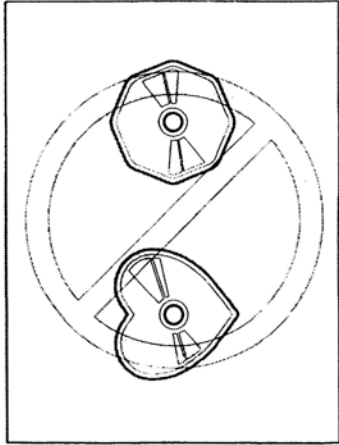

- Do not use non-conventional discs such as heart-shaped, octagonal discs, etc. The CD player/changer could be damaged.

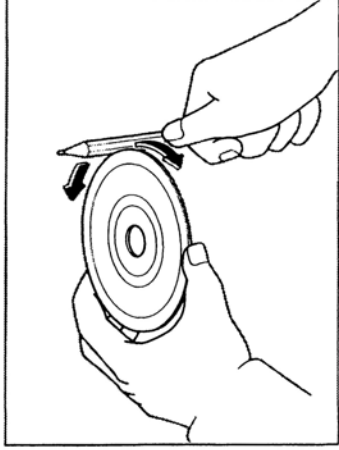

- A new CD may have rough edges on its inner and outer perimeters. If a disc with rough edges is used, proper setting will not be possible and the CD player/changer will not play the CD. Remove the rough edges in advance by using a ball-point pen or pencil as shown above. To remove the rough edges, rub the side of the pen or pencil against the inner and outer perimeter of the CD.

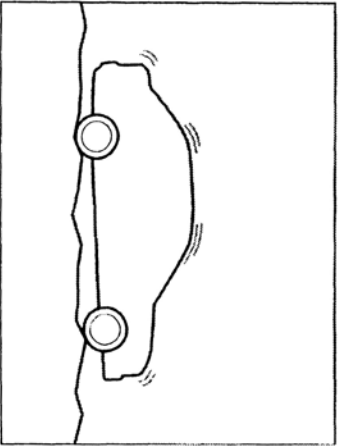

- When driving over uneven surfaces, the sound will jump.



- The CD player/changer has been designed to play CDs bearing the identification logo as shown. No other discs can be played.

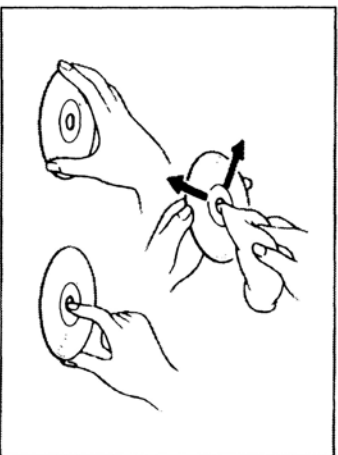

- Be sure never to touch the signal surface when handling the CDs. Pick up a CD by grasping the outer edge or the edge of the hole and the outer edge.
- Do not stick paper or tape on the CD. Avoid scratching the reverse side (the side without a label).

- Dust, finger smudges, and dirt can decrease the amount of light reflected from the signal surface, thus affecting sound quality. If the CD should become soiled, gently wipe it with a soft cloth from the center of the CD to the edge.
- Do not use record sprays, antistatic agents, or household spray cleaners. Volatile chemicals such as benzine and thinner can also damage the surface of the CD and must not be used. Anything that can damage, warp, or fog plastic should never be used to clean CDs.
- CDs, like traditional audio records, are made of plastic. To avoid warping, keep the CDs in their cases and do not store them where they will be exposed to direct sunlight.
- The CD player/changer ejects the CD if the CD is inserted upside down. Also dirty and/or defective CDs may be ejected.
- 8 cm (3 in) CDs and CD accessories (e.g. 8 cm disc adapter) cannot be used in the CD player/changer.
- Do not insert cleaning discs in the CD player/changer.
- Do not insert any disc with a peel-off or seal on it.

## Audio System Operation from the Steering Wheel

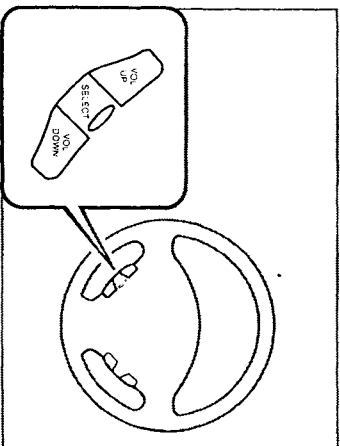

■ **Adjusting the Volume**

To increase the volume, press VOL UP

To decrease the volume, press VOL DOWN.

■ **SELECT Switch**

▼ **When listening to the radio**

Press the switch to seek a higher frequency automatically.

▼ **When playing a cassette tape**

Press the switch to the beginning of the next selection.

▼ **When playing a compact disc**

Press the switch once to skip forward to the beginning of the next track.

## Antenna

The rear window antennas receive both AM and FM signals.

**(With diversity tuning)**

After FM signals have been received from the rear window antennas, one of the antennas is selected, and provides the best FM reception. This is known as diversity tuning. With this method you will be able to enjoy the highest quality FM reception.

### **WARNING**

*Using Audio Control Panel:  
Driving is dangerous. Your attention  
could be diverted and cause an  
accident. When driving, always use  
the audio system operation from the  
steering wheel.*

### **CAUTION**

When washing the inside rear window, use a soft cloth dampened in luke warm water, gently wiping the antenna lines.  
Use of glass cleaning products could damage the antenna.

# 6

## In Case of an Emergency

*Because an emergency can occur anytime, we strongly urge you to become familiar with this section of your manual. It provides helpful information on what to do if the engine overheats, if you have a flat tire, and if the battery is discharged.*

*You will also find out what to do if you confront a problem in the electrical system; and, there's some guidance on the correct way to tow your Mazda.*



Hazard Warning Flasher	6- 2
Overheating	6- 2
Emergency Starting	6- 4
Fuses	6- 6
Towing	6-12
Flat Tire	6-15

## In Case of an Emergency

### Hazard Warning Flasher

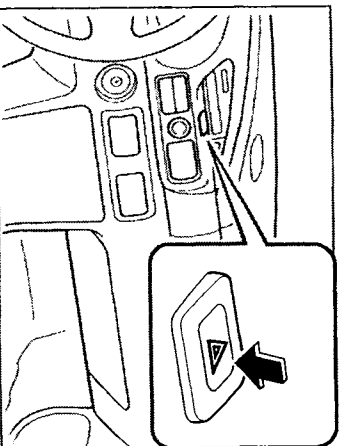

The hazard warning lights warn other drivers that your vehicle is a traffic hazard and that they must take extreme caution when near it.

The hazard warning lights should always be used when you stop on or near a roadway.

Depress the hazard warning switch and all four turn signals will flash at once.

#### NOTE

- The turn signals don't work when the hazard warning lights are on.
- Check local regulations about the use of hazard warning lights while the vehicle is being towed. They may forbid it.

### Overheating

If the temperature gauge indicates overheating, you experience power loss, or you hear a loud knocking or pinging noise, the engine is probably too hot.

If this happens:

1. Drive safely to the side of the road and park off the right-of-way.
2. Shift into park (P). Apply the parking brake.
3. Turn off the air conditioner.



**⚠ WARNING**

*Steam from Overheated Engine:*  
*Steam from an overheated engine is dangerous. The escaping steam could seriously burn you. Open the hood ONLY after steam is no longer escaping from the engine.*

5. Check the coolant level. If it's low, look for leaks in the radiator hoses and connections, heater hoses and connections, radiator, and water pump. If you find a leak or other damage, or if coolant is still leaking, stop the engine and call an Authorized Mazda Dealer.

4. Check whether coolant or steam is escaping from under the hood or from the engine compartment.

If steam is coming from the engine compartment, don't go near the front of the vehicle. Stop the engine. Then turn the ignition switch to the ON position without starting the engine. The radiator cooling fans will start to cool the engine.

If neither coolant nor steam is escaping, open the hood and idle the engine until it cools. If this doesn't lower the temperature, stop the engine and let it cool.

**⚠ WARNING**

*Cooling System Caps:*  
*When the engine and radiator are hot, scalding coolant and steam may shoot out under pressure and cause serious injury. Don't remove either cooling system cap when the engine and radiator are hot.*

**⚠ CAUTION**

If the engine continues to overheat or frequently overheats, have the cooling system inspected. The engine could be seriously damaged unless repairs are made.

## In Case of an Emergency

### Emergency Starting

#### ■ Jump-Starting

Jump-starting is dangerous if done incorrectly. So follow the procedure carefully. If you feel unsure about jump-starting, we strongly recommend that you have a competent service technician do the work.

### CAUTION

Use only a 12 V booster system. You can damage a 12 V starter, ignition system, and other electrical parts beyond repair with a 24 V power supply (two 12 V batteries in series or a 24 V motor generator set).

### WARNING

**Battery-Related Explosion:**  
*Flames and sparks near open battery cells are dangerous. Hydrogen gas, produced during normal battery operation, could ignite and cause the battery to explode. An exploding battery can cause serious burns and injuries. Keep all flames, including cigarettes, and sparks away from open battery cells.*

### WARNING

**Jump-Starting:**  
*Jump-starting a frozen battery or one with a low fluid level is dangerous. It may rupture or explode, causing serious injury. Don't jump-start a frozen battery or one with a low fluid level.*

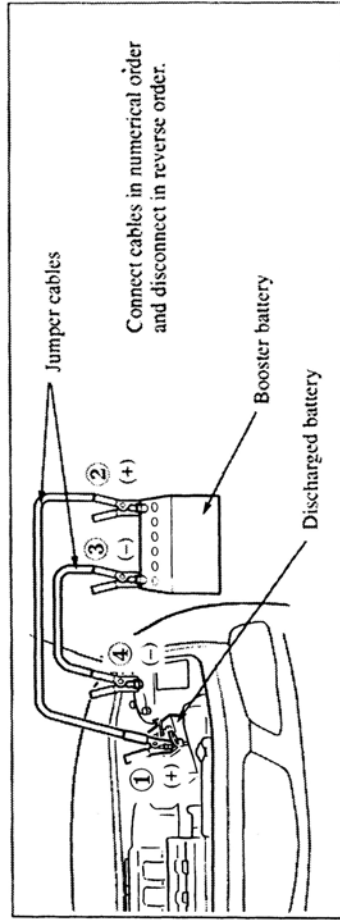

1. Make sure the booster battery is 12 V and that its negative terminal is grounded.
2. If the booster battery is in another vehicle, don't allow the vehicles to touch. Turn off the engine of the vehicle with the booster battery and all unnecessary electrical loads in both vehicles.
3. Connect the jumper cables in the exact sequence as in the illustration.
  - (1) Connect one end of a cable to the positive terminal on the discharged battery ①.
  - (2) Attach the other end to the positive terminal on the booster battery ②.
  - (3) Connect one end of the other cable to the negative terminal of the booster battery ③.
  - (4) Connect the other end to a solid, stationary, exposed metallic point (for example, the strut mounting bolt) away from the discharged battery ④.
4. Start the engine of the booster vehicle and run it a few minutes. Then start the engine of the other vehicle.
5. When finished, carefully disconnect the cables in the reverse order described in Step 3.

**⚠ WARNING**

Connecting to Negative Terminal:  
 Connecting the end of the second cable to the negative (-) terminal of the discharged battery is dangerous. A spark could cause the gas around the battery to explode and injure someone. Connect the cable to a point away from the battery.

**⚠ WARNING**

Connecting Jumper Cable to a Moving Part:  
 Connecting a jumper cable near or to a moving part is dangerous. The cable could get caught when the engine starts and cause serious injury. Never connect a jumper cable to or near any part that moves.

## Fuses

### ■ Push-Starting

You can't start a vehicle with an automatic transaxle by pushing it.

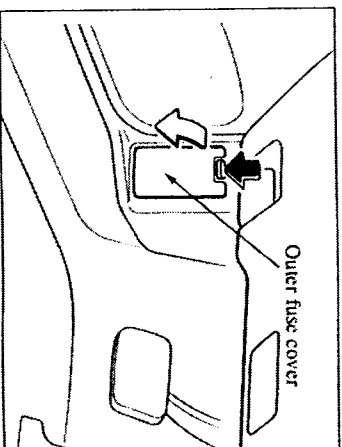

Your vehicle's electrical system is protected by fuses.

If any lights, accessories, or controls don't work, inspect the appropriate circuit protector. If a fuse has blown, the inside element will be melted.

If the same fuse blows again, avoid using that system and consult an Authorized Mazda Dealer as soon as possible.

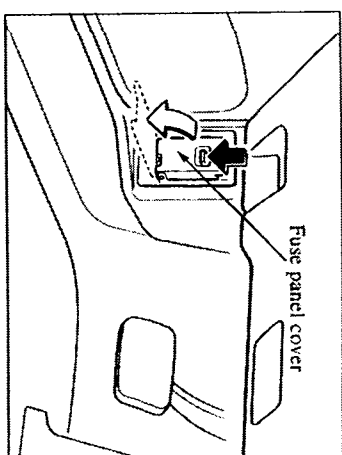

### ■ Fuse Replacement

If the electrical system doesn't work, first inspect the fuses on the driver's side.

1. Turn off the ignition switch and other switches.
2. Remove the outer fuse cover.
3. Open the fuse panel cover.

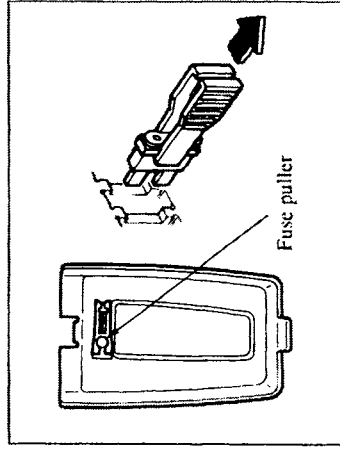

4. Pull the fuse straight out with the fuse puller provided on the inside of the outer fuse cover.

**NOTE**

The check engine light comes on when a ROOM fuse blows or when a ROOM fuse is removed. When installing a ROOM fuse, turn the ignition switch off and wait 60 seconds before installing the fuse. If the check engine light comes on and doesn't go off, there is a problem other than the fuse system. Consult your Authorized Mazda Dealer.

If you have no spare fuses, borrow one of the same rating from a circuit not essential to vehicle operation, such as the RADIO circuit.

**CAUTION**

Always replace a fuse with one of the same rating. Otherwise you may damage the electric system.

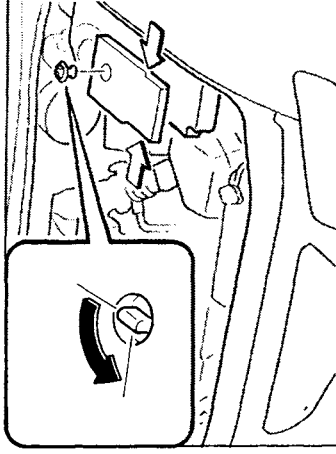

If the headlights or other electrical components don't work and the fuses in the cabin are OK, inspect the fuse block under the hood. If a fuse is blown, it must be replaced. Follow these steps:

1. Turn off the ignition switch and all other switches.
2. Open the fuse block cover by unhooking the tabs and lifting up on the cover.

## In Case of an Emergency

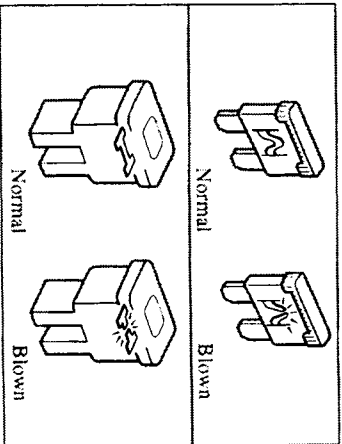

3. If a fuse is blown, replace it with a new one of the same rating.

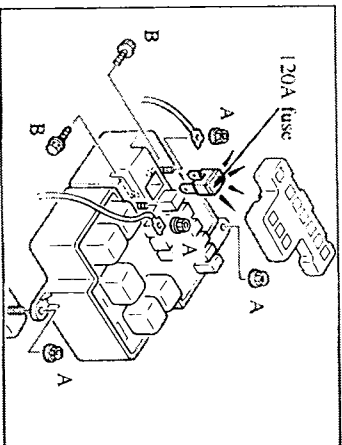

When replacing the 120A fuse:

- 1 Turn off the ignition switch.
2. Remove the negative battery terminal.
3. Remove the A nuts.
4. Lift the fuse block and remove the B bolts.
5. Replace the fuse with a new one of the same rating.
6. Install in the reverse order of removal.

■ Fuse Panel Description

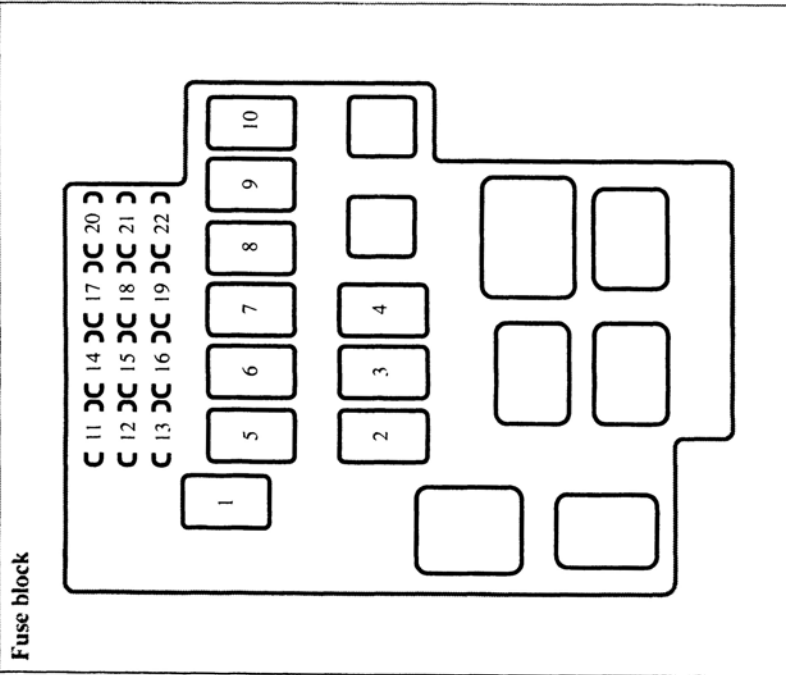

▼ Fuse block (engine compartment)

DESCRIPTION	FUSE RATING	PROTECTED COMPONENT
1 MAIN	120A	For protection of all circuits
2 AD.FAN	30A	Additional cooling fan for air conditioner
3 EGI INJ	30A	Fuel injection system
4 HEAD	40A	Headlights
5 IG KEY	60A	RADIO, TURN, METER, ENGINE, S/ROOF and P/WIND fuses, Ignition system
6 COOLING FAN	30A	Cooling fan
7 ABS*	60A	Antilock brake system
8 HEATER	40A	Heater, Air conditioner
9 DEFOG	40A	Rear window defroster
10 BTN	60A	STOP ROOM and D/LOCK fuses. Fuel lid opener, Power door lock
11 AUDIO*	20A	Audio system
12 P/WINDOW	30A	Power windows
13 P.SEAT*	30A	Power seat
14 HORN	10A	Horn

\*Some models.

**In Case of an Emergency**

DESCRIPTION	FUSE RATING	PROTECTED COMPONENT
15 IDL UP	10A	Engine control system
16 ST.SIGN	10A	Engine control unit
17 FOG*	15A	Fog lights
18 S.WARM*	20A	Seat warmer*
19 TAIL	15A	Taillights, Parking lights, License plate lights, Instrument panel illumination, Glove box light, Clock
20	--	--
21	--	--
22	--	--

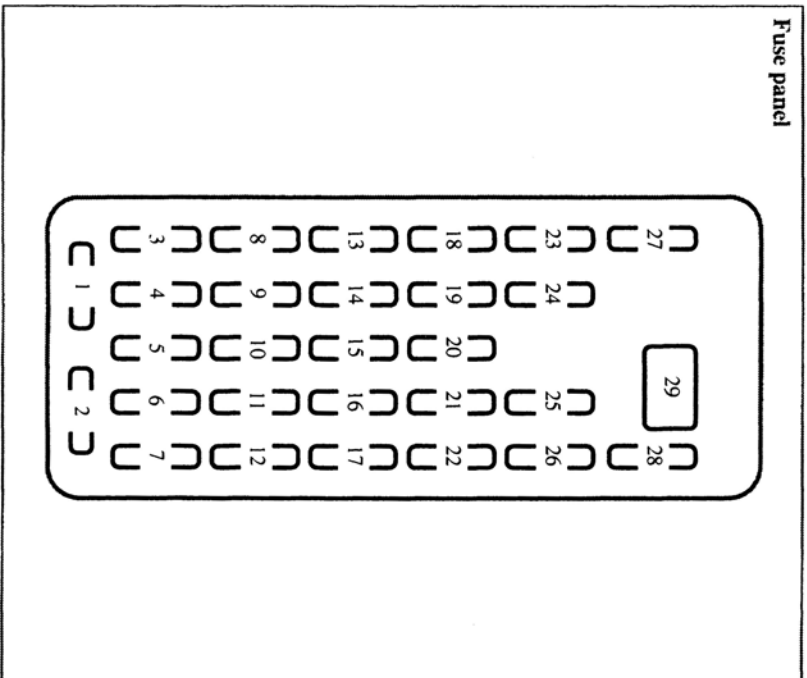

**6-10** \*Some models.



**In Case of an Emergency**

▼ Fuse panel (Driver's side)

DESCRIPTION	FUSE RATING	PROTECTED COMPONENT
1 HAZARD	15A	Hazard warning light
2 ROOM	15A	Clock, Interior light
3 S/ROOF	15A	Sunroof
4 METER	15A	Gauges, Back-up lights, Turn signals, Cruise control
5 STOP	20A	Brake lights
6 —	—	—
7 IIA	15A	IIA
8 R.DEF	10A	Rear window defroster
9 A/C	10A	Air conditioner
10 WIPER	20A	Windshield wipers and washer
11 M.DEF	10A	Mirror defroster
12 START	15A	Starter
13 TURN	10A	Turn signal lights
14 BLOWER	10A	Air conditioner
15 —	—	—
16 —	—	—
17 —	—	—
18 RADIO	10A	Radio
19 ENGINE	15A	Engine control system

DESCRIPTION	FUSE RATING	PROTECTED COMPONENT
20 ILLUMI	10A	Dashboard illumination
21 OPENER	15A	Trunk lid opener, Fuel-lid opener
22 —	—	—
23 CIGAR	15A	Cigar lighter
24 —	—	—
25 —	—	—
26 SPARE	30A	—
27 —	—	—
28 —	—	—
29 D/LOCK	30A	Power door lock

## In Case of an Emergency

### Towing

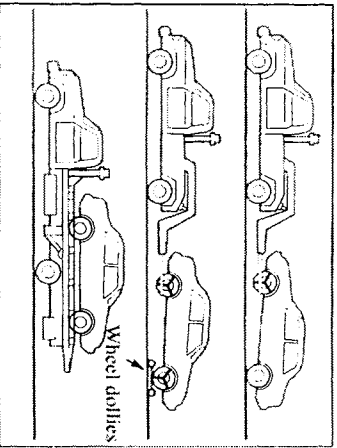

We recommend that towing be done only by an Authorized Mazda Dealer or a commercial tow-truck service.

Proper lifting and towing are necessary to prevent damage to the vehicle. State and local laws must be followed.

A towed vehicle usually should have its front wheels off the ground. If excessive damage or other conditions prevent this, use wheel dollies.

When towing with the rear wheels on the ground, release the parking brake.

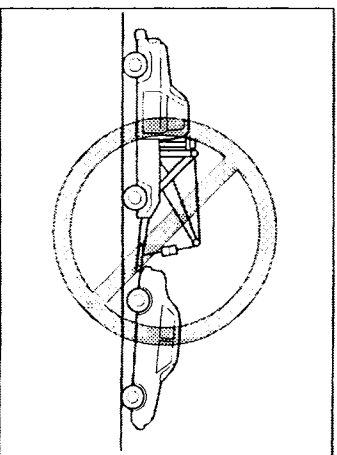
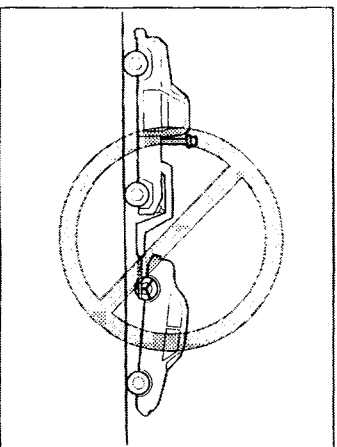

### ⚠ CAUTION

Don't tow the vehicle backward with driving wheels on the ground. This may cause internal damage to the transaxle.

### ⚠ CAUTION

Don't tow with sling-type equipment. This could damage your vehicle. Use wheel-lift or flatbed equipment.

If all four wheels are on the ground, the vehicle may be towed only forward. Don't exceed 56 km/h (35 mph) and a distance of 80 km (50 miles); you could damage the transaxle.

If speed must exceed 56 km/h (35 mph) or a towing distance of 80 km (50 miles), use one of these methods:

- Place the front wheels on dollies.
- Tow with the front wheels off the ground.
- Transport the vehicle on a flat bed truck.

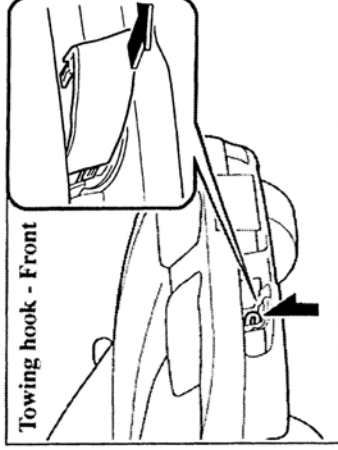

Towing hook - Front

### ⚠ CAUTION

Follow these instructions when towing the vehicle with all wheels on the ground.

1. Shift to neutral.
2. Turn the ignition switch to the ACC position.
3. Release the parking brake.

Remember that power assist for the brakes and steering will not be available when the engine is not running.

### ⚠ CAUTION

- The towing hooks should be used only in an emergency (to get the vehicle out of a ditch or a snow bank, for example).
- When using the towing hooks, always pull the cable or chain in a straight direction with respect to the hook. Apply no sideways force.

**In Case of an Emergency**

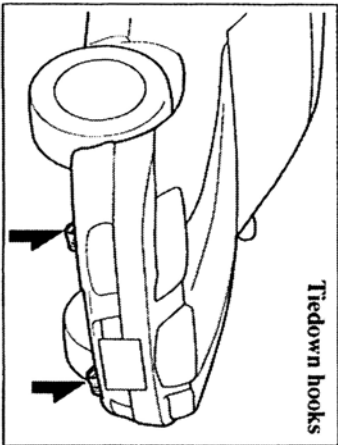
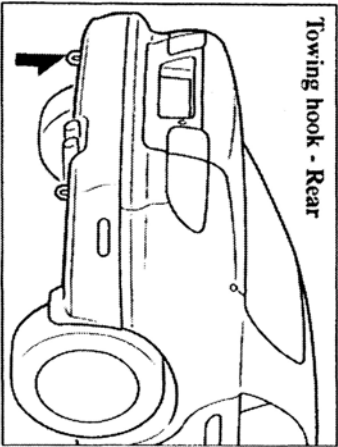

**⚠ CAUTION**

Don't use the hook loops under the front for towing. They are designed **ONLY** for tying down the vehicle when it's being transported. Using them for towing will damage the bumper.

**Flat Tire**

- Tire, Jack, Jack Handle, and Lug Wrench

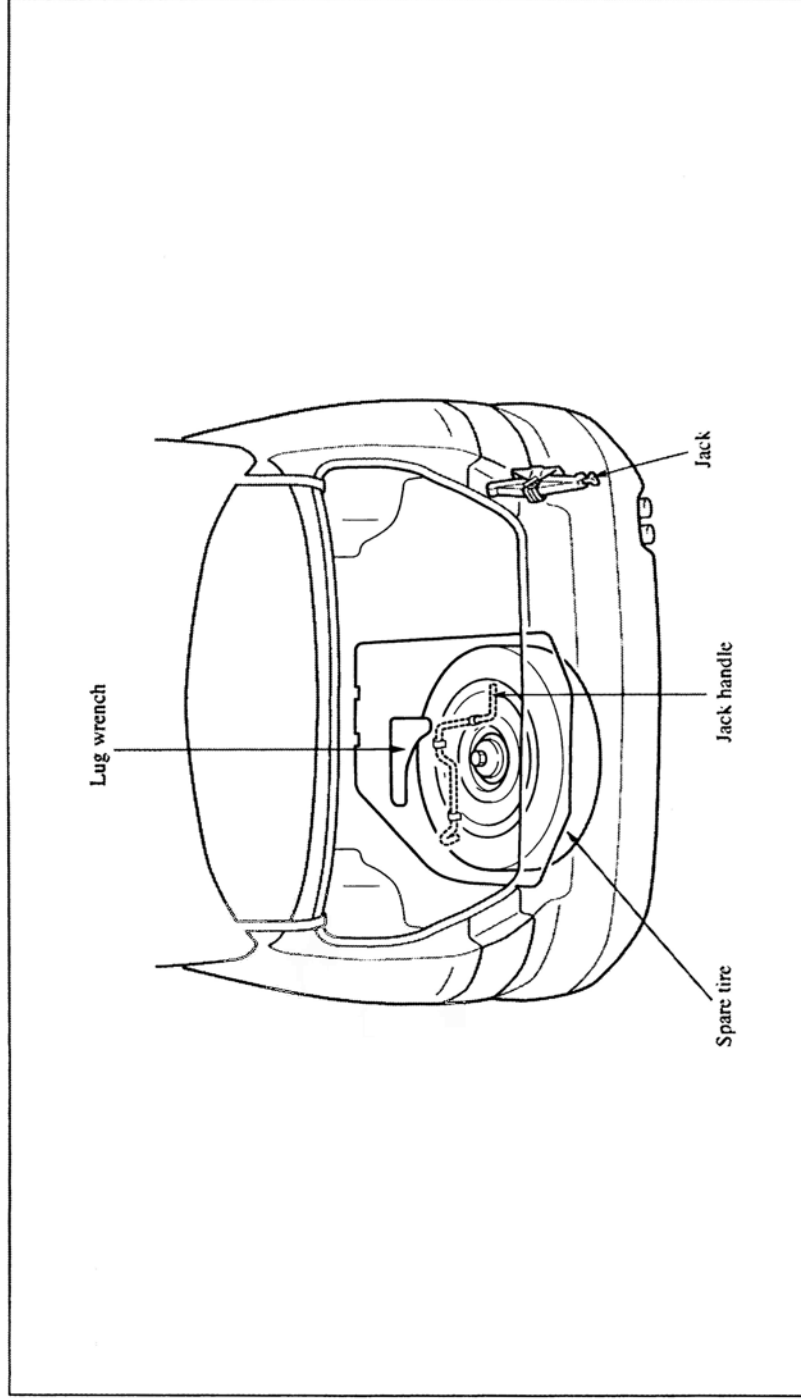

**In Case of an Emergency**

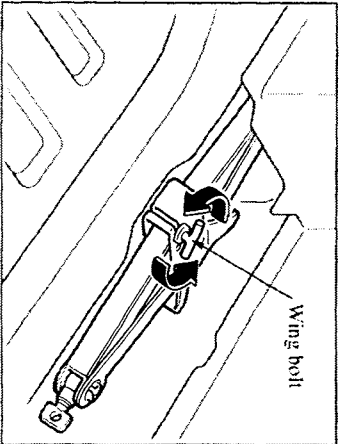

▼ **To remove the jack**

Turn the wing bolt counterclockwise.

▼ **To secure the jack**

Perform the removal procedure in reverse.

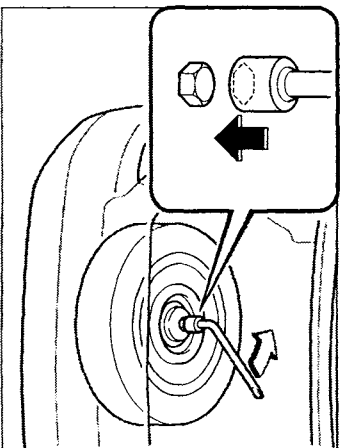

▼ **To remove the spare tire**

Turn the tire hold-down bolt counterclockwise with the lug wrench.

■ **Changing a Flat Tire**

**NOTE**

If the following occurs while driving, it could indicate a flat tire.

- Steering becomes difficult.
- The vehicle begins to vibrate excessively.
- The vehicle pulls in one direction.

If you have a flat tire, drive slowly to a level spot that is well off the road and out of the way of traffic to change the tire. Stopping in traffic or on the shoulder of a busy road is dangerous.

**⚠ WARNING**

***Jacking a Vehicle:  
Changing a tire can be dangerous.  
The vehicle can slip off the jack and  
seriously injure someone.  
Be sure to follow the directions for  
changing a tire, and never get under  
a vehicle that is supported only by a  
jack.***

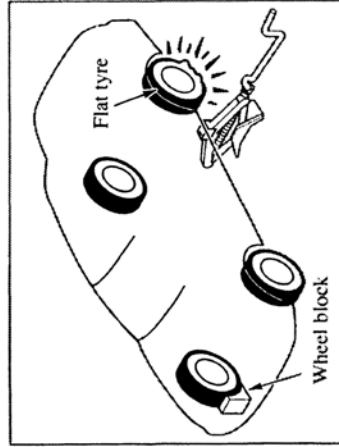

5. Remove the jack, jack handle, lug wrench, and spare tire.
6. Block the wheel diagonally opposite the flat tire. When blocking a front wheel, place the block in front of the tire. When blocking a rear wheel, place the block behind the tire.

To change a flat tire, follow procedure 1 through 14 carefully.

1. Park on a level surface off the right-of-way and firmly set the parking brake.
2. Shift into park (P) and turn off the engine.
3. Turn on the hazard warning flasher.
4. Have everyone get out of the vehicle and away from the vehicle and traffic.

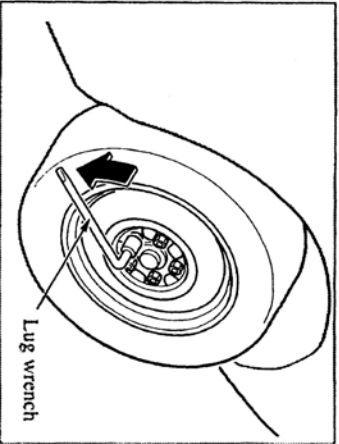

7. Loosen the lug nuts by turning them counterclockwise one turn each, but don't remove any until the tire has been raised off the ground.

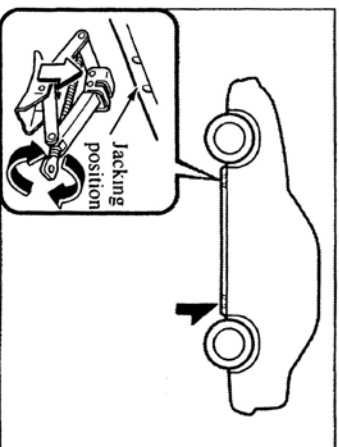

8. Place the jack under the jacking position closest to the tire being changed.

**⚠ WARNING**

***Incorrect Jacking Position:***  
*Attempting to jack the vehicle in positions other than those recommended in this manual is dangerous. The vehicle could slip off the jack and seriously injure or even kill someone. Use only the front and rear jacking positions recommended in this manual.*

**⚠ WARNING**

***Improper Jack:***  
*Using a jack that isn't designed for your Mazda is dangerous. The vehicle could slip off the jack and seriously injure someone. Use only the jack provided with your Mazda.*



**⚠ WARNING**

***Placing Objects Under the Jack:***  
*Jacking the vehicle with an object under the jack is dangerous. The jack could slip and someone could be seriously injured by the jack or the falling vehicle. Never place objects under the jack.*

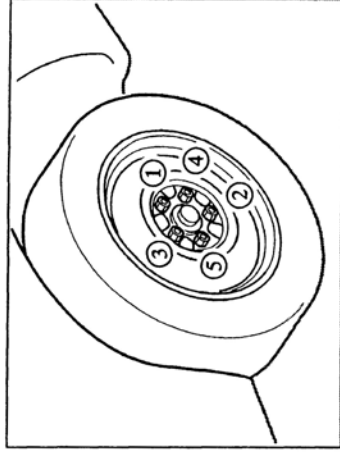
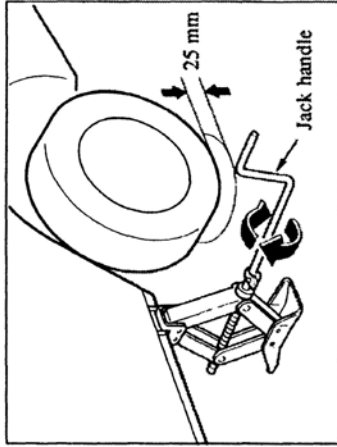

- 9 Insert the jack handle into the jack and turn it clockwise until the tire just clears the ground, less than 25 mm (1 in). Before removing the lug nuts, make sure your Mazda is firmly in position and that it cannot slip or move.
10. Remove the lug nuts by turning them counterclockwise; then remove the wheel.
11. Mount the spare tire.
12. Install the lug nuts with the beveled edge inward; tighten them by hand.
13. Turn the jack handle counterclockwise and lower the vehicle. Use the lug wrench to tighten the nuts in the order shown.

If you're unsure of how tight the nuts should be, have them inspected at a service station. The specified torque is 88 to 127 N·m (9.0 to 13.0 kgf·m, 65 to 94 ft·lbf).

 **WARNING**

Loose Lug Nuts:  
*Improperly or loosely tightened lug nuts are dangerous. The wheel could wobble or come off. This could result in loss of vehicle control and cause a serious accident. Always securely and correctly tighten the lug nuts.*

 **WARNING**

Incorrect Tire Air Pressure:  
*Driving on tires with incorrect air pressure is dangerous. Tires with incorrect pressure could affect handling and result in an accident. Don't drive with any tires that have incorrect air pressure. When you check the regular tire's air pressure, check the spare tire, too.*

■ **Spare Tire**

Your Mazda has a temporary spare tire. It's lighter and smaller than a conventional tire, is designed only for emergency use and should be used only for VERY short periods. Temporary spares should NEVER be used for long drives or extended periods.

 **WARNING**

Metric Studs and Lug Nuts:  
*Because the wheel studs and lug nuts on your Mazda have metric threads, using a non-metric nut is dangerous. On a metric stud, it would not secure the wheel and would damage the stud, which could cause the wheel to slip off and cause an accident. Be sure to reinstall the same nuts you removed or replace them with metric nuts of the same configuration.*

14. Store the damaged tire in the trunk. Repair it and replace the spare with it as soon as possible.

**NOTE**

To prevent the jack, jack handle, and tool bag from rattling, store them properly.

**⚠ WARNING**

*Driving with a Temporary Spare Tire on Ice or Snow:*  
*Driving with a spare tire on the front (driving) wheels on ice or snow is dangerous. Handling will be affected. You could lose control of the vehicle and have an accident. Put the spare tire on the rear axle and move a regular tire to the front.*

**⚠ CAUTION**

To avoid damage to the temporary spare or to the vehicle, observe the following:

- Don't exceed 80 km/h (50 mph).
- Avoid driving over obstacles. Also, don't drive through an automatic car wash. This tire's diameter is smaller than a conventional tire's, so the ground clearance is reduced about 25 mm (1 in).
- Don't use a tire chain on this tire because it won't fit properly.
- Don't use your temporary spare on any other vehicle; it has been designed only for your Mazda.
- Use only one temporary spare tire on your vehicle at the same time.



# 7

## Appearance Care

*This section features care, inside and out, of your Mazda...how best to keep it clean and looking good.*

*Be aware that appearance is not the only reason for cleanliness. Road grime tends to eat away at the metal, so keeping your vehicle clean in the way Section 7 prescribes will help prevent its early deterioration and rusting.*



How to Minimize Environmental Paint Damage	7- 2
Exterior Care	7- 4
Interior Care	7- 9

## How to Minimize Environmental Paint Damage

The paintwork on your Mazda represents the latest technical developments in composition and methods of application.

Environmental hazards, however, can harm the paint's protective properties, if proper care is not taken.

Here are some examples of possible damage, with tips on how to prevent them.

### ■ Etching Caused by Acid Rain or Industrial Fallout

#### ▼ Occurrence

Industrial pollutants and vehicle emissions drift into the air and mix with rain or dew to form acids. These acids can settle on a vehicle's finish. As the water evaporates, the acid becomes concentrated and can damage the finish. And the longer the acid remains on the surface, the greater the chance is for damage.

#### ▼ Prevention

It is necessary to wash and wax your vehicle to preserve its finish according to the instructions in this section. These steps should be taken immediately after you suspect that acid rain has settled on your vehicle's finish.

### ■ Damage Caused by Bird Droppings, Insects, or Tree Sap

#### ▼ Occurrence

Bird droppings contain acids. If these aren't removed they can eat away the clear and color base coat of the vehicle's paintwork.

When insects stick to the paint surface and decompose, corrosive compounds form. These can erode the clear and color base coat of the vehicle's paintwork if they are not removed.

Tree sap will harden and adhere permanently to the paint finish. If you scratch the sap off while it is hard, some vehicle paint could come off with it.

▼ **Prevention**

It is necessary to have your Mazda washed and waxed to preserve its finish according to the instructions in this section. This should be done as soon as possible.

Bird droppings can be removed with a soft sponge and water. If you are traveling and these are not available, a moistened tissue may also take care of the problem. The cleaned area should be waxed according to the instructions in this section.

Insects and tree sap are best removed with a soft sponge and water or a commercially available chemical cleaner.

Another method is to cover the affected area with dampened newspaper for one to two hours. After removing the newspaper, rinse off the loosened debris with water.

■ **Water Marks**

▼ **Occurrence**

Rain, fog, dew, and even tap water can contain harmful minerals such as salt and lime. If moisture containing these minerals settles on the vehicle and evaporates, the minerals will concentrate and harden to form white rings. The rings can damage your vehicle's finish.

▼ **Prevention**

It is necessary to wash and wax your vehicle to preserve its finish according to the instructions in this section. These steps should be taken immediately after you find water marks on your vehicle's finish.

■ **Paint Chipping**

▼ **Occurrence**

Paint chipping occurs when gravel is thrown in the air by another vehicle's tires hits your vehicle.

▼ **How to avoid paint chipping**

Keeping a safe distance between you and the vehicle ahead reduces the chances of having your paint chipped by flying gravel.

## Exterior Care

Follow **all** label and container directions when using a chemical cleaner or polish. Read all warnings and cautions.

### ■ Maintaining the Finish

#### ▼ Washing

To help protect the finish from rust and deterioration, wash your Mazda thoroughly and frequently, at least once a month, with lukewarm or cold water.

If the vehicle is washed improperly, the paint surface could be scratched. Here are some examples of how scratching could occur:

Scratches occur on the paint surface when:

- The vehicle is washed without first rinsing off dirt and other foreign matter.
- The vehicle is washed with a rough, dry, or dirty cloth.
- The vehicle is washed at a car wash that uses brushes that are dirty or too stiff.

### NOTE

- The paint chipping zone varies with the speed of the vehicle. For example, when traveling at 90 km/h (56 mph), the paint chipping zone is 50 m (164 ft).
- In low temperatures a vehicle's finish hardens. This increases the chance of paint chipping.
- Chipped paint can lead to rust forming on your Mazda. Before this happens, repair the damage by using Mazda touch-up paint according to the instructions in this section. Failure to repair the affected area could lead to serious rusting and expensive repairs.



- Cleansers or wax containing abrasives are used.

<b>NOTE</b>
<ul style="list-style-type: none"><li>• Mazda is not responsible for scratches caused by automatic car washes or improper washing.</li><li>• Scratches are more noticeable on vehicles with darker paint finishes.</li></ul>

- Take your vehicle only to a car wash that keeps its brushes well maintained.
- Don't use abrasive cleansers or wax that contain abrasives.

<b>CAUTION</b>
<ul style="list-style-type: none"><li>• Don't use steel wool, abrasive cleaners, or strong detergents containing highly alkaline or caustic agents on chrome-plated or anodized aluminum parts. This may damage the protective coating; also, cleaners and detergents may discolor or deteriorate the paint.</li><li>• To prevent damaging the antenna, retract it before entering a car wash facility or passing beneath a low overhead clearance.</li></ul>

To minimize scratches on the vehicle's paint finish:

- Rinse off any dirt or other foreign matter using lukewarm or cold water before washing.
- Use plenty of lukewarm or cold water and a soft cloth when washing the vehicle. Do not use a nylon cloth.
- Rub gently when washing or drying the vehicle.

Pay special attention to removing salt, dirt, mud, and other foreign material from the underside of the wings, and make sure the drain holes in the lower edges of the doors and rocker panels are clean.

Insects, tar, tree sap, bird droppings, industrial fallout, and similar deposits can damage the finish if not removed immediately. When prompt washing with plain water is ineffective, use a mild soap made for use on vehicles.

Thoroughly rinse off all soap with lukewarm or cold water. Don't allow soap to dry on the finish.

After washing the vehicle, dry it with a clean chamois to prevent water spots from forming.

**⚠ WARNING**

*Driving with Wet Brakes: Driving with wet brakes is dangerous. Increased stopping distance or the vehicle pulling to one side when braking could result in a serious accident. Light braking will indicate whether the brakes have been affected. Dry the brakes by driving very slowly and applying the brakes lightly until brake performance is normal.*

**▼ Waxing**

Your vehicle needs to be waxed when water no longer beads on the finish. Always wash and dry the vehicle before waxing it. In addition to the vehicle body, wax the metal trim to maintain its luster.

1. Use wax which contains no abrasives. Waxes containing abrasive will remove paint and could damage bright metal parts.
2. Use a good grade of natural wax for metallic, mica, and solid colors.
3. When waxing, coat evenly with the sponge supplied or a soft cloth.
4. Wipe off the wax with a soft cloth.

**NOTE**

A spot remover to remove oil, tar, and similar materials will usually also take off the wax. Rewax these areas even if the rest of the vehicle doesn't need it.

■ **Repairing Damage to the Finish**

Deep scratches or chips on the finish should be repaired promptly. Exposed metal quickly rusts and can lead to major repairs.

**CAUTION**

If your Mazda is damaged and needs metal parts repaired or replaced, make sure the body shop applies anti-corrosion materials to all parts, both repaired and new. This will prevent them from rusting.

■ **Bright-Metal Maintenance**

- Use tar remover to remove road tar and insects. Never do this with a knife or similar tool.
- To prevent corrosion on bright-metal surfaces, apply wax or chrome preservative and rub it to a high luster.
- During cold weather or in coastal areas, cover bright-metal parts with a coating of wax or preservative heavier than usual. It would also help to coat them with noncorrosive petroleum jelly or some other protective compound.

■ **Underbody Maintenance**

Road chemicals and salt used for ice and snow removal and solvents used for dust control may collect on the underbody. If not removed, they will speed up rusting and deterioration of such underbody parts as fuel lines, frame, floor pan, and exhaust system, even though these parts may be coated with anti-corrosive material.

Thoroughly flush the underbody and wheel housings with lukewarm or cold water at the end of each winter. Try also to do this every month.

Pay special attention to these areas because they easily hide mud and dirt. **It will do more harm than good to wet down the road grime without removing it.**

The lower edges of doors, rocker panels, and frame members have drain holes that should not be clogged. Water trapped there will cause rusting.

**⚠ WARNING**

*Driving with Wet Brakes: Driving with wet brakes is dangerous. Increased stopping distance or the vehicle pulling to one side when braking could result in a serious accident. Light braking will indicate whether the brakes have been affected. Dry the brakes by driving very slowly and applying the brakes lightly until brake performance is normal.*

■ **Aluminum Wheel Maintenance**

A protective coating is provided over the aluminum wheels. Special care is needed to protect this coating.

**NOTE**

- Don't use a wire brush or any abrasive cleaner, polishing compound, or solvent on aluminum wheels. They may damage the coating.
- Only use a mild soap or neutral detergent and always use a sponge or soft cloth to clean the wheels. Rinse thoroughly with lukewarm or cold water. Also, be sure to clean the wheels after driving on dusty or salted roads. This helps prevent corrosion.
- Avoid washing your vehicle in an automatic car wash that uses high-speed or hard brushes.
- If your aluminum wheels lose luster, wax the wheels.

## Interior Care

### ■ Dashboard Precautions

Prevent caustic solutions such as perfume and cosmetic oils from contacting the dashboard. They'll damage and discolor it. If these solutions get on the dashboard, wipe them off immediately.

### ■ Cleaning the Upholstery and Interior Trim

#### ▼ Vinyl

Remove dust and loose dirt from vinyl with a whisk broom or vacuum cleaner. Clean vinyl with a leather-and-vinyl cleaner.

#### ▼ Leather

Real leather isn't uniform and may have scars, scratches, and wrinkles. Clean it with a leather cleaner or mild soap.

Wipe it with a **damp** soft cloth; then dry and buff it with a **dry** soft cloth.

#### ▼ Fabric

Remove dust and loose dirt from fabric with a whisk broom or vacuum cleaner. Clean it with a mild soap solution good for upholstery and carpets. Remove fresh spots immediately with a fabric spot cleaner.

To keep the fabric looking clean and fresh, take care of it. Otherwise its color will be affected, it can be stained easily, and its fire-resistance may be reduced.

## ⚠ CAUTION

Use only recommended cleaners and procedures. Others may affect appearance and fire-resistance.

■ **Cleaning the Lap/Shoulder Belt Webbing**

Clean the webbing with a mild soap solution recommended for upholstery or carpets. Follow instructions. Don't bleach or dye the webbing; this may weaken it.

■ **Cleaning the Window Interiors**

If the windows become covered with an oily, greasy, or waxy film, clean them with glass cleaner. Follow the directions on the container.

**⚠ WARNING**

**Damaged Seat Belt:**  
*Using damaged seat belts is dangerous. In a collision, damaged belts cannot provide adequate protection. Have your Authorized Mazda Dealer replace damaged belts immediately.*

**⚠ CAUTION**

Don't scrape or scratch the inside of the rear window. You may damage the rear window defroster grid.

# 8

## Maintenance

*Because your Mazda is a large piece of intricate machinery, it needs regular care in the form of maintenance and servicing. Many owners prefer to do much of this work themselves.*

*So Section 8 has been prepared as a guide for the operator who wants to self-service such minor jobs as changing the engine oil, replacing bulbs and wiper blades, charging the battery, and rotating the tires. All maintenance schedules are included, along with instructions on how to make regular inspections of such things as fluid levels.*



Introduction	8- 2
Scheduled Maintenance	8- 3
Owner Maintenance	8- 8

## Introduction

Be extremely careful to prevent injury to yourself and others and damage to your vehicle when using this manual for inspection and maintenance.

The owner should retain evidence that proper maintenance has been performed as prescribed.

A claim against a warranty will not qualify if it results from lack of maintenance and not from defective material or authorized Mazda workmanship.

Any auto repair shop using parts equivalent to your Mazda's original equipment may perform maintenance. **But we recommend that it always be done by an Authorized Mazda Dealer using genuine Mazda parts.**

If you're unsure about any procedure it describes, we strongly urge you to have a reliable and qualified service shop perform the work, preferably an Authorized Mazda Dealer.

Factory-trained Mazda technicians and genuine Mazda parts are best for your vehicle. Without this expertise and the parts that have been designed and made especially for your Mazda, inadequate, incomplete, and insufficient servicing may result in problems. This could lead to vehicle damage or an accident and injuries.

For expert advice and quality service, consult an Authorized Mazda Dealer.



### Scheduled Maintenance

Follow Schedule 1 if the vehicle is operated mainly where none of the following conditions apply. If any do apply, follow Schedule 2 (Puerto Rico residents follow Schedule 2).

- Repeated short-distance driving
- Driving in dusty conditions
- Driving with an extended use of brakes
- Driving in areas where salt or other corrosive materials are being used
- Driving on rough or muddy roads
- Extended periods of idling or low-speed operation
- Driving for a prolonged period in cold temperatures or extremely humid climates

<b>NOTE</b>
-------------

After the described period, continue to follow the described maintenance at the recommended intervals.
--

## Maintenance

### Schedule 1

I Inspect and repair, clean, adjust, or replace if necessary. (Oil-permeated air filter cannot be cleaned using the air-blow method.)  
R. Replace

MAINTENANCE ITEM	MAINTENANCE INTERVALS		Number of months or km (miles), whichever comes first											
	Months ×1000 km (×1000 miles)		6	12	18	24	30	36	42	48				
Engine valve clearance (Miller Cycle Engine V6 DOHC)			(7.5)	(15)	(22.5)	(30)	(37.5)	(45)	(52.5)	(60)				
Engine oil			R	R	R	R	R	R	R	R				
Engine oil filter			R	R	R	R	R	R	R	R				
Drive belts (tension)	2.5 liter V6 DOHC										I			I
	Miller Cycle Engine V6 DOHC		Replace every 168,000 km (105,000 miles)											
Engine timing belt	2.5 liter V6 DOHC		Inspect at 96,000km (60,000 miles) Replace every 168,000 km (105,000 miles)											
	Miller Cycle Engine V6 DOHC		Replace every 96,000 km (60,000 miles)											
Hoses and tubes for emission														I*1
Air filter						R								R
Spark plugs	2.5 liter V6 DOHC		Replace every 48,000 km (30,000 miles)											
	Miller Cycle Engine V6 DOHC		Replace every 96,000 km (60,000 miles)											
Cooling system											I			I
Engine coolant			Replace at first 72,000 km (45,000 miles) or 36 months; after that, every 48,000 km (30,000 miles) or 24 months											

\*1 According to state and federal regulations, failure to perform maintenance on these items will not void your emissions warranties. However, Mazda recommends that all maintenance services be performed at the recommended time or kilometrage (mileage) period to ensure long-term reliability.

**Maintenance**

**I** Inspect and repair, clean, adjust, or replace if necessary.

**Schedule 1 (Cont'd)**

MAINTENANCE INTERVALS	Number of months or km (miles), whichever comes first									
	Months	6	12	18	24	30	36	42	48	
MAINTENANCE ITEM	×1000 km	12	24	36	48	60	72	84	96	
	(×1000 miles)	(7.5)	(15)	(22.5)	(30)	(37.5)	(45)	(52.5)	(60)	
Idle speed					I				I	
Fuel lines and hoses					I*1				I*1	
Brake lines, hoses and connections					I				I	
Disc brakes					I				I	
Steering operation and linkages					I				I	
Front and rear suspension ball joints					I				I	
Drive shaft dust boots					I				I	
Bolts and nuts on chassis and body					I				I	
Body inspection (paint, corrosion)		I	I	I	I	I	I	I	I	
Exhaust system heat shields					I				I	
Air-conditioner compressor operation			I		I		I		I	
Air-conditioner air-filter (if installed)										
Automatic transaxle fluid level					I				I	

**Replace once a year or every 20,000 km (12,000 miles)**

\*1 According to state and federal regulations, failure to perform maintenance on these items will not void your emissions warranties. However, Mazda recommends that all maintenance services be performed at the recommended time or kilometrage (mileage) period to ensure long-term reliability.

## Maintenance

**Schedule 2** I Inspect and repair, clean, adjust, or replace if necessary. (Oil-permeated air filter cannot be cleaned using the air-blow method.)  
R Replace

MAINTENANCE ITEM	MAINTENANCE INTERVALS		Number of months or km (miles), whichever comes first																							
	Months ×1000 km (×1000 miles)		4	8	12	16	20	24	28	32	36	40	44	48	4	8	12	16	20	24	28	32	36	40	44	48
MAINTENANCE ITEM																										
Engine valve clearance (Miller Cycle Engine V6 DOHC)			(5)	(10)	(15)	(20)	(25)	(30)	(35)	(40)	(45)	(50)	(55)	(60)												
Engine oil	Except Puerto Rico		R	R	R	R	R	R	R	R	R	R	R	R												
	Puerto Rico																									
Engine oil filter																										
Drive belts (tension)	2.5 liter V6 DOHC		R	R	R	R	R	R	R	R	R	R	R	R												
	Miller Cycle Engine V6 DOHC																									
Engine timing belt	2.5 liter V6 DOHC*2																									
	Miller Cycle Engine V6 DOHC																									
Hoses and tubes for emission																										
Air filter																										
Spark plugs	2.5 liter V6 DOHC																									
	Miller Cycle Engine V6 DOHC																									
Cooling system																										
Engine coolant																										

\*1 According to state and federal regulations, failure to perform maintenance on these items will not void your emissions warranties. However, Mazda recommends that all maintenance services be performed at the recommended time or kilometrage (mileage) period to ensure long-term reliability.

\*2 If the vehicle is operated in cold districts (below -18°C (0°F)), replace the timing belt at 96,000 km (60,000 miles).

## Maintenance

I Inspect and repair, clean, adjust, or replace if necessary.

**Schedule 2 (Cont'd)**

MAINTENANCE INTERVALS	Number of months or km (miles), whichever comes first															
	Months ×1000 km (×1000 miles)	4	8	12	16	20	24	28	32	36	40	44	48			
MAINTENANCE ITEM	(5)	(10)	(15)	(20)	(25)	(30)	(35)	(40)	(45)	(50)	(55)	(60)				
Engine coolant level	I	I	I	I	I	I	I	I	I	I	I	I				
Idle speed						I										
Fuel lines and hoses						I*1						I*1				
Brake lines, hoses and connections						I						I				
Brake fluid level	I	I	I	I	I	I	I	I	I	I	I	I				
Disc brakes						I						I				
Tire inflation pressure and tire wear	I	I	I	I	I	I	I	I	I	I	I	I				
Steering operation and linkages						I						I				
Power steering fluid level	I	I	I	I	I	I	I	I	I	I	I	I				
Front and rear suspension ball joints						I						I				
Bolts and nuts on chassis and body						I						I				
Body inspection (paint, corrosion)	I	I	I	I	I	I	I	I	I	I	I	I				
Exhaust system heat shields						I						I				
Drive shaft dust boots						I						I				
Air-conditioner compressor operation						I						I				
Air-conditioner air-filter (if installed)						Replace once a year or every 20,000 km (12,000 miles)										
Automatic transaxle fluid level												I				
Function of all lights	I	I	I	I	I	I	I	I	I	I	I	I				
Washer fluid level	I	I	I	I	I	I	I	I	I	I	I	I				

\*1 According to state and federal regulations, failure to perform maintenance on these items will not void your emissions warranties. However, Mazda recommends that all maintenance services be performed at the recommended time or kilometrage (mileage) period to ensure long-term reliability.

## Maintenance

---

### Owner Maintenance

#### ■ Owner Maintenance Schedule

The owner or a qualified service technician should make these vehicle inspections at the indicated intervals to ensure safe and dependable operation.

Bring any problem to the attention of an Authorized Mazda Dealer or qualified service technician as soon as possible.

#### ▼ At least monthly

- Tire inflation pressures (page 8-31)

#### ▼ At least twice a year (for example, every spring and fall)

- Automatic transaxle fluid level (page 8-21)
- Power steering fluid level (page 8-20)

You can do the following scheduled maintenance items if you have some mechanical ability and a few basic tools and if you closely follow the directions in this manual.

#### ▼ When refueling

- Brake fluid level (page 8-19)
- Engine coolant level (page 8-15)
- Engine oil level (page 8-13)
- Washer fluid level (page 8-24)
- Air filter (page 8-25)
- Engine coolant (page 8-15)
- Engine oil and oil filter (page 8-13)

■ **Owner Maintenance Precautions**

Improper or incomplete service may result in problems. This section gives instructions only for items easy to perform.

**⚠ WARNING**

Maintenance Procedures:

*Performing maintenance work on a vehicle is dangerous if not done properly. You can be seriously injured while performing some maintenance procedure. If you lack sufficient knowledge and experience to do the work, have it done by a qualified technician.*

Improper owner maintenance during the warranty period may affect warranty coverage. For details, read the separate Mazda Warranty statement provided with the vehicle. If you're unsure about any servicing or maintenance procedure, have it done by an Authorized Mazda Dealer.

**⚠ WARNING**

Running the Engine:

*Working under the hood with the engine running is dangerous. It becomes even more dangerous when you wear jewelry or loose clothing. Either can become entangled in moving parts and result in injury. Therefore, if you must run the engine while working under the hood, make certain that you remove all jewelry (especially rings, bracelets, watches, and necklaces) and all neckties, scarves, and similar loose clothing before getting near the engine or cooling fan.*

**⚠ WARNING**

Electrical Fan and Engine

Inspection:

*Inspecting the engine with the ignition switch in the ON position is dangerous. The cooling fan could come on unexpectedly even when the engine isn't running. You could be seriously injured by the fan. Turn the ignition switch off and remove the key from the ignition switch when you inspect the engine.*

As explained in the Introduction (page 8-2), several procedure can be done only by a qualified service technician with special tools.

Maintenance

■ Engine Compartment Overview  
(2.5 liter V6 DOHC)

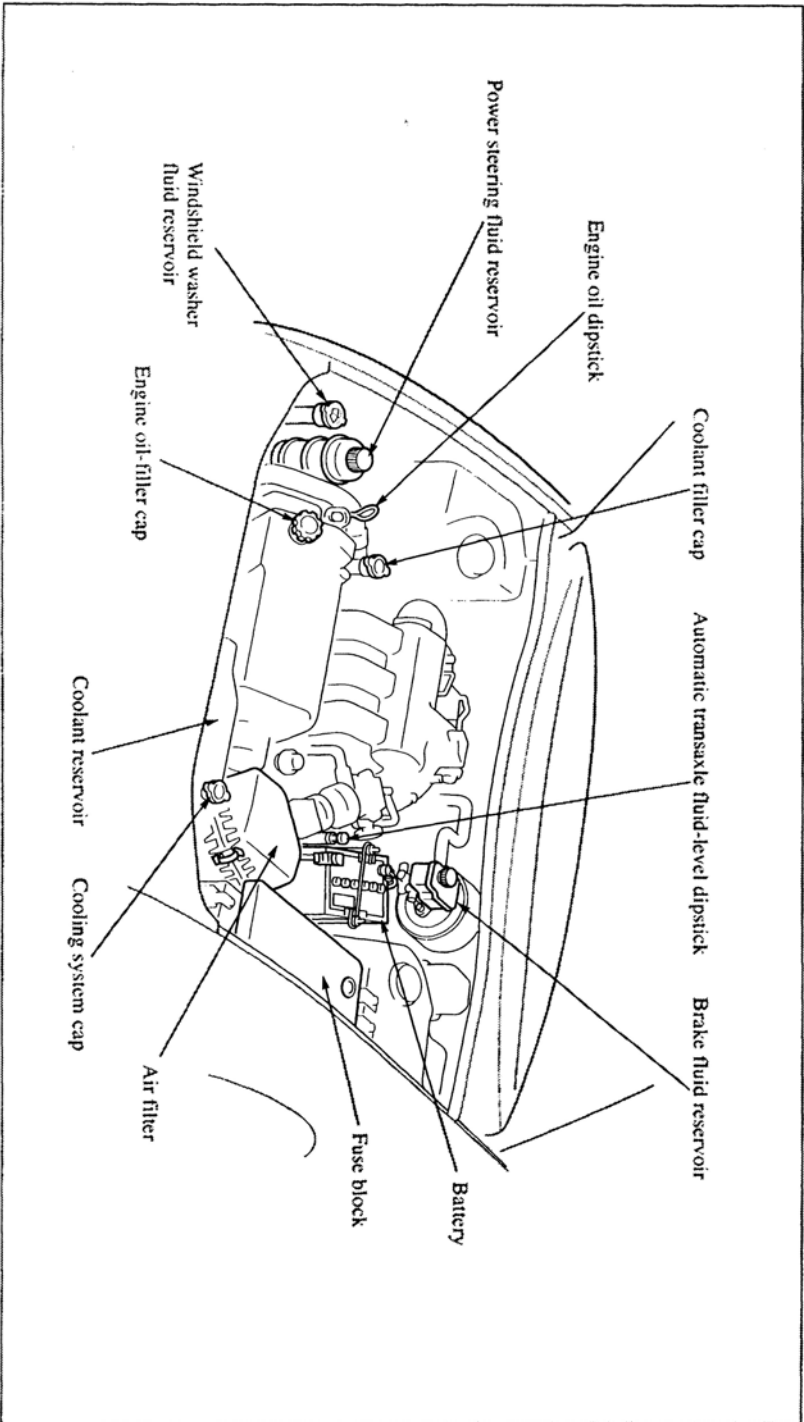



(Miller Cycle Engine V6 DOHC)

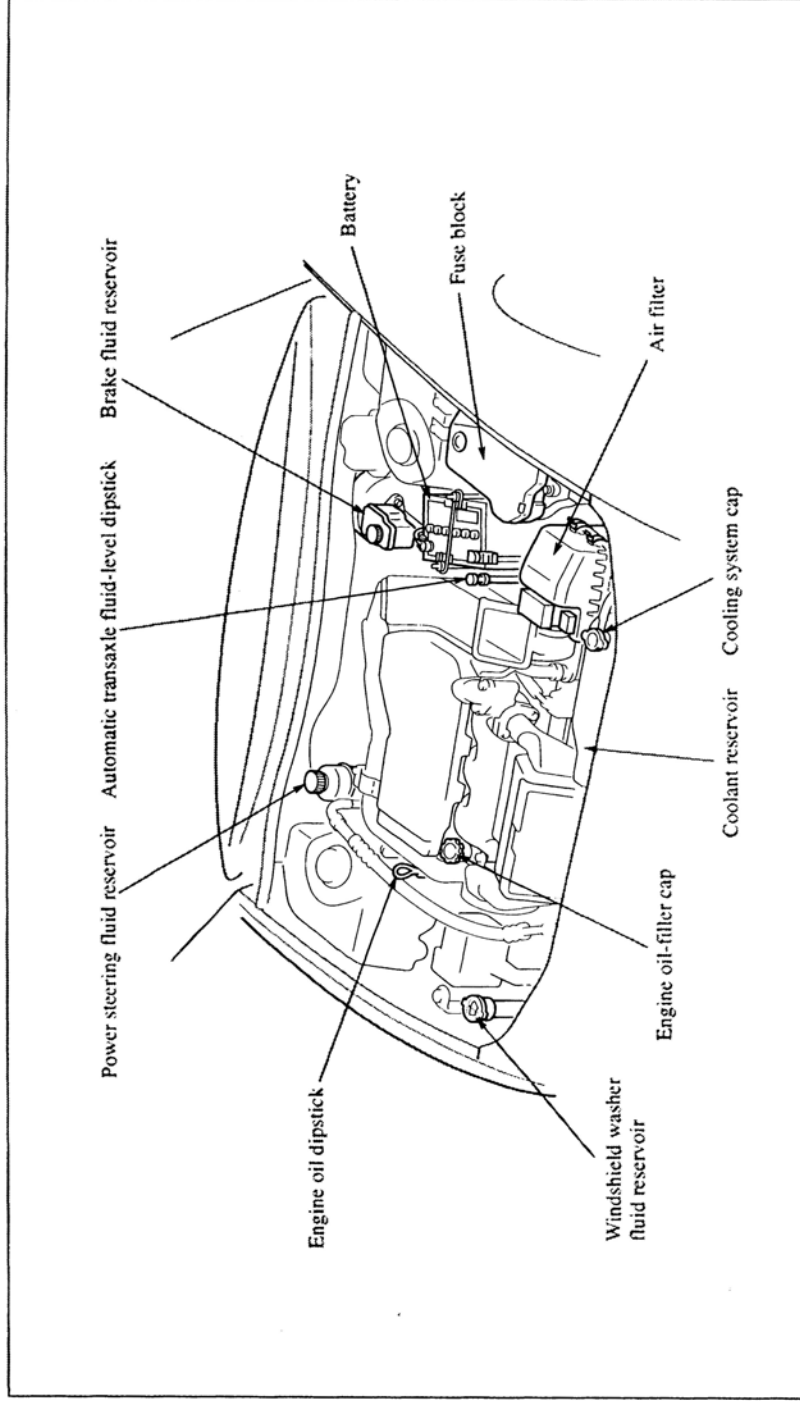

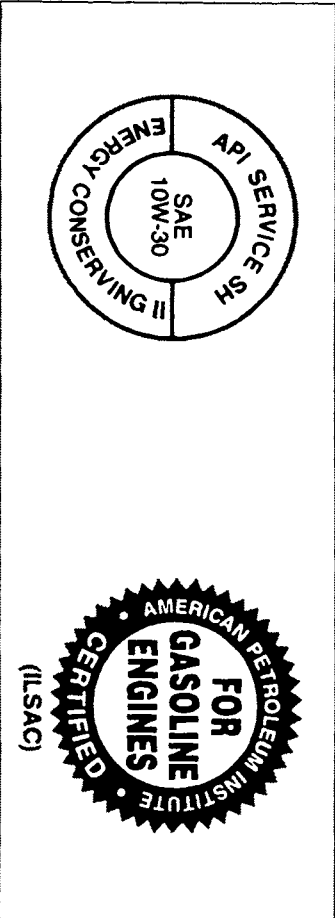

■ Engine Oil

▼ Recommended oil

Oil container labels provide important information.

The quality designation "SG", "SH", "SJ", or "ILSAC" must be on the label.

Engine oil viscosity, or thickness, has an effect on fuel economy and cold-weather operation (starting and oil flow).

Low-viscosity engine oils can provide

improved fuel economy and cold-weather performance. But high-temperature weather conditions require higher-viscosity engine oils for satisfactory lubrication.

When choosing an oil, consider the temperature range your vehicle will operate in before the next oil change. Then select the recommended viscosity from this chart.

Oil	°C (°F)										
	-20	-10	0	10	20	30	40	50	60	70	80
SAE 10W-30											
SAE 5W-30											

**CAUTION**

Using oils of viscosity besides those recommended for specific temperature ranges could result in engine damage.

Energy conserving oils are recommended. A chief contribution they make to fuel economy is reducing the amount of fuel necessary to overcome engine friction.

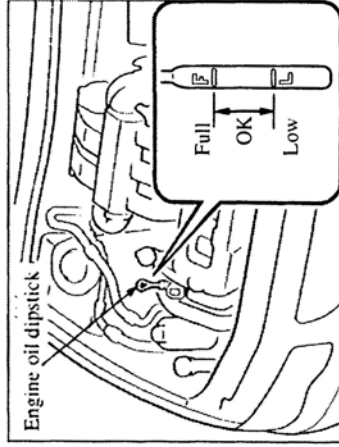

▼ Inspecting engine oil level

1. Be sure the vehicle is on a level surface.
2. Warm up the engine to normal operating temperature.
3. Turn it off and wait 5 minutes for the oil to return to the oil pan.
4. Pull out the dipstick, wipe it clean, and reinsert it fully.

5. Pull it out again and examine the level. It's OK between L and F

But if it's near at or below L, add enough oil to bring the level to F

⚠ CAUTION

Don't add engine oil over F. This may cause engine damage.

NOTE

The distance between L and F on the dipstick represents **0.9 L (1.0 US qt, 0.8 Imp qt)**.

▼ Changing engine oil and filter

Change engine oil and filter according to Scheduled Maintenance (page 8-3).

Please act responsibly—protect the environment and take used oil to a recycling facility. Ask your dealer or a service station for information.

⚠ WARNING

**Handling Used Engine Oil:**  
*Continuous contact with used engine oil is dangerous. It could cause skin cancer. Always wash with soap and water immediately after changing oil and filter.*

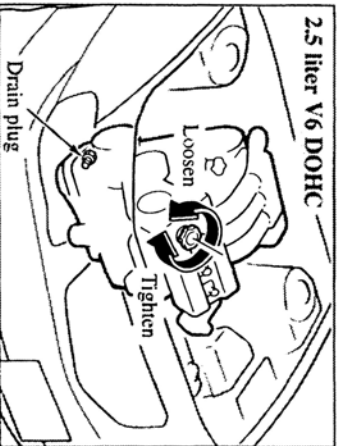

### Changing engine oil

1. Warm up the engine for a few minutes and turn it off. Remove the oil-filler cap.
2. Remove the drain plug and drain the oil into a suitable container.

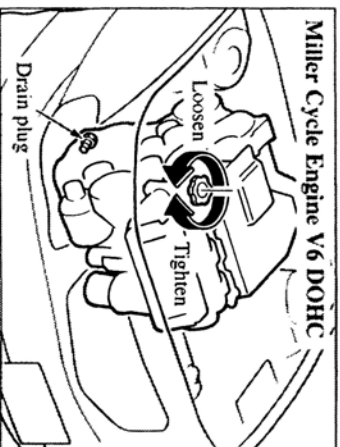

3. Replace the plug tightly after the oil has thoroughly drained.
4. Fill the engine with new oil to the F mark on the dipstick.
5. Securely replace the oil-filler cap.
6. Start the engine and inspect around the drain plug for leaks.
7. Turn it off and wait 5 minutes for the oil to return to the oil pan.

### **⚠** WARNING

***Checking or Changing Engine Oil:***  
***Hot engine oil is dangerous. If the engine has been running, the engine oil becomes very hot. You could be seriously burned. Don't check or change the engine oil when the engine is hot.***

Check the oil level and fill to the F mark if necessary.

**Oil capacity (General reference only)**

**2.5 liter V6 DOHC:**  
**3.7 L (3.9 US qt, 3.3 Imp qt)**

**Miller Cycle Engine V6 DOHC:**  
**3.8 L (4.0 US qt, 3.4 Imp qt)**

**NOTE**

Use only specified engine oil (page 8-12).

**Changing oil filter**

Because you need a special tool to retighten the filter, an Authorized Mazda Dealer should do the work.

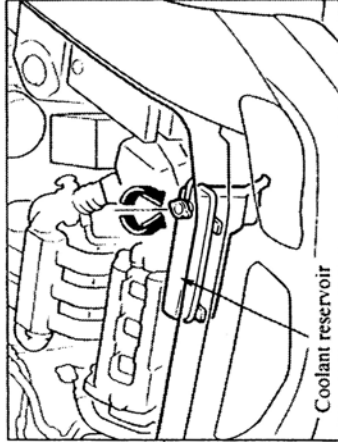

Inspect the antifreeze protection and coolant level in the coolant reservoir at least once a year—at the beginning of the winter season—and before traveling where temperatures may drop below freezing.

Inspect the condition and connections of all cooling system and heater hoses. Replace any that are swollen or deteriorated.

■ Engine Coolant

▼ Inspecting coolant level

The coolant should be at full in the radiator and between the FULL and LOW marks on the coolant reservoir when the engine is cool.

**⚠ WARNING**

**Hot Engine:**

*A hot engine is dangerous. If the engine has been running, parts of the engine compartment can become very hot. You could be burned. Don't inspect the coolant system or add coolant when the engine is hot.*

## Maintenance

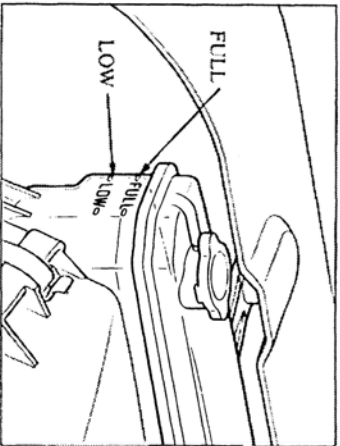

If it's at or near **LOW**, add enough coolant to the coolant reservoir to provide freezing and corrosion protection and to bring the level to **FULL**.

### Do not overfill.

If new coolant is required frequently, consult an Authorized Mazda Dealer.

### ⚠ CAUTION

Radiator coolant will damage paint. Rinse it off quickly.

### ▼ Changing coolant

Change coolant according to Scheduled Maintenance (page 8-3).

### ⚠ CAUTION

- Use only soft (demineralized) water in the coolant mixture. Water that contains minerals will cut down on the coolant's effectiveness.
- Don't add only water. Always add a proper coolant mixture.
- The engine has aluminum parts and must be protected by an ethylene-glycol-based coolant to prevent corrosion and freezing.

**DO NOT USE** alcohol or methanol antifreeze. **DO NOT MIX** alcohol or methanol with the coolant. This could damage the cooling system.  
(Continued)

- Don't use a solution that contains more than 60 % antifreeze. This would reduce effectiveness.

For mixture percentage:

Protection	Volume	
	Antifreeze solution	Water
Above -16°C (3°F)	35%	65%
Above -26°C (-15°F)	45	55
Above -40°C (-40°F)	55	45

### **⚠ WARNING**

**Removing the Cooling System Cap:**  
*Removing the cooling system cap or drain plug while the engine is running or hot is dangerous. This might lead to cooling system and engine damage and could result in serious injury from escaping hot coolant or steam. Turn off the engine and wait until it's cool. Even then, be very careful when removing the cap or drain plug. Wrap a thick cloth around it and slowly turn it counterclockwise to the first stop. Step back while the pressure escapes. When you're sure all the pressure is gone, press down on the cap — still using a cloth — turn the cap, and remove it.*

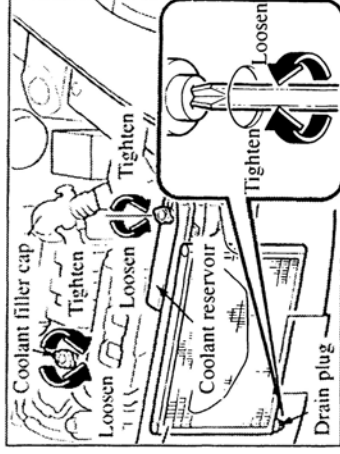

### To Change Coolant (2.5 liter V6 DOHC)

- 1 Remove the coolant filler cap.
2. Only when the engine is cool, remove the radiator drain plug and drain the coolant into a suitable container.
3. Flush out the system with running water.
4. Drain the system completely. Insert and tighten the plug.

## Maintenance

5. Fill the system (to the top of the filler neck) and then the coolant reservoir (to F) with as much ethylene-glycol-based coolant and water as necessary to provide protection from freezing and corrosion.  
  
In extremely cold climates, add the amount recommended by the coolant manufacturer.
6. Reinstall the coolant filler cap.
7. Run the engine at idle for about 10 minutes, then turn it off. If the coolant level warning light comes on during this time, turn the engine off.  
  
After turning off the engine, inspect the drain plug and the water hoses for leaks.
8. After the engine has cooled, remove the coolant filler cap and inspect the coolant level. If it's low, repeat steps 5 to 7.

Because this procedure requires technical expertise, we recommend that it be done by an Authorized Mazda Dealer.

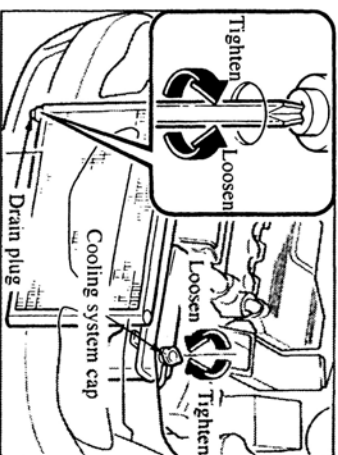

### To change coolant (Miller Cycle Engine V6 DOHC)

1. Remove the cooling system cap.
2. Only when the engine is cool, remove the radiator drain plug and drain the coolant into a suitable container.
3. Flush out the system with running water.



4. Drain the system completely. Insert and tighten the plug. Add as much ethylene-glycol-based coolant and water as necessary to provide freezing and corrosion protection.

In extremely cold climates, add the amount recommended in the coolant manufacturer's instructions.

5. Run the engine at idle with the cooling system cap off. Slowly add additional coolant if necessary.

6. At this point, wait until the engine reaches normal operating temperature; then depress the accelerator two or three times. Add more coolant, if necessary, until the system is full.

7. Install the cooling system cap. Inspect all connections for leaks. Inspect the level in the coolant reservoir one more time.



Brake fluid reservoir

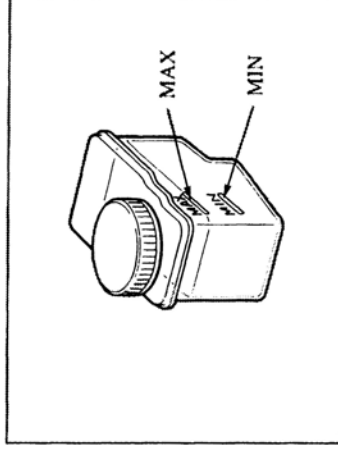

■ **Inspecting Brake Fluid Level**

Inspect the fluid level in the reservoir regularly. It should be kept at MAX. If it's low, add fluid until it reaches MAX.

Before adding fluid, thoroughly clean the area around the cap.

The level normally drops with accumulated distance, a condition associated with wear of brake linings. If it is excessively low, have the brake system inspected by an Authorized Mazda Dealer.

**CAUTION**

Brake fluid will damage painted surfaces. If brake fluid does get on a painted surface, wipe it off immediately.

## ⚠ CAUTION

Using nonspecified brake fluids (see chart, page 10-2) will damage the system. Mixing different fluids will also damage it.

If the brake system frequently requires new fluid, consult an Authorized Mazda Dealer.

## ⚠ WARNING

### Spilled Brake Fluid:

*Spilled brake fluid is dangerous. If it gets in your eyes, they could be seriously injured. If this happens, immediately flush your eyes with water and get medical attention.*

*Brake fluid spilled on a hot engine could cause a fire. Be careful not to spill brake fluid on yourself or on the engine.*

## ⚠ WARNING

### Low Brake Fluid Levels:

*Low brake fluid levels could be dangerous. Low levels could signal brake lining wear or a brake system leak. Your brakes could fail and cause an accident. If you find a low fluid level, have the brakes inspected.*

2.5 liter V6 DOHC

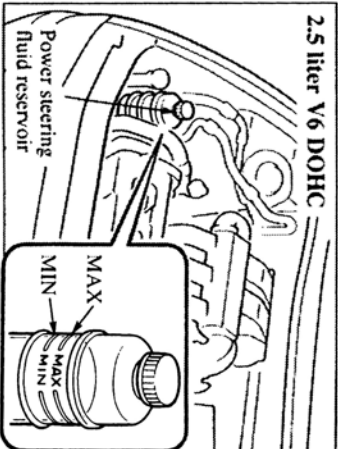

### ■ Inspecting Power Steering Fluid Level

Inspect the fluid level in the reservoir at each engine oil change with the engine off and cold. Add fluid if necessary; it does not require periodic changing.

The level must be kept between MIN and MAX.

Visually examine the lines and hoses for leaks and damage.

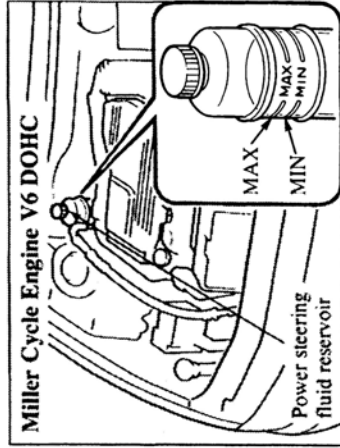

**NOTE**

Use specified power steering fluid (chart, page 10-2).

■ **Inspecting Automatic Transaxle Fluid Level**

The automatic transaxle fluid level should be inspected regularly. Measure it as described below.

The volume of fluid changes with the temperature. Fluid must be checked at idle without driving at normal operating temperature.

If new fluid is required frequently, consult an Authorized Mazda Dealer.

**CAUTION**

To avoid damage to the power steering pump, don't operate the vehicle for long periods when the power steering fluid level is low.

**CAUTION**

- Low fluid level causes transaxle slippage. Overfilling can cause foaming, loss of fluid, and malfunction.
- Use specified fluid (page 10-2). A nonspecified fluid could result in transaxle malfunction and failure.

## Maintenance

1. Park on a level surface and set the parking brake firmly.
2. Idle the engine about two minutes. Push down on the brake pedal.
3. Move the shift lever through all ranges and set it at P

 <b>WARNING</b>
<p><b><u>Sudden Vehicle Movement:</u></b> <i>Shifting the shift lever without first depressing the brake pedal is dangerous. The vehicle could move suddenly and cause an accident. Make sure the brake pedal is applied before shifting the shift lever.</i></p>

4. With the engine still idling, pull out the dipstick, wipe it clean, and put it back.
  5. Pull it out again.
- The proper fluid level is marked on the dipstick as follows.

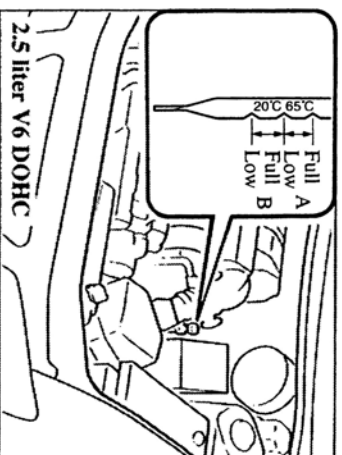

### ▼ Fluid hot scale A

When the vehicle has been driven and the fluid is at normal operating temperature, about 65°C (150°F), the level must be between Full and Low.

### ▼ Fluid cold scale B

When the engine has not been running and the outside temperature is about 20°C (70°F), the level must be between Full and Low.

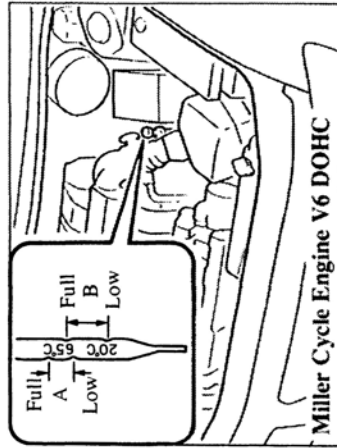

**NOTE**

- Use the cold scale only as a reference.
- If outside temperature is lower than about 20°C (70°F), start the engine and inspect the fluid level after the engine reaches operating temperature.
- If the vehicle has been driven for an extended period at high speeds or in city traffic in hot weather, inspect the level only after stopping the engine and allowing the fluid to cool for 30 minutes.

Fully insert the dipstick. When adding fluid, inspect with the dipstick to make sure it doesn't pass full.

**NOTE**

Inspect both sides of the dipstick for accurate reading.

## Maintenance

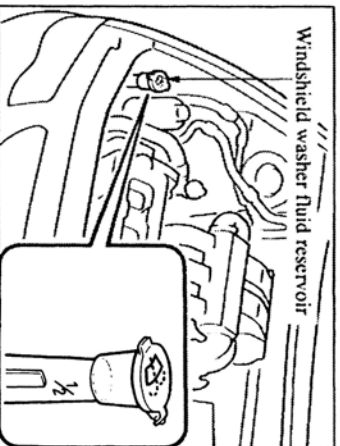

### ■ Inspecting Washer Fluid Level

Inspect fluid level in the washer fluid reservoir; add fluid if necessary.

Use plain water if fluid is unavailable.  
But use only washer fluid in cold weather to prevent it from freezing.

## ⚠ WARNING

### Substitute Washer Fluid:

*Using radiator antifreeze as washer fluid is dangerous. If sprayed on the windshield, it will dirty the windshield, affect your visibility, and could result in an accident. Use only windshield washer fluid or plain water in the reservoir.*

### ■ Body Lubrication

All moving points of the body, such as door and hood hinges and locks, should be lubricated each time the engine oil is changed. Use a nonfreezing lubricant on locks during cold weather.

Make sure the engine hood's secondary latch keeps the hood from opening when the primary latch is released.

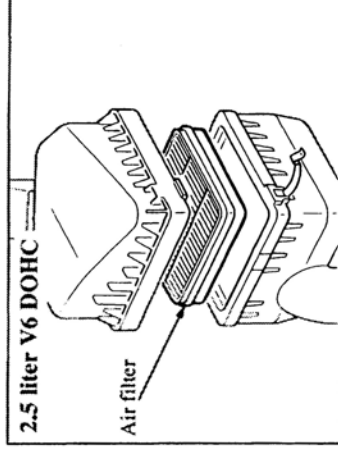
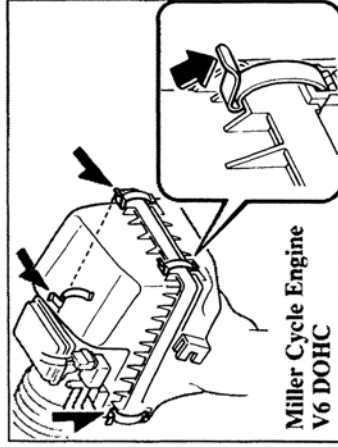
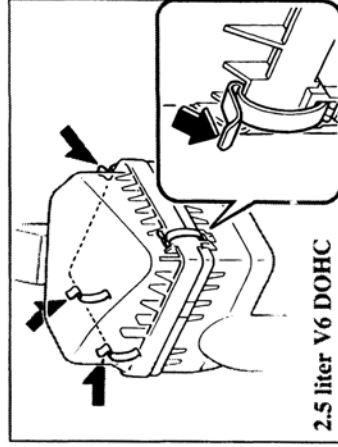

■ **Maintaining the Air Filter**

This air filter may be cleaned with compressed air and reused, or replaced, depending on its condition. Unless it is very dirty, simply shake it to remove foreign particles. Each time you inspect it, wipe inside the air cleaner housing with a damp cloth.

- 1 Unfasten the clamps.
2. Lift off the air filter cover and remove the filter.
3. Wipe inside the air cleaner housing with a damp cloth.
4. Clean or replace the filter.
5. Install in the reverse order of removal.

Replace the filter according to Scheduled Maintenance (page 8-3).

## Maintenance

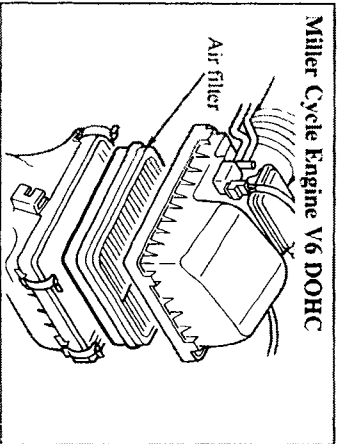

Miller Cycle Engine V6 DOHC

### NOTE

If the vehicle is operated in very dusty or sandy areas, replace the filter more often than recommended intervals.

### ⚠ CAUTION

Don't drive without an air filter. This could result in excessive engine wear.

### ■ Maintaining Wiper Blades

### ⚠ CAUTION

Hot waxes applied by automatic car washes have been known to affect the cleanability of windows.

Contamination of either the windshield or the blades with foreign matter can reduce wiper effectiveness. Common sources are insects, tree sap, and hot wax treatments used by some commercial car washes.

If the blades are not wiping properly, clean the window and blades with a good cleaner or mild detergent, then rinse thoroughly with clean water. Repeat if necessary.



**CAUTION**

To prevent damage to the wiper blades, don't use gasoline, kerosene, paint thinner, or other solvents on or near them.

■ Replacing Windshield Wiper Blades

When the wipers no longer clean well, the blades are probably worn or cracked. Replace them.

**CAUTION**

To prevent damage to the wiper arms and other components, don't move the wipers by hand.

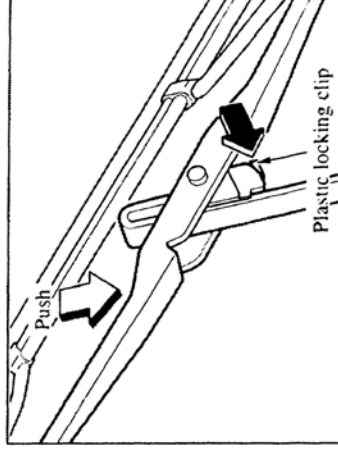

- 1 Raise the wiper arm and turn the blade assembly to expose the plastic locking clip.
2. Compress the clip and slide the assembly downward; then lift it off the arm.

**CAUTION**

To prevent damage to the windshield, don't let the wiper arm fall on it.

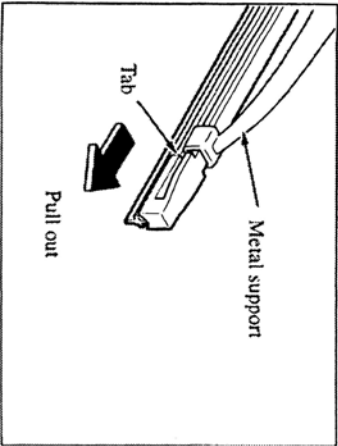

3. Hold the end of the rubber and pull until the tabs are free of the metal support.

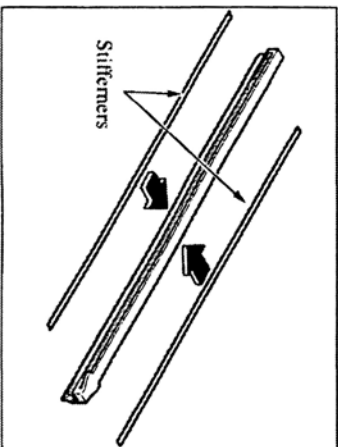

4. Remove the metal stiffeners from the blade rubber and install them in new blades.

### **⚠ CAUTION**

- Don't bend the stiffeners. You need to use them again.
- If the metal stiffeners are switched, the blade's wiping efficiency could be reduced.

So don't use the driver's side metal stiffeners on the passenger's side, or vice versa.

- Be sure to reinstall the metal stiffeners in the new blade rubber so that the curve is the same as it was in the old blade rubber.

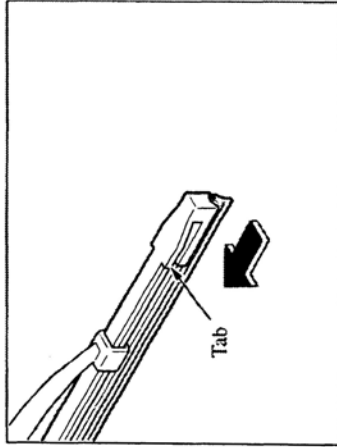

5. Carefully insert the new blade rubber. Then install the blade assembly in the reverse order of removal.

**NOTE**

Install the blade so that the tabs are toward the bottom of the wiper arm.

■ Battery

**⚠ WARNING**

**Battery-Related Lead Materials:**  
Battery posts, terminals and related accessories contain lead and lead compounds, chemicals known to the State of California to cause cancer and reproductive harm.  
Wash hands after handling.

**⚠ WARNING**

**Spilled Battery Fluid:**  
Spilled battery fluid is dangerous. Battery fluid contains **SULFURIC ACID** which could cause serious injuries, if it gets in your eyes or on your skin. If this happens, immediately flush your eyes with water for 15 minutes or wash your skin thoroughly and get medical attention. Be careful not to get battery fluid on yourself.

**⚠ WARNING**

**Battery-Related Explosion:**

*Flames and sparks near open battery cells are dangerous. Hydrogen gas, produced during normal battery operation, could ignite and cause the battery to explode. An exploding battery can cause serious burns and injuries. Keep all flames, including cigarettes, and sparks away from open battery cells.*

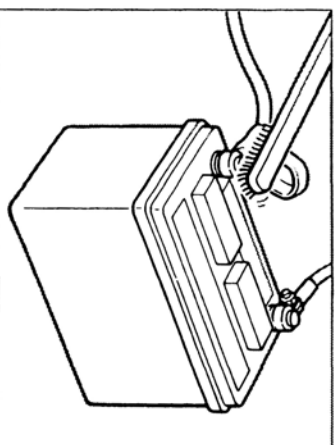

- If the vehicle will not be used for an extended time, disconnect the battery cables.

To get the best service from a battery:

- Keep it securely mounted.
- Keep the top clean and dry.
- Keep terminals and connections clean, tight, and coated with petroleum jelly or terminal grease.
- Rinse off spilled electrolyte immediately with a solution of water and baking soda.

**⚠ WARNING**

**Children and Batteries:**

*Allowing children to play near batteries is dangerous. Battery fluid could cause serious injuries if it gets in the eyes or on the skin. Always keep batteries out of the reach of children.*

■ Tires

For reasons of proper performance, safety, and better fuel economy, always maintain recommended tire inflation pressures and stay within the recommended load limits and weight distribution.

**⚠ WARNING**

***Using Wrong-Sized Tires:***  
*Using any other tire size than what is specified for your Mazda (page 10-4) is dangerous. It could seriously affect ride, handling, ground clearance, tire clearance, and speedometer calibration. This could cause you to have an accident. Use only tires that are the correct size specified for your Mazda.*

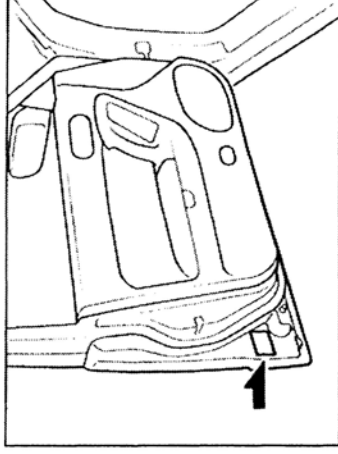

▼ Tire inflation pressure

Inspect all tire pressures monthly (including the spare) when the tires are cold. Maintain recommended pressures for the best ride, top handling, and minimum tire wear.

Refer to the specification charts (page 10-4).

**⚠ WARNING**

***Using Different Tire Types:***  
*Driving your vehicle with different types of tires is dangerous. It could cause poor handling and poor braking; leading to loss of control. Except when using the temporary spare tire, use only the same type tires (radial, bias-belted, bias-type) on all four wheels.*

**NOTE**

- Warm tires normally exceed recommended pressures. Don't release air from warm tires to adjust the pressure.
  - Underinflation can cause reduced fuel economy and poor sealing of the tire bead, which will deform the wheel and cause separation of tire from rim.
  - Overinflation can produce a harsh ride and a greater possibility of damage from road hazards.
- Keep your tire pressure at the correct levels. If one frequently needs inflating, have it inspected.

**⚠ WARNING**

*Incorrect Tire Inflation: Overinflation or underinflation of tires is dangerous. Adverse handling or unexpected tire failure could result in a serious accident. Always inflate the tires to the correct pressure (page 10-4).*

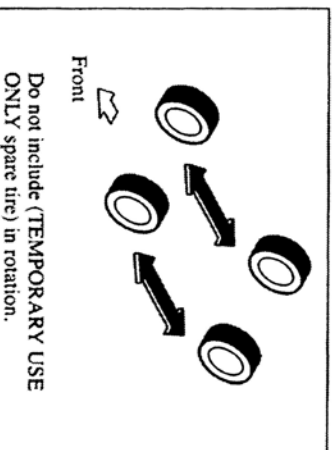

**▼ Tire rotation**

To equalize tread wear, rotate the tires every 6,000 km (3,750 miles), or sooner if irregular wear develops. During rotation, inspect them for correct balance.

Also, inspect them for uneven wear and damage. Abnormal wear is usually caused by one or a combination of the following:

- Incorrect tire pressure

- Improper wheel alignment
- Out-of-balance wheel
- Severe braking

After rotation, bring all tire pressures to specification (page 10-4) and inspect the lug nuts for tightness.

<b>CAUTION</b>
Rotate unidirectional tires and radial tires that have an asymmetrical tread pattern or studs only from front to rear, not from side to side. Tire performance will be weakened if rotated from side to side.

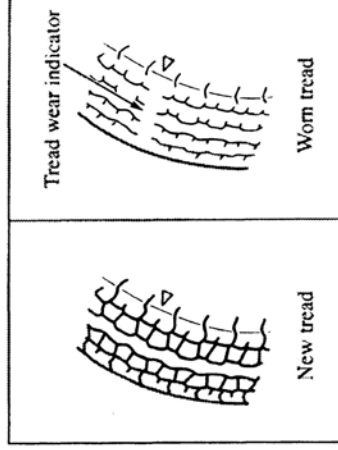

▼ Replacing a tire

If a tire wears evenly, a wear indicator will appear as a solid band across the tread. Replace the tire when this happens. You may need to replace it before the band is across the entire tread.

**⚠ WARNING**

***Worn Tires:***  
***Driving with worn tires is dangerous. Reduced braking, steering, and traction could result in an accident. Always use tires that are in good condition.***

▼ **Temporary spare tire**

Inspect the temporary spare tire at least monthly to make sure it's properly inflated and stored.

The temporary spare tire is easier to handle because of its construction. It is lighter and smaller than a conventional tire and should be used only for an emergency and only for a short distance.

Use the temporary only until the conventional tire is repaired, which should be as soon as possible.

Maintain its pressure at 420 kPa (60 psi).

**⚠ CAUTION**

- Don't use your temporary spare tire rim with a snow tire or a conventional tire. Neither will properly fit and could damage both tire and rim.
- The temporary spare tire has a tread life of up to 4,800 km (3,000 miles), depending on road conditions and driving habits.
- When the tread wear solid-band indicator appears, replace the tire with the same type of temporary spare.



▼ Replacing a wheel

When replacing a wheel, make sure the new one is the same as the original factory wheel in diameter, rim width, and offset.

Proper tire balancing provides the best riding comfort and helps reduce tread wear. Out-of-balance tires can cause vibration and uneven wear, such as cupping and flat spots.

**⚠ WARNING**

*Using a Wrong-Sized Wheel:  
Using a wrong-sized wheel is dangerous. Braking and handling could be affected, leading to loss of control and an accident. Always use wheels of the correct size on your vehicle.*

**⚠ CAUTION**

A wrong-sized wheel may adversely affect

- Tire fit
- Wheel and bearing life
- Ground clearance
- Snow-chain clearance
- Speedometer calibration
- Headlight aim
- Bumper height

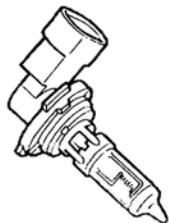

Do not touch the glass surface

■ Replacing a Headlight Bulb

Your Mazda's headlights have replaceable halogen bulbs.

**⚠ WARNING**

Handling Halogen Bulbs:

*When a halogen bulb breaks, it is dangerous. These bulbs contain pressurized gas. If one is broken, it will explode and serious injuries could be caused by the flying glass. If the glass portion is touched with bare hands, body oil could cause the bulb to overheat and explode when lit. Never touch the glass portion of the bulb with your bare hands and always wear eye protection when handling or working around halogen bulbs.*

**⚠ WARNING**

Children and Halogen Bulbs:

*Playing with a halogen bulb is dangerous. Serious injuries could be caused by dropping a halogen bulb or breaking it some other way. Always keep halogen bulbs out of the reach of children.*

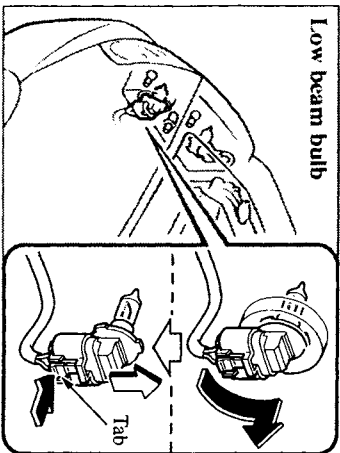

**▼ To remove a halogen bulb :**

1. Make sure the headlight switch is off.
2. Lift the hood and find the bulb in the rear of the headlight body.
3. Turn the socket and bulb assembly counterclockwise and remove it while holding the rubber socket cover in place. Carefully remove the headlight bulb from its socket in the reflector by gently pulling it straight backward out of the socket.

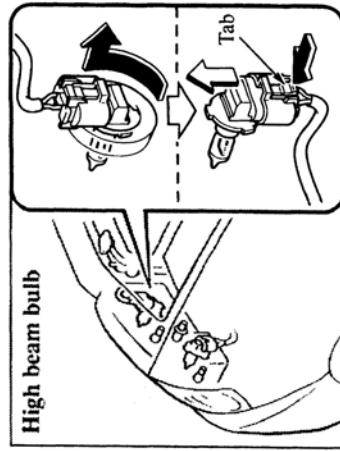

6. Install the new bulb in the reverse order of removal.

<b>NOTE</b>
Use the protective cover and carton to dispose of the old bulb promptly out of the reach of children.

4. Remove the bulb from the electrical connector by pressing the tab on the connector with your finger and pulling the bulb upward.
5. Install the new bulb in the reverse order of removal.

Maintenance

■ Replacing a Bulb (Front)

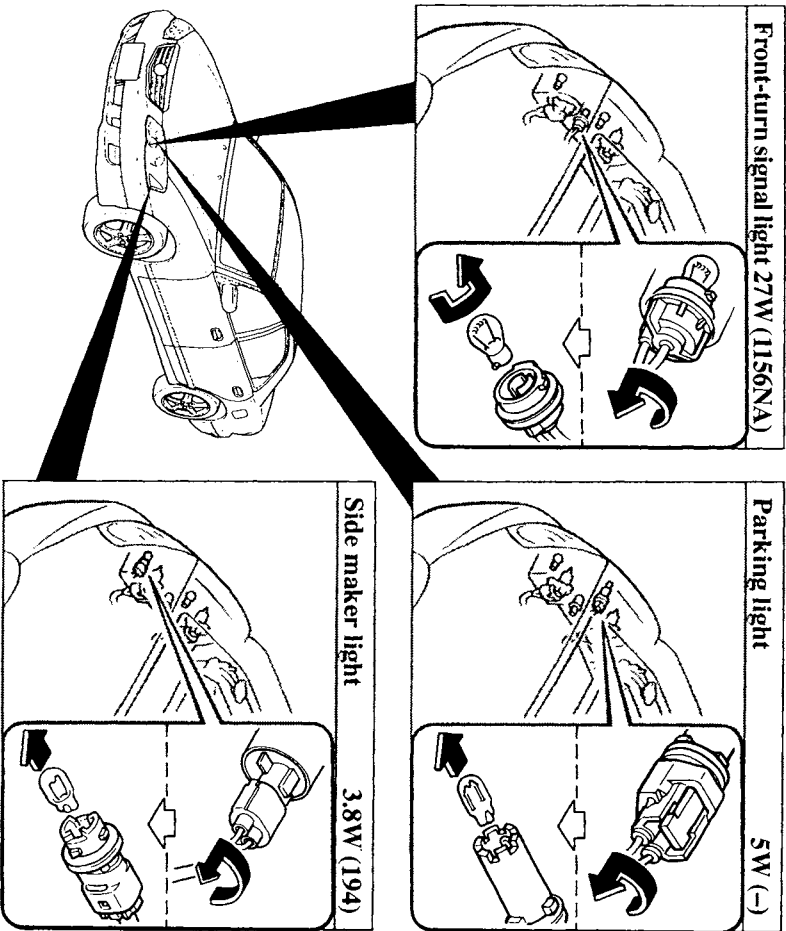

To replace the fog light bulbs, contact an Authorized Mazda Dealer.  
The number in ( ) shows the bulb number.

8-38

■ Replacing a Bulb (Rear)

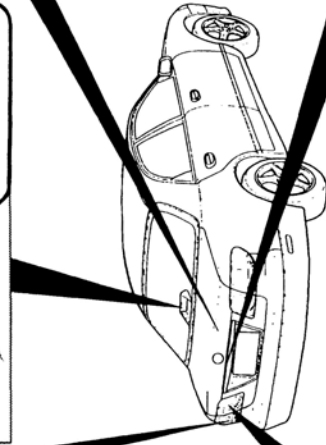
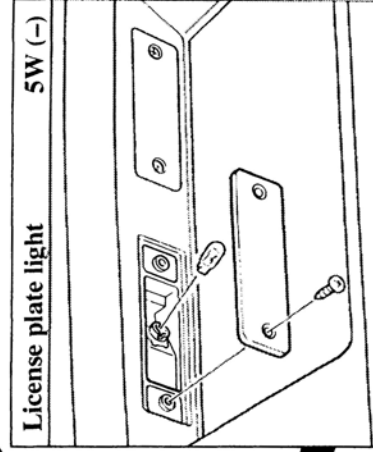
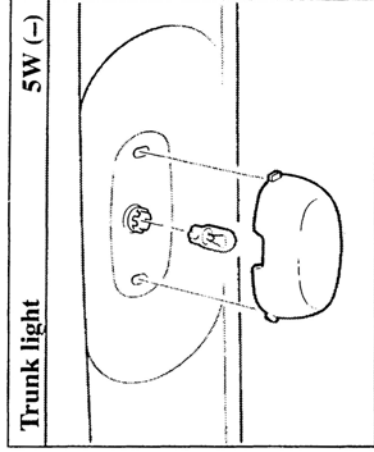
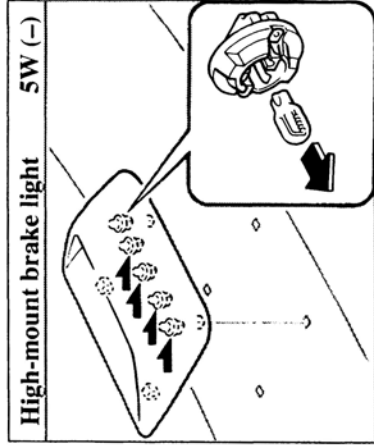
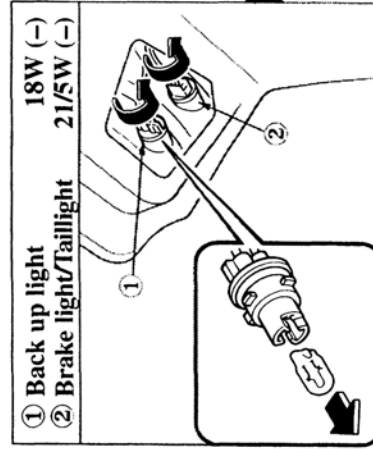
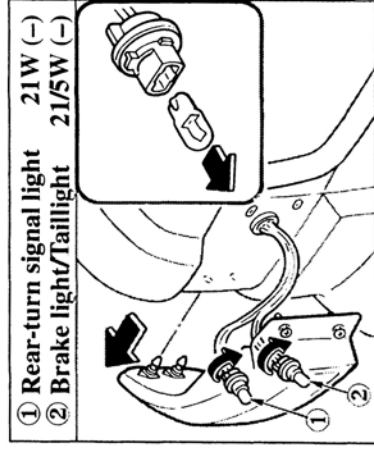

The number in ( ) shows the bulb number.

## Maintenance

### ■ Replacing a Bulb (Interior)

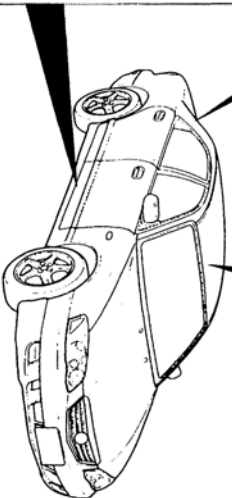
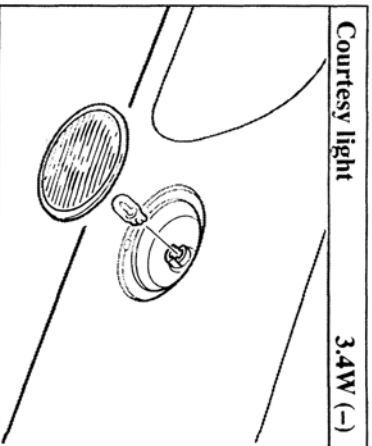
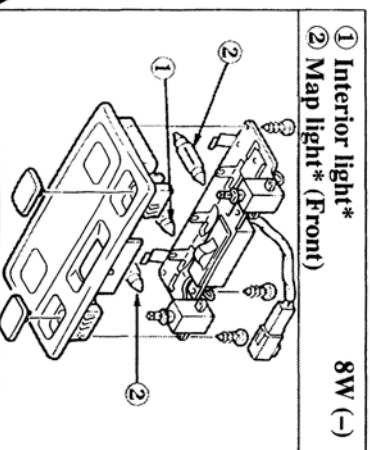
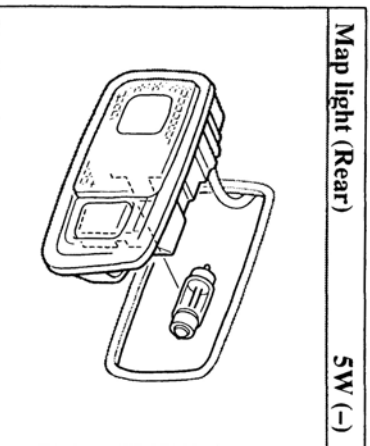

The number in ( ) shows the bulb number.

8-40

\* To replace the bulbs, contact an Authorized Mazda Dealer

# 9

## Customer Information

*Who to consult about a problem; what to do if your vehicle has a safety defect; what warranties protect your vehicle; driving outside the United States and Canada; adding equipment; tire quality grades: This is the kind of consumer information you'll find in Section 9*

Customer Assistance	9- 2
Mazda Importer/Distributors	9- 5
Warranties for Your Mazda	9- 6
Outside the United States and Canada	9- 6
Add-On Non-Genuine Parts and Accessories	9- 7
Uniform Tire Quality Grading System (UTQGS)	9- 8
Reporting Safety Defects	9- 9
Service Publications	9-11

**Customer Information**

**Customer Assistance (Except Puerto Rico)**

Your complete and permanent satisfaction is our business. We are here to serve you. All Authorized Mazda Dealers have the knowledge and the tools to keep your Mazda vehicle in top condition.

If you have any questions or recommendations for improvement regarding the service of your Mazda vehicle or servicing by Mazda Dealer personnel, we recommend that you take the following steps:

**STEP 1: Contact Your Mazda Dealer**

Discuss the matter with an Authorized Mazda Dealer. This is the quickest and best way to address the issue. If your concern has not been resolved by the CUSTOMER RELATIONS, SALES, SERVICE, or PARTS MANAGER, then please contact the GENERAL MANAGER of the dealership or the OWNER.

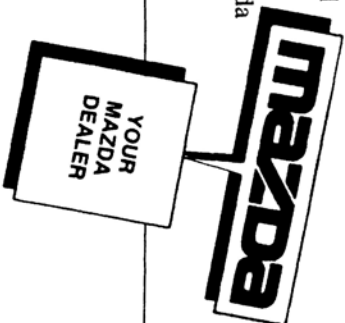

**STEP 2: Call the Mazda National Customer Assistance Center #800**

If for any reason you feel the need for further assistance after contacting your dealership management, call Mazda North American Operations' Customer Assistance Center toll-free at: **1 (800) 222-5500**

In order to serve you efficiently and effectively, please help us by providing the following information:

1. Your name, address, and telephone number
2. Year and model of vehicle
3. Vehicle Identification Number (17 digits, noted on your registration or title or located on the upper driver's side corner of the dash)
4. Purchase date and current mileage
5. Your dealer's name and location
6. Your question(s)





**Customer Information**

---

If you would like to write a letter, please address it to the following, Attn: Customer Assistance, which corresponds with your state:

<b>REGIONAL OFFICE</b>	<b>AREAS COVERED</b>
Mazda North American Operations 7755 Irvine Center Drive Irvine, CA 92618-2922 P.O. Box 19734 Irvine, CA 92623-9734	All states

This way, we can be sure to respond to you as efficiently as possible. That is our goal.

If you live outside the U.S.A., please contact your nearest Mazda Distributor.

## Customer Information

---

### Customer Assistance (Puerto Rico)

Your complete and permanent satisfaction is our business. That is why all Authorized Mazda Dealers have the knowledge and the tools to keep your Mazda vehicle in top condition.

If you have any questions or recommendations for improvement regarding the service of your Mazda vehicle or servicing by Mazda Dealer personnel, we recommend that you take the following steps:

#### **STEP 1**

Discuss the matter with an Authorized Mazda Dealer. This is the quickest and best way to address the issue. If your concern has not been resolved by the CUSTOMER RELATIONS, SALES, SERVICE, or PARTS MANAGER, then please contact the GENERAL MANAGER of the dealership or the OWNER.

#### **STEP 2**

If, after following STEP 1, you feel the need for further assistance, please contact your area's Mazda representative (Indicated on the next page).

Please help us by providing the following information:

1. Your name, address, and telephone number
2. Year and model of vehicle
3. Vehicle Identification Number (17 digits, noted on your registration or title or located on the upper driver's side corner of the dash)
4. Purchase date and current mileage
5. Your dealer's name and location
6. Your question(s)

**Mazda Importer/Distributors**

**U.S.A. (Importer/Distributor)**

**Mazda North American Operations**

7755 Irvine Center Drive  
Irvine, CA 92618-2922  
P.O. Box 19734  
Irvine, CA 92623-9734  
1 (800) 222-5500 (in U.S.A.)  
(949) 727-1990 (outside U.S.A.)

(Distributor in each area)

**CANADA**

**Mazda Canada Inc.**

305 Milner Avenue, Suite 400  
Scarborough, Ontario M1B 3V4 Canada  
TEL. 1 (800) 263-4680 (in Canada)  
(416) 609-9909 (outside Canada)

**PUERTO RICO**

**Plaza Motors Corp. (Mazda de Puerto Rico)**

P.O. Box 362722, San Juan, Puerto Rico 00936-2722  
TEL. (787) 788-9300

**GUAM**

**Triple J Motors**

157 South Marine Drive, Tamuning,  
GUAM 96911 USA  
P.O. Box 6066 Tamuning, Guam 96931  
TEL. (671) 649-6555

**SAIPAN**

**Pacific International Marianas, Inc.**

(d.b.a. Midway Motors)  
P.O. Box 887 Saipan, MP 96950  
TEL. (670) 234-7524

**AMERICAN SAMOA**

**Polynesia Motors, Inc.**

P.O. Box 1120, Pago Pago, American Samoa 96799  
TEL. (684) 699-9347

## Customer Information

### Warranties for Your Mazda

- New Vehicle Limited Warranty
- Safety Restraint System Limited Warranty
- Anti-perforation Limited Warranty
- Federal Emission Control Warranty
  - Emission Defect Warranty
  - Emission Performance Warranty
- California Emission Control Warranty (if applicable)
- Replacement Parts and Accessories Limited Warranty
- Tire Warranty

#### NOTE

Detailed warranty information is provided with your Mazda.

### Outside the United States and Canada

Government regulations in the United States require that automobiles meet specific emission regulations and safety standards. Therefore, vehicles built for use in the United States, its territories, and Canada may differ from those sold in other countries.

The differences may make it difficult or even impossible for your vehicle to receive satisfactory servicing in other countries. We strongly recommend that you NOT take your Mazda outside these areas.

You may have these problems if you do:

- Recommended fuel may be unavailable. Any kind of leaded fuel or low-octane fuel will affect vehicle performance and damage the emission controls and engine.
- Proper repair facilities, tools, testing equipment, and replacement parts may not be available.

The Mazda warranty applies only to Mazda vehicles registered and normally operated in the United States, its territories, and Canada.

### Add-On Non-Genuine Parts and Accessories

Non-genuine parts and accessories for Mazda vehicles can be found in stores. These may fit your vehicle, but they are not approved by the Mazda for use with Mazda vehicles. When you install non-genuine parts or accessories, they could affect your vehicle's performance or safety system; the Mazda warranty doesn't cover this. Before you install any non-genuine parts or accessories, consult an Authorized Mazda Dealer.

#### **WARNING**

Installation of Non-Genuine Parts or Accessories:  
*Installation of non-genuine parts or accessories is dangerous. Improperly designed parts or accessories could seriously affect your vehicle's performance or safety system. This could cause you to have an accident or increase your chances of injuries in an accident. Always consult an Authorized Mazda Dealer before you install non-genuine parts or accessories.*

#### **WARNING**

Add-On Electrical and Electronic Equipment:  
*Incorrectly choosing or installing improper add-on equipment or choosing an improper installer is dangerous. Essential systems could be damaged, causing engine stalling, air-bag (SRS) activation, ABS inactivation, or a fire in the vehicle. Be very careful in choosing and installing add-on electrical equipment, such as mobile telephones, two-way radios, stereo systems, and car alarm systems.*

Mazda assumes no responsibility for death, injury, or expenses that may result from the installation of add-on non-genuine parts or accessories.

## Customer Information

---

### Uniform Tire Quality Grading System (UTQGS)

This information relates to the tire grading system developed by the U.S. National Highway Traffic Safety Administration for grading tires by tread wear, traction, and temperature performance.

#### ■ Tread Wear

The tread wear grade is a comparative rating based on the wear rate of the tire when tested under controlled conditions on a specified government test course. For example, a tire graded 150 would wear one-and-a-half times as well on the government course as a tire graded 100.

The relative performance of tires depends upon the actual conditions of their use, however, and may depart significantly from the norm because of variations in driving habits, service practices and differences in road characteristics and climate.

#### ■ Traction—AA, A, B, C

The traction grades, from highest to lowest, are AA, A, B, and C. These

grades represent the tire's ability to stop on wet pavement as measured under controlled conditions on specified government test surfaces of asphalt and concrete. A tire marked C may have poor traction performance.

#### WARNING:

*The traction grade assigned to this tire is based on braking (straight ahead) traction tests and does not include acceleration cornering (turning), hydroplaning, or peak traction characteristics.*

#### ■ Temperature—A, B, C

The temperature grades are A (the highest), B, and C, represent the tire's resistance to the generation of heat and its ability to dissipate heat when tested under controlled conditions on a specified indoor laboratory test wheel. Sustained high temperature can cause the material of the tire to degenerate and reduce tire life, and excessive temperatures can lead to sudden tire failure.

Grade C corresponds to a level of performance which all passenger vehicle tires must meet under the Federal Motor Vehicle Safety Standard No. 109. Grades B and A represent higher levels of performance on the laboratory test wheel than the minimum required by law.

#### WARNING:

*The temperature grade for this tire is established for a tire that is properly inflated and not overloaded. Excessive speed, underinflation, or excessive loading, either separately or in combination, can cause heat buildup and possible tire failure.*

These grades will be added to the sidewalls of passenger vehicle tires over the next several years according to a schedule established by the NHTSA and the tire manufacturers.

The grade of tires available as standard or optional equipment on Mazda vehicle may vary with respect to grade.

ALL PASSENGER VEHICLE TIRES  
MUST CONFORM TO THESE  
GRADES AND TO ALL OTHER  
FEDERAL TIRE-SAFETY  
REQUIREMENTS.

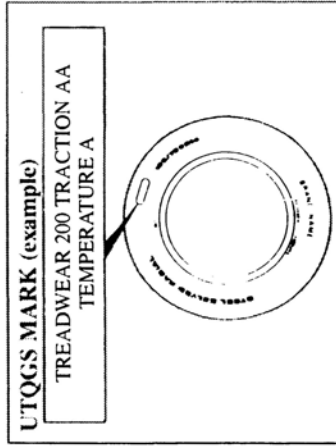

### Reporting Safety Defects

If you believe that your vehicle has a defect which could cause a crash or could cause injury or death, you should immediately inform the National Highway Traffic Safety Administration (NHTSA) in addition to notifying Mazda Motor Corporation (Your Mazda Importer/Distributor).

If NHTSA receives similar complaints, it may open an investigation, and if it finds that a safety defect exists in a group of vehicles, it may order a recall and remedy campaign. However, NHTSA cannot become involved in individual problems between you, your dealer, or Mazda Motor Corporation (Your Mazda Importer/Distributor).

### Uniform Tire Quality Grading

Quality grades can be found where applicable on the tire sidewall between tread shoulder and maximum section width. For example:

**Treadwear 200 Traction AA  
Temperature A**

## **Customer Information**

---

To contact NHTSA, you may either call the Auto Safety Hotline toll-free at 1 (800) 424-9393 (or 366-0123 in Washington, D.C. area) or write to: NHTSA, U.S. Department of Transportation, Washington, D.C. 20590. You can also obtain other information about motor vehicle safety from the Hotline.

(Note)

If you live in the U.S.A., all correspondence to Mazda Motor Corporation should be forwarded to:

Mazda North American Operations  
7755, Irvine Center Drive  
Irvine, California 92618-2922  
P.O. Box 19734  
Irvine, CA 92623-9734  
Customer Assistance Center  
or toll free at 1 (800) 222-5500

If you live outside of the U.S.A., please contact the nearest Mazda Distributor shown on page 9-5 in this booklet.



### Service Publications

Factory-authorized Mazda service publications are available for owners who wish to do some of their own maintenance and repair.

When requesting any of our publications through an Authorized Mazda Dealer, refer to the chart below.

If they don't have what you need in stock, they can order it for you.

PUBLICATION ORDER NUMBER	PUBLICATION DESCRIPTION
9999 95 058B 01	2001 WORKSHOP MANUAL (English)
9999 95 036G 01	2001 WIRING DIAGRAM (English)
9999 95 077C 01 (Except Puerto Rico)	2001 OWNER'S MANUAL

#### WORKSHOP MANUAL:

Covers recommended maintenance and repair procedures of the drive train, body and chassis.

#### WIRING DIAGRAM:

Provides electrical schematics as well as component location for the entire electrical system.

#### OWNER'S MANUAL:

This booklet contains information regarding the proper care and operation of your vehicle. This is not a technician's manual.



Lubricant Quality	10- 2
Dimensions	10- 2
Weights	10- 2
Engine	10- 3
Electrical System	10- 3
Capacities	10- 4
Air Conditioner	10- 4
Tires	10- 4
Light Bulbs	10- 5



**Specifications**

**Lubricant Quality**

Lubricant	Classification	
	API Service	ILSAC
Engine oil*1	SG (Energy Conserving II)	—
	SH (Energy Conserving II)	GF-1
	SJ	GF-II
Automatic transaxle fluid	ATF M-III or equivalent (e.g. Dexon® II)	
Power steering fluid	ATF M-III or equivalent (e.g. Dexon® II)	
Brake fluid	FMVSS116 DOT-3	

\*1 Refer to the recommended SAE viscosity numbers on page 8-12.

**Dimensions**

Overall length	4,860 (191.3), 4,870 (191.7)*	Unit: mm (in)
Overall width	1,770 (69.7)	
Overall height	1,395 (54.9)	
Front tread	1,520 (59.8)	
Rear tread	1,520 (59.8)	
Wheelbase	2,750 (108.3)	

\* With license plate holder

**Weights**

GVWR	1,985 (4,376)		Unit: kg (lb)
GAWR	Front	1,116 (2,460)	
	Rear	880 (1,940)	

GVWR: Gross Vehicle Weight Rating  
GAWR: Gross Axle Weight Rating

**Specifications**

Item	Model	2.5 liter V6 DOHC	Miller Cycle Engine V6 DOHC
Bore × Stroke		84.5 × 74.2 mm (3.33 × 2.92 in)	80.3 × 74.2 mm (3.16 × 2.92 in)
Displacement		2,496 mℓ (2,496 cc, 152.3 cu in)	2,254 mℓ (2,254 cc, 137.5 cu in)
Compression ratio		9.2	10.0

<b>Electrical System</b>			
Item	Model	2.5 liter V6 DOHC	Miller Cycle Engine V6 DOHC
Battery		Maintenance-free, 12V—48AH/5HR, 52AH/5HR (Cold areas)	Maintenance-free, 12V—52AH/5HR, 55AH/5HR (Cold areas)
Alternator		12V—110 A	12V—110 A
Starter		12V—1.6 kW	12V—2.0 kW
Spark- plug number	NGK	ZFR5F-11 ZFR6F-11	PZFR6F PZFR5F
	DENSO	—	PKJ20CR8 PKJ16CR8
	CHAMPION	—	RC8PMPA RC10PMPA
Spark-plug gap		1.0—1.1 mm (0.039—0.043 in)	0.7—0.8 mm (0.027—0.031 in)

**Specifications**

**Capacities (Approximate Quantities)**

Item	Unit		L	US qt	Imp qt
Engine oil	2.5 liter V6 DOHC	with oil filter replacement	4.0	4.2	3.5
		without oil filter replacement	3.7	3.9	3.3
	Miller Cycle Engine V6 DOHC	with oil filter replacement	4.1	4.3	3.6
		without oil filter replacement	3.8	4.0	3.4
Coolant			7.5	7.9	6.6
Automatic transaxle fluid	2.5 liter V6 DOHC		8.0	8.4	7.0
	Miller Cycle Engine V6 DOHC		7.4	7.8	6.5
Fuel tank		L		US gal	Imp gal
			68	18.0	15.0

Check oil and fluid levels with dipsticks or reservoir gauges.

**Air Conditioner**

Gas complies with SAE J639	R-134a
Maximum operating charge	0.8 kg (28.2 oz)

**Tires**

■ Standard tire

Tire size	Inflation pressure kPa (kgf/cm <sup>2</sup> , psi or lb/po <sup>2</sup> )		
	Front	Rear	
2.5 liter V6 DOHC	P215/55 R16 91V	220 (2.2, 32)	200 (2.0, 29)
Miller Cycle Engine V6 DOHC	215/50 R17 91V	230 (2.3, 34)	210 (2.1, 31)
	P215/55 R16 91V	220 (2.2, 32)	200 (2.0, 29)

■ Temporary spare tire

Tire size	Inflation pressure kPa (psi)
T135/70 D16	420 (60)

Fuses ..... Refer to page 6-9

**Light Bulbs**

Light bulb	Wattage	Bulb trade number
Headlights	High beam (HB3)	9005
	Low beam (HB4)	9006
Front-turn signal lights	27	1156NA
Parking lights	5	—
Fog lights	55	(H3)
Side marker lights	3.8	194
High-mount brake lights	5	—
Rear-turn signal lights	21	—
Brake lights/Taillights	21/5	—
Back up lights	18	—
License plate lights	5	—
Trunk light	5	—
Interior lights	8	—
Map light	Front	—
	Rear	—
Courtesy lights	3.4	—







## Index

A	Page	B	Page	C	Page
Accessory Socket	5-42	Battery	8-29	Capacities	10-4
Add-On Non-Genuine Parts and Accessories	9-7	Charging system warning light	5-30	Cassette Tape Player	5-64
Air Bag Restraint System	2-25	Jump-starting	6-4	Center Console	5-47
Supplemental Restraint System	2-25	Before Driving		Chains	4-10
Warning light	5-33	After getting in	4-6	Changing a Flat Tire	6-16
Air-Conditioning System	5-50	Before getting in	4-6	Changing Coolant	8-16
Aluminum Wheel Maintenance	7-8	Body Lubrication	8-24	Changing the Oil	8-13
Antenna	5-92	Brakes		Charging System Warning Light	5-30
Antilock Brake System (ABS)	5-16	Antilock brake system (ABS)	5-16	Check Engine Light	5-31
Warning light	5-32	Fluid level	8-19	Checking	
Ashtray	5-45	Foot brake	5-13	Automatic transaxle fluid level	8-21
Audio System	5-64	Pad wear indicator	5-14	Brake fluid level	8-19
Automatic Transaxle		Parking brake	5-15	Coolant level	8-15
Driving tips	5-7	System warning light	5-28	Engine oil level	8-13
Fluid level	8-21	Break-In Period	4-6	Power steering fluid level	8-20
Hold mode	5-8	Bright-Metal Maintenance	7-7	Washer fluid level	8-24
Shift-lock override	5-10	Bulb Replacement		Child Restraint, Precautions	2-16
Shift-lock system	5-9	Front	8-38	Child Safety Lock for Rear Door	3-7
Transaxle ranges	5-6	Headlight	8-35	Child-Restraint Systems	2-18
Auto-Tilt Steering Column	3-23	Interior	8-40	Installing	2-19
		Rear	8-39	Cigarette Lighter	5-42
				Cleaning	
				Dashboard	7-9
				Lap/shoulder belt webbing	7-10
				Upholstery and interior trim	7-9

	Page		Page		Page
Window interiors	7-10	<b>D</b>		<b>E</b>	
Climate Control System	5-50	Dashboard Illumination		Emergency Starting	5-27
Clock	5-41	Dashboard Overview		Jump-starting	1-3
Coin Box	5-47	Dashboard Precautions		Push-starting	7-9
Compact Disc Changer	5-64	Day/Night Mirror		Emission Control System	4-3
Compact Disc Player	5-64	Defroster		Engine Compartment Overview	8-10
Coolant, Engine		8-15 Outside mirrors		Engine Coolant	
Adding	8-15	8-16 Rear window		Adding coolant	8-15
Changing	8-16	8-15 Door Locks		Changing coolant	8-16
Inspecting		3-32 Inside door lock		Inspecting coolant level	8-15
Courtesy Lights	5-17	5-17 Outside door lock		Overheating	6-2
Cruise Control		5-48 Door-Ajar Warning Light		Engine Exhaust Gas	
Cup Holder	9-4	9-4 Doors		(Carbon Monoxide)	
Customer Assistance		9-1 Driving in Flooded Areas		Engine Oil	4-4
Customer Information				Changing engine oil and filter	8-13
				Inspecting engine oil level	8-13
				Recommended oil	8-12
				Engine Oil Pressure Warning Light	5-30
				Engine Starting	5-3
				Exhaust (Carbon Monoxide)	4-4
				Exterior Care	7-4

## Index

	Page		Page		Page
<b>F</b>		<b>Fuses</b>	6-6	<b>H</b>	
Finish Damage	7-7	Fuse panel description	6-9	Halogen Bulb	8-35
Flasher, Hazard Warning	6-2	Replacement	6-6	Hazard Warning Flasher	6-2
Flat Tire	6-15			Hazardous Driving	4-8
Fluids				Headlight Bulb Replacement	8-35
Automatic transaxle	8-21	<b>G</b>		Headlights	5-35
Brake	8-19	Gauges		High-beam indicator light	5-34
Power steering	8-20	Fuel	5-26	Hold Mode	5-8
Washer	8-24	Odometer and trip meter	5-24	Indicator light	5-34
Fog Lights, Front	5-37	Speedometer	5-24	Hood Release	3-18
Foot Brake	5-13	Tachometer	5-27	Horn	3-24
Front Fog Lights	5-37	Water temperature	5-26	How to Minimize Environmental Paint Damage	7-2
Front Seat Belts	2-10	Glove Box	5-46	Damage caused by bird droppings, insects, or tree sap	7-2
Front Seats				Etching caused by acid rain or industrial fallout	7-2
Head restraint	2-4			Paint chipping	7-3
Height adjustment	2-3			Water marks	7-3
Lumber support adjustment	2-4				
Recline	2-3				
Seat-bottom front height adjustment	2-2				
Seat-bottom rear height adjustment	2-3				
Slide	2-2				
Front-Door Storage Compartments	5-47				
Fuel Gauge	5-26				
Fuel Requirements	4-2				
Fuel-Filler Cap	3-22				
Fuel-Filler Lid	3-22				

	Page		Page		Page
<b>I</b>					
Ignition Key Reminder	5-33	<b>J</b>		On reminder	5-33
Ignition Switch Positions	5-2	Jack and Lug Wrench	6-15	Low Fuel Warning Light	5-31
In Case of Emergency	6-1	Jump-Starting	6-4	Low Washer Fluid Level Warning	
Indicator Lights				Light	5-32
Cruise set	5-34	<b>K</b>		Lug Wrench	6-15
Headlight high-beam	5-34	Keyless Entry System	3-8	Luggage Compartment	1-6
Hold	5-34	Maintenance	3-10		
Light-on	5-34	Transmitter	3-8	<b>M</b>	
Traction control system (TCS) OFF	5-34	Keys	3-2	Maintaining the Air Filter	8-25
Inspecting				Maintaining the Finish	7-4
Automatic transaxle fluid level	8-21	<b>L</b>		Maintaining Wiper Blades	8-26
Brake fluid level	8-19	Label Information	4-12	Maintenance	8-1
Coolant level	8-15	Lane-Change Signals	5-36	Introduction	8-2
Engine oil level	8-13	Light		Owner	8-8
Power steering fluid level	8-20	Courtesy	3-32	Scheduled	8-3
Washer fluid level	8-24	Interior	3-30	Map Lights	3-31
Instrument Cluster	5-23	Map	3-31	Mirrors	
Interior Care	7-9	Trunk	3-31	Defroster	3-26
Interior Light	3-30	Lighter	5-42	Outside mirrors	3-24
Interior Overview	1-2	Light-on Indicator Light	5-34	Rearview mirror (day/night)	3-26
		Lights		Vanity	5-50
		Front fog	5-37	Money-Saving Suggestions	4-7
		Headlights	5-35		

## Index

---

<b>O</b>		<b>P</b>		<b>R</b>	
	Page		Page		Page
Odometer and Trip Meter	5-24	Paint Damage	7-2	Radio	5-64
Outside Mirrors	3-24	Damage caused by bird droppings, insects, or tree sap	7-2	Reception	5-60
Outside the United States and Canada	9-6	Etching caused by acid rain or industrial fallout	7-2	Rear Door Child Safety Lock	3-7
Overheating	6-2	Water marks	7-2	Rear Seat	2-6
Overloading	4-12	Parking Brake	7-3	Armrest	2-7
Owner Maintenance		Power Control Mirror	5-15	Head restraint	2-6
Precautions	8-9	Power Door Locks	3-25	Rear Seat Belts	2-12
Schedule	8-8	Power Steering	3-6	Rear Window Defroster	5-40
		Power Steering Fluid Level	5-17	Rear-Window Defroster	5-48
		Power Windows	8-20	Rearview Mirror (Day/Night)	3-26
		Driver's door	3-12	Repairing Damage to the Finish	7-7
		Lock switch	3-13	Replacing	
		Passenger-Door	3-14	Bulb (rear)	8-39
		Pregnant Women	2-16	Bulb (front, interior)	8-38
		Push-Starting	6-6	Headlight bulb	8-35
				Tire	8-33
				Wheel	8-35
				Windshield wiper blades	8-27
				Rocking the Vehicle	4-8

	Page	Page	Page
<b>S</b>			
Safety Certification		10-1	2-32
Scheduled Maintenance	5-62	10-4	2-27
Seat Belt	8-3	10-4	Front air bag activation
Extender	2-15	10-2	How the air bags work
Front	2-10	10-3	Limitations to side air bag activation
Pregnant women	2-16	10-3	Maintenance
Rear	2-12	10-5	Non-activation of side air-bags
System	2-7	10-2	Side air-bag activation
Warning light/beep	5-29	10-4	System description
Seat Warmer	2-5	10-2	Warning light
Seats			
Head restraint	2-4	5-24	
Height adjustment	2-2, 2-3	5-3	
Lumber support adjustment	2-4		
Recline	2-3		
Slide	2-2		
Service Publications	9-11		
Snow Tires	4-10		
Socket	5-42		
Spare Tire	6-20, 8-34		
Special Driving Conditions			
Driving in flooded areas	4-11		
Hazardous driving	4-8		
Rocking the vehicle	4-8		
Winter driving	4-9		
Specifications			
Air conditioner		10-1	
Capacities		10-4	
Dimensions		10-4	
Electrical system		10-2	
Engine		10-3	
Light bulbs		10-3	
Lubricant quality		10-5	
Tires		10-2	
Weights		10-4	
Speedometer		10-2	
Starting the Engine		5-24	
Steering Wheel		5-3	
Audio system operation		5-92	
Auto-tilt steering column		3-23	
Horn		3-24	
Storage Compartments		5-46	
Sunroof			
Operation		3-28	
Sunshade		3-29	
Sunvisors		5-50	
Supplemental Restraint System			
Limitations to front air bag activation		2-33	
Non-activation of front air bags		2-34	
Supplemental Restraint System			
Constant monitoring		2-38	
Tachometer			5-27
Temporary Spare Tire			8-34
Theft-Deterrent System			3-19
How to arm the system			3-20
Labels			3-21
Operation			3-19
To stop an alarm			3-21
To turn off an armed system			3-20
Tires			
Chains			4-10
Flat tire			6-15
Inflation pressure			8-31
Replacement			8-33
Rotation			8-32

