

Table of contents

Introduction	2
Instrumentation	6
Controls and features	15
Starting	22
Driving	27
Roadside emergencies	39
Maintenance and care	57
Capacities and specifications	93
Customer Assistance	98
Reporting Safety Defects	99
Index	100

All rights reserved. Reproduction by any means, electronic or mechanical including photocopying, recording or by any information storage and retrieval system or translation in whole or part is not permitted without written authorization from Ford Motor Company. Ford may change the contents without notice and without incurring obligation.

Copyright © 2000 Ford Motor Company

Introduction

The following warning may be required by California law:

CALIFORNIA Proposition 65 Warning

 **WARNING:** Engine exhaust, some of its constituents, and certain vehicle components contain or emit chemicals known to the State of California to cause cancer and birth defects or other reproductive harm. In addition, certain fluids contained in vehicles and certain products of component wear contain or emit chemicals known to the State of California to cause cancer and birth defects or other reproductive harm.

ICONS

Indicates a safety alert. Read the following section on *Warnings*.



Indicates vehicle information related to recycling and other environmental concerns will follow.



Correct vehicle usage and the authorized disposal of waste cleaning and lubrication materials are significant steps towards protecting the environment.

Indicates a message regarding child safety restraints. Refer to *Seating and safety restraints* for more information.



Indicates that this Owner Guide contains information on this subject. Please refer to the Index to locate the appropriate section which will provide you more information.



Introduction

WARNINGS

Warnings provide information which may reduce the risk of personal injury and prevent possible damage to others, your vehicle and its equipment.

BREAKING-IN YOUR VEHICLE

There are no particular breaking-in rules for your vehicle. During the first 1 600 km (1 000 miles) of driving, vary speeds frequently. This is necessary to give the moving parts a chance to break in.

INFORMATION ABOUT THIS GUIDE

The information found in this guide was in effect at the time of printing. Ford may change the contents without notice and without incurring obligation.

SPECIAL NOTICES

Notice to owners of Class A Motorhome Vehicles



















The Ford Motorhome Chassis is not suitable for producing ambulances or school buses. In addition, Ford urges manufacturers to follow the recommendations of the "Ford Incomplete Vehicle Manual," the "Ford Truck Body Builder's Layout Book," and other pertinent supplements.

Notification of delayed warranty start date and accumulated mileage

















Verify that your recreational vehicle dealer has submitted a Notification of Delayed Warranty Start Date and Accumulated Mileage (FCS 900) to Ford Motor Company.

Introduction

These are some of the symbols you may see on your vehicle.

Safety Alert		See Owner's Guide	
Fasten Safety Belt		Air Bag-Front	
Air Bag-Side		Child Seat	
Child Seat Installation Warning		Child Seat Tether Anchorage	
Brake System		Anti-Lock Brake System	
Brake Fluid - Non-Petroleum Based		Traction Control	
Master Lighting Switch		Hazard Warning Flasher	
Fog Lamps-Front		Fuse Compartment	
Fuel Pump Reset		Windshield Wash/Wipe	
Windshield Defrost/Demist		Rear Window Defrost/Demist	
Power Windows Front/Rear		Power Window Lockout	
Child Safety Door Lock/Unlock		Interior Luggage Compartment Release Symbol	

Introduction

Panic Alarm		Engine Oil	
Engine Coolant		Engine Coolant Temperature	
Do Not Open When Hot		Battery	
Avoid Smoking, Flames, or Sparks		Battery Acid	
Explosive Gas		Fan Warning	
Power Steering Fluid		Maintain Correct Fluid Level	
Emission System		Engine Air Filter	
Passenger Compartment Air Filter		Jack	
Check fuel cap			

Instrumentation

WARNING LIGHTS AND CHIMES

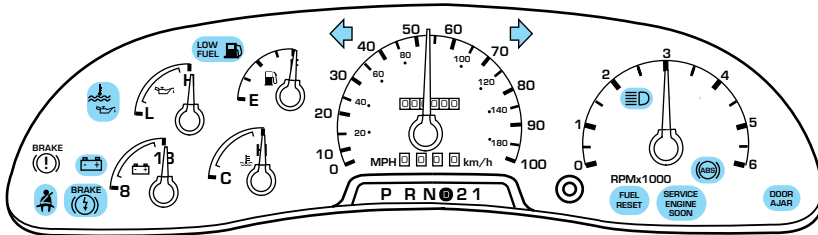

Low fuel

Illuminates as an early reminder of a low fuel condition indicated on the fuel gauge (refer to *Fuel Gauge* in this chapter for more information).



When refueling, after the light comes on, the amount of fuel that is added will be less than the advertised capacity since there is fuel still in the tank. The ignition must be in the ON position for this lamp to illuminate. The lamp will also illuminate for several seconds after the ignition is turned to the ON position regardless of the fuel level to ensure your bulb is working.

Oil pressure/Engine coolant

This light will come on when the key is in the ON position and the:

- engine coolant temperature is very high
- engine oil pressure is low

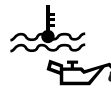

The light serves as a notice that a system needs your attention and to check the engine coolant temperature gauge and the engine oil pressure gauge.

Refer to *Engine coolant temperature gauge* and *Engine oil pressure gauge* in this chapter for more information.

Instrumentation

Charging system

Illuminates when the ignition is turned to the ON position and the engine is off. The light also illuminates when the battery is not charging properly, requiring electrical system service.



Brake system warning

Momentarily illuminates when the ignition is turned to the ON position to ensure the circuit is functional. Also illuminates if the parking brake is engaged. If the brake warning lamp does not illuminate at these times, seek service immediately. Illumination after releasing the parking brake indicates low brake fluid level and the brake system should be inspected immediately.



Safety belt

Momentarily illuminates when the ignition is turned ON to remind you to fasten your safety belts.



Brake reserve system warning (if equipped)

Illuminates to indicate normal Hydromax booster reserve system activation when the engine is OFF and the service brake pedal is applied, or when the ignition is in the ON or START position.



This light may also illuminate momentarily if the engine is running and the driver turns the steering wheel fully in one direction while braking.

If the light remains on while the engine is running, this indicates inadequate hydraulic booster pressure or reserve pump system failure. Safely stop the vehicle as soon as possible and seek service immediately.

Instrumentation

Service engine soon

Your vehicle is equipped with a computer that monitors the engine's emission control system. This system is commonly known as the On Board Diagnostics System (OBD). This OBD system protects the environment by ensuring that your vehicle continues to meet government emission standards. The OBD system also assists the service technician in properly servicing your vehicle.



The *Service Engine Soon* indicator light illuminates when the ignition is first turned to the ON position to check the bulb. If it comes on after the engine is started, one of the engine's emission control systems may be malfunctioning. The light may illuminate without a driveability concern being noted. The vehicle will usually be drivable and will not require towing.

What you should do if the Service Engine Soon light illuminates Light turns on solid:

This means that the OBD system has detected a malfunction.

Temporary malfunctions may cause your *Service Engine Soon* light to illuminate. Examples are:

1. The vehicle has run out of fuel. (The engine may misfire or run poorly.)
2. Poor fuel quality or water in the fuel.
3. The fuel cap may not have been properly installed and securely tightened.

These temporary malfunctions can be corrected by filling the fuel tank with high quality fuel of the recommended octane and/or properly installing and securely tightening the gas cap. After three driving cycles without these or any other temporary malfunctions present, the *Service Engine Soon* light should turn off. (A driving cycle consists of a cold engine startup followed by mixed city/highway driving.) No additional vehicle service is required.

If the *Service Engine Soon* light remains on, have your vehicle serviced at the first available opportunity.

Instrumentation

Light is blinking:

Engine misfire is occurring which could damage your catalytic converter. You should drive in a moderate fashion (avoid heavy acceleration and deceleration) and have your vehicle serviced at the first available opportunity.



Under engine misfire conditions, excessive exhaust temperatures could damage the catalytic converter, the fuel system, interior floor coverings or other vehicle components, possibly causing a fire.

The Transmission Control Indicator Light (TCIL), which is located on the gearshift lever (the word OFF), may flash steadily if a transmission malfunction has been detected. It

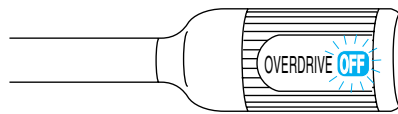

the TCIL is flashing, contact your Ford dealer as soon as possible. If this condition persists, damage to the transmission may occur.

Anti-lock brake system (ABS) (if equipped)

Momentarily illuminates when the ignition is turned to the ON position to ensure the circuit is functional. If the light remains on after the vehicle is started, continues to flash



or fails to illuminate, have the system serviced immediately. With the ABS light on, the anti-lock brake system is disabled and normal braking is still effective unless the brake warning light also remains illuminated.

Door ajar (if equipped)

Illuminates when the ignition switch is in the ON or START position and any door is open.



Instrumentation

Fuel reset

Illuminates when the ignition is turned to the ON position and the fuel pump shut-off switch has been triggered. For more information, refer to *Fuel pump shut-off switch* in the *Roadside emergencies* chapter.

**FUEL
RESET**

High beams

Illuminates when the high beam headlamps are turned on.



Turn signal

Illuminates when the left or right turn signal or the hazard lights are turned on. Refer to *Bulbs* in the *Maintenance and care* chapter.



Safety belt warning chime (if equipped)

Sounds to remind you to fasten your safety belts.

Key-in-ignition warning chime (if equipped)

Sounds when the key is left in the ignition in the OFF/LOCK or ACC position and the driver's door is opened.

Headlamps on warning chime (if equipped)

Sounds when the headlamps or parking lamps are on, the ignition is off (and the key is not in the ignition) and the driver's door is opened.

Instrumentation

GAUGES

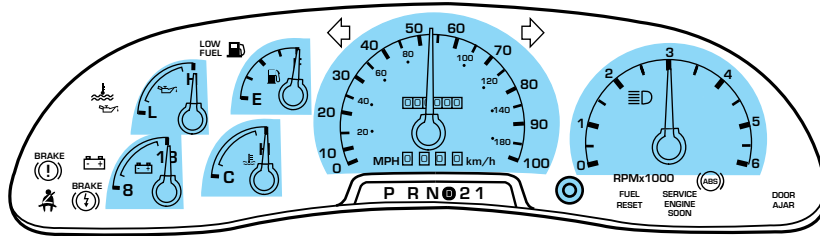

Fuel gauge

Displays approximately how much fuel is in the fuel tank (when the key is in the ON position). The ignition should be in the OFF position while the vehicle is being refueled. When the gauge first indicates empty, there is a small amount of reserve fuel in the tank. When refueling the vehicle from empty indication, the amount of fuel that can be added will be less than the advertised capacity due to the reserve fuel.

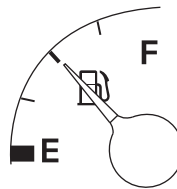

Engine oil pressure gauge

This shows the engine oil pressure in the system. Sufficient pressure exists as long as the needle remains in the normal range (the area between the "L" and "H").

If the gauge indicates low pressure, stop the vehicle as soon as safely possible and switch off the engine immediately. Check the oil level. Add oil if needed (refer to *Engine oil* in the *Maintenance and care* chapter). If the oil level is correct, have your vehicle checked at your dealership or by a qualified technician.

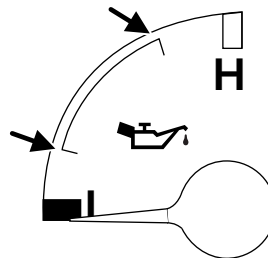

Instrumentation

Battery voltage gauge

This shows the battery voltage when the ignition is in the ON position. If the pointer moves and stays outside the normal operating range (as indicated), have the vehicle's electrical system checked as soon as possible.

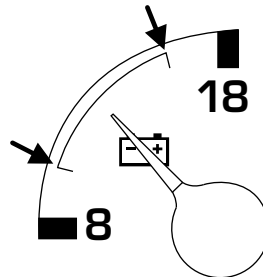

Engine coolant temperature gauge

Indicates the temperature of the engine coolant. At normal operating temperature, the needle remains within the normal area (the area between the "H" and "C"). If it enters the red section, the engine is overheating. Stop the vehicle as soon as safely possible, switch off the engine immediately and let the engine cool. Refer to *Engine coolant* in the *Maintenance and care* chapter.

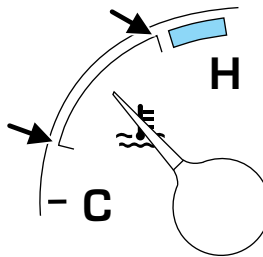

Never remove the coolant reservoir cap while the engine is running or hot.

This gauge indicates the temperature of the engine coolant, not the coolant level. If the coolant is not at its proper level the gauge indication will not be accurate.

Instrumentation

Speedometer

Indicates the current vehicle speed.

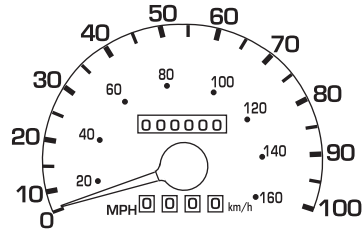

Odometer

Registers the total kilometers (miles) of the vehicle.

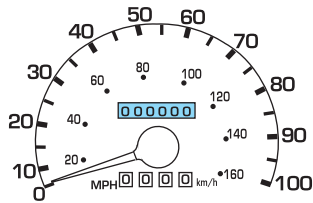

Trip odometer

Registers the kilometers (miles) of individual journeys. To reset, depress the control.

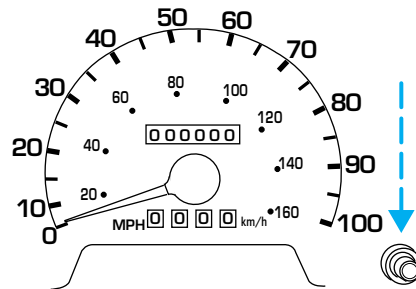

Instrumentation

Tachometer

Indicates the engine speed in revolutions per minute.

Driving with your tachometer pointer continuously at the top of the scale may damage the engine.

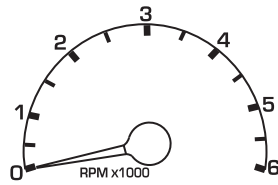

Controls and features

HEADLAMP CONTROL ☼

Rotate the headlamp control to the first position to turn on the parking lamps. Rotate to the second position to also turn on the headlamps.

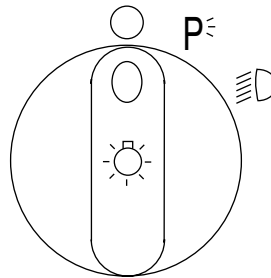

Daytime running lamps (DRL) (if equipped)

The daytime running light system turns the headlamps on, with a reduced light output, when:

- the vehicle is running and
- the headlamp system is in the OFF position or parking lamp position.

 Always remember to turn on your headlamps at dusk or during inclement weather. The Daytime Running Light (DRL) System does not activate your tail lamps and generally may not provide adequate lighting during these conditions. Failure to activate your headlamps under these conditions may result in a collision.

High beams ≡D

Push forward to activate.

Pull toward you to deactivate.

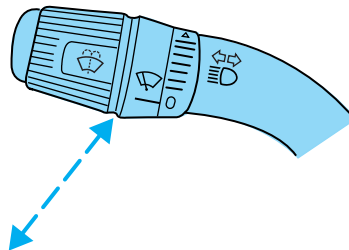

Controls and features

Flash to pass

Pull toward you to activate and release to deactivate.

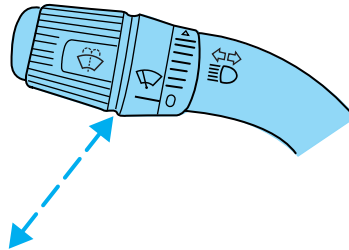

PANEL DIMMER CONTROL

Use to adjust the brightness of the instrument panel during headlamp and parklamp operation.

- Rotate up to brighten.
- Rotate down to dim.
- Rotate to full up position (past detent) to turn on interior lamps.

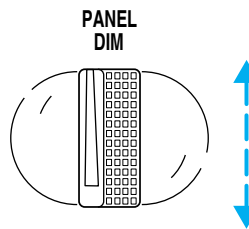

POSITIONS OF THE IGNITION

1. ACCESSORY, allows the electrical accessories such as the radio to operate while the engine is not running.

2. LOCK, locks the automatic transmission gearshift lever and allows key removal.

3. OFF, shuts off the engine and all accessories without locking the steering wheel.

4. ON, all electrical circuits operational. Warning lights illuminated. Key position when driving.

5. START, cranks the engine. Release the key as soon as the engine starts.

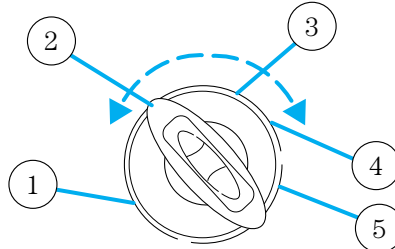

Controls and features

SPEED CONTROL

To turn speed control on

- Press ON.

Vehicle speed cannot be controlled until the vehicle is traveling at or above 48 km/h (30 mph).

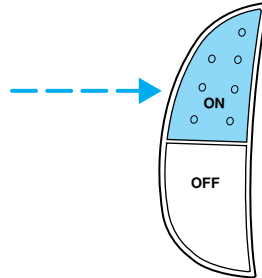

Do not use the speed control in heavy traffic or on roads that are winding, slippery, or unpaved.



Do not shift the gearshift lever into N (Neutral) with the speed control on.

To turn speed control off

- Press OFF or
- Turn off the vehicle ignition.

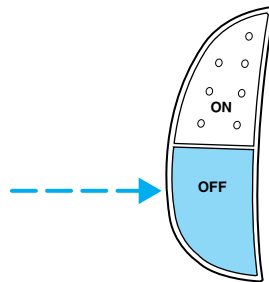

Once speed control is switched off, the previously programmed set speed will be erased.

Controls and features

To set a speed

- Press SET ACCEL. For speed control to operate, the speed control must be ON and the vehicle speed must be greater than 48 km/h (30 mph).

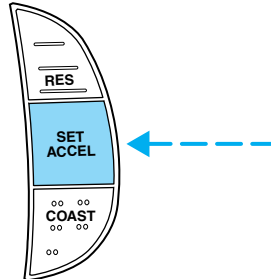

If you drive up or down a steep hill, your vehicle speed may vary momentarily slower or faster than the set speed. This is normal.

Speed control cannot reduce the vehicle speed if it increases above the set speed on a downhill. If your vehicle speed is faster than the set speed while driving on a downhill, you may want to shift to the next lower gear or apply the brakes to reduce your vehicle speed.

If your vehicle slows down more than 16 km/h (10 mph) below your set speed on an uphill, your speed control will disengage. This is normal. Pressing RES will re-engage it.



Do not use the speed control in heavy traffic or on roads that are winding, slippery, or unpaved.

To set a higher set speed

- Press and hold SET ACCEL. Release the control when the desired vehicle speed is reached or
- Press and release SET ACCEL to operate the Tap-Up function. Each press will increase the set speed by 1.6 km/h (1 mph) or
- Accelerate with your accelerator pedal. When the desired vehicle speed is reached, press and release SET ACCEL.

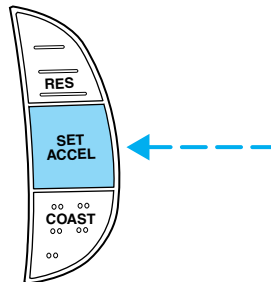

Controls and features

You can accelerate with the accelerator pedal at any time during speed control usage. Releasing the accelerator pedal will return your vehicle to the previously programmed set speed.

To set a lower set speed

- Press and hold COAST. Release the control when the desired speed is reached or
- Press and release COAST to operate the Tap-Down function. Each press will decrease the set speed by 1.6 km/h (1 mph) or

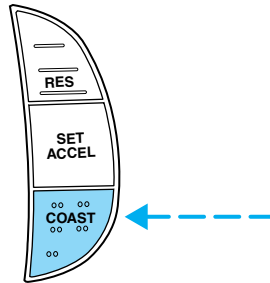

- Depress the brake pedal. When the desired vehicle speed is reached, press SET ACCEL.

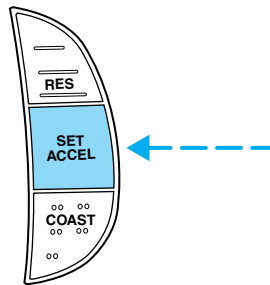

To disengage speed control

- Depress the brake pedal.

Disengaging the speed control will not erase the previously programmed set speed.

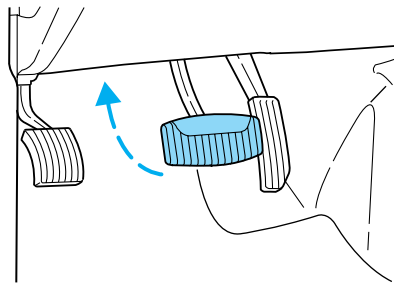

Controls and features

Pressing OFF will erase the previously programmed set speed.

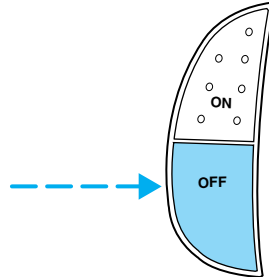

To return to a previously set speed

- Press RES. For RES to operate, the vehicle speed must be faster than 48 km/h (30 mph).

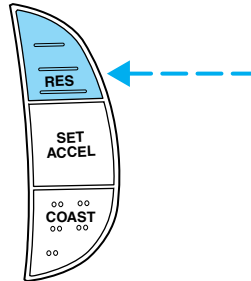

HAZARD FLASHER

For information on the hazard flasher control, refer to *Hazard flasher* in the *Roadside emergencies* chapter.

WINDSHIELD WIPER/WASHER CONTROLS

Rotate the windshield wiper control to the desired interval, low or high speed position.

The bars of varying length are for intermittent wipers. When in this position rotate the control upward for fast intervals and downward for slow intervals.

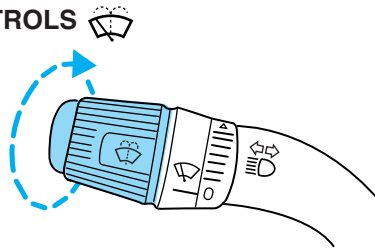

Controls and features

Push the control on the end of the stalk to activate washer. Push and hold for a longer wash cycle. The washer will automatically shut off after ten seconds of continuous use.

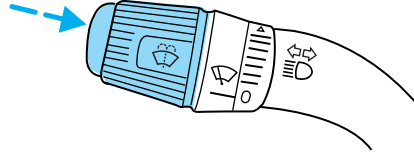

OVERDRIVE CONTROL

Activating overdrive

D (Overdrive) is the normal drive position for the best fuel economy.

The overdrive function allows automatic upshifts to second, third and fourth gear.



Deactivating overdrive

Press the Transmission Control Switch (TCS) located on the end of the gearshift lever. The Transmission Control Indicator Light (TCIL) (the word OFF) will illuminate on the end of the gearshift lever.

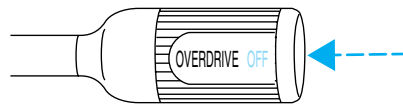

The transmission will operate in all gears except overdrive. To return to normal overdrive mode, press the Transmission Control Switch again. The TCIL (the word OFF) will no longer be illuminated.

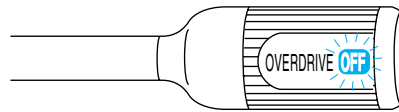

When you shut off and re-start your vehicle, the transmission will automatically return to normal **D** (Overdrive) mode.

For additional information about the gearshift lever and the transmission control switch operation refer to the *Automatic Transmission Operation* section of the *Driving* chapter.

Starting

PREPARING TO START YOUR VEHICLE

Engine starting is controlled by the powertrain control system. This system meets all Canadian Interference-Causing Equipment standard requirements regulating the impulse electrical field strength of radio noise.

When starting a fuel-injected engine, avoid pressing the accelerator before or during starting. Only use the accelerator when you have difficulty starting the engine. For more information on starting the vehicle, refer to *Starting the engine* in this chapter.



Extended idling at high engine speeds can produce very high temperatures in the engine and exhaust system, creating the risk of fire or other damage.



Do not park, idle, or drive your vehicle in dry grass or other dry ground cover. The emission system heats up the engine compartment and exhaust system, which can start a fire.



Do not start your vehicle in a closed garage or in other enclosed areas. Exhaust fumes can be toxic. Always open the garage door before you start the engine. See *Guarding against exhaust fumes* in this chapter for more instructions.



If you smell exhaust fumes inside your vehicle, have your dealer inspect your vehicle immediately. Do not drive if you smell exhaust fumes.

Starting

Important safety precautions

A computer system controls the engine's idle revolutions per minute (RPM). When the engine starts, the idle RPM runs faster to warm the engine. If the engine idle speed does not slow down automatically, have the vehicle checked. Do not allow the vehicle to idle for more than 10 minutes.

Before starting the vehicle:

1. Make sure all vehicle occupants have buckled their safety belts.
2. Make sure the headlamps and vehicle accessories are off.
3. Make sure the parking brake is set.

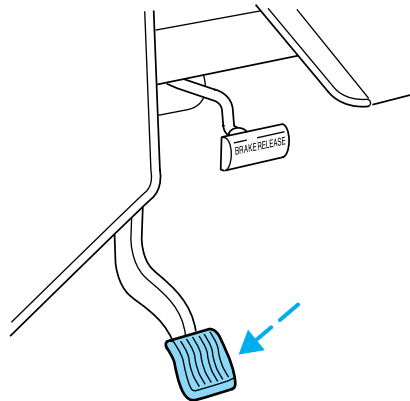

4. Make sure the gearshift is in P (Park).



5. Turn the key to 4 (ON) without turning the key to 5 (START).

If there is difficulty in turning the key, firmly rotate the steering wheel left and right until the key turns freely. This condition may occur when:

- front wheels are turned
- front wheel is against the curb

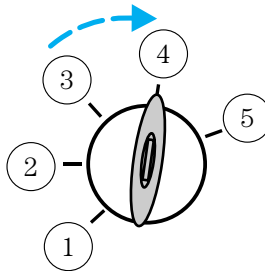

Starting

- steering wheel is turned when getting in or out of the vehicle

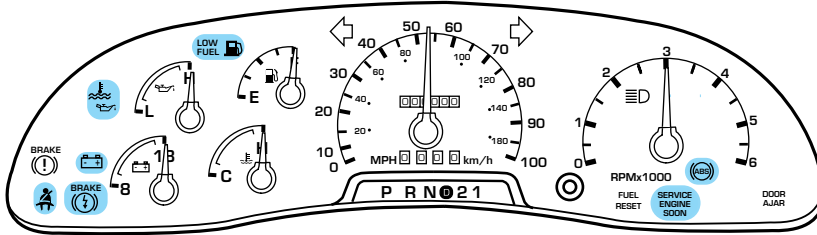

Make sure the corresponding lights illuminate briefly. If a light fails to illuminate, have the vehicle serviced.

- If the driver's safety belt is fastened, the  light may not illuminate.

STARTING THE ENGINE

1. Turn the key to 5 (START) without pressing the accelerator pedal and release as soon as the engine starts. The key will return to 4 (ON).

2. If the temperature is above -12°C (10°F) and the engine does not start within five seconds on the first try, turn the key to OFF, wait 10 seconds and try again.

3. If the temperature is below -12°C (10°F) and the engine does not start in 15 seconds on the first try, turn the key OFF and wait 10 seconds and try again. If the engine does not start in two attempts, press the accelerator pedal all the way to floor and hold. Turn the key to START position.

4. When the engine starts, release the key, then release the accelerator pedal gradually as the engine speeds up.

5. After idling for a few seconds, apply the brake and release the parking brake.

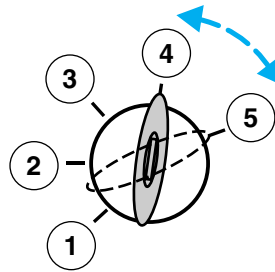

Starting

Using the engine block heater (if equipped)

An engine block heater warms the engine coolant, which improves starting, warms up the engine faster and allows the heater-defroster system to respond quickly. Use of an engine block heater is strongly recommended if you live in a region where temperatures reach -23°C (-10°F) or below.

For best results, plug the heater in at least three hours before starting the vehicle. Using the heater for longer than three hours will not harm the engine, so the heater can be plugged in the night before starting the vehicle.



To prevent electrical shock, do not use your heater with ungrounded electrical systems or two-pronged (cheater) adapters.

Guarding against exhaust fumes

Although odorless and colorless, carbon monoxide is present in exhaust fumes. Take precautions to avoid its dangerous effects.



If you ever smell exhaust fumes of any kind inside your vehicle, have your dealer inspect and fix your vehicle immediately. Do not drive if you smell exhaust fumes. These fumes are harmful and could kill you.

Have the exhaust and body ventilation systems checked whenever:

- the vehicle is raised for service.
- the sound of the exhaust system changes.
- the vehicle has been damaged in a collision.



WARNING: Engine exhaust, some of its constituents, and certain vehicle components contain or emit chemicals known to the State of California to cause cancer and birth defects or other reproductive harm. In addition, certain fluids contained in vehicles and certain products of component wear contain or emit chemicals known to the State of California to cause cancer and birth defects or other reproductive harm.

Starting

Important ventilating information

If the engine is idling while the vehicle is stopped in an open area for long periods of time, open the windows at least 2.5 cm (one inch).

Adjust the heating or air conditioning (if equipped) to bring in fresh air.

Improve vehicle ventilation by keeping all air inlet vents clear of snow, leaves and other debris.

BRAKES

Your service brakes are self-adjusting. Refer to the Scheduled maintenance guide for scheduled maintenance.

Occasional brake noise is normal and often does not indicate a performance concern with the vehicle's brake system. In normal operation, automotive brake systems may emit occasional or intermittent squeal or groan noises when the brakes are applied. Such noises are usually heard during the first few brake applications in the morning; however, they may be heard at any time while braking and can be aggravated by environmental conditions such as cold, heat, moisture, road dust, salt or mud. If a "metal-to-metal," "continuous grinding" or "continuous squeal" sound is present while braking, the brake linings may be worn-out and should be inspected by a qualified service technician.



If you are driving down a long or steep hill, shift to a lower gear. Do not apply your brakes continuously, as they may overheat and become less effective.

Anti-lock brake system (ABS)

On vehicles equipped with an anti-lock braking system (ABS), a noise from the hydraulic pump motor and pulsation in the pedal may be observed during ABS braking events. Pedal pulsation coupled with noise while braking under panic conditions or on loose gravel, bumps, wet or snowy roads is normal and indicates proper functioning of the vehicle's anti-lock brake system. The ABS performs a self-check after you start the engine and begin to drive away. A brief mechanical noise may be heard during this test. This is normal. If a malfunction is found, the ABS warning light will come on. If the vehicle has continuous vibration or shudder in the steering wheel while braking, the vehicle should be inspected by a qualified service technician.

The ABS operates by detecting the onset of wheel lockup during brake applications and compensates for this tendency. The wheels are prevented from locking even when the brakes are firmly applied. The accompanying illustration depicts the advantage of an ABS equipped

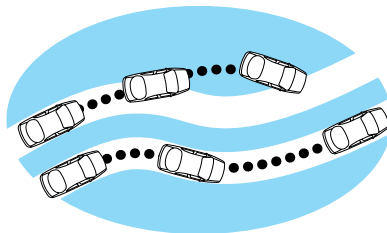

Driving

vehicle (on bottom) to a non-ABS equipped vehicle (on top) during hard braking with loss of front braking traction.

ABS warning lamp

The  warning lamp in the instrument cluster momentarily illuminates when the ignition is turned to the ON position. If the light remains on after the vehicle is started, continues to flash or fails to illuminate, have the system serviced immediately. With the ABS light on, the anti-lock brake system is disabled and normal braking is still effective unless the brake warning light also remains illuminated.

With the ABS light on, the anti-lock brake system is disabled and normal braking is still effective unless the brake warning light also remains illuminated with parking brake

released. (If your brake warning lamp illuminates, have your vehicle serviced immediately.)

BRAKE

Using ABS

- In an emergency or when maximum efficiency from the four wheel ABS is required, apply continuous force on the brake. The four wheel ABS will be activated immediately, thus allowing you to retain full steering control of your vehicle and, providing there is sufficient space, will enable you to avoid obstacles and bring the vehicle to a controlled stop.
- The Anti-Lock system does not decrease the time necessary to apply the brakes or always reduce stopping distance. Always leave enough room between your vehicle and the vehicle in front of you to stop.
- We recommend that you familiarize yourself with this braking technique. However, avoid taking any unnecessary risks.

Hydraulic brake booster system (Hydroboost or Hydromax)

The Hydroboost and Hydromax systems receive fluid pressure from the power steering pump to provide power assist during braking.

The Hydromax booster receives backup pressure from the reserve system electric pump whenever the fluid in the power steering system is not flowing. When the engine is OFF, the pump will turn on if the brake pedal is applied, or if the ignition is turned to the ON position.

Driving

The sound of the pump operating may be heard by the driver, but this is a normal characteristic of the system.

The reserve system provides reduced braking power, so the vehicle should be operated under these conditions with caution, and only to seek service repair and remove the vehicle from the roadway.

For Hydromax-equipped vehicles operating under normal conditions, the noise of the fluid flowing through the booster may be heard whenever the brake is applied. This condition is normal. Vehicle service is not required.

If braking performance or pedal response becomes very poor, even when the pedal is strongly depressed, it may indicate the presence of air in the hydraulic system or leakage of fluid. Stop the vehicle safely as soon as possible and seek service immediately.

Parking brake (P)

Apply the parking brake whenever the vehicle is parked. Push pedal downward to set the parking brake.

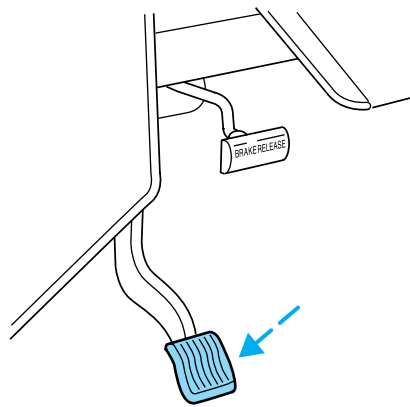

The BRAKE warning lamp in the instrument cluster illuminates and remains illuminated (when the ignition is turned ON) until the parking brake is released.

BRAKE
(!)



Always set the parking brake fully and make sure the gearshift is latched in P (Park). Turn off the ignition whenever you leave your vehicle.

Driving

The parking brake is not recommended to stop a moving vehicle. However, if the normal brakes fail, the parking brake can be used to stop your vehicle in an emergency. Since the parking brake applies only the transmission mounted parking brake assembly, the vehicle's stopping distance will increase greatly and the handling of your vehicle will be adversely affected.

Push the service brake pedal with your foot and pull the parking brake release handle to release the parking brake.

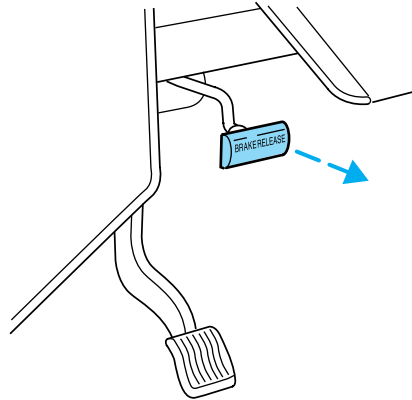

AUTOMATIC TRANSMISSION OPERATION (IF EQUIPPED)

Brake-shift interlock

This vehicle is equipped with a brake-shift interlock feature that prevents the gearshift lever from being moved from P (Park) when the ignition is in the ON position unless brake pedal is depressed.

If you cannot move the gearshift lever out of P (Park) with ignition in the ON position and the brake pedal depressed:

1. Apply the parking brake, turn ignition key to LOCK, then remove the key.
2. Insert the key and turn it to OFF. Apply the brake pedal and shift to N (Neutral).
3. Start the vehicle.

If it is necessary to use the above procedure to move the gearshift lever, it is possible that a fuse has blown or the vehicle's brakelamps are not operating properly. Refer to *Fuses and relays* in the *Roadside emergencies* chapter.

Driving



Do not drive your vehicle until you verify that the brakelamps are working.

If your vehicle gets stuck in mud or snow it may be rocked out by shifting from forward and reverse gears, stopping between shifts, in a steady pattern. Press lightly on the accelerator in each gear.

Do not rock the vehicle if the engine is not at normal operating temperature or damage to the transmission may occur.

Do not rock the vehicle for more than a few minutes or damage to the transmission and tires may occur or the engine may overheat.



Always set the parking brake fully and make sure the gearshift is latched in P (Park). Turn off the ignition whenever you leave your vehicle.



If the parking brake is fully released, but the brake warning lamp remains illuminated, the brakes may not be working properly. See your dealer or a qualified service technician.

Driving with a 4–speed automatic transmission

Understanding gearshift positions

To put your vehicle in gear, start the engine, depress the brake pedal, then move gearshift lever out of P (Park).



Hold the brake pedal down while you move the gearshift lever from P (Park) to another position. If you do not hold the brake pedal down, your vehicle may move unexpectedly and injure someone.

P (Park)

Always come to a complete stop before shifting into P (Park). Make sure the gearshift lever is securely latched in P (Park). This position locks the transmission and prevents the rear wheels from turning.



Driving

 Always set the parking brake fully and make sure the gearshift lever is latched in P (Park). Turn off the ignition whenever you leave your vehicle.

R (Reverse)

With the gearshift lever in R (Reverse), the vehicle will move backward. Always come to a complete stop before shifting into and out of R (Reverse).



N (Neutral)

With the gearshift lever in N (Neutral), the vehicle can be started and is free to roll. Hold the brake pedal down while in this gear.



D (Overdrive)

The normal driving position for the best fuel economy. Transmission operates in gears one through four.



D (Overdrive) can be deactivated by pressing the transmission control switch (TCS) on the end of the gearshift lever.

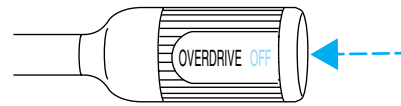

The transmission control indicator light (TCIL) (the word OFF) on the end of the gearshift lever will illuminate.

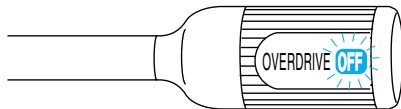

Drive – Not shown on the display. Activate by pressing the transmission control switch (TCS) on the end of the gearshift lever with the gearshift in the **D** position. The TCIL (the word OFF) will illuminate on the gearshift lever. Transmission operates in gears one through three. **D** (Drive) provides more engine braking than **D** (Overdrive) and is useful when:

- driving with a heavy load.

Driving

- towing a trailer up or down steep hills.
- additional engine downhill braking is desired. If towing a trailer, refer to *Driving while you tow* in the *Trailer towing* section.

To return to **D** (Overdrive) mode, press the transmission control switch (TCS). The TCIL (the word OFF) will no longer be illuminated.

Each time the vehicle is started, the transmission will automatically return to normal overdrive mode.

Every time the vehicle is shut off and restarted, you must press the transmission control switch to cancel overdrive operation if driving in overdrive is not desired.

2 (Second)

Use 2 (Second) to start-up on slippery roads or to provide additional engine braking on downgrades.



1 (First)

Use 1 (Low) to provide maximum engine braking on steep downgrades. Upshifts can be made by shifting to 2 (Second) or to **D** (Overdrive). Selecting 1 (Low) at higher speeds causes the transmission to shift to a lower gear, and will shift to 1 (Low) after vehicle decelerates to the proper speed.



Forced Downshifts

To gain acceleration in **D** (Overdrive) or Drive (O/D OFF) when passing another vehicle, push the accelerator to the floor. The transmission will downshift to the appropriate gear: third, second or first gear.

VEHICLE LOADING

Your vehicle's load capacity is designed by weight, not volume, so you cannot necessarily use all available space with large or heavy loads. Maximum safe vehicle weights as well as tire, rim sizes and inflation pressures are specified for your vehicle on the Safety Compliance Certification Label. A Certification Label was supplied by Ford Motor Company to the Motorhome Manufacturer. The manufacturer uses this information and supplies a Certification Label which is located inside the vehicle to the left of the driver.

Driving

Before loading a vehicle, familiarize yourself with the following terms:

- **Base Curb Weight:** Weight of the vehicle including any standard equipment, fluids, lubricants, etc. It does not include passengers or aftermarket equipment.
- **Payload:** Combined maximum allowable weight of cargo, passengers and optional equipment. The payload equals the gross vehicle weight rating minus base curb weight.
- **GVW (Gross Vehicle Weight):** Base curb weight plus payload weight. The GVW is not a limit or a specification.
- **GVWR (Gross Vehicle Weight Rating):** Maximum total weight of the base vehicle, passengers, optional equipment and cargo. The GVWR is specific to each vehicle and is listed on the Certification Label, located near the driver's seat or on the driver's door pillar.
- **GAWR (Gross Axle Weight Rating):** Carrying capacity for each axle system. The GAWR is specific to each vehicle and is listed on the Certification Label, located near the driver's seat or on the driver's door pillar.
- **GCWR (Gross Combined Weight Rating):** Maximum combined weight of towing vehicle (including passengers and cargo) and the trailer.
- **Maximum Trailer Weight Rating:** Maximum weight of a trailer the loaded vehicle (including passengers and cargo) is permitted to tow. The maximum trailer weight rating is determined by subtracting the vehicle curb weight for each engine/transmission combination, any required option weight for trailer towing and the weight of the driver from the GCWR for the towing vehicle.
- **Trailer Weight Range:** Specified weight range that the trailer must fall within that ranges from zero to the maximum trailer weight rating.

Remember to figure in the tongue load of your loaded trailer when figuring the total weight.



Do not exceed the GVWR or the GAWR specified on the certification label.

Do not use replacement tires with lower weight capacities than the originals because they may lower the vehicle's GVWR and GAWR limitations. Replacement tires with a higher weight limit than the originals do not increase the GVWR and GAWR limitations.

Calculating the load your vehicle can carry/tow

1. Use the appropriate maximum gross combined weight rating (GCWR) chart to find the maximum GCWR for your type engine and rear axle ratio.
2. Weigh your vehicle as you customarily operate the vehicle without cargo. To obtain correct weights, try taking your vehicle to a shipping company or an inspection station for trucks.
3. Subtract your loaded vehicle weight from the maximum GCWR on the following charts. This is the maximum combined cargo and trailer weight your vehicle can carry/tow and must fall below the maximum shown under maximum trailer weight on the chart. Refer to the definition of Maximum Trailer Weight below Vehicle Loading in this chapter to determine the maximum trailer weight permitted for a loaded vehicle.

TRAILER TOWING

Your vehicle may tow a class I, II or III trailer provided the maximum trailer weight is less than or equal to the maximum trailer weight listed for your engine and rear axle ratio on the following chart:

GCWR (Gross Combined Weight Rating)/Trailer Weights				
Engine	Rear axle ratio	Maximum GCWR - kg (lbs.)	Trailer weight range - kg (lbs.) (0-Maximum)	Maximum Frontal Area of Trailer - m² (ft²)
6.8L	5.38	11 794 (26 000)	0-4 763 (0-10 000)	5.6 (60)
For high altitude operation reduce GCW by 2% per 300 meters (1 000 ft) elevation. To determine the maximum trailer weight designed for your particular vehicle as equipped, follow the section <i>Calculating the load your vehicle can carry/tow</i> earlier in this chapter.				

Preparing to tow

Use the proper equipment for towing a trailer, and make sure it is properly attached to your vehicle. See your dealer or a reliable trailer dealer if you require assistance.

Hitches

You must distribute the load in your trailer so that 10 – 15% of the total weight of the trailer is on the tongue.

Driving

Load equalizing hitch

When hooking up a trailer using a load equalizing hitch, always use the following procedure:

1. Park the unloaded vehicle on a level surface. With the ignition on and all doors closed, allow the vehicle to stand for several minutes so that it can level.
2. Measure the height of a reference point on the front and rear bumpers at the center of the vehicle.
3. Attach the trailer to the vehicle and adjust the hitch equalizers so that the front bumper height is within 0–13 mm (0.5 in) of the reference point. After proper adjustment, the rear bumper should be no higher than in Step 3.



Adjusting an equalizing hitch so the rear bumper of the vehicle is lower or higher than it was unloaded will defeat the function of the load equalizing hitch and may cause unpredictable handling.

Safety chains

Always connect the trailer's safety chains to the frame or hook retainers of the vehicle. To connect the trailer's safety chains, cross the chains under the trailer tongue and allow slack for turning corners.

If you use a rental trailer, follow the instructions that the rental agency gives to you.

Do not attach safety chains to the bumper.

Trailer brakes

Electric brakes and manual, automatic or surge-type brakes are safe if installed properly and adjusted to the manufacturer's specifications. The trailer brakes must meet local and Federal regulations.



Do not connect a trailer's hydraulic brake system directly to your vehicle's brake system. Your vehicle may not have enough braking power and your chances of having a collision greatly increase.

The towing vehicle braking system is rated for operation at the GVWR, not the GCWR.

Separate functioning brake systems are required for safe control of towed vehicles and trailers weighing more than 680 kg (1 500 lbs) when loaded.

Trailer lamps

Trailer lamps are required on most towed vehicles. Make sure your trailer lamps conform to local and Federal regulations. See your dealer or trailer rental agency for proper instructions and equipment for hooking up trailer lamps.

Driving while you tow

When towing a trailer:

- Ensure that you turn off your speed control. The speed control may shut off automatically when you are towing on long, steep grades.
- Consult your local motor vehicle speed regulations for towing a trailer.
- Use a lower gear when towing up or down steep hills. This will eliminate excessive downshifting and upshifting for optimum fuel economy and transmission cooling.
- Anticipate stops and brake gradually.

Servicing after towing

If you tow a trailer for long distances, your vehicle will require more frequent service intervals. Refer to your scheduled maintenance guide for more information.

Trailer towing tips

- Practice turning, stopping and backing up before starting on a trip to get the feel of the vehicle trailer combination. When turning, make wider turns so the trailer wheels will clear curbs and other obstacles.
- Allow more distance for stopping with a trailer attached.
- The trailer tongue weight should be 10% of the loaded trailer weight.
- After you have traveled 80 km (50 miles), thoroughly check your hitch, electrical connections and trailer wheel lug nuts.
- When stopped in traffic for long periods of time in hot weather, place the gearshift in P (Park) and increase idle speed. This aids engine cooling and air conditioner efficiency.
- Vehicles with trailers should not be parked on a grade. If you must park on a grade, place wheel chocks under the trailer's wheels.

Driving

DRIVING THROUGH WATER

Do not drive quickly through standing water, especially if the depth is unknown. Traction or brake capability may be limited and if the ignition system gets wet, your engine may stall. Water may also enter your engine's air intake and severely damage your engine.

If driving through deep or standing water is unavoidable, proceed very slowly. Never drive through water that is higher than the bottom of the hubs (for trucks) or the bottom of the wheel rims (for cars).

Once through the water, always try the brakes. Wet brakes do not stop the vehicle as effectively as dry brakes. Drying can be improved by moving your vehicle slowly while applying light pressure on the brake pedal.

Driving through deep water where the transmission vent tube is submerged may allow water into the transmission and cause internal transmission damage.

Roadside emergencies

HAZARD LIGHTS CONTROL

Use only in an emergency to warn traffic of vehicle breakdown, approaching danger, etc. The hazard flashers can be operated when the ignition is off.

- The hazard lights control is located on top of the steering column.
- Depress hazard lights control to activate the hazard flashers.
- Depress control again to turn the flashers off.

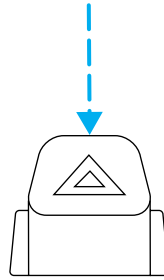

RESETTING THE FUEL PUMP SHUT-OFF SWITCH FUEL RESET

The fuel pump shut-off switch is a device intended to stop the electric fuel pump when your vehicle has been involved in a substantial jolt.

After a collision, if the engine cranks but does not start, the fuel pump shut-off switch may have been activated.

Roadside emergencies

The fuel pump shut-off switch is located on a bracket above the brake pedal.

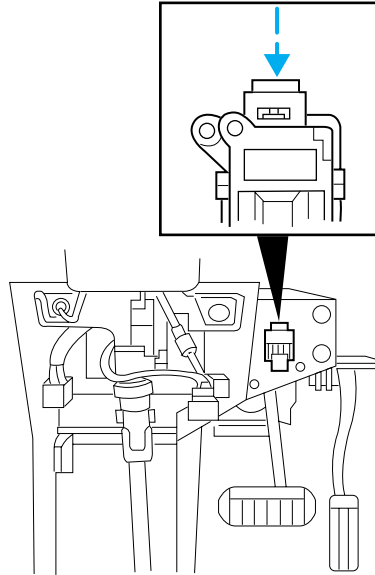

Use the following procedure to reset the fuel pump shut-off switch.

1. Turn the ignition to the OFF position.
2. Check the fuel system for leaks.
3. If no fuel leak is apparent, reset the fuel pump shut-off switch by pushing in on the reset button.
4. Turn the ignition to the ON position. Pause for a few seconds and return the key to the OFF position.
5. Make a further check for leaks in the fuel system.

Roadside emergencies

FUSES AND RELAYS

Standard fuse amperage rating and color

COLOR					
Fuse Rating	Mini Fuses	Standard Fuses	Maxi Fuses	Cartridge Maxi Fuses	Fuse Link Cartridge
2A	Grey	Grey	—	—	—
3A	Violet	Violet	—	—	—
4A	Pink	Pink	—	—	—
5A	Tan	Tan	—	—	—
7.5A	Brown	Brown	—	—	—
10A	Red	Red	—	—	—
15A	Blue	Blue	—	—	—
20A	Yellow	Yellow	Yellow	Blue	Blue
25A	Natural	Natural	—	—	—
30A	Green	Green	Green	Pink	Pink
40A	—	—	Orange	Green	Green
50A	—	—	Red	Red	Red
60A	—	—	Blue	—	Yellow
70A	—	—	Tan	—	Brown
80A	—	—	Natural	—	Black

Roadside emergencies

Passenger compartment fuse panel

The fuse panel is located below and to the left of the steering wheel by the brake pedal. Remove the panel cover to access the fuses.

To remove a fuse use the fuse puller tool provided on the fuse panel cover.

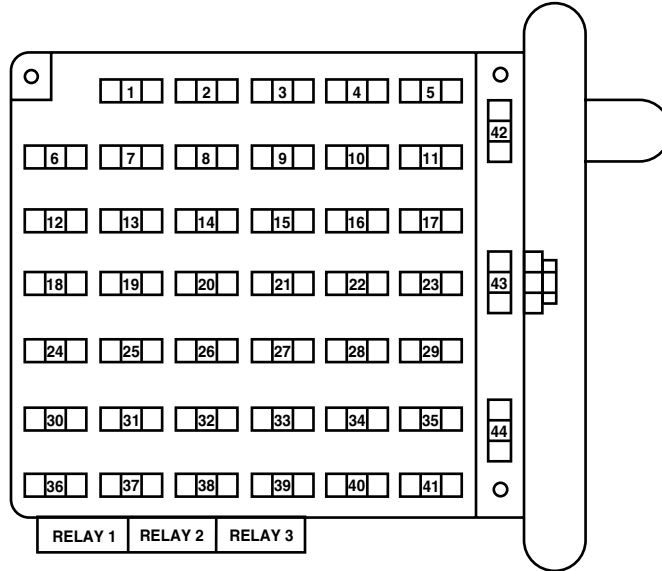

The fuses are coded as follows.

Fuse/Relay Location	Fuse Amp Rating	Passenger Compartment Fuse Panel Description
1	20A	Right turn signal relay coil, Left turn signal relay coil, Right turn indicator, Left turn indicator, Body builder right rear turn/stop feed, Body builder left rear turn/stop feed
2	—	Not used
3	—	Not used
4	15A	Courtesy lamp relay, Interior lamp feed
5	10A	Body builder accessory feed (accessory and run)

Roadside emergencies

Fuse/Relay Location	Fuse Amp Rating	Passenger Compartment Fuse Panel Description
6	10A	Trailer tow left stop/turn feed
7	15A	Blower motor relay coil
8	—	Not used
9	20A	Stoplamps: Trailer tow Electric Brake controller feed, Body builder right rear turn/stop feed, Body builder left rear turn/stop feed, Body builder stop lamp feed, Trailer left turn/stop fuse feed, Trailer right turn/stop fuse feed
10	5A	Instrument cluster memory, Power Brake Assist Lamp*
11	30A	Wiper/Washer Module, Wiper Feed
12	10A	Trailer tow Stop/Turn feed
13	10A	ABS Module
14	10A	Warning chime module, Power brake assist module*, Instrument cluster power, Instrument cluster warning lamps, Transmission control switch
15	15A	Left turn signal feed
16	20A	Body builder battery (+12V) feed
17	5A	Body builder radio feed
18	—	Not Used
19	5A	DRL relays
20	—	Not Used
21	15A	Right turn signal feed
22	—	Not Used
23	—	Not Used
24	—	Not Used
25	10A	Right headlamp feed (low beam)
26	10A	Speed control module, Brake shift interlock actuator
27	—	Not used

Roadside emergencies

Fuse/Relay Location	Fuse Amp Rating	Passenger Compartment Fuse Panel Description
28	—	Not used
29	—	Not used
30	—	Not used
31	10A	Left headlamp feed (low beam)
32	10A	Backup lamp feed
33	—	Not used
34	—	Not used
35	20A	Body builder high beam feed, High beam indicator
36	—	Not used
37	—	Not used
38	10A	Body builder accessory feed (run only)
39	—	Not used
40	—	Not used
41	10A	Instrument illumination
42	—	Not used
43	—	Not used
44	—	Not used
Relay 1	—	Left turn signal relay
Relay 2	—	Courtesy lamps relay
Relay 3	—	Right turn signal relay

*Vehicles with Hydromax brake assist only

Power distribution box

The power distribution box is located in the engine compartment. The power distribution box contains high-current fuses that protect your vehicle's main electrical systems from overloads.



Always disconnect the battery before servicing high current fuses.

Roadside emergencies



Always replace the cover to the Power Distribution Box before reconnecting the battery or refilling fluid reservoirs.

If the battery has been disconnected and reconnected, refer to the *Battery* section of the *Maintenance and care* chapter.

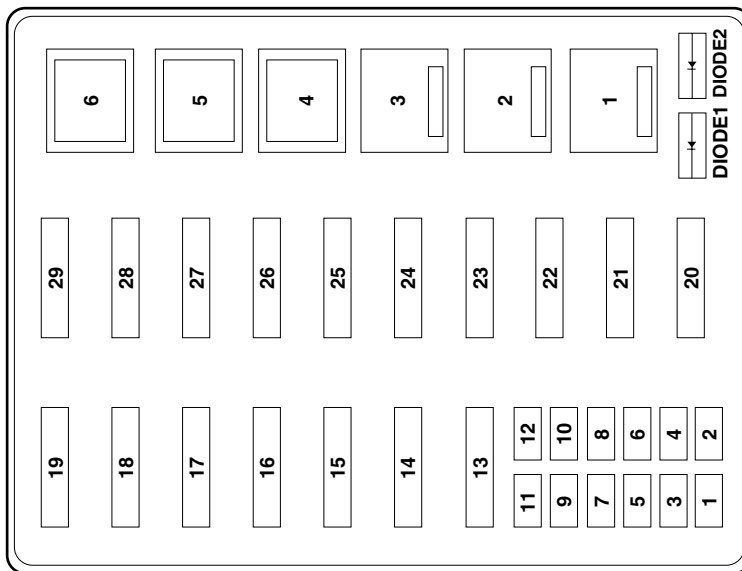

The high-current fuses are coded as follows.

Fuse/Relay Location	Fuse Amp Rating	Power Distribution Box Description
1	5A*	Power Brake Assist Module***
2	10A*	A/C System
3	20A*	4R100 Transmission, Vapor Management Valve Solenoid, Heated Exhaust Gas Oxygen (HEGO) Sensors
4	5A*	Powertrain Control Module Memory

Roadside emergencies

Fuse/Relay Location	Fuse Amp Rating	Power Distribution Box Description
5	15A*	Powertrain Control Module Power, Fuel Pump Relay Coil, Fuel Injectors, Mass Air Flow Sensor with IAT, A/C System Relay Coil
6	20A*	Parklamp Feeds, Instrument Panel Fuse #41, Warning Chime Module, Trailer Tow Running Lamp Relay Coil, I/P Dimmer Module
7	15A*	Starter Relay Coil, BB Neutral Sense
8	10A*	Stoplamp Switch (Logic): Brake Pressure Switch, Power Brake Assist Module***, Speed Control Module, Powertrain Control Module, ABS module, Brake Shift Interlock Actuator
9	5A*	Alternator
10	20A*	Daytime Running (DRL) Lamps
11	30A*	Ignition Coils, Radio Capacitors #1 and #2, Powertrain Control Module Relay
12	20A*	Trailer Tow Running Lamps Feed, Trailer Tow Backup Lamps Feed, IP-Backup Lamp Feed
13	30A**	Trailer Tow Electric Brake Controller Feed
14	60A**	Instrument Panel Battery Feed (Fuse #9, 15, 21)
15	--	Not Used
16	60A**	ABS Module
17	--	Not Used
18	20A**	Horn Feed
19	--	Not Used
20	40A**	Powertrain Control Module Relay
21	20A**	Fuel Pump Motor
22	20A**	Diagnostic Tool Connector, Cigar Lighter Feed

Roadside emergencies

Fuse/Relay Location	Fuse Amp Rating	Power Distribution Box Description
23	40A**	Blower Motor Feed
24	40A**	Instrument Panel Battery Feed (fuses #4, 10, 16)
25	50A**	Ignition Switch Feed (Instrument Panel Fuses #1, 5, 7, 11, 13, 14, 17, 19, PDB fuses #7, 9, 11)
26	60A**	Ignition Switch Feed (Instrument Panel Fuses #5, 11, 17, 26, 32, 38)
27	30A**	Multifunction Switch (Headlamps)
28	—	Not Used
29	60A**	Power Brake Assist Motor***
Relay 1	—	Daytime Running Lamps On/Off Relay
Relay 2	—	Fuel Pump Relay
Relay 3	—	Horn Relay
Relay 4	—	A/C System Relay
Relay 5	—	Blower Motor Relay
Relay 6	—	Powertrain Control Module Relay
Diode 1	—	Powertrain Control Module Diode
Diode 2	—	Park Brake Diode
* Mini Fuses ** Maxi Fuses ***Vehicles with Hydromax brake assist only		

Roadside emergencies

Relay module

The relay box is located by the power distribution box in front of the radiator in the engine compartment.

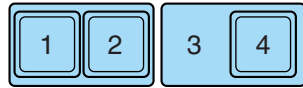

The relays are coded as follows:

Relay location	Description
1	Back up Lamp
2	Running Lamp
3	Not Used
4	Headlamp DRL

CHANGING THE TIRES

If you get a flat tire while driving, do not apply the brake heavily. Instead, gradually decrease your speed. Hold the steering wheel firmly and slowly move to a safe place on the side of the road.

Tire change procedure

Preparing to change the tire



To prevent the vehicle from moving when you change a tire, be sure the parking brake is set, then block (in both directions) the wheel that is diagonally opposite (other side and end of the vehicle) to the tire being changed.

1. Park on a level surface.
2. Activate the warning flashers.
3. Place the gearshift in P (Park).

Roadside emergencies

4. Apply the parking brake and turn engine OFF.

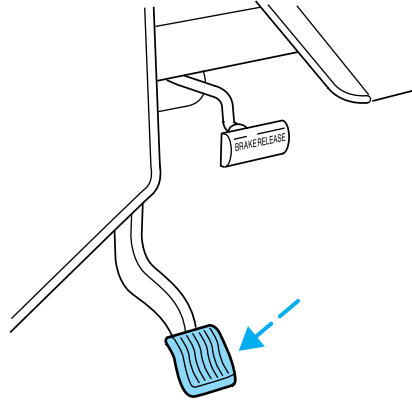

5. Block the wheel that is diagonally opposite the tire you are changing.

The parking brake is on the transmission. Therefore, the vehicle will not be prevented from moving when a rear wheel is lifted, even if the parking brake is applied. Be

sure to block both directions of the wheel that is diagonally opposite to the wheel that is being lifted.

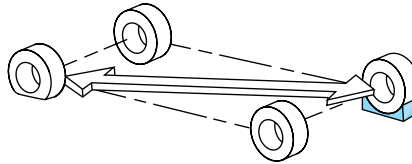

If the vehicle slips off the jack, you or someone else could be seriously injured.

6. Remove the spare tire and jack from the storage location.

7. Loosen the wheel nut by pulling up on the handle of the lug nut wrench about one-half turn (counterclockwise). Do not remove the wheel lug nuts until you raise the tire off the ground.

Replacing the tire



To lessen the risk of personal injury, do not put any part of your body under the vehicle while changing a tire. Do not start the engine when your vehicle is on the jack. The jack is only meant for changing the tire.

8. Position the jack to raise the front or rear wheel.

Roadside emergencies

- Never use the front or rear differential as a jacking point.

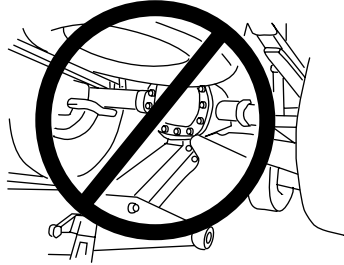

Rear axle jacking points:

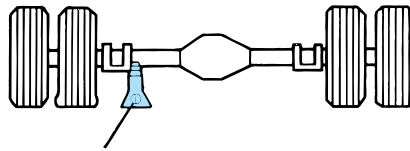

Front axle jacking points:

Place the jack under the front axle.

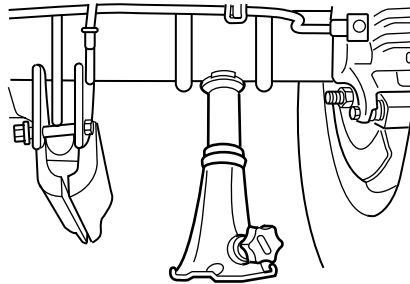

9. Raise the vehicle until the wheel is completely off the ground.
10. Remove the lug nuts with the lug nut wrench.
11. Replace the flat tire with the spare tire.
12. Use the lug nut wrench to screw the lug nut snugly against the wheel.
13. Lower the vehicle.

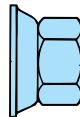

Roadside emergencies

14. Remove the jack and fully tighten the lug nuts in the following pattern:

 Never use wheels or lug nuts different than the original equipment as this could damage the wheel or mounting system. This damage could allow the wheels to come off while the vehicle is being driven.

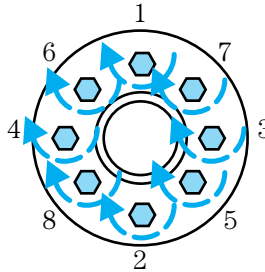

15. Replace any wheel trim.
 16. Stow the jack, handle and lug wrench.
 17. Unblock the wheels.

On vehicles equipped with dual rear wheels, retighten the wheel lug nuts to the specified torque at 160 km (100 miles), and again at 800 km (500 miles) of new vehicle operation and after any wheel disturbance (tire rotation, changing a flat tire, wheel removal, etc.).

Bolt size	Wheel lug nut torque*	
	Nm	Lb-ft
M14 x 1.5	200-225	150-165

* Torque specifications are for nut and bolt threads free of dirt and rust. Use only Ford recommended replacement fasteners.

On all two-piece flat wheel nuts, apply one drop of motor oil between the flat washer and the nut. Do not apply motor oil to the wheel nut threads or the wheel stud threads.

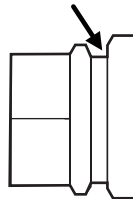

 When a wheel is installed, always remove any corrosion, dirt or foreign materials present on the mounting surfaces of the wheel or the surface of the front disc brake hub and rotor that contacts the wheel. Installing wheels without correct metal-to-metal contact at the wheel mounting surfaces can cause the wheel nuts to loosen and the wheel to come off while the vehicle is in motion, resulting in loss of control.

Roadside emergencies

JUMP STARTING YOUR VEHICLE

 The gases around the battery can explode if exposed to flames, sparks, or lit cigarettes. An explosion could result in injury or vehicle damage.

 Batteries contain sulfuric acid which burns skin, eyes, and clothing.

Preparing your vehicle

When the battery is disconnected or a new battery is installed, the transmission must relearn its adaptive strategy. As a result of this, the transmission may shift firmly. This operation is considered normal and will not effect function or durability of the transmission. Over time, the adaptive learning process will fully update transmission operation to its optimum shift feel.

1. **Use only a 12-volt supply to start your vehicle.**
2. Do not disconnect the battery of the disabled vehicle as this could damage the vehicle's electrical system.
3. Park the booster vehicle close to the hood of the disabled vehicle making sure the two vehicles **do not** touch. Set the parking brake on both vehicles and stay clear of the engine cooling fan and other moving parts.
4. Check all battery terminals and remove any excessive corrosion before you attach the battery cables. Ensure that vent caps are tight and level.
5. Turn the heater fan on in both vehicles to protect any electrical surges. Turn all other accessories off.

Connecting the jumper cables

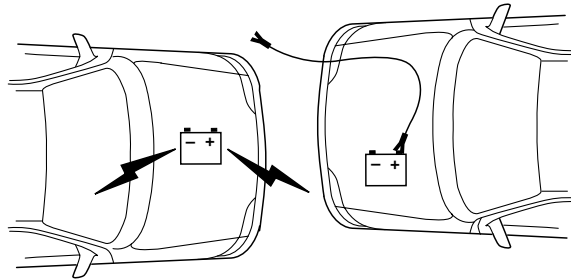

Roadside emergencies

1. Connect the positive (+) booster cable to the positive (+) terminal of the discharged battery.

Note: In the illustrations, *lightning bolts* are used to designate the assisting (boosting) battery.

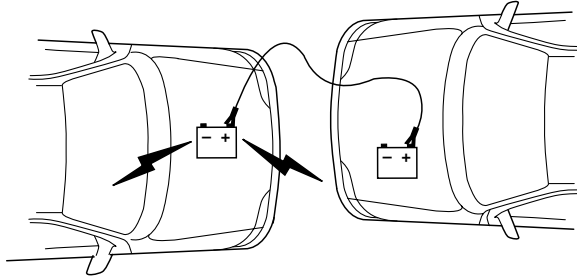

2. Connect the other end of the positive (+) cable to the positive (+) terminal of the assisting battery.

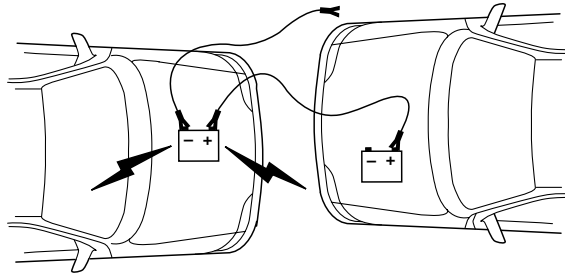

3. Connect the negative (-) cable to the negative (-) terminal of the assisting battery.

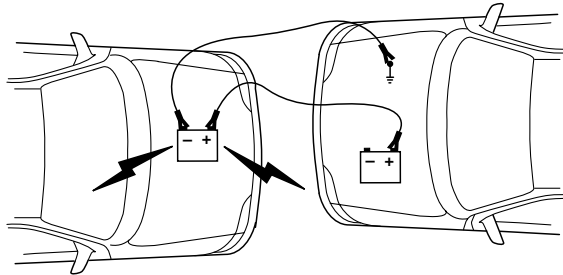

Roadside emergencies

4. Make the final connection of the negative (-) cable to an exposed metal part of the stalled vehicle's engine, away from the battery and the carburetor/fuel injection system. **Do not** use fuel lines, engine rocker covers or the intake manifold as *grounding* points.

 Do not connect the end of the second cable to the negative (-) terminal of the battery to be jumped. A spark may cause an explosion of the gases that surround the battery.

5. Ensure that the cables are clear of fan blades, belts, moving parts of both engines, or any fuel delivery system parts.

Jump starting

1. Start the engine of the booster vehicle and run the engine at moderately increased speed.
2. Start the engine of the disabled vehicle.
3. Once the disabled vehicle has been started, run both engines for an additional three minutes before disconnecting the jumper cables.

Removing the jumper cables

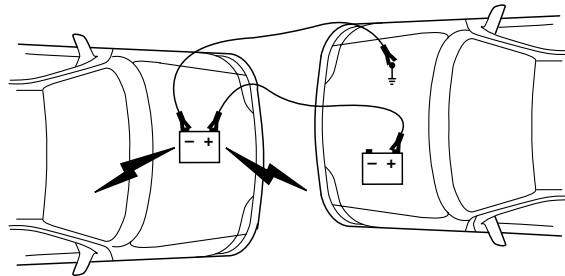

Remove the jumper cables in the reverse order that they were connected.

1. Remove the jumper cable from the *ground* metal surface.

Note: In the illustrations, *lightning bolts* are used to designate the assisting (boosting) battery.

Roadside emergencies

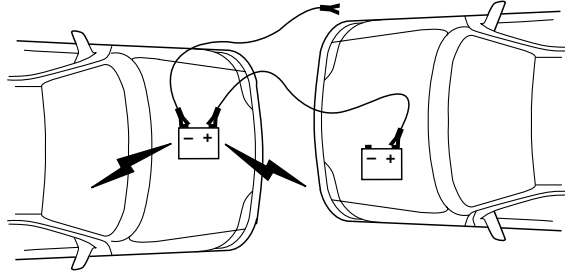

2. Remove the jumper cable on the negative (-) connection of the booster vehicle's battery.

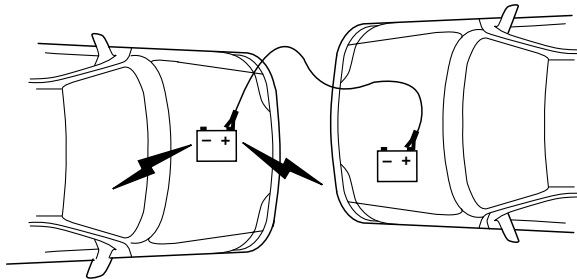

3. Remove the jumper cable from the positive (+) terminal of the booster vehicle's battery.

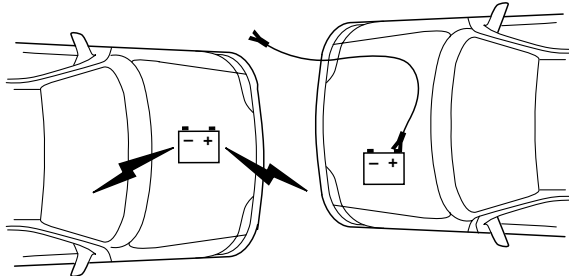

4. Remove the jumper cable from the positive (+) terminal of the disabled vehicle's battery.

Roadside emergencies

After the disabled vehicle has been started and the jumper cables removed, allow it to idle for several minutes so the engine computer can *relearn* its idle conditions.

When the battery is disconnected or a new battery is installed, the transmission must relearn its adaptive strategy. As a result of this, the transmission may shift firmly. This operation is considered normal and will not effect function or durability of the transmission. Over time, the adaptive learning process will fully update transmission operation to its optimum shift feel.

WRECKER TOWING

If you need to have your vehicle towed, contact a professional towing service or, if you are a member, your roadside assistance center.

It is recommended that your vehicle be towed with a wheel lift or flatbed equipment.

If the vehicle is towed by other means or incorrectly, vehicle damage may occur.

When calling for a tow truck, tell the operator what kind of vehicle you have.

Maintenance and care

SERVICE RECOMMENDATIONS

To help you service your vehicle:

- We highlight do-it-yourself items in the engine compartment for easy location.
- We provide a scheduled maintenance guide which makes tracking routine service easy.

If your vehicle requires professional service, your dealership can provide the necessary parts and service. Check your “Warranty Guide” to find out which parts and services are covered.

Use only recommended fuels, lubricants, fluids and service parts conforming to specifications. Motorcraft parts are designed and built to provide the best performance in your vehicle.

PRECAUTIONS WHEN SERVICING YOUR VEHICLE

Be especially careful when inspecting or servicing your vehicle.

- Do not work on a hot engine.
- When the engine is running, make sure that loose clothing, jewelry or long hair does not get caught up in moving parts.
- Do not work on a vehicle with the engine running in an enclosed space, unless you are sure you have enough ventilation.
- Keep all lit cigarettes, open flames and other lit material away from the battery and all fuel related parts.

If you disconnect the battery, the engine must “relearn” its idle conditions before your vehicle will drive properly, as explained in *Battery* in this chapter.

Working with the engine off

1. Set the parking brake and ensure the gearshift is securely latched in P (Park).
2. Turn off the engine and remove the key.
3. Block the wheels to prevent the vehicle from moving unexpectedly.

Working with the engine on

1. Set the parking brake and ensure the gearshift is securely latched in P (Park).
2. Block the wheels to prevent the vehicle from moving unexpectedly.

Maintenance and care



Do not start your engine with the air cleaner removed and do not remove it while the engine is running.

IDENTIFYING COMPONENTS IN THE ENGINE COMPARTMENT

6.8L V10 ENGINE

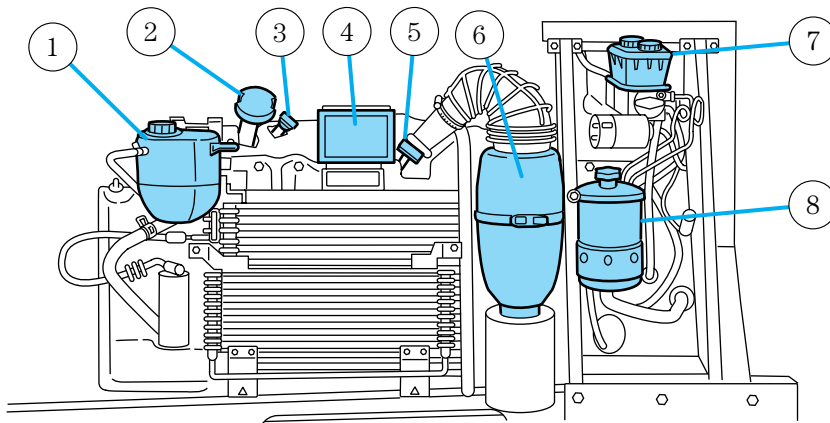

1. Engine coolant reservoir
2. Engine oil filler cap
3. Automatic transmission fluid dipstick
4. Power distribution box
5. Engine oil dipstick
6. Air filter assembly
7. Brake fluid reservoir
8. Power steering fluid reservoir

ENGINE OIL

Checking the engine oil

Refer to the scheduled maintenance guide for the appropriate intervals for checking the engine oil.

1. Make sure the vehicle is on level ground.

Maintenance and care

2. Turn the engine off and wait a few minutes for the oil to drain into the oil pan.
3. Set the parking brake and ensure the gearshift is securely latched in P (Park).
4. Open the hood. Protect yourself from engine heat.
5. Locate and carefully remove the engine oil level indicator (dipstick).

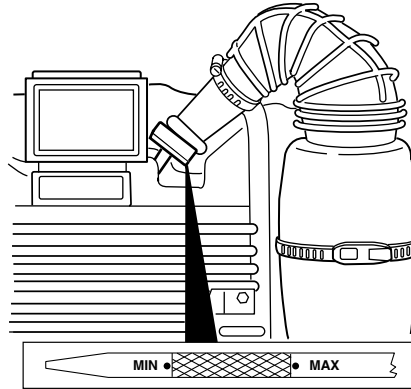

6. Wipe the indicator clean. Insert the indicator fully, then remove it again.
 - If the oil level is **between the MIN and MAX marks**, the oil level is acceptable. **DO NOT ADD OIL.**
 - If the oil level is below the MIN mark, add enough oil to raise the level within the MIN-MAX range.
 - Oil levels above the MAX mark may cause engine damage. Some oil must be removed from the engine by a service technician.
7. Put the indicator back in and ensure it is fully seated.

Adding engine oil

1. Check the engine oil. For instructions, refer to *Checking the engine oil* in this chapter.
2. If the engine oil level is not within the MIN and MAX ranges, add only certified engine oil of the recommended viscosity. Remove the engine oil filler cap and use a funnel to pour the engine oil into the opening.
3. Recheck the engine oil level. Make sure the oil level is not above the MAX mark on the engine oil level indicator (dipstick).

Maintenance and care

4. Install the indicator and ensure it is fully seated.
5. Fully install the engine oil filler cap by turning the filler cap clockwise until three clicks can be heard.

To avoid possible oil loss, DO NOT operate the vehicle with the engine oil level indicator and/or the engine oil filler cap removed.

Engine oil and filter recommendations

Look for this certification trademark.

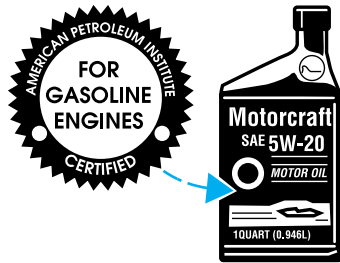

SAE 5W-20 engine oil is recommended.

Only use oils “Certified For Gasoline Engines” by the American Petroleum Institute (API). Use Motorcraft (Part: XO-5W20-QSP in U.S.) or an equivalent oil meeting Ford specification WSS-M2C153-H. **SAE 5W-20 oil provides optimum fuel economy and durability performance meeting all requirements for your vehicle’s engine .**

Do not use supplemental engine oil additives, oil treatments or engine treatments. They are unnecessary and could, under certain conditions, lead to engine damage which is not covered by your warranty.

Change your engine oil and filter according to the appropriate schedule listed in the scheduled maintenance guide.

Ford production and aftermarket (Motorcraft) oil filters are designed for added engine protection and long life. If a replacement oil filter is used that does not meet Ford material and design specifications, start-up engine noises or knock may be experienced.

It is recommended you use the appropriate Motorcraft oil filter (or another brand meeting Ford specifications) for your engine application.

Maintenance and care

AIR FILTER MAINTENANCE

Refer to the scheduled maintenance guide for the appropriate intervals for changing the air filter element.

When changing the air filter element, use only the Motorcraft air filter element listed. Refer to *Motorcraft Part Numbers* in the *Capacities and specifications* chapter.



Do not start your engine with the air cleaner removed and do not remove it while the engine is running.

Changing the air filter element

1. Loosen the clamp that secures the air filter element in place.

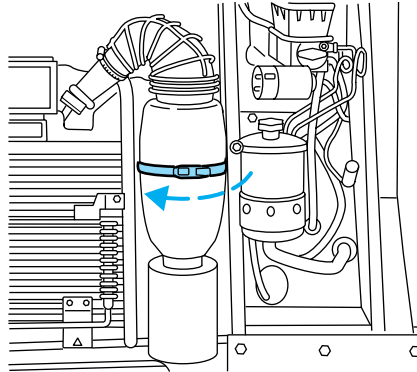

2. Carefully separate the two halves of the air filter housing.

3. Remove the air filter element from the open end of the air filter housing.

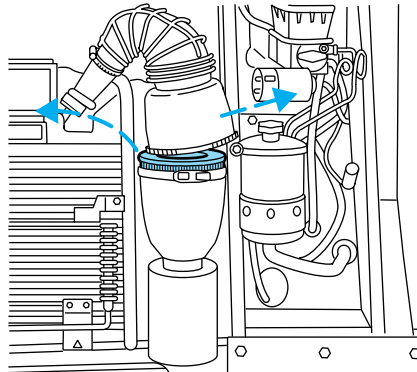

Maintenance and care

4. Install a new air filter element, ensuring the arrow on the top half of the air filter housing lines up with the notch on the bottom half of air filter housing. Be careful not to crimp the filter element edges between the air filter housing. This could cause filter damage and allow unmetered air to enter the engine if not properly seated.
5. Replace the two halves of the air filter housing and secure the clamp.

BRAKE FLUID (⚠)

Checking and adding brake fluid

Brake fluid should be checked and refilled as needed. Refer to the scheduled maintenance guide for the service interval schedules.

- Hydroboost brake fluid reservoir

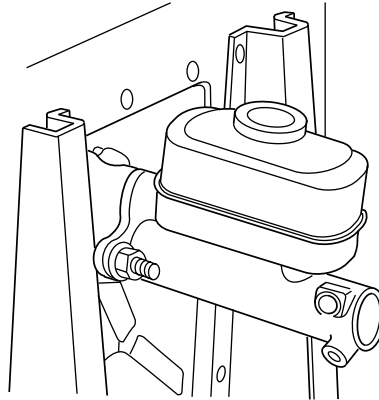

Maintenance and care

- Hydromax brake fluid reservoir

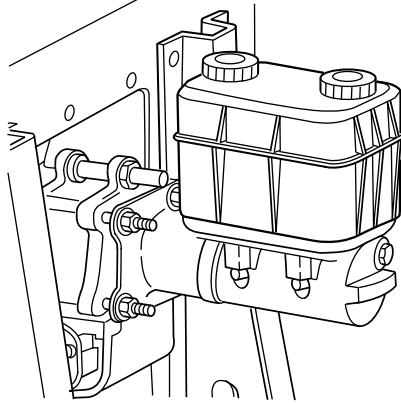

1. Clean the reservoir cap before removal to prevent dirt or water from entering the reservoir.
2. Visually inspect the fluid level.
3. If necessary, add brake fluid from a clean un-opened container until the level reaches MAX. Do not fill above this line.
4. Use only a DOT 3 brake fluid certified to meet Ford specifications. Refer to *Lubricant specifications* in the *Capacities and specifications* chapter.



Brake fluid is toxic. If brake fluid contacts the eyes, flush eyes with running water for 15 minutes. Seek medical attention if irritation persists. If taken internally, drink water and induce vomiting. Seek medical attention immediately.



If you use a brake fluid that is not DOT 3, you will cause permanent damage to your brakes.



Do not let the reservoir for the master cylinder run dry. This may cause the brakes to fail.

Brake system fluid should be replaced on a regular basis to maintain optimum braking performance, especially under heavy-duty driving conditions such as frequent steep grades or heavy towing loads. Refer to the scheduled maintenance guide for the service interval schedules.

Maintenance and care

ENGINE COOLANT

Checking engine coolant

Your engine's cooling system has been factory-filled with a 50/50 mixture of distilled water and Ford G05 Engine Coolant per Ford Specification WSS-M97B51-A1.

A **50/50 mixture** of distilled water and Ford G05 Engine Coolant provides:

- maximum cooling system efficiency.
- freeze protection down to -36°C (-34°F).
- boiling protection up to 129°C (265°F).
- protection against rust and other forms of corrosion.
- an accurate temperature readout from the engine coolant gauge.

The engine coolant must be maintained at the correct fluid level and concentration to work properly. If the engine coolant fluid level and concentration is not maintained correctly, damage to the engine and cooling system may result.

When the engine is cold, check the level of the engine coolant in the reservoir.

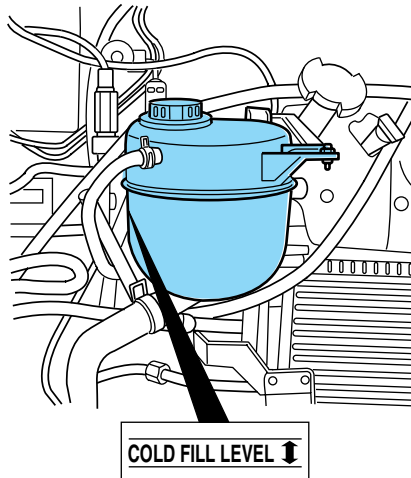

Maintenance and care

- The engine coolant should be at the “cold fill level” or within the “cold fill range” as listed on the engine coolant reservoir (depending upon application).
- Refer to the scheduled maintenance guide for service interval schedules.
- Be sure to read and understand *Precautions when servicing your vehicle* in this chapter.

If the engine coolant has not been checked at the recommended interval, the engine coolant reservoir may become low or empty. If the reservoir is low or empty, add engine coolant to the reservoir. Refer to *Adding engine coolant* in this chapter.



Automotive fluids are not interchangeable; do not use engine coolant, antifreeze or windshield washer fluid outside of its specified function and vehicle location.

Adding engine coolant

Use only Ford Premium Engine Coolant E2FZ-19549-AA (in Canada, Motorcraft CXC-10) or a premium engine coolant that meets Ford specification ESE-M97B44-A. Use only Ford G05 Engine Coolant WSS—M97B51-A1 (in Canada, Motorcraft CXC-10) or a premium engine coolant that meets Ford specification ESE-M97B44-A.

- **DO NOT USE Ford Extended Life Engine Coolant F6AZ-19544-AA (orange in color).**
- **DO NOT USE a DEX-COOL® engine coolant or an equivalent engine coolant that meets Ford specification WSS-M97B44-D.**
- **DO NOT USE alcohol or methanol antifreeze or any engine coolants mixed with alcohol or methanol antifreeze.**
- **DO NOT USE supplemental coolant additives in your vehicle. These additives may harm your engine’s cooling system.**
- **DO NOT MIX recycled coolant and conventional coolant together in your vehicle. Mixing of engine coolants may harm your engine’s cooling system.**

Maintenance and care

- **The use of an improper coolant may harm engine and cooling system components and may void the warranty of your vehicle's engine cooling system. If you are unsure which type of coolant your vehicle requires, contact your local dealer.**



Do not put engine coolant in the windshield washer fluid reservoir. If engine coolant is sprayed onto the windshield, it could make it difficult to see through the windshield.

When the engine is cool, add a **50/50 mixture** of engine coolant and distilled water to the engine coolant reservoir, until the coolant is at the “cold fill level” or within the “cold fill range” as listed in the engine coolant reservoir (depending upon application).

- **NEVER increase the coolant concentration above 60%.**
- **NEVER decrease the coolant concentration below 40%.**
- **Engine coolant concentrations above 60% or below 40% will decrease the freeze protection characteristics of the engine coolant and may cause engine damage.**

Plain water may be added in an emergency, but you **must** replace it with a 50/50 mixture of engine coolant and distilled water as soon as possible.

Check the coolant level in the reservoir before you drive your vehicle the next few times (with the engine cool). If necessary, add a **50/50 mixture** of engine coolant and distilled water to the engine coolant reservoir until the coolant level is at the “cold fill level” or within the “cold fill range” as listed on the reservoir (depending upon application).

Have your dealer check the engine cooling system for leaks if you have to add more than 1.0 liter (1.0 quart) of engine coolant per month.



To avoid scalding hot steam or coolant from being released from the engine cooling system, never remove the reservoir cap while the engine is running or hot. Failure to follow this warning may result in damage to the engine's cooling system and possible severe personal injury.

If you must remove the coolant cap, follow these steps to avoid personal injury:

1. Before you remove the cap, turn the engine off and let it cool.

Maintenance and care

2. When the engine is cool, wrap a thick cloth around the cap. Slowly turn cap counterclockwise until pressure begins to release.
3. Step back while the pressure releases.
4. When you are sure that all the pressure has been released, use the cloth to turn it counterclockwise and remove the cap.

Recycled engine coolant

Ford Motor Company recommends the use of a recycled engine coolant produced by Ford-approved processes.

Not all coolant recycling processes produce coolant which meets Ford specification ESE-M97B44-A. Use of a recycled engine coolant which does not meet the Ford specification may harm engine and cooling system components.



Always dispose of used automotive fluids in a responsible manner. Follow your community's regulations and standards for recycling and disposing of automotive fluids.

Coolant refill capacity

To find out how much fluid your vehicle's cooling system can hold, refer to *Refill capacities* in the *Capacities and specifications* chapter.

Fill your engine coolant reservoir as outlined in *Adding engine coolant* in this chapter.

Severe climates

If you drive in extremely cold climates (less than -36°C [-34°F):

- **it may be necessary to increase the coolant concentration above 50%.**
- **NEVER increase the coolant concentration above 60%.**
- **increased engine coolant concentrations above 60% will decrease the overheat protection characteristics of the engine coolant and may cause engine damage.**
- **refer to the chart on the coolant container to ensure the coolant concentration in your vehicle will provide adequate freeze protection at the temperatures in which you drive in the winter months.**

Maintenance and care

If you drive in extremely hot climates:

- **it is still necessary to maintain the coolant concentration above 40%.**
- **NEVER decrease the coolant concentration below 40%.**
- **decreased engine coolant concentrations below 40% will decrease the corrosion protection characteristics of the engine coolant and may cause engine damage.**
- **decreased engine coolant concentrations below 40% will decrease the freeze protection characteristics of the engine coolant and may cause engine damage.**
- **refer to the chart on the coolant container to ensure the coolant concentration in your vehicle will provide adequate protection at the temperatures in which you drive.**



Vehicles driven year-round in non-extreme climates should use a 50/50 mixture of engine coolant and distilled water for optimum cooling system and engine protection.

What you should know about fail-safe cooling

If the engine coolant supply is depleted, this feature allows the vehicle to be driven temporarily before incremental component damage is incurred. The “fail-safe” distance depends on ambient temperatures, vehicle load and terrain.

How fail-safe cooling works

If the engine begins to overheat:

- the engine coolant temperature gauge will move to the red (hot) area.
- the  symbol will illuminate.
- the  symbol will illuminate.
- the *Service Engine Soon* indicator light will illuminate.

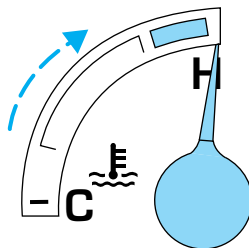

If the engine reaches a preset over-temperature condition, the engine will automatically switch to alternating cylinder operation. Each disabled cylinder acts as an air pump and cools the engine.

Maintenance and care

When this occurs the vehicle will still operate. However:

- the engine power will be limited.
- the air conditioning system will be disabled.

Continued operation will increase the engine temperature and the engine will completely shut down, causing steering and braking effort to increase.

Once the engine temperature cools, the engine can be re-started. Take your vehicle to a service facility as soon as possible to minimize engine damage.

When fail-safe mode is activated

You have limited engine power when in the fail-safe mode, so drive the vehicle with caution. The vehicle will not be able to maintain high-speed operation and the engine will run rough. Remember that the engine is capable of completely shutting down automatically to prevent engine damage, therefore:

1. Pull off the road as soon as safely possible and turn off the engine.
2. Arrange for the vehicle to be taken to a service facility.
3. If this is not possible, wait a short period for the engine to cool.
4. Check the coolant level and replenish if low.



Never remove the coolant reservoir cap while the engine is running or hot.

5. Re-start the engine and take your vehicle to a service facility.



Driving the vehicle without repairing the engine problem increases the chance of engine damage. Take your vehicle to a service facility as soon as possible.

Maintenance and care

CHECKING AND ADDING POWER STEERING FLUID

Check the power steering fluid.
Refer to the scheduled maintenance guide for the service interval schedules. If adding fluid is necessary, use only MERCON® ATF.

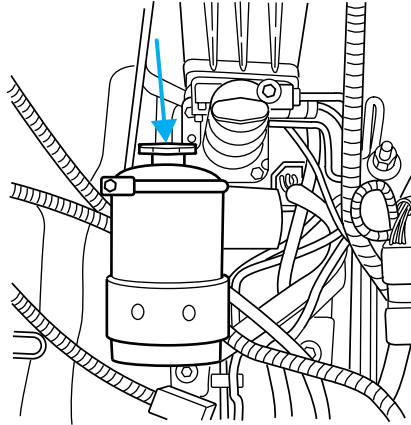

1. Start the engine and let it run until it reaches normal operating temperature (the engine coolant temperature gauge indicator will be near the center of the normal area between H and C).
2. While the engine idles, turn the steering wheel left and right several times.
3. Turn the engine off.
4. Check the fluid level on the dipstick. It should be between the arrows in the FULL range on the side of the dipstick with the words MAX. HOT at the top. Do not add fluid if the level is within this range.

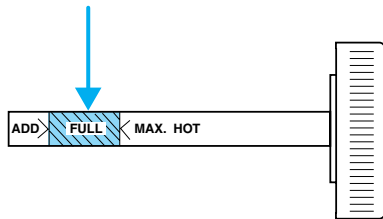

5. If the fluid is low, add fluid in small amounts, continuously checking the level until it reaches the FULL range. Be sure to put the dipstick back in the reservoir.

Maintenance and care

TRANSMISSION FLUID

Checking automatic transmission fluid

Refer to your scheduled maintenance guide for scheduled intervals for fluid checks and changes. Your transmission does not consume fluid. However, the fluid level should be checked if the transmission is not working properly, i.e., if the transmission slips or shifts slowly or if you notice some sign of fluid leakage.

Automatic transmission fluid expands when warmed. To obtain an accurate fluid check, drive the vehicle until it is at normal operating temperature (approximately 30 km [20 miles]). If your vehicle has been operated for an extended period at high speeds, in city traffic during hot weather or pulling a trailer, the vehicle should be turned off for about 30 minutes to allow fluid to cool before checking.

1. Drive the vehicle 30 km (20 miles) or until it reaches normal operating temperature.
2. Park the vehicle on a level surface and engage the parking brake.
3. With the parking brake engaged and your foot on the brake pedal, start the engine and move the gearshift lever through all of the gear ranges. Allow sufficient time for each gear to engage.
4. Latch the gearshift lever in P (Park) and leave the engine running.
5. Remove the dipstick, wiping it clean with a clean, dry lint free rag. If necessary, refer to *Identifying components in the engine compartment* in this chapter for the location of the dipstick.
6. Install the dipstick making sure it is fully seated in the filler tube.
7. Remove the dipstick and inspect the fluid level. The fluid should be in the designated area for normal operating temperature or ambient temperature.

Low fluid level

Do not drive the vehicle if the fluid level is at the bottom of the dipstick and the ambient temperature is above 10°C (50°F).



Maintenance and care

Correct fluid level

The transmission fluid should be checked at normal operating temperature 66°C-77°C (150°F-170°F) on a level surface. The normal operating temperature can be reached after approximately 30 km (20 miles) of driving.

You can check the fluid without driving if the ambient temperature is above 10°C (50°F). However, if fluid is added at this time, an overfill condition could result when the vehicle reaches normal operating temperature.

The transmission fluid should be in this range if at normal operating temperature (66°C-77°C [150°F-170°F]).

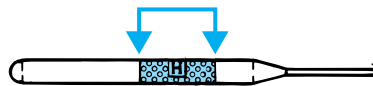

The transmission fluid should be in this range if at ambient temperature (10°C-35°C [50°F-95°F]).



High fluid level

Fluid levels above the safe range may result in transmission failure.

An overfill condition of transmission fluid may cause shift and/or engagement concerns and/or possible damage.

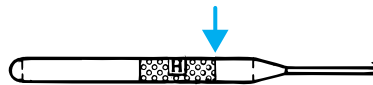

High fluid levels can be caused by an overheating condition.

Adjusting automatic transmission fluid levels

Before adding any fluid, make sure the correct type is used. The type of fluid used is normally indicated on the dipstick and also in the *Lubricant specifications* section in the *Capacities and specifications* chapter.

Use of a non-approved automatic transmission fluid may cause internal transmission component damage.

If necessary, add fluid in 250 mL (1/2 pint) increments through the filler tube until the level is correct.

If an overfill occurs, excess fluid should be removed by a qualified technician.

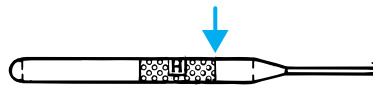

Maintenance and care

An overfill condition of transmission fluid may cause shift and/or engagement concerns and/or possible damage.

DRIVELINE UNIVERSAL JOINT AND SLIP YOKE

The original universal joints are equipped with grease fittings. Lubrication will be necessary. Refer to the scheduled maintenance guide for maintenance intervals.

BATTERY

Your vehicle is equipped with a Motorcraft maintenance-free battery which normally does not require additional water during its life of service.

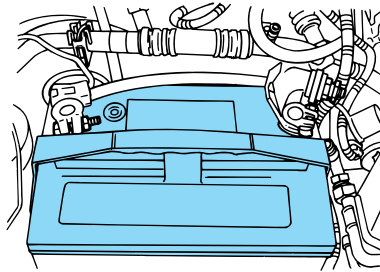

However, for severe usage or in high temperature climates, check the battery electrolyte level. Refer to the scheduled maintenance guide for the service interval schedules.

Keep the electrolyte level in each cell up to the “level indicator”. Do not overfill the battery cells.

If the electrolyte level in the battery is low, you can add plain tap water to the battery, as long as you do not use hard water (water with a high mineral or alkali content). If possible, however, try to only fill the battery cells with distilled water. If the battery needs water often, have the charging system checked.

If your battery has a cover/shield, make sure it is reinstalled after the battery has been cleaned or replaced.

For longer, trouble-free operation, keep the top of the battery clean and dry. Also, make certain the battery cables are always tightly fastened to the battery terminals.

If you see any corrosion on the battery or terminals, remove the cables from the terminals and clean with a wire brush. You can neutralize the acid with a solution of baking soda and water.

Maintenance and care

When the battery is disconnected or a new battery installed, the transmission must learn its adaptive strategy. As a result of this, the transmission may shift firmly. This operation is considered normal and will fully update transmission operation to its optimum shift feel.

 Batteries normally produce explosive gases which can cause personal injury. Therefore, do not allow flames, sparks or lighted substances to come near the battery. When working near the battery, always shield your face and protect your eyes. Always provide proper ventilation.

 When lifting a plastic-cased battery, excessive pressure on the end walls could cause acid to flow through the vent caps, resulting in personal injury and/or damage to the vehicle or battery. Lift the battery with a battery carrier or with your hands on opposite corners.

 Keep batteries out of reach of children. Batteries contain sulfuric acid. Avoid contact with skin, eyes or clothing. Shield your eyes when working near the battery to protect against possible splashing of acid solution. In case of acid contact with skin or eyes, flush immediately with water for a minimum of 15 minutes and get prompt medical attention. If acid is swallowed, call a physician immediately.

 Battery posts, terminals and related accessories contain lead and lead compounds. **Wash hands after handling** .

To account for customer driving habits and conditions, your automatic transmission (4R100) electronically controls the shift quality by using an adaptive learning strategy. The adaptive learning strategy is maintained by power from the battery. When the battery is disconnected or a new battery is installed, the transmission must relearn its adaptive strategy. Optimal shifting will resume within a few hundred kilometers (miles) of operation.

If the shift quality does not improve within a few hundred kilometers (miles) of operation, or if the downshifts and other throttle conditions do not function normally or after a long deceleration period, see your dealer or a qualified service technician as soon as possible.

Maintenance and care

Because your vehicle's engine is also electronically controlled by a computer, some control conditions are maintained by power from the battery. When the battery is disconnected or a new battery is installed, the engine must relearn its idle and fuel trim strategy for optimum driveability and performance. To begin this process:

1. With the vehicle at a complete stop, set the parking brake.
 2. Put the gearshift in P (Park), turn off all accessories and start the engine.
 3. Run the engine until it reaches normal operating temperature.
 4. Allow the engine to idle for at least one minute.
 5. Turn the A/C on and allow the engine to idle for at least one minute.
 6. With your foot on the brake pedal and with the A/C on, put the vehicle in D (Drive) and allow the engine to idle for at least one minute.
 7. Drive the vehicle to complete the relearning process.
- The vehicle may need to be driven 16 km (10 miles) or more to relearn the idle and fuel trim strategy.
 - **If you do not allow the engine to relearn its idle trim, the idle quality of your vehicle may be adversely affected until the idle trim is eventually relearned.**

If the battery has been disconnected or a new battery has been installed, the clock and the preset radio stations must be reset once the battery is reconnected.

- Always dispose of automotive batteries in a responsible manner. Follow your local authorized standards for disposal. Call your local authorized recycling center to find out more about recycling automotive batteries.

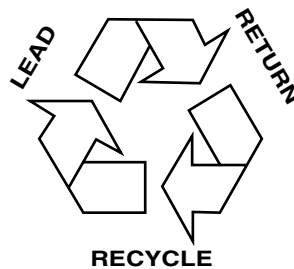

Maintenance and care

INFORMATION ABOUT UNIFORM TIRE QUALITY GRADING

New vehicles are fitted with tires that have a rating on them called Tire Quality Grades. The Quality grades can be found where applicable on the tire sidewall between tread shoulder and maximum section width. For example:

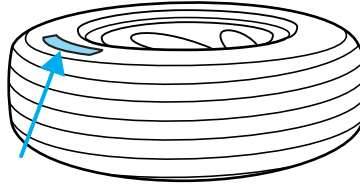

- **Treadwear 200 Traction AA Temperature A**

These Tire Quality Grades are determined by standards that the United States Department of Transportation has set.

Tire Quality Grades apply to new pneumatic tires for use on passenger cars. They do not apply to deep tread, winter-type snow tires, space-saver or temporary use spare tires, tires with nominal rim diameters of 10 to 12 inches or limited production tires as defined in Title 49 Code of Federal Regulations Part 575.104(c)(2).

U.S. Department of Transportation-Tire quality grades: The U.S. Department of Transportation requires Ford to give you the following information about tire grades exactly as the government has written it.

Treadwear

The treadwear grade is a comparative rating based on the wear rate of the tire when tested under controlled conditions on a specified government test course. For example, a tire graded 150 would wear one and one-half (1 1/2) times as well on the government course as a tire graded 100. The relative performance of tires depends upon the actual conditions of their use, however, and may depart significantly from the norm due to variations in driving habits, service practices, and differences in road characteristics and climate.

Traction AA A B C

The traction grades, from highest to lowest are AA, A, B, and C. Those grades represent the tire's ability to stop on wet pavement as measured under controlled conditions on specified government test surfaces of asphalt and concrete. A tire marked C may have poor traction performance.

Maintenance and care



The traction grade assigned to this tire is based on straight-ahead braking traction tests, and does not include acceleration, cornering, hydroplaning or peak traction characteristics.

Temperature A B C

The temperature grades are A (the highest), B, and C, representing the tire's resistance to the generation of heat and its ability to dissipate heat when tested under controlled conditions on a specified indoor laboratory test wheel. Sustained high temperature can cause the material of the tire to degenerate and reduce tire life, and excessive temperature can lead to sudden tire failure. The grade C corresponds to a level of performance which all passenger car tires must meet under the Federal Motor Vehicle Safety Standard No. 109. Grades B and A represent higher levels of performance on the laboratory test wheel than the minimum required by law.



The temperature grade for this tire is established for a tire that is properly inflated and not overloaded. Excessive speed, underinflation, or excessive loading, either separately or in combination, can cause heat buildup and possible tire failure.

SERVICING YOUR TIRES

Checking the tire pressure

- Use an accurate tire pressure gauge.
- Check the tire pressure when tires are cold, after the vehicle has been parked for at least one hour or has been driven less than 5 km (3 miles).
- Adjust tire pressure to recommended specifications found on the Certification Label.



Improperly inflated tires can affect vehicle handling and can fail suddenly, possibly resulting in loss of vehicle control.

Maintenance and care

Tire rotation

Because your vehicle's tires perform different jobs, they often wear differently. To make sure your tires wear evenly and last longer, rotate them as indicated in the scheduled maintenance guide. If you notice that the tires wear unevenly, have them checked.

Your front tires should be rotated from side to side. If the spare tire is used in the rotation, the pattern should be; left front to right front; right front to the spare and the spare to left front.

Do not rotate the dual tires.

Replacing the tires

Replace the tires when the wear band is visible through the tire treads.

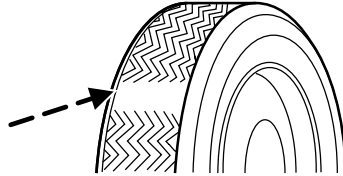

When replacing full size tires, never mix radial bias-belted, or bias-type tires. Use only the tire sizes that are listed on the Certification Label. Make sure that all tires are the same size, speed rating, and load-carrying capacity. Use only the tire combinations recommended on the label. If you do not follow these precautions, your vehicle may not drive properly and safely.



Make sure that all replacement tires are of the same size, type, load-carrying capacity and tread design (e.g., "All Terrain", etc.), as originally offered by Ford.



Failure to follow these precautions may adversely affect the handling of the vehicle and make it easier for the driver to lose control and roll over.

Maintenance and care

Tires that are larger or smaller than your vehicle's original tires may also affect the accuracy of your speedometer.

The tires on your vehicle have been match mounted to the original equipment wheels. Replacement tires should be mounted so that the match mount mark on the tire aligns with the small dimple in the face of the wheel rim.

SNOW TIRES AND CHAINS



Snow tires must be the same size and grade as the tires you currently have on your vehicle.

The tires on your vehicle have all weather treads to provide traction in rain and snow. However, in some climates, you may need to use snow tires and chains. If you need to use chains, it is recommended that steel wheels (of the same size and specifications) be used as chains may chip aluminum wheels.

Follow these guidelines when using snow tires and chains:

- Use only SAE Class S chains.
- Install chains securely, verifying that the chains do not touch any wiring, brake lines or fuel lines.
- Drive cautiously. If you hear the chains rub or bang against your vehicle, stop and re-tighten the chains. If this does not work, remove the chains to prevent damage to your vehicle.
- If possible, avoid fully loading your vehicle.
- Remove the tire chains when they are no longer needed. Do not use tire chains on dry roads.
- The suspension insulation and bumpers will help prevent vehicle damage. Do not remove these components from your vehicle when using snow tires and chains.

Maintenance and care

WHAT YOU SHOULD KNOW ABOUT AUTOMOTIVE FUELS

Important safety precautions



Do not overfill the fuel tank. The pressure in an overfilled tank may cause leakage and lead to fuel spray and fire.



The fuel system may be under pressure. If the fuel filler cap is venting vapor or if you hear a hissing sound, wait until it stops before completely removing the fuel filler cap. Otherwise, fuel may spray out and injure you or others.



If you do not use the proper fuel filler cap, excessive pressure or vacuum in the fuel tank may damage the fuel system or cause the fuel cap to disengage in a collision, which may result in possible personal injury.



Automotive fuels can cause serious injury or death if misused or mishandled.



Gasoline may contain benzene, which is a cancer-causing agent.

Observe the following guidelines when handling automotive fuel:

- Extinguish all smoking materials and any open flames before fueling your vehicle.
- Always turn off the vehicle before fueling.
- Automotive fuels can be harmful or fatal if swallowed. Fuel such as gasoline is highly toxic and if swallowed can cause death or permanent injury. If fuel is swallowed, call a physician immediately, even if no symptoms are immediately apparent. The toxic effects of fuel may not be visible for hours.



Maintenance and care

- Avoid inhaling fuel vapors. Inhaling too much fuel vapor of any kind can lead to eye and respiratory tract irritation. In severe cases, excessive or prolonged breathing of fuel vapor can cause serious illness and permanent injury.
- Avoid getting fuel liquid in your eyes. If fuel is splashed in the eyes, remove contact lenses (if worn), flush with water for 15 minutes and seek medical attention. Failure to seek proper medical attention could lead to permanent injury.
- Fuels can also be harmful if absorbed through the skin. If fuel is splashed on the skin and/or clothing, promptly remove contaminated clothing and wash skin thoroughly with soap and water. Repeated or prolonged skin contact with fuel liquid or vapor causes skin irritation.
- Be particularly careful if you are taking “Antabuse” or other forms of disulfiram for the treatment of alcoholism. Breathing gasoline vapors, or skin contact could cause an adverse reaction. In sensitive individuals, serious personal injury or sickness may result. If fuel is splashed on the skin, promptly wash skin thoroughly with soap and water. Consult a physician immediately if you experience an adverse reaction.



When refueling always shut the engine off and never allow sparks or open flames near the filler neck. Never smoke while refueling. Fuel vapor is extremely hazardous under certain conditions. Care should be taken to avoid inhaling excess fumes.



The flow of fuel through a fuel pump nozzle can produce static electricity, which can cause a fire if fuel is pumped into an ungrounded fuel container.

Use the following guidelines to avoid static build-up when filling an ungrounded fuel container:

- Place approved fuel container on the ground.
- DO NOT fill a fuel container while it is in the vehicle.
- Keep the fuel pump nozzle in contact with the fuel container while filling.
- DO NOT use a device that would hold the fuel pump handle in the fill position.

Maintenance and care

Choosing the right fuel

Use only UNLEADED FUEL. The use of leaded fuel is prohibited by law and could damage your vehicle.

Do not use fuel containing methanol. It can damage critical fuel system components.

Your vehicle was not designed to use fuel or fuel additives with metallic compounds, including manganese-based compounds containing MMT.

Repairs to correct the effects of using a fuel for which your vehicle was not designed may not be covered by your warranty.

Octane recommendations

Your vehicle is designed to use “Regular” unleaded gasoline with pump (R+M)/2 octane rating of 87. We do not recommend the use of gasolines labeled as “Regular” that are sold with octane ratings of 86 or lower in high altitude areas.

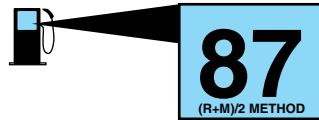

Do not be concerned if your engine sometimes knocks lightly. However, if it knocks heavily under most driving conditions while you are using fuel with the recommended octane rating, see your dealer or a qualified service technician to prevent any engine damage.

Fuel quality

If you are experiencing starting, rough idle or hesitation driveability problems during a cold start, try a different brand of “Regular” unleaded gasoline. “Premium” unleaded gasoline is not recommended (particularly in the United States) because it may cause these problems to become more pronounced. If the problems persist, see your dealer or a qualified service technician.

It should not be necessary to add any aftermarket products to your fuel tank if you continue to use high quality fuel of the recommended octane rating. Aftermarket products could cause damage to the fuel system. Repairs to correct the effects of using an aftermarket product in your fuel may not be covered by your warranty.

Maintenance and care

Many of the world's automakers issued the World-wide Fuel Charter that recommends gasoline specifications to provide improved performance and emission control system protection for your vehicle. Gasolines that meet the World-wide Fuel Charter should be used when available. Ask your fuel supplier about gasolines that meet the World-wide Fuel Charter. In Canada, look for fuels that display the **Auto Makers' Choice**[™] logo.

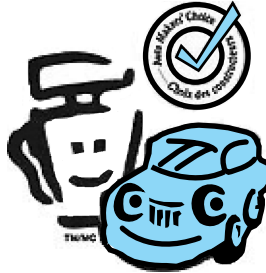

Cleaner air

Ford endorses the use of reformulated “cleaner-burning” gasolines to improve air quality.

Running out of fuel

Avoid running out of fuel because this situation may have an adverse affect on powertrain components.

If you have run out of fuel:

- You may need to cycle the ignition from OFF to ON several times after refueling, to allow the fuel system to pump the fuel from the tank to the engine.
- Your “Service Engine Soon” indicator may come on. For more information on the “Service Engine Soon” indicator, refer to the *Instrumentation* chapter.

ESSENTIALS OF GOOD FUEL ECONOMY

Measuring techniques

Your best source of information about actual fuel economy is you, the driver. You must gather information as accurately and consistently as possible. Fuel expense, frequency of fillups or fuel gauge readings are NOT accurate as a measure of fuel economy. We do not recommend taking fuel economy measurements during the first 1 600 km (1 000 miles) of driving (engine break-in period). You will get a more accurate measurement after 3 000 km–5 000 km (2 000 miles–3 000 miles).

Maintenance and care

Filling the tank

The advertised fuel capacity of the fuel tank on your vehicle is equal to the rated refill capacity of the fuel tank as listed in the *Refill Capacities* section of the *Capacities and specifications* chapter.

The advertised capacity is the amount of the indicated capacity and the empty reserve combined. Indicated capacity is the difference in the amount of fuel in a full tank and a tank when the fuel gauge indicates empty. Empty reserve is the small amount of fuel remaining in the fuel tank after the fuel gauge indicates empty.

The amount of usable fuel in the empty reserve varies and should not be relied upon to increase driving range. When refueling your vehicle after the fuel gauge indicates empty, you might not be able to refuel the full amount of the advertised capacity of the fuel tank due to the empty reserve still present in the tank.

For consistent results when filling the fuel tank:

- Turn the engine/ignition switch to the off position prior to refueling, an error in the reading will result if the engine is left running.
- Use the same filling rate setting (low — medium — high) each time the tank is filled.
- Allow no more than 2 automatic click-offs when filling.
- Always use fuel with the recommended octane rating.
- Use a known quality gasoline, preferably a national brand.
- Use the same side of the same pump and have the vehicle facing the same direction each time you fill up.
- Have the vehicle loading and distribution the same every time.

Your results will be most accurate if your filling method is consistent.

Calculating fuel economy

1. Fill the fuel tank completely and record the initial odometer reading (in kilometers or miles).
2. Each time you fill the tank, record the amount of fuel added (in liters or gallons).
3. After at least three to five tank fill-ups, fill the fuel tank and record the current odometer reading.
4. Subtract your initial odometer reading from the current odometer reading.

Maintenance and care

5. Follow one of the simple calculations in order to determine fuel economy:

Multiply liters used by 100, then divide by total kilometers traveled.

Divide total miles traveled by total gallons used.

Keep a record for at least one month and record the type of driving (city or highway). This will provide an accurate estimate of the vehicle's fuel economy under current driving conditions. Additionally, keeping records during summer and winter will show how temperature impacts fuel economy. In general, lower temperatures give lower fuel economy.

Driving style — good driving and fuel economy habits

Give consideration to the lists that follow and you may be able to change a number of variables and improve your fuel economy.

Habits

- Smooth, moderate operation can yield up to 10% savings in fuel.
- Steady speeds without stopping will usually give the best fuel economy.
- Idling for long periods of time (greater than one minute) may waste fuel.
- Anticipate stopping; slowing down may eliminate the need to stop.
- Sudden or hard accelerations may reduce fuel economy.
- Slow down gradually.
- Driving at reasonable speeds (traveling at 88 km/h [55 mph] uses 15% less fuel than traveling at 105 km/h [65 mph]).
- Revving the engine before turning it off may reduce fuel economy.
- Using the air conditioner or defroster may reduce fuel economy.
- You may want to turn off the speed control in hilly terrain if unnecessary shifting between third and fourth gear occurs. Unnecessary shifting of this type could result in reduced fuel economy.
- Warming up a vehicle on cold mornings is not required and may reduce fuel economy.
- Resting your foot on the brake pedal while driving may reduce fuel economy.

Maintenance and care

- Combine errands and minimize stop-and-go driving.

Maintenance

- Keep tires properly inflated and use only recommended size.
- Operating a vehicle with the wheels out of alignment will reduce fuel economy.
- Use recommended engine oil. Refer to *Lubricant Specifications*.
- Perform all regularly scheduled maintenance items. Follow the recommended maintenance schedule and owner maintenance checks found in your vehicle scheduled maintenance guide.

Conditions

- Heavily loading a vehicle or towing a trailer may reduce fuel economy at any speed.
- Carrying unnecessary weight may reduce fuel economy (approximately 0.4 km/L [1 mpg] is lost for every 180 kg [400 lb] of weight carried).
- Adding certain accessories to your vehicle (for example bug deflectors, rollbars/light bars, running boards, ski/luggage racks) may reduce fuel economy.
- Using fuel blended with alcohol may lower fuel economy.
- Fuel economy may decrease with lower temperatures during the first 12–16 km (8–10 miles) of driving.
- Driving on flat terrain offers improved fuel economy as compared to driving on hilly terrain.
- Transmissions give their best fuel economy when operated in the top cruise gear and with steady pressure on the gas pedal.
- Close windows for high speed driving.

EPA window sticker

Every new vehicle should have the EPA window sticker. Contact your dealer if the window sticker is not supplied with your vehicle. The EPA window sticker should be your guide for the fuel economy comparisons with other vehicles.

It is important to note the box in the lower left corner of the window sticker. These numbers represent the Range of L/100 km (MPG) expected on the vehicle under optimum conditions. Your fuel economy may vary depending upon the method of operation and conditions.

Maintenance and care

FUEL FILTER REPLACEMENT

The fuel filter assembly is located inside the driver side frame rail, near the transmission.

The fuel filter should be replaced every 24 000 km (15 000 miles).

Removal

 If the fuel filter is being serviced with the rear of the vehicle higher than the front, or if the fuel tank is pressurized, fuel leakage or siphoning from the tank fuel tubes could occur. To prevent this condition, maintain the vehicle front end at or above the level of the rear of the vehicle.

 Do not smoke or carry lighted tobacco or open flame of any type when working on or near any fuel related component. Highly flammable mixtures are always present and may be ignited, resulting in possible personal injury.

 Fuel in the fuel system remains under high pressure even when the engine is not running. Before servicing or disconnecting any of the fuel lines or fuel system components, the fuel system pressure must be relieved in order to prevent accidental spraying of fuel, causing personal injury or a fire hazard.

1. Shut the engine off and relieve the fuel system pressure.

- Remove the Schrader valve cap (located at the right rear of intake manifold) and install the EFI/CFI Fuel Pressure Gauge. The EFI/CFI Fuel Pressure Gauge 310-012 (T80L-9974-B) is available at a certified Ford parts dealer.

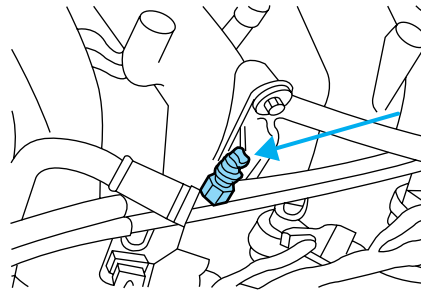

Maintenance and care

- Open the manual valve slowly on the EFI/CFI Fuel Pressure Gauge and relieve the fuel pressure. This will drain some fuel out of the system; place the fuel in a suitable container.

2. Use the fuel line disconnect tool to disconnect the fuel lines from the fuel filter. The Fuel Line Disconnect Tool 310-S039 (T90T-9550-S) is available at a certified Ford parts dealer.

- Disconnect the safety clip from the male hose.

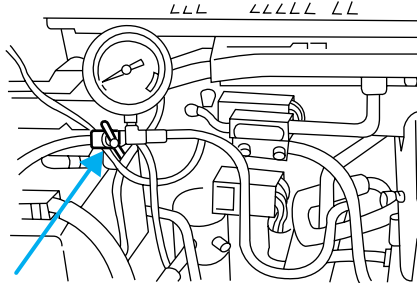

- Install the fuel line disconnect tool and push into the fitting.

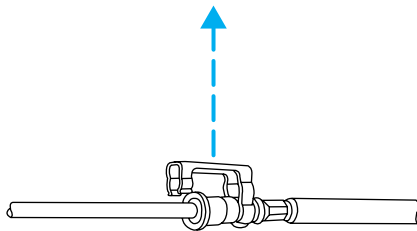

- Separate the fittings. Clean the fittings and inspect the fittings for damage.

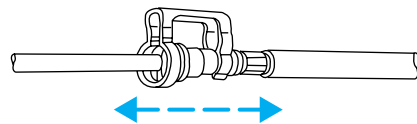
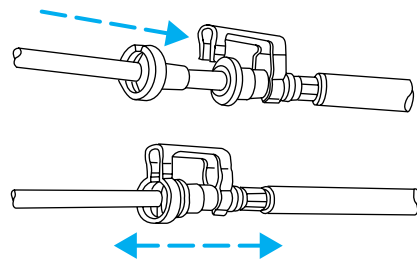

Maintenance and care

Installation

1. Install the fuel filter.
2. Lubricate the tube end with clean engine oil meeting Ford specification WSS-M2C153-G to ease assembly.

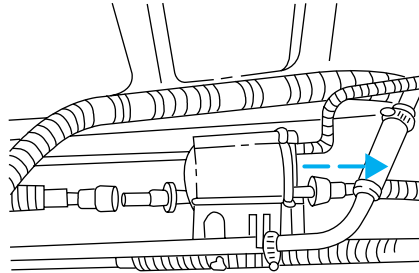

- Pull on the fitting to make sure it is fully engaged, then install safety clip.
3. Remove the EFI/CFI Fuel Pressure Gauge.
 4. Install the Schrader valve cap securely.

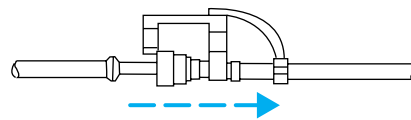
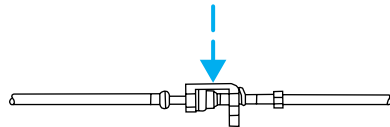

EMISSION CONTROL SYSTEM

Your vehicle is equipped with various emission control components and a catalytic converter which will enable your vehicle to comply with applicable exhaust emission standards. To make sure that the catalytic converter and other emission control components continue to work properly:

- Use only the specified fuel listed.
- Avoid running out of fuel.
- Do not turn off the ignition while your vehicle is moving, especially at high speeds.
- Have the items listed in your scheduled maintenance guide performed according to the specified schedule.

The scheduled maintenance items listed in the scheduled maintenance guide are essential to the life and performance of your vehicle and to its emissions system.

Maintenance and care

If other than Ford, Motorcraft or Ford-authorized parts are used for maintenance replacements or for service of components affecting emission control, such non-Ford parts should be equivalent to genuine Ford Motor Company parts in performance and durability.



Do not park, idle, or drive your vehicle in dry grass or other dry ground cover. The emission system heats up the engine compartment and exhaust system, which can start a fire.

Illumination of the “Service Engine Soon” light, charging system warning light or the temperature warning light, fluid leaks, strange odors, smoke or loss of engine power, could indicate that the emission control system is not working properly.



Exhaust leaks may result in entry of harmful and potentially lethal fumes into the passenger compartment.

Do not make any unauthorized changes to your vehicle or engine. By law, vehicle owners and anyone who manufactures, repairs, services, sells, leases, trades vehicles, or supervises a fleet of vehicles are not permitted to intentionally remove an emission control device or prevent it from working. Information about your vehicle’s emission system is on the Vehicle Emission Control Information Decal located on or near the engine. This decal identifies engine displacement and gives some tune up specifications.

Please consult your “Warranty Guide” for complete emission warranty information.

Readiness for Inspection/Maintenance (I/M) testing

In some localities, it may be a legal requirement to pass an I/M test of the on-board diagnostics system. If your “Check Engine/Service Engine Soon” light is on, refer to the description in the *Warning Lights and Chimes* section of the *Instrumentation* chapter. Your vehicle may not pass the I/M test with the “Check Engine/Service Engine Soon” light on.

If the vehicle’s powertrain system or its battery has just been serviced, the on-board diagnostics system is reset to a “not ready for I/M test” condition. To ready the on-board diagnostics system for I/M testing, a minimum of 30 minutes of city and highway driving is necessary as described below:

- First, at least 10 minutes of driving on an expressway or highway.

Maintenance and care

- Next, at least 20 minutes driving in stop-and-go, city-type traffic with at least four idle periods.

Allow the vehicle to sit for at least eight hours without starting the engine. Then, start the engine and complete the above driving cycle. The engine must warm up to its normal operating temperature. Once started, do not turn off the engine until the above driving cycle is complete.

BULBS

Replacing exterior bulbs

Check the operation of the following lamps frequently:

- Headlamps
- Tail lamps
- Brakelamps
- Turn signals
- Backup lamps
- License plate lamp

Do not remove lamp bulbs unless they will be replaced immediately. If a bulb is removed for an extended period of time, contaminants may enter the lamp housings and affect performance.

CLEANING AND CARING FOR YOUR VEHICLE

Refer to the Customer Assistance chapter for a list of Ford-approved cleaners, polishes and waxes.

Cleaning the wheels

Wash with the same detergent as the body of your vehicle. Do not use acid-based or alcohol-based wheel cleaners, steel wool, fuel or strong detergents. Never use abrasives that will damage the finish of special wheel surfaces. Use a tar remover to remove grease and tar.

The brushes used in some automatic car washes may damage the finish on your wheels. Before going to a car wash, find out if the brushes are abrasive.

Maintenance and care

Cleaning the engine

Engines are more efficient when they are clean because grease and dirt buildup keep the engine warmer than normal. When washing:

- Take care when using a power washer to clean the engine. The high pressure fluid could penetrate the sealed parts and cause damage.
- Do not spray with cold water to avoid cracking the engine block or other engine components.
- Cover the air cleaner and battery to prevent water damage when cleaning the engine.
- Never wash or rinse the engine while it is running; water in the running engine may cause internal damage.

Underbody

Flush the complete underside of vehicle frequently. Keep body drain holes unplugged. Inspect for road damage.

Capacities and specifications

MOTORCRAFT PART NUMBERS

Component	6.8L V10 engine
Air filter element	FA-1634
Battery	BXT-65-750
Fuel filter	FG-986B
Oil filter	FL-820-S
PCV valve	EV-233
Spark plugs*	AWSF-22E

*Refer to Vehicle Emissions Control Information (VECI) decal for spark plug gap information.

Capacities and specifications

REFILL CAPACITIES

Fluid	Ford Part Name	Application	Capacity
Brake fluid	High Performance DOT 3 Motor Vehicle Brake Fluid	All	Fill to line on reservoir
Engine oil (includes filter change)	Motorcraft SAE 5W-20 Super Premium Motor Oil	All	5.7L (6.0 quarts)
Engine coolant ¹	Premium Engine Coolant	All	29.0L (30.6 quarts)
Power steering fluid	Motorcraft MERCON® ATF	All	Keep in FULL range on dispstick
Rear axle ²	Motorcraft SAE 75W-140 Synthetic Rear Axle Lubricant	Dana 80	3.9L (4.0 quarts) ³
		Dana 135	11.7L (12.0 quarts) ³
Fuel tank	N/A	All	284.0L (75 .0 gallons)
Transmission ⁴	Motorcraft MERCON® ATF	All	16.8L (17.7 quarts) ⁵

Your vehicle's rear axle is filled with a synthetic rear axle lubricant and is considered lubricated for life. These lubricants do not need to be checked or changed unless a leak is suspected, service is required or the axle assembly has been submerged in water. The axle lubricant should be changed any time the rear axle has been submerged in water.

¹ Use Ford Premium Engine Coolant (green in color). DO NOT USE Ford Extended Life Engine Coolant (orange in color). Refer to *Adding engine coolant, in the Maintenance and Care chapter*.

² Fill 6 mm to 14 mm (1/4 inch to 9/16 inch) below bottom of fill hole.

³ Fill Dana rear axles to 6 mm to 14 mm (1/4 inch to 3/4 inch) below bottom of fill hole.

⁴ Ensure the correct automatic transmission fluid is used. Transmission fluid requirements are indicated on the dipstick or on the dipstick handle. Check the container to verify the fluid being added is of the

Capacities and specifications

correct type. Refer to your scheduled maintenance guide to determine the correct service interval.

Some transmission fluids may be labeled as dual usage, such as MERCON® and MERCON® V. These dual usage fluids are not to be used in an automatic transmission that requires use of the MERCON® type fluid. However, these dual usage fluids may be used in transmissions that require the MERCON® V type fluid.

MERCON® and MERCON® V type fluids are not interchangeable. DO NOT mix MERCON® and MERCON® V. Use of a transmission fluid that indicates dual usage (MERCON® and MERCON® V) in an automatic transmission application requiring MERCON® may cause transmission damage. Use of any fluid other than the recommended fluid may cause transmission damage.

⁵ Indicates only approximate dry-fill capacity. Some applications may vary based on cooler size and if equipped with in-tank cooler. The amount of transmission fluid and fluid level should be set by the indication on the dipstick's normal operating range.

LUBRICANT SPECIFICATIONS

Item	Ford part name	Ford part number	Ford specification
Brake fluid	High Performance DOT 3 Motor Vehicle Brake Fluid	C6AZ-19542-AB	ESA-M6C25-A and DOT 3
Engine coolant	Ford Premium Engine Coolant	E2FZ-19549-AA (in Canada, Motorcraft CXC-10)	ESE-M97B44-A
Engine oil	Motorcraft SAE 5W-20 Super Premium Motor Oil	XO-5W20-QSP	WSS-M2C153-H with API Certification Mark
Automatic transmission (4R100) ¹	Motorcraft MERCON® ATF	XT-2-QDX	MERCON®
Power steering fluid	Motorcraft MERCON® ATF	XT-2-QDX	MERCON®

Capacities and specifications

Item	Ford part name	Ford part number	Ford specification
Parking brake assembly	Motorcraft MERCON®	XT-2-QDX	MERCON®
Dana Axle	Motorcraft SAE 75W-140 High Performance Synthetic Rear Axle Lubricant	F1TZ-19580-B	WSL-M2C192-A

¹ Ensure the correct automatic transmission fluid is used. Transmission fluid requirements are indicated on the dipstick or on the dipstick handle. Check the container to verify the fluid being added is of the correct type. Refer to your scheduled maintenance guide to determine the correct service interval.

Some transmission fluids may be labeled as dual usage, such as MERCON® and MERCON® V. These dual usage fluids are not to be used in an automatic transmission that requires use of the MERCON® type fluid. However, these dual usage fluids may be used in transmissions that require the MERCON® V type fluid.

MERCON® and MERCON® V type fluids are not interchangeable. DO NOT mix MERCON® and MERCON® V. Use of a transmission fluid that indicates dual usage (MERCON® and MERCON® V) in an automatic transmission application requiring MERCON® may cause transmission damage. Use of any fluid other than the recommended fluid may cause transmission damage.

ENGINE DATA

Engine	6.8L V10 engine
Cubic inches	415
Required fuel	87 octane
Firing order	1-6-5-10-2-7-3-8-4-9
Spark plug gap	1.3-1.4 mm (0.052-0.056 inch)
Ignition system	Coil on plug
Compression ratio	9.0:1

Capacities and specifications

VEHICLE IDENTIFICATION NUMBER

Incomplete vehicles

On completed derivations of incomplete vehicles, the certification label is affixed at a location determined by a subsequent stage manufacturer of the completed vehicle. In these cases the completed vehicle is manufactured in two or more stages by two or more separate manufacturers.

Customer Assistance

IF YOU HAVE A SERVICE CONCERN, PLEASE FOLLOW THESE STEPS:

1. Call our Motor Home Customer Assistance Center **(1-800-444-3311)** which is available 24 hrs/day. If inspections or repairs are required let the assistance center make an appointment for you at the most appropriate repair location in your area. Please have the following information ready before you call:

- **Vehicle Identification Number**
- **Current Mileage**
- **A Summary of Your Concern**

2. When you arrive at the repair location explain your concern fully to the service writer. If your concern is resolved please contact **(1-800-444-3311)** and advise them accordingly. If not...

3. Ask to see the Service Manager and review your concern with him. If you are still not satisfied...

4. Contact **(1-800-444-3311)** and our Motor Home Customer Assistance Center will assist you and or the repair location as needed.

Reporting Safety Defects

REPORTING SAFETY DEFECTS (U.S. ONLY)

If you believe that your vehicle has a defect that could cause a crash, or could cause injury or death, you should immediately inform the National Highway Traffic Safety Administration (NHTSA) in addition to notifying Ford Motor Company.



If NHTSA receives similar complaints, it may open an investigation, and if it finds that a safety defect exists in a group of vehicles, it may order a recall and remedy campaign. However, NHTSA cannot become involved in individual problems between you, your dealer or Ford Motor Company.

To contact NHTSA, you may either call the Auto Safety Hotline toll-free at 1-800-424-9393 (202-366-0123 in the Washington D.C. area) or write to:

NHTSA
U.S. Department of Transportation
400 Seventh Street
Washington D.C. 20590

You can also obtain other information about motor vehicle safety from the Hotline.

Index

A

- Air cleaner filter61, 93
- Ambulance packages3
- Antifreeze (see Engine coolant)64
- Anti-lock brake system (see Brakes)27–28
- Automatic transmission
 - driving an automatic overdrive31
 - fluid, adding71
 - fluid, checking71
 - fluid, refill capacities94
 - fluid, specification96
- Axle
 - lubricant specifications95–96
 - refill capacities94

B

- Battery73
 - acid, treating emergencies73
 - charging system warning light ..7
 - jumping a disabled battery52
 - maintenance-free73
 - replacement, specifications93
 - servicing73
 - voltage gauge12
- Brakes27–28
 - anti-lock27–28
 - anti-lock brake system (ABS) warning light9, 28
 - brake warning light7
 - fluid, checking and adding62
 - fluid, refill capacities94
 - fluid, specifications95–96
 - lubricant specifications95–96
 - shift interlock30

- Break-in period3

C

- Capacities for refilling fluids94
- Cleaning your vehicle91
 - engine compartment92
 - exterior92
 - wheels91
- Coolant
 - checking and adding64
 - refill capacities67, 94
 - specifications95–96
- Cruise control (see Speed control)17

D

- Daytime running lamps (see Lamps)15
- Dipstick
 - automatic transmission fluid ...71
 - engine oil58
- Doors
 - door ajar warning9
 - lubricant specifications95
- Driveline universal joint and slip yoke73
- Driving under special conditions
 - through water38

E

- Emergencies, roadside
 - jump-starting52
- Emission control system89
- Engine96–97

Index

- check engine/service engine soon light8
- cleaning92
- coolant64
- fail-safe coolant68
- idle speed control73
- lubrication specifications ...95–96
- refill capacities94
- service points58
- starting after a collision39
- Engine block heater25
- Engine oil58
 - checking and adding58
 - dipstick58
 - filter, specifications60, 93
 - recommendations60
 - refill capacities94
 - specifications95–96
- Exhaust fumes25
- F**
- Fail safe cooling68
- Fluid capacities94
- Fuel80
 - calculating fuel economy83
 - capacity94
 - choosing the right fuel82
 - comparisons with EPA fuel economy estimates86
 - detergent in fuel83
 - filling your vehicle with fuel ...80, 84
 - filter, specifications87, 93
 - fuel pump shut-off switch39
 - gauge11
 - improving fuel economy83
 - low fuel warning light6
 - octane rating82, 96–97
 - quality82
 - running out of fuel83
 - safety information relating to automotive fuels80
- Fuses41–42
- G**
- Gas mileage (see Fuel economy)83
- Gauges11
 - battery voltage gauge12
 - engine coolant temperature gauge12
 - engine oil pressure gauge11
 - fuel gauge11
 - odometer13
 - speedometer13
 - tachometer14
 - trip odometer13
- GAWR (Gross Axle Weight Rating)33
 - calculating35
 - definition33
 - driving with a heavy load33
 - location33
- GVWR (Gross Vehicle Weight Rating)33
 - calculating33, 35
 - definition33
 - driving with a heavy load33
 - location33
- H**
- Hazard flashers39
- Headlamps15
 - daytime running lights15
 - flash to pass16
 - high beam10, 15
 - turning on and off15

Index

- warning chime10
- I**
- Ignition16, 96–97
- Inspection/maintenance (I/M)
testing90
- Instrument panel
cluster6
lighting up panel and
interior16
- J**
- Jack48
positioning48
storage48
- Jump-starting your vehicle52
- K**
- Keys
key in ignition chime10
positions of the ignition16
- L**
- Lamps
cargo lamps16
daytime running light15
headlamps15
headlamps, flash to pass16
instrument panel, dimming16
replacing bulbs91
- Lights, warning and indicator6
anti-lock brakes (ABS)9, 28
brake7
charging system7
check coolant6
door ajar9
- engine oil pressure6
fuel reset10
high beam10
low fuel6
safety belt7
service engine soon8
turn signal indicator10
- Load limits33
GAWR33
GVWR33
trailer towing33
- Lubricant specifications95–96
- M**
- Motorcraft parts87, 93
- O**
- Octane rating82
- Odometer13
- Oil (see Engine oil)58
- Overdrive21
- P**
- Parking brake29
- Parts (see Motorcraft parts)93
- Power distribution box (see
Fuses)44
- Power steering
fluid, checking and adding70
fluid, refill capacity94
fluid, specifications95–96
- R**
- Relays41, 48

Index

S

- Safety belts (see Safety restraints)10
- Safety defects, reporting99
- Safety restraints
 - warning light and chime7, 10
- Servicing your vehicle57
- Spark plugs, specifications93, 96–97
- Special notice3, 98
- Specification chart, lubricants95–96
- Speed control17
- Speedometer13
- Starting your vehicle22–24
 - jump starting52

T

- Tachometer14
- Tires48, 76–77
 - changing48
 - checking the pressure77
 - replacing49, 78
 - rotating78
 - snow tires and chains79
 - tire grades77

- treadwear76
- Towing35, 77
 - trailer towing35
 - wrecker56
- Transmission30
 - fluid, checking and adding (automatic)71
 - fluid, refill capacities94
 - lubricant specifications95–96
- Trip odometer13
- Turn signal10

V

- Vehicle Identification Number (VIN)97
- Vehicle loading33
- Ventilating your vehicle26

W

- Warning chimes10
- Warning lights (see Lights)6
- Water, Driving through38
- Windshield washer fluid and wipers
 - operation20
- Wrecker towing56

Filling station information

FILLING STATION INFORMATION

Fuel information	Unleaded only - 87 octane
Fuel tank capacity	284.0L (75 gallons)
Engine oil (includes filter change)	5.7L (6.0 quarts). Use Motorcraft SAE 5W-20 Super Premium Motor Oil, Ford specification WSS-M2C153-H.
Tire size and pressure	Refer to the Certification Label.
Power steering fluid capacity	Keep in FULL range on dipstick. Use Motorcraft MERCON® ATF.
Automatic transmission fluid capacity ¹	16.8L (17.7 quarts). Use Motorcraft MERCON® ATF.

¹ Ensure the correct automatic transmission fluid is used. Transmission fluid requirements are indicated on the dipstick or on the dipstick handle. Check the container to verify the fluid being added is of the correct type. Refer to your scheduled maintenance guide to determine the correct service interval.

Some transmission fluids may be labeled as dual usage, such as MERCON® and MERCON® V. These dual usage fluids are not to be used in an automatic transmission that requires use of the MERCON® type fluid. However, these dual usage fluids may be used in transmissions that require the MERCON® V type fluid.

MERCON® and MERCON® V type fluids are not interchangeable. DO NOT mix MERCON® and MERCON® V. Use of a transmission fluid that indicates dual usage (MERCON® and MERCON® V) in an automatic transmission application requiring MERCON® may cause transmission damage. Use of any fluid other than the recommended fluid may cause transmission damage.