

A Word to Mazda Owners

Thank you for choosing a Mazda. We at Mazda design and build vehicles with complete customer satisfaction in mind.

To help ensure enjoyable and trouble-free operation of your Mazda, read this manual carefully and follow its recommendations.

An Authorized Mazda Dealer knows your vehicle best. So when maintenance or service is necessary, that's the place to go.

Our nationwide network of Mazda professionals is dedicated to providing you with the best possible service.

We assure you that all of us at Mazda have an ongoing interest in your motoring pleasure and in your full satisfaction with your Mazda product.

Mazda North American Operations

Important Notes About This Manual

Keep this manual in the glove box as a handy reference for the safe and enjoyable use of your Mazda. Should you resell the vehicle, leave this manual with it for the next owner.

Please be aware that this manual applies to all models, equipment and options. As a result, you may find some explanations for equipment not installed on your vehicle.

A Word to Mazda Owners

All specifications and descriptions are accurate at the time of printing. Because improvement is a constant goal at Mazda, we reserve the right to make changes in specifications at any time without notice and without obligation.

Air Conditioning and the Environment

Your Mazda's genuine air conditioner is filled with R134a, a refrigerant that has been found not to damage the earth's ozone layer. If the air conditioner does not operate properly, consult an Authorized Mazda Dealer.

How to Use This Manual

We want to help you get the most driving pleasure from your vehicle. Your owner's manual, when read from cover to cover, can do that in many ways.

Illustrations complement the words of the manual to best explain how to enjoy your Mazda. By reading your manual, you can find out about the features, about important safety information, and about driving under various road conditions.

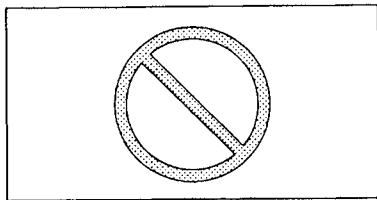

The above symbol in this manual means "Do not do this" or "Do not let this happen"

Index: A good place to start is the Index, an alphabetical listing of all information in your manual.

Sections: This manual has eleven sections. Sections 1 through 10 begin with a brief list of contents, so you can usually tell at a glance if that section has the information you want.

You'll find several WARNINGS, CAUTIONS, and NOTES in the manual.

How to Use This Manual

WARNING

A WARNING indicates a situation in which serious injury or death could result if the warning is ignored.

NOTE

A NOTE provides information and sometimes suggests how to make better use of your vehicle.













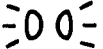



CAUTION

A CAUTION indicates a situation in which bodily injury or damage to your vehicle, or both, could result if the caution is ignored.

How to Use This Manual

Graphic symbols:

Some of the following symbols are used to identify controls and displays on your vehicle.

					
LIGHTS	HEADLIGHT HIGH BEAM	HEADLIGHT LOW BEAM	PARKING LIGHTS	ILLUMINATION CONTROL	TURN SIGNALS
					
HOOD RELEASE	TRUNK RELEASE	FUEL	ENGINE COOLANT TEMPERATURE	ENGINE OIL	BATTERY CHARGING SYSTEM
					
BRAKE SYSTEM	VENTILATION FAN	AIR RECIRCULATION	FRESH AIR	VENT	VENT-FLOOR

How to Use This Manual











					
HAZARD WARNING FLASHER	SEAT BELTS	FLOOR	FLOOR DEFROSTING	DEFROSTING	REAR WINDOW DEFROSTER
					
WINDSHIELD WIPER & WASHER	LIGHTER	HORN	WASHER FLUID	CHECK ENGINE LIGHT	

Table of Contents

Your Vehicle at a Glance	1
Essential Safety Equipment	2
Knowing Your Mazda	3
Protecting Your Mazda	4
Driving Your Mazda	5
In Case of Emergency	6
Appearance Care	7
Maintenance	8
Customer Information Including Information on How to Report Safety Defects (page 9-14)	9
Specifications	10
Index	11

1

Your Vehicle at a Glance

Your Mazda is a complex vehicle, but the design throughout considers your safety and comfort paramount. This requires many controls, locks, graphic symbols, mechanisms and amenities that need to be understood for proper operation.

Section 1 illustrates this information to familiarize you with what needs to be known to help make your motoring safer and easier, and lots more fun.

Interior Overview	1-2
Dashboard Overview	1-3
Doors	1-4
Luggage Compartment	1-5

Your Vehicle at a Glance

Interior Overview

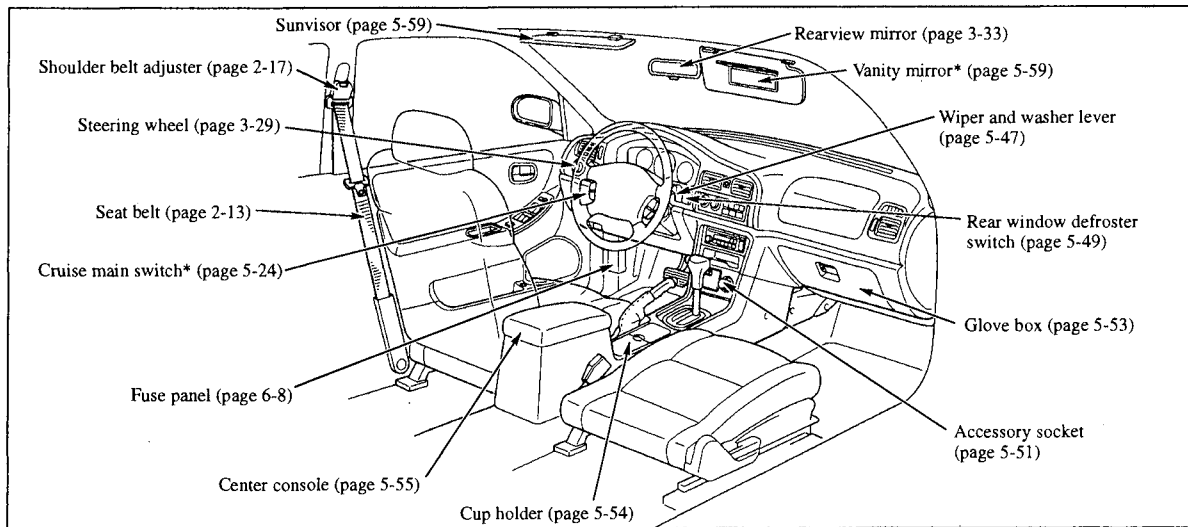

Dashboard Overview

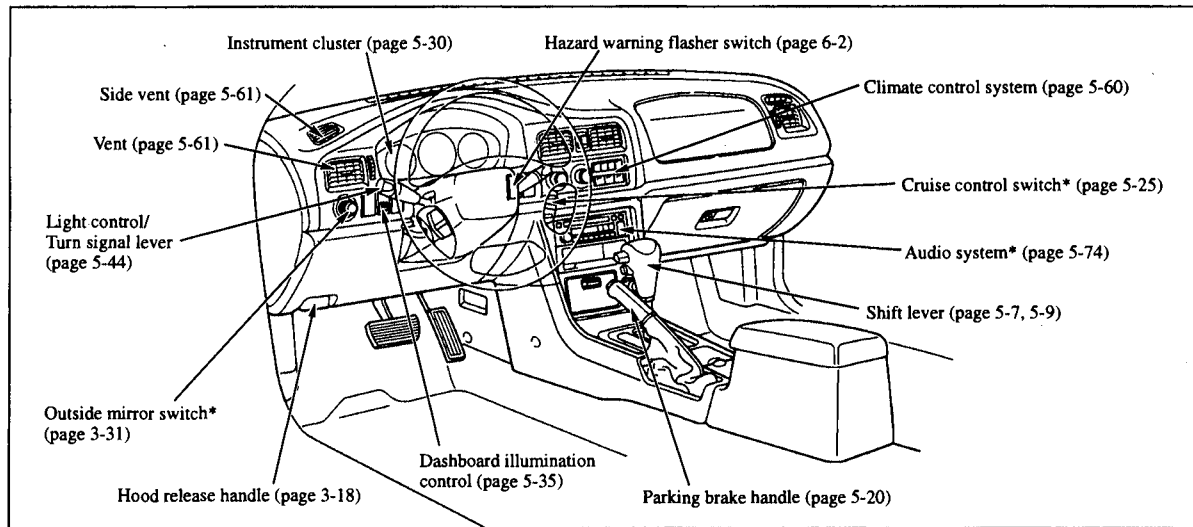

*Some models.

Your Vehicle at a Glance

Doors

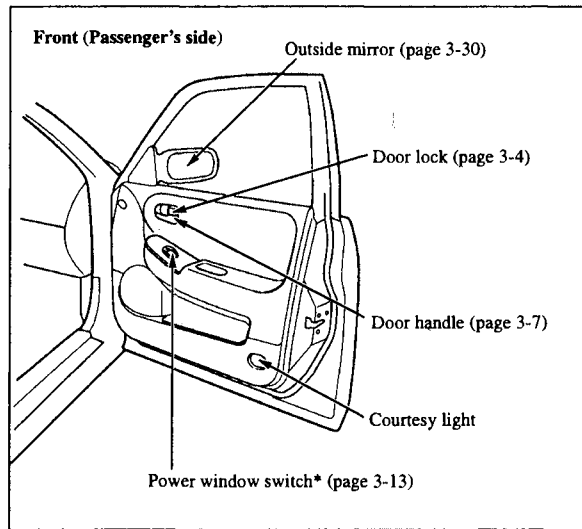
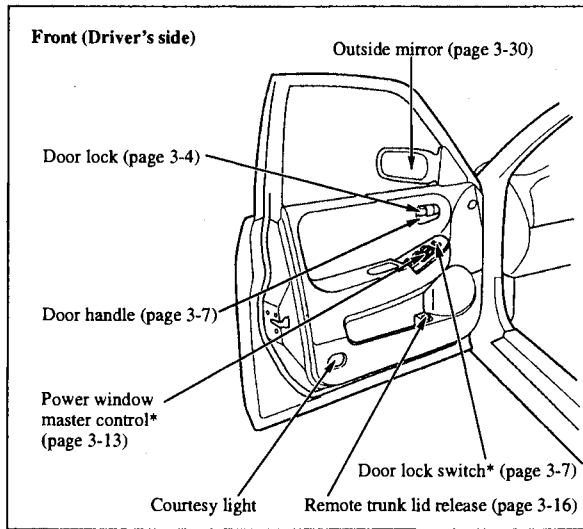

Luggage Compartment

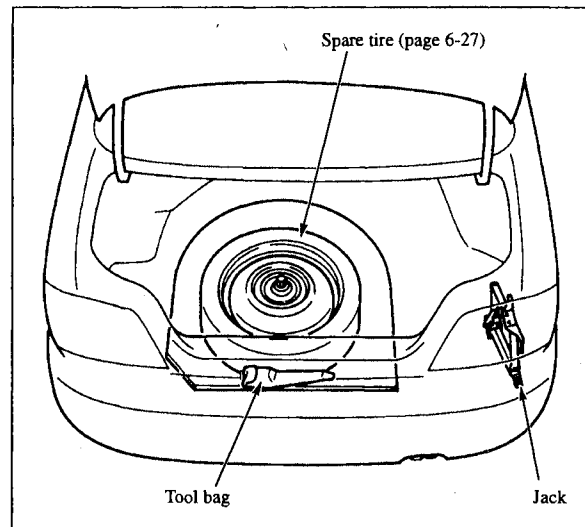
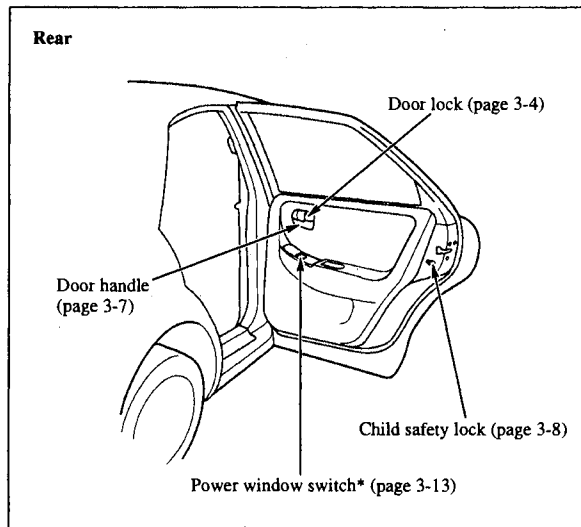

2

Essential Safety Equipment

Personal safety and comfort are what make driving your Mazda a pleasurable experience. Section 2 describes essential information for optimal safe driving including seats, seat belt systems and the supplemental restraint systems.

Front Seats	2- 2
Rear Seat	2- 9
Seat Belt System	2-13
Child Restraint	2-25
Supplemental Restraint Systems	2-34

Front Seats (Manually Operated)

WARNING

Securing the Front Seats:
Adjustable seats and seatbacks that are not securely latched are dangerous. In a sudden stop or collision, the seat or seatback could move, causing injury. Make sure the adjustable components of the seat are locked in place.

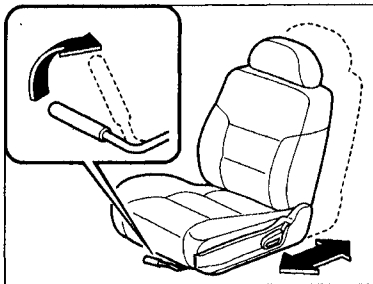

WARNING

Driver's Seat Adjustment:
Adjusting the driver's seat while the vehicle is moving is dangerous. The driver could lose control of the vehicle and have an accident. Adjust the driver's seat only when the vehicle is stopped.

■ Seat Slide

To move each individual front seat forward or backward, raise the lever and slide the seat to the desired position.

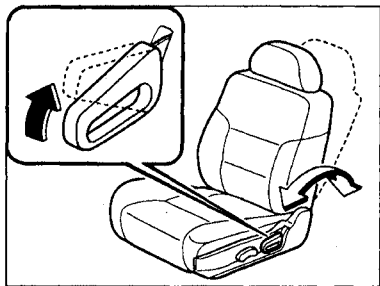

■ Seat Recline

To change each individual seatback angle, lean forward slightly while raising the lever. Then lean back to the desired position and release the lever.

Make sure the lever returned to its

original position and the seatback is locked in place by attempting to push it forward and backward.

⚠ WARNING

Reclining:

Sitting in a reclined position while the vehicle is moving is dangerous because you don't get the full protection from seat belts. During sudden braking or a collision, you can slide under the lap belt and suffer serious internal injuries. For maximum protection, sit well back and upright.

■ Head Restraint

⚠ WARNING

Head Restraints Adjustment:
Driving with the head restraints adjusted too low or removed is dangerous. With no support behind your head, your neck could be seriously injured in a collision. Always drive with the head restraints inserted when seats are being used and make sure they are properly adjusted.

Essential Safety Equipment

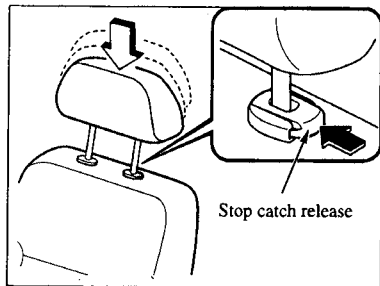

Adjust the head restraint so that the top parallels the top of the passenger's ears, never the passenger's neck.

▼ Height adjustment

To raise a head restraint, pull it up to the desired position.

To lower the head restraint, press the stop-catch release, then push the head restraint down.

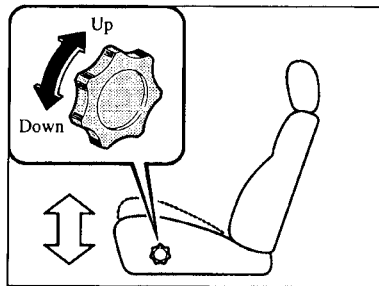

■ Seat Tilt (Driver's Seat)

The seat-bottom angle can be adjusted by rotating the dial. The dial tilts the seat-bottom upward.

Front Seats (Electrically Operated)

The seat-bottom tilt, seat height and seat slide can be electrically adjusted. Move them to the desired positions by using the switch on the seat's lower side.



CAUTION

- The seat-bottom power adjust is operated by a motor. Avoid extended operation because excessive use can damage the motor.
- To prevent the battery from running down, avoid using the power adjust when the engine is stopped. The adjuster uses a great amount of electric power.

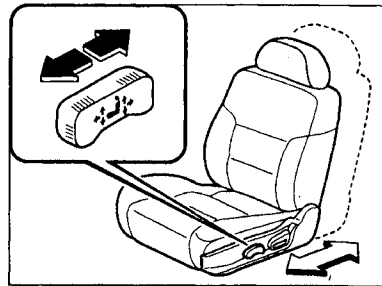

■ Seat Slide

To slide the front seat, move the slide lifter switch on the left side of the seat to the front or back and hold it. Release the switch when the seat is where you want it.

Essential Safety Equipment

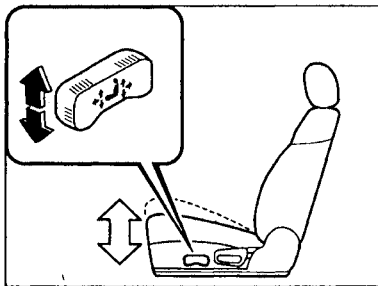

■ Seat-Bottom Front Height Adjustment

To adjust the front height of the seat-bottom, raise or lower the front of the slide lifter switch on the left side of the seat.

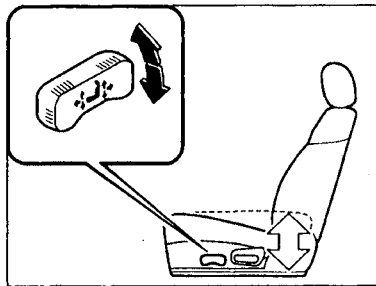

■ Seat-Bottom Rear Height Adjustment

Raise or lower the back of the switch to adjust the rear height of the seat-bottom.

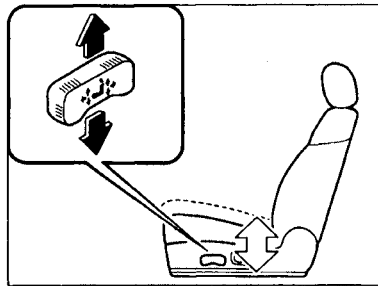

■ Seat Height Adjustment

Raise the seat-bottom by pulling up on the center of the switch. Release the switch when the seat is where you want it.

Lower the seat-bottom by pressing down on the center and releasing it when the seat is where you want it.

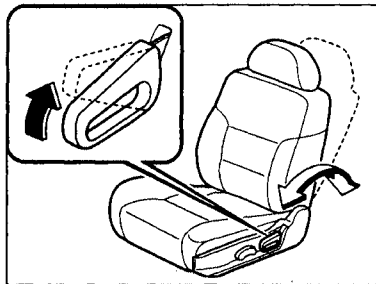

■ Seat Recline

To change each individual seatback angle, lean forward slightly while raising the lever. Then lean back to the desired position and release the lever.

Make sure the lever returned to its original position and the seatback is locked in place by attempting to push it forward and backward.

WARNING

Reclining:

Sitting in a reclined position while the vehicle is moving is dangerous because you don't get the full protection from seat belts. During sudden braking or a collision, you can slide under the lap belt and suffer serious internal injuries. For maximum protection, sit well back and upright.

■ Head Restraint

WARNING

Head Restraints Adjustment:
Driving with the head restraints adjusted too low or removed is dangerous. With no support behind your head, your neck could be seriously injured in a collision. Always drive with the head restraints inserted when seats are being used and make sure they are properly adjusted.

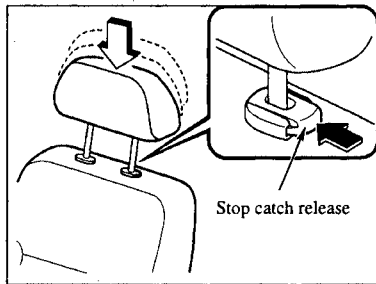

Adjust the head restraint so that the top parallels the top of the passenger's ears, never the passenger's neck.

▼ Height adjustment

To raise a head restraint, pull it up to the desired position.

To lower the head restraint, press the stop-catch release, then push the head restraint down.

Rear Seat

⚠ WARNING

Stacking Cargo:

Stacking luggage or other cargo higher than the seatbacks or putting things on the rear package tray is dangerous. During sudden braking or a collision, it can become a projectile that may hit and injure passengers. Don't stack things higher than the seatbacks or put things on the rear package tray.

⚠ WARNING

Securing Seat:

Adjustable seats and seatbacks that are not securely latched are dangerous. In a sudden stop or collision, the seat or seatback could move, causing injury. Make sure the adjustable components of the seat are locked in place.

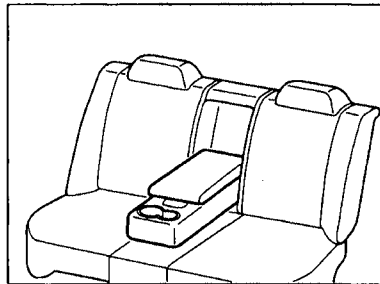

■ **Armrest***

The armrest can be used or placed upright.

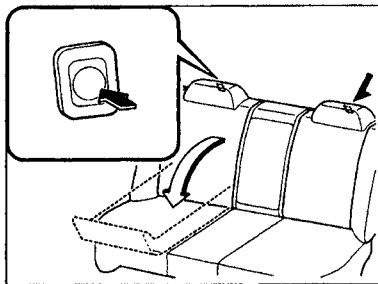

■ Split-Folding Rear Seat

To provide more space in the trunk:

1. Unfasten the lap portion of the rear-center seat belt (page 2-21).

2. Push the button and fold the seatback forward.

NOTE

Unlock the seatback before you fold it forward (page 2-12).

⚠ CAUTION

Don't let the seat belt or buckle get caught between the seat bottom and seatback when folding the seat. The seat belt and buckle could be damaged.

To return the seatbacks to their original positions:

1. Lift the seatback and push it firmly into place.
2. Fasten the lap portion of the rear-center seat belt (page 2-21).

⚠ CAUTION

Don't let the rear-center seat belt plates or buckles get caught between the seatback and the rear package tray.

NOTE

When you return the seatbacks to their original position:

- Make sure the seatbacks are securely latched by attempting to push the seatback forward and backward.
- Make sure the rear seat belts can be pulled out of the retractors. If a belt is locked, firmly pull and release it, then slowly pull it out again.

**WARNING****Unlocked Seatback:**

A seatback plays an important role in your protection in a vehicle. Leaving the seatback unlocked is dangerous as it can allow passengers to be ejected or thrown around and baggage to strike occupants in a sudden stop or collision, resulting in severe injury. After returning the seat at any time, even when there are no other passengers, attempt to push the seatback forward and backward to make sure it is locked in place.

**WARNING****Passenger on the Folded Seatback:**

Driving with a passenger on the folded seatback is dangerous. Allowing a child to sit up on the folded seatback while the vehicle is moving is particularly dangerous. In a sudden stop or even a minor collision, a child not in a proper seat or child-restraint system and seat belt could be thrown forward, back or even out of the car resulting in serious injuries or death. The child or other objects in the baggage area could be thrown into other

(Continued)

occupants and cause serious injury. Never allow a passenger to sit or stand on the folded seatback while the vehicle is moving.

WARNING

Children and the Folding Rear Seat:
Playing with the folding rear seat is dangerous. The folding rear seatbacks cannot be folded down from inside the luggage compartment. Do not give the car keys to children and do not allow them to play in the vehicle.

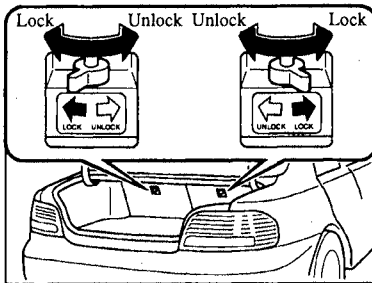

■ Rear Seatback Lock

To lock or unlock a seatback, move the lever.

NOTE

The seatback locks are part of the trunk security system (page 3-17).

Seat Belt System

Seat belts help to decrease the possibility of severe injury during accidents and sudden stops. Mazda recommends that the driver and all passengers always wear seat belts.

All of the seat belt retractors are designed to keep the lap/shoulder belts out of the way when not in use.

The driver's seat belt has no provisions for child-restraint systems and has only an emergency locking mode. The driver may wear it comfortably, and it will lock during a collision.

However, the front passenger's seat and rear lap/shoulder belt retractors

operate in two modes, emergency locking mode and for child-restraint systems, automatic locking mode.

Emergency locking mode

If the belt has fully retracted, it will always be in the emergency locking mode until you move it into automatic locking mode by pulling the belt all the way out to its full length. In the emergency locking mode, the belt remains comfortable on the occupant and the retractor will lock in position during a collision.

If the belt feels tight and hinders comfortable movement while the vehicle is stopped or in motion, you

may be in the automatic locking mode because you have pulled the belt too far out. To return to the more comfortable emergency locking mode, wait until you can stop the vehicle in a safe area, retract the belt fully to convert it back to emergency locking mode and then again extend it around you.

Automatic locking mode

Always use the automatic locking mode to keep the child-restraint system from shifting to an unsafe position in the event of an accident. To get the seat belt into the automatic locking mode, pull it all the way out and connect it as instructed on the

child-restraint system. It will retract down to the child-restraint system and stay locked on it. See the section on child restraint (page 2-25).

WARNING

Not Wearing Seat Belts:
Not wearing a seat belt is extremely dangerous. During a collision, occupants not wearing seat belts could hit someone or things inside the vehicle or even be thrown out of the vehicle. They could be seriously injured or even killed. In the same collision, occupants wearing seat belts would be much safer. Always wear your seat belt and make sure all occupants are properly restrained.

WARNING

Seat Belt Damaged During an Accident:
Using a damaged seat belt is dangerous. An accident could damage the belt webbing of the seat belt in use. A damaged seat belt cannot provide adequate protection in a collision. Have an Authorized Mazda Dealer inspect all seat belt systems in use during an accident before they are used again.

⚠ WARNING

Twisted Seat Belts:

Twisted seat belts can cause injury. In a collision, the full width of the belt isn't available to absorb the impact. This puts more force on the bones beneath the belt, which could break them or cause other serious injury or death. Don't wear twisted seat belts.

⚠ WARNING

One Belt, One Passenger:

Using one seat belt for more than one person at a time is dangerous. A seat belt used in this way can't spread the impact forces properly and the two passengers could be crushed together and seriously injured or even killed. Never use one belt for more than one person at a time.

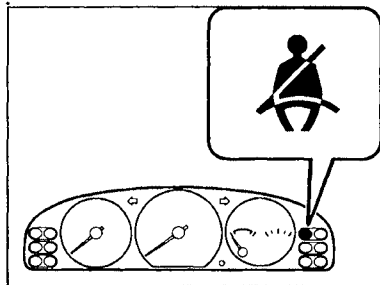

■ **Seat Belt Warning Light/Beep**

If the driver's seat belt is not fastened when the ignition switch is turned to the ON position, a beep will sound for about 6 seconds and the seat belt warning light will remain on until the belt is fastened.

If the system does not operate correctly, consult an Authorized Mazda Dealer.

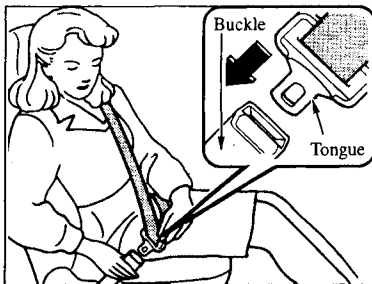

3. Insert the tongue into the buckle until you hear a click.
4. Make sure the shoulder belt is snugly fitted against your body.

■ Front Seat Belts

To fasten:

1. Grasp the buckle and tongue.
2. Slowly pull out the lap/shoulder belt.

⚠ WARNING

Positioning the Shoulder Portion of the Seat Belt:

Improper positioning of the shoulder portion of the seat belt is dangerous. An improperly positioned belt will provide little or no protection in a collision. Always make sure the shoulder portion of the seat belt is positioned across your shoulder and near your neck, but never under your arm, on your neck, or on your upper arm.

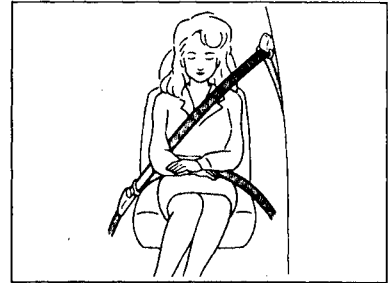
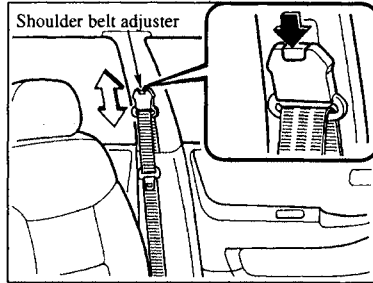

This adjusts the shoulder belt angle for a more comfortable fit. Simply push the button, move it to the desired position, and then release it. Make sure the adjuster is locked.

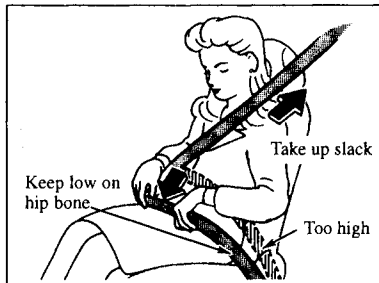

⚠ WARNING

Positioning the Lap Portion of the Seat Belt:

The lap portion of the seat belt worn too high can be dangerous. In a collision, this would concentrate the impact force directly on the abdominal area, causing serious injury. Wear the lap portion of the belt snugly and as low as possible.

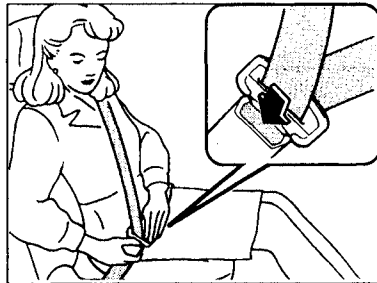

To unfasten:

Press the button on the buckle.

NOTE

If a belt does not fully retract, inspect it for kinks and twists.

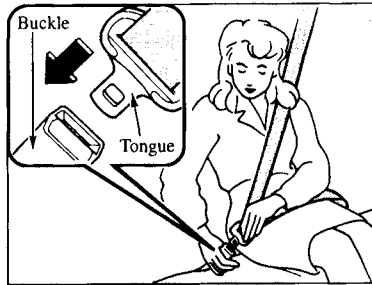

2. Insert this tongue into the buckle until you hear a click.
3. Make sure the shoulder belt is snugly fitted against your body.

The retractor will take up excess belt and maintain tension.

■ Rear Seat Belts

To fasten:

1. Grasp the tongue and pull it to the desired length.

⚠ WARNING

Positioning the Shoulder Portion of the Seat Belt:

Improper positioning of the shoulder portion of the seat belt is dangerous. An improperly positioned belt will provide little or no protection in a collision. Always make sure the shoulder portion of the seat belt is positioned across your shoulder and near your neck, but never under your arm, on your neck, or on your upper arm.

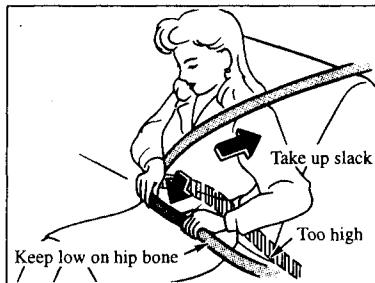

⚠ WARNING

Positioning the Lap Portion of the Seat Belt:

The lap portion of the seat belt worn too high can be dangerous. In a collision, this would concentrate the impact force directly on the abdominal area, causing serious injury. Wear the lap portion of the belt snugly and as low as possible.

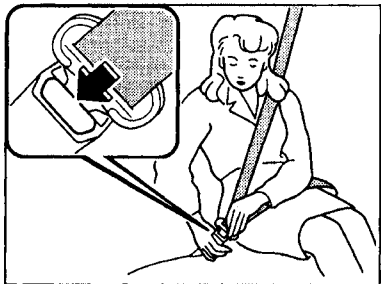

To unfasten:

Depress the button on the buckle.

NOTE

If a belt does not fully retract, inspect it for kinks and twists.

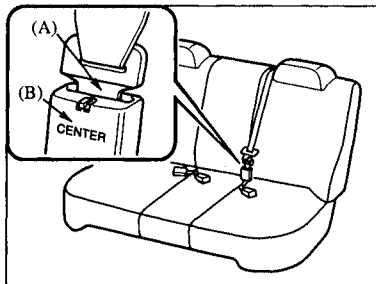

▼ Rear-center belt

To use the rear-center belt:

Before using the rear-center lap/shoulder belt make sure tongue (A) and anchor buckle (B) are fastened.

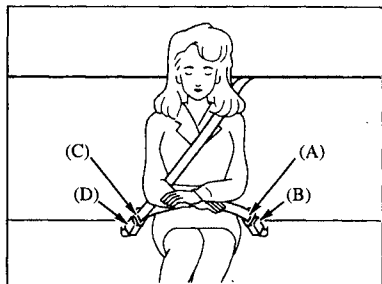

This portion will serve as the lap belt portion of the lap/shoulder belt when tongue (C) and buckle (D) are fastened.

WARNING

Fastening the Rear-Center Seat Belt Only with one Buckle:

Fastening the rear-center seat belt only with one buckle could be dangerous. If only one pair of seat belt tongue and buckle, either tongue (A) and buckle (B) or tongue (C) and buckle (D), is fastened, the seat belt cannot provide full protection. In a sudden stop or collision, the user could slide under the belt and suffer serious injuries. Always make sure that both pair of seat belt tongues and buckles are fastened properly.

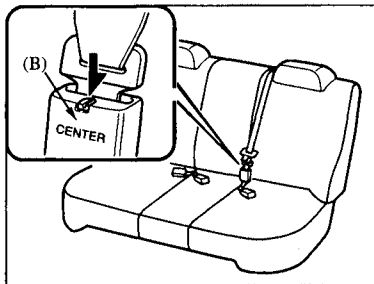

To unfasten the lap belt portion:

Insert a small object in the anchor buckle (B) slot, such as a key.

NOTE

Always unfasten the lap portion of the belt before folding the rear-left seatback. Leaving the lap portion of the belt fastened could cause damage to the seatback.

To fasten the lap belt portion:

Grasp tongue (A) and insert it into the anchor buckle (B) until you hear a click. It is now secure for passenger use.

NOTE

After returning the rear-left seatback to its upright position, fasten the lap portion of the belt.

■ **Seat Belt Extender**

If your seat belt is not long enough, even when fully extended, a seat belt extender may be available to you at no charge from your Authorized Mazda Dealer. This extender will be only for you and for the particular vehicle and seat. Even if it plugs into other seat belts, it may not hold in the critical moment of a crash. When ordering an extender, only order one that provides the necessary additional length to fasten the seat belt properly. Please contact your Authorized Mazda Dealer for more information.

 **WARNING**

***Unnecessary Use of an Extender:**
Using a seat belt extender when not necessary is dangerous. The seat belt will be too long and not fit properly. In an accident, the seat belt will not provide adequate protection and you could be seriously injured. Only use the extender when it is required to fasten the seat belt properly.*

WARNING

Using an Improper Extender:
Using a seat belt extender that is for another person or a different vehicle or seat is dangerous. The seat belt will not provide adequate protection and the user could be seriously injured in an accident. Only use the extender provided for you and for the particular vehicle and seat. NEVER use the extender in a different vehicle or seat.

WARNING

Using an Extender That is Too Long:
Using an extender that is too long is dangerous. The seat belt will not fit properly. In an accident, the seat belt will not provide adequate protection and you could be seriously injured. Don't use the extender or choose one shorter in length if the distance between the extender's buckle and the center of the user's body is less than 6 inches (15 cm).

■ **Pregnant Women**

Pregnant women should wear seat belt assemblies as recommended by their doctors. The lap belt should be worn **SNUGLY AND AS LOW AS POSSIBLE.**

Child Restraint

■ Child Restraint Precautions

Statistics confirm that the rear seat is the best place for all children up to 12 years of age-the more so with a supplemental restraint system (air bags).



WARNING

Holding a Child While the Vehicle is Moving:

Holding a child in your arms while the vehicle is moving is extremely dangerous. No matter how strong the person may be, he or she cannot hold onto a child in a sudden stop or collision and could result in serious injury or death to the child or other occupants. Always secure a child in a proper child-restraint system.



WARNING

One Belt, One Passenger:

Using one seat belt for more than one person at a time is dangerous. A seat belt used in this way can't spread the impact forces properly and the two passengers could be crushed together and seriously injured or even killed. Never use one belt for more than one person at a time.

 **WARNING**

Proper Size of Child-Restraint System:

For effective protection in vehicle accidents and sudden stops, a child must be properly restrained using a seat belt or child-restraint system depending on age and size. If not, the child could be seriously injured or even killed in an accident.

 **WARNING**

Unattended Children and Pets:

Leaving a child or an animal unattended in a parked vehicle is dangerous. In hot weather, temperatures inside a vehicle can become high enough to cause brain damage or even death. Always take all children and animals with you or leave a responsible person with them.

 **WARNING**

Seating Position with Side Air Bag:

Allowing a child to lean over or against the front door is dangerous. If the vehicle is equipped with side air bags, the impact of an inflating side air bag could cause serious injury or death to the child. If a child can't be seated in the rear seat, do not allow the child to lean over or against the front door, even if the child is seated in a child-restraint system.



CAUTION

A seat belt or child-restraint system can become very hot in a closed vehicle during warm weather. To avoid burning yourself or a child, inspect either before using.

▼ Small children

You are required by law to use child-restraint system for children in the U.S. and Canada. Small children, generally those who are four years old or younger and who weigh under 40 lbs. (18 kg), riding in your vehicle must be protected by child-restraint systems made especially for children.

Check your local and state or provincial laws for specific requirements regarding the safety of children riding in your vehicle.

▼ Older children

A child who has outgrown child-restraint systems should sit in the rear and use seat belts, both lap and shoulder. If the shoulder belt crosses the neck or face, move the child closer to the center.

■ Child-Restraint System

A child-restraint system for a small child or baby must itself be properly secured on the seat with the seat belt. You must carefully consult the manufacture's instructions which accompany your child-restraint system.

To provide proper restraint, use a child-restraint system in accordance with the age and size of the child as recommended by the child-restraint system manufacturer.

WARNING

Manufacturer's Instructions for Child-Restraint System:

An unsecured child-restraint system is dangerous. In a sudden stop or a collision it could move causing serious injury or death to the child or other occupants. Make sure the child-restraint system is properly secured in place according to the manufacturer's instructions.

WARNING

Unsecured Child-Restraint System:

A child-restraint system that is not securely fastened down can be dangerous. In a sudden stop or collision, it can become a projectile and hit someone, causing serious injury. When not in use, remove it from the vehicle, put it in the luggage compartment or at least secure it with a seat belt.

■ **Installing a Child-Restraint System**

Accident statistics reveal that a child is safer in the rear seat. Furthermore, the front passenger's seat is not safe for a rear-facing child-restraint system. The rear seat is usually the safest place. Nevertheless, the front and rear passenger lap/shoulder belts can easily be converted into the automatic locking mode, which must be done to hold the child-restraint system.

NOTE

Installation of a child-restraint system which requires a tether on the front passenger's seat, is not possible.



WARNING

Manufacturer's Instructions for Child-Restraint System:
An unsecured child-restraint system is dangerous. In a sudden stop or a collision it could move causing serious injury or death to the child or other occupants. Make sure the child-restraint system is properly secured in place according to the manufacturer's instructions.

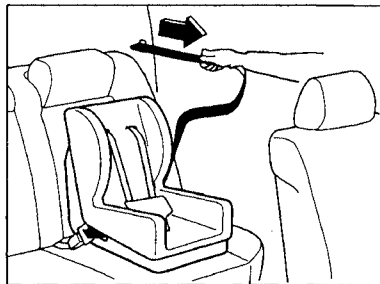

▼ Rear seat

Follow these instructions when using a child-restraint system.

1. Secure the child-restraint system with the lap portion of the lap/shoulder belt. See the

Essential Safety Equipment

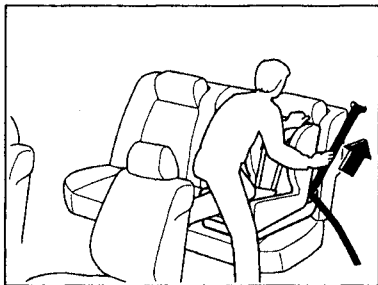

instructions on the child-restraint system for belt routing instructions.

2. To get the retractor into the automatic locking mode, pull the shoulder belt portion of the seat belt until the entire length of the belt is out of the retractor. Push the

child-restraint system firmly into the vehicle seat. Be sure the belt retracts as snugly as possible. Clicking from the retractor will be heard during retraction if the system is in the automatic locking mode. If the belt does not lock, repeat this step.

3. Inspect this function before each use of the child-restraint system. You should not be able to pull the shoulder belt out of the retractor while the system is in the automatic locking mode. When you remove the child-restraint system, be sure the belt fully retracts to return the system to emergency locking mode before occupants use the seat belts.

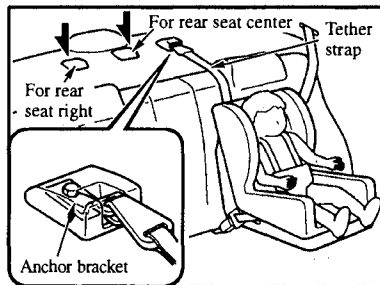

4. If your child-restraint system requires the use of a tether strap, hook the tether strap by following the manufacture's instructions.



WARNING

Child-Restraint Tether Usage:
Using the tether to secure anything but a child-restraint system is dangerous. This could cause the anchor to fail and result in injury. Use the tether to secure only a child-restraint system.

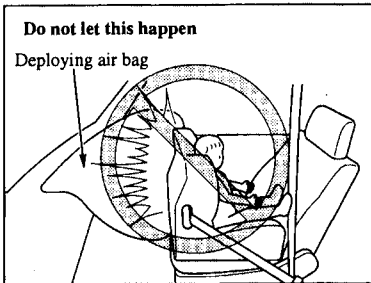

child-restraint system on the front seat is unavoidable, follow these instructions when using a front-facing child-restraint system in the front passenger's seat.

▼ Front passenger's seat

A rear-facing child-restraint system should never be used in the front seat because it would be too close to the air bag. The front passenger's seat is also the least preferred seat for other child-restraint systems. If installing the

WARNING

Child-Restraint System

Positioning:

Rear-facing child-restraint systems on the front seat are particularly dangerous. The child-restraint system can be hit by a deploying air bag and moved violently backward resulting in serious injury or death to the child. Never use a rear-facing child-restraint system in the front seat with an air bag that could deploy.

WARNING

Seating Position with Side Air Bag:

Allowing a child to lean over or against the front door is dangerous. If the vehicle is equipped with side air bags, the impact of an inflating side air bag could cause serious injury or death to the child. If a child can't be seated in the rear seat, do not allow the child to lean over or against the front door, even if the child is seated in a child-restraint system.

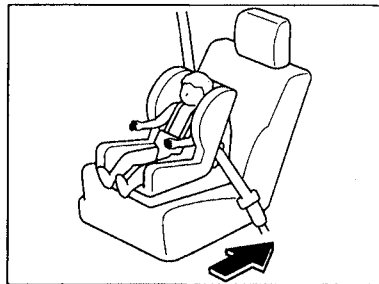

1. Slide the seat as far back as possible.



WARNING

Front Passenger's Seat Position:
If your vehicle is equipped with a passenger air bag, a front-facing child-restraint system could be put on the front seat only when it is unavoidable. Always move the seat as far back as possible, because the force of a deploying air bag could cause serious injury or death to the child.

2. Secure the child-restraint system with the lap portion of the lap/shoulder belt. See the instructions on the child-restraint system for belt routing instructions.
3. To get the retractor into the automatic locking mode, pull the shoulder belt portion of the seat belt until the entire length of the belt is out of the retractor. Push the child-restraint system firmly into the vehicle seat. Be sure the belt retracts as snugly as possible. Clicking from the retractor will be heard during retraction if the system is in automatic locking mode. If the belt does not lock, repeat this step.
4. Inspect this function before each use of the child-restraint system. You should not be able to pull the shoulder belt out of the retractor while the system is in the automatic locking mode. When you remove the child-restraint system, be sure the belt fully retracts to return the system to emergency locking mode before occupants use the seat belts.

Supplemental Restraint Systems

■ **The front and side* supplemental restraint systems include 4 air bags. They are located in:**

- **The steering wheel**
- **The passenger side dashboard**
- **The outboard sides of the front seatbacks**

These systems operate independently depending on the type of accident encountered; both side air bags are not likely to deploy in the same accident because a vehicle is not often hit from both sides. The front and side air bag systems will not normally deploy during the same type of accident unless a combination of frontal and side impacts occur.

In a front-end or side impact, the air bag supplemental restraint systems are designed to provide only supplemental protection for the driver and front seat passenger. Seat belts must still be worn.

Without seat belt usage, the air bags cannot provide adequate protection during an accident. Seat belt usage is necessary to:

- **Keep the passenger away from an inflating air bag.**
- **Reduce the possibility of injuries during an accident that is not designed for air bag inflation, such as roll-over or rear impact.**

- **Reduce the possibility of injuries in frontal or side collisions that are not severe enough to activate the air bag.**
- **Reduce the possibility of being thrown from your vehicle.**
- **Reduce the possibility of injuries to lower body and legs during an accident because the air bag allows no protection to these parts.**
- **Hold the driver in a position which allows better control of the vehicle.**

 **WARNING**

Air Bags without Seat Belts:
Depending only on the air bags for protection during an accident is dangerous. Alone, air bags may not prevent serious injuries. The appropriate air bags can be expected to inflate only during a frontal, side or near-frontal collision of at least moderate force. Vehicle occupants should always wear seat belts.

Small children, those under 40 lbs. (18 kg), should be protected by a child-restraint system (page 2-25).

 **WARNING**

Child in the Front Seat:
Placing a child, 12 years or under, in the front seat is dangerous. The child could be hit by a deploying air bag and be seriously injured or even killed. A sleeping child is more likely to lean against the door and be hit by the side air bag in a moderate, right-side collision. Whenever possible, always secure a child 12 years and under in the rear seat with an appropriate child-restraint system for the child's age and size. Never use a rear-facing

(Continued)

child-restraint system on the front seat with an air bag that could deploy.

WARNING

Child-Restraint System

Positioning:

Rear-facing child restraint systems on the front seat are particularly dangerous. The child-restraint system can be hit by a deploying air bag and moved violently backward resulting in serious injury or death to the child. Never use a rear-facing child-restraint system in the front seat with an air bag that could deploy.

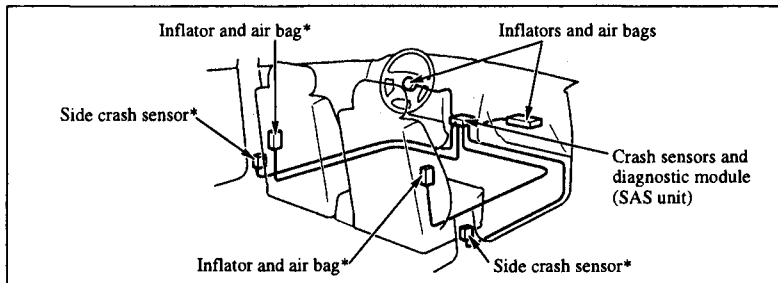

■ System Description

The supplemental restraint systems have two basic subsystems:

- The electric system with crash sensors and diagnostic module.
- The air bag system with inflators and air bags.

The air bags are mounted in the following locations: the center of the steering wheel, the passenger-side of the dashboard, and in the outboard sides of the front seatbacks. They are out of sight until activated.

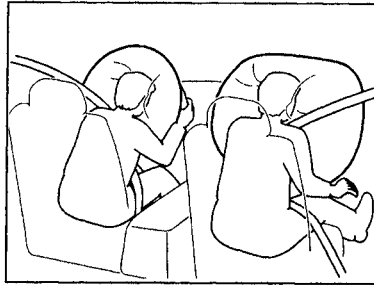

bags quickly deflate.

■ How the Air Bags Work

When air bag crash sensors detect a frontal or side impact of greater than moderate force, an electrical current is sent to the inflators. Nitrogen and argon gases are produced to inflate the air bags. After the inflation, the air

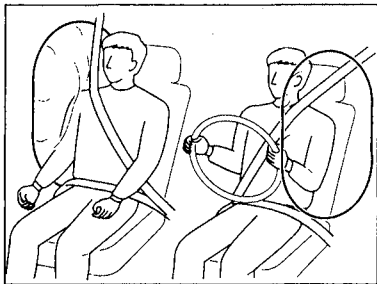

The air bags will function only once. After that, **the air bags will not work again and must be replaced.**

Only an Authorized Mazda Dealer can replace the systems.

WARNING

Seating Position with Front Air Bags:

Sitting too close to the air bag storage compartments or placing hands or feet on them is extremely dangerous. Front air bags inflate with great force and speed.

Serious injuries could occur if someone is too close. The driver should always hold onto only the rim of the steering wheel. The front seat passenger should keep both feet on the floor. Front seat occupants should adjust their seats as far back as possible and

(Continued)

always sit upright against the seatbacks with seat belts worn properly.

 **WARNING****Seating Position with Side Air Bags**

Sitting too close to the side air bag storage compartments or placing hands on them is extremely dangerous. A side air bag inflates with great force and speed directly out of the outboard shoulder of the front seat and expands along the front door on the side the car is hit.

Serious injury could occur if someone is sitting too close to the door or leaning against a window in the front seats or if rear seat occupants grab the sides of the

(Continued)

front seatbacks. Furthermore, sleeping up against the door or hanging out the driver's-side window while driving could block the side air bag and eliminate the advantages of supplemental protection.

Give the side air-bags room to work by sitting in the center of the seat while the vehicle is moving with seat belts worn properly.

NOTE

When an air bag deploys, a loud inflation noise can be heard and some smoke will be released. Neither is likely to cause injury.

 **WARNING****Hot Air Bag Inflators:**

Hot air bag inflators are dangerous. Immediately after inflation, the inflators in the steering wheel, dashboard or the seatbacks are very hot. You could get burned. Don't touch the internal components of the air bag storage areas after the bags have inflated.

WARNING

Modification of the Supplemental Restraint System:

Modifying the components or wiring of the supplemental restraint system is dangerous. You could accidentally activate it or make it inoperable. Don't make any modifications to the supplemental restraint system.

This includes installing trim, badges, or anything else over the air bag storage areas. It also includes installing extra electric equipment on or near system components or wiring.

*An Authorized Mazda Dealer can
(Continued)*

provide the special care needed in the removal and installation of front seats. It is important to protect the side air bag wiring and connections to assure that the bags do not accidentally deploy and that the seats retain an undamaged air bag connection.

WARNING

Installation of Front-End Equipment:

Installation of front-end equipment, such as a frontal protection bar (kangaroo bar, bull bar, push bar, etc.), snowplow, or winches, is dangerous. The air bag crash sensor system could be affected. This could cause air bags to inflate unexpectedly, or it could prevent the air bags from inflating during an accident. Front occupants could be seriously injured. Never install any front-end equipment to your vehicle.

 **WARNING**

Front Air Bag Storage Areas:
*Attaching an object to a front air bag storage area or placing something in front of it is dangerous. In an accident, the object could interfere with front air bag inflation and injure the occupants.
Always keep the front air bag storage areas free of objects.*

 **WARNING**

Side Air Bag Storage Areas:
*Attaching things to the seat in such a way as to cover the outboard side of the seat in any way is dangerous. In an accident the object could interfere with the side air bag, which inflates from the outboard side of the front seats, impeding the added protection of the side air bag system or redirecting the air bag in a way that is dangerous. Furthermore, the bag could be cut open spewing exhaust. Do not hang net bags, map pouches or back pads with side
(Continued)*

straps on the front seats. Always keep the side air bag storage areas in your front seats free to deploy in the event of a side collision.

 **WARNING**

Using Seat Covers:
Using a seat cover on the front seats could be dangerous. In a severe side collision, the seat covers could interfere with the side air bag inflation and serious injuries could result. Never use seat covers on the front seats.

WARNING

Damaged Air Bag Sensors:
Driving with damaged air bag sensors is dangerous. A collision, even one not strong enough to inflate the air bags, could damage the sensors. If there was a subsequent collision, a damaged sensor would not inflate the air bags. Always have an Authorized Mazda Dealer inspect the supplemental restraint systems after a collision.

WARNING

Suspension Adjustment:
Adjusting the vehicle suspension is dangerous. If the vehicle's height or the suspension's damping is changed, the vehicle will be unable to accurately detect a collision resulting in incorrect or unexpected air bag deployment and the possibility of serious injuries.

CAUTION

To prevent damage to the side air bag wiring, don't place luggage or other objects under the front seats.

■ Front Air Bag Activation

A greater than moderate impact will cause the front air bags to inflate in the following cases:

- ① Hitting a solid wall straight on at greater than about 14 mph (22 km/h).
- ② Frontal impact within about a 30 degree range from head on to the vehicle.
- ③ Hitting a curb, pavement edge or hard object.
- ④ Driving into a big hole or hitting the far side of a hole.
- ⑤ Landing hard or the vehicle falling.

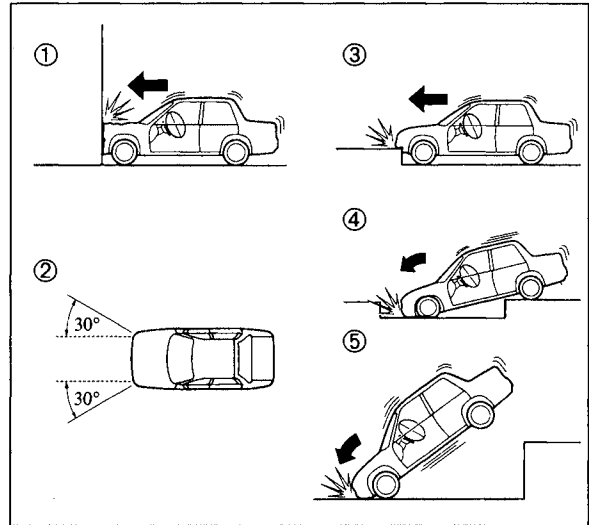

Essential Safety Equipment

■ Limitations to Front Air Bag Activation

Depending of the severity of impact, the front air bags may not inflate in the following cases:

- ① Impacts involving trees or poles cause severe cosmetic damage but may not have enough impact to activate the air bag.
- ② Rear-ending or running under a truck's tail gate may not provide the stopping force necessary for air bag deployment.
- ③ Frontal offset impact to the vehicle may not provide the stopping force necessary for air bag deployment.

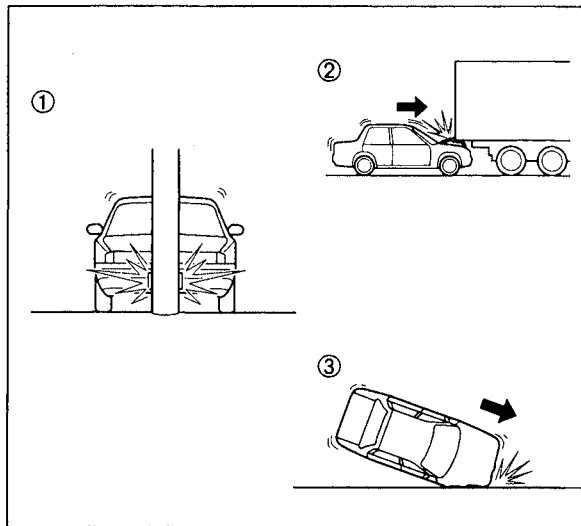

■ Non-Activation of Front Air Bags

Front air bags will not normally inflate in the following cases:

- ① Collision from the rear.
- ② Vehicle roll-over, may deploy the side air bag(s) but not the front air bags.
- ③ Impact to the side, but it may deploy a side air bag.

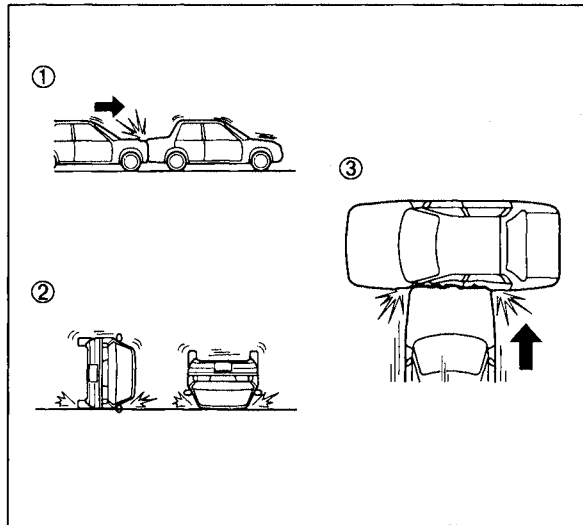

Essential Safety Equipment

■ Side Air Bag Activation

Greater than moderate impact to one side of the vehicle (driver or passenger side areas) will cause a side air bag* to inflate, but it will not normally deploy the front air bags.

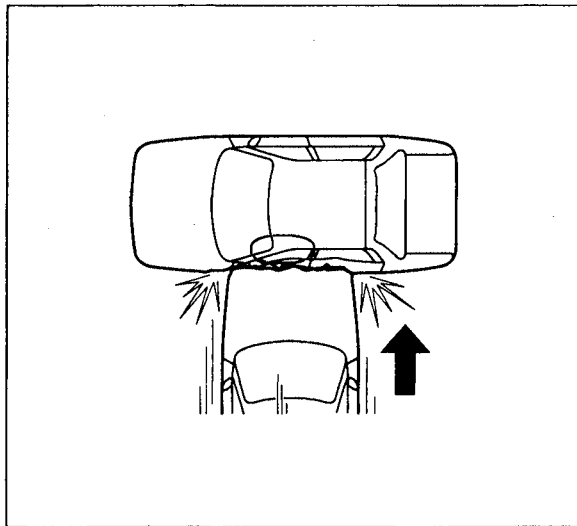

■ Limitations to Side Air Bag Activation

Depending on the severity of impact, a side air bag* may not inflate in the following cases:

- ① Frontal offset impact may not provide enough side impact to deploy a side air bag.
- ② Side impacts involving trees or poles can cause severe cosmetic damage but may have enough impact force to activate a air bag.
- ③ Vehicle roll-over may not provide enough side force to deploy the side air bags.
- ④ Side impacts with two-wheeled vehicles may not provide enough force to deploy a side air bag.

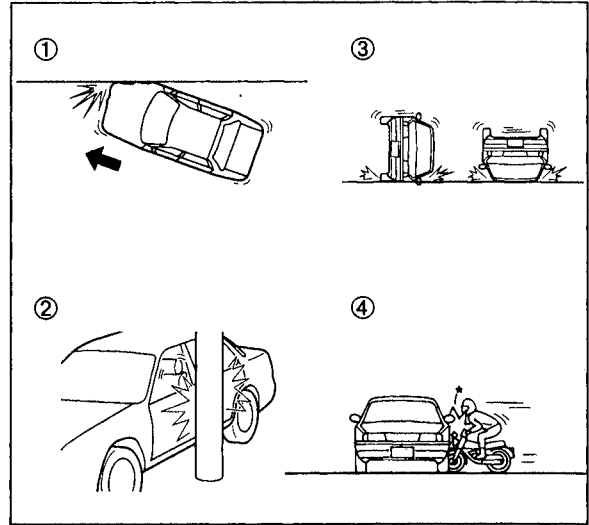

■ Non-Activation of Side Air Bags

A side air bag* will not normally inflate in the following cases:

- ① Collision from the rear.
- ② Collision from the front, but it may deploy the front air bags.

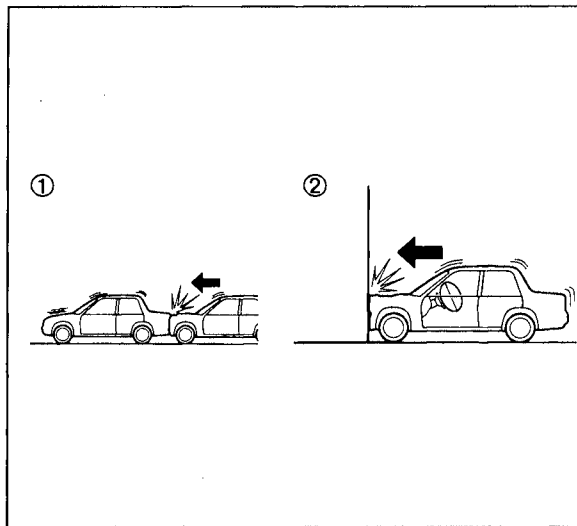

■ Constant Monitoring

The following components of the supplement restraint systems are monitored by a diagnostic system:

- SAS unit
- Air bag modules
- Side air bag crash sensors*
- Related wiring

A diagnostic module continuously monitors the system's readiness. This begins when the ignition switch is turned to the "ON" position and continues while the vehicle is being driven.

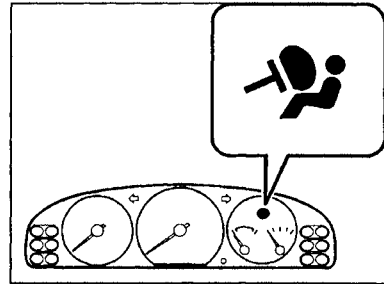

▼ Supplemental restraint system warning light

If the supplemental restraint system is OK, the SRS warning light comes on when the ignition switch is turned to the ON position or after the engine is cranked.

After about 6 seconds it goes out.

A system malfunction is indicated when the SRS warning light constantly flashes, stays on or doesn't come on at all. If any of these occur, consult an Authorized Mazda Dealer as soon as possible. The system may not work in an accident.

WARNING

Self-Servicing the Supplemental Restraint Systems:
Self-servicing or tampering with the supplemental restraint systems is dangerous. An air bag could accidentally activate or become disabled. This could cause serious injuries. Never tamper with the supplemental restraint systems and always have an Authorized Mazda Dealer perform all servicing and repairs.

WARNING

Removing Interior Parts:
Removing the front seat, front dashboard, the steering wheel or parts containing air bag sensors is dangerous. These parts contain essential air bag parts. The air bag could accidentally activate and cause serious injuries. Always have an Authorized Mazda Dealer remove these parts.

 **WARNING*****Air Bag Disposal:***

Improper disposal of an air bag or a vehicle with live air bags in it can be extremely dangerous.

Unless all safety procedures are followed, injury can result. Ask an Authorized Mazda Dealer how to safely dispose of an air bag or how to scrap an air bag equipped vehicle.

■ Maintenance

The supplemental restraint system is maintenance-free. But if any of the following occurs, take your vehicle to an Authorized Mazda Dealer as soon as possible:

- The supplemental restraint system warning light flashes.
- The supplemental restraint system warning light stays on.
- The supplemental restraint system warning light stays off when the ignition switch is turned to the ON position.

- Air bags inflate

NOTE

Should you sell your Mazda, we urge you to tell the new owner of its supplemental restraint systems and that familiarization with all instructions about them, from the Owner's Manual, is important.

3

Knowing Your Mazda

Security takes many forms and is very important to owner and occupants. Section 3 describes the safe way to use your Mazda: keys, locks, windows and interior lighting.

Keys	3- 2
Door Locks	3- 4
Keyless Entry System	3- 9
Power Windows	3-13
Trunk Lid	3-15
Hood Release	3-18
Immobilizer System	3-19
Theft-Deterrent System	3-23
Fuel-Filler Lid	3-27
Fuel-Filler Cap	3-28
Steering Wheel	3-29
Mirrors	3-30
Sunroof	3-34
Interior Light	3-37
Map Lights	3-38
Trunk Light	3-38

Keys

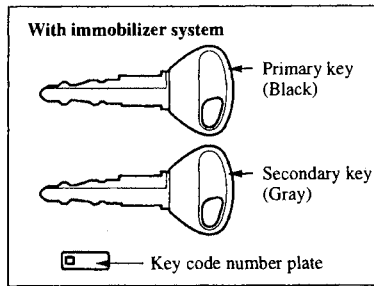
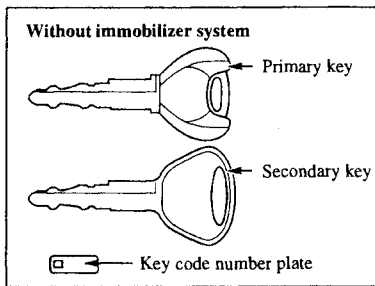

Your Mazda has two kinds of keys: primary and secondary.

(With immobilizer system)*

CAUTION

To avoid damage to the key, do not:

- Drop the key.
- Get the key wet.
- Expose the key to any kind of magnetic field.
- Expose the key to high temperatures on places such as the dashboard or hood, under direct sunlight.

 CAUTION
<p>When starting the engine, do not let the following materials touch the key grip. The engine may not start:</p> <ul style="list-style-type: none"> • Spare keys. • Keys for other vehicles equipped with an immobilizer system. • Metal objects that touch or pass through the hole in the such as key rings.

Here's what the keys are used for.

Key Lock Operates	Primary	Secondary
Ignition switch and steering column lock	Yes	Yes
Doors	Yes	Yes
Glove box	Yes	No
Trunk	Yes	No

If you must leave your vehicle with another person, such as a parking attendant, protect items by locking the glove box and trunk lid with the primary key. Keep that key and give the other person only the secondary key.

A code number is stamped on the plate attached to the key set; detach this plate and store it in a safe place (not in the vehicle) for use if you need to make a replacement key.

Also write down the code number and keep it in another safe and handy place, but not in the vehicle.

If your key is lost, consult your Authorized Mazda Dealer with the code number ready.

Door Locks

WARNING

Keys and Children:

Leaving small children in a vehicle with the ignition key is dangerous. This could result in someone being badly injured or even killed. They could play with power windows or other controls, or even make the vehicle move.

Don't leave the keys in your vehicle with small children.

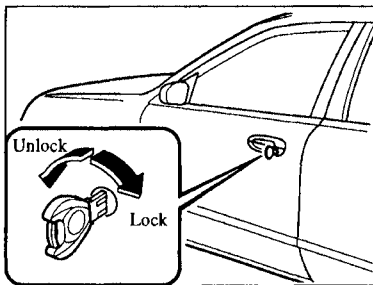

Turn the key counter-clockwise to unlock, clockwise to lock.

■ Outside Door Lock

▼ Locking, unlocking, with key

Either front door can be locked or unlocked with a key.

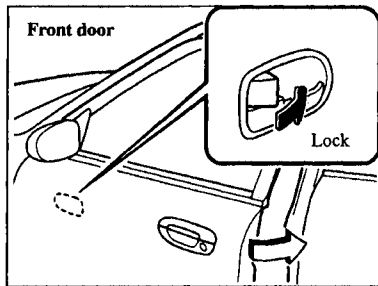

NOTE

When locking the doors this way, be careful not to leave the key inside the vehicle.

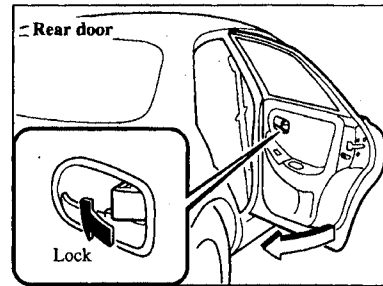

▼ Locking without key

To lock a front door without a key, push the door lock and close the door.

To lock a rear door, push the inside lock button and close the door.

WARNING

Unattended Children and Pets:
Leaving a child or an animal unattended in a parked vehicle is dangerous. In hot weather, temperatures inside a vehicle can become high enough to cause brain damage or even death. Always take all children and animals with you or leave a responsible person with them.

NOTE

Always remove the key from the ignition switch, close all windows, and lock all doors when leaving your vehicle unattended. This discourages intruders and thieves.

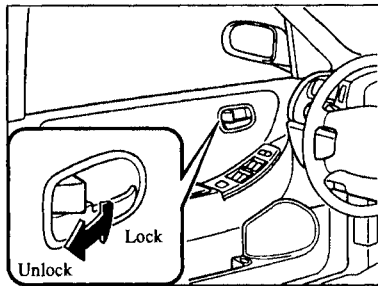

■ **Inside Door Lock**

To lock any door, push the door lock button into the door handle area.

To unlock, pull it.

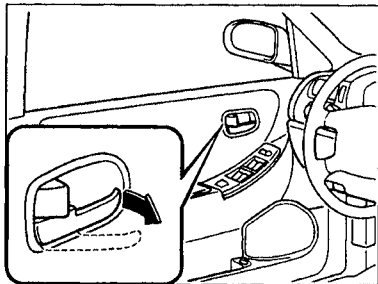

To open, pull the door handle.

⚠ WARNING

Unlocked Doors:
Unlocked doors in a moving vehicle can be dangerous. Passengers can fall out if a door is accidentally opened and can more easily be thrown out in an accident. So keep all doors locked when driving.

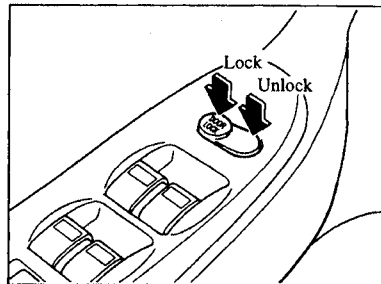

▼ Locking and unlocking with door lock switch*

All doors lock automatically when DOOR LOCK is pushed. They all unlock when the unmarked part of the door-lock switch is pushed.

WARNING

Keys and Children:

Leaving small children in a vehicle with the ignition key is dangerous. This could result in someone being badly injured or even killed. They could play with power windows or other controls, or even make the vehicle move. Don't leave the keys in your vehicle with small children.

NOTE

Always remove the key from the ignition switch, close all windows, and lock all doors when leaving your vehicle unattended. This discourages intruders and thieves.

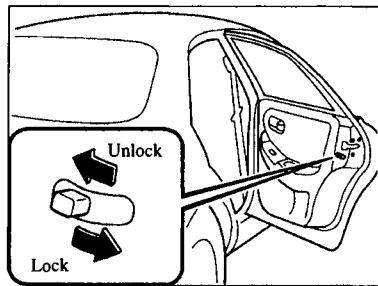

■ Rear Door Child Safety Lock

This lock is intended to help prevent children from accidentally opening the rear doors. Use it whenever a child rides in the vehicle.

Keyless Entry System*

If you slide the child safety lock to the lock position before closing that door, the door cannot be opened from the inside. The door can be opened only by lifting the outside handle.

This system locks and unlocks the doors and opens the trunk.



CAUTION

To avoid damaging the transmitter, don't drop it, get it wet, or expose it to heat or sunlight.

NOTE

- The keyless entry system is designed to operate up to about 8 feet (2.5 meters) from the center of the vehicle, but this may vary because of local conditions.
- The system doesn't operate when the ignition switch is in the ON position.

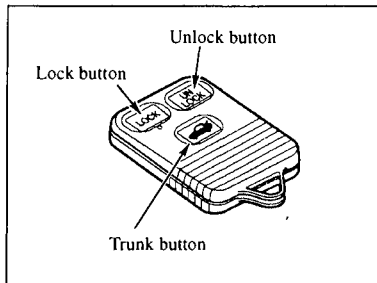

■ Transmitter

NOTE

This device complies with part 15 of the FCC Rules and with RSS-210 of Industry Canada. Operation is subject to the following two conditions: (1) This device may not cause harmful interference, and (2) this device must accept any interference received, including interference that may cause undesired operation. (Outside transmissions may momentarily interfere with the device's operation.)

▼ Lock button (Keyless entry system)

To lock all the doors, press the LOCK button.

To confirm that all doors have been locked, press the LOCK button again within 5 seconds. If they are closed, the horn will sound.

NOTE

Confirm all doors are locked visually or aurally by use of the double click.

▼ **Unlock button (Keyless entry system)**

To unlock the driver's door, press the UNLOCK button.

To unlock all the doors, press the UNLOCK button again within 5 seconds.

▼ **Trunk button (Keyless entry system)**

To open the trunk, press the  button.

NOTE

- If the transmitter does not work, open the back cover and check the battery for correct installation.
- Additional transmitters can be obtained at an Authorized Mazda Dealer. Up to 3 additional transmitters can be used with the keyless entry system per vehicle. Bring all transmitters to an Authorized Mazda Dealer when the electronic codes need to be reset.

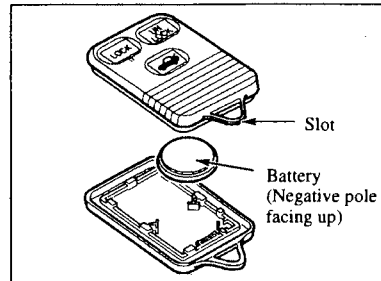

■ **Maintenance**

▼ **Replacing the transmitter battery**

1. Insert a small coin into the slot and gently pry open the transmitter.
2. Pull the battery out.

3. Put in the new battery (CR2032 or the equivalent) with the negative pole (-) facing up.
4. Align the front and back covers and snap the transmitter shut.

▼ Service

If you have a problem with the keyless entry system, consult an Authorized Mazda Dealer.

If your transmitter is lost or stolen, bring all remaining transmitters to an Authorized Mazda Dealer as soon as possible for a replacement and to make the lost or stolen transmitter inoperative.



CAUTION

- Change or modifications could void your right to operate the keyless entry system.
- Damage to your keyless entry system will affect the vehicle warranty coverage.

Power Windows*

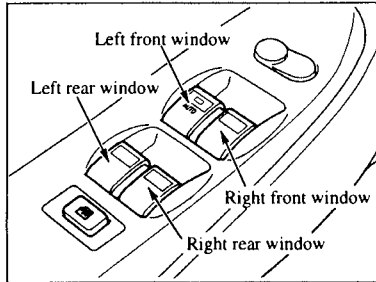

■ Power Window Master Control

The ignition switch must be in the ON position for the power windows to operate.

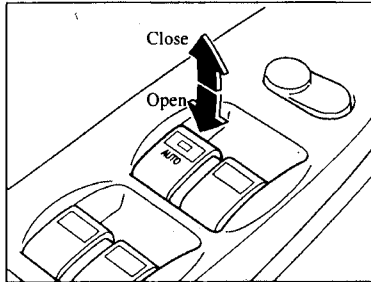

Windows may be opened or closed by the power window master control switches on the driver's door. Also, each door has a switch to open and close its window.

■ One-Touch Power Window (Driver's Window Only)

When the switch is pressed firmly, the window will move to its fully open position. To stop the window partway, lift the switch.

Lift the switch continually to close the window all the way.

WARNING

Closing Power Windows:

Closing power windows can be dangerous. A person's hands, head, or even neck could be caught by the window and result in serious injury. This warning applies especially to children. Make sure the opening is clear before closing a window.

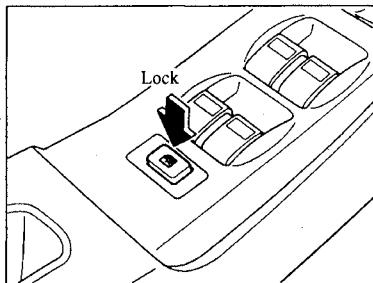

■ Power Window Main Switch

With the main switch in the unlocked position, all power window switches may be used.

With the main switch in the locked position, only the driver's window can be operated.

WARNING

Unintentional Window Operation:

Unintentional window operation could be dangerous. A person's hands, head, or neck could be caught by the window and result in serious injury. Unless a passenger needs to operate a window, keep the power window main switch in the locked position.

⚠ CAUTION

To prevent burning out the fuse and damaging the power window system, don't open or close more than two windows at once.

⚠ WARNING

Children Playing with Power Windows:

Playing with power windows is dangerous. Someone's hands, head, or neck could get caught in a closing window. They would be seriously injured or even killed. Don't let children play with power windows.

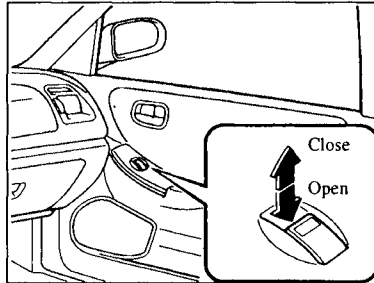

■ **Passenger Door Power Window Switch**

To open the window, push down on its switch. To close, pull the switch up.

Trunk Lid

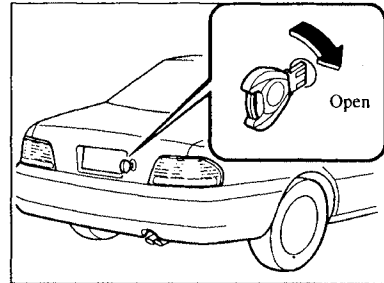

■ **Key-Operated Trunk**

To open the trunk lid, insert the primary key and turn it clockwise.

The secondary key will not operate this lock (page 3-2).

To close, push the lid down until the lock snaps shut. Don't slam it.

Then pull up on it to make sure it's secure.

WARNING

Open Trunk and Exhaust Gas:
Exhaust gas in the cabin of a vehicle is dangerous. This gas contains CO (carbon monoxide), which is colorless, odorless, and highly poisonous. If inhaled, it can cause loss of consciousness and death. Because exhaust gas can get into the cabin through an open trunk, keep the trunk closed when driving.

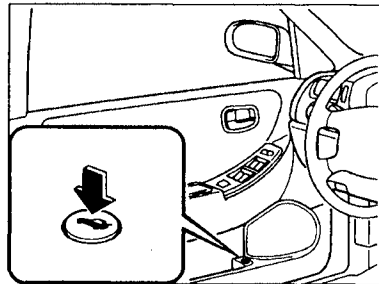

■ Remote Trunk Lid Release

To release the trunk lid from inside the vehicle, push the button.

■ Trunk Security

In some situations you may want to prevent the trunk from being opened with the remote trunk lid release.

If you must leave your Mazda with another person, such as a parking attendant, protect valuables in the trunk by locking the rear seat backs and trunk. Give the other person only the secondary key, which does not open the trunk.

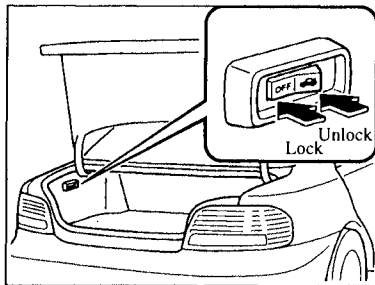

push the right side of the trunk-lock switch.

To secure the trunk lid, lock the rear seatbacks (page 2-12), push the left side of the trunk-lock switch, and close the trunk.

To cancel the security feature, insert the primary key into the lock, turn the key clockwise to open the trunk, and

Hood Release

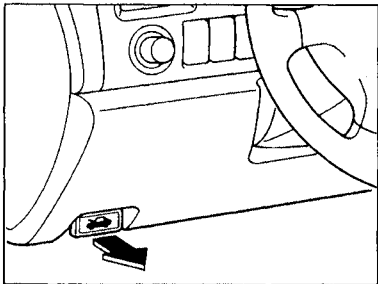

1. With the vehicle parked, pull the release handle to unlock the hood.

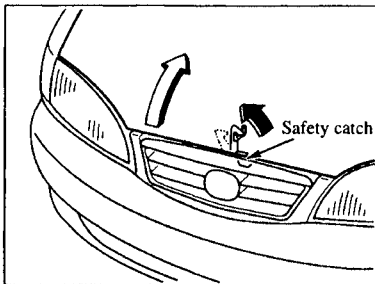

2. Push the safety catch to the left and lift the hood.

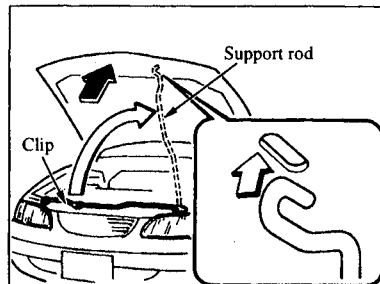

3. Use the support rod to hold the hood open.

Before closing the hood, secure the rod in its clip.

Immobilizer System*

To close the hood:

- Check under the hood area to make certain all filler caps are in place and all loose items (e.g. tools, oil containers, etc.) have been removed.
- Close the hood so that it locks securely.

If the engine is started without the proper key, the immobilizer system will cause the engine to stall, thereby helping to prevent the theft of your vehicle.

If the system is working properly, the warning light will come on when the ignition switch is turned to the START position. The light will go out when the engine starts.

If the light flashes rapidly, fails to come on, or comes on and stays on, it indicates a system malfunction. If any of these occur, contact an Authorized Mazda Dealer as soon as possible.



CAUTION

Changes or modifications not expressly approved by the manufacturer could void the user's authority to operate the equipment.

NOTE

This device complies with part 15 of the FCC Rules and with RSS-210 of Industry Canada. Operation is subject to the following two conditions: (1) This device may not cause harmful interference, and (2) this device must accept any interference received, including interference that may cause undesired operation. (Outside transmissions may momentarily interfere with the device's operation.)

NOTE

- Signals from a TV or radio station, or from a transceiver or a mobile telephone, could interfere with your immobilizer system. If you are using the proper key and your engine fails to start, check the warning light. If it is flashing, turn the key to the OFF position and try again. If the engine doesn't start after 3 or more tries, contact an Authorized Mazda Dealer.

(Continued)

- If the warning light flashes continuously while you are driving, don't shut off the engine. Go to an Authorized Mazda Dealer and have it checked. If you shut off the engine while the light is flashing you won't be able to restart it.

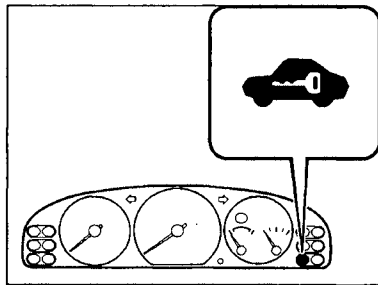

■ **Operation**

When you start the engine with a key the system recognizes, the system will allow the engine to continue running. However, if someone attempts to start the engine with an unrecognized key, the system will stall the engine

immediately after it starts.

NOTE

If the warning light comes on and stays on when the ignition is turned to the ON position, the engine will not start.

■ **Maintenance**

If you have a problem with the immobilizer system or the key, consult an Authorized Mazda Dealer.

NOTE

- The keys carry a unique electronic code. For this reason, and to assure your safety, replacement keys require some waiting time to obtain. They are only available through an Authorized Mazda Dealer.
- Always keep a replacement key, in case one is lost. If a key is lost, contact an Authorized Mazda Dealer as soon as possible.

(Continued)

- If you lose a key, an Authorized Mazda Dealer will reset the electronic codes of your remaining keys and the immobilizer system. Starting the vehicle with a key that has not been reset is not possible.



CAUTION

To avoid damage to the key, do not:

- Drop the key.
- Get the key wet.
- Expose the key to any kind of magnetic field.
- Expose the key to high temperatures on places such as the dashboard or hood, under direct sunlight.



CAUTION

When starting the engine, do not let the following materials touch the key grip. The engine may not start:

- Spare keys.
- Keys for other vehicles equipped with an immobilizer system.
- Metal objects that touch or pass through the hole in the such as key rings.

Theft-Deterrent System*

■ Modification and Add-On Equipment

Mazda cannot guarantee the system's operation if the system has been modified or if any add-on equipment has been installed to it.



CAUTION

To avoid damaging your vehicle, don't modify the system or install any add-on equipment to it.

The optional theft-deterrent system is designed to prevent your vehicle or its contents from being stolen when all of the doors, hood, and trunk lid are locked.

If forcible entry is attempted, the system sounds the horn and flashes the hazard warning lights and headlights.

NOTE

The theft-deterrent system has been designed to operate mainly with the keyless entry system transmitter.

The system won't function unless it's properly armed.

So when you leave your vehicle:

- Lock all doors
- Close all windows
- Take your key and keyless entry system transmitter
- Make sure the security indicator light is flashing

■ Operation

What turns it on:

- Forcing open a door, the hood or the trunk lid.
- Opening the hood or the trunk lid by operating the hood release lever or remote trunk lid release button.
- Opening a door after unlocking the doors with the key or an inside door-lock button.

NOTE
The alarm will activate about 15 seconds after a door has been opened. The indicator light flashes rapidly for about 15 seconds.

What it does:

- The horn sounds intermittently and the hazard warning lights and headlights flash.
- The alarm continues for about 3 minutes, then stops.

When it is triggered, the warning lights and horn will activate. They will shut off when:

- The doors are unlocked with the keyless entry system transmitter.
- The trunk lid is opened with the key or the keyless entry system transmitter.
- The ignition is turned to the ON position.

■ **How to Arm the System**

1. Remove the ignition key.
2. Close the hood and the trunk lid. Then close the doors and press the LOCK button on the keyless entry system transmitter

NOTE

Locking the doors with a key will not arm the system.

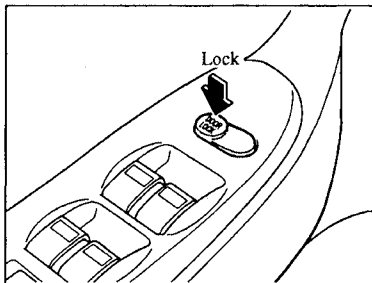

The following method will also arm the theft-deterrent system. Close the hood and the trunk lid. Press the area on the door-lock switch marked "DOOR LOCK" once and then close all the doors.

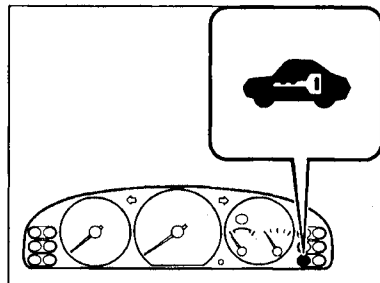

3. The turn signal lights flash for about 2 seconds, then the security indicator light starts to flash every 3 seconds to indicate that the system is fully armed. It continues to flash until the theft-deterrent system is turned off.

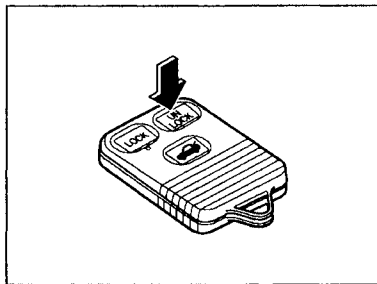

■ To Turn off an Armed System

An armed system can be turned off by pressing the UNLOCK button on the keyless entry system transmitter. If the transmitter doesn't work, unlock the driver's door with a key. Open the door and within 15 seconds, put the

key into the ignition and turn it to the ON position. If it takes longer than 15 seconds the alarm will sound.

NOTE

The trunk lid can be opened with the key or the keyless entry system transmitter even when the system is armed. The alarm will not come on and the system will remain armed.

■ To Stop the Warning Alarm

A triggered alarm can be turned off by opening the trunk with the key or pressing the UNLOCK button or the  button on the keyless entry system transmitter. If the transmitter doesn't work, put the key into the ignition and turn it to the ON position.

NOTE

If you have any problem with the theft-deterrent system, consult an Authorized Mazda Dealer.

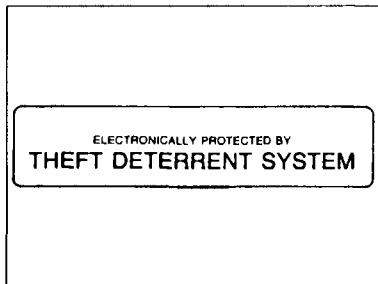

■ **Theft-Deterrent Labels**

Labels indicating that your vehicle is equipped with a Theft-Deterrent System are in the glove box.

Mazda recommends that you affix them to the lower rear corner of the front door windows.

Fuel-Filler Lid

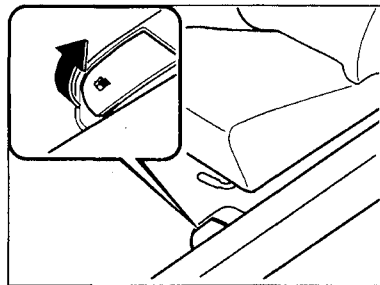

To open, pull the remote fuel-filler lid release up.

Fuel-Filler Cap

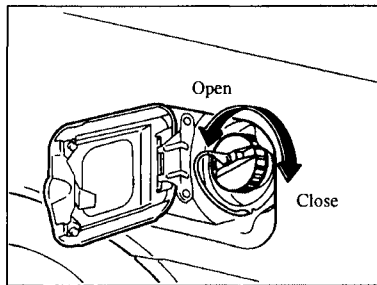

- To remove the filler cap, turn it counterclockwise.
- To replace the filler cap, turn it clockwise until it clicks.

WARNING

Fuel Spray:

Fuel spray is dangerous. Fuel can burn skin and eyes and cause illness when ingested. Fuel spray happens when there is pressure in the fuel tank and the fuel cap is removed too quickly. When removing the fuel cap, loosen the cap slightly and wait for any hissing to stop. Then remove it.

WARNING

Fuel Vapor:

Fuel vapor is dangerous. It could be ignited by sparks or flames; causing serious burns and injuries. Before refueling, stop the engine. And always keep sparks and flames away from the filler neck.

⚠ CAUTION

Always use only a designated Mazda fuel cap or an approved equivalent, available at Authorized Mazda Dealers. The wrong cap can result in a serious malfunction of the fuel and emission control systems. It may also cause the check engine light in the instrument cluster to appear.

⚠ CAUTION

Make sure the fuel-filler cap is tightened securely. The check engine light comes on when the cap isn't tightened securely. If the light remains on (even after you have tightened the cap securely, driven, and restarted the engine several times), it may indicate a different problem. Contact an Authorized Mazda Dealer as soon as possible.

Steering Wheel

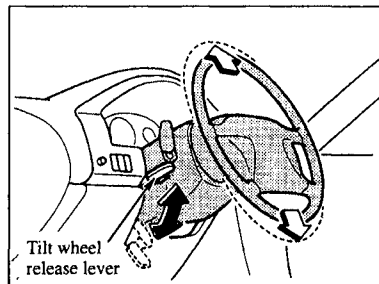

■ Tilt Wheel

To change the angle of the steering wheel, stop the vehicle, pull the tilt wheel release lever on the left side of the steering column down, adjust the wheel, then push the release lever up to lock the column.

After adjusting, push the wheel up and down to be certain it's locked before driving.

WARNING

Adjusting the Tilt Wheel:
Adjusting the tilt wheel while the vehicle is moving can be dangerous. Moving it up and down can very easily cause the driver to abruptly turn to the left or right. This can lead to loss of control or an accident. Never adjust the tilt wheel while the vehicle is moving.

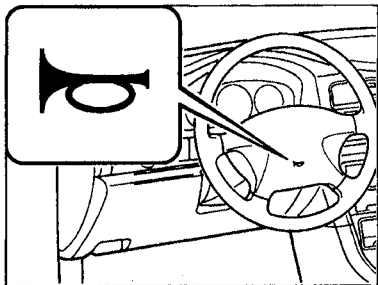

■ **Horn**

To sound the horn, press the center of the steering wheel.

Check the horn's operation regularly.

Mirrors

■ **Outside Mirrors**

Check the mirrors' angles before driving.

WARNING

Convex Mirror on Passenger Side:
Changing lanes without taking into account the actual distance of the vehicle in the convex mirror is dangerous. You could have a serious accident. What you see in the convex mirror (passenger's side) is closer than it appears. Be sure to look over your shoulder or to check your inside mirror before changing lanes.

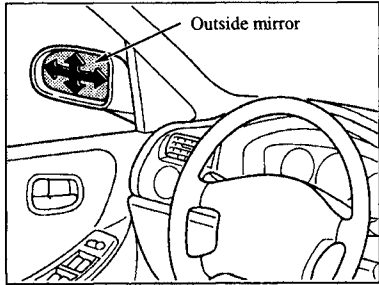

▼ **Manual control mirror**

Adjust by hand.

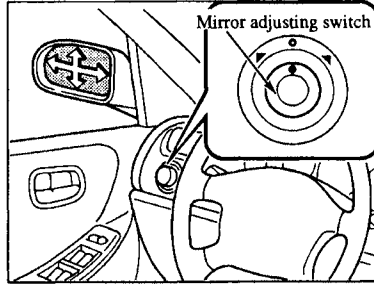

▼ **Power control mirror**

The ignition switch must be in the ACC or ON position.

To adjust:

1. Rotate the mirror adjusting switch to the left or right to choose the mirror.
2. Depress the switch in the appropriate direction.

After adjusting the mirror, lock the control by rotating the switch to the middle position.

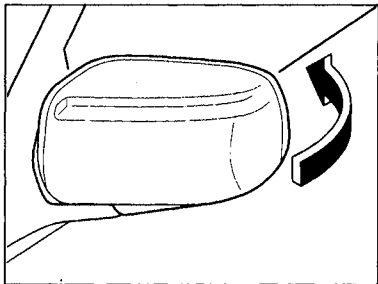

▼ Folding mirror

If you have a folding outside mirror, it will fold flat against the vehicle when pushed toward the side window.



WARNING

Driving with Mirrors Folded In:
It is dangerous to drive with the outside mirrors folded in. Your rear view will be restricted, and you could have an accident. Always return the outside mirrors to the driving position before you start driving.

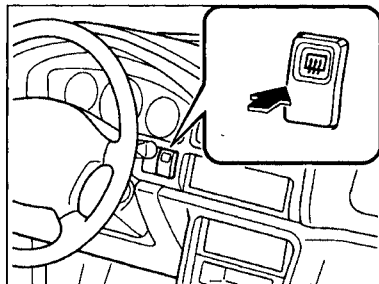

▼ Mirror defroster*

To turn on the mirror defroster, turn the ignition on and push the rear window defroster switch (page 5-49).

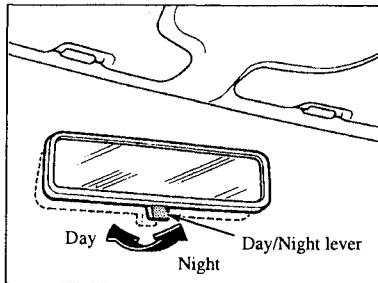

Push the lever forward for day driving. Pull it back to reduce glare from headlights.

**■ Rearview Mirror
(With Day/Night Function)**

Before driving, adjust the rearview mirror to center on the scene through the rear window. Do this with the day/night lever in the day position.

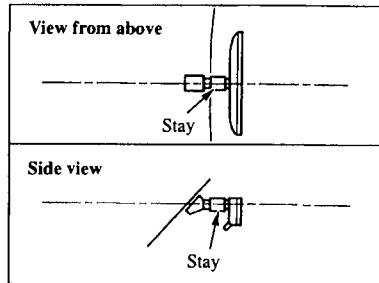

NOTE

If your forward view is obstructed by the mirror or the sunvisor hits the mirror, adjust the mirror stay to the center-horizontal position.

Sunroof*

WARNING

Blocked View:

Cargo stacked higher than the seatbacks can be dangerous. It can block your view in the rearview mirror, which might cause you to hit another car when changing lanes. Don't stack things higher than the seatbacks.

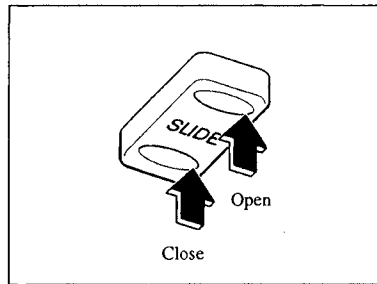
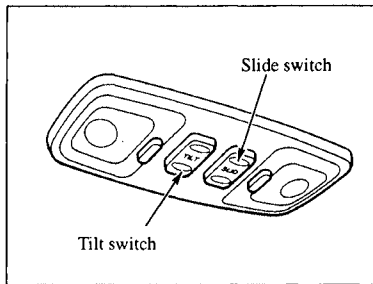

■ Sunroof Operation

The sunroof can be opened or closed only when the ignition switch is in the ON position.

To open to any position, press the rear of the slide switch located on the right of the overhead console.

To close, press the front of the slide switch.

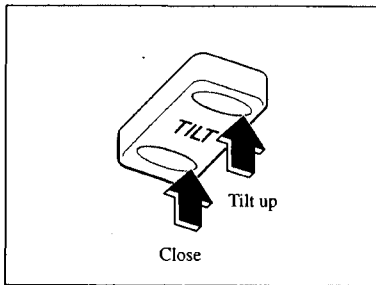

To close, push the front of the tilt switch.

The rear of the sunroof can be tilted open to provide more ventilation.

To tilt, push the rear of the tilt switch located on the left of the overhead console.

⚠ WARNING

Extending the Head or Arms Through the Sunroof:
Extending the head, arms, or other parts of the body through the sunroof is dangerous. The head or arms could hit something while the vehicle is moving. This could cause death or serious injury. Don't let passengers stand up or extend anything through the open sunroof while the vehicle is moving.

WARNING

Closing the Sunroof:

A closing sunroof can be dangerous. The hands, head, or even neck of a person - especially a child - could be caught in it as it closes, causing serious injury. Make sure the opening is clear before closing the sunroof.

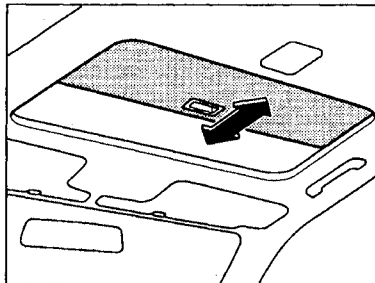

The sunshade opens automatically when the sunroof is opened, but must be closed by hand.

CAUTION

The sunshade doesn't tilt. To avoid damaging the sunshade, don't push up on it.

NOTE

After washing your Mazda or after a rain, wipe the water off the sunroof before operating it.

■ Sunshade

The sunshade can be opened and closed by hand when the sunroof is closed.

Interior Light

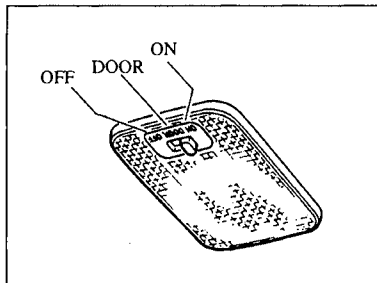

- OFF — Light off
- DOOR — Light on when a door is open
- ON — Light on

NOTE

When the switch is in the DOOR position, the interior light comes on for:

- about 30 seconds when the driver's door is unlocked by the transmitter or the door lock switch and the ignition key is removed.
- about 15 seconds after the key is removed from the ignition.

The light also goes out when:

- the ignition is turned to the
(Continued)

ON position.

- the door is locked by the transmitter or the door lock switch.

When the interior light comes on by opening a door, it goes out about 15 seconds after the door is closed.

Even if the door isn't closed, the light goes out after about 5 minutes.

Knowing Your Mazda

Map Lights*

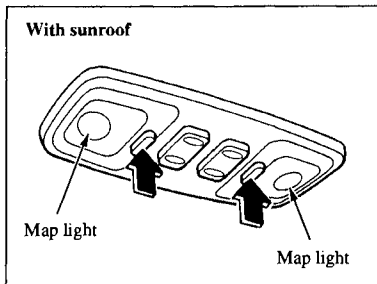

The map lights are switched on or off by pressing the switches indicated.

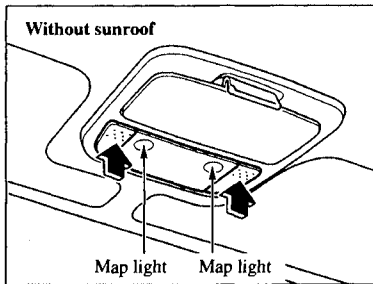

Trunk Light

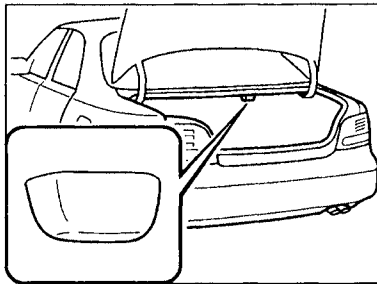

The trunk light is on when the lid is open and off when it's closed.

4

Protecting Your Mazda

Most people like to save money. With an automobile, that can be done in several ways from its first day of operation. Probably tops on the list of cost-efficiency is using the right kind of fuel and using that fuel conservatively.

Section 4 explains how to do this. Further, it discusses proper loading and how to respond to unusual driving conditions. It also illustrates where important vehicle information labels may be found.

Fuel Requirements	4- 2
Emission Control System	4- 4
Engine Exhaust	4- 6
Before Driving	4- 7
Break-In Period	4- 8
Money-Saving Suggestions	4- 9
Special Driving Conditions	4-10
Vehicle Information Labels	4-16

Fuel Requirements

(2.0-liter engine)

Vehicles equipped with catalytic converters must use **ONLY UNLEADED FUEL**, which will reduce exhaust emissions and keep spark plug fouling to a minimum.

Your Mazda will perform best with regular unleaded fuel having an octane rating (antiknock index) of at least 87 [(R+M)/2 method].

Fuel with a lower rating could cause the emission control system to lose effectiveness. It could also cause engine knocking and serious engine damage.

(2.5-liter engine)

Vehicles equipped with catalytic converters must use **ONLY UNLEADED FUEL**, which will reduce exhaust emissions and keep spark plug fouling to a minimum.

Your Mazda will perform best with premium unleaded fuel having an octane rating (antiknock index) of at least 91 [(R+M)/2 method].

You may use a regular unleaded gasoline with a rating from 87 to 90; this will slightly reduce performance.

Also, fuel with a rating lower than 87 octane could cause the emission control system to lose effectiveness. It could also cause engine knocking and serious engine damage.

U.S. federal law requires that octane ratings be posted on gasoline station pumps.

 **CAUTION**

NEVER USE LEADED FUEL.

It is harmful to the catalytic converter. The lead will accumulate on the oxygen sensor and the catalyst inside the converter.

This will result in a malfunction of the emission control system, causing poor performance.

Gasoline blended with oxygenates such as alcohol or ether compounds are generally referred to as oxygenated fuels. The common gasoline blend that can be used with your vehicle is ethanol blended at no more than 10%. Gasoline containing alcohol, such as ethanol or methanol, may be marketed under the name "Gasohol".

 **CAUTION**

Your vehicle can only use oxygenated fuels containing no more than 10% ethanol by volume. Damage to your vehicle may occur when ethanol exceeds this recommendation, or if the gasoline contains any methanol.

Stop using gasohol of any kind if your vehicle engine is performing poorly.



CAUTION

Never add fuel system additives.
Never add cleaning agents other than those specified by Mazda.
Other cleaning agents and additives may damage the system.
Consult an Authorized Mazda Dealer.

Vehicle damage and drivability problems resulting from the use of the following may not be covered by the manufacturer's warranty.

- 1) Gasohol containing more than 10% ethanol
- 2) Gasoline or gasohol containing methanol
- 3) Leaded fuel or leaded gasohol

Emission Control System

Your vehicle is equipped with an emission control system (the catalytic converter is part of this system) that enables your vehicle to comply with U.S. exhaust emissions requirements.

Under U.S. federal law, any modification to the original-equipment emission control system before the first sale and registration of a vehicle is subject to penalties. In some states, such modification made on a used vehicle is also subject to penalties.

 **WARNING**

Parking Over Things That Burn:
Parking over or near anything inflammable, such as dry grass, is dangerous. Even with the engine turned off, the exhaust system could ignite it because the exhaust system gets very hot during normal use. A resulting fire could cause serious injury or death. Never park over or near anything inflammable.

 **CAUTION**

Ignoring the following precautions could cause lead to accumulate on the catalyst inside the converter or cause the converter to get very hot. Either condition will damage the converter and cause poor performance.

- USE ONLY UNLEADED FUEL.
- Don't drive your Mazda with any sign of engine malfunction.
- Don't coast with the ignition switch turned off.

(Continued)

- Don't descend steep grades in gear with the ignition switch turned off.
- Don't operate the engine at high idle for more than 5 minutes.
- Don't tamper with the emission control system. All inspections and adjustments must be made by a qualified technician.
- Don't try to push-start or pull-start your vehicle.

Engine Exhaust (Carbon Monoxide)

WARNING

Carbon Monoxide:
Engine exhaust is dangerous. This gas contains carbon monoxide (CO), which is colorless, odorless, and poisonous. When inhaled, it can cause loss of consciousness and death. If you smell exhaust gas inside your vehicle, keep all windows fully open and contact an Authorized Mazda Dealer immediately.

WARNING

Exhaust Gas in Enclosed Area:
Running the engine inside an enclosed area, such as a garage, is dangerous. Exhaust gas, which contains poisonous carbon monoxide, could easily enter the cabin. Loss of consciousness or even death could occur. Don't run the engine when inside an enclosed area.

WARNING

Idling with the Windows Closed:
Exhaust gas is dangerous. When your vehicle is stopped with the windows closed and the engine running for a long time in an open area, exhaust gas, which contains poisonous carbon monoxide, could enter the cabin. Loss of consciousness or even death could occur. Open the windows or adjust the heating or cooling system to draw fresh air.

Before Driving

WARNING

Snow Blocking the Exhaust Gas:
Running the engine when a vehicle is stopped in deep snow is dangerous. The exhaust pipe could be blocked by the snow, allowing exhaust gas to enter the cabin. Because exhaust gas contains poisonous carbon monoxide, anyone in the cabin could be injured or killed. Clear the snow from underneath and around your vehicle before starting the engine.

■ Before Getting In

- Be sure the windows, outside mirror(s), and outside lights are clean.
- Inspect inflation pressures and condition of tires.
- Look under the vehicle for any sign of a leak.
- If you plan to back up, make sure nothing will be in your way.

NOTE

Engine oil, engine coolant, brake/clutch fluid, washer fluid, and other fluid levels should be inspected daily, weekly, or at refueling, depending on the fluid. See Maintenance, Section 8.

Break-In Period

■ After Getting In

- Are all doors closed and locked?
 - Are the inside and outside mirrors adjusted?
 - Is everyone's seat belt fastened?
 - Do all the lights work?
 - Check all gauges.
 - Check all warning lights when the ignition switch is turned to the ON position.
- Release the parking brake and make sure the brake warning light goes off.

Always be thoroughly familiar with your Mazda.

No special break-in is necessary, but a few precautions in the first 600 miles (1,000 km) may add to the performance, economy, and life of your Mazda.

- Don't race the engine.
- Don't maintain one constant speed for long periods.
- Avoid unnecessary hard stops.
- Avoid full-throttle starts.

Money-Saving Suggestions

How you operate your Mazda determines how far it will travel on a tank of fuel. Use these suggestions to help save money on fuel and repairs.

- Avoid long warm-ups. Once the engine runs smoothly, begin driving.
- Avoid fast starts.
- Keep the engine tuned. Follow the maintenance schedule (page 8-3) and have an Authorized Mazda Dealer perform inspections and servicing.
- Use the air conditioner only when necessary.
- Slow down on rough roads.
- Keep the tires properly inflated.
- Don't carry unnecessary weight.
- Don't rest your foot on the brake pedal while driving.
- Keep the wheels in correct alignment.
- Keep windows closed at high speeds.
- Slow down when driving in crosswinds and headwinds.



WARNING

Coasting:

Turning off the engine to coast down a hill can be dangerous. This causes the loss of power steering and power brake control. Any loss of steering or braking control could cause an accident. Never turn off the engine and coast down a hill.

Special Driving Conditions

■ Hazardous Driving

When driving on ice or in water, snow, mud, sand, or similar hazard:

- Be cautious and allow extra distance for braking.
- Avoid sudden braking and quick steering.
- Brake with the pedal by using a light up-down motion. Don't hold the pedal down constantly.
- If you get stuck, shift to 1 or 2 and accelerate slowly. Don't spin the front wheels.

- For more traction in starting, use sand, rock salt, chains, carpeting, or other nonslip material under the front wheels.



WARNING

Downshifting on Slippery

Surfaces:

Downshifting into first gear with a manual transaxle or into low with an automatic transaxle while driving on slippery surfaces could be dangerous. The sudden change in tire speed could cause the tires to skid. This could lead to loss of vehicle control and an accident. If it is necessary to downshift on slippery surfaces, be very careful.

■ **Rocking the Vehicle**

If you must rock the vehicle to free it from snow, sand, or mud, depress the accelerator slightly and...

(Automatic transaxle)

Slowly move the shift lever back and forth from D to R.

(Manual transaxle)

Slowly move the shift lever back and forth from 1 to R.

 **WARNING**

Spinning the Wheels:
When the vehicle is stuck, spinning the wheels at high speed could be dangerous. The spinning tire could overheat and explode. This could cause serious injuries. Don't spin the wheels at more than 35 mph (56 km/h), and don't allow anyone to stand behind a wheel when pushing the vehicle.

 **CAUTION**

Too much rocking may cause engine overheating, transaxle failure, and tire damage.

■ Winter Driving

- Carry emergency gear, including tire chains, window scraper, flares, a small shovel, jumper cables, and a small bag of sand or salt.
- Have the proper ratio of antifreeze in the radiator (page 8-24).
- Inspect the battery and its cables. Cold reduces battery capacity.
- Use only cold-weather engine oil (page 8-18).
- Inspect the ignition system for damage and loose connections.

- Use washer fluid made with antifreeze—but don't use engine coolant antifreeze for washer fluid (page 8-35).
- Don't use the parking brake if it might freeze. Instead, shift to P with an automatic transaxle and to 1 or R with a manual. Block the rear wheels.

▼ Snow tires

Your vehicle is originally equipped with all season radials designed to be used all year around. In some extreme climates you may find it necessary to replace them with snow tires during the winter months to further improve traction on snow and ice covered roads.

Use snow tires on all four wheels.

Don't go faster than 75 mph (120 km/h). Inflate snow tires 28 kPa (0.3 kgf/cm², 4 psi) more than recommended on the tire pressure label (driver's door), but never more than the maximum cold-tire pressure shown on the tires.



WARNING

Mixing Tire Types:

Using tires different in size or type is dangerous. Your vehicle's handling could be greatly affected and result in an accident. Use only the same size and type tires (snow, radial, or non-radial) on all four wheels.

NOTE

Check local regulations before using studded tires.

▼ Tire chains

Check local regulations before using tire chains.

Install the chains on the front tires. Don't use chains on the rear tires. Use only SAE Class "S" chains, and make sure they fit.

To install the chains:

1. Remove the wheel covers, or the chain bands will scratch them.
2. Secure the chains on the front tires as tightly as possible. Always follow the chain manufacturer's instructions.
3. Retighten the chains after driving 1/4-1/2 mile (1/2-1 km).

CAUTION

- Chains may scratch or chip aluminum wheels. Install tire chains on steel wheels only.
- Chains may affect handling.
- Don't go faster than 30 mph (50 km/h) or the chain manufacturer's recommended limit, whichever is lower.
- Drive carefully and avoid bumps, holes, and sharp turns.
- Avoid locked-wheel braking.

(Continued)

- Don't use chains on the temporary tire; it may result in damage to the vehicle and to the tire.
- Don't use chains on roads that are free of snow or ice. The tires and chains could be damaged.

■ Driving in Flooded Areas

CAUTION

Make sure water does not enter the vehicle interior or the engine area. The vehicle interior could become wet or the engine could be damaged.

 **WARNING**

Driving with Wet Brakes:
Driving with wet brakes is dangerous. Increased stopping distance or the vehicle pulling to one side when braking could result in a serious accident. Light braking will indicate whether the brakes have been affected. Dry the brakes by driving very slowly and applying the brakes lightly until brake performance returns to normal.

■ **Trailer Towing**

Never tow a trailer with your Mazda.

■ **Overloading**

 **WARNING**

Vehicle Load Weight:
The gross axle weight rating (GAWR) and the gross vehicle weight rating (GVWR) of your vehicle are on the Motor Vehicle Safety Standard Label on the driver's door frame. Exceeding these ratings can cause an accident or vehicle damage. You can estimate the weight of your load by weighing the items (or people) before putting them in the vehicle. Be careful not to overload your vehicle.

Vehicle Information Labels

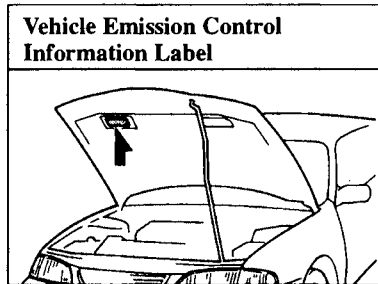
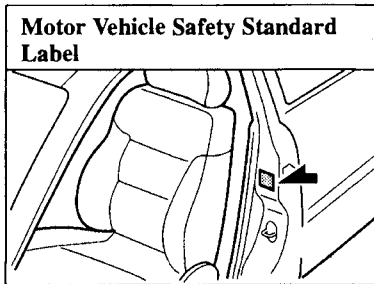
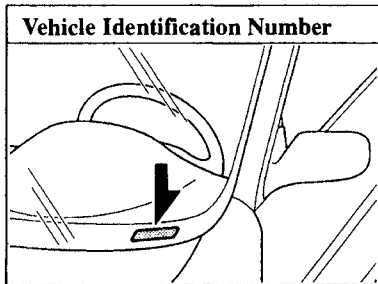

The vehicle identification number legally identifies your vehicle. The number is on a plate attached to the left top side of the dashboard. This plate can easily be seen through the windshield.

Chassis Number

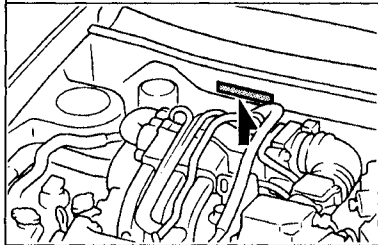

Engine number

2.0-liter engine

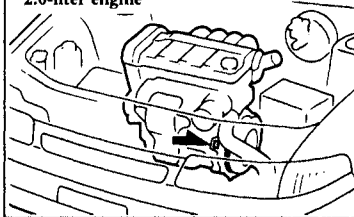

2.5-liter engine

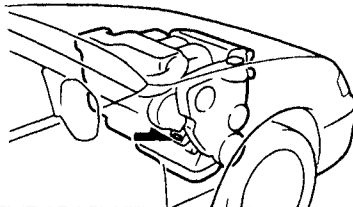

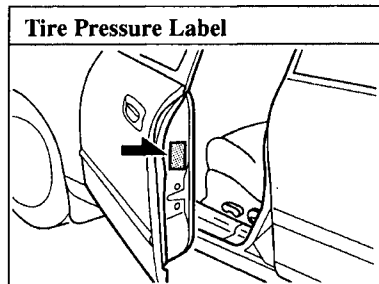

5

Driving Your Mazda

Operating your vehicle requires a good understanding of the many controls you must know and use. Section 5 describes all this in step-by-step information from use of the ignition switch to cruise control and braking.

Also highlighted are the gearshift and shifting modes, power steering, instruments and gauges, warnings and indicators, windshield wipers, and interior features. You'll find complete details about the advanced audio system too.

Ignition Switch Positions	5- 2	Clock	5- 51
Starting the Engine	5- 4	Accessory Socket	5- 51
Manual Transaxle Operation	5- 7	Glove Box	5- 53
Automatic Transaxle	5- 9	Cup Holders	5- 54
Traction Control System (TCS)	5- 15	Storage Compartments	5- 55
Brake System	5- 18	Sunvisors	5- 59
Power Steering	5- 23	Vanity Mirrors	5- 59
Cruise Control	5- 24	Climate Control System	5- 60
Instrument Cluster	5- 30	Radio Reception	5- 74
Gauges	5- 31	Safety Certification	5- 78
Dashboard Illumination	5- 35	AM/FM Radio with Compact Disc Player	5- 81
Warning Lights/Beeps	5- 35	AM/FM Radio with Cassette Tape and Compact Disc Player	5-103
Lighting Control and Turn Signals	5- 44	AM/FM Radio with Cassette Tape Player and Compact Disc Changer	5-133
Windshield Wipers and Washer	5- 47	Antenna	5-165
Rear Window Defroster	5- 49		

Ignition Switch Positions

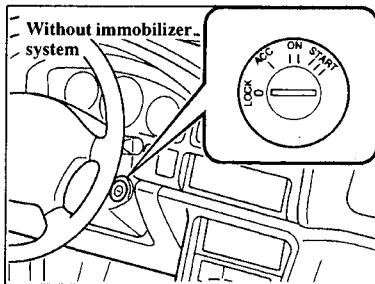

■ ON

This is the normal running position after the engine is started. The warning lights (except brakes) should be inspected before the engine is started (page 5-35).

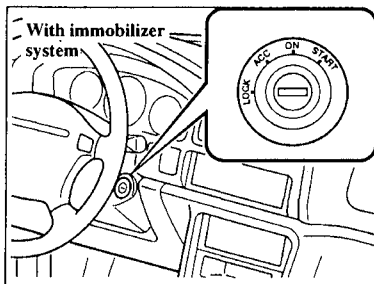

■ START

The engine is started in this position. It will crank until you release the key; then it returns to the ON position. The brake warning light can be checked after the engine is started (page 5-35).

■ ACC (Accessory)

The steering wheel unlocks and some electrical accessories will operate.

■ LOCK

The steering wheel locks to protect against theft. Only in this position can the key be removed.

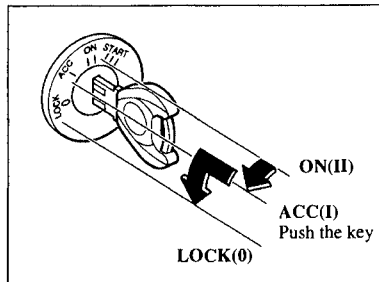

▼ Manual transaxle

When turning the ignition switch to the LOCK position, push the key in at the ACC position.

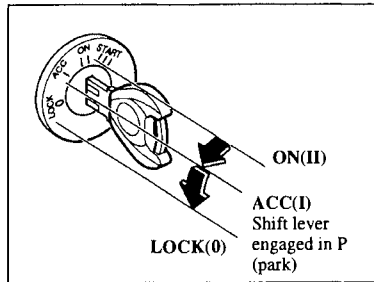

▼ Automatic transaxle

When turning the ignition switch to the LOCK position, keep the shift lever at P.

NOTE

If turning the key is difficult, jiggle the steering wheel from side to side.

⚠ WARNING

Removing the Key:

It's dangerous to remove the key from the ignition switch while the vehicle is moving. Removing the key allows the steering wheel to lock. You will lose steering control and a serious accident could occur. Remove the key only when the vehicle is parked.

 **WARNING**

Not Setting the Parking Brake:
Leaving the driver's seat without setting the parking brake is dangerous. Unexpected vehicle movement could occur if the parking brake is not set. This could cause an accident. Before leaving the driver's seat, always set the parking brake and make sure the shift lever is at P with an automatic transaxle or in 1 or R with a manual transaxle.

NOTE

If the ignition switch is in the LOCK or ACC position, a beep will sound when any door is opened.

Starting the Engine

1. Occupants should fasten their seat belts.
2. Make sure the parking brake is on.
3. Depress the brake pedal.

4. **(Manual transaxle)**

Depress the clutch pedal all the way and shift into neutral. Keep the pedal depressed while cranking the engine.

(Automatic transaxle)

Place the shift lever in P. If you must restart the engine while the vehicle is moving, shift the lever to N.

NOTE

The starter will not operate...

- If the shift lever is **not** in P or N (automatic), or
- If the clutch pedal is **not** pushed down all the way (manual).

5. Turn the ignition switch to the START position and hold (up to 10 seconds at a time) until the engine starts.



CAUTION

Don't try the starter for more than 10 seconds at a time. If the engine stalls or fails to start, wait 10 seconds before trying again. Otherwise, you may damage the starter and drain the battery.

6. After starting the engine, let it idle for about 10 seconds.

NOTE

In extremely cold weather, below 0°F (-18°C), or after the vehicle has stood idle several days, let the engine warm up without operating the accelerator.

NOTE

Whether cold or warm, the engine should be started without use of the accelerator.

If the engine fails to start, it may be flooded (excessive fuel in the engine).

Follow this procedure:

1. Depress the accelerator all the way and hold it there.

2. Turn the ignition switch to the START position and hold it there—for up to 10 seconds. If the engine starts, release the key and accelerator immediately because the engine will suddenly rev up.
3. If the engine fails to start, crank it without using the accelerator—for up to 10 seconds.

Manual Transaxle Operation

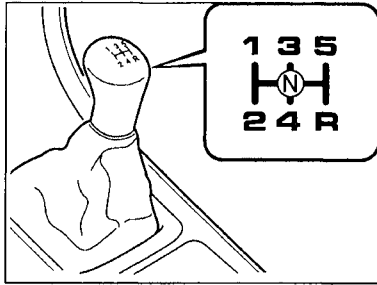

A safety feature prevents accidental shifting from 5 to R. The shift lever must be put in neutral before being shifted to R.

■ Manual Transaxle Shift Pattern

The shift pattern of the transaxle is conventional, as shown.

Press the clutch pedal all the way down while shifting; then release it slowly.

NOTE

- Make sure the vehicle is stopped before shifting to R.
- If shifting into reverse is difficult, shift into neutral, release the clutch pedal, and try again.

CAUTION

Keep your foot off the clutch pedal except when shifting gears. Also, don't use the clutch to hold the vehicle on an upgrade. This will avoid needless clutch wear and damage.

■ Recommendations for Shifting

▼ Upshifting

For normal acceleration, we recommend these shift points.

	2.0-liter engine	2.5-liter engine
1 to 2	16 mph (26 km/h)	17 mph (27 km/h)
2 to 3	28 mph (45 km/h)	30 mph (48 km/h)
3 to 4	33 mph (53 km/h)	35 mph (56 km/h)
4 to 5	39 mph (63 km/h)	39 mph (63 km/h)

For cruising, we recommend these shift points.

	2.0-liter engine	2.5-liter engine
1 to 2	8 mph (13 km/h)	8 mph (13 km/h)
2 to 3	20 mph (32 km/h)	21 mph (34 km/h)
3 to 4	31 mph (50 km/h)	32 mph (52 km/h)
4 to 5	42 mph (68 km/h)	41 mph (66 km/h)

▼ Downshifting

When you must slow down in heavy traffic or on a steep **upgrade**, downshift before the engine starts to overwork. This reduces the chance of

stalling and gives better acceleration when you need more speed.

On a steep **downgrade**, downshifting helps maintain safe speed and prolongs brake life.

Automatic Transaxle

■ Automatic Transaxle Controls

Lock-release button
To prevent unsafe shifting

Shift lever

Overdrive button
For selecting either a three-speed or four-speed transaxle

Shift pattern indicator
Shows shift lever position

Various Lockouts:
Indicates that you must depress the brake pedal and, hold in the lock-release button to shift (The ignition switch must be in the ACC or ON position.)

The shift lever can be shifted freely into any position indicated by the ↑ arrow.

Indicates that you must hold in the lock-release button to shift.

O/D OFF indicator
This indicator comes on when the overdrive button is in the OFF position

■ Transaxle Ranges

The shift lever must be at P or N to operate the starter.

▼ P (Park)

P locks the transaxle and prevents the front wheels from rotating.

WARNING

Holding the Vehicle with P:
Setting the shift lever at the P position without using the parking brake to hold the vehicle could be dangerous. If P fails to hold, the vehicle could move and cause an accident. To hold the vehicle, set the shift lever at P AND set the parking brake.

CAUTION

- Shifting into P or R while the vehicle is moving can damage your transaxle.
- Shifting into a driving gear or reverse when the engine is running faster than idle can damage the transaxle.

▼ R (Reverse)

In position R, the vehicle moves only backward. You must be at a complete stop before shifting from R, except as explained under Rocking the Vehicle (page 4-11).

▼ N (Neutral)

In N, the wheels and transaxle are not locked. The vehicle will roll freely even on the slightest incline unless the parking brake or brakes are on.

**WARNING*****Shifting from N or P:***

It's dangerous to shift from N or P into a driving gear when the engine is running faster than idle. If this is done, the vehicle could move suddenly, causing an accident or serious injury. If the engine is running faster than idle, don't shift from N or P into a driving gear.

▼ D (Drive)

D is the normal driving position. From a stop, the transaxle will automatically shift through a 4-gear sequence.

▼ 2 (Second)

The 2 position is helpful when driving in heavy, slow-moving traffic and climbing hills; for braking assist when going down hills; or for starting on slick surfaces and other situations where gentle acceleration may be necessary. Do not exceed 72 mph (116 km/h)^{*1} or 65 mph (104 km/h)^{*2} in the 2 position.

*1 2.0-liter engine

*2 2.5-liter engine

▼ 1 (Low)

Use the 1 position for maximum power in hard-pulling situations, or for climbing and descending very steep grades. Do not exceed 39 mph (63 km/h)*¹ or 38 mph (60 km/h)*² in the 1 position.

*¹ 2.0-liter engine

*² 2.5-liter engine

■ Driving Tips

▼ Passing

For extra power when passing another vehicle or climbing steep grades, depress the accelerator fully. The transaxle will shift to a lower gear, depending on vehicle speed.

▼ Climbing steep grades from a stop

To climb a steep grade from a stopped position:

1. Depress the brake pedal.

2. Shift to D or 1 depending on the load weight and grade steepness.

3. Release all brakes while gradually accelerating.

▼ Descending steep grades

When descending a steep grade, shift to 2 or 1, depending on load weight and grade steepness. Descend slowly, using the brakes only occasionally to prevent them from overheating.

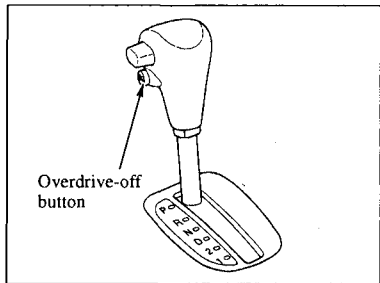

■ **Overdrive**

▼ **Overdrive operation**

In D, the transaxle automatically shifts to overdrive, which improves fuel economy and reduces noise.

But to increase engine braking, don't use overdrive when going down a steep grade.

And for a smoother ride with less shifting, don't use it when

- Going up a steep grade;
- Driving in stop-and-go traffic;
- Pulling heavy loads.

To turn off the overdrive, push the button.

The transaxle will then shift through a three-gear sequence in D.

Shift patterns without overdrive:

- D = 1st, 2nd, 3rd
- 2 = 2nd (1st, 2nd)*
- 1 = 1st

* (2.5-liter engine only)
With Traction Control System (TCS)

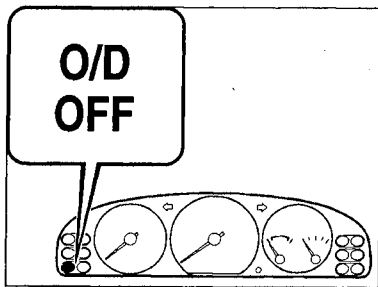

▼ Overdrive-off indicator

This indicator comes on when the overdrive button is off.

To turn it on, push the button again.

Shift patterns with overdrive:

D = 1st, 2nd, 3rd, 4th

2 = 2nd (1st, 2nd)*

1 = 1st

* (2.5-liter engine only)
With Traction Control System (TCS)

■ Shift-Lock System

For your safety, the automatic transaxle has a shift-lock, which prevents shifting out of P unless the brake pedal is depressed.

To shift from P:

1. Depress and hold the brake pedal.
2. Start the engine.
3. Push and hold the lock-release button.
4. Move the shift lever.

Traction Control System (TCS)*

NOTE

- When the ignition switch is in the LOCK position, the transaxle cannot be shifted from P.
- To be sure the vehicle is in park, **the ignition key cannot be removed unless the shift is in P.**

The Traction Control System (TCS) enhances traction and safety by regulating engine torque. When the TCS detects driving wheel slippage, it lowers engine torque to prevent loss of traction.

This means that on a slick surface, the engine adjusts automatically to provide optimum power to the drive wheels without causing them to spin and lose traction.

WARNING

TCS and Unsafe Driving:
The traction control system (TCS) cannot compensate for unsafe and reckless driving, excessive speed, tailgating (following another vehicle too closely), and hydroplaning (reduced tire friction and road contact because of water on the road surface). You can still have an accident. So don't rely on the traction control system as a substitute for safe driving.

! WARNING

TCS and Snow and Ice:

Driving without proper traction devices on snow- and ice-covered roads is dangerous. The traction control system (TCS) alone cannot provide adequate traction and you could still have an accident. Use snow tires or tires chains and drive at reduced speeds when roads are covered with ice and snow.

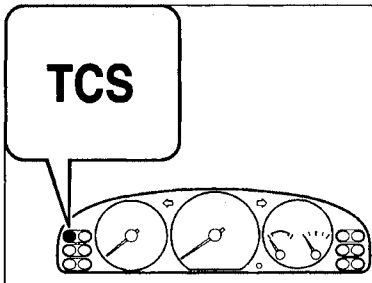

It flashes when the system regulates engine torque. If the light stays on, take your vehicle to an Authorized Mazda Dealer. The traction control system may have a malfunction.

■ Traction Control Indicators

▼ Traction control system (TCS) warning light

This warning light stays on for a few seconds when the ignition switch is turned to the ON position.

NOTE

- In addition to the TCS warning light flashing, a slight lugging sound will come from the engine. This indicates that the traction control system is operating properly.
- On slippery surfaces, such as fresh snow, it will be impossible to achieve high rpm when the traction control system is on.

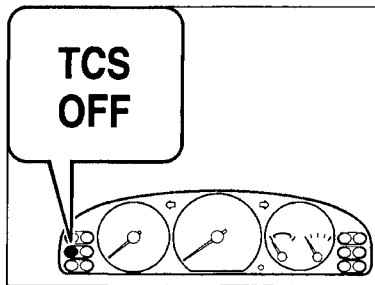

▼ TCS OFF Indicator Light

This light comes on when the ignition switch is turned to the ON position. It goes off when the engine is started.

It also comes on when you switch off the traction control system or when the system has a malfunction.

NOTE

After starting the engine on very cold days, the TCS OFF indicator will remain on and the system will not operate until the engine is warm.

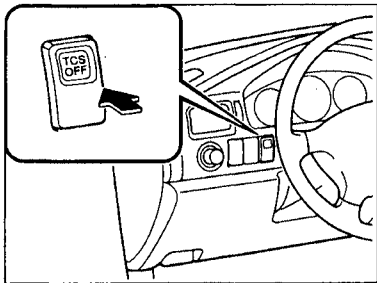

■ TCS OFF Switch

Push this switch once to turn off the TCS. Push it again to turn the TCS back on.

NOTE

- If the TCS is off when the engine is turned off, it automatically activates when the ignition switch is turned on.
- Leaving the TCS on will provide the best traction.

Brake System

■ Foot Brake

Your Mazda has power-assisted brakes that adjust automatically through normal use.

Should power assist fail, you can stop by applying greater force than normal to the brake pedal. But the distance required to stop will be greater than usual.

 **WARNING**

Driving with the Engine Off:
Continuing to drive when the engine is stalled or turned off is dangerous. Braking will require more effort, and the brake's power assist could be depleted if you pump the brake. This will cause longer stopping distances or even an accident. Don't continue driving when the engine is stalled or turned off, find a safe place to stop.

 **WARNING**

Riding the Brakes:
Driving with your foot continuously on the brake pedal or steadily applying the brakes for long distances is dangerous. This causes overheated brakes, resulting in longer stopping distances or even total brake failure. This could cause loss of vehicle control and a serious accident. Avoid continuous application of the brakes. Shift to a lower gear when going down steep hills.

 **WARNING**

Driving with Wet Brakes:
Driving with wet brakes is dangerous. Increased stopping distance or the vehicle pulling to one side when braking could result in a serious accident. Light braking will indicate whether the brakes have been affected. Dry the brakes by driving very slowly and applying the brakes lightly until brake performance is normal.

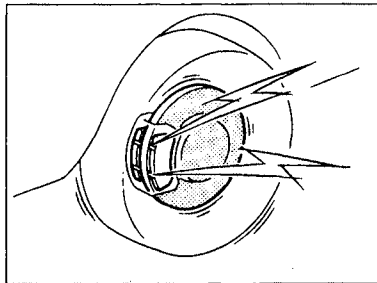

■ Brake Pad Wear Indicator

When the disc brake pads become worn, the built-in wear indicators contact the disc plates. This causes a screeching noise to warn that the pads should be replaced.

When you hear this noise, consult an Authorized Mazda Dealer as soon as possible.

WARNING

Driving with Worn Disc Pads:
Driving with worn disc pads is dangerous. The brakes could fail and cause a serious accident. As soon as you hear the pad wear indicator consult an Authorized Mazda Dealer.

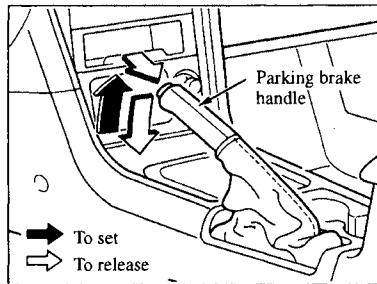

■ Parking Brake

To set the parking brake, depress the brake pedal; then pull the brake handle fully upward.

To release it, pull the handle up and press the button. Depress the brake

pedal; then lower the handle to the release position while holding the button in. Release the pedal when it's safe to do so.



CAUTION

Driving with the parking brake on will cause excessive wear of the brake linings or pads.

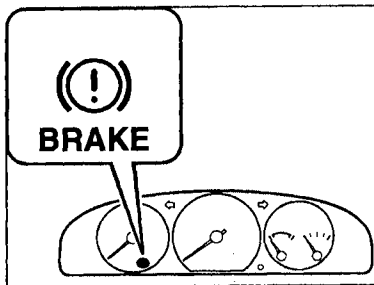

■ Brake System Warning Light

The brake warning light comes on when you start the engine. It should be on when the engine is running and the parking brake is set.

If the brake warning light stays on after the parking brake is fully released, the brake system has a malfunction. Refer to Warning Lights/Beeps (page 5-36).

■ Antilock Brake System (ABS)*

The ABS control unit continuously monitors the speed of each wheel. If one is about to lock up, the ABS responds by automatically releasing and reapplying that wheel's brake.

The driver will feel a slight vibration in the brake pedal and may hear a chattering noise from the brake system. This is normal when the ABS operates. Don't pump the brakes, continue to press down on the brake pedal.

NOTE

If the ABS warning light stays on while you're driving, the ABS control unit has detected a system malfunction. If this occurs, your brakes will function normally as if they had no ABS. Should this happen, consult an Authorized Mazda Dealer as soon as possible.

NOTE

Braking distances may be longer on loose surfaces (snow or gravel, for example) which usually have a hard foundation. A vehicle with a normal braking system may require less distance to stop under these conditions because the tires will build up a wedge of surface layer when the wheels skid.



WARNING

ABS:

The ABS cannot compensate for unsafe and reckless driving, excessive speed, tailgating (following another vehicle too closely), and hydroplaning (reduced tire friction and road contact because of water on the road surface). You can still have an accident. So don't rely on ABS as a substitute for safe driving.

NOTE

When the engine is jump-started, an unevenness of rpm occurs and the ABS warning light comes on. This is due to a lack of battery capacity and doesn't indicate a malfunction.

Have the battery recharged as soon as possible.

Power Steering

Power steering uses energy from the engine. If the engine is off or if the power steering system becomes inoperative, you can still steer, but it will require more effort.

If you find steering hard in normal driving, consult an Authorized Mazda Dealer.



CAUTION

Never hold the steering wheel to the extreme left or right for more than five seconds with the engine running. This could damage the power steering system.

Cruise Control*

With cruise control, you can set and automatically maintain any speed of more than about 25 mph (40 km/h).

WARNING

Cruise Control Use:
Using cruise control in the following conditions could cause you to lose control of the vehicle:

- *Heavy or unsteady traffic*
- *Slippery or winding roads*
- *Similar restrictions that require inconsistent speed*

Don't use cruise control in these situations.

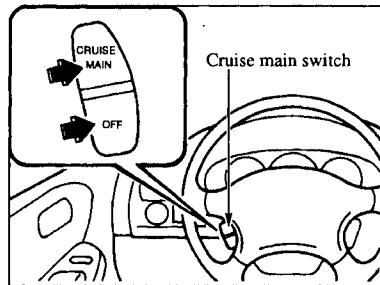

To activate the system, push the CRUISE MAIN end of the switch.

To deactivate the system, push the OFF end.

⚠ WARNING

Cruise Main Switch:
If the Cruise main switch is left on, cruise control may be switched on accidentally. This could result in loss of vehicle control. Keep the Cruise main switch off when cruise control is not in use.

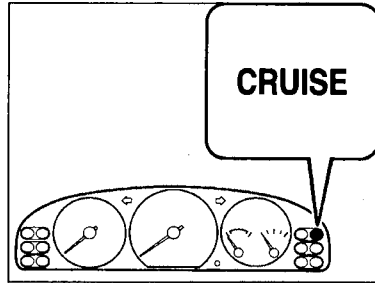

■ **Cruise Set Indicator Light**

The cruise set indicator comes on when a cruising speed is set.

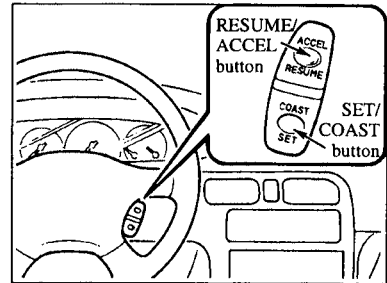

■ **To Set Speed**

1. Turn on the Cruise main switch.
2. Accelerate to the desired speed, which must be more than 25 mph (40 km/h).

3. Press the SET/COAST button and release it at the speed you want. Release the accelerator at the same time.

NOTE

- The SET function can't be activated until approximately 2 seconds after the Cruise main switch has been engaged.
- On a steep grade, the vehicle may momentarily slow down going up or speed up while going down.

■ To Cancel

To turn off the system, use **one** of these methods:

- Press the OFF end of the Cruise main switch.
- Slightly depress the brake pedal.
- **(Manual transaxle)**
Depress the clutch pedal.

The system is off when the ignition is off.

NOTE

Cruise control will cancel at approximately 9 mph (15 km/h) below the preset speed or below 25 mph (40 km/h).

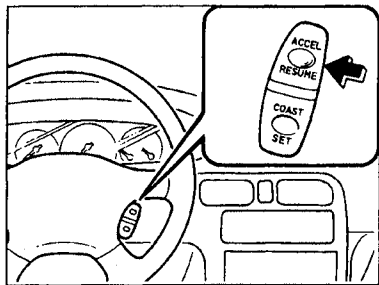

■ To Increase Cruising Speed

Follow either of these procedures.

- Press and hold RESUME/ACCEL switch. Release the switch when the desired speed is reached.

- Accelerate to the desired speed, then press SET/COAST switch and release.

Your vehicle has a “tap-up” feature that allows you to increase your current speed in increments of 1 mph (1.6 km/h) by a momentary tap of the RESUME/ACCEL switch. Multiple taps will increase your vehicle speed 1 mph (1.6 km/h) for each tap. For example, if you are currently set at 60 mph (96 km/h) and tap the RESUME/ACCEL switch 5 times, your vehicle speed will increase and set at 65 mph (104 km/h).

■ Accelerating with Cruise Control On

Accelerate if you want to speed up temporarily when the cruise control is on. Greater speed will not interfere with it or change the set speed.

Take your foot off the accelerator to return to the set speed.

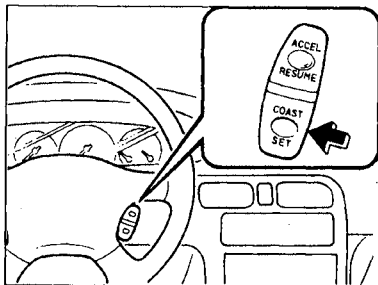

current speed in decrements of 1 mph (1.6 km/h) by a momentary tap of the SET/COAST switch. Multiple taps will decrease your vehicle speed 1 mph (1.6 km/h) for each tap. For example, if you are currently set at 65 mph (104 km/h) and tap the SET/COAST switch 5 times, your vehicle speed will decrease and set at 60 mph (96 km/h).

■ To Decrease Cruising Speed

Press and hold SET/COAST switch. Release the switch at the speed you want.

Your vehicle has a “tap-down” feature that allows you to decrease your

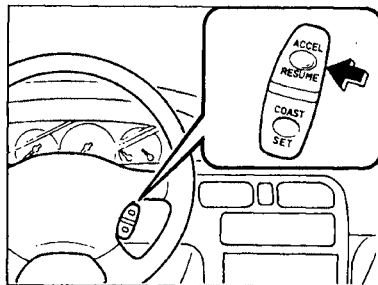

■ To Resume Cruising Speed at More Than 25 mph (40 km/h)

If something besides the Cruise main switch was used to cancel cruising speed and the system is still activated, the most recent set speed will automatically resume when the

RESUME/ACCEL switch is pressed.
If vehicle speed is below 25 mph (40 km/h), increase the vehicle speed up to 25 mph (40 km/h) and press the RESUME/ACCEL switch.

NOTE

With an automatic transaxle vehicle, the gear is automatically selected when going uphill.

Instrument Cluster

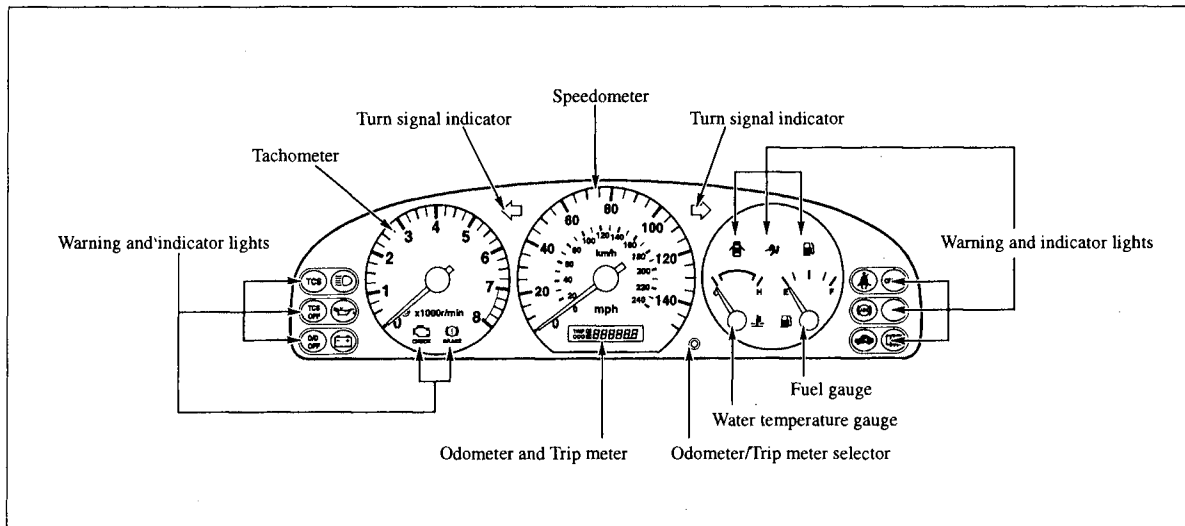

Gauges

■ Speedometer

The speedometer shows speed in miles and kilometers per hour.

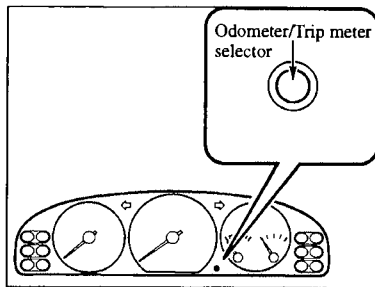

The display mode can be changed from odometer to trip meter A to trip meter B and then back to odometer by pressing the selector. The selected mode will be displayed.

■ Odometer and Trip Meter

The ignition switch must be in the ON position.

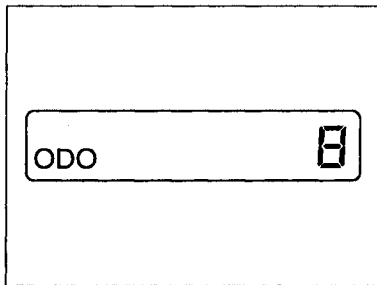

▼ Odometer

When this mode is selected, ODO will be displayed.

The odometer records the total distance the vehicle has been driven.

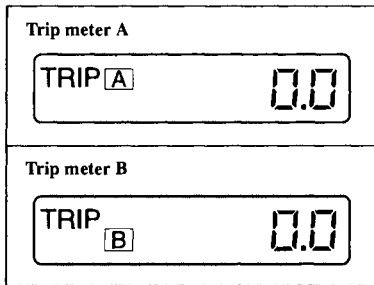

▼ Trip meter

The trip meter can record the total distance of two trips. One is recorded in trip meter A, and the other is recorded in trip meter B.

For instance, trip meter A can record the distance from the point of origin, and trip meter B can record the distance from where the fuel tank is filled.

When trip meter A is selected, pressing the selector again within one second will change the trip meter to B mode.

When trip meter A is selected, TRIP A will be displayed. When trip meter B is selected, TRIP B will be displayed.

The trip meter records the total distance the vehicle is driven until the meter is again reset. Return it to "0.0" by holding the selector depressed for more than 1 second.

Use this meter to measure trip distances and in computing fuel consumption.

NOTE

Only the trip meters record tenths of miles (kilometers).

NOTE

If the power supply is interrupted (blown fuse or the battery is disconnected), the trip record will be erased.

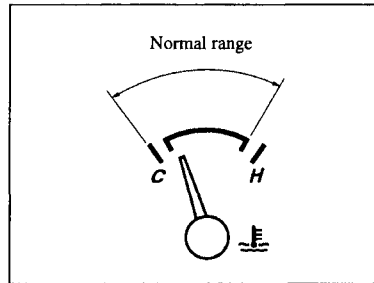

■ **Water Temperature Gauge**

This gauge shows the temperature of the engine coolant.

If the needle exceeds normal range toward H, it indicates overheating.



CAUTION

Driving with an overheated engine can cause serious engine damage (page 6-2).

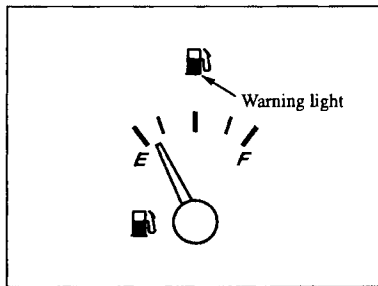

■ Fuel Gauge

The fuel gauge shows approximately how much fuel is in the tank. We recommend keeping the tank over 1/4 full. When the low fuel warning light illuminates or when the needle is near E, refuel as soon as possible.

5-34

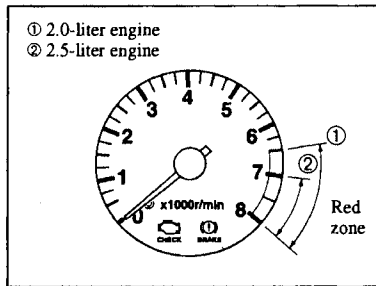

■ Tachometer

The tachometer shows engine speed in thousands of revolutions per minute (rpm).

Use it while selecting shift points and to prevent lugging and overrevving (page 5-8).

CAUTION

Don't run the engine with the tachometer needle in the RED ZONE.

This may cause severe engine damage.

Dashboard Illumination

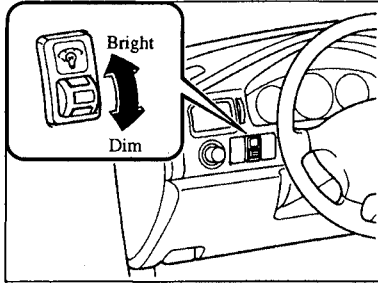

When the parking lights or headlights are on, rotate the thumb wheel to adjust the brightness of the dashboard lights.

Warning Lights/Beeps

■ Warning Lights Inspection

Inspect the warning lights by turning the ignition switch to the ON position with the engine off and the parking brake on. Consult an Authorized Mazda Dealer about any light that doesn't come on.

If the brake system warning light is off when the ignition switch is in the START position, have the system inspected by an Authorized Mazda Dealer.

After starting the engine, make sure all warning lights are off. If one stays on, it's signaling for attention.

The brake system warning light should go off when the parking brake is released.

■ Brake System Warning Light



This warning has two functions.

▼ Parking brake warning

The light comes on when the parking brake is applied with the ignition switch in the START or ON position. It goes off when the brake is fully released.

▼ Low brake fluid level warning

If the light stays on after the parking brake is fully released, you may have a brake problem.

If it stays on:

1. Be sure the parking brake is fully released.
2. Check the light.

If this light is still on, drive to the side of the road and park off the right-of-way.

You may notice that the pedal is harder to push or that it may go closer to the floor. In either case, it will take longer to stop the vehicle.

3. With the engine stopped, check the brake fluid level immediately and add fluid as required (page 8-27).

4. After adding fluid, check the light again.

If the warning light remains on, or if the brakes do not operate properly, do not drive the vehicle. Have it towed to an Authorized Mazda Dealer.

Even if the light goes off, have your brake system inspected as soon as possible.

 **WARNING**

Brake Warning Light:
Driving with the brake system warning light on is dangerous. It indicates that your brakes may not work at all or that they could completely fail at any time. If this light remains on, have the brakes inspected immediately. Don't drive with this light on.

■ **Seat Belt Warning Light/Beep**



If the driver's seat belt is not fastened when the ignition switch is turned to the ON position, a beep will sound for about 6 seconds and the seat belt warning light will remain on until the belt is fastened.

If the system does not operate correctly, consult an Authorized Mazda Dealer.

■ **Charging System Warning Light**



This warning light indicates a malfunction of the alternator or of the charging system.

If the light comes on while driving:

1. Drive to the side of the road and park off the right-of-way.
2. Turn off the engine. Inspect the alternator drive belt for looseness and breakage.

3. If it's OK, the charging system has a problem. Consult an Authorized Mazda Dealer as soon as possible.

⚠ CAUTION

Don't drive with a loose or broken alternator belt. The engine could overheat because this belt also drives the water pump.

■ Engine Oil Pressure Warning Light



This warning light indicates low engine oil pressure.

If the light comes on while driving:

1. Drive to the side of the road and park off the right-of-way.
2. Turn off the engine and inspect the engine oil level (page 8-19). If it's low, add oil.

3. Check the light.

If the light remains on even after you add oil, have your vehicle towed to the nearest service station or to an Authorized Mazda Dealer.

⚠ CAUTION

Don't run the engine if oil pressure is low. It could result in extensive engine damage.

■ Traction Control System (TCS) Warning Light*



This warning light stays on for a few seconds when the ignition switch is turned to the ON position.

The light flashes when the system regulates engine torque and will stay on if the system malfunctions. If it stays on while the system is operating, consult an Authorized Mazda Dealer.

■ Low Fuel Warning Light



This warning signals that the fuel tank will soon be empty. Get fuel as soon as possible.

■ Check Engine Light



If this light comes on while driving, the vehicle may have a problem. It is important to note the driving conditions when the light came on and consult an Authorized Mazda Dealer.

The check engine light may come on in the following cases:

- The fuel tank level being very low or approaching empty.
- The engine's electrical system has a problem.

- The emission control system has a problem.
- A ROOM fuse blows or is removed.
- The fuel-filler cap is missing or not tightened securely.

If the check engine light flashes continuously, decrease your speed and consult an Authorized Mazda Dealer as soon as possible.

■ Door-Ajar Warning Light



This warning light comes on when any door or trunk isn't securely closed.

■ Antilock Brake System (ABS) Warning Light*



The warning light stays on for a few seconds when the ignition switch is turned to the ON position.

If the ABS control unit determines that some components are operating incorrectly, the control unit turns the ABS warning light on.

NOTE

When the engine is jump-started to charge the battery, uneven rpm occurs and the ABS warning light comes on. This is due to a weak battery, not a malfunction.

Recharge the battery.

■ Supplemental Restraint System Warning Light

If the supplemental restraint system is OK, the warning light comes on when the ignition switch is turned to the ON position or after the engine is cranked. After about 6 seconds it goes out.

A system malfunction is indicated when this light constantly flashes, stays on or doesn't come on at all. If one of these occur, consult an Authorized Mazda Dealer as soon as possible. The system may not work in an accident.

⚠ WARNING**Self-Servicing the Supplemental Restraint System:**

Self-servicing or tampering with the supplemental restraint system is dangerous. The air bags could accidentally activate or become disabled. This could cause serious injuries. Never tamper with the supplemental restraint system and always have an Authorized Mazda Dealer perform all servicing and repairs.

■ Immobilizer System Warning/Security Indicator Light*



▼ Immobilizer system warning light

When the key is in the ignition, this light serves as the immobilizer system warning light.

If the immobilizer system is working properly, the light will come on when the ignition is turned to the start position. The light will go out when the engine starts.

If the light flashes rapidly, fails to come on, or comes on and stays on, it indicates a system malfunction. If any of these occur, contact an Authorized Mazda Dealer as soon as possible.

▼ Security indicator light

When there is no key in the ignition, and the theft-deterrent system has been armed, the light will flash once every three seconds. This indicates that the system is working properly.

■ Ignition Key Reminder

If the ignition switch is in the LOCK or ACC position, a beep will sound when any door is opened.

■ Lights-On Reminder

If lights are on and the key is removed from the ignition switch, a beep will sound when any door is opened.

■ **Headlight High-Beam Indicator Light**



This light indicates one of two things:

- The high-beam headlights are on.
- The turn-signal lever is in the flash-to-pass position.

■ **Rear Window Defroster Indicator Light**



This light comes on when the rear window defroster is on.

■ **O/D OFF Indicator Light (Automatic Transmission)**



This light comes on when the O/D button is in the off position.

■ **Cruise Set Indicator Light***



This light comes on when a cruising speed is set.

■ **Traction Control System (TCS) OFF Indicator Light***



This light comes on when the ignition switch is turned to the ON position. It goes off when the engine is started.

The light also comes on when you switch off the TCS. If the TCS has malfunctioned, the TCS OFF indicator light will come on. If it comes on while you're driving, consult an Authorized Mazda Dealer.

Lighting Control and Turn Signals

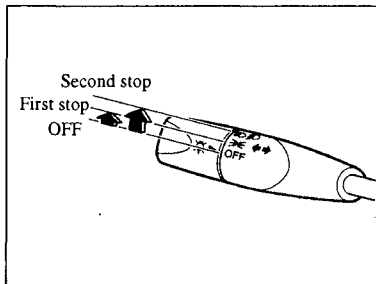

■ Headlights

To turn on the lights, turn the knob on the end of the control lever.

The first stop (㊦) turns on the taillights, dashboard lights, parking lights, and license plate lights.

The second stop (㊧) turns on the headlights, taillights, dashboard lights, parking lights, and license plate lights.

If the light switch is left on, the lights will automatically switch off after 5 seconds of turning of the ignition switch (LOCK position) or removing the key.

The light will automatically switch on when the ignition switch is turned to the ACC or ON position.

▼ Lights-on reminder

If lights are on and the key is removed from the ignition switch, a beep will sound when the any door is opened.

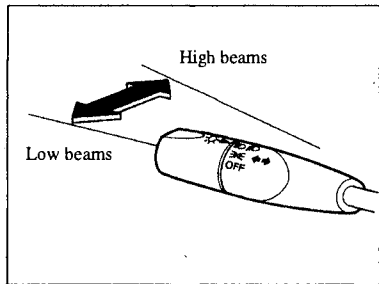

▼ **Headlight high-low beam**

Push the lever forward for high beams.
Pull it back for low.

The high-beam indicator light on the dashboard is blue.

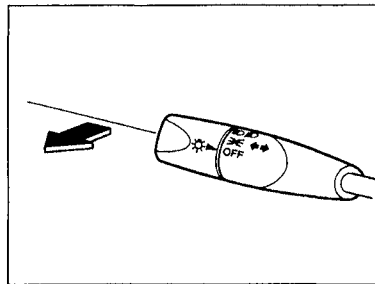

▼ **Flashing the headlights**

To flash the headlights, pull the lever fully toward you. The headlight switch need not be on, and the lever will return to the normal position when released.

The high-beam indicator light on the dashboard is blue.

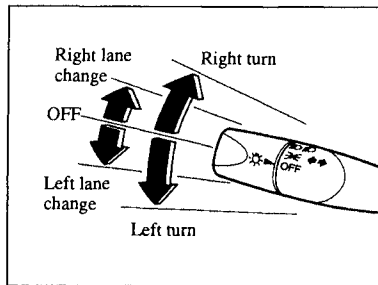

■ Turn and Lane-Change Signals

▼ Turn signal

Move the signal lever down (for a left turn) or up (for a right turn) to the stop position. The signal will self-cancel after the turn is completed.

Green indicators on the dashboard show which signal is working.

If the indicator light continues to flash after a turn, manually return the lever to its original position.

▼ Lane-change signals

Move the lever slightly toward the direction of the change—until the indicator flashes—and hold it there. It will return to the off position when released.

NOTE

If an indicator light stays on without flashing or if it flashes abnormally, the turn-signal bulb may be burned out.

Windshield Wipers and Washer

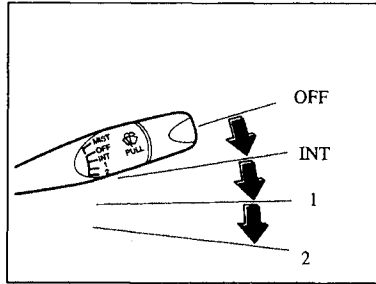

■ Windshield Wipers

The ignition switch must be in the ON position.

Turn the wipers on by pulling the lever down.

- INT — Intermittent
- 1 — Normal
- 2 — Fast

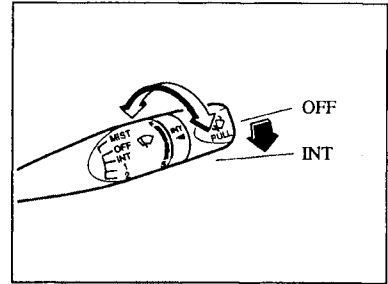

▼ Variable-speed intermittent wipers*

Set the lever at INT and choose the interval timing by rotating the ring.

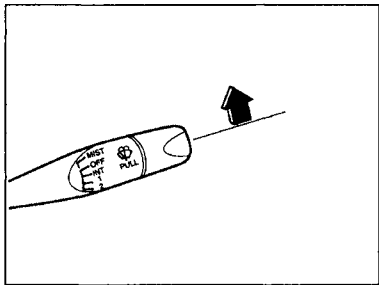

▼ One-touch wipers

For a single wiping cycle, push the lever up to MIST.

NOTE

Because heavy ice and snow can jam the wiper blades, the wiper motor is protected by a circuit breaker. This mechanism will automatically stop operation of the blades, but only for about 5 minutes.

If this happens, turn off the wiper switch and pull off the right-of-way. After 5 minutes, turn on the switch and the blades should operate normally. If they don't, consult an Authorized Mazda Dealer as soon as possible.

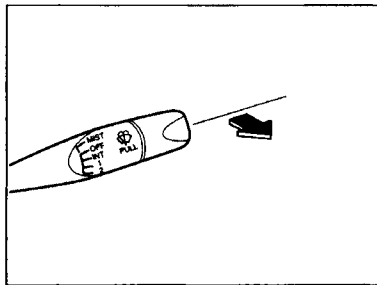

■ Windshield Washer

The ignition switch must be in the ON position.

Pull the lever toward you and hold it to spray washer fluid. In the OFF or INT position, the wipers will be activated until the lever is released.

If the washer doesn't work, inspect the fluid level (page 8-35). If it's OK, consult an Authorized Mazda Dealer.



WARNING

Frozen Washer Fluid:
Using windshield washer fluid in freezing temperatures could be dangerous. The washer fluid could freeze on the windshield and block your vision. You could have an accident. Don't use the washer without first warming the windshield.

Rear Window Defroster

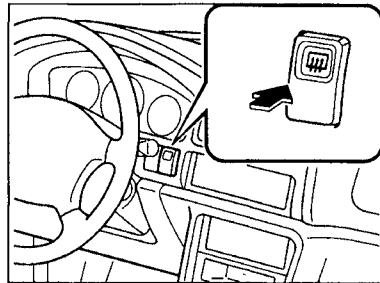

The rear defroster clears frost, fog, and thin ice from the rear window.

The ignition switch must be in the ON position.

Push the switch to turn on the rear window defroster; the indicator light will come on.

Push the switch again to turn it off.



CAUTION

Don't use sharp instruments or window cleaners with abrasives to clean the inside of the rear window surface. They may damage the defroster grid inside the window.

NOTE

- When the switch is turned on, the defroster comes on for about 15 minutes. Then the defroster cycles — 3 minutes off, 2 minutes on — for as long as the switch remains on. The indicator light stays on constantly.
- The rear defroster shuts off when the ignition switch is turned off.

NOTE

This defroster is not designed for melting snow. If there is an accumulation of snow on the rear window, brush it off before using the defroster.

Clock*

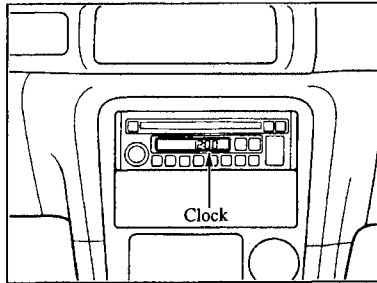

The clock is built into the audio system (page 5-85).

Accessory Socket*

Only use genuine Mazda accessories or the equivalent.

To use the accessory, the ignition switch must be in the ACC or ON position.

When you use any accessory, use one that requires less than 12V—10A.

CAUTION

Socket damage or electrical failure may occur, if you use accessories that;

- Require more than 12V—10A.
- Are not genuine Mazda accessories or the equivalent.

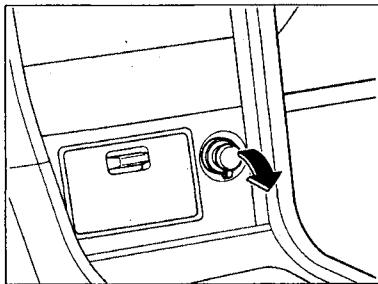

■ Front Accessory Socket

The front accessory socket is in the center panel.

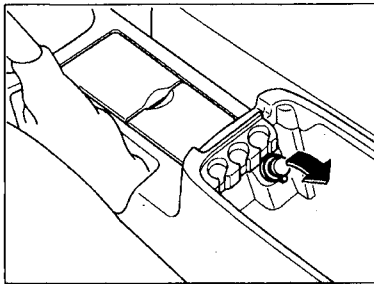

■ Rear Accessory Socket

The rear accessory socket is in the center console box (page 5-56)

The front accessory socket can be used for a lighter.

If a lighter is needed, one can be purchased from your Authorized Mazda Dealer.

After you have used the socket for other plug-in accessories, the socket may become unsuitable for the lighter. Before using the lighter, have the socket checked by your Authorized Mazda Dealer.

Glove Box

CAUTION

- If you use a lighter, overheating may occur when the lighter doesn't pop out within 30 seconds.
- Don't use a lighter in the rear accessory socket.

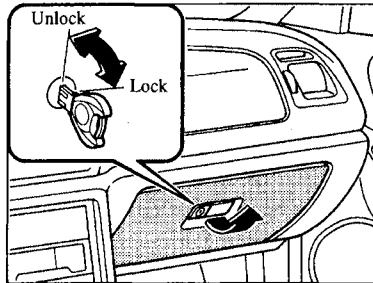

To open the glove box, pull the latch toward you.

WARNING

Open Glove Box:
An open glove box can be dangerous while the vehicle is moving. To reduce the possibility of injury in an accident or a sudden stop, keep the glove box closed while the vehicle is moving.

The door has a lock, insert the primary key and turn it clockwise to lock and counterclockwise to unlock.

Cup Holders

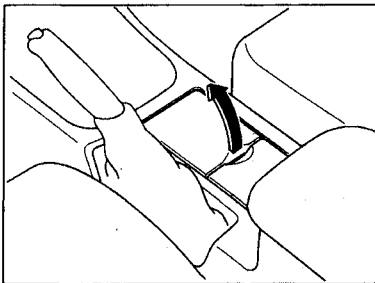

■ Front Cup Holders

The front cup holders are on the center console.

To use, lift the covers.

To open the rear cover, open the front first, then open the rear.

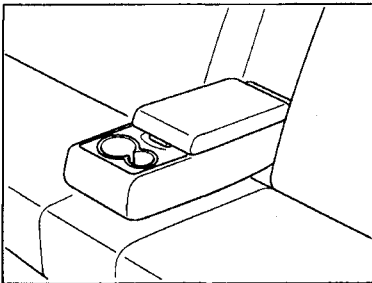

■ Rear Cup Holders

The rear cup holders are on the rear center armrest.

WARNING

Using the Cup Holder:
Using the cup holder to hold hot liquids while the vehicle is moving is dangerous. If the contents spill, you could be scalded. Never use the cup holder to hold hot liquids while the vehicle is moving.

Storage Compartments

WARNING

Open Storage Box:
Driving with a storage box open is dangerous. To reduce the possibility of injury in an accident or a sudden stop, keep the storage boxes closed when driving.

CAUTION

In hot weather, don't leave combustible materials or objects which will deform in extreme heat such as lighters and glasses in the vehicle.

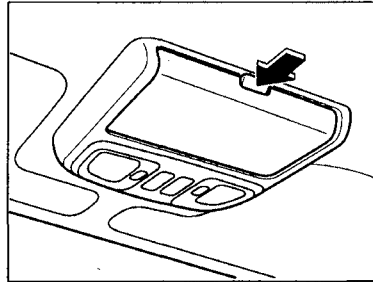

■ Eyeglass Holder

(With sunroof)

To open, push the release catch.

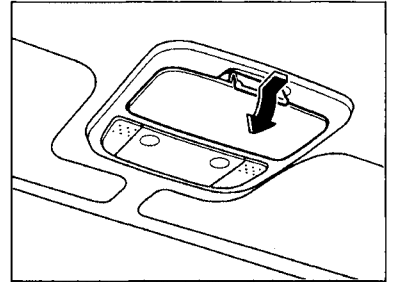

(Without sunroof)

To open, unlatch the release catch.

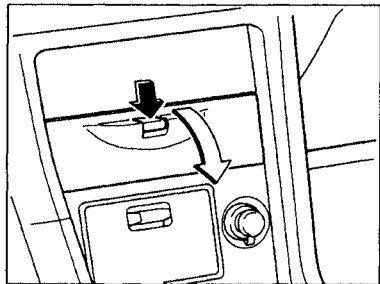

■ Storage Pocket*

To open, push the release catch down and pull the lid downward.

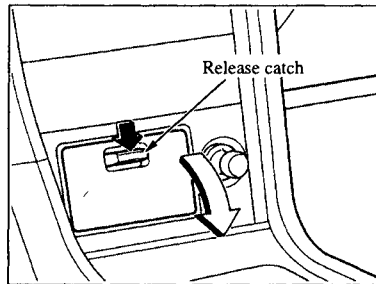

■ Center Pocket

To open, push the release catch down and pull the lid downward.

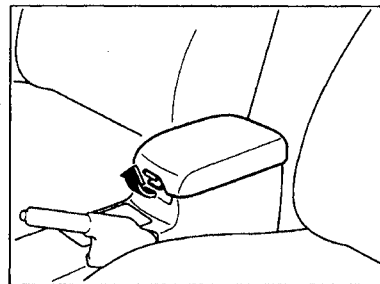

■ Center Console Box

To open the center console box, pull the lower release catch.

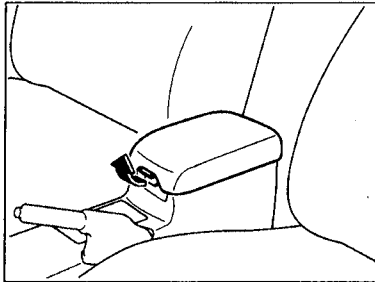

Small items can be placed in the tray of the center console lid.

To open, pull the upper release catch.

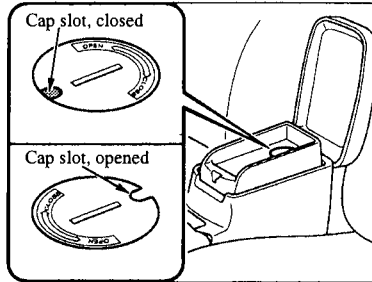

When placing an electrical device (e.g. cellular phone) in the tray which is connected with the rear accessory socket, pass the plug cord through the slot in the cap.

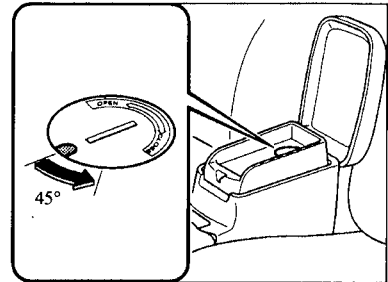

1. Using a coin, turn the cap counterclockwise (about 45° from the closed position) and remove it.

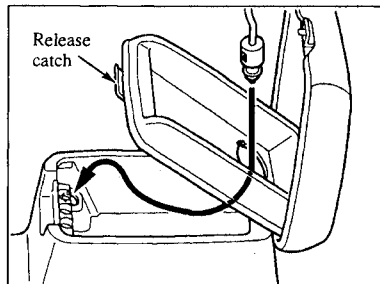

2. Open the tray by pulling the release catch.
3. Pass the plug and the cord through the hole of the tray and insert the plug in the socket.

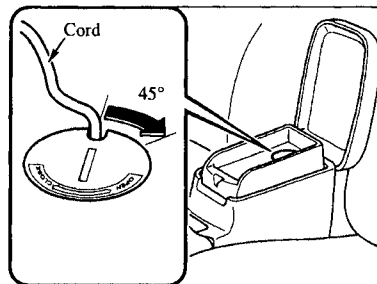

4. Make sure the plug cord is running through the cap slot, reinstall the cap and turn it clockwise (about 45° to the opened position).

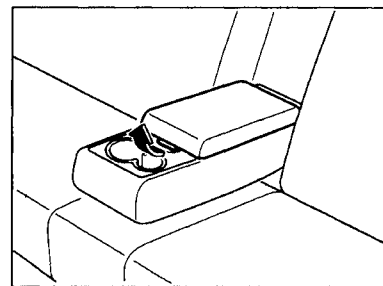

■ Rear Armrest Box

To open, pull the release catch.

Sunvisors

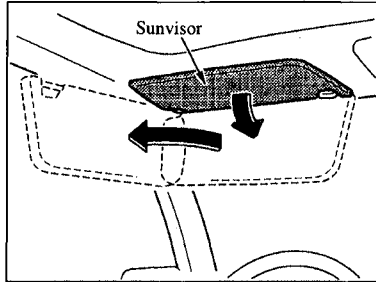

When you need a sunvisor, lower it for use in front or swing it to the side.

Vanity Mirrors*

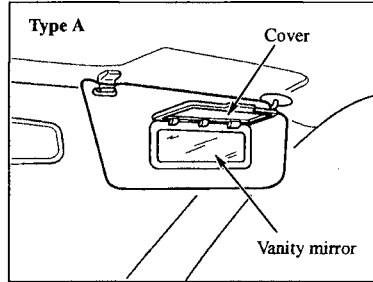

(Type A)
To use the vanity mirror, lower the sunvisor and pull the mirror cover up.

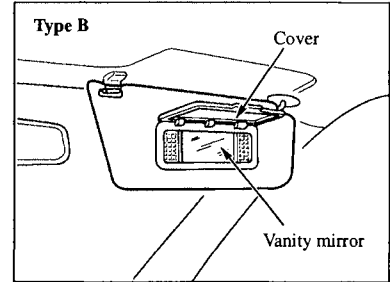

(Type B)
To use the vanity mirror, lower the sunvisor and pull the mirror cover up. The vanity mirror light will come on when you pull the cover up.

Climate Control System

■ Operating Tips

▼ Operating the climate control system

Operate the climate control system with the engine running.

▼ Foggy windows

The windows may fog up easily in humid weather. Use the climate control system to defrost the windows.

▼ Outside/Recirculated air position

Use the outside air position in normal conditions. The recirculated air position can be used temporarily when driving on dusty roads or for quick cooling of the interior.

▼ Parking in direct sunlight

If the vehicle has been parked in direct sunlight during hot weather, open the windows to let warm air escape, then run the climate control system.

▼ Not using for a long period

Run the air conditioner at least once a month to keep internal parts lubricated.

▼ Check the refrigerant before weather gets hot



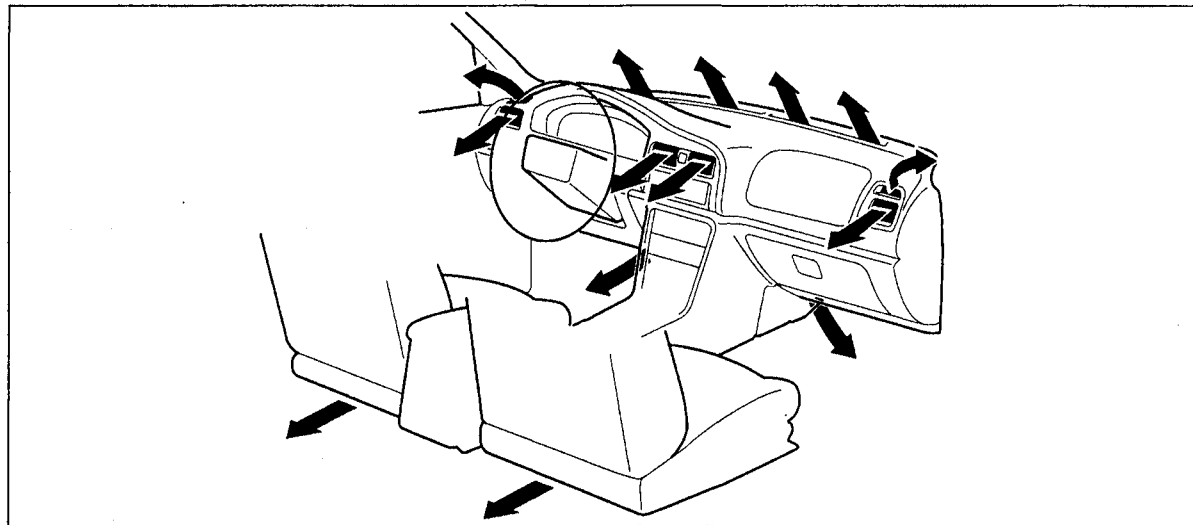

Have the air conditioner checked before weather gets hot. Lack of refrigerant may make the air conditioner less efficient. Consult an Authorized Mazda Dealer for refrigerant inspection.

■ Vent Locations and Airflow



Driving Your Mazda

▼ Selecting the airflow mode

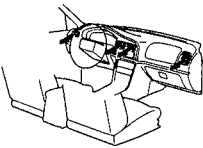
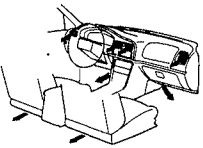
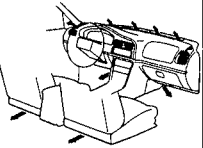
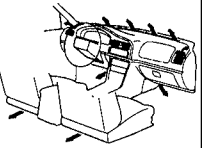
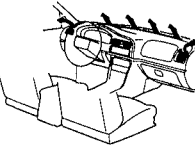
Use	When you want air to the face.	When you want air to the face and the floor.	When you want air mainly to the floor.	When you want air to the floor and defrost the windshield.	When you want to defrost the windshield.
Mode					
Airflow					

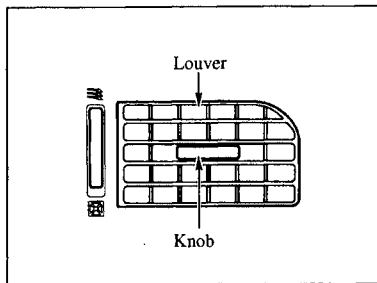

▼ Directing airflow

You can direct air flow by moving the adjustment knobs and louvers.

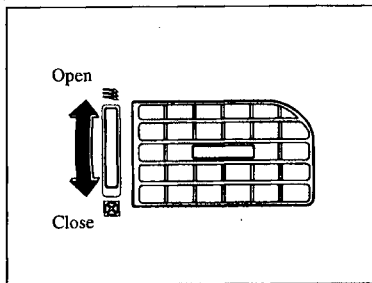

▼ Adjusting the amount of airflow

These vents can be opened by rotating the vertical wheels up or closed by rotating them down.

NOTE

When using the air conditioner, mist may come out from the vents. This is not a sign of trouble but a result of humid air being suddenly cooled.

■ Control Panel

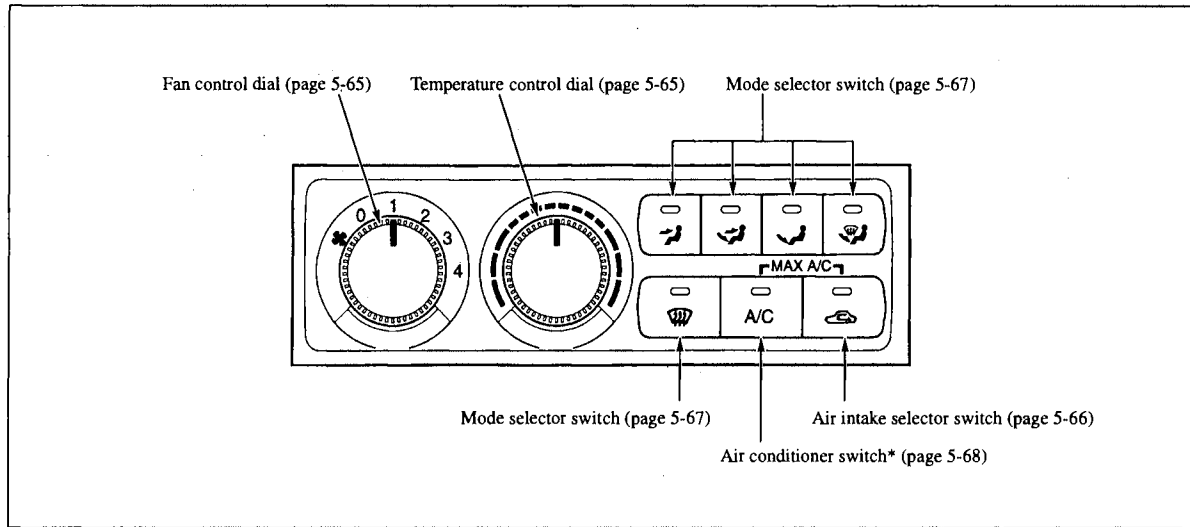

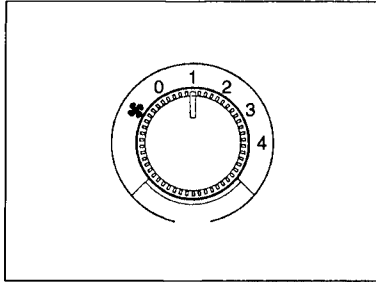

▼ Fan control dial

This dial allows variable fan speeds.

- 0 — Fan off
- 1 — Low speed
- 2 — Medium low speed
- 3 — Medium high speed
- 4 — High speed

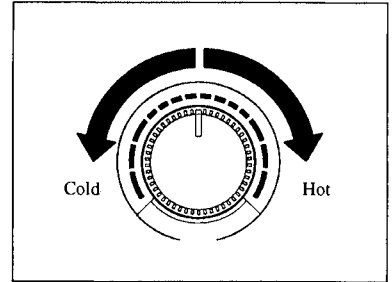

▼ Temperature control dial

This dial controls temperature of the air coming through the system. Turn it clockwise for hot (red) and counterclockwise for cold (blue).

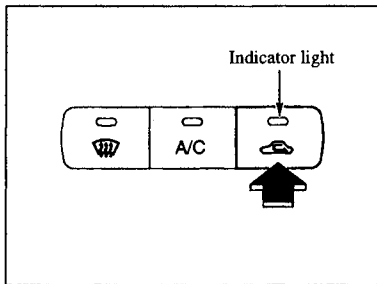

▼ Air intake selector switch

This switch controls the source of air entering the vehicle.

The switch should be kept in the outside air position under normal conditions.

5-66

Press the switch to alternate between the two positions. The indicator light illuminates when the recirculated air position is selected.

Outside air position:

This position is automatically selected when the ignition switch is turned to the ON position.

Use it for normal ventilation and heating.

The indicator light is out when the outside air position is selected.

Recirculated air position:



This position recirculates air within the vehicle. Don't use the recirculated air position for long periods when the vehicle is stopped.

The indicator light is on when the recirculated air position is selected.

WARNING

The Recirculated Air Position:
Using the recirculated air position in cold weather will cause the glass to fog up. Your vision will be hampered, which could lead to a serious accident. Do not use the recirculated air position in cold weather.

NOTE

- Clear all snow and ice from the hood and the air inlet in the cowl grille to improve heater and defroster efficiency and to reduce the probability of fogging on the inside of the windshield.
- When using the  and the  mode, select the outside air position (indicator light off) for maximum defogging of the front windshield.

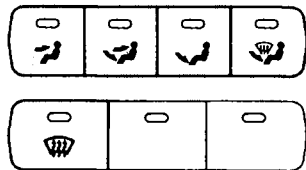

▼ **Mode selector switch**

Press the mode selector switch to select airflow mode. (page 5-62)

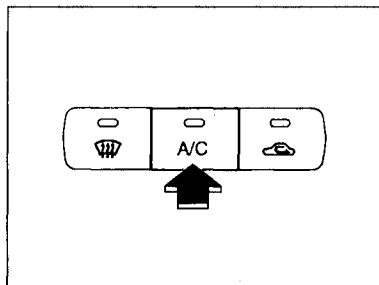

▼ Air conditioner switch (With air conditioner)*

Press the switch to turn the air conditioner on. An indicator light on the switch will illuminate when the fan switch is on. Press the switch once again to turn the air conditioner off.

5-68 *Some models.

NOTE

The air conditioner may not function when the outside temperature is too cold.

NOTE

- The optional air conditioner is filled with R134a, a refrigerant that will not damage the ozone layer.
- If the air conditioner is low on refrigerant or has a malfunction, consult an Authorized Mazda Dealer.

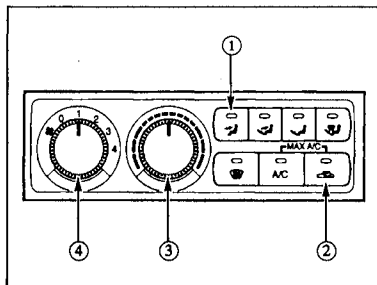

▼ Ventilation

1. Set the mode selector switch to the  position.
2. Set the air intake selector switch to the outside air position (indicator light off).

3. Set the temperature control dial to the desired position.
4. Set the fan control dial to the desired speed.

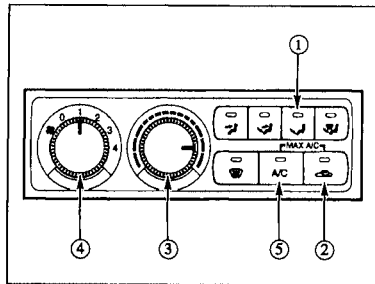



3. Set the temperature control dial to the hot position.
4. Set the fan control dial to the desired speed.
5. If dehumidified heating is desired, turn on the air conditioner.

▼ Heating

1. Set the mode selector switch to the  position.
2. Set the air intake selector switch to the outside air position (indicator light off).

NOTE

If the windshield fogs up easily, set the mode selector switch to the  position.

If cooler air is desired at face level, set the mode selector switch at the  position and adjust the temperature control dial to maintain maximum comfort.

The air to the floor is warmer than air to the face (except when the temperature control dial is set at the extreme hot or cold position).

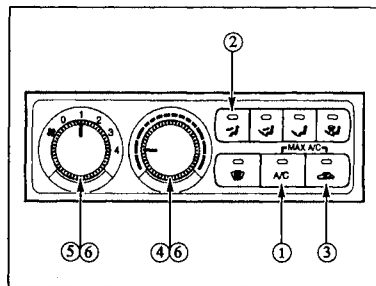

▼ Cooling (With air conditioner)*

1. Press the air conditioner switch to turn the air conditioner on.
2. Set the mode selector switch to the  position.

3. Set the air intake selector switch to the either position.
4. Set the temperature control dial to the desired position.
5. Set the fan control dial to the desired speed.
6. Adjust the fan control dial and temperature control dial to maintain maximum comfort.

NOTE

When maximum cooling is desired, set the temperature control dial to the extreme cold position and set the air intake selector switch to the recirculated air position, then set the fan control dial to position 4.

If warmer air is desired at floor level, set the mode selector switch at the  position and adjust the temperature control dial to maintain maximum comfort.

The air to the floor is warmer than air to the face (except when the temperature control dial is set at the extreme hot or cold position).



CAUTION

When using the air conditioner while driving up long hills or in heavy traffic, closely monitor the temperature gauge. The air conditioner may cause engine overheating. If the gauge indicates overheating, turn the air conditioner off. (Refer to Overheating on page 6-2.)

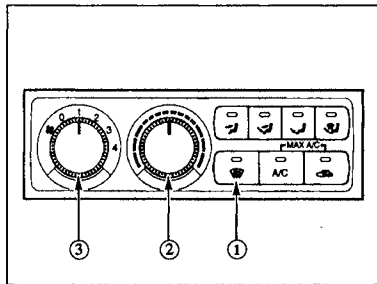



▼ Windshield defrosting and defogging

1. Set the mode selector switch to the  position.
2. Set the temperature control dial to the desired position.



3. Set the fan control dial to the desired speed.

WARNING

Foggy Windshield:

Using the  position with the temperature control set to the cold position will cause the outside of the glass to fog up. Your vision will be hampered, which could lead to a serious accident. Set the temperature control to the hot or warm position when using the  position.

NOTE

- When the mode selector switch is set to  or , the outside air position is selected automatically. The air intake selector switch cannot be changed to the recirculated air position.
- For maximum defrosting, set the temperature control dial to the extreme hot position and the fan control dial to position 4.
- If warm air is desired at the floor, set the mode selector switch to the  position.

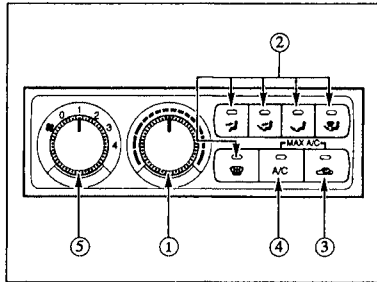

▼ **Dehumidifying
(With air conditioner)***

Operate the air conditioner in cool or cold weather to help defog the windshield and side windows.

1. Set the temperature control dial at a comfortable position.
2. Set the mode selector switch to the desired position.
3. Set the air intake selector switch at the either position.
4. Turn on the air conditioner.
5. Set the fan control dial to the desired speed.

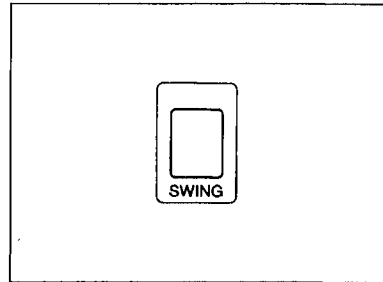

■ **Oscillating Air Vent***

The air from the center ventilation louver can automatically be swung in both right and left directions. To turn on, push the switch in. Another push will turn it off. When the switch is turned off, the direction of

airflow can manually be adjusted by the thumb wheel.

NOTE

When the switch is turned on, the louver always swings even when no air comes out from the center ventilation.

Radio Reception

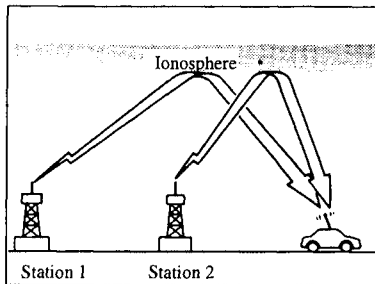

signals. Because of this, two stations may sometimes be picked up on the same frequency at the same time.

■ AM Characteristics

▼ Station mixing

AM signals bend around such things as buildings or mountains and bounce off the ionosphere. Therefore, they can reach longer distances than FM

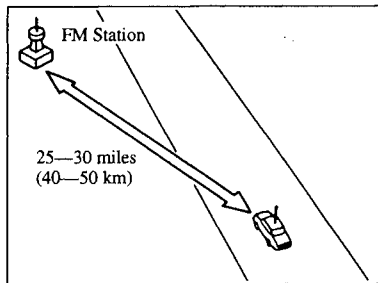

Because of extra coding needed to break the sound into two channels, stereo FM has even less range than monaural (nonstereo) FM.

■ **FM Characteristics**

An FM broadcast range is usually about 25—30 miles (40—50 km) from the source.

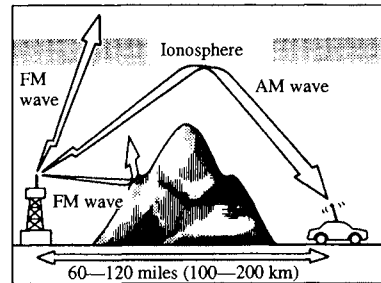

Signals from an FM transmitter are similar to beams of light because they do not bend around corners, but they do reflect. Unlike AM signals, FM signals cannot travel beyond the horizon. Therefore, FM stations cannot be received at the great distances possible with AM reception.

Atmospheric conditions can also affect FM reception. High humidity will cause poor reception. However, cloudy days may provide better reception than clear days.

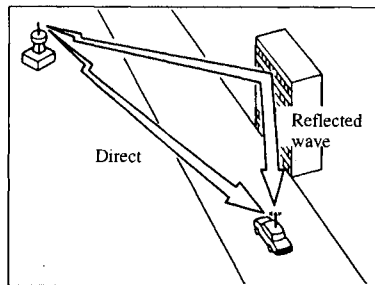

This condition may also be encountered when in close proximity to the transmitter.

▼ Multipath noise

Since FM signals can be reflected by obstructions, it is possible to receive both the direct signal and the reflected signal at the same time. This causes a slight delay in reception and may be heard as a broken sound or a distortion.

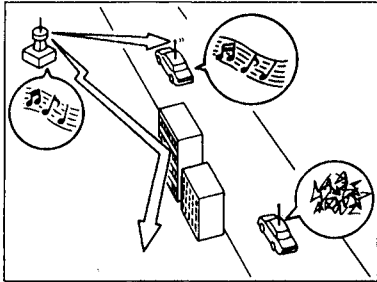

▼ Flutter/Skip noise

Signals from an FM transmitter move in straight lines and become weak in valleys between tall buildings, mountains, and other obstacles.

When a vehicle passes through such an area, the reception conditions may change suddenly, resulting in annoying noise.

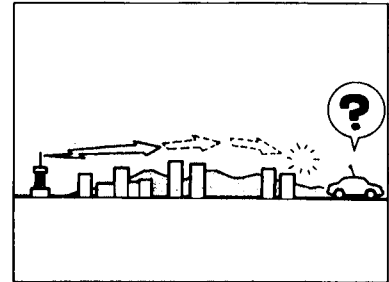

▼ Weak signal noise

In some areas, broadcast signals become weak because of distance from the transmitter. Reception in such fringe areas is characterized by sound breakup.

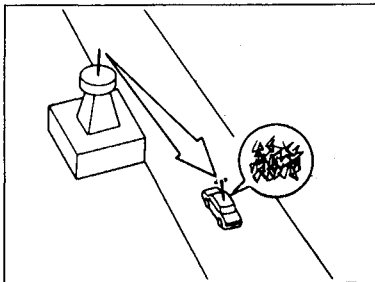

▼ Strong signal noise

This occurs very close to a transmitter tower. The broadcast signals are extremely strong, so the result is noise and sound breakup at the radio receiver.

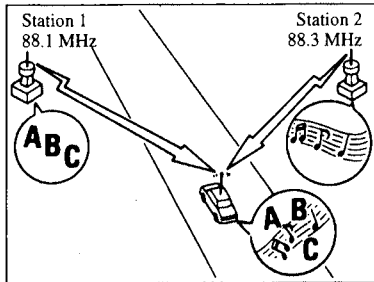

▼ Station drift noise

When a vehicle reaches the area of two strong stations broadcasting at similar frequencies, the original station may be temporarily lost and the second station picked up. At this time there will be some noise from this disturbance.

Safety Certification

This compact disc player is made and tested to meet exacting safety standards. It meets FCC requirements and complies with safety performance standards of the U.S. Department of Health and Human Services.

 **CAUTION**

- This compact disc player should not be adjusted or repaired by anyone except qualified service personnel. If servicing required, contact an Authorized Mazda dealer.
- Use of controls or adjustments or performance of procedures other than those specified herein may result in hazardous radiation exposure. Never operate the compact disc player with the top case of the unit removed.

(Continued)

- Changes or modifications not expressly approved by Mazda may void the user's authority to operate this equipment.

NOTE

For compact disc player section: This device complies with part 15 of the FCC Rules. Operation is subject to the following two conditions: (1) This device may not cause harmful interference, and (2) this device must accept any interference received, including interference that may cause undesired operation.

NOTE

This equipment has been tested and found to comply with the limits for a Class B digital device, pursuant to part 15 of the FCC Rules. These limits are designed to provide reasonable protection against harmful interference in a residential installation. This equipment generates, uses, and can radiate radio frequency energy and, if not installed and used in accordance with the instructions, may cause harmful interference to radio communications. However, there is no guarantee that interference will not occur in a particular installation.

AM/FM Radio with Compact Disc Player*

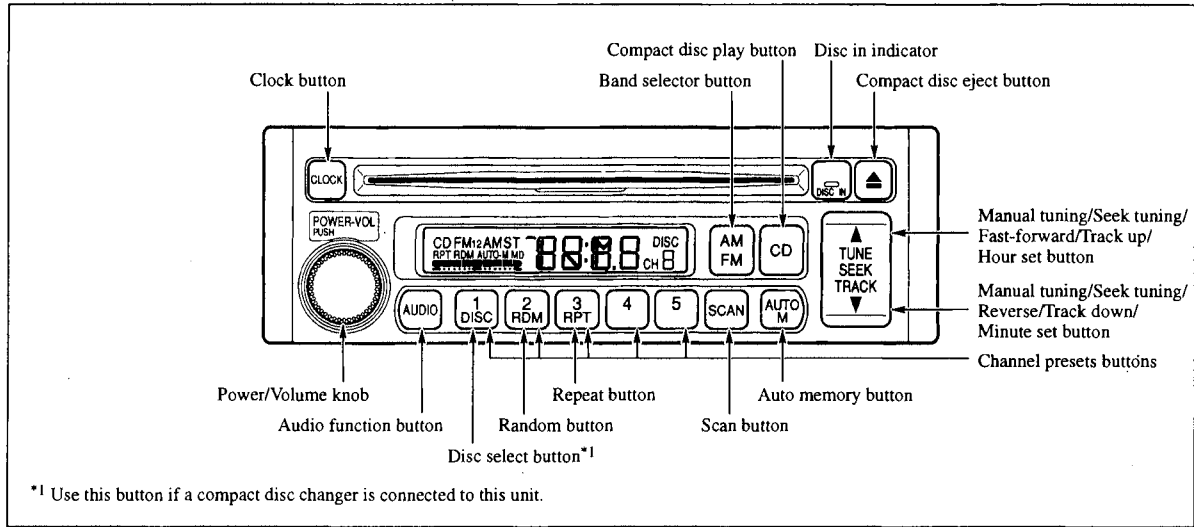

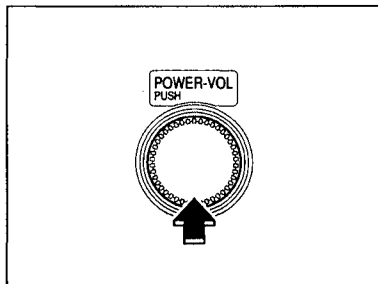

Press the power/volume knob again to turn the audio system off.

NOTE

To prevent the battery from being discharged, do not leave the audio system on for a long period while the engine is not running.

■ Power ON/OFF

Turn the ignition switch to the ACC or ON position.

Press the power/volume knob button to turn the audio system on.

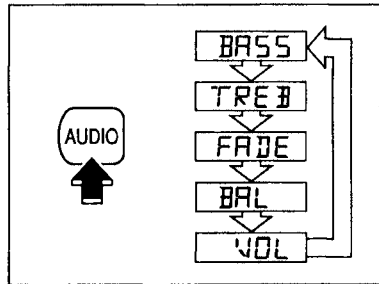

▼ Audio sound adjustment

1. Press the audio function button to select bass, treble, fade, balance, or volume control. The selected function will be indicated.

NOTE

About 5 seconds after selecting any mode, the volume function will be automatically selected. To reset bass, treble, fade, and balance, press the audio function button for 2 seconds. The unit will beep and "CL" will be displayed.

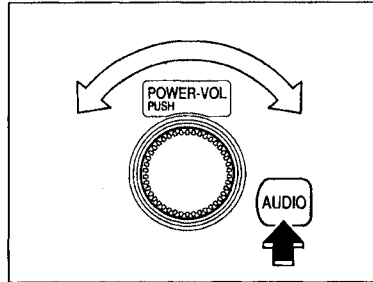

NOTE

The volume can be adjusted without pressing the audio function button.

2. Turn the power/volume knob to adjust the selected function; bass, treble, fade, balance, or volume.

Bass control

To adjust the lower tonal qualities, select BASS by pressing the audio function button. "BASS" will be displayed.

Turn the power/volume knob to the right to increase lower-pitched tones, to the left to decrease them. The level will be displayed.

Release the power/volume knob when the desired level has been reached.

Treble control

To adjust the higher tonal qualities, select TREB by pressing the audio function button. "TREB" will be

displayed.

Turn the power/volume knob to the right to increase higher-pitched tones, to the left to decrease them. The level will be displayed.

Release the power/volume knob when the desired level has been reached.

Fade control

To adjust the sound distribution between front and rear speakers, select FADE by pressing the audio function button. "FADE" will be displayed.

Turn the power/volume knob to the right to shift the sound to the rear, to the left to shift the sound to the front.

The level will be displayed.

Release the power/volume knob when the desired level has been reached.

Balance control

To adjust the sound distribution between left and right speakers, select BAL by pressing the audio function button. "BAL" will be displayed.

Turn the power/volume knob to the right to shift the sound to the right, to the left to shift the sound to the left. The level will be displayed.

Release the power/volume knob when the desired level has been reached.

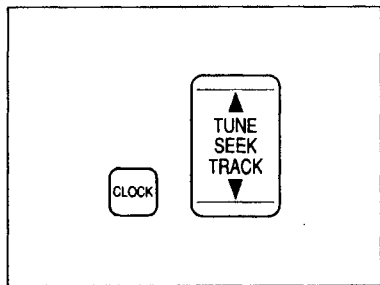

■ Clock

▼ Setting the time

The clock can be set at any time when the ignition switch is in the ACC or ON position.

1. To adjust the time, press the clock button for about 2 seconds until a beep is heard.
2. The clock's current time will flash until the time is set.

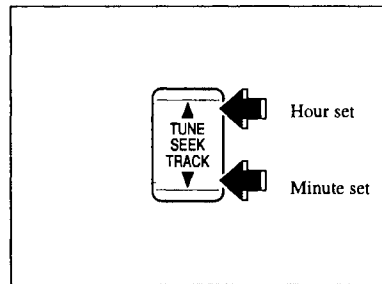

3. To advance the hours, press the hour set button (▲); to advance the minutes, press the minute set button (▼) while the time is flashing.
4. Press the clock button again to start the clock.

NOTE

If the power supply to the unit is interrupted (if the fuse blows or the vehicle's battery is disconnected), the clock will need to be reset.

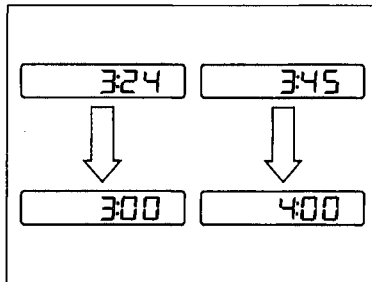

NOTE

If the time is not adjusted while the clock's current time is flashing (if neither the ▲ nor ▼ button is pressed), and the clock button is pressed a second time, the minutes will be set to 00.

If the clock's current time setting is within the latter part of the hour (from 30 to 59 min), the hour setting will automatically advance one hour.

▼ Changing the display mode

The display on the unit can be changed by pushing the clock button. This alternates the display between time and audio. When the time mode has been selected, the time will be displayed.

NOTE

If audio operation is selected, while the time mode is on, the selected audio mode will be displayed for 10 seconds, then the display will revert to the time mode.

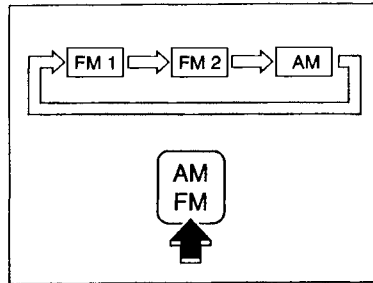

■ Operating the Radio

To operate the radio, turn the ignition switch to the ACC or ON position.

▼ Radio ON

Press the band selector button to turn the radio on.

▼ Band selection

Press band selector button to change FM1, FM2, and AM. The selected mode will be indicated. If FM stereo is being received, "ST" will be displayed.

NOTE

If the FM broadcast signal becomes weak, reception automatically changes from STEREO to MONO for reduced noise, and the "ST" indicator will go out.

▼ Tuning

The radio has five tuning methods: Manual, Seek, Scan, Preset channel, and Auto memory tuning. The easiest way to tune stations is to set them on preset channels.

NOTE

If the power supply is interrupted (fuse blows or the battery is disconnected), the preset channels will be canceled.

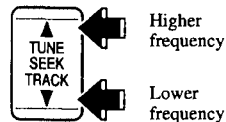

Manual tuning

Pressing the manual tuning button will change to a higher or lower frequency.

Seek tuning

Pressing the seek tuning button for more than about half a second until a beep is heard will cause the tuner to seek a higher or lower frequency automatically.

NOTE

If you continue to press and hold the button, the frequency will change rapidly and the unit will not seek. Please release the switch after the beep.

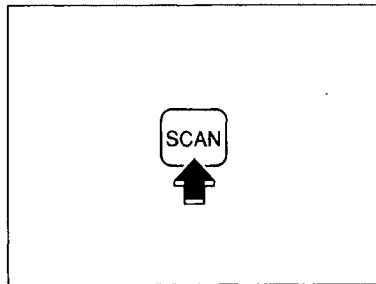

Scan tuning

Press the scan button to automatically sample strong stations. Scanning stops at each station for about 5 seconds. To hold a station, merely press the scan button again during this interval.

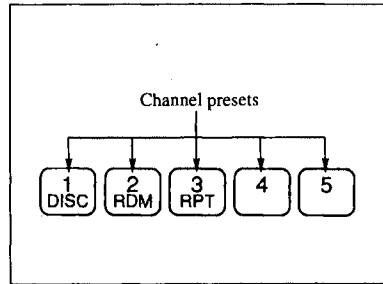

Preset channel tuning

The five preset channels can be used to store 5 AM and 10 FM stations.

To set a channel first select AM, FM1, or FM2. Tune to the station you want and depress a channel preset button for about 2 seconds until a beep is heard. The preset channel number and station frequency will be displayed. The station is now held in the memory. Repeat this operation for the other stations and bands you want to store. To tune one in the memory, select AM, FM1 or FM2 and then press its channel preset button. The station frequency and the channel number will be displayed.

NOTE

If the power supply is interrupted (fuse blows or the battery is disconnected), the preset channels will be canceled.



Auto memory tuning

This is especially useful when driving in an area where the local stations are not known. Additional AM/FM stations can be memorized without disturbing the previously set channels.

Press and hold the auto memory button for about 2 seconds until a beep is heard; the system will automatically scan and temporarily store the six strongest stations of each selected band in that area.

After scanning is completed, the strongest station will be tuned and its frequency displayed.

Press and release the auto memory button to recall stations from the auto-memorized stations. One memorized station will be selected each time; "AUTO-M" and channel number will be displayed.

NOTE

If no stations can be tuned after scanning operations, "A" will be displayed.

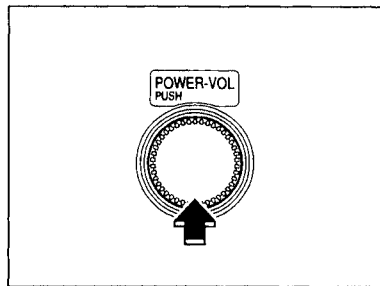

▼ Radio OFF

Press the power/volume knob to turn off the radio.

NOTE

Press the power/volume knob again to listen to the frequency last tuned to.

■ Operating the Compact Disc Player

To operate the compact disc player, turn the ignition switch to the ACC or ON position.

▼ Inserting the compact disc

Insert the compact disc into the slot, label-side up. The auto-loading mechanism will set the compact disc and begin play. There will be a short lapse before play begins while the player reads the digital signals on the compact disc.

The DISC IN indicator light will illuminate and the track number will be displayed.

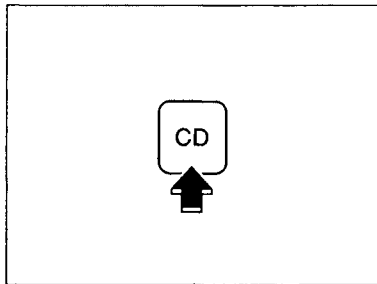

▼ Playing

Press the compact disc play button to start playing when a compact disc is in the unit.

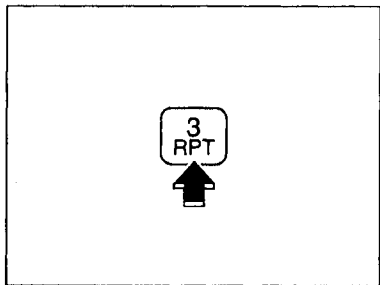

Press the repeat button once again to cancel repeat play.

▼ Repeat play

This feature makes it possible to listen to a selection repeatedly.

Press the repeat button during play. The current selection playing will be repeated ("RPT" will be displayed).

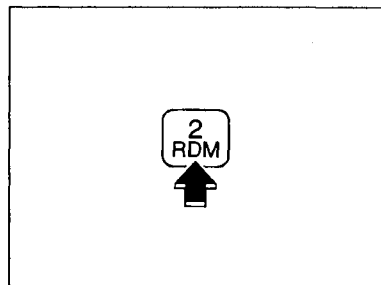

▼ Random play

This feature allows the compact disc player to select the order of the songs that the compact disc will play.

Press the random button during play. The next selection play will be

randomly selected ("RDM" will be displayed).
Press the random button once again to cancel random play.

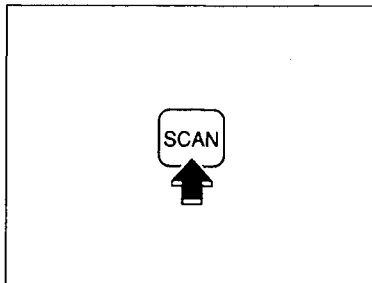

▼ Music scan

This feature helps to find a program by playing about the first 10 seconds of each track.

Press the scan button during play to start scan play operation (the track number will flash).

Press the scan button once again to cancel scan play.

NOTE

If the unit is left in scan, normal play will resume where scan was selected.

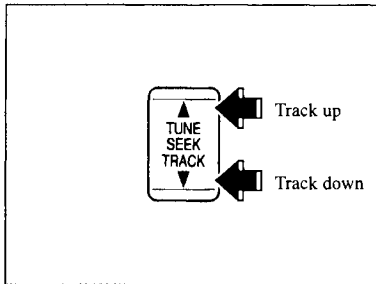

▼ Track search

Press the track up button (▲) once to skip forward to the beginning of the next track.

Press the track down button (▼) once to skip back to the beginning of the current track.

▼ Fast forward/Reverse

Press and hold the fast-forward button (▲) to advance through a track at high speed.

Press and hold the reverse button (▼) to reverse through a track at high speed.

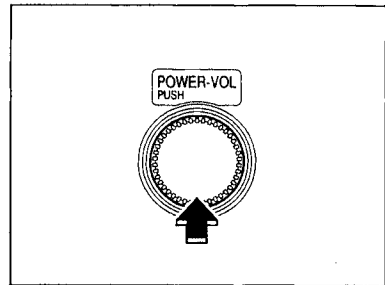

▼ Stopping

Press the power/volume knob to stop compact disc play.

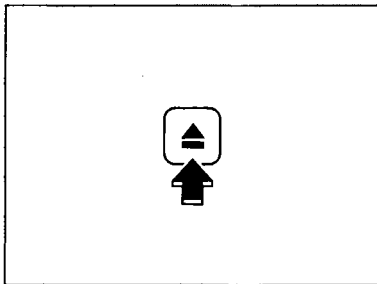

▼ Ejecting the compact disc

Press the compact disc eject button to eject the compact disc.

■ Operating the Compact Disc Changer* (with Controls on the Radio/Compact Disc Player Unit)

The compact disc changer can be connected to the radio/compact disc player unit and operated by the controls on the unit. Regarding operation of the compact disc changer itself, please refer to the instructions attached to the changer.

NOTE

Operating the compact disc changer is generally the same as that of the compact disc player (pages 5-92 — 5-96).

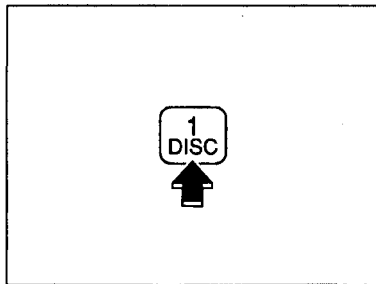

▼ Selecting a compact disc

Press the disc select button to select a compact disc.

■ Error Indications

If you see an error indication on the display of the radio/compact disc player unit, find the cause in the chart. If you cannot clear the error indication, take the vehicle to an Authorized Mazda Dealer.

Indication	Cause	Solution
E01	Compact disc mechanism problem	Consult an Authorized Mazda Dealer
E07	Compact disc is inserted upside down	Insert the compact disc properly. If the code does not disappear, consult an Authorized Mazda Dealer
	Compact disc is defective	Try another disc
E30	High temperature	Will disappear when the temperature returns to normal

■ Operating Tips for Compact Disc Player

▼ Condensation phenomenon

Immediately after turning on the heater when the vehicle is cold, the compact disc or optical components (prism and lens) in the compact disc player may become clouded with condensation. At this time, the compact disc will eject immediately when placed in the unit. A clouded compact disc can be corrected simply by wiping it with a soft cloth. Clouded optical components will clear naturally in about an hour. Wait for normal operation to return before attempting to use the unit.

▼ Handling the compact disc player

The following precautions should be observed.

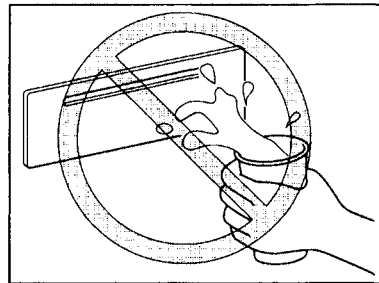

- Do not spill any liquid on the audio system.

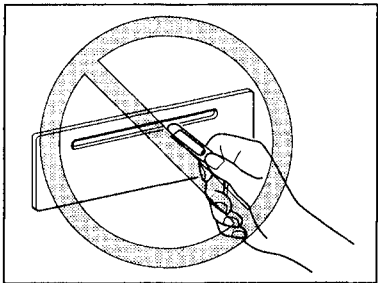

- Do not insert any objects, other than compact disc, into the slot.

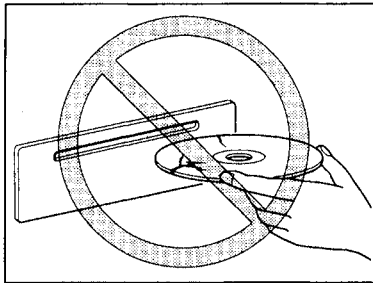

- The compact disc revolves at high speed within the player unit. Defective (cracked or badly bent) compact discs should never be used.

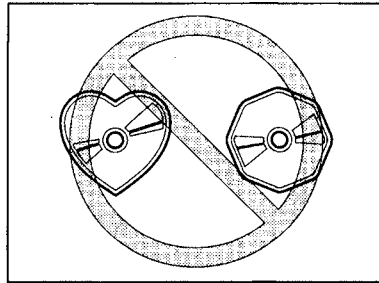

- Do not use non-conventional discs such as heart-shaped, octagonal discs, etc. The compact disc player could be damaged.

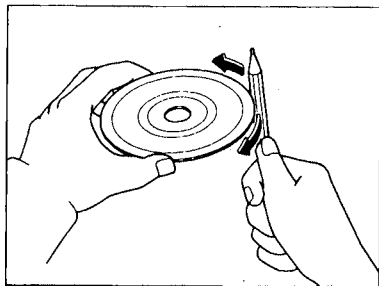

ball-point pen or pencil as shown on the right. To remove the rough edges, press the side of the pen or pencil against the inner and outer perimeter of the compact disc.

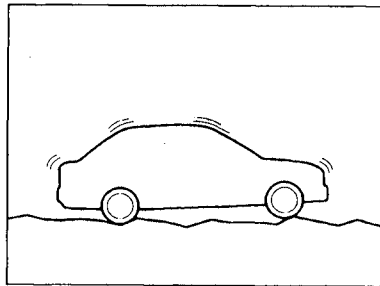

- A new compact disc may have rough edges on its inner and outer perimeters. If a disc with rough edges is used, proper setting will not be possible and the compact disc player/changer will not play the compact disc. Remove the rough edges in advance by using a

- When driving over uneven surfaces, the sound will jump.



- The compact disc player has been designed to play compact discs bearing the identification logo as shown. No other discs can be played.

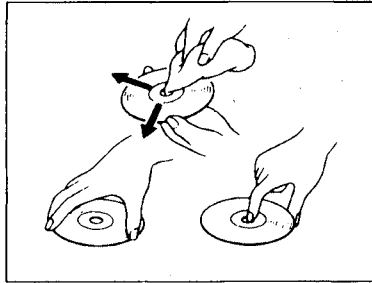

- Be sure never to touch the signal surface when handling the compact discs. Pick up a compact disc by grasping the outer edge or the edge of the hole and the outer edge.

- Do not stick paper or tape on the compact disc. Avoid scratching the reverse side (the side without a label).
- Dust, finger smudges, and dirt can decrease the amount of light reflected from the signal surface, thus affecting sound quality. If the compact disc should become soiled, gently wipe it with a soft cloth from the center of the compact disc to the edge.

- Do not use record sprays, antistatic agents, or household spray cleaners. Volatile chemicals such as benzine and thinner can also damage the surface of the compact disc and must not be used. Anything that can damage, warp, or fog plastic should never be used to clean compact discs.
- Compact discs, like traditional audio records, are made of plastic. To avoid warping, keep the compact discs in their cases and do not store them where they will be exposed to direct sunlight.
- The compact disc player ejects the compact disc if the compact disc is inserted upside down. Also dirty and/or defective compact discs may be ejected.
- Do not insert cleaning discs in the compact disc player.
- Do not insert any disc with a peel-off or seal on it.

AM/FM Radio with Cassette Tape and Compact Disc Player*

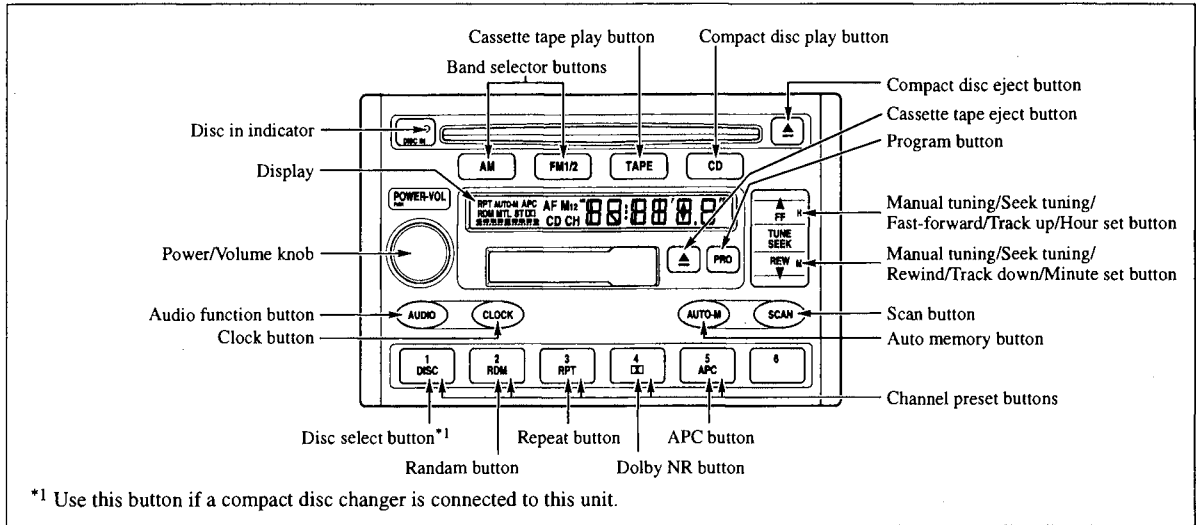

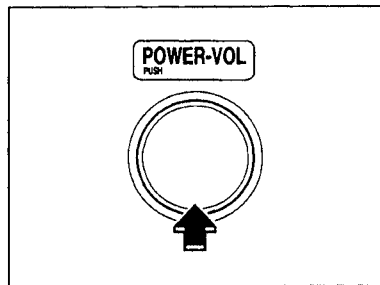

■ Power ON/OFF

Turn the ignition switch to the ACC or ON position.

Press the power/volume knob to turn the audio system on. Press the power/volume knob again to turn the audio system off.

NOTE

To prevent the battery from being discharged, do not leave the audio system on for a long period when the engine is not running.

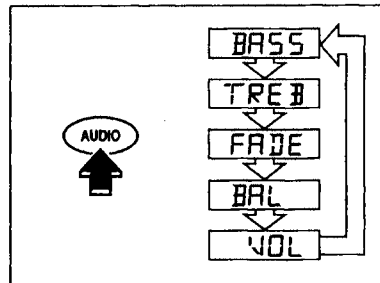

▼ Audio sound adjustment

1. Press the audio function button to select bass, treble, fade, balance, or volume control. The selected function will be indicated.

NOTE

About 5 seconds after selecting any mode, the volume function will be automatically selected. To reset bass, treble, fade, and balance, press the audio function button for 2 seconds. The unit will beep and "CL" will be displayed.

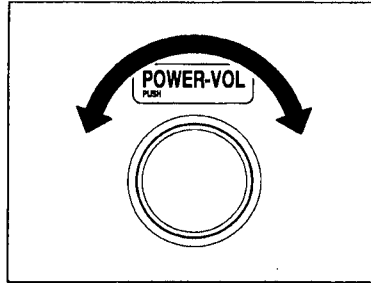

NOTE

The volume can be adjusted without pressing the audio function button.

2. Turn the power/volume knob to adjust the selected function; bass, treble, fade, balance, or volume.

Bass control

To adjust the lower tonal qualities, select BASS by pressing the audio function button. "BASS" will be displayed.

Turn the power/volume knob to the right to increase lower-pitched tones, to the left to decrease them. The level will be displayed.

Release the power/volume knob when the desired level has been reached.

Treble control

To adjust the higher tonal qualities, select TREB by pressing the audio function button. "TREB" will be

displayed.

Turn the power/volume knob to the right to increase higher-pitched tones, to the left to decrease them. The level will be displayed.

Release the power/volume knob when the desired level has been reached.

Fade control

To adjust the sound distribution between front and rear speakers, select FADE by pressing the audio function button. "FADE" will be displayed.

Turn the power/volume knob to the right to shift the sound to the rear, to the left to shift the sound to the front.

The level will be displayed.

Release the power/volume knob when the desired level has been reached.

Balance control

To adjust the sound distribution between left and right speakers, select BAL by pressing the audio function button. "BAL" will be displayed.

Turn the power/volume knob to the right to shift the sound to the right, to the left to shift the sound to the left. The level will be displayed.

Release the power/volume knob when the desired level has been reached.

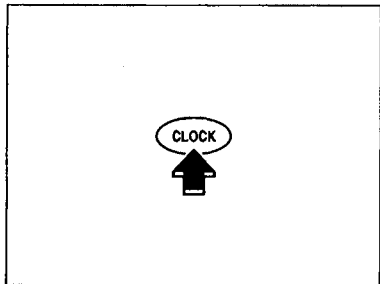

■ **Clock**

▼ **Setting the time**

The clock can be set at any time when the ignition switch is in the ACC or ON position.

1. To adjust the time, press the clock button for about 2 seconds until a beep is heard.
2. The clock's current time will flash until the time is set.

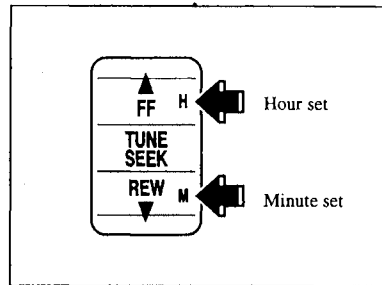

3. To advance the hours, press the hour set button (▲) to advance the minutes, press the minute set button (▼) while the time is flashing.
4. Press the clock button again to start the clock.

NOTE

If the power supply to the unit is interrupted (if the fuse blows or the vehicle's battery is disconnected), the clock will need to be reset.

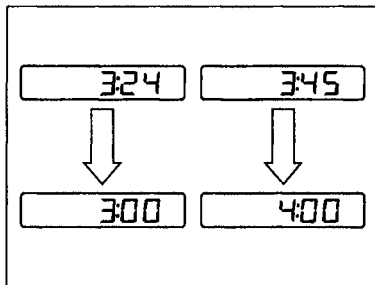

NOTE

If the time is not adjusted while the clock's current time is flashing (if neither the ▲ nor ▼ is pressed), and the clock button is pressed a second time, the minutes will be set to 00. If the clock's current time setting is within the latter part of the hour (from 30 to 59 min), the hour setting will automatically advance one hour.

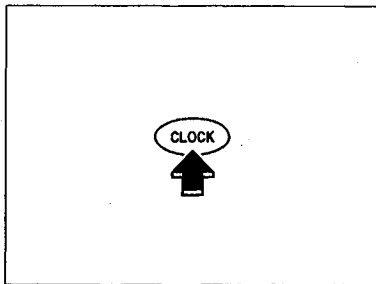

▼ **Changing the display mode**

The display on the unit can be changed by pressing the clock button. This alternates the display between time and audio. When the time mode has been selected, the time will be displayed.

NOTE

If audio operation is selected while the time mode is on, the selected audio mode will be displayed for 10 seconds, then the display will revert to the time mode.

■ **Operating the Radio**

To operate the radio, turn the ignition switch to the ACC or ON position.

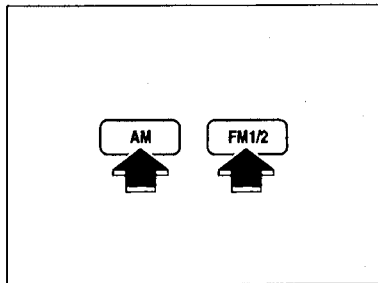

▼ Radio ON

Press the AM or FM1/2 button to turn the radio on.

▼ Band selection

Choose AM by pressing the AM button and FM1 or FM2 by pressing the FM1/2 button.

The selected mode will be indicated. If FM stereo is being received, "ST" will be displayed.

NOTE

If the FM broadcast signal becomes weak, reception automatically changes from STEREO to MONO for reduced noise, and the "ST" indicator will go out.

▼ Tuning

The radio has five tuning methods: Manual, Seek, Scan, Preset channel, and Auto memory tuning.

The easiest way to tune stations is to set them on preset channels.

NOTE

If the power supply is interrupted (fuse blows or the battery is disconnected), the preset channels will be canceled.

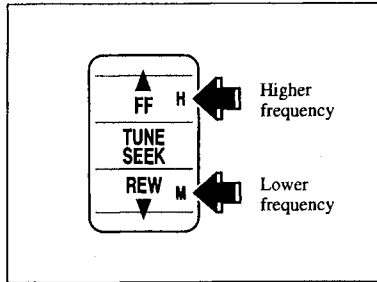

Manual tuning

Pressing the manual tuning button will change to a higher or lower frequency.

Seek tuning

Pressing the seek tuning button for more than about half a second until a beep is heard will cause the tuner to seek a higher or lower frequency automatically.

NOTE

If you continue to press and hold the button, the frequency will continue changing without stopping. Please release the button after the beep.

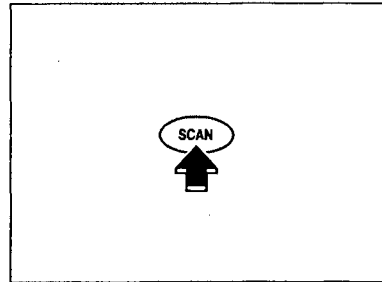

Scan tuning

Press the scan button to automatically sample strong stations. Scanning stops at each station for about 5 seconds. To hold a station, merely press the scan button again during this interval.

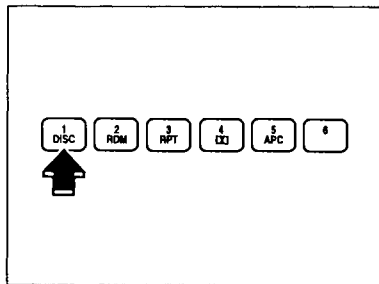

Preset channel tuning

The six preset channels can be used to store 6 AM and 12 FM stations.

To set a channel first select AM, FM1, or FM2. Tune to the station you want and depress a channel preset button for

about 2 seconds until a beep is heard. The preset channel number and station frequency will be displayed. The station is now held in the memory. Repeat this operation for the other stations and bands you want to store. To tune one in the memory, select AM, FM1, or FM2 and then press its channel preset button. The station frequency and the channel number will be displayed.

NOTE

If the power supply is interrupted (fuse blows or the battery is disconnected), the preset channels will be canceled.

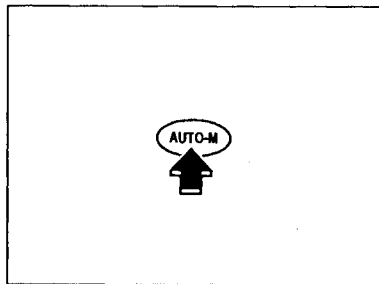

Auto memory tuning

This is especially useful when driving in an area where the local stations are not known. Additional AM/FM stations can be memorized without disturbing the previously set channels.

Press and hold the auto memory button for about 2 seconds until a beep is heard; the system will automatically scan and temporarily store the six strongest stations of each selected band in that area.

After scanning is completed, the strongest station will be tuned and its frequency displayed. Press and release the auto memory button to recall stations from the auto-memorized stations. One memorized station will be selected each time; "AUTO-M" and channel number will be displayed.

NOTE

If no stations can be tuned after scanning operations, "A" will be displayed.

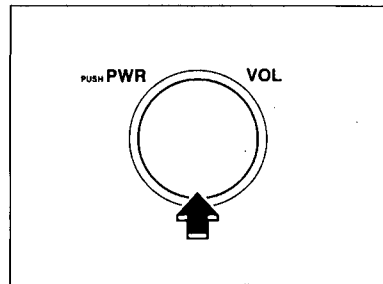

▼ Radio OFF

Press the power/volume knob to turn off the radio.

NOTE

Press the power/volume knob again to listen to the frequency last tuned to.

■ Operating the Cassette Tape Player

To operate the cassette tape player, turn the ignition switch to the ACC or ON position.

▼ Cassette tape insert

Insert the cassette tape into the slot, open edge to the right and cassette tape will begin play and "TAPE" will be displayed. At the end of the cassette tape, the unit automatically reverses cassette tape play.

When ▲ is lit, the cassette tape's top side is playing. When ▼ is lit, the bottom side is on.

NOTE

When a metal tape is inserted, the player will automatically compensate for it and "MTL" will be displayed.

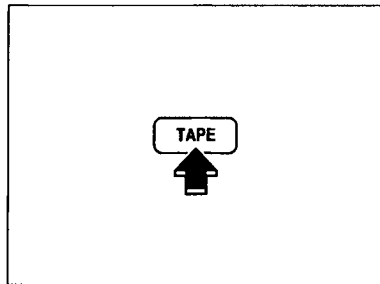

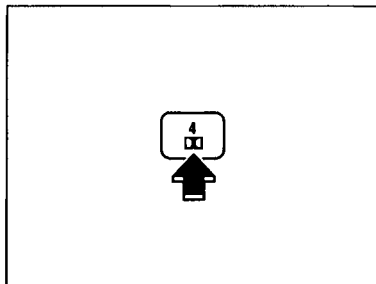

▼ **Playing**

Press the cassette tape play button to start playing when a cassette tape is in the unit. If there isn't a cassette tape in the unit when the cassette tape play button is pressed, "NO TAPE" will flash on and off in sequence.



▼ **Dolby noise reduction**

When using a tape with Dolby NR*, push the  button. The  symbol will be displayed. To play a tape without Dolby NR, push the button once again.

* Noise reduction system manufactured under license from Dolby Laboratories Licensing Corporation.

Dolby and the double-D symbol  are trademarks of Dolby Laboratories Licensing Corporation.

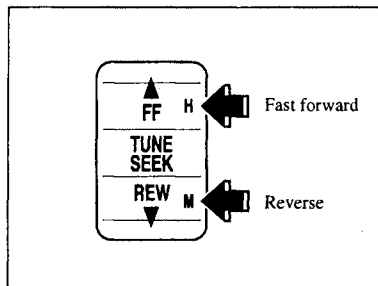

▼ Fast forward/Rewind

Press the fast-forward button to fast forward.

Press the rewind button to rewind.
To stop this operation and play the cassette tape, press the button again.

NOTE

When the cassette tape ends during fast forward or rewind, it automatically stops and starts playing.

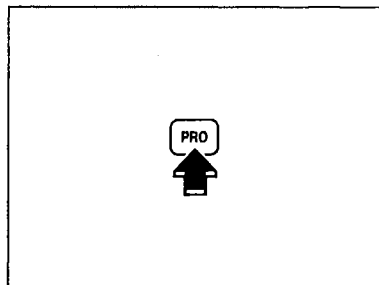

▼ Reversing

Press the program button to change cassette tape-playing direction.

NOTE

When the cassette tape ends, the unit automatically reverses play.

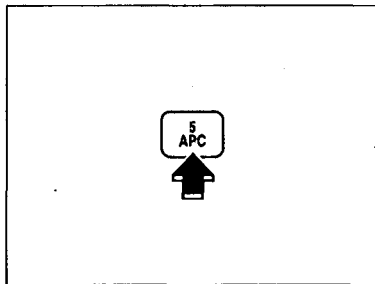
**▼ APC (Automatic Program Control)**

APC is used to find the beginning of either the next program or the one being played.

Press the APC button. Then push the fast-forward button (▲) or the rewind button (▼). "APC" will be displayed and the tape will automatically advance (if FF is pushed) to the beginning of the next selection or reverse (if REW is pushed) to the beginning of the one being played.

Press the APC button again to cancel the operation.

If APC detects 15 seconds of blank space it will automatically advance the tape to the next selection.

NOTE

APC may not operate properly if

- A tape was recorded at a low level.
- A tape has long, silent intervals.
- A tape is a live recording.
- A tape has very short intervals of less than 3 seconds.



▼ Repeat play

This feature makes it possible to listen to a selection repeatedly.

Press the repeat button during play. The current selection playing will be repeated ("RPT" will be displayed).

Press the repeat button once again to cancel repeat play.

NOTE

RPT may not operate properly if

- A tape was recorded at a low level.
- A tape has long, silent intervals.
- A tape is a live recording.
- A tape has very short intervals of less than 3 seconds.

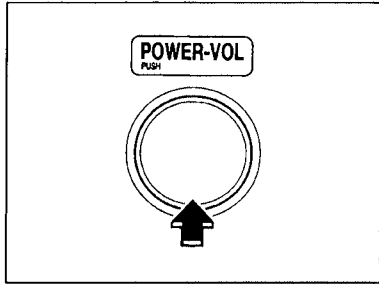

▼ Stopping

Press the power/volume knob to stop cassette tape play.

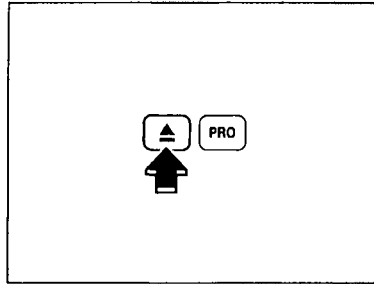

▼ Ejecting the cassette tape

Press the cassette tape eject button to eject the cassette tape.

NOTE

The cassette tape can be ejected when the ignition switch is off.

■ Operating Tips for Cassette Tape player

▼ Cleaning the cassette tape player

The tape head, capstans, and pinch rollers will gather oxide residue from cassette tapes. This can cause weak or wavering sounds and damage to the cassette tapes and player. Use a good quality head-cleaning tape or a liquid cleaner cassette tape to remove it. Should the unit not operate normally, consult an Authorized Mazda Dealer. Never attempt to repair it or insert a screwdriver or anything else.

▼ Handling the cassette tape player

The following precautions should be observed.

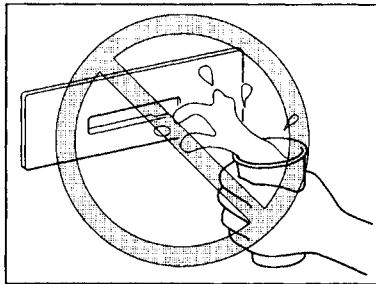

- Do not spill any liquid on the audio system.

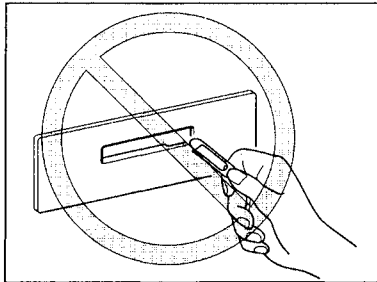

- Do not insert any objects, other than cassette tape, into the slot.

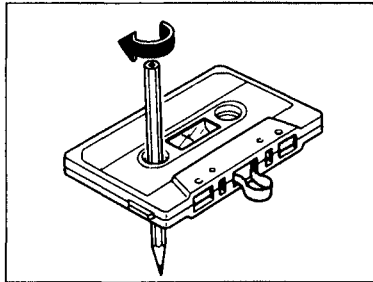

- If the cassette tape is loose, it may produce poor sound or performance during playback. Use a pencil or something similar to remove any slack.

- Only cassette tapes that play no longer than 90 minutes should be used. Cassette tapes exceeding 90 minutes are thin and may easily break.
- Do not leave a cassette tape in the player slot when not in use. Remove it completely to permit the slot door to close and to protect the mechanism from dust.
- Store cassette tapes away from extreme heat, magnetic fields, and direct sunlight. Protect the exposed cassette tape from dirt and damage. Store cassette tapes in their original cases or other protective cases.

- Insert only cassette tapes into the slot. If objects other than cassette tapes are inserted, they may damage the player.

■ Operating the Compact Disc Player

To operate the compact disc player, turn the ignition switch to the ACC or ON position.

▼ Inserting the compact disc

Insert the compact disc into the slot, label-side up. The auto-loading mechanism will set the compact disc and begin play. There will be a short lapse before play begins while the player reads the digital signals on the compact disc.

The DISC IN indicator light will illuminate and the track number will be displayed.

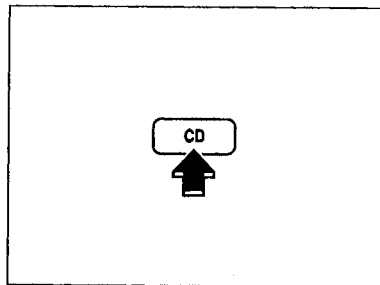

▼ Playing

Press the compact disc play button to start playing when a compact disc is in the unit.

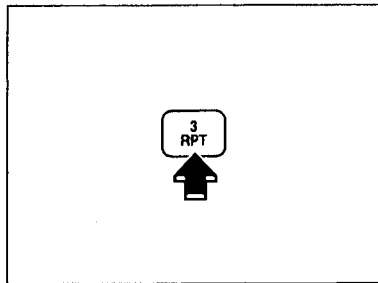

Press the repeat button once again to cancel repeat play.

▼ Repeat play

This feature makes it possible to listen to a selection repeatedly.

Press the repeat button during play. The current selection playing will be repeated ("RPT" will be displayed).

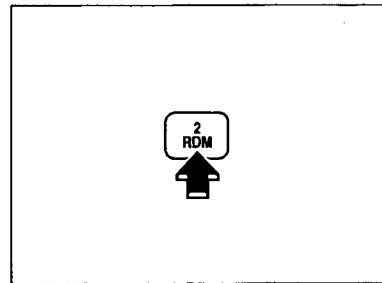

▼ Random play

This feature allows the compact disc player to select the order of the songs that the compact disc will play.

Press the random button during play. The next selection play will be

randomly selected (“RDM” will be displayed).
Press the random button once again to cancel random play.

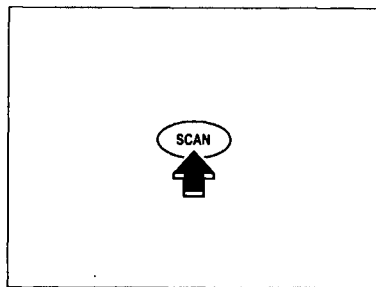

number will flash).
Press the scan button once again to cancel scan play.

NOTE

If the unit is left in scan, normal play will resume where scan was selected.

▼ Music scan

This feature helps to find a program by playing about the first 10 seconds of each track.

Press the scan button during play to start scan play operation (the track

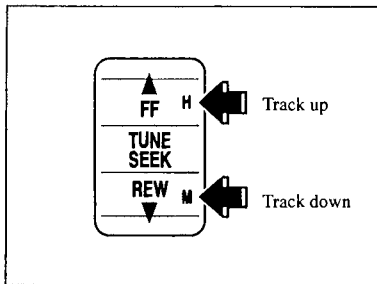

▼ Track search

Press the track up button once to skip forward to the beginning of the next track.

Press the track down button once to skip back to the beginning of the current track.

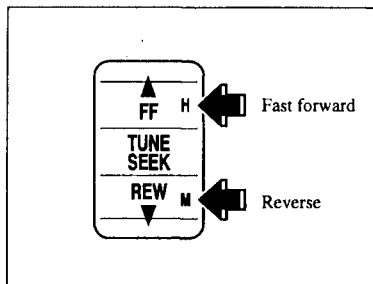

▼ Fast forward/Reverse

Press and hold the fast-forward button to advance through a track at high speed.

Press and hold the reverse button to reverse through a track at high speed.

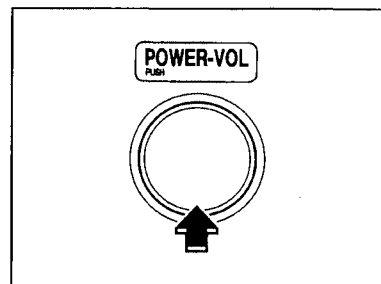

▼ Stopping

Press the power/volume knob to stop compact disc play.

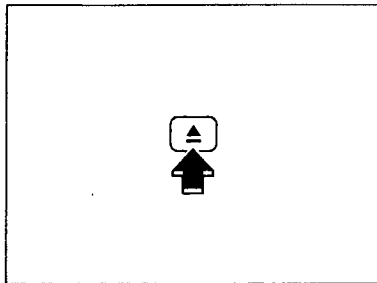

▼ Ejecting the compact disc

Press the compact disc eject button to eject the compact disc.

■ Operating the Compact Disc Changer (with Controls on this Unit)*

The compact disc changer can be connected to the unit and operated by the controls on the unit. Regarding operation of the compact disc changer itself, please refer to the instructions attached to the changer.

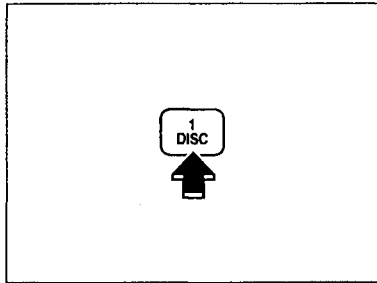

▼ Selecting a compact disc

Press the disc select button to select a compact disc.

NOTE

Operating the compact disc changer is generally the same as that of the compact disc player (pages 5-122 — 5-126).

■ Error Indications

If you see an error indication on the display, find the cause in the chart. If you cannot clear the error indication, take the vehicle to an Authorized Mazda Dealer.

Indication	Cause	Solution
E01	Compact disc mechanism problem	Consult an Authorized Mazda Dealer
E07	Compact disc is inserted upside down	Insert the compact disc properly. If the code does not disappear, consult an Authorized Mazda Dealer
	Compact disc is defective	Try another compact disc
E30	High temperature	Will disappear when the temperature returns to normal

■ Operating Tips for Compact Disc Player

▼ Condensation phenomenon

Immediately after turning on the heater when the vehicle is cold, the compact disc or optical components (prism and lens) in the compact disc player may become clouded with condensation. At this time, the compact disc will eject immediately when placed in the unit. A clouded compact disc can be corrected simply by wiping it with a soft cloth. Clouded optical components will clear naturally in about an hour. Wait for normal operation to return before attempting to use the unit.

▼ Handling the compact disc player

The following precautions should be observed.

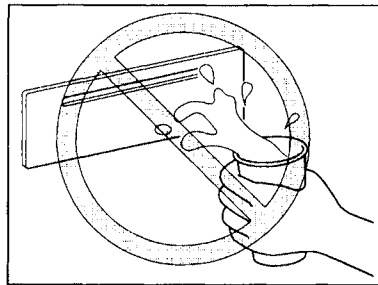

- Do not spill any liquid on the audio system.

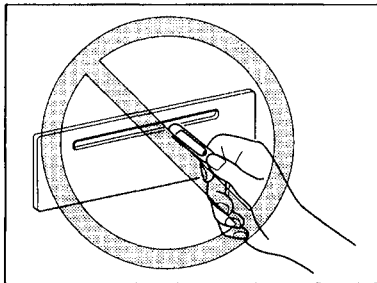

- Do not insert any objects, other than compact disc, into the slot.

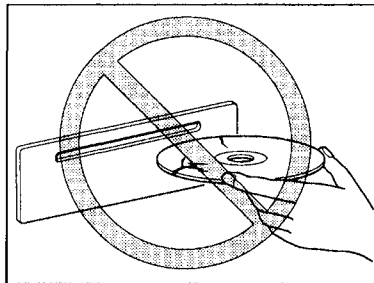

- The compact disc revolves at high speed within the player unit. Defective (cracked or badly bent) compact discs should never be used.

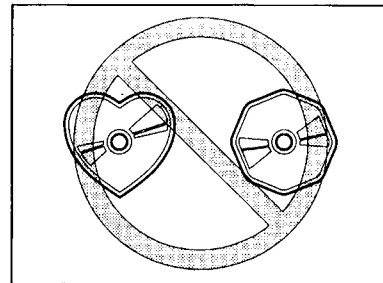

- Do not use non-conventional discs such as heart-shaped, octagonal discs, etc. The compact disc player could be damaged.

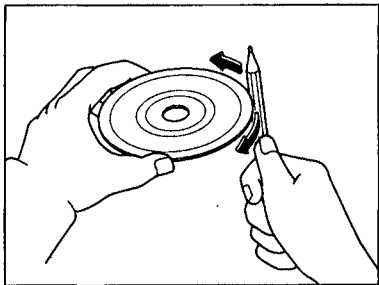

- A new compact disc may have rough edges on its inner and outer perimeters. If a disc with rough edges is used, proper setting will not be possible and the compact disc player/changer will not play the compact disc. Remove the rough edges in advance by using a

ball-point pen or pencil as shown on the right. To remove the rough edges, press the side of the pen or pencil against the inner and outer perimeter of the compact disc.

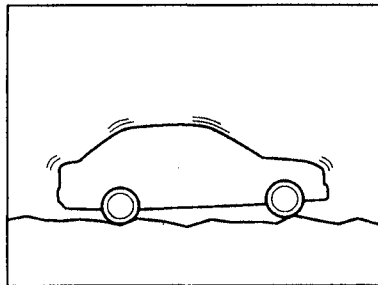

- When driving over uneven surfaces, the sound will jump.



- The compact disc player has been designed to play compact discs bearing the identification logo as shown. No other discs can be played.

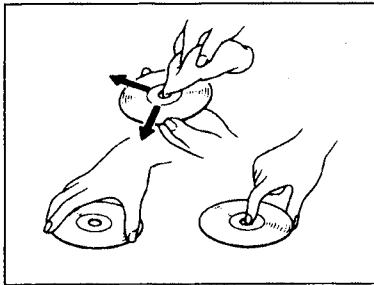

- Be sure never to touch the signal surface when handling the compact discs. Pick up a compact disc by grasping the outer edge or the edge of the hole and the outer edge.

- Do not stick paper or tape on the compact disc. Avoid scratching the reverse side (the side without a label).
- Dust, finger smudges, and dirt can decrease the amount of light reflected from the signal surface, thus affecting sound quality. If the compact disc should become soiled, gently wipe it with a soft cloth from the center of the compact disc to the edge.

- Do not use record sprays, antistatic agents, or household spray cleaners. Volatile chemicals such as benzine and thinner can also damage the surface of the compact disc and must not be used. Anything that can damage, warp, or fog plastic should never be used to clean compact discs.
- Compact discs, like traditional audio records, are made of plastic. To avoid warping, keep the compact discs in their cases and do not store them where they will be exposed to direct sunlight.
- The compact disc player ejects the compact disc if the compact disc is inserted upside down. Also dirty and/or defective compact discs may be ejected.
- Do not insert cleaning discs in the compact disc player.
- Do not insert any disc with a peel-off or seal on it.

AM/FM Radio with Cassette Tape Player and Compact Disc Changer*

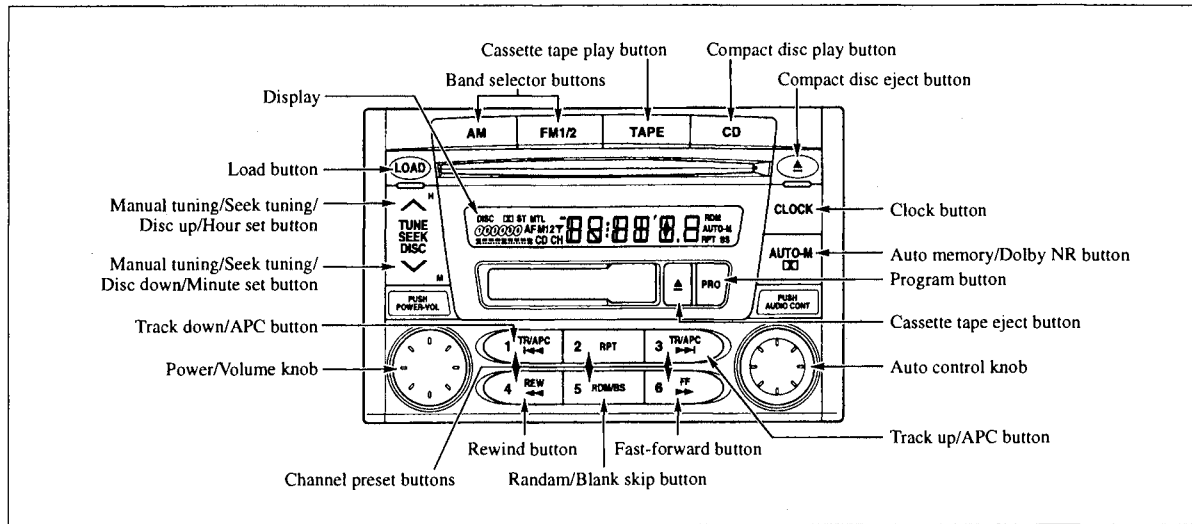

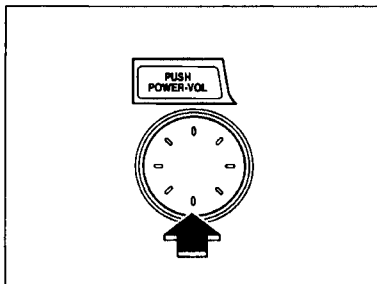

■ Power ON/OFF

Turn the ignition switch to the ACC or ON position.

Press the power/volume knob to turn the audio system on. Press the power/volume knob again to turn the audio system off.

NOTE

To prevent the battery from being discharged, do not leave the audio system on for a long period when the engine is not running.

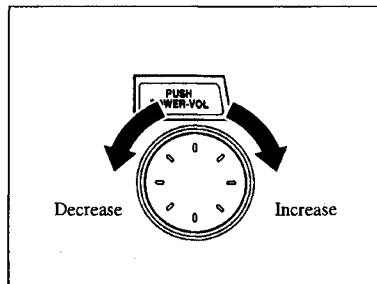

▼ Volume adjustment

Turn the power/volume knob to adjust the volume.

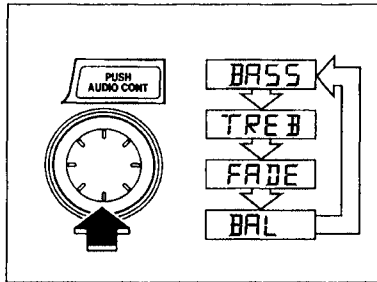

NOTE

About 5 seconds after selecting any mode, the volume function will be automatically selected. To reset bass, treble, fade, and balance, press the audio control knob for 2 seconds. The unit will beep and "CL" will be displayed.

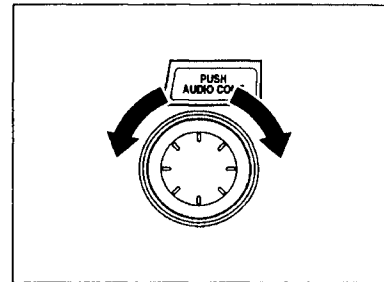

▼ **Audio sound adjustment**

1. Press the audio control knob to select bass, treble, fade or balance control. The selected function will be indicated.

2. Turn the audio control knob to adjust the selected function; bass, treble, fade or balance.

Bass control

To adjust the lower tonal qualities, select BASS by pressing the audio control knob. "BASS" will be displayed.

Turn the audio control knob to the right to increase lower-pitched tones, to the left to decrease them. The level will be displayed.

Release the audio control knob when the desired level has been reached.

Treble control

To adjust the higher tonal qualities, select TREB by pressing the audio control knob. "TREB" will be

displayed.

Turn the audio control knob to the right to increase higher-pitched tones, to the left to decrease them. The level will be displayed.

Release the audio control knob when the desired level has been reached.

Fade control

To adjust the sound distribution between front and rear speakers, select FADE by pressing the audio control knob. "FADE" will be displayed.

Turn the audio control knob to the right to shift the sound to the rear, to the left to shift the sound to the front.

The level will be displayed.

Release the audio control knob when the desired level has been reached.

Balance control

To adjust the sound distribution between left and right speakers, select BAL by pressing the audio control knob. "BAL" will be displayed.

Turn the audio control knob to the right to shift the sound to the right, to the left to shift the sound to the left. The level will be displayed.

Release the audio control knob when the desired level has been reached.

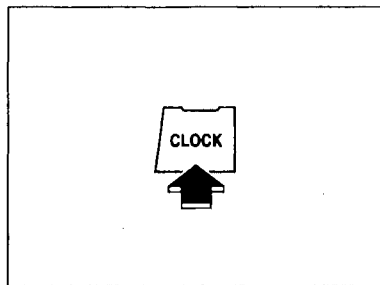

■ Clock

▼ Setting the time

The clock can be set at any time when the ignition switch is in the ACC or ON position.

1. To adjust the time, press the clock button for about 2 seconds until a beep is heard.
2. The clock's current time will flash until the time is set.

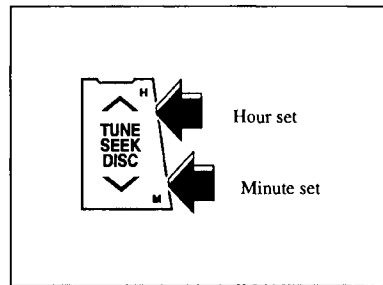

3. To advance the hours, press the hour set button (\wedge) to advance the minutes, press the minute set button (\vee) while the time is flashing.
4. Press the clock button again to start the clock.

NOTE

If the power supply to the unit is interrupted (if the fuse blows or the vehicle's battery is disconnected), the clock will need to be reset.

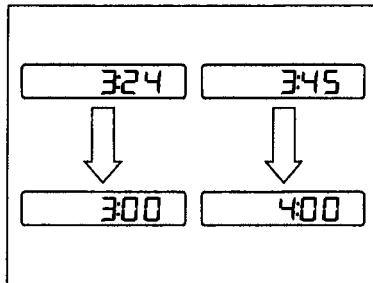

NOTE

If the time is not adjusted while the clock's current time is flashing (if neither the \wedge nor \vee is pressed), and the clock button is pressed a second time, the minutes will be set to 00. If the clock's current time setting is within the latter part of the hour (from 30 to 59 min), the hour setting will automatically advance one hour.

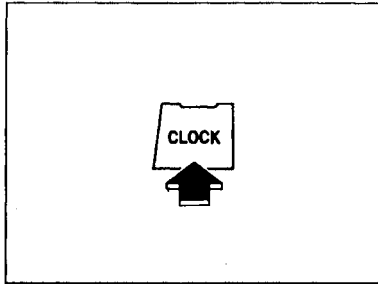

▼ **Changing the display mode**

The display on the unit can be changed by pressing the clock button. This alternates the display between time and audio. When the time mode has been selected, the time will be displayed.

NOTE

If audio operation is selected while the time mode is on, the selected audio mode will be displayed for 10 seconds, then the display will revert to the time mode.

■ **Operating the Radio**

To operate the radio, turn the ignition switch to the ACC or ON position.

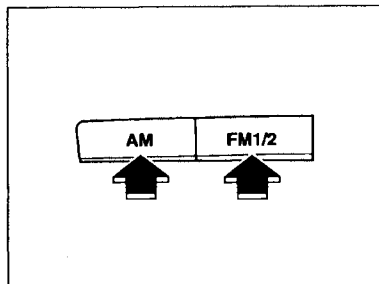

▼ Radio ON

Press the AM or FM1/2 button to turn the radio on.

▼ Band selection

Choose AM by pressing the AM button and FM1 or FM2 by pressing the FM1/2 button.

The selected mode will be indicated. If FM stereo is being received, "ST" will be displayed.

NOTE

If the FM broadcast signal becomes weak, reception automatically changes from STEREO to MONO for reduced noise, and the "ST" indicator will go out.

▼ Tuning

The radio has four tuning methods: Manual, Seek, Preset channel, and Auto memory tuning.

The easiest way to tune stations is to set them on preset channels.

NOTE

If the power supply is interrupted (fuse blows or the battery is disconnected), the preset channels will be canceled.

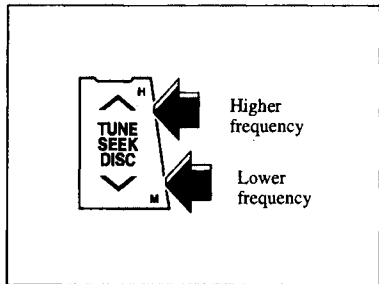

Manual tuning

Pressing the manual tuning button will change to a higher or lower frequency.

Seek tuning

Pressing the seek tuning button for more than about half a second until a beep is heard will cause the tuner to seek a higher or lower frequency automatically.

NOTE

If you continue to press and hold the button, the frequency will continue changing without stopping. Please release the button after the beep.

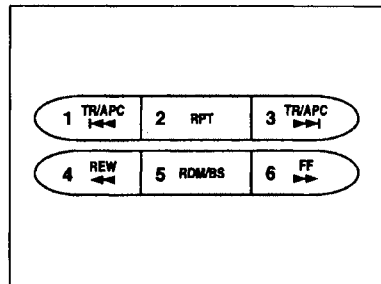

Preset channel tuning

The six preset channels can be used to store 6 AM and 12 FM stations.

To set a channel first select AM, FM1, or FM2. Tune to the station you want and depress a channel preset button for

about 2 seconds until a beep is heard. The preset channel number and station frequency will be displayed. The station is now held in the memory. Repeat this operation for the other stations and bands you want to store.

To tune one in the memory, select AM, FM1, or FM2 and then press its channel preset button. The station frequency and the channel number will be displayed.

NOTE

If the power supply is interrupted (fuse blows or the battery is disconnected), the preset channels will be canceled.

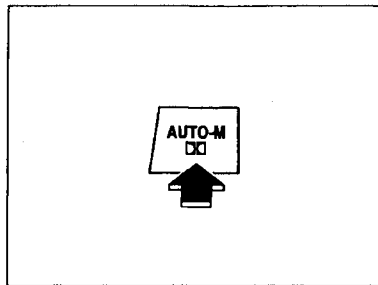

Auto memory tuning

This is especially useful when driving in an area where the local stations are not known. Additional AM/FM stations can be memorized without disturbing the previously set channels.

Press and hold the auto memory button for about 2 seconds until a beep is heard; the system will automatically scan and temporarily store the six strongest stations of each selected band in that area to the preset channels.

The scanning operation tunes in the strongest station and displays its frequency.

Press the preset channels to recall the auto-memorized stations. One memorized station will be selected each time displaying the channel number and frequency.

NOTE

If no stations can be tuned after scanning operations, "A" will be displayed.

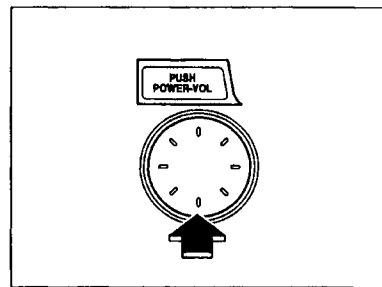

▼ Radio OFF

Press the power/volume knob to turn off the radio.

NOTE

Press the power/volume knob again to listen to the frequency last tuned to.

■ Operating the Cassette Tape Player

To operate the cassette tape player, turn the ignition switch to the ACC or ON position.

▼ Cassette tape insert

Insert the cassette tape into the slot, open edge to the right and cassette tape will begin play and "TAPE" will be displayed. At the end of the cassette tape, the unit automatically reverses cassette tape play.

When ▲ is lit, the cassette tape's top side is playing. When ▼ is lit, the bottom side is on.

NOTE

When a metal tape is inserted, the player will automatically compensate for it and "MTL" will be displayed.

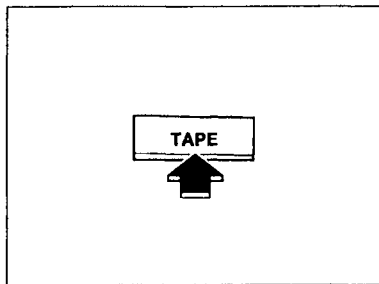



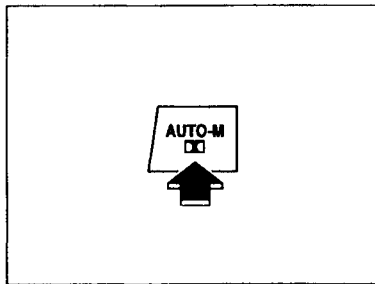

▼ **Playing**



Press the cassette tape play button to start playing when a cassette tape is in the unit. If there isn't a cassette tape in the unit when the cassette tape play button is pressed, "NO TAPE" will flash on and off in sequence.



▼ **Dolby noise reduction**

When using a tape with Dolby NR*, push the   button. The   symbol will be displayed. To play a tape without Dolby NR, push the button once again.

* Noise reduction system manufactured under license from Dolby Laboratories Licensing Corporation.

Dolby and the double-D symbol   are trademarks of Dolby Laboratories Licensing Corporation.

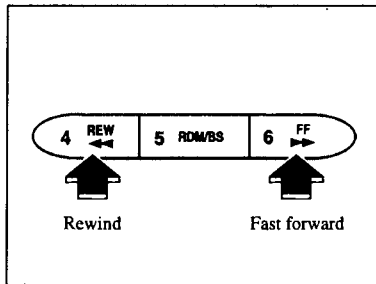

▼ Fast forward/Rewind

Press the fast-forward button to fast forward.

Press the rewind button to rewind.

To stop this operation and play the cassette tape, press the button again.

NOTE

When the cassette tape ends during fast forward or rewind, it automatically stops and starts playing.

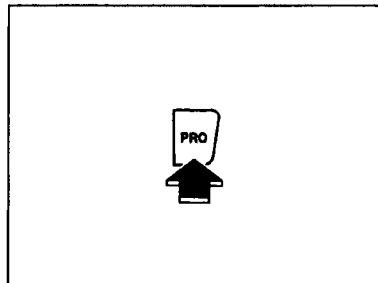

▼ Reversing

Press the program button to change cassette tape-playing direction.

NOTE

When the cassette tape ends, the unit automatically reverses play.

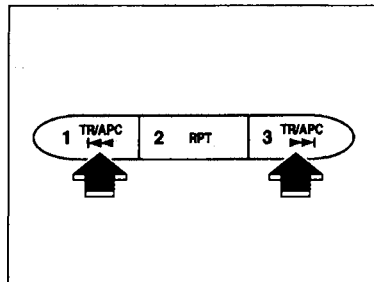
**▼ APC (Automatic Program Control)**

APC is used to find the beginning of either the next program or the one being played.

Press the APC button (▶▶) to the beginning of the next selection. Press the APC button (◀◀) to the beginning of the one being played. To stop this operation and play the cassette tape, press the button again.

If APC detects 15 seconds of blank space it will automatically advance the tape to the next selection.

NOTE

APC may not operate properly if

- A tape was recorded at a low level.
- A tape has long, silent intervals.
- A tape is a live recording.
- A tape has very short intervals of less than 3 seconds.

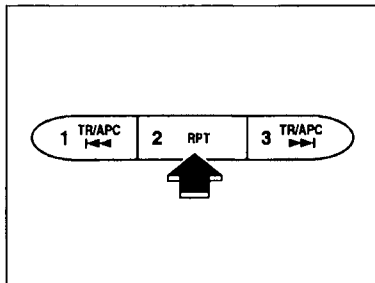

▼ Repeat play

This feature makes it possible to listen to a selection repeatedly.

Press the repeat button during play. The current selection playing will be repeated ("RPT" will be displayed).

Press the repeat button once again to cancel repeat play.

NOTE

RPT may not operate properly if

- A tape was recorded at a low level.
- A tape has long, silent intervals.
- A tape is a live recording.
- A tape has very short intervals of less than 3 seconds.

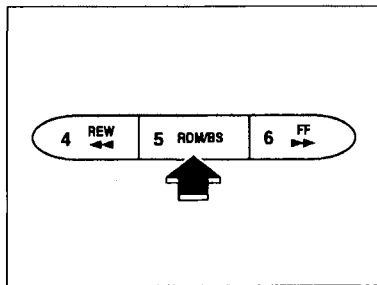

▼ Blank skip

This feature makes it possible to automatically skip intervals between songs if the interval is 15 seconds long or longer.

Press the blank skip button to set the blank skip ("BS" will be displayed).

Press the blank skip button once again to cancel the blank skip function.

NOTE

- BS may not operate properly if
 - Noise is in an interval between songs.
 - The song has a silent part which is 15 seconds long or longer.

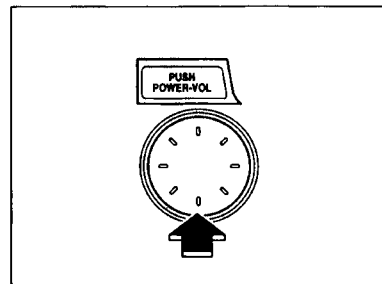

▼ Stopping

Press the power/volume knob to stop cassette tape play.

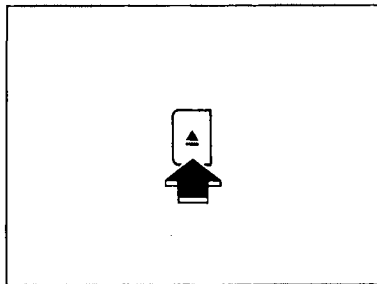

▼ Ejecting the cassette tape

Press the cassette tape eject button to eject the cassette tape.

NOTE

The cassette tape can be ejected when the ignition switch is off.

■ Operating Tips for Cassette Tape player

▼ Cleaning the cassette tape player

The tape head, capstans, and pinch rollers will gather oxide residue from cassette tapes. This can cause weak or wavering sounds and damage to the cassette tapes and player. Use a good quality head-cleaning tape or a liquid cleaner cassette tape to remove it. Should the unit not operate normally, consult an Authorized Mazda Dealer. Never attempt to repair it or insert a screwdriver or anything else.

▼ **Handling the cassette tape player**

The following precautions should be observed.

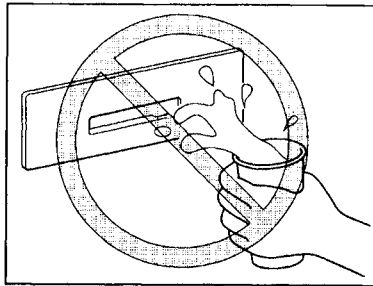

- Do not spill any liquid on the audio system.

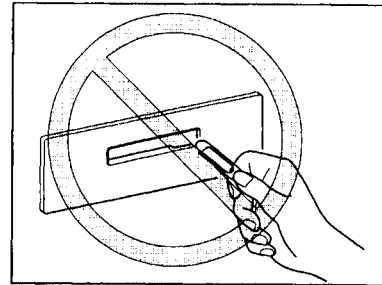

- Do not insert any objects, other than cassette tape, into the slot.

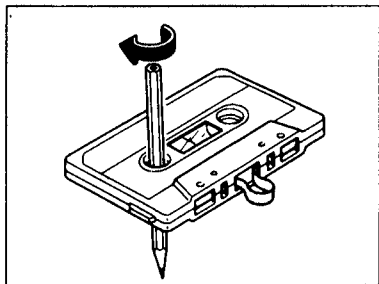

- If the cassette tape is loose, it may produce poor sound or performance during playback. Use a pencil or something similar to remove any slack.
- Only cassette tapes that play no longer than 90 minutes should be used. Cassette tapes exceeding 90 minutes are thin and may easily break.
- Do not leave a cassette tape in the player slot when not in use. Remove it completely to permit the slot door to close and to protect the mechanism from dust.
- Store cassette tapes away from extreme heat, magnetic fields, and direct sunlight. Protect the exposed cassette tape from dirt and damage. Store cassette tapes in their original cases or other protective cases.
- Insert only cassette tapes into the slot. If objects other than cassette tapes are inserted, they may damage the player.

■ Operating the Compact Disc Changer

To operate the compact disc changer, turn the ignition switch to the ACC or ON position.

▼ Inserting the compact disc

The compact disc must be label-side up when inserting. The auto-loading mechanism will set the compact disc and begin play. There will be a short lapse before play begins while the player reads the digital signals on the compact disc.

The disc number and the track number will be displayed.

NOTE

A compact disc cannot be inserted while the display reads "WAIT". A beeping sound can be heard during this waiting time.

Simultaneously pressing the power/volume knob and the load button for about 2 seconds will turn this beeping sound ON or OFF.

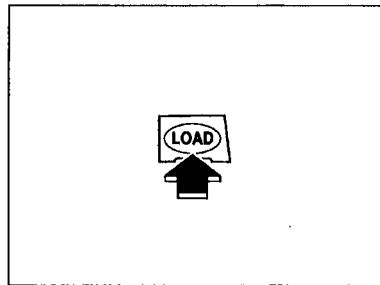

Normal insertion

1. Press the load button.
2. When "In" is displayed, insert the compact disc.

Multiple insertion

1. Press and hold the load button for about 2 seconds until a beep is heard.
2. When "In" is displayed, insert the compact disc.
3. When "In" is displayed again, insert the next compact disc.

NOTE

The first-inserted compact disc will be played automatically when:

- No compact disc is inserted within 15 seconds after "In" is displayed.
- The compact disc trays are full.

Inserting to desired tray number

1. Press and hold the load button for about 2 seconds until a beep is heard.
2. Press the channel preset button for the desired tray number within five seconds after the beep is heard.
3. When "In" is displayed, insert the compact disc.

NOTE

The compact disc can not be inserted to the desired tray number if the number is already occupied.

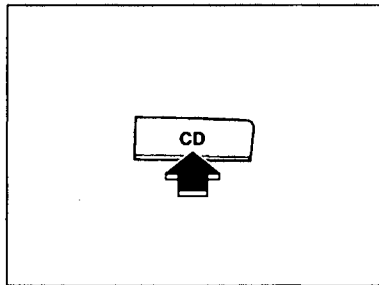

▼ **Playing**

Press the compact disc play button to start playing when a compact disc is in the unit.

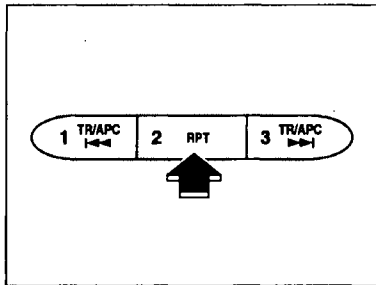

▼ **Repeat play**

This feature makes it possible to listen to a selection repeatedly.

Press the repeat button during play. The current selection playing will be repeated ("RPT" will be displayed).

Press the repeat button once again to cancel repeat play.

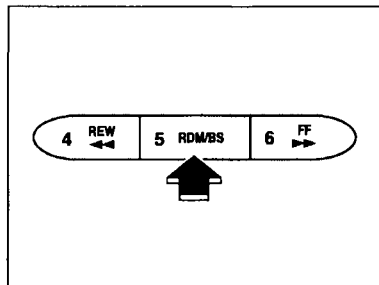

randomly selected ("RDM" will be displayed).
Press the random button once again to cancel random play.

▼ Random play

This feature allows the compact disc player to select the order of the songs that the compact disc will play.

Press the random button during play. The next selection play will be

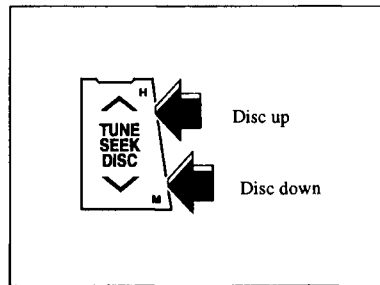

▼ Disc search

Press the disc up button (^) to skip forward to the beginning of the next compact disc.

Press the disc down button (v) to skip back to the beginning of the previous compact disc.

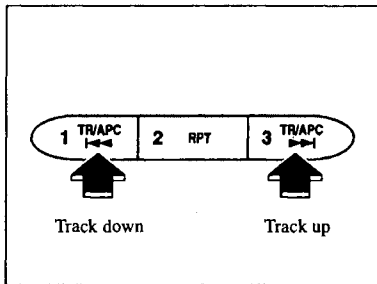

▼ Track search

Press the track up button once to skip forward to the beginning of the next track.

Press the track down button once to skip back to the beginning of the current track.

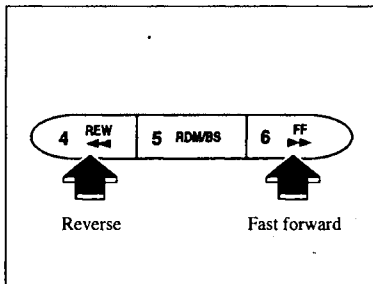

▼ Fast forward/Reverse

Press and hold the fast-forward button to advance through a track at high speed.

Press and hold the reverse button to reverse through a track at high speed.

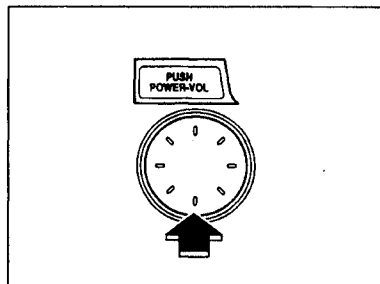

▼ Stopping

Press the power/volume knob to stop compact disc play.

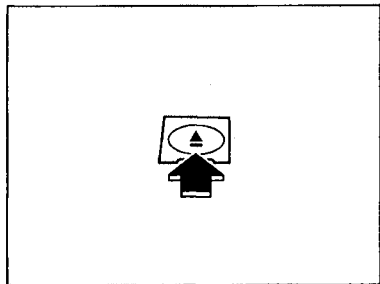

▼ Ejecting the compact disc

Normal ejection

1. Press the eject button.
2. Pull out the compact disc.

NOTE

When the compact disc is ejected during play:

- The next compact disc will be played automatically.
- "No Disc" will be displayed if no disc is in the tray.

Multiple ejection

1. Press and hold the eject button for about 2 seconds until a beep is heard.
2. Wait 5 seconds or press the eject button again within 5 seconds after the beep is heard.
3. Pull out the compact disc, then the next compact disc will be ejected.

NOTE

- Compact discs will be ejected starting with the one with the lowest number.
- All compact discs in the tray will be ejected continuously.
- Compact discs can be ejected when the ignition switch is off. Press and hold the eject button for about 2 seconds and all compact discs will eject.

Ejecting to desired tray number

1. Press and hold the eject button for about 2 seconds until a beep is heard.
2. Press the channel preset button for the desired compact disc number within 5 seconds after the beep is heard.
3. Pull out the compact disc.

■ Error Indications

If you see an error indication on the display, find the cause in the chart. If you cannot clear the error indication, take the vehicle to an Authorized Mazda Dealer.

Indication	Cause	Solution
E01	Compact disc mechanism problem	Consult an Authorized Mazda Dealer
E07	Compact disc is inserted upside down	Insert the compact disc properly. If the code does not disappear, consult an Authorized Mazda Dealer
	Compact disc is defective	Try another compact disc
E30	High temperature	Will disappear when the temperature returns to normal

■ Operating Tips for Compact Disc Changer

▼ Condensation phenomenon

Immediately after turning on the heater when the vehicle is cold, the compact disc or optical components (prism and lens) in the compact disc changer may become clouded with condensation. At this time, the compact disc will eject immediately when placed in the unit. A clouded compact disc can be corrected simply by wiping it with a soft cloth. Clouded optical components will clear naturally in about an hour. Wait for normal operation to return before attempting to use the unit.

▼ Handling the compact disc changer

The following precautions should be observed.

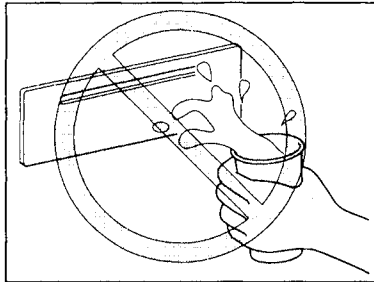

- Do not spill any liquid on the audio system.

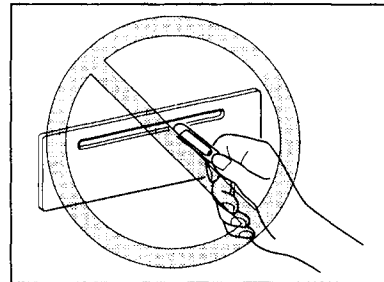

- Do not insert any objects, other than compact disc, into the slot.

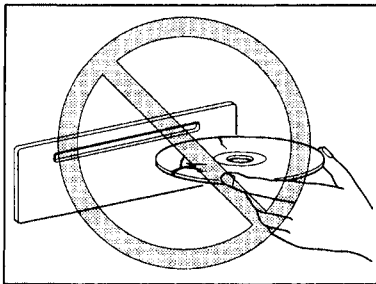

- The compact disc revolves at high speed within the player unit. Defective (cracked or badly bent) compact discs should never be used.

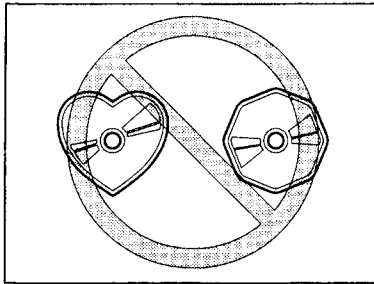

- Do not use non-conventional discs such as heart-shaped, octagonal discs, etc. The compact disc changer could be damaged.

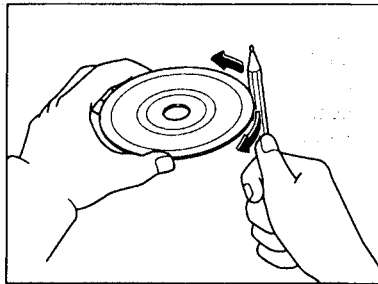

- A new compact disc may have rough edges on its inner and outer perimeters. If a disc with rough edges is used, proper setting will not be possible and the compact disc changer will not play the compact disc. Remove the rough edges in advance by using a

ball-point pen or pencil as shown on the right. To remove the rough edges, press the side of the pen or pencil against the inner and outer perimeter of the compact disc.

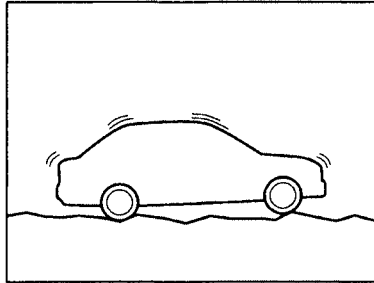

- When driving over uneven surfaces, the sound will jump.



- The compact disc changer has been designed to play compact discs bearing the identification logo as shown. No other discs can be played.

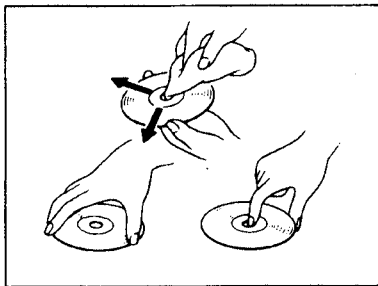

- Be sure never to touch the signal surface when handling the compact discs. Pick up a compact disc by grasping the outer edge or the edge of the hole and the outer edge.
- Do not stick paper or tape on the compact disc. Avoid scratching the reverse side (the side without a label).
- Dust, finger smudges, and dirt can decrease the amount of light reflected from the signal surface, thus affecting sound quality. If the compact disc should become soiled, gently wipe it with a soft cloth from the center of the compact disc to the edge.
- Do not use record sprays, antistatic agents, or household spray cleaners. Volatile chemicals such as benzine and thinner can also damage the surface of the compact disc and must not be used. Anything that can damage, warp, or fog plastic should never be used to clean compact discs.
- Compact discs, like traditional audio records, are made of plastic. To avoid warping, keep the compact discs in their cases and do not store them where they will be exposed to direct sunlight.

Antenna

- The compact disc changer ejects the compact disc if the compact disc is inserted upside down. Also dirty and/or defective compact discs may be ejected.
- 3-inch (8 cm) compact discs and compact disc accessories (e.g. 3-inch disc adapter) cannot be used in the compact disc changer.
- Do not insert cleaning discs in the compact disc changer.
- Do not insert any disc with a peel-off or seal on it.

The rear window antennas receive both AM and FM signals.



CAUTION

When washing the inside rear window, use a soft cloth dampened in luke warm water, gently wiping the antenna lines.
Use of glass cleaning products could damage the antenna.

6

In Case of Emergency

Because an emergency can occur anytime, we strongly urge you to become familiar with this section of your manual. It provides helpful information on what to do if the engine overheats, if you have a flat tire, and if the battery is discharged.

You will also find out what to do if you confront a problem in the electrical system; and, there's some guidance on the correct way to tow your Mazda.

Hazard Warning Flasher	6- 2
Overheating	6- 2
Emergency Starting	6- 4
Fuses	6- 8
Towing	6-16
Flat Tire	6-19

Hazard Warning Flasher

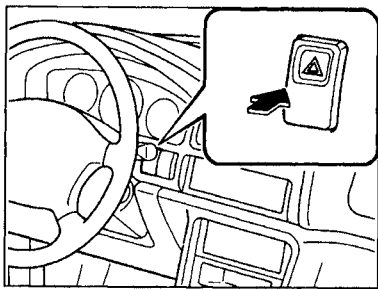

The hazard warning lights warn other drivers that your vehicle is a traffic hazard and that they must take extreme caution when near it.

The hazard warning lights should always be used when you stop on or near a roadway.

6-2

Depress the hazard warning switch and all four turn signals will flash at once.

NOTE

- The turn signals don't work when the hazard warning lights are on.
- Check local regulations about the use of hazard warning lights while the vehicle is being towed. They may forbid it.

Overheating

If the temperature gauge indicates overheating, if you experience power loss, or if you hear a loud knocking or pinging noise, the engine is probably too hot.

If this happens:

1. Drive safely to the side of the road and park off the right-of-way.
2. Set an automatic transaxle in P, a manual transaxle in neutral. Apply the parking brake.
3. Turn off the air conditioner.

 **WARNING**

Steam from Overheated Engine:
Steam from an overheated engine is dangerous. The escaping steam could seriously burn you. Open the hood ONLY after steam is no longer escaping from the engine.

4. Check whether coolant or steam is escaping from the hood or from the engine compartment.

If steam is coming from the engine compartment, don't go near the front of the vehicle. Stop the engine. Then turn the ignition switch to the ON position without starting the engine. The radiator

cooling fans will start to cool the engine.

If neither coolant nor steam is escaping, open the hood and idle the engine until it cools. If this doesn't lower the temperature, stop the engine and let it cool.

5. Check the coolant level.

If it's low, look for leaks in the radiator hoses and connections, heater hoses and connections, radiator, and water pump.

If you find a leak or other damage, or if coolant is still leaking, stop the engine and call an Authorized Mazda Dealer.

If you find no problems, the engine is cool, and no leaks are obvious, carefully add coolant as required (page 8-23).

Emergency Starting

WARNING

Cooling System Caps:
When the engine and radiator are hot, scalding coolant and steam may shoot out under pressure and cause serious injury. Don't remove either cooling system cap when the engine and radiator are hot.

CAUTION

If the engine continues to overheat or frequently overheats, have the cooling system inspected. The engine could be seriously damaged unless repairs are made.

■ Jump-Starting

Jump-starting is dangerous if done incorrectly. So follow the procedure carefully. If you feel unsure about jump-starting, we strongly recommend that you have a competent service technician do the work.

CAUTION

Use only a 12-volt booster system. You can damage a 12-volt starter motor, ignition system, and other electrical parts beyond repair with a 24-volt power supply (two 12-volt batteries in series or a 24-volt motor generator set).

WARNING

Battery-Related Explosion:
Flames and sparks near open battery cells are dangerous. Hydrogen gas, produced during normal battery operation, could ignite and cause the battery to explode. An exploding battery can cause serious burns and injuries. Keep all flames, including cigarettes, and sparks away from open battery cells.

⚠ WARNING

Jump-Starting:

Jump-starting a frozen battery or one with a low fluid level is dangerous. It may rupture or explode, causing serious injury. Don't jump-start a frozen battery or one with a low fluid level.

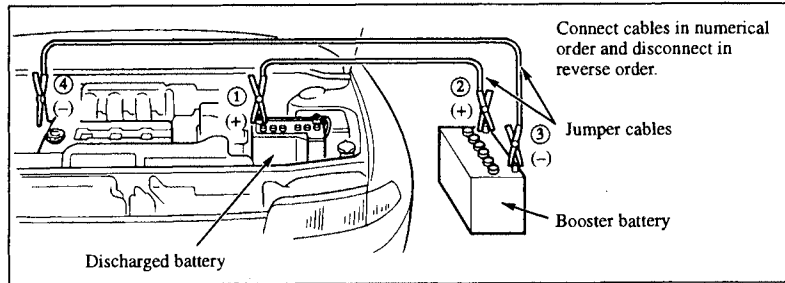

1. Make sure the booster battery is 12 volts and that its negative terminal is grounded.

⚠ CAUTION

If the booster battery is in another vehicle, don't allow the vehicles to touch. A short could be created.

2. Turn off the engine of the vehicle with the booster battery and all unnecessary electrical loads in both vehicles.
3. Connect the jumper cables in the exact sequence as in the illustration.
 - (1) Connect one end of a cable to the positive terminal on the discharged battery ①.
 - (2) Attach the other end to the positive terminal on the booster battery ②.
 - (3) Connect one end of the other cable to the negative terminal of the booster battery ③.
 - (4) Connect the other end to a solid, stationary, exposed metallic point (for example, the strut mounting bolt) away from the discharged battery ④.
4. Start the engine of the booster vehicle and run it a few minutes. Then start the engine of the other vehicle.
5. When finished, carefully disconnect the cables in the reverse order described in Step 3.



WARNING

Connecting to Negative Terminal:
Connecting the end of the second cable to the negative (-) terminal of the discharged battery is dangerous. A spark could cause the gas around the battery to explode and injure someone. Connect the cable to a point away from the battery.

 **WARNING**

Connecting Jumper Cable to a Moving Part:

Connecting a jumper cable near or to a moving part is dangerous. The cable could get caught when the engine starts and cause serious injury. Never connect a jumper cable to or near any part that moves.

■ **Push-Starting**

You can't start a vehicle with an automatic transaxle by pushing it.

 **CAUTION**

You shouldn't push-start a vehicle that has a manual transaxle. It can damage the emission control system.

 **WARNING**

Towing a Vehicle to Start It:
Towing a vehicle to start it could be dangerous. The vehicle being towed could surge forward when its engine starts, causing the two vehicles to collide. The occupants could be injured. Never tow a vehicle to start it.

Fuses

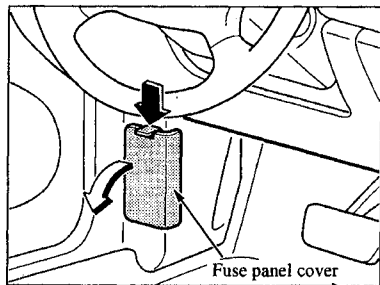

Your vehicle's electrical system is protected by fuses.

If any lights, accessories, or controls don't work, inspect the appropriate circuit protector. If a fuse has blown, the inside element will be melted.

If the same fuse blows again, avoid using that system and consult an Authorized Mazda Dealer as soon as possible.

■ Fuse Replacement

If the electrical system doesn't work, first inspect fuses on the driver's side.

1. Turn off the ignition switch and other switches.
2. Open the fuse panel.
3. Pull the fuse straight out.

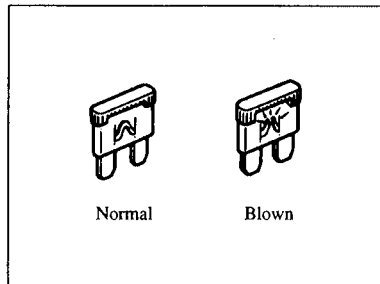

4. Inspect it and replace if it's blown.

NOTE

The check engine light comes on when a ROOM fuse blows or when a ROOM fuse is removed. When installing a ROOM fuse, turn the ignition switch off and wait 60 seconds before installing the fuse. If the check engine light comes on and doesn't go off, there is a problem other than the fuse system. Consult your Authorized Mazda Dealer.

5. Push in a new fuse of the same rating, and make sure it fits tightly. If it doesn't, have an Authorized Mazda Dealer install it.

If you have no spare fuses, borrow one of the same rating from a circuit not essential to vehicle operation, such as the RADIO circuit.

 **CAUTION**

Always replace a fuse with one of the same rating. Otherwise you may damage the electric system.

In Case of Emergency

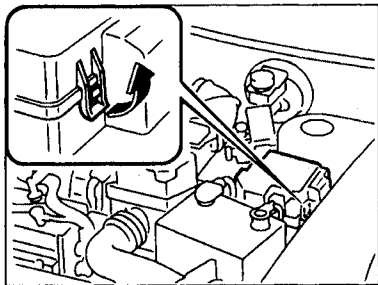

If the headlights or other electrical components don't work and the fuses in the cabin are OK, inspect the fuse block under the hood. If a fuse is blown, it must be replaced. Follow these steps:

1. Turn off the ignition switch and all other switches.
2. Open the fuse block cover by unhooking the tab and lifting up on the cover.

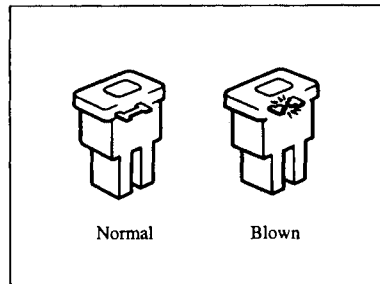

3. If a fuse is blown, replace it with a new one **of the same rating.**

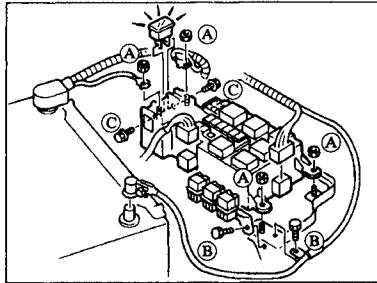

When replacing the 100A fuse:

1. Turn off the ignition switch.
2. Remove the negative battery terminal.
3. Remove nuts A and bolts B.

4. Lift the fuse block and remove bolts C.
5. Replace the fuse with a new one of **the same rating.**
6. Install in the reverse order of removal.

■ Fuse Panel Description

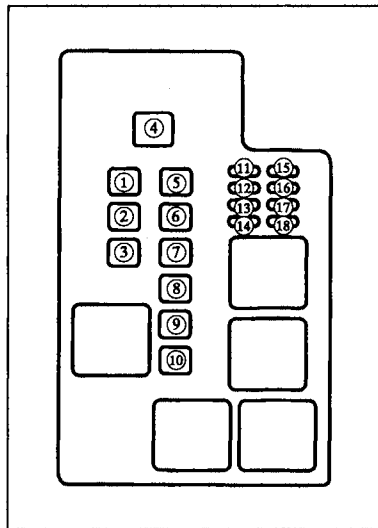

▼ Fuse block (engine compartment)

DESCRIPTION	FUSE RATING	COLOR	PROTECTED COMPONENT
1 EGI INJ	30A	PINK	Fuel-injection system
2 DEFOG	40A	GREEN	Rear window defroster
3 —	—	—	—
4 MAIN	100A	BLUE	For protection of all circuits
5 IG KEY	30A	PINK	RADIO, SUNROOF*, TURN, METER, ENGINE, POWER WINDOW*, WIPER fuses, Ignition system
6 HEATER	40A	GREEN	Heater, Air conditioner*
7 BTN	40A	GREEN	TAIL, STOP, ROOM, DOOR LOCK, HAZARD, POWER SEAT* fuses
8 COOLING FAN	30A	PINK	Cooling fan
9 AD FAN	30A	PINK	Additional fan*
10 (ABS)	60A	YELLOW	Antilock brake system*

DESCRIPTION		FUSE RATING	COLOR	PROTECTED COMPONENT
11	TAIL	15A	BLUE	Tail lights, Parking lights, Dashboard illumination, License plate lights, Switches illumination
12	HORN	15A	BLUE	Horn
13	(ABS)	20A	YELLOW	Antilock brake system*
14	—	—	—	—
15	ST. SIGN	10A	RED	Starter signal
16	H/L-L	15A	BLUE	Head light (Left)
17	H/L-R	15A	BLUE	Head light (Right)
18	(ABS)	20A	YELLOW	Antilock brake system*

In Case of Emergency

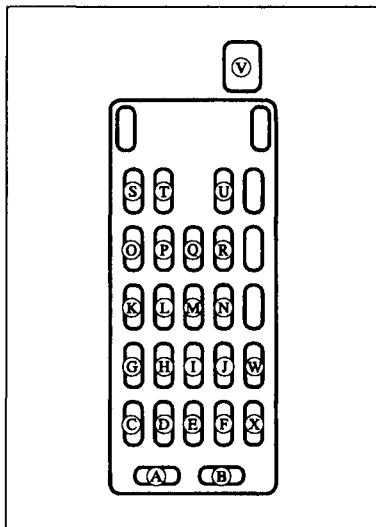

▼ Fuse panel (driver's side)

DESCRIPTION	FUSE RATING	COLOR	PROTECTED COMPONENT
A AUDIO	15A	BLUE	Audio system*
B ROOM	15A	BLUE	Interior lights, Trunk light
C S. ROOF	15A	BLUE	Sunroof*
D METER	10A	RED	Gauges, Back-up lights
E D. LOCK	30A	GREEN	Power door lock*
F HAZARD	15A	BLUE	Hazard warning lights
G A/B&ABS	10A	RED	Air bag system, Antilock brake system*
H —	—	—	—
I A/C	10A	RED	Air conditioner*
J —	—	—	—
K TURN	10A	RED	Turn signals
L WIPER	20A	YELLOW	Windshield wipers and washer

DESCRIPTION		FUSE RATING	COLOR	PROTECTED COMPONENT
M	P. WIND	30A	GREEN	Power windows*
N	—	—	—	—
O	RADIO	15A	BLUE	Audio system*, Socket, outside mirror
P	ENGINE	10A	RED	Engine control system
Q	ILLUMI	10A	RED	Tail light, License plate lights, parking lights, Dashboard illumination
R	STOP	15A	BLUE	Brake lights, Horn, Cruise control*
S	CIGAR	15A	BLUE	Accessory socket, clock*, radio*, outside mirror
T	—	—	—	—
U	—	—	—	—
V	P. SEAT	30A	PINK	Power seat*
W	M. DEF	15A	BLUE	Mirror defroter*
X	P. POINT	15A	BLUE	Power point

In Case of Emergency

Towing

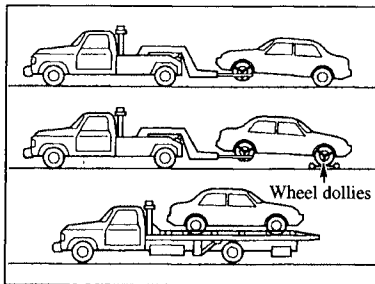

A towed vehicle usually should have its front wheels off the ground. If excessive damage or other conditions prevent this, use wheel dollies.

When towing with the rear wheels on the ground, release the parking brake.

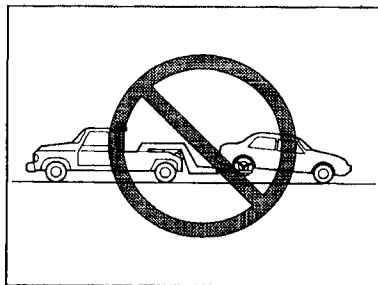

We recommend that towing be done only by an Authorized Mazda Dealer or a commercial tow-truck service.

Proper lifting and towing are necessary to prevent damage to the vehicle. State and local laws must be followed.



CAUTION

Don't tow the vehicle backward with driving wheels on the ground. This may cause internal damage to the transaxle.

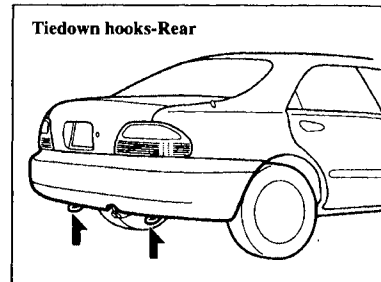
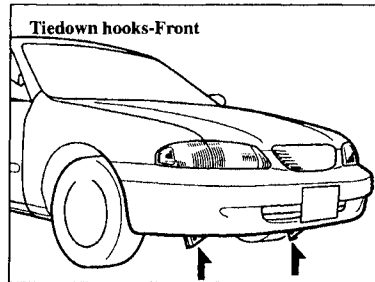
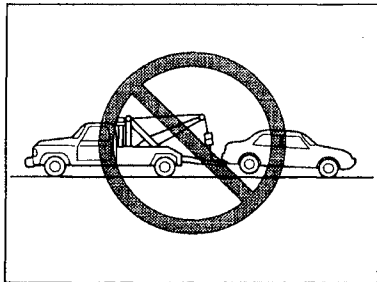

⚠ CAUTION

Don't tow with sling-type equipment. This could damage your vehicle. Use wheel-lift or flatbed equipment.

 **CAUTION**

Don't use the hook loops under the front and rear for towing. They are designed **ONLY** for tying down the vehicle when it's being transported. Using them for towing will damage the bumper.

Flat Tire

■ Tire, Jack, and Lug Wrench

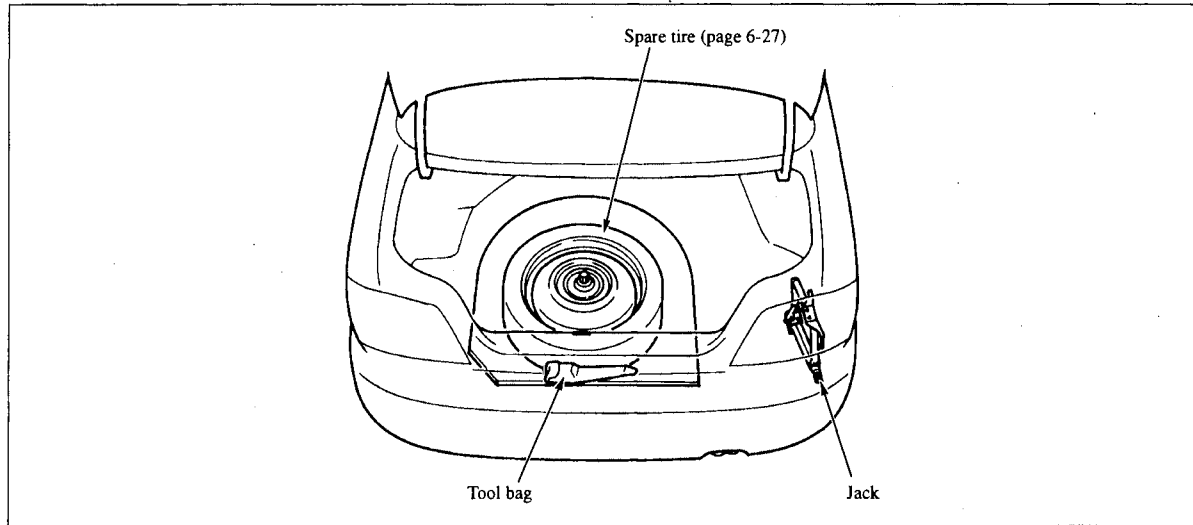

In Case of Emergency

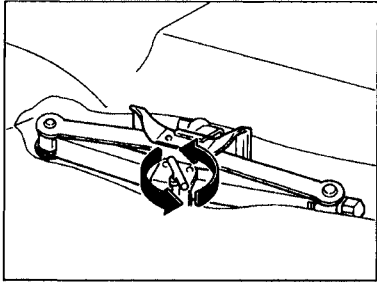

▼ To remove the jack

Turn the wing bolt counterclockwise.

▼ To secure the jack

Perform the removal procedure in reverse.

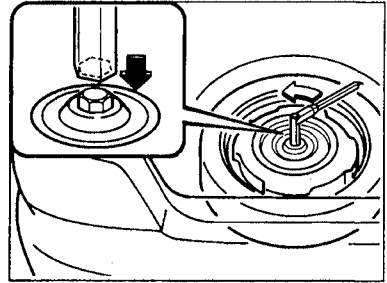

▼ To remove the spare tire

Turn the tire hold-down bolt counterclockwise with the lug wrench.

■ Changing a Flat Tire

NOTE

If the following occurs while driving, it could indicate a flat tire.

- Steering becomes difficult.
- The vehicle begins to vibrate excessively.
- The vehicle pulls in one direction.

If you have a flat tire, drive slowly to a level spot that is well off the road and out of the way of traffic to change the tire. Stopping in traffic or on the shoulder of a busy road is dangerous.

WARNING

Jacking a Vehicle:
Changing a tire can be dangerous. The vehicle can slip off the jack and seriously injure someone.

Be sure to follow the directions for changing a tire, and never get under a vehicle that is supported only by a jack.

To change a flat tire, follow procedure 1 through 15 carefully.

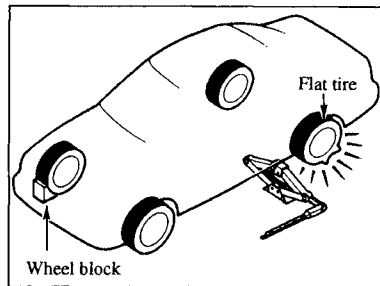

1. Park on a level surface off the right-of-way and firmly set the parking brake.
2. Shift an automatic transaxle to P or shift a manual transaxle to R, and turn off the engine.

In Case of Emergency

3. Turn on the hazard warning flasher.
4. Have everyone get out of the vehicle and away from the vehicle and traffic.
5. Remove the jack, lug wrench, and spare tire.
6. Block the wheel diagonally opposite the flat tire. When blocking a front wheel, place the block in front of the tire. When blocking a rear wheel, place the block behind the tire.

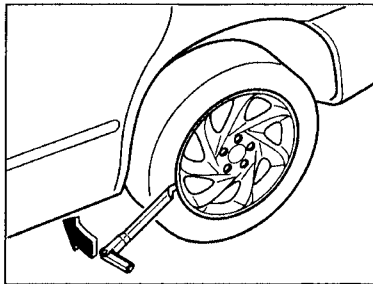

7. Pry off the wheel cover or center cap with the beveled end of the lug wrench.

NOTE

Force the end of the wrench firmly between wheel and cover or cap, or removal will be difficult.

⚠ CAUTION

(Center Cap)

There is a valve-stem mark inside the center cap. When installing the center cap, align this mark with the tire's valve stem.

(Wheel Cover)

Align the notch on the wheel cover with the valve stem when installing it.

Damage could occur during installation if the center cap or wheel cover is not properly aligned.

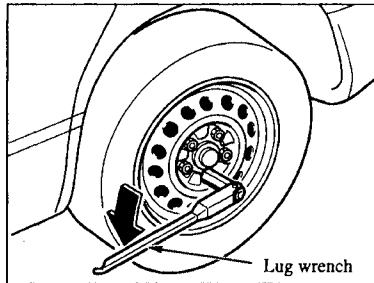

8. Loosen the lug nuts by turning them counterclockwise one turn each, but don't remove any until the tire has been raised off the ground.

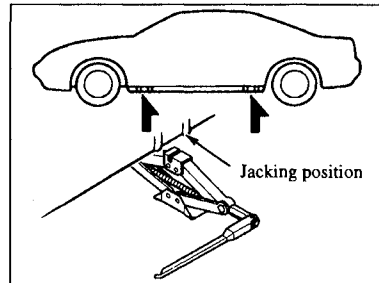

9. Place the jack under the jacking position closest to the tire being changed.

 **WARNING**

Incorrect Jacking Position:
Attempting to jack the vehicle in positions other than those recommended in this manual is dangerous. The vehicle could slip off the jack and seriously injure or even kill someone. Use only the front and rear jacking positions recommended in this manual.

 **WARNING**

Improper Jack:
Using a jack that isn't designed for your Mazda could be dangerous. The vehicle could slip off the jack and seriously injure someone. Use only the jack provided with your Mazda.

 **WARNING**

Placing Objects Under the Jack:
Jacking the vehicle with an object under the jack is dangerous. The jack could slip and someone could be seriously injured by the jack or the falling vehicle. Never place objects under the jack.

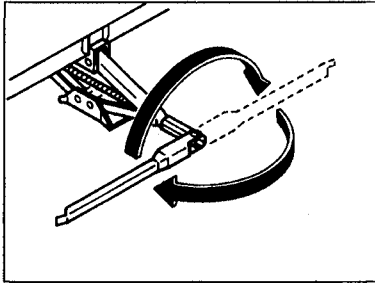

10. Insert the lug wrench into the jack and turn it clockwise until the tire just clears the ground, less than 1 inch (25mm). Before removing the lug nuts, make sure your Mazda is firmly in position and that it cannot slip or move.

11. Remove the lug nuts by turning them counterclockwise; then remove the wheel.
12. Mount the spare tire.
13. Install the lug nuts with the beveled edge inward; tighten them by hand.

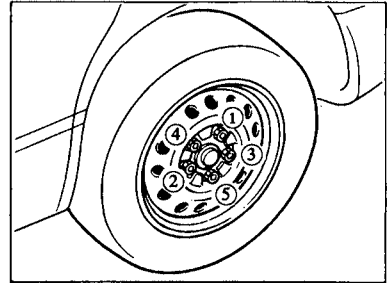

14. Turn the lug wrench counterclockwise and lower the vehicle. Use the lug wrench to tighten the nuts in the order shown.

If you're unsure of how tight the nuts should be, have them inspected at a service station. The specified torque is 90 to 120 N-m (9.0 to 12.0 kg-m, 65 to 87 ft-lb).

WARNING

Loose Lug Nuts:
Improperly or loosely tightened lug nuts are dangerous. The wheel could wobble or come off. This could result in loss of vehicle control and cause a serious accident. Always securely and correctly tighten the lug nuts.

WARNING

Metric Studs and Lug Nuts:
Because the wheel studs and lug nuts on your Mazda have metric threads, using a nonmetric nut would be dangerous. On a metric stud, it would not secure the wheel and would damage the stud, which could cause the wheel to slip off and cause an accident. Be sure to reinstall the same nuts you removed or replace them with metric nuts of the same configuration.

WARNING

Incorrect Tire Air Pressure:
Driving on tires with incorrect air pressure is dangerous. Tires with incorrect pressure could affect handling and result in an accident. Don't drive with any tires that have incorrect air pressure. When you check the regular tire's air pressure, check the spare tire, too.

15. Temporarily store the damaged tire. Have it repaired and replace the spare with it as soon as possible.

NOTE

To prevent the jack and lug wrench from rattling, store them properly.

■ **Spare Tire**

Your Mazda has a temporary spare tire. It's lighter and smaller than a conventional tire, is designed only for emergency use and should be used only for VERY short periods. Temporary spares should NEVER be used for long drives or extended periods.

 **WARNING**

Driving with a Temporary Spare Tire on Ice or Snow:

Driving with a spare tire on the front (driving) wheels on ice or snow is dangerous. Handling will be affected. You could lose control of the vehicle and have an accident. Put the spare tire on the rear axle and move a regular tire to the front.



CAUTION

To avoid damage to the temporary spare or to the vehicle, observe the following:

- Don't exceed 50 mph (80 km/h).
- Avoid driving over obstacles. Also, don't drive through an automatic car wash. This tire's diameter is smaller than a conventional tire's; so the ground clearance is reduced about 1 inch (25 mm).
- Don't use a tire chain on this

(Continued)

tire because it won't fit properly.

- Don't use your temporary spare on any other vehicle; it has been designed only for your Mazda.
- Use only one temporary spare tire on your vehicle at the same time.

7

Appearance Care

This section features care, inside and out, of your Mazda...how best to keep it clean and looking good.

Be aware that appearance is not the only reason for cleanliness. Road grime tends to eat away at the metal, so keeping your vehicle clean in the way Section 7 prescribes will help prevent its early deterioration and rusting.

How to Minimize Environmental Paint Damage	7- 2
Exterior Care	7- 6
Interior Care	7-12

How to Minimize Environmental Paint Damage

The paintwork on your Mazda represents the latest technical developments in composition and methods of application.

Environmental hazards, however, can harm the paint's protective properties, if proper care is not taken.

Here are some examples of possible damage, with tips on how to prevent them.

■ Etching Caused by Acid Rain or Industrial Fallout

▼ Occurrence

Industrial pollutants and vehicle emissions drift into the air and mix with rain or dew to form acids. These acids can settle on a vehicle's finish. As the water evaporates, the acid becomes concentrated and can damage the finish. And the longer the acid remains on the surface, the greater the chance is for damage.

▼ Prevention

It is necessary to wash and wax your vehicle to preserve its finish according to the instructions in this section. These steps should be taken immediately after you suspect that acid rain has settled on your vehicle's finish.

■ Damage Caused by Bird Dropping, Insects, or Tree Sap

▼ Occurrence

Bird dropping contain acids. If these aren't removed they can eat away the clear and color base coat of the vehicle's paintwork.

When insects stick to the paint surface and decompose, corrosive compounds form. These can erode the clear and color base coat of the vehicle's paintwork if they are not removed.

Tree sap will harden and adhere permanently to the paint finish. If you scratch the sap off while it is hard, some vehicle paint could come off with it.

▼ Prevention

It is necessary to have your Mazda washed and waxed to preserve its finish according to the instructions in this section. This should be done as soon as possible.

Bird droppings can be removed with a soft sponge and water. If you are traveling and these are not available, a moistened tissue may also take care of the problem. The cleaned area should be waxed according to the instructions in this section.

Insects and tree sap are best removed with a soft sponge and water or a commercially available chemical cleaner.

Another method is to cover the affected area with dampened newspaper for one to two hours. After removing the newspaper, rinse off the loosened debris with water.

■ Water Marks

▼ Occurrence

Rain, fog, dew, and even tap water can contain harmful minerals such as salt and lime. If moisture containing these minerals settles on the vehicle and evaporates, the minerals will concentrate and harden to form white rings. The rings can damage your vehicle's finish.

▼ Prevention

It is necessary to wash and wax your vehicle to preserve its finish according to the instructions in this section. These steps should be taken immediately after you find water marks on your vehicle's finish.

■ Paint Chipping

▼ Occurrence

Paint chipping occurs when gravel thrown in the air by another vehicle's tires hits your vehicle.

▼ How to avoid paint chipping

Keeping a safe distance between you and the vehicle ahead reduces the chances of having your paint chipped by flying gravel.

NOTE

- The paint chipping zone varies with the speed of the vehicle. For example, when traveling at 56 mph (90 km/h), the paint chipping zone is 164 feet (50 meters).
- In low temperatures a vehicle's finish hardens. This increases the chance of paint chipping.
- Chipped paint can lead to rust forming on your Mazda. Before this happens, repair the damage by using Mazda touch-up paint according to the instructions in
(Continued)

this section. Failure to repair the affected area could lead to serious rusting and expensive repairs.

Exterior Care

Follow **all** label and container directions when using a chemical cleaner or polish. Read all warnings and cautions.

■ Maintaining the Finish

▼ Washing

To help protect the finish from rust and deterioration, wash your Mazda thoroughly and frequently, at least once a month, with lukewarm or cold water.

If the vehicle is washed improperly, the paint surface could be scratched. Here are some examples of how scratching could occur.

Scratches occur on the paint surface when:

- The vehicle is washed without first rinsing off dirt and other foreign matter.
- The vehicle is washed with a rough, dry, or dirty cloth.
- The vehicle is washed at a car wash that uses brushes that are dirty or too stiff.
- Cleansers or wax containing abrasives are used.

NOTE

- Mazda is not responsible for scratches caused by automatic car washes or improper washing.
- Scratches are more noticeable on vehicles with darker paint finishes.

To minimize scratches on the vehicle's paint finish:

- Rinse off any dirt or other foreign matter using lukewarm or cold water before washing.

- Use plenty of lukewarm or cold water and a soft cloth when washing the vehicle. Do not use a nylon cloth.
- Rub gently when washing or drying the vehicle.
- Take your vehicle only to a car wash that keeps its brushes well maintained.
- Don't use abrasive cleansers or wax that contain abrasives.



CAUTION

- Don't use steel wool, abrasive cleaners, or strong detergents containing highly alkaline or caustic agents on chrome-plated or anodized aluminum parts. This may damage the protective coating; also, cleaners and detergents may discolor or deteriorate the paint.
- To prevent damaging the antenna, retract it before entering a car wash facility or passing beneath a low overhead clearance.

Pay special attention to removing salt, dirt, mud, and other foreign material from the underside of the wings, and make sure the drain holes in the lower edges of the doors and rocker panels are clean.

Insects, tar, tree sap, bird droppings, industrial fallout, and similar deposits can damage the finish if not removed immediately. When prompt washing with plain water is ineffective, use a mild soap made for use on vehicles.

Thoroughly rinse off all soap with lukewarm or cold water. Don't allow soap to dry on the finish.

After washing the vehicle, dry it with a clean chamois to prevent water spots from forming.



WARNING

Driving with Wet Brakes:

Driving with wet brakes is dangerous. Increased stopping distance or the vehicle pulling to one side when braking could result in a serious accident. Light braking will indicate whether the brakes have been affected. Dry the brakes by driving very slowly and applying the brakes lightly until brake performance is normal.

▼ Waxing

Your vehicle needs to be waxed when water no longer beads on the finish. Always wash and dry the vehicle before waxing it. In addition to the vehicle body, wax the metal trim to maintain its luster.

1. Use wax which contains no abrasives. Waxes containing abrasive will remove paint and could damage bright metal parts.
2. Use a good grade of natural wax for metallic, mica, and solid colors.
3. When waxing, coat evenly with the sponge supplied or a soft cloth.

4. Wipe off the wax with a soft cloth.

NOTE

A spot remover to remove oil, tar, and similar materials will usually also take off the wax. Rewax these areas even if the rest of the vehicle doesn't need it.

■ **Repairing Damage to the Finish**

Deep scratches or chips on the finish should be repaired promptly. Exposed metal quickly rusts and can lead to major repairs.



CAUTION

If your Mazda is damaged and needs metal parts repaired or replaced, make sure the body shop applies anticorrosion materials to all parts, both repaired and new. This will prevent them from rusting.

■ **Bright-Metal Maintenance**

- Use tar remover to remove road tar and insects. Never do this with a knife or similar tool.
- To prevent corrosion on bright-metal surfaces, apply wax or chrome preservative and rub it to a high luster.
- During cold weather or in coastal areas, cover bright-metal parts with a coating of wax or preservative heavier than usual. It would also help to coat them with noncorrosive petroleum jelly or some other protective compound.

■ Underbody Maintenance

Road chemicals and salt used for ice and snow removal and solvents used for dust control may collect on the underbody. If not removed, they will speed up rusting and deterioration of such underbody parts as fuel lines, frame, floor pan, and exhaust system, even though these parts may be coated with anticorrosive material.

Thoroughly flush the underbody and wheel housings with lukewarm or cold water at the end of each winter. Try also to do this every month.

Pay special attention to these areas because they easily hide mud and dirt.

It will do more harm than good to wet down the road grime without removing it.

The lower edges of doors, rocker panels, and frame members have drain holes that should not be clogged. Water trapped there will cause rusting.

WARNING

Driving with Wet Brakes:
Driving with wet brakes is dangerous. Increased stopping distance or the vehicle pulling to one side when braking could result in a serious accident. Light braking will indicate whether the brakes have been affected. Dry the brakes by driving very slowly and applying the brakes lightly until brake performance is normal.

■ **Aluminum Wheel Maintenance**

A protective coating is provided over the aluminum wheels. Special care is needed to protect this coating.

NOTE

- Don't use a wire brush or any abrasive cleaner, polishing compound, or solvent on aluminum wheels. They may damage the coating.
- Only use a mild soap or neutral detergent and always use a sponge or soft cloth to clean the wheels. Rinse thoroughly with lukewarm or cold water. Also, be sure to clean the wheels after driving on dusty or salted roads. This helps prevent corrosion.

(Continued)

- Avoid washing your vehicle in an automatic car wash that uses high-speed or hard brushes.
- If your aluminum wheels lose luster, wax the wheels.

Interior Care

■ Dashboard Precautions

Prevent caustic solutions such as perfume and cosmetic oils from contacting the dashboard. They'll damage and discolor it. If these solutions get on the dashboard, wipe them off immediately.

■ Cleaning the Upholstery and Interior Trim

▼ Vinyl

Remove dust and loose dirt from vinyl with a whisk broom or vacuum cleaner. Clean vinyl with a leather-and-vinyl cleaner.

▼ Leather

Real leather isn't uniform and may have scars, scratches, and wrinkles. Clean it with a leather cleaner or mild soap.

Wipe it with a **damp** soft cloth; then dry and buff it with a **dry** soft cloth.

▼ Fabric

Remove dust and loose dirt from fabric with a whisk broom or vacuum cleaner. Clean it with a mild soap solution good for upholstery and carpets. Remove fresh spots immediately with a fabric spot cleaner.

To keep the fabric looking clean and fresh, take care of it. Otherwise its color will be affected, it can be stained easily, and its fire-resistance may be reduced.



CAUTION

Use only recommended cleaners and procedures. Others may affect appearance and fire-resistance.

■ Cleaning the Lap/Shoulder Belt Webbing

Clean the webbing with a mild soap solution recommended for upholstery or carpets. Follow instructions. Don't bleach or dye the webbing; this may weaken it.



WARNING

Damaged Seat Belt:
Using damaged seat belts is dangerous. In a collision, damaged belts cannot provide adequate protection. Have your Authorized Mazda Dealer replace damaged belts immediately.

■ Cleaning the Window Interiors

If the windows become covered with an oily, greasy, or waxy film, clean them with glass cleaner. Follow the directions on the container.



CAUTION

Don't scrape or scratch the inside of the rear window. You may damage the rear window defroster grid.

8

Maintenance

Because your Mazda is a large piece of intricate machinery, it needs regular care in the form of maintenance and servicing. Many owners prefer to do much of this work themselves.

So Section 8 has been prepared as a guide for the operator who wants to self-service such minor jobs as changing the engine oil, replacing bulbs and wiper blades, charging the battery, and rotating the tires. All maintenance schedules are included, along with instructions on how to make regular inspections of such things as fluid levels.

Introduction	8- 2
Scheduled Maintenance	8- 3
Owner Maintenance	8-13

Introduction

Be extremely careful to prevent injury to yourself and others and damage to your vehicle when using this manual for inspection and maintenance.

If you're unsure about any procedure it describes, we strongly urge you to have a reliable and qualified service shop perform the work, preferably an Authorized Mazda Dealer.

Factory-trained Mazda technicians and genuine Mazda parts are best for your vehicle. Without this expertise and the parts that have been designed and made especially for your Mazda, inadequate, incomplete, and insufficient servicing may result in problems. This could lead to vehicle

damage or an accident and injuries.

For expert advice and quality service, consult an Authorized Mazda Dealer.

The owner should retain evidence that proper maintenance has been performed as prescribed.

A claim against a warranty will not qualify if it results from lack of maintenance and not from defective material or authorized Mazda workmanship.

Any auto repair shop using parts equivalent to your Mazda's original equipment may perform maintenance. **But we recommend that it always be done by an Authorized Mazda Dealer using genuine Mazda parts.**

Scheduled Maintenance

Follow Schedule 1 if the vehicle is operated mainly where none of the following conditions applies. If any of them apply, follow Schedule 2 (Puerto Rico residents follow Schedule 2).

- Repeated short-distance driving
- Driving in dusty conditions
- Driving with an extended use of brakes
- Driving in areas where salt or other corrosive materials are being used
- Driving on rough or muddy roads
- Extended periods of idling or low-speed operation
- Driving for a prolonged period in cold temperatures or extremely humid climates

Maintenance

NOTE

After the described period, continue to follow the described maintenance at the recommended intervals.

I : Inspect and repair, clean, adjust, or replace if necessary

R : Replace

Schedule 1

MAINTENANCE INTERVALS MAINTENANCE ITEM	Number of months or miles (kilometers), whichever comes first								
	Months	6	12	18	24	30	36	42	48
	× 1000 miles	7.5	15	22.5	30	37.5	45	52.5	60
(× 1000 km)	(12)	(24)	(36)	(48)	(60)	(72)	(84)	(96)	
Engine valve clearance									I
Engine oil	R	R	R	R	R	R	R	R	R
Engine oil filter	R	R	R	R	R	R	R	R	R
Drive belts (tension)					I				I

I : Inspect and repair, clean, adjust, or replace if necessary

Schedule 1 (Cont'd)

MAINTENANCE INTERVALS		Number of months or miles (kilometers), whichever comes first								
		Months	6	12	18	24	30	36	42	48
MAINTENANCE ITEM		× 1000 miles	7.5	15	22.5	30	37.5	45	52.5	60
		(× 1000 km)	(12)	(24)	(36)	(48)	(60)	(72)	(84)	(96)
Engine timing belt	2.0-liter engine	*1 Replace every 60,000 miles (96,000 km)								
		*2, *5 Inspect for 60,000 miles (96,000 km), 90,000 miles (144,000 km) Replace every 105,000 miles (168,000 km)								

*1 Vehicles not covered under *2 below.

*2 If your vehicle was initially registered in one of these listed states, the scheduled maintenance services set forth in this section apply to it:
California, New York, Massachusetts, Connecticut, Vermont, New Jersey, Rhode Island, Delaware, Maryland, New Hampshire, Pennsylvania, Virginia, Maine, Washington DC.

*5 According to state and federal regulations, failure to perform maintenance on these items will not void your emissions warranties. However, Mazda recommends that all maintenance services be performed at the recommended time or mileage (kilometrage) period to ensure long-term reliability.

Maintenance

I : Inspect and repair, clean, adjust, or replace if necessary (Air filter cannot be cleaned using the air-blow method.)

R : Replace

Schedule 1 (Cont'd)

MAINTENANCE INTERVALS MAINTENANCE ITEM		Number of months or miles (kilometers), whichever comes first								
		Months	6	12	18	24	30	36	42	48
		× 1000 miles	7.5	15	22.5	30	37.5	45	52.5	60
		(× 1000 km)	(12)	(24)	(36)	(48)	(60)	(72)	(84)	(96)
Engine timing belt	2.5-liter engine	^{*3} Replace every 60,000 miles (96,000 km)								
		^{*4, *5} Inspect for 60,000 miles (96,000 km), 90,000 miles (144,000 km) Replace every 105,000 miles (168,000 km)								
Hoses and tubes for emission									I ^{*5}	
Air filter						R			R	
Spark plugs						R			R	
Idle speed						I ^{*5}			I ^{*5}	
Fuel lines and hoses						I ^{*5}			I ^{*5}	

^{*3} Vehicles not covered under ^{*4} below.

^{*4} If your vehicle was initially registered in one of these listed states, the scheduled maintenance services set forth in this section apply to it:
California, Massachusetts, Vermont, New York, Maine.

^{*5} According to state and federal regulations, failure to perform maintenance on these items will not void your emissions warranties. However, Mazda recommends that all maintenance services be performed at the recommended time or mileage (kilometrage) period to ensure long-term reliability.

I : Inspect and repair, clean, adjust, or replace if necessary

L : Lubricate

Schedule 1 (Cont'd)

MAINTENANCE INTERVALS MAINTENANCE ITEM	Number of months or miles (kilometers), whichever comes first								
	Months	6	12	18	24	30	36	42	48
	× 1000 miles	7.5	15	22.5	30	37.5	45	52.5	60
	(× 1000 km)	(12)	(24)	(36)	(48)	(60)	(72)	(84)	(96)
Cooling system					I				I
Engine coolant	Replace at first 105,000 miles (168,000 km) or 60 months; after that, every 30,000 miles (48,000 km) or 24 months								
Brake lines, hoses and connections					I				I
Drum brakes					I				I
Disc brakes					I				I
Steering operation and linkages					I				I
Front suspension ball joints					I				I
Driveshaft dust boots					I				I
Bolts and nuts on chassis and body					I				I
Exhaust system heat shields					I				I
All locks and hinges	L	L	L	L	L	L	L	L	L

Maintenance

I : Inspect and repair, clean, adjust, or replace if necessary

Schedule 1 (Cont'd)

MAINTENANCE INTERVALS	Number of months or miles (kilometers), whichever comes first								
	Months	6	12	18	24	30	36	42	48
MAINTENANCE ITEM	× 1000 miles	7.5	15	22.5	30	37.5	45	52.5	60
	(× 1000 km)	(12)	(24)	(36)	(48)	(60)	(72)	(84)	(96)
Air-conditioner refrigerant (if installed)			I		I		I		I
Air-conditioner compressor (if installed)			I		I		I		I
Cabin air filter (if installed)		Replace once a year or every 12,000 miles (20,000 km)							

I : Inspect and repair, clean, adjust, or replace if necessary
 R : Replace

Schedule 2

MAINTENANCE INTERVALS MAINTENANCE ITEM		Number of months or miles (kilometers), whichever comes first												
		Months	4	8	12	16	20	24	28	32	36	40	44	48
		× 1000 miles	5	10	15	20	25	30	35	40	45	50	55	60
		(× 1000 km)	(8)	(16)	(24)	(32)	(40)	(48)	(56)	(64)	(72)	(80)	(88)	(96)
Engine valve clearance													I	
Engine oil	Except Puerto Rico	R	R	R	R	R	R	R	R	R	R	R	R	
	Puerto Rico	Replace every 3,000 miles (4,800 km) or 3 months												
Engine oil filter		R	R	R	R	R	R	R	R	R	R	R	R	
Drive belts (tension)							I						I	
Engine timing belt	2.0-liter engine	^{*1} Replace every 60,000 miles (96,000 km)												
		^{*2, *5} Inspect for 60,000 miles (96,000 km), 90,000 miles (144,000 km) Replace every 105,000 miles (168,000 km)												

*1 Vehicles not covered under *2 below.

*2 If your vehicle was initially registered in one of these listed states, the scheduled maintenance services set forth in this section apply to it:
 California, New York, Massachusetts, Connecticut, Vermont, New Jersey, Rhode Island, Delaware, Maryland, New Hampshire, Pennsylvania, Virginia, Maine, Washington DC.

*5 According to state and federal regulations, failure to perform maintenance on these items will not void your emissions warranties. However, Mazda recommends that all maintenance services be performed at the recommended time or mileage (kilometrage) period to ensure long-term reliability.

Maintenance

I : Inspect and repair, clean, adjust, or replace if necessary (Air filter cannot be cleaned using the air-blow method.)

R : Replace

Schedule 2 (Cont'd)

MAINTENANCE INTERVALS		Number of months or miles (kilometers), whichever comes first												
		Months	4	8	12	16	20	24	28	32	36	40	44	48
MAINTENANCE ITEM		× 1000 miles	5	10	15	20	25	30	35	40	45	50	55	60
		(× 1000 km)	(8)	(16)	(24)	(32)	(40)	(48)	(56)	(64)	(72)	(80)	(88)	(96)
Engine timing belt	2.5-liter engine	* ³ Replace every 60,000 miles (96,000 km)												
		* ⁴ , * ⁵ Inspect for 60,000 miles (96,000 km), 90,000 miles (144,000 km) Replace every 105,000 miles (168,000 km)												
Hoses and tubes for emission														I* ⁵
Air filter				I* ⁵			R			I* ⁵				R
Spark plugs							R							R
Idle speed							I* ⁵							I* ⁵
Fuel lines and hoses							I* ⁵							I* ⁵

*³ Vehicles not covered under *⁴ below.

*⁴ If your vehicle was initially registered in one of these listed states, the scheduled maintenance services set forth in this section apply to it:
California, Massachusetts, Vermont, New York, Maine.

*⁵ According to state and federal regulations, failure to perform maintenance on these items will not void your emissions warranties. However, Mazda recommends that all maintenance services be performed at the recommended time or mileage (kilometrage) period to ensure long-term reliability.

I : Inspect and repair, clean, adjust, or replace if necessary

Schedule 2 (Cont'd)

MAINTENANCE INTERVALS MAINTENANCE ITEM	Number of months or miles (kilometers), whichever comes first												
	Months	4	8	12	16	20	24	28	32	36	40	44	48
	× 1000 miles	5	10	15	20	25	30	35	40	45	50	55	60
	(× 1000 km)	(8)	(16)	(24)	(32)	(40)	(48)	(56)	(64)	(72)	(80)	(88)	(96)
Cooling system							I						I
Engine coolant	Replace at first 105,000 miles (168,000 km) or 60 months; after that, every 30,000 miles (48,000 km) or 24 months												
Engine coolant level	I	I	I	I	I	I	I	I	I	I	I	I	I
Function of all lights	I	I	I	I	I	I	I	I	I	I	I	I	I
Brake lines, hoses and connections							I						I
Brake and clutch fluid level	I	I	I	I	I	I	I	I	I	I	I	I	I
Drum brakes							I						I
Disc brakes			I				I		I				I
Tire inflation pressure and tire wear	I	I	I	I	I	I	I	I	I	I	I	I	I
Steering operation and linkages							I						I
Power steering fluid level	I	I	I	I	I	I	I	I	I	I	I	I	I

Maintenance

Schedule 2 (Cont'd)

I : Inspect and repair, clean, adjust, or replace if necessary

L : Lubricate

MAINTENANCE INTERVALS MAINTENANCE ITEM	Number of months or miles (kilometers), whichever comes first												
	Months	4	8	12	16	20	24	28	32	36	40	44	48
	× 1000 miles	5	10	15	20	25	30	35	40	45	50	55	60
	(× 1000 km)	(8)	(16)	(24)	(32)	(40)	(48)	(56)	(64)	(72)	(80)	(88)	(96)
Front suspension ball joints							I						I
Driveshaft dust boots							I						I
Bolts and nuts on chassis and body			I				I		I				I
Exhaust system heat shields							I						I
All locks and hinges	L	L	L	L	L	L	L	L	L	L	L	L	L
Washer fluid level	I	I	I	I	I	I	I	I	I	I	I	I	I
Air-conditioner refrigerant (if installed)			I				I			I			I
Air-conditioner compressor (if installed)			I				I			I			I
Cabin air filter (if installed)	Replace once a year or every 12,000 miles (20,000 km)												

Owner Maintenance

■ Owner Maintenance Schedule

The owner or a qualified service technician should make these vehicle inspections at the indicated intervals to ensure safe and dependable operation.

Bring any problem to the attention of an Authorized Mazda Dealer or qualified service technician as soon as possible.

▼ When refueling

- Brake and clutch fluid level (page 8-27)

- Engine coolant level (page 8-23)

- Engine oil level (page 8-19)

- Washer fluid level (page 8-35)

▼ At least monthly

- Tire inflation pressures (page 8-43)

▼ At least twice a year (for example, every spring and fall)

- Automatic transaxle fluid level (page 8-31)
- Power steering fluid level (page 8-29)

You can do the following scheduled maintenance items if you have some mechanical ability and a few basic tools and if you closely follow the directions in this manual.

- Air filter (page 8-36)

- Engine coolant (page 8-24)
- Engine oil and oil filter (page 8-20)

■ Owner Maintenance Precautions

Improper or incomplete service may result in problems. This section gives instructions only for items easy to perform.



WARNING

Maintenance Procedures:

Performing maintenance work on a vehicle can be dangerous. You can be seriously injured while performing some maintenance procedure. If you lack sufficient knowledge and experience or the proper tools and equipment to do the work, have it done by a qualified technician.

As explained in the Introduction (page 8-2), several procedure can be done only by a qualified service technician with special tools.

Improper owner maintenance during the warranty period may affect warranty coverage. For details, read the separate Mazda Warranty statement provided with the vehicle. If you're unsure about any servicing or maintenance procedure, have it done by an Authorized Mazda Dealer.

 **WARNING**

Running the Engine:
Working under the hood with the engine running is dangerous. It becomes even more dangerous when you wear jewelry or loose clothing. Either can become entangled in moving parts and result in injury. Therefore, if you must run the engine while working under the hood, make certain that you remove all jewelry (especially rings, bracelets, watches, and necklaces) and all neckties, scarves, and similar loose clothing before getting near the engine or cooling fan.

 **WARNING**

Electrical Fan and Engine Inspection:
Inspecting the engine with the ignition switch in the ON position is dangerous. The cooling fan could come on unexpectedly even when the engine isn't running. You could be seriously injured by the fan. Turn the ignition switch off and remove the key from the ignition switch when you inspect the engine.

Maintenance

■ Engine Compartment Overview

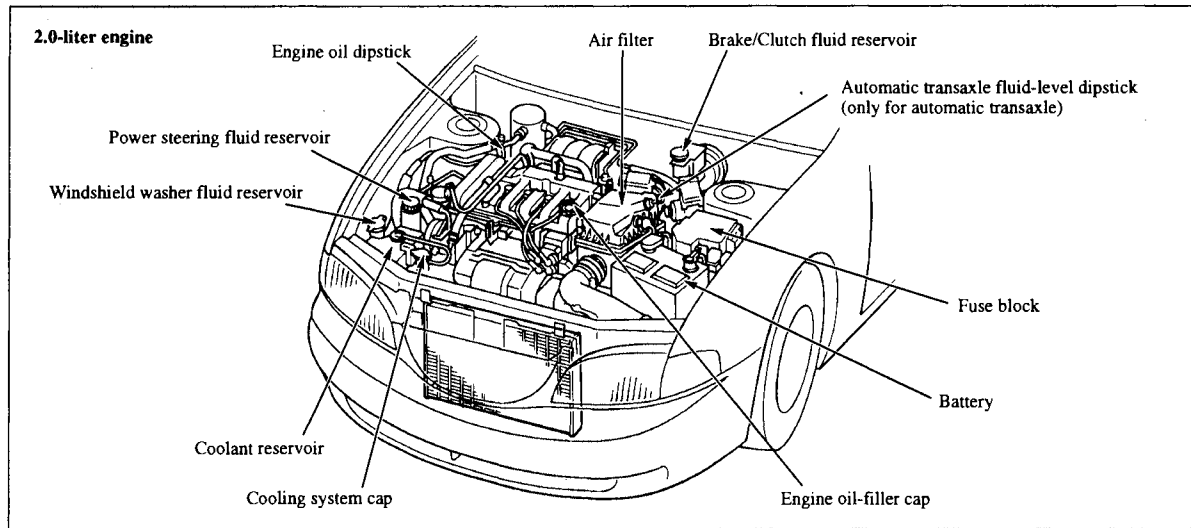

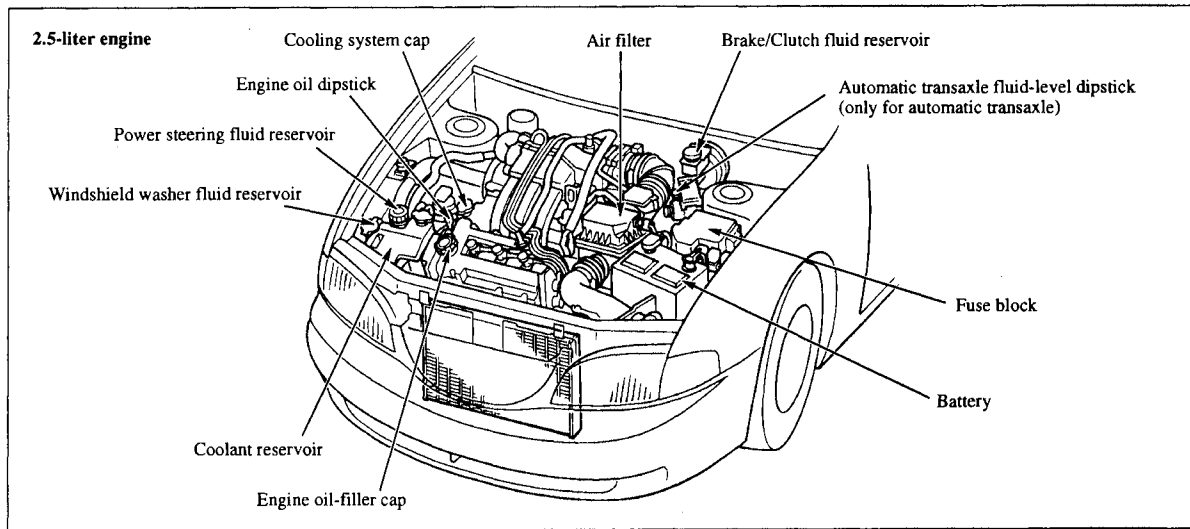

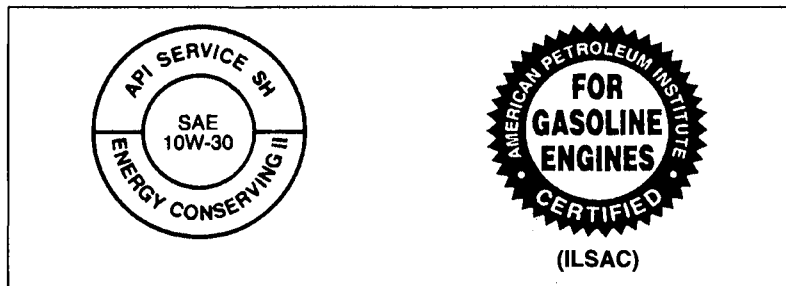

■ Engine Oil

▼ Recommended oil

Oil container labels provide important information.

The quality designation “SG”, “SH”,

“SJ”, or “ILSAC” must be on the label.

Engine oil viscosity, or thickness, has an effect on fuel economy and cold-weather operation (starting and oil flow). Low-viscosity engine oils can provide improved fuel economy and cold-weather performance.

But high-temperature weather conditions require higher-viscosity engine oils for satisfactory lubrication.

When choosing an oil, consider the temperature range your vehicle will operate in before the next oil change. Then select the recommended viscosity from this chart.

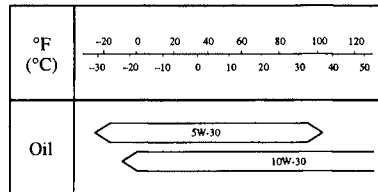

⚠ CAUTION

Using oils of viscosity besides those recommended for specific temperature ranges could result in engine damage.

Energy conserving oils are recommended. A chief contribution they make to fuel economy is reducing the amount of fuel necessary to overcome engine friction.

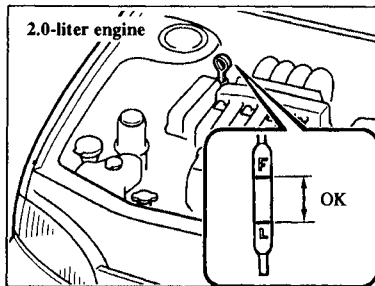
**▼ Inspecting engine oil level**

1. Be sure the vehicle is on a level surface.
2. Warm up the engine to normal operating temperature.

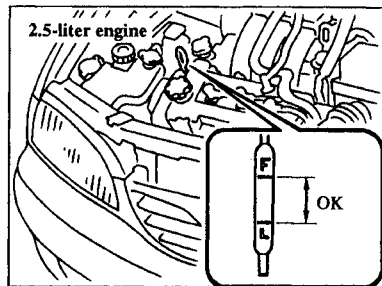

3. Turn it off and wait 5 minutes for the oil to return to the oil pan.
4. Pull out the dipstick, wipe it clean, and reinsert it fully.

5. Pull it out again and examine the level. It's OK between L and F.

But if it's near at or below L, add enough oil to bring the level to F.



CAUTION

Don't add engine oil over F.
This may cause engine damage.

NOTE

The distance between L and F on the dipstick represents **1.06 US qt (0.88 Imp qt, 1.0 liter)**.

▼ Changing engine oil and filter

Change engine oil and filter according to Scheduled Maintenance (page 8-3).

Please act responsibly—protect the environment and take used oil to a recycling facility. Ask your dealer or a service station for information.



WARNING

Handling Used Engine Oil:
Continuous contact with used engine oil could be dangerous. It could cause skin cancer. Always wash with soap and water immediately after changing oil and filter.

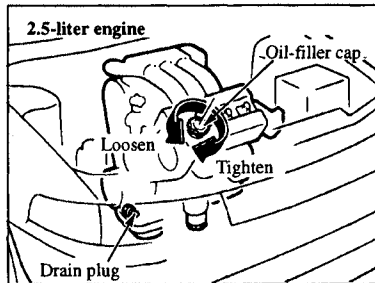
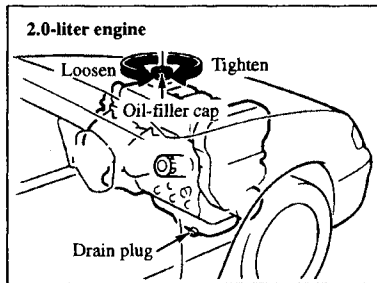

⚠ WARNING

Checking or Changing Engine Oil:
Hot engine oil could be dangerous. If the engine has been running, the engine oil becomes very hot. You could be seriously burned. Don't check or change the engine oil when the engine is hot.

Changing engine oil

1. Warm up the engine for a few minutes and turn it off. Remove the oil-filler cap.

2. Remove the drain plug and drain the oil into a suitable container.

3. Replace the plug tightly after the oil has thoroughly drained.
4. Fill the engine with new oil to the F mark on the dipstick.
5. Securely replace the oil-filler cap.
6. Start the engine and inspect around the drain plug for leaks.
7. Turn it off and wait 5 minutes for the oil to return to the oil pan.

Check the oil level and fill to the F mark if necessary.

Oil capacity
(General reference only)

2.0-liter engine:
3.5 US qt (2.9 Imp qt, 3.3 liter)

2.5-liter engine:
3.9 US qt (3.3 Imp qt, 3.7 liter)

NOTE

- The indicated engine oil capacities are for general reference purposes only. When adding or changing oil, verify the engine oil level with the oil dipstick.
- Use only specified engine oil (page 8-18).

Changing oil filter

Because you need a special tool to retighten the filter, an Authorized Mazda Dealer should do the work.

■ Engine Coolant

▼ Inspecting coolant level

WARNING

Hot Engine:

A hot engine is dangerous. If the engine has been running, parts of the engine compartment can become very hot. You could be burned. Don't inspect the coolant system or add coolant when the engine is hot.

Inspect the antifreeze protection and coolant level in the coolant reservoir at least once a year—at the beginning of the winter season—and before traveling where temperatures may drop below freezing.

Inspect the condition and connections of all cooling system and heater hoses. Replace any that are swollen or deteriorated.

The coolant should be at full in the radiator and between the F and L marks on the coolant reservoir when the engine is cool.

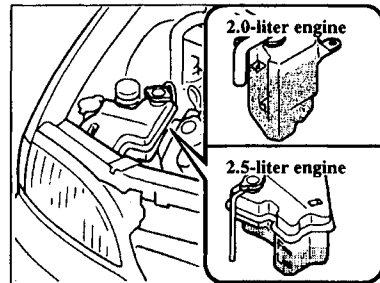

If it's at or near L, add enough coolant to the coolant reservoir to provide freezing and corrosion protection and to bring the level to F.

Do not overfill.

If new coolant is required frequently, consult an Authorized Mazda Dealer.

CAUTION

Radiator coolant will damage paint. Rinse it off quickly.

NOTE

Mixing green coolant with orange coolant could decrease the service life expectancy of the coolant. Use only genuine Mazda orange colored or equivalent coolant.

▼ Changing coolant

Change coolant according to Scheduled Maintenance (page 8-3).

CAUTION

- Use only soft (demineralized) water in the coolant mixture. Water that contains minerals will cut down on the coolant's effectiveness.
- Don't add only water. Always add a proper coolant mixture.

CAUTION

- The engine has aluminum parts and must be protected by an ethylene-glycol-based coolant to prevent corrosion and freezing.
- DO NOT USE alcohol or methanol antifreeze. DO NOT MIX alcohol or methanol with the coolant. This could damage the cooling system.
- Don't use a solution that contains more than 60 percent antifreeze. This would reduce effectiveness.

For mixture percentage:

Protection	Volume	
	Antifreeze solution	Water
Above 3°F (-16°C)	35%	65%
Above -15°F (-26°C)	45	55
Above -40°F (-40°C)	55	45

WARNING

Removing the Cooling System

Cap:

Removing the cooling system cap or drain plug while the engine is running or hot is dangerous. This might lead to cooling system and

(Continued)

engine damage and could result in serious injury from escaping hot coolant or steam. Turn off the engine and wait until it's cool. Even then, be very careful when removing the cap or drain plug. Wrap a thick cloth around it and slowly turn it counterclockwise to the first stop. Step back while the pressure escapes. When you're sure all the pressure is gone, press down on the cap — still using a cloth — turn the cap, and remove it.

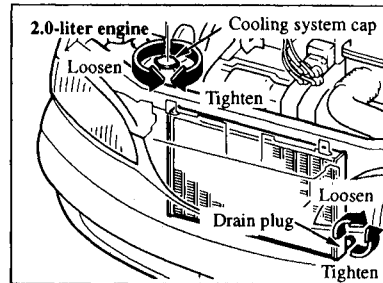

To change coolant

1. Remove the cooling system cap.
2. Only when the engine is cool, loosen the radiator drain plug and drain the coolant into a suitable container.

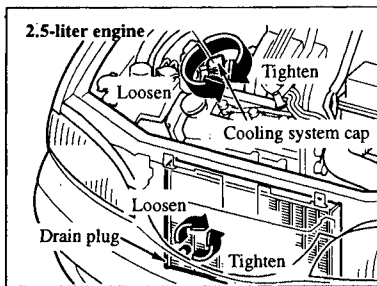

3. With the drain plug loose but not fully removed, flush out the system with running water.
4. Drain the system completely and retighten the plug.

5. Fill the radiator (to the top of the filler neck) and then the coolant reservoir (to F) with as much ethylene-glycol-based coolant and water as necessary to provide protection from freezing and corrosion. In extremely cold climates, add the amount recommended by the coolant manufacturer.

6. Reinstall the cooling system cap.
7. Run the engine at idle for about 10 minutes.

8. Then do this:

- Run the engine at 2,500 rpm for about 5 minutes.
- Increase the engine speed to 3,000 rpm for about 5 seconds and then release the accelerator.
- Do this 4 or 5 times.
- Make sure the engine temperature gauge does not reach the HOT zone.

After turning off the engine, inspect the drain plug and the water hoses for leaks.

9. After the engine has cooled, remove the cooling system cap and inspect the coolant level. If it's low, repeat steps 5 to 8.

Because this procedure requires technical expertise, we recommend that it be done by an Authorized Mazda Dealer.

NOTE

Mixing green coolant with orange coolant could decrease the service life expectancy of the coolant. Use only genuine Mazda orange colored or equivalent coolant

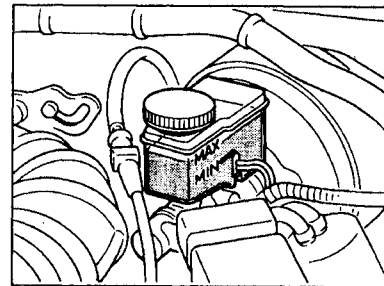
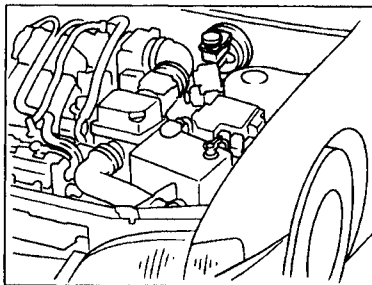

■ **Inspecting Brake/Clutch Fluid Level**

The brakes and clutch draw fluid from the same reservoir.

Inspect the fluid level in the reservoir regularly. If it's low, add fluid until it reaches MAX. It should be kept at MAX.

Before adding fluid, thoroughly clean the area around the cap.

The level normally drops with accumulated mileage, a condition associated with wear of brake and clutch linings. If it is excessively low, have the brake/clutch system inspected by an Authorized Mazda Dealer.

 **CAUTION**

Brake and clutch fluid will damage painted surfaces. If brake or clutch fluid does get on a painted surface, wipe it off immediately.

 **CAUTION**

Using nonspecified brake and clutch fluids (see chart, page 10-2) will damage the systems. Mixing different fluids will also damage them.

If the brake/clutch system frequently requires new fluid, consult an Authorized Mazda Dealer.

 **WARNING**

Spilled Brake Fluid:
Spilled brake fluid is dangerous. If it gets in your eyes, they could be seriously injured. If this happens, immediately flush your eyes with water and get medical attention. Brake fluid spilled on a hot engine could cause a fire. Be careful not to spill brake fluid on yourself or on the engine.

⚠ WARNING

Low Brake/Clutch Fluid Levels:
Low brake/clutch fluid levels could be dangerous. Low levels could signal brake lining wear or a brake system leak. Your brakes could fail and cause an accident. If you find a low fluid level, have the brakes and clutch inspected.

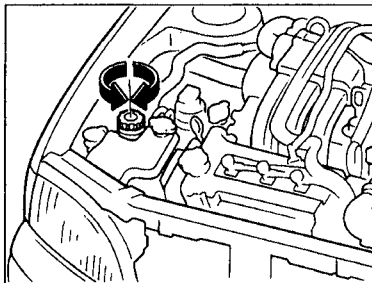
**■ Inspecting Power Steering Fluid Level**

Inspect the fluid level at each engine oil change. Add fluid if necessary; it does not require periodic changing.

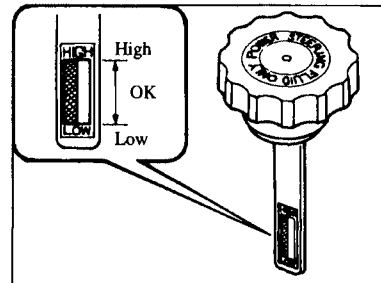

The level must be kept between the HIGH and LOW marks.

Visually examine the lines and hoses for leaks and damage.

1. Park on a level surface, well off the right-of-way, and set the parking brake firmly.
2. Turn off the engine and allow it to cool.
3. Remove the filler cap and attached dipstick.
4. Wipe them clean and put them back.
5. Remove again and inspect the level.

6. It must be between HIGH and LOW. Add fluid if necessary.

Don't overfill.

If new fluid is required frequently, consult an Authorized Mazda Dealer.

 CAUTION
To avoid damage to the power steering pump, don't operate the vehicle for long periods when the power steering fluid level is low.

NOTE
Use specified power steering fluid (chart, page 10-2).

■ Inspecting Automatic Transaxle Fluid Level

The automatic transaxle fluid level should be inspected regularly. Measure it as described below.

The volume of fluid changes with the temperature. Fluid must be checked at idle without driving at normal operating temperature.



CAUTION

- Low fluid level causes transaxle slippage. Overfilling can cause foaming, loss of fluid, and malfunction.
- Use specified fluid (page 10-2). A nonspecified fluid could result in transaxle malfunction and failure.

1. Park on a level surface and set the parking brake firmly.
2. Idle the engine about two minutes. Push down on the brake pedal.
3. Move the shift lever through all ranges and set it at P.

WARNING

Sudden Vehicle Movement:
Shifting the shift lever without first depressing the brake pedal is dangerous. The vehicle could move suddenly and cause an accident. Make sure the brake pedal is applied before shifting the shift lever.

4. With the engine still idling, pull out the dipstick, wipe it clean, and put it back.
5. Pull it out again.

The proper fluid level is marked on the dipstick as follows.

8-32

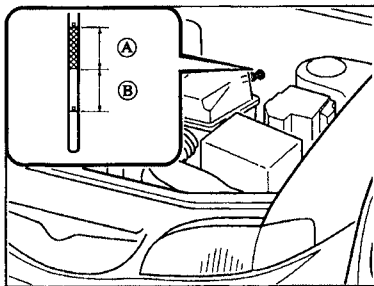

2.0-liter engine

▼ **Scale (A)**

When the engine has been running and the fluid is at normal operating temperature, about 150°F (65°C) to 170°F (77°C), the level must be within

the crosshatched area on the dipstick.

▼ **Scale (B)**

When the engine has not been running, and the outside temperature is above 50°F (10°C), the level should be between the bottom hole on the dipstick and the bottom of the crosshatched area on the dipstick.

NOTE

- Use scale B only as a reference.
- If the outside temperature is lower than 50°F (10°C), start the engine and inspect the fluid level after the engine reaches operating temperature.
- If the vehicle has been driven for an extended period at high speeds or in city traffic in hot weather, inspect the level only after stopping the engine and allowing the fluid to cool for 30 minutes or more.

Fully insert the dipstick. When adding fluid, make sure the fluid level doesn't pass the crosshatched area on the dipstick.

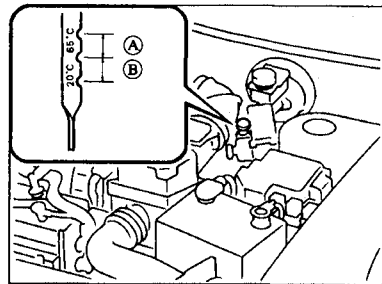
**2.5-liter engine****▼ Fluid hot scale (A)**

When the vehicle has been driven and the fluid is at normal operating temperature, about 150°F (65°C), the level must be between Full and Low.

▼ Fluid cold scale **B**

When the engine has not been running and the outside temperature is about 70°F (20°C), the level must be between Full and Low.

NOTE

- Use the cold scale only as a reference.
- If outside temperature is lower than about 70°F (20°C), start the engine and inspect the fluid level after the engine reaches operating temperature.
- If the vehicle has been driven for an extended period at high speeds or in city traffic in hot weather, inspect the level only after stopping the engine and allowing the fluid to cool for 30 minutes.

Fully insert the dipstick. When adding fluid, inspect with the dipstick to make sure it doesn't pass full.

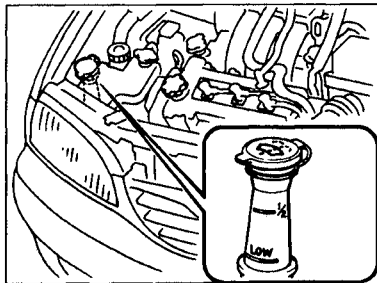

■ Inspecting Washer Fluid Level

Inspect fluid level in the washer fluid reservoir; add fluid if necessary.

Use plain water if fluid is unavailable. But use only washer fluid in cold weather to prevent it from freezing.

WARNING

Substitute Washer Fluid:
Using radiator antifreeze as washer fluid is dangerous. If sprayed on the windshield, it will dirty the windshield, affect your visibility, and could result in an accident. Use only windshield washer fluid or plain water in the reservoir.

■ Body Lubrication

All moving points of the body, such as door and hood hinges and locks, should be lubricated each time the engine oil is changed. Use a nonfreezing lubricant on locks during cold weather.

Make sure the engine hood's secondary latch keeps the hood from opening when the primary latch is released.

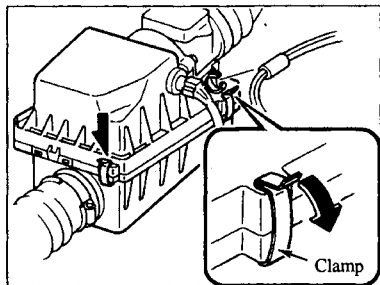

■ Maintaining the Air Filter

A viscous paper air filter fits inside the air cleaner housing, as shown. It's been specially treated and should not be cleaned and reused. Replace it when necessary.

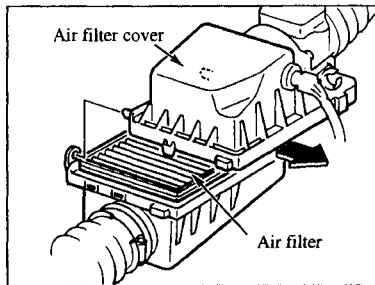

1. Unfasten the clamps.
2. Lift off the air filter cover and remove the filter.
3. Wipe inside the air cleaner housing with a damp cloth.

4. Replace the filter.
5. Install in the reverse order of removal.

Replace the filter according to Scheduled Maintenance (page 8-3).

NOTE

If the vehicle is operated in very dusty or sandy areas, replace the filter more often than recommended intervals.

 **CAUTION**

Don't drive without an air filter. This could result in excessive engine wear.

■ **Maintaining Wiper Blades**

 **CAUTION**

Hot waxes applied by automatic car washes have been known to affect the cleanability of windows.

Contamination of either the windshield or the blades with foreign matter can reduce wiper effectiveness. Common sources are insects, tree sap, and hot wax treatments used by some commercial car washes.

If the blades are not wiping properly, clean the window and blades with a good cleaner or mild detergent; then rinse thoroughly with clean water. Repeat if necessary.

 **CAUTION**

To prevent damage to the wiper blades, don't use gasoline, kerosene, paint thinner, or other solvents on or near them.

■ Replacing Windshield Wiper Blades

When the wipers no longer clean well, the blades are probably worn or cracked. Replace them.

CAUTION

To prevent damage to the wiper arms and other components, don't move the wipers by hand.

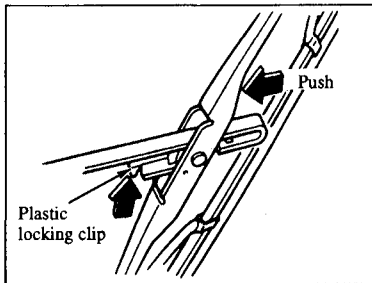

1. Raise the wiper arm and turn the blade assembly to expose the plastic locking clip.
2. Compress the clip and slide the assembly downward; then lift it off the arm.

CAUTION

To prevent damage to the windshield, don't let the wiper arm fall on it.

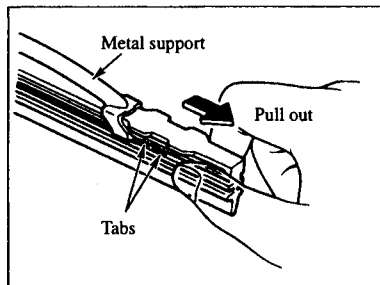

3. Hold the end of the rubber and pull until the tabs are free of the metal support.

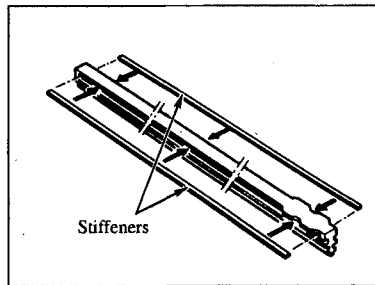

4. Remove the metal stiffeners from the blade rubber and install them in new blades.

CAUTION

- Don't bend the stiffeners. You need to use them again.
- If the metal stiffeners are switched, the blade's wiping efficiency could be reduced.

So don't use the driver's side metal stiffeners on the passenger's side, or vice versa.

- Be sure to reinstall the metal stiffeners in the new blade rubber so that the curve is the same as it was in the old blade rubber.

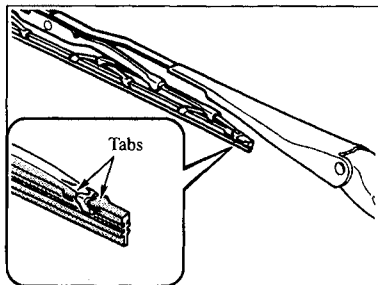

- Carefully insert the new blade rubber.
Then install the blade assembly in the reverse order of removal.

NOTE

Install the blade so that the tabs are toward the bottom of the wiper arm.

■ Battery

WARNING

Spilled Battery Fluid:
Spilled battery fluid is dangerous. Battery fluid contains SULFURIC ACID which could cause serious injuries, if it gets in your eyes or on your skin. If this happens, immediately flush your eyes with water for 15 minutes or wash your skin thoroughly and get medical attention. Be careful not to get battery fluid on yourself.

⚠ WARNING

Battery-Related Explosion:
Flames and sparks near open battery cells are dangerous. Hydrogen gas, produced during normal battery operation, could ignite and cause the battery to explode. An exploding battery can cause serious burns and injuries. Keep all flames, including cigarettes, and sparks away from open battery cells.

⚠ WARNING

Children and Batteries:
Allowing children to play near batteries is dangerous. Battery fluid could cause serious injuries if it gets in the eyes or on the skin. Always keep batteries out of the reach of children.

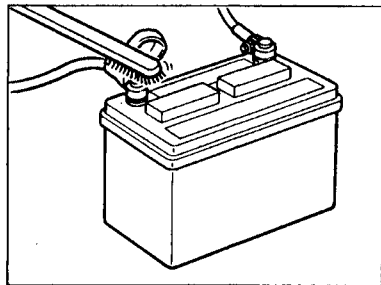

To get the best service from a battery:

- Keep it securely mounted.
- Keep the top clean and dry.

- Keep terminals and connections clean, tight, and coated with petroleum jelly or terminal grease.
- Rinse off spilled electrolyte immediately with a solution of water and baking soda.
- If the vehicle will not be used for an extended time, disconnect the battery cables.

■ Tires

For reasons of proper performance, safety, and better fuel economy, always maintain recommended tire inflation pressures and stay within the recommended load limits and weight distribution.



WARNING

*Using Different Tire Types:
Driving your vehicle with
different types of tires is
dangerous. It could cause poor
handling and poor braking;
leading to loss of control. Except
when using the temporary spare
tire, use only the same type tires
(radial, bias-belted, bias-type) on
all four wheels.*

⚠ WARNING

Using Wrong-Sized Tires:
Using any other tire size than what is specified for your Mazda (page 10-6) is dangerous. It could seriously affect ride, handling, ground clearance, tire clearance, and speedometer calibration. This could cause you to have an accident. Use only tires that are the correct size specified for your Mazda.

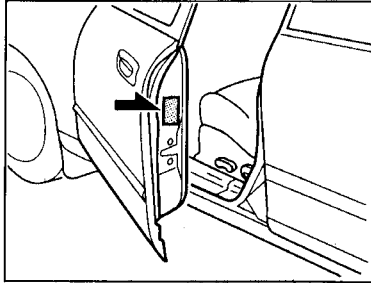

Refer to the specification charts (page 10-6).

▼ Tire inflation pressure

Inspect all tire pressures monthly (including the spare) when the tires are cold. Maintain recommended pressures for the best ride, top handling, and minimum tire wear.

NOTE

- Warm tires normally exceed recommended pressures. Don't release air from warm tires to adjust the pressure.
- Underinflation can cause reduced fuel economy and poor sealing of the tire bead, which will deform the wheel and cause separation of tire from rim.
- Overinflation can produce a harsh ride and a greater possibility of damage from road hazards.

(Continued)

- Keep your tire pressure at the correct levels. If one frequently needs inflating, have it inspected.



WARNING

Incorrect Tire Inflation:
Overinflation or underinflation of tires is dangerous. Adverse handling or unexpected tire failure could result in a serious accident. Always inflate the tires to the correct pressure (page 10-6).

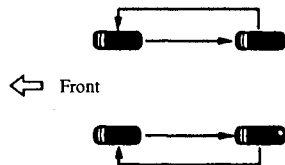

Do not include (TEMPORARY USE ONLY spare tire) in rotation.

▼ Tire rotation

To equalize tread wear, rotate the tires every 3,750 miles (6,000 km), or sooner if irregular wear develops. During rotation, inspect them for correct balance.

Also, inspect them for uneven wear and damage. Abnormal wear is usually caused by one or a combination of the following:

- Incorrect tire pressure
- Improper wheel alignment
- Out-of-balance wheel
- Severe braking

After rotation, bring all tire pressures to specification (page 10-6) and inspect the lug nuts for tightness.

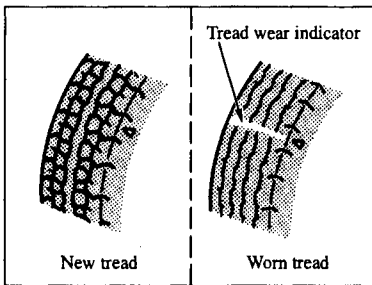

▼ Replacing a tire

If a tire wears evenly, a wear indicator will appear as a solid band across the tread. Replace the tire when this happens. You may need to replace it before the band is across the entire tread.

WARNING

Worn Tires:

Driving with worn tires is dangerous. Reduced braking, steering, and traction could result in an accident. Always use tires that are in good condition.

▼ Temporary spare tire

Inspect the temporary spare tire at least monthly to make sure it's properly inflated and stored.

The temporary spare tire is easier to handle because of its construction. It is lighter and smaller than a conventional tire and should be used only for an emergency and only for a short distance.

Use the temporary only until the conventional tire is repaired, which should be as soon as possible.

Maintain its pressure at 415 kPa (4.2 kgf/cm², 60 psi).



CAUTION

- Don't use your temporary spare tire rim with a snow tire or a conventional tire. Neither will properly fit and could damage both tire and rim.
- The temporary spare tire has a tread life of up to 3,000 miles (4,800 km), depending on road conditions and driving habits.
- When the tread wear solid-band indicator appears, replace the tire with the same type of temporary spare.

▼ Replacing a wheel

When replacing a wheel, make sure the new one is the same as the original factory wheel in diameter, rim width, and offset.

Proper tire balancing provides the best riding comfort and helps reduce tread wear. Out-of-balance tires can cause vibration and uneven wear, such as cupping and flat spots.

⚠ WARNING

*Using a Wrong-Sized Wheel:
Using a wrong-sized wheel is dangerous. Braking and handling could be affected, leading to loss of control and an accident. Always use wheels of the correct size on your vehicle.*

⚠ CAUTION

A wrong-sized wheel may adversely affect

- Tire fit
- Wheel and bearing life
- Ground clearance
- Snow-chain clearance
- Speedometer calibration
- Headlight aim
- Bumper height

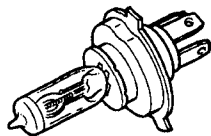

Do not touch the glass surface

■ Replacing a Headlight Bulb

Your Mazda's headlights have replaceable halogen bulbs. One can be replaced without disturbing the rest of the headlight.

WARNING

Handling Halogen Bulbs:

When a halogen bulb breaks, it is dangerous. These bulbs contain pressurized gas. If one is broken, it will explode and serious injuries could be caused by the flying glass. If the glass portion is touched with bare hands, body oil could cause the bulb to overheat and explode when lit. Never touch the glass portion of the bulb with your bare hands and always wear eye protection when handling or working around halogen bulbs.

WARNING

Children and Halogen Bulbs:

Playing with a halogen bulb is dangerous. Serious injuries could be caused by dropping a halogen bulb or breaking it some other way. Always keep halogen bulbs out of the reach of children.

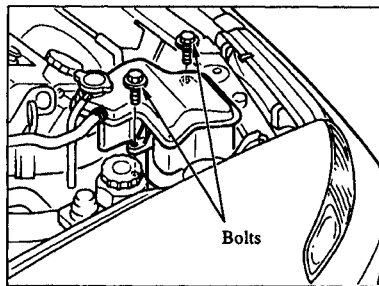

1. Make sure the headlight switch is off.
2. Lift the hood and find the bulb in the rear of the headlight body.
3. (2.5-liter engine)
Remove the bolts and the coolant reservoir.

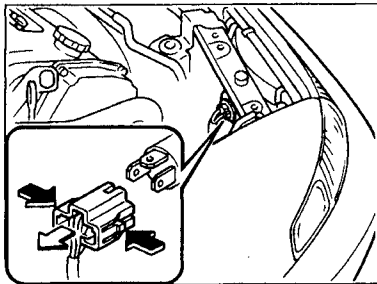

4. Disconnect the electrical connector from the bulb by squeezing the tabs and pulling it to the rear.

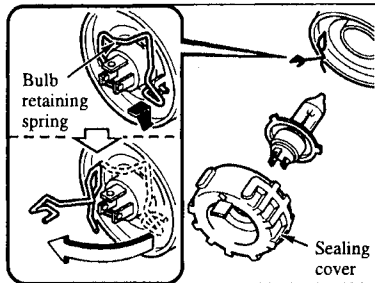

5. Pull off the sealing cover.
6. Unhook the bulb retaining spring.
7. Swing the retaining spring out and away to free the headlight bulb.

8. Carefully remove the headlight bulb from the socket by pulling it straight back.
9. Replace the bulb.
10. Install in the reverse order of removal.

NOTE

Use the protective cover and carton to dispose of the old bulb promptly out of the reach of children.

Maintenance

■ Replacing a Bulb (Front, Interior)

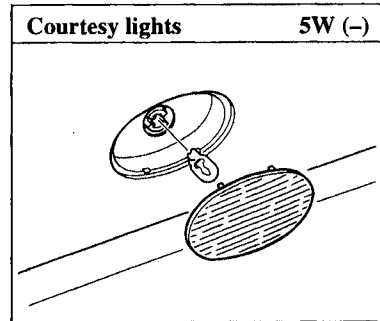
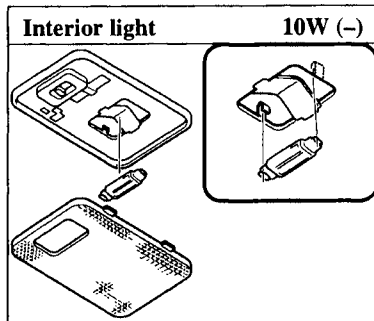
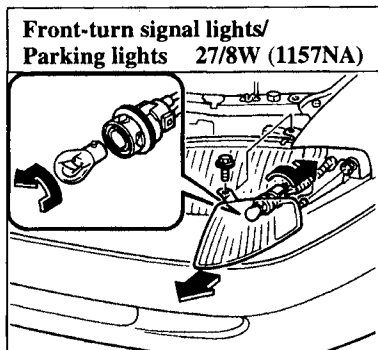

The number in () shows the bulb number.

8-50

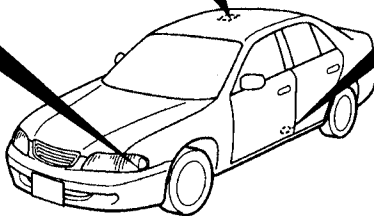

To replace the map light bulbs, contact an Authorized Mazda Dealer.

■ Replacing a Bulb (Rear)

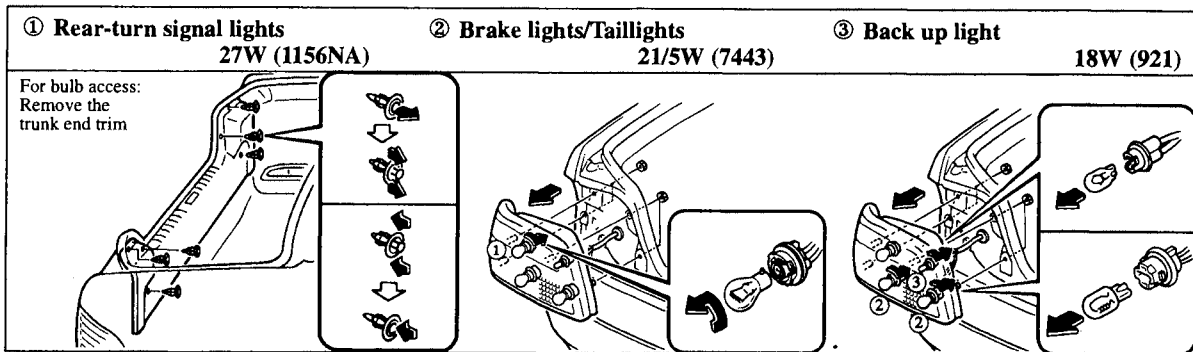

The number in () shows the bulb number.

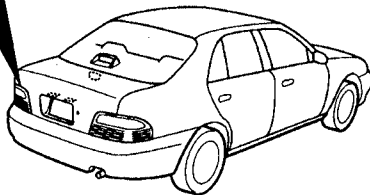

Maintenance

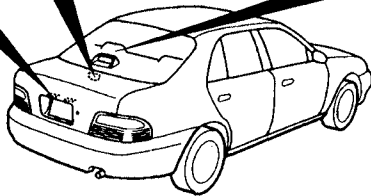
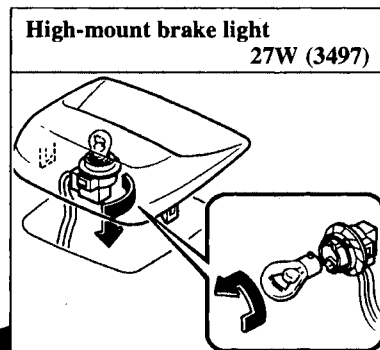
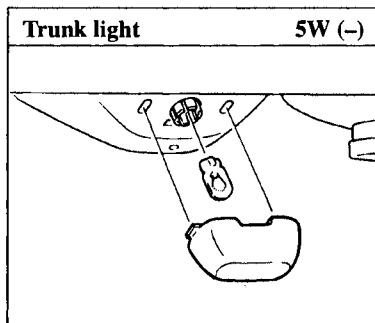
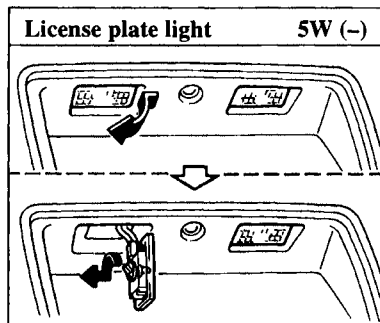

The number in () shows the bulb number.

9

Customer Information

Who to consult about a problem; what to do if your vehicle has a safety defect; what warranties protect your vehicle; driving outside the United States and Canada; adding equipment; tire quality grades: This is the kind of consumer information you'll find in Section 9.

Customer Assistance	9- 2
Mazda Importer/Distributors	9- 7
Warranties for Your Mazda	9- 9
Outside the United States and Canada	9-10
Add-On Non-Genuine Parts and Accessories	9-10
Uniform Tire Quality Grading System (UTQGS)	9-12
Reporting Safety Defects	9-14
Service Publications	9-16

Customer Information

Customer Assistance (Except Puerto Rico)

Your complete and permanent satisfaction is our business. We are here to serve you. All Authorized Mazda Dealers have the knowledge and the tools to keep your Mazda vehicle in top condition.

If you have any questions or recommendations for improvement regarding the service of your Mazda vehicle or servicing by Mazda Dealer personnel, we recommend that you take the following steps:

STEP 1: Contact Your Mazda Dealer

Discuss the matter with an Authorized Mazda Dealer. This is the quickest and best way to address the issue. If your concern has not been resolved by the CUSTOMER RELATIONS, SALES, SERVICE, or PARTS MANAGER, then please contact the GENERAL MANAGER of the dealership or the OWNER.

STEP 2: Call the Mazda National Customer Relations #800

If for any reason you feel the need for further assistance after contacting your dealership management, call Mazda North American Operations' Customer Assistance toll-free at:

1 (800) 222-5500

In order to serve you efficiently and effectively, please help us by providing the following information:

1. Your name, address, and telephone number
2. Year and model of vehicle
3. Vehicle Identification Number (17 digits, noted on your registration or title or located on the upper driver's side corner of the dash)
4. Purchase date and current mileage
5. Your dealer's name and location
6. Your question(s)

Customer Information

If you would like to write a letter, please address it to the following, Attn: Customer Assistance, which corresponds with your state:

REGIONAL OFFICE	COVERING AREAS
Mazda North American Operations 7755 Irvine Center Drive Irvine, CA 92618-2922 P.O. Box 19734 Irvine, CA 92623-9734	All States

This way, we can be sure to respond to you as efficiently as possible. That is our goal.

If you live outside the U.S.A., please contact your nearest Mazda Distributor.

Customer Assistance (Puerto Rico)

Your complete and permanent satisfaction is our business. That is why all Authorized Mazda Dealers have the knowledge and the tools to keep your Mazda vehicle in top condition.

If you have any questions or recommendations for improvement regarding the service of your Mazda vehicle or servicing by Mazda Dealer personnel, we recommend that you take the following steps:

STEP 1

Discuss the matter with an Authorized Mazda Dealer. This is the quickest and best way to address the issue. If your concern has not been resolved by the CUSTOMER RELATIONS, SALES, SERVICE, or PARTS MANAGER, then please contact the GENERAL MANAGER of the dealership or the OWNER.

STEP 2

If, after following STEP 1, you feel the need for further assistance, please contact your area's Mazda representative (Indicated on the next page).

Please help us by providing the following information:

1. Your name, address, and telephone number

Customer Information

2. Year and model of vehicle
3. Vehicle Identification Number (17 digits, noted on your registration or title or located on the upper driver's side corner of the dash)
4. Purchase date and current mileage
5. Your dealer's name and location
6. Your question(s)

Mazda Importer/Distributors

U.S.A. (Importer/Distributor)

Mazda North American Operations

7755 Irvine Center Drive

Irvine, CA 92618-2922

P.O. Box 19734

Irvine, CA 92623-9734

TEL: 1 (800) 222-5500 (in U.S.A.)

(949) 727-1990 (outside U.S.A.)

(Distributor in each area)

CANADA

Mazda Canada Inc.

305 Milner Avenue, Suite 400

Scarborough, Ontario M1B 3V4 Canada

TEL: 1 (800) 263-4680 (in Canada)

(416) 609-9909 (outside Canada)

PUERTO RICO

Plaza Motors Corp. (Mazda de Puerto Rico)

P.O. Box 362722, San Juan, Puerto Rico 00936-2722

TEL: (787) 788-9300

GUAM

Keico Motors Ltd.

P.O. Box CP, Agana, Guam 96910

TEL: (671) 477-7807

Customer Information

SAIPAN

Pacific International Marianas, Inc.

(d.b.a. Midway Motors)

P.O. Box 887 Saipan, MP 96950

TEL: (670) 234-7524

AMERICAN SAMOA

Polynesia Motors, Inc.

P.O. Box 1120, Pago Pago, American Samoa 96799

TEL: (684) 699-9347

Warranties for Your Mazda

- New Vehicle Limited Warranty
- Safety Restraint System Limited Warranty
- Anti-perforation Limited Warranty
- Federal Emission Control Warranty
 - Emission Defect Warranty
 - Emission Performance Warranty
- California Emission Control Warranty
(if applicable)
- Replacement Parts and Accessories Limited Warranty
- Tire Warranty

NOTE
Detailed warranty information is provided with your Mazda.

Outside the United States and Canada

Government regulations in the United States require that automobiles meet specific emission regulations and safety standards. Therefore, vehicles built for use in the United States, its territories, and Canada may differ from those sold in other countries.

The differences may make it difficult or even impossible for your vehicle to receive satisfactory servicing in other countries. We strongly recommend that you **NOT** take your Mazda outside these areas.

Example of problems encountered outside the United States and Canada:

- Recommended fuel may be unavailable. Any kind of leaded fuel or low-octane fuel will affect vehicle performance and damage the emission controls and engine.
- Proper repair facilities, tools, testing equipment, and replacement parts may not be available.

The manufacturer's warranty applies only to Mazda vehicles registered and normally operated in the United States, its territories, and Canada.

Add-On Non-Genuine Parts and Accessories

Non-genuine parts and accessories for Mazda vehicles can be found in stores. These may fit your vehicle, but they are not approved by the manufacturer for use with Mazda vehicles. When you install non-genuine parts or accessories, they could affect your vehicle's performance or safety system; the manufacturer's warranty doesn't cover this. Before you install any non-genuine parts or accessories, consult an Authorized Mazda Dealer.

 **WARNING****Installation of Non-Genuine Parts or Accessories:**

Installation of non-genuine parts or accessories could be dangerous. Improperly designed parts or accessories could seriously affect your vehicle's performance or safety system. This could cause you to have an accident or increase your chances of injuries in an accident. Always consult an Authorized Mazda Dealer before you install non-genuine parts or accessories.

 **WARNING****Add-On Electrical and Electronic Equipment:**

Incorrectly choosing or installing improper add-on equipment or choosing an improper installer could be dangerous. Essential systems could be damaged, causing engine stalling, air-bag (SRS) activation, ABS inactivation, or a fire in the vehicle. Be very careful in choosing and installing add-on electrical equipments, such as mobile telephones, two-way radios, stereo systems, and car alarm systems.

Mazda assumes no responsibility for death, injury, or expenses that may result from the installation of add-on non-genuine parts or accessories.

Uniform Tire Quality Grading System (UTQGS)

This information relates to the tire grading system developed by the U.S. National Highway Traffic Safety Administration for grading tires by tread wear, traction, and temperature performance.

■ Tread Wear

The tread wear grade is a comparative rating based on the wear rate of the tire when tested under controlled conditions on a specified government test course. For example, a tire graded 150 would wear one-and-a-half times as well on the government course as a tire graded 100.

The relative performance of tires depends upon the actual conditions of their use, however, and may depart significantly from the norm because of variations in driving habits, service practices and differences in road characteristics and climate.

■ Traction—AA, A, B, C

The traction grades, from highest to lowest, are AA, A, B, and C. These grades represent the tire's ability to stop on wet pavement as measured under controlled conditions on specified government test surfaces of asphalt and concrete. A tire marked C may have poor traction performance.

WARNING

The traction grade assigned to this tire is based on braking (straight ahead) traction tests and does not include acceleration cornering (turning), hydroplaning, or peak traction characteristics.

■ Temperature—A, B, C

The temperature grades are A (the highest), B, and C, represent the tire's resistance to the generation of heat and its ability to dissipate heat when tested under controlled conditions on a specified indoor laboratory test wheel.

Sustained high temperature can cause the material of the tire to degenerate and reduce tire life, and excessive temperatures can lead to sudden tire failure.

Grade C corresponds to a level of performance which all passenger vehicle tires must meet under the Federal Motor Vehicle Safety Standard No. 109. Grades B and A represent higher levels of performance on the laboratory test wheel than the minimum required by law.



WARNING

The temperature grade for this tire is established for a tire that is properly inflated and not overloaded. Excessive speed, underinflation, or excessive loading, either separately or in combination, can cause heat buildup and possible tire failure.

These grades will be added to the sidewalls of passenger vehicle tires over the next several years according to a schedule established by the NHTSA and the tire manufacturers.

The grade of tires available as standard or optional equipment on Mazda vehicle may vary with respect to grade.

**ALL PASSENGER VEHICLE TIRES
MUST CONFORM TO THESE
GRADES AND TO ALL OTHER
FEDERAL TIRE-SAFETY
REQUIREMENTS.**

Reporting Safety Defects

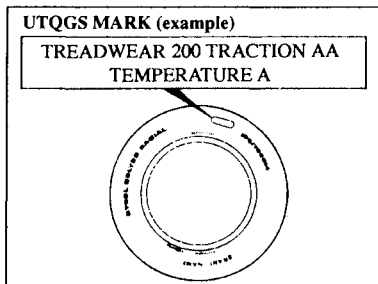

Uniform Tire Quality Grading

Quality grades can be found where applicable on the tire sidewall between tread shoulder and maximum section width. For example:

Treadwear 200 Traction AA Temperature A

If you believe that your vehicle has a defect which could cause a crash or could cause injury or death, you should immediately inform the National Highway Traffic Safety Administration (NHTSA) in addition to notifying Mazda Motor Corporation (Your Mazda Importer/Distributor).

If NHTSA receives similar complaints, it may open an investigation, and if it finds that a safety defect exists in a group of vehicles, it may order a recall and remedy campaign. However, NHTSA cannot become involved in individual problems between you, your dealer, or Mazda Motor Corporation (Your Mazda Importer/Distributor).

To contact NHTSA, you may either call the Auto Safety Hotline toll-free at 1 (800) 424-9393 (or 366-0123 in Washington, D.C. area) or write to: NHTSA, U.S. Department of Transportation, Washington, D.C. 20590. You can also obtain other information about motor vehicle safety from the Hotline.

NOTE

If you live in the U.S.A., all correspondence to Mazda Motor Corporation should be forwarded to:

Mazda North American Operations
7755, Irvine Center Drive
Irvine, California 92618-2922
P.O. Box 19734
Irvine, CA 92623-9734
Customer Assistance Center
or toll free at 1 (800) 222-5500

If you live outside of the U.S.A., please contact the nearest Mazda Distributor shown on page 9-7 in this booklet.

Customer Information

Service Publications

Factory-authorized Mazda service publications are available for owners who wish to do some of their own maintenance and repair.

When requesting any of our publications through an Authorized Mazda Dealer, refer to the chart below.

If they don't have what you need in stock, they can order it for you.

PUBLICATION ORDER NUMBER	PUBLICATION DESCRIPTION
9999 95 019B 00	2000 WORKSHOP MANUAL (English)
9999 95 021G 00	2000 WIRING DIAGRAM (English)
9999 95 17CS 00 (Except Puerto Rico)	2000 OWNER'S MANUAL

WORKSHOP MANUAL:

Covers recommended maintenance and repair procedures of the drive train, body and chassis.

WIRING DIAGRAM:

Provides electrical schematics as well as component location for the entire electrical system.

OWNER'S MANUAL:

This booklet contains information regarding the proper care and operation of your vehicle. This is not a technician's manual.

10

Specifications

Lubricant Quality	10-2
Dimensions	10-3
Weights	10-3
Engine	10-4
Electrical System	10-4
Capacities	10-5
Air Conditioner	10-6
Tires	10-6
Light Bulbs	10-6

Specifications

Lubricant Quality

Lubricant		Classification	
Engine oil*		API Service	ILSAC
		SG (Energy Conserving II)	—
		SH (Energy Conserving II)	GF-I
		SJ	GF-II
Manual transaxle oil		Any temperature API Service GL-4 or GL-5 (SAE 75W-90) Above 50°F (10°C) API Service GL-4 or GL-5 (SAE 80W-90)	
Automatic transaxle fluid	2.0-liter	ATF M-III or equivalent (e.g. Mercon®)	
	2.5-liter	ATF M-III or equivalent (e.g. Dexron® II)	
Power steering fluid		ATF M-III or equivalent (e.g. Dexron® II)	

Lubricant	Classification
Brake/clutch fluid	FMVSS116 DOT-3

* Refer to the recommended SAE viscosity numbers on page 8-18.

Dimensions

Unit: inch (mm)

Overall length		187.4 (4,760)
Overall width		69.3 (1,760)
Overall height		55.1 (1,400)
Front tread	14 inch wheel	59.8 (1,520)
	15 and 16 inch wheel	59.1 (1,500)
Rear tread	14 inch wheel	59.4 (1,510)
	15 and 16 inch wheel	58.7 (1,490)
Wheelbase		105.1 (2,670)

Weights

Unit: pound (kg)

Model		2.0-liter	2.5-liter
GVWR		3,904 (1,771)	4,028 (1,827)
GAWR	Front	2,114 (959)	2,214 (1,004)
	Rear	1,790 (812)	1,814 (823)

GVWR: Gross Vehicle Weight Rating

GAWR: Gross Axle Weight Rating

Specifications

Engine

Item \ Model	2.0-liter	2.5-liter
Type	DOHC-16V in-line, 4-cyl	DOHC-24V V6 6-cyl
Bore × Stroke	3.27 × 3.62 in (83.0 × 92.0mm)	3.33 × 2.92 in (84.5 × 74.2mm)
Displacement	121.5 cu in (1,991 cc)	152.3 cu in (2,496 cc)
Compression ratio	9.1	9.5

Electrical System

Item \ Model	2.0-liter	2.5-liter	
Battery	Maintenance-free 12V—48AH/5HR		
Alternator	12V—80A	12V—90A	
Starter	12V—1.0 kW	*1 12V—1.7 kW *2 12V—1.6 kW	
Spark plug number	NGK	BKR5E-11, BKR6E-11	—
	DENSO	K16PR-U11, K20PR-U11	PKJ16CR8, PKJ20CR8
Spark plug gap	0.039—0.043 in (1.0—1.1 mm)	0.027—0.031 in (0.7—0.8 mm)	

*1 Manual transaxle

*2 Automatic transaxle

Capacities

Item			Unit	US qt	Imp qt	Liter
Engine oil*	2.0-liter	with oil filter replacement		3.7	3.1	3.5
		without oil filter replacement		3.5	2.9	3.3
	2.5-liter	with oil filter replacement		4.2	3.5	4.0
		without oil filter replacement		3.9	3.3	3.7
Coolant				7.9	6.6	7.5
Transaxle oil	Manual transaxle			2.9	2.4	2.7
	Automatic transaxle	2.0-liter		9.2	7.7	8.7
		2.5-liter		8.5	7.0	8.0
Fuel tank				US gal	Imp gal	Liter
				16.9	14.1	64.0

* The indicated engine oil capacities are for general reference purposes only. When adding or changing oil, verify the engine oil level with the oil dipstick.

Specifications

Air Conditioner

Gas complies with SAE J639	R-134a
Maximum operating charge	1 lb—11 oz (0.75 kg)

Tires

Item Type	Size	Inflation pressure kgf/cm ² (psi or lb/po ²)	
		Front	Rear
2.0-liter engine	P185/70R14 87S	2.2 (32)	1.8 (26)
	P205/60R15 90H		
2.5-liter engine	P205/60R15 90H	2.2 (32)	1.8 (26)
	P205/55R16 89H	2.2 (32)	2.0 (29)
Temporary spare	T125/70D15	4.2 (60)	

psi: pounds per square inch

Light Bulbs

Light bulb	Wattage	Bulb trade number
Headlights	60/55	HB2
Front-turn signal/Parking lights	27/8	1157NA
Rear-turn signal lights	27	1156NA
Brake lights/Taillights	21/5	7443
High-mount brake light	27	3497
Back up lights	18	921
License plate lights	5	—
Trunk light	5	—
Interior light	10	—
Map lights	5	—
Courtesy lights	5	—

Fuses Refer to page 6-12

Index

	Page		Page		Page
A		Fluid level	8-31	Break-In Period	4-8
Accessory Socket	5-51	Overdrive	5-13	Bright-Metal Maintenance	7-9
Add-On Non-Genuine Parts and Accessories	9-10	Shift-lock system	5-14	Bulb Replacement	
Air Bag Restraint System	2-34	Transaxle ranges	5-10	Front, Interior	8-50
Warning light	5-41			Headlight	8-47
Air Filter	8-36	B		Rear	8-51
Aluminum Wheel Maintenance	7-11	Battery	8-40		
Antenna	5-165	Charging system warning light	5-37		
Antilock Brake System (ABS)	5-22	Jump-starting	6-4		
Warning light	5-40	Before Driving			
Appearance Care	7-1	After getting in	4-8		
Audio System		Before getting in	4-7		
Cassette tape player	5-103, 5-133	Body Lubrication	8-35		
Compact disc changer	5-133	Brakes			
Compact disc player	5-81, 5-103	Antilock brake system (ABS)	5-22		
Radio	5-81, 5-103, 5-133	Fluid level	8-27		
Automatic Transaxle		Foot brake	5-18		
Controls	5-9	Pad wear indicator	5-20		
Driving tips	5-12	Parking brake	5-20		
		System warning light	5-36		

	Page		Page		Page
C					
Capacities	10-5	Child Restraint	2-25	Customer Information	9-1
Cassette Tape Player	5-103, 5-133	Child restraint precautions	2-25	D	
Catalytic Converter (see Emission Control System)		Child restraint system	2-27	Dashboard Illumination	5-35
Center Console Box	5-56	Installing a child	2-28	Dashboard Overview	1-3
Center Pocket	5-56	Child Safety Lock for Rear Door	3-8	Dashboard Precautions	7-12
Chains	4-13	Cleaning		Day/Night Mirror	3-33
Changing a Flat Tire	6-21	Dashboard	7-12	Defroster	
Changing Coolant	8-24	Lap/shoulder belt webbing	7-13	Outside mirrors	3-32
Changing the Oil	8-20	Upholstery and interior trim	7-12	Rear window	5-49
Charging System Warning Light	5-37	Window interiors	7-13	Door Locks	3-4
Check Engine Light	5-39	Climate Control System	5-60	Inside door lock	3-6
Checking		Clock	5-51	Outside door lock	3-4
Automatic transaxle fluid level	8-31	Compact Disc Changer	5-133	Door-Ajar Warning Light	5-40
Brake/clutch fluid level	8-27	Compact Disc Player	5-81, 5-103	Doors	1-4
Coolant level	8-23	Coolant, Engine		Driving	
Engine oil level	8-19	Adding	8-23	Hazardous driving	4-10
Power steering fluid level	8-29	Changing	8-24	In flooded areas	4-14
Washer fluid level	8-35	Inspecting	8-23	Rocking the vehicle	4-11
		Cruise Control	5-24	Winter driving	4-12
		Cup Holders	5-54		
		Customer Assistance	9-2, 9-5		

Index

	Page		Page
E			
Emergency Starting		Exhaust (Carbon Monoxide)	4-6
Jump-starting	6-4	Exterior Care	7-6
Push-starting	6-7	Eyeglass Holder	5-55
Emission Control System	4-4	F	
Engine Compartment Overview	8-16	Finish Damage	7-9
Engine Coolant		Flasher, Hazard Warning	6-2
Adding coolant	8-23	Flat Tire	6-19
Changing coolant	8-24	Fluids	
Inspecting coolant level	8-23	Automatic transaxle	8-31
Overheating	6-2	Brake/clutch	8-27
Engine Coolant Temperature Gauge		Power steering	8-29
(see Water)		Washer	8-35
Engine Exhaust (Carbon Monoxide)	4-6	Foot Brake	5-18
Engine Oil		Front Seat Belts	2-16
Changing engine oil and filter	8-20	Front Seats (Electrically Operated)	
Inspecting engine oil level	8-19	Head restraint height adjustment	2-8
Recommended oil	8-18	Height adjustment	2-6
Engine Oil Pressure Warning Light	5-38	Recline	2-7
Engine Starting	5-4		
		Seat cushion front height	
		adjustment	2-6
		Seat cushion rear height	
		adjustment	2-6
		Seat slide	2-5
		Front Seats (Manually Operated)	
		Head restraint height adjustment	2-4
		Recline	2-3
		Slide	2-2
		Tilt	2-4
		Fuel Gauge	5-34
		Fuel Requirements	4-2
		Fuel-Filler Cap	3-28
		Fuel-Filler Lid	3-27
		Fuses	6-8
		Fuse panel description	6-12
		Replacement	6-8

	Page		Page
G		How to Minimize Environmental Paint Damage	7-2
Gauges		Damage caused by bird dropping, insects, or tree sap	7-3
Fuel	5-34	Etching caused by acid rain or industrial fallout	7-2
Odometer and trip meter	5-31	Paint chipping	7-4
Speedometer	5-31	Water marks	7-4
Tachometer	5-34		
Water temperature	5-33	I	
Glove Box	5-53	Ignition Key Reminder	5-42
		Ignition Switch Positions	5-2
H		Immobilizer System	3-19, 5-42
Halogen Bulb	8-47	Maintenance	3-21
Hazard Warning Flasher	6-2	Operation	3-21
Hazardous Driving	4-10	Warning light	5-42
Headlight Bulb Replacement	8-47	In Case of Emergency	6-1
Headlights	5-44	Indicator Lights	
High-beam indicator light	5-43	Cruise set	5-43
Hood Release	3-18	Headlight high-beam	5-43
Horn	3-30		
		O/D (overdrive) OFF	5-43
		Rear window defroster	5-43
		Security	5-42
		Traction control system (TCS) OFF	5-43
		Inspecting	
		Automatic transaxle fluid level	8-31
		Brake/clutch fluid level	8-27
		Coolant level	8-23
		Engine oil level	8-19
		Power steering fluid level	8-29
		Washer fluid level	8-35
		Instrument Cluster	5-30
		Interior Care	7-12
		Interior Light	3-37
		Interior Overview	1-2
		Introduction, Maintenance	8-2

Index

	Page		Page		Page
J		L		M	
Jack and Lug Wrench	6-19	Label Information	4-16	Maintaining the Air Filter	8-36
Jump-Starting	6-4	Lane-Change Signals	5-46	Maintaining the Finish	7-6
K		Light		Maintaining Wiper Blades	8-37
Keyless Entry System	3-9	Interior	3-37	Maintenance	8-1
Maintenance	3-11	Map	3-38	Maintenance, Scheduled	8-3
Transmitter	3-9	Trunk	3-38	Manual Transaxle	
Keys	3-2	Lighter	5-51	Operation	5-7
		Lighting Control	5-44	Recommendations for shifting	5-8
		Lights		Shift pattern	5-7
		Headlights	5-44	Map Lights	3-38
		On reminder	5-42	Mazda Importer/Distributors	9-7
		Low Fuel Warning Light	5-39	Mirrors	
		Lug Wrench	6-19	Defroster	3-32
		Luggage Compartment	I-5	Outside mirrors	3-30
				Rearview mirror (day/night)	3-33
				Vanity	5-59
				Money-Saving Suggestions	4-9

O	Page	P	Page	R	Page
Odometer and Trip Meter	5-31	Paint Damage	7-2	Radio	5-81, 5-103, 5-133
Oil (see Engine)		Damage caused by bird dropping, insects, or tree sap	7-3	Radio Reception	5-74
Outside Mirrors	3-30	Etching caused by acid rain or industrial fallout	7-2	Rear Armrest Box	5-58
Outside the United States and Canada	9-10	Paint chipping	7-4	Rear Door Child Safety Lock	3-8
Overheating	6-2	Water marks	7-4	Rear Seat	2-9
Overloading	4-15	Parking Brake	5-20	Armrest	2-9
Owner Maintenance	8-13	Power Control Mirror	3-31	Rear Seat Belts	2-19
Precautions	8-14	Power Steering	5-23	Rear Window Defroster	5-49
Schedule	8-13	Power Steering Fluid Level	8-29	Indicator light	5-43
		Power Windows	3-13	Rearview Mirror (Day/Night)	3-33
		Lock switch	3-14	Remote Trunk Lid Release	3-16
		Master control	3-13	Repairing Damage to the Finish	7-9
		One-touch power window	3-13	Replacing	
		Passenger door	3-15	Bulb (Front, Interior)	8-50
		Pregnant Women	2-25	Bulb (Rear)	8-51
		Push-Starting	6-7	Headlight bulb	8-47
				Tire	8-45
				Wheel	8-46
				Windshield wiper blade	8-38

Index

	Page		Page		Page
Reporting Safety Defects	9-14	Seat Belt	2-23	Light bulbs	10-6
Rocking the Vehicle	4-11	Cleaning	7-13	Lubricant quality	10-2
S		Extender	2-23	Tires	10-6
Safety Belt (see Seat Belt)		Front	2-16	Weights	10-3
Safety Certification	5-78	Pregnant women	2-25	Speedometer	5-31
Safety Defects, Reporting	9-14	Rear	2-19	Starting the Engine	5-4
Scheduled Maintenance	8-3	System	2-13	Steering Wheel	
Seat Adjustment (Electrically Operated)		Warning light	5-37	Horn	3-30
Head restraint height	2-8	Seat Belt Extender	2-23	Tilt wheel	3-29
Height	2-6	Service Publications	9-16	Storage Compartments	5-55
Recline	2-7	Snow Tires	4-12	Storage Pocket	5-56
Seat cushion front height	2-6	Socket	5-51	Sunroof	
Seat cushion rear height	2-6	Spare Tire	6-27, 8-46	Power operation of sunroof	3-34
Seat slide	2-5	Special Driving Conditions	4-10	Sunshade	3-36
Seat Adjustment (Manually Operated)		Specification	10-1	Sunvisors	5-59
Head restraint height	2-4	Specifications		Supplemental Restraint System	2-34
Recline	2-3	Air conditioner	10-6	Constant monitoring	2-49
Slide	2-2	Capacities	10-5	Front air bag activation	2-43
Tilt	2-4	Dimensions	10-3	How the air bag works	2-37
		Electrical system	10-4	Limitations to front air bag	
		Engine	10-4	activation	2-44

	Page		Page		Page
Limitations to side air bag activation	2-47	To turn off an armed system	3-26	Transaxle, Automatic	5-9
Maintenance	2-51	Tilt Steering	3-29	Transaxle, Manual	5-7
Non-activation of front air bags	2-45	Tire Chains	4-13	Transmission (see Transaxle)	
Non-activation of side air bags	2-48	Tire Quality Grading	9-12	Trip meter	5-31
Side air bag activation	2-46	Tire, Flat	6-19	Trunk Lid	3-15
System description	2-36	Tire, Spare	6-27, 8-46	Key-operated trunk lid release	3-15
Warning light	5-41	Tires	8-42	Remote trunk lid release	3-16
		Inflation pressure	8-43	Trunk security	3-17
		Replacement	8-45	Trunk Light	3-38
		Rotation	8-44	Turn and Lane-Change Signals	5-46
		Snow tires	4-12	Turn Signal	5-46
		Towing	6-16		
		Traction Control System (TCS)	5-15		
		Indicators	5-16		
		TCS OFF switch	5-18		
		Traction Control System (TCS) OFF			
		Indicator Light	5-43		
		Traction Control System (TCS)			
		Warning Light	5-39		
		Trailer Towing	4-15		
		Transaxle Ranges, Automatic	5-10		

T				U	
Tachometer	5-34			Underbody Maintenance	7-10
Temporary Spare Tire	8-46			Uniform Tire Quality Grading System (UTQGS)	9-12
Theft-Deterrent System	3-23			Temperature—A, B, C	9-12
How to arm the system	3-25			Traction—AA, A, B, C	9-12
Modification and Add-On Equipment	3-23			Tread wear	9-12
Operation	3-24				
Security indicator light	5-42				
Theft-deterrent labels	3-27				
To stop the warning alarm	3-26				

Index

	Page		Page
V		W	
Vanity Mirrors	5-59	Warning Lights/Beeps	
Vehicle Information Labels	4-16	Antilock brake system (ABS)	5-40
		Brake system	5-36
		Charging system	5-37
		Check engine	5-39
		Door-ajar	5-40
		Engine oil pressure	5-38
		Ignition key reminder	5-42
		Immobilizer system	5-42
		Lights-on reminder	5-42
		Low fuel	5-39
		Seat-belt	5-37
		Supplemental restraint system	5-41
		Traction control system (TCS)	5-39
		Warning lights inspection	5-35
		Warranties for Your Mazda	9-9
		Washing	7-6
		Water Temperature Gauge	5-33
		Waxing	7-8
		Wheel Replacement	8-46
		Windshield Washer	5-48
		Windshield Washer Fluid Level	8-35
		Windshield Wipers	5-47
		Winter Driving	4-12
		Wiper Blade, Maintaining	8-37
		Wiper Blade, Windshield	8-38