

Before driving**Introduction 2****Instrumentation 4****Controls and features 20****Seating and safety restraints 72****Starting and driving****Starting 104****Driving 112****Roadside emergencies 137****Servicing****Maintenance and care 158****Capacities and specifications 217****Customer assistance 223****Reporting safety defects (U.S. only) 235****Index 236**

Introduction

ICONS

Indicates a warning. Read the following section on *Warnings* for a full explanation.



Indicates that vehicle information related to recycling and other environmental concerns will follow.



We must all play our part in protecting the environment. Correct vehicle usage and the authorized disposal of waste cleaning and lubrication materials are significant steps toward this aim.

WARNINGS

How can you reduce the risk of personal injury and prevent possible damage to others, your vehicle and its equipment?

In this owner's guide, answers to such questions are contained in comments highlighted by the warning triangle symbol.

BREAKING IN YOUR VEHICLE

There are no particular breaking-in rules for your vehicle. Simply avoid driving too fast during the first 1 600 km (1 000 miles). Vary speeds frequently. This is necessary to give the moving parts a chance to break in.

If possible, you should avoid hard braking for the first 1 600 km (1 000 miles).

From 1 600 km (1 000 miles) onwards, you can gradually increase the performance of your vehicle up to the permitted maximum speeds.

INFORMATION ABOUT THIS GUIDE

The information found in this guide was in effect at the time of printing. Ford may change the contents without notice and without incurring obligation.

Instrumentation

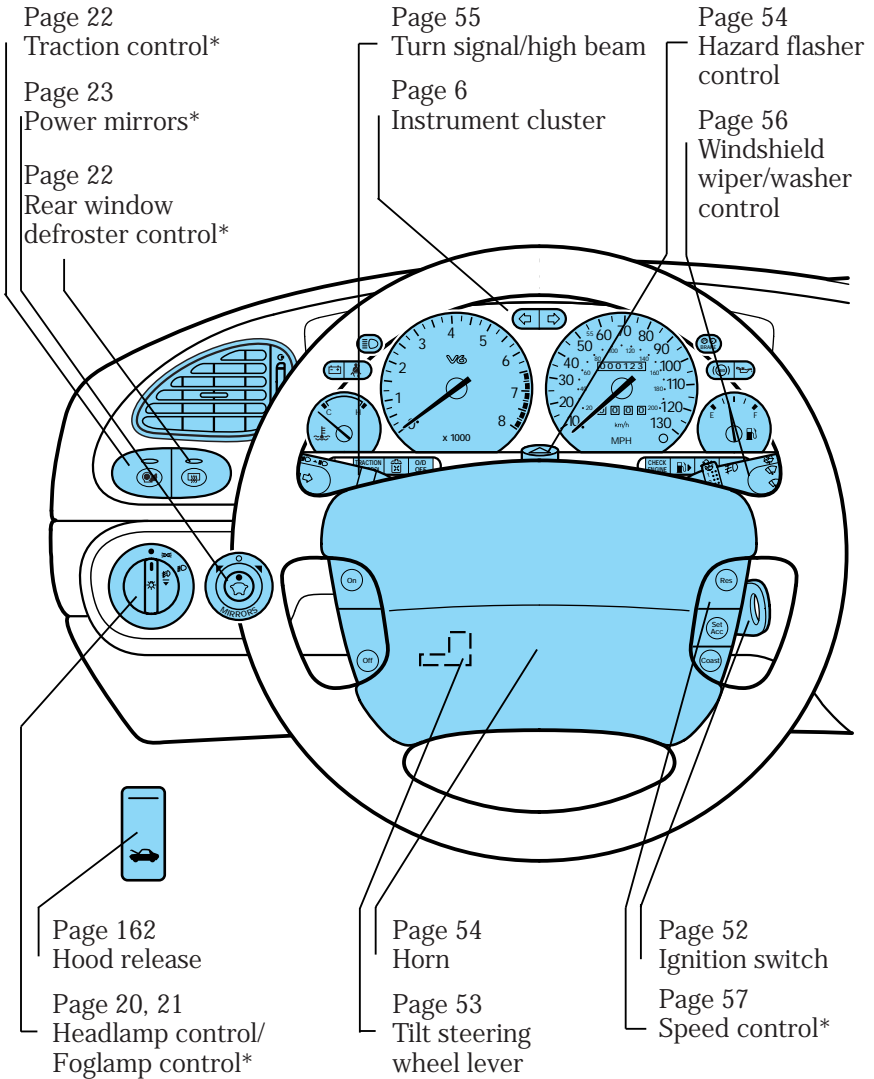

Page 23
Instrument panel
dimmer switch

On various models the appearance and location of some items may differ from those shown here. However, the page references given still apply.

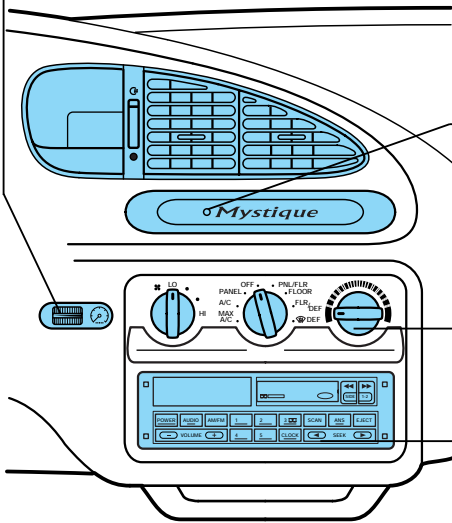

Page 70
Anti-theft system status
indicator*

Page 24
Climate control system

Page 32
Electronic sound system

* if equipped

Instrumentation

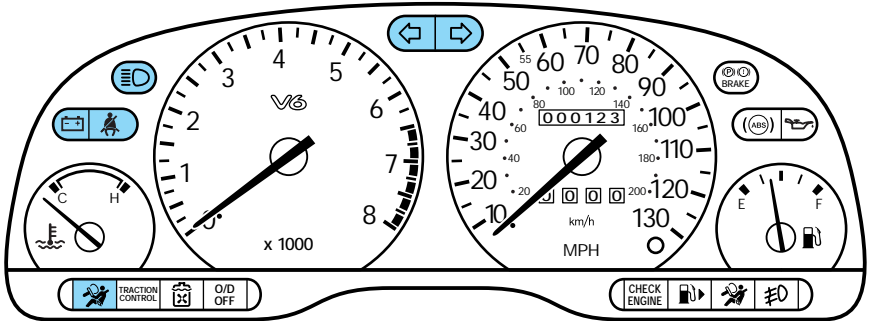
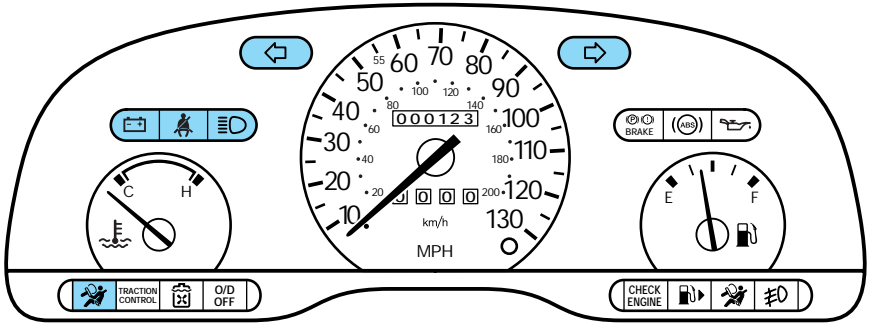

INSTRUMENT CLUSTER LIGHTS AND CHIMES

There are two different instrument cluster designs. The individual warning and indicator lights are described on the following pages.

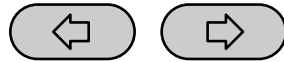

Turn signal

Flashes when the left or right turn signal or hazard lights are activated.

Alternative design

Charging system

Briefly illuminates when the ignition is turned on and the engine is off. The light also illuminates when the battery is not charging properly and the vehicle may require electrical system service.



Alternative design

Safety belt

Illuminates when the ignition is switched on as a reminder to fasten the safety belts. For more information, refer to *Safety belt indicator light and warning chime* in the *Seating and safety restraints* chapter.



Alternative design

High beams

Illuminates when the headlamp high beams are on.



Alternative design

Air bag secondary warning

Flashes periodically when there is a malfunction with the air bag system.

For more information, refer to the *Seating and safety restraints* chapter.



Instrumentation

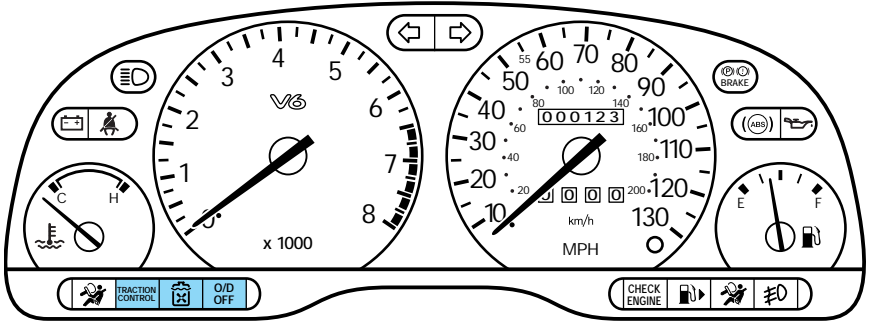
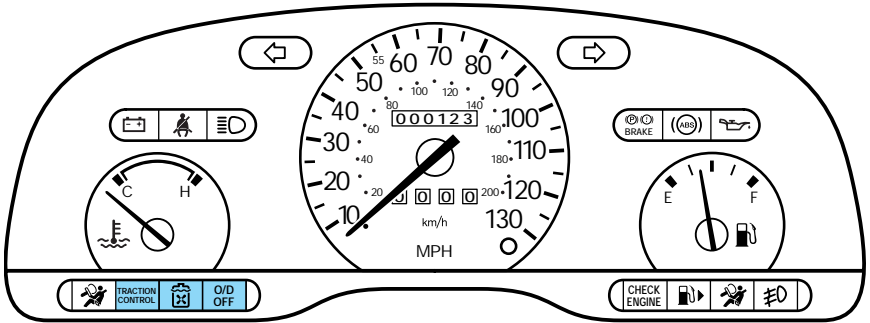

Traction control system light (if equipped)

This light comes on when the traction control system has been disengaged. It may flash on and off while driving to indicate the system is operating.



If the light stays on for more than three (3) seconds after the ignition is turned to the ON position or stays on continuously while you are driving, have the traction control system checked by a qualified technician as soon as possible.

For more information, refer to *Traction Control* in the *Driving* chapter.

Low coolant (if equipped)

Briefly illuminates when the ignition is turned on and the engine is off. Illuminates when the engine coolant level is low. Refer to the *Maintenance and care* chapter to check the engine coolant level.



O/D Off indicator (Automatic transaxle only)

Illuminates and remains illuminated when the transaxle control switch (TCS) on the side of the gearshift lever is pressed and overdrive is turned off. For details, refer to the *Driving* chapter.

Indicates the status of the transaxle and will flash steadily if a malfunction is detected. If the flashing persists, have your transaxle serviced by your dealer or a qualified service technician as soon as possible.

If the condition persists, your transaxle may be damaged.



Instrumentation

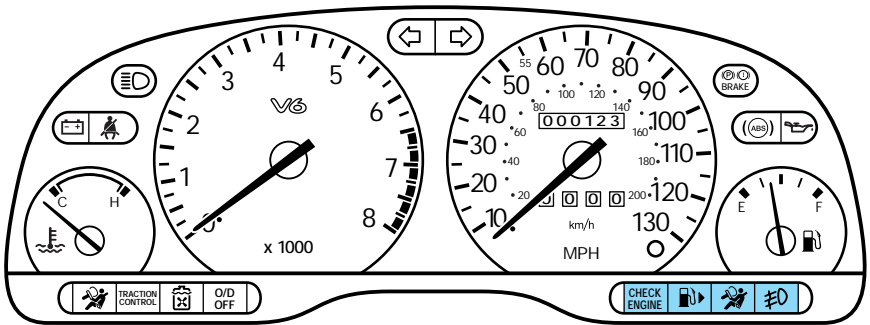
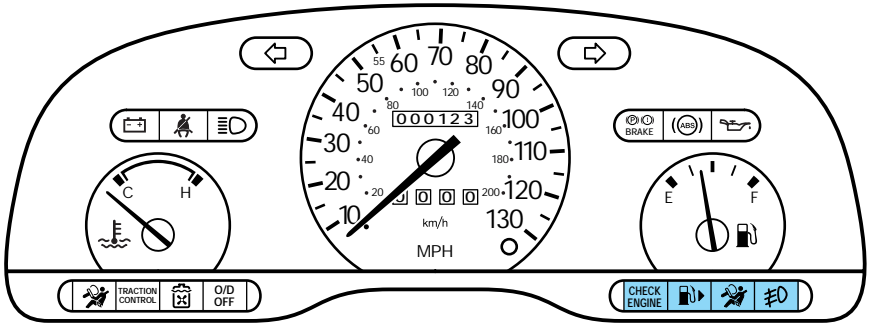

Check engine

Your vehicle is equipped with a computer that monitors the engine's emission control system. This system is commonly known as the On Board Diagnostics (OBD II) system. This OBD II system protects the environment by ensuring that your vehicle continues to meet government emission standards. The OBD II system also assists the service technician in properly servicing your vehicle.

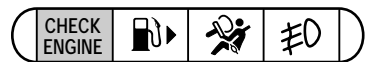

The *check engine* indicator light illuminates when the ignition is first turned to the ON position to check the bulb. If it comes on after the engine is started, one of the engine's emission control systems may be malfunctioning. The light may illuminate without a driveability concern being noted. The vehicle will usually be drivable and will not require towing.

What you should do if the check engine light illuminates

Light turns on solid:

This means that the OBD II system has detected a malfunction.

Temporary malfunctions may cause your *check engine* light to illuminate. Examples are:

- The vehicle has run out of fuel (The engine may misfire or run poorly.)
- Poor fuel quality or water in the fuel
- The fuel cap may not have been securely tightened.

Instrumentation

These temporary malfunctions can be corrected by filling the fuel tank with good quality fuel and/or properly tightening the fuel cap. After three drive cycles without these or any other temporary malfunctions present, the *check engine* light should turn off. (A driving cycle consists of a cold engine startup followed by mixed city/highway driving.) No additional vehicle service is required. If the “*check engine*” light remains on, have your vehicle serviced at the first available opportunity.

Light is blinking:

Engine misfire is occurring which could damage your catalytic converter. You should drive in a moderate fashion (avoid heavy acceleration and deceleration) and have your vehicle serviced at the first available opportunity.



Under engine misfire conditions, excessive exhaust temperatures could damage the catalytic converter, the fuel system, interior floor coverings or other vehicle components, possibly causing a fire.

Low fuel

Illuminates when the fuel tank has approximately eight liters (two gallons) remaining. The lamp will also illuminate when the ignition key is turned to ON and the engine is off.



Air bag readiness

Briefly illuminates when the ignition is turned on. If the light fails to illuminate, continues to flash, or remains on, have the system serviced immediately.



Front foglamps (if equipped)

Illuminates when foglamps are switched on.

Refer to *Foglamp control* in the *Controls and features* chapter for notes on use.

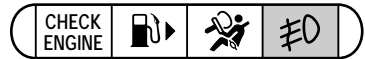

Instrumentation

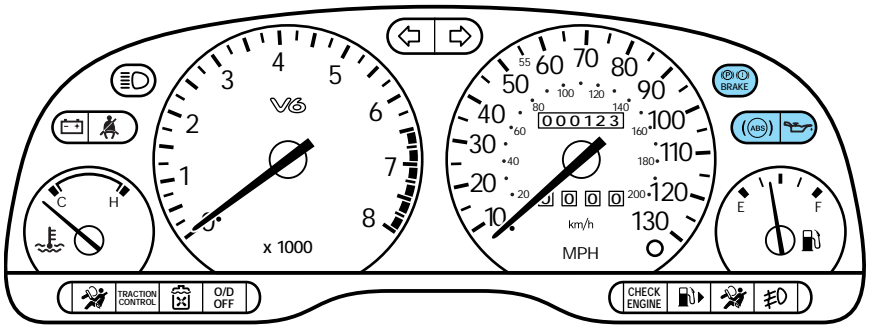
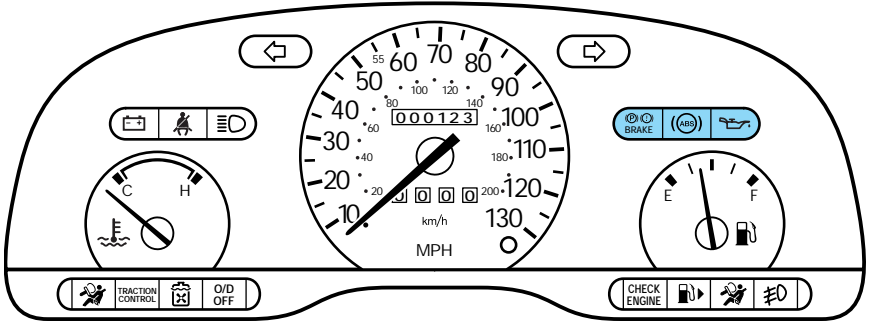

Brake system warning

Extinguishes when the parking brake is released. Illuminates after releasing the parking brake to indicate low brake fluid level.

Illumination while driving may indicate that one of the braking circuits has failed. The second braking circuit will remain intact. However, you will need to brake harder and allow for increased stopping distances.



Alternative design

Have the system checked by your dealer or qualified technician before continuing your journey.

Anti-lock brake system (ABS) (if equipped)

Momentarily illuminates when the ignition is turned on and the engine is off. If the light stays on or continues to flash, the ABS needs to be serviced.



Alternative design

Brake system and ABS warning lights

If both warning lights illuminate at the same time while driving, stop the vehicle as soon as it is safe to do so. Have the braking system checked by your dealer or qualified service technician before continuing your journey.

When stopping the vehicle, slowly reduce the speed. Use the brakes with great care.



Alternative design

Instrumentation

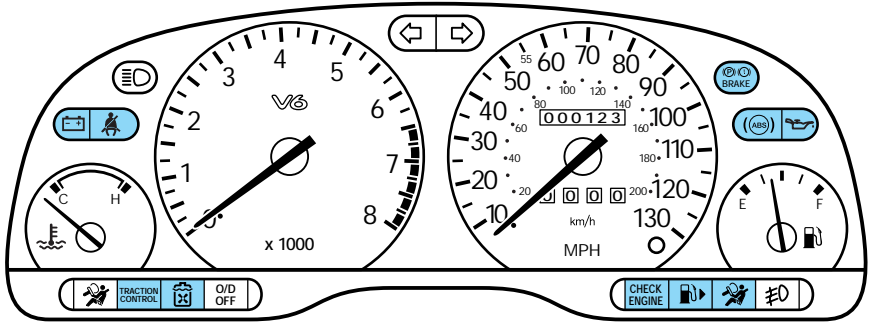
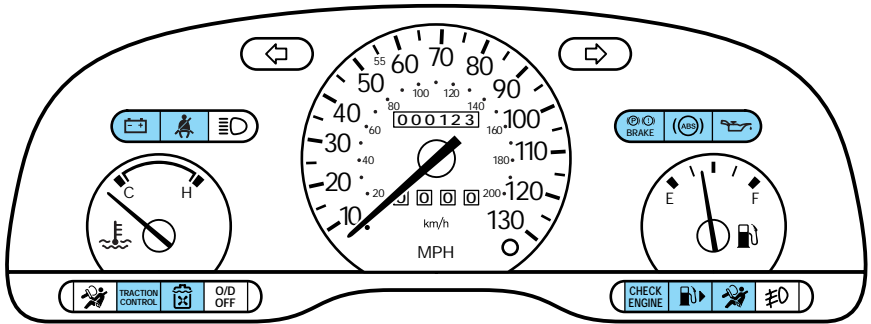

Engine oil pressure

Illuminates when the ignition is turned on and the engine is off. The light also illuminates when engine oil pressure has been lost. Refer to the *Maintenance and care* chapter to check the engine oil level as soon as possible. If the engine oil level is correct and the light stays on, see your dealer or qualified service technician.



Alternative design

Testing the warning and indicator lights and chimes

Turn the ignition key to the on position without starting the engine. The following warning and indicator lights will illuminate briefly: charging system, safety belt (does not illuminate, if the driver's safety belt is fastened), traction control, ABS, brake, low coolant, low fuel, engine oil pressure, check engine and air bag readiness.

If any of these lights do not illuminate, see your dealer or qualified service technician.

Headlamps on warning chime

Sounds when the headlamps are on, the ignition is off (and the key is not in the ignition) and the driver's door is open.

Key-in-ignition warning chime

Sounds when the key is left in the off/lock or accessory position and the driver's door is open.

Safety belt warning chime

For information on the safety belt warning chime, refer to the *Seating and safety restraints* chapter.

Instrumentation

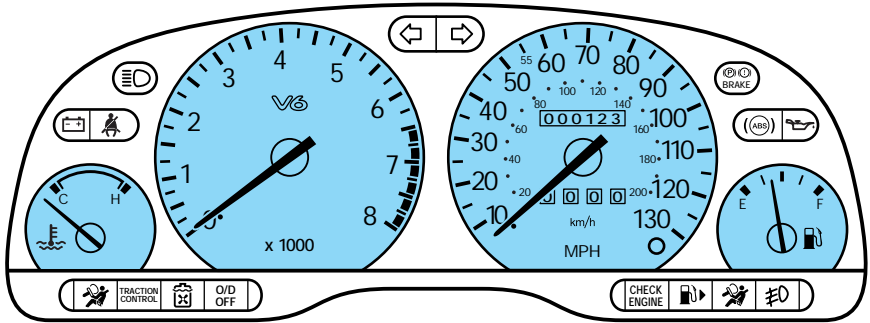
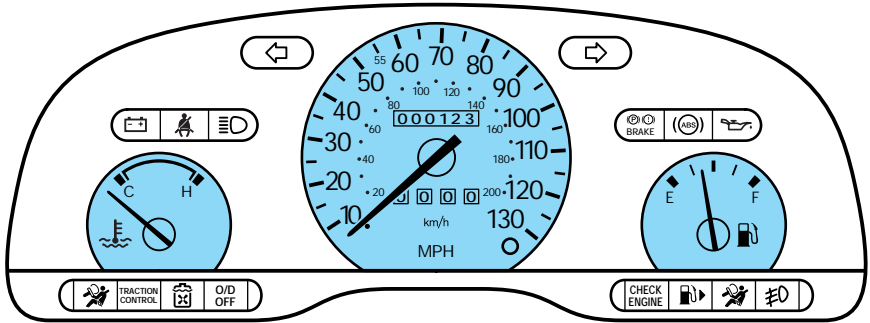

INSTRUMENT CLUSTER GAUGES

Engine coolant temperature gauge

Indicates the temperature of the engine coolant. If it enters the red section, the engine is overheating. Switch off the ignition and determine the source of the problem. Refer to *Checking and adding engine coolant* in the *Maintenance and care* chapter.

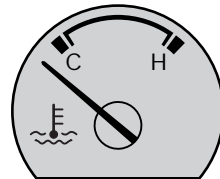

Tachometer

Indicates the engine speed in revolutions per minute (rpm).

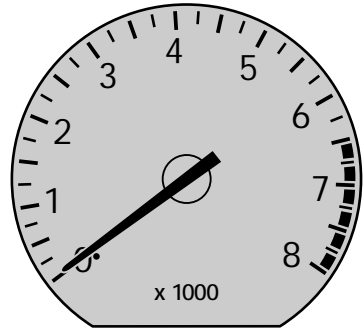

Speedometer

Indicates the current vehicle speed.

Odometer

Registers the total mileage of the vehicle.

Trip odometer

The trip odometer can register the mileage of individual journeys. To reset, depress the button.

Speedometer

Odometer

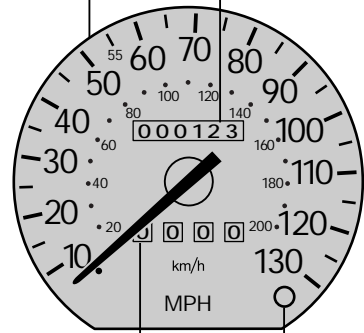

Trip odometer

Reset button

Fuel gauge

The fuel gauge displays the approximate level of usable fuel left in the fuel reservoir.

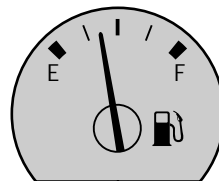

Controls and features

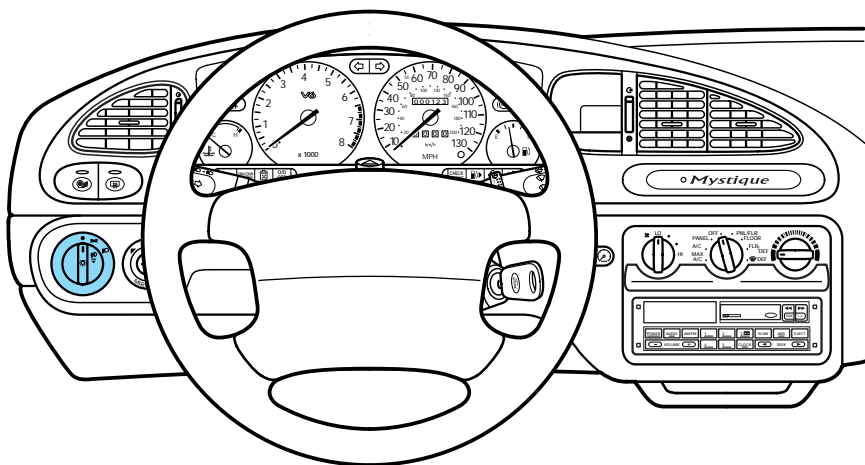

INSTRUMENT PANEL CONTROLS

Headlamp control

- Lamps off.

☰ Turn one position clockwise:
Parking lamps, instrument panel
lamps, license plate lamps, and tail
lamps on

☞ Turn two positions clockwise:
Headlamps on.

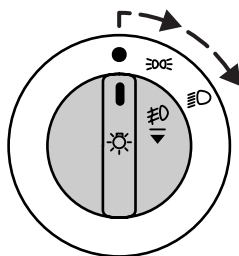

Foglamp control (if equipped)

Pull out the control while the headlamps are on to turn the foglamps on.

Push the control in to deactivate the foglamps.

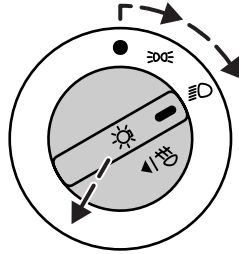

Daytime running light (DRL) (Canadian vehicles only)

The DRL system turns on the highbeam headlamps, with a reduced light output, when:

- the vehicle is running and the ignition is in the on position and
- the headlamp system is in the off position.

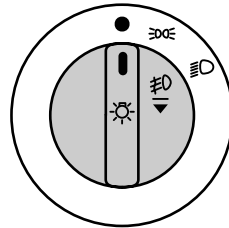

The daytime running light (DRL) system will not illuminate the tail lamps and parking lamps. Turn on your headlamps at dusk. Failure to do so may result in a collision.

Controls and features

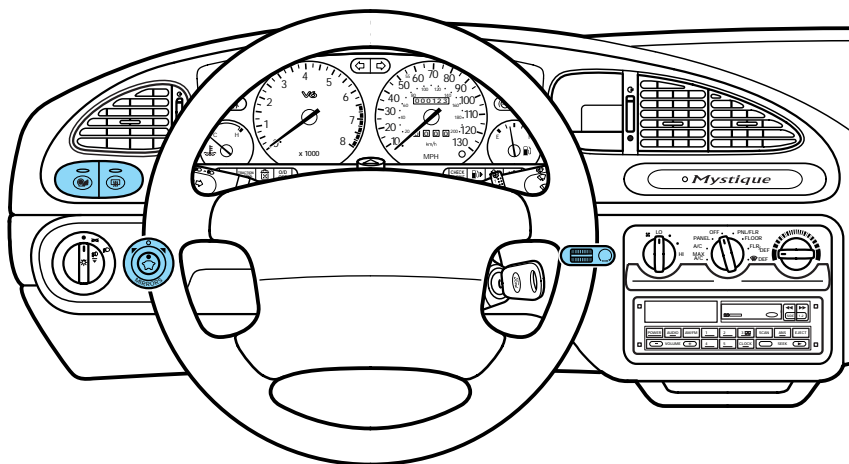

Rear window defroster (if equipped)

Press the defroster control to clear the rear window of thin ice and fog.

The ignition must be in the on position to operate the rear window defroster.

The defroster turns off automatically after 10 minutes or when the ignition is turned to the off position. To manually turn off the defroster, push the control again.

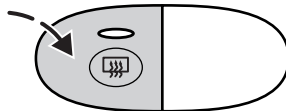
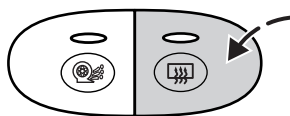

Traction control system (if equipped)

This button turns the traction control system off and on. See *Driving* for more information.

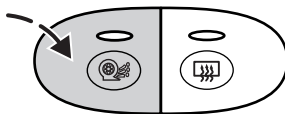

Panel dimmer control

Adjust the control to vary the intensity of the panel lighting. Operates only when the exterior lights are switched on.

To switch on the interior lamp, rotate the control completely to the left.

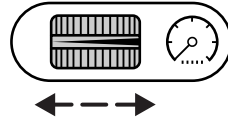

Power mirrors

The control can be swivelled and turned.

Turn the control counterclockwise to adjust the driver's side mirror, clockwise to adjust the passenger's side mirror. Adjust the selected mirror by moving the center control in the desired direction. Then turn the control back to the center position.

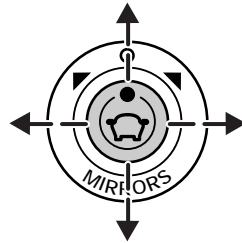
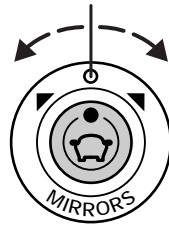

Controls and features

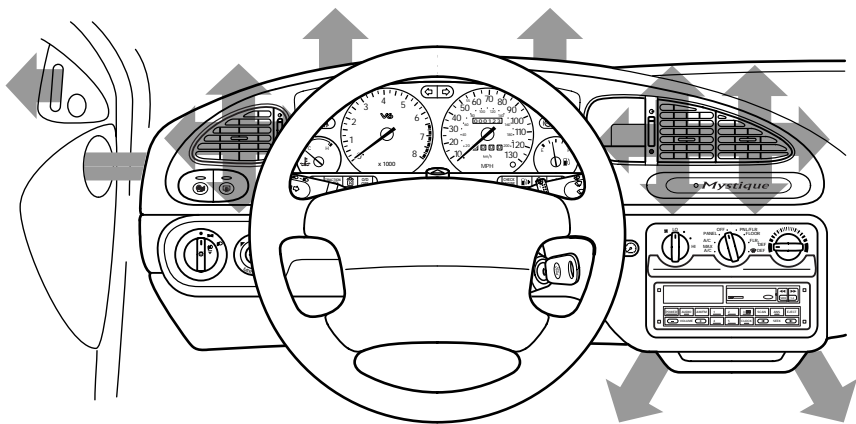

Climate control system

Your vehicle has one of the following climate control systems:

- Manual heating system
- Manual heating and air conditioning system

In some modes, the two systems function similarly. In modes where the systems do not function similarly, the different functions are noted.

Vents

Airflow from the vents may be adjusted by moving the horizontal control or vertically adjusting the vent (except passenger side outer vent) according to your airflow preference.

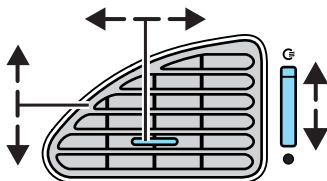

Heater only system (if equipped)

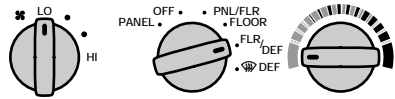

Fan speed control

Controls the volume of air circulated in the vehicle.

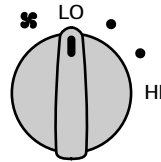

Temperature control knob

Controls the temperature of the airflow inside the vehicle. On heater-only systems, the air cannot be cooled below the outside temperature.

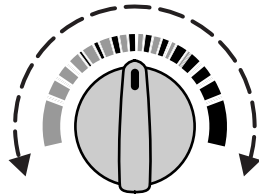

Mode selector control

Controls the direction of the airflow to the inside of the vehicle.

- PANEL – Distributes outside air through the instrument panel registers.
- OFF – Outside air is shut out and the fan will not operate.
- PNL/FLR – Distributes outside air through the instrument panel registers and the floor ducts.
- FLOOR – Allows for maximum heating. Distributes outside air through floor ducts.

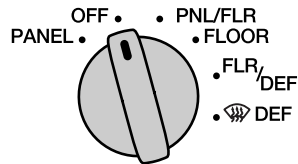

Controls and features

- FLR/DEF – Distributes outside air through the floor ducts and the windshield defroster ducts.
- DEF – Distributes outside air through the windshield defroster ducts. It can be used to clear ice or fog from the windshield.

Operating tips

- In humid weather, select DEF before driving. This will help to prevent your windshield from fogging. After a few minutes, select any desired position.
- To prevent humidity buildup inside the vehicle, don't drive with the climate control system in the OFF position.
- Don't put objects under the front seat that will interfere with the airflow to the back seats.
- Remove any snow, ice or leaves from the air intake area (at the bottom of the windshield under the hood).
- When placing objects on top of your instrument panel, be careful to not place them over the defroster outlets. These objects can block airflow and reduce your ability to see through your windshield. Also, avoid placing small objects on top of your instrument panel. These objects can fall down into the defroster outlets and block airflow and possibly damage your climate control system.

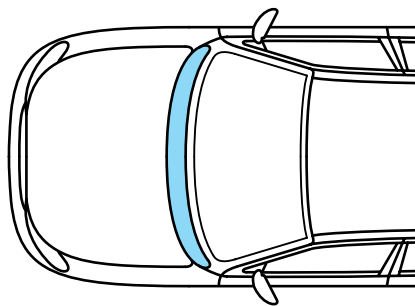

Manual heating and air conditioning system (if equipped)

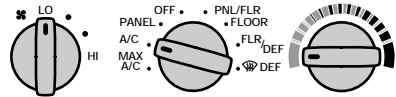

Fan speed control

Controls the volume of air circulated in the vehicle.

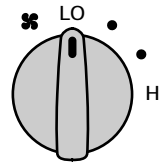

Temperature control knob

Controls the temperature of the airflow inside the vehicle.

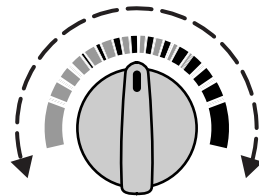

Mode selector control

Controls the direction of the airflow to the inside of the vehicle.

The air conditioning compressor will operate in all modes except PANEL, PNL/FLR, and FLOOR. However, the air conditioning will only function if the outside temperature is about 10°C (50°F) or above.

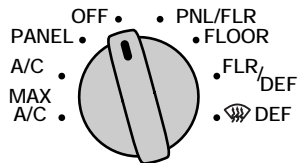

Since the air conditioner removes considerable moisture from the air during operation, it is normal if clear water drips on the ground under the air conditioner drain while the system is working and even after you have stopped the vehicle.

Controls and features

Under normal conditions, your vehicle's climate control system should be left in any position other than MAX A/C or OFF when the vehicle is parked. This allows the vehicle to "breathe" through the outside air inlet duct.

- **MAX A/C** – Uses recirculated air to cool the vehicle. MAX A/C is noisier than A/C but more economical and will cool the inside of the vehicle faster. Airflow will be from the instrument panel registers. This mode can also be used to prevent undesirable odors from entering the vehicle.
- **A/C** – Uses outside air to cool the vehicle. It is quieter than MAX A/C but not as economical. Airflow will be from the instrument panel registers.
- **PANEL** – Distributes outside air through the instrument panel registers. However, the air will not be cooled below the outside temperature because the air conditioning does not operate in this mode.
- **OFF** – Outside air is shut out and the fan will not operate. For short periods of time only, use this mode to prevent undesirable odors from entering the vehicle.

- PNL/FLR – Distributes outside air through the instrument panel registers and the floor ducts. However, the air will not be cooled below the outside temperature because the air conditioning does not operate in this mode. For added customer comfort, when the temperature control knob is anywhere in between the full hot and full cold positions, the air distributed through the floor ducts will be slightly warmer than the air sent to the instrument panel registers.
- FLOOR – Allows for maximum heating by distributing outside air through the floor ducts. However, the air will not be cooled below the outside temperature because the air conditioning does not operate in this mode.
- FLR/DEF – Distributes outside air through the windshield defroster ducts and the floor ducts. Heating and air conditioning capabilities are provided in this mode. For added customer comfort, the air distributed through the floor ducts will be slightly warmer than the air sent to the windshield defroster ducts. If the temperature is about 10°C (50°F) or higher, the air conditioner will automatically dehumidify the air to prevent fogging.

Controls and features

- DEF – Distributes outside air through the windshield defroster ducts. It can be used to clear ice or fog from the windshield. If the temperature is about 10°C (50°F) or higher, the air conditioner will automatically dehumidify the air to prevent fogging.

Operating tips

- In humid weather, select DEF before driving. This will prevent your windshield from fogging. After a few minutes, select any desired position.
- To prevent humidity buildup inside the vehicle, don't drive with the climate control system in the OFF position.
- Don't put objects under the front seat that will interfere with the airflow to the back seats.
- Remove any snow, ice or leaves from the air intake area (at the bottom of the windshield under the hood).
- If your vehicle has been parked with the windows closed during hot weather, the air conditioner will do a much faster job of cooling if you drive for two or three minutes with the windows open. This will force most of the hot, stale air out of the vehicle. Then operate your air conditioner as you would normally.

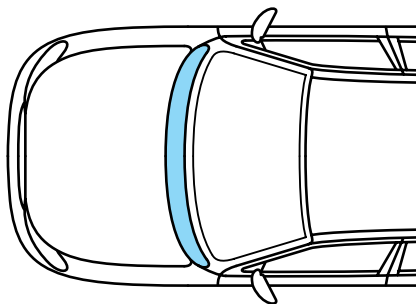

- When placing objects on top of your instrument panel, be careful to not place them over the defroster outlets. These objects can block airflow and reduce your ability to see through your windshield. Also, avoid placing small objects on top of your instrument panel. These objects can fall down into the defroster outlets and block airflow and possibly damage your climate control system.

Cabin air filter

Your vehicle is equipped with an air filter that removes pollen and road dust from outside air before it is directed to the interior of the vehicle. Refer to the *Maintenance and care* chapter for maintenance of this filter.

Controls and features

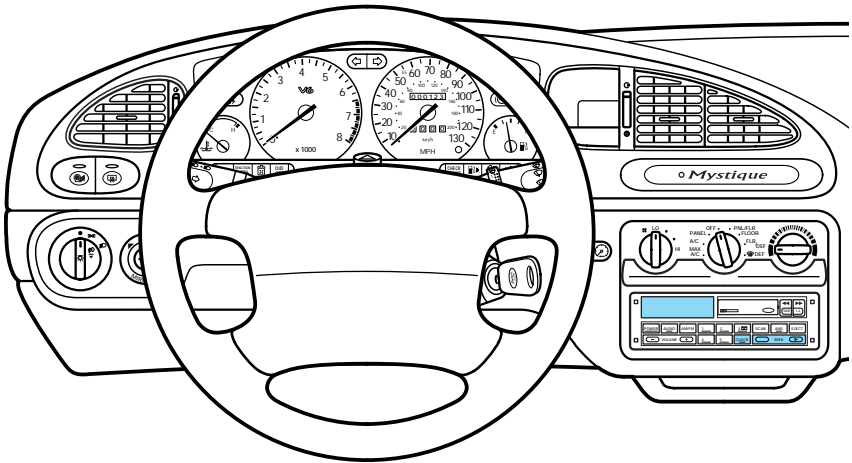

AUDIO SYSTEMS

Compact disc radio

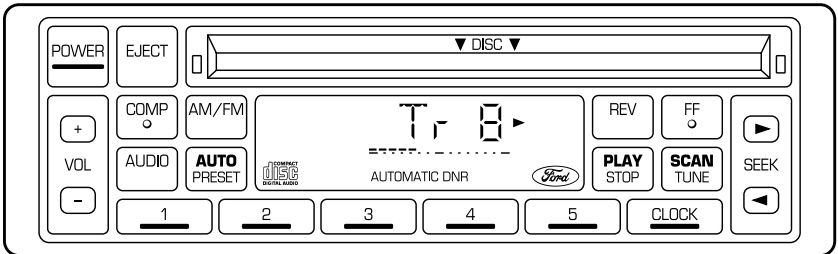

Controls and features

Electronic stereo radio with cassette

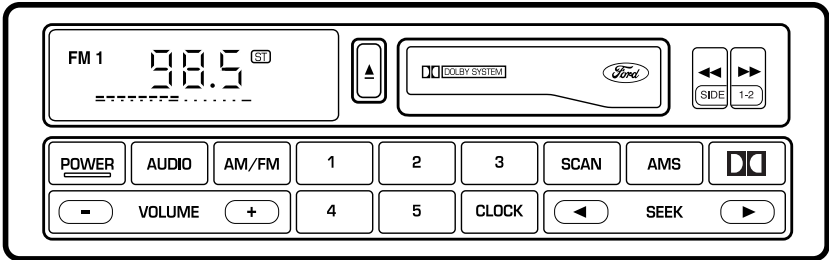



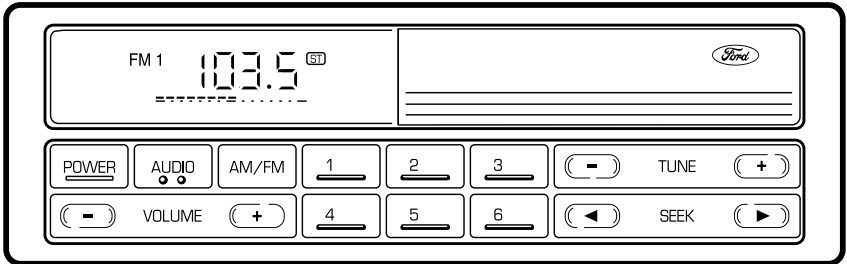

Electronic stereo radio

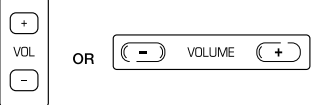

Controls and features

Audio System Feature

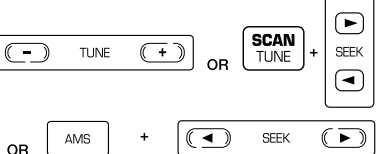
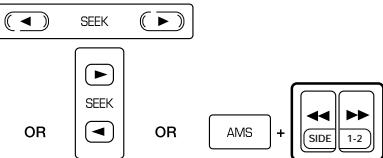
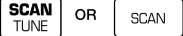
Audio System











	Name	Compact Disc Radio	Electronic Stereo Radio with Cassette	Electronic Stereo Radio
	Power Control	✓	✓	✓
	Volume Control	✓	✓	✓
	AM/FM Select	✓	✓	✓
	Tune Adjust	✓	✓	✓
	Seek Function (AMS-Automatic Music Search)	✓	✓	✓
	Scan Function	✓	✓	✓
	Radio Station Memory Preset	✓	✓	✓
	Tone Balance/ Speaker Output	✓	✓	✓

✓ = Feature included on audio system

Controls and features

Audio System Feature

Audio System

	Name	Compact Disc Radio	Electronic Stereo Radio with Cassette	Electronic Stereo Radio
	Dolby® Noise Reduction		✓	
	Automatic Memory Store	✓		
	Tape Direction Select		✓	
	Tape Fast Forward Function		✓	
	Tape Rewind Function		✓	
	CD Fast Forward Function	✓		
	CD Reverse Function	✓		
	Tape Eject		✓	
	CD Eject	✓		
	CD Play/Stop	✓		
	Compression Adjust	✓		

✓ = Feature included on audio system

Controls and features

Power control

Press the control to turn the audio system on or off.

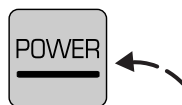

Volume control

Press the control to raise or lower volume.

If the volume is set above a certain level and the ignition is turned off, the volume will come back on at a “nominal” listening level when the ignition switch is turned back on.

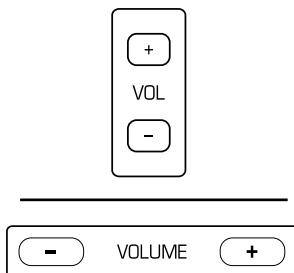

AM/FM select

The AM/FM select control works in radio mode and allows you to select AM or FM frequency bands.

Press the control to switch between AM, FM1 or FM2 memory preset stations.



Tune adjust

The tune control works in radio mode.

The tune adjust with electronic stereo radio

- Press (-) to move to the next frequency down the band (whether or not a listenable station is located there). Hold the control to move through the frequencies quickly.
- Press (+) to move to the next frequency up the band (whether or not a listenable station is located there). Hold for quick movement.



Tune adjust with compact disc radio

- Press the SCAN/TUNE control twice.
- Within approximately five seconds press and release either ◀ or ▶ on the SEEK button to change to the next frequency up or down.
- Press and hold down ◀ or ▶ to quickly move through the frequencies.



Tune adjust with electronic stereo cassette radio

- Press the AMS control.



Controls and features

- Within approximately five seconds, press and release either ◀ or ▶ on the SEEK control to change to the next frequency up or down.
- Press and hold down ◀ or ▶ to quickly move through the frequencies.

Seek function

The seek function control works in radio or tape mode.



Seek function in radio mode

- Press ◀ to find the next listenable station down the frequency band.
- Press ▶ to find the next listenable station up the frequency band.



Seek function in tape mode

- Press the AMS control.
- Press ◀◀ to listen to the previous selection on the tape.
- Press ▶▶ to listen to the next selection on the tape.

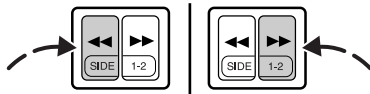

Scan function

The scan function works in radio and CD mode (if equipped).

Scan function with electronic stereo cassette radio

Press the SCAN control to hear a brief sampling of all listenable stations on the frequency band. Press the control again to stop the scan mode.

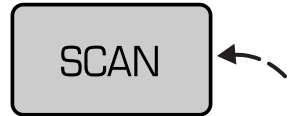

Scan function with compact disc radio

- Press the SCAN/TUNE control once.
- Push ► on the SEEK control to hear a brief sampling of listenable stations up the frequency band.
- Push ◀ to hear a brief sampling of listenable stations down the frequency band.



Radio station memory preset

The radio is equipped with six station memory preset controls. These controls can be used to select up to six preset AM stations and twelve FM stations (six in FM1 and six in FM2).

Controls and features

Setting memory preset stations

1. Select the frequency band with the AM/FM select control.
2. Select a station. Refer to *Tune adjust* or *Seek function* for more information on selecting a station.



3. Press and hold a memory preset control until the sound returns, indicating the station is held in memory on the control you selected.

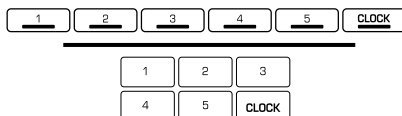

If the battery is disconnected, the memory preset stations will need to be reset.

Automatic memory store (if equipped)

Automatic memory store allows you to set strong radio stations without losing your original manually set preset stations. This feature is helpful on trips when you travel between cities with different radio stations.

Starting automatic memory store (if equipped)

1. Select a frequency using the AM/FM select control.



2. Press the AUTO PRESET control.
3. When the first six strong stations are filled, the station stored in memory preset control 1 will start playing.

If there are less than six strong stations available on the frequency band, the remaining memory preset controls will all store the last strong station available.

Deactivating automatic memory store

To deactivate automatic memory store and return to your audio system's manually set memory stations, press the AUTO PRESET control again.

Bass adjust

The bass adjust control allows you to increase or decrease the audio system's bass output.

- Push the AUDIO control repeatedly until the display reads BASS.
- Press (+) or (-) on the volume control to increase or decrease bass output.

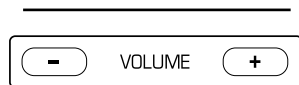
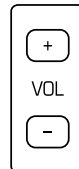

Controls and features

Treble adjust

The treble adjust control allows you to increase or decrease the audio system's treble output.

- Push the AUDIO control repeatedly until the display reads TREB.
- Press (+) or (-) on the volume control to increase or decrease treble output.

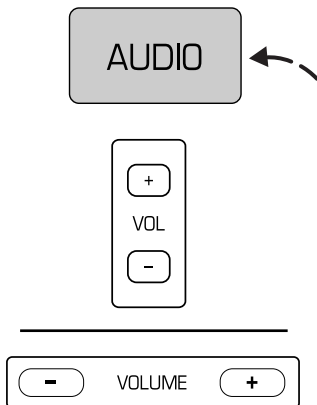

Speaker balance adjust

Speaker sound distribution can be adjusted between the right and left speakers.

- Push the AUDIO control repeatedly until the display reads BAL.
- Press the (+) side of the volume control to shift sound to the right speakers.
- Press the (-) side of the volume control to shift sound to the left speakers.

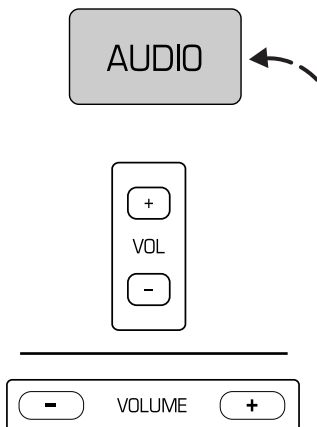

Speaker fade adjust

Speaker sound distribution can be adjusted between the front and rear speakers.

- Push the AUDIO control repeatedly until the display reads FADE.

- Press the (+) side of the volume control to shift sound to the front speakers.

- Press the (-) side of the volume control to shift sound to the rear speakers.

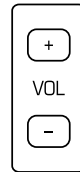

Clock

Viewing the clock

Press the CLOCK control to display the time on the audio system display.

Time is displayed:

- until an audio function control is pressed
- approximately ten seconds after each audio system change
- when the audio system is off and the ignition is ON.

To remove the clock display, press the control again.



Controls and features

Setting the clock

Press and hold CLOCK, then press SEEK ◀ to increase the hours or ▶ to increase minutes.

The clock will display 12-hour time with no AM/PM indications.

On the single CD audio system, the clock can be set with the radio power on or off.



Tape play select

Insert a tape to begin tape play.

Push only slightly when inserting a cassette tape (with the open edge to the right). A cassette deck loading mechanism pulls the tape in the rest of the way.

CD play select

Insert a disc to begin CD play.

Press the PLAY/STOP control to begin CD play if a disc is loaded in the CD player. The first track of the disc will begin playing if the disc has just been loaded. After that, CD play will begin where it was stopped last.



Rewind/fast forward

The rewind and fast forward controls work in tape and CD modes (if equipped).

Rewind/fast forward function in tape mode

- Press ◀◀ to rewind the tape. Play will continue once the beginning of the tape is reached or rewind is stopped.
- Press ▶▶ to fast forward the tape. Once the end of the tape is reached, tape direction reverses and the opposite side of the tape plays.

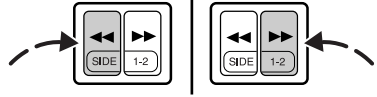

Rewind/fast forward in CD mode

- Press the control for less than three seconds for slow rewind.
- Press the control for more than three seconds for fast rewind.
- Press the control for less than three seconds for slow forward action.
- Press the control for more than three seconds for fast forward action.

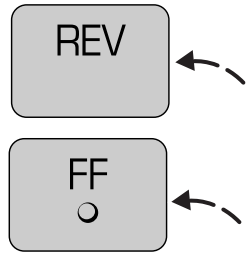

Tape direction select

Press both ◀◀ and ▶▶ to play the alternate side of a tape.

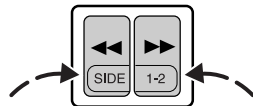

Tape eject

Press the control to stop and eject a tape.

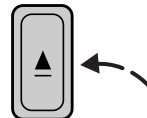

Controls and features

CD eject

Press the control to stop and eject a CD.

If a disc is ejected from the CD player but is not removed within approximately 10 seconds, the player will automatically reload the disc for storage (unless the disc is automatically ejected because it was inserted upside down, in which case the disc will not be automatically reloaded).

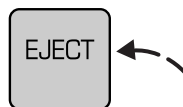

Dolby® noise reduction

Dolby® noise reduction manufactured under license from Dolby Laboratories Licensing Corporation operates only in tape mode. Dolby® reduces the amount of hiss and static during tape playback.

Press the  button to activate and deactivate Dolby® noise reduction.



Compression adjust (if equipped)



Compression adjust brings soft and loud CD passages together for a more consistent listening level.

Press the control to activate and deactivate compression adjust.



DISPLAY SCREEN

The display screen gives information on the status of the audio system.

Display	Information
AM, FM1 or FM2	Indicates which frequency band the audio system is in
87.9 to 107.9 (530 to 1610 Am)	Indicates currently playing radio station
Illuminated bars	Indicates volume, relative levels of bass and treble and relative levels of speaker balance and fade
	Indicates Dolby® Noise Reduction activation
1 or 2	Indicates side of tape playing
	Indicates CD play
	Indicates CD stop
TUNE	Indicates tune mode activated
M	Indicates manual tuning is activated
SCN or SCAN	Indicates scan mode activated
AUTO	Indicates Auto Memory Store (AMS)
BASS	Indicates bass mode activated
TREB	Indicates treble mode activated
BAL	Indicates speaker balance adjust
FADE	Indicates speaker fade adjust
SHUF	Indicates shuffle feature activated
COMP	Indicates compression feature activated
TOO HOT	Indicates CD player temperature is above 75°C (167°F). CD play will stop. CD play can continue once the temperature reaches the normal range.

Troubleshooting the CD Player



The laser beam used in the compact disc player is harmful to the eyes. Do not attempt to disassemble the case.

If sound skips:

- You may be travelling on a rough road, playing scratched discs or the disc may be dirty. Skipping will not scratch the discs or damage the player.

If player does not work:

- The disc is inserted with the label surface downward.
- The disc is dusty or defective.
- The player's internal temperature is above 75°C (167°F). Allow the player to cool down before operating.
- A disc with format and dimensions not within industry standards is inserted.

Cleaning compact discs

Inspect all discs for contamination before playing. If necessary, clean discs only with an approved CD cleaner and wipe the center out to the edge. Do not use circular motion.

CD and CD player care

- Handle discs by their edges only. Never touch the playing surface.
- Do not insert more than one disc at a time.
- Do not expose discs to direct sunlight or heat sources for extended periods of time.
- After playing, store the disc in its case.

Cleaning cassette player (if equipped)

Clean the tape player head with a cassette cleaning cartridge after ten to twelve hours of play in order to maintain the best sound and operation.

Cassette and cassette player care

- Use only cassettes that are 90 minutes long or less.
- Do not expose tapes to direct sunlight, high humidity, extreme heat or extreme cold. Allow tapes that may have been exposed to extreme temperatures to reach a moderate temperature before playing.
- Tighten very loose tapes by inserting a finger or pencil into the hole and turning the hub.

Controls and features

- Remove loose labels before inserting tapes.
- Do not leave tapes in the cassette player for a long time when not being played.

RADIO FREQUENCY INFORMATION

The Federal Communications Commission (FCC) and the Canadian Radio and Telecommunications Communications (CRTC) establish the frequencies AM and FM stations may use for their broadcasts. Allowable frequencies are:

AM 530, 540–1600, 1610 kHz

FM 87.9, 88.1–107.1, 107.9 MHz

Not all frequencies are used in a given area.

Radio reception factors

Three factors can affect radio reception:

- **Distance/strength.** The further an FM signal travels, the weaker it is. The listenable range of the average FM station is approximately 40 km (24 miles). This range can be affected by “signal modulation”.

Signal modulation is a process radio stations use to increase their strength/volume relative to other stations.

- **Terrain.** Hills, mountains and tall buildings between your vehicle's antenna and the radio station signal can cause FM reception problems. Static can be caused on AM stations by power lines, electric fences, traffic lights and thunderstorms. Moving away from an interfering structure (out of its "shadow") returns your reception to normal.

- **Station overload.** Weak signals are sometimes captured by stronger signals when you pass a broadcast tower. A stronger signal may temporarily overtake a weaker signal and play while the weak station frequency is displayed.

The audio system automatically switches to single channel reception if it will improve the reception of a station normally received in stereo.

AUDIO SYSTEM WARRANTIES AND SERVICE

Refer to the "Warranty Guide" for audio system warranty information.

If service is necessary, see your dealer or a qualified technician.

Controls and features

STEERING COLUMN CONTROLS

Ignition

1. Ignition off, steering wheel locked.

On vehicles with automatic transaxles, the ignition key can return to this position only if the gearshift lever is in P (Park).

2. The accessory position. Steering unlocked, radio operational. Ignition and all main electrical circuits are disabled.

The ignition key should not be left in this position for too long to avoid discharging the battery unnecessarily.

3. Ignition switched on, all electrical circuits operational. Warning and indicator lights illuminate. This key position is for normal driving.

4. Starter motor activated. Release the key as soon as the engine starts.

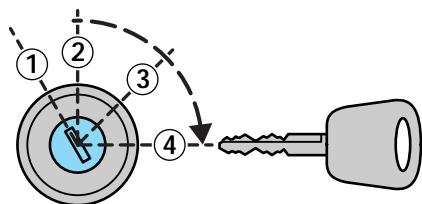
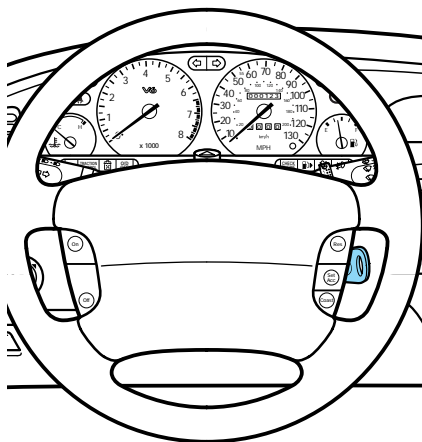

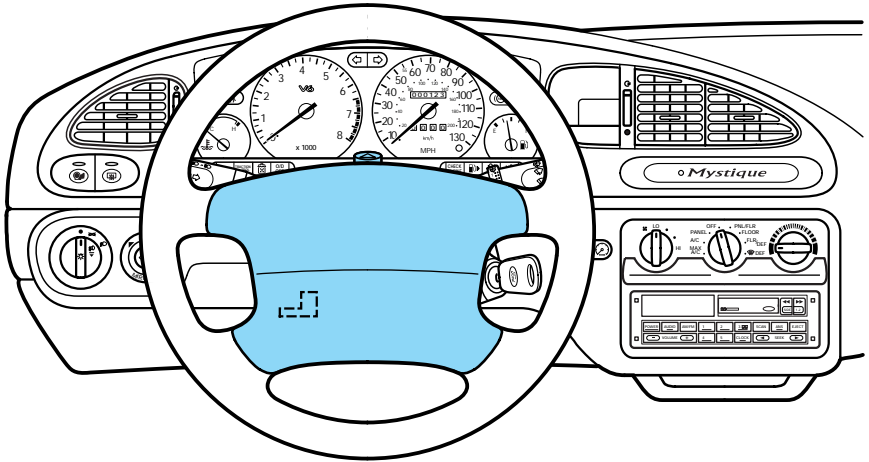

Tilt steering

Pull the locking lever on the steering column cover up to adjust the steering column position. Secure the wheel by releasing the lever thereby allowing the lever to return to the lock position.

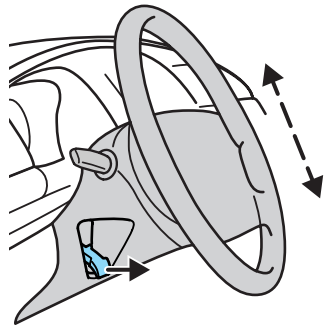

Never adjust the steering wheel while the vehicle is moving.

Controls and features

Hazard flasher control

Use only in an emergency to warn traffic of vehicle breakdown or approaching danger. Depress to activate. Depress again to switch off. The hazard lights can be operated when the ignition is off.

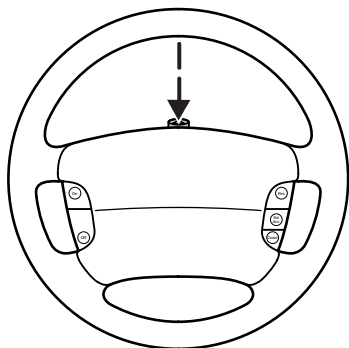

Horn

Press the pad. The horn can be operated when the ignition is off.

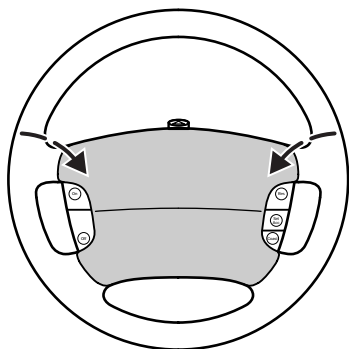

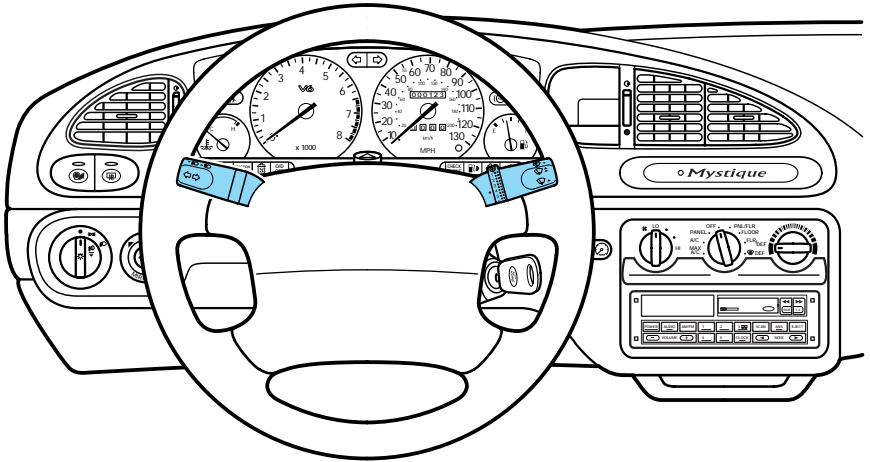

Multi-function switch

The turn signal functions are available only with the ignition switch on.

Right turn signal

Move the lever up.

Left turn signal

Move the lever down.

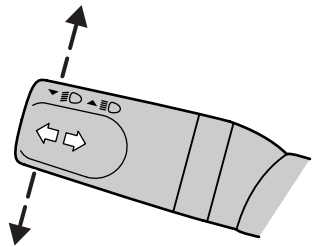

Flash-to-pass

Pull the lever toward you and release quickly for "flash-to-pass" operation.

High beam headlamps

Push the lever toward the instrument panel.

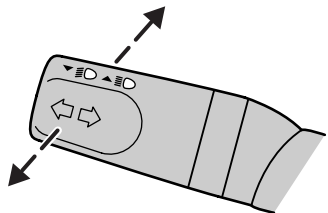

Controls and features

Windshield wipers and washer

Wipers

Lift the windshield wiper lever to the desired speed interval.

- Intermittent: push lever up to the first position.
- Low: push lever up to the second position.
- High: push lever up to the third position.

For a single wipe, push the lever downward.

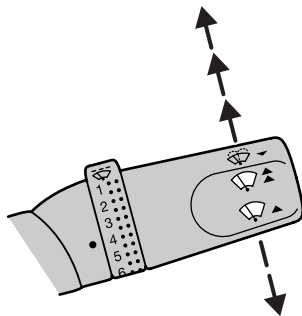

Intermittent wiper control (if equipped)

Rotate the variable intermittent wiper control to the desired speed.

1 = Short time interval

6 = Extended time interval

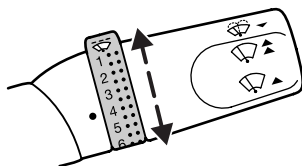

Washer

Pull the lever toward the steering wheel. The washer operates in conjunction with the windshield wipers.

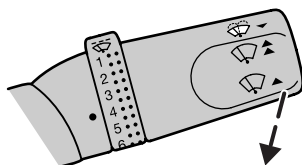

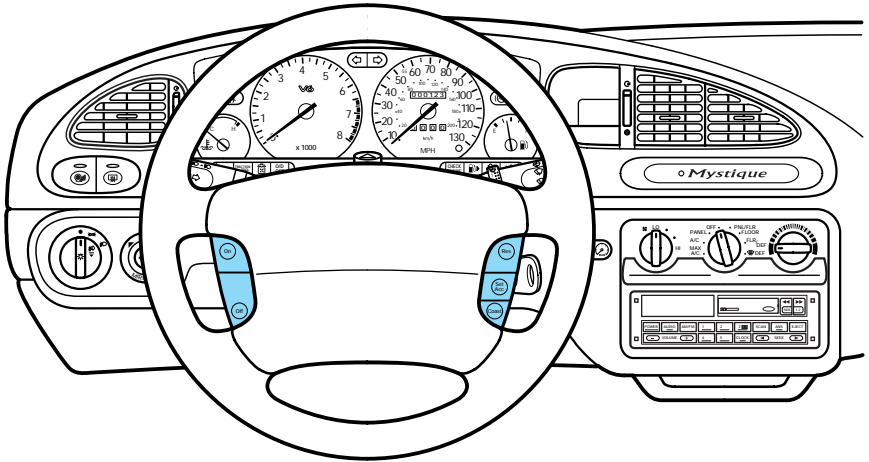

Speed control (if equipped)



Do not use the speed control in heavy traffic or on roads that are winding, slippery, or unpaved.

To turn speed control off

- Press Off, or
- turn off the vehicle ignition.

Once the speed control is switched off, the previously programmed set speed will be erased.

To turn speed control on

- Press On.

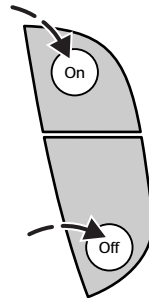

Controls and features

To set a speed

Press Set Acc. For speed control to operate, the speed control must be on and the vehicle speed must be greater than 48 km/h (30 mph).

If you drive up or down a steep hill, your vehicle speed may vary momentarily slower or faster than the set speed. This is normal.

Speed control cannot reduce the vehicle speed if it increases above the set speed on a downhill. If your vehicle speed is faster than the set speed while driving on a downhill in overdrive, you may want to shift to the next lower gear to reduce your vehicle speed.

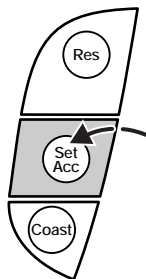

If your vehicle slows down more than 16 km/h (10 mph) below your set speed on an uphill, your speed control will disengage. This is normal. Press Res to re-engage it.

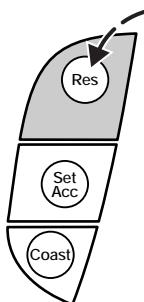

To set a higher speed

- Press and hold Set Acc. Release when the desired set speed is reached, or
- press and release Set Acc. Each press will increase the set speed by 1.6 km/h (1 mph), or
- accelerate with your accelerator pedal, then press Set Acc.

You may accelerate with the accelerator pedal at any time during speed control usage. Releasing the accelerator pedal will return your vehicle speed to the previously set speed.

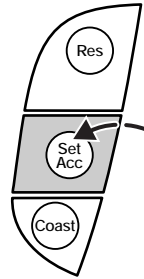

To set a lower speed

- Press and hold Coast. Release the control when the desired vehicle speed is reached, or
- press and release Coast. Each press will decrease the set speed by 1.6 km/h (1 mph), or
- depress the brake pedal. When the desired vehicle speed is reached, press Set Acc.

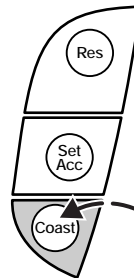

Controls and features

To return to a set speed

- Press Res. For Res to operate, the vehicle speed must be faster than 48 km/h (30 mph).

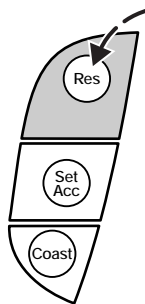

To disengage speed control

- Depress the brake pedal.

Disengaging the speed control will not erase the previously programmed set speed.

OVERHEAD CONTROLS

Interior lamps with reading lamps (if equipped)

The reading lamps and controls are located on the dome lamp. Press the controls on either side of each lamp to activate the lamps.

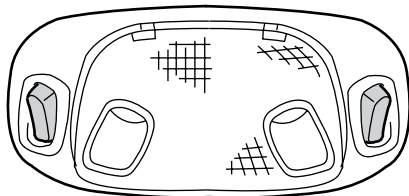

Interior lamps (sunroof equipped vehicles)

The reading lamps are operated by separate on/off switches and can be adjusted to point in the desired direction.

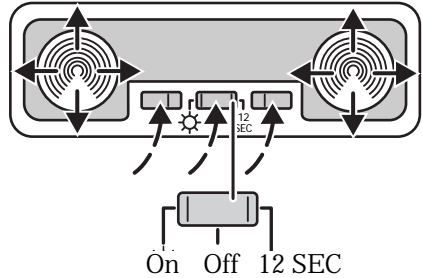

Sunroof (if equipped)

The electric sunroof can be operated only when the ignition is switched on.

To open and close the sunroof

Press the rear part of the control on the rocker switch in the roof console to open the sunroof. Press the front control to close it.

To lift the rear of the sunroof

Close the sunroof and press the front part of the control again. Press the rear control to lower the sunroof.

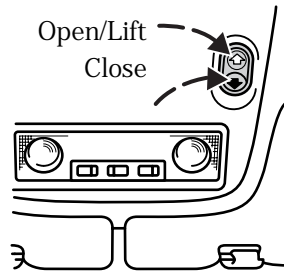

Controls and features

DOOR MOUNTED CONTROLS

Power door locks (if equipped)

Push to lock or unlock all doors.

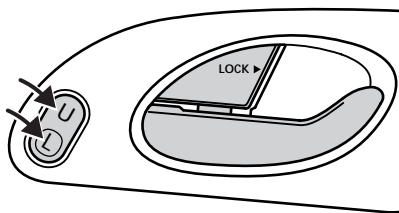

Power windows (if equipped)

The windows will only operate when the ignition is switched on. Press the appropriate control to operate the power windows at each door position. All of the windows can be controlled from the control on the driver door. The passenger door window and the rear windows can be operated individually with separate door controls on the respective door.

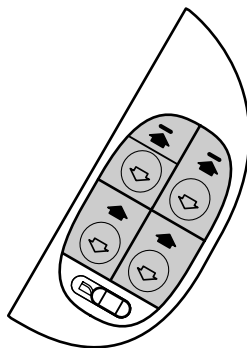

One-touch-down feature

The one-touch-down feature allows you to completely open the driver window by briefly pressing and releasing the bottom of the window switch. To stop the window before it opens completely, press the switch again.

The one-touch down feature only opens the window. To close the window, you must press and hold the top of the switch.

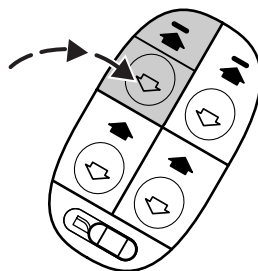

Safety switch

Move the switch to the left to prevent passengers from operating the windows.

Move the switch to the right to allow passengers to operate the windows.

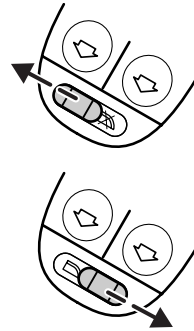

Rear door childproof safety locks

When the lever in the rear door lock is pushed inwards, the door can be opened only from the outside of the vehicle.

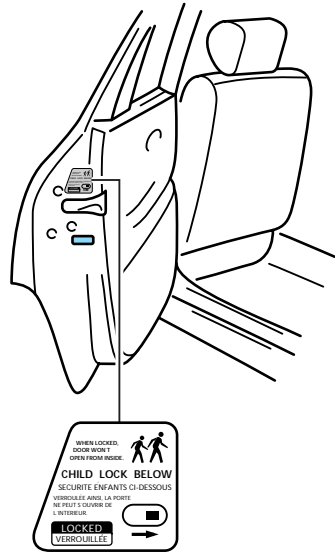

Controls and features

FLOOR MOUNTED CONTROLS

Parking brake

For information on the parking brake, refer to *Preparing to start the vehicle* in the *Starting* chapter.

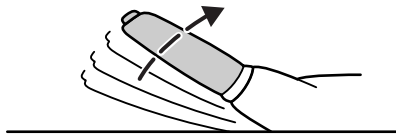

Remote luggage compartment control

Pull the control located on the left of the driver seat to open the luggage compartment.

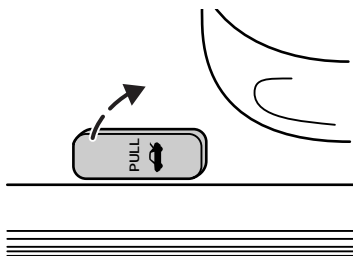

Fuel pump shut-off switch

For information on the fuel pump shut-off switch, refer to *Fuel pump shut-off switch* in the *Roadside emergencies* chapter.

Positive retention floor mat

Position the floor mat in the footwell. Place the mat eyelet over the pointed end of the retention post from the rear and rotate forward to install. Adjust the floor mat position to allow proper operation of accelerator pedal, brake pedal and clutch pedal (if equipped).

To remove, lift the floor mat just forward of the retention post and rotate it rearward to disengage it from the retention post.

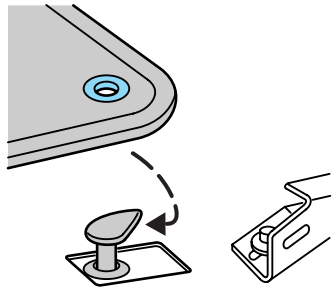

Controls and features

REMOTE KEYLESS ENTRY SYSTEM

(if equipped)

If your vehicle has a remote entry system, you can lock and unlock the vehicle doors and open the luggage compartment without using a key. The remote also has a personal alarm feature.

The remote entry feature only operates with the ignition in the off position.

Locking the doors

Press the LOCK control.

To signal that the doors are locked, press the LOCK control again within five seconds. The doors will lock again and the horn will sound.

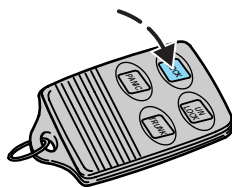

Unlocking the doors

Press the UNLOCK control to open the driver door.

To unlock the other doors, press the UNLOCK control a second time within five seconds.

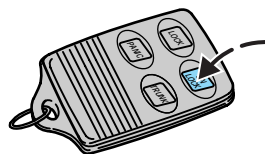

Opening the luggage compartment

Press the TRUNK control.

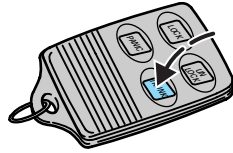

Sounding the panic alarm

Press the PANIC control. The horn will sound and the headlamps and tail lamps will flash for approximately 2 minutes and 45 seconds.

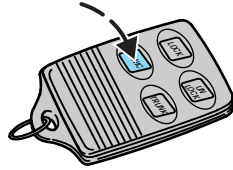

To deactivate the alarm, press the PANIC control again or turn the ignition key to the on position.

Replacing the batteries

The transmitter is powered by two coin-type, three-volt lithium batteries. A decrease in operating range can be caused by:

- battery failure,
- weather conditions, or
- structures around the vehicle.

Replacement batteries for the remote entry system transmitters may be purchased at pharmacies, watch stores or at authorized dealers.

Controls and features

To replace the batteries:

1. Twist a thin coin between the two halves of the transmitter. Do not take the front part of the transmitter apart.
2. Remove the old batteries.
3. Place the positive (+) side of the new batteries down.
4. Snap the two halves of the transmitter back together.

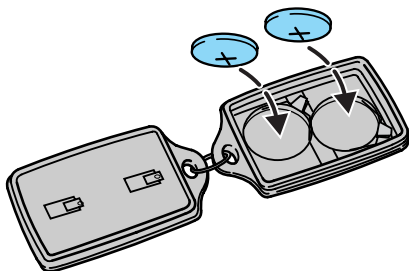

Replacing lost transmitters

Take your transmitters to the dealer for reprogramming if:

- a transmitter is lost, or
- you want to purchase additional transmitters.

This device complies with part 15 of the FCC rules. Operation is subject to the two following conditions: (1) The device may not cause harmful interference, and (2) This device must accept any interference received, including interference that may cause undesired operation.

PASSIVE ANTI-THEFT SYSTEM (if equipped)

The Passive Anti-Theft system (PATS) is an engine immobilization system. It is an additional theft protection feature that prevents the engine from being started unless a coded key is used..

This system is only available with 2.5 litre engines.

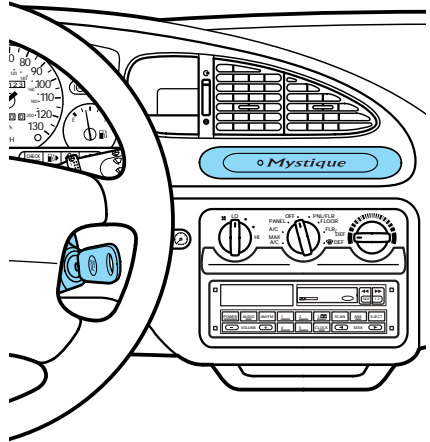

Automatic arming

The system is armed five seconds after switching off the ignition.

The armed status is indicated when the control light flashes every two seconds.

Automatic disarming

Switching on the ignition disarms the system if the correct code is recognized.

Keys

Your vehicle is supplied with two coded keys.

Only these keys can be used to start your vehicle.

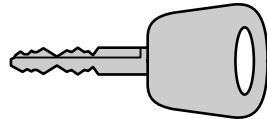

Controls and features

Functional check

When the ignition is switched on, the control light will illuminate for approximately three seconds to indicate that the system is operating correctly.

If the control light flashes rapidly for approximately one minute and then repeatedly at irregular intervals, the system did not recognize the key code. Remove the key and try again.

If the control light illuminates continuously for approximately one minute and then flashes repeatedly at irregular intervals, a system malfunction has occurred.

Have the malfunction repaired by your dealer or a qualified technician as soon as possible.

To ensure a trouble-free exchange between vehicle and key, do not shield the keys with any metal objects.

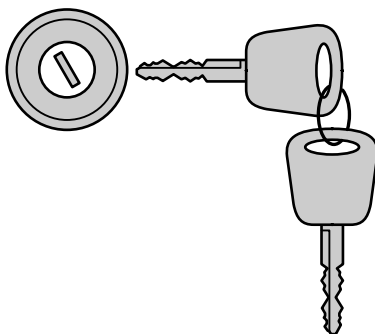

Spare key programming

A maximum of 8 keys in all can be coded with any two coded keys.

- Insert the first key in the ignition switch and turn to position 3.
- Turn the key back to position 1 and remove from the ignition switch within 5 seconds.
- Insert the second key in the ignition switch and turn to position 3 within 5 seconds.
- Turn the key back to position 1 and remove from the ignition switch within 5 seconds - the key coding mode is now activated.
- If an uncoded key is now inserted in the ignition switch and turned to position 3 within 10 seconds, this key is coded to the system.

If coding is not completed correctly, the control light flashes after the ignition is switched on with the newly coded key. Repeat the coding process after waiting 20 seconds with the ignition in position 3.

If keys become lost, you must have your dealer clear and reprogram the code for security reasons.

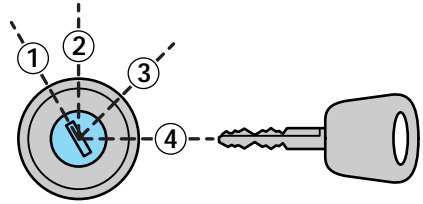

SEATING

Manually adjusting the seats

Pull the lever located at the front edge of the seat to move the seat forward or backward.



Reclining the seats

Pull the lever on the outside of the seat to recline the seat.



Seat

- (1) Forward and backward
- (2) Height of the entire seat
- (3) Height of the front of the seat
- (4) Height of the rear of the seat

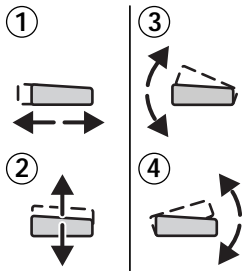

Lumbar support

Pull the lever to adjust lumbar support.



unbuckle the end of the belt from the small buckle on the seat cushion and let the retractor reel it up. Reconnect the belt tongue to the buckle when you fold the seat back up. Refer to *Center position three-point safety belts* in this chapter.

To raise the rear seat back, push the seat back upward until it locks in place. Make sure it is firmly latched by pushing forward and back on it.



Check to see that the seat and seat back are latched securely in position. Keep luggage area free of objects that would prevent proper engagement.



Front and rear seat occupants including pregnant women, should wear safety belts for optimum protection in an accident.



Always drive and ride with your seatback upright and the lap belt snug and low across the hips.



Lock the doors of your vehicle before driving to lessen the risk of the door coming open in a collision.



Cargo should always be secured to prevent it from

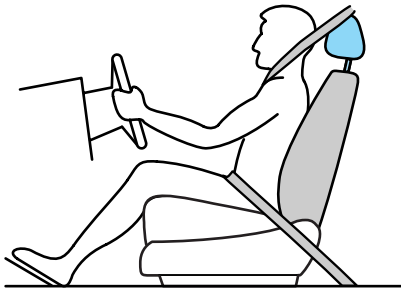

The passenger safety restraints in the vehicle are combination lap and shoulder belts. The front and rear seat passenger safety belts have two types of locking modes.



Each seating position in your vehicle has a specific safety belt assembly which is made up of one buckle and one tongue that are designed to be used as a pair.

Use the shoulder belt on the outside shoulder only. Never wear the shoulder belt under the arm.

Never swing it around your neck over the inside shoulder.

Never use a single belt for more than one person.

safety belts will lock to help reduce the forward movement of the driver and passengers.



The retractor can be made to lock by pulling sharply on the belt.

Automatic locking mode

In this mode, the shoulder belt is automatically prelocked; however, the belt will react to remove any slack in the shoulder belt.

The automatic locking mode is not available on the driver's safety belt.

When to use the automatic



3. Allow the belt to retract. As the belt retracts, you will hear a clicking sound. This indicates that the safety belt is now in the automatic locking mode.



Canceling automatic locking mode

Disconnect the combination lap and shoulder belt and allow it to completely retract. This will cancel the automatic locking mode and activate the vehicle sensitive

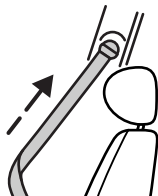

shoulder belt is off your shoulder, on your upper arm or neck, there is a greater risk of severe injury in a collision.

To lower the height of the shoulder belt:

1. Push the control down.
2. Slide down.

To raise the height of the shoulder belt:

1. Slide up.
2. Pull down on the height adjuster to make sure that it is locked in place.

except when the seatback is folded down and cargo that might damage the seatbelt or get it dirty is being hauled.

Pull the seat belt across the hips and insert the big (sliding) tongue into the appropriate buckle until a distinct “click” is heard.

Should the center rear belt need to be unlatched from its anchorage, a thin probe is required to be inserted into the hole located on the underside of the floor mounted buckle. If the buckle and tongue are not reconnected, then the belt is not safe to be used.

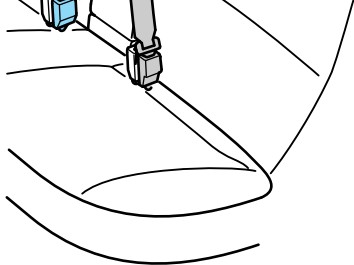

illuminated and the reminder chime is sounding, the safety belt indicator light and reminder turn off.

Safety belt extension assembly

The safety belt may be too short even when fully extended. Approximately 20 cm (8 inches) may be added to the length of the belt with a safety belt extension (part number 611C22). Safety belt extensions are available at no cost from your dealer.

Only use extensions manufactured by the same supplier as the safety belt. Manufacturer identification is

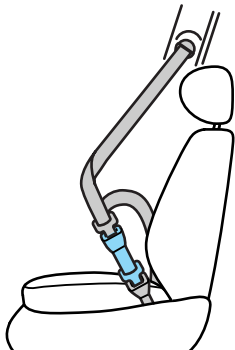

replaced and the anchorages checked by your dealer or a qualified technician.



Failure to follow these instructions will affect the performance of the safety belts and increase the risk of personal injury.

Safety belt warning label

A warning label has been placed on the buckle of each of your vehicle's front seat safety belts.

In a collision of sufficient severity while the safety belt is in use, the safety belt buckle will pull out of

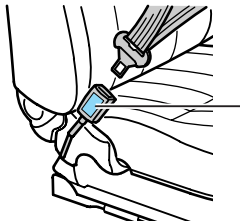

⚠ WARNING Replace buckle assembly if this vehicle is in a collision or if any orange portion of this label is visible. (See Owner Guide). Failure to replace this buckle assembly under the above conditions could result in severe personal injuries in the event of collision.

⚠ AVERTISSEMENT Remplacer l'ensemble de boucle de ceinture en cas de collision avec ce véhicule, ou si la partie orange de cette étiquette est visible (Voir le Guide du propriétaire). Faute de remplacer cet ensemble de boucle, des blessures graves pourraient être encourues en cas de collision.

AIR BAG SUPPLEMENTAL RESTRAINT SYSTEM (SRS)

Important supplemental restraint system (SRS) precautions

The supplemental restraint system (SRS) is designed to:

- work with the safety belt to protect the driver and right front passenger.
- reduce certain upper body injuries.



(SRS) or its fuses. See your Ford or Lincoln-Mercury dealer.

Children and air bags

For additional important safety information, read all information on safety restraints in this guide.

Children should always wear safety belts. Failure to follow these instructions may increase the risk of injury in a collision.

⚠ When installing forward-



that something is wrong with the system. Rather, it means the forces were not of the type sufficient to cause activation.

The air bags inflate and deflate rapidly upon activation.

After air bag deployment, it is normal to notice a smoke-like, powdery residue or smell the burned propellant. This may consist of cornstarch, talcum powder (to lubricate the bag), or sodium compounds (e.g., baking soda) that result from the combustion process that inflates the air bag. Small amounts of sodium hydroxide may be present, which may irritate the skin and eyes, but none of the residue is toxic.



replaced, the unrepaired area will increase the risk of injury in a collision.

The SRS consists of the following:

- driver and passenger air bag modules (which include the inflators and air bags),
- one impact and one safing sensor,
- a readiness light and secondary warning light, and
- the electrical wiring and components.

The diagnostic module monitors its own internal circuits and the supplemental air bag electrical system readiness (including the

A difficulty with the system is indicated by one or more of the following:

- The readiness light will either flash or stay lit.
- The readiness light will not illuminate after ignition is turned on.
- The air bag secondary warning light will flash five times. The pattern will repeat periodically until the problem or the readiness light is repaired.

If any of these things happen, even intermittently, have the SRS serviced at your dealership or by a qualified technician immediately. Unless serviced, the system may



statistics indicate that children are safer when properly restrained in the rear seats than in the front seats.



Do not leave children, unreliable adults, or pets unattended in your vehicle.



Safety belts and seats can become hot in a vehicle that has been closed up in sunny weather; they could burn a small child. Check seat covers and buckles before you place a child anywhere near them.



It is extremely dangerous to

children. Check your local and state or provincial laws for specific requirements regarding the safety of children in your vehicle.



Never let a passenger hold a child on his or her lap while the vehicle is moving. The passenger cannot protect the child from injury in a collision.

Always follow the instructions and warnings that come with any infant or child restraint you might use.

When possible, place children in the rear seat of your vehicle.

If the shoulder belt portion of a combination lap and shoulder belt can be positioned so it does not cross or rest in front of the child's face or neck, the child should wear the lap and shoulder belt. Moving the child closer to the center of the vehicle may help provide a good shoulder belt fit.

If the shoulder belt cannot be properly positioned:

- move the child to one of the seats with a lap belt only (if equipped).

OR

- if the child is the appropriate size, restrain the child in a safety seat.



fit of lap and shoulder belts on the child. A belt-positioning booster seat should be used if the shoulder belt rests in front of the child's face or neck, or if the lap belt does not fit snugly on both thighs, or if the thighs are too short to let the child sit all the way back on the seat cushion when the lower legs hang over the edge of the seat cushion. You may wish to discuss the special needs of your child with your pediatrician.

information on the built-in child seat.

Use the built-in child seat only if the child is at least one year old, weighs 10-27 kg (22-60 lbs) and the child's shoulders fit below the shoulder harness slots on the built-in child seat.

Children not meeting these requirements should be secured in an aftermarket seat. Refer to *Child safety seats* in this chapter.



All built-in child restraints, including seats, buckles, retractors, seat latches, interlocks, and attaching hardware should be inspected by a qualified dealer technician after any collision.

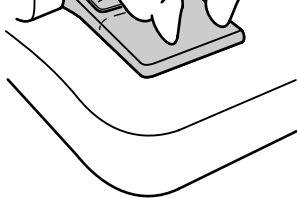

deployed, the seatback cannot be released.

Built-in child seat retractors

The belts on built-in child seats are equipped with a retractor. The retractor will automatically snug the belts around the child. If the belts do not remain snug, take the vehicle to your dealer or a qualified technician for child seat repair. The belts will not remain snug during a collision if the retractor is not functioning properly.



Never use the built-in child seat as a booster cushion with the adult safety belts. A child using the adult belts could slide forward and out from under the safety belts.



The rear seatback must be fully locked before operating the child safety restraint system.

1. Make sure that the seatback is securely latched in place.
2. Grasp the child seat cushion and pull the top forward to release the latch. Continue to unfold the child

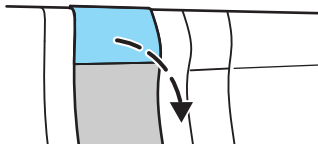



4. If connected, squeeze the tabs on the top and bottom of the chest clip and pull the halves apart to open the chest clip. Then release the lower half of belt by pressing the red button.

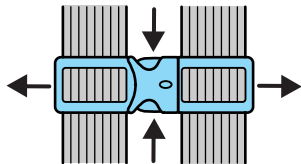

5. Place the child in the child seat and position the shoulder belts over each shoulder.



If both tongues do not latch in the buckle, do not use the child seat. See your dealer for repairs.

7. Fasten both halves of the chest clip below the child's shoulders and adjust it to comfortably hold the shoulder belts in place on the child's chest. The color green must appear in the indicator window when fastened.

8. Pull the lap portion of the belts toward you to make sure the crotch safety belt buckle is properly fastened and the retractor is

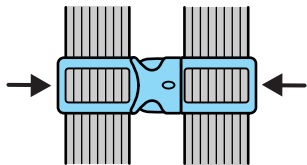

child's shoulders and remove the child.

To stow the built-in child seat

Return the child seat cushion to the upright position, then press firmly in the center and top of the child seat.

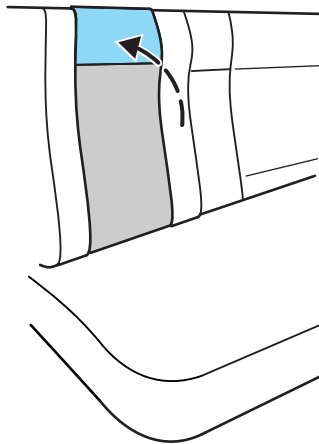

Inspecting the built-in child seat after a collision

All built-in child restraints, including seats, buckles, retractors,

Ford recommends the use of a child safety seat having a top tether strap. Install the child safety seat in a seating position which is capable of providing a tether anchorage. For more information on top tether straps see *Attaching safety seats with tether straps* in this chapter.

When installing a child safety seat:

- Use the correct safety belt buckle for that seating position.
- Make sure the tongue is securely fastened in the buckle.
- Keep the buckle release button pointing up and away from the safety seat, with the tongue between the child seat and the release button, to prevent accidental unbuckling.

the instrument panel as possible.
Never secure rear-facing infant seats in the front seat.

2. Pull down on the shoulder belt and then grasp the shoulder belt and lap belt together.

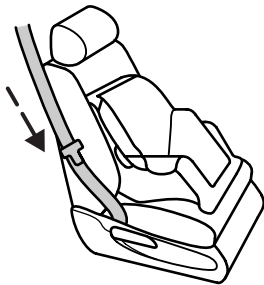

3. While holding the shoulder and lap belt portions together, route



5. To put the retractor in the automatic locking mode, grasp the shoulder portion of the belt and pull downward until all of the belt is extracted and a click is heard.

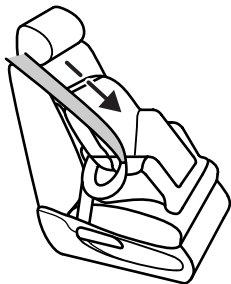

6. Allow the belt to retract. The belt will click as it retracts to



mode (you should not be able to pull more belt out). If the retractor is not locked, unbuckle the belt and repeat steps two through nine.

Check to make sure the child seat is properly secured before each use.

Attaching safety seats with tether straps

Some manufacturers make safety seats that include a tether strap that goes over the back of the vehicle seat and attaches to an anchoring point. Other

To install a tethered child safety seat in the rear seat, you will need tether anchor hardware.



Tighten the anchor according to specifications. Otherwise, the safety seat may not be properly secured and the child may be injured in a sudden stop or collision.

Tether anchor hardware

Tether anchor hardware kits (part

Starting

IMPORTANT SAFETY PRECAUTIONS

A computer system controls the engine's idle revolutions per minute (rpm). When the engine starts, the idle rpm runs faster to warm the engine. If the engine idle speed does not slow down automatically, have the vehicle checked by your dealer or a qualified service technician. Do not allow the vehicle to idle for more than ten minutes.

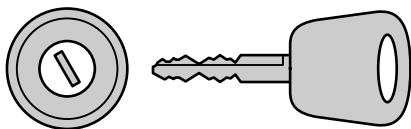

Extended idling at high engine speeds can produce very high temperatures in the engine and exhaust system, creating the risk of fire or other damage.



Do not park, idle, or drive your vehicle in dry grass or other dry ground cover. The emission system heats up the engine compartment and exhaust system, which can start a fire.



Do not start your vehicle in a closed garage or in other enclosed areas. Exhaust fumes can be toxic. Always open the garage door before you start the engine. See *Guarding against exhaust fumes* in this chapter for more instructions.

IMPORTANT VENTILATION INFORMATION

If the engine is idling while the vehicle is stopped in an open area for long periods of time, open the windows at least 2.5 cm (1 inch).

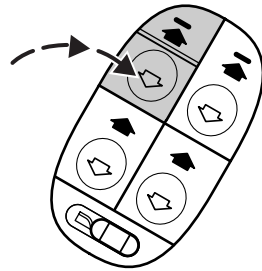

Adjust the heating or air conditioning to bring in fresh air.

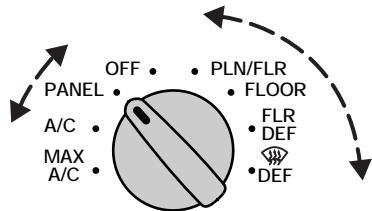

Starting

Improve vehicle ventilation by keeping all air inlet vents clear of snow, leaves, and other debris.

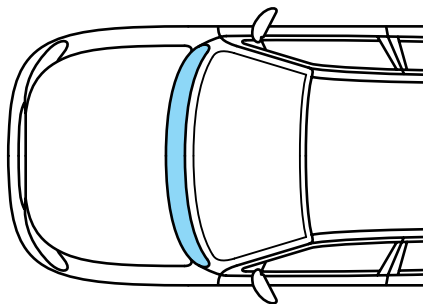

Guarding against exhaust fumes

Although odorless and colorless, carbon monoxide is present in exhaust fumes. Take precautions to avoid its dangerous effects.



If you ever smell exhaust fumes of any kind inside your vehicle, have your dealer inspect and fix your vehicle immediately. Do not drive if you smell exhaust fumes. These fumes are harmful and could kill you.

Have the exhaust and body ventilation system checked whenever:

- the vehicle is raised for service.
- the sound of the exhaust system changes.
- the vehicle has been damaged in a collision.

PREPARING TO START THE VEHICLE

Engine starting is controlled by the spark ignition system. This system meets all Canadian Interference-Causing Equipment standard requirements regulating the impulse electrical field strength of radio noise.

When starting a fuel-injected engine, avoid pressing the accelerator pedal before or during starting. Only use the accelerator pedal when you have difficulty starting the engine. For more information on starting the vehicle, refer to *Starting the engine* in this chapter.

Before starting the vehicle:

1. Make sure all vehicle occupants have buckled their safety belts. For more information on safety belts and their proper usage, refer to the *Seating and safety restraints* chapter.
2. Make sure the headlamps and vehicle accessories are off.

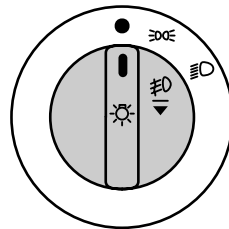

Starting

If starting a vehicle with an automatic transaxle:

- Make sure the parking brake is set.
- Make sure the gearshift is in P (Park).

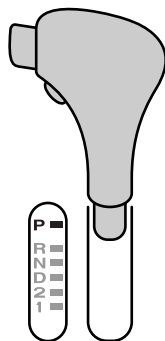

If starting a vehicle with a manual transaxle:

- Make sure the parking brake is set.
- Push the clutch pedal to the floor. Otherwise, the engine will not crank (turn over).
- Put the gearshift into neutral.

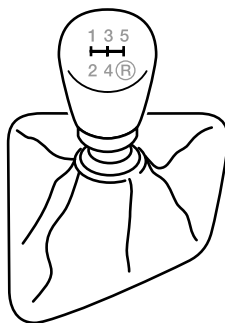

3. Turn the key to the on position (without turning the key to start).

Make sure the following lights illuminate briefly. If a light fails to illuminate, have the vehicle serviced by your dealer or a qualified service technician.



Alternative design

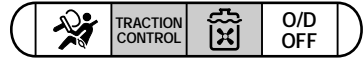
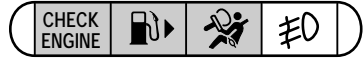

- If the driver's safety belt is fastened the safety belt warning light does not illuminate.



Alternative design

Starting

STARTING THE ENGINE

1. Turn the key to the start position (4) without pressing the accelerator pedal and release as soon as the engine starts. The key will return to the on (3) position.

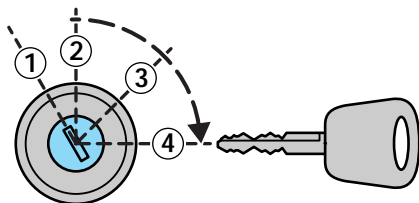

2. If the engine does not start within five seconds, wait ten seconds and try again.

3. If the engine does not start in two attempts OR the temperature is below -12°C (10°F), depress the accelerator pedal and start the engine while holding the accelerator pedal down. Release the accelerator pedal when the engine starts.

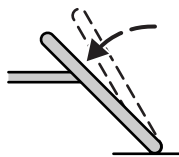

Vehicles equipped with the 2.0 l engine: If the engine fails to start, continue to crank with the accelerator depressed about 1/4 of the way down and hold that position until the engine starts.

DO NOT crank for more than 30 seconds or you could damage the starter.

4. After idling the engine for a few seconds, apply the brake pedal and release the parking brake.

USING THE ENGINE BLOCK HEATER (if equipped)

An engine block heater warms the engine coolant, which improves starting, warms up the engine faster and allows the heater-defroster system to respond quickly. It is strongly recommended if you live in a region where temperatures reach -23°C (-10°F) or below.

For best results, plug the heater in at least three hours before starting the vehicle. Using the heater for more than three hours will not harm the engine, so the heater can be plugged in the night before starting the vehicle.



To prevent electrical shock, do not use your heater with ungrounded electrical systems or two-pronged (cheater) adapters.

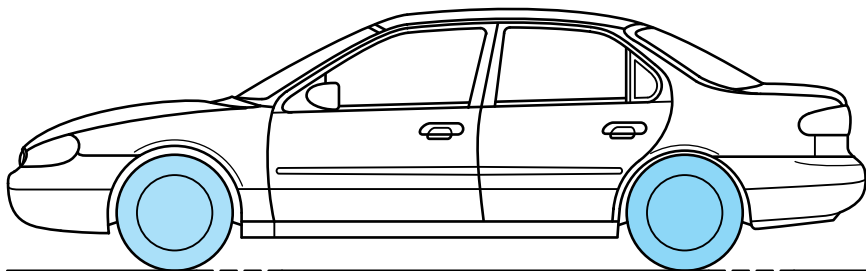

BRAKES

Your brakes are self-adjusting. Refer to the “Scheduled Maintenance Guide” for maintenance intervals.

Anti-lock braking system (ABS) (if equipped)

The ABS operates by detecting the onset of wheel lock-up during brake applications and compensating for this tendency. The wheels are prevented from locking even when the brakes are firmly applied, helping to ensure that the vehicle can be steered and the driver can avoid obstacles.

Operation of the anti-lock braking system

The anti-lock braking system is not employed during normal braking. It becomes operational only when it senses differences in the rotational speed of the road wheels, indicating that they are about to lock-up. Its operation is indicated by a pulsing of the brake pedal. Do not release the pedal while braking.

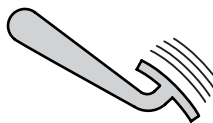

Braking with ABS

- In an emergency, apply full force on the brake pedal. In vehicles with manual transaxles, you must also depress the clutch pedal. The anti-lock braking system will be activated immediately, allowing you to retain full steering control of your vehicle and, providing there is sufficient space, will enable you to avoid obstacles.

- We recommend that you familiarize yourself with this braking technique. However, avoid taking any unnecessary risks.

- Although the ABS ensures optimum braking efficiency, stopping distances can vary greatly, depending on the road surface and conditions. Use of the ABS cannot eliminate the dangers inherent in driving too close to the vehicle in front of you, hydroplaning, excessive cornering speed, or poor road surfaces.

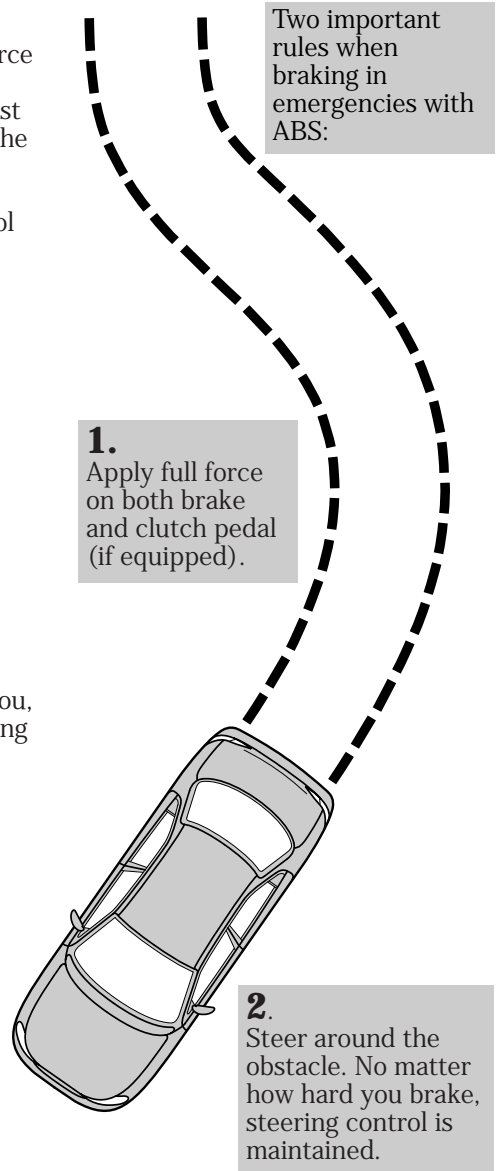

Driving

Parking brake

To engage the parking brake:

Pull the handle upward.

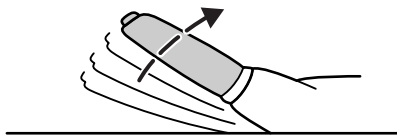

To release the parking brake:

1. Press and hold the release button.
2. Push handle downward to the off position.

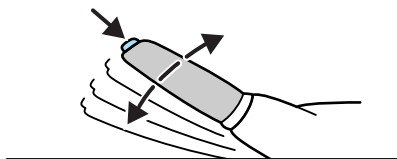

 Always set the parking brake fully and make sure that the gearshift is securely latched in P (Park) (automatic transaxle) or in 1 (first) (manual transaxle).

 To prevent personal injury, do not release the parking brake while outside the vehicle.

TRACTION CONTROL (if equipped)

This system prevents wheel spin at all speeds. The control will toggle this function on and off, but the feature defaults to on after each cycle of the ignition key.

The traction control system controls excessive wheel spin by automatically applying and releasing the brakes in conjunction with engine torque reductions.

This can occur when accelerating on a slippery road, a loose surface or when pulling away on a hill. The traction control lamp flashes on the instrument panel when the system is functioning to regulate tire traction.

When the ignition is turned to the on position, the traction control system light comes on for approximately three (3) seconds. If the light does not come on when the ignition is turned to the on position or if it remains on when the traction control system is turned on, have the system serviced by your dealer or a qualified service technician. You can continue to drive and do not need to have the vehicle towed in.

You should not take unnecessary driving risks because of the system's safety potential.

Switching off traction control

If you become stuck in snow or on a slippery road surface, try switching off the traction control system by pressing the switch. This may allow the excess wheel spin to “dig” the vehicle out or enable a successful “rocking” maneuver. Do not rock the vehicle for more than a few minutes, because it could damage the vehicle.

The light in the control illuminates continuously when the system has been switched off. To reactivate the system, depress the switch again or restart the engine.

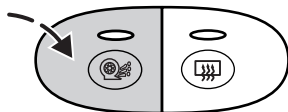

STEERING YOUR VEHICLE

Your vehicle comes with power steering. Power steering uses energy from the engine to help steer your vehicle.

If the amount of effort needed to steer your vehicle at a constant vehicle speed, have the power steering system checked. If the power steering system breaks down (or if the engine is turned off), you can steer the vehicle manually but it takes more effort.

Never hold the steering wheel to the extreme right or left for more than five seconds if the engine is running. This can damage the power steering pump.

Speed sensitive power steering (if equipped)

The steering system is speed sensitive. This means that the steering effort is light for parking and heavier for highway driving. However, if you have to swerve around an object or another vehicle, your vehicle will have full power assist.

TRANSAXLE OPERATION

Automatic transaxle (if equipped)

Vehicles equipped with an automatic transaxle are equipped with a brake-shift interlock feature that prevents the gearshift lever from being moved from the P (Park) position unless the brake pedal is depressed.

Putting your vehicle in gear

You must push the thumb button to move the gearshift to the position you choose.

To operate:

1. Start the engine.
2. Depress and hold the brake pedal.
3. Move the gearshift lever out of P (Park).

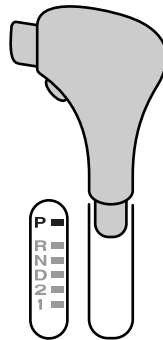

Overriding the brake-shift interlock feature

If it is necessary to use this procedure to move the gearshift lever, it is possible that a fuse has blown and the vehicle's brakelamps may not be working. Refer to *Fuses and relays* in the *Roadside emergencies* chapter.

If you cannot move the gearshift lever from P (Park) with the brake pedal depressed:

1. Turn the ignition off and remove the ignition key.
2. Apply the parking brake and the brake pedal.
3. Insert a screwdriver or similar item about 5 cm (2 inches) into the square opening to the right of the gearshift at the base of the console.
4. Rotate the screwdriver point rearward.
5. Push and hold the thumb button and move the gearshift.
6. Remove the screwdriver when the gearshift moves from the P (Park) position.

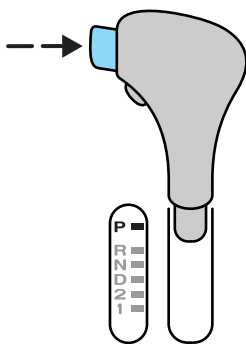
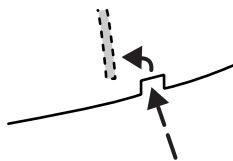
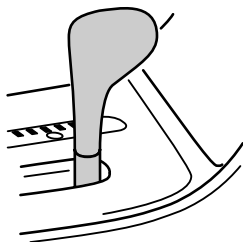

The console-mounted gearshift will lock when you turn the key to the lock position. When the gearshift is in any position except P (Park), the ignition key cannot be turned to lock or removed from the steering column. To remove the key, the gearshift lever must be in P (Park).

Once the gearshift is secure in the desired position, release the brake pedal and use the accelerator as necessary.

Driving



Never leave a vehicle unattended while it is running.

- **P** (Park)

Always come to a complete stop before shifting into P (Park). This locks the transaxle and prevents the front wheels from rotating.

- **R** (Reverse)

The vehicle only moves backward. Always come to a complete stop before shifting in or out of R (Reverse).

P = Park **P** ■

R = Reverse **R** ■

N = Neutral. **N** ■

D = Drive: Gear 1 to 4
with overdrive. **D** ■
Gear 1 to 3
with overdrive
cancelled

2 = Gear 2 **2** ■

1 = Gear 1 **1** ■

Driving

- **N** (Neutral)

The wheels of the transaxle are not locked. Your vehicle will roll freely, even on the slightest incline, unless the parking brake or brakes are on.

- **D** (Overdrive)

Note that the vehicle's gearshift is console-mounted on the floor. The transaxle control switch (TCS) is located on the gearshift handle. The transaxle control indicator light (O/D light) is located on the instrument panel.

Overdrive is not shown on the display, but is the default mode for the D gearshift position. This is the normal driving mode for the best fuel economy. The transaxle operates in gears one through four. The O/D light is off (not illuminated) during normal vehicle operation.

Overdrive can be deactivated by pressing the transaxle control switch (TCS) located on the gearshift handle. The O/D OFF indicator light will illuminate in the instrument cluster.

- **D (Drive)**

D (Drive) provides more engine braking than overdrive and is useful when driving through hilly terrain or if your vehicle requires additional power for climbing hills. Activate by pressing the transaxle control switch (TCS) located on the gearshift handle. The O/D OFF indicator light will illuminate in the instrument cluster. Transaxle operates in gears one through three.

To return to overdrive mode, press the transaxle control switch. The O/D OFF indicator light will extinguish.

When starting your vehicle, the transaxle will automatically return to normal overdrive mode when the D (Drive) gearshift position is selected.

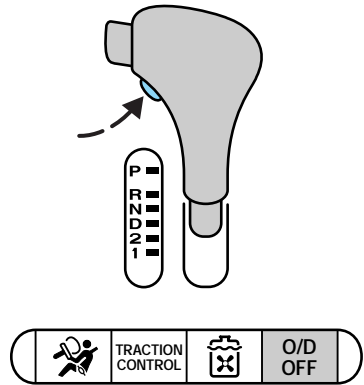

- **2** (Second)

Use the 2 (Second) position to start up on slippery roads or to provide additional braking on downgrades. When your vehicle is in 2 (Second), it automatically starts off in second gear. Do not go faster than 90 km/h (55 mph) in this gear.

- **1** (First)

Use the 1 (First) position to provide maximum engine braking on steep downgrades. Upshifts will not occur while the gearshift lever remains in the 1 (First) position. Upshifts may be made by shifting to the 2 (second) position or to D (Drive). Selecting the 1 (First) position at high speeds causes the transaxle to downshift through the gears and will shift to 1 (First) after the vehicle decelerates to the transaxle first gear designed speed. Do not go faster than 60 km/h (38 mph) in this gear.

Manual transaxle (if equipped)

Vehicles equipped with a manual transaxle have a starter interlock that prevents cranking the engine unless the clutch pedal is fully depressed.

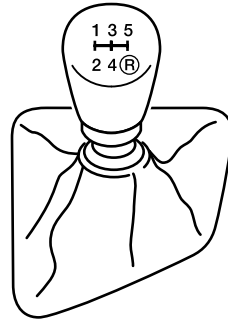

Using the clutch

When starting a vehicle with a manual transaxle:

1. Hold down the brake pedal.
2. Depress the clutch pedal.
3. Put the gearshift lever in neutral.
4. Start the vehicle.
5. Put the gearshift in 1 (First) or R (Reverse).
6. Release the clutch slowly while pressing gradually down on the accelerator pedal.

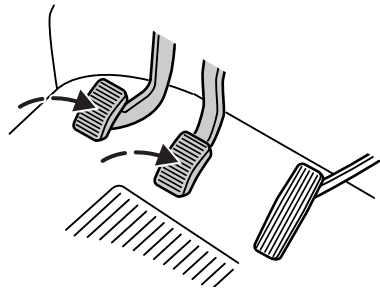

Do not drive with your foot resting on the clutch pedal. Do not use the clutch to hold your vehicle at a standstill while waiting on a hill. These actions may reduce the clutch life.

Recommended shift speeds

2.0 litre engine 5-speed transaxle shift speed schedules				
Recommended upshifts:	During acceleration:		During cruise*:	
	km/h	mph	km/h	mph
Shift from				
First to second	22	14	19	12
Second to third	40	25	32	20
Third to fourth	53	33	46	29
Fourth to fifth	77	48	64	40

2.5 litre engine 5-speed transaxle shift speed schedules				
Recommended upshifts:	During acceleration:		During cruise*:	
	km/h	mph	km/h	mph
Shift from				
First to second	22	14	16	10
Second to third	40	25	32	20
Third to fourth	53	33	50	31
Fourth to fifth	73	45	64	40

*The vehicle can be shifted at lower speeds to improve fuel economy.

Parking

1. Apply the brake and the clutch and shift into neutral.
2. Engage the parking brake.
3. Shift into 1 (First) or R (Reverse).
4. Turn the ignition off.



Do not park your vehicle in Neutral, it may move unexpectedly and injure someone. Use 1 (first) gear and set the parking brake.

Reverse

To shift into R (Reverse):

1. Completely stop your vehicle.
2. Depress the clutch pedal to the floor and place the gearshift lever in the neutral position. Do not release the clutch pedal.
3. If the following direction is not followed, a grinding noise may occur.

Wait a minimum of three seconds before attempting to shift into R (Reverse) gear.

4. Push the gearshift lever completely to the right, pull up the ring on the stalk of the gearshift lever, and then pull rearward on the gearshift lever to engage the R (Reverse) gear.

5. If the R (Reverse) gear is engaged, slowly release the clutch pedal from the floor.

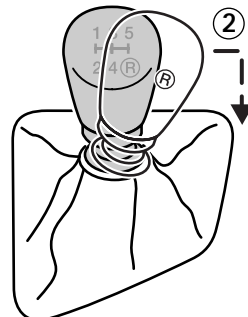
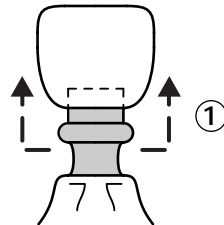
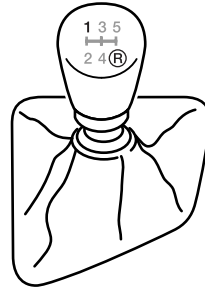
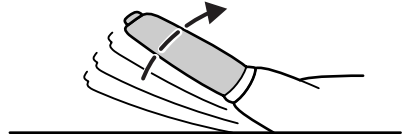

LOADING YOUR VEHICLE

Before loading your vehicle, familiarize yourself with these terms.

Base curb weight

Weight of the vehicle including any standard equipment, fluids and lubricants. It does not include passengers or aftermarket equipment.

Payload

Combined maximum allowable weight of passengers, cargo and optional equipment.

GVW (Gross Vehicle Weight)

Base curb weight plus the payload weight. The GVW is not a limit or a specification.

GVWR (Gross Vehicle Weight Rating)

Maximum total weight of the base vehicle, passengers, optional equipment and cargo. The GVWR is specific to each vehicle and is listed on the Safety Compliance Certification Label on the driver's door pillar.

GAWR (Gross Axle Weight Rating)

Carrying capacity for each axle system (front and rear). The GAWR is specific to each vehicle and is listed on the Safety Compliance Certification Label on the driver's door pillar.

GCW (Gross Combined Weight)

The GCW is the maximum combined weight of the towing vehicle (including passengers and cargo) and the loaded trailer. The GCW is specified by the manufacturer to indicate the combined maximum loaded weight that the vehicle is designed to tow.

Payload = GVWR minus Base curb weight

To obtain the correct weight for your vehicle, try taking your vehicle to a shipping company or an inspection station for trucks.

Do not use replacement tires with lower weight capacities than the originals because they might lower the vehicle's GVWR and GAWR. (Replacement tires with a higher weight limit than the originals do not increase the GVWR and GAWR limitations.)

In high altitudes, engines will lose power at a rate of 3% power per 300 m (1 000 ft) increase in elevation. A reduction in GVW and GCW is recommended for maximum vehicle performance.

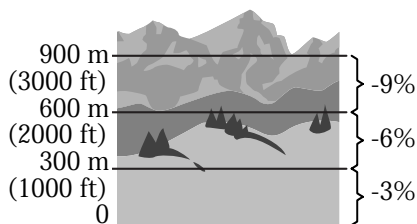

Do not exceed the GVWR or the GAWR specified on the Safety Compliance Certification Label.



It is extremely dangerous to ride in a cargo area, inside or outside of a vehicle. In a collision, people riding in these areas are more likely to be seriously injured or killed. Do not allow people to ride in any area of your vehicle that is not equipped with seats and safety belts. Be sure everyone in your vehicle is in a seat and using a safety belt properly.

Driving with a heavy load

The total weight of the vehicle plus the total weight of passengers and cargo should never exceed the GVWR.

The weight that the vehicle carries over the front and rear axles should never exceed the GAWR for the respective axle.

The weight limits of your vehicle's tires affect the GVWR and GAWR limitations. Using tires with higher weight limits than the original tires will not increase the GVWR or GAWR of your vehicle; using tires with lower weight limits may lower the GVWR or GAWR of your vehicle.

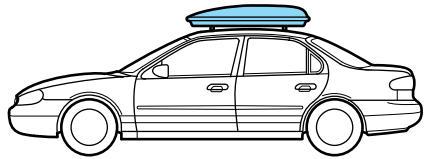

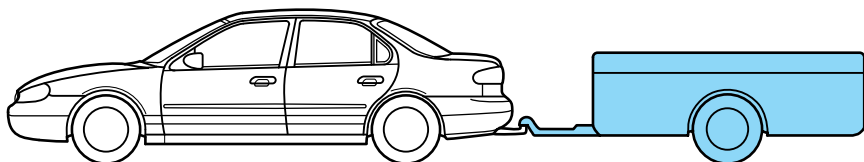

TRAILER TOWING

Your vehicle is capable of towing a trailer of up to a maximum of 454 kg (1 000 lbs) gross trailer weight with a maximum tongue load of 45 kg (100 lbs). It should also have 2.3 sq. meters (25 sq. feet) or less frontal area. Do not drive faster than 72 km/h (45 mph) while towing a 454 kg (1 000 lb) trailer.

Your vehicle does not come from the factory fully equipped to tow. No towing packages are available through Ford or Lincoln/Mercury dealers.

Trailer towing puts additional loads on your vehicle's engine, transaxle, axle, brakes, tires, and suspension. For your safety and to maximize vehicle performance, be sure to use the proper equipment while towing.

Follow these guidelines to ensure safe towing procedure:

- Stay within your vehicle's load limits.
- Thoroughly prepare your vehicle for towing. Refer to *Preparing to tow* in this chapter.
- Use extra caution when driving while trailer towing. Refer to *Driving while towing a trailer* in this chapter.
- Service your vehicle more frequently if you tow a trailer. Refer to the severe duty schedule in the maintenance guide and or service guide.
- Do not tow a trailer until your vehicle has been driven at least 800 km (500 miles).
- Refer to the instructions included with towing accessories for the proper installation and adjustment specifications.

Driving

Do not exceed the maximum loads listed on the Safety Compliance Certification Label. For load specification terms found on the label, refer to *Loading your vehicle* in this chapter. Remember to figure in the tongue load of your loaded vehicle when figuring the total weight.



Towing trailers beyond the maximum recommended gross trailer weight exceeds the limit of the vehicle and could result in engine damage, transaxle damage, structural damage, loss of control, and personal injury.

Preparing to tow

Use the proper equipment for towing a trailer and make sure that it is properly attached to your vehicle. See your dealer or a reliable trailer retailer if you require assistance.

Auxiliary coolers are recommended for the power steering system and automatic transaxle system if you are planning on:

- Traveling farther than 80 km (50 miles).
- Towing in hilly terrain.
- Towing frequently.

Using a hitch

Do not use hitches that:

- Clamp onto the vehicle bumper.
- Attach to the axle.

Distribute the load so that only 10 to 15% of the total weight of the trailer is on the tongue. Tie down the load so that it does not shift and change weight on the hitch. Follow the instructions of a reputable rental agency.

Using trailer lamps

See your local trailer retailer or rental agency for proper instructions and equipment for hooking up trailer lamps.

Do not hook the trailer lamps directly into the vehicle's wiring system. If the trailer lamps are not working properly, the warning lights in the instrument cluster may not work properly.

Using trailer brakes

Use electric brakes or manual, automatic or surge type hydraulic brakes that meet federal and local regulations. Install and adjust brakes according to the manufacturer's instructions.



Do not connect a trailer's hydraulic brake system directly to your vehicle's brake system. Your vehicle may not have enough braking power and your chances of having a collision greatly increase.

Using safety chains

Always connect the trailer's safety chains to the vehicle. To connect the chains, cross the chains under the trailer tongue and attach to the vehicle frame or hook retainers (not the bumper). Make sure there is enough slack to allow the vehicle to turn corners.

Driving while towing a trailer

Do not drive faster than 72 km/h (45 mph) while towing a 454 kg (1 000 lb) trailer. Do not drive faster than 72 km/h (45 mph) with any weight trailer while towing in hilly terrain or on hot days.

Speed control (if equipped) may not work properly while towing on long, steep grades.

If driving with an automatic transaxle:

- Use D (Drive) or a low gear rather than D (Overdrive) by depressing the TCS button on the side of the gearshift lever, while towing up or down steep inclines.
- Anticipate stops and brake gradually.

If driving with a manual transaxle:

- Select a gear that avoids jerking or excessive engine speed.
- Avoid driving excessively in first or second gear. If you need to drive excessively in first or second gear, the trailer may be too big or too heavily loaded for the vehicle drivetrain.
- Shift to a lower gear while towing up or down steep hills.
- Anticipate stops and brake gradually.

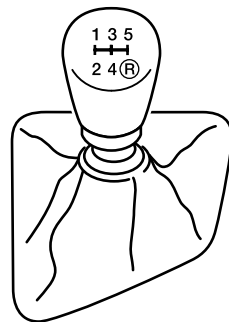
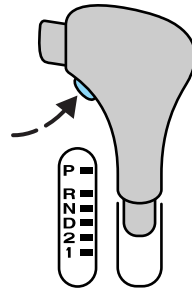

FUEL CONSUMPTION

Fuel economy can be improved by avoiding:

- lack of regular, scheduled maintenance,
- excessive speed,
- rapid acceleration,
- driving with the brake pedal depressed,
- sudden stops,
- extended engine idling,
- use of speed control in hilly terrain,
- extended use of the air conditioner, defroster, rear window defroster and other accessories,
- underinflated tires,
- heavy loads,
- aftermarket add-ons such as bike, ski or luggage racks, bug deflectors, etc.

HAZARD FLASHER CONTROL

Use only in an emergency to warn traffic of vehicle breakdown or approaching danger. Depress to activate. Depress again to switch off. The hazard lights can be operated when the ignition is off.

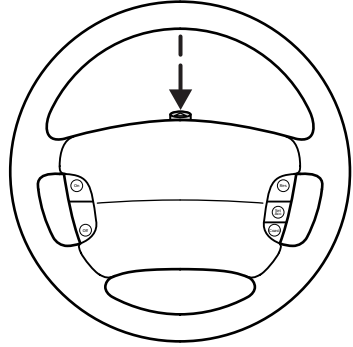

FUEL PUMP SHUT-OFF SWITCH

If the engine cranks, but does not start or does not start after a collision, the fuel pump shut-off switch may have been activated. The shut-off switch is a device intended to stop the electric fuel pump when your vehicle has been involved in a substantial jolt.

Once the shut-off switch is activated, you must reset the switch by hand before you can start your vehicle. The switch is located on the side panel in front of the driver's side door.

Roadside emergencies

 If you see or smell fuel, do not reset the switch or try to start your vehicle. Have all the passengers get out of the vehicle and call the local fire department or a towing service.

If your engine cranks but does not start after a collision or substantial jolt:

1. Turn the ignition key to the off position.
2. Check under the vehicle for leaking fuel.
3. If you do not see or smell fuel, push the red reset button down. If the button is already set, you may have a different mechanical problem.
4. Turn the ignition key to the on position for a few seconds, then turn it to the off position.
5. Check under the vehicle again for leaking fuel. If you see or smell fuel, do not start your vehicle again. If you do not see or smell fuel, you can try to start your vehicle again.

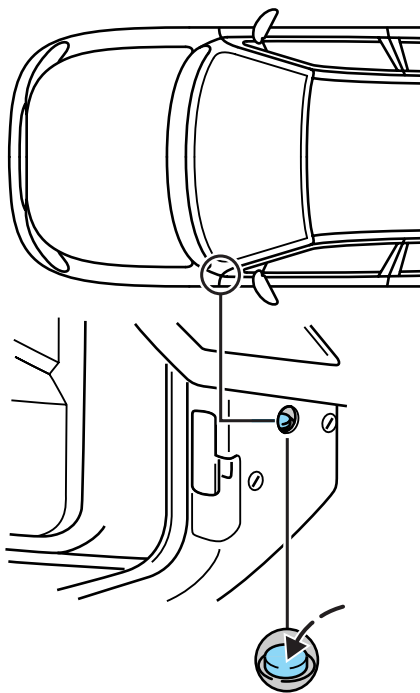

FUSES AND RELAYS

If electrical components in the vehicle are not working, a fuse may have blown. Blown fuses are identified by a broken wire. Check the appropriate fuses before replacing any electrical components.

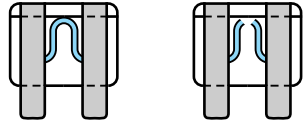

Always replace a fuse with one that has the specified amperage rating. Using a fuse with higher amperage rating can cause severe wire damage and could start a fire.

Even after a fuse is replaced, it will continue to blow if the cause of the overload is not identified and corrected. If the fuse continues to blow, have the vehicle's electrical system checked by your dealer or a qualified service technician.

To reset a circuit breaker press the reset button.

The passenger compartment fuse panel is located on the driver's side under the instrument panel. The power distribution box is located on the driver's side of the engine compartment.

They contain the main fuses and the main relays. The circuits protected are identified by numbers on the passenger compartment fuse panel and inside the cover on the power distribution box.

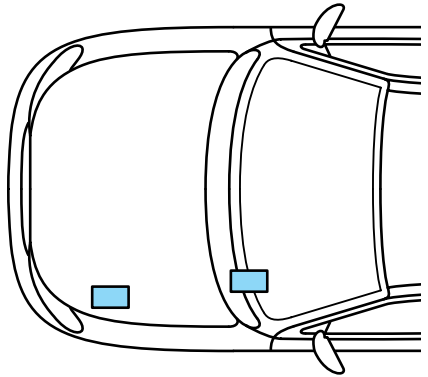

Roadside emergencies

Power distribution box

To check or replace a fuse or a relay, remove the cover of the fuse box in the engine compartment by releasing the latch (1) and lifting up.

A blown fuse can be identified by a break in the wire.

All fuses are a push fit.

Five reserve fuses with different current ratings are attached to the inside cover of the power distribution box in case of emergency fuse replacement.

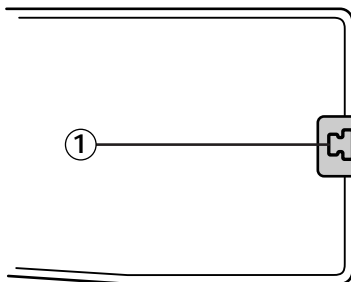

Always replace the cover to the Power Distribution Box before reconnecting the battery or refilling fluid reservoirs.

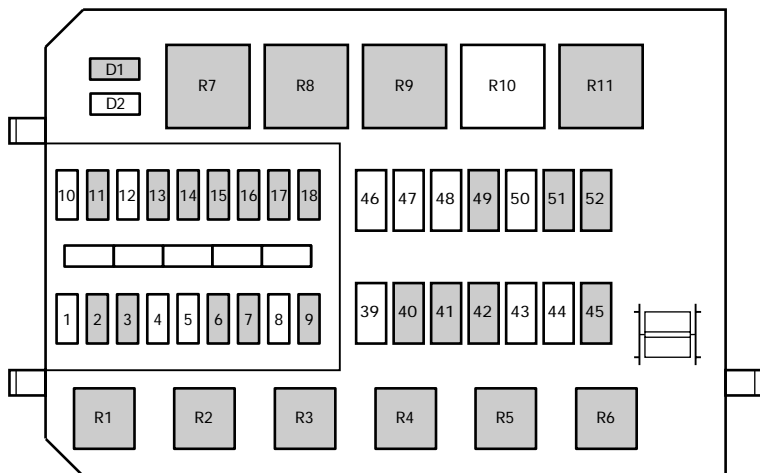

Roadside emergencies

Power distribution box (engine compartment)		
Fuse	Ampere rating	Circuits protected
1	—	Not used
2	7.5	Alternator
3	20	Fog lamps
4	—	Not used
5	—	Not used
6	3	EEC ignition module (memory)
7	20	Horn and hazard flasher warning system
8	—	Not used
9	15	Fuel pump
10	—	Not used
11	20	Ignition, Electronic Engine Control
12	—	Not used
13	20	HEGO sensor
14	7.5	ABS module
15	7.5	Low beam headlamp (passenger's side)
16	7.5	Low beam headlamp (driver's side)
17	7.5	High beam headlamp (passenger's side)
18	7.5	High beam headlamp (driver's side)
39	—	Not used
40	20*	Ignition, light switch, central junction box
41	20*	EEC relay
42	40*	Central junction box (fuse 37 to blower relay)
43	—	Not used
44	—	Not used
45	60*	Ignition
46	—	Not used
47	—	Not used
48	—	Not used
49	60*	Engine cooling
50	—	not used
51	60*	ABS
52	60*	Central junction box (central timer module, rear window defrost relay, fuses 24, 25, 27, 28, 34)

* Have these fuses replaced by your dealer or qualified technician.

Roadside emergencies

Power distribution box (engine compartment)

Relay	Circuits switched
R 1	Fuel pump
R 2	EEC module
R 3	Air conditioning
R 4	Low beam
R 5	High beam
R 6	Horn
R 7	Starter solenoid
R 8	Engine cooling fan (high speed)
R 9	Engine cooling fan
R 10	Not used
R 11	Daytime running lights
D1	Reverse voltage protection
D2	Not used

Passenger compartment fuse panel

To check or change a fuse or a relay, open the fuse box by pulling down the lock release lever (1).

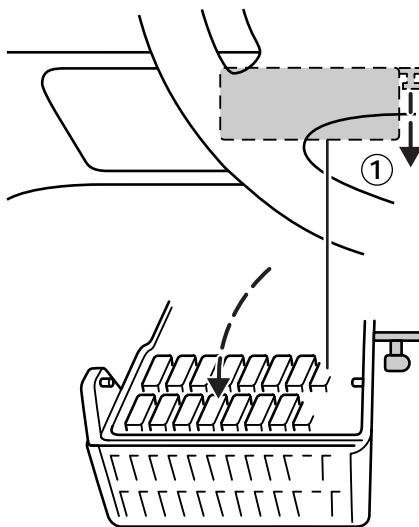

Roadside emergencies

A blown fuse can be identified by a break in the wire.

All fuses are a push fit.

Five reserve fuses with different current ratings are attached to the inside cover of the power distribution box in case of emergency fuse replacement.

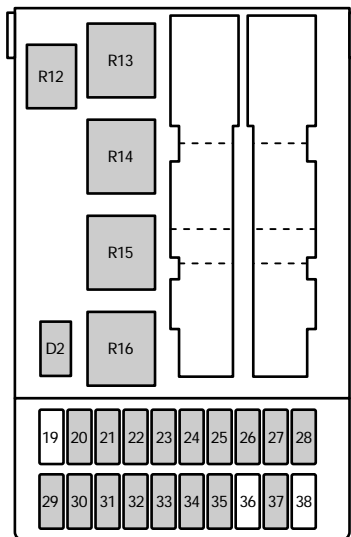

Passenger compartment fuse panel (below instrument panel)

Relay	Circuit switched
R 12	Interior lighting
R 13	Rear window defrost
R 14	Heater blower motor
R 15	Wiper motor
R 16	Ignition
D 2	Reverse voltage protection

Roadside emergencies

Passenger compartment fuse panel (below instrument panel)

Fuse	Ampere rating	Circuits protected
19	—	Not used
20	C10	Wiper motors (circuit breaker)
21	40	Power windows
22	7.5	ABS module
23	15	Backup lamps
24	15	Brake lamps
25	20	Door locks
26	7.5	Main light
27	15	Cigar lighter
28	30	Electric seats
29	30	Rear window defrost
30	7.5	Engine management system
31	7.5	Instrument panel illumination
32	7.5	Radio
33	7.5	Parking lamps - driver's side
34	7.5	Interior lighting/electric mirror adjustment
35	7.5	Parking lamps - passenger's side
36	—	Not used
37	30	Heater blower motor
38	—	Not used

Roadside emergencies

Standard fuse amperage ratings and colors

Fuse rating	Color
3 amp	violet
7.5 amp	brown
10 amp	red
15 amp	light blue
20 amp	yellow
30 amp	light green
30 amp fuse link	pink
40 amp	orange
60 amp fuse link	yellow
80 amp fuse link	black
100 amp fuse link	blue

Auxiliary relays (outside of fuse boxes)

Relay	Circuits switched	Location
R 18	“One touch” switch (driver’s window)	Driver’s door
R 20	Not used	—
R 21	Not used	—
R 22	Fog lamps	Module bracket
R 23	Turn signals	Steering column
R 24	Panic alarm – driver’s side	Door lock module bracket
R 25	Panic alarm – right-hand side	Door lock module bracket
R 26	Not used	—

Roadside emergencies

CHANGING TIRES

Park your vehicle in such a position that neither the traffic nor you are hindered or endangered when changing the tire. Ensure that the vehicle is on firm, level ground. Secure your vehicle further by blocking the wheels.

Activate the hazard lights.

Apply the parking brake and engage first or reverse gear if the vehicle has a manual transaxle or, if the vehicle has an automatic transaxle, select the P (Park) position.

If parking on a slope is unavoidable, block the wheels.

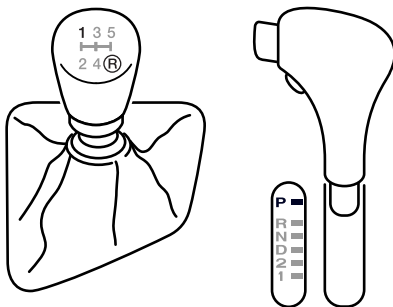
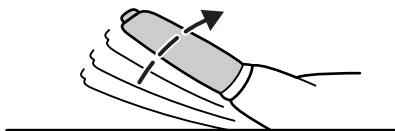

The temporary spare tire

The vehicle may have a high pressure temporary spare tire. This spare is smaller than a regular tire and is designed for emergency use only. This tire should be replaced as soon as possible.



If you use the temporary spare tire continuously or do not follow these precautions, the tire could fail, causing you to lose control of the vehicle, possibly injuring yourself or others.

When driving with a temporary spare tire:

- Do not exceed the maximum speed of 80 km/h (50 mph) and only drive the shortest possible distance.
- Do not exceed the permissible gross weight of the vehicle.
- Do not install more than one spare wheel on your vehicle at any one time.
- Do not use snow chains on this type of wheel.
- Do not drive through an automatic car wash.



Spare tire location

The spare tire and tools are located under the floor cover in the luggage compartment.

Removing the spare tire and tools

1. Raise the rear of the floor cover in the luggage compartment.
2. Completely unscrew the bolt and remove the bolt and cup.
3. Lift out the spare wheel.
4. Unscrew the jack bolt and remove jack.
5. Obtain jack handle, which is located on the floor under the spare wheel.

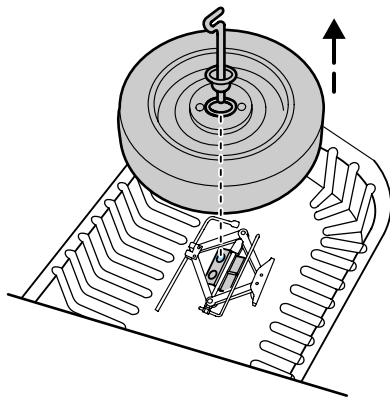

Roadside emergencies

Tire changing procedure

Removing a tire

1. Apply the parking brake and 1 (first) gear (manual transaxle) or the P (Park) position (automatic transaxle).
2. Activate the hazard flashers.
3. The driver and all passengers must leave the vehicle.
4. Secure the vehicle against rolling or sliding.
5. Insert the tapered end of the jack handle between the rim and hub cover and push in. Twist off to remove the cover.
6. Loosen the wheel nuts slightly.
7. Place jack with complete support surface on the ground.
8. The jack must be applied exactly vertical to the jacking point of the vehicle.
9. Jack up the vehicle until the tire is clear of the ground. Unscrew and remove the wheel nuts and remove the wheel.

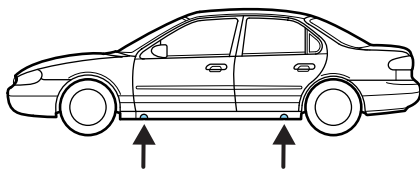
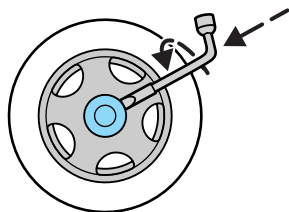
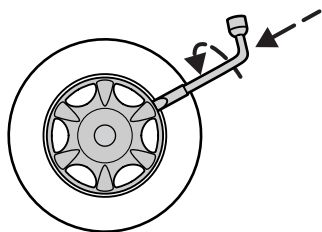

Replacing a tire

1. Push the spare tire onto the wheel studs.
2. Screw on the wheel nuts, ensuring the tapered end of the wheel nuts are facing the wheel, and secure in a clockwise direction.
3. Lower the vehicle and remove the jack by turning the handle counterclockwise.
4. Fully tighten the wheel nuts in a crosswise pattern.
5. Align the hub cap with the valve and push firmly into position with the ball of the hand.
6. Stow the jack and damaged tire in the luggage compartment by reversing the spare tire removal instructions.

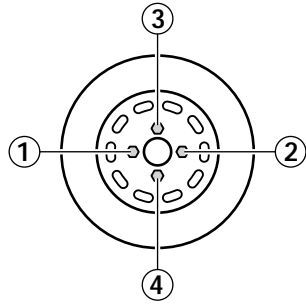
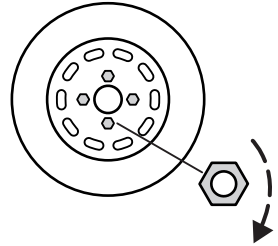

Roadside emergencies

JUMP STARTING YOUR VEHICLE

 The gases around the battery can explode if exposed to flames, sparks, or lit cigarettes. An explosion could result in injury or vehicle damage.

 Do not push start your vehicle. You could damage the catalytic converter.

 Batteries contain sulfuric acid which burns skin, eyes, and clothing if contacted.

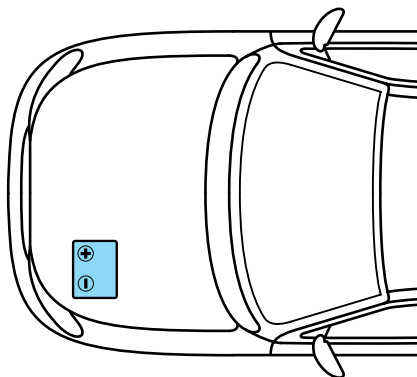

Do not attempt to push start your vehicle. Automatic transaxles do not have push-start capability.

Preparing your vehicle

- 1. Use only a 12-volt supply to start your vehicle.**
2. Do not disconnect the battery of the disabled vehicle as this could damage the vehicles electrical system.

3. Park the booster vehicle close to the hood of the disabled vehicle, making sure the two vehicles **do not** touch. Set the parking brake on both vehicles and stay clear of the engine cooling fan and other moving parts.
4. Check all battery terminals and remove any excessive corrosion before you attach the battery cables. Ensure that vent caps are tight and level.
5. Turn the heater fan on in both vehicles to protect from any electrical surges. Turn all other accessories off.

Connecting the jumper cables

1. Connect the positive (+) booster cable to the positive (+) terminal of the discharge battery.

Note: In the illustrations, “lightning bolts” are used to designate the assisting (boosting) battery.

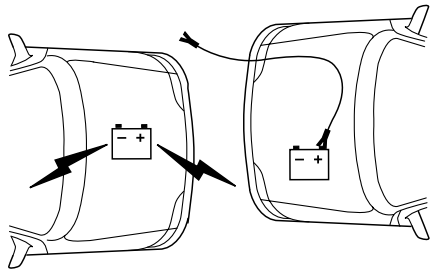

Roadside emergencies

2. Connect the other end of the positive (+) cable to the positive (+) terminal of the assisting battery.

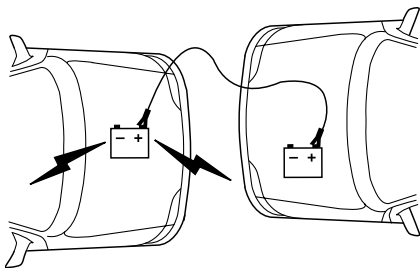

3. Connect the negative (-) cable to the negative (-) terminal of the assisting battery.

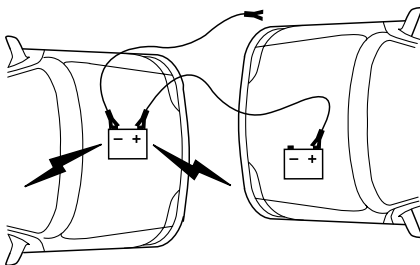

4. Make the final connection of the negative (-) cable to an exposed metal part of the stalled vehicle's engine, away from the battery and the carburetor.

The preferred locations of an exposed metal part (to “ground” the circuit) are the accessible engine mount studs or an engine lifting “eye”. **Do not** use fuel lines, engine rocker covers, or the intake manifold as “grounding” points.

Roadside emergencies

 Do not connect the end of the second cable to the negative (-) terminal of the battery to be jumped. A spark may cause an explosion of the gases that surround the battery.

- 2.0 litre engine

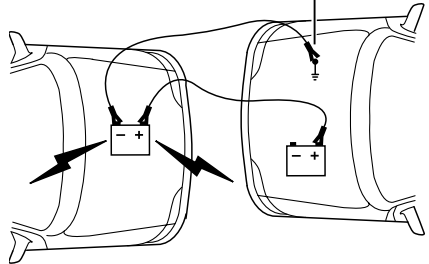
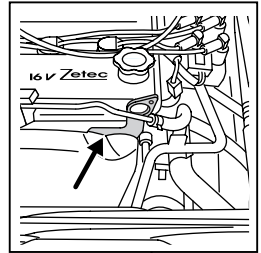

- 2.5 litre engine

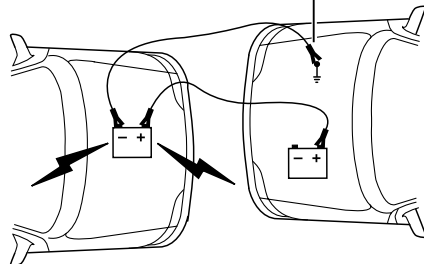
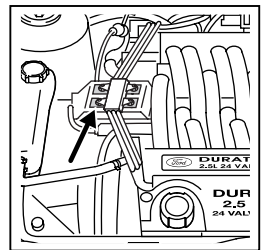

Roadside emergencies

5. Be sure that the cables are clear of fan blades, belts and other moving parts of both engines.

Jump starting

1. Start the engine of the booster vehicle and run the engine at a moderately increased speed.
2. Start the engine of the disabled vehicle.
3. Once the disabled vehicle has been started, run both engines for a further three minutes before disconnecting the jumper cables.

Removing jumper cables

Remove the jumper cables in the reverse order that they were connected.

1. Remove the jumper cable from the “ground” metal surface.

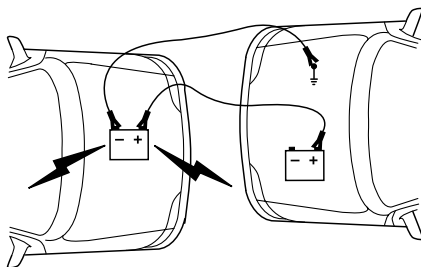

Roadside emergencies

2. Remove the jumper cable on the negative (-) connection of the booster vehicle's battery.

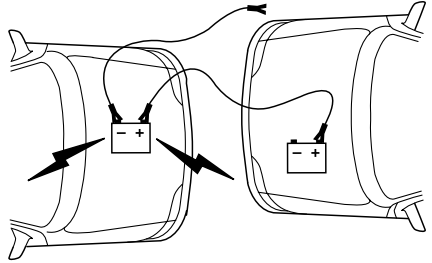

3. Remove the jumper cable from the positive (+) terminal of the booster vehicle's battery

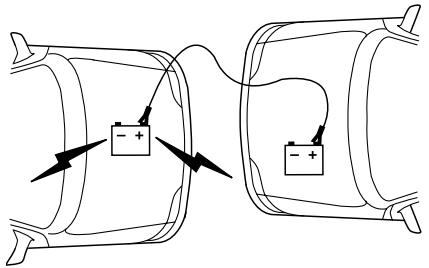

4. Remove the jumper cable from the positive (+) terminal of the disabled vehicle's battery.

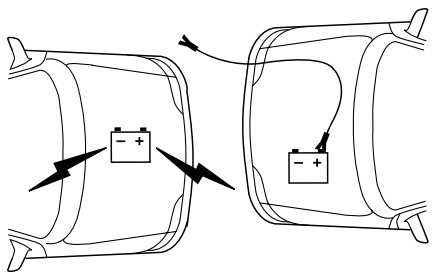

After the disabled vehicle has been started and the jumper cables removed, allow it to idle for several minutes so the engine computer can "relearn" its idle conditions.

Roadside emergencies

WRECKER TOWING

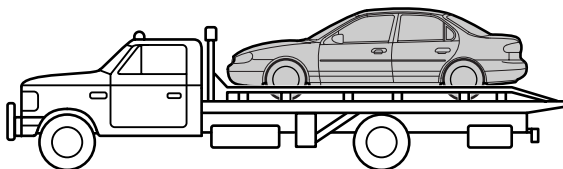
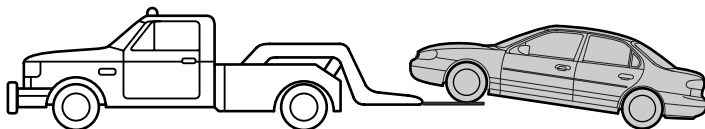

If towing is necessary, it is recommended that your vehicle be towed with a wheel lift or flatbed equipment. Do not tow with slingbelt equipment. Ford Motor Company has not developed or approved a T-hook or slingbelt towing procedure.

TOWING YOUR VEHICLE BEHIND ANOTHER VEHICLE

Before you have your vehicle towed:

- release the parking brake,
- move the gearshift to N (Neutral),
- turn the ignition to the off position and
- unlock the steering wheel.

Automatic transaxle

Do not tow your vehicle at a speed faster than 55 km/h (35 mph) or for a distance greater than 80 km (50 miles) unless the drive wheels are placed on dollies.

Manual transaxle

Do not tow your vehicle at a speed faster than 90 km/h (55 mph). Your maximum towing distance is unlimited.



Never use a tow bar that attaches to the bumper when you tow your vehicle. This could damage the bumper and cause an accident.

Maintenance and care

SERVICE RECOMMENDATIONS

- We highlight do-it-yourself items in the engine compartment for easy location.
- As possible, we design parts that can be replaced without tools.
- We provide you with a maintenance guide and or service guide which makes tracking routine service for your vehicle easy.

If your vehicle requires professional service, your Ford or Lincoln/Mercury dealership can provide necessary parts and service. Check your “Warranty Guide” to find out which parts and services are covered.

Use only recommended fuels, lubricants, fluids and service parts conforming to specifications. Motorcraft parts are designed and built to provide the best performance in your vehicle.

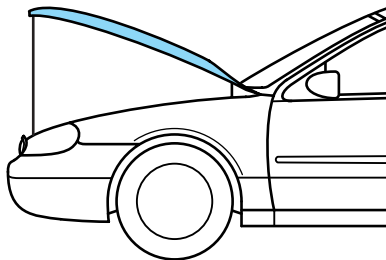

Precautions when servicing your vehicle

Be especially careful when inspecting or servicing your vehicle. Here are some general precautions for your safety:

- Do not work on a hot engine.



The cooling fan is automatic and may come on at any time. Always disconnect the negative terminal of the battery before working near the fan.

- If you must work with the engine running, avoid wearing loose clothing or jewelry that could get caught in moving parts. Take precautions with long hair.
- Do not work on a vehicle with the engine running in an enclosed space, unless you are sure you have enough ventilation.
- Keep all lit cigarettes, open flames and other lit material away from the battery and all fuel related parts.

If you disconnect the battery, the engine must “relearn” its idle conditions before your vehicle will drive properly, as explained under *Battery* in this chapter.

Maintenance and care

Working with engine off (automatic transaxle)

1. Set the parking brake fully and ensure the gearshift is securely latched in P (Park).
2. Turn off the engine and remove the key.
3. Block the wheels to prevent the vehicle from moving unexpectedly.

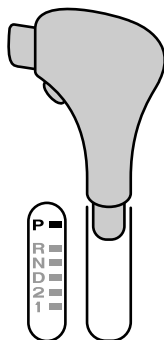

Working with engine off (manual transaxle)

1. Set the parking brake, depress the clutch and place the gearshift in 1 (first) or R (Reverse).
2. Turn off the engine and remove the key.
3. Block the wheels to prevent the vehicle from moving unexpectedly.

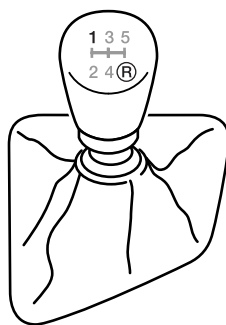

Working with engine on (automatic transaxle)

1. Set the parking brake fully and ensure the gearshift is securely latched in P (Park).
2. Block the wheels to prevent the vehicle from moving unexpectedly.

 Do not start your engine with the air cleaner removed and do not remove it while the engine is running.

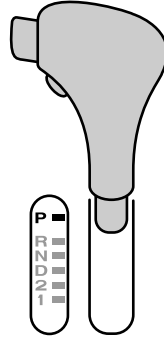

Working with engine on (manual transaxle)

1. Set the parking brake, depress the clutch and place the gearshift in neutral.
2. Block the wheels to prevent the vehicle from moving unexpectedly.

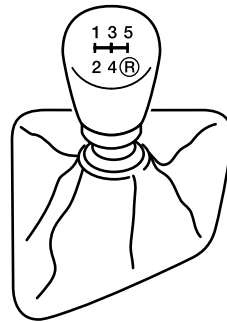

Maintenance and care

Opening the hood

- Pull the handle (1) located under the instrument panel.

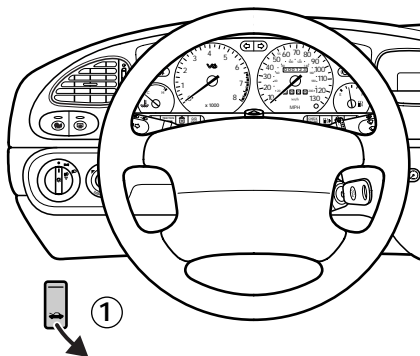

- Release the safety catch by reaching under the hood (2) (adjacent to the Mercury emblem) and pushing it to the left.

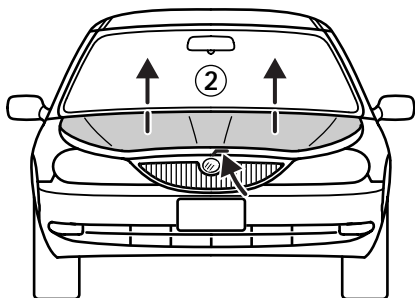

- Raise the hood and support it with the strut (3) in the yellow colored retainer, ensuring it is secure. Hold the support at the yellow colored insulation section.

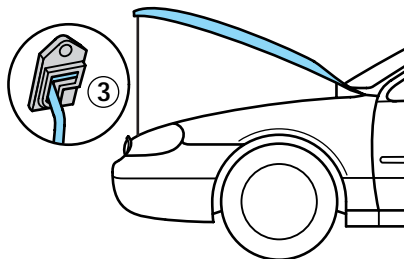

To close, replace the support strut in its retaining clip, lower the hood and allow it to drop into the catch for the last 20 – 30 cm (8 – 12 inches).

Always check to ensure that the hood lock is fully engaged.

2.0 litre EFI-engine compartment

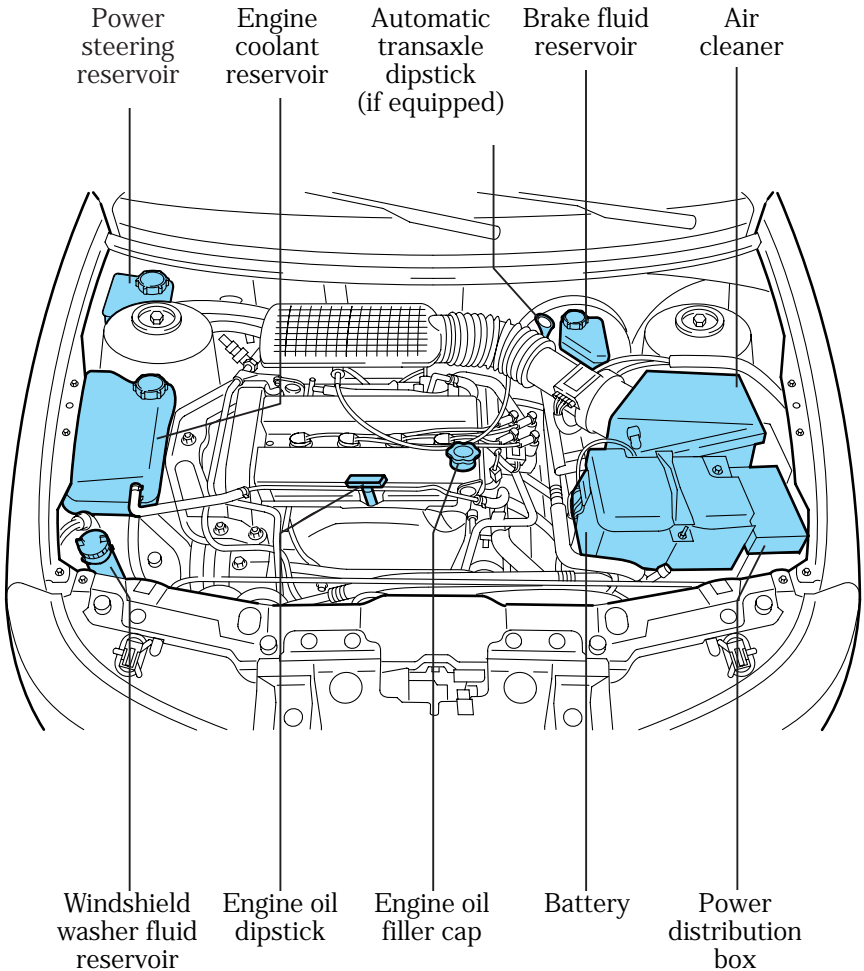

For ease of identification, all filler caps and the engine oil dipstick are marked yellow/black.

Maintenance and care

2.5 litre EFI-engine compartment

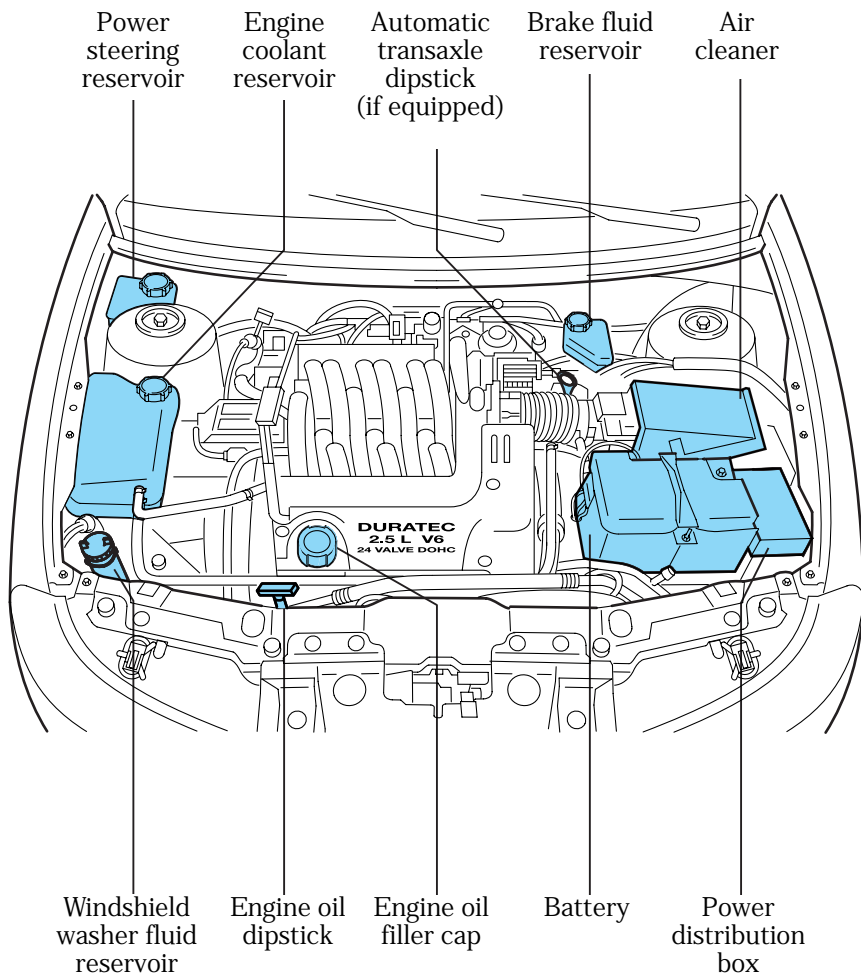

For ease of identification, all filler caps and the engine oil dipstick are marked yellow/black.

Engine oil

Use SAE 5W-30 motor oil CERTIFIED FOR GASOLINE ENGINES by the American Petroleum Institute.

Do not use supplemental engine oil additives, oil treatments or engine treatments. They are unnecessary and could, under certain conditions, lead to engine damage which is not covered by Ford Warranty.

Checking the engine oil

Check the engine oil each time you fuel your vehicle.

To check the oil:

1. Make sure the vehicle is on level ground. If the engine is warm, turn the engine off and wait a few minutes for the oil to drain into the oil pan.
2. Set the parking brake and ensure the gearshift is securely latched in P (Park). Put the manual gearshift in 1 (first) or R (Reverse).
3. Open the hood. Protect yourself from engine heat.
4. Locate and carefully remove the engine oil dipstick.
5. Wipe the dipstick clean. Insert the dipstick fully, then remove it again. The oil level should be in the range shown on the dipstick.

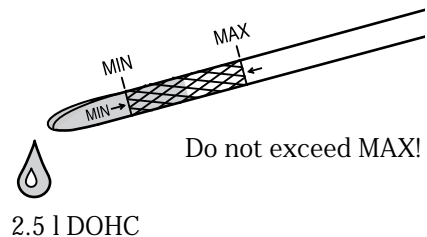
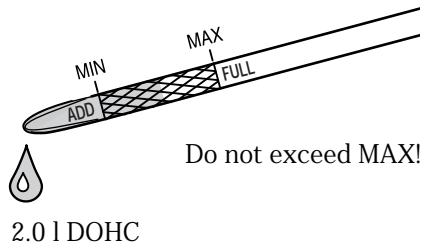
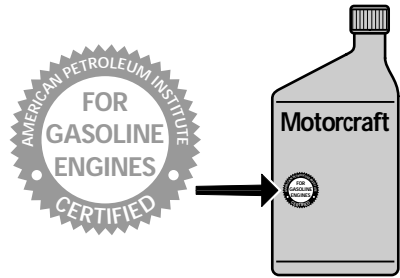

Maintenance and care

6. If the oil level is below the minimum line, add engine oil as necessary. If the oil level is beyond the maximum line, engine damage or high oil consumption may occur and some oil must be removed from the engine by a service technician.

7. Put the dipstick back in and ensure it is fully seated.



Continuous contact with used motor oil has caused cancer in laboratory mice.

Adding engine oil

1. Check the engine oil. For instructions, refer to *Checking the engine oil* in this chapter.

2. If the fluid level is not within the normal range, add only certified engine oil of the preferred viscosity. Add engine oil through the oil filler cap. Remove the filler cap and use a funnel to pour oil in the opening.

3. Recheck the oil level. **Make sure the oil level is not above the MAX mark on the dipstick.**

Change your engine oil and oil filter according to the scheduled mileage and time requirements, whichever occurs first.

Refer to the maintenance guide and or service guide for additional information.

It is recommended you use the appropriate Motorcraft oil filter (or another brand meeting Ford specifications) for your engine application.

 Always dispose of used automotive fluids in a responsible manner. Follow your community's standards for disposing of these types of fluids. Call your local recycling center to find out more about recycling automotive fluids.

Engine oil filler cap

The design of the filler cap varies by engine. To open, turn in the direction of the arrow and pull. Do not open the cap while the engine is running.

 Empty and used oil containers must be disposed of at an authorized waste disposal facility.

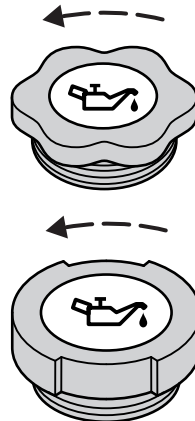

Maintenance and care

Brake/clutch fluid reservoir

Brake and clutch fluid systems are supplied from the same reservoir.

The level of the fluid must lie between the MIN and MAX marks on the side of the reservoir. If the level falls below the MIN mark, the brake fluid level warning light on the instrument cluster will illuminate. Add only DOT 3, DOT 4 or Super DOT 4 brake fluid that meets the Ford specification (see the chapter *Capacities and specifications*).

If you use brake fluid that is not DOT 3, DOT 4 or Super DOT 4 you will cause permanent damage to your brakes.

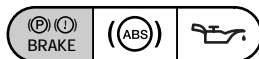
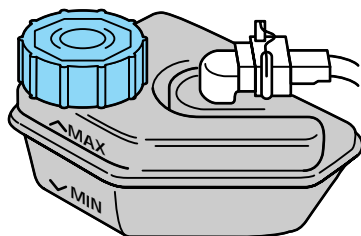

Alternative design



Brake fluid is toxic.



Do not let the reservoir for the master cylinder run dry. This may cause the brakes to fail.

Windshield washer system

If necessary, add enough washer fluid to fill the reservoir. Follow the instructions on the washer fluid label.



Do not put engine coolant in the container for the windshield washer fluid.

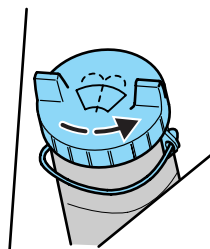

Engine coolant maintenance

Checking and adding engine coolant

Check the level of the coolant in the reservoir at least once a month. Be sure to read and understand *Precautions when servicing your vehicle* in this chapter.

If the engine coolant has not been checked for a long period of time, the engine coolant reservoir may eventually empty. If this occurs, add engine coolant to the coolant reservoir. For more information refer to *Adding engine coolant* in this chapter.

Automotive fluids are not interchangeable; do not use engine coolant, antifreeze or windshield washer fluid outside its specified function and vehicle location.

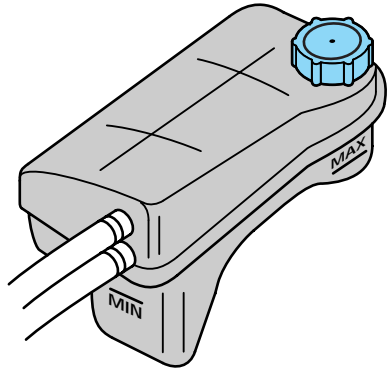

Do not put windshield washer fluid in the container for engine coolant.

When adding engine coolant

Ford recommends Ford Premium Cooling System Fluid, which is an optimized formula that will protect all metals and rubber elastomers used in Ford engines for four years or 80 000 km (50 000 miles).

It is neither necessary nor recommended to use supplemental coolant additives in your gasoline-powered vehicle. These additives may harm your engine coolant system.

When you change or add engine coolant, it is important to maintain engine coolant concentration between 40% (-24°C [-11°F]) and 60% (-52°C [-62°F]), depending on your local climate conditions.

A coolant concentration below 40% will result in a loss of freeze protection. A concentration above 60% may cause the engine to overheat on a warm day.

Refer to *Lubricant specifications* in the *Capacities and specifications* chapter. Use only a premium nationally-recognized brand name engine coolant or equivalent.

Recycled engine coolant

Ford Motor Company recommends that Ford and Lincoln-Mercury dealers use recycled engine coolant produced by Ford-approved processes. Not all coolant recycling processes produce coolant which meets Ford specifications ESE-M97B44-A, and use of such coolant may harm engine and cooling system components.



Always dispose of used automotive fluids in a responsible manner. Follow your community's standards for recycling and disposing of automotive fluids.

Maintenance and care

Adding engine coolant

1. Before removing the engine coolant recovery cap, turn the engine off and allow it to cool.
2. When the engine is cool, turn and remove the cap.

 Never remove the coolant recovery cap while the engine is running or hot.

- Step back for a moment while the pressure in the reservoir is released.
 - Stand away from the reservoir opening. Hot steam or coolant spray may be released.
3. Add engine coolant until the fluid level in the reservoir is between the MAX and MIN lines on the reservoir.

Follow the recommended service interval for changing engine coolant as outlined in the maintenance guide and or service guide. Refer to *Capacities and specifications* for more information on engine coolant specifications.

Have your dealer or a qualified service technician check the engine coolant system for leaks if you have to add more than a litre (quart) of engine coolant per month.

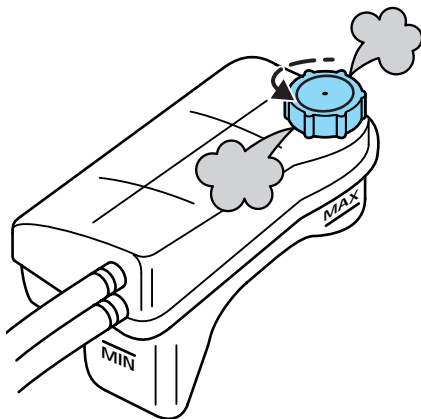

Severe winter climate

If you drive in extremely cold climates (less than -36°C [-34°F]), it may be necessary to increase the coolant concentration above 50%. Refer to the chart on the coolant container to ensure the coolant concentration in your vehicle is such that the coolant will not freeze at the temperature level in which you drive during the winter months. Never increase the engine coolant concentration above 60%. Leave a 50/50 mixture of engine coolant and water in your vehicle year-round in non-extreme climates.

Checking and adding power steering fluid

Switch off the engine. With the steering system at normal operating temperature, the fluid level should come up to the MAX mark.

If the fluid level drops below the MIN mark, add the specified fluid. Refer to the *Capacities and specifications* chapter.

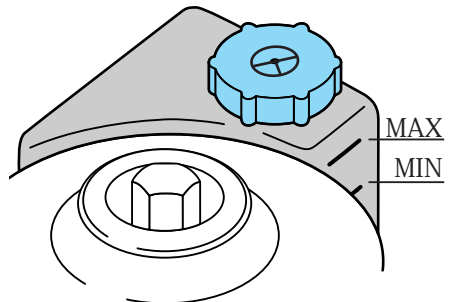

Maintenance and care

Automatic transaxle fluid

Follow the scheduled service intervals outlined in the maintenance guide and or service guide.

Before adding any fluid, make sure the correct type is used. The type of fluid used is normally indicated on the dipstick and/or dipstick handle and also in the *Lubricant specifications* section in the *Capacities and specifications* chapter.

Do not drive the vehicle if the fluid level is below the hole at the bottom of the dipstick and outside temperatures are above 10°C (50°F).

Your transaxle does not use up fluid. However, it is recommended that you check the transaxle fluid at least twice a year. The fluid level should be checked if the transaxle is not working properly, i.e., if the transaxle slips or shifts slowly or if you notice some sign of fluid leakage.

Transaxle fluid should be checked at normal operating temperatures of 66°C - 77°C (150°F - 170°F) on a level surface while the engine is running in the P (Park) gearshift lever position. The normal operating temperature can be reached after approximately 32 km (20 miles) of driving.

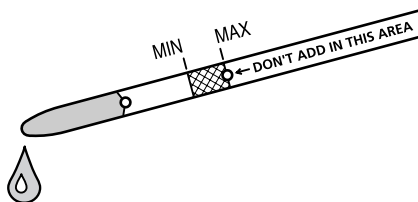

The transaxle fluid should be in this range if at normal operating temperature 66°C - 77°C (150°F - 170°F).

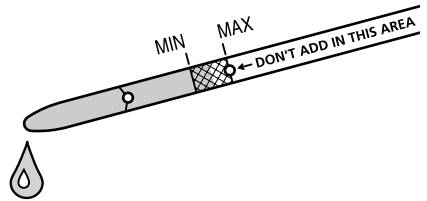

The transaxle fluid should be in this range if at room temperature 10°C - 35°C (50°F - 95°F).

If the vehicle has been operated for an extended period at high speeds, in the city during hot weather or pulling a trailer, the vehicle should be turned off for about thirty minutes to allow the fluid to cool before checking.

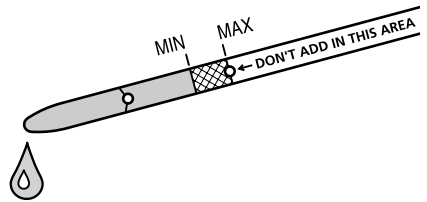

1. Park the vehicle on a level surface and engage the parking brake.
2. With the parking brake engaged and your foot on the brake pedal, start the engine and move the gearshift lever through all of the gear ranges. Allow sufficient time for each gear to engage.
3. Latch the gearshift lever in P (Park) and leave the engine running.
4. Remove the dipstick, wiping it clean with a clean, dry lint free rag.
5. Install the dipstick making sure it is fully seated in the filler tube.

Maintenance and care

6. Remove the dipstick and inspect the fluid level. The fluid level should be in the crosshatched area on the dipstick.

7. If necessary, add fluid in .25 litre (1/2 pint) increments through the filler tube until the level is correct.

8. If an overfill occurs, excess fluid should be removed by a qualified technician.

An overfill condition of transaxle fluid may cause shift and/or engagement concerns and/or possible damage.

Battery

Your vehicle may be equipped with a Motorcraft maintenance-free battery. The Motorcraft maintenance-free battery normally does not require additional water during its life of service. However, for severe service usage or in high temperature climates, refer to the maintenance guide and or service guide for additional information. Keep the electrolyte in each cell up to the "level" indicator. Do not overfill the battery cell.

For longer, trouble-free operation, keep the top of the battery clean and dry. Also, make certain the battery cables are always tightly fastened to the battery terminals.

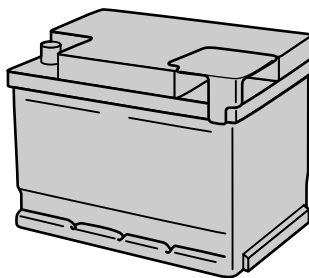

If you see any corrosion on the battery cables or terminals, remove the cables from the terminal(s) and clean with a wire brush. You can neutralize the acid with a solution of baking soda and water. Reinstall the cables when you are done cleaning them, and apply a small quantity of grease to the top of each battery terminal to help prevent corrosion.

Battery replacement

If your original equipment battery requires replacement while under warranty, it will be replaced with a Motorcraft service battery, identical in design technology. Like the original equipment battery, it should not require water addition during its normal life of service; however, for severe service usage or in high temperature climates, refer to the maintenance guide and or service guide for additional information. Do not overfill the battery cell.

If the electrolyte level in your battery gets low, you can add plain tap water to the battery, as long as you do not use hard water (water with a high mineral or alkali content). If possible, however, try to only fill the battery cell with distilled water. If the battery needs water often, have the charging system checked.

Maintenance and care



Applying too much pressure on the ends when lifting a battery could cause acid to spill. Lift the battery with a carrier or with your hands on the opposite corners.



Batteries normally produce explosive gases which can cause personal injury. Do not allow flames, sparks or lit tobacco to come near the battery. Always cover your face and protect your eyes and also provide ventilation.



Follow these steps to minimize risk of personal injury.



Always dispose of automotive batteries in a responsible manner. Follow your community's local standards for disposal. Call your local recycling center to find out more about recycling automotive batteries.

Relearning the idle function

Because your vehicle's engine is electronically controlled, some control conditions are maintained by power from the battery. When the battery is disconnected or a new battery is installed, the computer must "relearn" its idle conditions before your vehicle can drive properly. To begin this process:

1. Put the automatic transaxle gearshift in P (Park). Put the manual transaxle gearshift in neutral.
 2. Turn off all accessories and start the vehicle.
 3. Let the engine idle for at least one minute.
 4. The "relearning" process will automatically complete as you drive the vehicle.
- If you do not allow the engine to "relearn" its idle, the idle quality of your vehicle may be adversely affected until the idle is eventually "relearned".
 - If the battery has been disconnected or if a new battery has been installed, the clock and preset radio stations must be reset once the battery is reconnected.

Maintenance and care

Checking wiper blades

Check the wiper blades on your vehicle for roughness by running the tips of your fingers over the edge of the blade.

Traces of grease, silicone and fuel prevent wiper blades from functioning properly. We recommend Ford cleaning solutions or equivalent to clean wiper blades.

Change the wiper blades on your vehicle at least once a year.

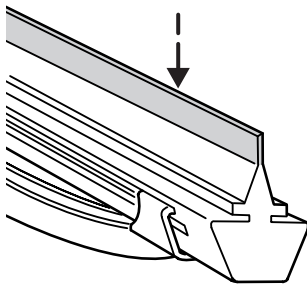

Cabin air filter replacement

In your climate control system, you have a filter that cleans the air before it enters the interior of the vehicle. This filter should be replaced at the intervals in the maintenance guide and or service guide.

To replace the cabin air filter:

1. Unscrew the nut in the base of each windshield wiper arm. Remove the windshield wiper arms.

Maintenance and care

2. Remove the plastic caps from the screws on the grille. Remove the screws.

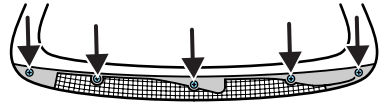

3. Open the hood. Pull off the rubber weatherstrip at the back of the engine compartment. Remove the screws that hold the grille, separate the two halves and remove the grille.

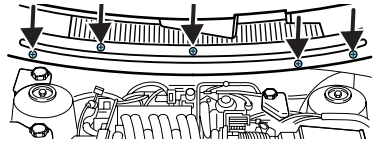

4. The filter is in a housing at the back of the engine compartment, on the passenger side. Pull off the two clips on the sides of the housing. Slide out the top part of the housing and filter.

5. Slide the filter out of the housing, replace with the new filter and slide the top part of the housing and cabin air filter back into place. Reinstall the clips on the housing.

6. Replace the grille and wiper arms.

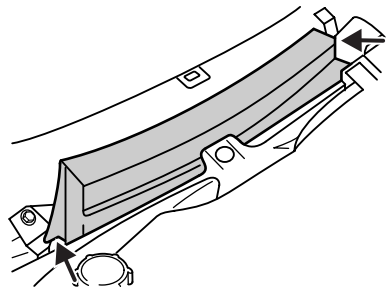

Maintenance and care

INFORMATION ABOUT TIRE QUALITY GRADES

New vehicles are fitted with tires that have their Tire Quality Grade (described below) molded into the tire's sidewall. These Tire Quality Grades are determined by standards that the United States Department of Transportation has set.

Tire Quality Grades apply to new pneumatic tires for use on passenger cars. They do not apply to deep tread, winter-type snow tires, space-saver or temporary use spare tires, tires with nominal rim diameters of 10 to 12 inches or limited production tires as defined in Title 49 Code of Federal Regulation Part 575.104(c)(2).

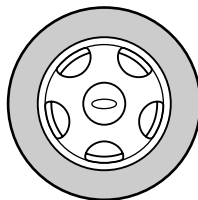

U.S. Department of Transportation – Tire quality grades: The U.S. Department of Transportation requires Ford to give you the following information about tire grades exactly as the government has written it.

Treadwear

The treadwear grade is a comparative rating based on the wear rate of the tire when tested under controlled conditions on a specified government test course. For example, a tire graded 150 would wear one and one-half (1 1/2) times as well on the government course as a tire graded 100. The relative performance of tires depends upon the actual conditions of their use, however, and may depart significantly from the norm due to variations in driving habits, service practices, and differences in road characteristics and climate.

Traction AA A B C

The traction grades, from highest to lowest are AA, A, B, and C. Those grades represent the tire's ability to stop on wet pavement as measured under controlled conditions on specified government test surfaces of asphalt and concrete. A tire marked C may have poor traction performance.



The traction grade assigned to this tire is based on straight-ahead braking traction tests, and does not include acceleration, cornering, hydroplaning, or peak traction characteristics.

Maintenance and care

Temperature A B C

The temperature grades are A (the highest), B, and C, representing the tire's resistance to the generation of heat and its ability to dissipate heat when tested under controlled conditions on a specified indoor laboratory test wheel.

Sustained high temperature can cause the material of the tire to degenerate and reduce tire life, and excessive temperature can lead to sudden tire failure. The grade C corresponds to a level of performance which all passenger car tires must meet under the Federal Motor Vehicle Safety Standard No. 109. Grades B and A represent higher levels of performance on the laboratory test wheel than the minimum required by law.



The temperature grade for this tire is established for a tire that is properly inflated and not overloaded. Excessive speed, underinflation, or excessive loading, either separately or in combination, can cause heat buildup and possible tire failure.

Checking tire pressure

Check the tire pressure periodically after the vehicle has been parked for at least one hour or has been driven less than 5 km (3 miles). Inflate the tires as necessary. To check the tire pressure, insert the tire pressure gauge into the valve.

The cold pressure amount is listed on the Safety Compliance Certification label.



Improperly inflated tires can affect vehicle handling and can fail suddenly, possibly resulting in loss of vehicle control.

Rotating tires

Rotate your tires at regular intervals for even wear. Rotation intervals are listed in the maintenance guide and or service guide.

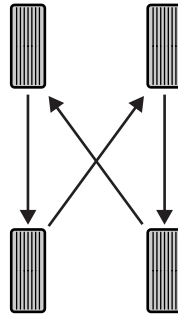

Maintenance and care

Replacing tires

Replace tires when the wear band is visible through the tire treads.



When replacing full size tires, never mix radial, bias-belted, or bias-type tires. Use only the tire sizes that are listed on the tire pressure decal. Make sure that all tires are the same size, speed rating, and load-carrying capacity. Use only the tire combinations recommended on the decal. If you do not follow these precautions, your vehicle may not drive properly and safely.



Do not replace your tires with “high performance” tires or larger size tires.



Failure to follow these precautions may adversely affect the handling of the vehicle and make it easier to lose control and roll over.

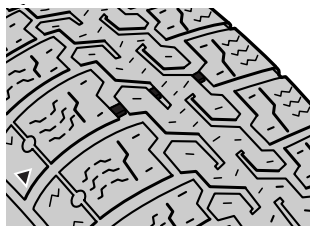



Dispose of worn tires in accordance with local environmental regulations.

Refer to the Safety Compliance Certification label to determine the specific size tire and wheel Ford Motor Company recommends for use on this vehicle.

When purchasing replacement tires for your vehicle, consult your dealer or a qualified service technician to ensure that the correct tire type is used.

Using snow tires and chains



Snow tires must be the same size and grade as the tires you currently have on your vehicle.

The tires on your vehicle have all-weather treads to provide traction in rain and snow. However, in some climates, using snow tires and chains may be necessary. Ford offers snow chains as a Ford approved accessory and recommends use of these or their equivalents on approved tires. See your dealer or a qualified service technician for more information on tire chains for your vehicle. Follow these guidelines when using snow tires and chains:

- Install chains securely, verifying that the chains do not touch any wiring, brake lines or fuel lines.
- Install the chains on the front tires only.
- Do not use tire chains on 205/60 tires and 205/55R16 Z rated tires. Steering, suspension and body components may be damaged by use of chains.

- Drive cautiously. If you hear the chains rub or bang against the vehicle, stop and retighten them. If this does not work, remove the chains to prevent vehicle damage.
- Local regulations may prohibit or restrict the use of tire chains. Investigate the laws and regulations in your area before installing chains.
- Avoid overloading your vehicle.
- Do not use tire chains on temporary spare tires.
- Remove the tire chains when they are no longer needed. Do not use chains on dry roads.
- The suspension insulation and bumpers will help prevent vehicle damage. Do not remove these components from the vehicle when using snow tires and chains.



Change over from winter to summer tires as soon as road conditions allow, this will reduce fuel consumption and noise in the vehicle's interior.

Maintenance and care

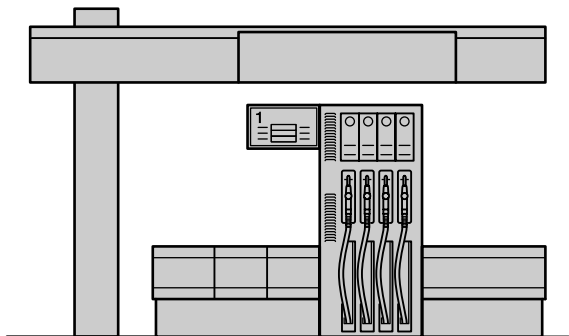



IMPORTANT FUEL INFORMATON

Important safety precautions

 Do not overfill the fuel tank. The pressure in an overfilled tank may cause leakage and lead to fuel spray and fire.

 If you do not use the proper fuel cap, the pressure in the fuel tank can damage the fuel system or cause it to work improperly in a collision.

 The fuel system may be under pressure. If the fuel cap is venting vapor or if you hear a hissing sound, wait until it stops before completely removing the cap.

 Automotive fuels can cause serious injury or death if misused or mishandled.

Observe the following guidelines when handling automotive fuel:

- Extinguish all smoking materials and any open flames before fueling your vehicle.
- Always turn off the vehicle before fueling.
- Make sure the fuel cap is correctly fitted after fueling. Failure to do so may cause the on board diagnostic system to illuminate the CHECK ENGINE light.
- Automotive fuels can be harmful or fatal if swallowed. If fuel is swallowed, call a physician immediately, even if no symptoms are immediately apparent. The toxic effects of fuel may not be visible for hours.
- Fuels can also be harmful if absorbed through the skin. If fuel is splashed on the skin, promptly remove contaminated clothing and wash skin thoroughly with soap and water.
- If fuel is splashed in the eyes, remove contact lenses (if worn), flush with water for 15 minutes and seek medical attention.
- Be particularly careful if you are taking “Antabuse” or other forms of disulfiram for the treatment of alcoholism. Breathing gasoline vapors or skin contact could cause an adverse reaction. Consult a physician immediately.

Choosing the right fuel

Use only UNLEADED FUEL. The use of leaded fuel is prohibited by law and could damage your vehicle. The damage may not be covered by your warranty.

Your vehicle was not designed to use fuel containing manganese-based additives such as MMT. Additionally, vehicles certified to California emission standards (indicated on the underhood Vehicle Emission Control Information label) are designed to operate on California reformulated gasolines. If California reformulated gasoline is not available when you refuel, your vehicle can be operated on non-California fuels. However, even though your engine will perform adequately on other gasolines, the performance of the emission control devices and systems may be adversely affected. Repair of damage caused by a fuel that your vehicle was not designed for may not be covered by your warranty.

Octane recommendations

Your vehicle is designed to use regular gasoline with an (R+M)/2 octane rating of 87. We do not recommend gasolines labeled as “regular” in high altitude areas that are sold with octane ratings of 86 or even less.

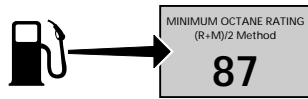

Do not be concerned if your vehicle sometimes knocks lightly. However, if it knocks heavily under most driving conditions on the recommended octane, see your dealer or a qualified service technician to prevent any engine damage.

Fuel quality

If you are experiencing starting, rough idle or hesitation problems try a different brand of fuel. If the condition persists, see your dealer or qualified service technician.

The American Automobile Manufacturers Association (AAMA) issued a gasoline specification to provide information on high quality fuels that optimize the performance of your vehicle. We recommend the use of gasolines that meet the AAMA specification if they are available.

It should not be necessary to add any aftermarket products to your fuel tank if you continue to use a high-quality fuel.

Maintenance and care

Cleaner air

Ford approves the use of gasolines to improve air quality, including reformulated gasolines that contain oxygenates such as a maximum of 10% ethanol or 15% MTBE. There should be no more than 5% methanol with cosolvents and additives to protect the fuel system.

Fuel filler cap

If the “check engine” indicator comes on and stays on when you start the engine, the fuel filler cap may not be properly installed. Turn off the engine, remove the fuel filler cap and reinstall it being careful to align the cap properly.

If you must replace the fuel filler cap, replace it with an authorized Motorcraft part. The customer warranty may be void for any damage to the fuel tank or fuel system if an authorized Motorcraft fuel filler cap is not used.



The fuel system may be under pressure. If the fuel filler cap is venting vapor or if you hear a hissing sound, wait until it stops before completely removing the fuel filler cap. Otherwise fuel may spray out and injure you or others.

Calculating fuel economy

To accurately calculate your vehicle's fuel economy:

1. Fill the tank completely and record the initial odometer reading.
2. Each time you fill the tank, record the amount of fuel added (in litres or gallons).
3. After at least three to five fill-ups, fill the fuel tank and record the current mileage reading.
4. Use one of the following equations to calculate fuel economy.

$\text{Litres used} \times 100 / \text{Total kilometres traveled.}$

$\text{Total miles traveled} / \text{Total gallons used.}$

Keep a record for at least one month. This will provide an accurate estimate of the vehicle's fuel economy.

EMISSION CONTROL SYSTEM

Your vehicle is equipped with various emission control components and a catalytic converter which will enable your vehicle to comply with applicable exhaust emission standards. To make sure that the catalytic converter and other emission control components continue to work properly:

- Use unleaded fuel only.
- Avoid running out of fuel.
- Do not turn off the ignition while your vehicle is moving, especially at high speeds.
- Have the items listed in your maintenance guide and or service guide performed according to the specified schedule.

The scheduled maintenance services listed in the maintenance guide and or service guide are required because they are considered essential to the life and performance of your vehicle and to its emissions system.

If other than Ford, Motorcraft, or Ford authorized parts are used for maintenance replacements or for service of components affecting emissions control, such non-Ford parts should be equivalent to genuine Ford Motor Company parts in performance and durability.

Maintenance and care

 Do not park, idle or drive your vehicle in dry grass or other dry ground cover. The emission system heats up the engine compartment and exhaust system, which can start a fire.

Watch for fluid leaks, strange odors, smoke, loss of oil pressure, engine overheating, illumination of the *charging system* warning light or the *check engine* warning light. These events could indicate that the emission control system is not working properly.

 Exhaust leaks may result in entry of harmful and potentially lethal fumes into the passenger compartment.



Alternative design



Alternative design

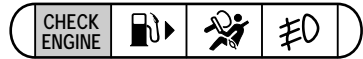

Maintenance and care

Do not make any unauthorized changes to your vehicle or engine. By law, vehicle owners and anyone who manufactures, repairs, services, sells, leases, trades vehicles, or supervises a fleet of vehicles are not permitted to intentionally remove an emission control device or prevent it from working. Information about your vehicle's emission system is on the Vehicle Emission Control Information Decal located under the hood. This decal identifies engine displacement and gives some tune up specifications.

Please consult your "Warranty Guide" for complete emission warranty information.



Readiness for inspection/maintenance (I/M) testing

In some localities, it may be a legal requirement to pass an I/M test of the on-board diagnostic (OBD-II) system. If your *check engine* light is on, refer to the description in the *Instrument Cluster Lights and Chimes* section of the *Instrumentation* chapter. Your vehicle may not pass the I/M test with the *check engine* light on.

If the vehicle's powertrain system or its battery has just been serviced, the OBD-II system is reset to a "not ready for I/M test" condition. To ready the OBD-II system for I/M testing, a minimum of 30 minutes of city and highway driving is necessary as described below:

- First, at least 10 minutes of driving on an expressway or highway.
- Next, at least 20 minutes of driving in stop and go, city-type traffic with at least four idle periods.

Allow the vehicle to sit for at least eight hours without starting the engine. Then, start the engine and complete the above driving cycle. The engine must warm up to its normal operating temperature. Once started, do not turn off the engine until the above driving cycle is complete.

Maintenance and care

BULB REPLACEMENT

Removing the headlamps assembly

 Handle a halogen headlamp bulb carefully and keep out of children's reach. Grasp the bulb only by its plastic base and do not touch the glass. The oil from your hand could cause the bulb to break the next time the headlamps are operated.

The bulbs for the low beam, high beam, turn signals and side lamps are housed in the lamp assembly. To replace a bulb, the complete lamp assembly has to be removed as follows:

1. Switch off the lamps.
2. Open the hood.
3. Remove the lower screw (2) from the headlamp housing.
4. Remove the two upper screws (1) from the headlamp housing.
5. Gently pull the headlamp housing outward.
6. Replace the headlamp bulbs.

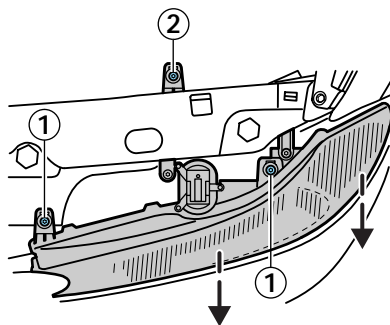

Reinstalling the headlamp assembly

The gasket lining must be seated properly around the lamp assembly when reinstalling.

All bulb connectors must be correctly connected.

Install in the reverse order.

Headlamp – low beam

Pull off the connector, release the wire clip and replace the bulb.

Pay attention to the tab guides when replacing.

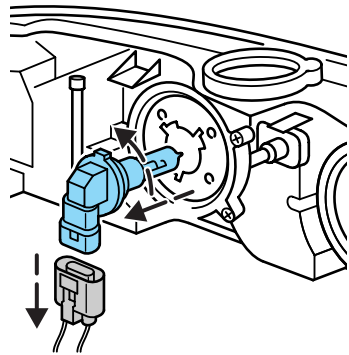

Headlamps – high beam

Replacement instructions are the same as for the low beam headlamp.

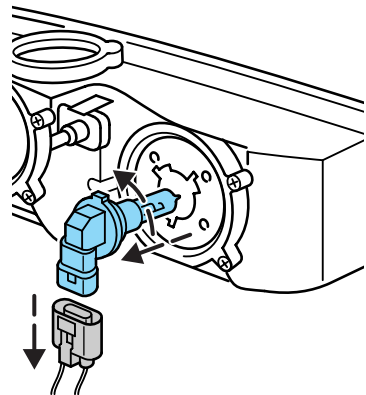

Headlamp alignment

Check the headlamp alignment after each replacement of a bulb. Refer to *Aiming the headlamps*.

Maintenance and care

Front turn signal/side lamps

Pull the socket out. Pull the bulb out and replace it.

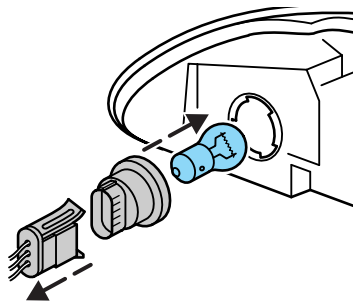

Foglamps (if equipped)

1. Turn the bulb counterclockwise and pull it out of the light assembly.
2. Remove the electrical connector.
3. Fit the new bulb in reverse order (do not touch the glass part of the bulb).

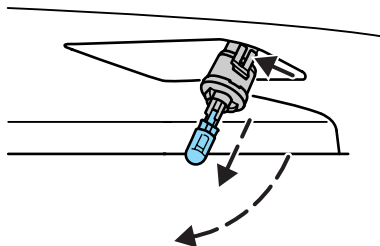

Brake/turn signal/tail lamps

1. Disconnect the electrical connector.
2. Turn the socket counterclockwise and pull it out.
3. Turn the bulb counterclockwise and pull it out.
4. To install, fit the new bulb in reverse order.

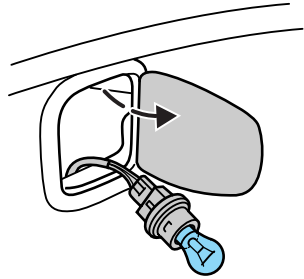

Backup lamps

The backup lamps are located in the trunk lid. Replacement instructions are the same as for the brake/turn signal/tail lamps.

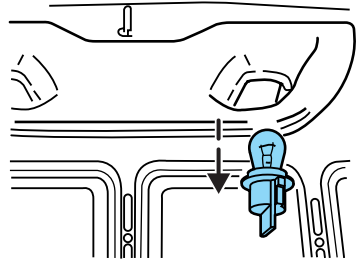

License plate lamp

Unscrew the bulb holder with a screwdriver. Remove the bulb from the clip holder.

Replace the new bulb in reverse sequence.

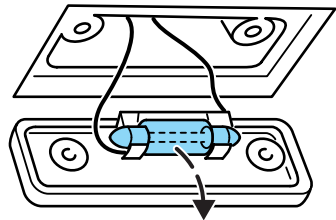

Maintenance and care

High-mounted brake lamp

Enter the rear seat compartment.

1. Remove the high mounted stop lamp assembly.
2. Remove the red bulb cover.
3. Remove inoperative stop lamp bulb.

To install, fit the new bulb in reverse sequence.

On vehicles equipped with a rear spoiler, the high-mounted brake lamp is included in the spoiler.

See your dealer for repair.

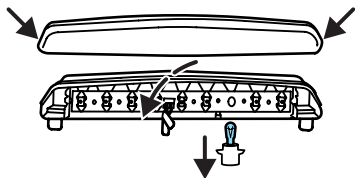

Luggage compartment lamp

Pry out the light assembly from the holder with a flat screwdriver. Turn the spherical bulb under slight pressure counterclockwise and remove.

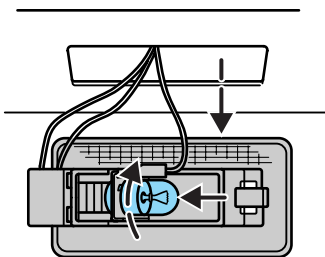

Interior lamps with reading lamps (if equipped)

Remove the clip located on lens to access the center bulb.

To replace the reading lamp bulbs, remove the two retaining screws to access the back of the lamp. Then, unclip the bulb covers and replace the bulb.

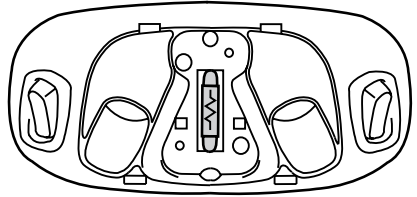

Interior lamps (sunroof equipped vehicles)

Open the lamp assembly.

The bulbs can be replaced after the contact plate has been hinged back.

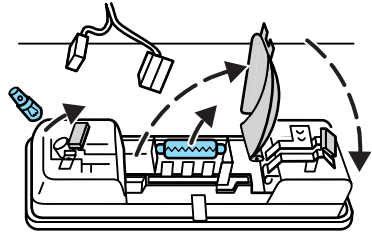

Maintenance and care

Bulb specifications

Function	Trade number
Front /turn lamp	3457 NA
Headlamp (high)	9005
Headlamp (low)	9006
Foglamp/License plate lamp	893
Rear tail/turn/brake lamp	1157
Backup lamp	1156
High-mounted brake lamp	2723
License plate lamp	C5W
Interior lamp	211-2
Reading lamp	578

AIMING THE HEADLAMPS

The alignment of your headlamps should be checked if:

- Oncoming motorists frequently signal you to deactivate your high beams, and your high beams are not activated.
- The headlamps do not seem to provide enough light for clear night vision.
- The headlamp beams are pointed substantially away from a slightly down and to the right position.

Aiming the headlamps

Your vehicle is equipped with a Vehicle Headlamp Aim Device (VHAD) on each headlamp body. Each headlamp may be properly aimed in the horizontal direction (left/right) and the vertical direction (up/down).

A non-zero bubble reading (vertical indicator) does not necessarily indicate out-of-aim headlamps. If your vehicle is not positioned **on a level surface**, the slope will be included in the vertical indication. Therefore, vertical and horizontal headlamp adjustment should be performed only when beam direction appears to be incorrect.

Maintenance and care

You will need one 7 mm box wrench, open end wrench or T-15 Torx drive.

If the vehicle has been in an accident, the vehicle's front structure should be properly aligned before aiming the headlamps.

Adjusting the horizontal aim

1. Make sure the vehicle is **on a level surface**.
2. With the hood open, locate the horizontal indicator and adjusting screw. Through the viewing hole on the outboard side of the headlamp.
3. Turn the horizontal adjusting screw until the "0" reference mark on the horizontal indicator aligns with the arrow pointer on the adjusting screw assembly.

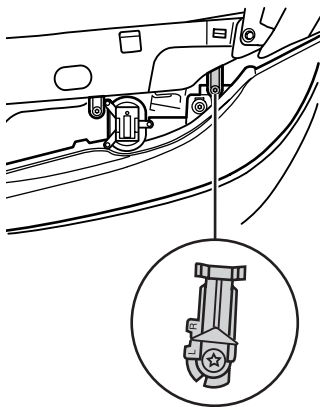

Adjusting the vertical aim

The numbers shown on the vial indicate beam direction in degrees up or down.

1. Make sure the vehicle is on level ground.
2. With the hood open, locate the bubble level vertical aim indicator, and adjusting screw. It is visible when viewed from the above the rear of the headlamp.
3. Turn the vertical adjusting screw until the bubble is centered over the "0" reference mark on the vertical indicator.
4. When the horizontal and vertical indicators are set on "0", the headlamp are properly aimed.

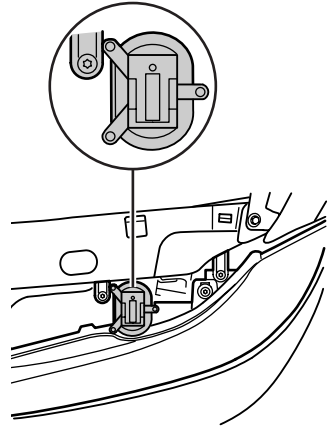

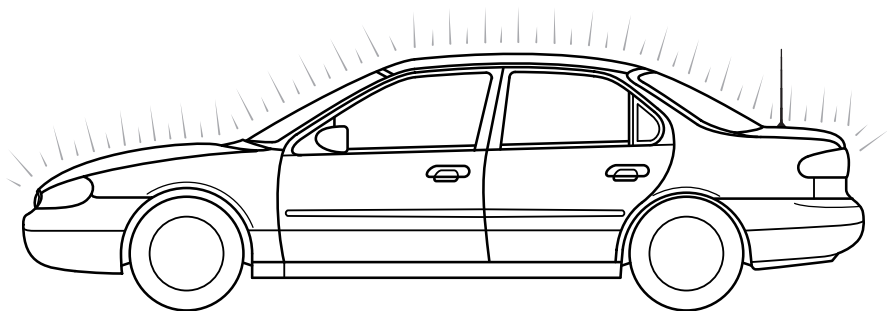

VEHICLE CARE

Washing your vehicle



Only use car washing areas that have environmentally friendly drainage systems.

Wash your vehicle regularly with cold or lukewarm water. Never use strong detergents or soap. If your vehicle is particularly dirty, use a quality car wash detergent. Always use a clean sponge, washing glove or similar device and plenty of water for best results. To avoid spots, avoid washing when the hood is still warm, immediately after or during exposure to strong sunlight.

During winter months, it is especially important to wash the vehicle on a regular basis. Large quantities of dirt and road salt are difficult to remove, and they also cause damage to the vehicle.

Remove or lower any exterior accessories, such as antennas, before entering a car wash.

Remove particles such as bird droppings, tree sap, insect remains, tar spots, road salt and industrial fallout immediately.

After washing, apply the brakes several times to dry them.

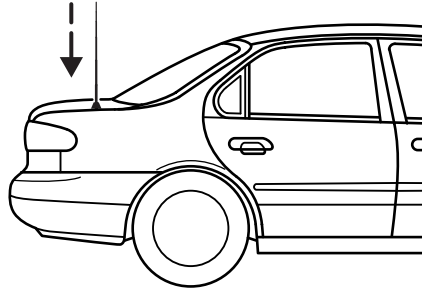

Waxing your vehicle

The best way to determine when the paintwork needs waxing is by noting when water stops beading on the surface. This could be every three or four months depending on operating conditions.

Use only carnauba or synthetic-based waxes. Remove any bugs and tar before waxing the vehicle. Use cleaning fluid or alcohol with a clean cloth to remove bugs. Use tar remover to remove any tar spots.

Maintenance and care

Repairing paint chips

Minor scratches or paint damage from road debris may be repaired with touch-up paint, paint repair foil or aerosol spray from the Ford accessories line. Observe the application instructions on the products.

Cleaning the wheels

Wash the wheels with the same detergent you use to clean the body of your vehicle. Do not use acid-based wheel cleaners, steel wool, fuel or strong detergents. Never use abrasives that will damage the finish of special wheel surfaces. Use a tar remover to remove grease and tar.

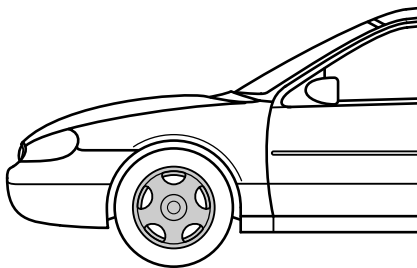

Cleaning the engine

Engines are more efficient when they are clean because grease and dirt buildup act as insulators and keep the engine warmer than normal. Follow these guidelines to clean your engine:

- Take care when using a power washer to clean the engine. The high pressure fluid could penetrate the sealed parts and cause damage.
- Do not spray with cold water, to avoid cracking the engine block.
- Cover the alternator to prevent water damage when cleaning the engine.
- Never wash or rinse the engine while it is running; water in the running engine may cause internal damage.

Maintenance and care

Cleaning plastic exterior parts

Use a vinyl cleaner for routine cleaning of plastic. Clean with a tar remover if necessary. Do not clean plastic parts with thinners, solvents or petroleum-based cleaners.

Cleaning the exterior lamps

Wash the exterior lamps with the same detergent you use to wash the exterior of your vehicle. Use glass cleaner or tar remover if necessary.

To avoid scratching the lamps, do not use a dry paper towel, chemical solvents or abrasive cleaners to clean the lamps.

Cleaning the wiper blades

If the wiper blades do not wipe properly, clean both the windshield and wiper blades using undiluted windshield wiper solution or a mild detergent. Rinse thoroughly with clean water. To avoid damaging the blades, do not use fuel, kerosene, paint thinner or other solvents.

Cleaning the instrument panel

Clean the instrument panel with a damp cloth, then dry with a dry cloth.

Any cleaner or polish that increases the gloss of the upper portion of the instrument panel should be avoided. The dull finish in this area is to help protect the driver from undesirable windshield reflection.

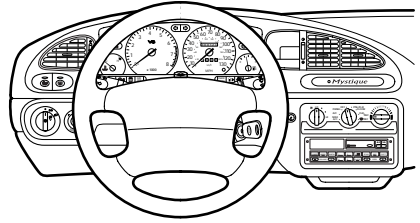

Cleaning the interior fabric

Remove dust and loose dirt with a whisk broom or a vacuum cleaner. Remove fresh spots immediately. Follow the directions that come with the cleaner.

Cleaning leather seats (if equipped)

For routine cleaning, wipe the surface with a soft, damp cloth. For more thorough cleaning, wipe the surface with a leather and vinyl cleaner or a mild soap.



Maintenance and care

Cleaning and maintaining the safety belts

Clean the safety belts with a mild soap solution recommended for cleaning upholstery or carpets and warm water. Do not bleach or dye the belts, because these actions may weaken the belt webbing.

Check the safety belt system periodically to make sure there are no nicks, wear or cuts.

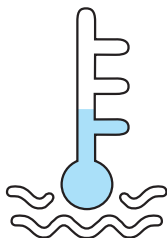
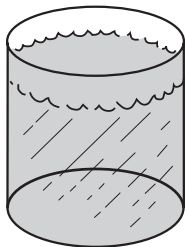

Ford recommends that all safety belt assemblies and attaching hardware should be inspected by a qualified technician after any collision. Safety belt assemblies not in use during a collision should also be inspected and replaced if either damage or improper operation is noted.

Cleaning and caring for your vehicle

Refer to the “Customer assistance” chapter for a list of Ford-approved cleaners, polishes and waxes.

Capacities and specifications

Motorcraft parts

Component	Part number	
	2.0 litre engine	2.5 litre engine
Spark plug*	AZFS-22F # 1+2** AZFS-22FE# 3+4	AWSF-32F
Air filter	FA-1612	FA-1613
Passenger compartment air filter	FP4	FP4
Fuel filter	FG-800A	FG-800A
Oil filter	FL-2005	FL-820
Battery	BXT-40R	BXT-40R
PCV valve	EV-224	EV-152
Crankcase ventilation filter	FA-1621	—

* Refer to Vehicle Emission Control Information (VECI) decal for spark plug and gap specifications.

** If a spark plug is removed for examination, it must be reinstalled in the same cylinder. If a spark plug needs to be replaced, use only spark plugs with the service part number suffix letter "FE" as shown on the engine decal.

Capacities and specifications

Capacities	2.0 litre engine	2.5 litre engine
Engine oil - with filter - without	4.25 l (4.5 qts) 3.75 l (4.0 qts)	5.5 l (5.8 qts) 5.0 l (5.3 qts)
Manual transaxle	1.9 l (2.0 qts)	
Automatic transaxle with oil cooler	8.5 l (9.0 qts.)	9.6 l (10.2 qts)
Power steering	Fill to MAX mark	
Cooling system with heating	6.6 l (7.0 qts)* 7.1 l (7.5 qts)**	9.5 l (10.0 qts)* 9.7 l (10.2 qts)**
Windshield washer fluid	Fill to top of reservoir	
Fuel tank	58.5 l (15.4 gallons)	
Braking system	Fill to MAX mark	

* Total capacity

** with automatic transaxle

Capacities and specifications

Lubricant Specifications

Item	Ford part name or equivalent	Ford part number	Ford specification
Brake fluid	High performance DOT 3 brake fluid, DOT 4 brake fluid or Super DOT 4	C6AZ-19542-AB for DOT 3	ESA-M6C25-A (DOT 3) ESD-M6C57-A (Super DOT 4)
Engine coolant	Premium engine coolant	E2FZ-19549-AA CXC-8-B	ESE-M97B44-A
Engine oil	Motorcraft motor oil 5W-30 super premium	XO-5W30-QSP	American Petroleum Institute Certification Mark and WSS-M2C153-G
Power steering fluid	MERCON [®] power steering fluid	E6AZ-19582 AA	ESW-M2C33-F
Transaxle fluid automatic/ 5-speed manual	Motorcraft MERCON [®] ATF*	XT-2-QDX	MERCON [®]
Windshield washer fluid	Ultra-clear windshield washer concentrate	C9AZ-19550-AC or C9AZ-19550-BC	ESR-M17P5-A

* Use only MERCON[®] approved transmission/transaxle fluid. Use of any fluid approved and/or labeled for MERCON[®] V may cause internal transaxle damage.

Capacities and specifications

Engine data

Engine			2.0 litre Engine	2.5 litre Engine
Capacity	cm ³		1988	2544
Power output	kW (HP) at rpm		96 (125) 5500	125 (170) 6250
Max. torque	Nm (lb-ft) at rpm		176 (130) 4000	220 (162) 4250
Fuel required	87 Octane			
Continuous engine speed	rpm		6150	6700
Max. intermittent engine speed	rpm		6375	6925
Idle speed (manual transaxle)	rpm		800±50 (880±50)	725±50 (725±50)
Mixture preparation	Injection system			
Firing order			1-3-4-2	1-4-2-5-3-6
Spark plug gap	mm		1.3	
Ignition system	Electronically controlled			
Valve clearances	Inlet	0.14 mm	0.11-0.18* 0.27-0.34*	Hydraulic valve adjusters
	Exhaust	0.30 mm		

* Mechanical valve adjuster

Capacities and specifications

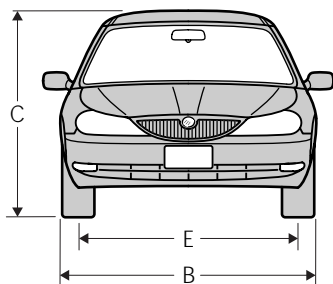
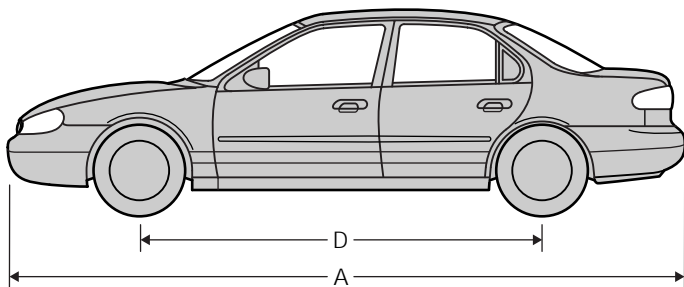

Dimensions		mm (inches)
A = Maximum length		4556 (179.4)
B = Overall width (without mirrors)		1751 (68.9)
C = Overall height (curb weight)		1380 - 1427 (54.3 - 56.2)
D = Wheelbase		2704 (106.5)
E = Track	Front	1499 - 1518* (59.0 - 59.8)
	Rear	1483 - 1502* (58.4 - 59.1)

* Dependent on tyre size

VEHICLE IDENTIFICATION NUMBER

The vehicle identification number (VIN) is attached to a metal tag and is located on the front driver's side of the instrument panel. The VIN tag may be seen by looking through the windshield from the outside of the vehicle.

GETTING ROADSIDE ASSISTANCE

To fully assist you should you have a vehicle concern. Ford offers a complimentary roadside assistance program. This program is separate from the New Vehicle Limited Warranty. The service is available:

- 24-hours, seven days a week
- for the Basic warranty period (Canada) or New Vehicle Limited Warranty period (U.S.) of three years or 60,000 km (36,000 miles), whichever comes first on Ford and Mercury vehicles, and four years or 80,000 km (50,000 miles) on Lincoln vehicles.

In the United States, you may purchase additional roadside assistance coverage beyond this period through the Ford Auto Club by contacting your Ford or Lincoln-Mercury dealer.

- Roadside assistance will cover
- changing a flat tire
- jump-starts
- lock-out assistance
- fuel delivery

towing to the nearest Ford of Canada or Ford Motor Company dealership, or towing to your selling dealership if within 56 km (35 miles). Even non-warranty related tows, like accidents or getting stuck in the mud or snow, are covered (some exclusions apply, such as impound towing or repossession.

Using roadside assistance

Complete the roadside assistance identification card and place it in your wallet for quick reference. In the United States, this card is found in the Owner Guide portfolio in the glove compartment in Ford vehicles and is mailed to you if you own a Mercury or Lincoln. In Canada, it's found in the Roadside Assistance book in the glove compartment.

To receive roadside assistance in the United States for Ford or Mercury vehicles, call 1-800-241-3673 or if you own a Lincoln vehicle, call 1-800-521-4140. In Canada call 1-800-665-2006.

Should you need to arrange assistance for yourself, Ford will reimburse a reasonable amount. To obtain information about reimbursement, call 1-800-241-3673 in the United States for Ford or Mercury vehicles; or if you own a Lincoln vehicle, call 1-800-521-4140. Call 1-800-665-2006 in Canada.

Customer assistance

Ford extended service plan

You can get more protection for your new car or light truck by purchasing Ford Extended Service Plan (Ford ESP) coverage. Ford ESP is an optional service contract which is backed by Ford Motor Company or Ford Motor Service Company (in the U.S.) and Ford of Canada (in Canada). It provides:

- Protection against repair costs after your New Vehicle Limited Warranty period expires

and

- other benefits during the warranty period (such as reimbursement for rentals and towing).

You may purchase Ford ESP from any participating Ford or Lincoln-Mercury or Ford of Canada dealer. There are several plans available in various time, distance and deductible combinations which can be tailored to fit your own driving needs. Ford ESP also offers reimbursement benefits for towing and rental coverage. (In Hawaii, rules vary. See your dealer for details.)

When you buy Ford ESP you receive Peace-of-Mind protection throughout the United States and Canada, provided by a network of more than 5,200 participating Ford, Lincoln-Mercury and Ford of Canada dealers.

If you did not take advantage of the Ford Extended Service Plan at the time of purchasing your vehicle, you may still be eligible. Please contact your dealer for further information. Since this information is subject to change, please ask your dealer for complete details about Ford Extended Service Plan coverage options.

Also, please be aware that some dealers offer service contracts that are not backed by Ford Motor Company or Ford of Canada. On the surface, many independent plans appear to be like Ford's. The problem is that they can often require the use of non-factory approved parts and have much more complex and restrictive claims coverage terms than Ford.

At Ford Motor Company and Ford of Canada, we are dedicated to providing Ford, Lincoln and Mercury vehicle owners with programs that will enhance your ownership experience and protect you from unexpected repair bills. Genuine Ford ESP is the only Extended Service Plan that enables us to provide that service.

Getting the service you need

At home

Ford Motor Company and Ford of Canada have authorized dealerships to service your vehicle. When you need warranty repairs your selling dealer would like you to return to it for that service, but you may also take your vehicle to another Ford Motor Company dealership authorized for warranty repairs. Certain warranty repairs require special training though, so not all dealers are authorized to perform all warranty repairs. That means that depending on the warranty repair needed, the vehicle may need to be taken to another dealer. If a particular dealership can not assist you, then contact the Customer Assistance Center.

If you are not satisfied with the service you receive at the dealership, speak with the service manager. If you are still not satisfied, speak with the owner or general manager of the dealership. In most cases, your concern will be resolved at this level.

Ford Motor Company and Ford of Canada dealerships also carry genuine Ford parts and accessories, providing you with original equipment reliability.

Away from home

If you are away from home when your vehicle needs service, or if you need more help than the dealership could provide, contact the Ford Customer Assistance Center to find an authorized dealership to help you in the United States

Ford Motor Company
Customer Assistance Center
16800 Executive Plaza Drive
P.O. Box 6248
Dearborn, Michigan 48121
1-800-392-3673 (FORD)
(TDD for the hearing impaired:
1-800-232-5952)

In Canada:
Customer Assistance Centre
Ford Motor Company of Canada,
Limited
P.O. Box 2000
Oakville, Ontario L6J 5E4
1-800-565-3673 (FORD)

Customer assistance

Please have the following information available when contacting Ford Customer Assistance:

- Your telephone number (home and business)
- The name of the dealer and the city where the dealership is located
- The year and make of your vehicle
- The date of vehicle purchase
- The current odometer reading
- The vehicle identification number (VIN)

If you still have a complaint involving a warranty dispute, you may wish to contact the Dispute Settlement Board (U.S.) or the Mediation/Arbitration Program (Canada).

In the United States, a warranty dispute must be submitted to the Dispute Settlement Board before taking action under the Magnuson-Moss Warranty Act, or to the extent allowed by state law, before pursuing replacement or repurchase remedies provided by certain state laws. This dispute handling procedure is not required prior to enforcing state created rights or other rights which are independent of the Magnuson-Moss Warranty Act or state replacement or repurchase laws.

THE DISPUTE SETTLEMENT BOARD (U.S. ONLY)

The Dispute Settlement Board is

- an independent, third-party arbitration program for warranty disputes
- available free to owners and lessees of qualifying Ford Motor Company vehicles

The Dispute Settlement Board may not be available in all states: Ford Motor Company reserves the right to change eligibility limitations, modify procedures and/or to discontinue this service without notice and without incurring obligations per applicable state law.

What kinds of cases does the Board review?

Unresolved warranty repair concerns or vehicle performance as designed concerns on Ford, Mercury and Lincoln cars and Ford or Mercury light trucks which are within the terms of any applicable written new vehicle warranty are eligible for review, except those involving:

- a non-Ford product
- a non-Ford dealership

- sales disputes between customer and dealer except those associated with warranty repairs or concerns with the vehicle's performance as designed
- a request for reimbursement of consequential expenses unless a service or product concern being reviewed
- items not covered by the New Vehicle Limited Warranty (including maintenance and wear items)
- alleged personal injury/property damage claims
- cases currently in litigation
- vehicles not used primarily for family, personal or household purposes (except in states where the Dispute Settlement Board is required to review commercial vehicles).
- vehicles with non-U.S. warranties

Concerns are ineligible for review if the New Vehicle Limited Warranty has expired at receipt of your application and in certain states eligibility is dependent upon the customer's possession of the vehicle.

Eligibility may differ according to state law. For example see the unique brochures for California, West Virginia, Georgia and Wisconsin purchasers/ lessees.

Board membership

The Board consists of:

- three consumer representatives
- a Ford or Lincoln-Mercury dealership representative

Consumer candidates for Board membership are recruited and trained by an independent consulting firm. The dealership Board member is chosen from Ford and Lincoln-Mercury dealership management, recognized for their business leadership qualities.

What the Board needs

To have your case reviewed you must complete the application in the DSB brochure and mail it to the address provided on the application form.

Your application is reviewed and, if it is determined to be eligible, you will receive an acknowledgement indicating:

- the file number assigned to your application
- the toll-free phone number of the DSB's independent administrator
- Your dealership and a Ford Motor Company representative are asked to submit statements at this time.

Customer assistance

To properly review your case, the Board needs the following information:

- legible copies of all documents and maintenance or repair orders relevant to the case
- the year, make, model, and Vehicle Identification Number (VIN) listed on your vehicle ownership license
- the date of repair(s) and mileage at the time of occurrence(s)
- the current mileage
- the name of the dealer who sold or serviced the vehicle
- a brief description of your unresolved concern
- a brief summary of the action taken by the dealer(s) and Ford Motor Company
- the names (if known) of all the people you contacted at the dealership(s)
- a description of the action you expect to resolve your concern
- You will receive a letter of explanation if your application does not qualify for Board review.

Oral presentations

If you would like to make an oral presentation indicate YES to question #6 on the application. While it is your right to make an oral presentation before the Board, this is not a requirement and the Board will decide the case whether or not an oral presentation is made. Oral presentation may be requested Board as well.

Making a decision

Board members review all available information related to each complaint, including oral presentations, and arrive at a fair and impartial decision.

Every effort is made to decide the case within 40 days of the date that all requested information is received by the Board. Since the Board generally meets once a month, it may take more than a month before the Board can consider some cases.

After a case is reviewed, the Board mails you a decision letter and a form on which to accept or reject the Board's decision. The decisions of the Board are binding on Ford (and, in some cases, on the dealer) but not on consumers who are free to pursue other remedies available to them under state or federal law.

To request a DSB brochure/application

For a brochure/application, speak to your dealer or write/call to the Board at the following address/phone number:

Dispute Settlement Board
P.O. Box 5120
Southfield, MI 48086-5120
1-800-428-3718

You may also contact the North American Customer Assistance Center at 1-800-392-3673 (Ford). TDD for the hearing impaired: 1-800-232-5952 or by writing to the Center at the following address:

Ford Motor Company
Customer Assistance Center
16800 Executive Plaza Drive
P.O. Box 6248
Dearborn, Michigan 48121

GETTING ASSISTANCE OUTSIDE THE U.S. AND CANADA

Before exporting your vehicle to a foreign country, contact the appropriate foreign embassy or consulate. These officials can inform you of local vehicle registration regulations and where to find unleaded fuel.

If you cannot find unleaded fuel or can only get fuel with an anti-knock index lower than is recommended for your vehicle, contact a district or owner relations/customer assistance office.

The use of leaded fuel in your vehicle without proper conversion may damage the effectiveness of your emission control system and may cause engine knocking or serious engine damage. Ford Motor Company/Ford of Canada is not responsible for any damage caused by use of improper fuel.

In the United States, using leaded fuel may also result in difficulty importing your vehicle back into the U.S.

Customer assistance

If your vehicle must be serviced while you are traveling or living in Central or South America, the Caribbean, or the Middle East, contact the nearest Ford dealership. If the dealership cannot help you, write or call:

FORD MOTOR COMPANY
WORLDWIDE DIRECT MARKET
OPERATIONS

1555 Fairlane Drive
Fairlane Business Park #3
Allen Park, Michigan 48101
U.S.A.

Telephone: (313) 594-4857
FAX: (313) 390-9804

If you are in another foreign country, contact the nearest Ford dealership. If the dealership employees cannot help you, they can direct you to the nearest Ford affiliate office.

If you buy your vehicle in North America and then relocate outside of the U.S. or Canada, register your vehicle identification number (VIN) and new address with Ford Motor Company Worldwide Direct Market Operations.

FORD ACCESSORIES FOR YOUR VEHICLE

Ford has many quality products available from your dealer to clean your vehicle and protect its finishes. For best results, use the following or products of equivalent quality

Ford Custom Clearcoat Polish*

Ford Custom Silicone Gloss Polish

Ford Custom Vinyl Protectant*

Ford Deluxe Leather and Vinyl Cleaner

Ford Extra Strength Tar and Road Oil Remover*

Ford Extra Strength Upholstery Cleaner

Ford Metal Surface Cleaner

Ford Multi-Purpose Cleaner*

Motorcraft Car Wash Concentrate

Motorcraft Carlite Glass Cleaner

Ford Spot and Stain Remover*

Ford Super Premium Tire and Trim Dressing

Ford Triple Clean

Ford Ultra-Clear Spray Glass Cleaner

* May be sold with the Motorcraft name

A wide selection of accessories is available through your local authorized Ford, Lincoln-Mercury or Ford of Canada dealer. These quality accessories have been specifically engineered to fulfill your automotive needs; they are custom designed to complement the style and aerodynamic appearance of your vehicle. In addition, each accessory is made from high quality materials and meets or exceeds Ford's rigid engineering and safety specifications. Ford accessories are warranted for up to 12 months or 20,000 km (12,000 miles) on all cars and light trucks and 12 months with unlimited distance on medium/heavy duty trucks unless the accessory is installed on a new vehicle, then the warranty becomes the balance of the new vehicle's warranty or the accessories warranty, whichever is greater. See your dealer for complete warranty information and availability.

Not all accessories are available for all models.

Vehicle Security

Remote keyless entry

Styled wheel protector locks

Vehicle security systems

Comfort and convenience

Air conditioner

Air filtration systems

Cargo nets

Cargo organizers

Cargo shades

Cargo trays

Dash trim

Engine block heaters

Gear shift knob

Luggage presenter (Continental only)

Manual sliding rear window

Tire step

Customer assistance

Travel equipment

Console
Console armrest
Daytime running lights
Factory luggage rack
Factory luggage rack adapters
Fog lights
Framed luggage covers
Heavy-duty battery
Neutral towing transfer case kit (Explorer 4.0L only)
Off road lights
Pickup box rails
Removable luggage rack
Removable luggage rack adapters
Retractable bed hooks and loops
Running boards
Snow traction cables
Soft luggage cover
Speed control
Towing mirrors
Trailer hitch
Trailer hitch bars and balls
Trailer hitch wiring adaptor

Protection and appearance equipment

Air bag anti-theft locks
Bed mat/bedliner tailgate covers
Bed mats
Bedliners
Car/truck covers
Cargo liners, interior
Carpet floor mats
Cleaners, waxes and polishes
Flat splash guards
Fronnd end covers (full and mini)
Hood deflectors
Locking gas cap
Lubricants and oils
Molded splash guards
Molded vinyl floor mats
Rallye bars
Rear air deflectors
Rear decklid spoilers
Side window air deflectors
Spare tire lock
Step bumpers
Step/sill plates
Tailgate covers
Tailgate lock
Tailgate protection
Tonneau covers
Touch-up paint
Universal floor mats

For maximum vehicle performance, keep the following information in mind when adding accessories or equipment to your vehicle:

- When adding accessories, equipment, passengers and luggage to your vehicle, do not exceed the total weight capacity of the vehicle or of the front or rear axle (GVWR or GAWR as indicated on the Safety compliance certification label). Consult your dealer for specific weight information.
- The Federal Communications Commission (FCC) and Canadian Radio Telecommunications Commission (CRTC) regulate the use of mobile communications systems - such as two-way radios, telephones and theft alarms - that are equipped with radio transmitters. Any such equipment installed in your vehicle should comply with FCC or CRTC regulations and should be installed only by a qualified service technician.

- Mobile communications systems may harm the operation of your vehicle, particularly if they are not properly designed for automotive use or are not properly installed. When operated, such systems may cause the engine to stumble or stall. In addition, such systems may be damaged or their performance may be affected by operating your vehicle. (Citizens band [CB] transceivers, garage door openers and other transmitters with outputs of five watts or less will not ordinarily affect your vehicle's operation.)
- Ford cannot assume responsibility for any adverse effects or damage that may result from the use of such equipment.

Customer assistance

ORDERING ADDITIONAL OWNER'S LITERATURE

To order the publications in this portfolio in the United States:

Make checks payable to:
HELM, INCORPORATED
P.O. Box 07150
Detroit, Michigan, 48207

**For a free publication catalog,
order toll free: 1-800-782-4356**

Monday-Friday 8:00 a.m. - 6:00
p.m. EST.,

for credit card holders only.

To order the publications in this portfolio in Canada

Make cheques payable to:
Ford Motor Company of Canada,
Ltd.

Service Publications
P.O. Box 1580, Station B
Mississauga, Ontario, Canada L4Y
4G3

**or order toll free:
1-800-387-4966**

Monday-Friday 8:00 a.m. - 6:00 p.m.

EST.,

for credit card holders only.

REPORTING SAFETY DEFECTS (U.S. ONLY)

If you believe that your vehicle has a defect that could cause a crash, or could cause injury or death, you should immediately inform the National Highway Traffic Safety Administration (NHTSA) in addition to Ford Motor Company.

If NHTSA receives similar complaints, it may open an investigation, and if it finds that a safety defect exists in a group of vehicles, it may order a recall and remedy campaign. However, NHTSA cannot become involved in individual problems between you, your dealer or Ford Motor Company.

To contact NHTSA, you may either call the Auto Safety Hotline toll-free at 1-800-424-9393 (202-366-0123 in the Washington D.C. area) or write to

NHTSA
U.S. Department of Transportation
400 Seventh Street
Washington D.C. 20590

You can also obtain other information about motor vehicle safety from the hotline.

Index

- | A | Page | B | Page |
|---|----------|---|---------|
| Accessory position on the ignition | 52 | Brake fluid | |
| Additives, engine oil | 165 | checking and adding | 168 |
| Air bag supplemental restraint system | | specifications | 219 |
| and child safety seats | 84 | Brake-shift interlock | 118 |
| description | 83 | Brakelamps | |
| disposal | 88 | (see Bulb replacement) | |
| indicator light | 13, 87 | Brakes | |
| operation | 85 | anti-lock brake system (ABS) | 112 |
| wearing safety belts | 83 | brake warning light | 14 |
| Air conditioning | | fluid, checking and adding | 168 |
| (see Climate control system) | | fluid, refill capacities | 218 |
| Alarm, activating panic | 67 | fluid, specification | 219 |
| Antenna, radio | | parking | 114 |
| (see Audio system) | 51 | Built-in child seat | |
| Anti-lock brake system (ABS) | 112 | folding up the seat | 98 |
| Anti-theft system (see Passive Anti-Theft System) | 69 | inspection after a collision | 98 |
| Antifreeze (see Engine coolant) | | interlock safety feature | 94 |
| Audio system | 32 | operation | 93 |
| Automatic transaxle | | retractors | 97 |
| driving with | 119 | Break-in period | 2 |
| fluid, adding | 174 | Bulbs, replacing | |
| fluid, checking | 174 | foglamps | 202 |
| fluid, refill capacities | 218 | headlamps | 200 |
| fluid, specification | 219 | high-mounted brake lamp | 204 |
| | | license plate lamp | 203 |
| | | rear lamps | 203 |
| | | specifications | 206 |
| B | | C | |
| Backing up | 119, 125 | Cabin air filter | 31, 180 |
| Battery | | Capacities for refilling fluids | 218 |
| charging system warning light | 7 | Carbon monoxide in exhaust | 197 |
| jumping a disabled battery | 150 | Catalytic converter | 196 |
| proper disposal, recycling | 178 | Chains, tires | 188 |
| replacement, specifications | 217 | Changing a tire | 146 |
| servicing | 176 | Charging system warning light | 7 |

Index

C	Page	D	Page
Child safety restraints		Daytime running lights	21
built-in child seat	93	Defects, reporting	235
child safety seats	99	Defrost	
children and safety belts . . .	89, 91	rear window	22
Child safety seats		windshield	30
and air bags	84	Dipstick, engine oil	163
attaching with tether straps . .	102	Door mounted controls	62
automatic locking mode	77	Driving under special conditions	
Childproof safety locks	63	heavy load	129
Chimes	17	towing a trailer	130
Circuit breakers	139	E	
Cleaning your vehicle		Electrical system	
engine compartment	213	fuses	139
exterior lamps	214	Emergencies, roadside	
fabric	215	fuel pump shut-off switch . . .	137
instrument panel	215	jump starting	150
plastic exterior parts	214	towing	156
safety belts	216	Emergency brake (see Parking	
wheels	212	brake)	
wiper blades	214	Emission control system	196
Climate control system		Engine	
air conditioning	27	check engine warning light . . .	10
controlling airflow	24	fuel pump shut-off switch . . .	137
defrosting	30	lubricant specifications	219
temperature	25	preparing to start	107
vents	24	refill capacities	218
Clock	43	starting	110
Clutch		Engine block heater	111
operation	123	Engine coolant	
recommended shift speeds . . .	124	checking and adding	167
Cold engine starting	110	disposal	171
Controls		low coolant warning light	9
instrument panel	18	refill capacities	218
power seats	73	specifications	219
steering column	53	Engine fan	159
Customer assistance	223		

Index

- E** Page
- Engine oil
 - changing oil and filter165
 - checking and adding165
 - dipstick163
 - disposal167
 - engine oil pressure
 - warning light16
 - filter specifications217
 - refill capacities218
 - specifications219
 - Exhaust fumes106, 197
- F**
- Fan (see Engine fan)
 - Flasher, hazard54, 137
 - Flashing the lights55
 - Floor mats65
 - Fluid refill capacities218
 - Foglamps21, 202
 - Fuel
 - calculating fuel economy195
 - capacity218
 - choosing the right fuel192
 - consumption136
 - fuel gauge19
 - low fuel warning light13
 - octane rating193
 - quality193
 - running out of fuel196
 - safety information relating
 - to automotive fuels190
 - Fuel pump shut-off switch . . .137
 - Fuse panels
 - engine compartment140
 - instrument panel142
- F** Page
- Fuses
 - charts141, 144
 - checking and replacing139
- G**
- Gas mileage (see Fuel)
 - Gauges
 - engine coolant temperature . .18
 - fuel19
 - odometer19
 - speedometer19
 - trip odometer19
 - GAWR
 - (Gross Axle Weight Rating) . . .127
 - Gearshift117, 123
 - GVWR
 - (Gross Vehicle Weight Rating) .127
- H**
- Hazard flashers54, 137
 - Head restraints72
 - Headlamps
 - aiming207
 - bulb specifications206
 - daytime running light21
 - flashing55
 - high beam55
 - replacing bulbs200
 - turning on and off20
 - warning chime17
 - High beams
 - indicator light7
 - operation55

H	Page	L	Page
High-mount brakelamp204	Lamps	
Hood		bulb replacement specification	
latch location162	chart206
release lever162	daytime running light system . .	.21
Horn54	flashing the lamps55
I		foglamps21, 202
Identification Number, Vehicle		hazard flashers54, 137
(VIN)222	headlamps20
Idle, relearning179	high beams55
Idle, speed179, 220	high-mounted brake lamp204
Ignition		instrument panel, dimming . .	.23
chime17	interior lamps60
positions on the ignition52	reading lamps61
Instrument cluster6	replacing bulbs200
Instrument panel		rear lamps203
cleaning215	Lights, warning and indicator	
lighting up the panel23	air bag13
Integrated child seat (see Built-in		anti-lock brakes (ABS)15
child seat)		brake14
Intermittent wipers56	charging system7
Introduction2	check engine10
J		engine oil pressure16
Jack		high beam7
positioning148	low coolant9
storage147	low fuel13
Jump starting your vehicle		overdrive off9
attaching cables151	safety belt7
disconnecting cables154	testing the warning lights17
K		turn signal indicator6
Keys		Load limits127
key in ignition warning chime . .	.17	Lubricant specifications219
positions of the ignition52	Luggage compartment64

Index

M	Page	P	Page
Maintenance (see Servicing)		Power distribution box (see Fuses)	
Manual transaxle		Power door locks	62
backing up (reverse)	125	Power features	
clutch	123	mirrors	23
fluid, capacity	218	seats	73
shift speeds	124	sunroof	61
Mileage, calculating fuel		windows	62
economy	195	Power steering	
Mirrors		fluid, checking and adding . .	173
side view mirrors (power) . . .	23	fluid, refill capacity	218
Motorcraft parts	217	fluid, specification	219
N		R	
National Highway Traffic Safety		Radio (see Audio system)	32
Administration	235	Rear window defroster	22
O		Refill capacities for fluids	218
Octane rating	193	Relays	139
Odometer	19	Remote control	
Oil (see Engine oil)		luggage compartment	64
Oil filter	165, 217	Remote entry system	
On-board diagnostic (OBD II)		locking/unlocking doors	66
system	198	opening the trunk	67
Overdrive	9, 120	panic alarm	67
Overhead controls	61	replacing the batteries	67
P		replacement/additional	
Panel dimmer control	23	transmitters	68
Panic alarm, remote entry sytem	67	Repairing paint chips	212
Parking brake	114	Reporting safety defects	235
Parts (see Motorcraft parts) . .	217	Restraints, safety	75
Passenger compartment		Rotating the tires	185
air filter (see Cabin air filter) .	181		
Passive Anti-Theft			
System (PATS)	69		

S	Page	S	Page
Safety belts		Spare tire	
(see Safety restraints)		changing the tire	146
Safety chains, when towing		removing the spare tire	148
a trailer	134	temporary spare tire	147
Safety Compliance Certification		Spark plugs, certifications . . .	217
Label	132	Specification charts, lubricants	219
Safety defects, reporting	235	Speed control	
Safety restraints		disengaging speed control . . .	60
adjusting the safety belts . .77, 79		return to a set speed	60
automatic locking mode		set a speed	58
(retractors)	77	set a higher speed	59
cleaning the safety belts	216	set a lower speed	59
extention assembly	81	turn speed control off	57
for children	89	turn speed control on	57
head restraints	72	Speedometer	19
lap and shoulder belts	76	Starting your vehicle	
maintenance	82, 216	preparing to start the vehicle .	107
vehicle sensitive locking mode .77		starting the engine	110
warning light and chime7, 17		Steering column controls	52
Safety seats for children		Steering wheel	
and air bags	84, 100	horn	54
attaching with tether straps . .102		speed control	57
automatic locking mode		tilting	53
(retractors)	78, 99	Sunroof	61
built-in child seat	93	Supplemental restraint	
in front seat	84, 100	system	83
tether anchorage hardware . .103		T	
Seats		Tachometer	19
adjusting the seats, manual . . .72		Tail lamps (see Lamps)	
adjusting the seats, power73		Temperature control	
folding rear seats	74	(see Climate control)	
head restraints	72	Testing the warning lights	17
Servicing your vehicle	158	Tether anchor installation	
Shift-lock system	118	(see Child safety restraints)	
Shift positions (see Gearshift)		Tilt steering wheel	53
Snow tires and chains	188		

Index

T	Page	V	Page
Tires		Variable interval wipers	56
changing	146	Vehicle care	210
checking tire pressure	185	Vehicle Identification Number (VIN)	222
cleaning	212	Vehicle Emission Control Information (VECI)	198
inspection and maintenance	185	Vehicle loading	126
replacing	149	Ventilating your vehicle	105
rotating	185	Viscosity (see Engine oil)	
snow tires and chains	188	W	
spare tire	147	Warning chimes	
tire grades	182	headlamps on	17
treadwear	183, 186	key in ignition	17
wearbands	186	safety belt	17
Towing your vehicle	156	Warning lights (see Lights)	
Traction control	22, 115	Washer fluid reservoir	163
Trailer towing	130	Weight limits (GAWR, GVWR)	127
Transaxle		Wheels	
automatic, operation	117	cleaning	212
fluid, checking and adding (automatic)	174	inspection and maintenance	185
fluid, refill capacities	218	Windows	
lubricant specifications	219	one-touch down	62
manual, operation	123	power windows, operating	62
Transmitter (see Remote entry)		rear, defrosting	22
Trip odometer	19	Windshield washer fluid and wipers	
Trunk (see Luggage compartment)		checking and adding fluid	168
remote release lever	64	checking and replacing	
using the remote entry system	66	wiper blades	180
Turn signal		operation	56
indicator lights	6	fluid, specification	219
lever	55	variable interval wipers	56
U		Wrecker towing	156
Used engine oil, disposal	167		

Filling station information

Fuel	UNLEADED FUEL ONLY Octane 87
Fuel tank capacity	58.5 litres (15.4 gallons)
Engine oil	Use Motorcraft 5W-30 Formula E Fuel Economy Motor Oil, Ford specification WSS-M2C153-G.
Tire size and pressure	Refer to Safety Compliance Certification label on driver's door pillar
Hood release location	Pull handle under the left side of the instrument panel
Fuel filler location	Right rear of vehicle