

# Contents

## Before driving

Introduction	2
Instrumentation	3
Controls and features	32
Seating and safety restraints	66

## Starting and driving

Starting	88
Driving	93
Roadside emergencies	107

## Servicing

Maintenance and care	123
Capacities and specifications	161
Reporting safety defects	167
Index	168

All rights reserved. Reproduction by any means, electronic or mechanical including photocopying, recording or by any information storage and retrieval system or translation in whole or part is not permitted without written authorization from Ford Motor Company.

# Introduction

## ICONS

Indicates a warning. Read the following section on *Warnings* for a full explanation.



Indicates vehicle information related to recycling and other environmental concerns will follow.



Correct vehicle usage and the authorized disposal of waste cleaning and lubrication materials are significant steps towards protecting the environment.

## WARNINGS

Warnings provide information which may reduce the risk of personal injury and prevent possible damage to others, your vehicle and its equipment.

## BREAKING-IN YOUR VEHICLE

There are no particular breaking-in rules for your vehicle. During the first 1 600 km (1 000 miles) of driving, vary speeds frequently. This is necessary to give the moving parts a chance to break in.

If possible, you should avoid full use of the brakes for the first 1 600 km (1 000 miles).

## INFORMATION ABOUT THIS GUIDE

The information found in this guide was in effect at the time of printing. Ford may change the contents without notice and without incurring obligation.

# Instrumentation

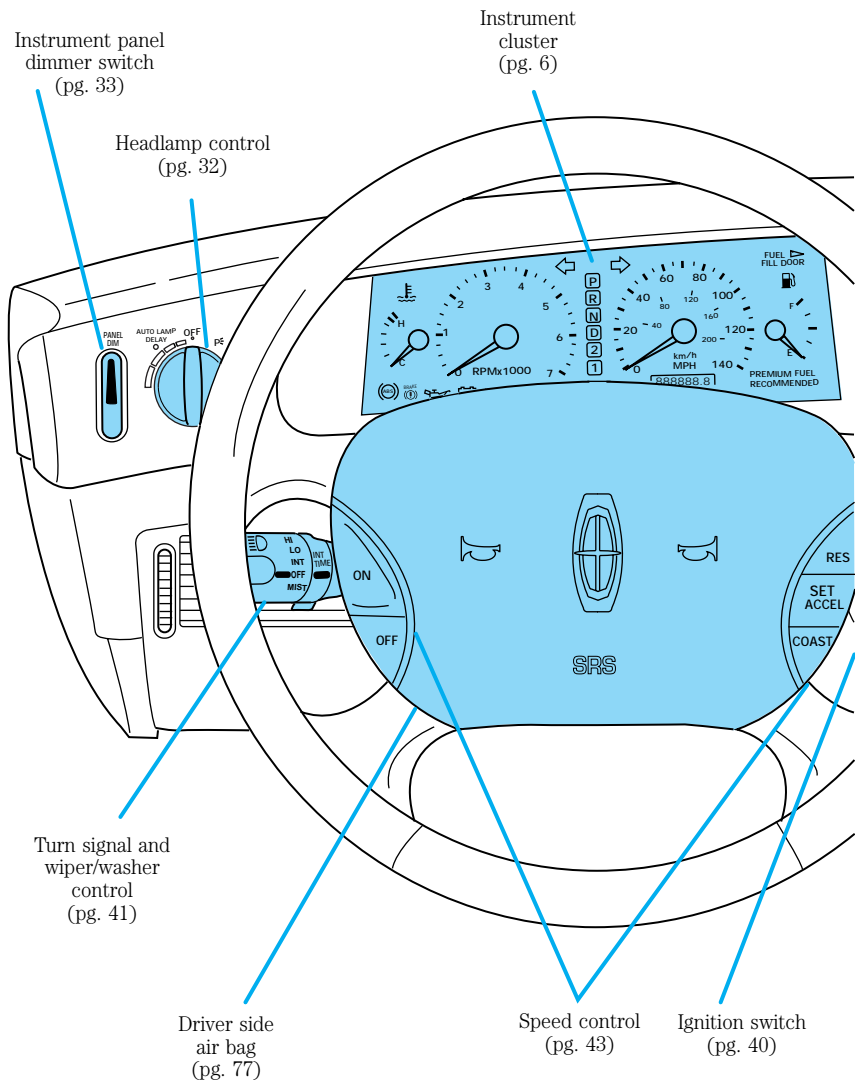

# Instrumentation

Message Center  
(pg. 14)

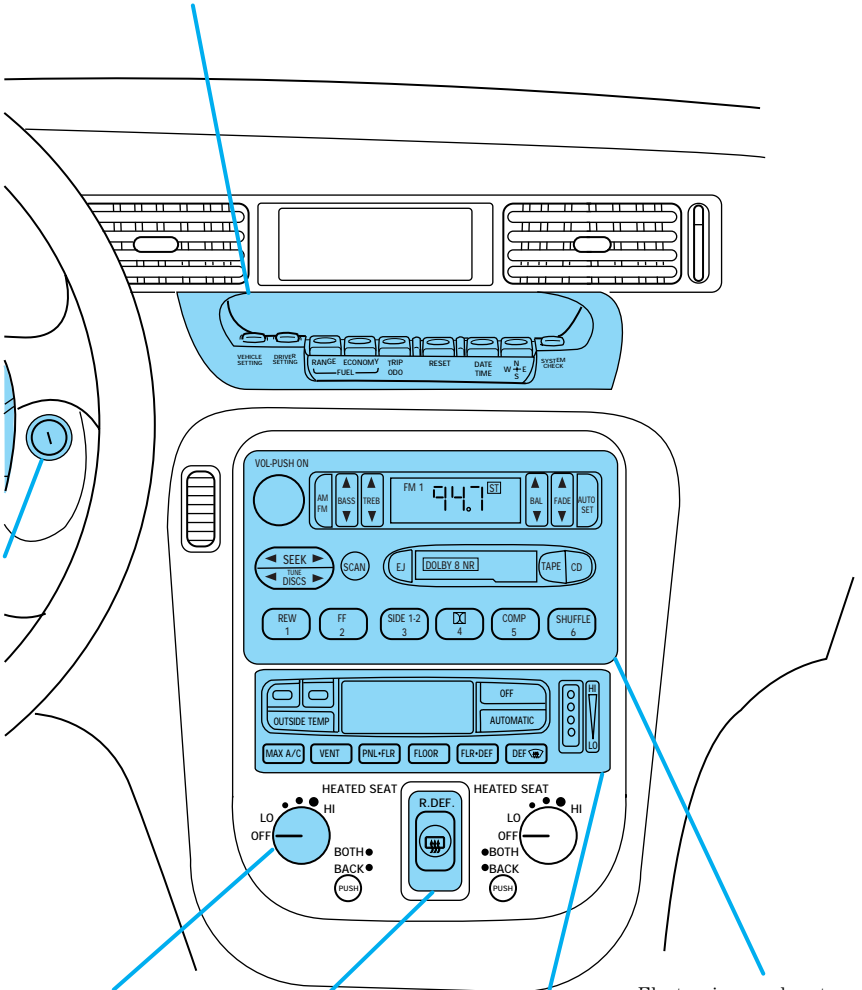

Heated seat control  
(if equipped)  
(pg. 67)

Rear window  
defroster control  
(pg. 40)

Climate control  
systems  
(pg. 34)

Electronic sound system;  
refer to Audio Guide  
(pg. 39)

# Instrumentation

## WARNING LIGHTS AND CHIMES

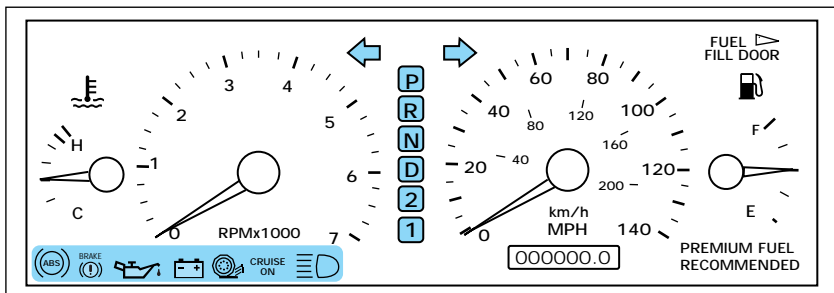

### Anti-lock brake system (ABS)

Momentarily illuminates when the ignition is turned to the ON position and the engine is off. If the light remains on, continues to flash or fails to illuminate, have the system serviced immediately.



### Brake system warning

Momentarily illuminates when the ignition is turned to the position ON and the engine is off. Also illuminates when the parking brake is engaged. Illumination after releasing the parking brake indicates low brake fluid level.



### Engine oil pressure

Illuminates when the oil pressure falls below the normal range. Stop the vehicle as soon as safely possible and switch off the engine immediately. Check the oil level and add oil if needed. Refer to *Engine oil* in the *Maintenance and Care* chapter.

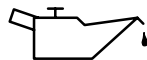

This lamp also illuminates when the ignition is turned to ON and the engine is off.

### Charging system

Momentarily illuminates when the ignition is turned to the ON position and the engine is off. The light also illuminates when the battery is not charging properly, requiring electrical system service.

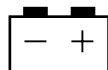

### Traction Control™ active

This light momentarily illuminates when the ignition is turned to ON. It also illuminates when the Traction Control™ system begins applying and releasing the brakes and adjusting the engine characteristics to limit a wheelspin condition. It will be lit for a maximum of four seconds or for the duration of the Traction Control™ event.



For more information, refer to the *Driving* chapter.

## Instrumentation

### Speed control (if equipped)

This light comes on when either the SET/ACCEL or RESUME controls are pressed. It turns off when the speed control OFF control is pressed, the brake is applied or the ignition is turned to the OFF position.

CRUISE  
ON

### High beams

Illuminates when the high beam headlamps are turned on.



### Redundant electronic gearshift indicator

These lights operate with the key in the ON position only and display the same gear selection as shown on the gear selector indicator located on the floor console next to the gearshift lever.



### Turn signal

Illuminates when the left or right turn signal or the hazard lights are turned on. If one or both of the indicators stay on continuously or flash faster, check for a burned-out turn signal bulb. Refer to *Exterior bulbs* in the *Maintenance and care* chapter.

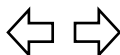

## Message center warning lights

The following warning lights are displayed directly above the message center controls.

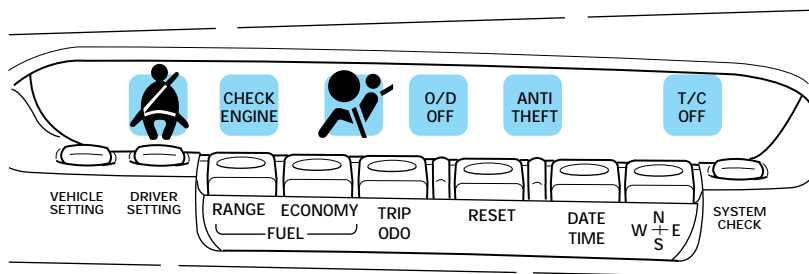

## Safety belt

Illuminates when the ignition is turned on to remind you to fasten your safety belts. For more information, refer to the *Seating and safety restraints* chapter.



## Check engine

Your vehicle is equipped with a computer that monitors the engine's emission control system. This system is commonly known as the On Board Diagnostics System (OBD II). This OBD II system protects the environment by ensuring that your vehicle continues to meet government emission standards. The OBD II system also assists the service technician in properly servicing your vehicle.

**CHECK  
ENGINE**

The *check engine* indicator light illuminates when the ignition is first turned to the ON position to check the bulb. If it comes on after the



## Instrumentation

engine is started, one of the engine's emission control systems may be malfunctioning. The light may illuminate without a driveability concern being noted. The vehicle will usually be drivable and will not require towing.

### **What you should do if the check engine light illuminates**

#### **Light turns on solid:**

This means that the OBD II system has detected a malfunction. Have your vehicle serviced at your first opportunity.

Temporary malfunctions may also cause your *check engine* light to illuminate. Examples follow:

- The vehicle has run out of fuel. (The engine may misfire or run poorly.)
- Poor fuel quality or water in the fuel.
- The fuel cap may not have been securely tightened.

These temporary malfunctions can be corrected by filling the fuel tank with good quality fuel and/or properly tightening the gas cap. After three drive cycles without these or any other temporary malfunctions present, the *check engine* light should turn off. **No** vehicle service is required.

#### **Light is blinking:**

Engine misfire is occurring which could damage your catalytic converter. You should drive in a moderate fashion (avoid heavy acceleration and deceleration) and have your vehicle serviced at the first available opportunity.



Under engine misfire conditions, excessive exhaust temperatures could damage the catalytic converter, the fuel system, interior floor coverings or other vehicle components, possibly causing a fire.

### **Air bag readiness**

Briefly illuminates when the ignition is turned on. If the light fails to illuminate, continues to flash or remains on, have the system serviced immediately.



### **O/D off**

This light momentarily illuminates when the ignition is turned to ON. It also illuminates when the transmission control switch been pushed. When the light is on, the transmission does not shift into overdrive. If the light does not come on when the transmission control switch is depressed or if the light flashes when you are driving, have your vehicle serviced.

O/D  
OFF

### **Anti-theft system**

This light indicates the anti-theft alarm system is armed. Refer to the *Controls and features* chapter.

ANTI  
THEFT

### **Traction Control™ off light**

This light tells you that the Traction Control™ system has been turned off using the Vehicle Settings menu in the Message Center. The Traction Control™ system defaults to “ON” (light is not illuminated) whenever the vehicle is shut off and restarted.

This light will also illuminate if there is a total Traction Control™ system shut down.

If this lamp continuously stays on, contact your dealer for service as soon as safely possible.

T/C  
OFF

### **Headlamps on warning chime**

Sounds when the headlamps or parking lamps are on, the ignition is off (and the key is not in the ignition) and either front door is opened.

### **Safety belt warning chime**

Chimes to remind you to fasten your safety belts.

For information on the safety belt warning chime, refer to the *Seating and safety restraints* chapter.

# Instrumentation

## Supplemental restraint system (SRS) warning chime

For information on the SRS warning chime, refer to the *Seating and safety restraints* chapter.

## Key-in-ignition warning chime

Sounds when the key is left in the ignition in the OFF/LOCK or ACC position and the driver's door is opened.

## GAUGES

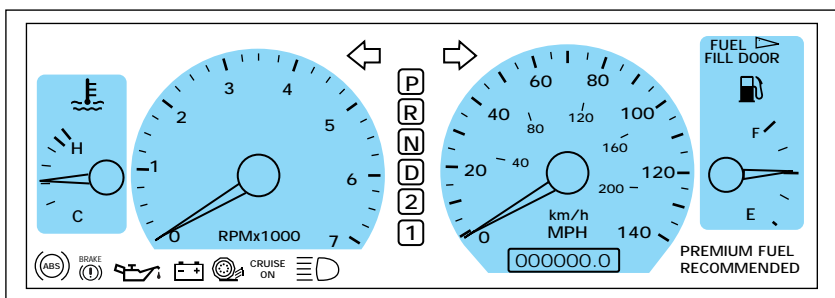

## Engine coolant temperature gauge

Indicates the temperature of the engine coolant. At normal operating temperature, the needle remains within the normal area (the area between the “H” and “C”). If it enters the red section, the engine is overheating. Stop the vehicle as soon as safely possible, switch off the engine immediately and let the engine cool. Refer to *Engine coolant* in the *Maintenance and care* chapter.

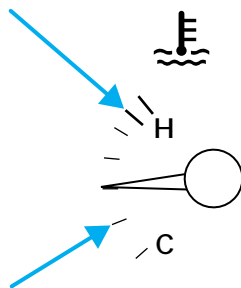

# Instrumentation



Never remove the coolant recovery cap while the engine is running or hot.

This gauge indicates the temperature of the engine coolant, not the coolant level. If the coolant is not at its proper level the gauge indication will not be accurate.

## Tachometer

Indicates the engine speed in revolutions per minute.

Driving with your tachometer pointer in the red zone may damage the engine.

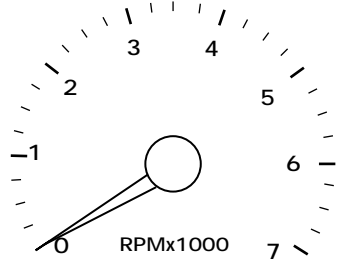

## Speedometer

Indicates the current vehicle speed.

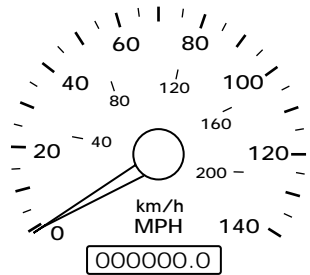

# Instrumentation

## Odometer

Indicates the total kilometers (miles) of the vehicle.

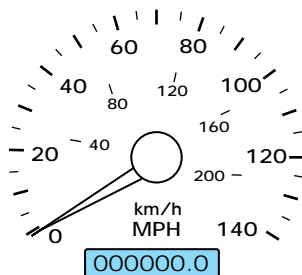

## Fuel gauge

Displays approximately how much fuel is in the fuel tank (when the key is in the ON position). The fuel gauge may vary slightly when the vehicle is in motion. The ignition should be in the OFF position while the vehicle is being refueled. When the gauge first indicates empty, there is a small amount of reserve fuel in the tank. When refueling the vehicle from empty indication, the amount of fuel that can be added will be less than the advertised capacity due to the reserve fuel.

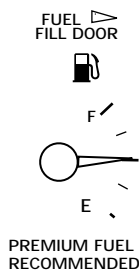

## ELECTRONIC MESSAGE CENTER

The electronic message center only works when the ignition is in the ON position.

The message center tells you about the condition of your vehicle by three methods:

- operator selectable features
- vehicle system status displays
- continuous warning reporting of monitored systems

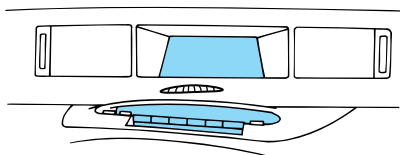

## Selectable features

You can select different features for the message center to display by using the message center controls located below the message center display. You will hear a tone when you press one of these controls. However, the message center will display the appropriate warning message if it detects a warning from any of the monitored systems.

## Vehicle setting

Each press of the VEHICLE SETTING control will select a different feature as follows:

- **TRACTION CONTROL.** This system helps prevent wheel spin to improve tire traction. The RESET control will toggle this feature on or off, but the feature defaults to ON after each cycle of the ignition key.
- **ENGLISH/METRIC.** This feature allows you to change the message center and electronic automatic temperature control units from metric to English units. The modes can be toggled by pressing the RESET control.
- **AUTOLAMP DELAY STATUS.** This feature displays the current autolamp delay setting. To change the delay setting, you must rotate the headlamp control.
- **WIPER/HEADLAMP ON.** When enabled, the headlamps will automatically switch on when the windshield wipers are in the intermittent, low or high speed settings. Use the RESET control to toggle the feature on or off.

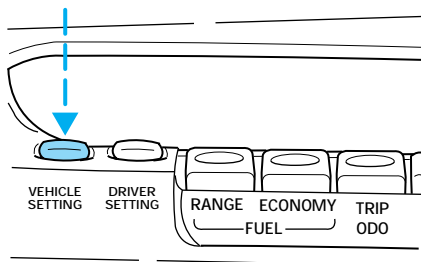

## Instrumentation

- **OIL CHANGE RESET.** This feature allows you to reset the oil monitoring system to 100 percent after each oil change. To reset, the RESET control must be pressed and held for 5 seconds while the display counts down. After a successful reset, the message center will display “OIL LIFE RESET TO 100%.” To ensure accurate oil life indicators, perform the reset procedure only after an oil change.

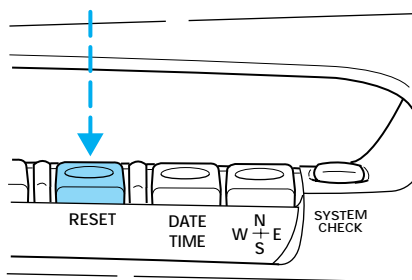

You can also set a personalized oil reset percentage, which allows you to establish a smaller oil change interval.

1. Press and hold the RESET control from the VEHICLE SETTINGS menu OIL CHANGE RESET screen.

2. While holding the RESET control as the display counts down the seconds to an oil change reset, press the VEHICLE SETTINGS control. The display will read START OIL LIFE AT XXX%, where XXX is the currently selected oil life percentage. Release both controls.

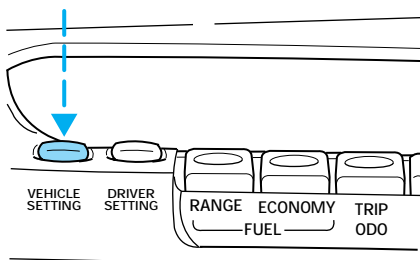

## Instrumentation

3. Press the RESET control to obtain the desired personalized oil change percentage. Your choices are 100%, 90%, 80%, 70%, 60%, 50%, 40% and 30%.

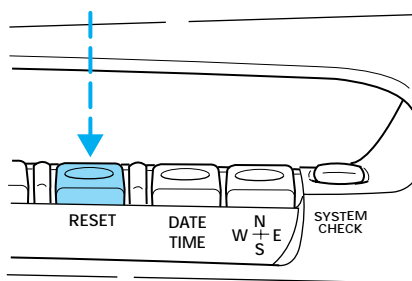

4. Press the VEHICLE SETTING control to complete the procedure. A press of any control other than RESET or VEHICLE SETTING will abort the procedure and will not establish a new personalized oil reset percentage.

Your personalized oil change percentage will begin upon completion of your next OIL CHANGE RESET procedure. Refer to *CHANGE OIL SOON/OIL CHANGE REQUIRED* for more information.

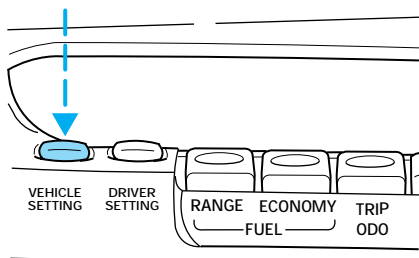

### Driver setting menu

The DRIVER SETTING menu allows you to cycle through seven (if equipped with phone) features, saved for each driver personality profile. These features can be turned on or off by pressing the RESET control.

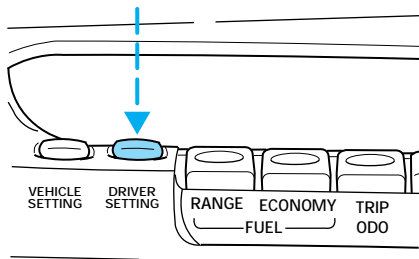



## Instrumentation

- **EXPRESS WINDOWS.** Allows one tap down operation of the driver's window using the window switch.
- **AUTO LOCK.** Automatically locks all doors when all doors are closed and the vehicle speed is at least 5 km/h (3 mph).
- **HORN CHIRP.** Briefly sounds the horn when the remote keyless entry LOCK control is pressed. Refer to *Remote keyless entry* in the *Controls and features* chapter for more information.
- **EASY ENTRY.** Moves the driver's seat back two inches and the steering column to the up and forward position when the key is removed from the ignition. The driver's seat and steering column return to the set position when the driver returns.
- **REVERSE MIRRORS.** When the vehicle is shifted to R (Reverse), the outside mirrors tilt down for an improved view of the side of the vehicle and the curb area when backing up. The mirrors return to their previous position when you shift out of reverse.
- **AUTO GLIDE.** Automatically moves the seat forward when the seatback is tilted forward.
- **PHONE SCREEN** (if equipped with a factory-installed phone). When a call is placed, information about the call is displayed in the message center.

### Fuel range

Press the RANGE control to display approximately how many kilometers (miles) you can drive before running out of fuel. To ensure accuracy, turn the ignition to OFF when you fill the fuel tank.

RANGE is calculated using a running average fuel economy set by the factory. This value is not the same as the average fuel economy display. The running average fuel economy is based on more than 800 km (500 miles) of driving history.

If **FUEL SENSOR SHORT** or **OPEN** are displayed, there is a problem with the fuel indication system. If these messages or **DATA ERROR** are displayed, you should contact your dealer as soon as possible.

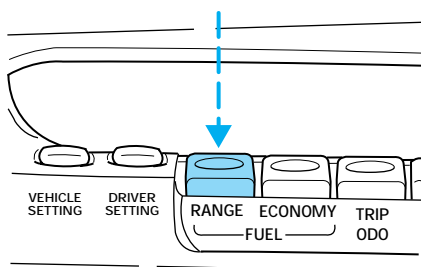

## Instrumentation

Press RANGE a second time to display the approximate amount of fuel left in the tank in whole numbers (liters or gallons). If the fuel tank is full or nearly full, the message center will display FULL FUEL TANK. If the fuel tank is nearly empty, the message center will display EMPTY FUEL TANK.

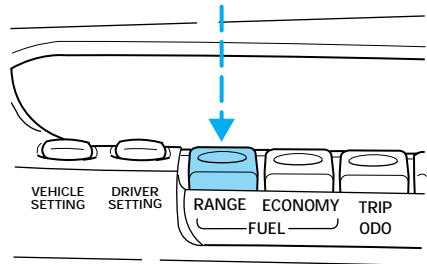

### Fuel economy

Press the ECONOMY control to display one of two features:

1. Average fuel economy. The message center display will indicate the vehicle's average fuel economy in liters/100 kilometers (miles/gallon).

- Press the RESET control to reset the average fuel economy feature.

2. Instantaneous fuel economy. The display will indicate the instantaneous fuel economy of your running vehicle. This figure is affected by such factors as braking, acceleration and road conditions.

When your vehicle is not moving, instantaneous fuel economy will be displayed at 99 kilometers/liter (0 miles/gallon). When you are moving, the message center will display between 1 and 99 kilometers/100 liters (0 and 99 miles/gallons).

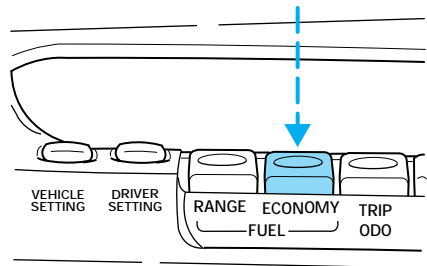

# Instrumentation

## Trip ODO

Press this control to display the first of two trip odometers. Press it again to display the second trip odometer.

To reset the displayed trip odometer, press the RESET control.

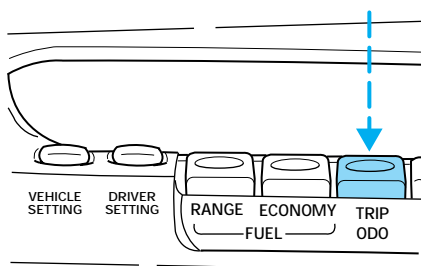

## Reset

Press this control to reset:

- warnings
- average fuel economy
- clock set
- compass adjustment
- vehicle settings
- driver settings

Range and instantaneous fuel economy are unaffected by pressing RESET.

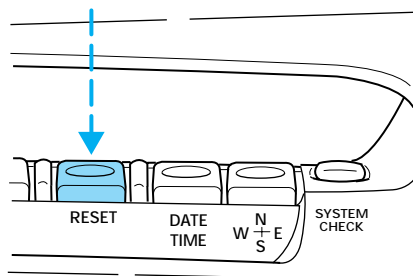

## Date/Time

Press this control to set/adjust the following features on the message center:

- day and date
- time only
- elapsed time

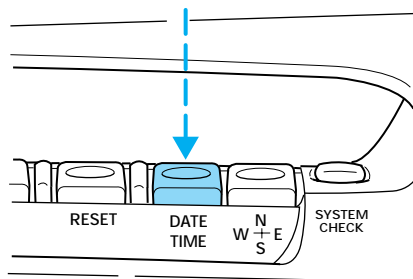

## **Day and date display**

To set the day:

1. Press the RESET control.
2. Press DATE/TIME repeatedly to select the correct day of the week.

To set the month:

1. Press RESET to proceed to the month adjustment display.
2. Press DATE/TIME repeatedly to select the correct month of the year.

To set the date:

1. Press RESET to proceed to the date adjustment display.
  2. Press DATE/TIME repeatedly to select the correct day of the month.
- When finished, press RESET to complete the set/adjustment procedure.

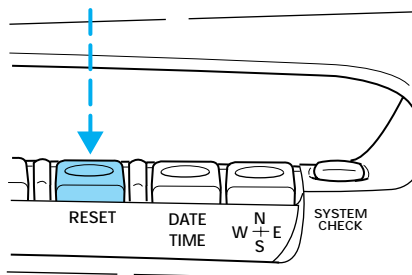

## **Time only display**

To set the hour:

1. Press the RESET control.
2. Press DATE/TIME repeatedly to select the correct hour.

To set the minute:

1. Press RESET to proceed to the minute adjustment display.
2. Press DATE/TIME repeatedly to select the correct minute.

When finished, press RESET to complete the set/adjustment procedure.

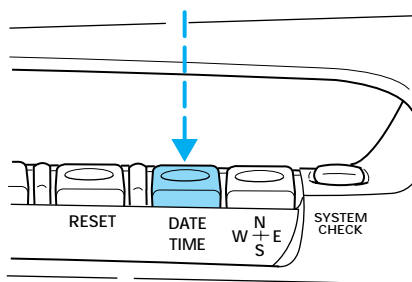

## **Elapsed time display**

This feature monitors the elapsed time if desired, regardless if the vehicle ignition is ON or OFF.

## Instrumentation

- To stop the elapsed time count while it is running without resetting the counter, briefly (less than two seconds) press the RESET control.
- To start the elapsed time count when it is stopped without resetting the counter, briefly (less than two seconds) press the RESET control.
- To reset the elapsed time counter, hold the RESET control down for about two seconds until the count reads 00:00:00.

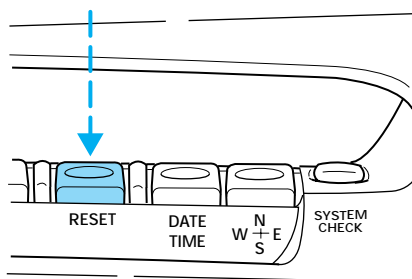

## Compass

The compass reading may be affected when you drive near large buildings, bridges, power lines and powerful broadcast antenna. Magnetic or metallic objects placed in or on the vehicle may also affect compass accuracy. Adjustments may be made to the zone and calibration of the compass.

### **Compass zone variation adjustment**

The variation adjustment is only needed if you travel outside your current compass zone.

1. Press and hold the COMPASS control, then press the RESET control. Then, release both controls.

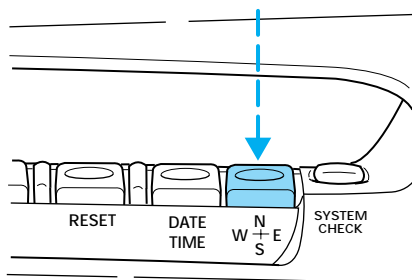

2. Determine which compass zone you are in by referring to the zone map.
3. Press the ECONOMY control until the current zone number is shown in the display.

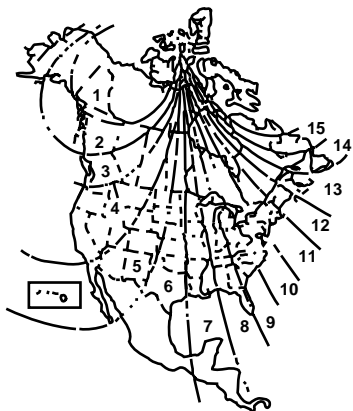

4. Press the RESET control until the number shown in the display is the correct number for the zone you are in.
5. Press the COMPASS control to complete the zone setting. (Press any control other than RESET or COMPASS to exit without setting a zone.)

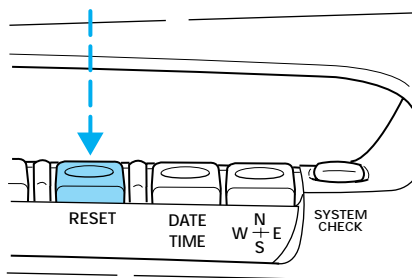

### **Compass calibration adjustment**

1. Locate an open, level area free from steel structures and high voltage lines. An empty, level parking lot is recommended.
2. Press and hold the COMPASS control, then press the RESET control. Next, release both controls.

## Instrumentation

3. Press the RESET control to enter the calibration mode. The display will show CIRCLE SLOWLY TO CAL.

4. Slowly drive the vehicle at less than 5 km/h (3 mph) in a circle, taking at least 20 seconds to complete one circle, until the display shows a direction (north, south, etc.).

5. The compass is now calibrated.

If the message center display shows CHECK COMPASS SYSTEM during any of the compass adjustment procedures, contact your dealer.

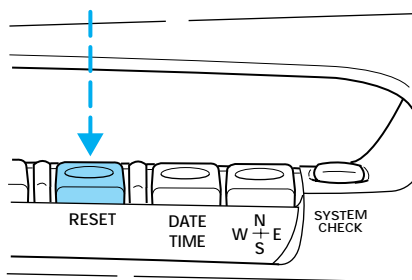

### System check

Pressing this control causes the message center to cycle through a status of each of the systems being monitored.

The sequence of the system check report is as follows:

- engine oil life status
- engine oil life left
- engine oil level
- voltage level
- engine coolant temperature
- engine coolant level
- washer fluid level
- doors closed (driver and passenger side)
- trunk closed
- exterior lamps (head, front turn, brake and tail)
- air ride system
- traction control
- fuel level
- kilometers to empty (miles to empty)

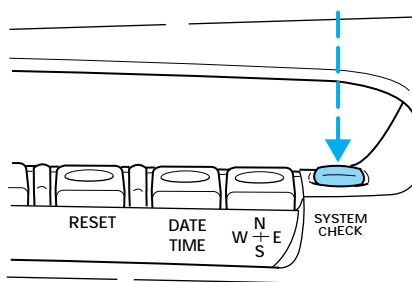

## Instrumentation

At normal conclusion of the system check sequence, the last displayed feature will be displayed.

Press the RESET control anytime during the system check to stop the cycle immediately. The last displayed feature before RESET was pressed will be displayed.

Press any of the other message center controls to stop the system check cycle and display the requested feature.

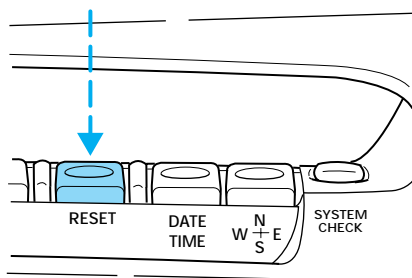

### Vehicle system status displays

These messages are displayed on the message center when the operation or use of one of the following vehicle systems occurs:

- **PHONE SCREEN.** The display will automatically appear on the message center during usage of the cellular phone (if equipped with a factory-installed phone) unless a warning is displayed or the phone screen feature is turned off in the DRIVER SETTING menu. To disable the phone screen and return to an operator selectable feature display during a phone call, press the corresponding feature control (TRIP ODO, DATE/TIME, etc.).
- **AUTO LAMP DELAY STATUS SCREEN.** This display indicates the amount of time the lights will stay on after the ignition is turned OFF (if the autolamps are turned on). This display automatically appears on the message center when the autolamp delay time is adjusted.
- **PERSONALITY EVENT SCREEN.** This display automatically appears when a vehicle system is adjusted and saved to the driver's personality profile, when a new driver personality profile is selected or when the personality feature is turned off.

### System warnings

System warnings alert you to possible problems or malfunctions in your vehicle's operating systems.



## Instrumentation

In the event of a multiple warning situation, the message center will cycle the display to show all warnings by displaying each one for 4 seconds.

The message center will display the last selected feature if there are no more warning messages. This allows you to use the full functionality of the message center after you acknowledge the warning by pressing the RESET control and clearing the warning message.

Warning messages that have been reset are divided into two categories:

- They will reappear on the display ten minutes from the reset.
- They will not reappear until an ignition OFF-ON cycle has been completed.

This acts as a reminder that these warning conditions still exist within the vehicle. All warning messages will reappear after an entire SYSTEM CHECK sequence has been completed.

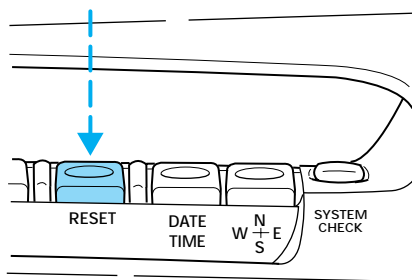

## Instrumentation

Driver's door ajar	Warning cannot be reset
Right door ajar	
Check engine temp	Warning returns after 10 minutes
Low oil level	
Check charging system	
Low fuel level	
Low engine coolant	
Engine temp data err	
Check transmission	
Transmission overheat	
Check brake lamps	
Check headlamps	
Check taillamps	
Check front turn lamps	
Low washer fluid	
Trunk ajar	
Check traction control	
Air ride switch off	
Check air ride system	
Oil change required	
Change oil soon	
Gear display data err	

**DRIVER'S DOOR AJAR.** Displayed when the driver's door is not completely closed and the ignition switch is either ON or in ACC mode.

**RIGHT DOOR AJAR.** Displayed when the passenger side door is not completely closed and the ignition switch either ON or in ACC mode.

**CHECK ENGINE TEMP.** Displayed when the engine coolant is overheating. Stop the vehicle as soon as safely possible, turn off the engine and let it cool. Check the coolant and coolant level. Refer to *Engine coolant* in the *Maintenance and care* chapter. If the warning stays on or continues to come on, contact your dealer as soon as safely possible.

## Instrumentation

**LOW OIL LEVEL.** Displayed when the engine oil level is low. If this warning message is displayed, check the level of the engine oil.

If you are parked on a steep incline, the LOW OIL LEVEL message may come on when you start your vehicle, even though the oil is at the correct level. The oil level is monitored while the engine is off so that the oil can drain into the oil pan to be measured. Some aftermarket devices such as remote starters, if improperly installed, can cause the engine to start without alerting the oil monitoring system. This may also cause the warning to appear when the vehicle is started, even though the oil level is correct. Refer to *Engine oil* in the *Maintenance and care* chapter for information about adding engine oil.

**CHECK CHARGING SYSTEM.** Displayed when the electrical system is not maintaining proper voltage. If you are operating electrical accessories when the engine is idling at a low speed, turn off as many of the electrical loads as soon as possible. If the warning stays on or comes on when the engine is operating at normal speeds, have the electrical system checked as soon as safely possible.

**LOW FUEL LEVEL.** Displayed when you have approximately 80 km (50 miles) or less left before you run out of fuel.

**LOW ENGINE COOLANT.** Displayed when the engine coolant level is low. Stop the vehicle as soon as safely possible, turn off the engine and let it cool. Check the coolant and level. Refer to *Engine coolant* in the *Maintenance and care* chapter.

**ENGINE TEMP DATA ERR.** Displayed when the engine coolant temperature information is missing or invalid. Check the instrument cluster temperature gauge. If the gauge indicates overheating, stop the vehicle as soon as safely possible, turn off the engine and let it cool. Check the coolant and level. Refer to *Engine coolant* in the *Maintenance and care* chapter. Contact your dealer for service as soon as safely possible to correct the engine temperature data error.

**CHECK TRANSMISSION.** Indicates the transmission is not operating properly. If this warning stays on, contact your dealer as soon as safely possible.

**TRANSMISSION OVERHEAT.** Indicates the transmission is overheating. This warning may appear when towing heavy loads or when driving in a low gear at a high speed for an extended period of time. Stop the vehicle as soon as safely possible, turn off the engine and let it cool. Check the transmission fluid and level. Refer to *Transmission fluid* in the *Maintenance and care* chapter. If the warning stays on or continues to come on, contact your dealer for transmission service as soon as safely possible.

**CHECK BRAKE LAMPS.** Displayed when the brake lamps are activated and at least one is burned out. Check the lamps as soon as safely possible and have the burned out lamp replaced. The center high-mount brakelamp is not monitored.

**CHECK HEADLAMPS.** Displayed when the headlamps are activated and at least one is burned out. Check the lamps as soon as safely possible and have the burned out lamp replaced. Refer to *Replacing headlamp bulbs* in the *Maintenance and care* chapter. The high beam lamps are not monitored.

**CHECK TAIL LAMPS.** Displayed when the tail lamps are activated and at least one is burned out. Check the lamps as soon as safely possible and have the burned out lamp replaced.

**CHECK FRT TURN LAMPS.** Displayed when the turn signals are activated and at least one is burned out. Check the lamps as soon as safely possible and have the burned out lamp replaced.

**LOW WASHER FLUID.** Indicates there is less than one quarter of washer fluid left in the reservoir. Check the washer fluid level. Refer to *Windshield washer fluid* in the *Maintenance and care* chapter.

**TRUNK AJAR.** Displayed when the trunk is not completely closed and the ignition switch is in ON or ACC.

**CHECK TRACTION CONTROL.** Displayed when the Traction Control™ system is not operating properly. If this message is displayed on the message center **and** the green T/C OFF light is **not** illuminated, the Traction Control™ system will be partially operable. If this warning stays on, contact your dealer for service as soon as possible. For further information, refer to *Traction control™* in the *Driving* chapter.

**AIR RIDE SWITCH OFF.** Displayed when the air suspension switch is in the OFF position.

## Instrumentation

**CHECK AIR RIDE SYSTEM.** Displayed when the air suspension system is not operating properly. If this message is displayed while driving, pull off the road as soon as safely possible. The message may also be displayed if the vehicle is loaded beyond the recommended maximum payload. This is a normal condition if the vehicle is overloaded. To correct this condition:

1. Remove or redistribute the payload per the recommended maximum requirements.
2. Turn the ignition switch from ON to OFF to ON again.

If the message reappears:

1. Turn the air suspension switch (located in the trunk) OFF.
2. Contact your dealer for service as soon as safely possible.

For more information, refer to *Air suspension* in the *Driving* chapter.

**CHANGE OIL SOON/OIL CHANGE REQUIRED.** Displayed when the engine oil life remaining is 5 percent or less. When oil life left is between 5% and 0%, the CHANGE OIL SOON message will be displayed. When oil life left reaches 0%, the OIL CHANGE REQUIRED message will be displayed.

An oil change is required whenever indicated by the message center. **USE ONLY RECOMMENDED ENGINE OILS.**

To reset the oil monitoring system to 100% (or your personalized oil reset percentage) after each oil change:

1. Press the VEHICLE SETTINGS control until the OIL CHANGE RESET display appears.

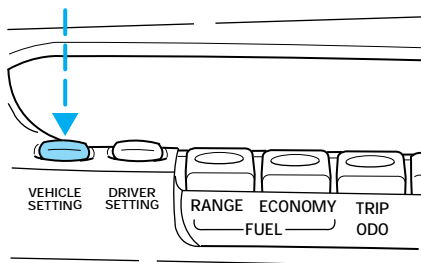

2. Press the RESET switch and hold it down for five seconds while the display counts down to trigger an oil change reset.

3. After a successful reset, the message center will display OIL LIFE RESET TO 100% (if you have established a personalized oil reset percentage, the display will instead show that percentage).

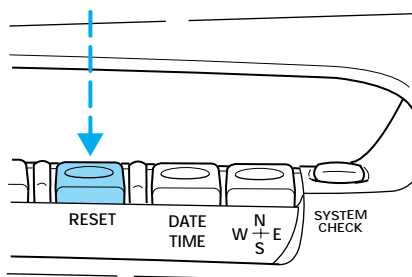

To ensure accurate oil life indicators, perform this reset procedure only after an oil change.

**GEAR DISPLAY DATA ERR.** Displayed when the data used to provide the redundant gear selection display on the instrument cluster is missing or invalid. In this case, the instrument cluster redundant gear selection display is turned off. The driver should use the mechanical position indication on the center console gear selector as temporary indication. If this warning stays on, contact your dealer as soon as safely possible.

### ***Function/status error messages***

A function/status error message may be displayed by the message center instead of a warning or requested function if the information is not currently available because of:

- improper operation of sensor systems
- the vehicle network communication between electronic modules

Error messages have two formats:

- **DATA ERROR** or **DATA ERR.** These messages indicate improper operation of the vehicle network communication between electronics modules. Contact your dealer as soon as safely possible if these messages occur on a regular basis.
- **SENSOR OPEN** or **SENSOR SHORT.** These messages indicate improper operation of vehicle sensor systems or vehicle wiring/connectors between the sensors and the message center. Contact your dealer as soon as safely possible if these messages occur on a regular basis.

## Controls and features

### HEADLAMP CONTROL

Rotate the headlamp control clockwise to the first position to turn on the parking lamps only. Rotate to the second position to also turn on the headlamps.

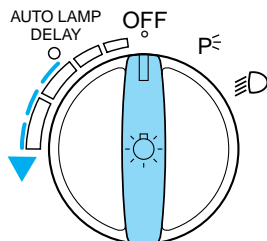

### Daytime running lamps (DRL) (if equipped)

Turns the highbeam headlamps on with a reduced output. To activate:

- the engine must be running
- the headlamp control is in the OFF or Parking lamps position.



The Daytime Running Light (DRL) system will not illuminate the tail lamps and parking lamps. Turn on your headlamps at dusk. Failure to do so may result in a collision.

### High beams

Pull back until lever latches to activate.

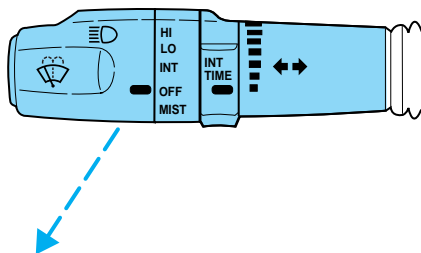

## Controls and features

### Flash to pass

Pull toward you to activate and release to deactivate.

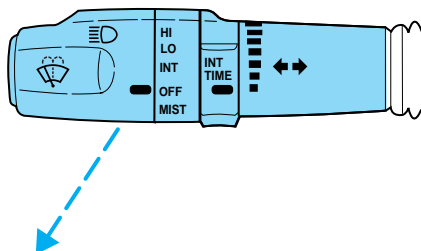

### PANEL DIMMER CONTROL

Use to adjust the brightness of the instrument panel.

- Rotate up to brighten.
- Rotate down to dim.
- Rotate fully up to turn on interior lights.

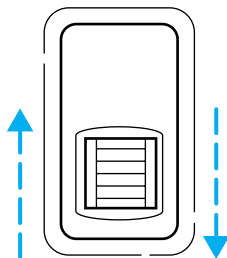

### AUTOLAMP CONTROL

The autolamp system provides light sensitive automatic on-off control of the exterior lights normally controlled by the headlamp control.

The autolamp system also keeps the lights on for a preselected period of time after the ignition switch is turned to OFF.

- To turn autolamps on, rotate the control counterclockwise. The

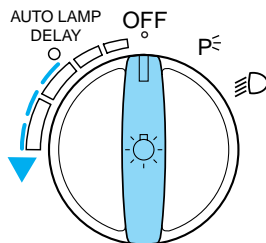



## Controls and features

preselected time lapse is adjustable up to approximately three minutes by continuing to rotate the control counterclockwise.

- To turn autolamps off, rotate the control clockwise to OFF.
- A small LED illuminates next to the autolamp control to indicate that the headlamps have been turned on by the autolamps.

### CLIMATE CONTROL SYSTEM

#### Electronic Automatic Temperature Control (EATC) system

The EATC system will maintain a selected temperature and automatically control airflow. You can override automatic operation with any of the override controls or the fan speed control.

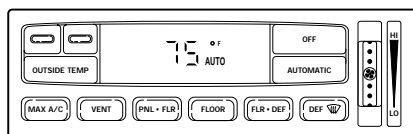

#### ***Turning the EATC on***

Press AUTOMATIC, any of the override controls or the fan speed control. The EATC will only operate when the ignition is in the ON position.

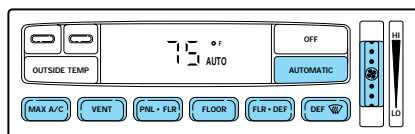

#### ***Turning the EATC off***

Press OFF. The Outside Temperature function will continue to operate until the ignition is turned off.

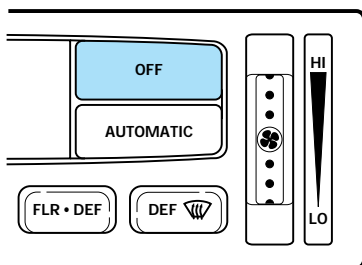

## Controls and features

### **Automatic operation**

Press AUTOMATIC and select the desired temperature. The selected temperature and the word AUTO will appear in the display window. The EATC system will either heat or cool to achieve the selected temperature. The system will automatically determine fan speed, airflow location and if fresh outside air or recirculated air is required. Fan speed remains automatic unless the fan speed thumbwheel is turned.

When in AUTOMATIC and weather conditions require heat, air will be sent to the floor. However, if the engine is not warm enough to provide heat, the fan will be at a low speed and the air will be directed to the windshield. In 3½ minutes or less, the fan speed will start to increase and the airflow location will change to the floor area.

If unusual conditions exist (i.e.-window fogging, etc.), the manual override controls allow you to select airflow locations and the fan control allows you to adjust fan speed as necessary.

### **Temperature selection**

The display window indicates the selected temperature, function (AUTO or one of the override controls) and manual control of fan speed (☼) if automatic fan speed is not desired.

To control the temperature, select any temperature between 18°C (65°F) and 29°C (85°F) by pressing the blue (cooler) or red (warmer) buttons.

☼ 75 °F  
AUTO

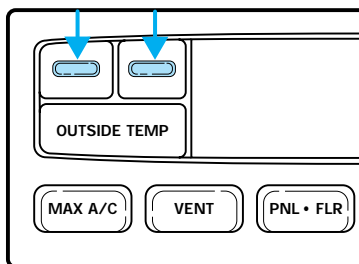

For continuous maximum cooling, push the blue button until 16°C (60°F) is shown in the display window. The EATC will continue maximum cooling (disregarding the displayed temperature) until a warmer temperature is selected by pressing the red button.

## Controls and features

For continuous maximum heating, push the red button until 32°C (90°F) is shown in the display window. The EATC will continue maximum heating (disregarding the displayed temperature) until a cooler temperature is selected by pressing the blue button.

### Temperature conversion

Press MAX A/C and DEF  at the same time (for one second) to switch between Fahrenheit and Celsius.

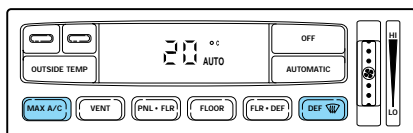

Your vehicle has an English/Metric (E/M) control to change your electronic message center display from English to Metric. This control will also change the temperature display. Refer to *Electronic Message Center* in the *Instrumentation* chapter.

### Fan speed

When AUTOMATIC is pressed, fan speed is adjusted automatically for existing conditions. You can override fan speed at any time. To control fan speed manually, use the thumbwheel to cancel automatic fan speed operation. Rotate the thumbwheel up for higher fan speed or down for lower fan speed.

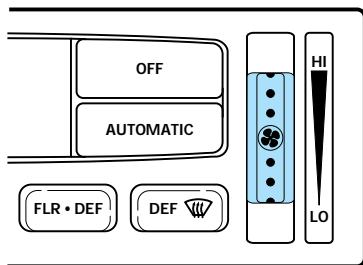

The display will show  to indicate manual fan operation.



To return to automatic fan operation, press AUTOMATIC.

## Controls and features

### Manual override controls

The override controls are located at the bottom of the EATC and allow you to determine where airflow is directed. To return to full automatic control, press AUTOMATIC.

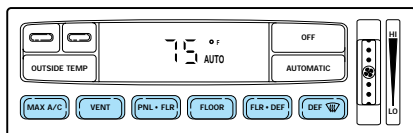

The air conditioning compressor will operate in all modes except FLOOR and VENT. It will also operate only when required when AUTOMATIC has been selected. However, the air conditioning will only function if the outside temperature is about 10°C (50°F) or above.

Since the air conditioner removes considerable moisture from the air during operation, it is normal if clear water drips on the ground under the air conditioner drain while the system is working and even after you have stopped the vehicle.

Under normal conditions, your vehicle's climate control system should be left in any position other than MAX A/C or OFF when the vehicle is parked. This allows the vehicle to "breathe" through the outside air inlet duct.

- **MAX A/C**-Uses recirculated air to cool the vehicle. The temperature will display 16°C (60°F). To exit, press AUTOMATIC or any other override controls. MAX A/C is noisier than normal A/C but more economical and will cool the inside of the vehicle faster. Airflow is from the instrument panel registers. This mode can also be used to prevent undesirable odors from entering the vehicle.
- **VENT**-Distributes outside air through the instrument panel registers. However, the air cannot be cooled below the outside temperature because the air conditioning does not operate in this mode.
- **PNL • FLR**-Distributes outside air through the instrument panel registers and the floor ducts. Heating and air conditioning capabilities are provided in this mode. The air will be heated or cooled based on the temperature selection. For added customer comfort, the air distributed through the floor ducts will be slightly warmer than the air sent to the instrument panel registers.

## Controls and features

- FLOOR-Allows for maximum heating by distributing outside air through the floor ducts. However, the air cannot be cooled below the outside temperature because the air conditioning does not operate in this mode.
- FLR • DEF-Distributes outside air through the windshield defroster ducts and the floor ducts. Heating and air conditioning capabilities are provided in this mode. The air will be heated or cooled based on the temperature selection. For added customer comfort, the air distributed through the floor ducts will be slightly warmer than the air sent to the windshield defroster ducts. If the temperature is about 10°C (50°F) or higher, the air conditioner will automatically dehumidify the air to prevent fogging.
- DEF  -Distributes outside air through the windshield defroster ducts. It can be used to clear ice or fog from the windshield. If the outside air temperature is about 10°C (50°F) or higher, the air conditioner will automatically dehumidify the air to prevent fogging.
- OFF-Outside air is shut out and the fan will not operate. For short periods of time only, use this mode to prevent undesirable odors from entering the vehicle.

### Displaying outside temperature

Press OUTSIDE TEMP to display the outside air temperature. It will be displayed for four seconds.

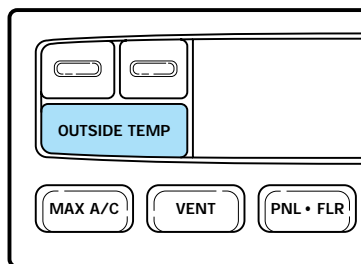

If a manual override function is selected while the outside temperature is displayed, the new function will be displayed for four seconds after it is changed, then the outside temperature will return to the window along with the override selection.

The outside temperature reading is most accurate when the vehicle is moving. Higher readings may be obtained when the vehicle is not

## Controls and features

moving. The readings that you get may not agree with temperatures given on the radio due to differences in vehicle and station locations.

### **Operating tips**

- In humid weather, select DEF  before driving. This will prevent your windshield from fogging. After a few minutes, select any desired position.
- To prevent humidity buildup inside the vehicle, don't drive with the climate control system in the OFF position.
- Don't put objects under the front seat that will interfere with the airflow to the back seats.
- Remove any snow, ice or leaves from the air intake area (at the bottom of the windshield).

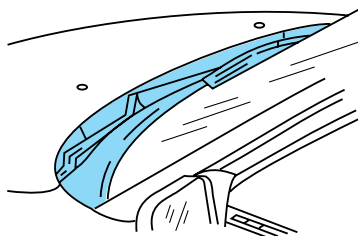

- If your vehicle has been parked with the windows closed during hot weather, the air conditioner will do a much faster job of cooling if you drive for two or three minutes with the windows open. This will force most of the hot, stale air out of the vehicle. Then operate the air conditioner as you would normally.
- When placing objects on top of your instrument panel, be careful to not place them over the defroster outlets. These objects can block airflow and reduce your ability to see through your windshield. Also, avoid placing small objects on top of your instrument panel. These objects can fall down into the defroster outlets and block airflow and possibly damage your climate control system.

### **AUDIO SYSTEM**

Refer to the “Audio Guide” for instructions on how to operate the audio system.

## Controls and features

### REAR WINDOW DEFROSTER

The rear defroster control is located on the instrument panel.

Press the defroster control to clear the rear window of thin ice and fog.

- The small LED will illuminate when the defroster is activated.



The ignition must be in the ON position to operate the rear window defroster.

The defroster turns off automatically after 10 minutes or when the ignition is turned to the OFF position. To manually turn off the defroster before ten minutes have passed, push the control again.

### POSITIONS OF THE IGNITION

1. LOCK, locks the gearshift lever and allows key removal.
2. OFF, shuts off the engine and all accessories without locking the steering wheel.
3. ACCESSORY, allows the electrical accessories such as the radio to operate while the engine is not running.
4. ON, all electrical circuits operational. Warning lights illuminated. Key position when driving.
5. START, cranks the engine. Release the key as soon as the engine starts.

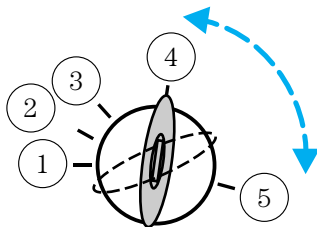

### Key system

The vehicle is equipped with a master key and valet key lock system. The master key will actuate doors, trunk, glove box, ignition and remote trunk release. The valet key (marked "valet") will actuate doors and ignition only.

## Controls and features

### WINDSHIELD WIPER/WASHER CONTROLS

Rotate the windshield wiper control to the desired interval, low or high speed position.

The bars of varying length are for intermittent wipers. When in this position rotate the control upward for fast intervals and downward for slow intervals.

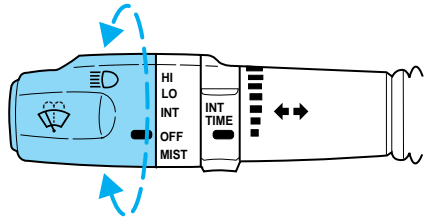

Push the control on the end of the stalk to activate washer. Push and hold for a longer wash cycle.

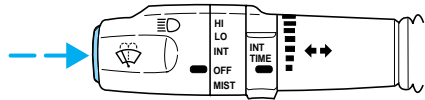

### TURN SIGNAL CONTROL

- Push down to activate the left turn signal.
- Push up to activate the right turn signal.

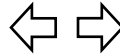

### Cornering lamps

When the turn signal is used when the headlamps are on, the cornering lamps will light either the right or left side depending on the direction of the turn.

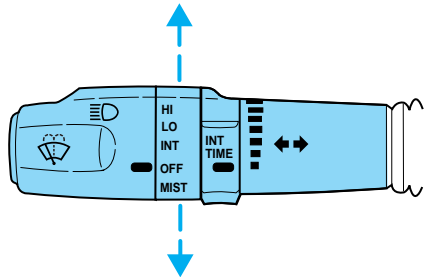



## Controls and features

### POWER TILT/TELESCOPE STEERING COLUMN



Never adjust the steering wheel when the vehicle is moving.

The steering column can be adjusted manually by moving the four-way rocker adjustment control located on the multi-function control below the turn signal/wiper control stalk. The control will adjust the column as long as held or until the column reaches the end of travel.

The telescope function is adjusted by moving the control towards the driver to telescope out and moving the control toward the instrument panel to telescope in.

The tilt function is adjusted by moving the control up to tilt up and moving the control down to tilt down.

The steering column positions are automatically saved and can be recalled along with the vehicle personality features when a memory position is selected through the keypad, keyless entry transmitter or memory switch on the driver's door.

During autoglide operation the column will move to the full in and up position. The column will return when autoglide is completed.

During easy exit (if activated through the Message Center) operation the column will move to the full in and up position. When the key is inserted into the ignition switch the column will return to the previous setting. When you remove the key the column will move away.

If the steering column adjustment control is pressed during memory recall it will cancel the automatic operation and the column will respond to manual adjustment of the control.

The manual adjustment of the steering column is adjustable with the ignition switch on or off.

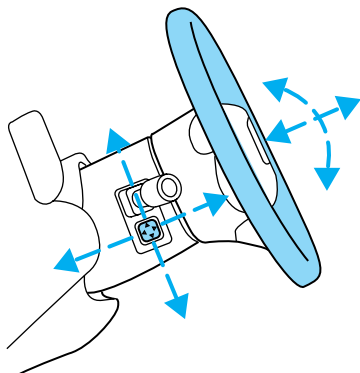

## Controls and features

If attempting to manually adjust the steering column and it does not respond see your local dealer for service.

### SPEED CONTROL

#### To turn speed control on

- Press ON.

Vehicle speed cannot be controlled until the vehicle is traveling at or above 48 km/h (30 mph).

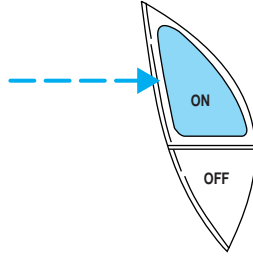

Do not use the speed control in heavy traffic or on roads that are winding, slippery, or unpaved.



Do not shift the gearshift lever into N (Neutral) with the speed control on.

#### To turn speed control off

- Press OFF or
- Turn off the vehicle ignition.

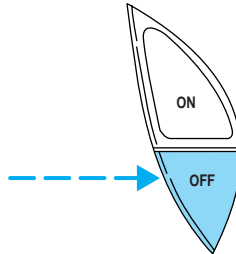

## Controls and features

Once speed control is switched off, the previously programmed set speed will be erased.

### To set a speed

- Press SET ACC/SET ACCEL. For speed control to operate, the speed control must be ON and the vehicle speed must be greater than 48 km/h (30 mph).

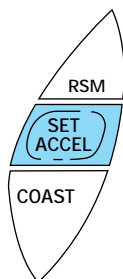

If you drive up or down a steep hill, your vehicle speed may vary momentarily slower or faster than the set speed. This is normal.

Speed control cannot reduce the vehicle speed if it increases above the set speed on a downhill. If your vehicle speed is faster than the set speed while driving on a downhill, you may want to shift to the next lower gear or apply the brakes to reduce your vehicle speed.

If your vehicle slows down more than 16 km/h (10 mph) below your set speed on an uphill, your speed control will disengage. This is normal. Pressing RES/RSM/RESUME will re-engage it.



Do not use the speed control in heavy traffic or on roads that are winding, slippery, or unpaved.

## Controls and features

### To set a higher set speed

- Press and hold SET ACC/SET ACCEL. Release the control when the desired vehicle speed is reached or
- Press and release SET ACC/SET ACCEL. Each press will increase the set speed by 1.6 km/h (1 mph) or
- Accelerate with your accelerator pedal, then press and release SET ACC/SET ACCEL.

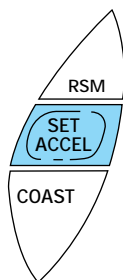

You can accelerate with the accelerator pedal at any time during speed control usage. Releasing the accelerator pedal will return your vehicle to the previously programmed set speed.

### To set a lower set speed

- Press and hold CST/COAST. Release the control when the desired speed is reached or
- Press and release CST/COAST. Each press will decrease the set speed by 1.6 km/h (1 mph) or

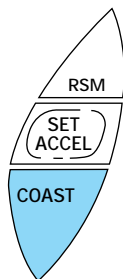

## Controls and features

- Depress the brake pedal. When the desired vehicle speed is reached, press SET ACC/SET ACCEL.

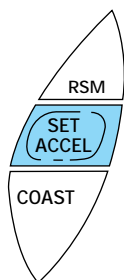

### To disengage speed control

- Depress the brake pedal.  
Disengaging the speed control will not erase the previously programmed set speed.

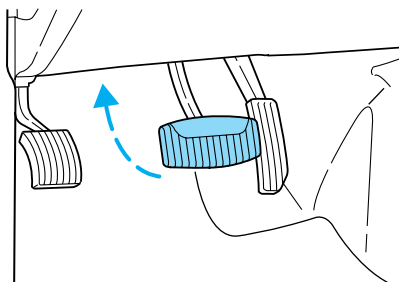

Pressing OFF will erase the previously programmed set speed.

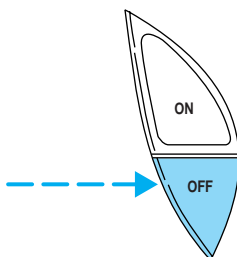

## Controls and features

### To return to a previously set speed

- Press RES/RSM/RESUME. For RES/RSM/RESUME to operate, the vehicle speed must be faster than 48 km/h (30 mph).

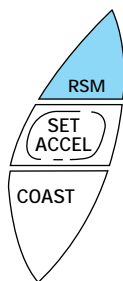

### Indicator light

This light comes on when either the SET ACC/SET ACCEL or RES/RSM/RESUME controls are pressed. It turns off when the speed control OFF control is pressed, the brake is applied or the ignition is turned to the OFF position.

CRUISE  
ON

### HAZARD FLASHER

For information on the hazard flasher control, refer to *Hazard lights control* in the *Roadside emergencies* chapter.

### HOMELINK® UNIVERSAL TRANSMITTER (IF EQUIPPED)

The HomeLink® Universal Transmitter, located underneath the driver's visor, provides a convenient way to replace up to three hand-held transmitters with a single built-in device. This feature will learn the radio frequency codes of most current transmitters to operate garage doors and gates, and can also control home or office lighting and security systems (with the available accessory package).



When programming your HomeLink® Universal Transmitter, you will be operating the garage door or gate. Be sure that people and objects are out to the way to prevent potential harm or damage.

## Controls and features

Do not use the HomeLink® Universal Transmitter with any garage door opener that lacks safety stop and reverse features as required by U.S. federal safety standards (this includes any garage door opener model manufactured before April 1, 1982). A garage door which cannot detect an object, signaling the door to stop and reverse, does not meet current U.S. federal safety standards. For more information on this matter, call toll-free: 1-800-355-3515.

### Programming

1. Prepare for programming the HomeLink® Universal Transmitter by erasing all three of the factory default channels by holding down the two outside controls until the red light begins to flash (20-30 seconds). Release both controls.

2. Hold the end of your hand-held transmitter against the HomeLink® Universal Transmitter (located on your visor) while keeping the red light in view.

3. Using both hands, press the hand-held transmitter control and the desired channel control on the HomeLink® Universal Transmitter. Do not release the controls until step 4 has been completed.

4. Hold down both controls until the red light begins to flash slowly and then rapidly. Rapid flashing indicates successful programming of the new frequency signal.

5. Follow steps 2 through 4 to program the remaining two channels.

If you do not successfully program the HomeLink® Universal Transmitter after repeated attempts, refer to *Training a rolling code* which follows or call toll-free customer assistance: 1-800-355-3515.

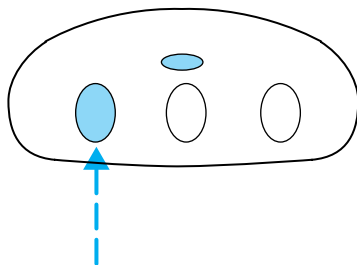
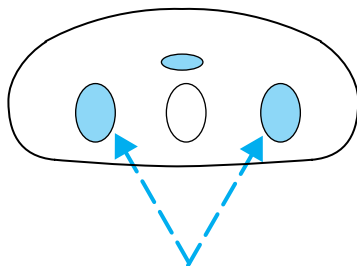

## Controls and features

### Note to Canadian residents

During programming, your hand-held transmitter may automatically stop transmitting after two seconds which may not be long enough to program the HomeLink® Universal Transmitter.

If you are programming from one of these hand-held transmitters:

- continue to hold the control on the HomeLink® Universal Transmitter
- re-press the hand-held transmitter every two seconds

You may have to repeat this function several times while programming.

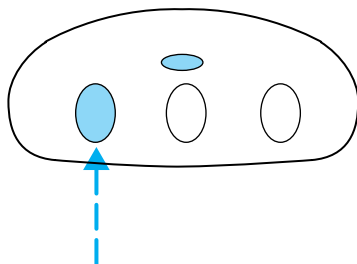

### Operating the HomeLink® Universal Transmitter

Once programmed, the HomeLink® Universal Transmitter can be used in place of hand-held transmitters. To operate, simply press the appropriate channel control on the transmitter (the red light will illuminate, indicating the signal is being transmitted).

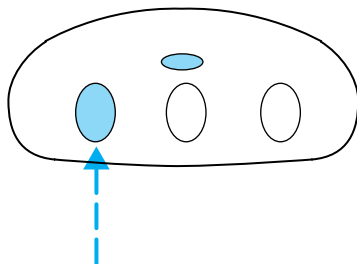



## Controls and features

### Training a rolling code system

Rolling code systems (garage door openers which are “code protected”) may be determined by the following:

- The hand-held transmitter appears to program the HomeLink® Universal Transmitter but does not activate the garage door.
- The garage door opener was manufactured after 1995.

Follow these steps to train a garage door with the rolling code feature:

1. Locate the training control on the garage door opener receiver. Refer to the garage door opener manual or call 1-800-355-3515 if there is difficulty locating the training control.

2. Press the training control on the garage door opener receiver until the training light (next to the control) begins to flash (1-2 seconds).

3. Press the programmed HomeLink® control in the vehicle until the training light on the garage door receiver turns solid (1-2 seconds). Release the HomeLink® control and repress to turn off the training light.

4. Press the HomeLink® control again. If the garage door activates, the HomeLink® Universal Transmitter has been trained to the receiver.

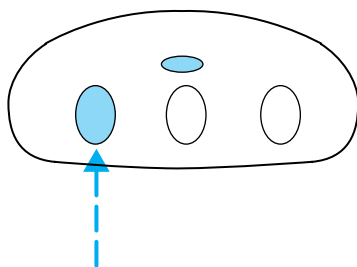

### Erasing channels

To erase all three programmed channels:

1. Hold down the two outside controls until the red light begins to flash.

2. Release both controls.

Channels cannot be erased individually, but can be reprogrammed. Refer to *Programming* for instructions.

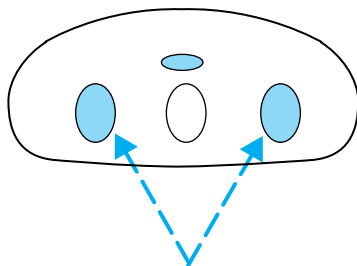

## Controls and features

### ILLUMINATED VISOR MIRROR (IF EQUIPPED)

To turn on the visor mirror lamps, lift the mirror cover.

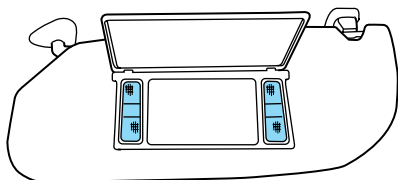

### MOON ROOF (IF EQUIPPED)

To open the moon roof:

- Press the front portion of the control to raise the moon roof to the vent position (when the glass panel is closed).
- Press and hold the rear portion of the control to open the moon roof to the intermediate position.
- Press the control again to fully open the moon roof.

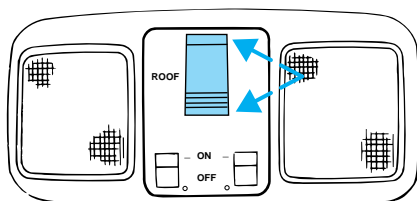

To close the moon roof:

- Press and hold the front portion of the control.
- To close from the vent position, press and hold the rear portion of the control.

# Controls and features

## INTERIOR LAMPS

### Map lamps

To turn on the map lamps, slide the control to the ON position.

To turn off the map lamps, slide the control to the OFF position.

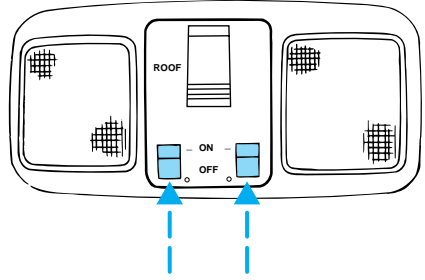

## POWER WINDOWS

Press and hold the rocker switches to open and close windows.

- Press the top portion of the rocker switch to close.

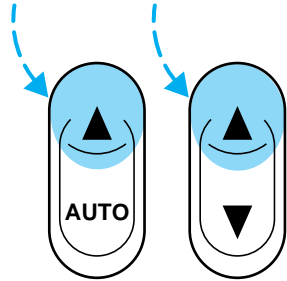

## Controls and features

- Press the bottom portion of the rocker switch to open.

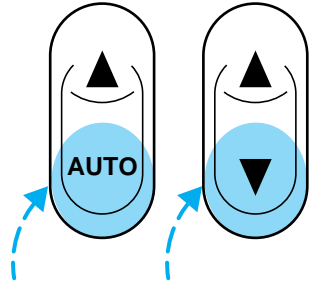

### Express down

- Press AUTO and release quickly. The window will open fully. Depress again to stop window operation. This function is programmable in the vehicle settings. For more information on programming this system, refer to *Message center* in the *Instrumentation chapter*.

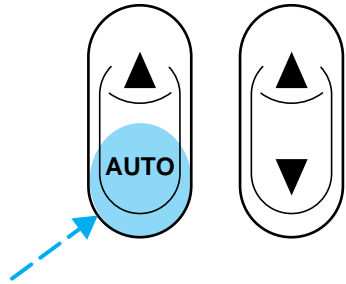

## Controls and features

### POWER DOOR LOCKS

Press U to unlock all doors and L to lock all doors.

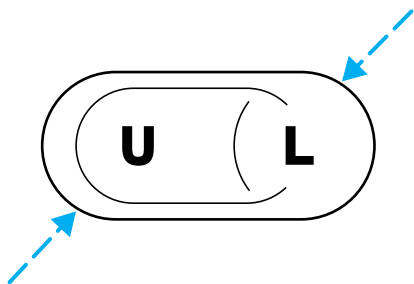

### Smart locks

With the key in the ignition, in any switch position, and either the driver's or passenger's door open, the doors cannot be locked using the front door lock switches.

While the key is in the ignition, the vehicle can be locked by manually pressing down the lock control or with remote entry transmitter.

### POWER SIDE VIEW MIRRORS

The ignition key must be in ACC or ON position to adjust the power side view mirrors.

To adjust your mirrors:

1. Select L to adjust the left mirror or R to adjust the right mirror.

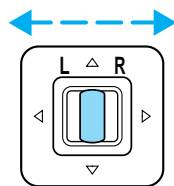

## Controls and features

2. Move the control in the direction you wish to tilt the mirror.

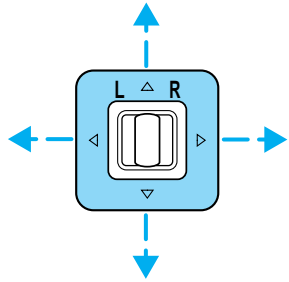

3. Return to the center position to lock mirrors in place.

### DRIVER PROFILE SYSTEM

The Personality Memory feature customizes your vehicle for up to two drivers. The following features are automatically recalled when unlocking the doors using the remote entry transmitter, keyless entry pad or by pressing the Memory 1 or Memory 2 controls on the driver side.

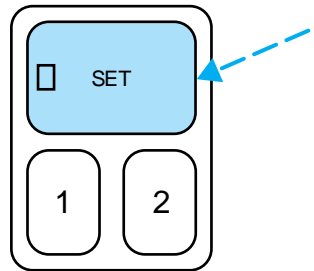

- All driver's seat positions except power lumbar and head restraint.
- Both left and right outside mirror settings.
- Steering column position.
- Seven Driver Menu settings.

Personality Memory also allows you to customize settings from the Driver menu located in the Message Center. Refer to *Message center* in the *Instrumentation* chapter for more information.

## Controls and features

### **Recalling Personality Memory**

All of these settings are automatically recalled when the driver unlocks the door using the remote entry transmitter, keyless entry keypad or selects either Memory 1 or Memory 2. The vehicle must be in P (Park ) or N (Neutral) to recall Personality Memory settings.

#### ***Remote entry***

Pressing UNLOCK on the remote entry transmitter unlocks the driver's door and recalls all of the Personality Memory settings. Two transmitters are delivered with the vehicle; one is programmed to always recall Driver 1 and the other will always recall Driver 2. Personality Memory 1 or 2 is indicated on the back of the transmitter.

Personality Memory recall from the remote transmitter can be disabled by sliding the control on the back of the transmitter to OFF. Personality Memory can still be recalled by using the keyless entry code.

#### ***Keyless entry***

Up to three unique keyless entry codes can be programmed by the customer. Two of the codes can be assigned to recall Personality Memory 1 or Memory 2. Each time the five-digit code is entered on the keypad, the driver's door will unlock and Personality Memory 1 or Memory 2 will be recalled.

Please note that even though the driver's Personality Memory may be recalled using the remote or keyless entry, the seats and mirrors will not move to the driver's set positions until the driver's door is opened. The steering column will move when the key is inserted in the ignition.

#### ***Memory controls***

Selecting either Memory 1 or Memory 2 will also recall the Personality Memory settings as selected, providing your vehicle is in P (Park ) or N (Neutral).

## Controls and features

### Auto save

Any change made by the driver to one or more of the above Personality Memory settings will be updated and saved automatically. The display, DRIVER 1 (or DRIVER 2) SETTING SAVED, will appear on the Message Center for five seconds as a confirmation of the update to Personality Memory.

If the driver does not use the remote entry transmitter or keyless entry keypad to unlock the doors when entering the vehicle, or does not select the Memory 1 or Memory 2, then any change to the Personality Memory settings will not be automatically saved. Instead, the driver will be prompted by the Message Center: "IDENTIFY DRIVER TO SAVE." Press SELECT (located on the right side of the instrument cluster) to identify yourself; otherwise, the new setting (and any subsequent changes) will not be saved.

### Turning Personality off

The Personality Memory feature can be turned off using the Memory OFF control on the driver's door. The amber indicator will be lit when the feature is turned off. Selecting either Memory 1 or Memory 2 will turn on the Personality Memory feature and recall the saved settings.

When Personality is off, the vehicle will function normally. When Personality is off and the driver tries to make a setting change, there will be no prompts on the Message Center asking which driver to save the setting to.

### CENTER CONSOLE

Your vehicle is equipped with a variety of console features. These include:

- utility compartment
- cupholders
- ashtray and lighter
- rear ashtray



Use only soft cups in the cupholder. Hard objects can injure you in a collision.



## Controls and features

### Cellular phone

Refer to the “Cellular phone guide” for instructions on operation.

### POSITIVE RETENTION FLOOR MAT

Position the floor mat so that the eyelet is over the pointed end of the retention post and rotate forward to lock in. Make sure that the mat does not interfere with the operation of the accelerator or the brake pedal. To remove the floor mat, reverse the installation procedure.

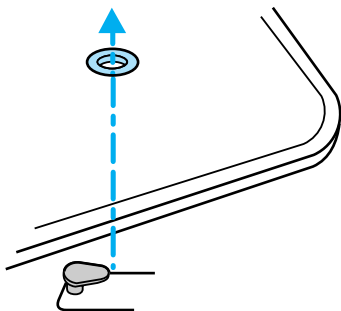

### REMOTE ENTRY SYSTEM

The remote entry system allows you to lock or unlock all vehicle doors without a key.

The remote entry features only operate with the ignition in the OFF position.

#### Unlocking the doors

Press this control to unlock the driver door. The interior lamps will illuminate.

Press the control a second time within five seconds to unlock all doors.

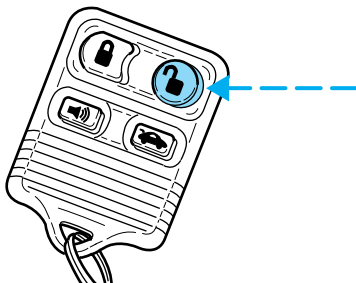

## Controls and features

### Locking the doors

Press this control to lock all doors.

The horn will chirp to confirm that the control was pressed. The horn chirp feature can be turned on/off by using the feature menu in the message center.

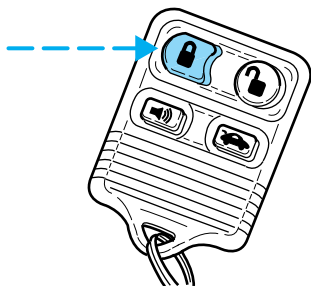

This process will arm your anti-theft system (if equipped). For more information on arming the anti-theft system, refer to *Perimeter anti-theft system* in this chapter.

### Opening the trunk

Press the control once to open the trunk.

Be certain the trunk is closed before driving your vehicle. The trunk may appear closed, but it may not be latched. Failure to do so may cause objects to fall out of the trunk or block rear view vision.

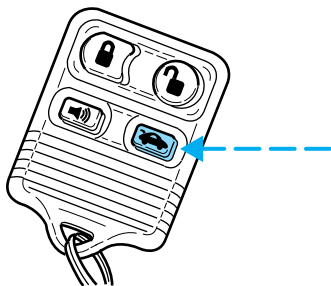

## Controls and features

### Sounding a panic alarm

Press this control to activate the alarm.

To deactivate the alarm, press the control again or turn the ignition to ACC or ON.

This device complies with part 15 of the FCC rules and with RS-210 of Industry Canada. Operation is subject to the following two conditions: (1) This device may not cause harmful interference, and (2) This device must accept any interference received, including interference that may cause undesired operation.

**Changes or modifications not expressly approved by the party responsible for compliance could void the user's authority to operate the equipment.**

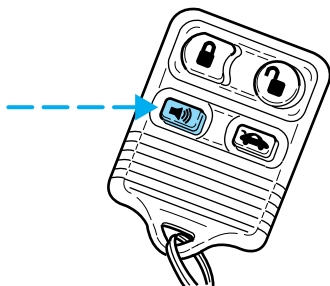

### KEYLESS ENTRY SYSTEM

With the keyless entry keypad, you can:

- lock or unlock the vehicle doors without using the key.
- arm and disarm the perimeter alarm system (if equipped)
- reprogram remote entry transmitters.

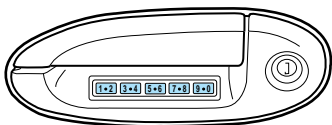

See also *Remote entry system* and *Perimeter alarm system* in this chapter for more information.

Your vehicle has a factory-set 5 digit code that operates the keyless entry system. You can also program your own 5 digit personal entry code.

The factory-set code is located:

- on the owner's wallet card in the glove compartment
- taped to the computer module
- in the interior of the trunk

## Controls and features

When pressing the controls on the keyless entry keypad, press the middle of the buttons to ensure a good activation.

### Programming your own entry code

1. Enter the factory-set code (keypad will illuminate when pressed).
2. Press the 1/2 control within five seconds of step 1.
3. Enter your personal 5 digit code. Enter each digit within five seconds of the previous one.
4. Enter a sixth digit to indicate which personality feature should be recalled by the personal code.
  - 1/2 recalls personality 1
  - 3/4 recalls personality 2
  - 9/0 does not recall a personality

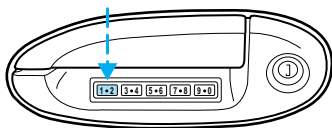

All of the vehicle doors will lock and unlock to confirm programming of the new code. Each personality driver profile (personality 1 or personality 2) can be associated with only one personal code. The factory-set code cannot be associated with a personality profile.

Do not set a code that includes five of the same number or presents them in sequential order. Thieves can easily figure out these types of codes.

You can program up to three personal codes to unlock your vehicle. These codes do not replace the permanent code that the dealership gave you.

### Erasing personal code

To erase all of the personal entry codes programmed to a vehicle:

1. Enter the factory-set code.
2. Press 1/2 within 5 seconds of step 1.
3. Press and hold 1/2 for two seconds. All of the vehicle doors will lock and then unlock to confirm erasure.

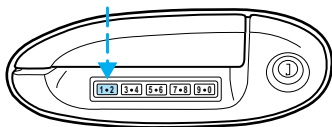

## Controls and features

### ***Unlocking the doors and releasing the trunk with the keyless entry system***

To unlock the driver door, enter either the factory-set code or personal code (each digit pressed within 5 seconds of prior digit). The interior lamps will illuminate.

To unlock all doors, enter the factory-set code or personal code (driver door unlocks) and press 3/4 within 5 seconds.

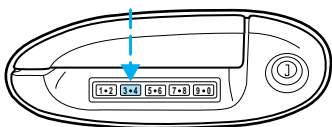

To release the trunk, enter the factory-set code or personal code (driver door unlocks) and press 5/6 within 5 seconds.

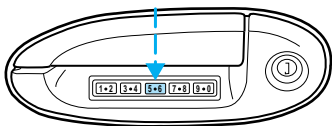

After the factory-set code or personal code has been entered, you can unlock all doors (press 3/4) and release the trunk (press 5/6) as long as the controls are pressed within 5 seconds of each other.

### ***Locking doors with the keyless entry system***

It is not necessary to enter the factory-set code prior to locking all doors. To lock the doors:

1. Press 7/8 and 9/0 at the same time.

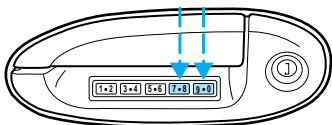

### Autolock

The autolock feature will lock all of the doors when:

- all vehicle doors are fully closed
- the ignition key is turned to the ON position
- the vehicle is in a forward gear and
- you exceed 5 km/h (3 mph).

The autolock feature repeats when:

- the ignition key remains in the ON position
- a door is opened and then closed
- the vehicle is in a forward gear, and
- you exceed 5 km/h (3 mph).

The autolock feature can be turned on/off by using the feature menu in the message center. Refer to *Electronic message center* for more information.

### PERIMETER ALARM SYSTEM

#### Arming the system

When armed, this system will help protect your vehicle from unauthorized entry. When unauthorized entry occurs, the system will flash the headlamps and/or parking lamps and the theft indicator lamp and will chirp the horn.

The system is ready to arm whenever the ignition is turned OFF. Any of the following actions will prearm the alarm system:

- Locking the doors with the remote transmitter (doors opened or closed). The horn will chirp to confirm that the control was pressed. The horn chirp feature can be turned on/off by using the feature menu in the message center.

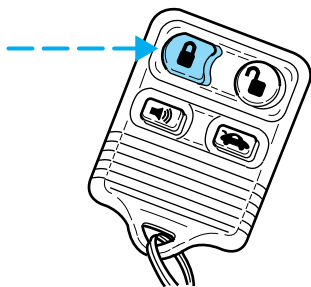

## Controls and features

- Pressing 7/8 and 9/0 on the keyless entry pad at the same time to lock the doors (doors opened or closed).
- Opening a door and pressing the power door lock control to lock the doors.

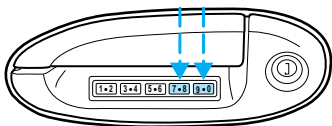

If a door is open, the system is prearmed and is waiting for the door to close. The anti-theft indicator on the instrument panel will be lit continuously when the system is prearmed.

Once the doors are closed, the system will arm in 30 seconds.

### Disarming the system

You can disarm the system by any of the following actions:

- Unlock the doors by using your remote entry transmitter.

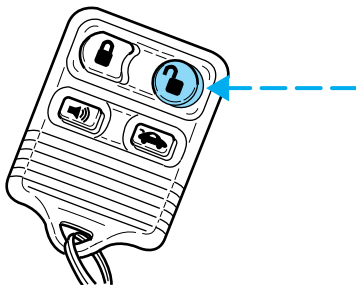

- Unlock the doors by using your keyless entry keypad.
- Unlock the doors with a key. Turn the key full travel (toward the front of the vehicle) to make sure the alarm disarms.
- Turn ignition to ACC or ON.

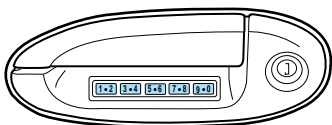

### **SECURILOCK™ ANTI-THEFT SYSTEM**

Your vehicle is equipped with a coded-key anti-theft system. Only the correct key will be able to start your vehicle. If your keys are lost or stolen, you must take your vehicle to a Ford/Lincoln-Mercury dealership for re-programming.

#### **Programming additional keys**

If you need additional keys electronically coded for your vehicle, spares can be purchased (a maximum of 16 keys can be programmed). To program a new key, perform the following procedure:

1. With the coded key in the ignition, turn the ignition from ON to OFF.
2. Within 15 seconds of turning ignition off, insert the new coded key into the ignition and turn it from OFF to ON or START. If successful, the THEFT indicator light will illuminate for two seconds. Repeat procedure for all new keys.

If key coding fails, the THEFT indicator light will flash.

Coding failure can be caused by any of the following:

- The new key was not inserted into the ignition within 15 seconds.
- 16 keys have already been programmed.
- The new key does not have an electronic code.



## Seating and safety restraints

### SEATING

The head restraints can be moved in four directions:

- up and down
- forward or backward

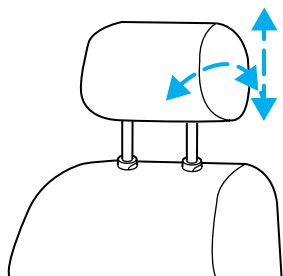

### Adjusting the power seats

The power seat controls are located on the outboard side of the seat.



Never adjust the driver's seat or seatback when the vehicle is moving.

Pull or push the horizontal control to move the seat up and down.

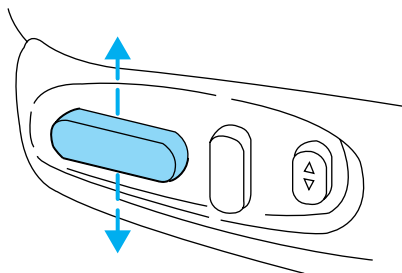

## Seating and safety restraints

Push the horizontal control to move the seat forward or backward.

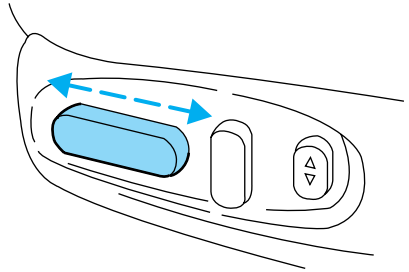

Push the vertical control to move the seatback.

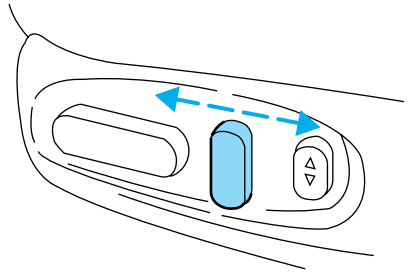

### Heated seats (if equipped)

To operate the heated seats:

- Push the control to select BACK to heat the seatback only.
- Push the control to select BOTH to heat the seatback and the seat cushion.

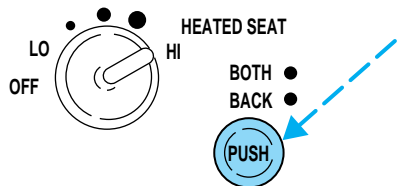

# Seating and safety restraints

- Rotate the control to select the desired heat (from OFF to HI). Allow five minutes for the heat level to stabilize.

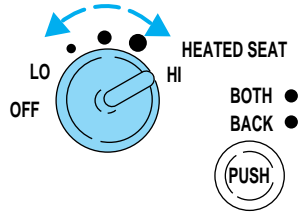

If the heated seat switch is not turned OFF, the seat will heat up to the selected temperature level each time the vehicle is started.

## Using the power lumbar support

The power lumbar control is located on the outboard side of the seat.

Press one side of the control to adjust firmness.

Press the other side of the control to adjust softness.

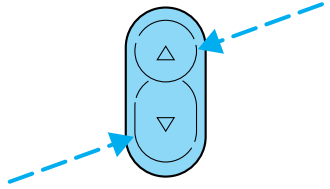

# Seating and safety restraints

## Emergency seatback release lever

Lift the lever to release the seatback.

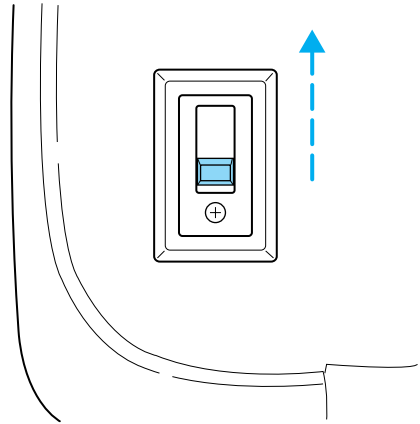

It is not necessary to use the release lever for rear seat entry or exit. The seatback remains unlocked with normal usage and locks only during emergency stopping, upon impact, or on steep downhill grades.

## Easy access/easy out feature (driver's side only)

This feature automatically moves the driver's seat backward when:

- the transmission is in N (Neutral) or P (Park)
- the driver's safety belt is buckled
- the ignition switch is turned to OFF.

The seat will move two inches forward (to the original position when:

- the transmission is in N (Neutral) or P (Park)
- the driver's safety belt is buckled
- the ignition switch is turned to ON.

## Auto-Glide seats

This feature automatically moves the seat forward or rearward when the seatback is tilted forward or rearward to allow ease of entry into the rear seat.

## Seating and safety restraints

With the ignition OFF:

- the driver seat Auto-Glide will function when the gearshift is in N (Neutral) or P (Park) and at least one of the vehicle doors is opened.
- the passenger seat Auto-Glide will only function when at least one of the vehicle doors is opened.

If the ignition is ON:

- the driver seat Auto-Glide will function with the gearshift in N (Neutral) or P (Park).
- the passenger seat Auto-Glide will function with the gearshift in N (Neutral) or P (Park).

Shifting the transmission:

- from N (Neutral) or P (Park) while the driver's seat is moving will stop the seat where it is.
- back to N (Neutral) or P (Park) will continue seat movement.

The power seat controls must be used to move the seat if the gearshift is not in N (Neutral) or P (Park).

### Rear seat entry

To enter the rear seat:

1. Rotate the safety belt boot rearward.
2. Enter the rear seat in front of the safety belt.
3. Rotate the safety belt boot forward to allow use by the front seat passengers.

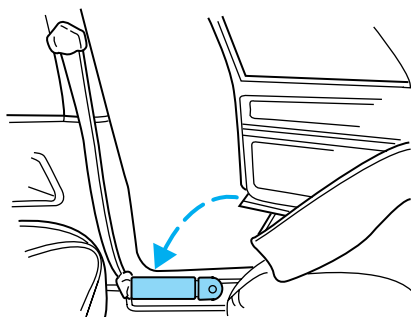

## Seating and safety restraints

### SAFETY RESTRAINTS

#### Safety restraints precautions



Always drive and ride with your seatback upright and the lap belt snug and low across the hips.



To prevent the risk of injury, make sure children sit where they can be properly restrained.



Never let a passenger hold a child on his or her lap while the vehicle is moving. The passenger cannot protect the child from injury in a collision.



All occupants of the vehicle, including the driver, should always wear their safety belts.



It is extremely dangerous to ride in a cargo area, inside or outside of a vehicle. In a collision, people riding in these areas are more likely to be seriously injured or killed. Do not allow people to ride in any area of your vehicle that is not equipped with seats and safety belts. Be sure everyone in your vehicle is in a seat and using a safety belt properly.



Each seating position in your vehicle has a specific safety belt assembly which is made up of one buckle and one tongue that are designed to be used as a pair. 1) Use the shoulder belt on the outside shoulder only. Never wear the shoulder belt under the arm. 2) Never swing it around your neck over the inside shoulder. 3) Never use a single belt for more than one person.

## Seating and safety restraints

### Combination lap and shoulder belts

1. To fasten, insert the tongue into the slot in the buckle.

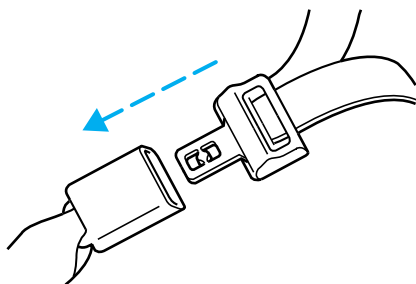

2. To unfasten, push the red release button and remove the tongue from the buckle.

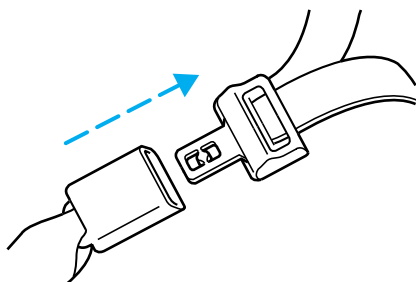

The front and rear outboard safety restraints in the vehicle are combination lap and shoulder belts. The front and rear seat passenger outboard safety belts have two types of locking modes described below:

### Vehicle sensitive mode

The vehicle sensitive mode is the normal retractor mode, allowing free shoulder belt length adjustment to your movements and locking in response to vehicle movement. For example, if the driver brakes suddenly or turns a corner sharply, or the vehicle receives an impact of 8 km/h (5 mph) or more, the combination safety belts will lock to help reduce forward movement of the driver and passengers.

## Seating and safety restraints

### Automatic locking mode

In this mode, the shoulder belt is automatically pre-locked. The belt will still retract to remove any slack in the shoulder belt.

The automatic locking mode is not available on the driver safety belt.

### When to use the automatic locking mode

- When a tight lap/shoulder fit is desired.
- **Anytime** a child safety seat is installed in the vehicle. Refer to *Safety Restraints for Children* or *Safety Seats for Children* later in this chapter.

### How to use the automatic locking mode

- Buckle the combination lap and shoulder belt.

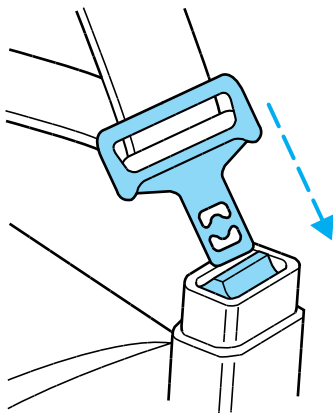



## Seating and safety restraints

- Grasp the shoulder portion and pull downward until the entire belt is extracted.



- Allow the belt to retract. As the belt retracts, you will hear a clicking sound. This indicates the safety belt is now in the automatic locking mode.

### ***How to disengage the automatic locking mode***

Disconnect the combination lap/shoulder belt and allow it to retract completely to disengage the automatic locking mode and activate the vehicle sensitive (emergency) locking mode.

### **Lap belts**

#### ***Adjusting the lap belt***

The lap belt does not adjust automatically. Adjust to fit snugly and as low as possible around your hips. Do not wear the lap belt around your waist.

## Seating and safety restraints

Insert the tongue into the correct buckle. To lengthen the belt, turn the tongue at a right angle to the belt and pull across your lap until it reaches the buckle. To tighten the belt, pull the loose end of the belt through the tongue until it fits snugly across the hips.

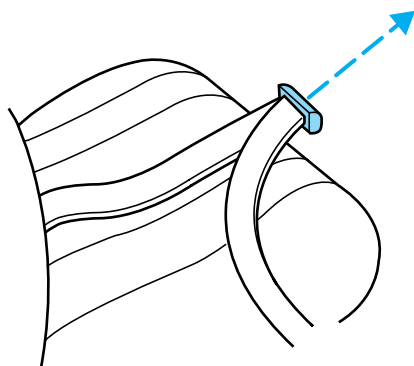

Shorten and fasten the belt when not in use.

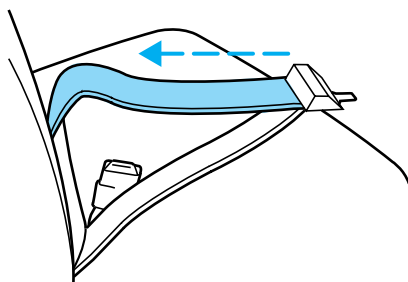

### Safety belt extension assembly

If the safety belt assembly is too short, even when fully extended, 20 cm (8 inches) can be added to the safety belt assembly by adding a safety belt extension assembly (part number 611C22). Safety belt extension assemblies can be obtained from your dealer at no cost.

Use only extensions manufactured by the same supplier as the safety belt. Manufacturer identification is located at the end of the webbing on the label. Also, use the safety belt extension only if the safety belt is too short for you when fully extended. Do not use extensions to change the fit of the shoulder belt across the torso.

## Seating and safety restraints

### Safety belt warning light and indicator chime

The seat belt warning light illuminates in the instrument cluster and a chime sounds to remind the occupants to fasten their safety belts.

#### Conditions of operation

If...	Then...
The driver's safety belt is not buckled before the ignition switch is turned to the ON position...	The safety belt warning light illuminates for one to two minutes and the warning chime sounds for four to eight seconds.
The driver's safety belt is buckled while the indicator light is illuminated and the warning chime is sounding...	The safety belt warning light and warning chime turn off.
The driver's safety belt is buckled before the ignition switch is turned to the ON position...	The safety belt warning light and indicator chime remain off.

### Safety belt maintenance

Check the safety belt systems periodically to make sure they work properly and are not damaged. Check the safety belts to make sure there are no nicks, wears or cuts. All safety belt assemblies, including retractors, buckles, front seat belt buckle assemblies (slide bar)(if equipped), shoulder belt height adjusters (if equipped), child safety seat tether bracket assemblies (if equipped), and attaching hardware, should be inspected after a collision. Ford recommends that all safety belt assemblies used in vehicles involved in a collision be replaced. However, if the collision was minor and a qualified technician finds that the belts do not show damage and continue to operate properly, they do not need to be replaced. Safety belt assemblies not in use during a collision should also be inspected and replaced if either damage or improper operation is noted.



Failure to replace the safety belt assembly under the above conditions could result in severe personal injuries in the event of a collision.

Refer to *Cleaning and maintaining the safety belts* in the *Maintenance and care* section.

# Seating and safety restraints

## AIR BAG SUPPLEMENTAL RESTRAINT SYSTEM (SRS)

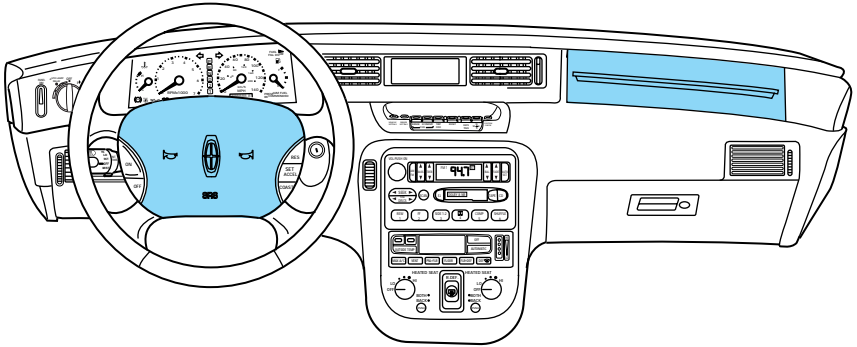

### Important supplemental restraint system (SRS) precautions

The supplemental restraint system is designed to:

- work with the safety belt to protect the driver and right front passenger.
- reduce certain upper body injuries.

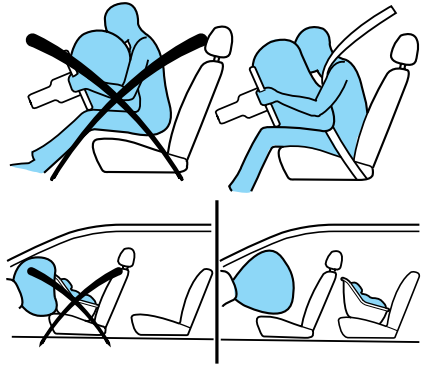

Failure to follow these instructions will affect the performance of the safety belts and increase the risk of personal injury.

## Seating and safety restraints



The right front passenger air bag is not designed to restrain occupants in the center front seating position.



All occupants of the vehicle including the driver should always wear their safety belts even when air bag SRS is provided.



Do not place objects or mount equipment on or near the air bag cover on the steering wheel or in front seat areas that may come into contact with a deploying air bag. Failure to follow this instruction may increase the risk of personal injury in the event of a collision.



Do not attempt to service, repair, or modify the Air Bag Supplemental Restraint System or its fuses. See your Ford or Lincoln-Mercury dealer.

### Children and air bags

For additional important safety information, read all information on safety restraints in this guide.

Children should always wear their safety belts. Failure to follow these instructions may increase the risk of injury in a collision.



Air bag can kill or injure a child in a child seat. If you must use a forward-facing child seat in the front seat, move seat all the way back.

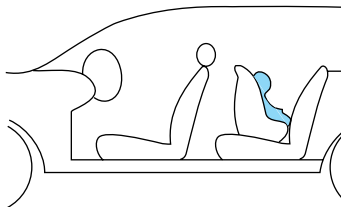
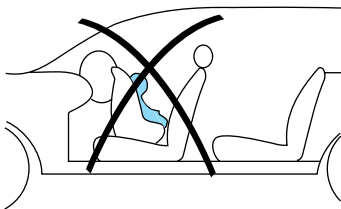

## Seating and safety restraints

### How does the air bag supplemental restraint system work?

The SRS is designed to activate when the vehicle sustains sufficient longitudinal deceleration.

The fact that the air bags did not inflate in a collision does not mean that something is wrong with the system. Rather, it means the forces were not of the type sufficient to cause activation.

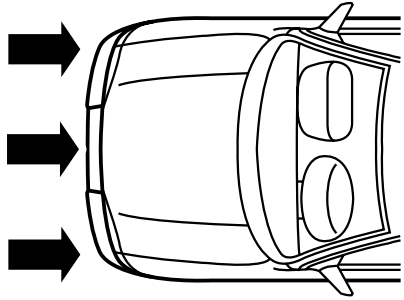

The air bags inflate and deflate rapidly upon activation.

After air bag deployment, it is normal to notice a smoke-like, powdery residue or smell the burnt propellant. This may consist of cornstarch, talcum powder (to lubricate the bag) or sodium compounds (e.g., baking soda) that result from the combustion process that inflates the air bag. Small amounts of sodium hydroxide may be present which may irritate the skin and eyes, but none of the residue is toxic.



Several air bag system components get hot after inflation. Do not touch them after inflation.

## Seating and safety restraints



If the air bag is inflated, **the air bag will not function again and must be replaced immediately**. If the air bag is not replaced, the unrepaired area will increase the risk of injury in a collision.

The SRS consists of:

- driver and passenger air bag modules (which include the inflators and air bags),
- one or more impact and safing sensors,
- a readiness light and tone
- and the electrical wiring which connects the components.

The diagnostic module monitors its own internal circuits and the supplemental air bag electrical system warning (including the impact sensors), the system wiring, the air bag system readiness light, the air bag back up power and the air bag ignitors.

### Determining if the system is operational

The SRS uses a readiness light in the instrument cluster or a tone to indicate the condition of the system. Refer to the *Air bag readiness* section in the *Instrumentation* chapter. Routine maintenance of the air bag is not required.

A difficulty with the system is indicated by one or more of the following:

- The readiness light will either flash or stay lit.
- The readiness light will not illuminate immediately after ignition is turned on.



- A series of five beeps will be heard. The tone pattern will repeat periodically until the problem and light are repaired.

If any of these things happen, even intermittently, have the SRS serviced at your dealership or by a qualified technician immediately. Unless serviced, the system may not function properly in the event of a collision.

# Seating and safety restraints

## Disposal of air bags and air bag equipped vehicles

For disposal of air bags or air bag equipped vehicles, see your local dealership or qualified technician. Air bags **MUST BE** disposed of by qualified personnel.

## SAFETY RESTRAINTS FOR CHILDREN

### Important child restraint precautions

You are required by law to use safety restraints for children in the U.S. and Canada. If small children ride in your vehicle (generally children who are four years old or younger and who weigh 18 kg [40 lbs] or less), you must put them in safety seats made especially for children. Check your local and state or provincial laws for specific requirements regarding the safety of children in your vehicle.



Never let a passenger hold a child on his or her lap while the vehicle is moving. The passenger cannot protect the child from injury in a collision.

Always follow the instructions and warnings that come with any infant or child restraint you might use.

When possible, place children in the rear seat of your vehicle. Accident statistics suggest that children are safer when properly restrained in the rear seating positions than in the front seating position.

### Children and safety belts

Children who are too large for child safety seats (as specified by your child safety seat manufacturer) should always wear safety belts.

Follow all the important safety restraint and air bag precautions that apply to adult passengers in your vehicle.

If the shoulder belt portion of a combination lap and shoulder belt can be positioned so it does not cross or rest in front of the child's face or neck, the child should wear the lap and shoulder belt. Moving the child closer to the center of the vehicle may help provide a good shoulder belt fit.

If the shoulder belt cannot be properly positioned:

- move the child to one of the seats with a lap belt only (if equipped) or
- if the child is the proper size, restrain the child in a safety seat.



## Seating and safety restraints



Do not leave children, unreliable adults, or pets unattended in your vehicle.

To improve the fit of lap and shoulder belts on children who have outgrown child safety seats, Ford recommends use of a belt-positioning booster seat that is labelled as conforming to all Federal motor vehicle safety standards. Belt-positioning booster seats raise the child and provide a shorter, firmer seating cushion that encourages safer seating posture and better fit of lap and shoulder belts on the child.

A belt-positioning booster should be used if the shoulder belt rests in front of the child's face or neck, or if the lap belt does not fit snugly on both thighs, or if the thighs are too short to let the child sit all the way back on the seat cushion when the lower legs hang over the edge of the seat cushion. You may wish to discuss the special needs of your child with your pediatrician.

### SAFETY SEATS FOR CHILDREN

#### Child and infant or child safety seats

Use a safety seat that is recommended for the size and weight of the child. Carefully follow all of the manufacturer's instructions with the safety seat you put in your vehicle. If you do not install and use the safety seat properly, the child may be injured in a sudden stop or collision.

When installing a child safety seat:

- Use the correct safety belt buckle for that seating position.
- Make sure the tongue is securely fastened in the buckle.
- Keep the buckle release button pointing up and away from the safety seat, with the tongue between the child seat and the release button, to prevent accidental unbuckling.
- Place seat back in upright position.
- Put the safety belt in the automatic locking mode. Refer to *Automatic locking mode*.

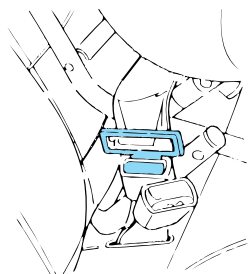

## Seating and safety restraints

Ford recommends the use of a child safety seat having a top tether strap. Install the child safety seat in a seating position which is capable of providing a tether anchorage. For more information on top tether straps, refer to *Attaching safety seats with tether straps*.



Carefully follow all of the manufacturer's instructions included with the safety seat you put in your vehicle. If you do not install and use the safety seat properly, the child may be injured in a sudden stop or collision.

### Installing child safety seats in combination lap and shoulder belt seating positions

1. Position the child safety seat in a seat with a combination lap and shoulder belt.

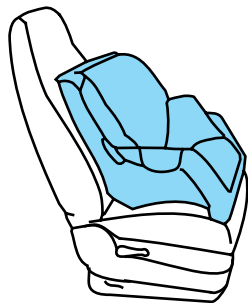

Air bag can kill or injure a child in a child seat. If you must use a forward-facing child seat in the front seat, move seat all the way back.

## Seating and safety restraints

2. Pull down on the shoulder belt and then grasp the shoulder belt and lap belt together.

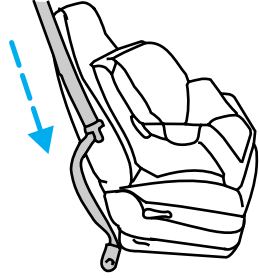

3. While holding the shoulder and lap belt portions together, route the tongue through the child seat according to the child seat manufacturer's instructions. Be sure the belt webbing is not twisted.

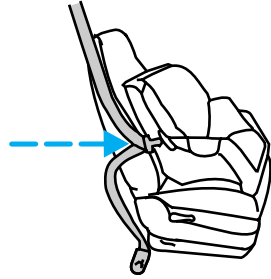

4. Insert the belt tongue into the proper buckle for that seating position until you hear and feel the latch engage. Make sure the tongue is latched securely by pulling on it.

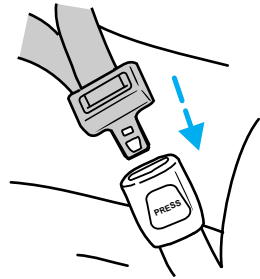

## Seating and safety restraints

5. To put the retractor in the automatic locking mode, grasp the shoulder portion of the belt and pull downward until all of the belt is extracted and a click is heard.

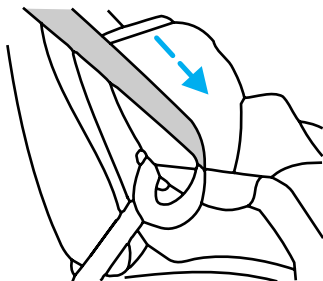

6. Allow the belt to retract. The belt will click as it retracts to indicate it is in the automatic locking mode.

7. Pull the lap belt portion across the child seat toward the buckle and pull up on the shoulder belt while pushing down with your knee on the child seat.

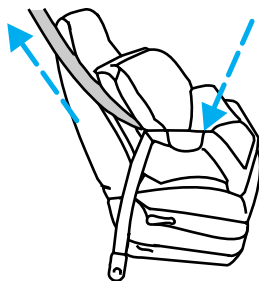

8. Allow the safety belt to retract to remove any slack in the belt.

9. Before placing the child in the seat, forcibly tilt the seat forward and back to make sure the seat is securely held in place.

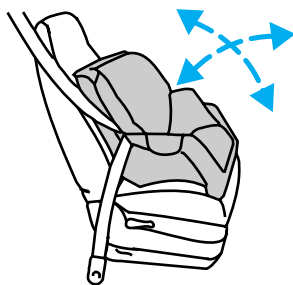

## Seating and safety restraints

10. Try to pull the belt out of the retractor to make sure the retractor is in the automatic locking mode (you should not be able to pull more belt out). If the retractor is not locked, unbuckle the belt and repeat steps two through nine.

Check to make sure the child seat is properly secured before each use.

### **Installing a child safety seat in the center seating position with adjustable lap belt**

1. Lengthen the lap belt. To lengthen the belt, hold the tongue so that its bottom is perpendicular to the direction of webbing while sliding the tongue up the webbing.
2. Place the child safety seat in the center seating position.
3. Route the tongue and webbing through the child seat according to the child seat manufacturer's instructions.
4. Insert the belt tongue into the proper buckle for the center seating position until you hear a snap and feel it latch. Make sure the tongue is securely fastened to the buckle by pulling on tongue.
5. Push down on the child seat while pulling on the loose end of the lap belt webbing to tighten the belt.
6. Before placing the child into the child seat, forcibly tilt the child seat from side to side and in forward direction to make sure that the seat is held securely in place. If the child seat moves excessively, repeat steps 5 through 6, or properly install the child seat in a different position.

### **Attaching safety seats with tether straps**

Some manufacturers make safety seats that include a tether strap that goes over the back of the vehicle seat and attaches to an anchoring point. Other manufacturers offer the tether strap as an accessory. Contact the manufacturer of your child safety seat for information about ordering a tether strap.

## Seating and safety restraints

### Tether anchorage hardware

Attachment holes (at each rear seating position) have been provided in your vehicle to attach anchor hardware, if required. Tether anchorage hardware kits (part number 613D74) including instructions, may be obtained at no charge from any Ford or Lincoln-Mercury dealer. All vehicles built for sale in Canada include a tether anchor hardware kit.

Be sure to follow the child safety seat manufacturer's instructions.



Tighten the anchor according to specifications. Otherwise, the safety seat may not be properly secured and the child may be injured in a sudden stop or collision.

## Starting

### PREPARING TO START YOUR VEHICLE

Engine starting is controlled by the ignition system. This system meets all Canadian Interference-Causing Equipment standard requirements regulating the impulse electrical field strength of radio noise.

When starting a fuel-injected engine, avoid pressing the accelerator before or during starting. Only use the accelerator when you have difficulty starting the engine. For more information on starting the vehicle, refer to *Starting the engine* in this chapter.



Extended idling at high engine speeds can produce very high temperatures in the engine and exhaust system, creating the risk of fire or other damage.



Do not park, idle, or drive your vehicle in dry grass or other dry ground cover. The emission system heats up the engine compartment and exhaust system, which can start a fire.



Do not start your vehicle in a closed garage or in other enclosed areas. Exhaust fumes can be toxic. Always open the garage door before you start the engine. See *Guarding against exhaust fumes* in this chapter for more instructions.



If you smell exhaust fumes inside your vehicle, have your dealer inspect your vehicle immediately. Do not drive if you smell exhaust fumes.

### Important safety precautions

A computer system controls the engine's idle revolutions per minute (RPM). When the engine starts, the idle RPM runs faster to warm the engine. If the engine idle speed does not slow down automatically, have the vehicle checked. Do not allow the vehicle to idle for more than ten minutes.

Before starting the vehicle:

1. Make sure all vehicle occupants have buckled their safety belts. For more information on safety belts and their proper usage, refer to the *Seating and safety restraints* chapter.
2. Make sure the headlamps and vehicle accessories are off.
3. Make sure the parking brake is set.

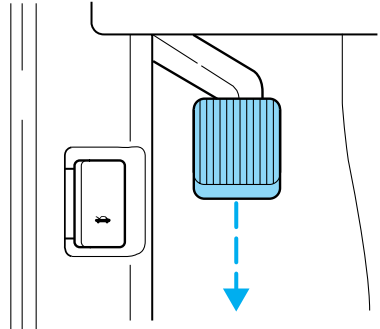

4. Make sure the gearshift is in P (Park).



5. Turn the key to 4 (ON) without turning the key to 5 (START).

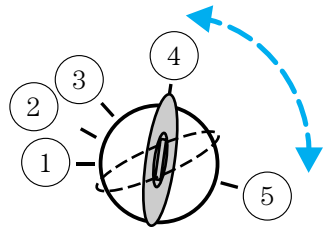



# Starting

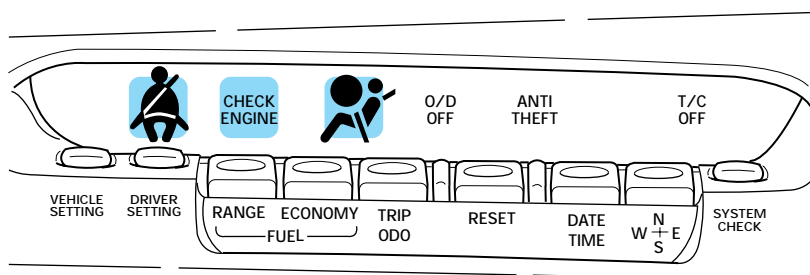
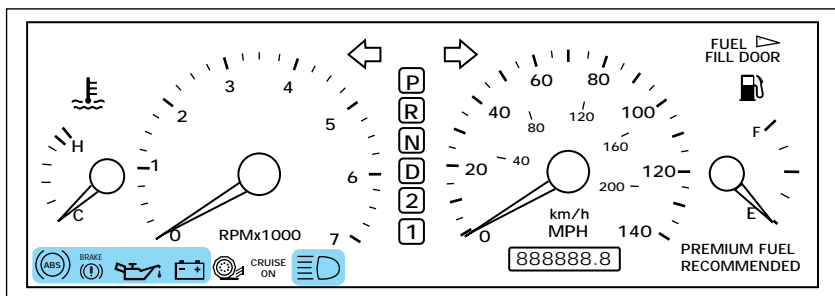

Make sure the corresponding lights illuminate briefly. If a light fails to illuminate, have the vehicle serviced.

- If the driver's safety belt is fastened, the light (  ) will not illuminate.

## STARTING THE ENGINE

1. Turn the key to 5 (START) without pressing the accelerator pedal and release as soon as the engine starts. The key will return to 4 (ON).

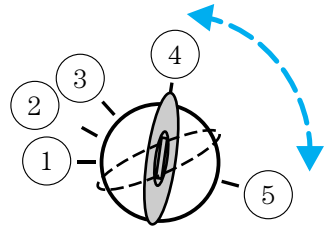

2. If the engine does not start within five seconds, wait ten seconds and try again.
3. If the engine does not start in two attempts or if the temperature is below  $-12^{\circ}\text{C}$  ( $10^{\circ}\text{F}$ ), depress the accelerator and start the engine while holding the accelerator down. Release the accelerator when the engine starts.
4. After idling for a few seconds, apply the brake and release the parking brake.

## Using the engine block heater (if equipped)

An engine block heater warms the engine coolant, which improves starting, warms up the engine faster and allows the heater-defroster system to respond quickly. They are strongly recommended if you live in a region where temperatures reach  $-23^{\circ}\text{C}$  ( $-10^{\circ}\text{F}$ ) or below.

For best results, plug the heater in at least three hours before starting the vehicle. Using the heater for longer than three hours will not harm the engine, so the heater can be plugged in the night before starting the vehicle.



To prevent electrical shock, do not use your heater with ungrounded electrical systems or two-pronged (cheater) adapters.

## Starting

### Guarding against exhaust fumes

Although odorless and colorless, carbon monoxide is present in exhaust fumes. Take precautions to avoid its dangerous effects.



If you ever smell exhaust fumes of any kind inside your vehicle, have your dealer inspect and fix your vehicle immediately. Do not drive if you smell exhaust fumes. These fumes are harmful and could kill you.

Have the exhaust and body ventilation systems checked whenever:

- the vehicle is raised for service.
- the sound of the exhaust system changes.
- the vehicle has been damaged in a collision.

### Important ventilating information

If the engine is idling while the vehicle is stopped in an open area for long periods of time, open the windows at least 2.5 cm (one inch).

Adjust the heating or air conditioning (if equipped) to bring in fresh air.

Improve vehicle ventilation by keeping all air inlet vents clear of snow, leaves and other debris.

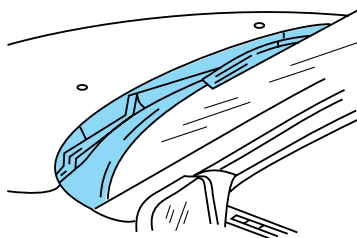

## BRAKES

Your brakes are self-adjusting. Refer to the “Service Guide” for scheduled maintenance.

Occasional brake noise is normal and often does not indicate a performance concern with the vehicle’s brake system. In normal operation, automotive brake systems may emit occasional or intermittent squeal or groan noises when the brakes are applied. Such noises are usually heard during the first few brake applications in the morning; however, they may be heard at any time while braking and can be aggravated by environmental conditions such as cold, heat, moisture, road dust, salt or mud. If a “metal-to-metal,” “continuous grinding” or “continuous squeal” sound is present while braking, the brake linings may be worn-out and should be inspected by a qualified service technician.

### Anti-lock brake system (ABS)

On vehicles equipped with an anti-lock braking system (ABS), a noise from the hydraulic pump motor and pulsation in the pedal may be observed during ABS braking events. Pedal pulsation coupled with noise while braking under panic conditions or on loose gravel, bumps, wet or snowy roads is normal and indicates proper functioning of the vehicle’s anti-lock brake system. If the vehicle has continuous vibration or shudder while braking, felt mainly in the steering wheel, the vehicle most likely needs service.

The ABS operates by detecting the onset of wheel lock up during brake applications and compensating for this tendency. The front wheels are prevented from locking even when the brakes are firmly applied. The accompanying illustration depicts the advantage of an ABS equipped vehicle (on bottom) to a non-ABS equipped vehicle (on top) during hard braking.

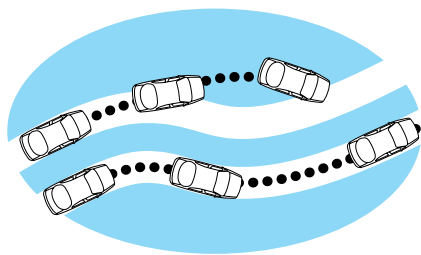

# Driving

## ABS warning lamp

The  warning lamp in the instrument cluster illuminates for about five seconds when starting the vehicle. If an ABS fault is detected, the light will remain on and your vehicle should be serviced as soon as possible.

Normal braking is still effective unless the BRAKE warning lamp is also illuminated.

**BRAKE**  

## Using ABS

- In an emergency or when maximum efficiency from the ABS is required, apply continuous full force on the brake. The ABS will be activated immediately, thus allowing you to retain full steering control of your vehicle and, providing there is sufficient space, will enable you to avoid obstacles and bring the vehicle to a controlled stop.
- We recommend that you familiarize yourself with this braking technique. However, avoid taking any unnecessary risks.

## Parking brake with auto-release

Apply the parking brake whenever the vehicle is parked.

To set the parking brake:

1. Move the gearshifter to P (Park).
2. Push pedal downward.

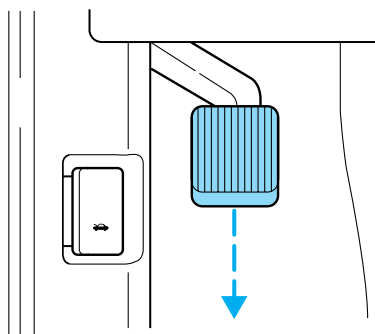

The BRAKE warning lamp in the instrument cluster illuminates and remains illuminated (when the ignition is turned ON) until the parking brake is released.

**BRAKE**  
(!)

 Always set the parking brake fully and make sure the gearshift is latched in P (Park). Turn off the ignition whenever you leave your vehicle.

The parking brake is not designed to stop a moving vehicle. However, if the normal brakes fail, the parking brake can be used to stop your vehicle in an emergency. Since the parking brake applies only the rear brakes, the vehicle's stopping distance will increase greatly and the handling of your vehicle will be adversely affected.

To release the parking brake:

1. Turn the ignition to the RUN position.
2. Press the brake pedal.
3. Move the gearshifter from the P (Park) position to R (Reverse) or one of the forward gears. The brake pedal must remain pressed while the gearshifter is moved.

If the parking brake fails to release after completing this procedure, use the manual parking brake release lever located on the floor between the driver's seat and the door.

Pull the lever up and push rearward to manually release the parking brake.

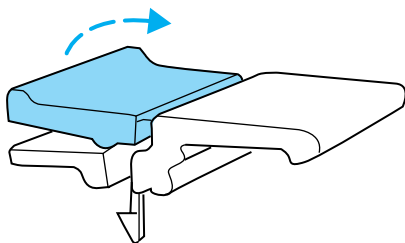

## Driving

### TRACTION CONTROL™

Your vehicle is equipped with the Traction Control™ system. This system helps maintain the stability and steerability of your vehicle. It is especially useful on slippery and/or hilly road surfaces. The system operates at all speeds by detecting and controlling wheel spin. The system borrows many of the electronic and mechanical elements already present in the anti-lock braking system (ABS).

Wheel-speed sensors allow excess rear wheel spin to be detected by the Traction Control™ portion of the ABS computer. Any excessive wheel spin is controlled by automatically applying and releasing the rear brakes in conjunction with engine torque reductions. Engine torque reduction is realized via the fully electronic spark and fuel injection systems. This process is very sensitive to driving conditions and very fast acting. The rear wheels “search” for optimum traction several times a second and adjustments are made accordingly.

The Traction Control™ system will allow your vehicle to make better use of available traction on slippery surfaces. The system is a driver aid which makes your vehicle easier to handle primarily on snow and ice covered roads. This is especially evident if wheel spin-up should occur while turning.

During Traction Control™ operation you may hear an electric motor type of sound coming from the engine compartment and the engine will not “rev-up” when you push further on the accelerator. This is normal system behavior.

If you should become stuck in snow or on a very slippery road surface, try switching the Traction Control™ system off. This may allow excess wheel spin to “dig” the vehicle out or enable a successful “rocking” maneuver. Refer to *Message center* in the *Instrumentation* chapter.

If the Traction Control™ system is cycled excessively, the brake portion of the system will shut down to prevent the rear brakes from overheating. A limited Traction Control™ function using only engine torque reduction will still control wheels from over-spinning. When the rear brakes have cooled down, the system will again function normally. Anti-lock braking is not affected by this condition and will function normally during the cool down period.

If the engine coolant temperature is below  $-23^{\circ}\text{C}$  ( $-10^{\circ}\text{F}$ ) the engine torque reduction portion of the Traction Control™ system is **NOT** active. The system will operate normally when the engine coolant warms up.

## AIR SUSPENSION SYSTEM

The air suspension system is designed to improve ride, handling and general vehicle performance during:

- certain road conditions
- steering maneuvers
- braking
- accelerations

This system maintains the vehicle height at a constant level by automatically adding air or releasing air from the air springs to offset changes in vehicle loads.

The air suspension shut-off switch is located in the trunk. If this switch is in the OFF position, the automatic leveling system will not operate.



On vehicles equipped with Air Suspension, turn OFF the Air Suspension switch prior to jacking, hoisting or towing your vehicle.

Normal vehicle operation does not require any action by the driver.

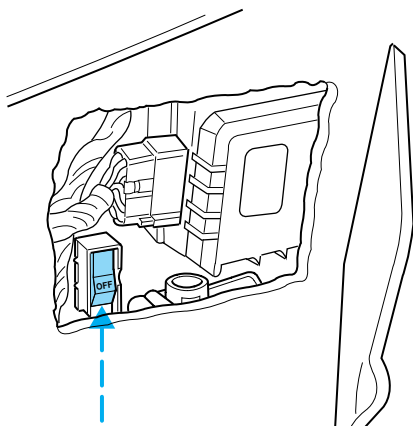

## AUTOMATIC TRANSMISSION OPERATION

### Brake-shift interlock

This vehicle is equipped with a brake-shift interlock feature that prevents the gearshift from being moved from P (Park) unless the brake pedal is pressed.

If you cannot move the gearshift out of P (Park) with the brake pedal depressed:



## Driving

1. Apply the parking brake, turn ignition key to LOCK, then remove the key.
2. Insert the key and turn it to OFF. Apply the brake pedal and shift to N (Neutral).
3. Start the vehicle.

If it is necessary to use the above procedure to move the gearshift, it is possible that a fuse has blown and the vehicle's brake lamps may not be operating properly. Refer to *Fuses and relays* in the *Roadside emergencies* chapter.



Do not drive your vehicle until you verify that the brakelamps are working.

If your vehicle gets stuck in mud or snow it may be rocked out by shifting from forward and reverse gears in a steady pattern. Press lightly on the accelerator in each gear.

**Do not rock the vehicle for more than a few minutes. The transmission and tires may be damaged or the engine can overheat.**



Always set the parking brake fully and make sure the gearshift is latched in P (Park). Turn off the ignition whenever you leave your vehicle.

### Driving with a 4-speed automatic transmission

#### ***Understanding gearshift positions***



Hold the brake pedal down while you move the gearshift lever from position to position. If you do not hold the brake pedal down, your vehicle may move unexpectedly and injure someone.

## **P (Park)**

Always come to a complete stop before shifting into or out of P (Park). Make sure the gearshift is securely latched in P (Park).

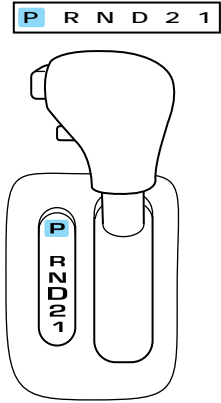

## **R (Reverse)**

With the gearshift in R (Reverse), the vehicle will move backward. Always come to a complete stop before shifting into and out of R (Reverse).

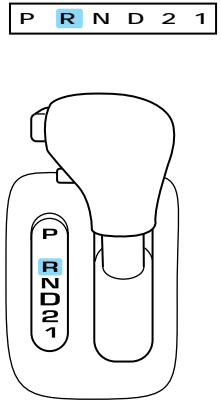

## Driving

### **N (Neutral)**

With the gearshift in N (Neutral), the vehicle can be started and is free to roll. Hold the brake pedal down while in this gear.

P R **N** D 2 1

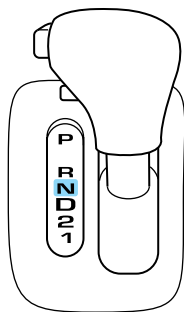

### **D (Overdrive)**

The normal driving position for the best fuel economy. Transmission operates in gears one through four.

P R N **D** 2 1

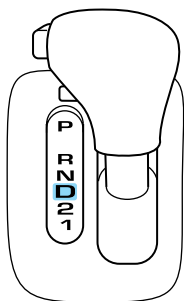

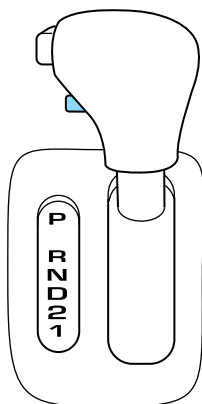

D (Overdrive) can be deactivated by pressing the transmission control switch on the side of the gearshift lever. The Message Center O/D OFF indicator will illuminate.

O/D  
OFF

**D (Drive)** – Activate by pressing the transmission control switch on the side of the gearshift lever. The transmission operates in gears one through three. D (Drive) provides more engine braking than **D** (Overdrive) and is useful whenever driving conditions (i.e., city traffic, hilly terrain, etc.) cause the transmission to excessively shift between **D** (Overdrive) and D (Drive). Also deactivate **D** (Overdrive) when:

- driving with a heavy load
- towing a trailer up or down steep hills
- additional engine braking is desired.

To return to **D** (Overdrive) mode, press the transmission control switch. The Message Center O/D OFF indicator will no longer be illuminated.

Every time the vehicle is shut off and restarted, you must press the transmission control switch to cancel overdrive operation if driving in overdrive is not desired.

## Driving

### 2 (Second)

Use 2 (Second) to start-up on slippery roads or to provide additional engine braking on downgrades.

P R N D 2 1

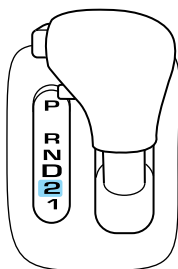

### 1 (First)

Use 1 (Low) to provide maximum engine braking on steep downgrades. Upshifts can be made by shifting to 2 (Second) or to **D** (Overdrive). Selecting 1 (Low) at higher speeds causes the transmission to shift to a lower gear, and will shift to 1 (Low) after vehicle decelerates to the proper speed.

P R N D 2 1

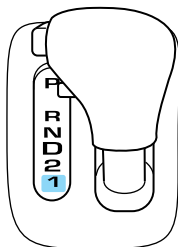

## VEHICLE LOADING

Before loading a vehicle, familiarize yourself with the following terms:

- **Base Curb Weight:** Weight of the vehicle including any standard equipment, fluids, lubricants, etc. It does not include passengers or aftermarket equipment.
- **Payload:** Combined maximum allowable weight of cargo, passengers and optional equipment. The payload equals the gross vehicle weight rating minus base curb weight.
- **GVW (Gross Vehicle Weight):** Base curb weight plus payload weight. The GVW is not a limit or a specification.
- **GVWR (Gross Vehicle Weight Rating):** Maximum total weight of the base vehicle, passengers, optional equipment and cargo. The GVWR is specific to each vehicle and is listed on the Safety Compliance Label on the driver's door pillar.
- **GAWR (Gross Axle Weight Rating):** Carrying capacity for each axle system. The GAWR is specific to each vehicle and is listed on the Safety Compliance Label on the driver's door pillar.
- **GCWR (Gross Combined Weight Rating):** Maximum combined weight of towing vehicle (including passengers and cargo) and the trailer. The GCWR indicates the maximum loaded weight that the vehicle is allowed to tow.
- **Maximum Trailer Weight Rating:** Maximum weight of a trailer the vehicle is permitted to tow. The maximum trailer weight rating is determined by subtracting the vehicle curb weight for each engine/transmission combination, any required option weight for trailer towing and the weight of the driver from the GCWR for the towing vehicle.
- **Maximum Trailer Weight:** maximum weight of a trailer the loaded vehicle (including passengers and cargo) is permitted to tow. It is determined by subtracting the weight of the loaded trailer towing vehicle from the GCWR for the towing vehicle.
- **Trailer Weight Range:** Specified weight range that the trailer must fall within that ranges from zero to the maximum trailer weight rating.

Remember to figure in the tongue load of your loaded trailer when figuring the total weight.

## Driving



Do not exceed the GVWR or the GAWR specified on the Safety Compliance Certification Label.

Do not use replacement tires with lower weight capacities than the originals because they may lower the vehicle's GVWR and GAWR limitations. Replacement tires with a higher weight limit than the originals do not increase the GVWR and GAWR limitations.

### DRIVING THROUGH WATER

Do not drive quickly through standing water, especially if the depth is unknown. Traction or brake capability may be limited and if the ignition system gets wet, your engine may stall. Water may also enter your engine's air intake and severely damage your engine.

If driving through deep or standing water is unavoidable, proceed very slowly. Never drive through water that is higher than the bottom of the hubs (truck)/wheel rims (car).

Once through the water, always try the brakes. Wet brakes do not stop the vehicle as effectively as dry brakes. Drying can be improved by moving your vehicle slowly while applying light pressure on the brake pedal.

### TRAILER TOWING

Your vehicle is classified as a light duty towing vehicle. It does not come from the factory fully equipped to tow. No towing packages are available through Ford or Mercury/Lincoln dealers. Do not tow a trailer until your vehicle has been driven at least 3 200 km (2 000 miles).

Towing a trailer places an additional load on your vehicle's engine, transmission, brakes, tires and suspension. Inspect these components carefully after towing.

The amount of weight your loaded trailer should be no more than 907 kg (2 000 lbs.).



Do not exceed the GVWR or the GAWR specified on the Safety Compliance Certification Label.



Towing trailers beyond the maximum recommended gross trailer weight could result in engine damage, transmission/axle damage, structural damage, loss of control, and personal injury.

### **Preparing to tow**

Use the proper equipment for towing a trailer, and make sure it is properly attached to your vehicle. See your dealer or a reliable trailer dealer if you require assistance.

### **Hitches**

Do not use hitches that clamp onto the vehicle bumper. Use a load carrying hitch. You must distribute the load in your trailer so that 10 – 15% of the total weight of the trailer is on the tongue.

### **Safety chains**

Always connect the trailer's safety chains to the vehicle. To connect the trailer's safety chains, cross the chains under the trailer tongue and allow slack for turning corners.

If you use a rental trailer, follow the instructions that the rental agency gives to you.

### **Trailer brakes**

Electric brakes and manual, automatic or surge-type brakes are safe if installed properly and adjusted to the manufacturer's specifications. The trailer brakes must meet local and Federal regulations.



Do not connect a trailer's hydraulic brake system directly to your vehicle's brake system. Your vehicle may not have enough braking power and your chances of having a collision greatly increase.

The braking system of the tow vehicle is rated for operation at the GVWR not GCWR

### **Trailer lamps**

Trailer lamps are required on most towed vehicles. Make sure your trailer lamps conform to local and Federal regulations. See your dealer or trailer rental agency for proper instructions and equipment for hooking up trailer lamps.



## Driving

### **Driving while you tow**

Do not drive faster than 88 km/h (55 mph) when towing a trailer. Speed control may shut off if you are towing on long, steep grades. When towing a trailer:

- Use a lower gear when towing up or down steep hills. This will eliminate excessive downshifting and upshifting for optimum fuel economy and transmission cooling.
- Anticipate stops and brake gradually.

### ***Servicing after towing***

If you tow a trailer for long distances, your vehicle will require more frequent service intervals. Refer to the Severe Duty Schedule in your “Service Guide” for more information.

### **Trailer towing tips**

- Practice turning, stopping and backing up in an area before starting on a trip to get the feel of the vehicle trailer combination. When turning, make wider turns so the trailer wheels will clear curbs and other obstacles.
- Allow more distance for stopping with a trailer attached.
- The trailer tongue weight should be 10–15% of the loaded trailer weight.
- After you have traveled 80 km (50 miles), thoroughly check your hitch, electrical connections and trailer wheel lug nuts.
- When stopped in traffic for long periods of time in hot weather, place the gearshift in P (Park) and increase idle speed. This aids engine cooling and air conditioner efficiency.
- Vehicles with trailers should not be parked on a grade. If you must park on a grade, place wheel chocks under the trailer’s wheels.

### **FUEL CONSUMPTION**

Fuel economy can be improved by avoiding:

- lack of regular, scheduled maintenance.
- excessive speed.
- rapid acceleration.
- extended idle.

# Roadside emergencies

## HAZARD LIGHTS CONTROL

Use only in an emergency to warn traffic of vehicle breakdown, approaching danger, etc. The hazard flashers can be operated when the ignition is off.

- The hazard lights control is located on top of the steering column.
- Depress hazard lights control to activate all hazard flashers simultaneously.
- Depress control again to turn the flashers off.

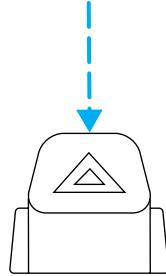

## FUEL PUMP SHUT-OFF SWITCH

If the engine cranks but does not start after a collision, the fuel pump shut-off switch may have been activated. The shut-off switch is a device intended to stop the electric fuel pump when your vehicle has been involved in a substantial jolt.

1. Turn the ignition to the OFF position.
2. Check the fuel system for leaks.
3. If no fuel leak is apparent, reset the fuel pump shut-off switch by pushing in the button on the switch.
4. Turn the ignition to the ON position. Pause for a few seconds and return the key to the OFF position.
5. Make a further check for leaks in the fuel system.

## Roadside emergencies

The fuel pump shut-off switch is located on the left side of the trunk behind the trunk liner.

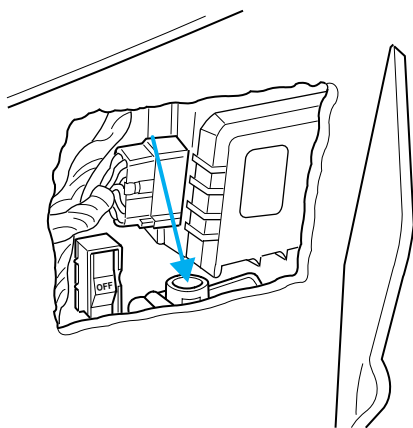

## FUSES AND RELAYS

### Fuses

If electrical components in the vehicle are not working, a fuse may have blown. Blown fuses are identified by a broken wire within the fuse. Check the appropriate fuses before replacing any electrical components.

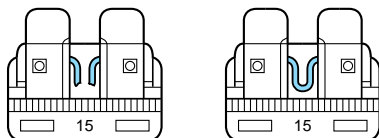

Always replace a fuse with one that has the specified amperage rating. Using a fuse with a higher amperage rating can cause severe wire damage and could start a fire.

## Roadside emergencies

### *Standard fuse amperage rating and color*

<b>Fuse rating</b>	<b>Color</b>
5 amp	Tan
7.5 amp	Brown
10 amp	Red
15 amp	Light blue
20 amp	Yellow
20 amp fuse link	Light blue
25 amp	Natural
30 amp	Light green
30 amp fuse link	Pink
40 amp fuse link	Green
50 amp fuse link	Red
60 amp fuse link	Yellow
80 amp fuse link	Black
100 amp fuse link	Dark blue

### **Passenger compartment fuse panel**

The fuse panel is located on the left hand side of the instrument panel facing the driver's side door. Pull the panel cover outward to access the fuses.

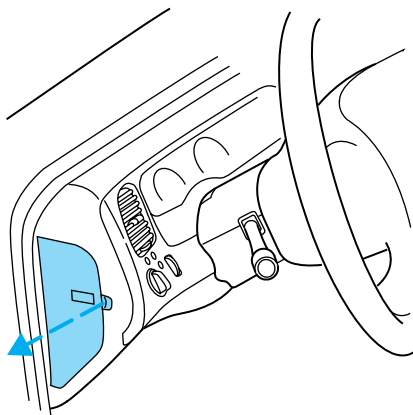

## Roadside emergencies

To remove a fuse use the fuse puller tool provided on the fuse panel cover.

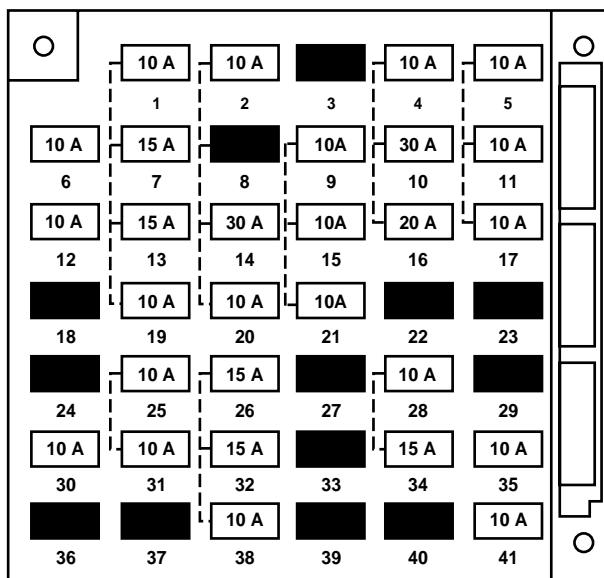

The fuses are coded as follows.

Fuse/Relay Location	Fuse Amp Rating	Description
1	10A	Steering Column/Ignition/Lighting Module (Brake Lamps, Climate Control Blower Motor, Hazard Lamps, Speed Control)
2	10A	Radio, Cellular Phone
3	—	Not Used
4	10A	Radio, Cellular Phone, Message Center, Compass, Day/Night Mirror, Passenger Seat Module

## Roadside emergencies

<b>Fuse/Relay Location</b>	<b>Fuse Amp Rating</b>	<b>Description</b>
5	10A	Day/Night Sensor, Cluster (Oil Pressure, Brake Warning, Speed Control), I/P Warning Indicator Display, Steering Column/Ignition/Lighting Module (Logic Input)
6	10A	Starter Motor Relay
7	15A	Steering Column/Ignition/Lighting Module (Left Turn Lamps)
8	—	Not Used
9	10A	Blower Motor Relay, Electronic Automatic Temperature Control Module
10	30A	Windshield Wipers
11	10A	Coil Drivers, Radio Noise Capacitors, PCM Relay
12	10A	Passenger's Power and Heated Seats
13	15A	Steering Column/Ignition/Lighting Module (Right Turn Lamps)
14	30A	Cigar Lighter, Cellular Phone, Power Point
15	10A	Air Bag Diagnostic Monitor
16	20A	Moonroof
17	10A	Instrument Cluster (Charging Indicator)
18	—	Not Used
19	10A	Steering Column/Ignition/Lighting Module (Left Low-Beam Headlamp)
20	10A	Message Center, Instrument Cluster, Electronic Automatic Temperature Control Module
21	10A	EVAC/Fill Connector, Anti-Lock Brake Control Module
22	—	Not Used
23	—	Not Used
24	—	Not Used

## Roadside emergencies

<b>Fuse/Relay Location</b>	<b>Fuse Amp Rating</b>	<b>Description</b>
25	10A	Steering Column/Ignition/Lighting Module (Right Low-Beam Headlamp)
26	15A	Steering Column/Ignition/Lighting Module (Courtesy Lighting, Demand Lighting)
27	—	Not Used
28	10A	Instrument Cluster, I/P Warning Indicator Display, Air Suspension/EVO Steering Module, Rear Window Defrost Module, Steering Wheel Position Sensor, Transmission Control Switch
29	—	Not Used
30	10A	Heated Mirrors
31	10A	Steering Column/Ignition/Lighting Module (Park Lamps)
32	15A	Brake On/Off Switch, Brake Pressure Switch
33	—	Not Used
34	15A	Heated Seats, Backup Lamps, Speed Control, Daytime Running Lamps, A/C Cycling Switch, Digital Transmission Range Sensor, Intake Manifold Runner Control Module
35	10A	Driver's Power and Heated Seats
36	—	Not Used
37	—	Not Used
38	10A	Data Link Connector
39	—	Not Used
40	—	Not Used
41	10A	Keyless Entry, Power Door Locks, Power Mirror Switch, Memory/Recall Switch, Driver's Door Module

# Roadside emergencies

## Power distribution box

The power distribution box is located in the engine compartment. The power distribution box contains high-current fuses that protect your vehicle's main electrical systems from overloads.



Always disconnect the battery before servicing high current fuses.



Always replace the cover to the Power Distribution Box before reconnecting the battery or refilling fluid reservoirs.

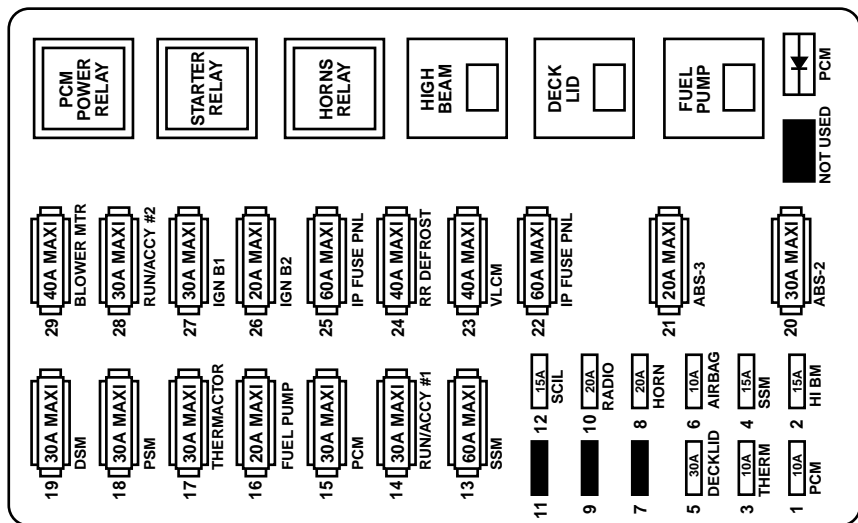



## Roadside emergencies

The high-current fuses are coded as follows.

<b>Fuse/Relay Location</b>	<b>Fuse Amp Rating</b>	<b>Description</b>
1	10A*	Powertrain Control Module (Keep-Alive Memory)
2	15A*	High Beam Relay, Daytime Running Lamps Module
3	10A*	Powertrain Control Module (EAM Pump Motor-Monitor)
4	15A*	Air Suspension, Electronically Variable Orifice Power Steering
5	30A*	Trunk Lid Relay, Fuel Filler Door Release
6	10A*	Air Bag Module
7	—	Not Used
8	20A*	Horn Relay
9	—	Not Used
10	20A*	Radio Amplifier, CD Changer
11	—	Not Used
12	15A*	Steering Column/Ignition/Lighting Module (Tilt/Telescoping Steering Column Motors, Mirror Lamps, Brake Shift Interlock, High Beam Indicator, Anti-Theft Indicator)
13	60A**	Air Suspension
14	30A**	Delayed Accessory Power Relay #1, I/P Fuses (4, 10, 16)
15	30A**	Powertrain Control Module, PCM Power Relay, Engine Compartment Fuse 1
16	20A**	Fuel Pump Relay, Fuel Pump Module
17	30A**	Electronic Air Management, Engine Compartment Fuse 3
18	30A**	Passenger Seat Module, Passenger Lumbar, I/P Fuse 12
19	30A**	Driver Seat Module, Driver Lumbar, I/P Fuse 35

## Roadside emergencies

Fuse/Relay Location	Fuse Amp Rating	Description
20	30A**	Anti-Lock Brake Control Module
21	20A**	Anti-Lock Brake Control Module, EVAC/Fill Connector
22	60A**	I/P Fuses (1, 7, 13, 19, 25, 31)
23	40A**	Variable Load Control Module
24	40A**	Rear Window Defrost Control, I/P Fuse 30
25	60A**	I/P Fuses (2, 14, 20, 26, 32, 38), Engine Compartment Fuse 5
26	20A**	Ignition Switch, I/P Fuses (5, 9, 11, 15, 17, 21)
27	30A**	Starter Motor Solenoid, Ignition Switch, I/P Fuses (6, 28, 34)
28	30A**	Delayed Accessory Power Relay #2, I/P Fuse 41
29	40A**	Blower Motor Relay
* Mini Fuses ** Maxi Fuses		

### CHANGING THE TIRES

If you get a flat tire while driving, do not apply the brake heavily. Instead, gradually decrease your speed. Hold the steering wheel firmly and slowly move to a safe place on the side of the road.

#### Tire change procedure

1. Park on a level surface, activate hazard flashers and set parking brake.
2. Place gearshift lever in P (Park).

## Roadside emergencies

3. Remove the spare tire, jack and lug wrench.
4. Remove the center ornament from the aluminum wheel with the tapered end of the wheel nut wrench that came with your vehicle. Insert and twist the handle, then pry against the wheel.

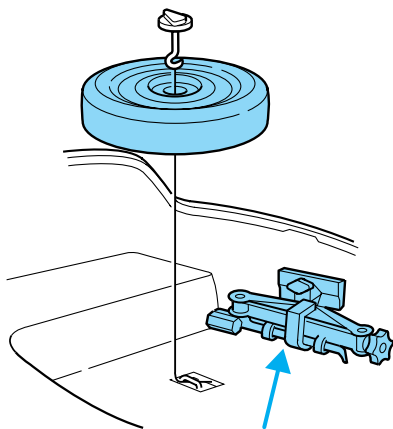

5. Loosen each wheel lug nut one-half turn counterclockwise but do not remove them until the wheel is raised off the ground. Refer to *Anti-theft lug nuts* for information on removing anti-theft lug nuts.

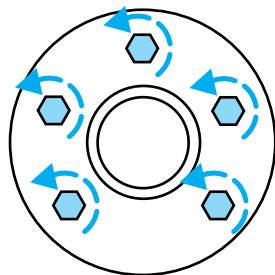

## Roadside emergencies

 On vehicles equipped with Air Suspension, turn OFF the Air Suspension switch prior to jacking, hoisting or towing your vehicle.

Refer to *Air suspension system* in the *Driving* chapter for more information.

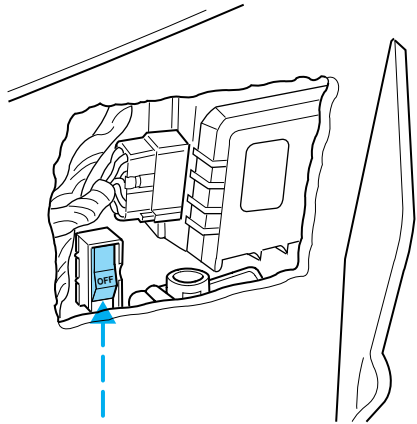

6. Put the jack in the jack notch next to the door closest to the tire you are changing. Turn the jack handle clockwise until the wheel is completely off the ground.

7. Remove the lug nuts with the lug wrench.

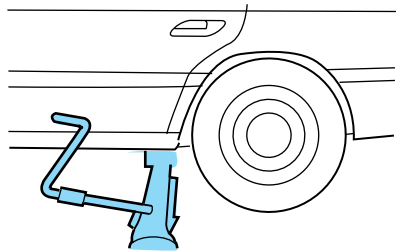

8. Replace the flat tire with the spare tire, making sure the valve stem is facing outward. Reinstall lug nuts until the wheel is snug against the hub. Do not fully tighten the lug nuts until the wheel has been lowered.

9. Lower the wheel by turning the jack handle counterclockwise.

## Roadside emergencies

10. Remove the jack and fully tighten the lug nuts in the order shown.
11. Put flat tire, jack and lug wrench away.
12. Turn on the air suspension switch.

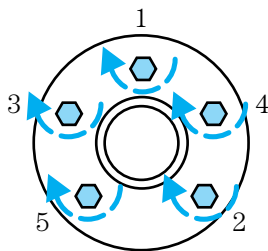

### Anti-theft lug nuts (if equipped)

If your vehicle is equipped with this feature, one of the lug nuts on each wheel must be removed and replaced with a special key. The key and registration card are attached to the lug wrench and stored with the spare tire. If you lose the key, send the registration card to the

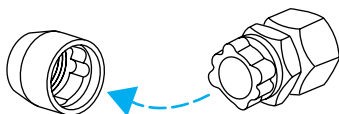

manufacturer (not the dealer) to get a replacement key. If the lug wrench/lug nut key assembly is lost, see your nearest Ford or Lincoln/Mercury dealer who has access to the master set of keys. **Do not use an impact wrench with the anti-theft key.**

### Removing the anti-theft lug nut

1. Insert the key over the locking lug nut. Make sure you hold the key square to the lug nut. If you hold the key at an angle, you could damage the key and the lug nut.
2. Place the lug nut wrench over the lug nut key and apply pressure on the key with the wrench.
3. Turn the wrench in a counterclockwise direction to remove the lug nut.

### Reinstalling the anti-theft lug nut

1. Insert the key over the locking lug nut.
2. Place the lug nut wrench over the lug nut key and apply pressure on the key with the wrench.
3. Install the lug nut.

## Roadside emergencies

### JUMP STARTING YOUR VEHICLE



The gases around the battery can explode if exposed to flames, sparks, or lit cigarettes. An explosion could result in injury or vehicle damage.



Do not push start your vehicle. You could damage the catalytic converter.



Batteries contain sulfuric acid which burns skin, eyes, and clothing.

### Preparing your vehicle

Also see the label on the battery.

1. Use only a 12-volt supply to start your vehicle. If you connect your battery to a 24-volt power supply you can damage your starter, ignition system and other electrical components.
2. Do not disconnect the battery of the disabled vehicle as this could damage the vehicle's electrical system.
3. Park the booster vehicle close to the hood of the disabled vehicle making sure they **do not** touch. Set the parking brake on both vehicles and stay clear of the engine cooling fan and other moving parts.
4. Check all battery terminals and remove any excessive corrosion before you attach the battery cables.
5. Turn the heater fan on in both vehicles to protect any electrical surges. Turn all other accessories off.

## Roadside emergencies

### Connecting the jumper cables

1. Position the vehicles so that they do not touch one another.
2. Switch off the engine. Switch off any unnecessary electrical equipment.
3. Connect the positive (+) terminal of the discharged battery (1) to the positive (+) terminal of the booster battery (2).
4. Connect one end of the second lead to the negative (-) terminal of the booster battery (3) and the other end to a metal part of the engine to be started (4), not to the negative (-) terminal of the discharged battery.
5. Make sure that the jump leads are clear of moving parts of the engine.

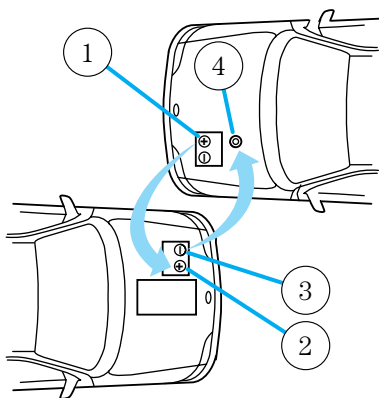

Do not connect the end of the second cable to the negative (-) terminal of the battery to be jumped. A spark may cause an explosion of the gases that surround the battery.

### Jump starting

1. Start the booster vehicle and run the engine at moderately increased speed.
2. Start the engine of the vehicle with the discharged battery.
3. Once the engine has been started, run both vehicles for a further three minutes before disconnecting the leads.

## Roadside emergencies

### Removing the jumper cables

1. Remove the jumper cables in reverse order. Take the cable off the metallic surface (1) first, followed by the cable on the negative (-) booster battery terminal (2).
2. Remove the cable from the positive (+) terminal of the booster battery (3) and then the discharged battery (4).
3. After the disabled vehicle has been started, allow it to idle for a while so the engine can “relearn” its idle conditions.

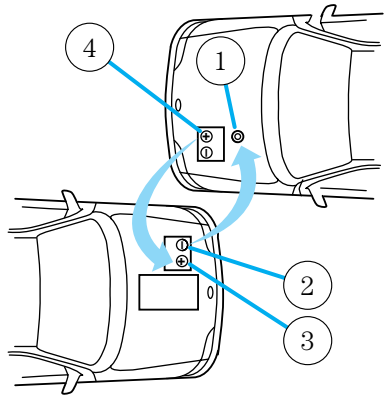



## Roadside emergencies

### WRECKER TOWING

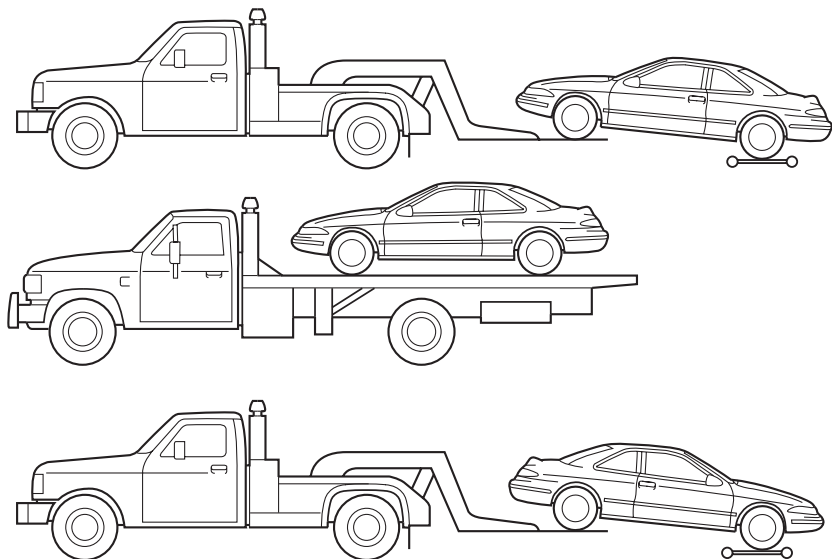

If you need to have your vehicle towed, contact a professional towing service or, if you are a member, your roadside assistance center. It is recommended that your vehicle be towed with wheel lift and dollies or flatbed equipment. Do not tow with slingbelt equipment. Ford Motor Company has not developed or approved a T-hook or slingbelt towing procedure.

When calling for a tow truck, tell the operator what kind of vehicle you have. A towing manual is available from Ford Motor Company for all authorized tow truck operators. Have your tow truck driver refer to this manual for proper hook-up and towing procedures for your vehicle.

### SERVICE RECOMMENDATIONS

To help you service your vehicle:

- We highlight do-it-yourself items in the engine compartment for easy location.
- We provide a “Service Guide” which makes tracking routine service easy.

If your vehicle requires professional service, your dealership can provide necessary parts and service. Check your “Warranty Guide” to find out which parts and services are covered.

Use only recommended fuels, lubricants, fluids and service parts conforming to specifications. Motorcraft parts are designed and built to provide the best performance in your vehicle.

### PRECAUTIONS WHEN SERVICING YOUR VEHICLE

Be especially careful when inspecting or servicing your vehicle.

- Do not work on a hot engine.
- When the engine is running, make sure that loose clothing, jewelry or long hair does not get caught up in moving parts.
- Do not work on a vehicle with the engine running in an enclosed space, unless you are sure you have enough ventilation.
- Keep all lit cigarettes, open flames and other lit material away from the battery and all fuel related parts.

If you disconnect the battery, the engine must “relearn” its idle conditions before your vehicle will drive properly, as explained in *Battery* in this chapter.

## Maintenance and care

### Working with the engine off

1. Set the parking brake and ensure the gearshift is securely latched in P (Park).
2. Turn off the engine and remove the key.
3. Block the wheels to prevent the vehicle from moving unexpectedly.

### Working with the engine on

1. Set the parking brake and ensure the gearshift is securely latched in P (Park).
2. Block the wheels to prevent the vehicle from moving unexpectedly.



Do not start your engine with the air cleaner removed and do not remove it while the engine is running.

### OPENING THE HOOD

1. Inside the vehicle, pull the hood release handle located under the bottom of the instrument panel.
2. Go to the front of the vehicle and release the auxiliary latch that is located under the front center of the hood. Lift the hood until the lift cylinders hold it open.

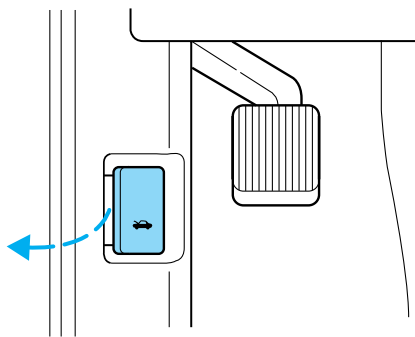

## Maintenance and care

### IDENTIFYING COMPONENTS IN THE ENGINE COMPARTMENT

#### 4.6L DOHC ENGINE

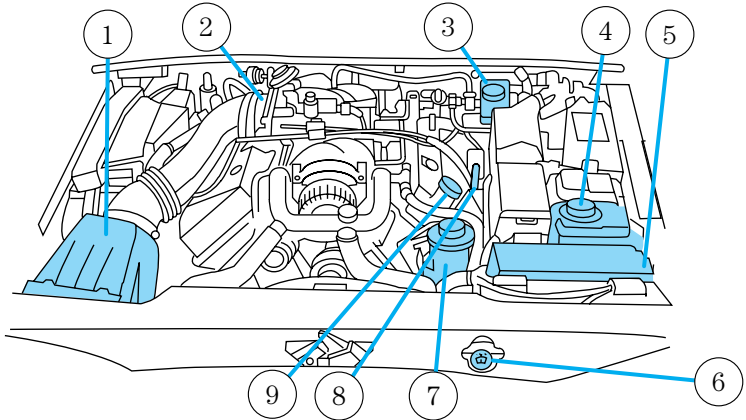

1. Air filter assembly
2. Transmission fluid dipstick
3. Brake fluid reservoir
4. Engine coolant reservoir
5. Battery
6. Windshield washer fluid reservoir
7. Power steering fluid reservoir
8. Engine oil dipstick
9. Engine oil fill cap

# Maintenance and care

## ENGINE OIL

### Checking the engine oil

Check the engine oil each time you fuel your vehicle.

1. Make sure the vehicle is on level ground.
2. Turn the engine off and wait a few minutes for the oil to drain into the oil pan.
3. Set the parking brake and ensure the gearshift is securely latched in P (Park).
4. Open the hood. Protect yourself from engine heat.
5. Locate and carefully remove the engine oil level indicator (dipstick).

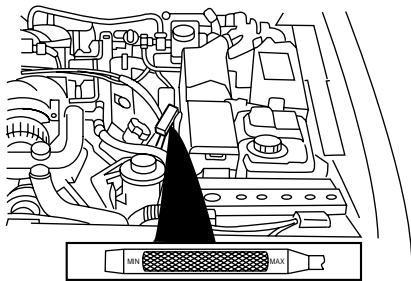

6. Wipe the indicator clean. Insert the indicator fully, then remove it again.

- If the oil level is **between the MIN and MAX marks**, the oil level is acceptable. **DO NOT ADD OIL.**
- If the oil level is below the MIN mark, add enough oil to raise the level within the MIN-MAX range.

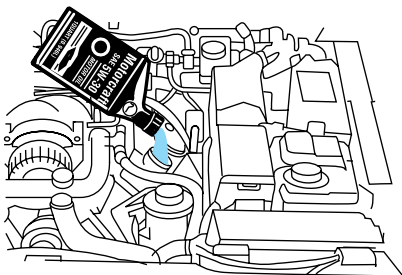

## Maintenance and care

- Oil levels above the MAX mark may cause engine damage. Some oil must be removed from the engine by a service technician.
7. Put the indicator back in and ensure it is fully seated.

### Adding engine oil

1. Check the engine oil. For instructions, refer to *Checking the engine oil* in this chapter.
2. If the fluid level is not within the normal range, add only certified engine oil of the preferred viscosity. Add engine oil through the oil filler cap. Remove the filler cap and use a funnel to pour oil in the opening.
3. Recheck the oil level. Make sure the oil level is not above the MAX mark on the dipstick.

### Engine oil recommendations

Look for this certification mark.

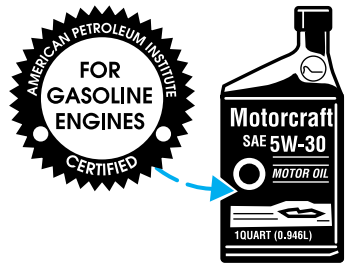

Ford oil specification is WSS-M2C153-G.

Use SAE 5W-30 motor oil certified for gasoline engines by the American Petroleum Institute.

Do not use supplemental engine oil additives, oil treatments or engine treatments. They are unnecessary and could, under certain conditions, lead to engine damage which is not covered by your warranty.

## Maintenance and care

### Changing the engine oil and filter

Change your engine oil and filter according to the following mileage and time requirements, whichever occurs first:

- Normal Schedule – 8,000 km (5,000 miles) or six months.
- Severe Duty Schedule - 5,000 km (3,000 miles) or three months.  
Severe duty operation would include extensive idling, trailer towing, driving in severe dust and police, taxi or delivery service.

Ford production and aftermarket (Motorcraft) oil filters are designed for added engine protection and long life. If a replacement oil filter is used that does not meet Ford material and design specifications, startup engine noises or knock may be experienced.

It is recommended you use the appropriate Motorcraft oil filter (or another brand meeting Ford specifications) for your engine application.

### BRAKE FLUID

#### Checking and adding brake fluid

Brake fluid should be checked and refilled as needed at least once each year:

1. Clean the reservoir cap before removal to prevent dirt or water from entering the reservoir.
2. Visually inspect the fluid level.
3. If necessary, add brake fluid until the level reaches MAX. Do not fill above this line.
4. Use only a DOT 3 brake fluid certified to meet Ford specifications. Refer to *Lubricant specifications* in the *Capacities and specifications* chapter.

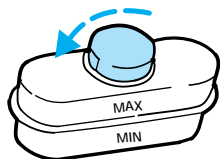
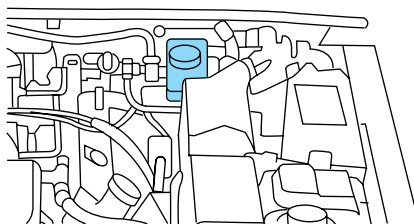

## Maintenance and care



Brake fluid is toxic.



If you use a brake fluid that is not DOT 3, you will cause permanent damage to your brakes.



Do not let the reservoir for the master cylinder run dry. This may cause the brakes to fail.

### WINDSHIELD WASHER FLUID

#### Checking and adding washer fluid

Check the washer fluid whenever you stop for fuel. The reservoir is on the right side of the engine compartment and is highlighted with a  symbol.

If the level is low, add enough fluid to fill the reservoir. In very cold weather, do not fill the reservoir all the way.

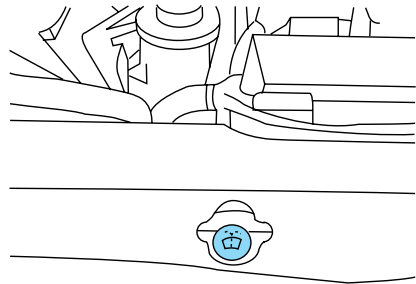

Do not put engine coolant in the container for the windshield washer fluid.



## Maintenance and care

### ENGINE COOLANT

Check the level of the coolant in the reservoir at least once a month. Be sure to read and understand *Precautions when servicing your vehicle* in this chapter.

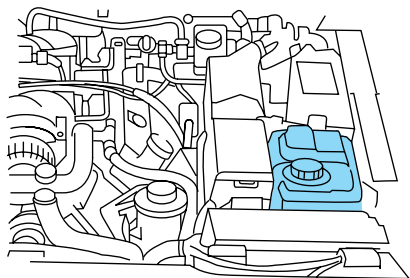

If the engine coolant has not been checked for a long period of time, the engine coolant reservoir may eventually empty. If this occurs, add engine coolant to the coolant reservoir. For more information on engine coolant maintenance, refer to *Adding engine coolant* in this chapter.

Automotive fluids are not interchangeable; do not use engine coolant, antifreeze or windshield washer fluid outside of its specified function and vehicle location.

### Adding engine coolant



Do not put engine coolant in the container for the windshield washer fluid.

If sprayed on the windshield, engine coolant could make it difficult to see through the windshield.

When the engine is cool, add a 50/50 mixture of engine coolant and water to the engine coolant recovery reservoir-**DO NOT ADD DIRECTLY TO THE RADIATOR**. Add straight water only in an emergency, but you should replace it with a 50/50 mixture of coolant and distilled water as soon as possible.

Check the coolant level in the coolant recovery reservoir the next few times you drive the vehicle. If necessary, add enough of a 50/50 mixture of coolant and water to bring the liquid level to the fill line on the reservoir.

## Maintenance and care



Never remove the coolant recovery cap while the engine is running or hot.

If you must remove the coolant recovery cap, follow these steps to avoid personal injury:

1. Before you remove the cap, turn the engine off and let it cool.
2. When the engine is cool, wrap a thick cloth around the cap. Slowly turn cap counterclockwise until pressure begins to release.
3. Step back while the pressure releases.
4. When you are sure that all the pressure has been released, use the cloth to turn it counterclockwise and remove the cap.

Use Ford Premium Cooling System Fluid E2FZ-19549-AA (in Canada, Motorcraft CXC-8-B) or an equivalent premium engine coolant that meets Ford specification ESE-M97B44-A. Ford Premium Engine Coolant is an optimized formula that will protect all metals and rubber elastomers used in Ford cooling systems for four years or 80,000 km (50,000 miles).

Do not use alcohol or methanol antifreeze or any engine coolants mixed with alcohol or methanol antifreeze. Do not use supplemental coolant additives in your vehicle. These additives may harm your engine cooling system. The use of an improper coolant may void your warranty of your vehicle's engine cooling system.

### Recycled engine coolant

Ford Motor Company recommends that Ford and Lincoln-Mercury dealers use recycled engine coolant produced by Ford-approved processes. Not all coolant recycling processes produce coolant which meets Ford specification ESE-M97B44-A, and use of such coolant may harm engine and cooling system components.



Always dispose of used automotive fluids in a responsible manner. Follow your community's regulations and standards for recycling and disposing of automotive fluids.

### Coolant refill capacity

To find out how much fluid your vehicle's cooling system can hold, refer to *Refill capacities* in the *Capacities and specifications* chapter.

Have your dealer check the engine cooling system for leaks if you have to add more than a liter (quart) of engine coolant per month.

## Maintenance and care

### Severe winter climate

If you drive in extremely cold climates (less than  $-36^{\circ}\text{C}$  [ $-34^{\circ}\text{F}$ ]), it may be necessary to increase the coolant concentration above 50%. Refer to the chart on the coolant container to ensure the coolant concentration in your vehicle is such that the coolant will not freeze at the temperature level in which you drive during winter months. Never increase the engine coolant concentration above 60%. Leave a 50/50 mixture of engine coolant and water in your vehicle year-round in non-extreme climates.

### CHECKING AND ADDING POWER STEERING FLUID

Check the power steering fluid at least twice a year. If adding fluid is necessary, use only MERCON® ATF power steering fluid.

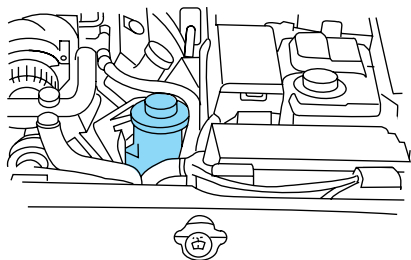

1. Start the engine and let it run until it reaches normal operating temperature (the engine coolant temperature gauge will be near the center of the NORMAL band).
2. While the engine idles, turn the steering wheel left and right several times.
3. Turn the engine off.
4. Check the fluid level in the reservoir. It should be between the MIN and MAX lines. Do not add fluid if the level is in this range.

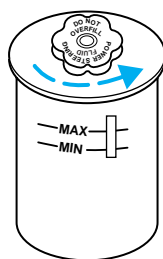

5. If the fluid is low, add fluid in small amounts, continuously checking the level until it reaches the range between the MIN and MAX lines. Be sure to put the cap back on the reservoir.

## TRANSMISSION FLUID

### Checking and adding automatic transmission fluid

Follow the scheduled service intervals outlined in the “Service Guide.”

Before adding any fluid, make sure the correct type is used. The type of fluid used is normally indicated on the dipstick and/or dipstick handle and also in the *Lubricant specifications* section in the *Capacities and specifications* chapter.

**An overfill condition of transmission fluid may cause shift and/or engagement concerns and/or possible damage.**

Do not drive the vehicle if the fluid level is below the bottom (cold) notch on the dipstick and outside temperatures are above 10°C (50°F) (see figure to the right).

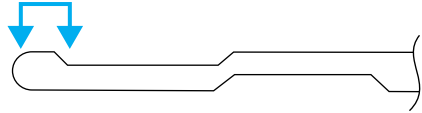

Your transmission does not use up fluid. However, it is recommended that you check the transmission fluid at least twice a year. The fluid level should be checked if the transmission is not working properly, i.e., if the transmission slips or shifts slowly or if you notice some sign of fluid leakage.

Transmission fluid should be checked at normal operating temperatures 66°C-77°C (150°F-170°F) on a level surface. The normal operating temperature can be reached after approximately 32 km (20 miles) of driving.

The transmission fluid should be in this range if at normal operating temperature (66°C-77°C [150°F-170°F]) (see figure to the right).

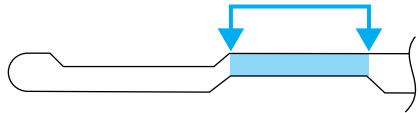

The transmission fluid should be in this range if at room temperature (10°C-35°C [50°F-95°F]) (see figure to the right).

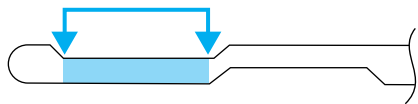

## Maintenance and care

If your vehicle has been operated for an extended period at high speeds, in city traffic during hot weather or pulling a trailer, the vehicle should be turned off for about 30 minutes to allow the fluid to cool before checking.

1. Park the vehicle on a level surface and engage the parking brake.
2. With the parking brake engaged and your foot on the brake pedal, start the engine and move the gearshift lever through all of the gear ranges. Allow sufficient time for each gear to engage.
3. Latch the gearshift lever in P (Park) and leave the engine running.



4. Remove the dipstick, wiping it clean with a clean, dry lint free rag.
5. Install the dipstick making sure it is fully seated in the filler tube.
6. Remove the dipstick and inspect the fluid level. The fluid level should be within the top notch (hot) area of the dipstick.
7. If necessary, add fluid in .25L (1/2 pint) increments through the filler tube until the level is correct.
8. If an overfill occurs, excess fluid should be removed by a qualified technician.

**An overfill condition of transmission fluid may cause shift and/or engagement concerns and/or possible damage.**

If the fluid level is above the top notch of the hot range after driving the vehicle approximately 30 km (20 miles), excess fluid should be removed by a qualified technician.

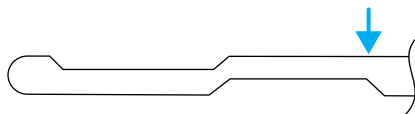

### BATTERY

Your vehicle may be equipped with a Superstart maintenance-free battery. If the original equipment battery needs replacing, it may be replaced with a low-maintenance battery. The low-maintenance battery normally does not require additional water during its life of service. However, for severe usage or in high temperature climates, check your battery electrolyte level, at least every 24 months or 40,000 km (24,000 miles). Keep the electrolyte in each cell up to the “level” indicator. Do not overfill the battery cells.

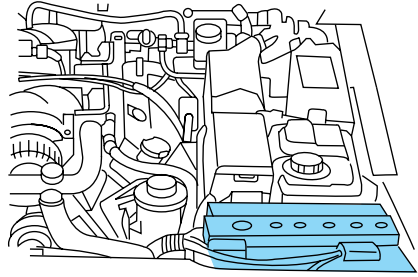

If the electrolyte level in the battery is low, you can add plain tap water to the battery, as long as you do not use hard water (water with a high alkali content). If possible, however, try to only fill the battery cells with distilled water. If the battery needs water often, have the charging system checked.

For longer, trouble-free operation, keep the top of the battery clean and dry. Also, make certain the battery cables are always tightly fastened to the battery terminals.

If you see any corrosion on the battery or terminals, remove the cables from the terminal(s) and clean with a wire brush. You can neutralize the acid with a solution of baking soda and water. Reinstall the cables when you are done cleaning them, and apply a small quantity of grease to the top of each battery terminal to help prevent corrosion.

**If your battery has a cover/shield, make sure it is reinstalled after the battery is replaced.**

Because your vehicle's engine is electronically controlled by a computer, some control conditions are maintained by power from the battery. When the battery is disconnected or a new battery is installed, the engine must relearn its idle conditions before your vehicle will drive properly. To begin this process:

1. Put the gearshift in P (Park), turn off all accessories and start the vehicle.
2. Let the engine idle for at least one minute.

## Maintenance and care

3. The relearning process will automatically complete as you drive the vehicle.

- If you do not allow the engine to relearn its idle, the idle quality of your vehicle may be adversely affected until the idle is eventually relearned.
- If the battery has been disconnected or a new battery has been installed, the clock and the preset radio stations must be reset once the battery is reconnected.
- Always dispose of automotive batteries in a responsible manner. Follow your community's standards for disposal. Call your local recycling center to find out more about recycling automotive batteries.



### WINDSHIELD WIPER BLADES

Check the wiper blades at least twice a year or when they seem less effective. Substances such as tree sap and some hot wax treatments used by commercial car washes reduce the effectiveness of wiper blades.

#### Checking the wiper blades

If the wiper blades do not wipe properly, clean both the windshield and wiper blades using undiluted windshield wiper solution or a mild detergent. Rinse thoroughly with clean water. To avoid damaging the blades, do not use fuel, kerosene, paint thinner or other solvents.

#### Changing the wiper blades

When replacing wiper blade assemblies, always use a Motorcraft part or equivalent. To make replacing the wipers easy, turn the ignition to ACC, then turn the wipers on. When the wipers reach the vertical position, turn the ignition to LOCK.

## Maintenance and care

To replace the wiper blades:

1. Pull the wiper arm away from the windshield and lock into the service position.
2. Turn the blade at an angle from the wiper arm. Push the lock pin with a screwdriver to release the blade and pull the wiper blade down toward the windshield to remove it from the arm.
3. Attach the new wiper to the wiper arm and press it into place until a click is heard.

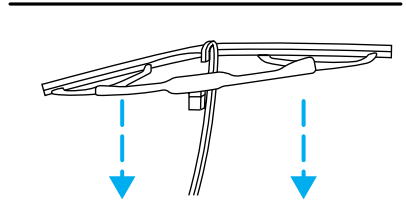
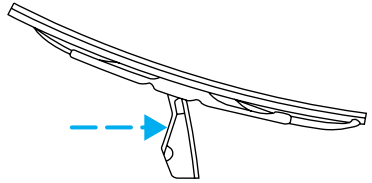

## INFORMATION ABOUT TIRE QUALITY GRADES

New vehicles are fitted with tires that have their Tire Quality Grade (described below) molded into the tire's sidewall. These Tire Quality Grades are determined by standards that the United States Department of Transportation has set.

Tire Quality Grades apply to new pneumatic tires for use on passenger cars. They do not apply to deep tread, winter-type snow tires, space-saver or temporary use spare tires, tires with nominal rim diameters of 10 to 12 inches or limited production tires as defined in Title 49 Code of Federal Regulations Part 575.104(c)(2).

**U.S. Department of Transportation-Tire quality grades:** The U.S. Department of Transportation requires Ford to give you the following information about tire grades exactly as the government has written it.

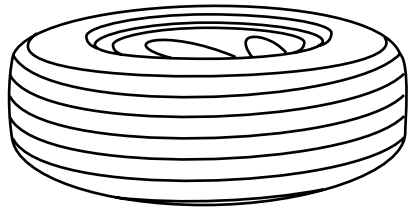



## Maintenance and care

### Treadwear

The treadwear grade is a comparative rating based on the wear rate of the tire when tested under controlled conditions on a specified government test course. For example, a tire grade 150 would wear one and one-half (1 1/2) times as well on the government course as a tire grade 100. The relative performance of tires depends upon the actual conditions of their use, however, and may depart significantly from the norm due to variations in driving habits, service practices, and differences in road characteristics and climate.

### Traction A B C

The traction grades, from highest to lowest are A, B, and C, and they represent the tire's ability to stop on wet pavement as measured under test surfaces of asphalt and concrete. A tire marked C may have poor traction performance.



The traction grade assigned to this tire is based on braking (straight ahead) traction tests and does not include cornering (turning) traction.

### Temperature A B C

The temperature grades are A (the highest), B, and C, representing the tire's resistance to the generation of heat and its ability to dissipate heat when tested under controlled conditions on a specified indoor laboratory test wheel. Sustained high temperature can cause the material of the tire to degenerate and reduce tire life, and excessive temperature can lead to sudden tire failure. The grade C corresponds to a level of performance which all passenger car tires must meet under the Federal Motor Vehicle Safety Standard No. 109. Grades B and A represent higher levels of performance on the laboratory test wheel than the minimum required by law.



The temperature grade for this tire is established for a tire that is properly inflated and not overloaded. Excessive speed, underinflation, or excessive loading, either separately or in combination, can cause heat buildup and possible tire failure.

## Maintenance and care

### SERVICING YOUR TIRES

#### Checking the tire pressure

- Use an accurate tire pressure gauge.
- Check the tire pressure when tires are cold, after the vehicle has been parked for at least one hour or has been driven less than 5 km (3 miles).
- Adjust tire pressure to recommended specifications found on the label located on the face of the passenger door jamb.



Improperly inflated tires can affect vehicle handling and can fail suddenly, possibly resulting in loss of vehicle control.

#### Tire rotation

Because your vehicle's tires perform different jobs, they often wear differently. To make sure your tires wear evenly and last longer, rotate them as indicated in the "Service Guide." If you notice that the tires wear unevenly, have them checked.

- Four tire rotation

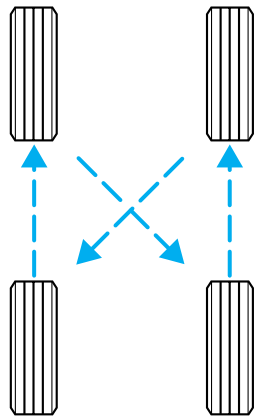

## Maintenance and care

### Replacing the tires

Replace the tires when the wear band is visible through the tire treads.

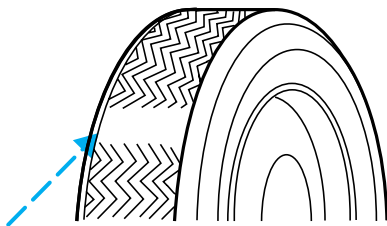

Failure to follow these precautions may adversely affect the handling of the vehicle and make it easier to lose control and roll over.

Tires that are larger or smaller than your vehicle's original tires may also affect the accuracy of your speedometer.

### SNOW TIRES AND CHAINS



Driving too fast for conditions creates the possibility of loss of vehicle control. Driving at very high speeds for extended periods of time may result in damage to vehicle components.



Snow tires must be the same size and grade as the tires you currently have on your vehicle.

Do not use any type of tire chains on this vehicle. This includes both conventional and cable-type chains.

The tires on your vehicle have all-weather treads that provide traction in rain or snow. However, during the winter months in some climates, you may need to use snow tires.

## Maintenance and care

### WHAT YOU SHOULD KNOW ABOUT AUTOMOTIVE FUELS

#### Important safety precautions



Do not overfill the fuel tank. The pressure in an overfilled tank may cause leakage and lead to fuel spray and fire.



If you do not use the proper fuel cap, the pressure in the fuel tank can damage the fuel system or cause it to work improperly in a collision.



The fuel system may be under pressure. If the fuel cap is venting vapor or if you hear a hissing sound, wait until it stops before completely removing the cap.



Automotive fuels can cause serious injury or death if misused or mishandled.

Observe the following guidelines when handling automotive fuel:

- Extinguish all smoking materials and any open flames before fueling your vehicle.
- Always turn off the vehicle before fueling.
- Automotive fuels can be harmful or fatal if swallowed. If fuel is swallowed, call a physician immediately, even if no symptoms are immediately apparent. The toxic effects of fuel may not be visible for hours.
- Fuels can also be harmful if absorbed through the skin. If fuel is splashed on the skin, promptly remove contaminated clothing and wash skin thoroughly with soap and water.
- If fuel is splashed in the eyes, remove contact lenses, flush with water for 15 minutes and seek medical attention.

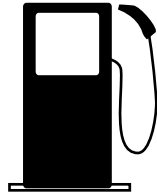

## Maintenance and care

- Be particularly careful if you are taking “Antabuse” or other forms of disulfiram for the treatment of alcoholism. Breathing gasoline vapors or skin contact could cause an adverse reaction. Consult a physician immediately.

### Choosing the right fuel

Use only UNLEADED FUEL. The use of leaded fuel is prohibited by law and could damage your vehicle.

Your vehicle was not designed to use fuel or fuel additives with metallic compounds, including manganese-based compounds containing MMT.

Vehicles certified to California emission standards (indicated on the underhood Vehicle Emissions Control Information label) are designed to operate on California reformulated gasolines. If California reformulated gasoline is not available when you refuel, your vehicle can be operated on non-California fuels. However, even though your engine will perform adequately on other gasolines, the performance of the emission control devices and systems may be adversely affected.

Repair of damage caused by using a fuel that your vehicle was not designed for may not be covered by your warranty.

### Octane recommendations

Your vehicle is designed to use “Premium” gasoline for optimum performance with an (R+M)/2 octane rating of 91 or higher. Gasolines with lower octane ratings can be used, but performance may decrease. We do not recommend gasolines labeled as “Premium” in high altitude areas that are sold with octane ratings less than 91.

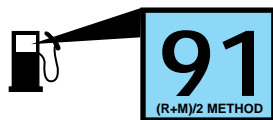

Do not be concerned if your vehicle sometimes knocks lightly. However, if it knocks heavily under most driving conditions on fuel with the recommended octane, see your dealer or a qualified service technician to prevent any engine damage.

### Fuel quality

If you are experiencing starting, rough idle or hesitation driveability problems during a cold start, try a different brand of “Regular” gasoline. “Premium” gasoline is not recommended (particularly in the United

## Maintenance and care

States) because it may cause these problems to become more pronounced. If the problems persist, see your dealer or a qualified service technician.

The American Automobile Manufacturers Association (AAMA) issued a gasoline specification to provide information on high quality fuels that optimize the performance of your vehicle. We recommend the use of gasolines that meet the AAMA specification if they are available.

It should not be necessary to add any aftermarket products to your fuel tank if you continue to use a high-quality fuel.

### Cleaner air

Ford approves the use of gasolines to improve air quality, including reformulated gasolines that contain oxygenates up to 10% ethanol or 15% MTBE.

Do not use gasolines containing methanol, which can damage critical fuel system components. Damage resulting from the use of methanol may not be covered by your warranty.

### Running out of fuel

Avoid running out fuel because this situation may have an adverse affect on modern powertrain components.

You may need to crank the engine several times before the system starts to pump fuel from the tank to the engine. If you run out of fuel, your Check Engine light may come on. For more information on the Check Engine light, refer to the *Instrumentation* chapter.

### Calculating fuel economy

To accurately calculate your vehicle's fuel economy:

1. Fill the tank completely and record the initial odometer reading.
2. Each time you fill the tank, record the amount of fuel added (in liters or gallons).
3. After at least three to five fuel tank fill-ups, fill the fuel tank and record the current mileage reading.
4. Use one of the following equations to calculate fuel economy.

Liters used  $\times 100 \div$  Total kilometers traveled

Total miles traveled  $\div$  Total gallons used

## Maintenance and care

Keep a record for at least one month. This will provide an accurate estimate of the vehicle's fuel economy.

### EMISSION CONTROL SYSTEM

Your vehicle is equipped with various emission control components and a catalytic converter which will enable your vehicle to comply with applicable exhaust emission standards. To make sure that the catalytic converter and other emission control components continue to work properly:

- Use only unleaded fuel.
- Avoid running out of fuel.
- Do not turn off the ignition while your vehicle is moving, especially at high speeds.
- Have the services listed in your "Service Guide" performed according to the specified schedule.

The Scheduled Maintenance Services listed in the "Service Guide" are required because they are considered essential to the life and performance of your vehicle and to its emissions system.

If other than Ford, Motorcraft or Ford authorized parts are used for maintenance replacements or for service of components affecting emission control such non-Ford parts should be equivalent to genuine Ford Motor Company parts in performance and durability.



Do not park, idle, or drive your vehicle in dry grass or other dry ground cover. The emission system heats up the engine compartment and exhaust system, which can start a fire.

Watch for fluid leaks, strange odors, smoke, loss of oil pressure, the charging system warning light, the "Check Engine" light or the temperature warning light. These events could indicate that the emission control system is not working properly.



If you smell exhaust fumes of any kind inside your vehicle, have the dealer inspect and fix your vehicle immediately. Do not drive if you smell exhaust fumes. These fumes are harmful and could kill you.

Do not make any unauthorized changes to your vehicle or engine. By law, vehicle owners and anyone who manufactures, repairs, services,

## Maintenance and care

sells, leases, trades vehicles, or supervises a fleet of vehicles are not permitted to intentionally remove an emission control device or prevent it from working. Information about your vehicle's emission system is on the Vehicle Emission Control Information Decal located on or near the engine. This decal identifies engine displacement and gives some tune up specifications.

Please consult your "Warranty Guide" for complete emission warranty information.

### Readiness for inspection/maintenance (I/M) testing

In some localities, it may be a legal requirement to pass an I/M test of the on-board diagnostic (OBD-II) system. If your "check engine/service engine soon" light is on, reference the applicable light description in the *Warning Lights and Chimes* section of your owners guide. Your vehicle may not pass the I/M test with the "check engine/service engine soon" light on.

If the vehicle's powertrain system or its battery has just been serviced, the OBD-II system is reset to a "not ready for I/M test" condition. To ready the OBD-II system for I/M testing, a minimum of 30 minutes of city and highway driving is necessary as described below:

- First, at least 10 minutes of driving on an expressway or highway.
- Next, at least 20 minutes driving in stop and go, city type traffic with at least four idle periods.

Allow the vehicle to sit for at least eight hours without starting the engine. Then, start the engine and complete the above driving cycle. The engine must warm up to its normal operating temperature. Once started, do not turn off the engine until the above driving cycle is complete.

## EXTERIOR BULBS

### Replacing exterior bulbs

Check the operation of the following lamps frequently:

- Headlamps
- Tail lamps
- Brakelamps
- High-mount brakelamp
- Turn signals



## Maintenance and care

- Backup lamps
- License plate lamp

Do not remove lamp bulbs unless they will be replaced immediately. If a bulb is removed for an extended period of time, contaminants may enter the lamp housings and affect performance.

### Replacing headlamp bulbs

The high beam headlamps on your vehicle use halogen bulbs. If the lamp burns out, simply replace it with a new one.



Handle a halogen headlamp bulb carefully and keep out of children's reach. Grasp the bulb only by its plastic base and do not touch the glass. The oil from your hand could cause the bulb to break the next time the headlamps are operated.

Unlike the high beam headlamps, the low beam headlamps on your vehicle use a "high intensity discharge" source. These lamps operate at a high voltage.

Low beam headlamps that flicker, are dim, or appear yellow or red should be replaced using the following instructions provided the vehicle is equipped with an orange sticker displayed near the front of the engine compartment which reads WARNING: HIGH VOLTAGE.

Take your vehicle to your Lincoln Mercury dealer for service if:

- One or both of your low beam headlamp bulbs are burned out and the orange sticker which reads WARNING: HIGH VOLTAGE is not displayed near the front of the engine compartment or
- The message center displays "CHECK HEADLAMPS."

### Replacing the low beam headlamp bulb

1. Make sure the headlamp switch is in the OFF position.
2. Lift the hood and disconnect the battery ground cable.
3. Remove the sight shield located above the headlamps.

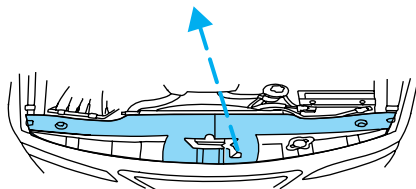

## Maintenance and care

4. Remove the retaining screw from the corner of the headlamp assembly.

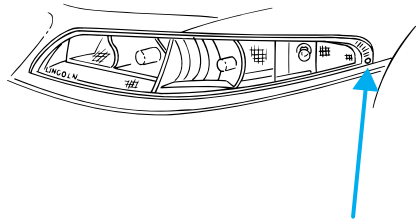

5. Remove the bolts from the top of the headlamp assembly.

6. Gently pull the headlamp assembly forward. Noting the location of each connector, disconnect the wire connectors from the headlamp assembly.

7. Remove the headlamp assembly and place it on a clean work surface.

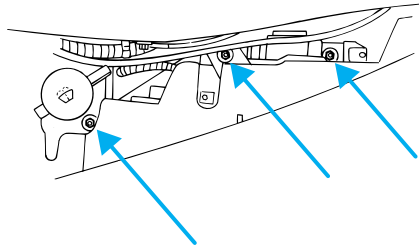

8. Remove the low beam headlamp housing cover by rotating counterclockwise 1/4 turn.

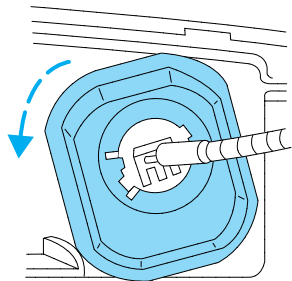

## Maintenance and care

9. Remove the headlamp bulb retaining nuts.

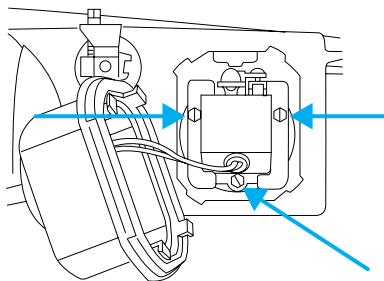

10. Remove the headlamp bulb assembly.

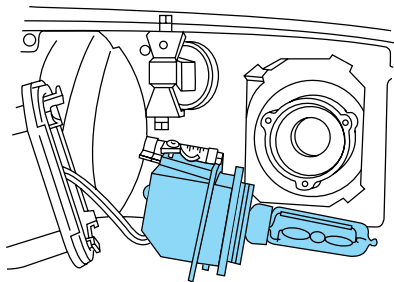

11. Slide the headlamp level and bracket off the bulb assembly and remove.

12. Twist headlamp housing counterclockwise to remove headlamp bulb from socket.

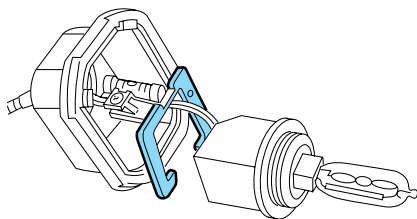

## Maintenance and care

To install the new low beam headlamp bulb:

1. Insert the new bulb into the socket and twist clockwise to lock into place.
2. Pull the headlamp level and bracket over the bulb assembly and snap into place.
3. Insert the bulb assembly into the socket opening.

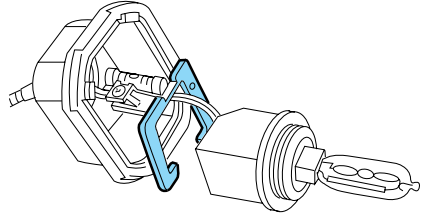

4. Install the retaining nuts. Tighten them 1/4 turn past finger tight.

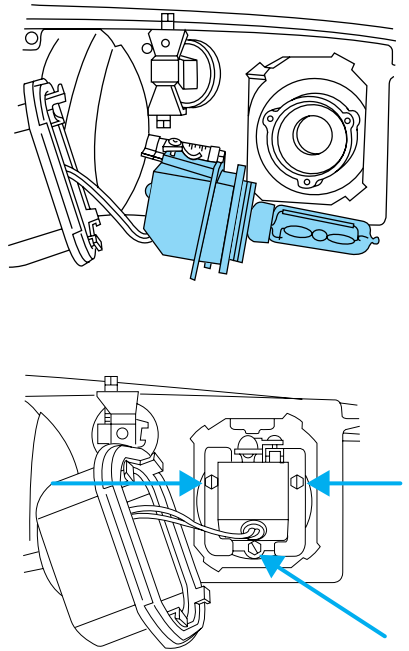

## Maintenance and care

5. Position the low beam headlamp housing cover over the bulb assembly and rotate clockwise to lock into place.

6. Match the remaining wire connectors with their proper mates and reinstall.

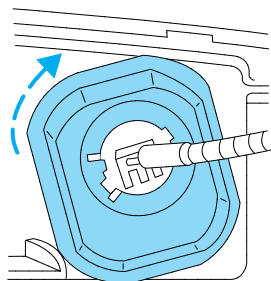

7. Reinstall the top bolts. Tighten 1/2 turn past finger tight.

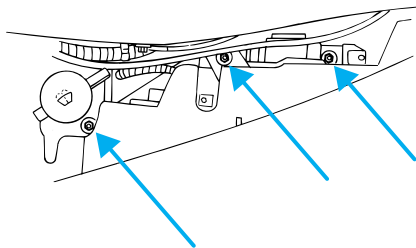

8. Reinstall the retaining screw at the corner of the headlamp assembly.

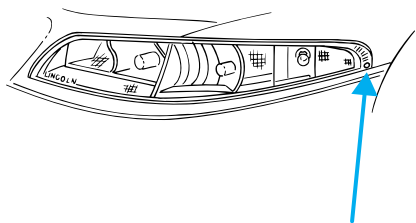

## Maintenance and care

9. Replace the sight shield.
10. Reconnect the battery ground cable and close the hood.

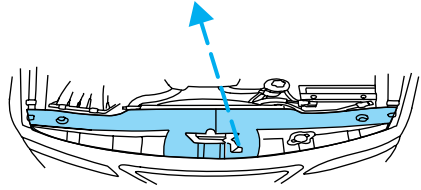

### **Replacing the high beam headlamp bulb**

To remove the high beam headlamp bulb:

1. Make sure the headlamp switch is in the OFF position.
2. Lift the hood and remove the sight shield located above the headlamps.
3. Remove the high beam headlamp housing cover by rotating it 1/4 turn counterclockwise.

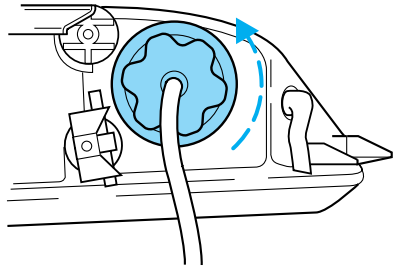
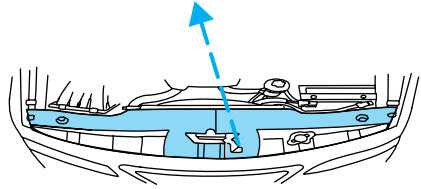

## Maintenance and care

4. Rotate the plastic bulb base counterclockwise and pull the bulb assembly out of the housing.

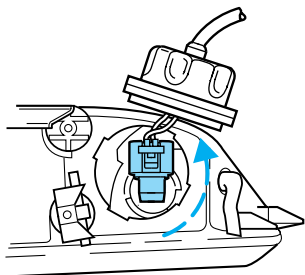

5. Pull the bulb socket retaining clip outward while carefully pulling up on the plastic base of the bulb.

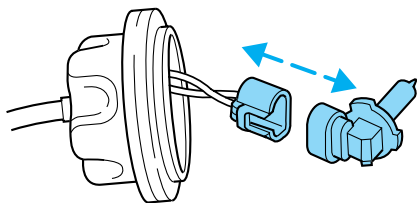

To install the new high beam headlamp bulb:

1. Hold the bulb by its plastic base and insert it into the socket.

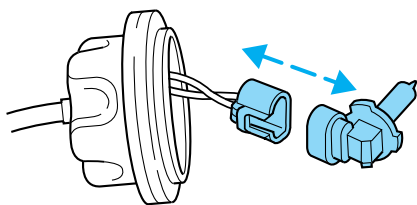

## Maintenance and care

2. Push the bulb down into the socket until the retaining clip snaps over it.

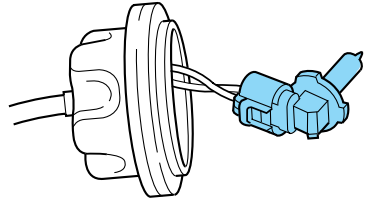

3. Carefully insert the bulb assembly into the headlamp housing while aligning the locking tabs.

4. Rotate the bulb assembly clockwise to lock it into place.

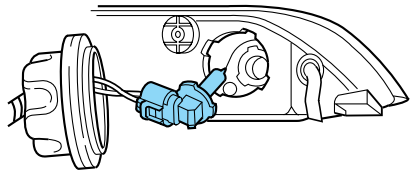

5. Position the headlamp cover over the bulb assembly. Align the tabs and rotate clockwise to lock into place.

6. Replace the sight shield and close the hood.

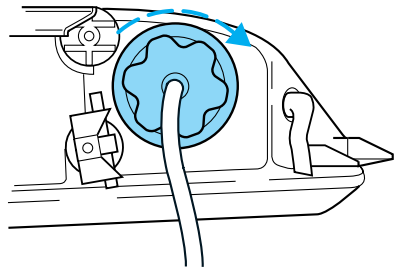



## Maintenance and care

### Using the right bulbs

Function	Trade Number
Headlamp low beam	9500
Headlamp high beam	9005
Park and turn lamp (front)	3157 NAK
Side marker lamp (front)	168
Cornering lamp (front)	3156
Tail lamp, brakelamp, turn lamp	3057K
Side marker (rear)	168
Backup lamp	3156
License plate lamp	168
High-mount brakelamp	3157K
Luggage compartment lamp	912
Dome/map lamp (with moon roof)	906
Dome lamp	906
Map lamp	168
Sun visor lighted mirror	Part # ES9Z-13466-B
Front door courtesy lamp/dual floorwell lamp	168
Rear reading/courtesy	912
Glove compartment	194
Ashtray	194
To replace all instrument panel lights - see your dealer.	

### AIMING THE HEADLAMPS

Your vehicle is equipped with a Vehicle Headlamp Aim Device (VHAD) on each headlamp body. Each headlamp may be properly aimed in the horizontal direction (left/right) and the vertical position (up/down).

A non-zero bubble reading does not necessarily indicate out-of-aim headlamps. If your vehicle is not positioned on a level surface, the slope will be included in the level indicator. Therefore, vertical headlamp adjustment should be performed only when beam direction appears to be incorrect or a level surface can not be verified.

The horizontal aim must be adjusted first. You will need one 4 mm box wrench or open end wrench.

## Maintenance and care

The following procedure assumes that the vehicle's front structure is properly aligned. If the vehicle has been in an accident requiring the front end of the vehicle to be repaired, the horizontal indicator should be recalibrated by the service facility.

### Horizontal aim adjustment

1. With the hood open, locate the horizontal indicator and adjusting screw.
2. Use a 4 mm wrench to turn the horizontal adjusting screw until the reference mark on the reflector extension aligns with the "0" reference mark on the horizontal indicator when viewed directly from above.
3. When the horizontal aim has been adjusted, close the headlamp access panel.

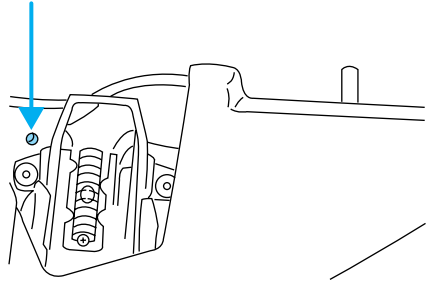

### Vertical aim adjustment

The numbers shown on the vial indicate beam direction in degrees up or down.

1. Do not adjust the vertical aim until after adjusting the horizontal aim.
2. With the hood open, locate the bubble level vertical aim indicator. It is visible when viewed from the above rear of the headlamp.
3. Use a 4 mm wrench to turn the vertical adjusting screw until the reference mark on the reflector extension aligns with the "0" reference mark on the vertical indicator when viewed directly from above.
4. Close the hood.

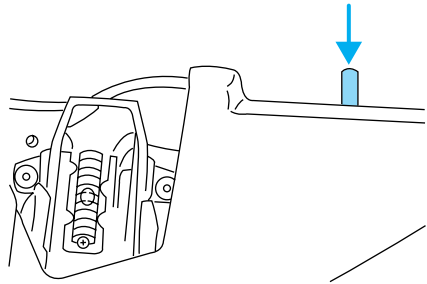

## Maintenance and care

### CLEANING AND CARING FOR YOUR VEHICLE

Refer to the “Customer Assistance Guide” for a list of Ford-approved cleaners, polishes and waxes.

#### Washing your vehicle

Wash your vehicle regularly with cold or lukewarm water. Never use strong detergents or soap. If your vehicle is particularly dirty, use a quality car wash detergent. Always use a clean sponge, washing glove or similar device and plenty of water for best results. To avoid spots, avoid washing when the hood is still warm, immediately after or during exposure to strong sunlight.

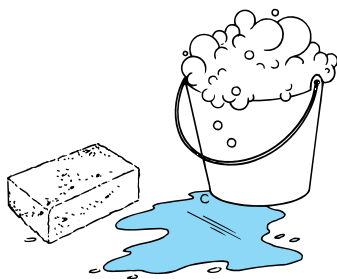

During winter months, it is especially important to wash the vehicle on a regular basis. Large quantities of dirt and road salt are difficult to remove and also cause damage to the vehicle. Remove any exterior accessories, such as antennas, before entering a car wash.

After washing, apply the brakes several times to dry them.

#### Waxing your vehicle

Wax when water stops beading on the surface. This could be every three or four months, depending on operating conditions.

Use only carnauba or synthetic-based waxes. Remove any bugs and tar before waxing vehicle. Use cleaning fluid or alcohol with a clean cloth to remove. Use tar remover to remove any tar spots.

#### Repairing paint chips

Minor scratches or paint damage from road debris may be repaired with touch-up paint, repair foil or aerosol paint spray from the Ford accessory line. Observe the application instructions on the products.

Remove particles such as bird droppings, tree sap, insect remains, tar spots, road salt and industrial fallout immediately.

## Maintenance and care

### Cleaning the wheels

Wash with the same detergent as the body of your vehicle. Do not use acid-based wheel cleaners, steel wool, fuel or strong detergents. Never use abrasives that will damage the finish of special wheel surfaces. Use a tar remover to remove grease and tar.

### Cleaning the engine

Engines are more efficient when they are clean because grease and dirt buildup keep the engine warmer than normal. When washing:

- Take care when using a power washer to clean the engine. The high pressure fluid could penetrate the sealed parts and cause damage.
- Do not spray with cold water to avoid cracking the engine block or other engine components.

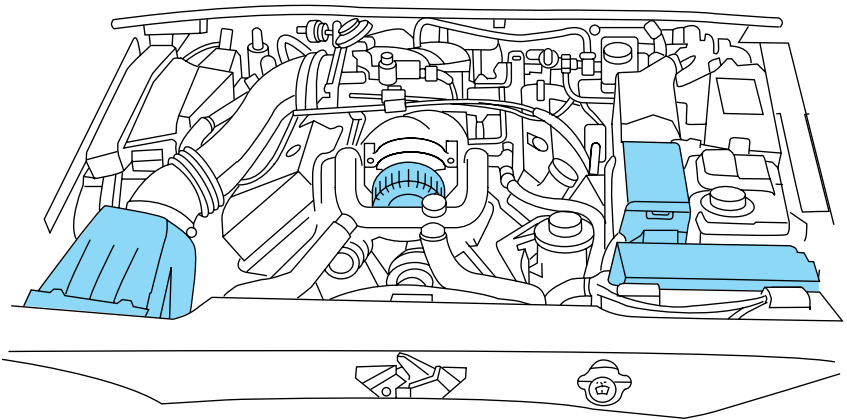

- Cover the highlighted areas to prevent water damage when cleaning the engine.
- Never wash or rinse the engine while it is running; water in the running engine may cause internal damage.

## Maintenance and care

### Cleaning plastic exterior parts

Use vinyl cleaner for routine cleaning. Clean with a tar remover if necessary. Do not clean plastic parts with thinners, solvents or petroleum-based cleaners.

### Cleaning the exterior lamps

Wash with the same detergent as the exterior of your vehicle. Use glass cleaner or tar remover if necessary.

To avoid scratching the lamps, do not use a dry paper towel, chemical solvents or abrasive cleaners.

### Cleaning the wiper blades

If the wiper blades do not wipe properly, clean the windshield and wiper blades with undiluted windshield wiper solution or a mild detergent. Rinse thoroughly with clean water. To avoid damaging the blades, do not use fuel, kerosene, paint thinner or other solvents.

### Cleaning the instrument panel

Clean with a damp cloth, then dry with a dry cloth.

Avoid cleaner or polish that increases the gloss of the upper portion of the instrument panel. The dull finish in this area helps protect the driver from undesirable windshield reflection.

### Cleaning the interior fabric

Remove dust and loose dirt with a whisk broom or a vacuum cleaner. Remove fresh spots immediately. Follow the directions that come with the cleaner.

### Cleaning and maintaining the safety belts

Clean the safety belts with a mild soap solution recommended for cleaning upholstery or carpets. Do not bleach or dye the belts, because these actions may weaken the belt webbing.

Check the safety belt system periodically to make sure there are no nicks, wear or cuts. If your vehicle has been involved in an accident, refer to the *Safety belt maintenance* section in the *Seating and safety restraints* chapter.

## Maintenance and care

### Underbody

Flush the complete underside of vehicle frequently. Keep body drain holes unplugged. Inspect for road damage.

### Cleaning leather seats (if equipped)

For routine cleaning, wipe the surface with a soft, damp cloth. For more thorough cleaning, wipe the surface with a mild soap.

If the leather cannot be completely cleaned using a mild soap and water solution, the leather may be cleaned using a commercially available cleaning product “Tanners Preserve Leather Cleaner” and a 3M “Type T” scrubbing pad by using the following steps;

**The type of scrubbing pad is very critical because the common 3M “Scotch Brite” green pad is too aggressive and will damage the leather surface**

- Spray a small amount of the leather cleaner on the pad and rub the area to be cleaned with the pad using a circular motion. Only clean 1/4 of the area at a time. For heavily soiled areas, spray the cleaner directly onto the leather (two squirts should be adequate) and rub with the pad. Repeat if necessary.
- Use a soft, damp cloth to remove the loosened dirt and foam.
- Dry with a soft cloth.

## Maintenance and care

**Do not use household cleaners, glass cleaner, alcohol solutions or cleaner intended for vinyl, rubber or plastics. These products can damage the leather.**

**In some instances, color or dye transfer can occur when wet clothing (wool, denim, leathers or other non-colorfast garments) comes in contact with leather upholstery. If this occurs, the leather should be cleaned immediately to avoid permanent staining.**

“Tanners Preserve Leather Cleaner” (product number AS-300) is available from “First Brands” by calling 1-800-726-1001. This product may also be available at many local automotive after market stores.

3M “Type T” Clean And Finish Scrubbing Pads (UPC 04011-01276) are available through your local 3M distributor. Call 1-800-742-9649 for the nearest distributor in your area.

<b>PART NUMBER</b>	<b>PART NAME</b>
(Obtain Locally)	Tanners Preserve Leather Cleaner
(Obtain Locally)	3M "Type T" Clean and Finish Scrubbing Pads

### **Woodtone trim**

Wipe stains with a soft cloth and a multi-purpose cleaning solution.

### **Inside windows**

Use glass cleaner for the inside windows if they become fogged.

### **Cleaning mirrors**

Do not clean your mirrors with a dry cloth or abrasive materials. Use a soft cloth and mild detergent and water. Be careful when removing ice from outside mirrors because you may damage the reflective surface.

## Capacities and specifications

### MOTORCRAFT PART NUMBERS

<b>Component</b>	<b>4.6L engine</b>
Air filter	FA-1602
Fuel filter	FG-881
Battery (standard)	BXT-65-650
Battery (optional)	BXT-65-850
Oil filter	FL-820S
PCV valve	EV-111
Spark plugs*	AWSF-32EE**
* Refer to Vehicle Emissions Control Information (VECI) decal for spark plug gap information.	
** If a spark plug is removed for inspection, it must be reinstalled in the same cylinder. Cylinders No. 1, 2, 3 and 4 have a "EG" suffix. Cylinders No. 5, 6, 7 and 8 have a "E" suffix. If a spark plug needs to be replaced, use only spark plugs with the same service part number suffix letter "EE" as shown on the engine decal.	



## Capacities and specifications

### REFILL CAPACITIES

<b>Fluid</b>	<b>Ford Part Name</b>	<b>Capacity</b>
Engine oil (includes filter change)	Motorcraft 5W30 Super Premium Motor Oil	5.7L (6.0 quarts)
Brake fluid	Ford High Performance DOT 3 Brake Fluid	Fill to line in reservoir
Power steering fluid	Motorcraft MERCON® ATF	Fill to line in reservoir
Transmission fluid	Motorcraft MERCON®V ATF	12.0L (12.8 quarts)
Engine coolant	Ford Premium Cooling System Fluid	15.1L (16.0 quarts)
Fuel tank	N/A	68.1L (18.0 gallons)
Rear axle fluid <sup>1</sup>	Motorcraft SAE 80W90 Rear Axle Lubricant	1.4-1.5L (2.9-3.1 pints)
Windshield washer fluid	Ultra-Clear Windshield Concentrate	Fill to line in reservoir

<sup>1</sup>Service refill capacities are determined by filling the rear axle 6 mm (1/4 inch) below the bottom of the filler hole.

Rear axles are considered lubricated for life when the vehicle is used for normal service. See your “Service Guide” for Severe Duty requirements.

## Capacities and specifications

### LUBRICANT SPECIFICATIONS

Item	Ford part name	Ford part number	Ford specification
Brake master cylinder	High Performance DOT 3 Motor Vehicle Brake Fluid	C6AZ-19542-AB	ESA-M6C25-A, DOT 3
Door weatherstrips	Silicone Lubricant	C0AZ-19553-AA and D7AZ-19553-AA	ESR-M13P4-A
Engine coolant	Ford Premium Cooling System Fluid	E2FZ-19549-AA	ESE-M97B44-A
Engine oil	Motorcraft 5W-30 Super Premium Motor Oil	XO-5W30-QSP	WSS-M2C153-G with API Certification Mark
Hinges, latches and striker plates	Multi-Purpose Grease	DOAZ-19584-AA	ESR-M1C159-A and ESB-M1C93-B
Lock cylinders	Penetrating Lubricant	E8AZ-19A501-B	N/A
Power steering reservoir	Motorcraft MERCON® ATF	XT-2-QDX	MERCON®
Automatic transmission (4R70W)	Motorcraft MERCON®V ATF	XT-5-QM	MERCON®V
Windshield washer fluid reservoir	Ultra-Clear Windshield Washer Concentrate	C9AZ-19550-AC or BC	ESR-M17P5-A
Rear axle	Motorcraft Premium Rear Axle Lubricant	XY-80W90-QL	WSL-M2C197-A

## Capacities and specifications

### ENGINE DATA

<b>Engine</b>	<b>4.6L DOHC engine</b>
Cubic inches	281
Horsepower (except LSC)	280 @ 5750 rpm
Horsepower (LSC)	290 @ 5750 rpm
Torque (except LSC)	285 lb. ft. @ 4500 rpm
Torque (LSC)	290 lb. ft. @ 4500 rpm
Recommended fuel grade	91 octane
Firing order	1-3-7-2-6-5-4-8
Spark plug gap	1.3-1.4 mm (0.052-.056 inch)
Ignition system	EDIS
Compression ratio	9.8:1

### VEHICLE DIMENSIONS

<b>Vehicle dimensions</b>	<b>mm (in)</b>
(1) Overall length	5 263 (207.2)
(2) Overall width	1 900 (74.8)
(3) Overall height	1 361 (53.6)
(4) Wheelbase	2 870 (113.0)
(5) Track - Front	1 565 (61.6)
(5) Track - Rear	1 530 (60.2)

## Capacities and specifications

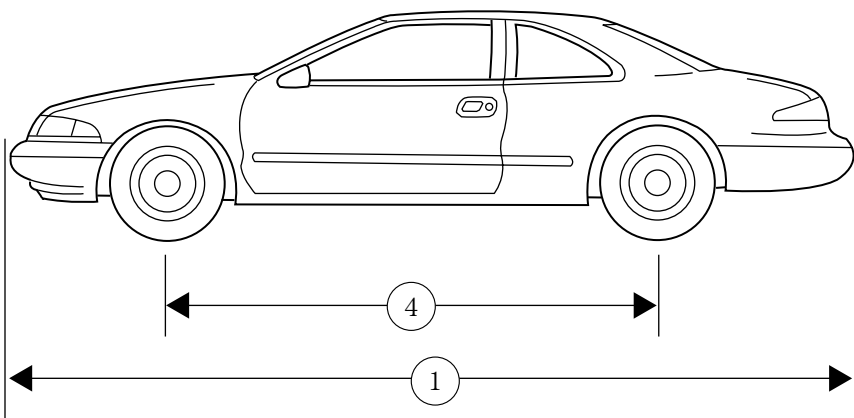
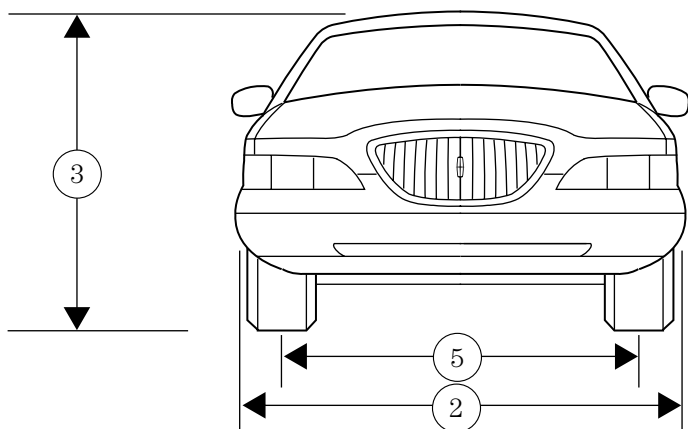

# Capacities and specifications

## IDENTIFYING YOUR VEHICLE

### Safety compliance label

The National Highway Traffic Safety Administration Regulations require that a Safety Compliance Certification Label be affixed to a vehicle and prescribe where the Safety Compliance Certification Label may be located. The Safety Compliance Certification Label is located on the front door latch pillar on the driver's side.

<b>MFD. BY FORD MOTOR CO. IN U.S.A.</b>		
DATE: XXXXX	GVWR: XXXXX LB/ XXXXX KG	
FGAWR: XXXXX/XXXXXXXX	RGAWR: XXXXX/XXXXXXXX	
THIS VEHICLE CONFORMS TO ALL APPLICABLE FEDERAL MOTOR VEHICLE SAFETY STANDARDS IN EFFECT ON THE DATE OF MANUFACTURE SHOWN ABOVE.		
VIN: XXXXXXXXXXXXXXXX TYPE: XXXXXXXXXXXXXXXX		
		
MAXIMUM LOAD=OCCUPANTS + LUGGAGE=XXXKG/XXXLB		
OCCUPANTS: X TOTAL X FR X 2ND X RR OCCUPANTS LUGGAGE		
XX XXKG/XXXLB		
X XXXKG/XXXLB		
TIRE: XXXX/XXXX XXX		
PRESSURE (FR) XXX kPa/33 PSI COLD		
PRESSURE (RR) XXX kPa/33 PSI COLD		
TRAILER TOWING - SEE OWNER GUIDE		
EXT PNT: XXXXX XXXXX	RC: XX   DSO: XXXX	F0000
BAR   INT TR   TP/PS   R   AXLE   TR   SPR	T0000	
X XX XXX X XX X XXX		
UTC VFOHT-15294A10-GA		

### Vehicle identification number

The vehicle identification number is attached to a metal tag and is located on the driver side instrument panel.

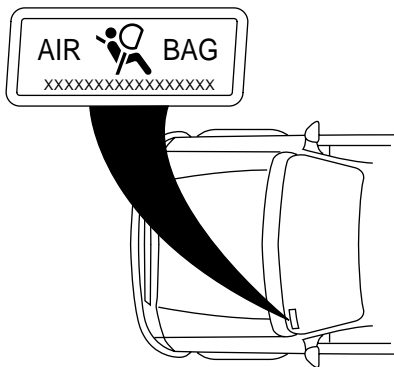

### Engine number

The engine number (the last eight numbers of the vehicle identification number) is stamped on the engine block, transmission, frame and transfer case (if so equipped).

## Reporting safety defects

### REPORTING SAFETY DEFECTS (U.S. ONLY)

If you believe that your vehicle has a defect that could cause a crash, or could cause injury or death, you should immediately inform the National Highway Traffic Safety Administration (NHTSA) in addition to notifying Ford Motor Company.



If NHTSA receives similar complaints, it may open an investigation, and if it finds that a safety defect exists in a group of vehicles, it may order a recall and remedy campaign. However, NHTSA cannot become involved in individual problems between you, your dealer or Ford Motor Company.

To contact NHTSA, you may either call the Auto Safety Hotline toll-free at 1-800-424-9393 (202-366-0123 in the Washington D.C. area) or write to:

NHTSA  
U.S. Department of Transportation  
400 Seventh Street  
Washington D.C. 20590

You can also obtain other information about motor vehicle safety from the Hotline.

## Index

- Aiming headlamps .....154
- Air bag supplemental restraint system .....77
- and child safety seats .....78
  - description .....77
  - disposal .....81
  - indicator light .....80
  - passenger air bag .....79
- Air suspension
- description .....97
- Anti-lock brake system (ABS)
- description .....93
- Anti-theft system .....63
- Battery .....135
- Brake fluid
- checking and adding .....128
- Brakes .....93
- anti-lock .....93
  - anti-lock brake system (ABS)
    - warning light .....94  - fluid, checking and adding ....128
- Brake-shift interlock .....97
- Break-in period .....2
- Bulbs, replacing .....145
- specifications .....154
- Changing a tire .....115
- Child safety seats .....82
- Chime
- headlamps on .....11
- Cleaning your vehicle .....156
- engine compartment .....157
  - fabric .....158
  - instrument panel .....158
  - plastic parts .....158
  - safety belts .....158
  - tail lamps .....158
  - washing .....156
  - waxing .....156
  - wheels .....157
  - windows .....160
  - woodtone trim .....160
- Climate control system
- automatic temperature control .....34,35,36,37,38,39
- Compass, electronic .....22,23
- Controls .....57,58
- Defrost
- rear window .....40
- Emission control system .....144
- Engine .....164
- service points .....125
- Engine block heater .....91
- Engine coolant
- checking and adding .....130
  - disposal .....131
  - refill capacities .....131
- Engine oil .....126,127
- changing oil and oil filter .....128
  - checking and adding .....126,127
- Exhaust fumes .....92
- Floor mats .....58
- Fuel
- calculating fuel economy .....143
  - improving fuel economy .....106
  - octane rating .....142
  - quality .....142
  - running out of fuel .....143
  - safety information relating to automotive fuels .....141
- Fuel gauge .....14
- Fuel pump shut-off switch .....107
- Fuse panels
- instrument panel .....109
  - power distribution box .....113
- Fuses .....108,109
- Gauges, Mechanical .....12
- engine coolant temperature gauge .....12
- Hazard flashers .....107
- Headlamps .....32
- daytime running lights .....32
  - flashing .....33
  - high beam .....32

- Heating .....34
- High beams
  - indicator light .....8
- Hood
  - release lever .....124
- Ignition
  - positions of the ignition .....40
- Instrument panel
  - lighting up panel  
and interior .....33
- Jump-starting
  - your vehicle .....119,120
    - attaching cables .....120
    - disconnecting cables .....121
- Keyless entry system
  - autolock .....63
  - keypad .....60
  - programming entry code ....61,62
- Keys
  - key in ignition chime .....12
- Lamps
  - headlamps .....146,151
  - interior lamps .....52
  - map lamps .....52
- Lights, warning and indicator
  - air bag .....10
  - anti-lock brakes (ABS) .....6
  - anti-theft .....11
  - brake .....6
  - charging system .....7
  - check engine .....9,10
  - cruise indicator .....8
  - oil pressure .....7
  - overdrive off .....11
  - safety belt .....9
  - turn signal indicator .....8
- Lubricant specifications .....163
- Message center .....14
  - reset button .....20
- Mirrors
  - cleaning .....160
  - side view mirrors (power) .....54
- Moon roof .....51
- Panic alarm feature, remote
  - entry system .....60
- Parking brake .....94
- Parts (see Motorcraft parts) ....161
- Power door locks .....54
- Power steering
  - fluid, checking and adding ....132
- Refill capacities for fluids .....162
- Relays .....108
- Remote entry system .....58
  - locking/unlocking doors .....58,59
- Reporting safety defects .....167
- Safety restraints
  - automatic locking mode  
(retractor) .....73,74
  - extension assembly .....75
  - for children .....81
  - lap and shoulder belts .....72
  - maintenance .....76
  - proper use .....71
  - warning light and chime ....11,76
- Safety seats for children
  - attaching with tether straps ....86
  - automatic locking mode  
(retractor) .....83
  - in rear seat .....86
  - tether anchorage hardware ....87
- Seats .....66
  - adjusting the seat, power .....66
  - auto-glide .....69
  - heated seats .....67
  - lumbar support .....68
  - rear seat access .....70
- Servicing your vehicle .....123
  - precautions when servicing ...123
- Speed control .....43
  - canceling a set speed .....46
  - indicator light .....47
  - resuming a set speed .....47
  - tap up/tap down .....45
  - turning off .....43



## Index

- Speedometer .....13
- Starting your vehicle .....88,91
- Sunvisor .....51
- Tachometer
  - mechanical cluster .....13
- Tilt steering wheel .....42
- Tires .....137,139
  - changing .....115
  - checking the pressure .....139
  - replacing .....140
  - rotating .....139
  - snow tires and chains .....140
  - treadwear .....138
- Traction control .....96
  - active light .....7
  - check traction control message .....25,31
  - how to enable/disable .....15
  - off light .....11
- Trailer towing .....104
  - tips .....106
- Transmission .....133
  - automatic operation .....97,98,99,100,102
  - fluid, checking and adding (automatic) .....133
- Trunk
  - using the remote entry system to open .....59
- Turn signal
  - lever .....41
- Universal transmitter .....47
  - erasing channels .....50
  - operating .....49
  - programming .....48
- Vehicle dimensions .....164
- Vehicle Identification Number (VIN) .....166
- Vehicle loading .....103
- Ventilating your vehicle .....92
- Warning chimes .....6
- Wheels
  - anti-theft lug nuts .....118
- Windows
  - power windows, operating .....52
- Windshield washer fluid and wipers
  - checking and adding fluid .....129
  - checking and replacing wiper blades .....136
  - operation .....41
- Wrecker towing .....122

## Filling station information

Recommended fuel	Unleaded fuel only - 91 octane (R+M/2)
Fuel tank capacity	68.1L (18.0 gallons)
Engine oil capacity (with filter change)	5.7L (6.0 quarts). Use Motorcraft 5W30 Super Premium Motor Oil, Ford Specification WSS-M2C153-G
Automatic transmission fluid capacity	12.0L (12.8 quarts). Use Motorcraft MERCON®V ATF (part# XT-5-QM), Ford Specification WSS-M2C202-B
Tire pressure and size	30 psi (measured cold). Refer to the label located on the front face of the passenger's door jamb
Hood release	Pull handle under the left side of the instrument panel
Coolant capacity	15.1L (16.0 quarts)
Power steering fluid capacity	Fill to line in reservoir. Use Motorcraft MERCON® ATF

Ensure correct automatic transmission fluid is used for a specific application. Check the container to verify the fluid is MERCON® and/or MERCON V® approved. Some fluids have been approved as meeting both MERCON® and MERCON® V requirements and will be labeled as such. Fluids labeled as meeting only MERCON® or only MERCON® V requirements must not be used interchangeably. DO NOT mix MERCON® and MERCON® V. Transmission fluid requirements are indicated on the dipstick or on the dipstick handle. Refer to your "Service Guide" to determine the correct service interval.