

CHEVROLET
BLAZER

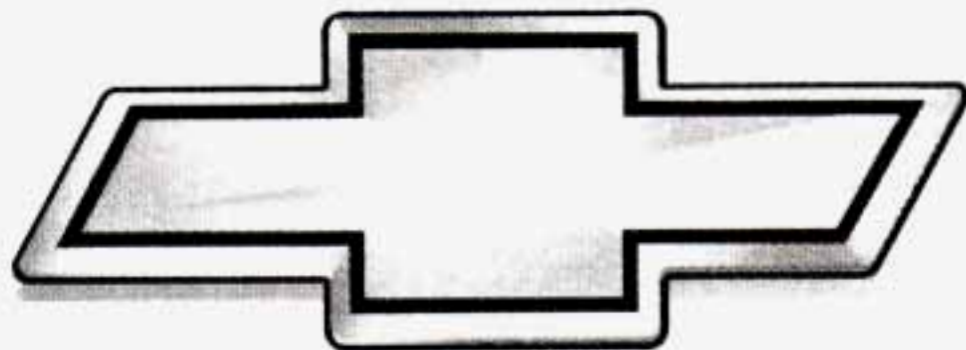

OWNER'S MANUAL
|||||

REPRODUCTION

The 1997 Chevrolet Blazer Owner's Manual

1-1 Seats and Restraint Systems

This section tells you how to use your seats and safety belts properly. It also explains the "SIR" system.

2-1 Features and Controls

This section explains how to start and operate your vehicle.

3-1 Comfort Controls and Audio Systems

This section tells you how to adjust the ventilation and comfort controls and how to operate your audio system.

4-1 Your Driving and the Road

Here you'll find helpful information and tips about the road and how to drive under different conditions.

5-1 Problems on the Road

This section tells what to do if you have a problem while driving, such as a flat tire or overheated engine, etc.

6-1 Service and Appearance Care

Here the manual tells you how to keep your vehicle running properly and looking good.

7-1 Maintenance Schedule

This section tells you when to perform vehicle maintenance and what fluids and lubricants to use.

8-1 Customer Assistance Information

This section tells you how to contact Chevrolet for assistance and how to get service and owner publications. It also gives you information on "Reporting Safety Defects" on page 8-10.

9-1 Index

Here's an alphabetical listing of almost every subject in this manual. You can use it to quickly find something you want to read.



GENERAL MOTORS, GM, the GM Emblem, CHEVROLET, the CHEVROLET Emblem and the name BLAZER are registered trademarks of General Motors Corporation.

This manual includes the latest information at the time it was printed. We reserve the right to make changes in the product after that time without further notice. For vehicles first sold in Canada, substitute the name "General Motors of Canada Limited" for Chevrolet Division whenever it appears in this manual.

Please keep this manual in your vehicle, so it will be there if you ever need it when you're on the road. If you sell the vehicle, please leave this manual in it so the new owner can use it.

Litho in U.S.A.
C9711 B First Edition



We support voluntary technician certification.

For Canadian Owners Who Prefer a French Language Manual:

Aux propriétaires canadiens: Vous pouvez vous procurer un exemplaire de ce guide en français chez votre concessionnaire ou au:

DGN Marketing Services Ltd.
1500 Bonhill Rd.
Mississauga, Ontario L5T 1C7

© Copyright General Motors Corporation 1996
All Rights Reserved

About Driving Your Vehicle

As with other vehicles of this type, failure to operate this vehicle correctly may result in loss of control or an accident. Be sure to read the “on-pavement” and “off-road” driving guidelines in this manual. (See “Driving Guidelines” and “Off-Road Driving with your Four-Wheel-Drive Vehicle” in the Index.)

How to Use this Manual

Many people read their owner’s manual from beginning to end when they first receive their new vehicle. If you do this, it will help you learn about the features and controls for your vehicle. In this manual, you’ll find that pictures and words work together to explain things quickly.

Index

A good place to look for what you need is the Index in the back of the manual. It’s an alphabetical list of what’s in the manual, and the page number where you’ll find it.

Safety Warnings and Symbols

You will find a number of safety cautions in this book. We use a box and the word CAUTION to tell you about things that could hurt you if you were to ignore the warning.



CAUTION:

These mean there is something that could hurt you or other people.

In the caution area, we tell you what the hazard is. Then we tell you what to do to help avoid or reduce the hazard. Please read these cautions. If you don’t, you or others could be hurt.

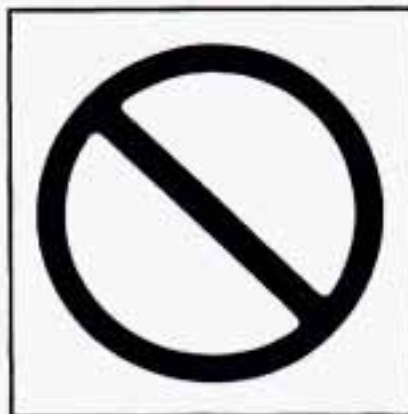

You will also find a circle with a slash through it in this book. This safety symbol means “Don’t,” “Don’t do this,” or “Don’t let this happen.”

In the notice area, we tell you about something that can damage your vehicle. Many times, this damage would not be covered by your warranty, and it could be costly. But the notice will tell you what to do to help avoid the damage.

When you read other manuals, you might see CAUTION and NOTICE warnings in different colors or in different words.

You’ll also see warning labels on your vehicle. They use the same words, CAUTION or NOTICE.

Vehicle Damage Warnings

Also, in this book you will find these notices:

NOTICE:

These mean there is something that could damage your vehicle.

Vehicle Symbols

These are some of the symbols you may find on your vehicle.

For example, these symbols are used on an original battery:

CAUTION
POSSIBLE
INJURY



PROTECT
EYES BY
SHIELDING



CAUSTIC
BATTERY
ACID COULD
CAUSE
BURNS



AVOID
SPARKS OR
FLAMES



SPARK OR
FLAME
COULD
EXPLODE
BATTERY



These symbols are important for you and your passengers whenever your vehicle is driven:

DOOR LOCK
UNLOCK



FASTEN
SEAT
BELTS



POWER
WINDOW



AIR BAG



These symbols have to do with your lamps:

MASTER
LIGHTING
SWITCH



TURN
SIGNALS

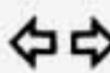

PARKING
LAMPS



HAZARD
WARNING
FLASHER



DAYTIME
RUNNING
LAMPS

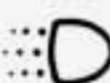

FOG LAMPS



These symbols are on some of your controls:

WINDSHIELD
WIPER



WINDSHIELD
WASHER



WINDSHIELD
DEFROSTER



REAR
WINDOW
DEFOGGER



VENTILATING
FAN



These symbols are used on warning and indicator lights:

ENGINE
COOLANT
TEMP



BATTERY
CHARGING
SYSTEM



BRAKE



COOLANT



ENGINE OIL
PRESSURE



ANTI-LOCK
BRAKES



Here are some other symbols you may see:

FUSE



LIGHTER



HORN



SPEAKER



FUEL



Model Reference

This manual covers these models:

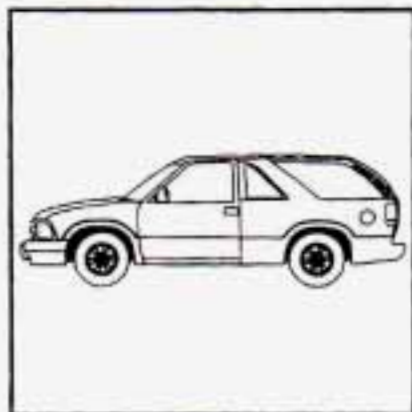

Two-Door Utility

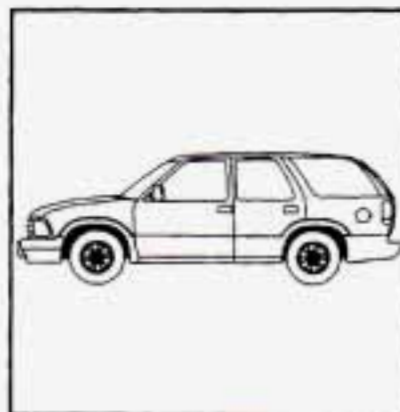

Four-Door Utility

Section 1 Seats and Restraint Systems

Here you'll find information about the seats in your vehicle and how to use your safety belts properly. You can also learn about some things you should *not* do with air bags and safety belts.

1-2	Seats and Seat Controls	1-28	Rear Seat Passengers
1-8	Safety Belts: They're for Everyone	1-31	Rear Safety Belt Comfort Guides for Children and Small Adults (4-Door Models)
1-12	Here Are Questions Many People Ask About Safety Belts -- and the Answers	1-34	Center Rear Passenger Position (4-Door Models)
1-13	How to Wear Safety Belts Properly	1-35	Children
1-13	Driver Position	1-37	Child Restraints
1-20	Supplemental Inflatable Restraint (SIR) System	1-44	Larger Children
1-26	Safety Belt Use During Pregnancy	1-47	Safety Belt Extender
1-26	Right Front Passenger Position	1-47	Checking Your Restraint Systems
1-26	Center Front Passenger Position (4-Door Models)	1-48	Replacing Restraint System Parts After a Crash

Seats and Seat Controls

This section tells you about the seats -- how to adjust them, and fold them up and down.

Manual Front Seat

CAUTION:

You can lose control of the vehicle if you try to adjust a manual driver's seat while the vehicle is moving. The sudden movement could startle and confuse you, or make you push a pedal when you don't want to. Adjust the driver's seat only when the vehicle is not moving.



Move the lever under the front of the standard seat toward the driver's door to unlock it. Slide the seat to where you want it. Then release the lever and try to move the seat with your body to make sure the seat is locked into place.



Move the lever under the front of the easy entry seat up to unlock it. Slide the seat to where you want it. Then release the lever and try to move the seat with your body to make sure the seat is locked into place.

Manual Lumbar Support

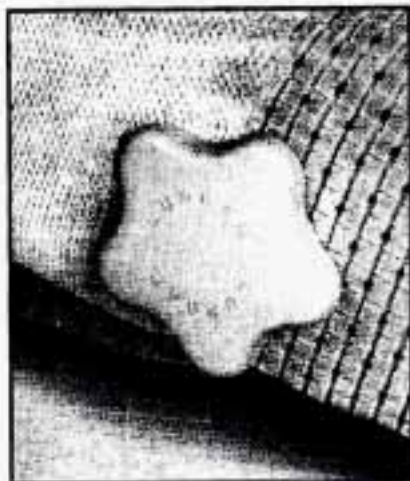

If you have this feature, there will be a knob on the outside of the driver and passenger bucket seats.

Turn the knob counterclockwise to increase lumbar support and clockwise to decrease lumbar support.

Power Driver's Seat (Option)

If you have this feature, there will be a control pad on your driver's seat.

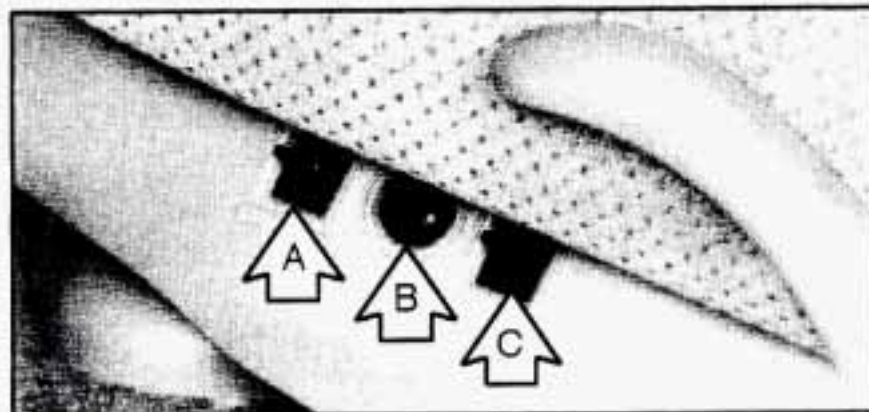

To make the front of the seat move up or down, use control A.

To make the rear of the seat move up or down, use control C.

Use control B to move the whole seat up, down, forward or backward.

Power Lumbar Control (Option)



If you have this control, it is located on the side of the driver's seat.

Press and hold the front of the control until you have the desired lumbar support. To decrease lumbar support, press the rear of the control.

Reclining Front Seatbacks



To adjust the seatback, lift the lever on the outer side of the seat.

Release the lever to lock the seatback where you want it. Pull up on the lever and the seat will go to an upright position.



But don't have a seatback reclined if your vehicle is moving.

⚠ CAUTION:

Sitting in a reclined position when your vehicle is in motion can be dangerous. Even if you buckle up, your safety belts can't do their job when you're reclined like this.

The shoulder belt can't do its job because it won't be against your body. Instead, it will be in front of you. In a crash you could go into it, receiving neck or other injuries.

The lap belt can't do its job either. In a crash the belt could go up over your abdomen. The belt forces would be there, not at your pelvic bones. This could cause serious internal injuries.

For proper protection when the vehicle is in motion, have the seatback upright. Then sit well back in the seat and wear your safety belt properly.

Head Restraints

Head restraints are fixed on some models and adjustable on others. Slide an adjustable head restraint up or down so that the top of the restraint is closest to the top of your ears. This position reduces the chance of a neck injury in a crash.

Your adjustable head restraint may also be tilted forward for greater comfort.

Seatback Latches



The front seatback folds forward to let people get into the back seat or to access the storage area behind the seat.

To fold the front seatback forward, lift the latch and push the seat forward.

To return the seatback to the upright position, push the seatback all the way back until the latch catches. If the seatback was reclined before being folded forward, it will return to the reclined position.



CAUTION:

If the seatback isn't locked, it could move forward in a sudden stop or crash. That could cause injury to the person sitting there. Always press rearward on the seatback to be sure it is locked.

Easy Entry Seat (2-Door Models)

The right front seat of your vehicle makes it easy to get in and out of the rear seat.

- Tilt the right front seatback completely forward and the whole seat will slide forward.
- Move the seatback to its original position after someone gets into the rear seat area. Then move the seat rearward until it locks.

CAUTION:

If an easy entry right front seat isn't locked, it can move. In a sudden stop or crash, the person sitting there could be injured. After you've used it, be sure to push rearward on an easy entry seat to be sure it is locked.

- Tilt the seatback completely forward again to get out.

Rear Seats

Your vehicle has a folding rear seat which lets you fold the seatbacks down for more cargo space.

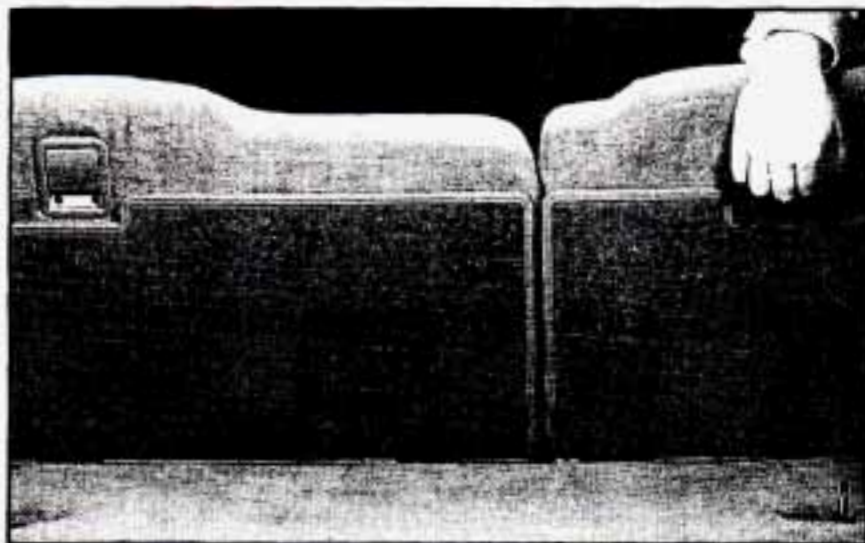

The rear seat release handles are in the upper center of the rear of the seatbacks. Push back on the seatbacks as you pull up on the handles.

To raise the seatbacks, just lift up the seatbacks and push until they lock in the upright position.

Push and pull on the seatbacks to check that the latches have locked in the upright position. If they haven't, have them fixed immediately.

Safety Belts: They're for Everyone

This part of the manual tells you how to use safety belts properly. It also tells you some things you should not do with safety belts.

And it explains the Supplemental Inflatable Restraint (SIR), or air bag system.

CAUTION:

Don't let anyone ride where he or she can't wear a safety belt properly. If you are in a crash and you're not wearing a safety belt, your injuries can be much worse. You can hit things inside the vehicle or be ejected from it. You can be seriously injured or killed. In the same crash, you might not be if you are buckled up. Always fasten your safety belt, and check that your passengers' belts are fastened properly too.

CAUTION:

It is extremely dangerous to ride in a cargo area, inside or outside of a vehicle. In a collision, people riding in these areas are more likely to be seriously injured or killed. Do not allow people to ride in any area of your vehicle that is not equipped with seats and safety belts. Be sure everyone in your vehicle is in a seat and using a safety belt properly.



Your vehicle has a light that comes on as a reminder to buckle up. (See “Safety Belt Reminder Light” in the Index.)

In most states and Canadian provinces, the law says to wear safety belts. Here’s why: *They work.*

You never know if you’ll be in a crash. If you do have a crash, you don’t know if it will be a bad one.

A few crashes are mild, and some crashes can be so serious that even buckled up a person wouldn’t survive. But most crashes are in between. In many of them, people who buckle up can survive and sometimes walk away. Without belts they could have been badly hurt or killed.

After more than 25 years of safety belts in vehicles, the facts are clear. In most crashes buckling up does matter ... a lot!

Why Safety Belts Work

When you ride in or on anything, you go as fast as it goes.

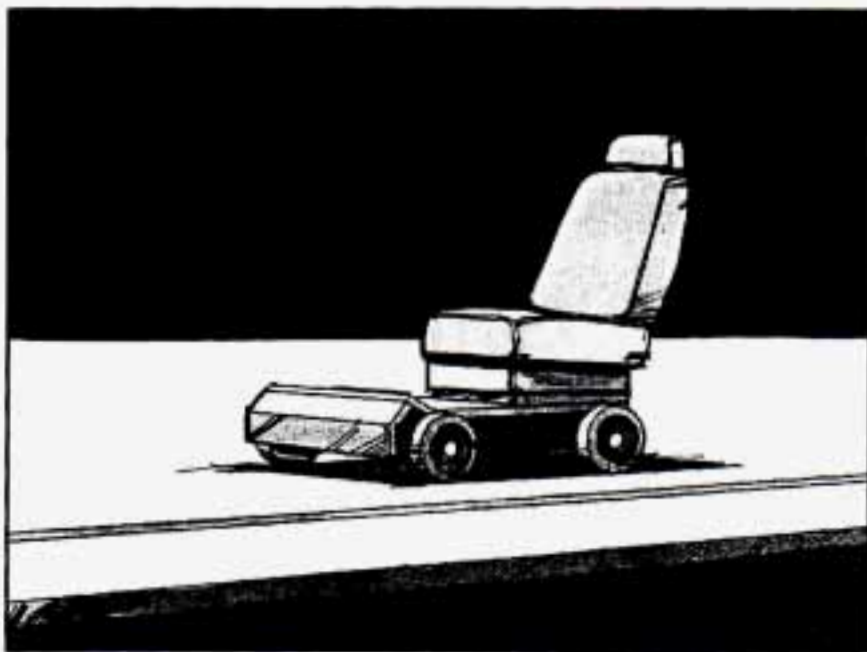

Take the simplest vehicle. Suppose it’s just a seat on wheels.

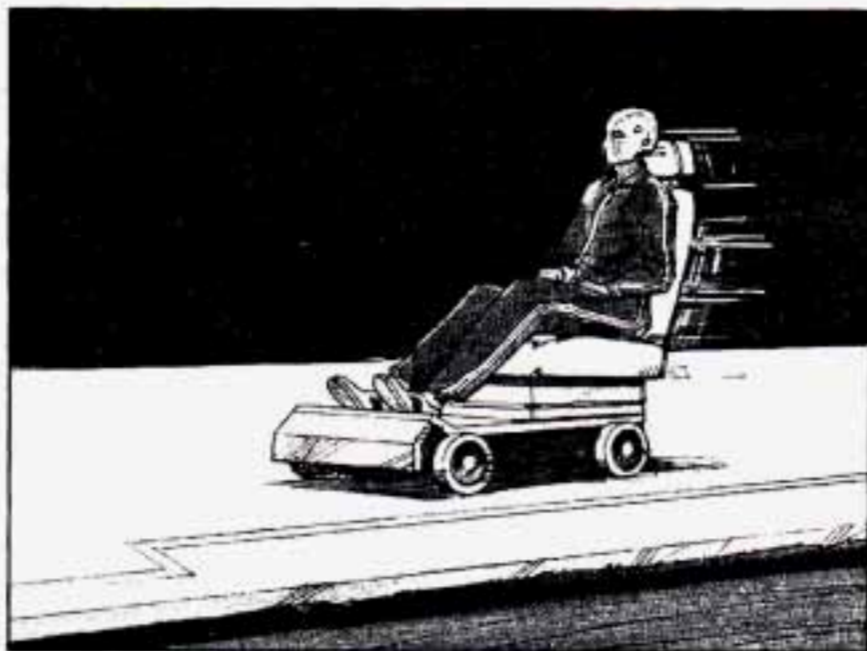

Put someone on it.



Get it up to speed. Then stop the vehicle. The rider doesn't stop.



The person keeps going until stopped by something.
In a real vehicle, it could be the windshield ...



or the instrument panel ...

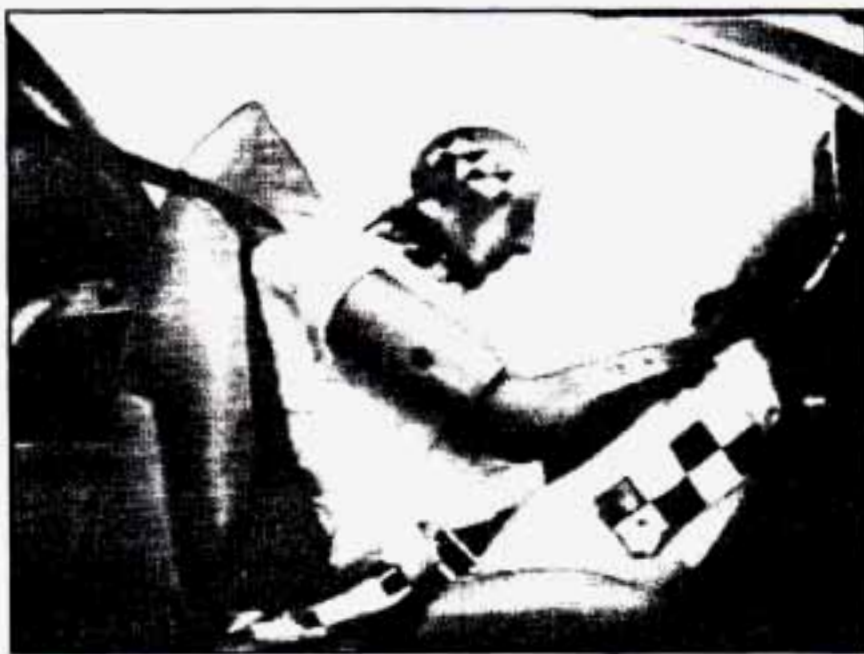

or the safety belts!

With safety belts, you slow down as the vehicle does. You get more time to stop. You stop over more distance, and your strongest bones take the forces. That's why safety belts make such good sense.

Here Are Questions Many People Ask About Safety Belts -- and the Answers

Q: Won't I be trapped in the vehicle after an accident if I'm wearing a safety belt?

A: You *could* be -- whether you're wearing a safety belt or not. But you can unbuckle a safety belt, even if you're upside down. And your chance of being conscious during and after an accident, so you *can* unbuckle and get out, is *much* greater if you are belted.

Q: If my vehicle has air bags, why should I have to wear safety belts?

A: Air bags are in many vehicles today and will be in most of them in the future. But they are supplemental systems only; so they work *with* safety belts -- not instead of them. Every air bag system ever offered for sale has required the use of safety belts. Even if you're in a vehicle that has air bags, you still have to buckle up to get the most protection. That's true not only in frontal collisions, but especially in side and other collisions.

Q: If I'm a good driver, and I never drive far from home, why should I wear safety belts?

A: You may be an excellent driver, but if you're in an accident -- even one that isn't your fault -- you and your passengers can be hurt. Being a good driver doesn't protect you from things beyond your control, such as bad drivers.

Most accidents occur within 25 miles (40 km) of home. And the greatest number of serious injuries and deaths occur at speeds of less than 40 mph (65 km/h).

Safety belts are for everyone.

How to Wear Safety Belts Properly

Adults

This part is only for people of adult size.

Be aware that there are special things to know about safety belts and children. And there are different rules for smaller children and babies. If a child will be riding in your vehicle, see the part of this manual called "Children." Follow those rules for everyone's protection.

First, you'll want to know which restraint systems your vehicle has.

We'll start with the driver position.

Driver Position

This part describes the driver's restraint system.

Lap-Shoulder Belt

The driver has a lap-shoulder belt. Here's how to wear it properly.

1. Close and lock the door.
2. Adjust the seat (to see how, see "Seats" in the Index) so you can sit up straight.



3. Pick up the latch plate and pull the belt across you. Don't let it get twisted.
4. Push the latch plate into the buckle until it clicks.
Pull up on the latch plate to make sure it is secure.
If the belt isn't long enough, see "Safety Belt Extender" at the end of this section.

Make sure the release button on the buckle is positioned so you would be able to unbuckle the safety belt quickly if you ever had to.

5. To make the lap part tight, pull down on the buckle end of the belt as you pull up on the shoulder belt.

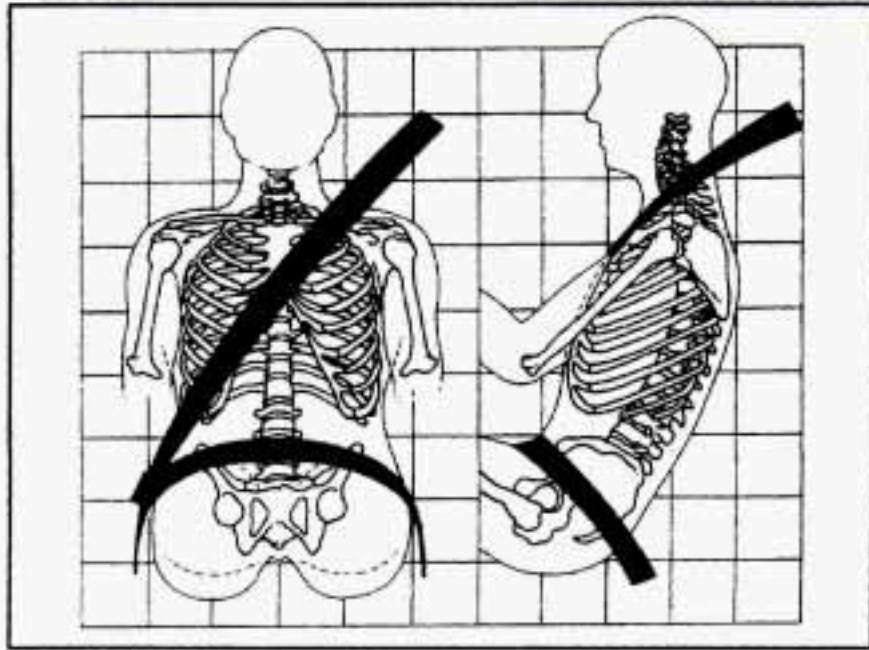

The lap part of the belt should be worn low and snug on the hips, just touching the thighs. In a crash, this applies force to the strong pelvic bones. And you'd be less likely to slide under the lap belt. If you slid under it, the belt would apply force at your abdomen. This could cause serious or even fatal injuries. The shoulder belt should go over the shoulder and across the chest. These parts of the body are best able to take belt restraining forces.

The safety belt locks if there's a sudden stop or a crash.

Q: What's wrong with this?

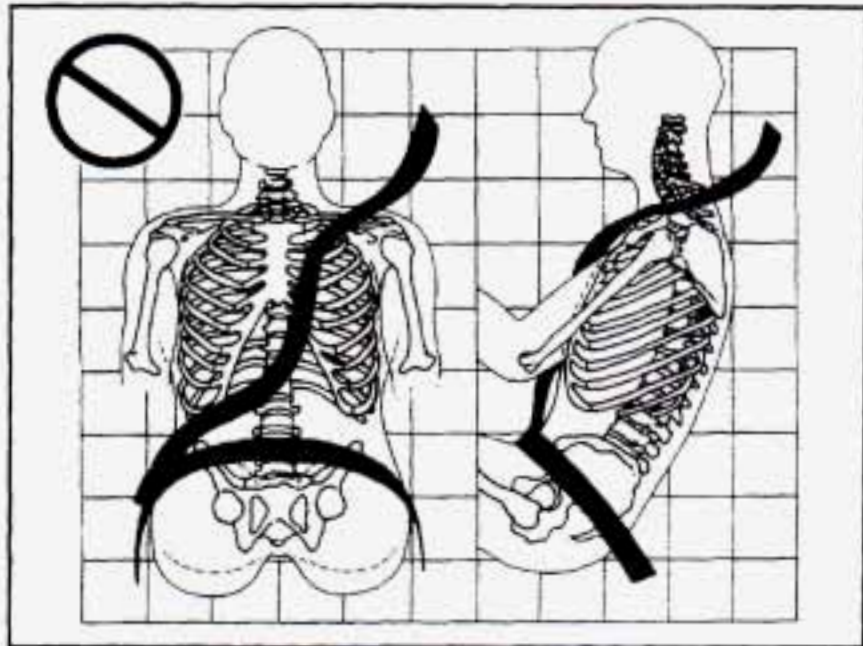

CAUTION:

You can be seriously hurt if your shoulder belt is too loose. In a crash, you would move forward too much, which could increase injury. The shoulder belt should fit against your body.

A: The shoulder belt is too loose. It won't give nearly as much protection this way.

Q: What's wrong with this?

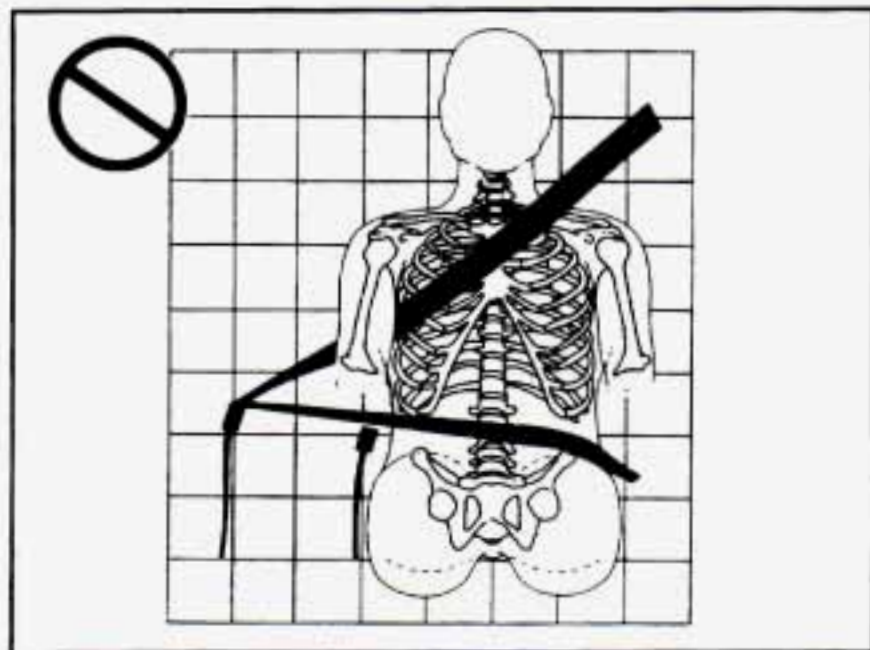

⚠ CAUTION:

You can be seriously injured if your belt is buckled in the wrong place like this. In a crash, the belt would go up over your abdomen. The belt forces would be there, not at the pelvic bones. This could cause serious internal injuries. Always buckle your belt into the buckle nearest you.

A: The belt is buckled in the wrong place.

Q: What's wrong with this?

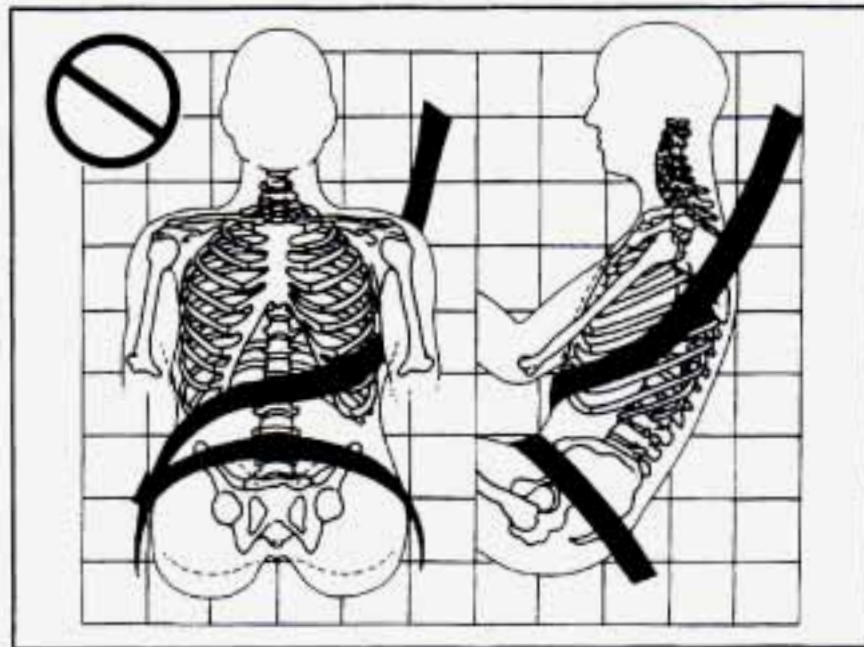

⚠ CAUTION:

You can be seriously injured if you wear the shoulder belt under your arm. In a crash, your body would move too far forward, which would increase the chance of head and neck injury. Also, the belt would apply too much force to the ribs, which aren't as strong as shoulder bones. You could also severely injure internal organs like your liver or spleen.

A: The shoulder belt is worn under the arm. It should be worn over the shoulder at all times.

Q: What's wrong with this?

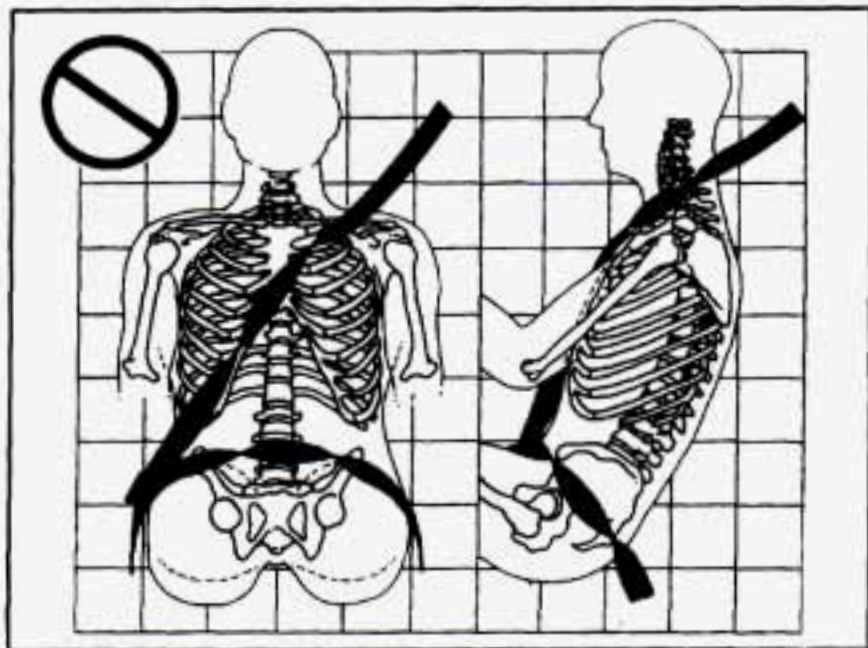

A: The belt is twisted across the body.

⚠ CAUTION:

You can be seriously injured by a twisted belt. In a crash, you wouldn't have the full width of the belt to spread impact forces. If a belt is twisted, make it straight so it can work properly, or ask your dealer to fix it.



To unlatch the belt, just push the button on the buckle. The belt should go back out of the way.

Before you close the door, be sure the belt is out of the way. If you slam the door on it, you can damage both the belt and your vehicle.

Supplemental Inflatable Restraint (SIR) System

This part explains the Supplemental Inflatable Restraint (SIR) system or air bag system.

Your vehicle has an air bag for the driver.

Here are the most important things to know about the air bag system:

CAUTION:

You can be severely injured or killed in a crash if you aren't wearing your safety belt -- even if you have an air bag. Wearing your safety belt during a crash helps reduce your chance of hitting things inside the vehicle or being ejected from it. Air bags are "supplemental restraints" to the safety belts. All air bags are designed to work with safety belts, but don't replace them. Air bags are designed to work only in moderate to severe crashes where the front of your vehicle hits something. They aren't designed to inflate at all

CAUTION: (Continued)

CAUTION: (Continued)

in rollover, rear, side or low-speed frontal crashes. Everyone in your vehicle should wear a safety belt properly -- whether or not there's an air bag for that person.

 **CAUTION:**

Air bags inflate with great force, faster than the blink of an eye. If you're too close to an inflating air bag, it could seriously injure you. Safety belts help keep you in position before and during a crash. Always wear your safety belt, even with an air bag, and sit as far back as you can while still maintaining control of your vehicle.

**AIR
BAG**

There is an air bag readiness light on the instrument panel, which shows AIR BAG.

The system checks the air bag electrical system for malfunctions. The light tells you if there is an electrical problem. See "Air Bag Readiness Light" in the Index for more information.

How the Air Bag System Works



Where is the air bag?

The driver's air bag is in the middle of the steering wheel.

CAUTION:

If something is between the driver and the air bag, the bag might not inflate properly or it might force the object into that person. The path of an inflating air bag must be kept clear. Don't put anything between an occupant and the air bag, and don't attach or put anything on or near the steering wheel hub.

When should an air bag inflate?

An air bag is designed to inflate in a moderate to severe frontal or near-frontal crash. The air bag will inflate only if the impact speed is above the system's designed "threshold level." If your vehicle goes straight into a wall that doesn't move or deform, the threshold level is about 14 to 18 mph (23 to 29 km/h). The threshold level can vary, however, with specific vehicle design, so that it can be somewhat above or below this range. If your vehicle strikes something that will move or deform, such as a parked car, the threshold level will be higher. The air bag is not designed to inflate in rollovers, side impacts or rear impacts, because inflation would not help the occupant.

In any particular crash, no one can say whether an air bag should have inflated simply because of the damage to a vehicle or because of what the repair costs were. Inflation is determined by the angle of the impact and how quickly the vehicle slows down in frontal and near-frontal impacts.

The air bag system is designed to work properly under a wide range of conditions, including off-road usage. Observe safe driving speeds, especially on rough terrain. As always, wear your safety belt. See "Off-Road Driving" in the Index for more tips on off-road driving.

What makes an air bag inflate?

In an impact of sufficient severity, the air bag sensing system detects that the vehicle is in a crash. The sensing system triggers a release of gas from the inflator, which inflates the air bag. The inflator, air bag and related hardware are all part of the air bag module inside the steering wheel.

How does an air bag restrain?

In moderate to severe frontal or near-frontal collisions, even belted occupants can contact the steering wheel. The air bag supplements the protection provided by safety belts. Air bags distribute the force of the impact more evenly over the occupant's upper body, stopping the occupant more gradually. But air bags would not help you in many types of collisions, including rollovers, rear impacts and side impacts, primarily because an occupant's motion is not toward the air bag. Air bags should never be regarded as anything more than a supplement to safety belts, and then only in moderate to severe frontal or near-frontal collisions.

What will you see after an air bag inflates?

After an air bag inflates, it quickly deflates, so quickly that some people may not even realize the air bag inflated. Some components of the air bag module in the steering wheel hub will be hot for a short time. The parts of the bag that come into contact with you may be warm, but not too hot to touch. There will be some smoke and dust coming from vents in the deflated air bag. Air bag inflation doesn't prevent the driver from seeing or from being able to steer the vehicle, nor does it stop people from leaving the vehicle.



CAUTION:

When an air bag inflates, there is dust in the air. This dust could cause breathing problems for people with a history of asthma or other breathing trouble. To avoid this, everyone in the vehicle should get out as soon as it is safe to do so. If you have breathing problems but can't get out of the vehicle after an air bag inflates, then get fresh air by opening a window or door.

- The air bag is designed to inflate only once. After it inflates, you'll need some new parts for your air bag system. If you don't get them, the air bag system won't be there to help protect you in another crash. A new system will include the air bag module and possibly other parts. The service manual for your vehicle covers the need to replace other parts.
- Your vehicle is equipped with a diagnostic module, which records information about the air bag system. The module records information about the readiness of the system, when the sensors are activated and driver's safety belt usage at deployment.
- Let only qualified technicians work on your air bag system. Improper service can mean that your air bag system won't work properly. See your dealer for service.

NOTICE:

If you damage the cover for the driver's air bag, the bag may not work properly. You may have to replace the air bag module. Do not open or break the air bag cover.

Servicing Your Air Bag-Equipped Vehicle

The air bag affects how your vehicle should be serviced. There are parts of the air bag system in several places around your vehicle. You don't want the system to inflate while someone is working on your vehicle. Your GM dealer and the GM Service Manual have information about servicing your vehicle and the air bag system. To purchase a service manual, see "Service and Owner Publications" in the Index.

CAUTION:

For up to two minutes after the ignition key is turned off and the battery is disconnected, an air bag can still inflate during improper service. You can be injured if you are close to an air bag when it inflates. Avoid wires wrapped with yellow tape, or yellow connectors. They are probably part of the air bag system. Be sure to follow proper service procedures, and make sure the person performing work for you is qualified to do so.

The air bag system does not need regular maintenance.

Adding Equipment to Your Air Bag-Equipped Vehicle

Q: If I add a push bumper or a bicycle rack to the front of my vehicle, will it keep the air bag from working properly?

A: As long as the push bumper or bicycle rack is attached to your vehicle so that the vehicle's basic structure isn't changed, it's not likely to keep the air bag from working properly in a crash.

Q: Is there anything I might add to the front of the vehicle that could keep the air bag from working properly?

A: Yes. If you add things that change your vehicle's frame, bumper system, front end sheet metal or height, they may keep the air bag system from working properly. Also, the air bag system may not work properly if you relocate any of the air bag sensors. If you have any question about this, you should contact Customer Assistance before you modify your vehicle. (The phone numbers and addresses for Customer Assistance are in Step Two of the Customer Satisfaction Procedure in this manual. See "Customer Satisfaction Procedure" in the Index.)

Safety Belt Use During Pregnancy

Safety belts work for everyone, including pregnant women. Like all occupants, they are more likely to be seriously injured if they don't wear safety belts.

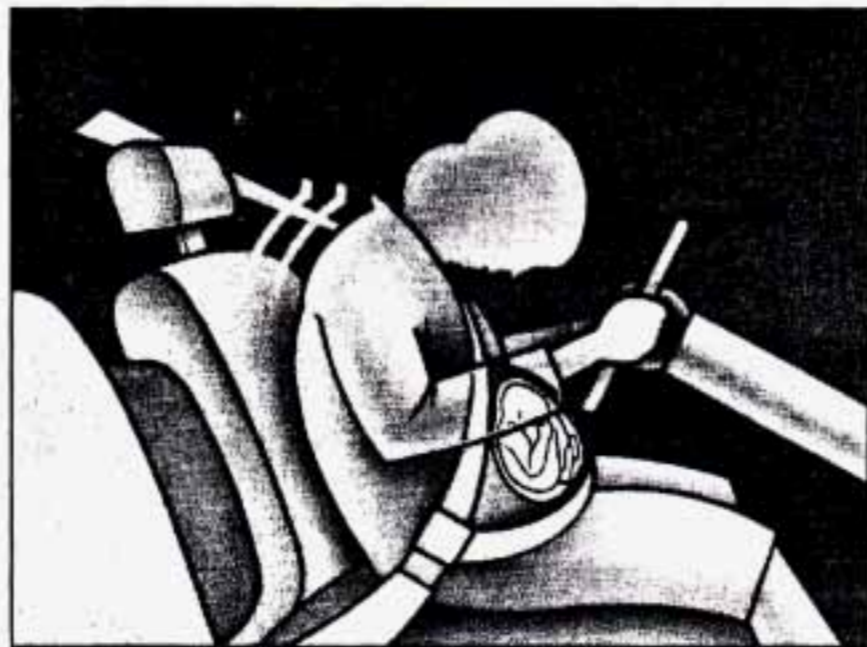

A pregnant woman should wear a lap-shoulder belt, and the lap portion should be worn as low as possible, below the rounding, throughout the pregnancy.

The best way to protect the fetus is to protect the mother. When a safety belt is worn properly, it's more likely that the fetus won't be hurt in a crash. For pregnant women, as for anyone, the key to making safety belts effective is wearing them properly.

Right Front Passenger Position

The right front passenger's safety belt works the same way as the driver's safety belt. See "Driver Position" earlier in this section.

When the shoulder belt is pulled out all the way, it will lock. If it does, let it go back all the way and start again.

Center Front Passenger Position (4-Door Models)

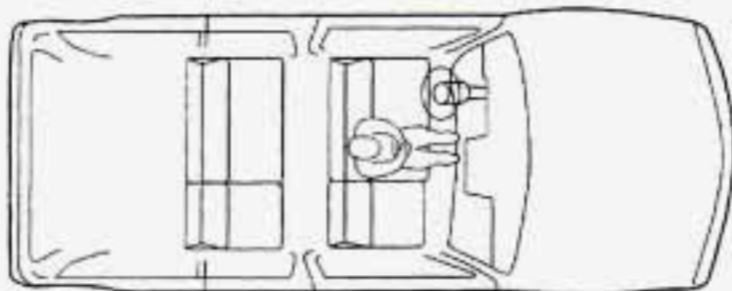

Lap Belt

If your vehicle has a front bench seat, someone can sit in the center position.

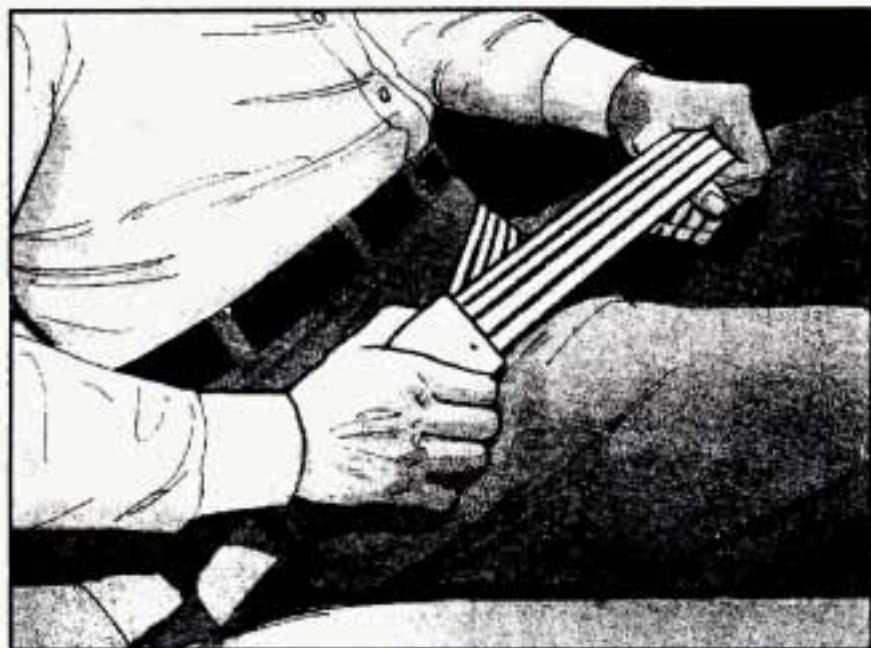

When you sit in the center front seating position, you have a lap safety belt, which has no retractor. To make the belt longer, tilt the latch plate and pull it along the belt.



To make the belt shorter, pull its free end as shown until the belt is snug.

Buckle, position and release it the same way as the lap part of a lap-shoulder belt. If the belt isn't long enough, see "Safety Belt Extender" at the end of this section.

Make sure the release button on the buckle is positioned so you would be able to unbuckle the safety belt quickly if you ever had to.

Rear Seat Passengers

It's very important for rear seat passengers to buckle up! Accident statistics show that unbelted people in the rear seat are hurt more often in crashes than those who are wearing safety belts.

Rear passengers who aren't safety belted can be thrown out of the vehicle in a crash. And they can strike others in the vehicle who are wearing safety belts.

Rear Seat Outside Passenger Positions

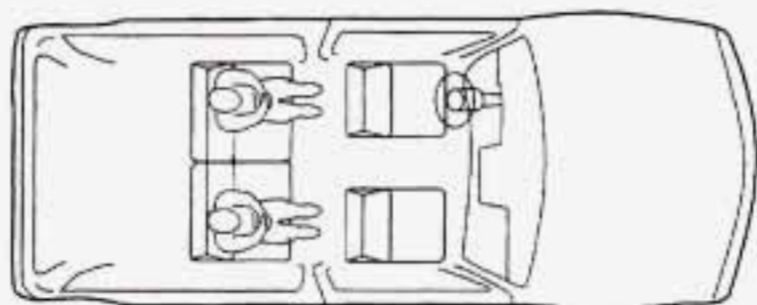

Lap-Shoulder Belt

The positions next to the windows have lap-shoulder belts. Here's how to wear one properly.



1. Pick up the latch plate and pull the belt across you. Don't let it get twisted. On four-door models, the shoulder belt may lock if you pull the belt across you very quickly. If this happens, let the belt go back slightly to unlock it. Then pull the belt across you more slowly.

2. Push the latch plate into the buckle until it clicks.

Pull up on the latch plate to make sure it is secure.

When the shoulder belt is pulled out all the way, it will lock. If it does, let it go back all the way and start again.

If the belt is not long enough, see "Safety Belt Extender" at the end of this section.

Make sure the release button on the buckle is positioned so you would be able to unbuckle the safety belt quickly if you ever had to.



3. To make the lap part tight, pull down on the buckle end of the belt as you pull up on the shoulder part.

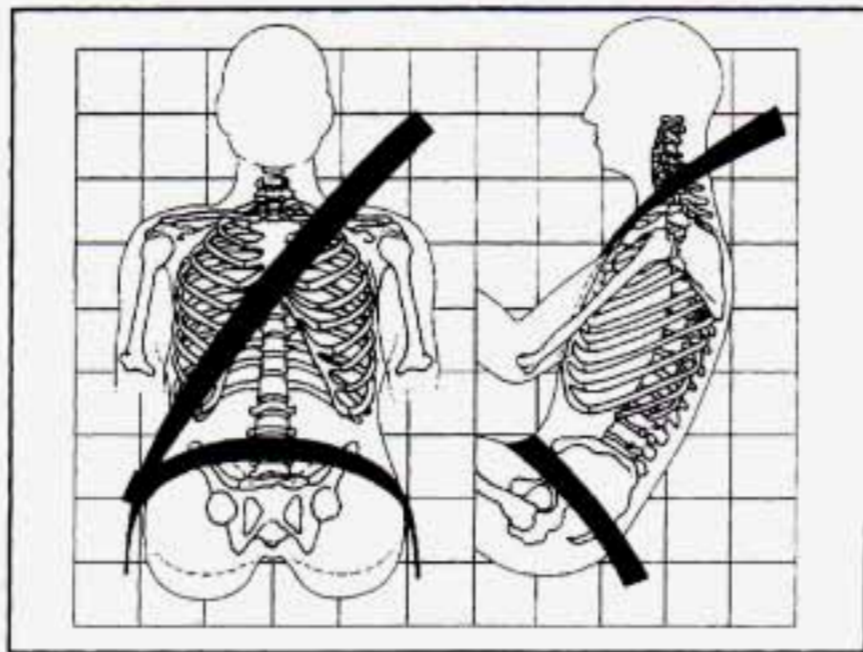

The lap part of the belt should be worn low and snug on the hips, just touching the thighs. In a crash, this applies force to the strong pelvic bones.

And you'd be less likely to slide under the lap belt. If you slid under it, the belt would apply force at your abdomen. This could cause serious or even fatal injuries. The shoulder belt should go over the shoulder and across the chest. These parts of the body are best able to take belt restraining forces.

The safety belt locks if there's a sudden stop or a crash.

On four-door models, the safety belt also locks if you pull the belt very quickly out of the retractor.

 **CAUTION:**

You can be seriously hurt if your shoulder belt is too loose. In a crash, you would move forward too much, which could increase injury. The shoulder belt should fit against your body.



To unlatch the belt, just push the button on the buckle.

Rear Safety Belt Comfort Guides for Children and Small Adults (4-Door Models)

Four-door models have rear shoulder belt comfort guides. This feature will provide added safety belt comfort for children who have outgrown child restraints and for small adults. When installed on a shoulder belt, the comfort guide pulls the belt away from the neck and head.

There is one guide for each outside passenger position in the rear seat. To provide added safety belt comfort for children who have outgrown child restraints and for smaller adults, the comfort guides may be installed on the shoulder belts. Here's how to install a comfort guide and use the safety belt:



1. Pull the elastic cord out from between the edge of the seatback and the interior body to remove the guide from its storage clip.



2. Slide the guide under and past the belt. The elastic cord must be under the belt. Then, place the guide over the belt, and insert the two edges of the belt into the slots of the guide.

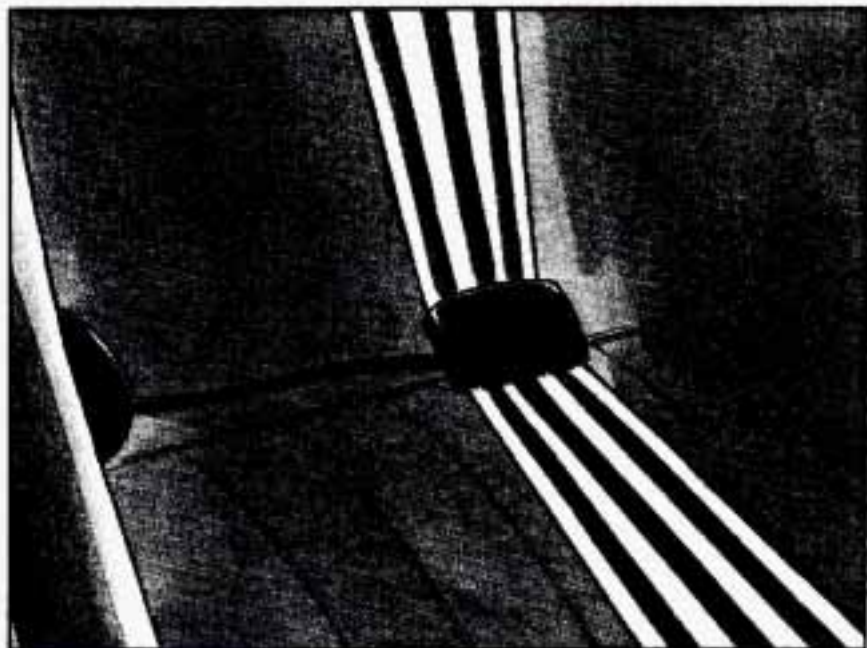

3. Be sure that the belt is not twisted and it lies flat. The elastic cord must be under the belt and the guide on top.



4. Buckle, position and release the safety belt as described in "Rear Seat Outside Passenger Positions" earlier in this section. Make sure that the shoulder belt crosses the shoulder.

To remove and store the comfort guides, squeeze the belt edges together so that you can take them out from the guides. Pull the guide upward to expose its storage clip, and then slide the guide onto the clip. Rotate the guide and clip inward and in between the seatback and the interior body, leaving only the loop of elastic cord exposed.

Center Rear Passenger Position (4-Door Models)

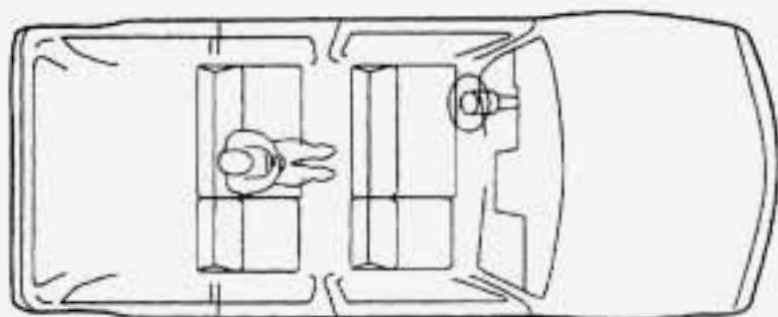

Lap Belt



When you sit in the center rear seating position, you have a lap safety belt which has a retractor.

1. Pick up the latch plate and pull the belt across you. Don't let it get twisted.
2. Push the latch plate into the buckle until it clicks. Pull up on the latch plate to make sure it is secure.
3. Feed the lap belt into the retractor to tighten it.



4. Position and release it the same way as the lap part of a lap-shoulder belt.

If the belt isn't long enough, see "Safety Belt Extender" at the end of this section. Make sure the release button on the buckle is positioned so you would be able to unbuckle the safety belt quickly if you ever had to.

Children

Everyone in a vehicle needs protection! That includes infants and all children smaller than adult size. In fact, the law in every state in the United States and in every Canadian province says children up to some age must be restrained while in a vehicle.

Smaller Children and Babies

CAUTION:

Smaller children and babies should always be restrained in a child or infant restraint. The instructions for the restraint will say whether it is the right type and size for your child. A very young child's hip bones are so small that a regular belt might not stay low on the hips, as it should. Instead, the belt will likely be over the child's abdomen. In a crash, the belt would apply force right on the child's abdomen, which could cause serious or fatal injuries. So, be sure that any child small enough for one is always properly restrained in a child or infant restraint.



⚠ CAUTION:

Never hold a baby in your arms while riding in a vehicle. A baby doesn't weigh much -- until a crash. During a crash a baby will become so

CAUTION: (Continued)

CAUTION: (Continued)

heavy you can't hold it. For example, in a crash at only 25 mph (40 km/h), a 12-lb. (5.5 kg) baby will suddenly become a 240-lb. (110 kg) force on your arms. The baby would be almost impossible to hold.

Secure the baby in an infant restraint.



Child Restraints

Be sure the child restraint is designed to be used in a vehicle. If it is, it will have a label saying that it meets Federal Motor Vehicle Safety Standards.

Then follow the instructions for the restraint. You may find these instructions on the restraint itself or in a booklet, or both. These restraints use the belt system in your vehicle, but the child also has to be secured within the restraint to help reduce the chance of personal injury. The instructions that come with the infant or child restraint will show you how to do that.

Where to Put the Restraint

Accident statistics show that children are safer if they are restrained in the rear rather than the front seat. We at General Motors therefore recommend that you put your child restraint in a rear seat outside position unless the child is an infant and you're the only adult in the vehicle. In that case, you might want to secure the restraint in the right front seat where you can keep an eye on the baby.

Wherever you install it, be sure to secure the child restraint properly.

Keep in mind that an unsecured child restraint can move around in a collision or sudden stop and injure people in the vehicle. Be sure to properly secure any child restraint in your vehicle -- even when no child is in it.

Top Strap

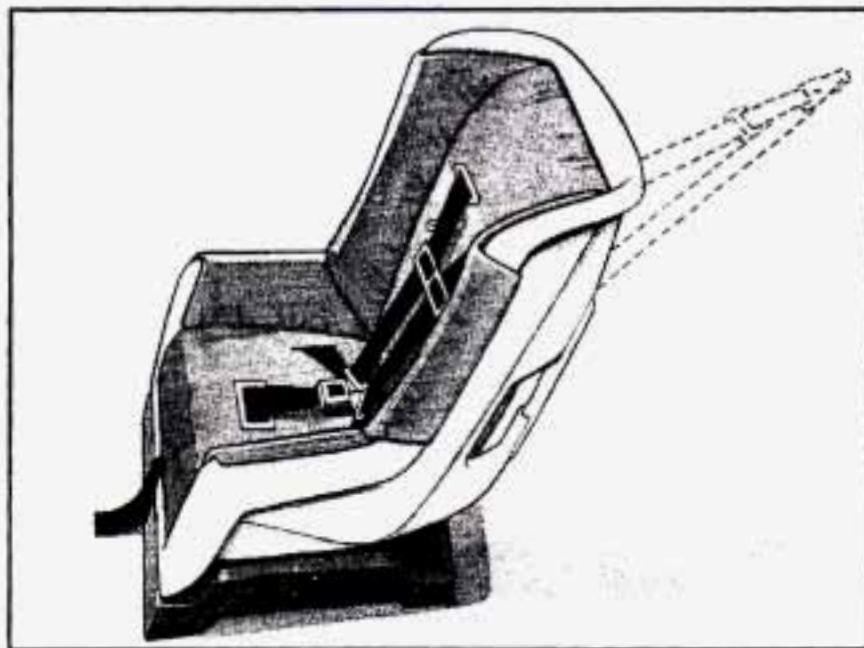

If your child restraint has a top strap, it should be anchored. Anchor brackets for the rear outside seat positions are located on the floor in the cargo area.

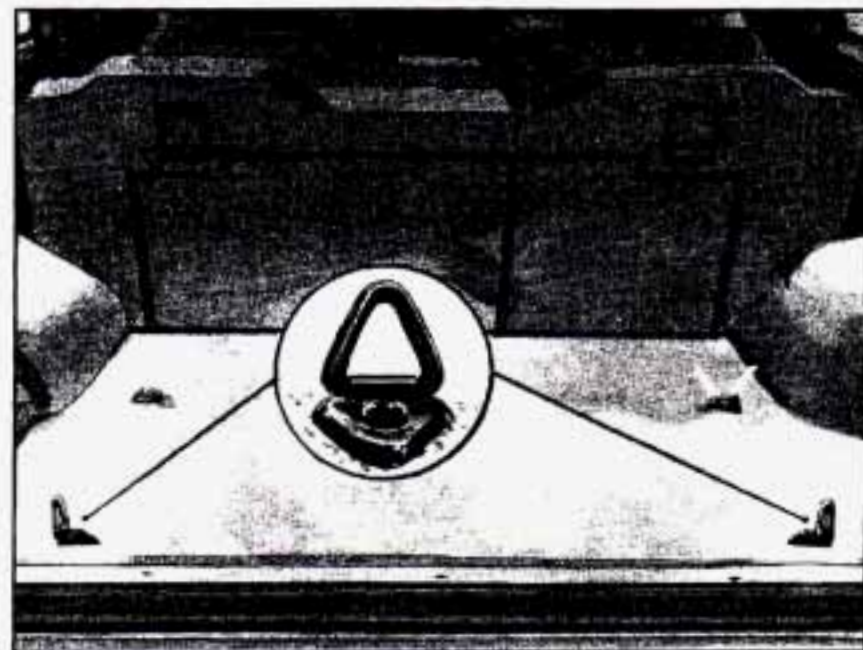

Don't use the front set of tie-down brackets. Anchor the top strap to the rearmost bracket on the same side of the vehicle as the child restraint.

Once you have the top strap anchored, you'll be ready to secure the child restraint itself.

Securing a Child Restraint in a Rear Outside Seat Position

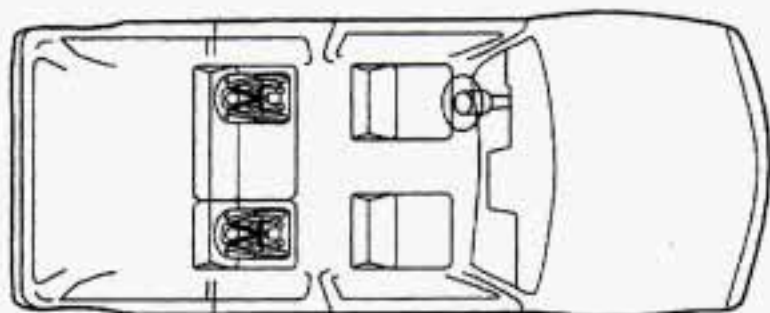

You'll be using the lap-shoulder belt. See the earlier part about the top strap if the child restraint has one.

1. Put the restraint on the seat. Follow the instructions for the child restraint.
2. Secure the child in the child restraint as the instructions say.
3. Pick up the latch plate, and run the lap and shoulder portions of the vehicle's safety belt through or around the restraint. The child restraint instructions will show you how.

If the shoulder belt goes in front of the child's face or neck, put it behind the child restraint.

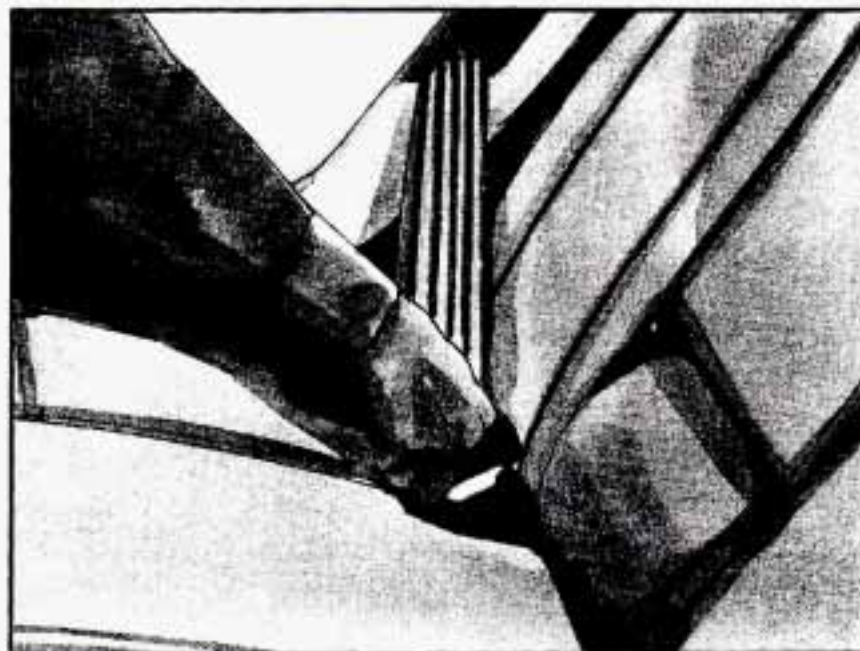

4. Buckle the belt. Make sure the release button is positioned so you would be able to unbuckle the safety belt quickly if you ever had to.



5. Pull the rest of the shoulder belt all the way out of the retractor to set the lock.



6. To tighten the belt, feed the shoulder belt back into the retractor while you push down on the child restraint.
7. Push and pull the child restraint in different directions to be sure it is secure.

To remove the child restraint, just unbuckle the vehicle's safety belt and let it go back all the way. The safety belt will move freely again and be ready to work for an adult or larger child passenger.

Center Seat Positions (4-Door Models)

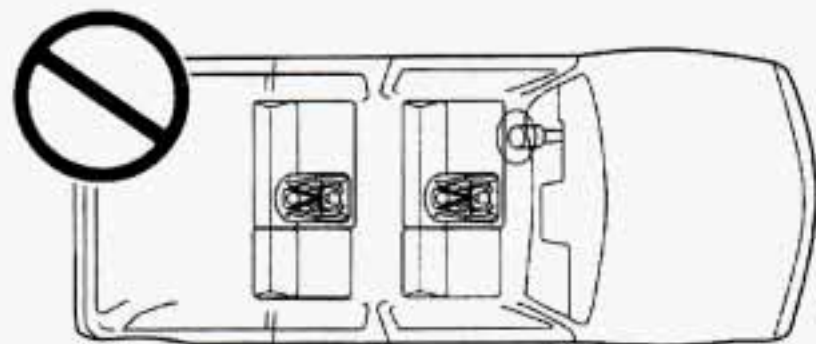

Don't use child restraints in these positions. The restraints won't work properly.

Securing a Child Restraint in the Right Front Seat Position

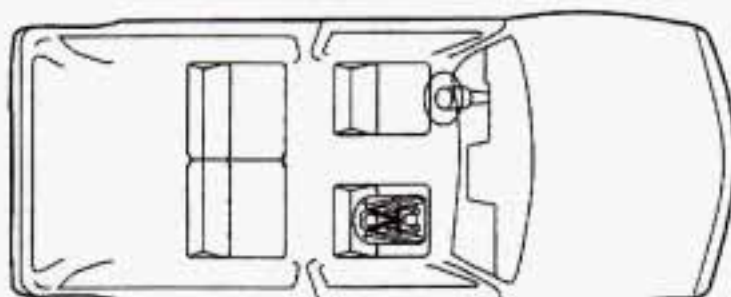

You'll be using the lap-shoulder belt. See the earlier part about the top strap if the child restraint has one.

1. Put the restraint on the seat. Follow the instructions for the child restraint.
2. Secure the child in the child restraint as the instructions say.
3. Pick up the latch plate, and run the lap and shoulder portions of the vehicle's safety belt through or around the restraint. The child restraint instructions will show you how.

If the shoulder belt goes in front of the child's face or neck, put it behind the child restraint.

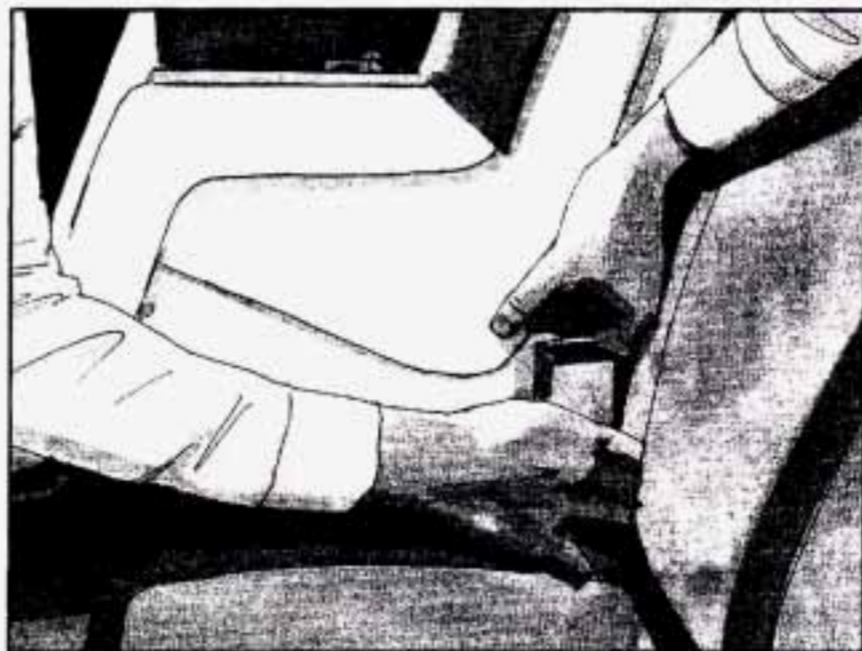

4. Buckle the belt. Make sure the release button is positioned so you would be able to unbuckle the safety belt quickly if you ever had to.



5. Pull the rest of the shoulder belt all the way out of the retractor to set the lock.



6. To tighten the belt, feed the shoulder belt back into the retractor while you push down on the child restraint.

7. Push and pull the child restraint in different directions to be sure it is secure. If you're using a bucket seat, adjust the seat forward until the lap portion of the safety belt holds the restraint firmly. But don't move it any more than needed to tighten the lap belt.

To remove the child restraint, just unbuckle the vehicle's safety belt and let it go back all the way. The safety belt will move freely again and be ready to work for an adult or larger child passenger.

Larger Children



Children who have outgrown child restraints should wear the vehicle's safety belts.

If you have the choice, a child should sit next to a window so the child can wear a lap-shoulder belt and get the additional restraint a shoulder belt can provide.

Accident statistics show that children are safer if they are restrained in the rear seat. But they need to use the safety belts properly.

- Children who aren't buckled up can be thrown out in a crash.
- Children who aren't buckled up can strike other people who are.

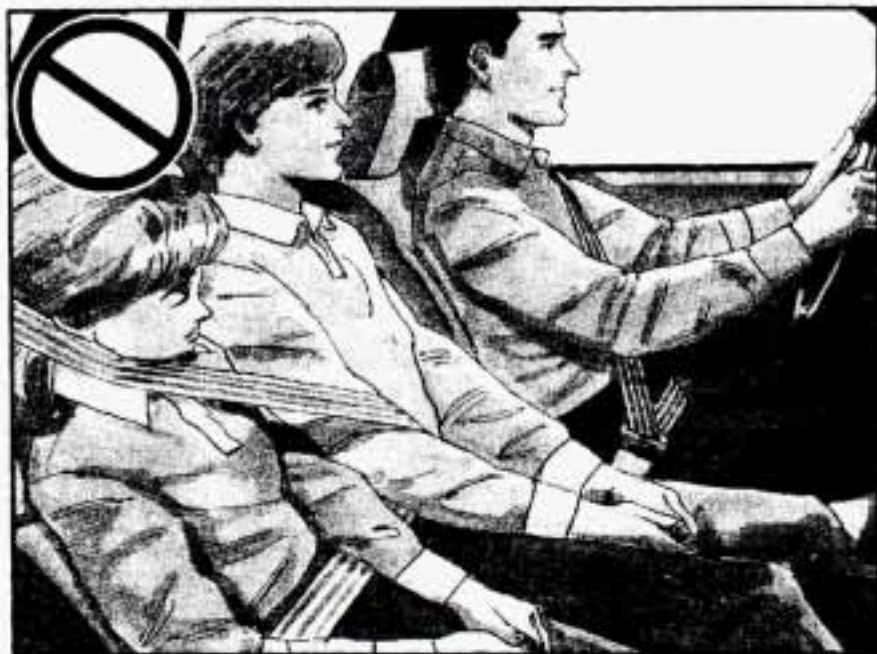

⚠ CAUTION:

Never do this.

Here two children are wearing the same belt. The belt can't properly spread the impact forces. In a crash, the two children can be crushed together and seriously injured. A belt must be used by only one person at a time.

Q: What if a child is wearing a lap-shoulder belt, but the child is so small that the shoulder belt is very close to the child's face or neck?

A: Move the child toward the center of the vehicle, but be sure that the shoulder belt still is on the child's shoulder, so that in a crash the child's upper body would have the restraint that belts provide. If the child is sitting in a rear outside position of a four-door model, see "Rear Safety Belt Comfort Guides" in the Index. If the child is so small that the shoulder belt is still very close to the child's face or neck, you might want to place the child in a seat that has a lap belt, if your vehicle has one.



⚠ CAUTION:

Never do this.

Here a child is sitting in a seat that has a lap-shoulder belt, but the shoulder part is behind the child. If the child wears the belt in this way, in a crash the child might slide under the belt. The belt's force would then be applied right on the child's abdomen. That could cause serious or fatal injuries.

Wherever the child sits, the lap portion of the belt should be worn low and snug on the hips, just touching the child's thighs. This applies belt force to the child's pelvic bones in a crash.

Safety Belt Extender

If the vehicle's safety belt will fasten around you, you should use it.

But if a safety belt isn't long enough to fasten, your dealer will order you an extender. It's free. When you go in to order it, take the heaviest coat you will wear, so the extender will be long enough for you. The extender will be just for you, and just for the seat in your vehicle that you choose. Don't let someone else use it, and use it only for the seat it is made to fit. To wear it, just attach it to the regular safety belt.

Checking Your Restraint Systems

Now and then, make sure the safety belt reminder light and all your belts, buckles, latch plates, retractors and anchorages are working properly. Look for any other loose or damaged safety belt system parts. If you see anything that might keep a safety belt system from doing its job, have it repaired.

Torn or frayed safety belts may not protect you in a crash. They can rip apart under impact forces. If a belt is torn or frayed, get a new one right away.

Also look for any opened or broken air bag covers, and have them repaired or replaced. (The air bag system does not need regular maintenance.)

Replacing Restraint System Parts After a Crash

If you've had a crash, do you need new belts?

After a very minor collision, nothing may be necessary. But if the belts were stretched, as they would be if worn during a more severe crash, then you need new belts.



If you ever see a label on the driver's safety belt buckle that says to replace the buckle assembly, be sure to do so. Then the new buckle assembly will be there to help protect you in a collision.

If belts are cut or damaged, replace them. Collision damage also may mean you will need to have safety belt or seat parts repaired or replaced. New parts and repairs may be necessary even if the belt wasn't being used at the time of the collision.

If an air bag inflates, you'll need to replace air bag system parts. See the part on the air bag system earlier in this section.

Section 2 Features and Controls

Here you can learn about the many standard and optional features on your vehicle, and information on starting, shifting and braking. Also explained are the instrument panel and the warning systems that tell you if everything is working properly -- and what to do if you have a problem.

- | | | | |
|------|---|------|--|
| 2-2 | Keys | 2-33 | Parking Your Vehicle (Manual Transmission Models Only) |
| 2-6 | Keyless Entry System (If Equipped) | 2-34 | Parking Over Things That Burn |
| 2-9 | Endgate/Liftgate | 2-34 | Engine Exhaust |
| 2-12 | Theft | 2-35 | Running Your Engine While You're Parked (Automatic Transmission) |
| 2-13 | New Vehicle "Break-In" | 2-36 | Windows |
| 2-13 | Ignition Positions | 2-38 | Turn Signal/Multifunction Lever |
| 2-15 | Starting Your Engine | 2-45 | Exterior Lamps |
| 2-17 | Engine Coolant Heater (Option) | 2-49 | Mirrors |
| 2-18 | Automatic Transmission Operation | 2-63 | Accessory Power Outlets (If Equipped) |
| 2-21 | Manual Transmission | 2-63 | Sunroof (If Equipped) |
| 2-23 | Locking Rear Axle | 2-64 | Universal Transmitter (If Equipped) |
| 2-23 | All-Wheel Drive (If Equipped) | 2-67 | Instrument Panel |
| 2-23 | Four-Wheel Drive (If Equipped) | 2-72 | Warning Lights, Gages and Indicators |
| 2-29 | Parking Brake | | |
| 2-30 | Shifting Into PARK (P) (Automatic Transmission Models Only) | | |
| 2-33 | Shifting Out of PARK (P) (Automatic Transmission) | | |

Keys

 **CAUTION:**

Leaving young children in a vehicle with the ignition key is dangerous for many reasons. A child or others could be badly injured or even killed.

They could operate power windows or other controls or even make the vehicle move. Don't leave the keys in a vehicle with young children.

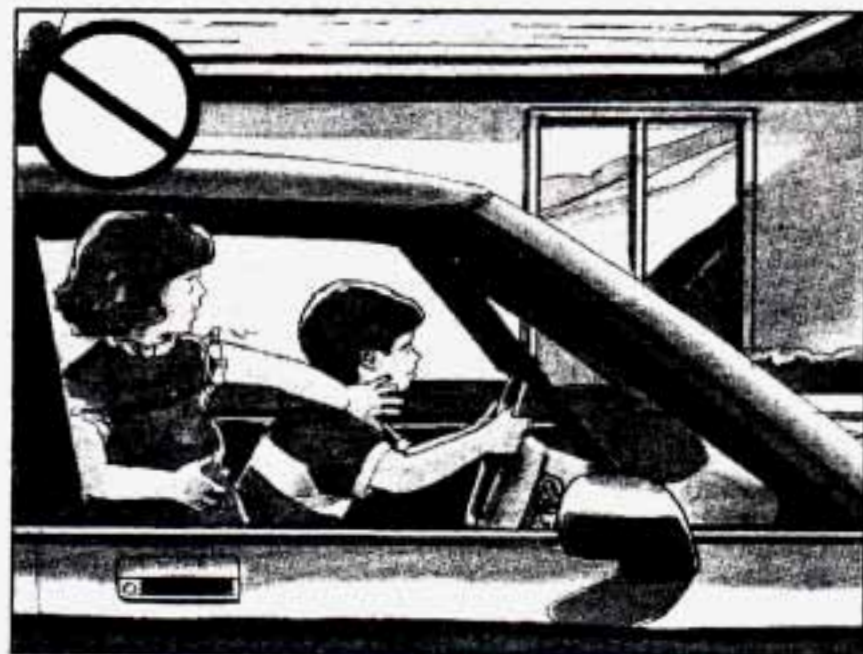



This vehicle has one double-sided key for the ignition, endgate, spare tire lock (two-door vehicles) and door locks. It will fit with either side up.

NOTICE:

Your vehicle has a number of new features that can help prevent theft. But you can have a lot of trouble getting into your vehicle if you ever lock your keys inside. You may even have to damage your vehicle to get in. So be sure you have extra keys.

When a new vehicle is delivered, the dealer provides the owner with a pair of identical keys and a key code number.

The key code number tells your dealer or a qualified locksmith how to make extra keys. Keep this number in a safe place. If you lose your keys, you'll be able to have new ones made easily using this number. Your selling dealer should also have this number.

Door Locks

CAUTION:

Unlocked doors can be dangerous.

Passengers -- especially children -- can easily open the doors and fall out. When a door is locked, the inside handle won't open it.

Outsiders can easily enter through an unlocked door when you slow down or stop your vehicle.

This may not be so obvious: You increase the chance of being thrown out of the vehicle in a crash if the doors aren't locked. Wear safety belts properly, lock your doors, and you will be far better off whenever you drive your vehicle.

There are several ways to lock and unlock your vehicle.

You can use the Keyless Entry System, if you have this option.

You can use your key to unlock your door from the outside.

To lock your door from the inside, slide the lever on your inside door rearward.



To unlock the door, slide the lever on your inside door forward. You will see a red area on the lever.

Power Door Locks (If Equipped)



If your vehicle has power door locks, the switch is located on the armrest. Press LOCK to lock all the doors at once.

To unlock the doors, press the raised area next to the key symbol.

On four-door models, the lever on each rear door works only that door's lock.

Rear Door Security Lock



With this feature, you can lock the rear doors so they can't be opened from the inside by passengers.

Move the lock up to lock the doors and down to release the door locks.

Leaving Your Vehicle

If you are leaving the vehicle, take your key, open your door and set the locks from inside. Then get out and close the door.

Keyless Entry System (If Equipped)

If your vehicle has this option, you can lock and unlock your doors and rear endgate from up to 30 feet (9 m) away using the remote keyless entry transmitter supplied with your vehicle.

Your Keyless Entry System operates on a radio frequency subject to Federal Communications Commission (FCC) Rules and with Industry and Science Canada.

This device complies with Part 15 of the FCC Rules. Operation is subject to the following two conditions: (1) this device may not cause harmful interference, and (2) this device must accept any interference received, including interference that may cause undesired operation.

This device complies with RSS-210 of Industry and Science Canada. Operation is subject to the following two conditions: (1) this device may not cause interference, and (2) this device must accept any interference received, including interference that may cause undesired operation of the device.

Changes or modifications to this system other than an authorized service facility could void authorization to use this equipment.

This system has a range of about 3 feet (1 m) up to 30 feet (9 m). At times you may notice a decrease in range. This is normal for any remote keyless entry system. If the transmitter does not work or if you have to stand closer to your vehicle for the transmitter to work, try this:

- Check to determine if battery replacement or resynchronization is necessary. See the instructions that follow.
- Check the distance. You may be too far from your vehicle. You may need to stand closer during rainy or snowy weather.
- Check the location. Other vehicles or objects may be blocking the signal. Take a few steps to the left or right, and try again.
- If you're still having trouble, see your GM dealer or a qualified technician for service.

Changes or modifications to this system by other than an authorized service facility could void authorization to use this equipment.

Operation

When you press UNLOCK, the driver's door and endgate will unlock automatically. If you press UNLOCK again within five seconds, all doors will unlock. Press LOCK to lock all the doors.

Press the REAR button twice within 3 1/2 seconds to unlock and unlatch the rear glass. If your vehicle has an automatic transmission, the transmission must be in PARK (P) or NEUTRAL (N). If your vehicle has a manual transmission, you must engage the parking brake.

Matching Transmitter(s) To Your Vehicle

Each remote keyless entry transmitter is coded to prevent another transmitter from unlocking your vehicle. If a transmitter is lost or stolen, a replacement can be purchased through your dealer. Remember to bring any remaining transmitters with you when you go to your dealer. When the dealer matches the replacement transmitter to your vehicle, any remaining transmitters must also be matched. Once your dealer has coded the new transmitter, the lost transmitter will not unlock your vehicle. Each vehicle can have only two transmitters matched to it.

Battery Replacement

Under normal use, the battery in your remote keyless entry transmitter should last about two years.

You can tell the battery is weak if the transmitter won't work at the normal range in any location. If you have to get close to your vehicle before the transmitter works, it's probably time to change the battery.

NOTICE:

When replacing the battery, use care not to touch any of the circuitry. Static from your body transferred to these surfaces may damage the transmitter.

To replace the battery in the Keyless Entry transmitter:



1. Insert a dime in the slot between the covers of the transmitter housing near the key ring hole. Remove the bottom by twisting the dime.
2. Remove and replace the battery with a three volt CR2032 or equivalent battery, positive (+) side down.
3. Align the covers and snap them together.
4. Check the operation of the transmitter.

Resynchronization

Resynchronization may be necessary due to the security method used by this system. The transmitter does not send the same signal twice to the receiver. The receiver will not respond to a signal it has been sent previously. This prevents anyone from recording and playing back the signal from the transmitter.

To resynchronize your transmitter, stand close to your vehicle and simultaneously press and hold the LOCK and UNLOCK buttons on the transmitter for at least five seconds. The door locks should cycle to confirm synchronization. If the locks do not cycle, see your dealer for service.

Endgate/Liftgate

CAUTION:

It can be dangerous to drive with the rear window, endgate or liftgate open because carbon monoxide (CO) gas can come into your vehicle. You can't see or smell CO. It can cause unconsciousness and even death.

If you must drive with the rear window, endgate or liftgate open or if electrical wiring or other cable connections must pass through the seal between the body and the rear window, endgate or liftgate:

- Make sure all windows are shut.
- Turn the fan on your heating or cooling system to its highest speed with the setting on VENT. That will force outside air into your vehicle. See "Comfort Controls" in the Index.
- If you have air outlets on or under the instrument panel, open them all the way.

See "Engine Exhaust" in the Index.

Endgate Mounted Spare

If your vehicle has an endgate-mounted spare tire carrier, you must move the carrier arm out of the way to open the glass.

Here's how to move the arm:



1. Squeeze the release handle to free the carrier arm.
2. Swing the carrier arm away from the endgate. You may need to give it a slight tug.
3. To latch the carrier arm, swing it toward the endgate.

Endgate Release

To open a mechanical lock system from the outside, insert the key into the lock and turn it counterclockwise to unlock the glass.

The endgate and glass will automatically lock when shut.

To open a power lock system from the outside, insert the key into the lock button and turn counterclockwise. All doors will unlock.

You may also use the keyless entry system, or the power door locks, if your vehicle is so equipped.



When doors are unlocked, press the button to open the glass.



Reach inside the endgate to lift the handle and open the endgate.

The endgate can be opened without a key if the driver's door is unlocked. The endgate glass will not release if the vehicle is in gear.

To lock a power lock system from the outside, insert the key into the lock button and turn clockwise. All doors will lock.

Remote Rear Glass Release



This button on the driver's side of the steering column allows you to release the rear glass from inside the vehicle.

If your vehicle has an automatic transmission, your shift lever must be in PARK (P) or NEUTRAL (N) for the release to work.

If you have a manual transmission, either with or without the Keyless Entry option, you must apply your parking brake before you can open the endgate glass.

Liftgate Release

Insert the key in the lock button and turn counterclockwise. All doors will unlock. You may also use the power lock switches or the keyless entry system, if your vehicle is so equipped. Use the handle to open the liftgate. Press the button to open the glass when the liftgate is closed. The glass won't release if the vehicle is in gear.

Emergency Release for Opening Endgate/Liftgate

1. Peel back or slit the carpet locally to expose the access hole in the trim panel.

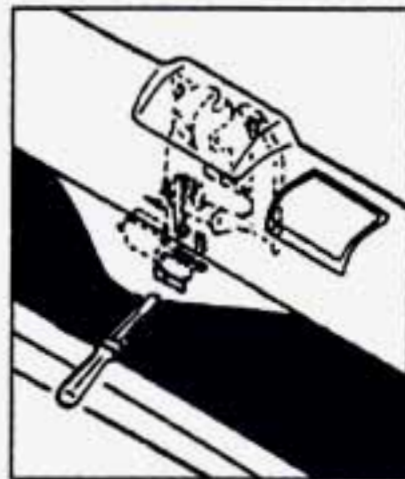

2. Use a thin screwdriver to reach through the access holes in both the trim panel and the hardware cover.

Pry the release lever toward the passenger's side until the glass latch pops open.

3. Reattach the carpet securely.

Theft

Vehicle theft is big business, especially in some cities. Although your vehicle has a number of theft-deterrent features, we know that nothing we put on it can make it impossible to steal. However, there are ways you can help.

Key in the Ignition

If you leave your vehicle with the keys inside, it's an easy target for joy riders or professional thieves -- so don't do it.

When you park your vehicle and open the driver's door, you'll hear a tone reminding you to remove your key from the ignition and take it with you. Always do this. Your steering wheel will be locked, and so will your ignition. If you have an automatic transmission, taking your key out also locks your transmission. And remember to lock the doors.

Parking at Night

Park in a lighted spot, close all windows and lock your vehicle. Remember to keep your valuables out of sight. Put them in a storage area, or take them with you.

Parking Lots

If you park in a lot where someone will be watching your vehicle, it's best to lock it up and take your keys. But what if you have to leave your ignition key? What if you have to leave something valuable in your vehicle?

- Put your valuables in a storage area, like your glove box.
- Lock all the doors except the driver's.

New Vehicle “Break-In”

NOTICE:

Your modern vehicle doesn't need an elaborate “break-in.” But it will perform better in the long run if you follow these guidelines:

- Keep your speed at 55 mph (88 km/h) or less for the first 500 miles (805 km).
- Don't drive at any one speed -- fast or slow -- for the first 500 miles (805 km). Don't make full-throttle starts.
- Avoid making hard stops for the first 200 miles (322 km) or so. During this time your new brake linings aren't yet broken in. Hard stops with new linings can mean premature wear and earlier replacement. Follow this breaking-in guideline every time you get new brake linings.
- Don't tow a trailer during break-in. See “Towing a Trailer” in the Index for more information.

Ignition Positions

Use the key to turn the ignition switch to five different positions.

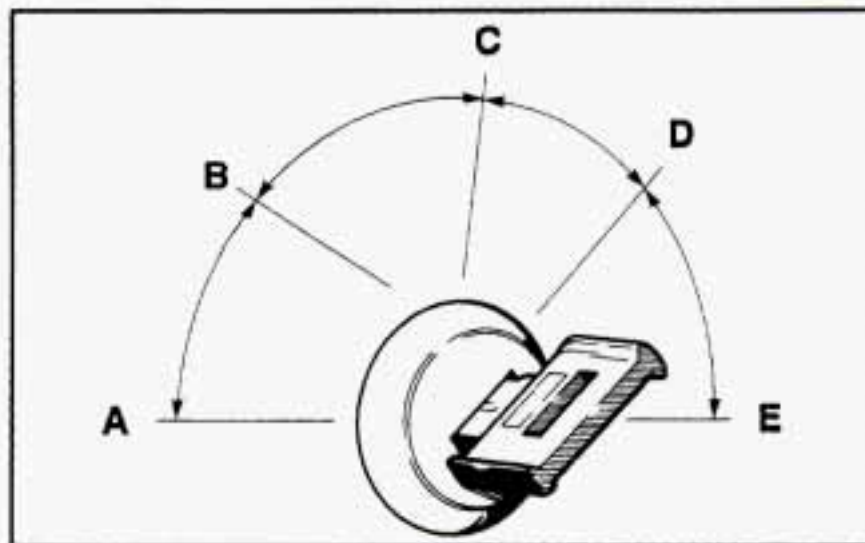

ACCESSORY (A): ACCESSORY lets you use things like the radio and the windshield wipers when the engine is off. Push in the key and turn it toward you. Your steering wheel will remain locked, just as it was before you inserted the key.

NOTICE:

Don't operate accessories in the ACCESSORY position for long periods of time. Prolonged operation of accessories in the ACCESSORY position could drain your battery and prevent you from starting your vehicle.

LOCK (B): This position locks your ignition, steering wheel and transmission. It's a theft-deterrent feature. You will only be able to remove your key when the ignition is turned to LOCK.

OFF (C): This position lets you turn off the engine but still turn the steering wheel. Use OFF if you must have your vehicle in motion while the engine is off (for example, if your vehicle is being towed).

RUN (D): This is the position for driving.

START (E): This starts your engine.



CAUTION:

On manual transmission vehicles, turning the key to LOCK will lock the steering column and result in a loss of ability to steer the vehicle. This could cause a collision. If you need to turn the engine off while the vehicle is moving, turn the key only to OFF. Don't press the key release button while the vehicle is moving.

NOTICE:

If your key seems stuck in LOCK and you can't turn it, be sure you are using the correct key; if so, is it all the way in? If it is, then turn the steering wheel left and right while you turn the key hard. But turn the key only with your hand. Using a tool to force it could break the key or the ignition switch. If none of this works, then your vehicle needs service.

Key Release Button



The key cannot be removed from the ignition of manual transmission vehicles unless the key release button is used.

To remove the key on manual transmission vehicles, turn the key to the OFF position. Then turn the key to the LOCK position while pressing the key release button down at the same time. Pull the key straight out.

On automatic transmission vehicles, turn the key to LOCK and pull it straight out.

Starting Your Engine

Automatic Transmission

Move your shift lever to PARK (P) or NEUTRAL (N). Your engine won't start in any other position -- that's a safety feature. To restart when you're already moving, use NEUTRAL (N) only.

NOTICE:

Don't try to shift to PARK (P) if your vehicle is moving. If you do, you could damage the transmission. Shift to PARK (P) only when your vehicle is stopped.

Manual Transmission

The gear selector should be in NEUTRAL (N). Hold the clutch pedal to the floor and start the engine. Your vehicle won't start if the clutch pedal is not all the way down -- that's a safety feature.

1. Without pushing the accelerator pedal, turn your ignition key to START. When the engine starts, let go of the key. The idle speed will go down as your engine gets warm.

NOTICE:

Holding your key in START for longer than 15 seconds at a time will cause your battery to be drained much sooner. And the excessive heat can damage your starter motor.

2. If it doesn't start right away, hold your key in START. If it doesn't start in 10 seconds, push the accelerator pedal all the way down for five more seconds, or until it starts.

3. If your engine still won't start (or starts but then stops), wait 15 seconds and start over.

When the engine starts, let go of the key and the accelerator pedal.

NOTICE:

Your engine is designed to work with the electronics in your vehicle. If you add electrical parts or accessories, you could change the way the engine operates. Before adding electrical equipment, check with your dealer. If you don't, your engine might not perform properly.

If you ever have to have your vehicle towed, see the part of this manual that tells how to do it without damaging your vehicle. See "Towing Your Vehicle" in the Index.

Engine Coolant Heater (Option)

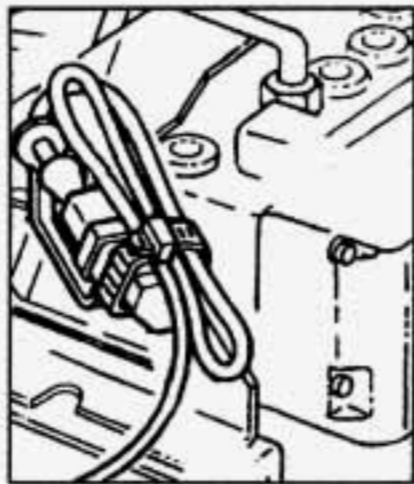

In very cold weather, 0°F (-18°C) or colder, the engine coolant heater can help.

You'll get easier starting and better fuel economy during engine warm-up. Usually, the coolant heater should be plugged in a minimum of four hours prior to starting your vehicle.

To Use the Coolant Heater

1. Turn off the engine.
2. Open the hood and unwrap the electrical cord.
3. Plug it into a normal, grounded 110-volt AC outlet.



CAUTION:

Plugging the cord into an ungrounded outlet could cause an electrical shock. Also, the wrong kind of extension cord could overheat and cause a fire. You could be seriously injured. Plug the cord into a properly grounded three-prong 110-volt AC outlet. If the cord won't reach, use a heavy-duty three-prong extension cord rated for at least 15 amps.

4. Before starting the engine, be sure to unplug and store the cord as it was before to keep it away from moving engine parts. If you don't, it could be damaged.

How long should you keep the coolant heater plugged in? The answer depends on the outside temperature, the kind of oil you have, and some other things. Instead of trying to list everything here, we ask that you contact your GM dealer in the area where you'll be parking your vehicle. The dealer can give you the best advice for that particular area.

Automatic Transmission Operation

Your automatic transmission may have a shift lever located on the console between the seats or on the steering column.

There are several different positions for your shift lever.

If your vehicle is equipped with a column shift lever, it features an electronic shift position indicator within the instrument cluster. This display must be powered anytime the shift lever is capable of being moved out of the PARK (P) position. This means that if your key is in the OFF position, but not locked, there will be a small current drain on your battery which could discharge your battery over a period of time. If you need to leave your key in the ignition in the OFF position for an extended period, it is recommended that you disconnect the battery cable from the battery to prevent discharging your battery.

PARK (P): This locks your rear wheels. It's the best position to use when you start your engine because your vehicle can't move easily.



CAUTION:

It is dangerous to get out of your vehicle if the shift lever is not fully in PARK (P) with the parking brake firmly set. Your vehicle can roll. Don't leave your vehicle when the engine is running unless you have to. If you have left the engine running, the vehicle can move suddenly. You or others could be injured. To be sure your vehicle won't move, even when you're on fairly level ground, always set your parking brake and move the shift lever to PARK (P).

If you have four-wheel drive, your vehicle will be free to roll -- even if your shift lever is in PARK (P) -- if your transfer case is in NEUTRAL (N). So, be sure the transfer case is in a drive gear, two-wheel high (2HI) or four-wheel high (4HI) or four-wheel low (4LO) -- not in NEUTRAL (N). See "Shifting Into PARK (P)" in the Index. If you're pulling a trailer, see "Towing a Trailer" in the Index.

Ensure the shift lever is fully in PARK (P) range before starting the engine. Your vehicle has a brake-transmission shift interlock. You have to fully apply your regular brakes before you can shift from PARK (P) when the ignition key is in the RUN position. If you cannot shift out of PARK (P), ease pressure on the shift lever -- push the shift lever all the way into PARK (P) (press the button in on the console shift lever) as you maintain brake application. Then move the shift lever into the gear you wish. See "Shifting Out of PARK (P)" in the Index.

REVERSE (R): Use this gear to back up.

NOTICE:

Shifting to REVERSE (R) while your vehicle is moving forward could damage your transmission. Shift to REVERSE (R) only after your vehicle is stopped.

To rock your vehicle back and forth to get out of snow, ice or sand without damaging your transmission, see "Stuck: In Sand, Mud, Ice or Snow" in the Index.

NEUTRAL (N): In this position, your engine doesn't connect with the wheels. To restart when you're already moving, use NEUTRAL (N) only.

CAUTION:

Shifting out of PARK (P) or NEUTRAL (N) while your engine is "racing" (running at high speed) is dangerous. Unless your foot is firmly on the brake pedal, your vehicle could move very rapidly. You could lose control and hit people or objects. Don't shift out of PARK (P) or NEUTRAL (N) while your engine is racing.

NOTICE:

Damage to your transmission caused by shifting out of PARK (P) or NEUTRAL (N) with the engine racing isn't covered by your warranty.

AUTOMATIC OVERDRIVE (Ⓢ): This position is for normal driving. If you need more power for passing, and you're:

- Going less than about 35 mph (56 km/h), push your accelerator pedal about halfway down.
- Going about 35 mph (56 km/h) or more, push the accelerator all the way down.

You'll shift down to the next gear and have more power.

AUTOMATIC OVERDRIVE (Ⓢ) should not be used when towing a trailer, carrying a heavy load, driving on steep hills, or for off-road driving. Select **DRIVE (D)** when operating the vehicle under any of these conditions.

DRIVE (D): This position is also used for normal driving, however it offers more power and lower fuel economy than **AUTOMATIC OVERDRIVE (Ⓢ)**. You should use **DRIVE (D)** when towing a trailer, carrying a heavy load, driving on steep hills or winding roads or for off-road driving.

SECOND (2): This position gives you more power but lower fuel economy. You can use **SECOND (2)** on hills. It can help control your speed as you go down steep mountain roads, but then you would also want to use your brakes off and on.

You can also use **SECOND (2)** for starting your vehicle from a stop on slippery road surfaces.

FIRST (1): This position gives you even more power (but lower fuel economy) than **SECOND (2)**. You can use it on very steep hills, or in deep snow or mud. If the selector lever is put in **FIRST (1)** while the vehicle is moving forward, the transmission won't shift into **FIRST (1)** until the vehicle is going slowly enough.

NOTICE:

If your rear wheels can't rotate, don't try to drive. This might happen if you were stuck in very deep sand or mud or were up against a solid object. You could damage your transmission.

Also, if you stop when going uphill, don't hold your vehicle there with only the accelerator pedal. This could overheat and damage the transmission. Use your brakes or shift into **PARK (P) to hold your vehicle in position on a hill.**

Manual Transmission Operation

5-Speed

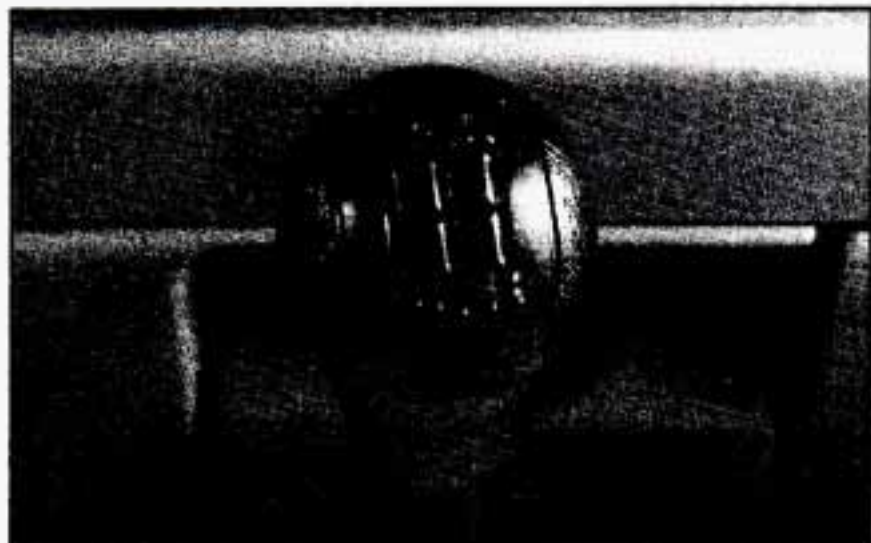

This is your shift pattern.

Here's how to operate your transmission:

FIRST (1): Press the clutch pedal and shift into FIRST (1). Then, slowly let up on the clutch pedal as you press the accelerator pedal.

You can shift into FIRST (1) when you're going less than 20 mph (32 km/h). If you've come to a complete stop and it's hard to shift into FIRST (1), put the shift lever in NEUTRAL (N) and let up on the clutch. Press the clutch pedal back down. Then shift into FIRST (1).

SECOND (2): Press the clutch pedal as you let up on the accelerator pedal and shift into SECOND (2). Then, slowly let up on the clutch pedal as you press the accelerator pedal.

THIRD, FOURTH AND FIFTH (3, 4 and 5): Shift into THIRD (3), FOURTH (4) and FIFTH (5) the same way you do for SECOND (2). Slowly let up on the clutch pedal as you press the accelerator pedal.

To stop, let up on the accelerator pedal and press the brake pedal. Just before the vehicle stops, press the clutch pedal and the brake pedal, and shift to NEUTRAL (N).

NEUTRAL (N): Use this position when you start or idle your engine.

REVERSE (R): To back up, press the clutch pedal, wait about six seconds, then shift into REVERSE (R). Then let up on the clutch pedal slowly while pressing the accelerator pedal.

NOTICE:

Shift to REVERSE (R) only after your vehicle is stopped. Shifting to REVERSE (R) while your vehicle is moving could damage your transmission.

Use REVERSE (R), along with the parking brake, for parking your vehicle.

Shift Light



If you have a manual transmission, you have a SHIFT light.

This light will show you when to shift to the next higher gear for best fuel economy.

When this light comes on, you can shift to the next higher gear if weather, road and traffic conditions let you. For the best fuel economy, accelerate slowly and shift when the light comes on.

While you accelerate, it is normal for the light to go on and off if you quickly change the position of the accelerator. Ignore the SHIFT light when you downshift.

 **CAUTION:**

If you skip more than one gear when you downshift, you could lose control of your vehicle. And you could injure yourself or others. Don't shift down more than one gear when you downshift.

If your vehicle has four-wheel drive and is equipped with a manual transmission, disregard the shift light when the transfer case is in 4LO.

Locking Rear Axle

If you have this feature, your rear axle can give you additional traction on snow, mud, ice, sand or gravel. It works like a standard axle most of the time, but when one of the rear wheels has no traction and the other does, the locking feature will allow the wheel with traction to move the vehicle.

All-Wheel Drive (If Equipped)

If your vehicle has all-wheel drive, your engine's driving power is sent to all four wheels for extra traction. This is like four-wheel drive, but there is no lever or switch to engage or disengage the front axle. It is fully automatic and adjusts itself as needed for road conditions.

Four-Wheel Drive (If Equipped)

If your vehicle has four-wheel drive, you can send your engine's driving power to all four wheels for extra traction. To shift out of two-wheel drive and into four-wheel drive, move the transfer case shift lever to 4HI or 4LO. You should use 2HI for most normal driving conditions.

NOTICE:

Driving in the 4HI or 4LO positions for a long time on dry or wet pavement could shorten the life of your vehicle's drivetrain.

Manual Transfer Case

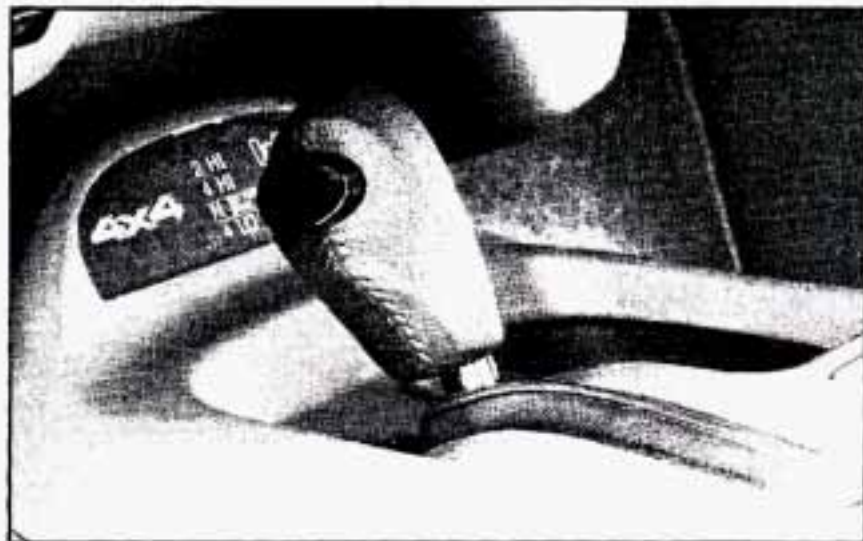

If your four-wheel-drive vehicle has the manual transfer case, the transfer case shift lever is on the floor next to the driver. Use this lever to shift into and out of four-wheel drive.



An indicator light near the lever shows you the transfer case settings:

- 2HI
- 4HI
- N SET PARK BRAKE
- 4LO

The front axle portion of the diagram on the indicator will light up when you shift into four-wheel drive. A slight delay between shifting and the pattern's lighting is normal. If the pattern does not light up, or if the front axle lights do not go out after you shift out of four-wheel drive, have your dealer check your system. Turn the INT LIGHTS switch located to the right of your headlamp switch to dim your transfer case indicator light when your headlamps or parking lamps are on. This will also cause your instrument panel lights to dim.

2HI: This setting is for driving in most street and highway situations. Your front axle is not engaged in two-wheel drive.

4HI: This setting engages your front axle to help drive your vehicle. Use 4HI when you need extra traction, such as on snowy or icy roads, or in most off-road situations.

N SET PARK BRAKE: Shift to this neutral setting only when your vehicle needs to be towed.

4LO: This setting also engages your front axle to give you extra traction and provides extra gear reduction. You may never need 4LO. It sends the maximum power to all four wheels. You might choose 4LO if you were driving off-road in sand, mud or deep snow and climbing or descending steep hills.

You can shift from 2HI to 4HI or from 4HI to 2HI while the vehicle is moving. Do not press the transfer case shift lever button when shifting from 2HI to 4HI or from 4HI to 2HI.

To shift your transfer case into N SET PARK BRAKE:

1. Stop the vehicle and shift your transmission into NEUTRAL (N).
2. Set the parking brake. Your vehicle can roll unless the brakes are applied.
3. Pull the transfer case shift lever into N SET PARK BRAKE.

To shift into or out of 4LO:

1. The vehicle must be moving less than 3 mph (4.8 km/h) with the transmission in NEUTRAL (N) for an automatic transmission. For a manual transmission, the clutch pedal must be engaged. The preferred method for shifting into or out of 4LO is to have your vehicle moving 1 to 2 mph (1.6 to 3.2 km/h).
2. Press the transfer case shift button and shift in one continuous motion.

Don't pause in N SET PARK BRAKE as you shift into or out of 4LO, or your gears could clash.

Remember that driving in 4HI or 4LO may reduce fuel economy. Also, driving in four-wheel drive on dry pavement could cause your tires to wear faster and make your transfer case harder to shift and reduce powertrain longevity.

Electronic Transfer Case (If Equipped)



If your four-wheel-drive vehicle has the electronic transfer case, the transfer case switches are above the radio controls.

Use these switches to shift into and out of four-wheel drive. You can choose among three driving settings:

2HI: This setting is for driving in most street and highway situations. Your front axle is not engaged in two-wheel drive. When this lamp is lit, it is about one-half as bright as the others.

4HI: This setting engages your front axle to help drive your vehicle. Use 4HI when you need extra traction, such as on snowy or icy roads, or in most off-road situations.

4LO: This setting also engages your front axle to give you extra traction. You may never need 4LO. It sends the maximum power to all four wheels. You might choose 4LO if you were driving off-road in sand, mud or deep snow and climbing or descending steep hills.

Indicator lights in the switches show you which setting you are in. The indicator lights will come on briefly when you turn on the ignition and one will stay on. If the lights do not come on, you should take your vehicle in for service. An indicator light will flash while shifting. It will remain illuminated when the shift is completed.

Shifting from 2HI to 4HI

Press and release the 4HI switch. This can be done at any speed, and the front axle will lock automatically.

Shifting from 4HI to 2HI

Press and release the 2HI switch. This can be done at any speed, and the front axle will unlock automatically.

Shifting from 2HI or 4HI to 4LO

To shift from 2HI or 4HI to 4LO, the vehicle must be stopped or moving less than 3 mph (4.8 km/h) with the transmission in NEUTRAL (N) in vehicles equipped with

an automatic transmission or the clutch pedal engaged in vehicles equipped with a manual transmission. The preferred method for shifting into 4LO is to have your vehicle moving 1 to 2 mph (1.6 to 3.2 km/h). Press and release the 4LO switch. You must wait for the 4LO indicator light to stop flashing and remain illuminated before shifting your transmission into gear or releasing the clutch pedal.

If the 4LO switch is pressed when your vehicle is in gear and/or moving, the 4LO indicator light will flash for 30 seconds and not complete the shift unless your vehicle is moving slower than 3 mph (4.8 km/h) and the transmission is in NEUTRAL (N) or the clutch pedal engaged.

On automatic transmission equipped vehicles, if your transfer case does not shift into 4LO, your transmission indicator switch may require adjustment. With your transmission in NEUTRAL (N), press and release the 4LO switch. While the 4LO indicator light is flashing, shift your transmission into PARK (P). Wait until the 4LO indicator light remains illuminated before shifting your transmission into gear. This will get you into 4LO, but you should take your vehicle in for service to restore normal operation.

Shifting from 4LO to 4HI or 2HI

To shift from 4LO to 4HI or 2HI, your vehicle must be stopped or moving less than 3 mph (4.8 km/h) with the transmission in NEUTRAL (N) or the clutch pedal engaged. The preferred method for shifting out of 4LO is to have your vehicle moving 1 to 2 mph (1.6 to 3.2 km/h). Press and release the 4HI switch. You must wait for the 4HI indicator light to stop flashing and remain illuminated before shifting your transmission into gear or releasing the clutch pedal.

If the 4HI switch is pressed when your vehicle is in gear and/or moving, the 4HI indicator light will flash for 30 seconds but not complete the shift unless the vehicle is moving slower than 3 mph (4.8 km/h) and the transmission is in NEUTRAL (N) or the clutch pedal engaged.

On automatic transmission equipped vehicles, if your transfer case does not shift into 4HI, your transmission indicator switch may require adjustment. With your transmission in NEUTRAL (N), press and release the 4HI switch. While the 4HI indicator light is flashing, shift your transmission into PARK (P). Wait until the 4HI indicator light remains illuminated before shifting your transmission into gear. This will get you into 4HI, but you should take your vehicle in for service to restore normal operation.

Parking Brake

To set the parking brake, hold the regular brake pedal down with your right foot. Push down the parking brake pedal with your left foot. If the ignition is on, the brake system warning light will come on.

To release the parking brake hold the regular brake pedal down.



Pull the BRAKE RELEASE lever. It is located on the bottom driver's side of the instrument panel.

NOTICE:

Driving with the parking brake on can cause your rear brakes to overheat. You may have to replace them, and you could also damage other parts of your vehicle.

If you are towing a trailer and you must park on a hill, see "Towing a Trailer" in the Index. That section shows what to do first to keep the trailer from moving.

Shifting Into PARK (P) (Automatic Transmission Models Only)

CAUTION:

It can be dangerous to get out of your vehicle if the shift lever is not fully in PARK (P) with the parking brake firmly set. Your vehicle can roll. If you have left the engine running, the vehicle can move suddenly. You or others could be injured. To be sure your vehicle won't move, even when you're on fairly level ground, use the steps that follow. If you have four-wheel drive with a manual transfer case shift lever and your transfer case is in NEUTRAL (N), your vehicle will be free to roll, even if your shift lever is in PARK (P). So, be sure the transfer case is in a drive gear -- not in NEUTRAL (N). If you're pulling a trailer, see "Towing a Trailer" in the Index.

Column Shift Lever

1. Hold the brake pedal down with your right foot and set the parking brake.
2. Move the shift lever into PARK (P) position like this:

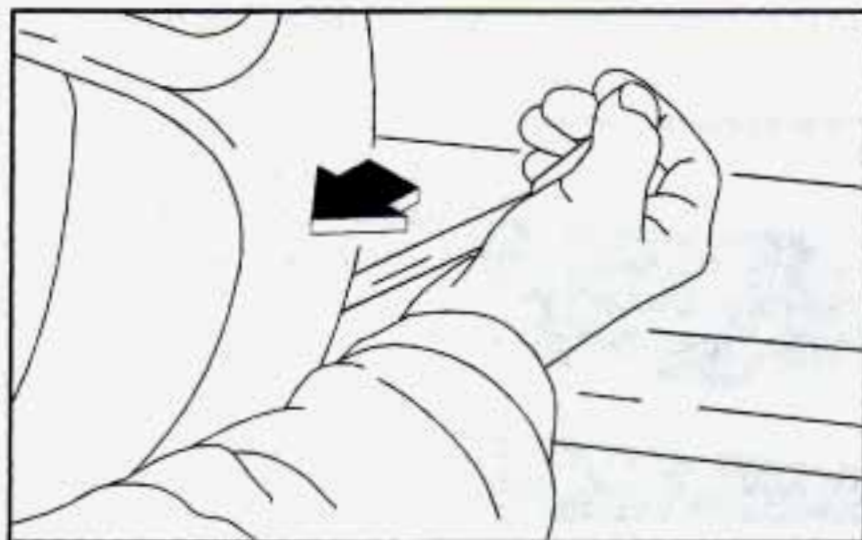

- Pull the lever toward you.

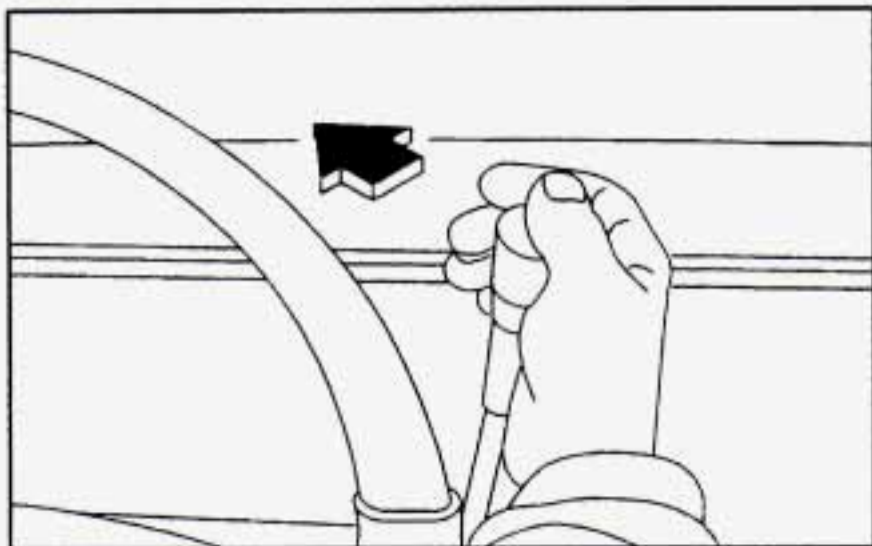

- Move the lever up as far as it will go.

3. If you have four-wheel drive with a manual transfer case shift lever, be sure the transfer case is in a drive gear -- not in NEUTRAL (N).
4. Turn the ignition key to LOCK.
5. Remove the key and take it with you. If you can leave your vehicle with the key, your vehicle is in PARK (P).

Console Shift Lever

1. Hold the brake pedal down with your right foot and set the parking brake.
2. Move the shift lever into PARK (P) position like this:



- Hold in the button on the lever.
 - Push the lever all the way toward the front of the vehicle.
3. Turn the ignition key to LOCK.
 4. Remove the key and take it with you. If you can leave your vehicle with the key, your vehicle is in PARK (P).

Leaving Your Vehicle With the Engine Running (Automatic Transmission Models Only)

CAUTION:

It can be dangerous to leave your vehicle with the engine running. Your vehicle could move suddenly if the shift lever is not fully in PARK (P) with the parking brake firmly set. If you have four-wheel drive with a manual transfer case shift lever and your transfer case is in NEUTRAL (N), your vehicle will be free to roll, even if your shift lever is in PARK (P). So be sure the transfer case is in a drive gear -- not in NEUTRAL (N). And, if you leave the vehicle with the engine running, it could overheat and even catch fire. You or others could be injured. Don't leave your vehicle with the engine running unless you have to.

If you have to leave your vehicle with the engine running, be sure your vehicle is in PARK (P) and your

parking brake is firmly set before you leave it. After you've moved the shift lever into the PARK (P) position, hold the regular brake pedal down. Then, see if you can move the shift lever away from PARK (P) without first pulling it toward you (or pressing the button on a console shift lever). If you can, it means that the shift lever wasn't fully locked into PARK (P).

Torque Lock (Automatic Transmission)

If you are parking on a hill and you don't shift your transmission into PARK (P) properly, the weight of the vehicle may put too much force on the parking pawl in the transmission. You may find it difficult to pull the shift lever out of PARK (P). This is called "torque lock." To prevent torque lock, set the parking brake and then shift into PARK (P) properly before you leave the driver's seat. To find out how, see "Shifting Into PARK (P)" in the Index.

When you are ready to drive, move the shift lever out of PARK (P) *before* you release the parking brake.

If torque lock does occur, you may need to have another vehicle push yours a little uphill to take some of the pressure from the parking pawl in the transmission, so you can pull the shift lever out of PARK (P).

Shifting Out of PARK (P) (Automatic Transmission)

Your vehicle has a brake-transmission shift interlock. You have to fully apply your regular brake before you can shift from PARK (P) when the ignition is in the RUN position. See “Automatic Transmission Operation” in the Index.

If you cannot shift out of PARK (P), ease pressure on the shift lever -- push the shift lever all the way into PARK (P) as you maintain brake application. Then move the shift lever into the gear you want (you must press the shift lever button if you have the console shift lever).

If you ever hold the brake pedal down but still can't shift out of PARK (P), try this:

1. Turn the key to OFF.
2. Apply and hold the brake until the end of Step 4.
3. Shift to NEUTRAL (N).
4. Start the vehicle and then shift to the drive gear you want.
5. Have the vehicle fixed as soon as you can.

Parking Your Vehicle (Manual Transmission Models Only)

Before you get out of your vehicle, turn off your engine, put your manual transmission in REVERSE (R) and firmly apply the parking brake.

If you have four-wheel drive with a manual transfer case shift lever, be sure your transfer case is in a drive gear. Your vehicle could roll if it isn't.

If you are parking on a hill, or if your vehicle is pulling a trailer, see “Towing a Trailer” in the Index.

Parking Over Things That Burn

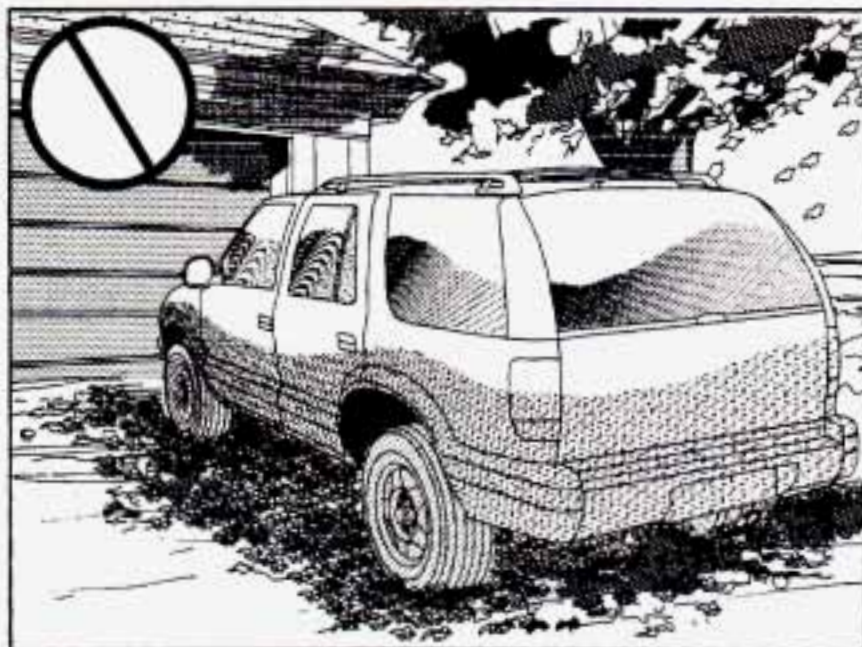

CAUTION:

Things that can burn could touch hot exhaust parts under your vehicle and ignite. Don't park over papers, leaves, dry grass or other things that can burn.

Engine Exhaust

CAUTION:

Engine exhaust can kill. It contains the gas carbon monoxide (CO), which you can't see or smell. It can cause unconsciousness and death.

You might have exhaust coming in if:

- Your exhaust system sounds strange or different.
- Your vehicle gets rusty underneath.
- Your vehicle was damaged in a collision.
- Your vehicle was damaged when driving over high points on the road or over road debris.
- Repairs weren't done correctly.
- Your vehicle or exhaust system had been modified improperly.

If you ever suspect exhaust is coming into your vehicle:

- Drive it only with all the windows down to blow out any CO; and
- Have your vehicle fixed immediately.

Running Your Engine While You're Parked (Automatic Transmission)

It's better not to park with the engine running. But if ever have to, here are some things to know.

CAUTION:

Idling the engine with the air system control off could allow dangerous exhaust into your vehicle (see the earlier Caution under "Engine Exhaust").

Also, idling in a closed-in place can let deadly carbon monoxide (CO) into your vehicle even if the fan switch is at the highest setting. One place this can happen is a garage. Exhaust -- with CO -- can come in easily. NEVER park in a garage with the engine running.

Another closed-in place can be a blizzard. (See "Blizzard" in the Index.)

CAUTION:

It can be dangerous to get out of your vehicle if the shift lever is not fully in PARK (P) with the parking brake firmly set. Your vehicle can roll. Don't leave your vehicle when the engine is running unless you have to. If you've left the engine running, the vehicle can move suddenly. You or others could be injured. To be sure your vehicle won't move, even when you're on fairly level ground, always set your parking brake and move the shift lever to PARK (P).

If you have four-wheel drive with a manual transfer case shift lever and your transfer case is in NEUTRAL (N), your vehicle will be free to roll, even if your shift lever is in PARK (P). So, be sure the transfer case is in a drive gear -- not in NEUTRAL (N). Always set your parking brake. Follow the proper steps to be sure your vehicle won't move. See "Shifting Into PARK (P)" in the Index.

If you're pulling a trailer, see "Towing a Trailer" in the Index.

Windows

Manual Windows

Turn the hand crank on each door to raise or lower your manual side door windows.

Power Windows (If Equipped)

If you have the optional power windows, the controls are on each of the side doors. Your power windows will only work when the ignition has been turned to RUN. The driver's door has a switch for the passenger windows as well.



Press the side of the switch with the down arrow to lower the window.

Press the side of the switch with the up arrow to raise the window.

Express-Down Window

The driver's window switch has an express-down feature that allows you to lower it without holding the window switch. Hold the driver's window switch down for more than a half a second to activate the express-down feature. Lightly tap the switch to open the window slightly. The express-down feature can be interrupted at any time by pressing the up arrow end of the switch.

Lockout Switch

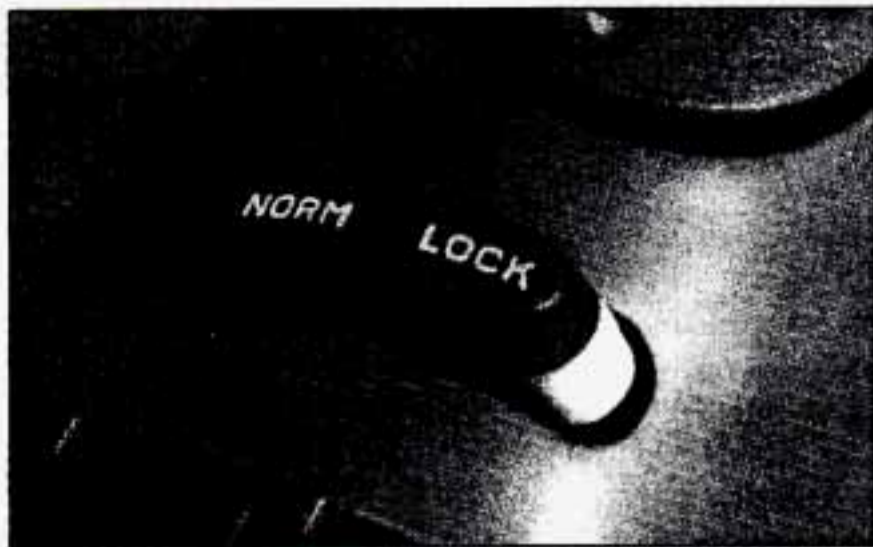

Four-door vehicles have a lockout feature to prevent passengers from operating power windows. It is located on the driver's door. Press LOCK to activate this feature. Press NORM and the windows return to normal operation.

Swing-Out Windows (2-Door Only)



If your vehicle has rear swing-out windows, unlatch them at their clasps and push out on the glass to open them.

When you close the window, be sure the latch catches.

Horn

To sound the horn, press the horn symbols on the steering wheel pad.

Tilt Wheel (If Equipped)



If you have the tilt steering wheel, you should adjust the steering wheel before you drive.

You can raise it to the highest level to give your legs more room when you enter and exit the vehicle.

To tilt the wheel, hold the steering wheel and pull the lever toward you. Move the steering wheel to a comfortable level, then release the lever to lock the wheel in place.

Do not adjust the steering wheel while driving.

Turn Signal/Multifunction Lever

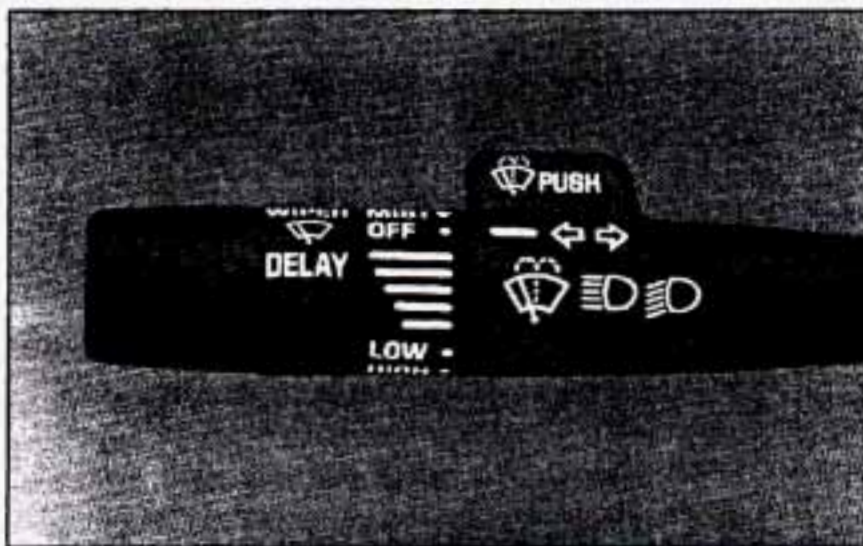

The lever on the left side of the steering column includes your:

- Turn Signal and Lane Change Indicator
- Headlamp High/Low Beam Changer
- Windshield Wipers
- Windshield Washer
- Cruise Control (If Equipped)

Turn and Lane Change Signals

The turn signal has two upward (for right) and two downward (for left) positions. These positions allow you to signal a turn or a lane change.

To signal a turn, move the lever all the way up or down. When the turn is finished, the lever will return automatically.

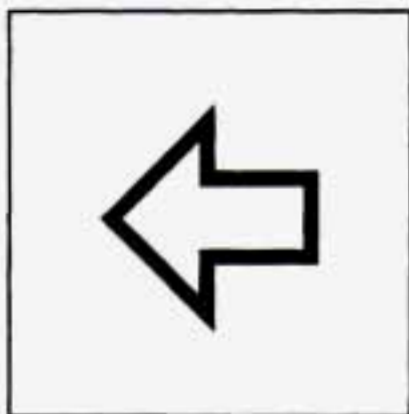

An arrow on the instrument panel will flash in the direction of the turn or lane change.

To signal a lane change, just raise or lower the lever until the arrow starts to flash. Hold it there until you complete your lane change. The lever will return by itself when you release it.

As you signal a turn or a lane change, if the arrows don't flash but just stay on, a signal bulb may be burned out and other drivers won't see your turn signal.

If a bulb is burned out, replace it to help avoid an accident. If the arrows don't go on at all when you signal a turn, check the fuse (see "Fuses and Circuit Breakers" in the Index) and for burned-out bulbs.

If you have a trailer towing option with added wiring for the trailer lamps, a different turn signal flasher is used. With this flasher installed, the signal indicator will flash even if a turn signal bulb is burned out. Check the front and rear turn signal lamps regularly to make sure they are working.

Headlamp High/Low Beam Changer

To change the headlamps from low-beam to high or high to low, pull the multifunction lever all the way toward you. Then release it.

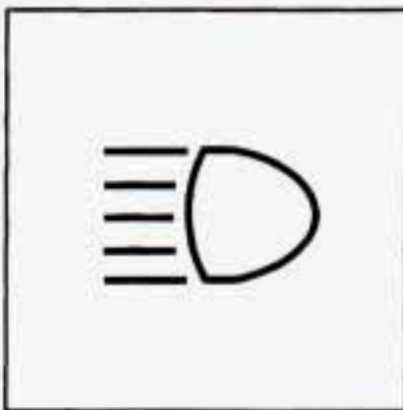

When the high beams are on, this indicator light on the instrument panel will also be on.

Windshield Wipers



You control the windshield wipers by turning the band with the wiper symbol on it.

For a single wiping cycle, turn the band to MIST. Hold it there until the wipers start, then let go. The wipers will stop after one wipe. If you want more wipes, hold the band on MIST longer.

You can set the wiper speed for a long or short delay between wipes. This can be very useful in light rain or snow. Turn the band to choose the delay time. The closer to LOW, the shorter the delay.

For steady wiping at low speed, turn the band away from you to the LOW position. For high-speed wiping, turn the band further, to HIGH. To stop the wipers, move the band to the OFF position.

Be sure to clear ice and snow from the wiper blades before using them. If they're frozen to the windshield, carefully loosen or thaw them. If your blades do become worn or damaged, get new blades or blade inserts.

Windshield Washer

At the top of the multifunction lever there's a paddle marked with the windshield washer symbol and PUSH. To spray washer fluid on the windshield, press the paddle. The wipers will clear the window and then either stop or return to your preset speed.

CAUTION:

In freezing weather, don't use your washer until the windshield is warmed. Otherwise the washer fluid can form ice on the windshield, blocking your vision.

Rear Window Washer/Wiper

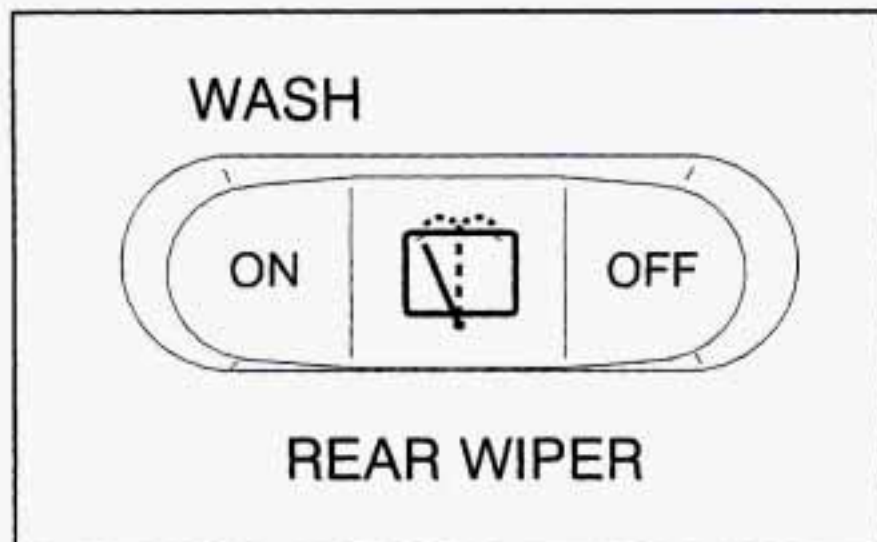

This switch is located on the instrument panel.

The rear window wiper operates with a constant five second delay when the rear wiper switch is in the ON position. If the rear glass is opened, the wiper arm will automatically park on the endgate. When the glass is completely closed, the wiper will resume the delay mode.

To wash the window, press and hold ON. The wipers will continue to work after you release the switch.

Press OFF to turn the wiper off.

The rear window washer uses the same fluid bottle as the windshield washer. However, the rear window washer will run out of fluid before the windshield washer. If you can wash your windshield but not your rear window, check your fluid level.

Cruise Control (If Equipped)



With cruise control, you can maintain a speed of about 25 mph (40 km/h) or more without keeping your foot on the accelerator. This can really help on long trips. Cruise control does not work at speeds below about 25 mph (40 km/h).

If you have an automatic transmission and you apply your brakes, the cruise control will shut off.

If you have a manual transmission and you apply your brakes or push the clutch pedal, the cruise control will shut off.

CAUTION:

- Cruise control can be dangerous where you can't drive safely at a steady speed. So, don't use your cruise control on winding roads or in heavy traffic.
- Cruise control can be dangerous on slippery roads. On such roads, fast changes in tire traction can cause needless wheel spinning, and you could lose control. Don't use cruise control on slippery roads.

Setting Cruise Control

CAUTION:

If you leave your cruise control switch on when you're not using cruise, you might hit a button and go into cruise when you don't want to. You could be startled and even lose control. Keep the cruise control switch OFF until you want to use it.

1. Move the cruise control switch to ON.
2. Get up to the speed you want.



3. Press in the SET button at the end of the lever and release it.
4. Take your foot off the accelerator pedal.

Resuming a Set Speed

Suppose you set your cruise control at a desired speed and then you apply the brake. This, of course, shuts off the cruise control. But you don't need to reset it.



Once you're going about 25 mph (40 km/h) or more, you can move the cruise control switch from ON to R/A for about a half a second.

You'll go right back up to your chosen speed and stay there.

Remember, if you hold the switch at R/A longer than a half a second, the vehicle will keep going faster until you release the switch or apply the brake. You could be startled and even lose control. So unless you want to go faster, don't hold the switch at R/A.

Increasing Speed While Using Cruise Control

There are two ways to go to a higher speed:

- Use the accelerator pedal to get to the higher speed. Press the button at the end of the lever, then release the button and the accelerator pedal. You'll now cruise at the higher speed.
- Move the cruise switch from ON to R/A. Hold it there until you get up to the speed you want, and then release the switch. (To increase your speed in very small amounts, move the switch to R/A. Each time you do this, your vehicle will go about 1 mph (1.6 km/h) faster.)

Reducing Speed While Using Cruise Control

Press in the button at the end of the lever until you reach the lower speed you want, then release it.

To slow down in very small amounts, press the button for less than a half a second. Each time you do this, you'll go 1 mph (1.6 km/h) slower.

Passing Another Vehicle While Using Cruise Control

Use the accelerator pedal to increase your speed. When you take your foot off the pedal, your vehicle will slow down to the cruise control speed you set earlier.

Using Cruise Control on Hills

How well your cruise control will work on hills depends upon your speed, load and the steepness of the hills. When going up steep hills, you may want to step on the accelerator pedal to maintain your speed. When going downhill, you may have to brake or shift to a lower gear to keep your speed down. Of course, applying the brake takes you out of cruise control. Many drivers find this to be too much trouble and don't use cruise control on steep hills.

Ending Cruise Control

There are two ways to turn off the cruise control:

- Step lightly on the brake pedal or push the clutch pedal, if you have a manual transmission.
- Move the cruise switch to OFF.

Erasing Speed Memory

When you turn off the cruise control or the ignition, your cruise control set speed memory is erased.

Exterior Lamps

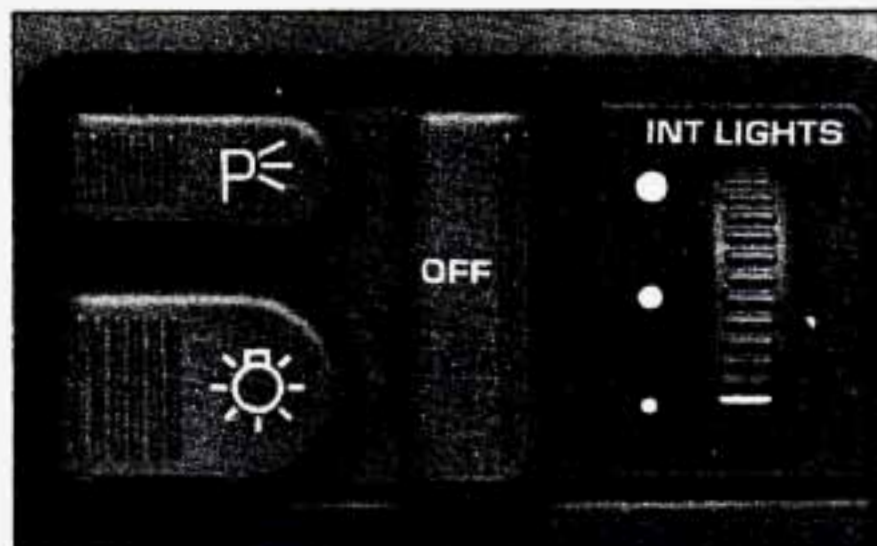

The switches are on the left side of your instrument panel.

Press the top switch with the parking lamps symbol on it to turn on:

- Parking Lamps
- Sidemarker Lamps
- Taillamps
- License Plate Lamps
- Instrument Panel Lights
- Transfer Case Indicator Light (if you have one)

Press the bottom switch with the master lamps symbol on it to turn on all the lamps listed as well as the headlamps.

Press the side of the switch marked OFF to turn off your lamps.

Lamps On Reminder

A reminder tone will sound when your headlamps or parking lamps are turned on and your ignition is in OFF, LOCK or ACCESSORY. To turn the tone off, press the OFF switch.

Daytime Running Lamps

Daytime Running Lamps (DRL) can make it easier for others to see the front of your vehicle during the day. DRL can be helpful in many different driving conditions, but they can be especially helpful in the short periods after dawn and before sunset.

The DRL system will make your headlamps come on at reduced brightness when:

- the ignition is on,
- the headlamp switch is off and
- the parking brake is released.

When the DRL are on, only your headlamps will be on. The taillamps, sidemarker and other lamps won't be on. The instrument panel won't be lit up either.

When it begins to get dark, your DRL indicator light is a reminder to turn your headlamp switch on. The other lamps that come on with your headlamps will also come on.

When you turn the headlamp switch off, the regular lamps will go off, and your headlamps will change to the reduced brightness of DRL.

To idle your vehicle with the DRL off, set the parking brake. The DRL will stay off until you release the parking brake.

As with any vehicle, you should turn on the regular headlamp system when you need it.

Fog Lamps (If Equipped)



Use your fog lamps for better vision in foggy or misty conditions. Your parking lamps or low-beam headlamps must be on for your fog lamps to work.

The fog lamp switch is on the instrument panel under the lamps switches. Press the side of the switch with the fog lamp symbol to turn the fog lamps on. Press OFF to turn them off. A light will glow in the switch when the fog lamps are on.

Remember, fog lamps alone will not give off as much light as your headlamps. Never use your fog lamps in the dark without turning on your headlamps.

Fog lamps will go off whenever your high-beam headlamps come on. When the high beams go off, the fog lamps will come on again.

Interior Lamps

Brightness Control

Turn the switch next to the headlamp switch up to make your instrument panel and transfer case lights brighter. Turn the switch all the way up to turn on the interior lamps.

Front Reading Lamps (If Equipped)

Press the button near each lamp on the overhead console to turn the reading lamps on and off. The lamps can be swiveled to point in the desired direction.

If you have the miniconsole, press the lens on each reading lamp to turn it on or off.

Front Map Lamps (If Equipped)

If your vehicle has optional front map lamps, they are located on the inside rearview mirror. They will automatically come on for approximately 20 seconds when either front door is opened or unlocked with the Keyless Entry System, if so equipped, or until the ignition key is turned to RUN or ACCESSORY. The lamps will also stay on for approximately 15 seconds after you exit the vehicle.

They will also stay on for 15 seconds when the INT LIGHTS switch on the instrument panel is turned on then off, while the ignition is off.

You can also turn the lamps on and off by pressing the switch near each lamp.

Dome Lamps

The rear dome lamp has a switch that lets you turn it on from the rear of the vehicle.

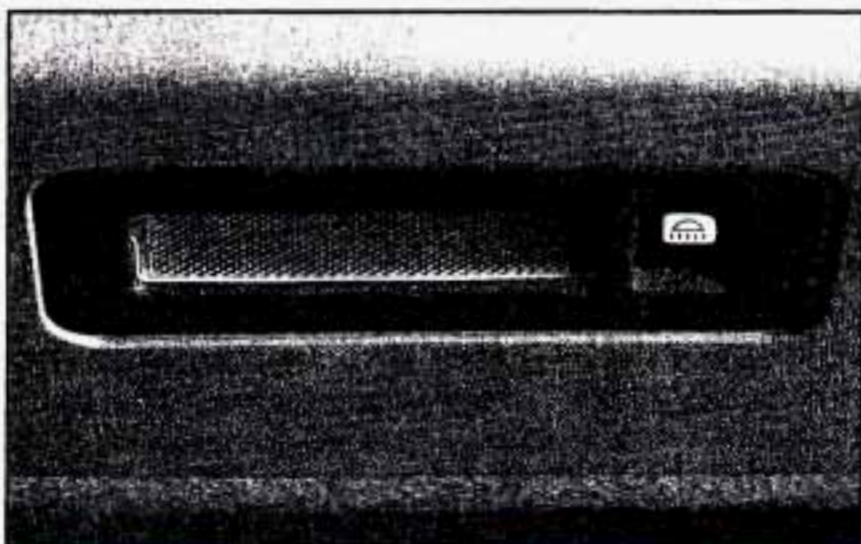

Press the side of the switch with the lamp symbol to turn on the front and rear dome lamps. Pressing the other side of the switch will turn the cargo area dome lamp off, even when the endgate or liftgate and doors are open.

Mirrors

Inside Day/Night Rearview Mirror

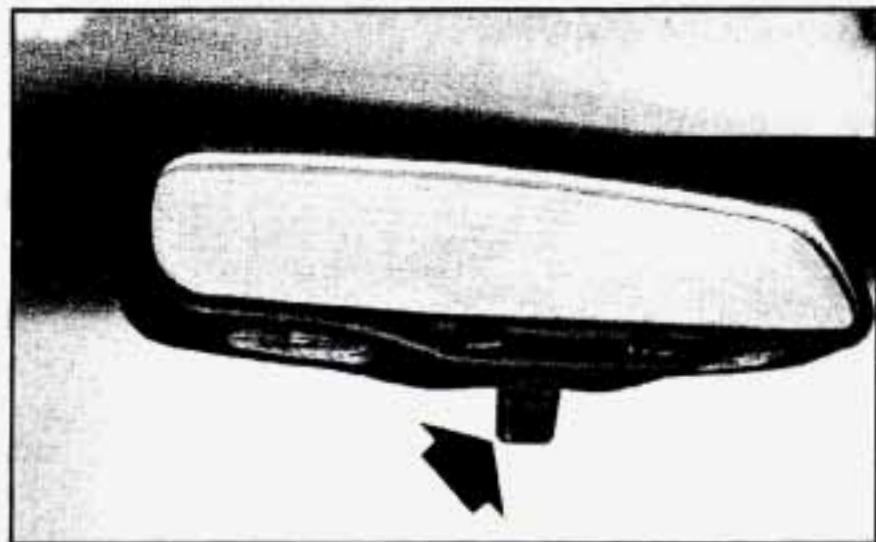

Press the tab under the mirror to reduce glare from headlamps behind you.

Outside Manual Adjust Mirror

Adjust your outside mirrors so you can just see the side of your vehicle.

You can fold them before entering a car wash. Pull the mirrors in toward the vehicle. Push the mirrors back out when finished.

Power Remote Control Mirror



The control is located on the driver's door armrest. Turn the control to L or R to choose the mirror, then press the arrows on the outside switch ring to adjust the mirror.

Convex Outside Mirror

Your passenger's side mirror is convex. A convex mirror's surface is curved so you can see more from the driver's seat.

CAUTION:

A convex mirror can make things (like other vehicles) look farther away than they really are. If you cut too sharply into the right lane, you could hit a vehicle on your right. Check your inside mirror or glance over your shoulder before changing lanes.

Storage Compartments

Glove Box

To open your glove box, squeeze the lever at the top of the glove box and lower the door. Two cup depressions are provided for your convenience, but the glove box should not be open while driving.

Overhead Console (If Equipped)



The overhead console includes reading lamps, a compartment for a garage door opener, a temperature and compass display and a storage compartment for sunglasses.

Reading Lamps



Press the button near each lamp to turn the reading lamps on and off.

The lamps can also be swiveled to point in the desired direction.

Installing a Garage Door Opener

If you have a garage door opener, the front overhead compartment can be used to conveniently store the opener.

To install the garage door opener, first open the compartment door by pressing the latch forward.



Peel the protective backing from the hook and loop patch.

Press it firmly to the back of your garage door opener, as close to the center of the opener as possible.

Center the garage door opener activation button over the console door button and press the opener firmly into place.



The pegs inside the compartment door are used to make sure the button on the compartment door will contact the control button on the garage door opener.

Add one peg at a time until the garage door opener operates with the compartment door closed when you press the button.



Now, with the compartment door closed, press the button again to make sure the garage door opener operates properly.

With the garage door opener positioned properly and the right number of pegs in place, you should only have to press the button slightly to operate the opener. Adjust the position of the garage door opener and add or remove pegs, as needed, until the opener operates properly.

Temperature and Compass Display



The outside air temperature and the compass are displayed at the front of the overhead console. The control switches are located to the left of the display.

Turn the display on or off by pressing the ON/OFF switch. Display the temperature in either degrees Fahrenheit (English) or Celsius (metric) by pressing the US/MET switch.

Before you turn on the ignition and move the vehicle, the temperature indicated will be the last outside temperature recorded with the ignition on.

If the outside temperature is 37°F (3°C) or lower when you turn on the ignition, ICE will appear on the display. This is a warning to the driver that road conditions may be icy, and that appropriate precautions should be taken.

The compass is self-calibrating, so it does not need to be manually set. However, when your vehicle is new, the compass may function erratically. If it does, CAL (Calibration) will appear on the display. To correct the problem, drive in a complete 360° circle three times, and the compass will function normally.

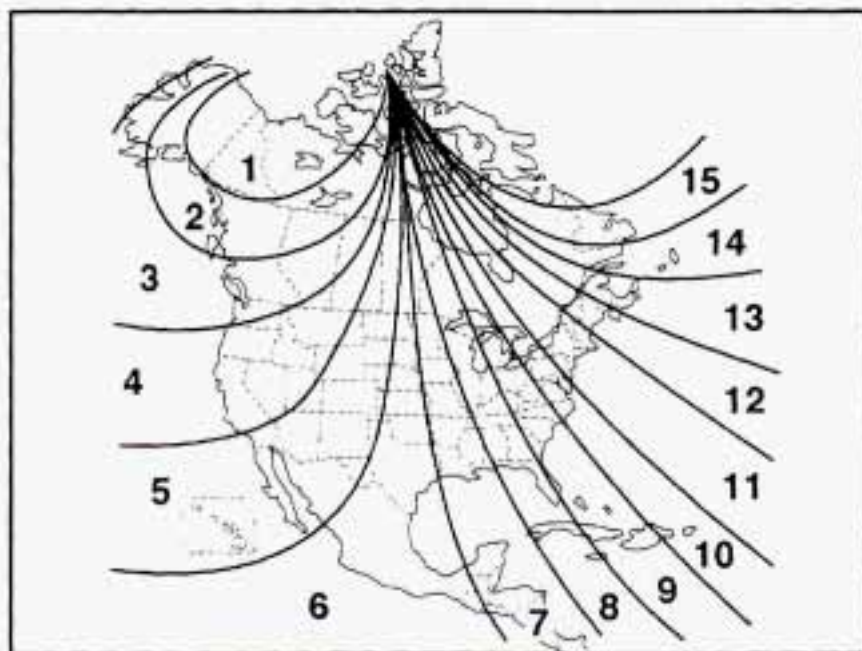

Variance is the difference between magnetic north and geographic north. In some areas, the difference between the two can be great enough to cause false compass readings. If this happens, follow these instructions to set the variance for your particular location:

1. Find your location on the zone map. Note your zone number.

2. Press and hold both the ON/OFF and the US/MET switches. The display will go off.
3. After five seconds, VAR CAL will appear on the display. When it does, release both buttons.
4. Press US/MET until your zone number appears on the display.
5. Press ON/OFF to enter your zone number. Your variance is now set.

Driver Information System (If Equipped)

This system displays the outside air temperature, compass direction and trip information in the overhead console.

The US/MET (United States/metric) button allows you to switch the display between the English and metric system.

The MODE button can be used to toggle between three modes of operation: OFF, COMP/TEMP and TRIP.

OFF: This turns the system off.

COMP/TEMP: The display provides the outside temperature and one of eight compass readings to indicate the direction the vehicle is facing.

The compass is self-calibrating, so it does not need to be manually set. However, if C (Calibration) is displayed, the compass will need to be calibrated. You may also place the compass in a noncalibrated mode by pressing and holding the MODE and US/MET buttons simultaneously while in the COMP/TEMP mode. After about 10 seconds, the compass will display C and you can release the buttons. Drive the vehicle in a complete 360° circle three times at a speed of less than 5 mph (8 km/h), and the compass will function normally. Once the calibration is complete, the display will return to a compass reading.

Variance is the difference between magnetic north and geographic north. In some areas, the difference between the two can be great enough to cause false compass readings. If this happens, follow these instructions to set the variance for your particular location:

1. Find your location on the zone map earlier in this section. Note your zone number.
2. Press and hold both the MODE and the US/MET buttons in the COMP/TEMP mode.
3. After five seconds, the compass will acknowledge the variation mode by displaying the current zone number. When it does, release both buttons.
4. Press US/MET until your zone number appears on the display.

5. Press MODE to enter your zone number. Your variance is now set and the display will return to the COMP/TEMP mode.

TRIP: Once in the TRIP mode, pressing the MODE button will step you through the following TRIP functions:

- **AVG ECON:** The average fuel economy since the last reset is displayed.
- **INST ECON:** Instantaneous fuel economy for the last second of driving is displayed.
- **RANGE:** The display indicates the estimated distance that can be travelled with the remaining fuel in the tank, based on the fuel economy for the last few hours of driving.
- **FUEL USED:** The fuel used since the last reset is displayed.
- **AVG SPEED:** The average speed since the last reset is displayed.

To reset the trip computer, press the MODE and US/MET buttons simultaneously for at least two seconds. All functions will be displayed for half a second once the system is reset. Reset can only be performed in the AVG ECON, FUEL USED and AVG SPEED modes. All three modes are reset simultaneously.

Sunglasses Storage Compartment

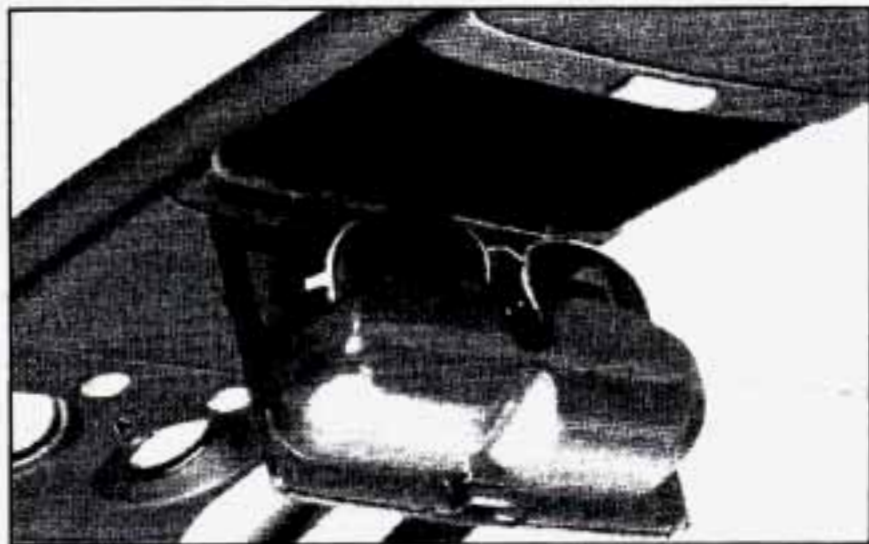

The console has a sunglasses storage compartment.

Door Storage

You will find a storage compartment on each of the front doors.

Four-door models have storage pockets and cupholders on rear doors.

Front Storage Area

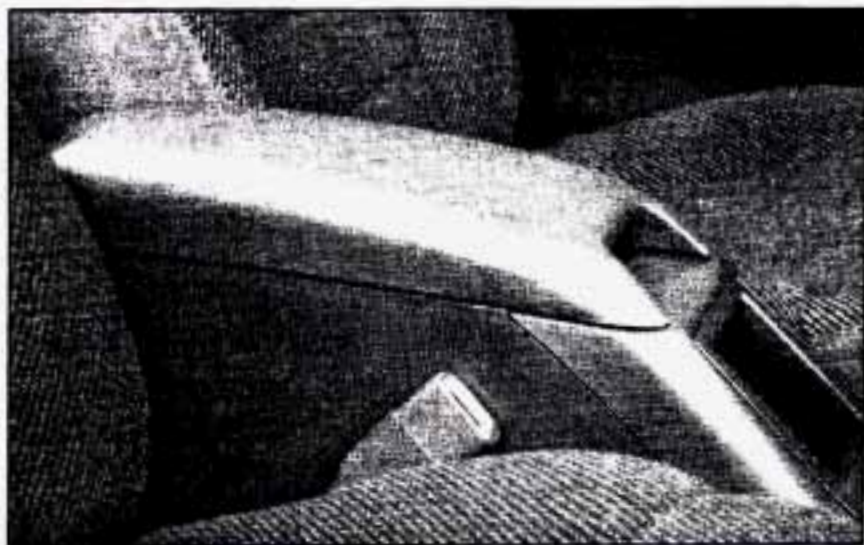

If your vehicle has this console compartment, squeeze the front lever while lifting the top to open it. You can store cassettes in the slots in the front of the compartment. If you have a compact disc player, you may store compact discs inside the console.

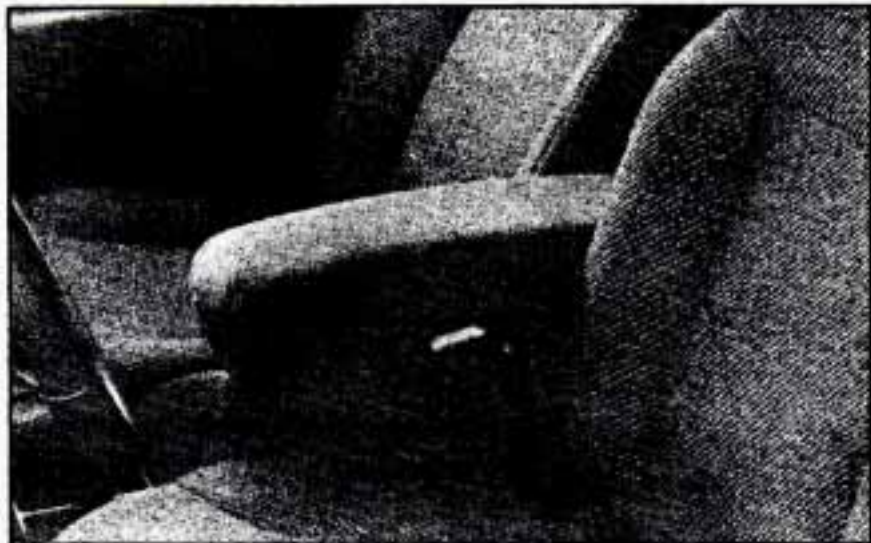

If your vehicle has the center armrest compartment, lift the cover to expose the storage area which includes slots for cassettes and a coinholder.

A storage compartment under your radio may be used to hold small items.

Convenience Net (If Equipped)

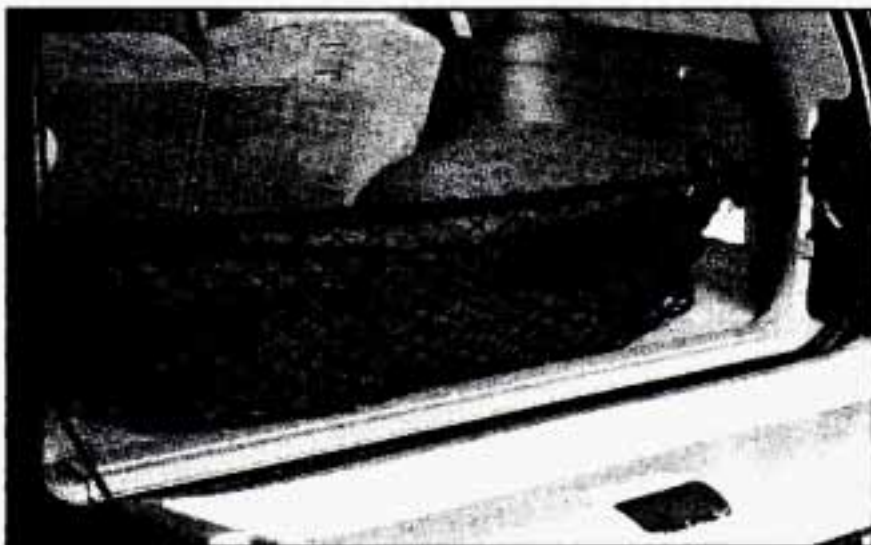

You may have a convenience net in the rear of your vehicle to help keep small items, like gloves and light clothing in place during sharp turns or quick stops and starts.

The net is not designed to retain these items during off-road use. The net is not for larger, heavier items.

The convenience net is anchored to the endgate door. Attach the upper loops to the retainers on either side of the endgate opening (the label should be in the upper passenger side corner, visible from the rear of vehicle). Attach the lower hooks to the rear cargo tie downs on the floor.

Roll-Up Cargo Cover (If Equipped)

If you have the optional cargo cover, you can use it to cover items in the cargo area of your vehicle.

Grasp the handle and unroll the cover. Latch the posts into the sockets on the inside trim panel on the passenger's side of the vehicle to secure it.

CAUTION:

An improperly stored cargo cover could be thrown about the vehicle during a collision or sudden maneuver. You or others could be injured. If you remove the cover, always store it outside of the vehicle. When you put it back, always be sure that it is securely reattached.

Cargo Tie Downs

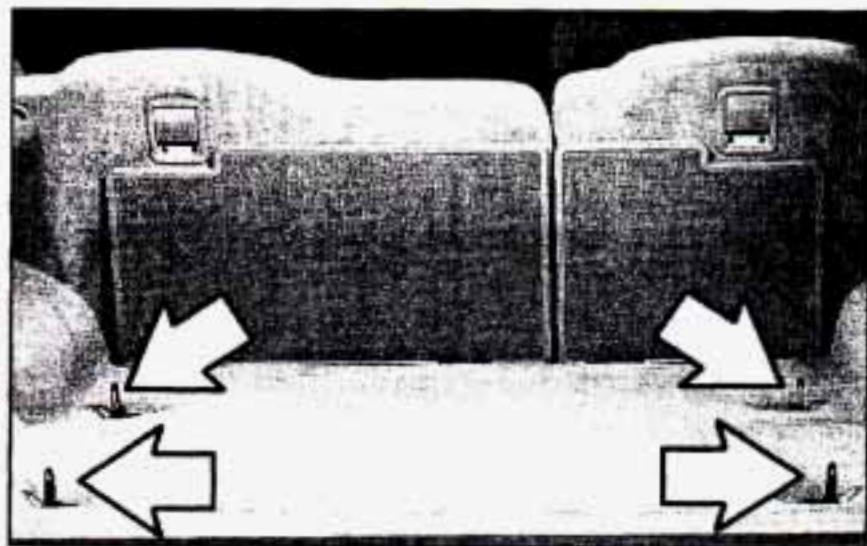

There are four cargo tie downs in the rear that allow you to strap cargo in and keep it from moving inside the vehicle.

Luggage Carrier (If Equipped)

 **CAUTION:**

If you try to carry something on top of your vehicle that is longer or wider than the luggage carrier -- like paneling, plywood, a mattress, and so forth -- the wind can catch it as you drive along. This can cause you to lose control. What you are carrying could be violently torn off, and this could cause you or other drivers to have a collision, and of course damage your vehicle. You may be able to carry something like this inside. But, never carry something longer or wider than the luggage carrier on top of your vehicle.

The luggage carrier has slats, side rails and crossrails attached to the roof to secure cargo. The moveable tie downs, attached to the side rails, should be used to secure loads to the luggage carrier.

Use GM accessory racks that are compatible with your luggage carrier for transporting sports equipment. These are available through your GM dealer.

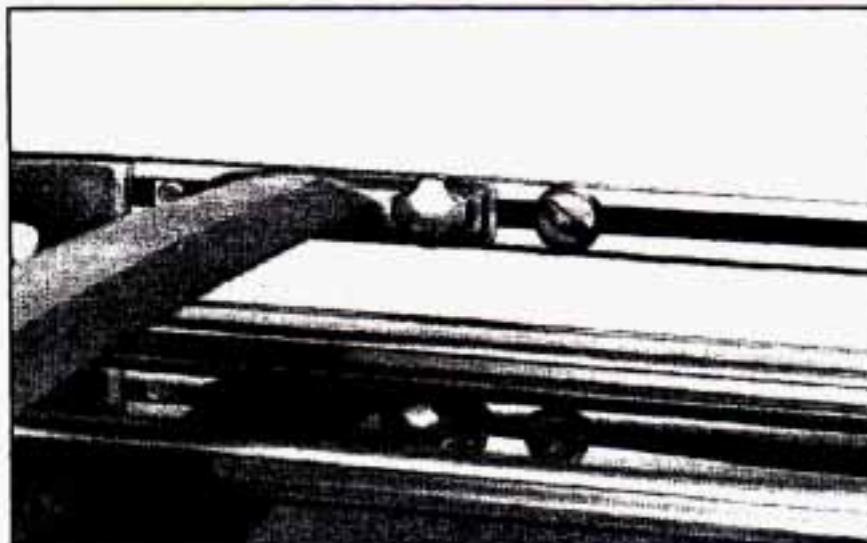

Remove the center rubber strips in the crossrails and attach the GM accessory rack to the nut plates provided through the center slots (four per crossrail).

The tap plates can be moved to accommodate various positions by sliding them inside the crossrail to the desired locations before mounting the accessory rack.

You can adjust the crossrails to handle different sized loads. Just loosen the slider knobs at each end of the crossrail and move them to where you want them. Make sure both sides of the crossrail are even, then tighten the slider knobs.

Be sure the cargo is properly loaded. Follow these guidelines:

- Carrying small, heavy loads on the roof is not recommended.
- Tie the load to the moveable tie down (two per each side of the side rails). Use the crossrails only to keep the load from sliding.
- If you need to carry long items, move the crossrails as far apart as possible. Tie the load to the moveable tie downs provided in the side rails. Also tie the load to the bumpers. Do not tie the load so tightly that the crossrails or side rails are damaged.

NOTICE:

Loading cargo that weighs more than 200 lbs. (91 kg) on the luggage carrier may damage your vehicle. When you carry large things, never let them hang over the rear or the sides of your vehicle. Load your cargo so that it rests on the slats and does not scratch or damage the vehicle. Put the cargo against the side rails and fasten it securely to the luggage carrier. Put the main weight as far forward as you can.

Don't exceed the maximum vehicle capacity when loading your vehicle. For more information on vehicle capacity and loading, see "Loading Your Vehicle" in the Index.

To prevent damage or loss of cargo as you're driving, check now and then to make sure the luggage carrier and cargo are still securely fastened.

Ashtrays and Cigarette Lighter

To use the lighter, press it in all the way, and let go. When it's ready, it will pop back by itself.

NOTICE:

Don't hold a cigarette lighter in with your hand while it is heating. If you do, it won't be able to back away from the heating element when it's ready. That can make it overload, damaging the lighter and the heating element.

The front ashtray must be completely pulled out to the open position before the ashtray cover opens and smoking material can be deposited.

NOTICE:

Don't put papers and other things that burn into your ashtray. If you do, cigarettes or other smoking materials could set them on fire causing damage.

To remove the front ashtray, lift the release tab as high as possible, then remove the tray.

Four-door vehicles have smaller ashtrays inside the rear doors. Press **PUSH** to turn the ashtray around for use.

Sun Visors

To block out glare, you can swing down the top and bottom visors. You can also swing the bottom visor from side to side. Your visors may have an extension that can be pulled out for additional glare protection and a strap for holding small items, such as maps.

Visor Vanity Mirror

Pull the sun visor down and lift the cover to expose the vanity mirror.

Illuminated Visor Vanity Mirror (If Equipped)

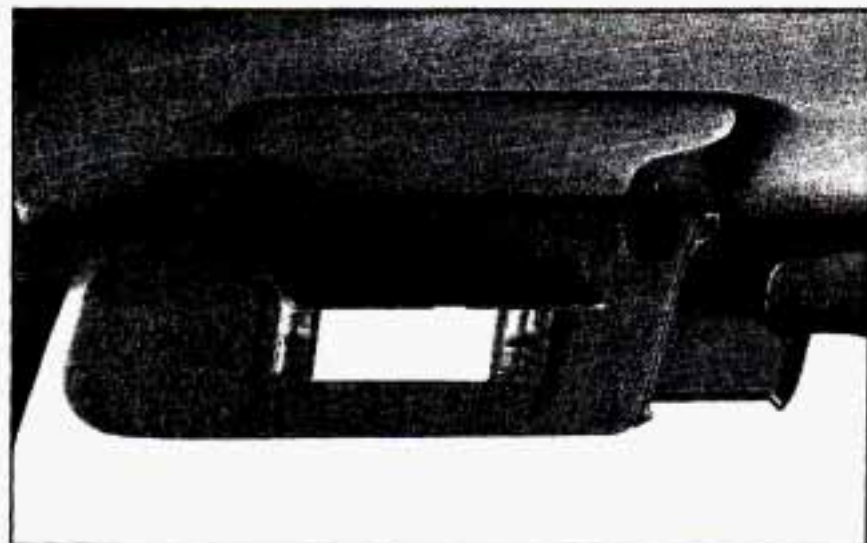

Pull the sun visor down and lift the mirror cover to turn on the lamps.

Accessory Power Outlets (If Equipped)

If you have accessory power outlets, you can plug in auxiliary electrical equipment. The accessory power outlets are located below the cigarette lighter. Just pull down from the top of the door and follow the proper installation instructions that are included with any electrical equipment you install.

These circuits are protected by a fuse and have maximum current levels.

NOTICE:

When using the accessory power outlets, maximum electrical load must not exceed 25 amps. Always turn off any electrical equipment when not in use. Leaving electrical equipment on for extended periods will drain your battery.

Sunroof (If Equipped)

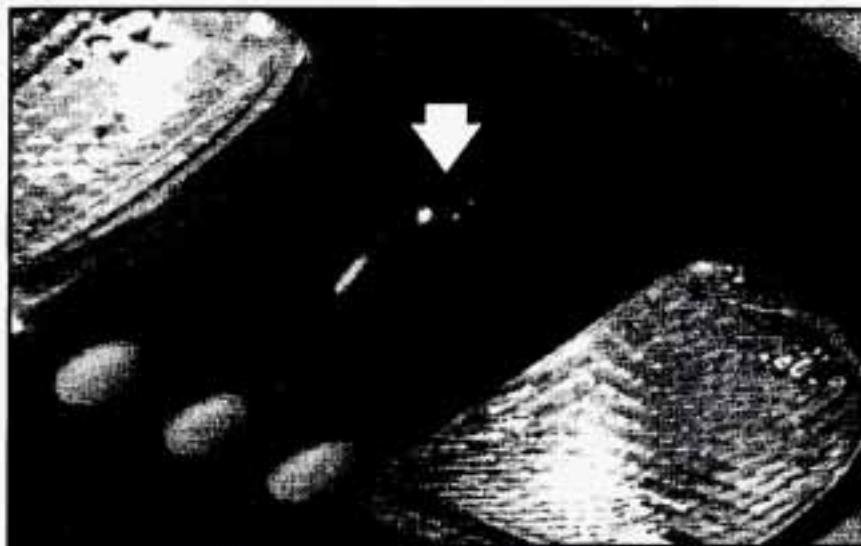

Your vehicle may be equipped with a power sliding sunroof. Press and release the rear side of the button in the miniconsole to open the sunroof. You can press the forward side of the button to close the sunroof. Once the sunroof is closed, press the forward side of the button to open the sunroof to the vent position.

The sunroof is also equipped with a sunshade which you can pull forward to block sun rays.

Universal Transmitter (If Equipped)

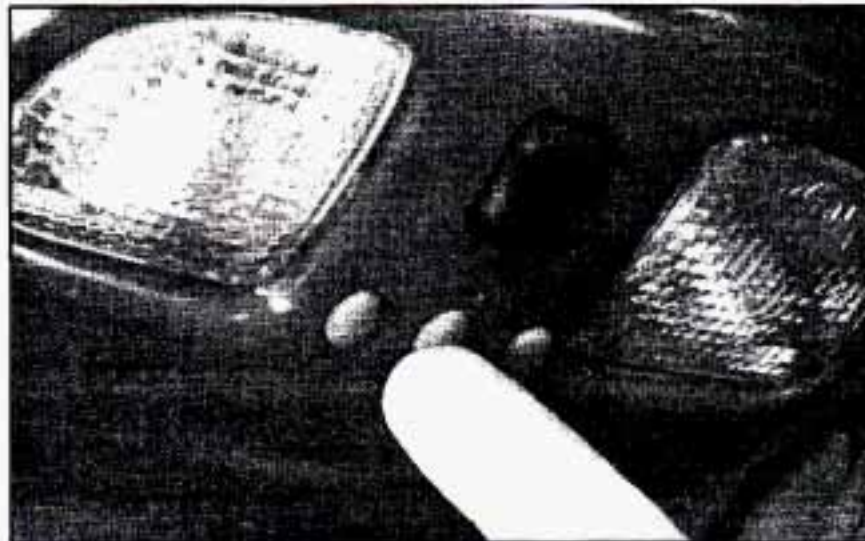

Mini Console



Full-Size Console

This transmitter allows you to consolidate the functions of up to three individual hand-held transmitters. It will operate garage doors and gates, or with the accessory package, other devices controlled by radio frequency such as home/office lighting systems and security systems.

The transmitter will learn and transmit the frequencies of most current transmitters and is powered by your vehicle's battery and charging system.

This device complies with Part 15 of the FCC Rules. Operation is subject to the following two conditions:
(1) This device may not cause harmful interference, and
(2) This device must accept any interference received, including interference that may cause undesired operation.

Programming the Transmitter

Do not use the transmitter with any garage door opener that does not have the "stop and reverse" feature. This includes any garage door opener model manufactured before April 1, 1982.

Be sure that people and objects are clear of the garage door you are programming!

Your vehicle's engine should be turned off while programming the transmitter. Follow these steps to program up to three channels:

1. If you have not previously programmed a universal channel, proceed to Step 2. Otherwise, hold down the two outside buttons on the universal transmitter until the red light begins to flash rapidly (approximately 20 seconds). Then release the buttons. This procedure initializes the memory and erases any previous settings for all three channels.

2. Hold the end of the hand-held transmitter against the bottom surface of the universal transmitter so that you can still see the red light.
3. Decide which one of the three channels you want to program. Using both hands, press the hand-held transmitter button and the desired button on the universal transmitter. Continue to hold both buttons through Step 4.
4. Hold down both buttons until you see the red light on the universal transmitter flash rapidly. The rapid flashing, which could take up to 90 seconds, indicates that the universal transmitter has been programmed. Release both buttons once the light starts to flash rapidly.

If you have trouble programming the universal transmitter, make sure that you have followed the directions exactly as described and that the battery in the hand-held transmitter is not dead. If you still cannot program it, rotate the hand-held transmitter end over end and try again. The universal transmitter may not work with older garage door openers that do not meet current Federal Consumer Safety Standards. If you cannot program the transmitter after repeated attempts, consult your GM dealer.

Be sure to keep the original hand-held transmitter in case you need to erase and reprogram the universal transmitter.

Operating the Transmitter

Press and hold the appropriate button on the universal transmitter. The red light comes on while the signal is being transmitted.

Note that the effective transmission range of the universal transmitter may differ from the hand-held transmitter and from one channel to another.

Erasing Channels

To erase all three programmed channels, hold down the two outside buttons until the red light begins to flash. Individual channels cannot be erased, but can be reprogrammed using the procedure for programming the transmitter explained earlier.

Training a Garage Opener with a "Rolling Code" Feature

If you programmed the universal transmitter, but the garage door will not open, and if your garage door opener was manufactured after 1995, your garage door may have a security feature that changes the "code" of your garage door opener every time it is opened or closed.

To determine if your garage door opener has this "rolling code" feature, press the appropriate button on the universal transmitter that was programmed. If the red light flashes rapidly for one to two seconds, then turns solid, your garage door opener has this feature.

To program a garage door opener with the rolling code feature, do the following:

1. Program your hand-held transmitter to the universal transmitter by following the steps provided under "Programming the Transmitter" earlier in this section.
2. Remove the cover panel from the garage door opener receiver. It is located near the garage door opener motor.
3. Locate the training button on the garage door opener receiver. The exact location and color will vary among brands.
4. Press the training button on the garage door opener receiver for one to two seconds.
5. Return to your vehicle and press the programmed button on the universal transmitter until the red light flashes rapidly (about two seconds).
6. Release the button, then repress it to confirm it was programmed to the garage door opener receiver.

You may now use either the universal transmitter or the hand-held transmitter to open your garage door. If you still have difficulty in programming and require assistance, please call 1-800-355-3515.

Accessories

Accessories for the universal transmitter are available from the manufacturer of the unit. If you would like additional information, please call 1-800-355-3515.

Instrument Panel

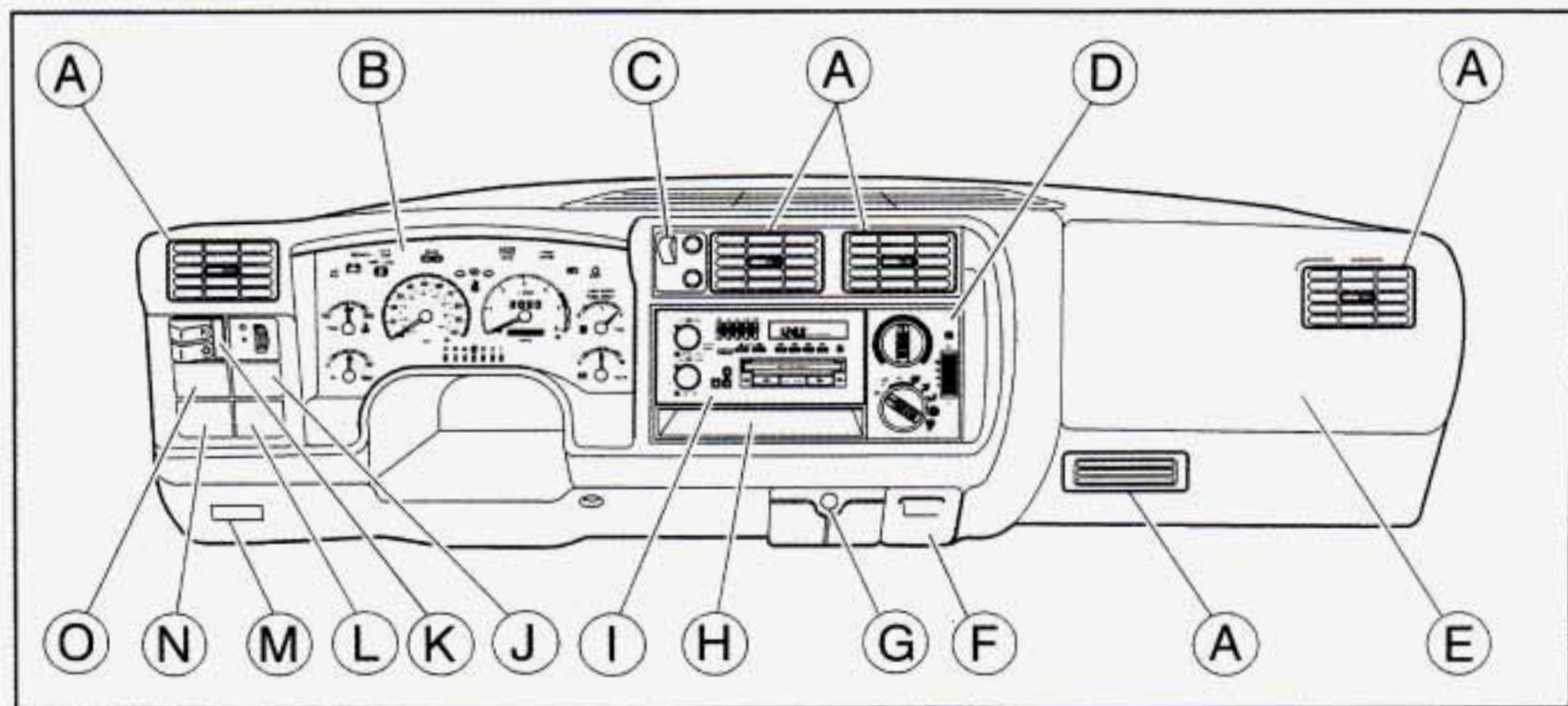

- A. Air Vents
- B. Instrument Cluster
- C. Electronic Transfer Case (If Equipped)
- D. Comfort Controls
- E. Glove Box
- F. Ashtray
- G. Cigarette Lighter/Power Auxiliary Outlets (If Equipped)
- H. Storage Compartment
- I. Audio System
- J. Fog Lamps (If Equipped)
- K. Lamp Controls
- L. Rear Endgate Release
- M. Brake Release
- N. Rear Window Washer/Wiper
- O. Rear Window Defogger (If Equipped)

Instrument Panel Cluster

Your instrument cluster is designed to let you know at a glance how your vehicle is running. You'll know how fast you're going, about how much fuel you've used, and many other things you'll need to know to drive safely and economically.

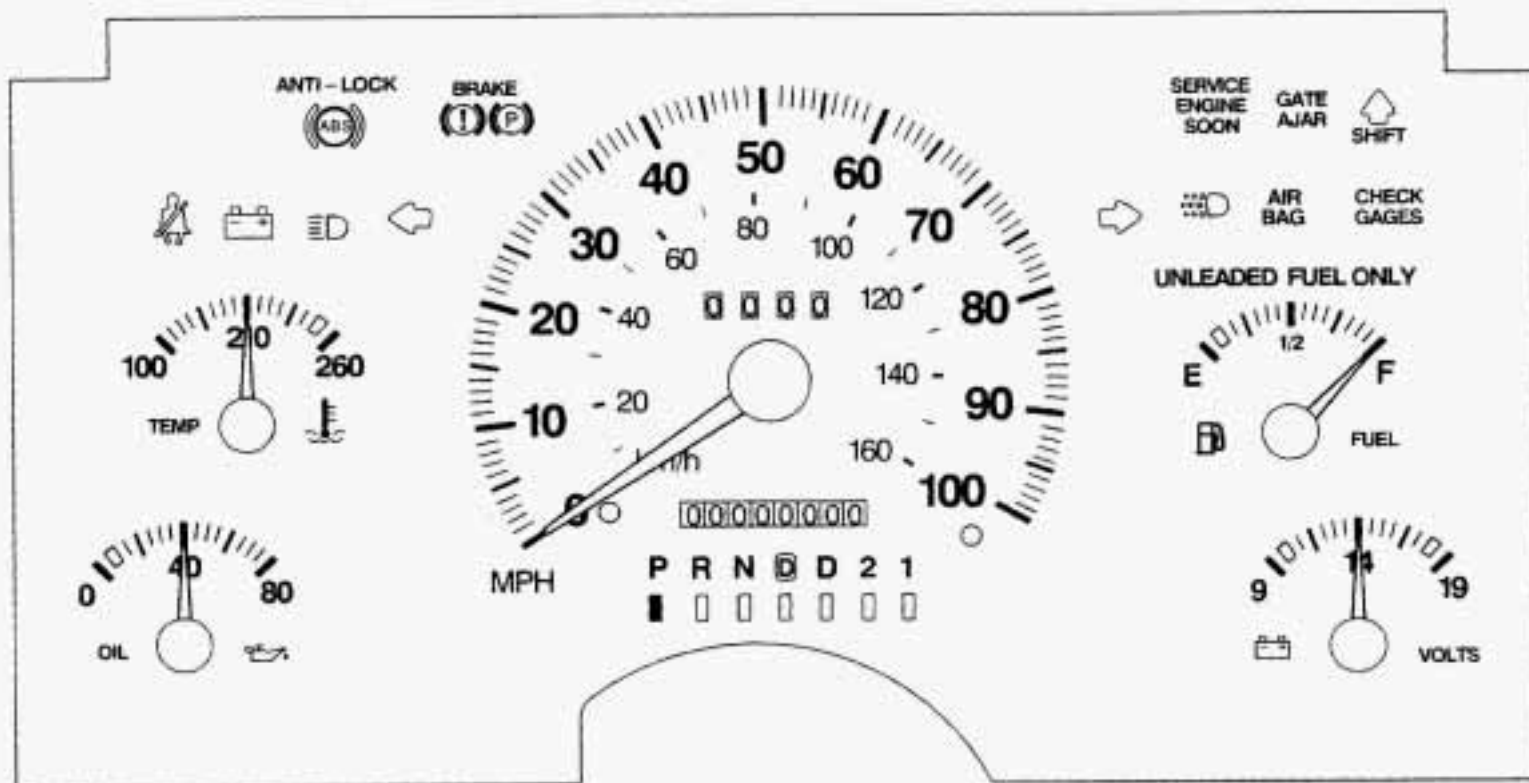

Standard Cluster



Optional Cluster

Speedometer and Odometer

Your speedometer lets you see your speed in both miles per hour (mph) and kilometers per hour (km/h).

Your odometer shows how far your vehicle has been driven, in either miles (used in the United States) or kilometers (used in Canada).

Your odometer is tamper resistant. It will show silver lines between the numbers if someone tries to turn it back.

You may wonder what happens if your vehicle needs a new odometer installed. If the new one can be set to the mileage total of the old odometer, then it must be. But if it can't, then it's set at zero, and a label must be put on the driver's door to show the old mileage reading when the new odometer was installed.

Trip Odometer

The trip odometer can tell you how far your vehicle has been driven since you last set the trip odometer to zero.

To set the trip odometer to zero, press the button near the readout.

Tachometer (If Equipped)

The tachometer displays the engine speed in revolutions per minute (rpm).

Each tachometer has a different limit depending on the powertrain in your vehicle. The tachometer has three areas: normal operating range, red warning range and red danger range.

The normal operating range shows your engine speed during normal driving conditions. For example, when the needle points to 2, it means the engine is running at 2,000 revolutions per minute (rpm). The tachometer needle will vary all the time that the engine is running.

The shaded red warning range tells you that your engine speed is reaching its upper limits. Don't drive very long with the tachometer in the red warning range. If you have a manual transmission, shift to a higher gear as soon as possible. If you have an automatic transmission, lift your foot off of the accelerator pedal.

The solid red danger range tells you that your engine speed is at its upper limits. You should immediately shift to a higher gear, or lift your foot off of the accelerator pedal.

NOTICE:

Do not operate the engine with the tachometer in the red range, or engine damage will occur.

Warning Lights, Gages and Indicators

This part describes the warning lights and gages that may be on your vehicle. The pictures will help you locate them.

Warning lights and gages can signal that something is wrong before it becomes serious enough to cause an expensive repair or replacement. Paying attention to your warning lights and gages could also save you or others from injury.

Warning lights come on when there may be or is a problem with one of your vehicle's functions. As you will see in the details on the next few pages, some warning lights come on briefly when you start the engine just to let you know they're working. If you are familiar with this section, you should not be alarmed when this happens.

Gages can indicate when there may be or is a problem with one of your vehicle's functions. Often gages and warning lights work together to let you know when there's a problem with your vehicle.

When one of the warning lights comes on and stays on when you are driving, or when one of the gages shows there may be a problem, check the section that tells you what to do about it. Please follow this manual's advice. Waiting to do repairs can be costly -- and even dangerous. So please get to know your warning lights and gages. They're a big help.

Safety Belt Reminder Light

When the key is turned to RUN or START, a tone will come on for about eight seconds to remind people to fasten their safety belts, unless the driver's safety belt is already buckled.



The safety belt light will also come on and stay on for about 20 seconds, then it will flash for about 55 seconds. If the driver's belt is already buckled, neither the tone nor the light will come on.

Air Bag Readiness Light

There is an air bag readiness light on the instrument panel, which shows AIR BAG. The system checks the air bag's electrical system for malfunctions. The light tells you if there is an electrical problem. The system check includes the air bag sensors, the air bag module, the wiring and the diagnostic module. For more information on the air bag system, see "Air Bag" in the Index.



This light will come on when you start your engine, and it will flash for a few seconds. Then the light should go out. This means the system is ready.

If the air bag readiness light stays on after you start the engine or comes on when you are driving, your air bag system may not work properly. Have your vehicle serviced right away.

The air bag readiness light should flash for a few seconds when you turn the ignition key to RUN. If the light doesn't come on then, have it fixed so it will be ready to warn you if there is a problem.

Charging System Indicator Light

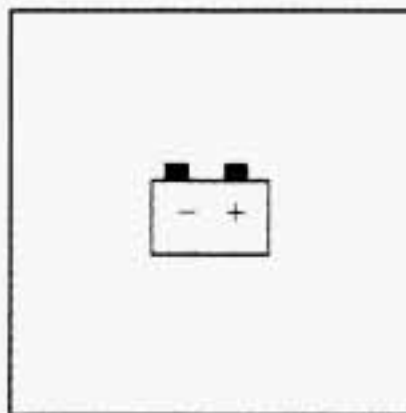

The charging system light will come on briefly when you turn on the ignition, but the engine is not running, as a check to show you it is working.

It should go out once the engine is running. If it stays on, or comes on while you are driving, you may have a problem with the charging system. It could indicate that you have problems with a generator drive belt, or another electrical problem. Have it checked right away. Driving while this light is on could drain your battery.

If you must drive a short distance with the light on, be certain to turn off all your accessories, such as the radio and air conditioner.

Voltmeter Gage

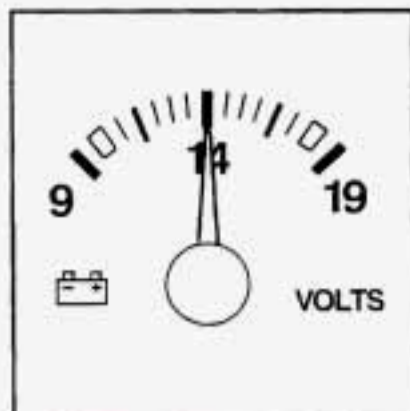

When your engine is not running, but the ignition is on (in the RUN position), this gage shows your battery's state of charge in DC volts.

When the engine is running, the gage shows the condition of the charging system. Readings between the low and high warning zones indicate the normal operating range.

Readings in the low warning zone may occur when a large number of electrical accessories are operating in the vehicle and the engine is left at an idle for an extended period. This condition is normal since the charging system is not able to provide full power at engine idle. As engine speeds are increased, this condition should correct itself as higher engine speeds allow the charging system to create maximum power.

You can only drive for a short time with the reading in either warning zone. If you must drive, turn off all unnecessary accessories.

Readings in either warning zone indicate a possible problem in the electrical system. Have the vehicle serviced as soon as possible.

Brake System Warning Light

Your vehicle's hydraulic brake system is divided into two parts. If one part isn't working, the other part can still work and stop you. For good braking, though, you need both parts working well.

If the warning light comes on, there could be a brake problem. Have your brake system inspected right away.

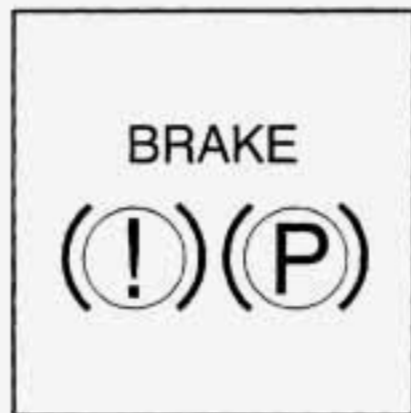

This light should come on briefly when you turn the ignition key to RUN. If it doesn't come on then, have it fixed so it will be ready to warn you if there's a problem.

If the light comes on while you are driving, pull off the road and stop carefully. You may notice that the pedal is harder to push. Or, the pedal may go closer to the floor. It may take longer to stop. If the light is still on, have the vehicle towed for service. (See "Towing Your Vehicle" in the Index.)



CAUTION:

Your brake system may not be working properly if the brake system warning light is on. Driving with the brake system warning light on can lead to an accident. If the light is still on after you've pulled off the road and stopped carefully, have the vehicle towed for service.

When the ignition is on, the brake system warning light will also come on when you set your parking brake. The light will stay on if your parking brake doesn't release fully. If it stays on after your parking brake is fully released, it means you have a brake problem.

Anti-Lock Brake System Warning Light

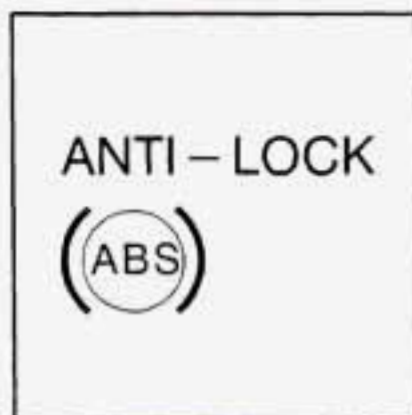

With the anti-lock brake system, this light will come on when you start your engine and may stay on for several seconds. That's normal.

If the light stays on, or comes on when you're driving, your vehicle needs service. If the regular brake system warning light isn't on, you still have brakes, but you don't have anti-lock brakes. If the regular brake system warning light is also on, you don't have anti-lock brakes and there's a problem with your regular brakes. See "Brake System Warning Light" earlier in this section.

The anti-lock brake system warning light should come on briefly when you turn the ignition key to RUN. If the light doesn't come on then, have it fixed so it will be ready to warn you if there is a problem.

Engine Coolant Temperature Gage

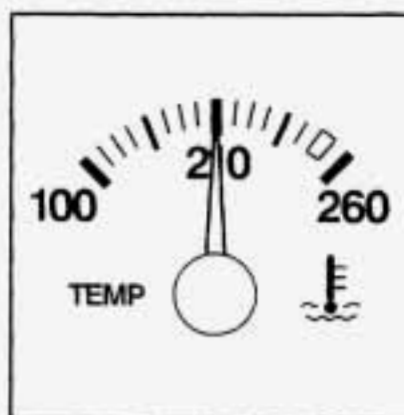

This gage shows the engine coolant temperature. If the gage pointer moves into the red area, your engine is too hot!

It means that your engine coolant has overheated. If you have been operating your vehicle under normal driving conditions, you should pull off the road, stop your vehicle and turn off the engine as soon as possible.

In "Problems on the Road," this manual show you what to do. See "Engine Overheating" in the Index.

Malfunction Indicator Lamp (Service Engine Soon Light)



SERVICE
ENGINE
SOON

Your vehicle is equipped with a computer which monitors operation of the fuel, ignition and emission control systems.

This system is called OBD II (On-Board Diagnostics-Second Generation) and is intended to assure that emissions are at acceptable levels for the life of the vehicle, helping to produce a cleaner environment. (In Canada, OBD II is replaced by Enhanced Diagnostics.) The SERVICE ENGINE SOON light comes on to indicate that there is a problem and service is required. Malfunctions often will be indicated by the system before any problem is apparent. This may prevent more serious damage to your vehicle. This system is also designed to assist your service technician in correctly diagnosing any malfunction.

NOTICE:

If you keep driving your vehicle with this light on, after a while, your emission controls may not work as well, your fuel economy may not be as good and your engine may not run as smoothly. This could lead to costly repairs that may not be covered by your warranty.

This light should come on, as a check to show you it is working, when the ignition is on and the engine is not running. If the light doesn't come on, have it repaired. This light will also come on during a malfunction in one of two ways:

- **Light Flashing** -- A misfire condition has been detected. A misfire increases vehicle emissions and may damage the emission control system on your vehicle. Dealer or qualified service center diagnosis and service is required.
- **Light On Steady** -- An emission control system malfunction has been detected on your vehicle. Dealer or qualified service center diagnosis and service may be required.

If the Light Is Flashing

The following may prevent more serious damage to your vehicle:

- Reducing vehicle speed.
- Avoiding hard accelerations.
- Avoiding steep uphill grades.
- If you are towing a trailer, reduce the amount of cargo being hauled as soon as it is possible.

If the light stops flashing and remains on steady, see “If the Light Is On Steady” following.

If the light continues to flash, when it is safe to do so, *stop the vehicle*. Find a safe place to park your vehicle. Turn the key off, wait at least 10 seconds and restart the engine. If the light remains on steady, see “If the Light Is On Steady” following. If the light is still flashing, follow the previous steps, and drive the vehicle to your dealer or qualified service center for service.

If the Light Is On Steady

You may be able to correct the emission system malfunction by considering the following:

Did you recently put fuel into your vehicle?

If so, reinstall the fuel cap, making sure to fully install the cap. The diagnostic system can determine if the fuel

cap has been left off or improperly installed. A loose or missing fuel cap will allow fuel to evaporate into the atmosphere. A few driving trips with the cap properly installed should turn the light off.

Did you just drive through a deep puddle of water?

If so, your electrical system may be wet. The condition will usually be corrected when the electrical system dries out. A few driving trips should turn the light off.

Have you recently changed brands of fuel?

If so, be sure to fuel your vehicle with quality fuel (see “Fuel” in the Index). Poor fuel quality will cause your engine not to run as efficiently as designed. You may notice this as stalling after start-up, stalling when you put the vehicle into gear, misfiring, hesitation on acceleration or stumbling on acceleration. (These conditions may go away once the engine is warmed up.) This will be detected by the system and cause the light to turn on.

If you experience one or more of these conditions, change the fuel brand you use. It will require at least one full tank of the proper fuel to turn the light off.

If none of the above steps have made the light turn off, have your dealer or qualified service center check the vehicle. Your dealer has the proper test equipment and diagnostic tools to fix any mechanical or electrical problems that may have developed.

Engine Oil Pressure Gage

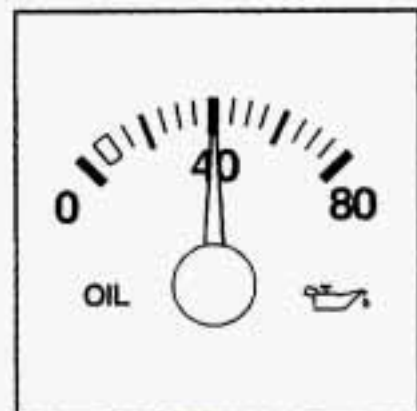

The oil pressure gage shows the engine oil pressure in psi (pounds per square inch) when the engine is running.

Canadian vehicles indicate pressure in kPa (kilopascals).

Oil pressure may vary with engine speed, outside temperature and oil viscosity, but readings above the low pressure zone indicate the normal operating range.

A reading in the low pressure zone may be caused by a dangerously low oil level or other problems causing low oil pressure.

CAUTION:

Don't keep driving if the oil pressure is low. If you do, your engine can become so hot that it catches fire. You or others could be burned. Check your oil as soon as possible and have your vehicle serviced.

NOTICE:

Damage to your engine from neglected oil problems can be costly and is not covered by your warranty.

Shift Light



You have the shift light if you have a manual transmission. This light comes on very briefly as a bulb check when you start the engine. Shifting when the indicator light is on will help you get the best fuel economy. See "Shift Light" in the Index.

Check Gages Light



The CHECK GAGES light will come on briefly when you are starting the engine.

Daytime Running Lamps Indicator Light

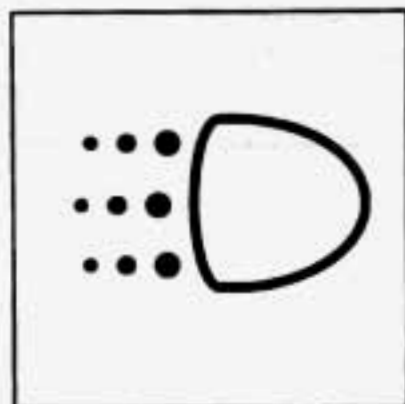

This light is on the instrument panel. It goes on whenever the DRL are on, the ignition is on, the headlamp switch is off and the parking brake is released.

If the light comes on and stays on while you are driving, check your coolant temperature and engine oil pressure gages to see if they are in the warning zones.

Gate Ajar Light



This light will come on briefly when you are starting the engine. If it stays on, your liftgate is ajar. Try closing the liftgate again. Never drive with the liftgate even partially open.

Fuel Gage

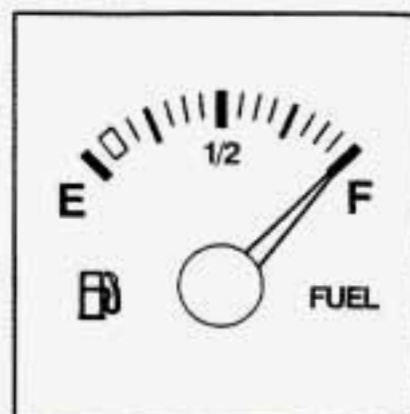

When the ignition is on, the fuel gage tells you about how much fuel you have remaining.

Here are four things that some owners ask about. None of these show a problem with your fuel gage:

- At the gas station, the gas pump shuts off before the gage reads FULL (F).
- It takes a little more or less fuel to fill up than the gage indicated. For example, the gage may have indicated the tank was half full, but it actually took a little more or less than half the tank's capacity to fill the tank.
- The gage moves a little when you turn a corner or speed up.
- The gage doesn't go back to EMPTY (E) when you turn off the ignition.

 **NOTES**

Section 3 Comfort Controls and Audio Systems

In this section, you'll find out how to operate the comfort control and audio systems offered with your vehicle. Be sure to read about the particular systems supplied with your vehicle.

3-2	Comfort Controls	3-8	AM-FM Stereo with Cassette Tape Player (If Equipped)
3-2	Climate Control System	3-10	AM-FM Stereo with Cassette Tape Player and Equalizer (If Equipped)
3-3	Air Conditioning	3-13	AM-FM Stereo with Compact Disc Player and Automatic Tone Control (If Equipped)
3-3	Heating	3-17	Theft-Deterrent Feature
3-4	Ventilation System	3-19	Understanding Radio Reception
3-5	Defogging and Defrosting	3-19	Tips About Your Audio System
3-5	Rear Window Defogger (Option)	3-20	Care of Your Cassette Tape Player
3-6	Audio Systems	3-21	Care of Your Compact Discs
3-6	Setting the Clock	3-21	Fixed Mast Antenna
3-6	Setting the Clock for AM-FM Stereo with Compact Disc Player and Automatic Tone Control		
3-6	AM-FM Stereo		

Comfort Controls

With this system, you can control the heating, cooling and ventilation in your vehicle.

Climate Control System

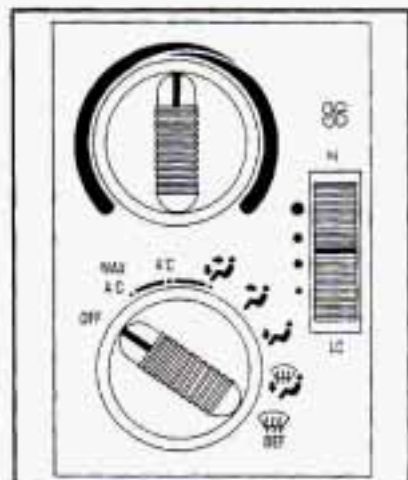

Fan Control

The switch with the fan symbol changes the fan speed. To increase the fan speed, move the switch upward toward HI. To decrease the fan speed, move the switch downward toward LO.

Temperature Knob

The upper knob regulates the temperature of the air coming through the system. Turn the knob clockwise for warmer air. Turn the knob counterclockwise for cooler air.

Mode Knob

The lower knob allows you to choose the direction of air delivery.

OFF: This setting turns the system off. Some outside air will still enter the vehicle whenever the vehicle is moving forward.

MAX A/C: This setting provides maximum cooling with the least amount of work. MAX A/C recirculates much of the air inside your vehicle so it cools quickly.

A/C: This setting cools the air entering your vehicle and directs it through the instrument panel outlets.





BI-LEVEL A/C: Air is delivered through the heater floor outlets as well as the instrument panel outlets.



VENT: This setting directs airflow through the instrument panel outlets. The air conditioning compressor is not working when VENT is selected.

 **HEATER:** This setting directs warmed air through the heater floor outlets and windshield defroster outlets.

 **BLEND:** Airflow is divided equally between the heater floor outlet and the windshield defroster outlets.

 **DEFROST:** This setting directs most air through the windshield defroster outlets and some through the heater outlets.

Air Conditioning

On hot days, open the windows long enough to let hot inside air escape. This reduces the time it takes for your vehicle to cool down. Then keep your windows closed for the air conditioner to work its best.

For quick cool-down on very hot days, use MAX A/C with the temperature knob turned counterclockwise. This setting should be used to keep odors and/or dust from entering the vehicle. For normal cooling on hot days, use A/C with the temperature knob turned counterclockwise.

On cool but sunny days, use BI-LEVEL A/C to deliver warm air to the floor and cooler air to the instrument panel outlets.

When the air conditioner is on, you may sometimes notice slight changes in your vehicle's engine speed and power. This is normal because the system is designed to cycle the compressor on and off to keep the desired temperature.

Heating

The heater works best if you keep your windows closed while using it. On cold days, use HEATER with the temperature knob turned clockwise. BLEND is useful in cool weather when you have fog or ice on the windshield or side windows.

If you use the optional engine coolant heater before starting your engine, your heating system will produce warmer air faster to heat the passenger compartment in cold weather. See "Engine Coolant Heater" in the Index.

Ventilation System

For mild outside temperatures when little heating or cooling is needed, use VENT to direct outside air through your vehicle. Airflow is through the instrument panel outlets.

Your vehicle's ventilation system supplies outside air to the inside of your vehicle when it is moving. When the vehicle is not moving, you can get outside air to flow through by selecting any mode and any fan speed.

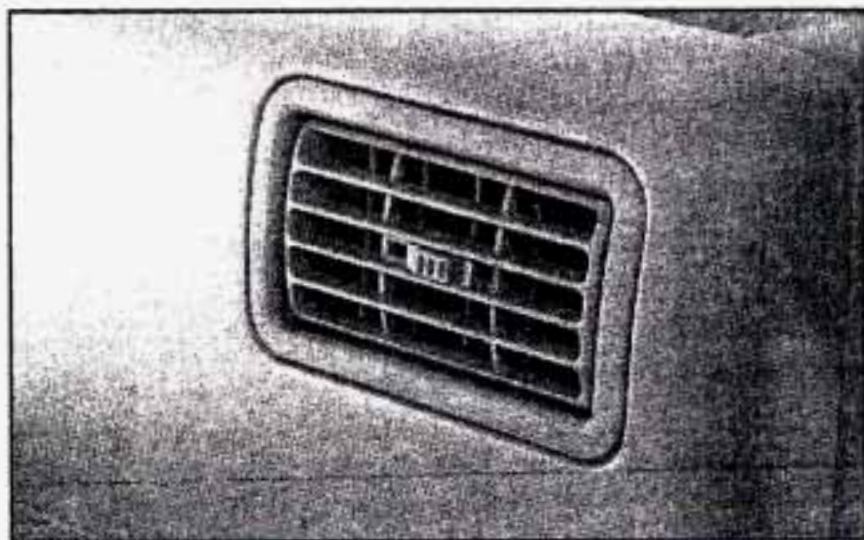

You will find air outlets in the center and on the sides of your instrument panel.

You can move the outlets to direct the flow of air, or close the outlets altogether. When you close an outlet, it will increase the flow of air coming out of any outlets that are open.

Ventilation Tips

- Keep the hood and front air inlet free of ice, snow or any other obstruction (such as leaves). The heater and defroster will work far better, reducing the chance of fogging the inside of your windows.
- When you enter a vehicle in cold weather, move the fan control to HI for a few moments before driving off. This helps clear the intake ducts of snow and moisture, and reduces the chance of fogging the inside of your windows.
- Keep the air path under the front seats clear of objects. This helps air to circulate throughout your vehicle.

Defogging and Defrosting

On cool, humid days, use BLEND to keep the windshield and side windows clear.

Use DEFROST to remove fog or ice from the windshield quickly in extreme humid or cold conditions. Turn the temperature knob clockwise and move the fan control toward HI.

Rear Window Defogger (Option)



If your vehicle has this option, the rear window will have lines that warm the glass. For best results, clear the

window of as much snow or ice as possible before using the rear window defogger.

To turn on the rear window defogger, find the switch marked REAR DEFOG on your instrument panel below the headlamp switch. Press ON until the light in the switch comes on, then release it. It will only work if the ignition switch is turned to RUN.

The rear window defogger will stay on for five to seven minutes, then turn off. If you need additional warming time, turn it on again. You can turn the defogger off at any time by pressing OFF.

Do not attach a temporary vehicle license, tape or decals across the defogger grid on the rear window.

NOTICE:

Don't use a razor blade or something else sharp on the inside of the rear window. If you do, you could cut or damage the warming grid, and the repairs wouldn't be covered by your warranty.

Audio Systems

Your Delco® audio system has been designed to operate easily and give years of listening pleasure. You will get the most enjoyment out of it if you acquaint yourself with it first. Find out what your Delco system can do and how to operate all its controls, to be sure you're getting the most out of the advanced engineering that went into it.

Setting the Clock

Press SET. Within five seconds, press and hold SEEK until the correct minute appears on the display. Press and hold SCAN until the correct hour appears on the display.

Setting the Clock for AM-FM Stereo with Compact Disc Player and Automatic Tone Control

Press and hold HR until the correct hour appears on the display. Press and hold MIN until the correct minute appears on the display. To display the clock with the ignition off, press RECALL, and the time will be displayed for a few seconds. There is an initial two-second delay before the clock goes into the time-set mode.

AM-FM Stereo

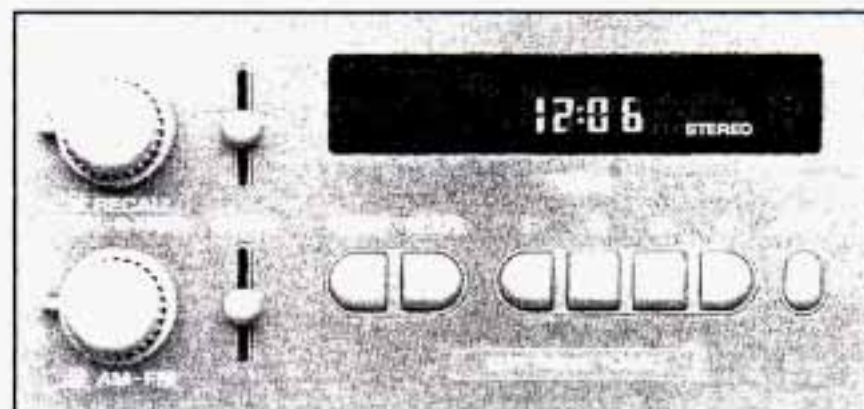

Playing the Radio

PWR-VOL: This knob turns the system on and off and controls the volume. To increase volume, turn the knob clockwise. Turn it counterclockwise to decrease volume.

RECALL: Display the time with the ignition off by pressing this knob. When the radio is playing, press this knob to recall the station frequency.

Finding a Station

AM-FM: Press the lower knob to switch between AM and FM. The display shows your selection.

TUNE: Turn the lower knob to tune in radio stations.

SEEK: Press this button to go to the next higher station and stop.

SCAN: Press this button to listen to each station for a few seconds. The radio will go to the next station, stop for a few seconds, then go to the next station. SCAN will appear on the display. Press SCAN again to stop scanning.

PUSHBUTTONS: The four numbered pushbuttons let you return to your favorite stations. You can set up to 14 stations (seven AM and seven FM). Just:

1. Turn the radio on.
2. Press AM-FM to select the band.
3. Tune in the desired station.
4. Press SET. (SET will appear on the display.)
5. Press one of the four pushbuttons, within five seconds. Whenever you press that numbered button, the station you set will return.
6. Repeat the steps for each pushbutton.

In addition to the four stations already set, up to three more stations may be preset on each band by pressing two adjoining buttons at the same time. Just:

1. Tune in the desired station.
2. Press SET. (SET will appear on the display.)
3. Press two adjoining pushbuttons at the same time, within five seconds. Whenever you press the same two buttons, the station you set will return.
4. Repeat the steps for each pair of pushbuttons.

Setting the Tone

BASS: Slide this lever up or down to increase or decrease bass.

TREBLE: Slide this lever up or down to increase or decrease treble. If a station is weak or noisy, you may want to decrease the treble.

Adjusting the Speakers

BAL: Turn the control behind the upper knob to move the sound to the left or right speakers. The middle position balances the sound between the speakers.

FADE: Turn the control behind the lower knob to move the sound to the front or rear speakers. The middle position balances the sound between the speakers.

AM-FM Stereo with Cassette Tape Player (If Equipped)



Playing the Radio

PWR-VOL: This knob turns the system on and off and controls the volume. To increase volume, turn the knob clockwise. Turn it counterclockwise to decrease volume.

RCL: Display the time with the ignition off by pressing this knob. When the radio is playing, press this knob to recall the station frequency.

Finding a Station

AM-FM: Press the lower knob to switch between AM and FM. The display shows your selection.

TUNE: Turn the lower knob to tune in radio stations.

SEEK: Press this button to go to the next higher station and stay there.

SCAN: Press this button to listen to each station for a few seconds. The radio will go to the next station, stop for a few seconds, then go to the next station. SCAN will appear on the display. Press SCAN again to stop scanning.

PUSHBUTTONS: The four numbered pushbuttons let you return to your favorite stations. You can set up to 14 stations (seven AM and seven FM). Just:

1. Turn the radio on.
2. Press AM-FM to select the band.
3. Tune in the desired station.
4. Press SET. (SET will appear on the display.)
5. Press one of the four pushbuttons, within five seconds. Whenever you press that numbered button, the station you set will return.
6. Repeat the steps for each pushbutton.

In addition to the four stations already set, up to three more stations may be preset on each band by pressing two adjoining buttons at the same time. Just:

1. Tune in the desired station.
2. Press SET. (SET will appear on the display.)
3. Press two adjoining pushbuttons at the same time, within five seconds. Whenever you press the same two buttons, the station you set will return.
4. Repeat the steps for each pair of pushbuttons.

Setting the Tone

BASS: Slide this lever up or down to increase or decrease bass.

TREBLE: Slide this lever up or down to increase or decrease treble. If a station is weak or noisy, you may want to decrease the treble.

Adjusting the Speakers

BAL: Turn the control behind the upper knob to move the sound to the left or right speakers. The middle position balances the sound between the speakers.

FADE: Turn the control behind the lower knob to move the sound to the front or rear speakers. The middle position balances the sound between the speakers.

Playing a Cassette Tape

Your tape player is built to work best with tapes that are 30 to 45 minutes long on each side. Tapes longer than that are so thin they may not work well in this player.

Once the tape is playing, use the PWR-VOL, BAL and FADE knobs just as you do for the radio. A lighted arrow will be displayed to show tape play direction.

FORWARD: Press the arrow button in the direction that the lighted arrow points to advance quickly to another part of the tape. Press STOP-EJECT lightly to stop forwarding and play the tape.

REVERSE: Press the arrow button in the opposite direction that the lighted arrow points to reverse quickly to another part of the tape. Press STOP-EJECT lightly to stop reversing and play the tape.

PROG: Press this knob to go from one side of the tape to the other.

STOP-EJECT: Press this button to remove the tape or stop playing the tape in order to play the radio. If you leave a cassette tape in the player while listening to the radio, it may become warm.

AM-FM Stereo with Cassette Tape Player and Equalizer (If Equipped)



Playing the Radio

PWR-VOL: This knob turns the system on and off and controls the volume. To increase volume, turn the knob clockwise. Turn it counterclockwise to decrease volume.

RCL: Display the time with the ignition off by pressing this knob. When the radio is playing, press this knob to recall station frequency.

AM-ST: Press this button to tune an AM station that broadcasts in stereo. Your STEREO light will come on when you're receiving AM stereo. If you press AM-ST and there is no more noise, it means the station is weak. You'll hear the station better if you do not use AM-ST. Press the button again to turn off stereo.

Finding a Station

AM-FM: Press the lower knob to switch between AM and FM. The display shows your selection.

TUNE: Turn the lower knob to tune in radio stations.

SEEK: Press this button to go to the next higher station and stay there.

SCAN: Press this button to listen to each station for a few seconds. The radio will go to the next station, stop for a few seconds, then go to the next station. SCAN will appear on the display. Press SCAN again to stop scanning.

PUSHBUTTONS: The four numbered pushbuttons let you return to your favorite stations. You can set up to 14 stations (seven AM and seven FM). Just:

1. Turn the radio on.
2. Press AM-FM to select the band.
3. Tune in the desired station.
4. Press SET. (SET will appear on the display.)
5. Press one of the four pushbuttons, within five seconds. Whenever you press that numbered button, the station you set will return.
6. Repeat the steps for each pushbutton.

In addition to the four stations already set, up to three more stations may be preset on each band by pressing two adjoining buttons at the same time. Just:

1. Tune in the desired station.
2. Press SET. (SET will appear on the display.)
3. Press two adjoining pushbuttons at the same time, within five seconds. Whenever you press the same two buttons, the station you set will return.
4. Repeat the steps for each pair of pushbuttons.

Setting the Tone

TONE ADJUSTMENT: Set the bass, midrange and treble by using the levers in the upper middle left corner to get the sound you want. The 60 and 250 levers adjust the bass, 1K is midrange, and the levers 3.5K and 10K control the treble.

We suggest you start with 1K in the midpoint position. Then move the other levers up until you get the amount of bass and treble you like.

Adjusting the Speakers

BAL: Turn the control behind the upper knob to move the sound to the left or right speakers. The middle position balances the sound between the speakers.

FADE: Turn the control behind the lower knob to move the sound to the front or rear speakers. The middle position balances the sound between the speakers.

Playing a Cassette Tape

Your tape player is built to work best with tapes that are 30 to 45 minutes long on each side. Tapes longer than that are so thin they may not work well in this player.

Once the tape is playing, use the PWR-VOL, BAL and FADE knobs just as you do for the radio. A lighted arrow will be displayed to show tape play direction.

REVERSE: Press the arrow button in the opposite direction that the lighted arrow points to reverse quickly to another part of the tape. Press STOP-EJECT lightly to stop reversing and play the tape.

FORWARD: Press the arrow button in the direction that the lighted arrow points to advance quickly to another part of the tape. Press STOP-EJECT lightly to stop forwarding and play the tape.

SEARCH: Press this button to the recessed position. Press the lighted arrow to skip to the next selection. Press the opposite direction arrow that is not lighted to replay the current selection or skip to the previous selection.

CrO₂: This button lets you set the system for the type of cassette being used. If you are using chrome or metal tapes, press the button in.

PROG: Press this knob to go from one side of the tape to the other.

STOP-EJECT: Press this button to remove the tape or stop playing the tape in order to play the radio. If you leave a cassette tape in the player while listening to the radio, it may become warm.

Your Delco system may be able to receive C-QUAM[®] stereo broadcasts. Many AM stations around the country use C-QUAM to produce stereo although some do not. C-QUAM is a registered trademark of Motorola, Inc. If your Delco system can get C-QUAM signals, your STEREO light will come on when you are receiving stereo.

AM-FM Stereo with Compact Disc Player and Automatic Tone Control (If Equipped)



Playing the Radio

PWR-VOL: Press this knob to turn the system on and off. To increase volume, turn the knob clockwise. Turn it counterclockwise to decrease volume. The knob is capable of rotating continuously.

RECALL: Display the time with the ignition off by pressing this button. When the radio is playing, press this button to recall the station frequency.

SCV: Your system has a feature called Speed-Compensated-Volume (SCV). With SCV, your audio system adjusts automatically to make up for road

and wind noise as you drive. Set the volume at the desired level. Move the control ring behind the upper knob clockwise to adjust the SCV. Then, as you drive, SCV automatically increases the volume, as necessary, to overcome noise at any particular speed. The volume level should always sound the same to you as you drive. If you don't want to use SCV, turn the control all the way down. Each detent on the control ring allows for more volume compensation at a faster rate of speed.

Finding a Station

AM-FM: Press this button to switch between AM, FM1 and FM2. The display will show your selection.

TUNE: Press this knob lightly so it extends. Turn it to choose radio stations. Push the knob back into its stored position when you're not using it.

SEEK: Press the right arrow to tune to the next higher station and the left arrow to tune to the next lower station and stay there. The sound will mute while seeking.

SCAN: Press and hold SEEK for two seconds until SCAN appears on the display. SCAN allows you to listen to stations for a few seconds. The receiver will continue to scan and momentarily stop at each station until you press the button again. The sound will mute while scanning.

PUSHBUTTONS: The six numbered pushbuttons let you return to your favorite stations. You can set up to 18 stations (six AM, six FM1 and six FM2). Just:

1. Turn the radio on.
2. Press AM-FM to select the band.
3. Tune in the desired station.
4. Press AUTO TONE to select the setting you prefer.
5. Press and hold one of the four pushbuttons. The sound will mute. When it returns, release the button. Whenever you press that numbered button, the station you set will return and the tone you selected will be automatically selected for that button.
6. Repeat the steps for each pushbutton.

P.SCAN: The preset scan button lets you scan through your favorite stations stored on your pushbuttons. Select either the AM, FM1 or FM2 mode and then press P.SCAN. It will scan through each station stored on your pushbuttons and stop for a few seconds before continuing to scan through all of the pushbuttons. Press P.SCAN again or one of the pushbuttons to stop scanning to listen to a specific stored station. P.SCAN will light up on the display while in this mode. If one of the stations stored on a pushbutton is too weak for the location you are in, the radio will skip the preset station and the radio display will show the channel number (P1 through P6) for several seconds before advancing to the next preset station.

Setting the Tone

BASS: Press lightly on this knob to release it from its stored position. Turn the knob clockwise to increase bass and counterclockwise to decrease bass. When the BASS control is rotated, the AUTO TONE setting will change to MAN.

TREB: Press lightly on this knob to release it from its stored position. Turn the knob clockwise to increase treble and counterclockwise to decrease treble. When the TREB control is rotated, the AUTO TONE setting will change to MAN. If a station is weak or noisy, you may want to decrease the treble.

Push these knobs back into their stored positions when you're not using them.

AUTO TONE: Press this button to select among the five preset equalization settings and tailor the sound to the music or voice being heard. Each time you press the button, the selection will switch to one of the preset settings of CLASSIC, NEWS, ROCK, POP or JAZZ. The display will show which mode the receiver is in. To return to the manual mode, press and release this button until MAN appears on the display. This will return the tone adjustment to the BASS and TREB controls. If a BASS or TREB control is rotated, the AUTO TONE setting will change to MAN.

Adjusting the Speakers

BAL: Press lightly on this knob to release it from its stored position. Turn the control clockwise to adjust sound to the right speakers and counterclockwise to adjust sound to the left speakers. The middle position balances the sound between the speakers.

FADE: Press lightly on this knob to release it from its stored position. Turn the control clockwise to adjust the sound to the front and counterclockwise for the rear speakers. The middle position balances the sound between the speakers.

Push these knobs back into their stored positions when you're not using them.

Playing a Compact Disc

PWR: Press this knob to turn the system on. (Please note that you can also turn the system on when you insert a compact disc into the player with the ignition on.)

Insert a disc partway into the slot, label side up. The player will pull it in. Wait a few seconds and the disc should play. CD and a CD symbol will also appear on the display. Anytime you are playing a CD, the letters CD will be next to the CD symbol.

If the disc comes back out and ERR appears on the display, it could be that:

- You are driving on a very rough road. (The disc should play when the road gets smoother.)
- The disc is upside down.
- It is dirty, scratched or wet.
- It is very humid. (If so, wait about an hour and try again.)
- The disc player is very hot.

Press RECALL to make ERR go off the display.

PREV (1): Press PREV or the SEEK left arrow to search for the previous selection. If you hold this button or press it more than once, the disc will advance further. Sound is muted in this mode.

RDM (2): Press this button to play the tracks on the disc in random, rather than sequential, order. While in the RDM mode, RANDOM appears on the display. Press RDM again to return to normal play.

NEXT (3): Press NEXT or the SEEK right arrow to search for the next selection. If you hold this button or press it more than once, the disc will advance further. The next track number will appear on the display. Sound is muted in this mode.

REV (4): Press and hold REV to return rapidly to a favorite passage. You will hear the disc selection play at high speed while you press the REV button. This allows you to listen and find out when the disc is at the desired selection. Release REV to resume playing.

FWD (6): Press and hold this button to advance rapidly within a track. You will hear the disc selection play at high speed while you press the FWD button. This allows you to listen and find out when the disc is at the desired selection. Release FWD to resume playing.

AM-FM: While in the CD mode, press this button to stop playing the CD and play the radio. The CD symbol will still display but the word CD will be replaced with either AM, FM1 or FM2. (If the radio is turned off, the disc stays in the player and will resume playing at the point where it stopped.)

RECALL: Press this button to see what track is playing. Press it again within five seconds to see how long the CD has been playing that track. Elapsed time is displayed in minutes and tenths of a second. The track number will also appear when a new track begins to play. Press RECALL again to return to the time display.

CD AUX: To switch between the player and the radio when a disc is playing, press the AM-FM button. To return to the player, press CD AUX. When a disc is playing, the letters CD and the CD symbol will appear on the display. (If the radio is turned off, the disc stays in the player and will resume playing at the point where it stopped.)

EJECT: Press this button to eject the disc from the player and play the radio.

When the same or a new disc is inserted, the disc will start playing on track one. If a compact disc is left sitting in the opening for more than a few seconds, the player will pull the CD back in. The radio will continue playing. When the ignition is off, press this button to load a CD. If you leave a compact disc in the player while listening to the radio, it may become warm.

Theft-Deterrent Feature

THEFTLOCK™ is designed to discourage theft of your radio. It works by using a secret code to disable all radio functions whenever battery power is removed.

The THEFTLOCK feature for the radio may be used or ignored. If ignored, the system plays normally and the radio is not protected by the feature. If THEFTLOCK is activated, your radio will not operate if stolen.

When THEFTLOCK is activated, the radio will display LOC to indicate a locked condition anytime battery power is removed. If your battery loses power for any reason, you must unlock the radio with the secret code before it will operate.

Activating the Theft-Deterrent Feature

The instructions which follow explain how to enter your secret code to activate the THEFTLOCK system. It is recommended that you read through all nine steps before starting the procedure.

NOTE: If you allow more than 15 seconds to elapse between any steps, the radio automatically reverts to time and you must start the procedure over at Step 4.

1. Write down any three or four-digit number from 000 to 1999 and keep it in a safe place separate from the vehicle.
2. Turn the ignition to ACCESSORY or RUN.
3. Turn the radio off.
4. Press the 1 and 4 buttons together. Hold them down until --- shows on the display. Next you will use the secret code number which you have written down.
5. Press MN and 000 will appear on the display.
6. Press MN again to make the last two digits agree with your code.
7. Press HR to make the first one or two digits agree with your code.
8. Press AM-FM after you have confirmed that the code matches the secret code you have written down. The display will show REP to let you know that you need to repeat Steps 5 through 7 to confirm your secret code.
9. Press AM-FM and this time the display will show SEC to let you know that your radio is secure. The indicator by the volume control will begin flashing when the ignition is turned off.

Unlocking the Theft-Deterrent Feature After a Power Loss

Enter your secret code as follows; pause no more than 15 seconds between steps:

1. LOC appears when the ignition is on.
2. Press MN and 000 will appear on the display.
3. Press MN again to make the last two digits agree with your code.
4. Press HR to make the first one or two digits agree with your code.
5. Press AM-FM after you have confirmed that the code matches the secret code you have written down. The display will show SEC, indicating the radio is now operable and secure.

If you enter the wrong code eight times, INOP will appear on the display. You will have to wait an hour with the ignition on before you can try again. When you try again, you will only have three chances to enter the correct code before INOP appears.

If you lose or forget your code, contact your dealer.

Disabling the Theft-Deterrent Feature

Enter your secret code as follows; pause no more than 15 seconds between steps:

1. Turn the ignition to ACCESSORY or RUN.
2. Turn the radio off.
3. Press the 1 and 4 buttons together. Hold them down until SEC shows on the display.
4. Press MN and 000 will appear on the display.
5. Press MN again to make the last two digits agree with your code.
6. Press HR to make the first one or two digits agree with your code.
7. Press AM-FM after you have confirmed that the code matches the secret code you have written down. The display will show ---, indicating that the radio is no longer secured.

If the code entered is incorrect, SEC will appear on the display. The radio will remain secured until the correct code is entered.

When battery power is removed and later applied to a secured radio, the radio won't turn on and LOC will appear on the display.

To unlock a secured radio, see "Unlocking the Theft-Deterrent Feature After a Power Loss" earlier in this section.

Understanding Radio Reception

FM Stereo

FM stereo will give you the best sound. But FM signals will reach only about 10 to 40 miles (16 to 65 km). Tall buildings or hills can interfere with FM signals, causing the sound to come and go.

AM

The range for most AM stations is greater than for FM, especially at night. The longer range, however, can cause stations to interfere with each other. AM can pick up noise from things like storms and power lines. Try reducing the treble to reduce this noise if you ever get it.

Tips About Your Audio System

Hearing damage from loud noise is almost undetectable until it is too late. Your hearing can adapt to higher volumes of sound. Sound that seems normal can be loud and harmful to your hearing. Take precautions by adjusting the volume control on your radio to a safe sound level before your hearing adapts to it.

To help avoid hearing loss or damage:

- Adjust the volume control to the lowest setting.
- Increase volume slowly until you hear comfortably and clearly.

NOTICE:

Before you add any sound equipment to your vehicle -- like a tape player, CB radio, mobile telephone or two-way radio -- be sure you can add what you want. If you can, it's very important to do it properly. Added sound equipment may interfere with the operation of your vehicle's engine, Delco radio or other systems, and even damage them. Your vehicle's systems may interfere with the operation of sound equipment that has been added improperly.

So, before adding sound equipment, check with your dealer and be sure to check Federal rules covering mobile radio and telephone units.

Care of Your Cassette Tape Player

A tape player that is not cleaned regularly can cause reduced sound quality, ruined cassettes or a damaged mechanism. Cassette tapes should be stored in their cases away from contaminants, direct sunlight and extreme heat. If they aren't, they may not operate properly or may cause failure of the tape player.

Your tape player should be cleaned regularly after every 50 hours of use. If you notice a reduction in sound quality, try a known good cassette to see if it is the tape or the tape player at fault. If this other cassette has no improvement in sound quality, clean the tape player.

Cleaning may be done with a scrubbing action, non-abrasive cleaning cassette with pads which scrub the tape head as the hubs of the cleaner cassette turn. It is normal for the cassette to eject while cleaning. Insert the cassette at least three times to ensure thorough cleaning. A scrubbing action cleaning cassette is available through your GM dealership.

You may also choose a non-scrubbing action, wet-type cleaner which uses a cassette with a fabric belt to clean the tape head. This type of cleaning cassette will not eject and, it may not clean as thoroughly as the scrubbing type cleaner.

Cassettes are subject to wear and the sound quality may degrade over time. Always make sure the cassette tape is in good condition before you have your tape player serviced.

Care of Your Compact Discs

Handle discs carefully. Store them in their original cases or other protective cases and away from direct sunlight and dust. If the surface of a disc is soiled, dampen a clean, soft cloth in a mild, neutral detergent solution and clean it, wiping from the center to the edge.

Be sure never to touch the signal surface when handling discs. Pick up discs by grasping the outer edges or the edge of the hole and the outer edge.

Fixed Mast Antenna

The fixed mast antenna can withstand most car washes without being damaged. If the mast should ever become slightly bent, you can straighten it out by hand. If the mast is badly bent, as it might be by vandals, you should replace it.

Check every once in a while to be sure the mast is still tightened to the fender.

 NOTES

Section 4 Your Driving and the Road

Here you'll find information about driving on different kinds of roads and in varying weather conditions. We've also included many other useful tips on driving.

4-2	Defensive Driving	4-34	Before Leaving on a Long Trip
4-3	Drunken Driving	4-35	Highway Hypnosis
4-6	Control of a Vehicle	4-35	Hill and Mountain Roads
4-6	Braking	4-37	Winter Driving
4-9	Steering	4-41	Recreational Vehicle Towing (Four-Wheel Drive with the Manual Shift Transfer Case Only)
4-11	Off-Road Recovery	4-42	Recreational Vehicle Towing (Except Four-Wheel Drive with the Manual Shift Transfer Case)
4-12	Passing	4-42	Loading Your Vehicle
4-13	Loss of Control	4-45	Towing a Trailer
4-14	Driving Guidelines		
4-28	Driving at Night		
4-29	Driving in Rain and on Wet Roads		
4-32	City Driving		
4-33	Freeway Driving		



Defensive Driving

The best advice anyone can give about driving is:
Drive defensively.

Please start with a very important safety device in your vehicle: Buckle up. (See "Safety Belts" in the Index.)

Defensive driving really means "be ready for anything." On city streets, rural roads or freeways, it means "always expect the unexpected."

Assume that pedestrians or other drivers are going to be careless and make mistakes. Anticipate what they might do. Be ready for their mistakes.

Rear-end collisions are about the most preventable of accidents. Yet they are common. Allow enough following distance. It's the best defensive driving maneuver, in both city and rural driving. You never know when the vehicle in front of you is going to brake or turn suddenly.

Drunken Driving

Death and injury associated with drinking and driving is a national tragedy. It's the number one contributor to the highway death toll, claiming thousands of victims every year.

Alcohol affects four things that anyone needs to drive a vehicle:

- Judgment
- Muscular Coordination
- Vision
- Attentiveness.

Police records show that almost half of all motor vehicle-related deaths involve alcohol. In most cases, these deaths are the result of someone who was drinking and driving. In recent years, some 17,000 annual motor vehicle-related deaths have been associated with the use of alcohol, with more than 300,000 people injured.

Many adults -- by some estimates, nearly half the adult population -- choose never to drink alcohol, so they never drive after drinking. For persons under 21, it's against the law in every U.S. state to drink alcohol. There are good medical, psychological and developmental reasons for these laws.

The obvious way to solve this highway safety problem is for people never to drink alcohol and then drive. But what if people do? How much is "too much" if the driver plans to drive? It's a lot less than many might think. Although it depends on each person and situation, here is some general information on the problem.

The Blood Alcohol Concentration (BAC) of someone who is drinking depends upon four things:

- The amount of alcohol consumed
- The drinker's body weight
- The amount of food that is consumed before and during drinking
- The length of time it has taken the drinker to consume the alcohol.

According to the American Medical Association, a 180-lb. (82 kg) person who drinks three 12-ounce (355 ml) bottles of beer in an hour will end up with a BAC of about 0.06 percent. The person would reach the same BAC by drinking three 4-ounce (120 ml) glasses of wine or three mixed drinks if each had 1-1/2 ounces (45 ml) of a liquor like whiskey, gin or vodka.

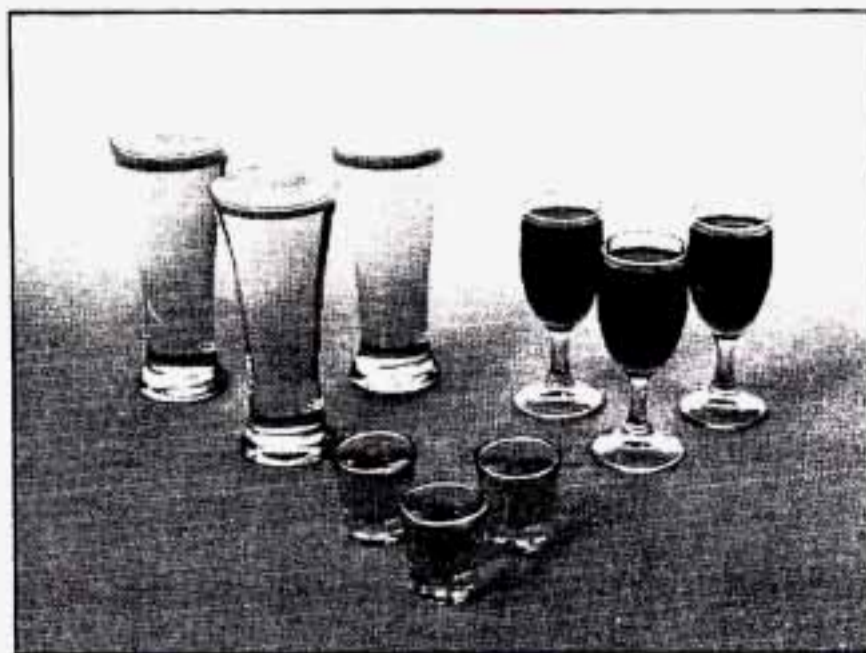

It's the amount of alcohol that counts. For example, if the same person drank three double martinis (3 ounces or 90 ml of liquor each) within an hour, the person's BAC would be close to 0.12 percent. A person who consumes food just before or during drinking will have a somewhat lower BAC level.

There is a gender difference, too. Women generally have a lower relative percentage of body water than men.

Since alcohol is carried in body water, this means that a woman generally will reach a higher BAC level than a man of her same body weight when each has the same number of drinks.

The law in many U.S. states sets the legal limit at a BAC of 0.10 percent. In a growing number of U.S. states, and throughout Canada, the limit is 0.08 percent. In some other countries, it's even lower. The BAC limit for all commercial drivers in the United States is 0.04 percent.

The BAC will be over 0.10 percent after three to six drinks (in one hour). Of course, as we've seen, it depends on how much alcohol is in the drinks, and how quickly the person drinks them.

But the ability to drive is affected well below a BAC of 0.10 percent. Research shows that the driving skills of many people are impaired at a BAC approaching 0.05 percent, and that the effects are worse at night. All drivers are impaired at BAC levels above 0.05 percent. Statistics show that the chance of being in a collision increases sharply for drivers who have a BAC of 0.05 percent or above. A driver with a BAC level of 0.06 percent has doubled his or her chance of having a collision. At a BAC level of 0.10 percent, the chance of this driver having a collision is 12 times greater; at a level of 0.15 percent, the chance is 25 times greater!

The body takes about an hour to rid itself of the alcohol in one drink. No amount of coffee or number of cold showers will speed that up. "I'll be careful" isn't the right answer. What if there's an emergency, a need to take sudden action, as when a child darts into the street? A person with even a moderate BAC might not be able to react quickly enough to avoid the collision.

There's something else about drinking and driving that many people don't know. Medical research shows that alcohol in a person's system can make crash injuries worse, especially injuries to the brain, spinal cord or heart. This means that when anyone who has been drinking -- driver or passenger -- is in a crash, that person's chance of being killed or permanently disabled is higher than if the person had not been drinking.



CAUTION:

Drinking and then driving is very dangerous. Your reflexes, perceptions, attentiveness and judgment can be affected by even a small amount of alcohol. You can have a serious -- or even fatal -- collision if you drive after drinking. Please don't drink and drive or ride with a driver who has been drinking. Ride home in a cab; or if you're with a group, designate a driver who will not drink.

Control of a Vehicle

You have three systems that make your vehicle go where you want it to go. They are the brakes, the steering and the accelerator. All three systems have to do their work at the places where the tires meet the road.

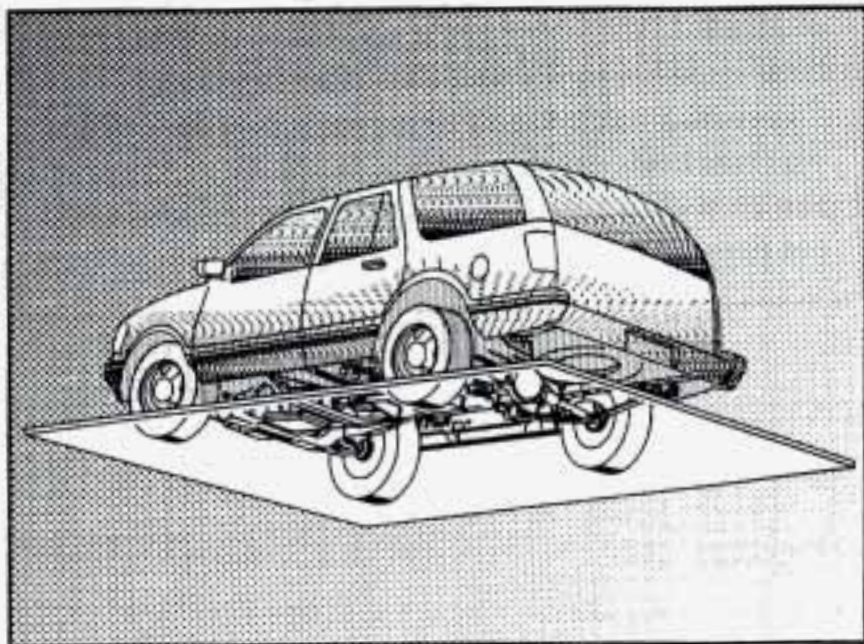

Sometimes, as when you're driving on snow or ice, it's easy to ask more of those control systems than the tires and road can provide. That means you can lose control of your vehicle.

Braking

Braking action involves *perception time* and *reaction time*.

First, you have to decide to push on the brake pedal. That's *perception time*. Then you have to bring up your foot and do it. That's *reaction time*.

Average *reaction time* is about $3/4$ of a second. But that's only an average. It might be less with one driver and as long as two or three seconds or more with another. Age, physical condition, alertness, coordination and eyesight all play a part. So do alcohol, drugs and frustration. But even in $3/4$ of a second, a vehicle moving at 60 mph (100 km/h) travels 66 feet (20 m). That could be a lot of distance in an emergency, so keeping enough space between your vehicle and others is important.

And, of course, actual stopping distances vary greatly with the surface of the road (whether it's pavement or gravel); the condition of the road (wet, dry, icy); tire tread; the condition of your brakes; the weight of the vehicle and the amount of brake force applied.

Avoid needless heavy braking. Some people drive in spurts -- heavy acceleration followed by heavy braking -- rather than keeping pace with traffic. This is a mistake. Your brakes may not have time to cool between hard stops. Your brakes will wear out much faster if you do a lot of heavy braking. If you keep pace with the traffic and allow realistic following distances, you will eliminate a lot of unnecessary braking. That means better braking and longer brake life.

If your engine ever stops while you're driving, brake normally but don't pump your brakes. If you do, the pedal may get harder to push down. If your engine stops, you will still have some power brake assist. But you will use it when you brake. Once the power assist is used up, it may take longer to stop and the brake pedal will be harder to push.

Anti-Lock Brakes (ABS)

Your vehicle has anti-lock brakes (ABS). ABS is an advanced electronic braking system that will help prevent a braking skid.

When you start your engine and begin to drive away, your anti-lock brake system will check itself. You may hear a momentary motor or clicking noise while this test is going on. This is normal.

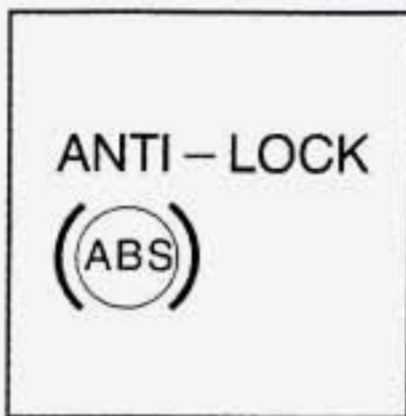

If there's a problem with the anti-lock brake system, this warning light will stay on. See "Anti-Lock Brake System Warning Light" in the Index.

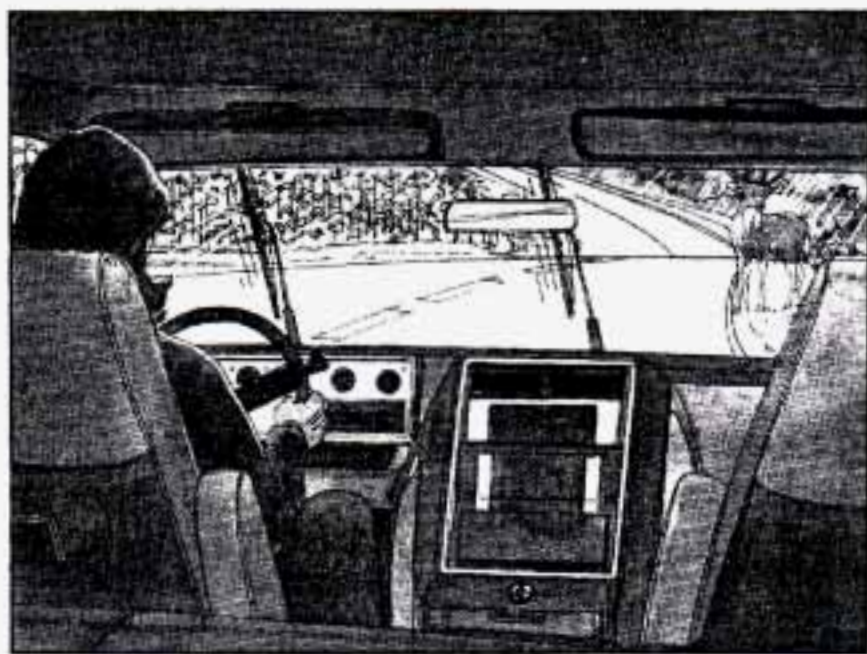

Here's how anti-lock works. Let's say the road is wet. You're driving safely. Suddenly an animal jumps out in front of you.

You slam on the brakes. Here's what happens with ABS.

A computer senses that wheels are slowing down. If one of the wheels is about to stop rolling, the computer will separately work the brakes at each front wheel and at the rear wheels.

The anti-lock system can change the brake pressure faster than any driver could. The computer is programmed to make the most of available tire and road conditions.



You can steer around the obstacle while braking hard.

As you brake, your computer keeps receiving updates on wheel speed and controls braking pressure accordingly.

Remember: Anti-lock doesn't change the time you need to get your foot up to the brake pedal or always decrease stopping distance. If you get too close to the vehicle in front of you, you won't have time to apply your brakes if that vehicle suddenly slows or stops. Always leave enough room up ahead to stop, even though you have anti-lock brakes.

Using Anti-Lock

Don't pump the brakes. Just hold the brake pedal down and let anti-lock work for you. You may feel the brakes vibrate, or you may notice some noise, but this is normal. On vehicles with four-wheel drive, your anti-lock brakes work at all times -- whether you are in two-wheel drive or four-wheel drive.

Braking in Emergencies

With anti-lock, you can steer and brake at the same time. In many emergencies, steering can help you more than even the very best braking.

Steering

Power Steering

If you lose power steering assist because the engine stops or the system is not functioning, you can steer but it will take much more effort.

Steering Tips

Driving on Curves

It's important to take curves at a reasonable speed.

A lot of the "driver lost control" accidents mentioned on the news happen on curves. Here's why:

Experienced driver or beginner, each of us is subject to the same laws of physics when driving on curves. The traction of the tires against the road surface makes it possible for the vehicle to change its path when you turn the front wheels. If there's no traction, inertia will keep the vehicle going in the same direction. If you've ever tried to steer a vehicle on wet ice, you'll understand this.

The traction you can get in a curve depends on the condition of your tires and the road surface, the angle at which the curve is banked, and your speed. While you're in a curve, speed is the one factor you can control.

Suppose you're steering through a sharp curve. Then you suddenly accelerate. Both control systems -- steering and acceleration -- have to do their work where the tires meet the road. Adding the sudden acceleration can demand too much of those places. You can lose control.

What should you do if this ever happens? Ease up on the accelerator pedal, steer the vehicle the way you want it to go, and slow down.

Speed limit signs near curves warn that you should adjust your speed. Of course, the posted speeds are based on good weather and road conditions. Under less favorable conditions you'll want to go slower.

If you need to reduce your speed as you approach a curve, do it before you enter the curve, while your front wheels are straight ahead.

Try to adjust your speed so you can "drive" through the curve. Maintain a reasonable, steady speed. Wait to accelerate until you are out of the curve, and then accelerate gently into the straightaway.

Steering in Emergencies

There are times when steering can be more effective than braking. For example, you come over a hill and find a truck stopped in your lane, or a car suddenly pulls out from nowhere, or a child darts out from between parked cars and stops right in front of you. You can avoid these problems by braking -- if you can stop in time. But sometimes you can't; there isn't room. That's the time for evasive action -- steering around the problem.

Your vehicle can perform very well in emergencies like these. First apply your brakes. (See "Braking in Emergencies" earlier in this section.) It is better to remove as much speed as you can from a possible collision. Then steer around the problem, to the left or right depending on the space available.



An emergency like this requires close attention and a quick decision. If you are holding the steering wheel at the recommended 9 and 3 o'clock positions, you can turn it a full 180 degrees very quickly without removing either hand. But you have to act fast, steer quickly, and just as quickly straighten the wheel once you have avoided the object.

The fact that such emergency situations are always possible is a good reason to practice defensive driving at all times and wear safety belts properly.

Off-Road Recovery

You may find sometime that your right wheels have dropped off the edge of a road onto the shoulder while you're driving.

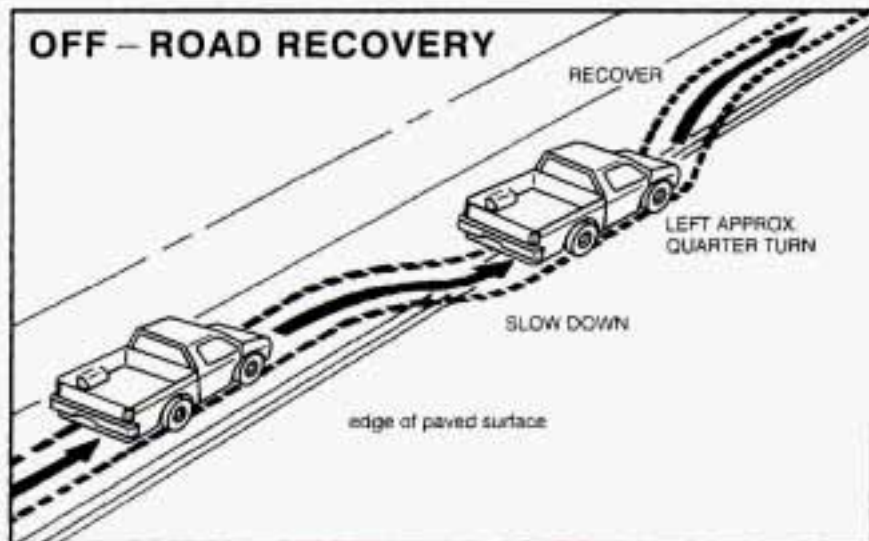

If the level of the shoulder is only slightly below the pavement, recovery should be fairly easy. Ease off the accelerator and then, if there is nothing in the way, steer so that your vehicle straddles the edge of the pavement. You can turn the steering wheel up to one-quarter turn until the right front tire contacts the pavement edge. Then turn your steering wheel to go straight down the roadway.

Passing

The driver of a vehicle about to pass another on a two-lane highway waits for just the right moment, accelerates, moves around the vehicle ahead, then goes back into the right lane again. A simple maneuver?

Not necessarily! Passing another vehicle on a two-lane highway is a potentially dangerous move, since the passing vehicle occupies the same lane as oncoming traffic for several seconds. A miscalculation, an error in judgment, or a brief surrender to frustration or anger can suddenly put the passing driver face to face with the worst of all traffic accidents -- the head-on collision.

So here are some tips for passing:

- “Drive ahead.” Look down the road, to the sides and to crossroads for situations that might affect your passing patterns. If you have any doubt whatsoever about making a successful pass, wait for a better time.
- Watch for traffic signs, pavement markings and lines. If you can see a sign up ahead that might indicate a turn or an intersection, delay your pass. A broken center line usually indicates it’s all right to pass (providing the road ahead is clear). Never cross a solid line on your side of the lane or a double solid line, even if the road seems empty of approaching traffic.
- Do not get too close to the vehicle you want to pass while you’re awaiting an opportunity. For one thing, following too closely reduces your area of vision, especially if you’re following a larger vehicle. Also, you won’t have adequate space if the vehicle ahead suddenly slows or stops. Keep back a reasonable distance.
- When it looks like a chance to pass is coming up, start to accelerate but stay in the right lane and don’t get too close. Time your move so you will be increasing speed as the time comes to move into the other lane. If the way is clear to pass, you will have a “running start” that more than makes up for the distance you would lose by dropping back. And if something happens to cause you to cancel your pass, you need only slow down and drop back again and wait for another opportunity.
- If other cars are lined up to pass a slow vehicle, wait your turn. But take care that someone isn’t trying to pass you as you pull out to pass the slow vehicle. Remember to glance over your shoulder and check the blind spot.

- Check your mirrors, glance over your shoulder and start your left lane change signal before moving out of the right lane to pass. When you are far enough ahead of the passed vehicle to see its front in your inside mirror, activate your right lane change signal and move back into the right lane. (Remember that your right outside mirror is convex. The vehicle you just passed may seem to be farther away from you than it really is.)
- Try not to pass more than one vehicle at a time on two-lane roads. Reconsider before passing the next vehicle.
- Don't overtake a slowly moving vehicle too rapidly. Even though the brake lamps are not flashing, it may be slowing down or starting to turn.
- If you're being passed, make it easy for the following driver to get ahead of you. Perhaps you can ease a little to the right.

Loss of Control

Let's review what driving experts say about what happens when the three control systems (brakes, steering and acceleration) don't have enough friction where the tires meet the road to do what the driver has asked.

In any emergency, don't give up. Keep trying to steer and constantly seek an escape route or area of less danger.

Skidding

In a skid, a driver can lose control of the vehicle. Defensive drivers avoid most skids by taking reasonable care suited to existing conditions, and by not "overdriving" those conditions. But skids are always possible.

The three types of skids correspond to your vehicle's three control systems. In the braking skid, your wheels aren't rolling. In the steering or cornering skid, too much speed or steering in a curve causes tires to slip and lose cornering force. And in the acceleration skid, too much throttle causes the driving wheels to spin.

A cornering skid and an acceleration skid are best handled by easing your foot off the accelerator pedal.

If your vehicle starts to slide, ease your foot off the accelerator pedal and quickly steer the way you want the vehicle to go. If you start steering quickly enough, your vehicle may straighten out. Always be ready for a second skid if it occurs.

Of course, traction is reduced when water, snow, ice, gravel or other material is on the road. For safety, you'll want to slow down and adjust your driving to these conditions. It is important to slow down on slippery surfaces because stopping distance will be longer and vehicle control more limited.

While driving on a surface with reduced traction, try your best to avoid sudden steering, acceleration or braking (including engine braking by shifting to a lower gear). Any sudden changes could cause the tires to slide. You may not realize the surface is slippery until your vehicle is skidding. Learn to recognize warning clues -- such as enough water, ice or packed snow on the road to make a "mirrored surface" -- and slow down when you have any doubt.

Remember: Any anti-lock brake system (ABS) helps avoid only the braking skid.

Driving Guidelines

This multipurpose passenger vehicle is defined as a utility vehicle in Consumer Information Regulations issued by the National Highway Traffic Safety Administration (NHTSA) of the United States Department of Transportation. Utility vehicles have higher ground clearance and a narrower track to make them capable of performing in a wide variety of off-road applications. Specific design characteristics give them a higher center of gravity than ordinary cars. An advantage of the higher ground clearance is a better view of the road allowing you to anticipate problems. They are not designed for cornering at the same speeds as conventional two-wheel-drive vehicles any more than low-slung sports cars are designed to perform satisfactorily under off-road conditions. If at all possible, avoid sharp turns or abrupt maneuvers. As with other vehicles of this type, failure to operate this vehicle correctly may result in loss of control or vehicle rollover.

Off-Road Driving with Your Four-Wheel-Drive Vehicle

This off-road guide is for vehicles that have four-wheel drive.

Also, see “Anti-Lock Brakes” in the Index.

If your vehicle doesn't have four-wheel drive, you shouldn't drive off-road unless you're on a level, solid surface.

Off-road driving can be great fun. But it does have some definite hazards. The greatest of these is the terrain itself.

“Off-roading” means you've left the great North American road system behind. Traffic lanes aren't marked. Curves aren't banked. There are no road signs. Surfaces can be slippery, rough, uphill or downhill. In short, you've gone right back to nature.

Off-road driving involves some new skills. And that's why it's very important that you read this guide. You'll find many driving tips and suggestions. These will help make your off-road driving safer and more enjoyable.

Before You Go Off-Roading

There are some things to do before you go out. For example, be sure to have all necessary maintenance and service work done. Check to make sure all underbody shields (if so equipped) are properly attached. Be sure you read all the information about your four-wheel-drive vehicle in this manual. Is there enough fuel? Is the spare tire fully inflated? Are the fluid levels up where they should be? What are the local laws that apply to off-roading where you'll be driving? If you don't know, you should check with law enforcement people in the area. Will you be on someone's private land? If so, be sure to get the necessary permission.

Loading Your Vehicle for Off-Road Driving

There are some important things to remember about how to load your vehicle.

- The heaviest things should be on the load floor and forward of your rear axle. Put heavier items as far forward as you can.
- Be sure the load is secured properly, so driving on the off-road terrain doesn't toss things around.



CAUTION:

- **Cargo on the load floor piled higher than the seatbacks can be thrown forward during a sudden stop. You or your passengers could be injured. Keep cargo below the top of the seatbacks.**
- **Unsecured cargo on the load floor can be tossed about when driving over rough terrain. You or your passengers can be struck by flying objects. Secure the cargo properly.**
- **Heavy loads on the roof raise the vehicle's center of gravity, making it more likely to roll over. You can be seriously or fatally injured if the vehicle rolls over. Put heavy loads inside the cargo area, not on the roof. Keep cargo in the cargo area as far forward and low as possible.**

You'll find other important information in this manual. See "Vehicle Loading," "Luggage Carrier" and "Tires" in the Index.

Environmental Concerns

Off-road driving can provide wholesome and satisfying recreation. However, it also raises environmental concerns. GM recognizes these concerns and urges every off-roader to follow these basic rules for protecting the environment:

- Always use established trails, roads and areas that have been specially set aside for public off-road recreational driving; obey all posted regulations.
- Avoid any driving practice that could damage the environment -- shrubs, flowers, trees, grasses -- or disturb wildlife (this includes wheel-spinning, breaking down trees or unnecessary driving through streams or over soft ground).
- Always carry a litter bag . . . make sure all refuse is removed from any campsite before leaving.
- Take extreme care with open fires (where permitted), camp stoves and lanterns.
- Never park your vehicle over dry grass or other combustible materials that could catch fire from the heat of the vehicle's exhaust system.

Traveling to Remote Areas

It makes sense to plan your trip, especially when going to a remote area. Know the terrain and plan your route. You are much less likely to get bad surprises. Get accurate maps of trails and terrain. Try to learn of any blocked or closed roads.

It's also a good idea to travel with at least one other vehicle. If something happens to one of them, the other can help quickly.

Does your vehicle have a winch? If so, be sure to read the winch instructions. In a remote area, a winch can be handy if you get stuck. But you'll want to know how to use it properly.

Getting Familiar with Off-Road Driving

It's a good idea to practice in an area that's safe and close to home before you go into the wilderness. Off-road driving does require some new and different driving skills. Here's what we mean.

Tune your senses to different kinds of signals. Your eyes, for example, need to constantly sweep the terrain for unexpected obstacles. Your ears need to listen for unusual tire or engine sounds. With your arms, hands, feet and body, you'll need to respond to vibrations and vehicle bounce.

Controlling your vehicle is the key to successful off-road driving. One of the best ways to control your vehicle is to control your speed. Here are some things to keep in mind. At higher speeds:

- you approach things faster and you have less time to scan the terrain for obstacles.
- you have less time to react.
- you have more vehicle bounce when you drive over obstacles.
- you'll need more distance for braking, especially since you're on an unpaved surface.



CAUTION:

When you're driving off-road, bouncing and quick changes in direction can easily throw you out of position. This could cause you to lose control and crash. So, whether you're driving on or off the road, you and your passengers should wear safety belts.

Scanning the Terrain

Off-road driving can take you over many different kinds of terrain. You need to be familiar with the terrain and its many different features. Here are some things to consider.

Surface Conditions. Off-roading can take you over hard-packed dirt, gravel, rocks, grass, sand, mud, snow or ice. Each of these surfaces affects the steering, acceleration and braking of your vehicle in different ways. Depending upon the kind of surface you are on, you may experience slipping, sliding, wheel spinning, delayed acceleration, poor traction and longer braking distances.

Surface Obstacles. Unseen or hidden obstacles can be hazardous. A rock, log, hole, rut or bump can startle you if you're not prepared for them. Often these obstacles are hidden by grass, bushes, snow or even the rise and fall of the terrain itself. Here are some things to consider:

- Is the path ahead clear?
- Will the surface texture change abruptly up ahead?
- Does the travel take you uphill or downhill? (There's more discussion of these subjects later.)
- Will you have to stop suddenly or change direction quickly?

When you drive over obstacles or rough terrain, keep a firm grip on the steering wheel. Ruts, troughs or other surface features can jerk the wheel out of your hands if you're not prepared.

When you drive over bumps, rocks, or other obstacles, your wheels can leave the ground. If this happens, even with one or two wheels, you can't control the vehicle as well or at all.

Because you will be on an unpaved surface, it's especially important to avoid sudden acceleration, sudden turns or sudden braking.

In a way, off-road driving requires a different kind of alertness from driving on paved roads and highways. There are no road signs, posted speed limits or signal lights. You have to use your own good judgment about what is safe and what isn't.

Drinking and driving can be very dangerous on any road. And this is certainly true for off-road driving. At the very time you need special alertness and driving skills, your reflexes, perceptions and judgment can be affected by even a small amount of alcohol. You could have a serious -- or even fatal -- accident if you drink and drive or ride with a driver who has been drinking. See "Drunken Driving" in the Index.

Driving on Off-Road Hills

Off-road driving often takes you up, down or across a hill. Driving safely on hills requires good judgment and an understanding of what your vehicle can and can't do. There are some hills that simply can't be driven, no matter how well built the vehicle.

CAUTION:

Many hills are simply too steep for any vehicle. If you drive up them, you will stall. If you drive down them, you can't control your speed. If you drive across them, you will roll over. You could be seriously injured or killed. If you have any doubt about the steepness, don't drive the hill.

Approaching a Hill

When you approach a hill, you need to decide if it's one of those hills that's just too steep to climb, descend or cross. Steepness can be hard to judge. On a very small hill, for example, there may be a smooth, constant incline with only a small change in elevation where you can easily see all the way to the top. On a large hill, the

incline may get steeper as you near the top, but you may not see this because the crest of the hill is hidden by bushes, grass or shrubs.

Here are some other things to consider as you approach a hill.

- Is there a constant incline, or does the hill get sharply steeper in places?
- Is there good traction on the hillside, or will the surface cause tire slipping?
- Is there a straight path up or down the hill so you won't have to make turning maneuvers?
- Are there obstructions on the hill that can block your path (boulders, trees, logs or ruts)?
- What's beyond the hill? Is there a cliff, an embankment, a drop-off, a fence? Get out and walk the hill if you don't know. It's the smart way to find out.
- Is the hill simply too rough? Steep hills often have ruts, gullies, troughs and exposed rocks because they are more susceptible to the effects of erosion.

Driving Uphill

Once you decide you can safely drive up the hill, you need to take some special steps.

- Use a low gear and get a firm grip on the steering wheel.
- Get a smooth start up the hill and try to maintain your speed. Don't use more power than you need, because you don't want your wheels to start spinning or sliding.
- Try to drive straight up the hill if at all possible. If the path twists and turns, you might want to find another route.

CAUTION:

Turning or driving across steep hills can be dangerous. You could lose traction, slide sideways, and possibly roll over. You could be seriously injured or killed. When driving up hills, always try to go straight up.

- Ease up on your speed as you approach the top of the hill.
- Attach a flag to the vehicle to make you more visible to approaching traffic on trails or hills.
- Sound the horn as you approach the top of the hill to let opposing traffic know you're there.
- Use your headlamps even during the day. They make you more visible to oncoming traffic.

CAUTION:

Driving to the top (crest) of a hill at full speed can cause an accident. There could be a drop-off, embankment, cliff, or even another vehicle. You could be seriously injured or killed. As you near the top of a hill, slow down and stay alert.

Q: What should I do if my vehicle stalls, or is about to stall, and I can't make it up the hill?

A: If this happens, there are some things you should do, and there are some things you must not do. First, here's what you *should* do:

- Push the brake pedal to stop the vehicle and keep it from rolling backwards. Also, apply the parking brake.
- If your engine is still running, shift the transmission to REVERSE (R), release the parking brake, and slowly back down the hill in REVERSE (R).
- If your engine has stopped running, you'll need to restart it. With the brake pedal depressed and the parking brake still applied, shift the transmission to PARK (P) (or, shift to NEUTRAL (N) if your vehicle has a manual transmission) and restart the engine. Then, shift to REVERSE (R), release the parking brake, and slowly back down the hill as straight as possible in REVERSE (R).

- As you are backing down the hill, put your left hand on the steering wheel at the 12 o'clock position. This way, you'll be able to tell if your wheels are straight and maneuver as you back down. It's best that you back down the hill with your wheels straight rather than in the left or right direction. Turning the wheel too far to the left or right will increase the possibility of a rollover.

Here are some things you *must not* do if you stall, or are about to stall, when going up a hill.

- Never attempt to prevent a stall by shifting into NEUTRAL (N) (or depressing the clutch, if you have a manual transmission) to "rev-up" the engine and regain forward momentum. This won't work. Your vehicle will roll backwards very quickly and you could go out of control.

Instead, apply the regular brake to stop the vehicle. Then apply the parking brake. Shift to REVERSE (R), release the parking brake, and slowly back straight down.
- Never attempt to turn around if you are about to stall when going up a hill. If the hill is steep enough to stall your vehicle, it's steep enough to cause you to roll over if you turn around. If you can't make it up the hill, you must back straight down the hill.

Q: Suppose, after stalling, I try to back down the hill and decide I just can't do it. What should I do?

A: Set the parking brake, put your transmission in PARK (P) (or the manual transmission in FIRST (1)) and turn off the engine. Leave the vehicle and go get some help. Exit on the uphill side and stay clear of the path the vehicle would take if it rolled downhill. Do not shift the transfer case to NEUTRAL (N) when you leave the vehicle. Leave it in some gear.



CAUTION:

If you have a manual transfer case shift lever, shifting the transfer case to NEUTRAL (N) can cause your vehicle to roll even if the transmission is in PARK (P) (or, if you have the manual transmission, even if you're in gear). This is because the NEUTRAL (N) position on the transfer case overrides the transmission. If you are going to leave your vehicle, set the parking brake and shift the transmission to PARK (P) (or, put your manual transmission in FIRST (1)). But do not shift the transfer case to the NEUTRAL (N) position. Leave the transfer case in the 2HI, 4HI or 4LO position.

Driving Downhill

When off-roading takes you downhill, you'll want to consider a number of things:

- How steep is the downhill? Will I be able to maintain vehicle control?
- What's the surface like? Smooth? Rough? Slippery? Hard-packed dirt? Gravel?
- Are there hidden surface obstacles? Ruts? Logs? Boulders?
- What's at the bottom of the hill? Is there a hidden creek bank or even a river bottom with large rocks?

If you decide you can go down a hill safely, then try to keep your vehicle headed straight down, and use a low gear. This way, engine drag can help your brakes and they won't have to do all the work. Descend slowly, keeping your vehicle under control at all times.



CAUTION:

Heavy braking when going down a hill can cause your brakes to overheat and fade. This could cause loss of control and a serious accident. Apply the brakes lightly when descending a hill and use a low gear to keep vehicle speed under control.

Q: Are there some things I should not do when driving down a hill?

A: Yes! These are important because if you ignore them you could lose control and have a serious accident.

- When driving downhill, avoid turns that take you across the incline of the hill. A hill that's not too steep to drive down may be too steep to drive across. You could roll over if you don't drive straight down.
- Never go downhill with the transmission in NEUTRAL (N), or with the clutch pedal depressed in a manual shift. This is called "free-wheeling." Your brakes will have to do all the work and could overheat and fade.

Q: Am I likely to stall when going downhill?

A: It's much more likely to happen going uphill. But if it happens going downhill, here's what to do.

- Stop your vehicle by applying the regular brakes. Apply the parking brake.
- Shift to PARK (P) (or to NEUTRAL (N) with the manual transmission) and, while still braking, restart the engine.
- Shift back to a low gear, release the parking brake, and drive straight down.
- If the engine won't start, get out and get help.

Driving Across an Incline

Sooner or later, an off-road trail will probably go across the incline of a hill. If this happens, you have to decide whether to try to drive across the incline. Here are some things to consider:

- A hill that can be driven straight up or down may be too steep to drive across. When you go straight up or down a hill, the length of the wheel base (the distance from the front wheels to the rear wheels) reduces the likelihood the vehicle will tumble end over end. But when you drive across an incline, the much more narrow track width (the distance between the left and right wheels) may not prevent the vehicle

from tilting and rolling over. Also, driving across an incline puts more weight on the downhill wheels. This could cause a downhill slide or a rollover.

- Surface conditions can be a problem when you drive across a hill. Loose gravel, muddy spots, or even wet grass can cause your tires to slip sideways, downhill. If the vehicle slips sideways, it can hit something that will trip it (a rock, a rut, etc.) and roll over.
- Hidden obstacles can make the steepness of the incline even worse. If you drive across a rock with the uphill wheels, or if the downhill wheels drop into a rut or depression, your vehicle can tilt even more.

For reasons like these, you need to decide carefully whether to try to drive across an incline. Just because the trail goes across the incline doesn't mean you have to drive it. The last vehicle to try it might have rolled over.

 **CAUTION:**

Driving across an incline that's too steep will make your vehicle roll over. You could be seriously injured or killed. If you have any doubt about the steepness of the incline, don't drive across it. Find another route instead.

Q: What if I'm driving across an incline that's not too steep, but I hit some loose gravel and start to slide downhill. What should I do?

A: If you feel your vehicle starting to slide sideways, turn downhill. This should help straighten out the vehicle and prevent the side slipping. However, a much better way to prevent this is to get out and "walk the course" so you know what the surface is like before you drive it.

Stalling on an Incline

If your vehicle stalls when you're crossing an incline, be sure you (and your passengers) get out on the uphill side, even if the door there is harder to open. If you get out on the downhill side and the vehicle starts to roll over, you'll be right in its path.

If you have to walk down the slope, stay out of the path the vehicle will take if it does roll over.

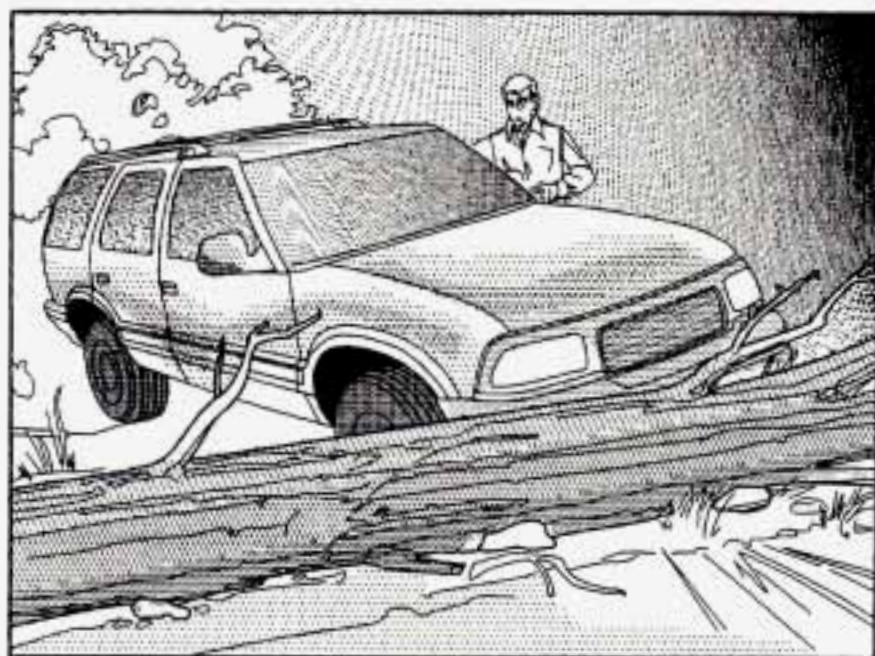

CAUTION:

Getting out on the downhill (low) side of a vehicle stopped across an incline is dangerous. If the vehicle rolls over, you could be crushed or killed. Always get out on the uphill (high) side of the vehicle and stay well clear of the rollover path.

Driving in Mud, Sand, Snow or Ice

When you drive in mud, snow or sand, your wheels won't get good traction. You can't accelerate as quickly, turning is more difficult, and you'll need longer braking distances.

It's best to use a low gear when you're in mud -- the deeper the mud, the lower the gear. In really deep mud, the idea is to keep your vehicle moving so you don't get stuck.

When you drive on sand, you'll sense a change in wheel traction. But it will depend upon how loosely packed the sand is. On loosely packed sand (as on beaches or sand dunes) your tires will tend to sink into the sand. This has an effect on steering, accelerating and braking. You may want to reduce the air pressure in your tires slightly when driving on sand. This will improve traction.

Hard packed snow and ice offer the worst tire traction. On these surfaces, it's very easy to lose control. On wet ice, for example, the traction is so poor that you will have difficulty accelerating. And if you do get moving, poor steering and difficult braking can cause you to slide out of control.



CAUTION:

Driving on frozen lakes, ponds or rivers can be dangerous. Underwater springs, currents under the ice, or sudden thaws can weaken the ice. Your vehicle could fall through the ice and you and your passengers could drown. Drive your vehicle on safe surfaces only.

Driving in Water

Light rain causes no special off-road driving problems. But heavy rain can mean flash flooding, and flood waters demand extreme caution.

Find out how deep the water is before you drive through it. If it's deep enough to cover your wheel hubs, axles or exhaust pipe, don't try it -- you probably won't get through. Also, water that deep can damage your axle and other vehicle parts.

If the water isn't too deep, then drive through it slowly. At fast speeds, water splashes on your ignition system and your vehicle can stall. Stalling can also occur if you get your tailpipe under water. And, as long as your tailpipe is under water, you'll never be able to start your engine. When you go through water, remember that when your brakes get wet, it may take you longer to stop.

 **CAUTION:**

Driving through rushing water can be dangerous. Deep water can sweep your vehicle downstream and you and your passengers could drown. If it's only shallow water, it can still wash away the ground from under your tires, and you could lose traction and roll the vehicle over. Don't drive through rushing water.

See "Driving Through Water" in the Index for more information on driving through water.

After Off-Road Driving

Remove any brush or debris that has collected on the underbody, chassis or under the hood. These accumulations can be a fire hazard.

After operation in mud or sand, have the brake linings cleaned and checked. These substances can cause glazing and uneven braking. Check the body structure, steering, suspension, wheels, tires and exhaust system for damage. Also, check the fuel lines and cooling system for any leakage.

Your vehicle will require more frequent service due to off-road use. Refer to the Maintenance Schedule for additional information.

Driving at Night

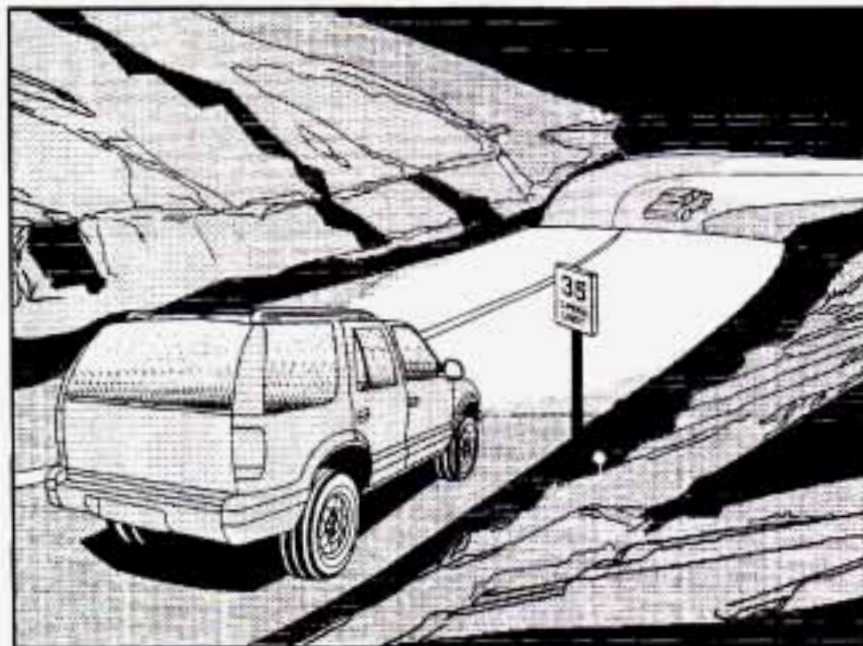

Night driving is more dangerous than day driving. One reason is that some drivers are likely to be impaired -- by alcohol or drugs, with night vision problems, or by fatigue.

Here are some tips on night driving.

- Drive defensively.
- Don't drink and drive.

- Adjust your inside rearview mirror to reduce the glare from headlamps behind you.
- Since you can't see as well, you may need to slow down and keep more space between you and other vehicles.
- Slow down, especially on higher speed roads. Your headlamps can light up only so much road ahead.
- In remote areas, watch for animals.
- If you're tired, pull off the road in a safe place and rest.

Night Vision

No one can see as well at night as in the daytime. But as we get older these differences increase. A 50-year-old driver may require at least twice as much light to see the same thing at night as a 20-year-old.

What you do in the daytime can also affect your night vision. For example, if you spend the day in bright sunshine you are wise to wear sunglasses. Your eyes will have less trouble adjusting to night. But if you're driving, don't wear sunglasses at night. They may cut down on glare from headlamps, but they also make a lot of things invisible.

You can be temporarily blinded by approaching headlamps. It can take a second or two, or even several seconds, for your eyes to readjust to the dark. When you are faced with severe glare (as from a driver who doesn't lower the high beams, or a vehicle with misaimed headlamps), slow down a little. Avoid staring directly into the approaching headlamps.

Keep your windshield and all the glass on your vehicle clean -- inside and out. Glare at night is made much worse by dirt on the glass. Even the inside of the glass can build up a film caused by dust. Dirty glass makes lights dazzle and flash more than clean glass would, making the pupils of your eyes contract repeatedly.

Remember that your headlamps light up far less of a roadway when you are in a turn or curve. Keep your eyes moving; that way, it's easier to pick out dimly lighted objects. Just as your headlamps should be checked regularly for proper aim, so should your eyes be examined regularly. Some drivers suffer from night blindness -- the inability to see in dim light -- and aren't even aware of it.

Driving in Rain and on Wet Roads



Rain and wet roads can mean driving trouble. On a wet road, you can't stop, accelerate or turn as well because your tire-to-road traction isn't as good as on dry roads. And, if your tires don't have much tread left, you'll get even less traction. It's always wise to go slower and be cautious if rain starts to fall while you are driving. The surface may get wet suddenly when your reflexes are tuned for driving on dry pavement.

The heavier the rain, the harder it is to see. Even if your windshield wiper blades are in good shape, a heavy rain can make it harder to see road signs and traffic signals, pavement markings, the edge of the road and even people walking.

It's wise to keep your wiping equipment in good shape and keep your windshield washer tank filled with washer fluid. Replace your windshield wiper inserts when they show signs of streaking or missing areas on the windshield, or when strips of rubber start to separate from the inserts.

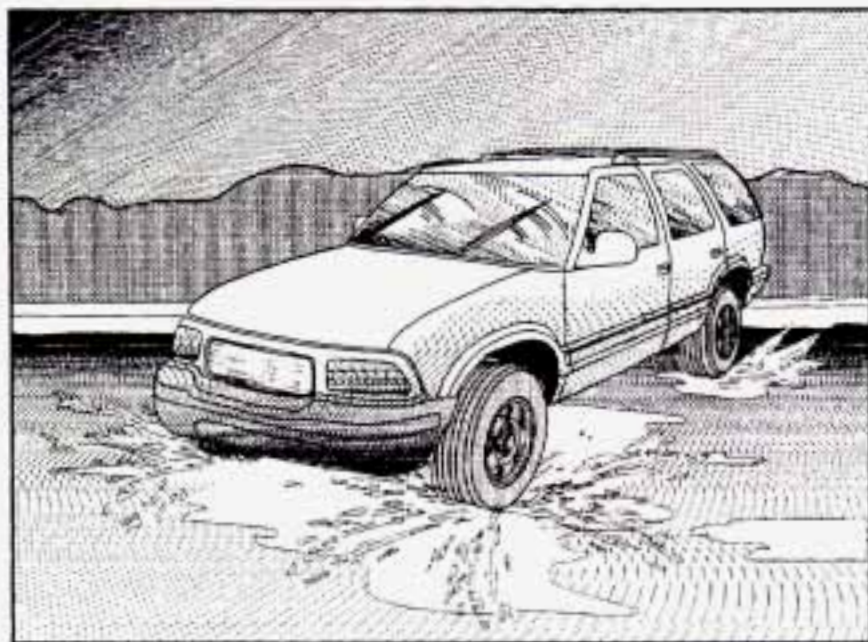

Driving too fast through large water puddles or even going through some car washes can cause problems, too. The water may affect your brakes. Try to avoid puddles. But if you can't, try to slow down before you hit them.

 **CAUTION:**

Wet brakes can cause accidents. They won't work as well in a quick stop and may cause pulling to one side. You could lose control of the vehicle.

After driving through a large puddle of water or a car wash, apply your brake pedal lightly until your brakes work normally.

Hydroplaning

Hydroplaning is dangerous. So much water can build up under your tires that they can actually ride on the water. This can happen if the road is wet enough and you're going fast enough. When your vehicle is hydroplaning, it has little or no contact with the road.

Hydroplaning doesn't happen often. But it can if your tires do not have much tread or if the pressure in one or more is low. It can happen if a lot of water is standing on the road. If you can see reflections from trees, telephone poles or other vehicles, and raindrops "dimple" the water's surface, there could be hydroplaning.

Hydroplaning usually happens at higher speeds. There just isn't a hard and fast rule about hydroplaning. The best advice is to slow down when it is raining.

Driving Through Deep Standing Water

NOTICE:

If you drive too quickly through deep puddles or standing water, water can come in through your engine's air intake and badly damage your engine. Never drive through water that is slightly lower than the underbody of your vehicle. If you can't avoid deep puddles or standing water, drive through them very slowly.

Some Other Rainy Weather Tips

- Besides slowing down, allow some extra following distance. And be especially careful when you pass another vehicle. Allow yourself more clear room ahead, and be prepared to have your view restricted by road spray.
- Have good tires with proper tread depth. (See "Tires" in the Index.)

City Driving



One of the biggest problems with city streets is the amount of traffic on them. You'll want to watch out for what the other drivers are doing and pay attention to traffic signals.

Here are ways to increase your safety in city driving:

- Know the best way to get to where you are going. Get a city map and plan your trip into an unknown part of the city just as you would for a cross-country trip.
- Try to use the freeways that rim and crisscross most large cities. You'll save time and energy. (See the next part, "Freeway Driving.")
- Treat a green light as a warning signal. A traffic light is there because the corner is busy enough to need it. When a light turns green, and just before you start to move, check both ways for vehicles that have not cleared the intersection or may be running the red light.

Freeway Driving

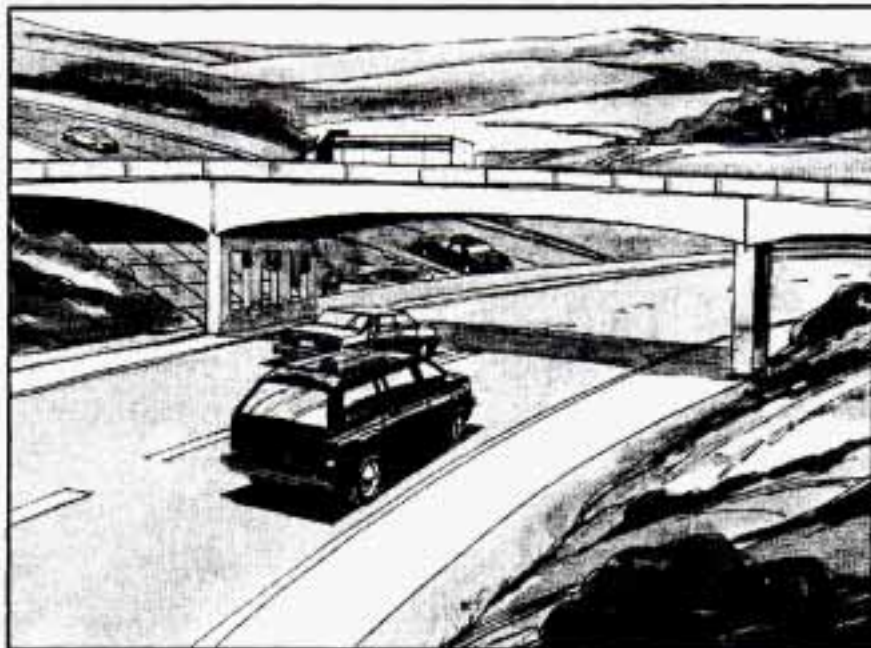

Mile for mile, freeways (also called thruways, parkways, expressways, turnpikes or superhighways) are the safest of all roads. But they have their own special rules.

The most important advice on freeway driving is: Keep up with traffic and keep to the right. Drive at the same speed most of the other drivers are driving. Too-fast or too-slow driving breaks a smooth traffic flow. Treat the left lane on a freeway as a passing lane.

At the entrance, there is usually a ramp that leads to the freeway. If you have a clear view of the freeway as you drive along the entrance ramp, you should begin to check traffic. Try to determine where you expect to blend with the flow. Try to merge into the gap at close to the prevailing speed. Switch on your turn signal, check your mirrors and glance over your shoulder as often as necessary. Try to blend smoothly with the traffic flow.

Once you are on the freeway, adjust your speed to the posted limit or to the prevailing rate if it's slower. Stay in the right lane unless you want to pass.

Before changing lanes, check your mirrors. Then use your turn signal.

Just before you leave the lane, glance quickly over your shoulder to make sure there isn't another vehicle in your "blind" spot.

Once you are moving on the freeway, make certain you allow a reasonable following distance. Expect to move slightly slower at night.

When you want to leave the freeway, move to the proper lane well in advance. If you miss your exit, do not, under any circumstances, stop and back up. Drive on to the next exit.

The exit ramp can be curved, sometimes quite sharply.

The exit speed is usually posted.

Reduce your speed according to your speedometer, not to your sense of motion. After driving for any distance at higher speeds, you may tend to think you are going slower than you actually are.

Before Leaving on a Long Trip

Make sure you're ready. Try to be well rested. If you must start when you're not fresh -- such as after a day's work -- don't plan to make too many miles that first part of the journey. Wear comfortable clothing and shoes you can easily drive in.

Is your vehicle ready for a long trip? If you keep it serviced and maintained, it's ready to go. If it needs service, have it done before starting out. Of course, you'll find experienced and able service experts in GM dealerships all across North America. They'll be ready and willing to help if you need it.

Here are some things you can check before a trip:

- *Windshield Washer Fluid:* Is the reservoir full? Are all windows clean inside and outside?
- *Wiper Blades:* Are they in good shape?
- *Fuel, Engine Oil, Other Fluids:* Have you checked all levels?
- *Lamps:* Are they all working? Are the lenses clean?
- *Tires:* They are vitally important to a safe, trouble-free trip. Is the tread good enough for long-distance driving? Are the tires all inflated to the recommended pressure?
- *Weather Forecasts:* What's the weather outlook along your route? Should you delay your trip a short time to avoid a major storm system?
- *Maps:* Do you have up-to-date maps?

Highway Hypnosis

Is there actually such a condition as “highway hypnosis”? Or is it just plain falling asleep at the wheel? Call it highway hypnosis, lack of awareness, or whatever.

There is something about an easy stretch of road with the same scenery, along with the hum of the tires on the road, the drone of the engine, and the rush of the wind against the vehicle that can make you sleepy. Don't let it happen to you! If it does, your vehicle can leave the road in *less than a second*, and you could crash and be injured.

What can you do about highway hypnosis? First, be aware that it can happen.

Then here are some tips:

- Make sure your vehicle is well ventilated, with a comfortably cool interior.
- Keep your eyes moving. Scan the road ahead and to the sides. Check your mirrors and your instruments frequently.
- If you get sleepy, pull off the road into a rest, service or parking area and take a nap, get some exercise, or both. For safety, treat drowsiness on the highway as an emergency.

Hill and Mountain Roads



Driving on steep hills or mountains is different from driving in flat or rolling terrain.

If you drive regularly in steep country, or if you're planning to visit there, here are some tips that can make your trips safer and more enjoyable. (See “Off-Road Driving” in the Index for information about driving off-road.)

- Keep your vehicle in good shape. Check all fluid levels and also the brakes, tires, cooling system and transmission. These parts can work hard on mountain roads.
- Know how to go down hills. The most important thing to know is this: let your engine do some of the slowing down. Shift to a lower gear when you go down a steep or long hill.

 **CAUTION:**

If you don't shift down, your brakes could get so hot that they wouldn't work well. You would then have poor braking or even none going down a hill. You could crash. Shift down to let your engine assist your brakes on a steep downhill slope.

 **CAUTION:**

Coasting downhill in NEUTRAL (N) or with the ignition off is dangerous. Your brakes will have to do all the work of slowing down. They could get so hot that they wouldn't work well. You would then have poor braking or even none going down a hill. You could crash. Always have your engine running and your vehicle in gear when you go downhill.

- Know how to go uphill. You may want to shift down to a lower gear. The lower gears help cool your engine and transmission, and you can climb the hill better.
- Stay in your own lane when driving on two-lane roads in hills or mountains. Don't swing wide or cut across the center of the road. Drive at speeds that let you stay in your own lane.
- As you go over the top of a hill, be alert. There could be something in your lane, like a stalled car or an accident.
- You may see highway signs on mountains that warn of special problems. Examples are long grades, passing or no-passing zones, a falling rocks area or winding roads. Be alert to these and take appropriate action.

Winter Driving



Here are some tips for winter driving:

- Have your vehicle in good shape for winter.
- You may want to put winter emergency supplies in your vehicle.

Include an ice scraper, a small brush or broom, a supply of windshield washer fluid, a rag, some winter outer clothing, a small shovel, a flashlight, a red cloth and reflective warning triangles. And, if you will be driving under severe conditions, include a small bag of sand, a piece of old carpet or a couple of burlap bags to help provide traction. Be sure you properly secure these items in your vehicle.

Driving on Snow or Ice

Most of the time, those places where your tires meet the road probably have good traction.

However, if there is snow or ice between your tires and the road, you can have a very slippery situation. You'll have a lot less traction or "grip" and will need to be very careful.

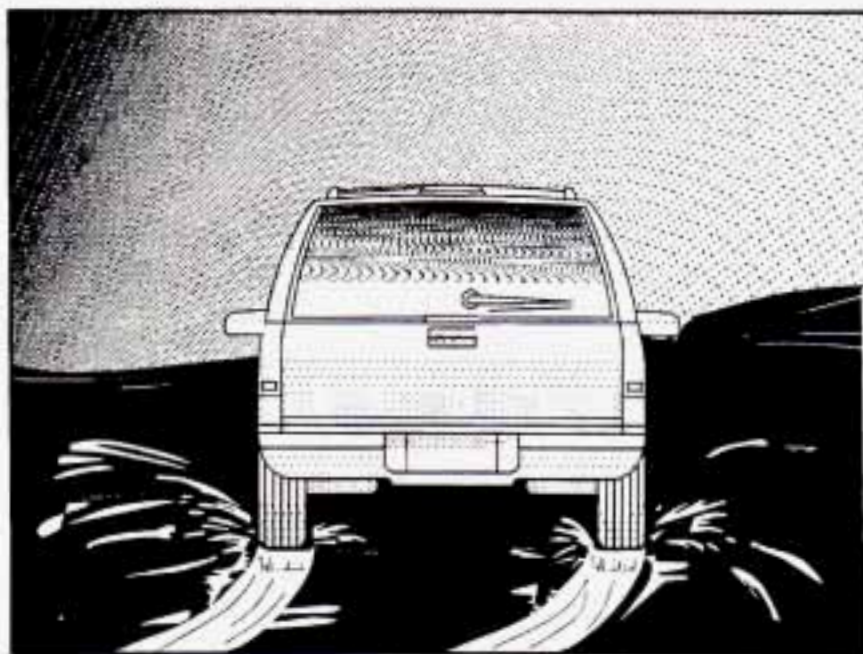

What's the worst time for this? "Wet ice." Very cold snow or ice can be slick and hard to drive on. But wet ice can be even more trouble because it may offer the least traction of all. You can get wet ice when it's about freezing (32°F; 0°C) and freezing rain begins to fall. Try to avoid driving on wet ice until salt and sand crews can get there.

Whatever the condition -- smooth ice, packed, blowing or loose snow -- drive with caution.

Accelerate gently. Try not to break the fragile traction. If you accelerate too fast, the drive wheels will spin and polish the surface under the tires even more.

Your anti-lock brakes improve your vehicle's stability when you make a hard stop on a slippery road. Even though you have an anti-lock braking system, you'll want to begin stopping sooner than you would on dry pavement. See "Anti-Lock" in the Index.

- Allow greater following distance on any slippery road.
- Watch for slippery spots. The road might be fine until you hit a spot that's covered with ice. On an otherwise clear road, ice patches may appear in shaded areas where the sun can't reach: around clumps of trees, behind buildings or under bridges. Sometimes the surface of a curve or an overpass may remain icy when the surrounding roads are clear. If you see a patch of ice ahead of you, brake before you are on it. Try not to brake while you're actually on the ice, and avoid sudden steering maneuvers.

If You're Caught in a Blizzard

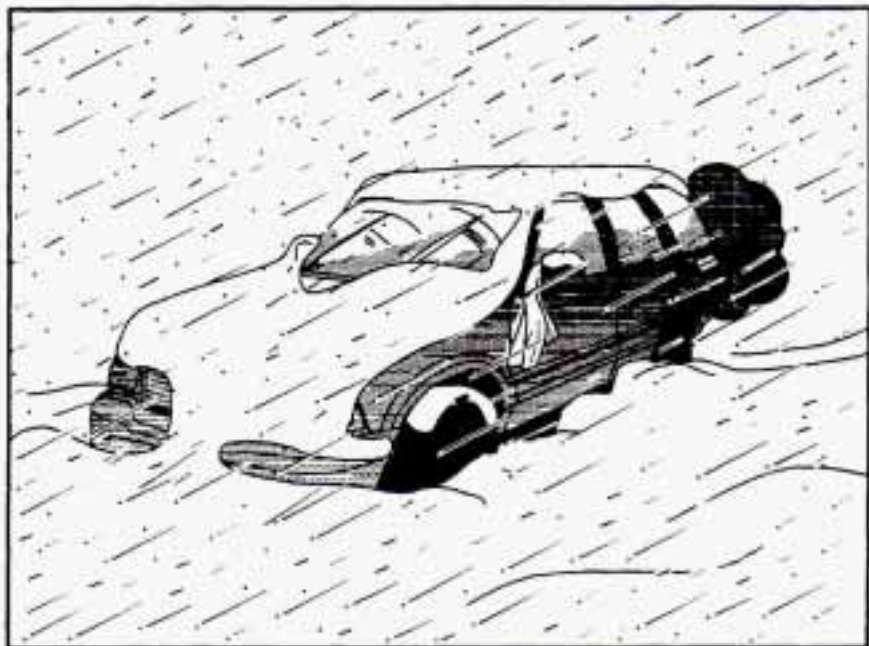

If you are stopped by heavy snow, you could be in a serious situation. You should probably stay with your vehicle unless you know for sure that you are near help and you can hike through the snow. Here are some things to do to summon help and keep yourself and your passengers safe:

- Turn on your hazard flashers.

- Tie a red cloth to your vehicle to alert police that you've been stopped by the snow.
- Put on extra clothing or wrap a blanket around you. If you have no blankets or extra clothing, make body insulators from newspapers, burlap bags, rags, floor mats -- anything you can wrap around yourself or tuck under your clothing to keep warm.

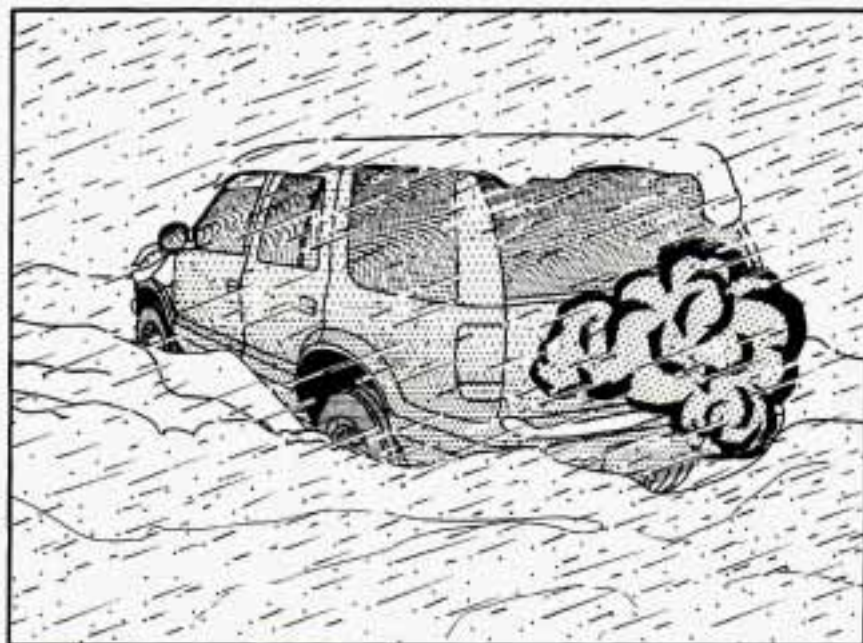

You can run the engine to keep warm, but be careful.



CAUTION:

Snow can trap exhaust gases under your vehicle. This can cause deadly CO (carbon monoxide) gas to get inside. CO could overcome you and kill you. You can't see it or smell it, so you might not know it is in your vehicle. Clear away snow from around the base of your vehicle, especially any that is blocking your exhaust pipe. And check around again from time to time to be sure snow doesn't collect there.

Open a window just a little on the side of the vehicle that's away from the wind. This will help keep CO out.

Run your engine only as long as you must. This saves fuel. When you run the engine, make it go a little faster than just idle. That is, push the accelerator slightly. This uses less fuel for the heat that you get and it keeps the battery charged. You will need a well-charged battery to restart the vehicle, and possibly for signaling later on with your headlamps. Let the heater run for a while.

Then, shut the engine off and close the window almost all the way to preserve the heat. Start the engine again and repeat this only when you feel really uncomfortable from the cold. But do it as little as possible. Preserve the fuel as long as you can. To help keep warm, you can get out of the vehicle and do some fairly vigorous exercises every half hour or so until help comes.

Recreational Vehicle Towing (Four-Wheel Drive With Manual Shift Transfer Case Only)

1. Set the parking brake firmly.
2. Place an automatic transmission in PARK (P) or a manual transmission in FIRST (1).
3. Firmly attach the vehicle being towed to the tow vehicle. Do not tow the vehicle by the rear bumper bar. Refer to the hitch manufacturer's instructions.
4. Place the manual shift transfer case shift lever in NEUTRAL (N).



CAUTION:

Shifting the transfer case into NEUTRAL (N) can cause your vehicle to roll even if the transmission is in PARK (P), for an automatic transmission, or if your vehicle is in gear, for a manual transmission. You or others could be injured. Make sure the parking brake is firmly set before you shift the transfer case into NEUTRAL (N).

5. Release the parking brake only after the vehicle being towed is firmly attached to the tow vehicle.
6. Insert the ignition key into the ignition switch and turn it one notch forward of the LOCK position. This places the key in the OFF position, which unlocks the steering column while preventing battery drain. Unlocking the steering column will allow for proper movement of the front wheels/tires during towing.

Recreational Vehicle Towing (Except Four-Wheel Drive With Manual Shift Transfer Case)

Vehicles with two-wheel drive or the optional electronic shift transfer case require special modifications before they can be towed in this manner. Please contact your dealer for the towing information that is appropriate for your particular vehicle.

Vehicles with all-wheel drive (AWD) can **not** be towed in this manner.

Loading Your Vehicle

The diagram shows a rectangular label with the following fields and labels:

- Top left: A small empty box.
- Top center: A long horizontal box.
- Below top center: Three boxes labeled "GVWR", "GAWR FRT", and "GAWR RR".
- Middle: A large horizontal box.
- Below middle: A horizontal line.
- Bottom left: "MODEL:" followed by a box.
- Bottom center: "RIM" followed by three stacked boxes.
- Bottom right: "COLD TIRE PRESSURE" followed by three stacked boxes.
- Bottom: "SEE OWNER'S MANUAL FOR ADDITIONAL INFORMATION." followed by a box.

A large, bold, diagonal watermark reading "EXAMPLE" is overlaid across the center of the label.

The Certification/Tire label is found on the driver's door edge, above the door latch. The label shows the size of your original tires and the inflation pressures needed to obtain the gross weight capacity of your vehicle. This is called the GVWR (Gross Vehicle Weight Rating). The GVWR includes the weight of the vehicle, all occupants, fuel, cargo and trailer tongue weight, if pulling a trailer.

The Certification/Tire label also tells you the maximum weights for the front and rear axles, called Gross Axle Weight Rating (GAWR). To find out the actual loads on your front and rear axles, you need to go to a weigh station and weigh your vehicle. Your dealer can help you with this. Be sure to spread out your load equally on both sides of the centerline.

Never exceed the GVWR for your vehicle, or the GAWR for either the front or rear axle.

If you do have a heavy load, you should spread it out.

Similar appearing vehicles may have different GVWRs and payloads. Please note your vehicle's Certification/Tire label or consult your dealer for additional details.

 **CAUTION:**

Do not load your vehicle any heavier than the GVWR, or either the maximum front or rear GAWR. If you do, parts on your vehicle can break, or it can change the way your vehicle handles. These could cause you to lose control. Also, overloading can shorten the life of your vehicle.

Using heavier suspension components to get added durability might not change your weight ratings. Ask your dealer to help you load your vehicle the right way.

NOTICE:

Your warranty does not cover parts or components that fail because of overloading.

If you put things inside your vehicle -- like suitcases, tools, packages, or anything else -- they will go as fast as the vehicle goes. If you have to stop or turn quickly, or if there is a crash, they'll keep going.



CAUTION:

Things you put inside your vehicle can strike and injure people in a sudden stop or turn, or in a crash.

- **Put things in the cargo area of your vehicle. Try to spread the weight evenly.**
- **Never stack heavier things, like suitcases, inside the vehicle so that some of them are above the tops of the seats.**
- **Don't leave an unsecured child restraint in your vehicle.**
- **When you carry something inside the vehicle, secure it whenever you can.**
- **Don't leave a seat folded down unless you need to.**

There's also important loading information for off-road driving in this manual. See "Loading Your Vehicle for Off-Road Driving" in the Index.

Payload

The payload capacity is shown on the Certification/Tire label. This is the maximum load capacity that your vehicle can carry. Be sure to include the weight of the occupants as part of your load. If you added any accessories or equipment after your vehicle left the factory, remember to subtract the weight of these things from the payload. Your dealer can help you with this.

Add-On Equipment

When you carry removable items, you may need to put a limit on how many people you carry inside your vehicle. Be sure to weigh your vehicle before you buy and install the new equipment.

NOTICE:

Your warranty doesn't cover parts or components that fail because of overloading.

Towing a Trailer

CAUTION:

If you don't use the correct equipment and drive properly, you can lose control when you pull a trailer. For example, if the trailer is too heavy, the brakes may not work well -- or even at all. You and your passengers could be seriously injured. Pull a trailer only if you have followed all the steps in this section. Ask your GM dealer for advice and information about towing a trailer with your vehicle.

NOTICE:

Pulling a trailer improperly can damage your vehicle and result in costly repairs not covered by your warranty. To pull a trailer correctly, follow the advice in this part, and see your GM dealer for important information about towing a trailer with your vehicle.

Every vehicle is ready for some trailer towing. If yours was built with trailering options, as many are, it's ready for heavier trailers. But trailering is different than just driving your vehicle by itself. Trailering means changes in handling, durability and fuel economy. Successful, safe trailering takes correct equipment, and it has to be used properly.

That's the reason for this part. In it are many time-tested, important trailering tips and safety rules. Many of these are important for your safety and that of your passengers. So please read this section carefully before you pull a trailer.

If You Do Decide To Pull A Trailer

If you do, here are some important points:

- There are many different laws, including speed limit restrictions, having to do with trailering. Make sure your rig will be legal, not only where you live but also where you'll be driving. A good source for this information can be state or provincial police.
- Consider using a sway control if your trailer will weigh 2,000 lbs. (900 kg) or less. You should always use a sway control if your trailer will weigh more than 2,000 lbs. (900 kg). You can ask a hitch dealer about sway controls.
- Don't tow a trailer at all during the first 500 miles (800 km) your new vehicle is driven. Your engine, axle or other parts could be damaged.
- Then, during the first 500 miles (800 km) that you tow a trailer, don't drive over 50 mph (80 km/h) and don't make starts at full throttle. This helps your engine and other parts of your vehicle wear in at the heavier loads.

- If you have an automatic transmission, you can use DRIVE (D) (or, as you need to, a lower gear) when towing a trailer. Operating your vehicle in DRIVE (D) when towing a trailer will minimize heat buildup and extend the life of your transmission. If you have a manual transmission and you are towing a trailer, it's better not to use FIFTH (5) gear. Just drive in FOURTH (4) gear (or, as you need to, a lower gear).

Three important considerations have to do with weight:

- the weight of the trailer,
- the weight of the trailer tongue
- and the weight on your vehicle's tires.

Weight of the Trailer

How heavy can a trailer safely be?

It depends on how you plan to use your rig. For example, speed, altitude, road grades, outside temperature and how much your vehicle is used to pull a trailer are all important. And, it can also depend on any special equipment that you have on your vehicle.

The following chart shows how much your trailer can weigh, based upon your vehicle model and options.

Vehicle	Axle Ratio	Trailer Wt.
2-Wheel Drive, Auto. Trans.	3.08 3.42	4,500 lbs. (2 041 kg) 5,500 lbs. (2 495 kg)
2-Wheel Drive, Manual Trans.	3.42	4,500 lbs. (2 041 kg)
4-Wheel Drive & All-Wheel Drive, Auto. Trans.	3.08 3.42 3.73	4,000 lbs. (1 814 kg) 5,000 lbs. (2 268 kg) 5,000 lbs. (2 268 kg)
4-Wheel Drive & All-Wheel Drive, Manual Trans.	3.42	4,000 lbs. (1 814 kg)

Maximum trailer weight is calculated assuming the driver and one passenger are in the tow vehicle and it has all the required trailering equipment. The weight of additional optional equipment, passengers and cargo in the tow vehicle must be subtracted from the maximum trailer weight.

You can ask your dealer for our trailering information or advice, or you can write us at the address listed in your Warranty and Owner Assistance Information Booklet.

In Canada, write to:

General Motors of Canada Limited
Customer Communication Centre
1908 Colonel Sam Drive
Oshawa, Ontario L1H 8P7

Weight of the Trailer Tongue

The tongue load (A) of any trailer is an important weight to measure because it affects the total or gross weight of your vehicle. The Gross Vehicle Weight (GVW) includes the curb weight of the vehicle, any cargo you may carry in it, and the people who will be riding in the vehicle. And if you will tow a trailer, you must add the tongue load to the GVW because your vehicle will be carrying that weight, too. See "Loading Your Vehicle" in the Index for more information about your vehicle's maximum load capacity.

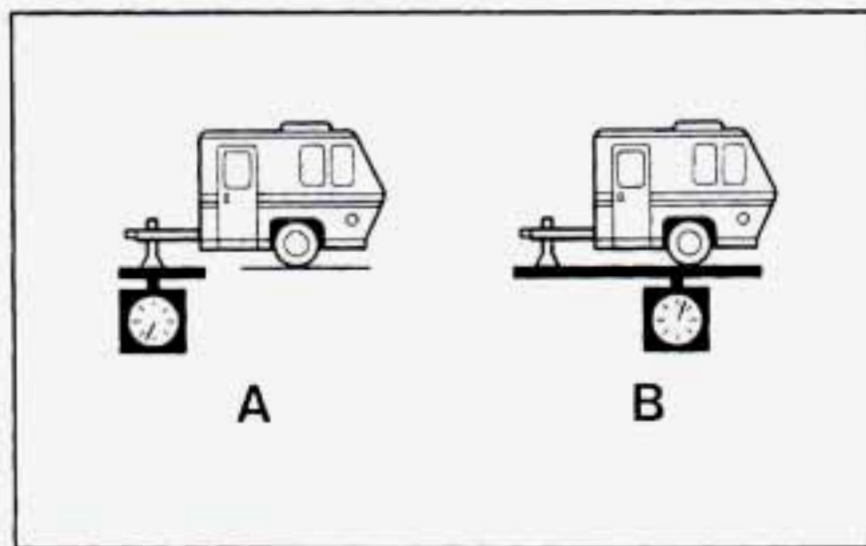

If you're using a weight-carrying hitch, the trailer tongue (A) should weigh 10 percent of the total loaded trailer weight (B). If you're using a weight-distributing hitch, the trailer tongue (A) should weigh 12 percent of the total loaded trailer weight (B).

After you've loaded your trailer, weigh the trailer and then the tongue, separately, to see if the weights are proper. If they aren't, you may be able to get them right simply by moving some items around in the trailer.

Total Weight on Your Vehicle's Tires

Be sure your vehicle's tires are inflated to the upper limit for cold tires. You'll find these numbers on the Certification/Tire label on the driver's door edge, above the door latch, or see "Tire Loading" in the Index. Then be sure you don't go over the GVW limit for your vehicle, including the weight of the trailer tongue.

Hitches

It's important to have the correct hitch equipment. Crosswinds, large trucks going by and rough roads are a few reasons why you'll need the right hitch. Here are some rules to follow:

- If you'll be pulling a trailer that, when loaded, will weigh more than 2,000 lbs. (900 kg), be sure to use a properly mounted, weight-distributing hitch and sway control of the proper size. This equipment is very important for proper vehicle loading and good handling when you're driving.

- Will you have to make any holes in the body of your vehicle when you install a trailer hitch?

If you do, then be sure to seal the holes later when you remove the hitch. If you don't seal them, deadly carbon monoxide (CO) from your exhaust can get into your vehicle (see "Carbon Monoxide" in the Index). Dirt and water can, too.

Safety Chains

You should always attach chains between your vehicle and your trailer. Cross the safety chains under the tongue of the trailer so that the tongue will not drop to the road if it becomes separated from the hitch. Instructions about safety chains may be provided by the hitch manufacturer or by the trailer manufacturer. Follow the manufacturer's recommendation for attaching safety chains and do not attach them to the bumper. Always leave just enough slack so you can turn with your rig. And, never allow safety chains to drag on the ground.

Trailer Brakes

If your trailer weighs more than 1,000 lbs. (450 kg) loaded, then it needs its own brakes -- and they must be adequate. Be sure to read and follow the instructions for the trailer brakes so you'll be able to install, adjust and maintain them properly.

Your trailer's brake system can tap into the vehicle's hydraulic brake system only if:

- The trailer parts can withstand 3,000 psi (20 650 kPa) of pressure.
- The trailer's brake system will use less than 0.02 cubic inch (0.3 cc) of fluid from your vehicle's master cylinder. Otherwise, both braking systems won't work well. You could even lose your brakes.

If everything checks out this far, then make the brake fluid tap at the port on the master cylinder that sends fluid to the rear brakes. But don't use copper tubing for this. If you do, it will bend and finally break off. Use steel brake tubing.

Driving with a Trailer

CAUTION:

If you have a rear-most window open and you pull a trailer with your vehicle, carbon monoxide (CO) could come into your vehicle. You can't see or smell CO. It can cause unconsciousness or death. (See "Engine Exhaust" in the Index.) To maximize your safety when towing a trailer:

- Have your exhaust system inspected for leaks, and make necessary repairs before starting on your trip.
- Keep the rear-most windows closed.
- If exhaust does come into your vehicle through a window in the rear or another opening, drive with your front, main heating or cooling system on and with the fan on any speed. This will bring fresh, outside air into your vehicle. Do not use MAX A/C because it only recirculates the air inside your vehicle. (See "Comfort Controls" in the Index.)

Towing a trailer requires a certain amount of experience. Before setting out for the open road, you'll want to get to know your rig. Acquaint yourself with the feel of handling and braking with the added weight of the trailer. And always keep in mind that the vehicle you are driving is now a good deal longer and not nearly as responsive as your vehicle is by itself.

Before you start, check the trailer hitch and platform (and attachments), safety chains, electrical connector, lamps, tires and mirror adjustment. If the trailer has electric brakes, start your vehicle and trailer moving and then apply the trailer brake controller by hand to be sure the brakes are working. This lets you check your electrical connection at the same time.

During your trip, check occasionally to be sure that the load is secure, and that the lamps and any trailer brakes are still working.

Following Distance

Stay at least twice as far behind the vehicle ahead as you would when driving your vehicle without a trailer. This can help you avoid situations that require heavy braking and sudden turns.

Passing

You'll need more passing distance up ahead when you're towing a trailer. And, because you're a good deal longer, you'll need to go much farther beyond the passed vehicle before you can return to your lane.

Backing Up

Hold the bottom of the steering wheel with one hand. Then, to move the trailer to the left, just move that hand to the left. To move the trailer to the right, move your hand to the right. Always back up slowly and, if possible, have someone guide you.

Making Turns

NOTICE:

Making very sharp turns while trailering could cause the trailer to come in contact with the vehicle. Your vehicle could be damaged. Avoid making very sharp turns while trailering.

When you're turning with a trailer, make wider turns than normal. Do this so your trailer won't strike soft shoulders, curbs, road signs, trees or other objects. Avoid jerky or sudden maneuvers. Signal well in advance.

Turn Signals When Towing a Trailer

When you tow a trailer, your vehicle has to have extra wiring and a heavy-duty turn signal flasher (included in the optional trailering package).

The arrows on your instrument panel will flash whenever you signal a turn or lane change. Properly hooked up, the trailer lamps will also flash, telling other drivers you're about to turn, change lanes or stop.

When towing a trailer, the arrows on your instrument panel will flash for turns even if the bulbs on the trailer are burned out. Thus, you may think drivers behind you are seeing your signal when they are not. It's important to check occasionally to be sure the trailer bulbs are still working.

Driving On Grades

Reduce speed and shift to a lower gear *before* you start down a long or steep downgrade. If you don't shift down, you might have to use your brakes so much that they would get hot and no longer work well.

On a long uphill grade, shift down and reduce your speed to around 45 mph (70 km/h) to reduce the possibility of engine and transmission overheating.

If you have an automatic transmission, you should use DRIVE (D) when towing a trailer. Operating your vehicle in DRIVE (D) when towing a trailer will minimize heat buildup and extend the life of your transmission. Or, if you have a manual transmission, it's better not to use FIFTH (5) gear, just drive in FOURTH (4) gear (or, as you need to, a lower gear).

When towing at high altitude on steep uphill grades, consider the following: Engine coolant will boil at a lower temperature than at normal altitudes. If you turn your engine off immediately after towing at high altitude on steep uphill grades, your vehicle may show signs similar to engine overheating. To avoid this, let the engine run while parked (preferably on level ground) with the automatic transmission in PARK (P) (or the manual transmission out of gear and the parking brake applied) for a few minutes before turning the engine off. If you do get the overheat warning, see "Engine Overheating" in the Index.

Parking on Hills

You really should not park your vehicle, with a trailer attached, on a hill. If something goes wrong, your rig could start to move. People can be injured, and both your vehicle and the trailer can be damaged.

But if you ever have to park your rig on a hill, here's how to do it:

1. Apply your regular brakes, but don't shift into PARK (P) yet, or into gear for a manual transmission. Then turn your wheels into the curb if facing downhill or into traffic if facing uphill.
2. Have someone place chocks under the trailer wheels.
3. When the wheel chocks are in place, release the regular brakes until the chocks absorb the load.
4. Reapply the regular brakes. Then apply your parking brake, and then shift into PARK (P), or REVERSE (R) for a manual transmission.
5. If you have a four-wheel-drive vehicle with a manual transfer case shift lever, be sure the transfer case is in a drive gear -- not in NEUTRAL (N).
6. Release the regular brakes.



CAUTION:

It can be dangerous to get out of your vehicle if the shift lever is not fully in PARK (P) with the parking brake firmly set. Your vehicle can roll. If you have left the engine running, the vehicle can move suddenly. You or others could be injured. To be sure your vehicle won't move, even when you're on fairly level ground, use the steps that follow.

If you have four-wheel drive with a manual transfer case shift lever and your transfer case is in NEUTRAL (N), your vehicle will be free to roll, even if your shift lever is in PARK (P). So, be sure the transfer case is in a drive gear -- not in NEUTRAL (N).

When You Are Ready to Leave After Parking on a Hill

1. Apply your regular brakes and hold the pedal down while you:
 - Start your engine;
 - Shift into a gear; and
 - Release the parking brake.
2. Let up on the brake pedal.
3. Drive slowly until the trailer is clear of the chocks.
4. Stop and have someone pick up and store the chocks.

Maintenance When Trailer Towing

Your vehicle will need service more often when you're pulling a trailer. See the Maintenance Schedule for more on this. Things that are especially important in trailer operation are automatic transmission fluid (don't overfill), engine oil, axle lubricant, belt, cooling system and brake adjustment. Each of these is covered in this manual, and the Index will help you find them quickly. If you're trailering, it's a good idea to review these sections before you start your trip.

Check periodically to see that all hitch nuts and bolts are tight.

Trailer Wiring Harness

The light duty trailer wiring is a six-wire harness assembly. The optional heavy-duty trailer wiring is an eight-wire harness assembly. The harnesses are stored under the vehicle, along the passenger-side frame crossmember on two-door vehicles or on the driver's side corner frame crossmember on four-door vehicles. The heavy-duty trailer wiring has a 30-amp feed wire with an inline fuse located by the junction block. See "Fuses and Circuit Breakers" in the Index. Both harnesses have no connector and should be wired by a qualified electrical technician. The technician can use the following color code chart when connecting the wiring harness to your trailer.

- Dark Blue: Use for electric trailer brakes or auxiliary wiring.
- Red: Use for battery charging; it connects to the starter solenoid (eight-wire harness only).

- Light Green: Back-up lamps (eight-wire harness only).
- Brown: Taillamps and parking lamps.
- Yellow: Left stoplamp and turn signal.
- Dark Green: Right stoplamp and turn signal.
- White (Heavy Gage): Ground wire.
- White (Light Gage): Auxiliary stoplamp.

Securely attach the harness to the trailer, then tape or strap it to your vehicle's frame rail. Be sure you leave it loose enough so the wiring doesn't bend or break, but not so loose that it drags on the ground. Store the harness in its original place. Wrap the harness together and tie it neatly so it won't be damaged.

 **NOTES**

Section 5 Problems on the Road

Here you'll find what to do about some problems that can occur on the road.

5-2	Hazard Warning Flashers	5-22	Engine Fan Noise
5-2	Other Warning Devices	5-22	If a Tire Goes Flat
5-3	Jump Starting	5-23	Changing a Flat Tire
5-7	Towing Your Vehicle	5-35	Compact Spare Tire (If Equipped)
5-12	Engine Overheating	5-36	If You're Stuck: In Sand, Mud, Ice or Snow

Hazard Warning Flashers

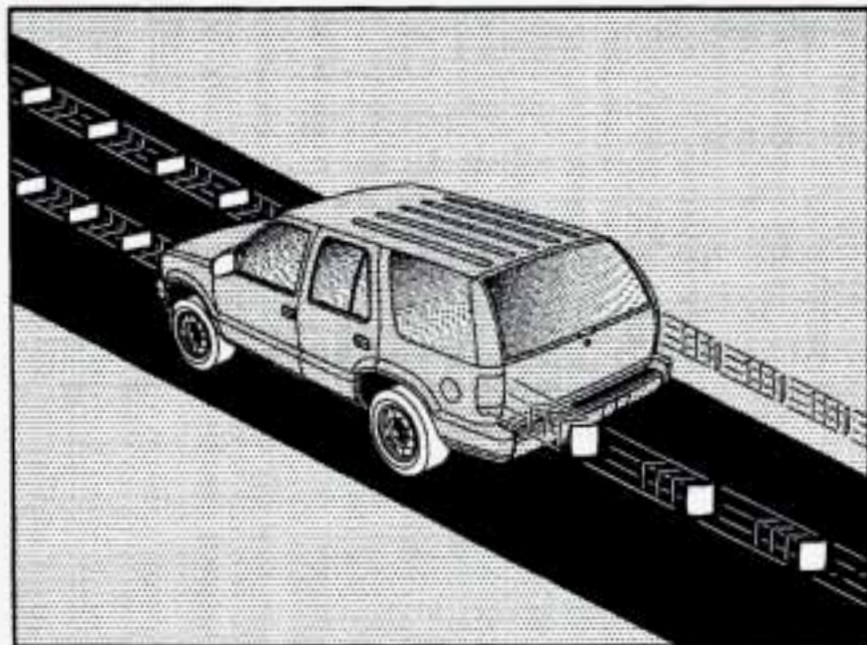

Your hazard warning flashers let you warn others. They also let police know you have a problem. Your front and rear turn signal lamps will flash on and off.



Press the button on top of the steering column all the way down to make your front and rear turn signal lamps flash on and off.

Your hazard warning flashers work no matter what position your key is in, and even if the key isn't in.

To turn off the flashers, press the button until the first click and release.

When the hazard warning flashers are on, your turn signals won't work.

Other Warning Devices

If you carry reflective triangles, you can set one up at the side of the road about 300 feet (100 m) behind your vehicle.

Jump Starting

If your battery has run down, you may want to use another vehicle and some jumper cables to start your vehicle. But please use the following steps to do it safely.

NOTICE:

Ignoring these steps could result in costly damage to your vehicle that wouldn't be covered by your warranty.

Do not try to start your vehicle by pushing or pulling it. This could damage your vehicle, even if you have a manual transmission. And if you have an automatic transmission, it won't start that way.

CAUTION:

Batteries can hurt you. They can be dangerous because:

- They contain acid that can burn you.
- They contain gas that can explode or ignite.
- They contain enough electricity to burn you.

If you don't follow these steps exactly, some or all of these things can hurt you.

1. Check the other vehicle. It must have a 12-volt battery with a negative ground system.

NOTICE:

If the other system isn't a 12-volt system with a negative ground, both vehicles can be damaged.

2. Get the vehicles close enough so the jumper cables can reach, but be sure the vehicles aren't touching each other. If they are, it could cause a ground connection you don't want. You wouldn't be able to start your vehicle, and the bad grounding could damage the electrical systems.

You could be injured if the vehicles roll. Set the parking brake firmly on each vehicle. Put an automatic transmission in PARK (P) or a manual transmission in NEUTRAL (N). If you have a four-wheel-drive vehicle with a manual transfer case shift lever, be sure the transfer case is not in NEUTRAL (N).

 **CAUTION:**

An electric fan can start up even when the engine is not running and can injure you. Keep hands, clothing and tools away from any underhood electric fan.

3. Turn off the ignition on both vehicles. Unplug unnecessary accessories plugged into the cigarette lighter, or accessory power outlets, if you have this option. Turn off all lamps that aren't needed as well as radios. This will avoid sparks and help save both batteries. In addition, it could save your radio!

NOTICE:

If you leave your radio on, it could be badly damaged. The repair wouldn't be covered by your warranty.

 **CAUTION:**

If your vehicle has air conditioning, the auxiliary electric fan under the hood can start up even when the engine is not running and can injure you. Keep hands, clothing and tools away from any underhood electric fan.

4. Open both hoods and locate the batteries. Find the positive (+) and negative (-) terminals on each battery.

⚠ CAUTION:

Using a match near a battery can cause battery gas to explode. People have been hurt doing this, and some have been blinded. Use a flashlight if you need more light.

Be sure the battery has enough water. You don't need to add water to the Delco Freedom[®] battery installed in every new GM vehicle. But if a battery has filler caps, be sure the right amount of fluid is there. If it is low, add water to take care of that first. If you don't, explosive gas could be present.

Battery fluid contains acid that can burn you. Don't get it on you. If you accidentally get it in your eyes or on your skin, flush the place with water and get medical help immediately.

5. Check that the jumper cables don't have loose or missing insulation. If they do, you could get a shock. The vehicles could be damaged too.

Before you connect the cables, here are some basic things you should know. Positive (+) will go to positive (+) and negative (-) will go to a metal engine part. Don't connect positive (+) to negative (-) or you'll get a short that would damage the battery and maybe other parts too.



6. Connect the red positive (+) cable to the positive (+) terminal of the vehicle with the dead battery.



7. Don't let the other end touch metal. Connect it to the positive (+) terminal of the good battery.



8. Now connect the black negative (-) cable to the good battery's negative (-) terminal.

Don't let the other end touch anything until the next step. The other end of the negative cable doesn't go to the dead battery. It goes to a heavy unpainted metal part on the engine of the vehicle with the dead battery.



9. Attach the cable at least 18 inches (45 cm) away from the dead battery, but not near engine parts that move.

The electrical connection is just as good there, but the chance of sparks getting back to the battery is much less.

10. Now start the vehicle with the good battery and run the engine for a while.
11. Try to start the vehicle with the dead battery. If it won't start after a few tries make sure all connections are good. If it still won't start, it probably needs service.

 **CAUTION:**

Fans or other moving engine parts can injure you badly. Keep your hands away from moving parts once the engines are running.

12. Remove the cables in reverse order to prevent electrical shorting. Take care that they don't touch each other or any other metal.

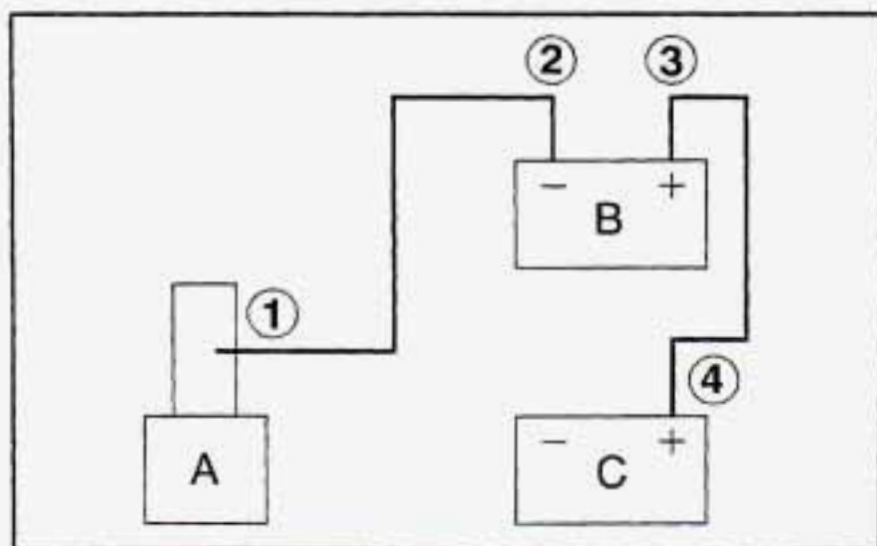

- A. Heavy Metal Engine Part
B. Good Battery
C. Dead Battery

Towing Your Vehicle

Try to have a GM dealer or a professional towing service tow your vehicle. See "Roadside Assistance" in the Index.

If your vehicle has been changed since it was factory-new by adding things like fog lamps, aero skirting, or special tires and wheels, these instructions may not be correct.

Before you do anything, turn on the hazard warning flashers.

When you call, tell the towing service:

- Whether your vehicle has rear-wheel drive, four-wheel drive or all-wheel drive.
- The make, model and year of your vehicle.
- Whether you can move the shift lever for the transmission and shift the transfer case, if you have one.
- If there was an accident, what was damaged.

When the towing service arrives, let the tow operator know that this manual contains these towing instructions. The operator may want to see them.



⚠ CAUTION:

To help avoid injury to you or others:

- Never let passengers ride in a vehicle that is being towed.
- Never tow faster than safe or posted speeds.
- Never tow with damaged parts not fully secured.
- Never get under your vehicle after it has been lifted by the tow truck.
- Always use separate safety chains on each side when towing a vehicle.
- Never use J-hooks. Use T-hooks instead.

⚠ CAUTION:

A vehicle can fall from a car carrier if it isn't adequately secured. This can cause a collision, serious personal injury and vehicle damage. The vehicle should be tightly secured with chains or steel cables before it is transported.

Don't use substitutes (ropes, leather straps, canvas webbing, etc.) that can be cut by sharp edges underneath the towed vehicle. Always use T-hooks inserted in the T-hook slots. Never use J-hooks. They will damage drivetrain and suspension components.

When your vehicle is being towed, have the ignition key turned to the OFF position. The steering wheel should be clamped in a straight-ahead position with a clamping device designed for towing service. Do not use the vehicle's steering column lock for this. The transmission should be in NEUTRAL (N) and the transfer case, if you have one, should be in 2HI. The parking brake should be released.

If your vehicle has a floor mounted shifter and no electrical power, the electrical solenoid lock must be overridden to shift from PARK (P) to NEUTRAL (N). Follow these steps:

1. Push the base of the shift lever boot forward with your thumb.
2. Lift the boot and find the white solenoid lever.



3. Move the solenoid lever toward the driver's side to unlock it.
4. While holding the solenoid lever in the unlock position, press the shift lever button and shift into NEUTRAL (N).
5. Release the solenoid lever and snap the boot back into place.

Don't have your vehicle towed on the drive wheels unless you must. If the vehicle must be towed on the drive wheels, be sure to follow the speed and distance restrictions later in this section or your transmission will be damaged. If these limitations must be exceeded, then the drive wheels have to be supported on a dolly.

Front Towing

Tow Limits -- 35 mph (56 km/h), 50 miles (80 km)

Vehicles with all-wheel-drive or four-wheel-drive with the electronic transfer case option must use a towing dolly under the rear wheels when towing from the front.

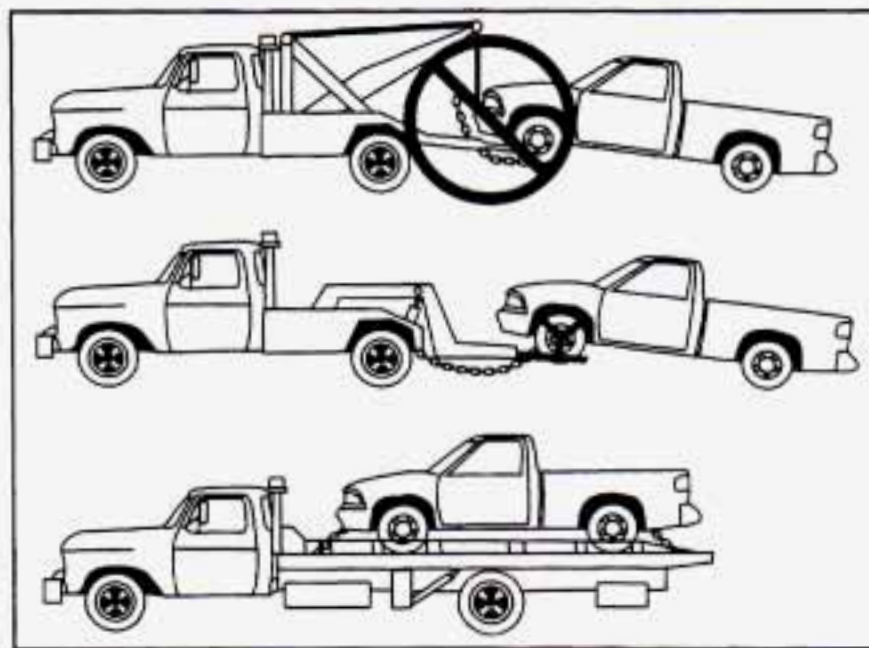

NOTICE:

Do not tow with sling-type equipment or fascia/fog lamp damage will occur. Use wheel-lift or car carrier equipment. Additional ramping may be required for car-carrier equipment. Use safety chains and wheel straps.

Towing a vehicle over rough surfaces could damage a vehicle. Damage can occur from vehicle to ground or vehicle to wheel-lift equipment. To help avoid damage, install a towing dolly and raise the vehicle until adequate clearance is obtained between the ground and/or wheel-lift equipment.

Do not attach winch cables or J-hooks to suspension components when using car-carrier equipment. Always use T-hooks inserted in the T-hook slots.

Rear Towing

Tow Limits -- 35 mph (56 km/h), 50 miles (80 km)

Vehicles with all-wheel-drive or four-wheel-drive and the electronic transfer case option must use a towing dolly under the front wheels when towing from the rear.

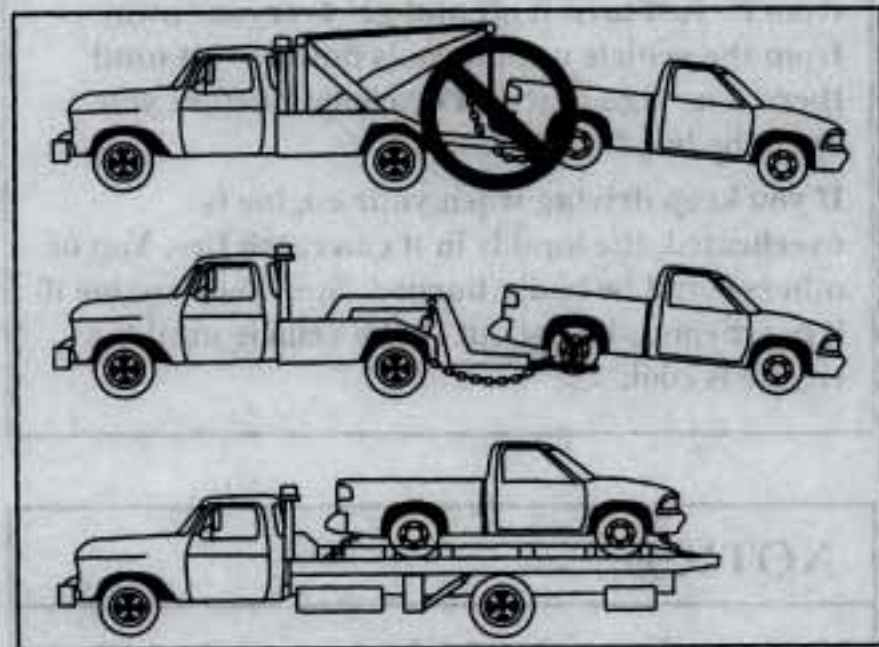

NOTICE:

Do not tow with sling-type equipment or rear bumper valance damage will occur. Use wheel-lift or car-carrier equipment. Additional ramping may be required for car-carrier equipment. Use safety chains and wheel straps.

Towing a vehicle over rough surfaces could damage a vehicle. Damage can occur from vehicle to ground or vehicle to wheel-lift equipment. Unless you have all-wheel drive, to help avoid damage, install a towing dolly and raise the vehicle until adequate clearance is obtained between the ground and/or wheel-lift equipment.

Do not attach winch cables or J-hooks to suspension components when using car-carrier equipment. Always use T-hooks inserted in the T-hook slots.

Engine Overheating

You will find a coolant temperature gage on your vehicle's instrument panel.

If Steam Is Coming From Your Engine



CAUTION:

Steam from an overheated engine can burn you badly, even if you just open the hood. Stay away from the engine if you see or hear steam coming from it. Just turn it off and get everyone away from the vehicle until it cools down. Wait until there is no sign of steam or coolant before you open the hood.

If you keep driving when your engine is overheated, the liquids in it can catch fire. You or others could be badly burned. Stop your engine if it overheats, and get out of the vehicle until the engine is cool.

NOTICE:

If your engine catches fire because you keep driving with no coolant, your vehicle can be badly damaged. The costly repairs would not be covered by your warranty.

If No Steam Is Coming From Your Engine

If you get the overheat warning but see or hear no steam, the problem may not be too serious. Sometimes the engine can get a little too hot when you:

- Climb a long hill on a hot day.
- Stop after high-speed driving.
- Idle for long periods in traffic.
- Tow a trailer. See “Driving on Grades” in the Index.

If you get the overheat warning with no sign of steam, try this for a minute or so:

1. Turn off your air conditioner.
2. Turn on your heater to full hot at the highest fan speed and open the window as necessary.
3. If you're in a traffic jam, shift to NEUTRAL (N); otherwise, shift to the highest gear while driving -- AUTOMATIC OVERDRIVE (Ⓢ) or DRIVE (D) for automatic transmissions.

If you no longer have the overheat warning, you can drive. Just to be safe, drive slower for about 10 minutes. If the warning doesn't come back on, you can drive normally.

If the warning continues, pull over, stop, and park your vehicle right away.

If there's still no sign of steam, push the accelerator until the engine speed is about twice as fast as normal idle speed. Bring the engine speed back to normal idle speed after two or three minutes. Now see if the warning stops. But then, if you still have the warning, *turn off the engine and get everyone out of the vehicle* until it cools down.

You may decide not to lift the hood but to get service help right away.

When you decide it's safe to lift the hood, here's what you'll see:

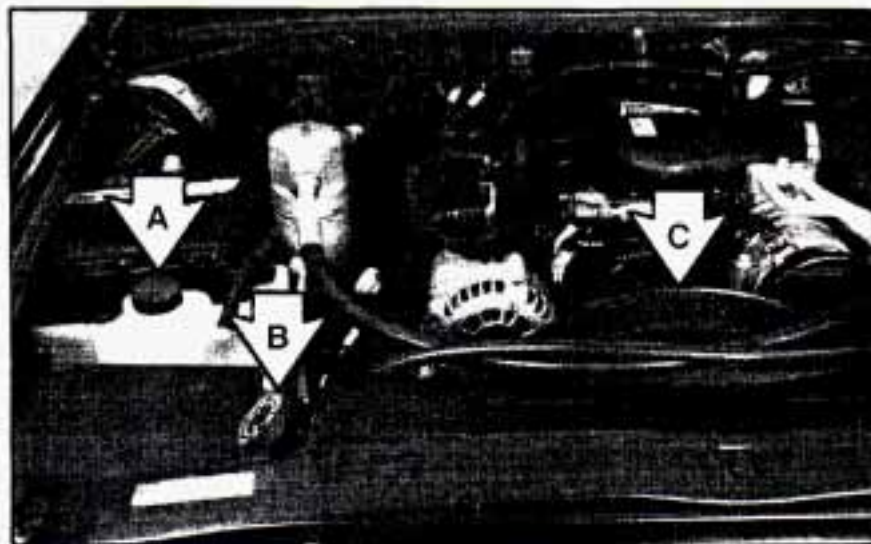

- A. Coolant Recovery Tank
- B. Radiator Pressure Cap
- C. Engine Fan

⚠ CAUTION:

If your vehicle has air conditioning, the auxiliary electric fan under the hood can start up even when the engine is not running and can injure you. Keep hands, clothing and tools away from any underhood electric fan.

If the coolant inside the coolant recovery tank is boiling, don't do anything else until it cools down.

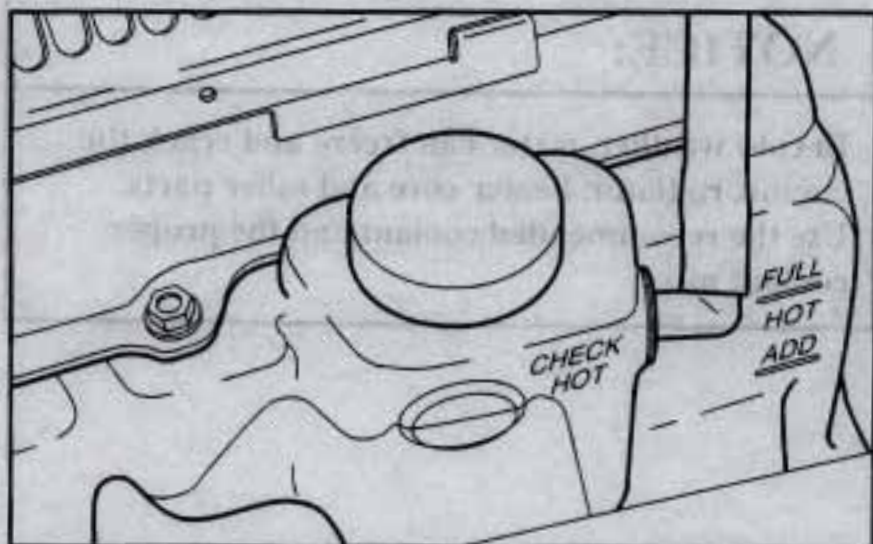

The coolant level should be at the ADD mark.

If it isn't, you may have a leak in the radiator hoses, heater hoses, radiator, water pump or somewhere else in the cooling system.

⚠ CAUTION:

Heater and radiator hoses, and other engine parts, can be very hot. Don't touch them. If you do, you can be burned.

Don't run the engine if there is a leak. If you run the engine, it could lose all coolant. That could cause an engine fire, and you could be burned. Get any leak fixed before you drive the vehicle.

NOTICE:

Engine damage from running your engine without coolant isn't covered by your warranty.

If there seems to be no leak, start the engine again. See if the fan speed increases when idle speed is doubled by pushing the accelerator pedal down. If it doesn't, your vehicle needs service. Turn off the engine.

How to Add Coolant to the Coolant Recovery Tank

If you haven't found a problem yet, but the coolant level isn't at the ADD mark, add a 50/50 mixture of *clean water* (preferably distilled) and DEX-COOL[®] (silicate-free) antifreeze at the coolant recovery tank. (See "Engine Coolant" in the Index for more information.)



CAUTION:

Adding only plain water to your cooling system can be dangerous. Plain water, or some other liquid like alcohol, can boil before the proper coolant mix will. Your vehicle's coolant warning system is set for the proper coolant mix. With plain water or the wrong mix, your engine could get too hot but you wouldn't get the overheat warning. Your engine could catch fire and you or others could be burned. Use a 50/50 mix of clean water and DEX-COOL[®] coolant.

NOTICE:

In cold weather, water can freeze and crack the engine, radiator, heater core and other parts. Use the recommended coolant and the proper coolant mix.



⚠ CAUTION:

You can be burned if you spill coolant on hot engine parts. Coolant contains ethylene glycol and it will burn if the engine parts are hot enough. Don't spill coolant on a hot engine.

When the coolant in the coolant recovery tank is at the ADD mark, start your vehicle.

If the overheat warning continues, there's one more thing you can try. You can add the proper coolant mix directly to the radiator, but be sure the cooling system is cool before you do it.

⚠ CAUTION:

Steam and scalding liquids from a hot cooling system can blow out and burn you badly. They are under pressure, and if you turn the radiator pressure cap -- even a little -- they can come out at high speed. Never turn the cap when the cooling system, including the radiator pressure cap, is hot. Wait for the cooling system and radiator pressure cap to cool if you ever have to turn the pressure cap.



How to Add Coolant to the Radiator



1. You can remove the pressure cap when the cooling system, including the pressure cap and upper radiator hose, is no longer hot. Turn the pressure cap slowly counterclockwise until it first stops. (Don't press down while turning the pressure cap.)

If you hear a hiss, wait for that to stop. A hiss means there is still some pressure left.



2. Then keep turning the pressure cap, but now push down as you turn it. Remove the pressure cap.



3. Fill the radiator with the proper DEX-COOL[®] coolant mixture, up to the base of the filler neck.



4. Then fill the coolant recovery tank to the ADD mark.
5. Put the cap back on the coolant recovery tank, but leave the pressure cap off.



6. Start the engine and let it run until you can feel the upper radiator hose getting hot. Watch out for the engine fan.
7. By this time, the coolant level inside the filler neck may be lower. If the level is lower, add more of the proper DEX-COOL[®] coolant mixture through the filler neck until the level reaches the base of the filler neck.



8. Then replace the pressure cap. At any time during this procedure if coolant begins to flow out of the filler neck, reinstall the pressure cap. Be sure the arrows on the pressure cap line up like this.

Engine Fan Noise

This vehicle has a clutched engine cooling fan. When the clutch is engaged, the fan spins faster to provide more air to cool the engine. In most everyday driving conditions, the clutch is not engaged. This improves fuel economy and reduces fan noise. Under heavy vehicle loading, trailer towing and/or high outside temperatures, the fan speed increases when the clutch engages. So you may hear an increase in fan noise. This is normal and should not be mistaken as the transmission slipping or making extra shifts. It is merely the cooling system functioning properly. The fan will slow down when additional cooling is not required and the clutch disengages.

You may also hear this fan noise when you start the engine. It will go away as the fan clutch disengages.

If a Tire Goes Flat

It's unusual for a tire to "blow out" while you're driving, especially if you maintain your tires properly. If air goes out of a tire, it's much more likely to leak out slowly. But if you should ever have a "blowout," here are a few tips about what to expect and what to do:

If a front tire fails, the flat tire will create a drag that pulls the vehicle toward that side. Take your foot off the accelerator pedal and grip the steering wheel firmly. Steer to maintain lane position, and then gently brake to a stop well out of the traffic lane.

A rear blowout, particularly on a curve, acts much like a skid and may require the same correction you'd use in a skid. In any rear blowout, remove your foot from the accelerator pedal. Get the vehicle under control by steering the way you want the vehicle to go. It may be very bumpy and noisy, but you can still steer. Gently brake to a stop -- well off the road if possible.

Changing a Flat Tire

If a tire goes flat, avoid further tire and wheel damage by driving slowly to a level place. Turn on your hazard warning flashers.

CAUTION:

Changing a tire can cause an injury. The vehicle can slip off the jack and roll over you or other people. You and they could be badly injured. Find a level place to change your tire. To help prevent the vehicle from moving:

1. Set the parking brake firmly.
2. Put an automatic transmission shift lever in PARK (P) or shift a manual transmission to FIRST (1) or REVERSE (R).

CAUTION: (Continued)

CAUTION: (Continued)

3. If you have a four-wheel-drive vehicle with a manual transfer case shift lever, be sure the transfer case is in a drive gear -- not in NEUTRAL (N).
4. Turn off the engine.
5. Put the wheel blocks at the front and rear of the tire farthest away from the one being changed. That would be the tire on the other side of the vehicle, at the opposite end.

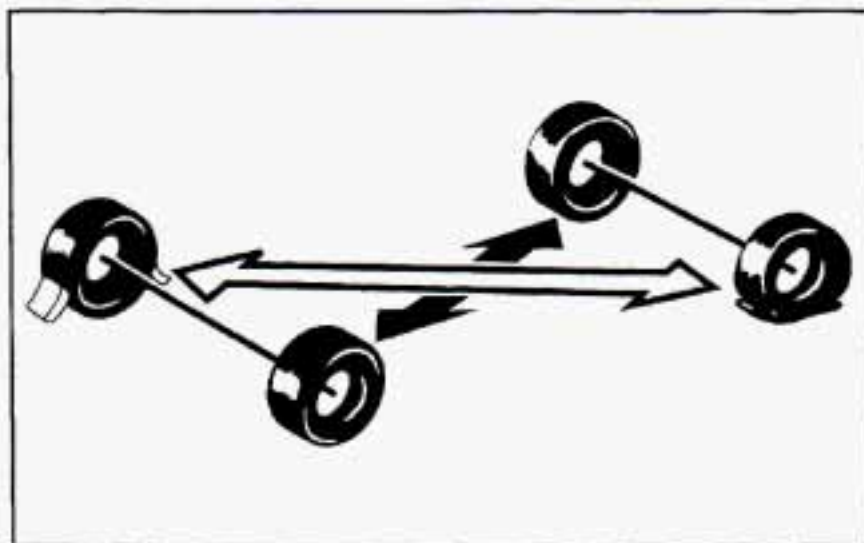

The following steps will tell you how to use the jack and change a tire.

Removing the Spare Tire and Tools

The jacking equipment you'll need is stored along the driver's rear wall. In some cases, you may have to remove the spare tire in order to reach the jack. Your vehicle is also equipped with work gloves and a plastic ground mat to assist in the changing of a flat tire.

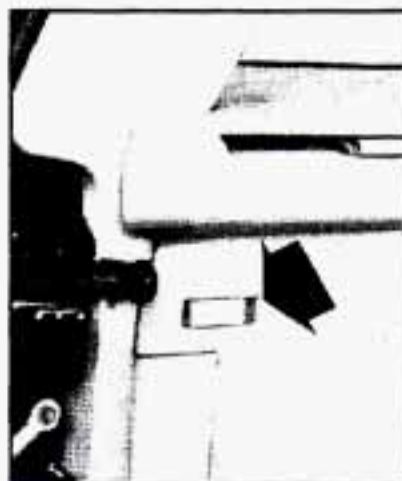

To remove your jack cover, pull up on the latch at the end of the cover, near the endgate and the latch on the top of the cover. Remove the wheel blocks, jack and wheel wrench.

The following instructions explain how to remove the spare tire, depending on where it is mounted on your vehicle.

NOTICE:

Never remove or restow a tire from/to a stowage position under the vehicle while the vehicle is supported by a jack. Always tighten the tire fully against the underside of the vehicle when restowing.



To remove the underbody-mounted spare, insert the chisel end of the wheel wrench, on an angle, into the hole in the rear bumper. Be sure the chisel end of the wheel wrench connects into the hoist shaft.

Turn the wheel wrench counterclockwise to lower the spare tire. Keep turning the wheel wrench until the spare tire can be pulled out from under the vehicle.

When the tire has been completely lowered, tilt the retainer at the end of the cable and pull it through the wheel opening. Pull the tire out from under the vehicle.

NOTICE:

To help avoid vehicle damage, do not drive the vehicle before the cable is restored.

If you have an inside-mounted spare tire, the tire must be removed in order to have access to the jack storage.

To remove an inside-mounted spare tire, reach into your tire's cover and unscrew the wing nut at the center of the wheel. Remove it and the retainer. Unhook the tire from the mounting bracket and remove the cover.

To remove a rear-mounted spare tire, first make sure that the carrier arm is fully latched to the endgate. Then remove the spare tire cover.



The locking wheel nut can be removed by snapping the rubber weather cover off the face of the lock case.



Insert the key and pull the lock case straight off. It is not necessary to turn the key.

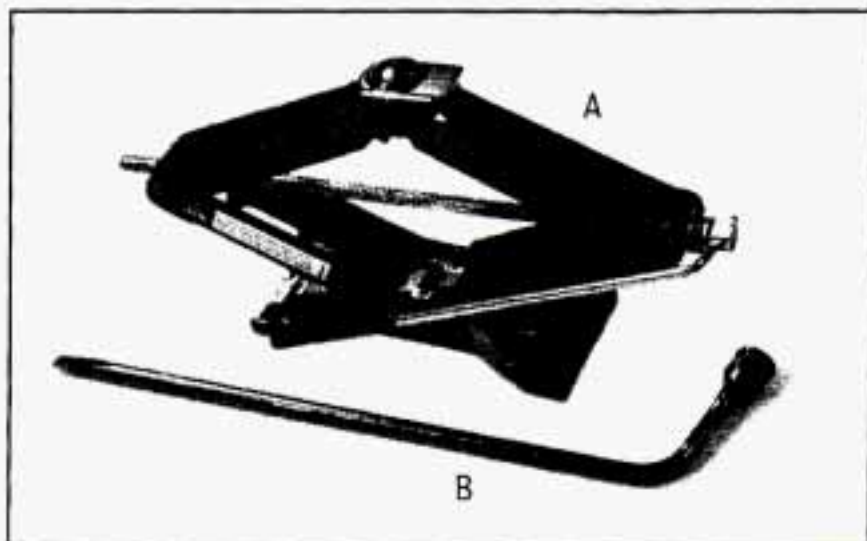

The tools you'll be using include the jack (A) and wheel wrench (B). Your vehicle may also have an optional hub cap removal tool.

Put the spare tire near the flat tire.



The optional hub cap removal tool is stowed with the jack.

Position the hub cap removal tool in the notch and pull straight away from the wheel to avoid potential damage to the hub cap and wheel surface.

Remove the hub cap. If you have an aluminum or plastic molded hub cap, pry it off with the chisel end of your wheel wrench.

Some of the molded plastic hub caps have imitation wheel nuts molded into them. The wheel wrench won't fit these imitation nuts, so don't try to remove them with the socket end of the wheel wrench.



If you have individual wheel nut caps that cover each nut, they must be removed in order to get to the wheel nuts. Use the socket end of the wheel wrench to remove the wheel nut caps.

Your wheel nut caps may attach your hub cap to the wheel. Remove these wheel nut caps before you take off the hub cap.

Removing the Flat Tire and Installing the Spare Tire

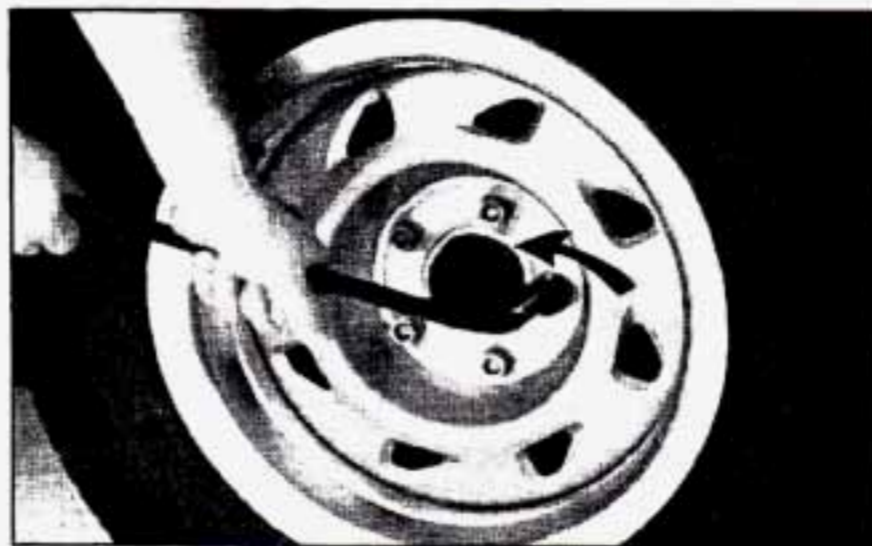

1. Using the wheel wrench, loosen all the wheel nuts. Don't remove them yet.
2. Turn the jack handle clockwise to raise the jack lift head.

3. Fit the jack into the appropriate hole nearest the flat tire.

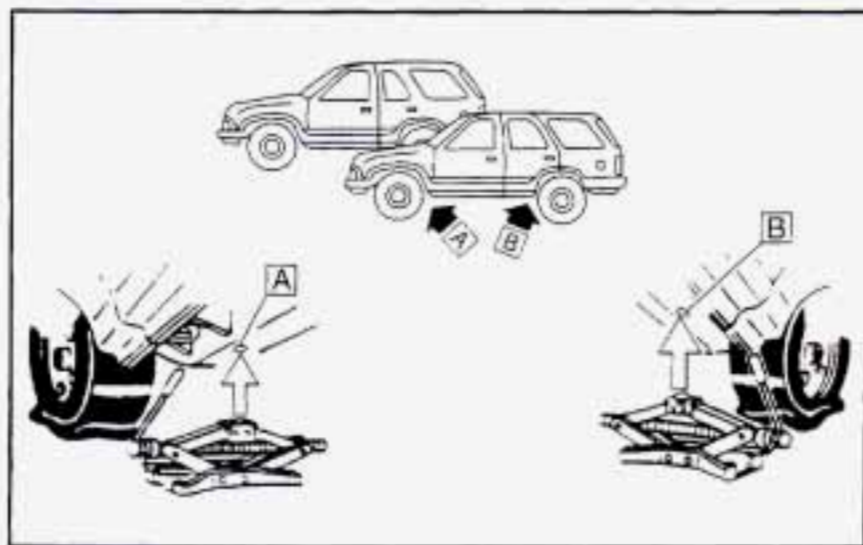

- A. Front Frame Hole
- B. Rear Frame Hole (2-Door) or Spring Hanger Hole (4-Door)

⚠ CAUTION:

Getting under a vehicle when it is jacked up is dangerous. If the vehicle slips off the jack, you could be badly injured or killed. Never get under a vehicle when it is supported only by a jack.

NOTICE:

Raising your vehicle with the jack improperly positioned can damage the vehicle and even make the vehicle to fall. To help avoid personal injury and vehicle damage, be sure to fit the jack lift head into the proper location before raising the vehicle.

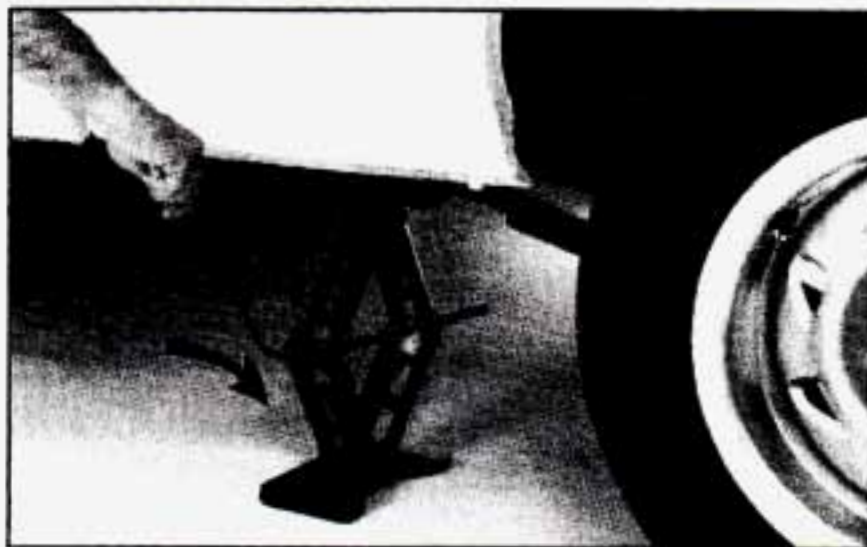

4. Raise the vehicle by turning the jack handle clockwise. Raise the vehicle far enough off the ground so there is enough room for the spare tire to fit.
5. Remove all the wheel nuts and take off the flat tire.

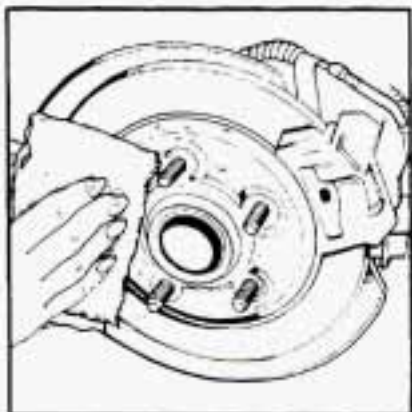

6. Remove any rust or dirt from the wheel bolts, mounting surfaces and spare wheel.

⚠ CAUTION:

Rust or dirt on the wheel, or on the parts to which it is fastened, can make the wheel nuts become loose after a time. The wheel could come off and cause an accident. When you change a wheel, remove any rust or dirt from the places where the wheel attaches to the vehicle. In an emergency, you can use a cloth or a paper towel to do this; but be sure to use a scraper or wire brush later, if you need to, to get all the rust or dirt off.

⚠ CAUTION:

Never use oil or grease on studs or nuts. If you do, the nuts might come loose. Your wheel could fall off, causing a serious accident.

7. Place the spare on the wheel mounting surface.



8. Put the nuts on by hand. Make sure the cone-shaped end is toward the wheel. Tighten each nut by hand until the wheel is held against the hub. If a nut can't be turned by hand, use the wheel wrench and see your dealer as soon as possible.

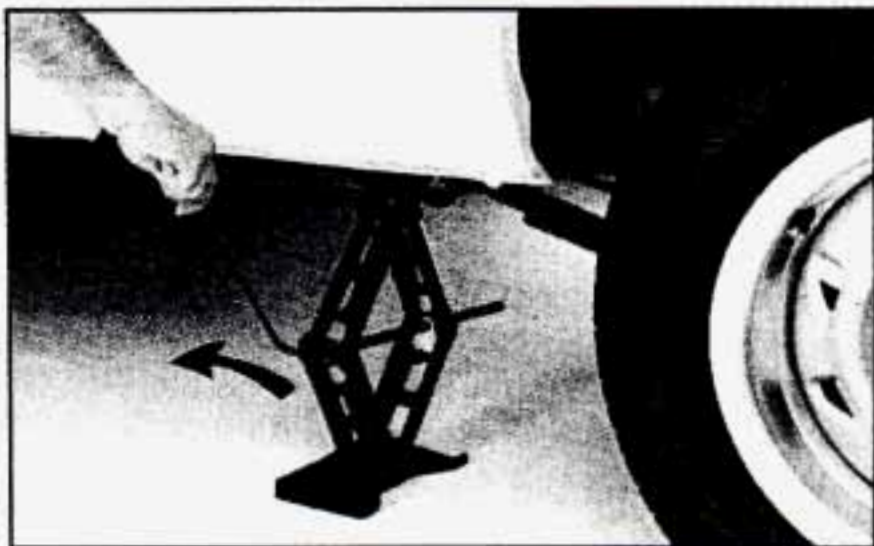

9. Lower the vehicle by turning the jack handle counterclockwise. Lower the jack completely.

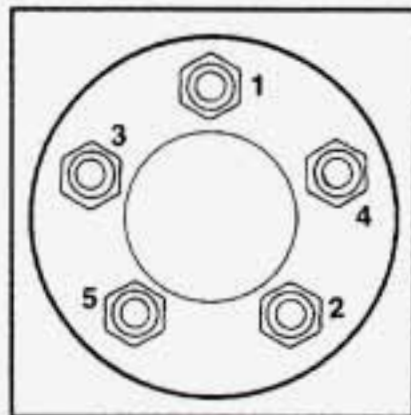

10. Use the wrench to tighten the wheel nuts firmly in a crisscross sequence as shown.

**CAUTION:**

Incorrect wheel nuts or improperly tightened wheel nuts can cause the wheel to become loose and even come off. This could lead to an accident. Be sure to use the correct wheel nuts. If you have to replace them, be sure to get new GM original equipment wheel nuts.

Stop somewhere as soon as you can and have the nuts tightened with a torque wrench to 95 lb-ft (130 N·m).

NOTICE:

Improperly tightened wheel nuts can lead to brake pulsation and rotor damage. To avoid expensive brake repairs, evenly tighten the wheel nuts in the proper sequence and to the proper torque specification.

Storing a Flat or Spare Tire and Tools**CAUTION:**

Storing a jack, a tire or other equipment in the passenger compartment of the vehicle could cause injury. In a sudden stop or collision, loose equipment could strike someone. Store all these in the proper place.

NOTICE:

An aluminum wheel with a flat tire should always be stored under the vehicle with the hoist. However, storing it that way for an extended period could damage the wheel. To avoid this, have the wheel repaired as soon as possible.

Follow this diagram to store the underbody-mounted spare.

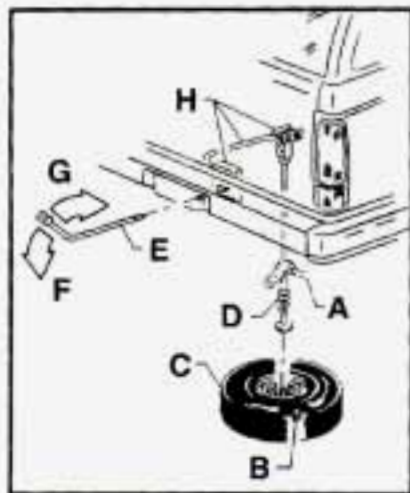

- A. Retainer
- B. Valve Stem
(Pointed Down)
- C. Spare or Flat Tire
- D. Spring
- E. Wheel Wrench
- F. Lower
- G. Raise
- H. Hoist Arm

1. Put the tire on the ground at the rear of the vehicle, with the valve stem pointed down and to the rear.
2. Pull the retainer through the wheel.
3. Put the chisel end of the wheel wrench, on an angle, through the hole in the rear bumper and into the hoist shaft. Turn the wheel wrench clockwise until the tire is raised against the underside of the vehicle.

You will hear two "clicks" when the tire is secure, but pull on the tire to make sure.

Follow this diagram for the inside-mounted spare.

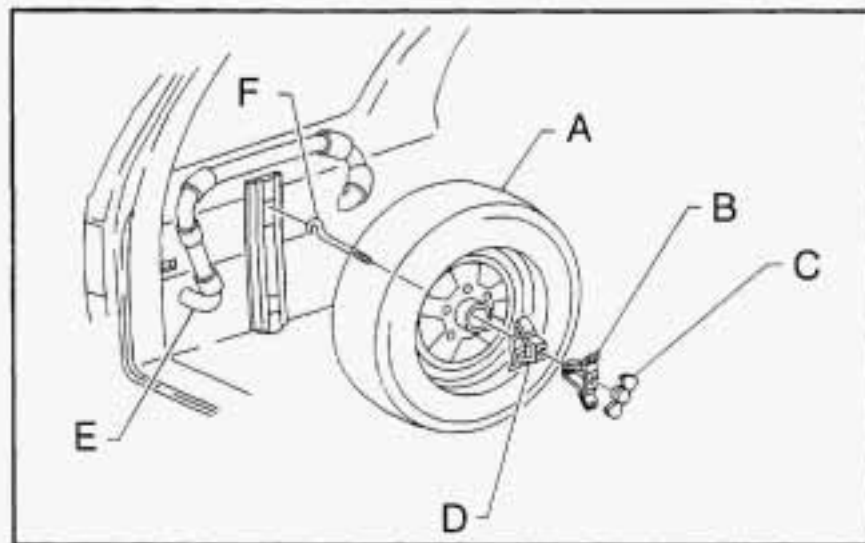

- A. Spare or Flat Tire
- B. Retainer (Two-Wheel Drive)
- C. Nut
- D. Retainer (Four-Wheel Drive)
- E. Wheel Carrier
- F. Hook

Follow this diagram for the rear-mounted spare.

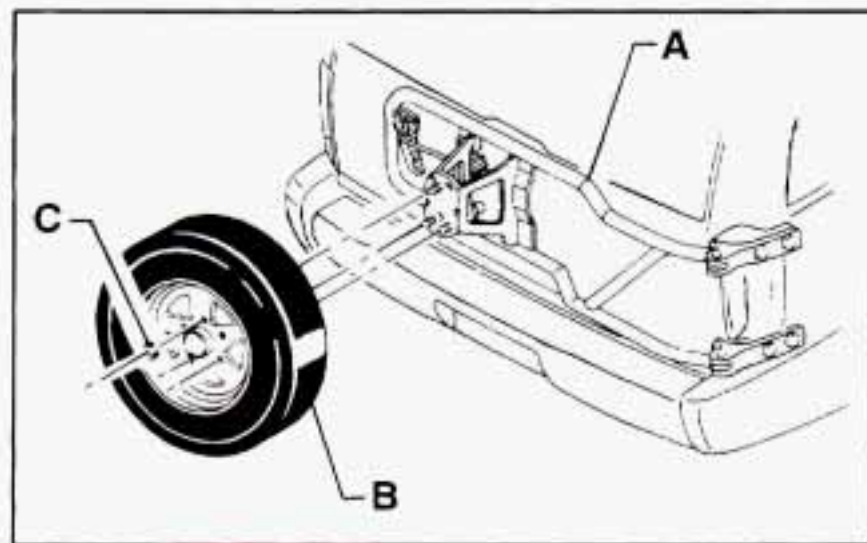

- A. Wheel Carrier
- B. Spare Tire
- C. Wheel Nut and Locking Nut Cylinder

Reinstall the locking wheel nut using the wheel wrench. Then push the lock case onto the lug nut until it stops. The key does not have to be inserted into the lock. Push the lock case to be sure it is secured. The special lug nut and lock case is not intended to be used on any road wheel, only on the spare wheel carrier. Tighten the nuts on the wheel carrier to 22 to 32 lb-ft (30 to 40 N·m).

Return the jack, wheel wrench and wheel blocks to the proper location in your vehicle's rear area. Secure the items and replace the jack cover.

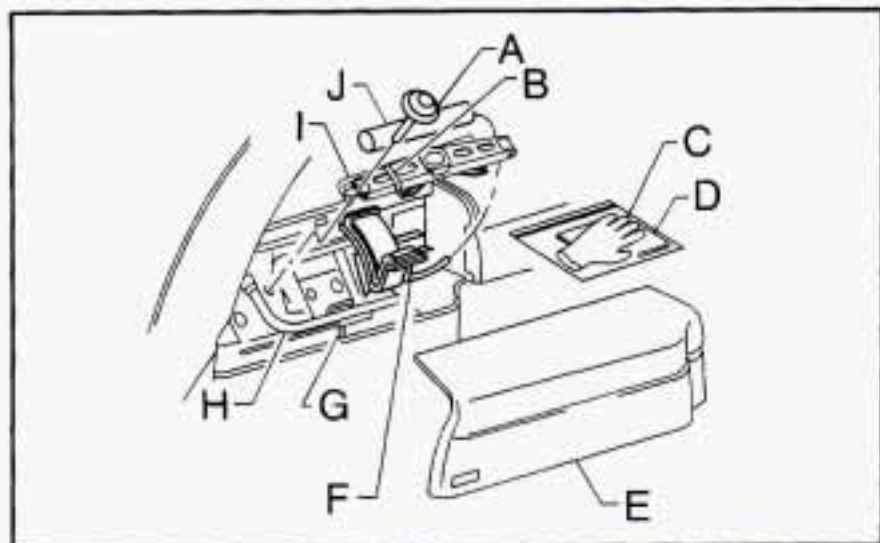

- | | |
|---------------------------------|--|
| A. Retainer | F. Wheel Blocks |
| B. Rubber Band
(Some Models) | G. Hub Cap Removal
Tool (Some Models) |
| C. Work Gloves | H. Wheel Wrench |
| D. Mat | I. Jack |
| E. Jack Storage Cover | J. Jacking Instructions |

CAUTION:

**Make sure the tire and carrier are secure.
Driving with the tire or carrier unlatched could
injure pedestrians or damage the vehicle.**

Compact Spare Tire (If Equipped)

Although the compact spare tire was fully inflated when your vehicle was new, it can lose air after a time. Check the inflation pressure regularly. It should be 60 psi (420 kPa).

After installing the compact spare on your vehicle, you should stop as soon as possible and make sure your spare tire is correctly inflated. The compact spare is made to perform well at speeds up to 65 mph (105 km/h) for distances up to 3,000 miles (5,000 km), so you can finish your trip and have your full-size tire repaired or replaced where you want. Of course, it's best to replace your spare with a full-size tire as soon as you can. Your spare will last longer and be in good shape in case you need it again.

NOTICE:

When the compact spare is installed, don't take your vehicle through an automatic car wash with guide rails. The compact spare can get caught on the rails. That can damage the tire and wheel, and maybe other parts of your vehicle.

Don't use your compact spare on other vehicles.

And don't mix your compact spare tire or wheel with other wheels or tires. They won't fit. Keep your spare tire and its wheel together.

NOTICE:

Tire chains won't fit your compact spare. Using them can damage your vehicle and can damage the chains too. Don't use tire chains on your compact spare.

If You're Stuck: In Sand, Mud, Ice or Snow

What you don't want to do when your vehicle is stuck is to spin your wheels too fast. The method known as "rocking" can help you get out when you're stuck, but you must use caution.



CAUTION:

If you let your tires spin at high speed, they can explode, and you or others could be injured. And, the transmission or other parts of the vehicle can overheat. That could cause an engine compartment fire or other damage. When you're stuck, spin the wheels as little as possible. Don't spin the wheels above 35 mph (55 km/h) as shown on the speedometer.

NOTICE:

Spinning your wheels can destroy parts of your vehicle as well as the tires. If you spin the wheels too fast while shifting your transmission back and forth, you can destroy your transmission.

For information about using tire chains on your vehicle, see "Tire Chains" in the Index.

Rocking Your Vehicle To Get It Out

First, turn your steering wheel left and right. That will clear the area around your front wheels. Then shift back and forth between REVERSE (R) and a forward gear (or with a manual transmission, between FIRST (1) or SECOND (2) and REVERSE(R)), spinning the wheels as little as possible. Release the accelerator pedal while you shift, and press lightly on the accelerator pedal when the transmission is in gear. If that doesn't get you out after a few tries, you may need to be towed out. Or, you can use your recovery hooks if your vehicle has them. If you do need to be towed out, see "Towing Your Vehicle" in the Index.

Using the Recovery Hooks

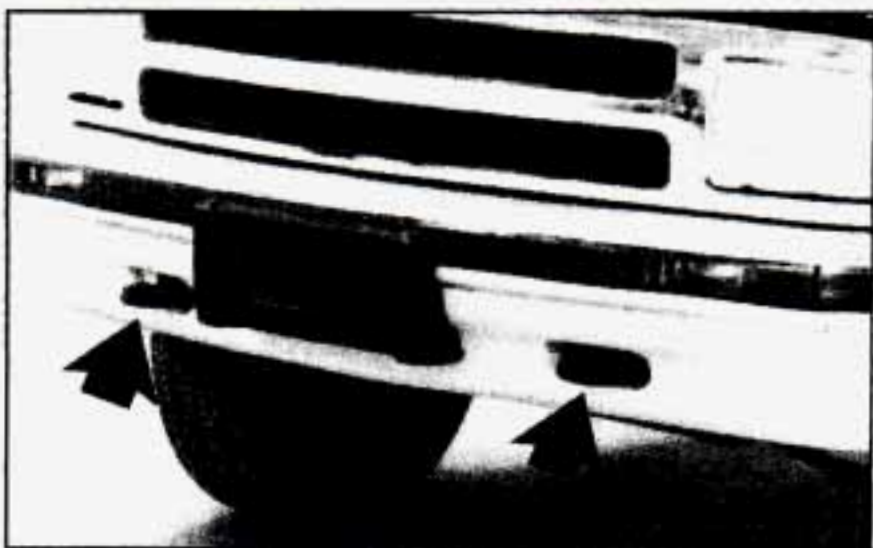

Your vehicle may be equipped with recovery hooks. The recovery hooks are provided at the front of your vehicle. You may need to use them if you're stuck off-road and need to be pulled to some place where you can continue driving.



⚠ CAUTION:

The recovery hooks, when used, are under a lot of force. Always pull the vehicle straight out. Never pull on the hooks at a sideways angle. The hooks could break off and you or others could be injured from the chain or cable snapping back.

NOTICE:

Never use the recovery hooks to tow the vehicle. Your vehicle could be damaged and it would not be covered by warranty.

Section 6 Service and Appearance Care

Here you will find information about the care of your vehicle. This section begins with service and fuel information, and then it shows how to check important fluid and lubricant levels. There is also technical information about your vehicle, and a part devoted to its appearance care.

6-3	Fuel	6-28	Brakes
6-4	Fuels in Foreign Countries	6-32	Battery
6-5	Filling Your Tank	6-33	Bulb Replacement
6-6	Checking Things Under the Hood	6-38	Windshield Wiper Blade Replacement
6-9	Engine Oil	6-40	Tires
6-13	Air Cleaner	6-49	Appearance Care
6-14	Automatic Transmission Fluid	6-49	Cleaning the Inside of Your Vehicle
6-18	Manual Transmission Fluid	6-52	Care of Safety Belts
6-19	Hydraulic Clutch	6-54	Cleaning the Outside of Your Vehicle
6-20	Rear Axle	6-57	Appearance Care Materials Chart
6-21	Four-Wheel Drive and All-Wheel Drive	6-58	Vehicle Identification Number (VIN)
6-23	Engine Coolant	6-58	Service Parts Identification Label
6-26	Radiator Pressure Cap	6-58	Electrical System
6-26	Thermostat	6-62	Replacement Bulbs
6-26	Power Steering Fluid	6-63	Capacities and Specifications
6-27	Windshield Washer Fluid	6-64	Air Conditioning Refrigerants

Service

Your GM dealer knows your vehicle best and wants you to be happy with it. We hope you'll go to your dealer for all your service needs. You'll get genuine GM parts and GM-trained and supported service people.

We hope you'll want to keep your GM vehicle all GM. Genuine GM parts have one of these marks:



Doing Your Own Service Work

If you want to do some of your own service work, you'll want to get the proper GM Service Manual. It tells you much more about how to service your vehicle than this manual can. To order the proper service manual, see "Service and Owner Publications" in the Index.

Your vehicle has an air bag system. Before attempting to do your own service work, see "Servicing Your Air Bag-Equipped Vehicle" in the Index.

You should keep a record with all parts receipts and list the mileage and the date of any service work you perform. See "Maintenance Record" in the Index.

CAUTION:

You can be injured and your vehicle could be damaged if you try to do service work on a vehicle without knowing enough about it.

- Be sure you have sufficient knowledge, experience, the proper replacement parts and tools before you attempt any vehicle maintenance task.
- Be sure to use the proper nuts, bolts and other fasteners. "English" and "metric" fasteners can be easily confused. If you use the wrong fasteners, parts can later break or fall off. You could be hurt.

Adding Equipment to the Outside of Your Vehicle

Things you might add to the outside of your vehicle can affect the airflow around it. This may cause wind noise and affect windshield washer performance. Check with your GM dealer before adding equipment to the outside of your vehicle.

Fuel

Use regular unleaded gasoline rated at 87 octane or higher. At a minimum, it should meet specifications ASTM D4814 in the United States and CGSB 3.5-M93 in Canada. Improved gasoline specifications have been developed by the American Automobile Manufacturers Association (AAMA) for better vehicle performance and engine protection. Gasolines meeting the AAMA specification could provide improved driveability and emission control system protection compared to other gasolines.

Be sure the posted octane is at least 87. If the octane is less than 87, you may get a heavy knocking noise when you drive. If it's bad enough, it can damage your engine.

If you're using fuel rated at 87 octane or higher and you still hear heavy knocking, your engine needs service. But don't worry if you hear a little pinging noise when you're accelerating or driving up a hill. That's normal, and you don't have to buy a higher octane fuel to get rid of pinging. It's the heavy, constant knock that means you have a problem.

If your vehicle is certified to meet California Emission Standards (indicated on the underhood tune-up label), it is designed to operate on fuels that meet California specifications. If such fuels are not available in states adopting California emissions standards, your vehicle will operate satisfactorily on fuels meeting federal specifications, but emission control system performance may be affected. The malfunction indicator lamp on your instrument panel may turn on and/or your vehicle may fail a smog-check test. If this occurs, return to your authorized GM dealer for diagnosis to determine the cause of failure. In the event it is determined that the cause of the condition is the type of fuels used, repairs may not be covered by your warranty.

Some gasolines that are not reformulated for low emissions contain an octane-enhancing additive called methylcyclopentadienyl manganese tricarbonyl (MMT); ask your service station operator whether or not his fuel contains MMT. General Motors does not recommend the use of such gasolines. If fuels containing MMT are used, spark plug life may be reduced and your emission control system performance may be affected. The malfunction indicator lamp on your instrument panel may turn on. If this occurs, return to your authorized GM dealer for service.

To provide cleaner air, all gasolines in the United States are now required to contain additives that will help prevent deposits from forming in your engine and fuel system, allowing your emission control system to function properly. Therefore, you should not have to add anything to the fuel. In addition, gasolines containing oxygenates, such as ethers and ethanol, and reformulated gasolines may be available in your area to help clean the air. General Motors recommends that you use these gasolines if they comply with the specifications described earlier.

NOTICE:

Your vehicle was not designed for fuel that contains methanol. Don't use it. It can corrode metal parts in your fuel system and also damage plastic and rubber parts. That damage wouldn't be covered under your warranty.

Fuels in Foreign Countries

If you plan on driving in another country outside the United States or Canada, the proper fuel may be hard to find. Never use leaded gasoline or any other fuel not recommended in the previous text on fuel. Costly repairs caused by use of improper fuel wouldn't be covered by your warranty.

To check on fuel availability, ask an auto club, or contact a major oil company that does business in the country where you'll be driving.

You can also write us at the following address for advice. Just tell us where you're going and give your Vehicle Identification Number (VIN).

General Motors International Product Center
1908 Colonel Sam Drive
Oshawa, Ontario L1H 8P7

Filling Your Tank

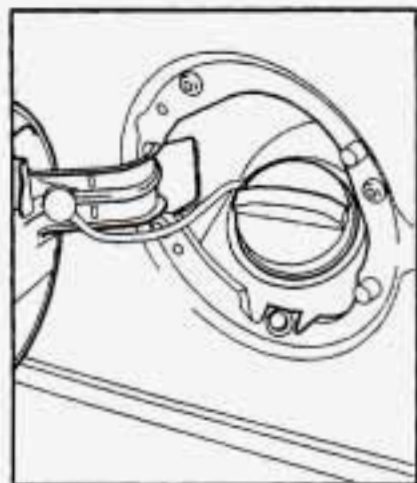

The fuel cap is behind a hinged door on the driver's side of your vehicle.

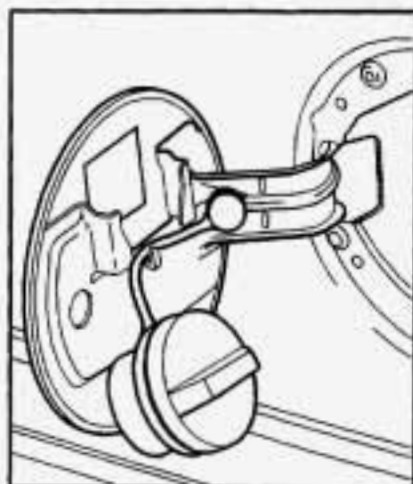

To take off the cap, turn it slowly to the left (counterclockwise). The cap has a spring in it; if you let go of the cap too soon, it will spring back to the right.

CAUTION:

Gasoline vapor is highly flammable. It burns violently, and that can cause very bad injuries. Don't smoke if you're near gasoline or refueling your vehicle. Keep sparks, flames and smoking materials away from gasoline.

CAUTION:

If you get gasoline on yourself and then something ignites it, you could be badly burned. Gasoline can spray out on you if you open the fuel filler cap too quickly. This spray can happen if your tank is nearly full, and is more likely in hot weather. Open the fuel filler cap slowly and wait for any "hiss" noise to stop. Then unscrew the cap all the way.

Be careful not to spill gasoline. Clean gasoline from painted surfaces as soon as possible. See "Cleaning the Outside of Your Vehicle" in the Index.

When you put the cap back on, turn it to the right (clockwise) until you hear a clicking sound. Make sure you fully install the cap. The diagnostic system can determine if the fuel cap has been left off or improperly installed. This would allow fuel to evaporate into the atmosphere. See "Malfunction Indicator Lamp" in the Index.

NOTICE:

If you need a new cap, be sure to get the right type. Your dealer can get one for you. If you get the wrong type, it may not fit properly. This may cause your malfunction indicator lamp to light and your fuel tank and emissions system may be damaged. See "Malfunction Indicator Lamp" in the Index.

Checking Things Under the Hood



To open the hood, first pull the handle inside the vehicle on the lower driver's side of the instrument panel.

Then go to the front of the vehicle and release the secondary hood release.

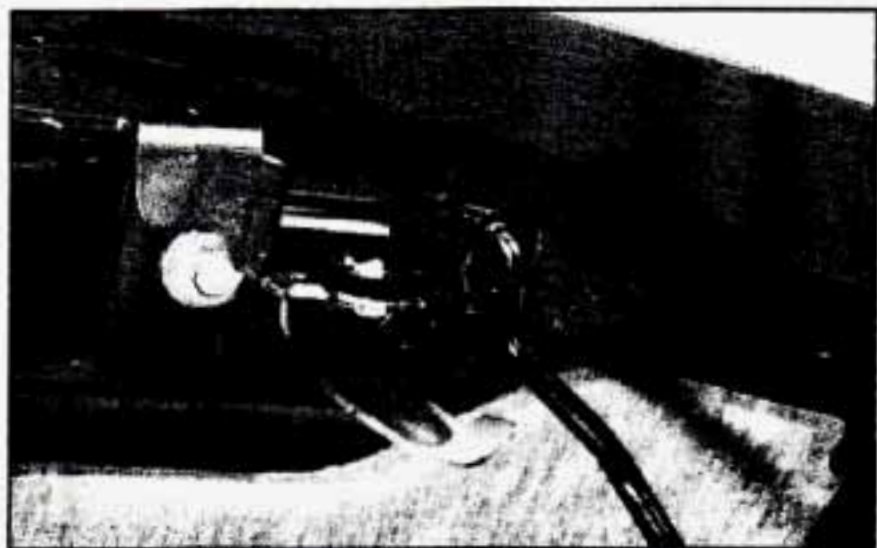

Lift the hood, release the hood prop from its retainer and put the hood prop into the slot in the hood. You may have a lamp that comes on when you lift the hood.

⚠ CAUTION:

Things that burn can get on hot engine parts and start a fire. These include liquids like gasoline, oil, coolant, brake fluid, windshield washer and other fluids, and plastic or rubber. You or others could be burned. Be careful not to drop or spill things that will burn onto a hot engine.

When you lift the hood, you'll see these items:

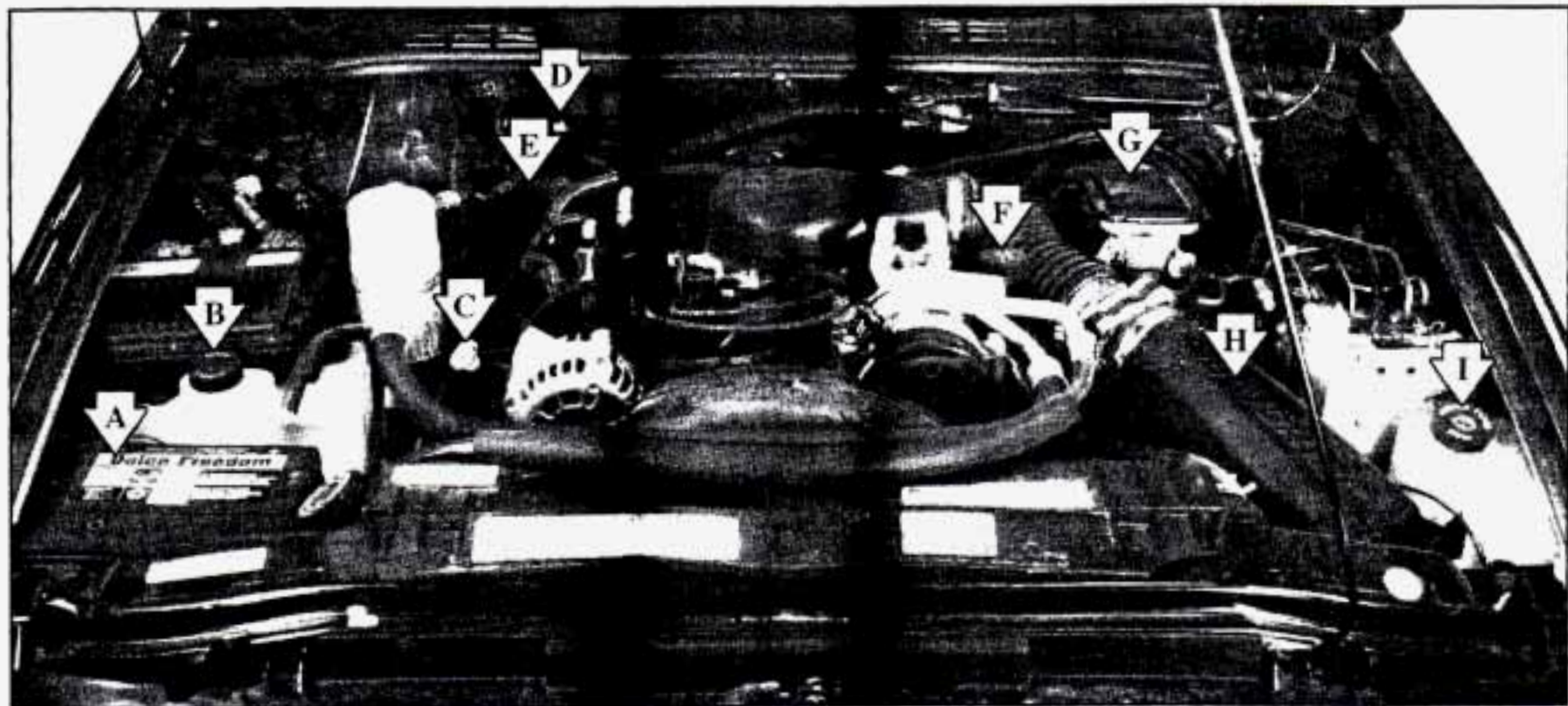

A. Battery

B. Coolant Recovery Tank

C. Engine Oil Dipstick

D. Transmission Dipstick

E. Engine Oil Fill

F. Power Steering Reservoir

G. Brake Master Cylinder

H. Air Cleaner

I. Windshield Washer Fluid

Before closing the hood, be sure all the filler caps are on properly. Then lift the hood to relieve pressure on the hood prop.

Remove the hood prop from the slot in the hood and return the prop to its retainer.

Then just pull the hood down firmly to close. It will latch when dropped from 10 to 12 inches (25 to 30 cm) without pressing on the hood.

Engine Oil

It's a good idea to check your engine oil every time you get fuel. In order to get an accurate reading, the oil must be warm and the vehicle must be on level ground.



The oil dipstick is a yellow ring.

Turn off the engine and give the oil a few minutes to drain back into the oil pan. If you don't, the oil dipstick might not show the actual level.

Checking Engine Oil

Pull out the dipstick and clean it with a paper towel or cloth, then push it back in all the way. Remove it again, keeping the tip down, and check the level.

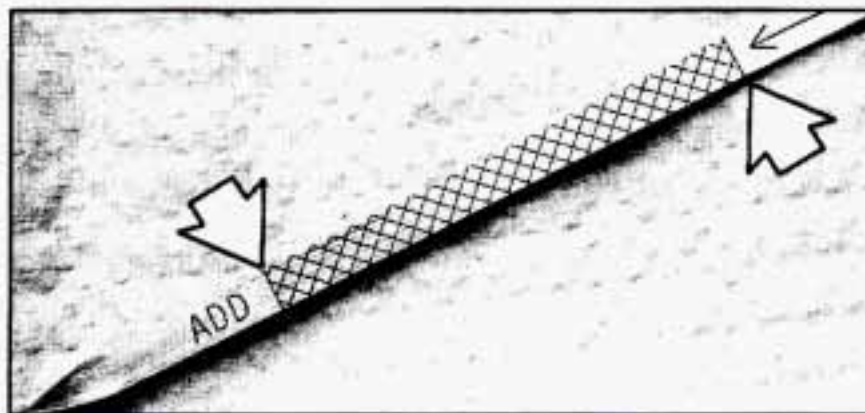

When to Add Oil

If the oil is at or below the ADD line, then you'll need to add at least one quart of oil. But you must use the right kind. This part explains what kind of oil to use. For crankcase capacity, see "Capacities and Specifications" in the Index.

NOTICE:

Don't add too much oil. If your engine has so much oil that the oil level gets above the cross-hatched area that shows the proper operating range, your engine could be damaged.

Be sure to fill it enough to put the level somewhere in the proper operating range. Push the dipstick all the way back in when you're through.

What Kind of Oil to Use

Oils recommended for your vehicle can be identified by looking for the "Starburst" symbol. This symbol indicates that the oil has been certified by the American Petroleum Institute (API). Do not use any oil which does not carry this Starburst symbol.



If you change your own oil, be sure you use oil that has the Starburst symbol on the front of the oil container. If you have your oil changed for you, be sure the oil put into your engine is American Petroleum Institute certified for gasoline engines.

You should also use the proper viscosity oil for your vehicle, as shown in the following chart:

RECOMMENDED SAE VISCOSITY GRADE ENGINE OILS

FOR BEST FUEL ECONOMY AND COLD STARTING, SELECT THE LOWEST SAE VISCOSITY GRADE OIL FOR THE EXPECTED TEMPERATURE RANGE.

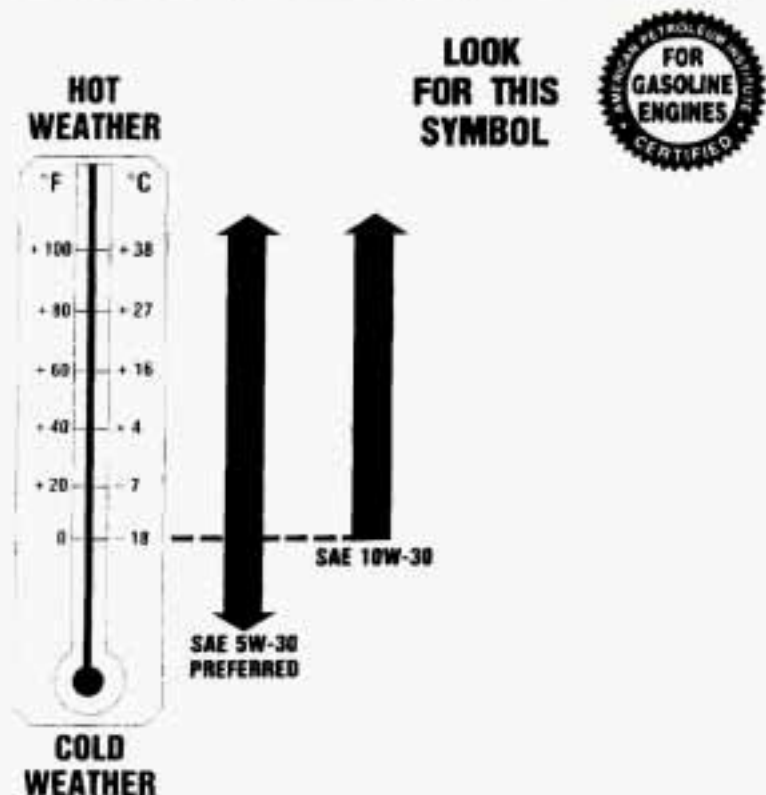

DO NOT USE SAE 20W-50 OR ANY OTHER GRADE OIL NOT RECOMMENDED

As shown in the chart, SAE 5W-30 is best for your vehicle. However, you can use SAE 10W-30 if it's going to be 0°F (-18°C) or above. These numbers on an oil container show its viscosity, or thickness. Do not use other viscosity oils, such as SAE 20W-50.

NOTICE:

Use only engine oil with the American Petroleum Institute Certified For Gasoline Engines "Starburst" symbol. Failure to use the recommended oil can result in engine damage not covered by your warranty.

GM Goodwrench[®] oil meets all the requirements for your vehicle.

If you are in an area where the temperature falls below -20°F (-29°C), consider using either an SAE 5W-30 synthetic oil or an SAE 0W-30 oil. Both will provide easier cold starting and better protection for your engine at extremely low temperatures.

Engine Oil Additives

Don't add anything to your oil. Your GM dealer is ready to advise if you think something should be added.

When to Change Engine Oil

If any one of these is true for you, use the short trip/city maintenance schedule:

- Most trips are less than 5 to 10 miles (8 to 16 km). This is particularly important when outside temperatures are below freezing.
- Most trips include extensive idling (such as frequent driving in stop-and-go traffic).
- You operate your vehicle in dusty areas or off-road frequently.
- You frequently tow a trailer or use a carrier on top of your vehicle.
- The vehicle is used for delivery service, police, taxi or other commercial application.

Driving under these conditions causes engine oil to break down sooner. If any one of these is true for your vehicle, then you need to change your oil and filter every 3,000 miles (5,000 km) or 3 months -- whichever occurs first.

If none of them is true, use the long trip/highway maintenance schedule. Change the oil and filter every 7,500 miles (12,500 km) or 12 months -- whichever occurs first. Driving a vehicle with a fully warmed engine under highway conditions causes engine oil to break down slower.

Remote Oil Filter (Four-Wheel Drive)

The access door for the remote oil filter is in the steering linkage shield assembly located under the radiator support. Twist the screw to unlock or lock the door. Make sure if you open the door, it is securely closed when you are finished.

What to Do with Used Oil

Did you know that used engine oil contains certain elements that may be unhealthy for your skin and could even cause cancer? Don't let used oil stay on your skin for very long. Clean your skin and nails with soap and water, or a good hand cleaner. Wash or properly throw away clothing or rags containing used engine oil. (See the manufacturer's warnings about the use and disposal of oil products.)

Used oil can be a real threat to the environment. If you change your own oil, be sure to drain all free-flowing oil from the filter before disposal. Don't ever dispose of oil by putting it in the trash, pouring it on the ground, into sewers, or into streams or bodies of water. Instead, recycle it by taking it to a place that collects used oil. If you have a problem properly disposing of your used oil, ask your dealer, a service station or a local recycling center for help.

Air Cleaner

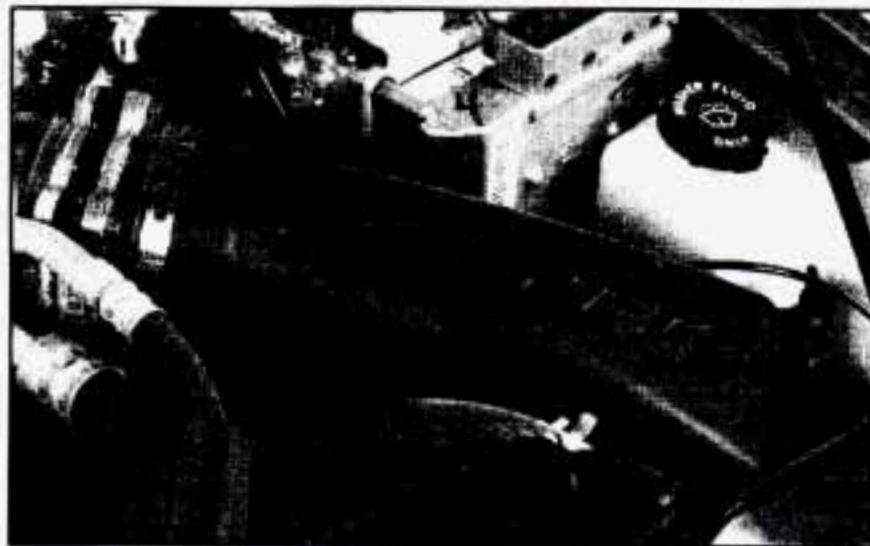

To remove the air cleaner, remove the wing nuts that hold the cover on. Remove the cover and lift out the air filter.

Insert a new air filter, then replace the air cleaner cover. Tighten the wing nuts to hold the cover in place.



CAUTION:

Operating the engine with the air cleaner off can cause you or others to be burned. The air cleaner not only cleans the air, it stops flame if the engine backfires. If it isn't there, and the engine backfires, you could be burned. Don't drive with it off, and be careful working on the engine with the air cleaner off.

NOTICE:

If the air cleaner is off, a backfire can cause a damaging engine fire. And, dirt can easily get into your engine, which will damage it. Always have the air cleaner in place when you're driving.

Automatic Transmission Fluid

When to Check and Change

A good time to check your automatic transmission fluid level is when the engine oil is changed.

Change both the fluid and filter every 50,000 miles (83 000 km) if the vehicle is mainly driven under one or more of these conditions:

- In heavy city traffic where the outside temperature regularly reaches 90°F (32°C) or higher.
- In hilly or mountainous terrain.
- When doing frequent trailer towing.
- Uses such as found in taxi, police or delivery service.

If you do not use your vehicle under any of these conditions, the fluid and filter do not require changing.

See "Scheduled Maintenance Services" in the Index.

How to Check

Because this operation can be a little difficult, you may choose to have this done at your GM dealership Service Department.

If you do it yourself, be sure to follow all the instructions here, or you could get a false reading on the dipstick.

NOTICE:

Too much or too little fluid can damage your transmission. Too much can mean that some of the fluid could come out and fall on hot engine parts or exhaust system parts, starting a fire. Be sure to get an accurate reading if you check your transmission fluid.

Wait at least 30 minutes before checking the transmission fluid level if you have been driving:

- When outside temperatures are above 90°F (32°C).
- At high speed for quite a while.
- In heavy traffic -- especially in hot weather.
- While pulling a trailer.

To get the right reading, the fluid should be at normal operating temperature, which is 180°F to 200°F (82°C to 93°C).

Checking Transmission Fluid Hot

Get the vehicle warmed up by driving about 15 miles (24 km) when outside temperatures are above 50°F (10°C). If it's colder than 50°F (10°C), drive the vehicle in DRIVE (D) until the engine temperature gage moves and then remains steady for 10 minutes. Then follow the hot check procedures.

Checking Transmission Fluid Cold

A cold check is made after the vehicle has been sitting for eight hours or more with the engine off and is used only as a reference. Let the engine run at idle for five minutes if outside temperatures are 50°F (10°C) or more. If it's colder than 50°F (10°C), you may have to idle the engine longer. Should the fluid level be low during a cold check, you *must* perform a hot check before adding fluid. This will give you a more accurate reading of the fluid level.

Checking the Fluid Hot or Cold

- Park your vehicle on a level place. Keep the engine running.
- With the parking brake applied, place the shift lever in PARK (P).
- With your foot on the brake pedal, move the shift lever through each gear range, pausing for about three seconds in each range. Then, position the shift lever in PARK (P).
- Let the engine run at idle for three minutes or more.

Then, without shutting off the engine, follow these steps:

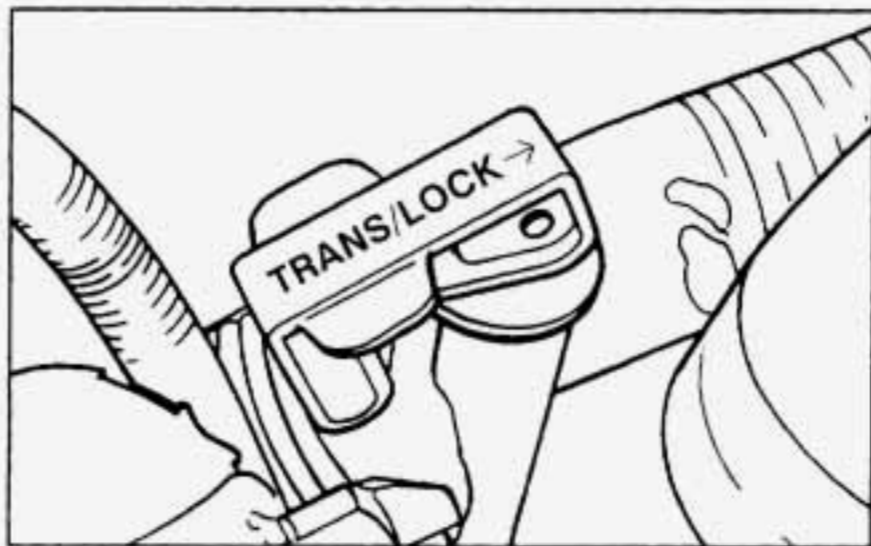

1. Flip the handle up and then pull out the dipstick and wipe it with a clean rag or paper towel.
2. Push it back in all the way, wait three seconds and then pull it back out again.

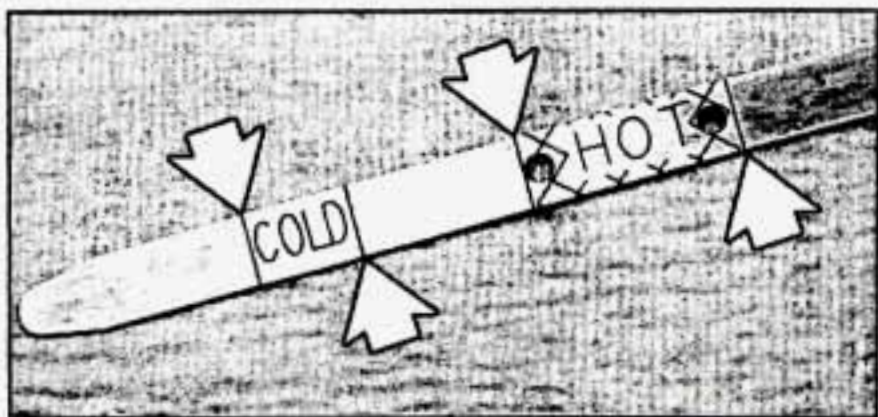

3. Check both sides of the dipstick, and read the lower level. The fluid level must be in the COLD area for a cold check or in the HOT area or cross-hatched area for a hot check.
4. If the fluid level is in the acceptable range, push the dipstick back in all the way; then flip the handle down to lock the dipstick in place.

How to Add Fluid

Refer to the Maintenance Schedule to determine what kind of transmission fluid to use. See "Recommended Fluids and Lubricants" in the Index.

Add fluid only after checking the transmission fluid HOT. (A COLD check is used only as a reference.) If the fluid level is low, add only enough of the proper fluid to bring the level up to the HOT area for a hot check. It doesn't take much fluid, generally less than one pint (0.5 L). *Don't overfill.*

NOTICE:

We recommend you use only fluid labeled DEXRON[®]-III, because fluid with that label is made especially for your automatic transmission. Damage caused by fluid other than DEXRON-III is not covered by your new vehicle warranty.

- After adding fluid, recheck the fluid level as described under "How to Check."
- When the correct fluid level is obtained, push the dipstick back in all the way; then flip the handle down to lock the dipstick in place.

Manual Transmission Fluid

When to Check

A good time to have it checked is when the engine oil is changed. However, the fluid in your manual transmission doesn't require changing.

How to Check

Because this operation can be a little difficult, you may choose to have this done at your GM dealership Service Department.

If you do it yourself, be sure to follow all the instructions here, or you could get a false reading.

NOTICE:

Too much or too little fluid can damage your transmission. Too much can mean that some of the fluid could come out and fall on hot engine parts or exhaust system parts, starting a fire. Be sure to get an accurate reading if you check your transmission fluid.

Check the fluid level only when your engine is off, the vehicle is parked on a level place and the transmission is cool enough for you to rest your fingers on the transmission case.

Then, follow these steps:

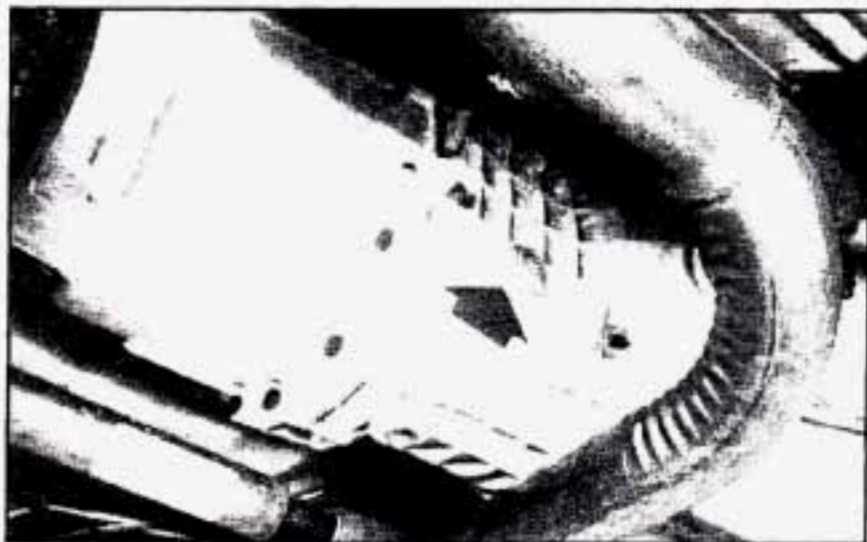

1. Remove the filler plug.
2. Check that the lubricant level is up to the bottom of the filler plug hole.
3. If the fluid level is good, install the plug and be sure it is fully seated. If the fluid level is low, add more fluid as described in the next steps.

How to Add Fluid

Here's how to add fluid. Refer to the Maintenance Schedule to determine what kind of fluid to use. See "Recommended Fluids and Lubricants" in the Index.

1. Remove the filler plug.
2. Add fluid at the filler plug hole. Add only enough fluid to bring the fluid level up to the bottom of the filler plug hole.
3. Install the filler plug. Be sure the plug is fully seated.

Hydraulic Clutch

The hydraulic clutch system in your vehicle is self-adjusting. A slight amount of play (1/4 inch to 1/2 inch or 6 mm to 12 mm) in the pedal is normal.

It isn't a good idea to "top off" your clutch fluid. Adding fluid won't correct a leak. A fluid loss in this system could indicate a problem. Have the system inspected and repaired.

When to Check and What to Use

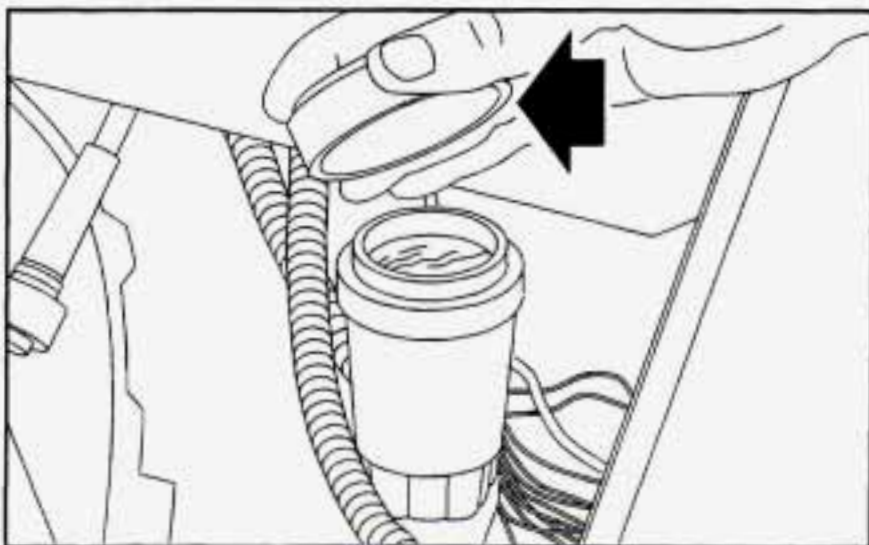

Refer to the Maintenance Schedule, Owner Checks and Services, to determine how often you should check the fluid level in your clutch master cylinder reservoir and for the proper fluid. See "Owner Checks and Services" and "Recommended Fluids and Lubricants" in the Index.

How to Check

The proper fluid should be added if the level does not reach the bottom of the diaphragm when it's in place in the reservoir. See the instructions on the reservoir cap.

Rear Axle

When to Check and Change Lubricant

Refer to the Maintenance Schedule to determine how often to check the lubricant and when to change it. See "Scheduled Maintenance Services" in the Index.

How to Check Lubricant

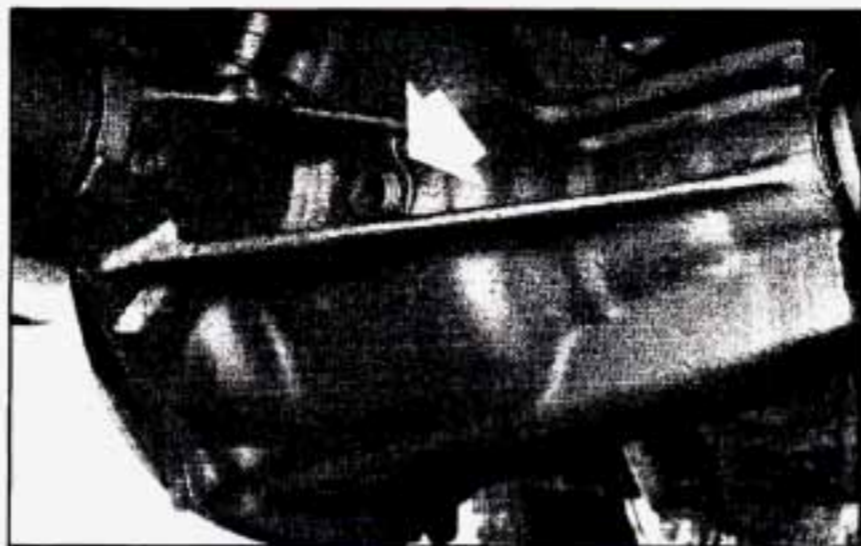

If the level is below the bottom of the filler plug hole, you'll need to add some lubricant. Add enough lubricant to raise the level to the bottom of the filler plug hole.

What to Use

Refer to the Maintenance Schedule to determine what kind of lubricant to use. See "Recommended Fluids and Lubricants" in the Index.

Four-Wheel Drive and All-Wheel Drive

Most lubricant checks in this section also apply to four-wheel-drive vehicles. However, they have two additional systems that need lubrication.

Transfer Case

When to Check Lubricant

Refer to the Maintenance Schedule to determine how often to check the lubricant. See “Periodic Maintenance Inspections” in the Index.

How to Check Lubricant

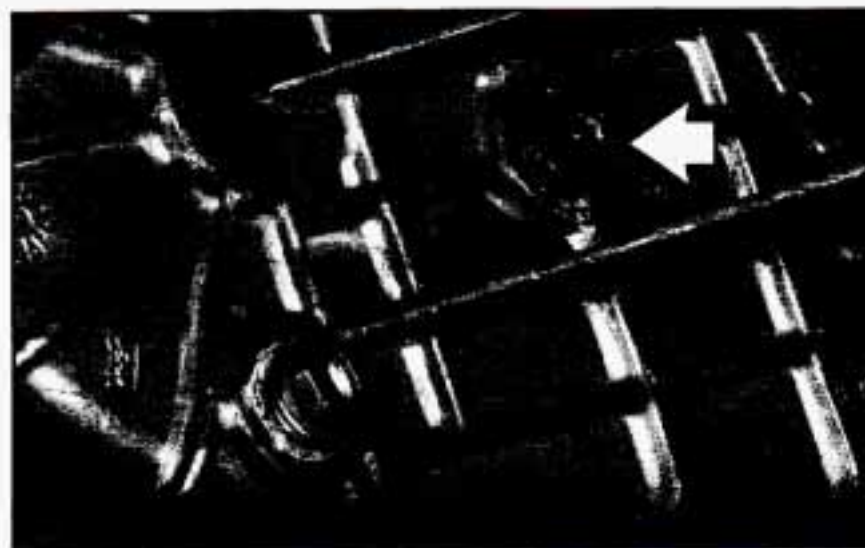

If the level is below the bottom of the filler plug hole, you'll need to add some lubricant. Add enough lubricant to raise the level to the bottom of the filler plug hole.

What to Use

Refer to the Maintenance Schedule to determine what kind of lubricant to use. See “Recommended Fluids and Lubricants” in the Index.

Front Axle

When to Check and Change Lubricant

Refer to the Maintenance Schedule to determine how often to check the lubricant and when to change it. See "Scheduled Maintenance Services" in the Index.

How to Check Lubricant

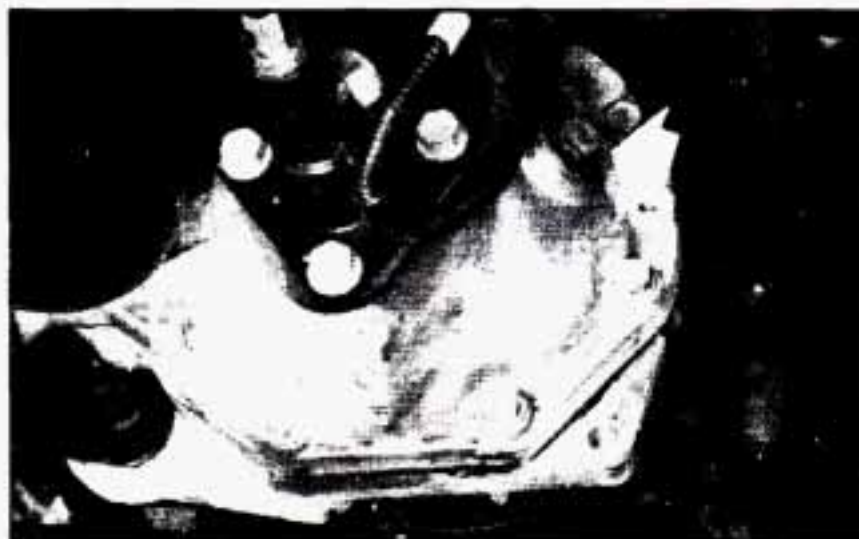

If the level is below the bottom of the filler plug hole, you'll need to add some lubricant.

If the differential is at operating temperature (warm), add enough lubricant to raise the level to the bottom of the filler plug hole.

If the differential is cold, add enough lubricant to raise the level to 1/2 inch (12 mm) below the filler plug hole.

What to Use

Refer to the Maintenance Schedule to determine what kind of lubricant to use. See "Recommended Fluids and Lubricants" in the Index.

Engine Coolant

The cooling system in your vehicle is filled with DEX-COOL[®] engine coolant. This coolant is designed to remain in your vehicle for 5 years or 150,000 miles (240 000 km), whichever occurs first, if you add only DEX-COOL[®] extended life coolant.

The following explains your cooling system and how to add coolant when it is low. If you have a problem with engine overheating, see "Engine Overheating" in the Index.

A 50/50 mixture of water and the DEX-COOL[®] coolant for your vehicle will:

- Give freezing protection down to -34°F (-37°C).
- Give boiling protection up to 265°F (129°C).
- Protect against rust and corrosion.
- Help keep the proper engine temperature.
- Let the warning lights and gages work as they should.

NOTICE:

When adding coolant, it is important that you use only DEX-COOL[®] (silicate-free) coolant.

If coolant other than DEX-COOL[®] is added to the system, premature engine, heater core or radiator corrosion may result. In addition, the engine coolant will require change sooner -- at 30,000 miles (50 000 km) or 24 months, whichever occurs first. Damage caused by the use of coolant other than DEX-COOL[®] is not covered by your new vehicle warranty.

What to Use

Use a mixture of one-half *clean water* (preferably distilled) and one-half DEX-COOL[®] coolant which won't damage aluminum parts. If you use this mixture, you don't need to add anything else.



CAUTION:

Adding only plain water to your cooling system can be dangerous. Plain water, or some other liquid like alcohol, can boil before the proper coolant mix will. Your vehicle's coolant warning system is set for the proper coolant mix. With plain water or the wrong mix, your engine could get too hot but you wouldn't get the overheat warning. Your engine could catch fire and you or others could be burned. Use a 50/50 mix of clean water and DEX-COOL[®] coolant.

NOTICE:

If you use an improper coolant mix, your engine could overheat and be badly damaged. The repair cost wouldn't be covered by your warranty. Too much water in the mix can freeze and crack the engine, radiator, heater core and other parts.

If you have to add coolant more than four times a year, have your dealer check your cooling system.

NOTICE:

If you use the proper coolant, you don't have to add extra inhibitors or additives which claim to improve the system. These can be harmful.

Checking Coolant

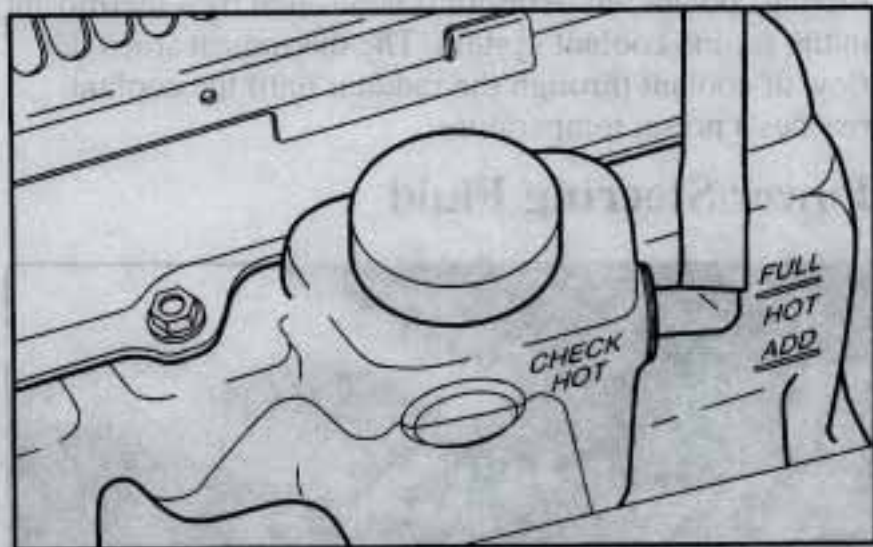

When your engine is cold, the coolant level should be at ADD, or a little higher. When your engine is warm, the level should be up to FULL HOT, or a little higher.

Adding Coolant

If you need more coolant, add the proper DEX-COOL[®] coolant mixture *at the coolant recovery tank*.

CAUTION:

Turning the radiator pressure cap when the engine and radiator are hot can allow steam and scalding liquids to blow out and burn you badly. With the coolant recovery tank, you will almost never have to add coolant at the radiator. Never turn the radiator pressure cap -- even a little -- when the engine and radiator are hot.

Add DEX-COOL[®] coolant mixture at the recovery tank, but be careful not to spill it.

CAUTION:

You can be burned if you spill coolant on hot engine parts. Coolant contains ethylene glycol, and it will burn if the engine parts are hot enough. Don't spill coolant on a hot engine.

Radiator Pressure Cap



NOTICE:

Your radiator cap is a 15 psi (105 kPa) pressure-type cap and must be tightly installed to prevent coolant loss and possible engine damage from overheating. Be sure the arrows on the cap line up with the overflow tube on the radiator filler neck.

Thermostat

Engine coolant temperature is controlled by a thermostat in the engine coolant system. The thermostat stops the flow of coolant through the radiator until the coolant reaches a preset temperature.

Power Steering Fluid



When to Check Power Steering Fluid

It is not necessary to regularly check power steering fluid unless you suspect there is a leak in the system or you hear an unusual noise. A fluid loss in this system could indicate a problem. Have the system inspected and repaired.

How To Check Power Steering Fluid

When the engine compartment is cool, wipe the cap and the top of the reservoir clean, then unscrew the cap and wipe the dipstick with a clean rag. Replace the cap and completely tighten it. Then remove the cap again and look at the fluid level on the dipstick.

The level should be between the ADD and FULL marks. If necessary, add only enough fluid to bring the level up to the proper range.

What to Use

To determine what kind of fluid to use, see "Recommended Fluids and Lubricants" in the Index. Always use the proper fluid. Failure to use the proper fluid can cause leaks and damage hoses and seals.

Windshield Washer Fluid

What to Use

When you need windshield washer fluid, be sure to read the manufacturer's instructions before use. If you will be operating your vehicle in an area where the temperature may fall below freezing, use a fluid that has sufficient protection against freezing.

Adding Washer Fluid



Open the cap labeled WASHER FLUID ONLY with the washer symbol on it. Add washer fluid until the tank is full.

NOTICE:

- When using concentrated washer fluid, follow the manufacturer's instructions for adding water.
- Don't mix water with ready-to-use washer fluid. Water can cause the solution to freeze and damage your washer fluid tank and other parts of the washer system. Also, water doesn't clean as well as washer fluid.
- Fill your washer fluid tank only three-quarters full when it's very cold. This allows for expansion if freezing occurs, which could damage the tank if it is completely full.
- Don't use radiator antifreeze in your windshield washer. It can damage your washer system and paint.

Brakes

Brake Fluid

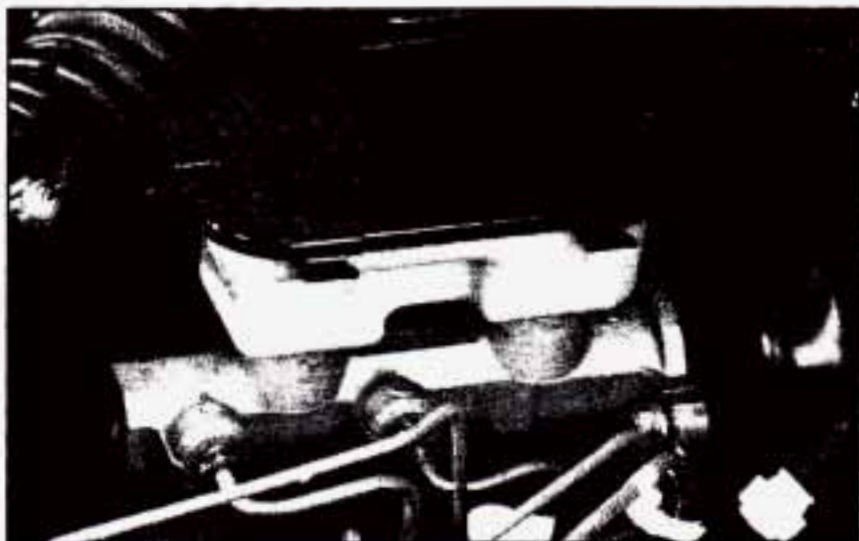

Your brake master cylinder reservoir is here. It is filled with DOT-3 brake fluid.

There are only two reasons why the brake fluid level in the reservoir might go down. The first is that the brake fluid goes down to an acceptable level during normal brake lining wear. When new linings are put in, the fluid level goes back up. The other reason is that fluid is leaking out of the brake system. If it is, you should have your brake system fixed, since a leak means that sooner or later your brakes won't work well, or won't work at all.

So, it isn't a good idea to "top off" your brake fluid. Adding brake fluid won't correct a leak. If you add fluid when your linings are worn, then you'll have too much fluid when you get new brake linings. You should add (or remove) brake fluid, as necessary, only when work is done on the brake hydraulic system.

⚠ CAUTION:

If you have too much brake fluid, it can spill on the engine. The fluid will burn if the engine is hot enough. You or others could be burned, and your vehicle could be damaged. Add brake fluid only when work is done on the brake hydraulic system.

Refer to the Maintenance Schedule to determine when to check your brake fluid. See "Periodic Maintenance Inspections" in the Index.

Checking Brake Fluid

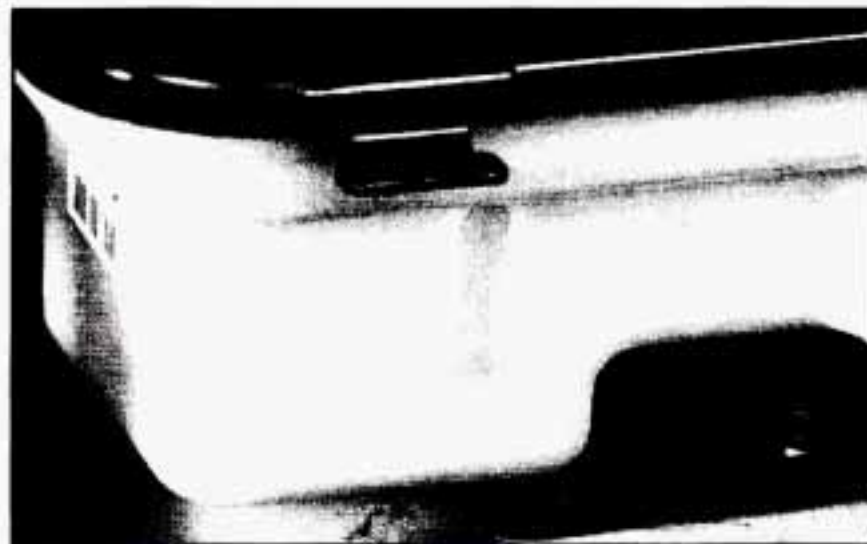

You can check the brake fluid without taking off the cap. Just look at the windows on the brake fluid reservoir. The fluid levels should be above MIN. If they aren't, have your brake system checked to see if there is a leak. After work is done on the brake hydraulic system, make sure the levels are above MIN and below the top of each window.

What to Add

When you do need brake fluid, use only DOT-3 brake fluid -- such as Delco Supreme 11[®] (GM Part No. 12377967). Use new brake fluid from a sealed container only.

Always clean the brake fluid reservoir cap and the area around the cap before removing it. This will help keep dirt from entering the reservoir.



CAUTION:

With the wrong kind of fluid in your brake system, your brakes may not work well, or they may not even work at all. This could cause a crash. Always use the proper brake fluid.

NOTICE:

- **Using the wrong fluid can badly damage brake system parts. For example, just a few drops of mineral-based oil, such as engine oil, in your brake system can damage brake system parts so badly that they'll have to be replaced. Don't let someone put in the wrong kind of fluid.**
- **If you spill brake fluid on your vehicle's painted surfaces, the paint finish can be damaged. Be careful not to spill brake fluid on your vehicle. If you do, wash it off immediately. See "Appearance Care" in the Index.**

Brake Wear

Your vehicle has front disc brakes and rear drum brakes. If you have the all-wheel drive option, your vehicle has four-wheel disc brakes.

Disc brake pads have built-in wear indicators that make a high-pitched warning sound when the brake pads are worn and new pads are needed. The sound may come and go or be heard all the time your vehicle is moving (except when you are pushing on the brake pedal firmly).

CAUTION:

The brake wear warning sound means that soon your brakes won't work well. That could lead to an accident. When you hear the brake wear warning sound, have your vehicle serviced.

NOTICE:

Continuing to drive with worn-out brake pads could result in costly brake repair.

Some driving conditions or climates may cause a brake squeal when the brakes are first applied or lightly applied. This does not mean something is wrong with your brakes.

Properly torqued wheel nuts are necessary to help prevent brake pulsation. When tires are rotated, inspect brake pads for wear and evenly torque wheel nuts in the proper sequence to GM specifications.

Your rear drum brakes don't have wear indicators, but if you ever hear a rear brake rubbing noise, have the rear brake linings inspected. Also, the rear brake drums should be removed and inspected each time the tires are removed for rotation or changing. When you have the front brake pads replaced, have the rear brakes inspected, too.

Brake linings should always be replaced as complete axle sets.

See "Brake System Inspection" in Section 7 of this manual under Part C "Periodic Maintenance Inspections."

Brake Pedal Travel

See your dealer if the brake pedal does not return to normal height, or if there is a rapid increase in pedal travel. This could be a sign of brake trouble.

Brake Adjustment

Every time you make a brake stop, your disc brakes adjust for wear.

If your brake pedal goes down farther than normal, your rear drum brakes may need adjustment. Adjust them by backing up and firmly applying the brakes a few times.

Replacing Brake System Parts

The braking system on a modern vehicle is complex. Its many parts have to be of top quality and work well together if the vehicle is to have really good braking. Your vehicle was designed and tested with top-quality GM brake parts.

When you replace parts of your braking system -- for example, when your brake linings wear down and you have to have new ones put in -- be sure you get new approved GM replacement parts. If you don't, your brakes may no longer work properly. For example, if someone puts in brake linings that are wrong for your vehicle, the balance between your front and rear brakes can change -- for the worse. The braking performance you've come to expect can change in many other ways if someone puts in the wrong replacement brake parts.

Battery

Every new vehicle has a Delco Freedom[®] battery. You never have to add water to one of these. When it's time for a new battery, we recommend a Delco Freedom battery. Get one that has the replacement number shown on the original battery's label.

Vehicle Storage

If you're not going to drive your vehicle for 25 days or more, take off the black, negative (-) cable from the battery. This will help keep your battery from running down.

CAUTION:

Batteries have acid that can burn you and gas that can explode. You can be badly hurt if you aren't careful. See "Jump Starting" in the Index for tips on working around a battery without getting hurt.

Contact your dealer to learn how to prepare your vehicle for longer storage periods.

Also, for your audio system, see "Theft-Deterrent Feature" in the Index.

Bulb Replacement

Before you replace any bulbs, be sure that all the lamps are off and the engine isn't running. See "Replacement Bulbs" in the Index.

Halogen Bulbs

CAUTION:

Halogen bulbs have pressurized gas inside and can burst if you drop or scratch the bulb. You or others could be injured. Be sure to read and follow the instructions on the bulb package.

Headlamps

Sealed Beam Lamps

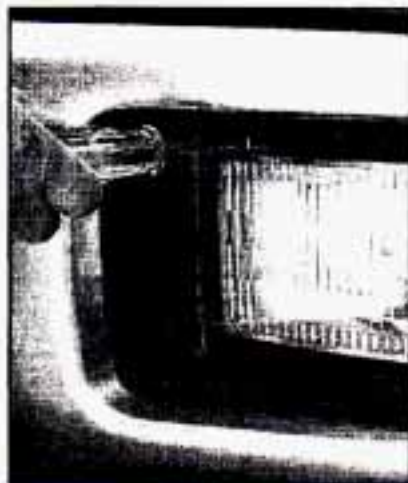

1. Remove the screws from the headlamp retainer.



2. Pull the headlamp out and remove the retainer.

3. Unplug and remove the headlamp.
4. Plug in the new headlamp and put it in place.
5. Put the retainer on the headlamp and install and tighten the screws.

Composite Headlamps

1. Open the hood.



2. Remove the black protective caps from the removal pins at the top of the radiator support. Use a hex socket to unscrew the pins.



3. Pull the headlamp lens assembly out. (Some vehicles may have side-by-side bulbs.)

4. Unplug the electrical connector.



5. Turn the bulb counterclockwise to remove it.

6. Put the new bulb into the headlamp lens assembly and turn it clockwise until it is tight.
7. Plug in the electrical connector.
8. Put the headlamp lens assembly back into the vehicle. Install and tighten the screws.

Front Turn Signal Lamps

If you have fog lamps, the fog lamp bracket must be removed before you can replace the front turn signal lamps.



1. Reach under the bumper and behind the turn signal lamp assembly.

2. Turn the socket counterclockwise and pull it out.
3. Holding the base of the bulb, pull the bulb straight out of the socket.
4. Push the new bulb into the socket until it clicks.
5. Put the socket back into the turn signal lamp assembly and turn it clockwise until it locks into place.

Front Sidemarker Lamps

1. Remove the lens retaining screws.
2. Remove the sidemarker lens from the radiator grille.
3. Turn the bulb and socket one-quarter turn counterclockwise.
4. Remove the bulb and socket from the lens.
5. Install the new bulb and socket to the sidemarker lens.
6. Rotate the bulb and socket one-quarter of a turn clockwise.
7. Install the sidemarker lens to the radiator grille.
8. Insert the tabs into the locators.
9. Install and tighten the screws.

Taillamps

1. Open the endgate.



2. Remove the two screws from the lamp assembly.

3. Pull the assembly away from the vehicle.
4. Turn the socket counterclockwise to remove it. Push the tab in while you turn the socket counterclockwise.
5. Holding the base of the bulb, pull the bulb straight out of the socket.

6. Push the new bulb straight into the socket until it clicks.
7. Put the socket into the lamp assembly and turn the socket clockwise until it locks into place.
8. Install the lamp assembly and screws.
9. Close the endgate.

Underhood Lamp

1. Disconnect the electrical connector from the underhood lamp assembly.
2. Remove the screws.
3. Disconnect the ground wire.
4. Remove the lamp assembly from the hood.
5. Install the new bulb.
6. Replace the assembly. Install and tighten the screws.
7. Connect the ground wire.
8. Connect the electrical connector to the lamp assembly.

Front Reading Lamps

1. Use a coin or small screwdriver to unscrew the center of the overhead console lamp lens while pressing in on the lamp assembly.
2. Remove the lamp assembly from the console.
3. Remove the bulb assembly from the lamp assembly.
4. Pull the bulb straight out of the base.
5. Put a new bulb into the bulb base.
6. Install the bulb assembly into the lamp assembly.
7. Place the lamp assembly into the console, turning it to latch it in place.
8. Install the lens.

Vanity Mirror Lamps

1. Insert the blade of a small screwdriver into the center slot at the bottom of the lens.
2. Gently pry the screwdriver down in order to lift out the lens.
3. Pry out the bulb.

4. Press the new bulb into place.
5. Slide the side tabs of the lens under the side of the vanity assembly frame.
6. Rotate the lens downward.
7. Snap the lens into the frame.

Windshield Wiper Blade Replacement

See "Normal Maintenance Replacement Parts" in the Index for the proper type of replacement blade.

NOTICE:

Use care when removing or installing a blade assembly. Accidental bumping can cause the arm to fall back and strike the windshield.

1. To remove the old wiper blades, lift the wiper arm until it locks into a vertical position.

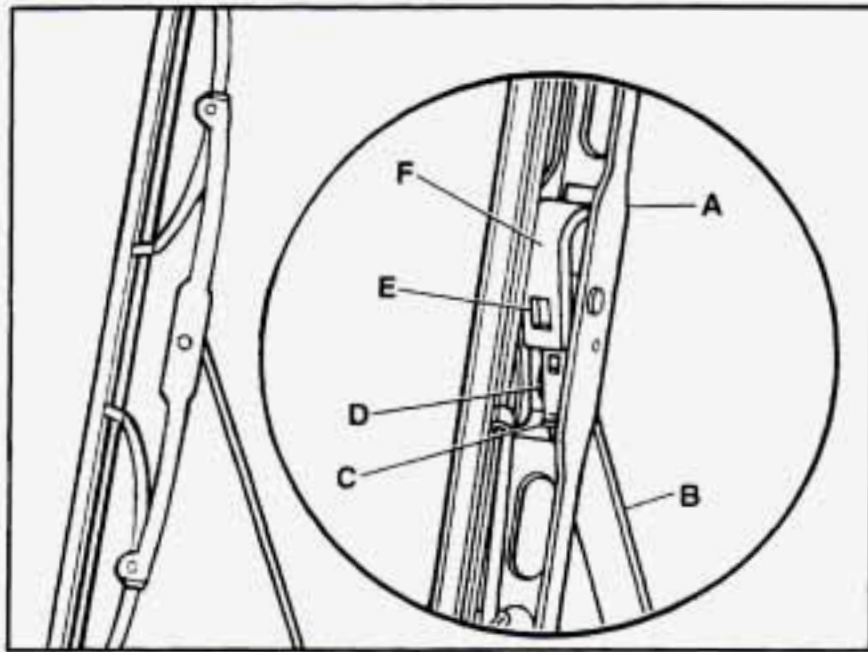

- | | |
|-------------------|----------------|
| A. Blade Assembly | D. Blade Pivot |
| B. Arm Assembly | E. Hook Slot |
| C. Locking Tab | F. Arm Hook |

2. Press down on the blade assembly pivot locking tab. Pull down on the blade assembly to release it from the wiper arm hook.

3. Remove the insert from the blade assembly. The insert has two notches at one end that are locked by the bottom claws of the blade assembly. At the notched end, pull the insert from the blade assembly.

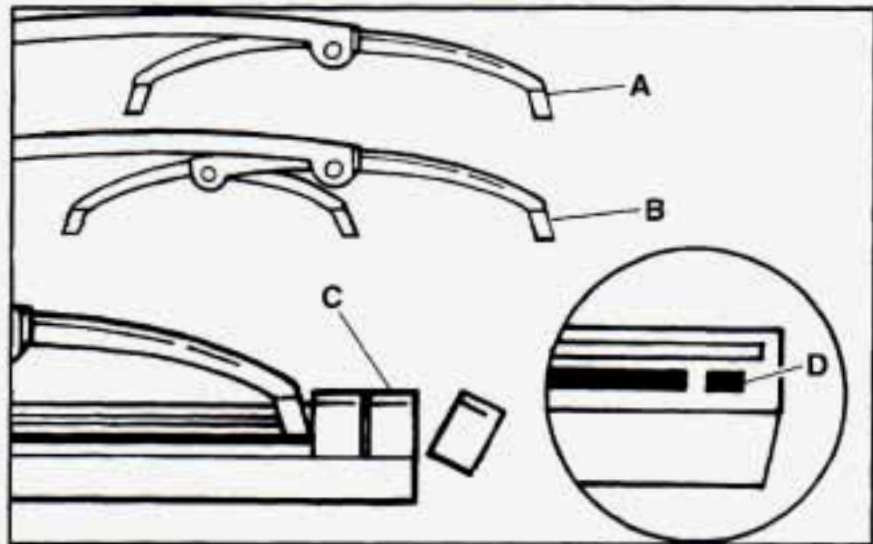

4. To install the new wiper insert, slide the insert (D), notched end last, into the end with two blade claws (A). Slide the insert all the way through the blade claws at the opposite end (B). The plastic caps (C) will be forced off as the insert is fully inserted.
5. Be sure that the notches are locked by the bottom claws. Make sure that all other claws are properly locked on both sides of the insert slots.

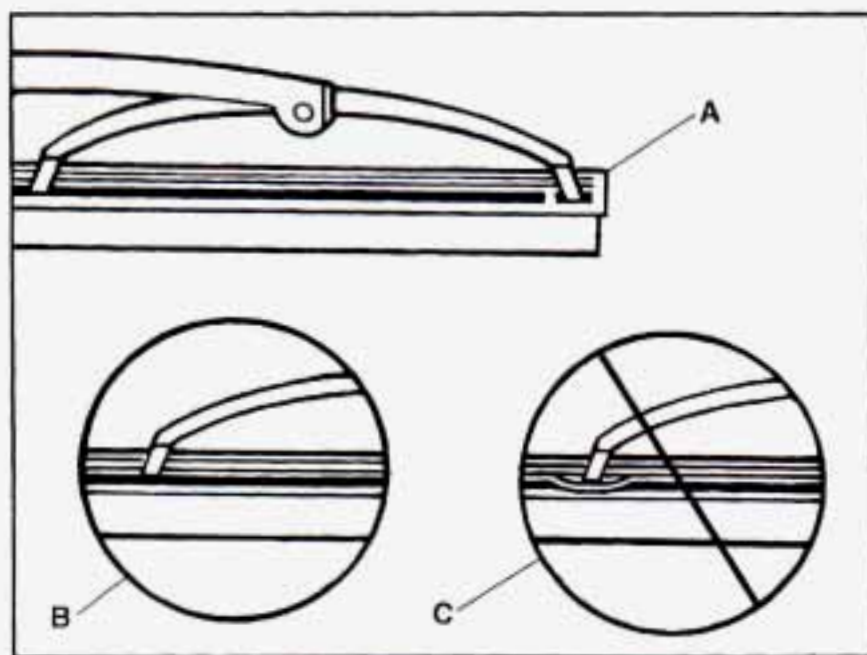

A. Claw in Notch

B. Correct Installation

C. Incorrect Installation

6. Put the blade assembly pivot in the wiper arm hook. Pull up until the pivot locking tab locks in the hook slot.
7. Carefully lower the wiper arm and blade assembly onto the windshield.

Backglass Wiper Blade Replacement

See "Windshield Wiper Blade Replacement" in this section for instructions on how to change the backglass wiper blade. The backglass wiper blade will not lock in a vertical position like the windshield wiper blade, so care should be used when pulling it away from the vehicle.

Tires

Your new vehicle comes with high-quality tires made by a leading tire manufacturer. If you ever have questions about your tire warranty and where to obtain service, see your warranty booklet for details.

 **CAUTION:**

Poorly maintained and improperly used tires are dangerous.

- **Overloading your tires can cause overheating as a result of too much friction. You could have an air-out and a serious accident. See “Loading Your Vehicle” in the Index.**
- **Underinflated tires pose the same danger as overloaded tires. The resulting accident could cause serious injury. Check all tires frequently to maintain the recommended pressure. Tire pressure should be checked when your tires are cold.**
- **Overinflated tires are more likely to be cut, punctured or broken by a sudden impact -- such as when you hit a pothole. Keep tires at the recommended pressure.**
- **Worn, old tires can cause accidents. If your tread is badly worn, or if your tires have been damaged, replace them.**

Inflation -- Tire Pressure

The Certification/Tire label, which is on the driver's door edge, above the door latch, shows the correct inflation pressures for your tires when they're cold. "Cold" means your vehicle has been sitting for at least three hours or driven no more than 1 mile (1.6 km).

NOTICE:

Don't let anyone tell you that underinflation or overinflation is all right. It's not. If your tires don't have enough air (underinflation), you can get the following:

- **Too much flexing**
- **Too much heat**
- **Tire overloading**
- **Bad wear**
- **Bad handling**
- **Bad fuel economy.**

NOTICE: (Continued)

NOTICE: (Continued)

If your tires have too much air (overinflation), you can get the following:

- **Unusual wear**
- **Bad handling**
- **Rough ride**
- **Needless damage from road hazards.**

When to Check

Check your tires once a month or more. Also, check the tire pressure of the spare tire.

If you have a compact spare tire, it should be at 60 psi (420 kPa).

How to Check

Use a good quality pocket-type gage to check tire pressure. You can't tell if your tires are properly inflated simply by looking at them. Radial tires may look properly inflated even when they're underinflated.

Be sure to put the valve caps back on the valve stems. They help prevent leaks by keeping out dirt and moisture.

Tire Inspection and Rotation

Tires should be rotated every 6,000 to 8,000 miles (10 000 to 13 000 km). Any time you notice unusual wear, rotate your tires as soon as possible and check wheel alignment. Also check for damaged tires or wheels. See "When It's Time for New Tires" and "Wheel Replacement" later in this section for more information.

The purpose of regular rotation is to achieve more uniform wear for all tires on the vehicle. The first rotation is the most important. See "Scheduled Maintenance Services" in the Index for scheduled rotation intervals.

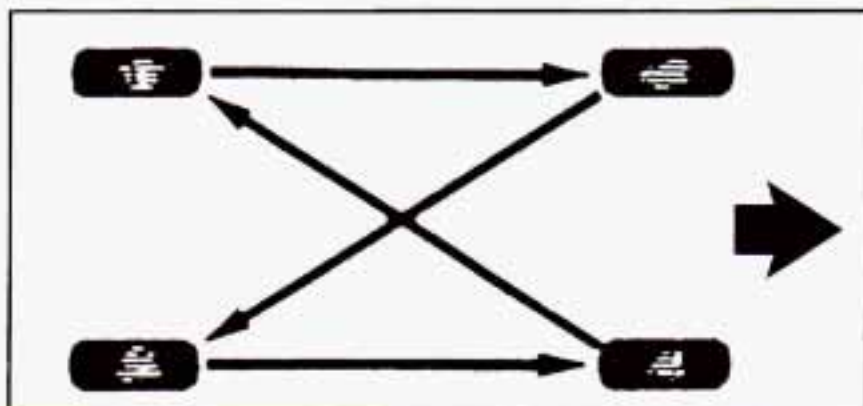

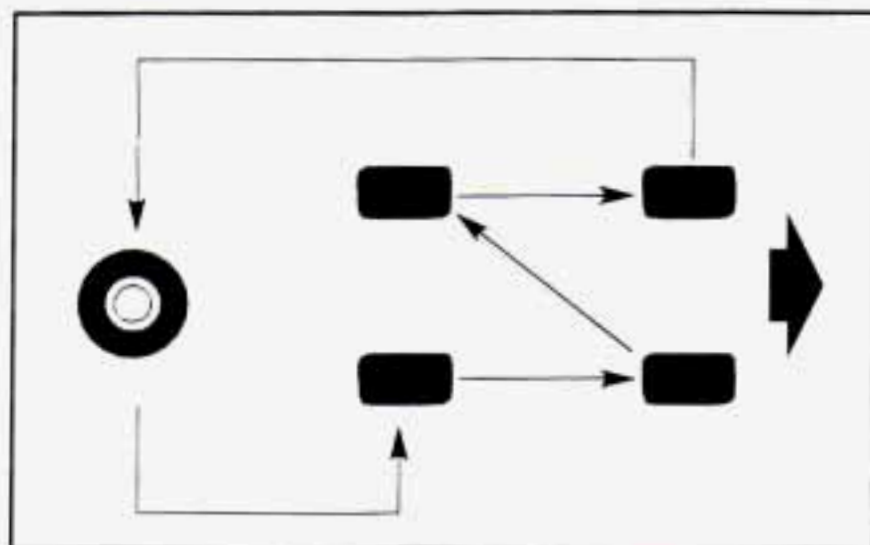

If your vehicle has a compact spare tire, don't include it in your tire rotation.

After the tires have been rotated, adjust the front and rear inflation pressures as shown on the Certification/Tire label. Make certain that all wheel nuts are properly tightened. See "Wheel Nut Torque" in the Index.

 **CAUTION:**

Rust or dirt on a wheel, or on the parts to which it is fastened, can make wheel nuts become loose after a time. The wheel could come off and cause an accident. When you change a wheel, remove any rust or dirt from places where the wheel attaches to the vehicle. In an emergency, you can use a cloth or a paper towel to do this; but be sure to use a scraper or wire brush later, if you need to, to get all the rust or dirt off. (See "Changing a Flat Tire" in the Index.)

When It's Time for New Tires

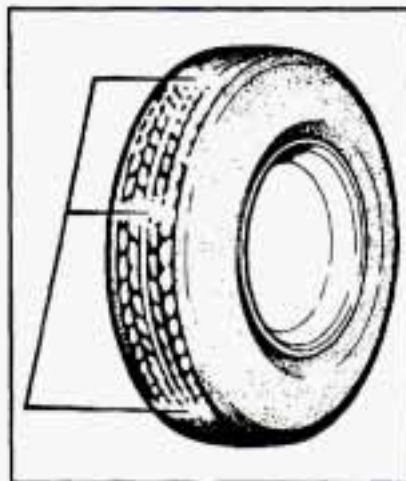

One way to tell when it's time for new tires is to check the treadwear indicators, which will appear when your tires have only 1/16 inch (1.6 mm) or less of tread remaining.

You need a new tire if any of the following statements are true:

- You can see the indicators at three or more places around the tire.
- You can see cord or fabric showing through the tire's rubber.
- The tread or sidewall is cracked, cut or snagged deep enough to show cord or fabric.

- The tire has a bump, bulge or split.
- The tire has a puncture, cut or other damage that can't be repaired well because of the size or location of the damage.

Buying New Tires

To find out what kind and size of tires you need, look at the Certification/Tire label.

The tires installed on your vehicle when it was new had a Tire Performance Criteria Specification (TPC Spec) number on each tire's sidewall. When you get new tires, get ones with that same TPC Spec number. That way your vehicle will continue to have tires that are designed to give proper endurance, handling, speed rating, traction, ride and other things during normal service on your vehicle. If your tires have an all-season tread design, the TPC number will be followed by an "MS" (for mud and snow).

If you ever replace your tires with those not having a TPC Spec number, make sure they are the same size, load range, speed rating and construction type (bias, bias-belted or radial) as your original tires.

 **CAUTION:**

Mixing tires could cause you to lose control while driving. If you mix tires of different sizes or types (radial and bias-belted tires), the vehicle may not handle properly, and you could have a crash. Using tires of different sizes may also cause damage to your vehicle. Be sure to use the same size and type tires on all wheels.

It's all right to drive with your compact spare (if you have one). It was developed for use on your vehicle.

Uniform Tire Quality Grading

The following information relates to the system developed by the United States National Highway Traffic Safety Administration, which grades tires by treadwear, traction and temperature performance. (This applies only to vehicles sold in the United States.) The grades are molded on the sidewalls of most passenger car tires. The Uniform Tire Quality Grading system does

not apply to deep tread, winter-type snow tires, space-saver or temporary use spare tires, tires with nominal rim diameters of 10 to 12 inches (25 to 30 cm), or to some limited-production tires.

While the tires available on General Motors passenger cars and light trucks may vary with respect to these grades, they must also conform to Federal safety requirements and additional General Motors Tire Performance Criteria (TPC) standards.

Treadwear

The treadwear grade is a comparative rating based on the wear rate of the tire when tested under controlled conditions on a specified government test course. For example, a tire graded 150 would wear one and a half (1 1/2) times as well on the government course as a tire graded 100. The relative performance of tires depends upon the actual conditions of their use, however, and may depart significantly from the norm due to variations in driving habits, service practices and differences in road characteristics and climate.

Traction -- A, B, C

The traction grades, from highest to lowest, are A, B, and C, and they represent the tire's ability to stop on wet pavement as measured under controlled conditions on specified government test surfaces of asphalt and concrete. A tire marked C may have poor traction performance.

Warning: The traction grade assigned to this tire is based on braking (straight ahead) traction tests and does not include cornering (turning) traction.

Temperature -- A, B, C

The temperature grades are A (the highest), B, and C, representing the tire's resistance to the generation of heat and its ability to dissipate heat when tested under controlled conditions on a specified indoor laboratory test wheel. Sustained high temperature can cause the material of the tire to degenerate and reduce tire life, and excessive temperature can lead to sudden tire failure. The grade C corresponds to a level of performance which all passenger car tires must meet under the Federal Motor Vehicle Safety Standard No. 109. Grades B and A represent higher levels of performance on the laboratory test wheel than the minimum required by law.

Warning: The temperature grade for this tire is established for a tire that is properly inflated and not overloaded. Excessive speed, underinflation, or excessive loading, either separately or in combination, can cause heat buildup and possible tire failure.

Wheel Alignment and Tire Balance

The wheels on your vehicle were aligned and balanced carefully at the factory to give you the longest tire life and best overall performance.

Scheduled wheel alignment and wheel balancing are not needed. However, if you notice unusual tire wear or your vehicle pulling one way or the other, the alignment may need to be reset. If you notice your vehicle vibrating when driving on a smooth road, your wheels may need to be rebalanced.

Wheel Replacement

Replace any wheel that is bent, cracked, or badly rusted or corroded. If wheel nuts keep coming loose, the wheel, wheel bolts and wheel nuts should be replaced. If the wheel leaks air, replace it (except some aluminum wheels, which can sometimes be repaired). See your GM dealer if any of these conditions exist.

Your dealer will know the kind of wheel you need.

Each new wheel should have the same load-carrying capacity, diameter, width, offset and be mounted the same way as the one it replaces.

If you need to replace any of your wheels, wheel bolts or wheel nuts, replace them only with new GM original equipment parts. This way, you will be sure to have the right wheel, wheel bolts and wheel nuts for your vehicle.

 **CAUTION:**

Using the wrong replacement wheels, wheel bolts or wheel nuts on your vehicle can be dangerous. It could affect the braking and handling of your vehicle, make your tires lose air and make you lose control. You could have a collision in which you or others could be injured. Always use the correct wheel, wheel bolts and wheel nuts for replacement.

NOTICE:

The wrong wheel can also cause problems with bearing life, brake cooling, speedometer or odometer calibration, headlamp aim, bumper height, vehicle ground clearance and tire or tire chain clearance to the body and chassis.

See "Changing a Flat Tire" in the Index for more information.

Used Replacement Wheels

 **CAUTION:**

Putting a used wheel on your vehicle is dangerous. You can't know how it's been used or how far it's been driven. It could fail suddenly and cause an accident. If you have to replace a wheel, use a new GM original equipment wheel.

Tire Chains

NOTICE:

If your vehicle has P235/75R15, P235/70R15 or 31x10.50R15LT/C size tires, don't use tire chains. They can damage your vehicle because there's not enough clearance.

Use another type of traction device only if its manufacturer recommends it for use on your vehicle and tire size combination and road conditions. Follow that manufacturer's instructions. To help avoid damage to your vehicle, drive slowly, readjust or remove the device if it's contacting your vehicle, and don't spin your wheels.

NOTICE: (Continued)

NOTICE: (Continued)

If you do find a traction device that will fit, install them on the rear tires.

If you have other size tires, use tire chains only where legal and only when you must. Use only SAE Class "S" type chains that are the proper size for your tires. Install them on the drive axle tires (four-wheel-drive vehicles can use chains on both axles) and tighten them as tightly as possible with the ends securely fastened. Drive slowly and follow the chain manufacturer's instructions. If you can hear the chains contacting your vehicle, stop and retighten them. If the contact continues, slow down until it stops. Driving too fast or spinning the wheels with chains on will damage your vehicle.

Appearance Care

Remember, cleaning products can be hazardous. Some are toxic. Others can burst into flame if you strike a match or get them on a hot part of the vehicle. Some are dangerous if you breathe their fumes in a closed space. When you use anything from a container to clean your vehicle, be sure to follow the manufacturer's warnings and instructions. And always open your doors or windows when you're cleaning the inside.

Never use these to clean your vehicle:

- Gasoline
- Benzene
- Naphtha
- Carbon Tetrachloride
- Acetone
- Paint Thinner
- Turpentine
- Lacquer Thinner
- Nail Polish Remover

They can all be hazardous -- some more than others -- and they can all damage your vehicle, too.

Don't use any of these unless this manual says you can. In many uses, these will damage your vehicle:

- Alcohol
- Laundry Soap
- Bleach
- Reducing Agents

Cleaning the Inside of Your Vehicle

Use a vacuum cleaner often to get rid of dust and loose dirt. Wipe vinyl or leather with a clean, damp cloth.

Your GM dealer has two cleaners, a solvent-type spot lifter and a foam-type powdered cleaner. They will clean normal spots and stains very well. Do not use them on vinyl or leather.

Here are some cleaning tips:

1. Always read the instructions on the cleaner label.
2. Clean up stains as soon as you can -- before they set.
3. Use a clean cloth or sponge, and change to a clean area often. A soft brush may be used if stains are stubborn.
4. Use solvent-type cleaners in a well-ventilated area only. If you use them, don't saturate the stained area.
5. If a ring forms after spot cleaning, clean the entire area immediately or it will set.

Using Foam-Type Cleaner on Fabric

1. Vacuum and brush the area to remove any loose dirt.
2. Always clean a whole trim panel or section. Mask surrounding trim along stitch or welt lines.
3. Mix Multi-Purpose Powdered Cleaner following the directions on the container label.
4. Use suds only and apply with a clean sponge. Don't saturate the material and don't rub it roughly.
5. As soon as you've cleaned the section, use a sponge to remove the suds.
6. Rinse the section with a clean, wet sponge.
7. Wipe off what's left with a slightly damp paper towel or cloth.
8. Dry it immediately with a blow dryer.
9. Wipe with a clean cloth.

Using Solvent-Type Cleaner on Fabric

First, see if you have to use solvent-type cleaner at all. Some spots and stains will clean off better with just water and mild soap.

If you need to use a solvent:

1. Gently scrape excess soil from the trim material with a clean, dull knife or scraper.
2. Use very little cleaner, light pressure and clean cloths (preferably cheesecloth). Cleaning should start at the outside of the stain, "feathering" toward the center.
3. Keep changing to a clean section of the cloth.
4. When you clean a stain from fabric, immediately dry the area with a blow dryer to help prevent a cleaning ring.

Fabric Protection

Your vehicle has upholstery and carpet that has been treated with Scotchgard™ Fabric Protector, a 3M product. It protects fabrics by repelling oil and water, which are the carriers of most stains. Even with this protection, you still need to clean your upholstery and carpet often to keep it looking new.

Further information on cleaning is available by calling 1-800-433-3296 (in Minnesota, 1-800-642-6167).

Special Cleaning Problems

Greasy or Oily Stains

Stains caused by grease, oil, butter, margarine, shoe polish, coffee with cream, chewing gum, cosmetic creams, vegetable oils, wax crayon, tar and asphalt can be removed as follows:

1. Carefully scrape off excess stain.
2. Follow the solvent-type instructions described earlier.

Shoe polish, wax crayon, tar and asphalt will stain if left on a vehicle's seat fabric. They should be removed as soon as possible. Be careful, because the cleaner will dissolve them and may cause them to spread.

Non-Greasy Stains

Stains caused by catsup, coffee (black), egg, fruit, fruit juice, milk, soft drinks, wine, vomit, urine and blood can be removed as follows:

1. Carefully scrape off excess stain, then sponge the soiled area with cool water.
2. If a stain remains, follow the foam-type instructions described earlier.
3. If an odor lingers after cleaning vomit or urine, treat the area with a water/baking soda solution:
1 teaspoon (5 ml) of baking soda to 1 cup (250 ml) of lukewarm water.
4. If needed, clean lightly with solvent-type cleaner.

Combination Stains

Stains caused by candy, ice cream, mayonnaise, chili sauce and unknown stains can be removed as follows:

1. Carefully scrape off excess stain.
2. Clean with cool water and allow to dry.
3. If a stain remains, clean it with solvent-type cleaner.

Cleaning Vinyl

Use warm water and a clean cloth.

- Rub with a clean, damp cloth to remove dirt. You may have to do it more than once.
- Things like tar, asphalt and shoe polish will stain if you don't get them off quickly. Use a clean cloth and a vinyl/leather cleaner. See your dealer for this product.

Cleaning Leather

Use a soft cloth with lukewarm water and a mild soap or saddle soap and wipe dry with a soft cloth. Then, let the leather dry naturally. Do not use heat to dry.

- For stubborn stains, use a leather cleaner. See your dealer for this product.
- *Never* use oils, varnishes, solvent-based or abrasive cleaners, furniture polish or shoe polish on leather.
- Soiled or stained leather should be cleaned immediately. If dirt is allowed to work into the finish, it can harm the leather.

Cleaning the Top of the Instrument Panel

Use only mild soap and water to clean the top surfaces of the instrument panel. Sprays containing silicones or waxes may cause annoying reflections in the windshield and even make it difficult to see through the windshield under certain conditions.

Care of Safety Belts

Keep belts clean and dry.



CAUTION:

Do not bleach or dye safety belts. If you do, it may severely weaken them. In a crash, they might not be able to provide adequate protection. Clean safety belts only with mild soap and lukewarm water.

Cleaning Glass Surfaces

Glass should be cleaned often. GM Glass Cleaner (GM Part No. 1050427) or a liquid household glass cleaner will remove normal tobacco smoke and dust films on interior glass.

Don't use abrasive cleaners on glass, because they may cause scratches. Avoid placing decals on the inside rear window, since they may have to be scraped off later. If abrasive cleaners are used on the inside of the rear window, an electric defogger element may be damaged. Any temporary license should not be attached across the defogger grid.

Cleaning the Outside of the Windshield, Backglass and Wiper Blades

If the windshield is not clear after using the windshield washer, or if the wiper blade chatters when running, wax, sap or other material may be on the blade or windshield.

Clean the outside of the windshield with GM Windshield Cleaner, Bon Ami[®] Powder (non-scratching glass cleaning powder), GM Part No. 1050011. The windshield is clean if beads do not form when you rinse it with water.

Grime from the windshield will stick to the wiper blades and affect their performance. Clean the blade by wiping vigorously with a cloth soaked in full-strength windshield washer solvent. Then rinse the blade with water.

Check the wiper blades and clean them as necessary; replace blades that look worn.

Weatherstrips

Silicone grease on weatherstrips will make them last longer, seal better, and not stick or squeak. Apply silicone grease with a clean cloth at least every six months. During very cold, damp weather more frequent application may be required. (See "Recommended Fluids and Lubricants" in the Index.)

Cleaning the Outside of Your Vehicle

The paint finish on your vehicle provides beauty, depth of color, gloss retention and durability.

Washing Your Vehicle

The best way to preserve your vehicle's finish is to keep it clean by washing it often with lukewarm or cold water.

Don't wash your vehicle in the direct rays of the sun. Don't use strong soaps or chemical detergents. Use liquid hand, dish or car washing (mild detergent) soaps. Don't use cleaning agents that are petroleum based, or that contain acid or abrasives. All cleaning agents should be flushed promptly and not allowed to dry on the surface, or they could stain. Dry the finish with a soft, clean chamois or an all-cotton towel to avoid surface scratches and water spotting.

High pressure car washes may cause water to enter your vehicle.

Cleaning Exterior Lamps/Lenses

Use lukewarm or cold water, a soft cloth and a liquid hand, dish or car washing (mild detergent) soap to clean exterior lamps and lenses. Follow instructions under "Washing Your Vehicle."

Finish Care

Occasional waxing or mild polishing of your vehicle by hand may be necessary to remove residue from the paint finish. You can get GM-approved cleaning products from your dealer. (See "Appearance Care and Materials" in the Index.)

Your vehicle has a "basecoat/clearcoat" paint finish. The clearcoat gives more depth and gloss to the colored basecoat. Always use waxes and polishes that are non-abrasive and made for a basecoat/clearcoat paint finish.

NOTICE:

Machine compounding or aggressive polishing on a basecoat/clearcoat paint finish may dull the finish or leave swirl marks.

Foreign materials such as calcium chloride and other salts, ice melting agents, road oil and tar, tree sap, bird droppings, chemicals from industrial chimneys, etc., can damage your vehicle's finish if they remain on painted surfaces. Wash the vehicle as soon as possible. If necessary, use non-abrasive cleaners that are marked safe for painted surfaces to remove foreign matter.

Exterior painted surfaces are subject to aging, weather and chemical fallout that can take their toll over a period of years. You can help to keep the paint finish looking new by keeping your vehicle garaged or covered whenever possible.

Protecting Exterior Bright Metal Parts

Bright metal parts should be cleaned regularly to keep their luster. Washing with water is all that is usually needed. However, you may use chrome polish on chrome or stainless steel trim, if necessary.

Use special care with aluminum trim. To avoid damaging protective trim, never use auto or chrome polish, steam or caustic soap to clean aluminum. A coating of wax, rubbed to high polish, is recommended for all bright metal parts.

Cleaning Aluminum Wheels (If Equipped)

Keep your wheels clean using a soft clean cloth with mild soap and water. Rinse with clean water. After rinsing thoroughly, dry with a soft clean towel. A wax may then be applied.

The surface of these wheels is similar to the painted surface of your vehicle. Don't use strong soaps, chemicals, abrasive polishes, abrasive cleaners or abrasive cleaning brushes on them because you could damage the surface.

Don't take your vehicle through an automatic car wash that has silicon carbide tire cleaning brushes. These brushes can also damage the surface of these wheels.

Cleaning Tires

To clean your tires, use a stiff brush with a tire cleaner.

NOTICE:

When applying a tire dressing always take care to wipe off any overspray or splash from all painted surfaces on the body or wheels of the vehicle. Petroleum-based products may damage the paint finish.

Sheet Metal Damage

If your vehicle is damaged and requires sheet metal repair or replacement, make sure the body repair shop applies anti-corrosion material to the parts repaired or replaced to restore corrosion protection.

Finish Damage

Any stone chips, fractures or deep scratches in the finish should be repaired right away. Bare metal will corrode quickly and may develop into a major repair expense.

Minor chips and scratches can be repaired with touch-up materials available from your dealer or other service outlets. Larger areas of finish damage can be corrected in your dealer's body and paint shop.

Underbody Maintenance

Chemicals used for ice and snow removal and dust control can collect on the underbody. If these are not removed, accelerated corrosion (rust) can occur on the underbody parts such as fuel lines, frame, floor pan and exhaust system even though they have corrosion protection.

At least every spring, flush these materials from the underbody with plain water. Clean any areas where mud and other debris can collect. Dirt packed in closed areas of the frame should be loosened before being flushed. Your dealer or an underbody car washing system can do this for you.

Chemical Paint Spotting

Some weather and atmospheric conditions can create a chemical fallout. Airborne pollutants can fall upon and attack painted surfaces on your vehicle. This damage can take two forms: blotchy, ringlet-shaped discolorations, and small irregular dark spots etched into the paint surface.

Although no defect in the paint job causes this, GM will repair, at no charge to the owner, the surfaces of new vehicles damaged by this fallout condition within 12 months or 12,000 miles (20 000 km) of purchase, whichever occurs first.

Appearance Care Materials Chart

PART NUMBER	SIZE	DESCRIPTION	USAGE
994954	23 in. x 25 in.	Polishing Cloth – Wax Treated	Exterior Polish
1050004	2.75 sq. ft.	Chamois	Shines vehicle without scratching
1050172	16 oz. (0.473 L)	Tar and Road Oil Remover	Also removes old waxes and polishes
1050173	16 oz. (0.473 L)	Chrome Cleaner and Polish	Removes rust and corrosion
1050174	16 oz. (0.473 L)	White Sidewall Tire Cleaner	Removes soil and black marks
1050200	1 gal. (3.785 L)	Magic Mirror Cleaner Polish	Exterior cleaner and polish
1050214	32 oz. (0.946 L)	Vinyl Cleaner	Spot and stain removal
1050427	23 oz. (0.680 L)	Glass Cleaner	Cleans grease, grime and smoke film
1052870	16 oz. (0.473 L)	Wash and Wax Concentrate	Exterior wash
1052918**	8 oz. (0.237 L)	Armor All™ Protector	Protects vinyl, leather and rubber
1052925	16 oz. (0.473 L)	Multi-Purpose Powdered Cleaner	Cleans vinyl, cloth, tires and mats
1052929	16 oz. (0.473 L)	Wheel Cleaner	Spray on wheel cleaner
1052930	8 oz. (0.237 L)	Capture Dry Spot Remover	Attracts and absorbs soils
12345002**	16 oz. (0.473 L)	Armor All™ Cleaner	Cleans vinyl, leather and rubber
12345725	12 oz. (0.354 L)	Silicone Tire Shine	Shines tires
12377964	16 oz. (0.473 L)	Cleaning Wax	Protects finish and removes fine scratches
12377966	16 oz. (0.473 L)	Finish Enhancer	Spot cleans paint and gives high luster
<p>See your General Motors Parts Department for these products. **Not recommended for use on instrument panel vinyl. See "Fluids and Lubricants" in the Index.</p>			

Vehicle Identification Number (VIN)

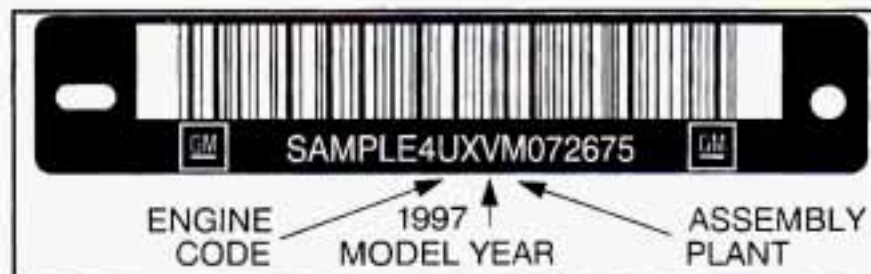

This is the legal identifier for your vehicle. It appears on a plate in the front corner of the instrument panel, on the driver's side. You can see it if you look through the windshield from outside your vehicle. The VIN also appears on the Vehicle Certification and Service Parts labels and the certificates of title and registration.

Engine Identification

The 8th character in your VIN is the engine code. This code will help you identify your engine, specifications and replacement parts.

Service Parts Identification Label

You'll find this label on the inside of the glove box. It's very helpful if you ever need to order parts. On this label is:

- your VIN,
- the model designation,
- paint information and
- a list of all production options and special equipment.

Be sure that this label is not removed from the vehicle.

Electrical System

Add-On Electrical Equipment

NOTICE:

Don't add anything electrical to your vehicle unless you check with your dealer first. Some electrical equipment can damage your vehicle and the damage wouldn't be covered by your warranty. Some add-on electrical equipment can keep other components from working as they should.

Your vehicle has an air bag system. Before attempting to add anything electrical to your vehicle, see "Servicing Your Air Bag-Equipped Vehicle" in the Index.

Headlamps

The headlamp wiring is protected by an internal circuit breaker. An electrical overload will cause the lamps to go on and off, or in some cases to remain off. If this happens, have your headlamp wiring checked right away.

Windshield Wipers

The windshield wiper motor is protected by a circuit breaker and a fuse. If the motor overheats due to heavy snow, etc., the wiper will stop until the motor cools. If the overload is caused by some electrical problem, be sure to get it fixed.

Power Windows and Other Power Options

Circuit breakers protect the power windows and other power accessories. When the current load is too heavy, the circuit breaker opens and closes, protecting the circuit until the problem is fixed or goes away.

Fuses and Circuit Breakers

The wiring circuits in your vehicle are protected from short circuits by a combination of fuses, circuit breakers and fusible thermal links. This greatly reduces the chance of fires caused by electrical problems.

Look at the silver-colored band inside the fuse. If the band is broken or melted, replace the fuse. Be sure you replace a bad fuse with a new one of the identical size and rating.

If you ever have a problem on the road and don't have a spare fuse, you can borrow one that has the same amperage. Just pick some feature of your vehicle that you can get along without -- like the radio or cigarette lighter -- and use its fuse, if it is the correct amperage. Replace it as soon as you can.

Instrument Panel Fuse Block



The fuse block is at the driver's end of the instrument panel.

Remove the cover by turning the fastener counterclockwise. Extra fuses and the fuse extractor are provided in the cover. To reinstall the fuse panel cover, push in and turn the fastener clockwise.

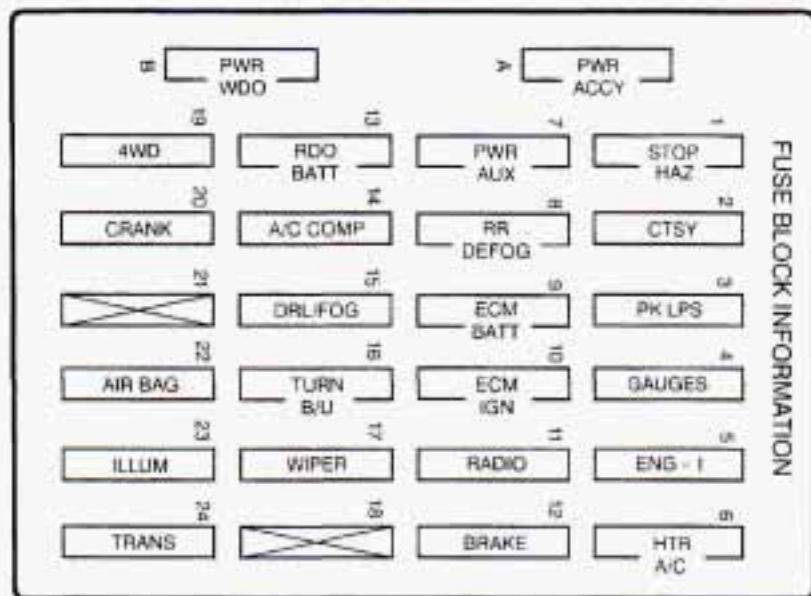

Fuse/Circuit Breaker Usage

- A Power Door Locks, Power Seat, Power Seat Lumbar, Remote Keyless Entry
- B Power Windows, Sunroof Module/Motor

Fuse/Circuit Breaker Usage

- 1 Stoplamps, Hazard Lamps, Chime, Center High-Mounted Stoplamp Relay, Center High-Mounted Stoplamp
- 2 Dome Lamps, Cargo Lamps, Visor Vanity Mirror, Cigarette Lighter, Inside Rearview Mirror Lamp, Overhead Console Lamps, Glove Box Lamp, Horns, Horn Relay, IP Courtesy Lamps, Power Outside Rearview Mirror, Liftglass Release Motor, Illuminated Entry Module
- 3 Parking Lamps, License Plate Lamps, Electric Shift Transfer Case Module, Underhood Lamp, Rear Wiper, Fog Lamp Relay, Door Switch Lamp, Ashtray Lamp, Headlamp Switch
- 4 A/C Compressor Relay, Cluster Chime Module, DRL Relay Coil, Four-Wheel-Drive Indicator Lamp, DRL Module, Rear Defog Timer, Transfer Case Control Module Ignition, SIR Redundant Ignition, RKE Ignition, Fuel Sender Module

Fuse/Circuit Breaker	Usage
5	Oxygen Sensor Heater, Exhaust Gas Recirculation, Cam Sensor, CANN, Purge, Canister Vent Solenoid, Mass Airflow Sensor, Cam Shaft Sensor
6	Blower Motor, Temperature Door Motor, HI Blower Relay Coil
7	Power Auxiliary Outlets, Assembly Line Diagnostic Link
8	Rear Window Defogger
9	PCM/VCM Battery, Fuel Pump
10	PCM/VCM Ignition, Injectors, Crank Sensor, Coil Driver Module
11	Radio, Inside Rearview Mirror Map Lamp, Overhead Console Reading Lamps, Rear Wiper, Rear Washer, Overhead Console Display
12	Anti-Lock Braking System, VCM IGN-3
13	Clock, Radio Battery, CD Player
14	A/C Compressor Battery Feed
15	Daytime Running Lamps, Fog Lamps, Fog Lamp Relay

Fuse/Circuit Breaker	Usage
16	Turn Signals and Back-Up Lamps, Brake-Transmission Shift Interlock Solenoid
17	Windshield Washer, Windshield Wiper Motor
18	Not Used
19	Electric Shift Transfer Case
20	Crank Relay, Air Bag Module
21	Not Used
22	Air Bag Module
23	Cluster Illumination, Radio Illumination, Heater Lamp, 4WD Illumination, Chime Module, Fog Lamp Illumination, Rear Wiper Switch Illumination, Rear Defogger Switch Illumination, Liftglass Release Switch Illumination, Overhead Console Illumination
24	PRNDL Power, 4L60E Automatic Transmission

Replacement Bulbs

Lamps	Quantity	Number
Halogen Headlamps, Sealed Beam	2	2E1
Halogen Headlamps, Composite Low-Beam	2	9006 HB4
Halogen Headlamps, Composite High-Beam	2	9005 HB3
Tail and Stoplamps	4	3057
Front Sidemarkers Lamps	2	194
Turn Signal Lamps	2	3157 NA
Underhood Lamp	1	93
Visor Vanity Mirror Lamps	4	74
Overhead Console Reading Lamps	2	194

Capacities and Specifications

Engine Description	“VORTEC” 4300
Type	V6
VIN Code	W
Firing Order	1-6-5-4-3-2
Horsepower	190 at 4,400 rpm
Thermostat Specification	195°F (91°C)
Spark Plug Gap	0.045 inches (0.114 cm)

Wheels and Tires

Wheel Nut Torque	95 lb-ft (130 N·m)
Tire Pressure	See the Certification/Tire label. See “Loading Your Vehicle” in the Index.

Normal Maintenance Replacement Parts

Replacement part numbers listed in this section are based on the latest information available at the time of printing, and are subject to change. If a part listed in this manual is not the same as the part used in your vehicle when it was built, or if you have any questions, please contact your GM truck dealer.

Thermostat	12551472
Oil Filter	PF52
Air Cleaner Filter	A1163C
PCV Valve	CV746C
Automatic Transmission Filter Kit	24200796
Spark Plugs	41-932
Fuel Filter	GF481
Front Windshield	
Wiper Blade	Trico (20 inches/50.8 cm)
Backglass Wiper Blade	Trico (14 inches/35.6 cm)

Capacities (Approximate)

Cooling System*

Automatic Trans. 11.7 quarts (11.1 L)

Manual Trans. 11.9 quarts (11.3 L)

Crankcase* 4.5 quarts (4.3 L)

Automatic Transmission

(Drain and Refill)* 5.0 quarts (4.7 L)

Differential Fluid

Rear 4.0 pints (1.9 L)

Front 2.6 pints (1.2 L)

Fuel Tank 19 gallons (72 L)

A/C Refrigerant . . . 30 oz. or 2 lbs. (0.9 kg) of R-134a

*After refill, the level *must* be checked.

Air Conditioning Refrigerants

Not all air conditioning refrigerants are the same. If the air conditioning system in your vehicle needs refrigerant, be sure the proper refrigerant is used. If you're not sure, ask your GM dealer.

Vehicle Dimensions*

Wheelbase

S/T10516 100.5 inches (255.3 cm)

S/T10506 107.0 inches (271.8 cm)

Length

S10516 175.0 inches (444.5 cm)

T10516 175.4 inches (445.5 cm)

S/T10506 181.5 inches (461.0 cm)

Height

S10516 66.0 inches (167.6 cm)

T10516 66.9 inches (170.0 cm)

S10506 65.9 inches (167.4 cm)

T10506 67.0 inches (170.2 cm)

Width 67.8 inches (172.2 cm)

Front Tread

S Series 55.0 inches (139.6 cm)

T Series 57.3 inches (145.4 cm)

Rear Tread

S Series 54.7 inches (138.8 cm)

T Series 55.1 inches (139.9 cm)

*Figures reflect base equipment only.

Section 7 Maintenance Schedule

This section covers the maintenance required for your vehicle. Your vehicle needs these services to retain its safety, dependability and emission control performance.

7-2	Introduction	7-7	Short Trip/City Maintenance Schedule
7-4	Part A: Scheduled Maintenance Services	7-30	Long Trip/Highway Maintenance Schedule
7-5	Short Trip/City Definition	7-46	Part B: Owner Checks and Services
7-5	Short Trip/City Intervals	7-50	Part C: Periodic Maintenance Inspections
7-6	Long Trip/Highway Definition	7-52	Part D: Recommended Fluids and Lubricants
7-6	Long Trip/Highway Intervals	7-55	Part E: Maintenance Record

**IMPORTANT:
KEEP ENGINE OIL
AT THE PROPER
LEVEL AND CHANGE AS
RECOMMENDED**



Have you purchased the GM Protection Plan? The Plan supplements your new vehicle warranties. See your Warranty and Owner Assistance booklet, or your GM dealer for details.

Introduction

Your Vehicle and the Environment

Proper vehicle maintenance not only helps to keep your vehicle in good working condition, but also helps the environment. All recommended maintenance procedures are important. Improper vehicle maintenance can even affect the quality of the air we breathe. Improper fluid levels or the wrong tire inflation can increase the level of emissions from your vehicle. To help protect our environment, and to keep your vehicle in good condition, please maintain your vehicle properly.

How This Section is Organized

The remainder of this section is divided into five parts:

“Part A: Scheduled Maintenance Services” shows what to have done and how often. Some of these services can be complex, so unless you are technically qualified and have the necessary equipment, you should let your dealer’s service department or another qualified service center do these jobs.

CAUTION:

Performing maintenance work on a vehicle can be dangerous. In trying to do some jobs, you can be seriously injured. Do your own maintenance work only if you have the required know-how and the proper tools and equipment for the job. If you have any doubt, have a qualified technician do the work.

If you are skilled enough to do some work on your vehicle, you will probably want to get the service information GM publishes. See “Service and Owner Publications” in the Index.

“Part B: Owner Checks and Services” tells you what should be checked and when. It also explains what you can easily do to help keep your vehicle in good condition.

“Part C: Periodic Maintenance Inspections” explains important inspections that your GM dealer’s service department or another qualified service center should perform.

“Part D: Recommended Fluids and Lubricants” lists some products GM recommends to help keep your vehicle properly maintained. These products, or their equivalents, should be used whether you do the work yourself or have it done.

“Part E: Maintenance Record” provides a place for you to record the maintenance performed on your vehicle. Whenever any maintenance is performed, be sure to write it down in this part. This will help you determine when your next maintenance should be done. In addition, it is a good idea to keep your maintenance receipts. They may be needed to qualify your vehicle for warranty repairs.

Part A: Scheduled Maintenance Services

Using Your Maintenance Schedule

We at General Motors want to help you keep your vehicle in good working condition. But we don't know exactly how you'll drive it. You may drive very short distances only a few times a week. Or you may drive long distances all the time in very hot, dusty weather. You may use your vehicle in making deliveries. Or you may drive it to work, to do errands or in many other ways.

Because of all the different ways people use their GM vehicles, maintenance needs vary. You may even need more frequent checks and replacements than you'll find in the schedules in this section. So please read this section and note how you drive. If you have any questions on how to keep your vehicle in good condition, see your GM dealer.

This part tells you the maintenance services you should have done and when you should schedule them. If you go to your dealer for your service needs, you'll know that GM-trained and supported service people will perform the work using genuine GM parts.

The proper fluids and lubricants to use are listed in Part D. Make sure whoever services your vehicle uses these. All parts should be replaced and all necessary repairs done before you or anyone else drives the vehicle.

These schedules are for vehicles that:

- carry passengers and cargo within recommended limits. You will find these limits on your vehicle's Certification/Tire label. See "Loading Your Vehicle" in the Index.
- are driven on reasonable road surfaces within legal driving limits.
- are driven off-road in the recommended manner. See "Off-Road Driving With Your Four-Wheel-Drive Vehicle" in the Index.
- use the recommended fuel. See "Fuel" in the Index.

Selecting the Right Schedule

First you'll need to decide which of the two schedules is right for your vehicle. Here's how to decide which schedule to follow:

Maintenance Schedule

Short Trip/City Definition

Follow the Short Trip/City Maintenance Schedule if any one of these conditions is true for your vehicle:

- Most trips are less than 5 to 10 miles (8 to 16 km). This is particularly important when outside temperatures are below freezing.
- Most trips include extensive idling (such as frequent driving in stop-and-go traffic).
- You operate your vehicle in dusty areas or off-road frequently.
- You frequently tow a trailer or use a carrier on top of your vehicle.
- If the vehicle is used for delivery service, police, taxi or other commercial application.

One of the reasons you should follow this schedule if you operate your vehicle under any of these conditions is that these conditions cause engine oil to break down sooner.

Short Trip/City Intervals

Every 3,000 Miles (5 000 km): Engine Oil and Filter Change (or 3 months, whichever occurs first). Chassis Lubrication (or 3 months, whichever occurs first). Drive Axle Service (or 3 months, whichever occurs first).

Short Trip/City Intervals

Every 6,000 Miles (10 000 km): Tire Rotation.

Every 15,000 Miles (25 000 km): Air Cleaner Filter Inspection, if driving in dusty conditions. Front Wheel Bearing Repack (2WD only) (or at each brake relining, whichever occurs first).

Every 30,000 Miles (50 000 km): Air Cleaner Filter Replacement. Fuel Filter Replacement.

Every 50,000 Miles (83 000 km): Automatic Transmission Service (severe conditions only).

Every 60,000 Miles (100 000 km): Engine Accessory Drive Belt Inspection. Fuel Tank, Cap and Lines Inspection.

Every 100,000 Miles (166 000 km): Spark Plug Wire Inspection. Spark Plug Replacement. Positive Crankcase Ventilation (PCV) Valve Inspection.

Every 150,000 Miles (240 000 km): Cooling System Service (or every 60 months, whichever occurs first).

These intervals only summarize maintenance services. Be sure to follow the complete maintenance schedule on the following pages.

Maintenance Schedule

Long Trip/Highway Definition

Follow this maintenance schedule *only* if none of the conditions from the Short Trip/City Maintenance Schedule is true. Do not use this schedule if the vehicle is used for trailer towing, driven in a dusty area or used off paved roads. Use the Short Trip/City schedule for these conditions.

Driving a vehicle with a fully warmed engine under highway conditions causes engine oil to break down slower.

Long Trip/Highway Intervals

Every 7,500 Miles (12 500 km): Engine Oil and Filter Change (or every 12 months, whichever occurs first). Chassis Lubrication (or every 12 months, whichever occurs first). Drive Axle Service. Tire Rotation.

Every 30,000 Miles (50 000 km): Fuel Filter Replacement. Air Cleaner Filter Replacement. Front Wheel Bearing Repack (2WD only) (or at each brake relining, whichever occurs first).

Every 50,000 Miles (83 000 km): Automatic Transmission Service (severe conditions only).

Every 60,000 Miles (100 000 km): Engine Accessory Drive Belt Inspection. Fuel Tank, Cap and Lines Inspection.

Every 100,000 Miles (166 000 km): Spark Plug Wire Inspection. Spark Plug Replacement. Positive Crankcase Ventilation (PCV) Valve Inspection.

Every 150,000 Miles (240 000 km): Cooling System Service (or every 60 months, whichever occurs first).

These intervals only summarize maintenance services. Be sure to follow the complete maintenance schedule on the following pages.

Short Trip/City Maintenance Schedule

The services shown in this schedule up to 100,000 miles (166 000 km) should be performed after 100,000 miles (166 000 km) at the same intervals. The services shown at 150,000 miles (240 000 km) should be performed at the same interval after 150,000 miles (240 000 km).

See "Owner Checks and Services" and "Periodic Maintenance Inspections" following.

Footnotes

† The U.S. Environmental Protection Agency or the California Air Resources Board has determined that the failure to perform this maintenance item will not nullify the emission warranty or limit recall liability prior to the completion of the vehicle's useful life. We, however, urge that all recommended maintenance services be performed at the indicated intervals and the maintenance be recorded.

Lubricate the front suspension, ball joints, steering linkage and transfer case shift linkage, parking brake cable guides, propshaft splines, universal joints and brake pedal springs.

+ A good time to check your brakes is during tire rotation. See "Brake System Inspection" under "Periodic Maintenance Inspection" in Part C of this schedule.

** Drive axle service (see "Recommended Fluids and Lubricants" in the Index for proper lubricant to use):

- Locking Differential -- Drain fluid and refill at first engine oil change. At subsequent oil changes, check fluid level and add fluid as needed. If driving in dusty areas or towing a trailer, drain fluid and refill every 15,000 miles (25 000 km).
- Standard Differential -- Check fluid level and add fluid as needed at every oil change. If driving in dusty areas or towing a trailer, drain fluid and refill every 15,000 miles (25 000 km).
- More frequent lubrication may be required for heavy-duty or off-road use.

Short Trip/City Maintenance Schedule

3,000 Miles (5 000 km)

- Change engine oil and filter (or every 3 months, whichever occurs first).
An Emission Control Service.
- Lubricate chassis components (or every 3 months, whichever occurs first).
(See footnote #.)
- Check rear/front axle fluid level and add fluid as needed. Check constant velocity joints and axle seals for leaking.
(See footnote **.)

DATE	ACTUAL MILEAGE	SERVICED BY:

6,000 Miles (10 000 km)

- Change engine oil and filter (or every 3 months, whichever occurs first).
An Emission Control Service.
- Lubricate chassis components (or every 3 months, whichever occurs first).
(See footnote #.)
- Check rear/front axle fluid level and add fluid as needed. Check constant velocity joints and axle seals for leaking. (See footnote **.)
- Rotate tires. See "Tire Inspection and Rotation" in the Index for proper rotation pattern and additional information.
(See footnote +.)

DATE	ACTUAL MILEAGE	SERVICED BY:

Short Trip/City Maintenance Schedule

9,000 Miles (15 000 km)

- Change engine oil and filter (or every 3 months, whichever occurs first).
An Emission Control Service.
- Lubricate chassis components (or every 3 months, whichever occurs first).
(See footnote #.)
- Check rear/front axle fluid level and add fluid as needed. Check constant velocity joints and axle seals for leaking.
(See footnote **.)

DATE	ACTUAL MILEAGE	SERVICED BY:

12,000 Miles (20 000 km)

- Change engine oil and filter (or every 3 months, whichever occurs first).
An Emission Control Service.
- Lubricate chassis components (or every 3 months, whichever occurs first).
(See footnote #.)
- Check rear/front axle fluid level and add fluid as needed. Check constant velocity joints and axle seals for leaking.
(See footnote **.)
- Rotate tires. See "Tire Inspection and Rotation" in the Index for proper rotation pattern and additional information.
(See footnote +.)

DATE	ACTUAL MILEAGE	SERVICED BY:

Short Trip/City Maintenance Schedule

15,000 Miles (25 000 km)

- Change engine oil and filter (or every 3 months, whichever occurs first).
An Emission Control Service.
- Lubricate chassis components (or every 3 months, whichever occurs first).
(See footnote #.)
- Inspect air cleaner filter if you are driving in dusty conditions. Replace filter if necessary.
An Emission Control Service. (See footnote †.)

- Check rear/front axle fluid level and add fluid as needed. Check constant velocity joints and axle seals for leaking.
(See footnote **.)
- For Two-Wheel-Drive vehicles only: Clean and repack the front wheel bearings (or at each brake relining, whichever occurs first).

DATE	ACTUAL MILEAGE	SERVICED BY:

Short Trip/City Maintenance Schedule

18,000 Miles (30 000 km)

- Change engine oil and filter (or every 3 months, whichever occurs first).
An Emission Control Service.
- Lubricate chassis components (or every 3 months, whichever occurs first).
(See footnote #.)
- Check rear/front axle fluid level and add fluid as needed. Check constant velocity joints and axle seals for leaking.
(See footnote **.)
- Rotate tires. See "Tire Inspection and Rotation" in the Index for proper rotation pattern and additional information.
(See footnote +.)

DATE	ACTUAL MILEAGE	SERVICED BY:

21,000 Miles (35 000 km)

- Change engine oil and filter (or every 3 months, whichever occurs first).
An Emission Control Service.
- Lubricate chassis components (or every 3 months, whichever occurs first).
(See footnote #.)
- Check rear/front axle fluid level and add fluid as needed. Check constant velocity joints and axle seals for leaking.
(See footnote **.)

DATE	ACTUAL MILEAGE	SERVICED BY:

Short Trip/City Maintenance Schedule

24,000 Miles (40 000 km)

- Change engine oil and filter (or every 3 months, whichever occurs first).
An Emission Control Service.
- Lubricate chassis components (or every 3 months, whichever occurs first).
(See footnote #.)
- Check rear/front axle fluid level and add fluid as needed. Check constant velocity joints and axle seals for leaking.
(See footnote **.)
- Rotate tires. See "Tire Inspection and Rotation" in the Index for proper rotation pattern and additional information.
(See footnote +.)

DATE	ACTUAL MILEAGE	SERVICED BY:

27,000 Miles (45 000 km)

- Change engine oil and filter (or every 3 months, whichever occurs first).
An Emission Control Service.
- Lubricate chassis components (or every 3 months, whichever occurs first).
(See footnote #.)
- Check rear/front axle fluid level and add fluid as needed. Check constant velocity joints and axle seals for leaking.
(See footnote **.)

DATE	ACTUAL MILEAGE	SERVICED BY:

Short Trip/City Maintenance Schedule

30,000 Miles (50 000 km)

- Change engine oil and filter (or every 3 months, whichever occurs first).
An Emission Control Service.
- Lubricate chassis components (or every 3 months, whichever occurs first).
(See footnote #.)
- Check rear/front axle fluid level and add fluid as needed. Check constant velocity joints and axle seals for leaking.
(See footnote **.)
- For Two-Wheel-Drive vehicles only: Clean and repack the front wheel bearings (or at each brake relining, whichever occurs first).

- Replace fuel filter. *An Emission Control Service.*
(See footnote †.)
- Replace air cleaner filter.
An Emission Control Service.
- Rotate tires. See "Tire Inspection and Rotation" in the Index for proper rotation pattern and additional information.
(See footnote +.)

DATE	ACTUAL MILEAGE	SERVICED BY:

Short Trip/City Maintenance Schedule

33,000 Miles (55 000 km)

- Change engine oil and filter (or every 3 months, whichever occurs first).
An Emission Control Service.
- Lubricate chassis components (or every 3 months, whichever occurs first).
(See footnote #.)
- Check rear/front axle fluid level and add fluid as needed. Check constant velocity joints and axle seals for leaking.
(See footnote **.)

DATE	ACTUAL MILEAGE	SERVICED BY:

36,000 Miles (60 000 km)

- Change engine oil and filter (or every 3 months, whichever occurs first).
An Emission Control Service.
- Lubricate chassis components (or every 3 months, whichever occurs first).
(See footnote #.)
- Rotate tires. See "Tire Inspection and Rotation" in the Index for proper rotation pattern and additional information.
(See footnote +.)
- Check rear/front axle fluid level and add fluid as needed. Check constant velocity joints and axle seals for leaking.
(See footnote **.)

DATE	ACTUAL MILEAGE	SERVICED BY:

Short Trip/City Maintenance Schedule

39,000 Miles (65 000 km)

- Change engine oil and filter (or every 3 months, whichever occurs first).
An Emission Control Service.
- Lubricate chassis components (or every 3 months, whichever occurs first).
(See footnote #.)
- Check rear/front axle fluid level and add fluid as needed. Check constant velocity joints and axle seals for leaking.
(See footnote **.)

DATE	ACTUAL MILEAGE	SERVICED BY:

42,000 Miles (70 000 km)

- Change engine oil and filter (or every 3 months, whichever occurs first).
An Emission Control Service.
- Lubricate chassis components (or every 3 months, whichever occurs first).
(See footnote #.)
- Check rear/front axle fluid level and add fluid as needed. Check constant velocity joints and axle seals for leaking.
(See footnote **.)
- Rotate tires. See "Tire Inspection and Rotation" in the Index for proper rotation pattern and additional information.
(See footnote +.)

DATE	ACTUAL MILEAGE	SERVICED BY:

Short Trip/City Maintenance Schedule

45,000 Miles (75 000 km)

- Change engine oil and filter (or every 3 months, whichever occurs first).
An Emission Control Service.
- Lubricate chassis components (or every 3 months, whichever occurs first).
(See footnote #.)
- Check rear/front axle fluid level and add fluid as needed. Check constant velocity joints and axle seals for leaking.
(See footnote **.)

- For Two-Wheel-Drive vehicles only: Clean and repack the front wheel bearings (or at each brake relining, whichever occurs first).
- Inspect air cleaner filter if you are driving in dusty conditions. Replace filter if necessary.
An Emission Control Service. (See footnote †.)

DATE	ACTUAL MILEAGE	SERVICED BY:

Short Trip/City Maintenance Schedule

48,000 Miles (80 000 km)

- Change engine oil and filter (or every 3 months, whichever occurs first).
An Emission Control Service.
- Lubricate chassis components (or every 3 months, whichever occurs first).
(See footnote #.)
- Check rear/front axle fluid level and add fluid as needed. Check constant velocity joints and axle seals for leaking.
(See footnote **.)
- Rotate tires. See "Tire Inspection and Rotation" in the Index for proper rotation pattern and additional information.
(See footnote +.)

DATE	ACTUAL MILEAGE	SERVICED BY:

50,000 Miles (83 000 km)

- Change automatic transmission fluid and filter if the vehicle is mainly driven under one or more of these conditions:
 - In heavy city traffic where the outside temperature regularly reaches 90°F (32°C) or higher.
 - In hilly or mountainous terrain.
 - When doing frequent trailer towing.
 - Uses such as found in taxi, police or delivery service.

(Continued)

Short Trip/City Maintenance Schedule

50,000 Miles (83 000 km) (Continued)

If you do not use your vehicle under any of these conditions, the fluid and filter do not require changing.

Manual transmission fluid doesn't require change.

DATE	ACTUAL MILEAGE	SERVICED BY:

51,000 Miles (85 000 km)

- Change engine oil and filter (or every 3 months, whichever occurs first).
An Emission Control Service.
- Lubricate chassis components (or every 3 months, whichever occurs first).
(See footnote #.)
- Check rear/front axle fluid level and add fluid as needed. Check constant velocity joints and axle seals for leaking.
(See footnote **.)

DATE	ACTUAL MILEAGE	SERVICED BY:

Short Trip/City Maintenance Schedule

54,000 Miles (90 000 km)

- Change engine oil and filter (or every 3 months, whichever occurs first).
An Emission Control Service.
- Lubricate chassis components (or every 3 months, whichever occurs first).
(See footnote #.)
- Check rear/front axle fluid level and add fluid as needed. Check constant velocity joints and axle seals for leaking.
(See footnote **.)
- Rotate tires. See "Tire Inspection and Rotation" in the Index for proper rotation pattern and additional information.
(See footnote +.)

DATE	ACTUAL MILEAGE	SERVICED BY:

57,000 Miles (95 000 km)

- Change engine oil and filter (or every 3 months, whichever occurs first).
An Emission Control Service.
- Lubricate chassis components (or every 3 months, whichever occurs first).
(See footnote #.)
- Check rear/front axle fluid level and add fluid as needed. Check constant velocity joints and axle seals for leaking.
(See footnote **.)

DATE	ACTUAL MILEAGE	SERVICED BY:

Short Trip/City Maintenance Schedule

60,000 Miles (100 000 km)

- Change engine oil and filter (or every 3 months, whichever occurs first).
An Emission Control Service.
- Lubricate chassis components (or every 3 months, whichever occurs first).
(See footnote #.)
- Check rear/front axle fluid level and add fluid as needed. Check constant velocity joints and axle seals for leaking.
(See footnote **.)
- For Two-Wheel-Drive vehicles only: Clean and repack the front wheel bearings (or at each brake relining, whichever occurs first).
- Inspect engine accessory drive belt.
- Replace fuel filter. *An Emission Control Service.*
(See footnote †.)

- Replace air cleaner filter.
An Emission Control Service.
- Inspect fuel tank, cap and lines for damage or leaks. Inspect fuel cap gasket for any damage. Replace parts as needed.
An Emission Control Service. (See footnote †.)
- Rotate tires. See "Tire Inspection and Rotation" in the Index for proper rotation pattern and additional information.
(See footnote +.)

DATE	ACTUAL MILEAGE	SERVICED BY:

Short Trip/City Maintenance Schedule

63,000 Miles (105 000 km)

- Change engine oil and filter (or every 3 months, whichever occurs first).
An Emission Control Service.
- Lubricate chassis components (or every 3 months, whichever occurs first).
(See footnote #.)
- Check rear/front axle fluid level and add fluid as needed. Check constant velocity joints and axle seals for leaking.
(See footnote **.)

DATE	ACTUAL MILEAGE	SERVICED BY:

66,000 Miles (110 000 km)

- Change engine oil and filter (or every 3 months, whichever occurs first).
An Emission Control Service.
- Lubricate chassis components (or every 3 months, whichever occurs first).
(See footnote #.)
- Check rear/front axle fluid level and add fluid as needed. Check constant velocity joints and axle seals for leaking.
(See footnote **.)
- Rotate tires. See "Tire Inspection and Rotation" in the Index for proper rotation pattern and additional information.
(See footnote +.)

DATE	ACTUAL MILEAGE	SERVICED BY:

Short Trip/City Maintenance Schedule

69,000 Miles (115 000 km)

- Change engine oil and filter (or every 3 months, whichever occurs first).
An Emission Control Service.
- Lubricate chassis components (or every 3 months, whichever occurs first).
(See footnote #.)
- Check rear/front axle fluid level and add fluid as needed. Check constant velocity joints and axle seals for leaking.
(See footnote **.)

DATE	ACTUAL MILEAGE	SERVICED BY:

72,000 Miles (120 000 km)

- Change engine oil and filter (or every 3 months, whichever occurs first).
An Emission Control Service.
- Lubricate chassis components (or every 3 months, whichever occurs first).
(See footnote #.)
- Check rear/front axle fluid level and add fluid as needed. Check constant velocity joints and axle seals for leaking.
(See footnote **.)
- Rotate tires. See "Tire Inspection and Rotation" in the Index for proper rotation pattern and additional information.
(See footnote +.)

DATE	ACTUAL MILEAGE	SERVICED BY:

Short Trip/City Maintenance Schedule

75,000 Miles (125 000 km)

- Change engine oil and filter (or every 3 months, whichever occurs first).
An Emission Control Service.
- Lubricate chassis components (or every 3 months, whichever occurs first).
(See footnote #.)
- For Two-Wheel-Drive vehicles only: Clean and repack the front wheel bearings (or at each brake relining, whichever occurs first).
- Inspect air cleaner filter if you are driving in dusty conditions. Replace filter if necessary.
An Emission Control Service. (See footnote†.)
- Check rear/front axle fluid level and add fluid as needed. Check constant velocity joints and axle seals for leaking.
(See footnote **.)

DATE	ACTUAL MILEAGE	SERVICED BY:

Short Trip/City Maintenance Schedule

78,000 Miles (130 000 km)

- Change engine oil and filter (or every 3 months, whichever occurs first).
An Emission Control Service.
- Lubricate chassis components (or every 3 months, whichever occurs first).
(See footnote #.)
- Check rear/front axle fluid level and add fluid as needed. Check constant velocity joints and axle seals for leaking.
(See footnote **.)
- Rotate tires. See "Tire Inspection and Rotation" in the Index for proper rotation pattern and additional information.
(See footnote +.)

DATE	ACTUAL MILEAGE	SERVICED BY:

81,000 Miles (135 000 km)

- Change engine oil and filter (or every 3 months, whichever occurs first).
An Emission Control Service.
- Lubricate chassis components (or every 3 months, whichever occurs first).
(See footnote #.)
- Check rear/front axle fluid level and add fluid as needed. Check constant velocity joints and axle seals for leaking.
(See footnote **.)

DATE	ACTUAL MILEAGE	SERVICED BY:

Short Trip/City Maintenance Schedule

84,000 Miles (140 000 km)

- Change engine oil and filter (or every 3 months, whichever occurs first).
An Emission Control Service.
- Lubricate chassis components (or every 3 months, whichever occurs first).
(See footnote #.)
- Check rear/front axle fluid level and add fluid as needed. Check constant velocity joints and axle seals for leaking.
(See footnote **.)
- Rotate tires. See "Tire Inspection and Rotation" in the Index for proper rotation pattern and additional information.
(See footnote +.)

DATE	ACTUAL MILEAGE	SERVICED BY:

87,000 Miles (145 000 km)

- Change engine oil and filter (or every 3 months, whichever occurs first).
An Emission Control Service.
- Lubricate chassis components (or every 3 months, whichever occurs first).
(See footnote #.)
- Check rear/front axle fluid level and add fluid as needed. Check constant velocity joints and axle seals for leaking.
(See footnote **.)

DATE	ACTUAL MILEAGE	SERVICED BY:

Short Trip/City Maintenance Schedule

90,000 Miles (150 000 km)

- Change engine oil and filter (or every 3 months, whichever occurs first).
An Emission Control Service.
- Lubricate chassis components (or every 3 months, whichever occurs first).
(See footnote #.)
- Check rear/front axle fluid level and add fluid as needed. Check constant velocity joints and axle seals for leaking.
(See footnote **.)
- For Two-Wheel-Drive vehicles only: Clean and repack the front wheel bearings (or at each brake relining, whichever occurs first).

- Replace fuel filter.
An Emission Control Service. (See footnote †.)
- Replace air cleaner filter.
An Emission Control Service.
- Rotate tires. See "Tire Inspection and Rotation" in the Index for proper rotation pattern and additional information.
(See footnote +.)

DATE	ACTUAL MILEAGE	SERVICED BY:

Short Trip/City Maintenance Schedule

93,000 Miles (155 000 km)

- Change engine oil and filter (or every 3 months, whichever occurs first).
An Emission Control Service.
- Lubricate chassis components (or every 3 months, whichever occurs first).
(See footnote #.)
- Check rear/front axle fluid level and add fluid as needed. Check constant velocity joints and axle seals for leaking.
(See footnote **.)

DATE	ACTUAL MILEAGE	SERVICED BY:

96,000 Miles (160 000 km)

- Change engine oil and filter (or every 3 months, whichever occurs first).
An Emission Control Service.
- Lubricate chassis components (or every 3 months, whichever occurs first).
(See footnote #.)
- Check rear/front axle fluid level and add fluid as needed. Check constant velocity joints and axle seals for leaking.
(See footnote **.)
- Rotate tires. See "Tire Inspection and Rotation" in the Index for proper rotation pattern and additional information.
(See footnote +.)

DATE	ACTUAL MILEAGE	SERVICED BY:

Short Trip/City Maintenance Schedule

99,000 Miles (165 000 km)

- Change engine oil and filter (or every 3 months, whichever occurs first).
An Emission Control Service.
- Lubricate chassis components (or every 3 months, whichever occurs first).
(See footnote #.)
- Check rear/front axle fluid level and add fluid as needed. Check constant velocity joints and axle seals for leaking.
(See footnote **.)

100,000 Miles (166 000 km)

- Inspect spark plug wires.
An Emission Control Service.
- Replace spark plugs.
An Emission Control Service.
- Change automatic transmission fluid and filter if the vehicle is mainly driven under one or more of these conditions:
 - In heavy city traffic where the outside temperature regularly reaches 90°F (32°C) or higher.
 - In hilly or mountainous terrain.

DATE	ACTUAL MILEAGE	SERVICED BY:

Short Trip/City Maintenance Schedule

- When doing frequent trailer towing.
- Uses such as found in taxi, police or delivery service.

If you do not use your vehicle under any of these conditions, the fluid and filter do not require changing.

Manual transmission fluid doesn't require change.

- Inspect Positive Crankcase Ventilation (PCV) valve. *An Emission Control Service.*

DATE	ACTUAL MILEAGE	SERVICED BY:

150,000 Miles (240 000 km)

- Drain, flush and refill cooling system (or every 60 months since last service, whichever occurs first). See "Engine Coolant" in the Index for what to use. Inspect hoses. Clean radiator, condenser, pressure cap and neck. Pressure test cooling system and pressure cap.
An Emission Control Service.

DATE	ACTUAL MILEAGE	SERVICED BY:

Long Trip/Highway Maintenance Schedule

The services shown in this schedule up to 100,000 miles (166 000 km) should be performed after 100,000 miles (166 000 km) at the same intervals. The services shown at 150,000 miles (240 000 km) should be performed at the same interval after 150,000 miles (240 000 km).

See "Owner Checks and Services" and "Periodic Maintenance Inspections" following.

Footnotes

† The U.S. Environmental Protection Agency or the California Air Resources Board has determined that the failure to perform this maintenance item will not nullify the emission warranty or limit recall liability prior to the completion of the vehicle's useful life. We, however, urge that all recommended maintenance services be performed at the indicated intervals and the maintenance be recorded.

Lubricate the front suspension, ball joints, steering linkage and transfer case shift linkage, parking brake cable guides, propshaft splines, universal joints and brake pedal springs.

+ A good time to check your brakes is during tire rotation. See "Brake System Inspection" under "Periodic Maintenance Inspections" in Part C of this schedule.

** Drive axle service (see "Recommended Fluids and Lubricants" in the Index for proper lubricant to use):

- Locking Differential -- Drain fluid and refill at first engine oil change. At subsequent oil changes, check fluid level and add fluid as needed.
- Standard Differential -- Check fluid level and add fluid as needed at every engine oil change.
- More frequent lubrication may be required for heavy-duty or off-road use.

Long Trip/Highway Maintenance Schedule

7,500 Miles (12 500 km)

- Change engine oil and filter (or every 12 months, whichever occurs first).
An Emission Control Service.
- Lubricate chassis components (or every 12 months, whichever occurs first).
(See footnote #.)
- Check rear/front axle fluid level and add fluid as needed. Check constant velocity joints and axle seals for leaking.
(See footnote **.)
- Rotate tires. See "Tire Inspection and Rotation" in the Index for proper rotation pattern and additional information.
(See footnote +.)

DATE	ACTUAL MILEAGE	SERVICED BY:

Long Trip/Highway Maintenance Schedule

15,000 Miles (25 000 km)

- Change engine oil and filter (or every 12 months, whichever occurs first).
An Emission Control Service.
- Lubricate chassis components (or every 12 months, whichever occurs first).
(See footnote #.)
- Check rear/front axle fluid level and add fluid as needed. Check constant velocity joints and axle seals for leaking.
(See footnote **.)
- Rotate tires. See "Tire Inspection and Rotation" in the Index for proper rotation pattern and additional information.
(See footnote +.)

DATE	ACTUAL MILEAGE	SERVICED BY:

Long Trip/Highway Maintenance Schedule

22,500 Miles (37 500 km)

- Change engine oil and filter (or every 12 months, whichever occurs first).
An Emission Control Service.
- Lubricate chassis components (or every 12 months, whichever occurs first).
(See footnote #.)
- Check rear/front axle fluid level and add fluid as needed. Check constant velocity joints and axle seals for leaking.
(See footnote **.)

- Rotate tires. See "Tire Inspection and Rotation" in the Index for proper rotation pattern and additional information.
(See footnote +.)

DATE	ACTUAL MILEAGE	SERVICED BY:

Long Trip/Highway Maintenance Schedule

30,000 Miles (50 000 km)

- Change engine oil and filter (or every 12 months, whichever occurs first).
An Emission Control Service.
- Lubricate chassis components (or every 12 months, whichever occurs first).
(See footnote #.)
- Check rear/front axle fluid level and add fluid as needed. Check constant velocity joints and axle seals for leaking.
(See footnote **.)
- For Two-Wheel-Drive vehicles only: Clean and repack the front wheel bearings (or at each brake relining, whichever occurs first).
- Rotate tires. See "Tire Inspection and Rotation" in the Index for proper rotation pattern and additional information.
(See footnote +.)
- Replace fuel filter.
An Emission Control Service. (See footnote †.)
- Replace air cleaner filter.
An Emission Control Service.

DATE	ACTUAL MILEAGE	SERVICED BY:

Long Trip/Highway Maintenance Schedule

37,500 Miles (62 500 km)

- Change engine oil and filter (or every 12 months, whichever occurs first).
An Emission Control Service.
- Lubricate chassis components (or every 12 months, whichever occurs first).
(See footnote #.)
- Check rear/front axle fluid level and add fluid as needed. Check constant velocity joints and axle seals for leaking.
(See footnote **.)
- Rotate tires. See "Tire Inspection and Rotation" in the Index for proper rotation pattern and additional information.
(See footnote +.)

DATE	ACTUAL MILEAGE	SERVICED BY:

Long Trip/Highway Maintenance Schedule

45,000 Miles (75 000 km)

- Change engine oil and filter (or every 12 months, whichever occurs first).
An Emission Control Service.
- Lubricate chassis components (or every 12 months, whichever occurs first).
(See footnote #.)
- Check rear/front axle fluid level and add fluid as needed. Check constant velocity joints and axle seals for leaking.
(See footnote **.)
- Rotate tires. See "Tire Inspection and Rotation" in the Index for proper rotation pattern and additional information.
(See footnote +.)

DATE	ACTUAL MILEAGE	SERVICED BY:

Long Trip/Highway Maintenance Schedule

50,000 Miles (83 000 km)

- Change automatic transmission fluid and filter if the vehicle is mainly driven under one or more of these conditions:
- In heavy city traffic where the outside temperature regularly reaches 90°F (32°C) or higher.
 - In hilly or mountainous terrain.
 - When doing frequent trailer towing.
 - Uses such as found in taxi, police or delivery service.

If you do not use your vehicle under any of these conditions, the fluid and filter do not require changing.

Manual transmission fluid doesn't require change.

DATE	ACTUAL MILEAGE	SERVICED BY:

Long Trip/Highway Maintenance Schedule

52,500 Miles (87 500 km)

- Change engine oil and filter (or every 12 months, whichever occurs first).
An Emission Control Service.
- Lubricate chassis components (or every 12 months, whichever occurs first).
(See footnote #.)
- Check rear/front axle fluid level and add fluid as needed. Check constant velocity joints and axle seals for leaking.
(See footnote **.)
- Rotate tires. See "Tire Inspection and Rotation" in the Index for proper rotation pattern and additional information.
(See footnote +.)

DATE	ACTUAL MILEAGE	SERVICED BY:

Long Trip/Highway Maintenance Schedule

60,000 Miles (100 000 km)

- Change engine oil and filter (or every 12 months, whichever occurs first).
An Emission Control Service.
- Lubricate chassis components (or every 12 months, whichever occurs first).
(See footnote #.)
- Check rear/front axle fluid level and add fluid as needed. Check constant velocity joints and axle seals for leaking.
(See footnote **.)
- For Two-Wheel-Drive vehicles only: Clean and repack the front wheel bearings (or at each brake relining, whichever occurs first).
- Rotate tires. See "Tire Inspection and Rotation" in the Index for proper rotation pattern and additional information.
(See footnote +.)
- Inspect engine accessory drive belt.

- Replace fuel filter.
An Emission Control Service. (See footnote †.)
- Replace air cleaner filter.
An Emission Control Service.
- Inspect fuel tank, cap and lines for damage or leaks. Inspect fuel cap gasket for any damage. Replace parts as needed.
An Emission Control Service. (See footnote †.)

DATE	ACTUAL MILEAGE	SERVICED BY:

Long Trip/Highway Maintenance Schedule

67,500 Miles (112 500 km)

- Change engine oil and filter (or every 12 months, whichever occurs first).
An Emission Control Service.
- Lubricate chassis components (or every 12 months, whichever occurs first).
(See footnote #.)
- Check rear/front axle fluid level and add fluid as needed. Check constant velocity joints and axle seals for leaking.
(See footnote **.)
- Rotate tires. See "Tire Inspection and Rotation" in the Index for proper rotation pattern and additional information.
(See footnote +.)

DATE	ACTUAL MILEAGE	SERVICED BY:

Long Trip/Highway Maintenance Schedule

75,000 Miles (125 000 km)

- Change engine oil and filter (or every 12 months, whichever occurs first).
An Emission Control Service.
- Lubricate chassis components (or every 12 months, whichever occurs first).
(See footnote #.)
- Check rear/front axle fluid level and add fluid as needed. Check constant velocity joints and axle seals for leaking.
(See footnote **.)

- Rotate tires. See "Tire Inspection and Rotation" in the Index for proper rotation pattern and additional information.
(See footnote +.)

DATE	ACTUAL MILEAGE	SERVICED BY:

Long Trip/Highway Maintenance Schedule

82,500 Miles (137 500 km)

- Change engine oil and filter (or every 12 months, whichever occurs first).
An Emission Control Service.
- Lubricate chassis components (or every 12 months, whichever occurs first).
(See footnote #.)
- Check rear/front axle fluid level and add fluid as needed. Check constant velocity joints and axle seals for leaking.
(See footnote **.)
- Rotate tires. See "Tire Inspection and Rotation" in the Index for proper rotation pattern and additional information.
(See footnote +.)

DATE	ACTUAL MILEAGE	SERVICED BY:

Long Trip/Highway Maintenance Schedule

90,000 Miles (150 000 km)

- Change engine oil and filter (or every 12 months, whichever occurs first).
An Emission Control Service.
- Lubricate chassis components (or every 12 months, whichever occurs first).
(See footnote #.)
- Check rear/front axle fluid level and add fluid as needed. Check constant velocity joints and axle seals for leaking.
(See footnote **.)
- For Two-Wheel-Drive vehicles only: Clean and repack the front wheel bearings (or at each brake relining, whichever occurs first).

- Replace fuel filter.
An Emission Control Service. (See footnote †.)
- Replace air cleaner filter.
An Emission Control Service.
- Rotate tires. See "Tire Inspection and Rotation" in the Index for proper rotation pattern and additional information.
(See footnote +.)

DATE	ACTUAL MILEAGE	SERVICED BY:

Long Trip/Highway Maintenance Schedule

97,500 Miles (162 500 km)

- Change engine oil and filter (or every 12 months, whichever occurs first).
An Emission Control Service.
- Lubricate chassis components (or every 12 months, whichever occurs first).
(See footnote #.)
- Check rear/front axle fluid level and add fluid as needed. Check constant velocity joints and axle seals for leaking.
(See footnote **.)
- Rotate tires. See "Tire Inspection and Rotation" in the Index for proper rotation pattern and additional information.
(See footnote +.)

DATE	ACTUAL MILEAGE	SERVICED BY:

100,000 Miles (166 000 km)

- Inspect spark plug wires.
An Emission Control Service.
- Replace spark plugs.
An Emission Control Service.
- Change automatic transmission fluid and filter if the vehicle is mainly driven under one or more of these conditions:
 - In heavy city traffic where the outside temperature regularly reaches 90°F (32°C) or higher.
 - In hilly or mountainous terrain.
 - When doing frequent trailer towing.
 - Uses such as found in taxi, police or delivery service.

Long Trip/Highway Maintenance Schedule

If you do not use your vehicle under any of these conditions, the fluid and filter do not require changing.

Manual transmission fluid doesn't require change.

- Inspect Positive Crankcase Ventilation (PCV) valve.

An Emission Control Service.

DATE	ACTUAL MILEAGE	SERVICED BY:

150,000 Miles (240 000 km)

- Drain, flush and refill cooling system (or every 60 months since last service, whichever occurs first). See "Engine Coolant" in the Index for what to use. Inspect hoses. Clean radiator, condenser, pressure cap and neck. Pressure test the cooling system and pressure cap.

An Emission Control Service.

DATE	ACTUAL MILEAGE	SERVICED BY:

Part B: Owner Checks and Services

Listed below are owner checks and services which should be performed at the intervals specified to help ensure the safety, dependability and emission control performance of your vehicle.

Be sure any necessary repairs are completed at once. Whenever any fluids or lubricants are added to your vehicle, make sure they are the proper ones, as shown in Part D.

At Each Fuel Fill

It is important for you or a service station attendant to perform these underhood checks at each fuel fill.

Engine Oil Level Check

Check the engine oil level and add the proper oil if necessary. See "Engine Oil" in the Index for further details.

Engine Coolant Level Check

Check the engine coolant level and add DEX-COOL[®] coolant mix if necessary. See "Engine Coolant" in the Index for further details.

Windshield Washer Fluid Level Check

Check the windshield washer fluid level in the windshield washer tank and add the proper fluid if necessary. See "Windshield Washer Fluid" in the Index for further details.

At Least Once a Month

Tire Inflation Check

Make sure tires are inflated to the correct pressures. See "Tires" in the Index for further details.

Cassette Deck Service

Clean cassette deck. Cleaning should be done every 50 hours of tape play. See "Audio Systems" in the Index for further details.

At Least Twice a Year

Restraint System Check

Make sure the safety belt reminder light and all your belts, buckles, latch plates, retractors and anchorages are working properly. Look for any other loose or damaged safety belt system parts. If you see anything that might keep a safety belt system from doing its job, have it repaired. Have any torn or frayed safety belts replaced.

Also look for any opened or broken air bag covers, and have them repaired or replaced. (The air bag system does not need regular maintenance.)

Wiper Blade Check

Inspect wiper blades for wear or cracking. Replace blade inserts that appear worn or damaged or that streak or miss areas of the windshield. Also see "Wiper Blades, Cleaning" in the Index.

Manual Transmission Check

Check the transmission fluid level; add if needed. See "Manual Transmission" in the Index. Check for leaks. A fluid loss may indicate a problem. Have the system inspected and repaired if needed.

Automatic Transmission Check

Check the transmission fluid level; add if needed. See "Automatic Transmission" in the Index. A fluid loss may indicate a problem. Check the system and repair if needed.

Hydraulic Clutch System Check

Check the fluid level in the clutch reservoir. See "Hydraulic Clutch Fluid" in the Index. A fluid loss in this system could indicate a problem. Have the system inspected and repaired at once.

At Least Once a Year

Key Lock Cylinders Service

Lubricate the key lock cylinders with the lubricant specified in Part D.

Body Lubrication Service

Lubricate all body door and fuel door hinges, rear compartment hinges, latches and locks including the glove box, console doors and the body hood and any moving seat hardware. Lubricate the hood safety lever pivot and prop rod pivot. Part D tells you what to use. More frequent lubrication may be required when exposed to a corrosive environment.

Starter Switch Check

CAUTION:

When you are doing this check, the vehicle could move suddenly. If it does, you or others could be injured. Follow the steps below.

1. Before you start, be sure you have enough room around the vehicle.
2. Firmly apply both the parking brake (see "Parking Brake" in the Index if necessary) and the regular brake.

NOTE: Do not use the accelerator pedal, and be ready to turn off the engine immediately if it starts.

3. On automatic transmission vehicles, try to start the engine in each gear. The starter should work only in PARK (P) or NEUTRAL (N). If the starter works in any other position, your vehicle needs service.

On manual transmission vehicles, put the shift lever in NEUTRAL (N), push the clutch down halfway and try to start the engine. The starter should work only when the clutch is pushed down all the way to the floor. If the starter works when the clutch isn't pushed all the way down, your vehicle needs service.

Brake-Transmission Shift Interlock (BTSI) Check (Automatic Transmission)

CAUTION:

When you are doing this check, the vehicle could move suddenly. If it does, you or others could be injured. Follow the steps below.

1. Before you start, be sure you have enough room around the vehicle. It should be parked on a level surface.
2. Firmly apply the parking brake (see "Parking Brake" in the Index if necessary).

NOTE: Be ready to apply the regular brake immediately if the vehicle begins to move.

3. With the engine off, turn the key to the RUN position, but don't start the engine. Without applying the regular brake, try to move the shift lever out of PARK (P) with normal effort. If the shift lever moves out of PARK (P), your vehicle's BTSI needs service.

Ignition Transmission Lock Check

While parked, and with the parking brake set, try to turn the ignition key to LOCK in each shift lever position.

- With an automatic transmission, the key should turn to LOCK only when the shift lever is in PARK (P).
- With a manual transmission, the key should turn to LOCK only when the shift lever is in REVERSE (R).

On vehicles with a key release button, try to turn the key to LOCK without pressing the button. The key should turn to LOCK only when you press the key button.

On all vehicles, the key should come out only in LOCK.

Parking Brake and Automatic Transmission PARK (P) Mechanism Check

CAUTION:

When you are doing this check, your vehicle could begin to move. You or others could be injured and property could be damaged. Make sure there is room in front of your vehicle in case it begins to roll. Be ready to apply the regular brake at once should the vehicle begin to move.

Park on a fairly steep hill, with the vehicle facing downhill. Keeping your foot on the regular brake, set the parking brake.

- To check the parking brake's holding ability: With the engine running and transmission in NEUTRAL (N), slowly remove foot pressure from the regular brake pedal. Do this until the vehicle is held by the parking brake only.
- To check the PARK (P) mechanism's holding ability: With the engine running, shift to PARK (P). Then release all brakes.

Part C: Periodic Maintenance Inspections

Listed below are inspections and services which should be performed at least twice a year (for instance, each spring and fall). You should let your GM dealer's service department or other qualified service center do these jobs. Make sure any necessary repairs are completed at once.

Proper procedures to perform these services may be found in a GM service manual. See "Service and Owner Publications" in the Index.

Steering, Suspension and Front Drive Axle Boot and Seal Inspection

Inspect the front and rear suspension and steering system for damaged, loose or missing parts, signs of wear or lack of lubrication. Inspect the power steering lines and hoses for proper hook-up, binding, leaks, cracks, chafing, etc. Clean and then inspect the drive axle boot seals for damage, tears or leakage. Replace seals if necessary.

Exhaust System Inspection

Inspect the complete exhaust system. Inspect the body near the exhaust system. Look for broken, damaged, missing or out-of-position parts as well as open seams, holes, loose connections or other conditions which could cause a heat build-up in the floor pan or could let exhaust fumes into the vehicle. See "Engine Exhaust" in the Index.

Radiator and Heater Hose Inspection

Inspect the hoses and have them replaced if they are cracked, swollen or deteriorated. Inspect all pipes, fittings and clamps; replace as needed.

Throttle Linkage Inspection

Inspect the throttle linkage for interference or binding, and for damage or missing parts. Replace parts as needed. Replace any cables that have high effort or excessive wear. Do not lubricate accelerator and cruise control cables.

Drive Axle Service

Check rear/front axle fluid level and add as needed.
Check constant velocity joints and axle seals for leaking.

Transfer Case (All-Wheel Drive) Inspection

Every 12 months or at oil change intervals, check front axle and transfer case and add lubricant when necessary. Check vent hose at transfer case for kinks and proper installation.

Transfer Case (Four-Wheel Drive) Inspection

Every 12 months or at oil change intervals, check front axle and transfer case and add lubricant when necessary. Check vent hose at transfer case for kinks and proper installation. More frequent lubrication may be required on off-road use.

Brake System Inspection (Two-Wheel and Four-Wheel Drive)

Inspect the complete system. Inspect brake lines and hoses for proper hook-up, binding, leaks, cracks, chafing, etc. Inspect disc brake pads for wear and rotors for surface condition. Also inspect drum brake linings for wear and cracks. Inspect other brake parts, including drums, wheel cylinders, calipers, parking brake, etc. Check parking brake adjustment. You may need to have your brakes inspected more often if your driving habits or conditions result in frequent braking.

Brake System Inspection (All-Wheel-Drive)

Inspect the complete system. Inspect brake lines and hoses for proper hook-up, binding, leaks, cracks, chafing, etc. Inspect disc brake pads for wear and rotors for surface condition. Inspect other brake parts, including calipers, parking brake, etc. Check parking brake adjustment. You may need to have your brakes inspected more often if your driving habits or conditions result in frequent braking.

Part D: Recommended Fluids and Lubricants

NOTE: Fluids and lubricants identified below by name, part number or specification may be obtained from your GM dealer.

USAGE	FLUID/LUBRICANT
Engine Oil	Engine oil with the American Petroleum Institute Certified For Gasoline Engines "Starburst" symbol of the proper viscosity. To determine the preferred viscosity for your vehicle's engine, see "Engine Oil" in the Index.
Engine Coolant	50/50 mixture of clean water (preferably distilled) and use only GM Goodwrench [®] DEX-COOL [™] or Havoline [®] DEX-COOL [™] coolant. See "Engine Coolant" in the Index.

USAGE	FLUID/LUBRICANT
Coolant Supplement Sealer	GM Part No. 3634621 or equivalent with a complete flush and refill.
Hydraulic Brake System	Delco Supreme 11 [®] Brake Fluid (GM Part No. 12377967 or equivalent DOT-3 brake fluid).
Hydraulic Clutch System	Hydraulic Clutch Fluid (GM Part No. 12345347 or equivalent DOT-3 brake fluid).
Parking Brake Cable Guides	Chassis lubricant (GM Part No. 12377985 or equivalent) or lubricant meeting requirements of NLGI # 2, Category LB or GC-LB.
Power Steering System	GM Power Steering Fluid (GM Part No. 1052884 - 1 pint, 1050017 - 1 quart, or equivalent).

USAGE	FLUID/LUBRICANT
Manual Transmission	Synchromesh Transmission Fluid (GM Part No. 12345349 or equivalent).
Automatic Transmission	DEXRON [®] -III Automatic Transmission Fluid.
Key Lock Cylinders	Multi-Purpose lubricant, Superlube [®] (GM Part No. 12346241 or equivalent).
Chassis Lubrication	Chassis lubricant (GM Part No. 12377985 or equivalent) or lubricant meeting requirements of NLGI # 2, Category LB or GC-LB.
Front Wheel Bearings	Wheel bearing lubricant meeting requirements of NLGI # 2, Category GC or GC-LB (GM Part No. 1051344 or equivalent).
Differential, Front and Rear Axle	Axle Lubricant (GM Part No. 1052271) or SAE 80W-90 GL-5 Gear Lubricant.

USAGE	FLUID/LUBRICANT
Transfer Case	DEXRON [®] -III Automatic Transmission Fluid.
Windshield Washer Solvent	GM Optikleen [®] Washer Solvent (GM Part No. 1051515) or equivalent.
Transfer Case Shift Lever, Propeller Shaft Slip Splines and Universal Joints	Chassis lubricant (GM Part No. 12377985 or equivalent) or lubricant meeting requirements of NLGI # 2, Category LB or GC-LB.
Clutch Pushrod to Clutch Fork Joint	Chassis lubricant (GM Part No. 12377985 or equivalent) or lubricant meeting requirements of NLGI # 2, Category LB or GC-LB.
Constant Velocity Universal Joint	Chassis lubricant (GM Part No. 12377985 or equivalent) or lubricant meeting requirements of NLGI # 2, Category LB or GC-LB.

USAGE	FLUID/LUBRICANT
Hood Latch Assembly, Pivots, Spring Anchor and Release Pawl	Lubriplate lubricant aerosol (GM Part No. 12346293 or equivalent) or lubricant meeting requirements of NLGI # 2, Category LB or GC-LB.
Hood and Door Hinges	Multi-purpose lubricant, Superlube [®] (GM Part No. 12346241 or equivalent).
Tailgate Mounted Spare Tire Carrier (if equipped), Outer Tailgate Handle Pivot Points and Hinges	Multi-purpose lubricant, Superlube [®] (GM Part No. 12346241 or equivalent).

USAGE	FLUID/LUBRICANT
Weatherstrip Conditioning	Dielectric Silicone Grease (GM Part No. 12345579 or equivalent).
Weatherstrip Squeaks	Multi-purpose lubricant, Superlube [®] (GM Part No. 12346241 or equivalent).

See "Replacement Parts" in the Index for recommended replacement filters, valves and spark plugs.

Part E: Maintenance Record

After the scheduled services are performed, record the date, odometer reading and who performed the service in the boxes provided after the maintenance interval. Any additional information from "Owner Checks and

Services" or "Periodic Maintenance" can be added on the following record pages. Also, you should retain all maintenance receipts. Your owner information portfolio is a convenient place to store them.

Maintenance Record

DATE	ODOMETER READING	SERVICED BY	MAINTENANCE PERFORMED

Section 8 Customer Assistance Information

Here you will find out how to contact Chevrolet if you need assistance. This section also tells you how to obtain service publications and how to report any safety defects.

8-2	Customer Satisfaction Procedure	8-10	Warranty Information
8-4	Address for Writing to Chevrolet/Geo	8-10	Reporting Safety Defects to the United States
8-4	Assistance for Text Telephone (TTY) Users	8-11	Reporting Safety Defects to Canada
8-5	Chevrolet/Geo Roadside Assistance Program	8-11	Reporting Safety Defects to General Motors
8-5	Phone Number for Roadside Assistance	8-11	Ordering Service Publications in Canada
8-7	Canadian Roadside Assistance	8-12	How to Order Service Publications
8-8	Chevrolet/Geo Courtesy Transportation	8-13	Order Form for Service Publications
8-9	BBB Autoline Information		

Customer Satisfaction Procedure



Chevrolet dealers have the facilities, trained technicians and up-to-date information to promptly address any concerns you may have. However, if a concern has not been resolved to your complete satisfaction, take the following steps:

STEP ONE -- Discuss your concern with a member of dealership management. Normally, concerns can be quickly resolved at that level. If the matter has already been reviewed with the Sales, Service or Parts Manager, contact the owner of the dealership or the General Manager.

STEP TWO -- If after contacting a member of dealership management, it appears your concern cannot be resolved by the dealership without further help, contact the Chevrolet Customer Assistance Center by calling 1-800-222-1020. In Canada, contact GM of Canada Customer Communication Centre in Oshawa by calling 1-800-263-3777 (English) or 1-800-263-7854 (French).

For help outside of the United States and Canada, call the following numbers as appropriate:

- In Mexico: (525) 625-3256
- In Puerto Rico: 1-800-496-9992 (English) or 1-800-496-9993 (Spanish)
- In the U.S. Virgin Islands: 1-800-496-9994
- In the Dominican Republic: 1-800-751-4135 (English) or 1-800-751-4136 (Spanish)
- In the Bahamas: 1-800-389-0009
- In Bermuda, Barbados, Antigua and the British Virgin Islands: 1-800-534-0122
- In all other Caribbean countries: (809) 763-1315
- In other overseas locations, call GM International Product Center in Canada at: (905) 644-4112.

For prompt assistance, please have the following information available to give the Customer Assistance Representative:

- Your name, address, home and business telephone numbers
- Vehicle Identification Number (This is available from the vehicle registration or title, or the plate at the top left of the instrument panel and visible through the windshield.)
- Dealership name and location
- Vehicle delivery date and present mileage
- Nature of concern

We encourage you to call us so we can give your inquiry prompt attention. However, if you wish to write Chevrolet, address your inquiry to:

Chevrolet Motor Division
Chevrolet Customer Assistance Center
P.O. Box 7047
Troy, MI 48007-7047

In Canada, write to:

General Motors of Canada Limited
Customer Communication Centre, 163-005
1908 Colonel Sam Drive
Oshawa, Ontario L1H 8P7

Refer to your Warranty and Owner Assistance Information booklet for addresses of GM Overseas offices.

When contacting Chevrolet, please remember that your concern will likely be resolved in the dealership, using the dealer's facilities, equipment and personnel. That is why we suggest you follow Step One first if you have a concern.

Customer Assistance for Text Telephone (TTY) Users

To assist customers who are deaf, hard of hearing, or speech-impaired and who use Text Telephones (TTYs), Chevrolet has TTY equipment available at its Customer Assistance Center. Any TTY user can communicate with Chevrolet by dialing: 1-800-833-CHEV. (TTY users in Canada can dial 1-800-263-3830.)

Chevrolet/Geo Roadside Assistance Program

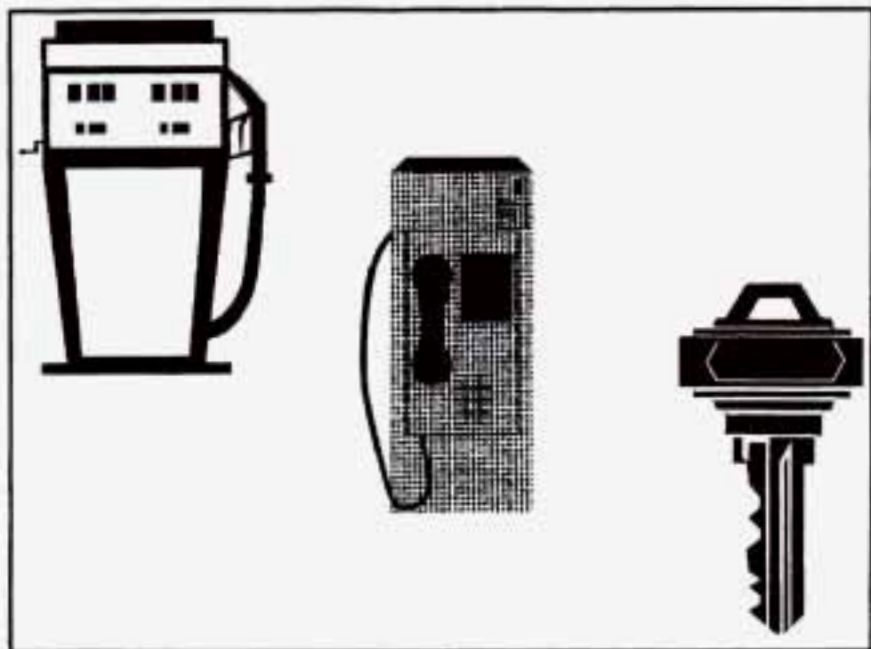

To enhance Chevrolet's strong commitment to customer satisfaction, Chevrolet is excited to announce the establishment of the Chevrolet/Geo Roadside Assistance Center. As the owner of a 1997 Chevrolet/Geo, membership in Roadside Assistance is free.

Roadside Assistance is available 24 hours a day, 365 days a year, by calling 1-800-CHEV-USA (1-800-243-8872). This toll-free number will provide you over-the-phone roadside assistance with minor mechanical problems. If your problem cannot be resolved over the phone, our advisors have access to a nationwide network of dealer recommended service providers. Roadside membership is free, however some services may incur costs.

Roadside offers two levels of service to the customer, *Basic Care* and *Courtesy™ Care*:

- Toll-free number, 1-800-CHEV-USA
- Free towing for warranty repairs
- Basic over-the-phone technical advice
- Available dealer services at reasonable costs (ie., wrecker services, locksmith/key service, glass repair, etc.)

ROADSIDE *Courtesy*™ Care PROVIDES:

- Roadside *Basic Care* services (as outlined above)
Plus:
- FREE Non-Warranty Towing (to the closest dealer from a legal roadway)
- FREE Locksmith/Key Service (when keys are lost on the road or locked inside)
- FREE Flat Tire Service (spare installed on the road)
- FREE Jump Start (at home or on the road)
- FREE Fuel Delivery (\$5 of fuel delivered on the road)

Chevrolet/Geo offers *Courtesy Transportation* for customers needing warranty service. *Courtesy Transportation* will be offered in conjunction with the coverage provided by the Bumper to Bumper New Vehicle Limited Warranty to eligible purchasers of 1997 Chevrolet/Geo passenger car and light duty trucks. (Please see your selling dealer for details.)

Note: *Courtesy Care* is available to Retail and Retail Lease Customers operating 1997 and newer Chevrolet/Geo vehicles for a period of 3 years/36,000 miles (60,000 km), whichever occurs first. All *Courtesy Care* services must be pre-arranged by Chevrolet Roadside or dealer Service Management.

Basic Care and *Courtesy Care* are not part of or included in the coverage provided by the New Vehicle Limited Warranty. Chevrolet reserves the right to modify or discontinue *Basic Care* and *Courtesy Care* at any time.

For complete program details, see your Chevrolet/Geo dealer to obtain a Roadside Assistance Center brochure.

The Roadside Assistance Center uses companies that will provide you with quality and priority service. When roadside services are required, our advisors will explain any payment obligations that may be incurred for utilizing outside services.

For prompt assistance when calling, please have the following available to give to the advisor:

- Vehicle Identification Number (VIN)
- License plate number
- Vehicle color
- Vehicle location
- Telephone number where you can be reached
- Vehicle mileage
- Description of problem

Please refer to the Roadside Assistance brochure inside your owner information portfolio for full program details.

Canadian Roadside Assistance

Vehicles purchased in Canada have an extensive Roadside Assistance program accessible from anywhere in Canada or the United States. Please refer to the separate brochure provided by the dealer or call 1-800-268-6800 for emergency services.

Courtesy Transportation

Chevrolet/Geo offers Courtesy Transportation for customers needing warranty service. Courtesy Transportation will be offered in conjunction with the coverage provided by the Bumper to Bumper New Vehicle Limited Warranty to retail purchasers of 1997 Chevrolet/Geo passenger cars and light duty trucks (please see your selling dealer for details).

Courtesy Transportation includes:

- One way shuttle ride for any warranty repair completed during the same day.
- Up to \$30 maximum daily vehicle rental allowance for any overnight warranty repair up to five days, OR
- Up to \$30 maximum daily cab, bus or other transportation allowance in lieu of rental for any overnight warranty repair up to five days, OR
- Up to \$10 daily fuel allowance for rides provided by another person (i.e., friend, neighbor, etc.) in lieu of rental for any overnight warranty repair up to five days.

Note: All Courtesy Transportation arrangements will be administered by your Chevrolet/Geo dealer service management. Claim amounts should reflect all actual costs.

- Chevrolet/Geo Courtesy Transportation is not part of the Bumper to Bumper New Vehicle Limited Warranty. Chevrolet/Geo reserves the right to make any changes or discontinue Courtesy Transportation at any time without notification.
- For additional program details, contact your Chevrolet/Geo dealer.

Some state insurance regulations make it impractical to rent vehicles to people under 21 years of age. If you are under 21 and have difficulty renting a vehicle, Chevrolet will reimburse up to \$30/day for documented transportation you receive.

For warranty repairs during the Complete Vehicle Coverage period in the New Vehicle Limited Warranty, interim transportation may be available under the Courtesy Transportation Program. Please consult your dealer for details. The Roadside Assistance program is available only in the United States and Canada.

In Canada, please consult your GM dealer for information on Courtesy Transportation.

GM Participation in an Alternative Dispute Resolution Program

This program is available in all 50 states and the District of Columbia. Canadian owners refer to your Warranty and Owner Assistance Information booklet for information on the Canadian Motor Vehicle Arbitration Plan (CAMVAP). General Motors reserves the right to change eligibility limitations and/or to discontinue its participation in this program.

Both Chevrolet and your Chevrolet dealer are committed to making sure you are completely satisfied with your new vehicle. Our experience has shown that, if a situation arises where you feel your concern has not been adequately addressed, the Customer Satisfaction Procedure described earlier in this section is very successful.

There may be instances where an impartial third party can assist in arriving at a solution to a disagreement regarding vehicle repairs or interpretation of the New Vehicle Limited Warranty. To assist in resolving these disagreements, Chevrolet voluntarily participates in BBB AUTO LINE.

BBB AUTO LINE is an out-of-court program administered by the Better Business Bureau system to settle automotive disputes. This program is available free of charge to customers who currently own or lease a GM vehicle.

If you are not satisfied after following the Customer Satisfaction Procedure, you may contact the BBB using the toll-free telephone number, or write them at the following address:

BBB AUTO LINE
Council of Better Business Bureaus, Inc.
4200 Wilson Boulevard
Suite 800
Arlington, VA 22203-1804
Telephone: 1-800-955-5100

To file a claim, you will be asked to provide your name and address, your Vehicle Identification Number (VIN) and a statement of the nature of your complaint. Eligibility is limited by vehicle age and mileage, and other factors.

We prefer you utilize the Customer Satisfaction Procedure before you resort to AUTO LINE, but you may contact the BBB at any time. The BBB will attempt to resolve the complaint serving as an intermediary. If this mediation is unsuccessful, an informal hearing will be scheduled where eligible customers may present their case to an impartial third-party arbitrator.

The arbitrator will make a decision which you may accept or reject. If you accept the decision, GM will be bound by that decision. The entire dispute resolution procedure should ordinarily take about 40 days from the time you file a claim until a decision is made.

Some state laws may require you to use this program before filing a claim with a state-run arbitration program or in the courts. For further information, contact the BBB at 1-800-955-5100 or the Chevrolet Customer Assistance Center at 1-800-222-1020.

Warranty Information

Your vehicle comes with a separate warranty booklet that contains detailed warranty information.

REPORTING SAFETY DEFECTS TO THE UNITED STATES GOVERNMENT

If you believe that your vehicle has a defect which could cause a crash or could cause injury or death, you should immediately inform the National Highway Traffic Safety Administration (NHTSA), in addition to notifying General Motors.

If NHTSA receives similar complaints, it may open an investigation, and if it finds that a safety defect exists in a group of vehicles, it may order a recall and remedy campaign. However, NHTSA cannot become involved in individual problems between you, your dealer or General Motors.

To contact NHTSA, you may either call the Auto Safety Hotline toll-free at 1-800-424-9393 (or 366-0123 in the Washington, D.C. area) or write to:

NHTSA, U.S. Department of Transportation
Washington, D.C. 20590

You can also obtain other information about motor vehicle safety from the Hotline.

REPORTING SAFETY DEFECTS TO THE CANADIAN GOVERNMENT

If you live in Canada, and you believe that your vehicle has a safety defect, you should immediately notify Transport Canada, in addition to notifying General Motors of Canada Limited. You may write to:

Transport Canada
Box 8880
Ottawa, Ontario K1G 3J2

REPORTING SAFETY DEFECTS TO GENERAL MOTORS

In addition to notifying NHTSA (or Transport Canada) in a situation like this, we certainly hope you'll notify us. Please call us at 1-800-222-1020 or write:

Chevrolet Motor Division
Chevrolet Customer Assistance Center
P.O. Box 7047
Troy, Michigan 48007-7047

In Canada, please call us at 1-800-263-3777 (English) or 1-800-263-7854 (French). Or, write:

General Motors of Canada Limited
Customer Communication Centre
1908 Colonel Sam Drive
Oshawa, Ontario L1H 8P7

Ordering Service and Owner Publications in Canada

Service manuals, service bulletins, owner's manuals and other service literature are available for purchase for all current and past model General Motors vehicles.

The toll-free telephone number for ordering information in Canada is 1-800-668-5539.

1997 CHEVROLET/GEO SERVICE PUBLICATIONS ORDERING INFORMATION

The following publications covering the operation and servicing of your vehicle can be purchased by filling out the Service Publication Order Form in this book and mailing it in with your check, money order, or credit card information to Helm, Incorporated (address below.)

CURRENT PUBLICATIONS FOR 1997 CHEVROLET/GEO

SERVICE MANUALS

Service Manuals have the diagnosis and repair information on engines, transmission, axle, suspension, brakes, electrical, steering, body, etc.

RETAIL SELL PRICE: \$90.00

TRANSMISSION, TRANSAXLE, TRANSFER CASE UNIT REPAIR MANUAL

This manual provides information on unit repair service procedures, adjustments and specifications for the 1997 GM transmissions, transaxles and transfer cases.

RETAIL SELL PRICE: \$40.00

SERVICE BULLETINS

Service Bulletins give technical service information needed to knowledgeable service General Motors cars and trucks. Each bulletin contains instructions to assist in the diagnosis and service of your vehicle.

PLEASE COMPLETE THE ORDER FORM SHOWN ON THE FOLLOWING PAGE AND MAIL TO:

Helm, Incorporated • P.O. Box 07130 • Detroit, MI 48207

OWNER'S INFORMATION

Owner publications are written directly for Owners and intended to provide basic operational information about the vehicle. The owner's manual will include the Maintenance Schedule for all models.

In-Portfolio: Includes a Portfolio, Owner's Manual and Warranty Booklet.

RETAIL SELL PRICE: \$15.00

Without Portfolio: Owner's Manual only.

RETAIL SELL PRICE: \$10.00

CURRENT & PAST MODEL ORDER FORMS

Service Publications are available for current and past model GM vehicles. To request an order form, please specify year and model name of the vehicle.

OR ORDER TOLL FREE: 1-800-782-4356

Monday-Friday 8:00 AM – 6:00 PM Eastern Time

For Credit Card Orders Only (VISA–MasterCard–Discover)

ORDER TOLL FREE*(NOTE: For Credit Card Holders Only)***1-800-782-4356***(Monday-Friday 8:00 AM – 6:00 PM EST)**FAX Orders Only 1-313-865-5927*

Orders will be mailed within 10 days of receipt. Please allow adequate time for postal service. If further information is needed, write to the address shown below or call 1-800-782-4356. Material cannot be returned for credit without packing slip with return information within 30 days of delivery. On returns, a re-stocking fee may be applied against the original order.

PUBLICATION FORM NUMBER	ITEM DESCRIPTION	VEHICLE MODEL		QTY.	PRICE EACH*	TOTAL PRICE
		NAME	YEAR			
	Service Manual		1997		\$90.00	
	Car & Light Truck Transmission Unit Repair		1997		\$40.00	
	Owner's Manual In Portfolio		1997		\$15.00	
	Owner's Manual Without Portfolio		1997		\$10.00	

NOTE: Dealers and Companies please provide dealer or company name, and also the name of the person to whose attention the shipment should be sent.

Mail completed order form to:

HELM, INCORPORATED • P.O. Box 07130 • Detroit, MI 48207

For purchases outside U.S.A. please write to the above address for quotation

(CUSTOMER'S NAME)

(ATTENTION)

(STREET ADDRESS—NO P.O. BOX NUMBERS)

(CITY)

(STATE)

(ZIP CODE)

DAYTIME TELEPHONE NO.

()
AREA CODE

**P
A
Y
M
E
N
T**

Check or Money
Order payable to
Helm, Inc. (USA funds
only — do not send cash.)

MasterCard

VISA

Discover

Account Number:

Expiration Date mo/yr: Check here if your billing address is different from your shipping address shown.

CUSTOMER SIGNATURE

TOTAL MATERIAL	
Michigan Purchasers add 6% sales tax	
U.S. Order Processing	\$5.00
Canadian Postage (See Note Below)	
GRAND TOTAL	

 **NOTES**

Section 9 Index

- Accessory Power Outlets 2-63
- Adding Equipment to the Outside of Your Vehicle 6-3
- Adding Sound Equipment 3-20
- Add-On Equipment 4-44
- Air Bag 1-20
 - Adding Equipment 1-25
 - How Does it Restrain 1-23
 - How it Works 1-22
 - Location 1-22
 - Readiness Light 1-21, 2-73
 - Servicing 1-25
 - What Makes it Inflate 1-23
 - What You See After it Inflates 1-24
 - When Should it Inflate 1-23
- Air Cleaner 6-13
- Air Conditioning 3-3
 - Refrigerants 6-64
- Alignment and Balance, Tire 6-46
- All-Wheel Drive 2-23, 6-21
- Aluminum Wheels, Cleaning 6-55
- Antenna, Fixed 3-21
- Anti-Lock Brake System Warning Light 2-76, 4-7
- Appearance Care 6-49
 - Materials 6-57
- Arbitration Program 8-9
- Armrest, Storage 2-56
- Ashtrays 2-61
- Audio Systems 3-6
- Automatic Overdrive 2-20
- Automatic Transmission
 - Check 7-47
 - Fluid 6-14
 - Operation 2-18
 - Park Mechanism Check 7-49
 - Shifting 2-18
 - Starting Your Engine 2-15
- Axle
 - Front 6-22
 - Rear 6-20
- B**ackglass Wipers, Blade Replacement 6-40
- Battery 6-32
 - Charge Light 2-73
 - Jump Starting 5-3
 - Replacement, Keyless Entry 2-7
 - Warnings 5-3, 5-5
- BBB Auto Line 8-9
- Better Business Bureau Mediation 8-9

Blizzard, Driving In	4-39	Changing a Flat Tire	5-23
Brake Fluid	6-28	Charging System Light	2-73
Brake, Parking	2-29	Check Gages Light	2-80
Brake System Warning Light	2-75	Checking Your Restraint Systems	1-47
Brakes		Chemical Paint Spotting	6-56
Adjustment	6-32	Child Restraints	1-37
Anti-Lock	4-7	Center Seat Positions	1-41
Master Cylinder	6-28	Securing in a Rear Outside Seat Position	1-39
Pedal Travel	6-32	Securing in the Right Front Seat Position	1-41
Replacing System Parts	6-32	Top Strap	1-38
Trailer	4-49	Where Not to Put	1-41
Wear	6-31	Where to Put	1-37
Brake-Transmission Shift Interlock Check	7-48	Cigarette Lighter	2-61
Braking	4-6	Circuit Breakers and Fuses	6-59
Braking in Emergencies	4-9	Cleaner, Air	6-13
Break-In, New Vehicle	2-13	Cleaning	
Brightness Control	2-47	Aluminum Wheels	6-55
BTSI Check	7-48	Fabric	6-50
Bulb Replacement	6-33, 6-62	Glass	6-53
		Inside of Your Vehicle	6-49
C anadian Roadside Assistance	8-7	Instrument Panel	6-52
Capacities and Specifications	6-63, 6-64	Leather	6-52
Carbon Monoxide	2-9, 2-34, 4-49, 4-50	Outside of Your Vehicle	6-54
Cargo Cover	2-58	Stains	6-51
Cargo Tie Downs	2-58	Tires	6-55
Center Front Passenger Position	1-26	Vinyl	6-52
Certification/Tire Label	4-42	Weatherstrips	6-53
Chains		Wheels	6-55
Safety	4-49	Windshield, Backglass and Wiper Blades	6-53
Tire	6-48	Climate Control System	3-2

Clock, Setting	3-6
Clutch, Hydraulic	6-19
Comfort Controls	3-1
Compact Disc Care	3-21
Compact Spare Tire	5-35
Control of a Vehicle	4-6
Convenience Net	2-57
Convex Outside Mirror	2-50
Coolant	5-14, 6-23
Coolant Heater, Engine	2-17
Courtesy Transportation	8-8
Cruise Control	2-42
Customer Assistance Information	8-1
Customer Satisfaction Procedure	8-2

D amage, Finish	6-56
Damage, Sheet Metal	6-55
Daytime Running Lamps	2-46
Daytime Running Lamps Indicator Light	2-80
Dead Battery	5-3
Defects, Reporting Safety	8-10, 8-11
Defensive Driving	4-2
Defogging	3-5
Defrosting	3-5
Dimensions, Vehicle	6-64
Dome Lamps	2-48
Door	
Locks	2-4
Storage	2-56
Drive, Automatic Transmission	2-20

Drive Axle Service	7-51
Driver Position	1-13
Driving	
City	4-32
Defensive	4-2
Drunken	4-3
Foreign Countries	6-4
Freeway	4-33
Guidelines	4-14
Hill and Mountain Roads	4-35
In a Blizzard	4-39
Night	4-28
Off-Road	4-15
On Curves	4-9
Rainy Conditions	4-29
Snowy and Icy Conditions	4-37
Through Deep Standing Water	4-31
Wet Roads	4-29
Winter	4-37
With a Trailer	4-50
Driving On Grades While Towing a Trailer	4-52
Drunken Driving	4-3

E asy Entry Seat	1-7
Electrical Equipment, Adding	3-20, 6-58
Electrical System	6-58
Endgate	2-9
Emergency Release	2-11
Manual Release	2-10
Remote Release	2-11

Engine	6-8	Finish Care	6-54
Coolant Heater	2-17	Finish Damage	6-56
Coolant Level Check	7-46	First Gear	
Coolant Temperature Gage	2-76	Automatic Transmission	2-20
Exhaust	2-34	Manual Transmission	2-21
Fan Noise	5-22	Flashers, Hazard Warning	5-2
Identification	6-58	Flat Tire, Changing	5-23
Oil Level Check	7-46	Fluids and Lubricants	6-64, 7-52
Overheating	5-12	Fog Lamp Switch	2-47
Running While Parked	2-35	Foreign Countries, Fuel	6-4
Specifications	6-63	Fourth Gear, Manual Transmission	2-21
Starting	2-15	Four-Wheel Drive	2-23, 6-21
Engine Oil	6-9	French Language Manual	ii
Adding	6-10	Front Axle	6-22
Additives	6-12	Front Map Lamps	2-48
Checking	6-9	Front Reading Lamps	2-47, 2-51, 6-38
Kind to Use	6-10	Front Sidemarkers Lamp Bulb Replacement	6-36
Pressure Gage	2-79	Front Storage Area	2-56
Used	6-13	Front Towing	5-10
When to Change	6-12	Front Turn Signal Lamp Bulb Replacement	6-36
Exhaust, Engine	2-34	Fuel	6-3
Express-Down Window	2-36	Filling Your Tank	6-5
Exterior Metal Parts, Protecting	6-55	Foreign Countries	6-4
		Gage	2-81
		Fuses and Circuit Breakers	6-59
F abric Cleaning	6-50		
Fifth Gear, Manual Transmission	2-21	G ages	
Filling Your Tank	6-5	Engine Coolant Temperature	2-76
Filter		Engine Oil Pressure	2-79
Air	6-13	Fuel	2-81
Remote Oil	6-12		

Garage Door Opener	2-51
Gas Cap	6-5
Gate Ajar Light	2-81
GAWR	4-43
Gear Positions	2-18
Glove Box	2-50
Gross Axle Weight Rating	4-43
Gross Vehicle Weight Rating	4-42
Guide en Français	ii
GVWR	4-42

H alogen Bulbs	6-33
Hazard Warning Flashers	5-2
Head Restraints	1-6
Headlamps	2-45
Bulb Replacement	6-33
High/Low Beam Changer	2-39
On Reminder	2-46
Wiring	6-59
Hearing Impaired, Customer Assistance	8-4
Heating	3-3
Highway Hypnosis	4-35
Hill and Mountain Roads	4-35
Hitches, Trailer	4-48
Hood	6-6
Horn	2-37
Hydraulic Clutch	6-19
Check	7-47
Hydroplaning	4-31

I gnition Positions	2-13
Inflation, Tire	6-41, 7-46
Inside Day/Night Rearview Mirror	2-49
Inspections	
Brake System	7-51
Exhaust Systems	7-50
Front Drive Axle Boot Seal	7-50
Radiator and Heater Hose	7-50
Steering	7-50
Suspension	7-50
Throttle Linkage	7-50
Transfer Case	7-51
Instrument Panel	2-67
Cleaning	6-52
Cluster	2-69
Fuse Block	6-59
Interior Lamps	2-47

J acking Equipment	5-26
Jump Starting	5-3

K ey in the Ignition	2-12
Key Lock Cylinders Service	7-47
Key Release Button	2-15
Keyless Entry System	2-6
Keys	2-2

L abels	
Certification/Tire	4-42
Fuse	6-60
Safety Belt	1-48
Service Parts Identification	6-58
Vehicle Identification Number	6-58
Lamps	2-45
Dome	2-48
Front Map	2-48
Front Reading	2-47, 2-51
Interior	2-47
On Reminder	2-46
Latches, Seatback	1-6
Leaving Your Vehicle	2-5
Leaving Your Vehicle with the Engine Running	2-32
Lighter	2-61
Lights	
Air Bag Readiness	1-21, 2-73
Anti-Lock Brake System Warning	2-76, 4-7
Brake System Warning	2-75
Charging System	2-73
Check Gages	2-80
Daytime Running Lamps Indicator	2-80
Gate Ajar	2-81
Safety Belt Reminder	1-9, 2-72
Service Engine Soon	2-77
Shift	2-22, 2-80
Loading Your Vehicle	4-42
Locking Rear Axle	2-23
Lockout Switch	2-37

Locks	2-4
Door	2-4
Key Lock Cylinder Service	7-47
Power Door	2-5
Rear Door Security	2-5
Steering Column Park Lock Check	7-49
Loss of Control	4-13
Lubricants and Fluids	6-64, 7-52
Lubrication Service, Body	7-47
Luggage Carrier	2-59
Lumbar Controls	1-3, 1-4
M aintenance Record	7-55
Maintenance Schedule	7-1
Long Trip/Highway	7-6, 7-30
Owner Checks and Services	7-46
Periodic Maintenance Inspections	7-50
Recommended Fluids and Lubricants	7-52
Scheduled Maintenance Services	7-4
Short Trip/City	7-5, 7-7
Maintenance, Underbody	6-56
Maintenance When Trailer Towing	4-54
Malfunction Indicator Lamp	2-77
Manual Front Seat	1-2
Manual Lumbar Support	1-3
Manual Transmission	
Check	7-47
Fluid	6-18
Shifting	2-21
Starting Your Engine	2-16

Methanol	6-4
Mirrors	2-49
Convex Outside	2-50
Inside Day/Night Rearview	2-49
Outside	2-49
Visor Vanity	2-62
Model Reference	vi
Mountain Roads	4-35
Multifunction Lever	2-38
N et, Convenience	2-57
Neutral	
Automatic Transmission	2-19
Manual Transmission	2-22
New Vehicle "Break-In"	2-13
Night Vision	4-28
Normal Maintenance Replacement Parts	6-63
O dometer	2-68
Off-Road Driving	4-15
Off-Road Recovery	4-11
Oil, Engine	6-9
Opener, Garage Door	2-51
Ordering Owner and Service Publications	8-11, 8-12
Outside Mirror	
Manual Adjust	2-49
Power Remote Control	2-49
Convex	2-50
Overdrive, Automatic Transmission	2-20

Overhead Console	2-50
Overheating Engine	5-12
Owner Checks and Services	7-46
Owner Publications	8-11, 8-12

P aint Spotting, Chemical	6-56
Park	
Automatic Transmission	2-18
Shifting Into	2-30
Shifting Out of	2-33
Parking	
At Night	2-12
Brake	2-29
Brake Mechanism Check	7-49
Lots	2-12
On Hills with a Trailer	4-52
Over Things That Burn	2-34
Your Vehicle, Manual Transmission	2-33
Passing	4-12
Payload	4-44
Periodic Maintenance Inspections	7-50
Power	
Accessory Outlets	2-63
Door Locks	2-5
Remote Control Mirror	2-49
Steering	4-9
Steering Fluid	6-26
Windows	2-36
Power Seat	1-3
Lumbar Controls	1-4

Pregnancy, Use of Safety Belts	1-26
Problems on the Road	5-1
Publications, Service and Owner	8-11, 8-12

R adiator, Adding Coolant	5-19
Radiator Pressure Cap	6-26
Radio Reception	3-19
Radios	
AM-FM Stereo	3-6
Cassette Care	3-20, 7-46
Cassette Tape Player	3-8, 3-10
Compact Disc Player	3-13
Theft-Deterrent Feature, CD Player	3-17
Rain, Driving	4-29
Rear	
Axle	6-20
Door Security Locks	2-5
Safety Belt Comfort Guides	1-31
Seat Passengers	1-28
Seats	1-7
Towing	5-11
Window Defogger	3-5
Window Washer/Wiper	2-41
Rear Seats	1-7
Rearview Mirror	2-49
Reclining Front Seatbacks	1-4
Recommended Fluids and Lubricants	6-64, 7-52
Recovery Hooks	5-37
Recovery Tank, Coolant	5-16
Recreational Vehicle Towing	4-41

Replacement	
Bulbs	6-62
Parts	6-63
Wheel	6-46
Reporting Safety Defects	8-10, 8-11
Restraints	
Check	7-47
Checking	1-47
Child	1-37
Head	1-6
Replacing Parts After a Crash	1-48
Reverse	
Automatic Transmission	2-19
Manual Transmission	2-22
Right Front Passenger Position	1-26
Roadside Assistance	8-5
Canadian	8-7
Rocking Your Vehicle	5-37
Rotation, Tires	6-42

S afety Belts	1-8
Adults	1-13
Care	6-52
Center Front Passenger Position	1-26
Center Rear Passenger Position	1-34
Children	1-35, 1-44
Driver Position	1-13
Extender	1-47
How to Wear Properly	1-13
Lap Belt	1-27, 1-34

Lap-Shoulder	1-13, 1-28	Signaling Turns	2-39
Questions and Answers	1-12	SIR	1-20
Rear Comfort Guides	1-31	Skidding	4-13
Rear Seat Passengers	1-28	Specifications and Capacities	6-63, 6-64
Replacing After a Crash	1-48	Speech Impaired, Customer Assistance	8-4
Right Front Passenger Position	1-26	Speedometer	2-71
Use During Pregnancy	1-26	Stains, Cleaning	6-51
Why They Work	1-9	Starter Switch Check	7-48
Safety Chains	4-49	Starting Your Engine	2-15
Safety Defects, Reporting	8-10, 8-11	Steam	5-12
Safety Warnings and Symbols	iii	Steering	
Scheduled Maintenance Services	7-4	In Emergencies	4-10
Seatback		Power	4-9
Latches	1-6	Steering Column Park Lock Check	7-49
Reclining Front	1-4	Steering Wheel, Tilt	2-38
Seats and Restraint Systems	1-1	Storage Compartments	2-50
Second Gear		Storage, Vehicle	6-33
Automatic Transmission	2-20	Storing a Flat or Spare Tire and Tools	5-32
Manual Transmission	2-21	Stuck: In Sand, Mud, Ice or Snow	5-36
Service and Appearance Care	6-1	Sun Visors	2-62
Service and Owner Publications	8-11, 8-12	Sunglasses Storage	2-56
Service Engine Soon Light	2-77	Sunroof	2-63
Service Parts Identification Label	6-58	Supplemental Inflatable Restraint	1-20
Service Work, Doing Your Own	6-2	Symbols, Vehicle	v
Servicing Your Air Bag-Equipped Vehicle	1-25		
Sheet Metal Damage	6-55	T achometer	2-71
Shift Light	2-22, 2-80	Taillamp Bulb Replacement	6-37
Shifting	2-18, 2-21	Tape Player Care	3-20
Into Park	2-30	Temperature and Compass Display	2-53
Out of Park	2-33		

Theft	2-12	Driving on Grades	4-52
THEFTLOCK™	3-17	Driving with a Trailer	4-50
Thermostat	6-26	Hitches	4-48
Third Gear, Manual Transmission	2-21	Maintenance When Towing	4-54
Tilt Steering Wheel	2-38	Parking on Hills	4-52
Time, Setting	3-6	Safety Chains	4-49
Tire Chains	6-48	Tongue Weight	4-47
Tires		Total Weight on Tires	4-48
Alignment and Balance	6-46	Towing	4-45
Buying New	6-44	Turn Signals	4-51
Changing a Flat	5-23	Weight	4-46
Cleaning	6-55	Wiring Harness	4-55
Inflation	6-41, 7-46	Transfer Case	6-21
Inspection and Rotation	6-42	Electronic	2-26
Pressure	6-41	Manual	2-24
Temperature	6-46	Transmission Fluid	
Traction	6-46	Automatic	6-14
Treadwear	6-45	Manual	6-18
Uniform Quality Grading	6-45	Transmitters, Keyless Entry	2-6
Wear Indicators	6-44	Transportation, Courtesy	8-8
When It's Time for New	6-44	Trip, Before Leaving	4-34
Top Strap	1-38	Trip Odometer	2-71
Torque Lock	2-32	TTY Users	8-4
Torque, Wheel Nut	5-32, 6-63	Turn Signal and Lane Change Signals	2-39
Towing a Trailer	4-45	Turn Signals When Towing a Trailer	4-51
Towing, Recreational Vehicle	4-41		
Towing Your Vehicle	5-7	U nderbody Maintenance	6-56
Trailer		Underhood Lamp Bulb Replacement	6-37
Brakes	4-49		

Universal Transmitter	2-64
Erasing Channels	2-66
Operation	2-66
Programming	2-65
Rolling Code Openers	2-66
Used Replacement Wheels	6-47

V anity Mirror Lamp Bulb Replacement	6-38
Vehicle Control	4-6
Vehicle Damage Warnings	iv
Vehicle Dimensions	6-64
Vehicle Identification Number	6-58
Vehicle Loading	4-42
Vehicle Storage	6-33
Vehicle Symbols	v
Ventilation System	3-4
Visors, Sun	2-62
Voltmeter	2-74

W arning Devices	5-2
Warning Lights, Gages and Indicators	2-72
Warranty Information	8-10
Washer Fluid, Windshield	6-27
Washing Your Vehicle	6-54

Weatherstrips	6-53
Wheel Alignment	6-46
Wheel Nut Torque	5-32, 6-63
Wheel Replacement	6-46
Windows	
Express-Down	2-36
Lockout Switch	2-37
Manual	2-36
Power	2-36
Swing-Out	2-37
Windshield Washer	2-40
Fluid	6-27
Fluid Level Check	7-46
Windshield Wiper	2-40
Blade Check	7-47
Blade Replacement	6-38
Fuses	6-59
Rear	2-41
Winter Driving	4-37
Wiring, Headlamp	6-59
Wrecker Towing	5-7

Service Station Checkpoints

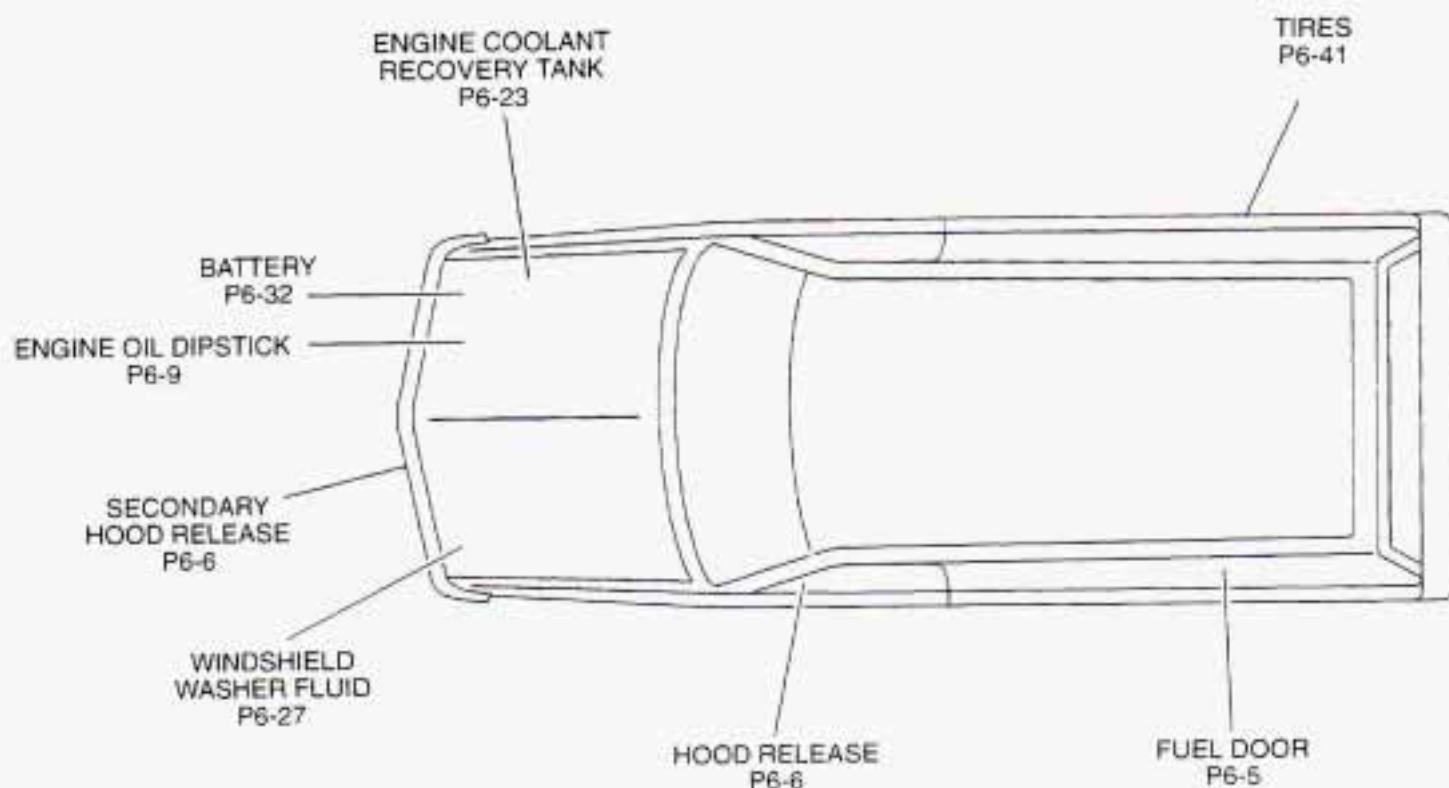

For detailed information, refer to the page number listed, or see the index in the back of the owner's manual.

C9711

