

1 9 9 7

SEVILLE



CADILLAC.

CREATING A HIGHER STANDARD.

REPRODUCTION



The 1997 Cadillac Seville Owner's Manual

1-1 Seats and Restraint Systems

This section tells you how to use your seats and safety belts properly. It also explains the "SIR" system.

2-1 Features and Controls

This section explains how to start and operate your Cadillac.

3-1 Comfort Controls and Audio Systems

This section tells you how to adjust the ventilation and comfort controls and how to operate your audio system.

4-1 Your Driving and the Road

Here you'll find helpful information and tips about the road and how to drive under different conditions.

5-1 Problems on the Road

This section tells what to do if you have a problem while driving, such as a flat tire or overheated engine, etc.

6-1 Service and Appearance Care

Here the manual tells you how to keep your Cadillac running properly and looking good.

7-1 Customer Assistance Information

This section tells you how to contact Cadillac for assistance and how to get service and owner publications. It also gives you information on "Reporting Safety Defects" on page 7-12.

8-1 Index

Here's an alphabetical listing of almost every subject in this manual. You can use it to quickly find something you want to read.



GENERAL MOTORS, GM and the GM Emblem, CADILLAC, the CADILLAC Emblem and the name SEVILLE are registered trademarks of General Motors Corporation.

This manual includes the latest information at the time it was printed. We reserve the right to make changes in the product after that time without further notice. For vehicles first sold in Canada, substitute the name "General Motors of Canada Limited" for Cadillac Motor Car Division whenever it appears in this manual.

Please keep this manual in your Cadillac, so it will be there if you ever need it when you're on the road. If you sell the vehicle, please leave this manual in it so the new owner can use it.

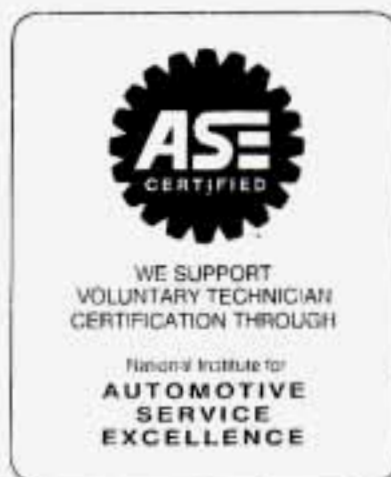

We support voluntary technician certification.

For Canadian Owners Who Prefer a French Language Manual:

Aux propriétaires canadiens: Vous pouvez vous procurer un exemplaire de ce guide en français chez votre concessionnaire ou au:

DGN Marketing Services Ltd.
1500 Bonhill Rd.
Mississauga, Ontario L5T 1C7

The PENALTY OF LEADERSHIP

IN every field of human endeavor, he that is first must perpetually live in the white light of publicity. ¶Whether the leadership be vested in a man or in a manufactured product, emulation and envy are ever at work. ¶In art, in literature, in music, in industry, the reward and the punishment are always the same. ¶The reward is widespread recognition: the punishment, fierce denial and detraction. ¶When a man's work becomes a standard for the whole world, it also becomes a target for the shafts of the envious few. ¶If his work be merely mediocre, he will be left severely alone – if he achieve a masterpiece, it will set a million tongues a-wagging. ¶Jealousy does not protrude its forked tongue at the artist who produces a commonplace painting. ¶Whatever you write, or paint, or play, or sing, or build, no one will strive to surpass, or to slander you, unless your work be stamped with the seal of genius. ¶Long, long after a great work or a good work has been done, those who are disappointed or envious continue to cry out that it can not be done. ¶Spiteful little voices in the domain of art were raised against our own Whistler as a mountebank, long after the big world had acclaimed him its greatest artistic genius. ¶Multitudes flocked to Bayreuth to worship at the musical shrine of Wagner, while the little group of those whom he had dethroned and displaced argued angrily that he was no musician at all. ¶The little world continued to protest that Fulton could never build a steamboat, while the big world flocked to the river banks to see his boat steam by. ¶The leader is assailed because he is a leader, and the effort to equal him is merely added proof of that leadership. ¶Failing to equal or to excel, the follower seeks to depreciate and to destroy – but only confirms once more the superiority of that which he strives to supplant. ¶There is nothing new in this. ¶It is as old as the world and as old as the human passions – envy, fear, greed, ambition, and the desire to surpass. ¶And it all avails nothing. ¶If the leader truly leads, he remains – the leader. ¶Master-poet, master-painter, master-workman, each in his turn is assailed, and each holds his laurels through the ages. ¶That which is good or great makes itself known, no matter how loud the clamor of denial. ¶That which deserves to live – lives.

Cadillac Motor Car Co. Detroit, Mich.

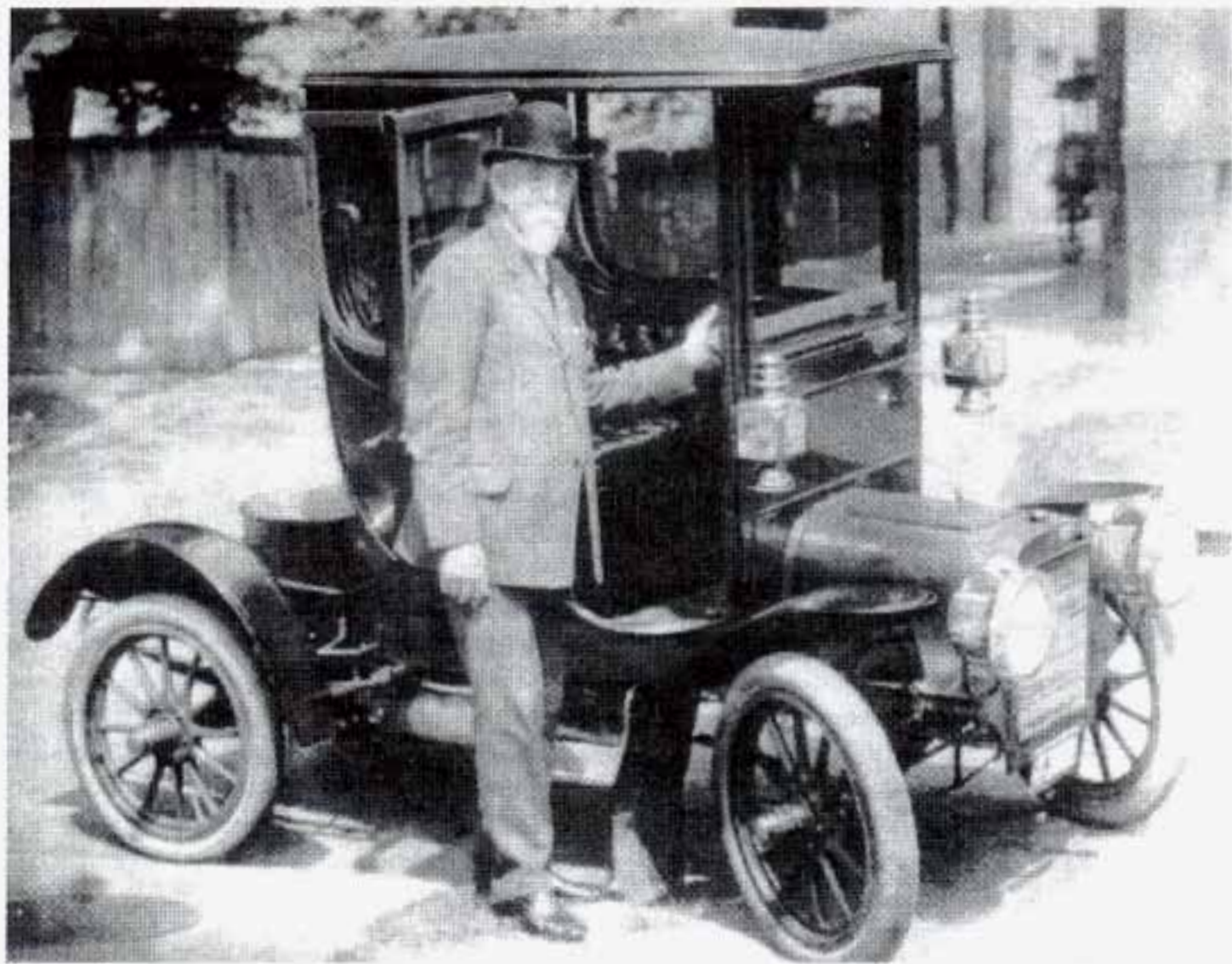

*Henry M. Leland,
founder of
Cadillac, stands
beside the 1905
"Osceola" which
was built to
evaluate the
feasibility of a
closed bodied car.*



Few automobiles are fortunate enough to have the rich heritage that is Cadillac. The name Cadillac is appropriately that of Antoine de La Mothe Cadillac, the French military commander who founded the city of Detroit in 1701. What better name for the oldest automobile manufacturer in Detroit.

Henry M. Leland, known as the master of precision, initiated his precision manufacturing techniques at the founding of Cadillac in 1902. His exacting standards prompted the motto by which Cadillac has been guided over the years — "Craftsmanship A Creed — Accuracy A Law."

The introduction of the first four cylinder engine in 1905 led the industry and enabled Cadillacs to travel at speeds up to 50 mph.

For attention to quality and innovation, the Royal Automobile Club of England awarded the prestigious **Dewar Trophy** to Cadillac twice . . . first in 1908 for achieving perfect interchangeability of parts and again for introducing the electric self starter, electric lighting and ignition system on 1912 models. Cadillac is the only American manufacturer to win this honor and the only manufacturer in the world to win it twice. As

commonplace as standardized parts are today, in 1908 parts were still individually hand fitted both in production and service.



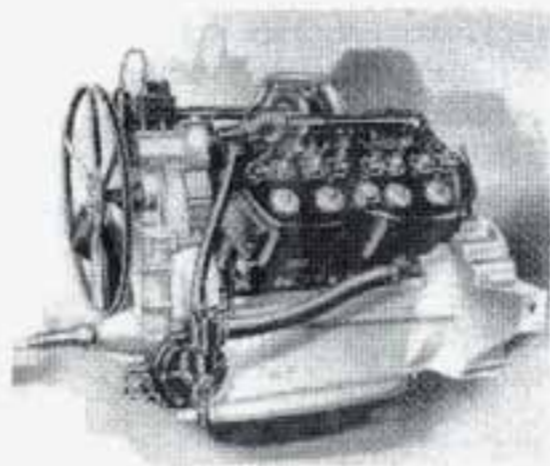

1914 V8 Engine

*V16 Engines
1930-1940*

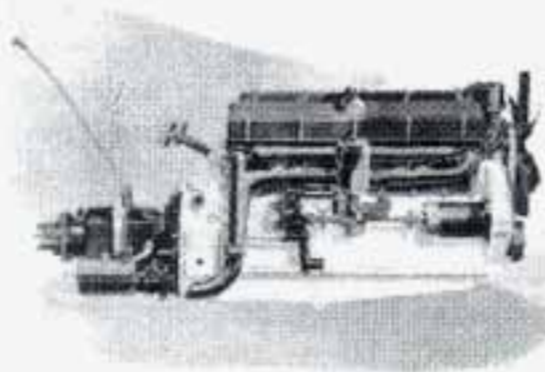

*1949 Overhead
Valve High
Compression
V8 Engine*

Standardization opened the eyes of the industrial world and was the cornerstone of modern **assembly line** production. From this achievement evolved the reference to Cadillac as “Standard of the World.”

In 1909 Cadillac was purchased by the then new General Motors Corporation.

Convenience, cleanliness and all-weather comfort were greatly enhanced in 1910 when Cadillac became the first manufacturer to offer closed bodies as standard equipment.

“The Penalty of Leadership” first appeared in the January 2, 1915 issue of The Saturday Evening Post as an expression of the Cadillac commitment to leadership, quality and innovation. It is widely regarded as one of the

finest documents ever written. It was published following the introduction of the first production V8 engine, which was standard in all Cadillacs beginning with the 1915 model.

Many Cadillac “firsts” have followed over the years, including the synchro-mech clashless transmission, a nationwide comprehensive service policy, security plate glass, chrome plating and the first car to be designed by a stylist (1927 LaSalle/Harley Earl). The '30s witnessed production of the powerful, smooth and quiet V12 and **V16 engines**. The crisp, contemporary lines of the 1938 60 Special series ushered in a new era in styling.

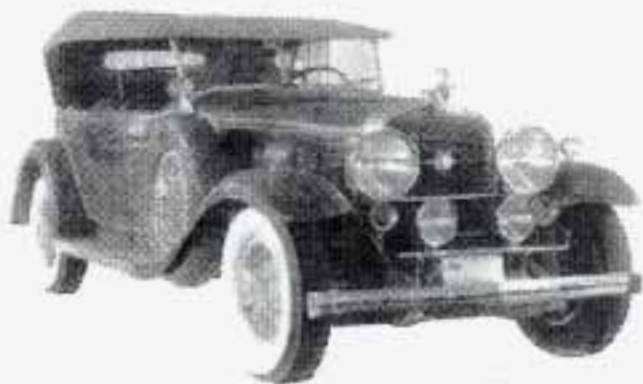

1931 V16 Sport Phaeton

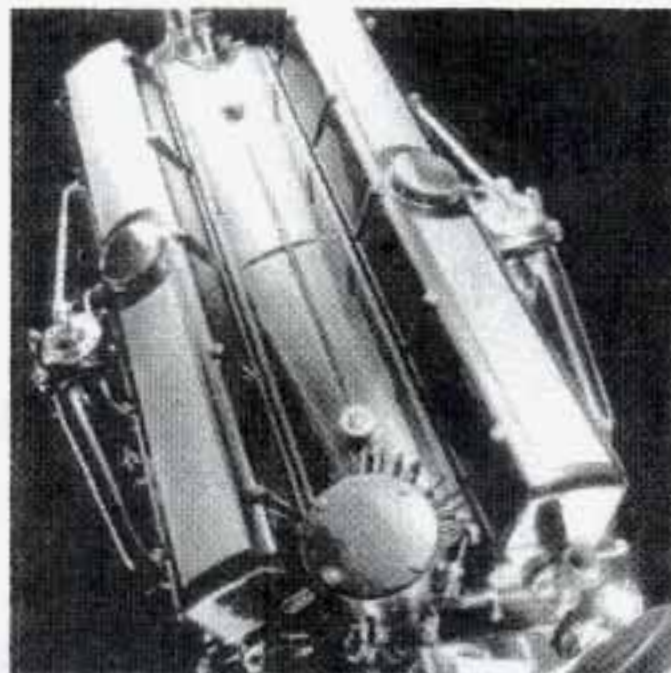

V16 Engine

During World War II, shortly after Pearl Harbor, Cadillac discontinued car production for the first time since 1902 in order to construct light tanks, combat vehicles and internal parts for Allison V1710 engines. Two Cadillac V8 engines and Hydra-Matic transmissions were used in each M5A1 and M24 tanks.

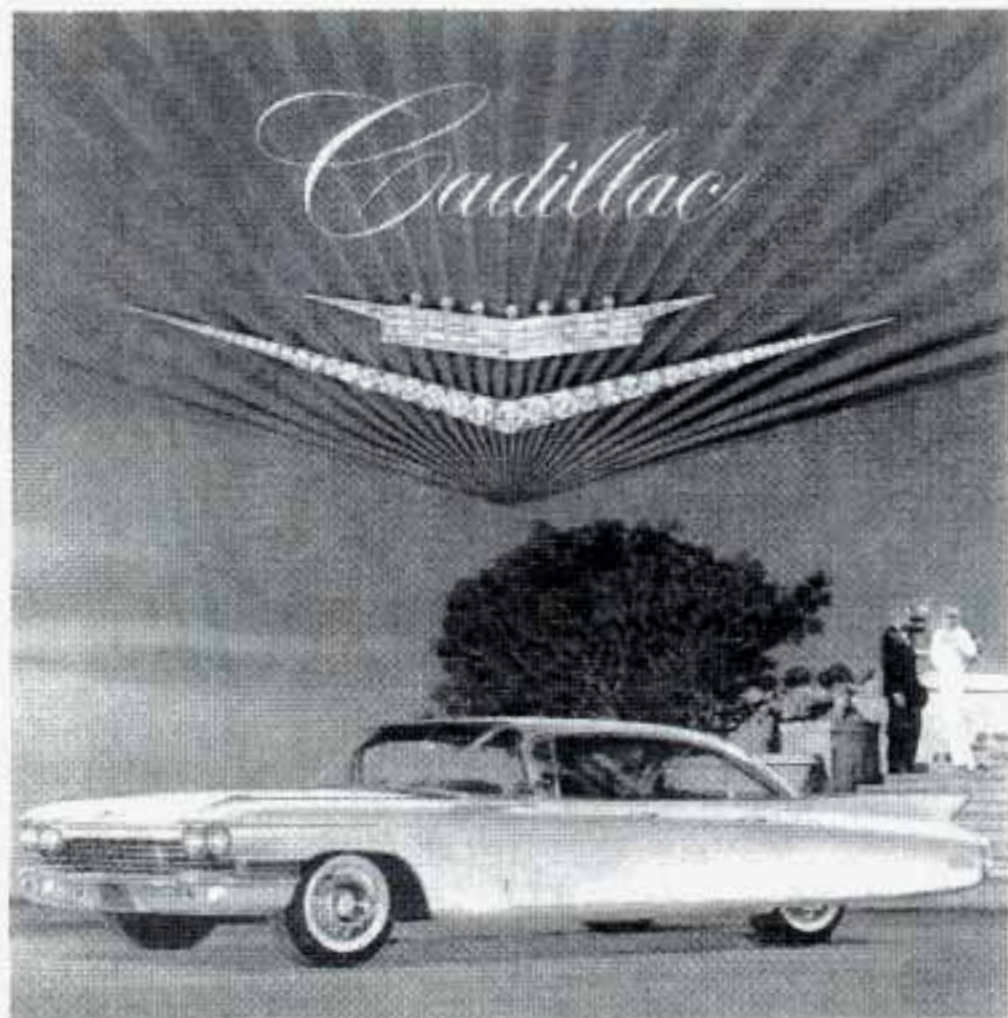

There are, to be sure, many ways to describe the superlative motor car pictured. "Beauty," "majesty," "brilliance" — all apply, in their fullest meaning, to this new Cadillac. And yet, from this wonderful vocabulary, we have selected "elegance" as the word that most fully characterizes the Cadillac of 1960. The car's beautiful, clean-lined styling is certainly elegant beyond compare. Its new interior luxury provides a feeling of elegance that can be sensed nowhere else in the world of motor cars. And even its new performance — smooth, quiet and effortless — might be summarized as "elegance in motion." Once you have seen and driven it for yourself, we think you will agree that the word is "elegance" — and that the car is Cadillac!

CADILLAC MOTOR CAR DIVISION, GENERAL MOTORS CORPORATION

"Elegance" is the word that expresses it!



For the 1948 model, Cadillac introduced the **legendary tail fin** which once more set the trend in automotive styling for nearly two decades. This was closely followed with the two door hardtop Coupe DeVille and the industry's first modern overhead valve, high compression V8 engine on the 1949 model.

Engineering innovations, conveniences and styling dominated the '50s and '60s. Cruise control, automatic climate control, tilt and telescoping steering wheels, twilight sentinel and four door hard tops all debuted in these years. In 1957 the Eldorado Brougham featured

advances such as air suspension, memory seat, automatic electric door locks, transistor radio, a brushed stainless steel roof and low profile tires.



1957 Eldorado Brougham

The Eldorado, introduced in 1953, was redesigned for 1967 as the first front wheel drive personal luxury car. The 472 cu. in. V8 engine used in all Cadillacs in 1968 and 1969 was enlarged to 500 cu. in. for all 1970 through 1976 Eldorados. The Track Master computerized skid control braking system option debuted on 1970 Eldorados.

A driver and passenger Air Cushion Restraint system (air bag) was available on all 1974, 1975 and 1976 Cadillacs.

Analog Electronic Fuel Injection was available, on 1975 Cadillacs and standard on the new international size 1976 Seville. In 1978, the Trip Computer option incorporated the first on-board microprocessor.

The electronics and computerization which were pioneered by Cadillac in the '70s came of age in the '80s with Digital Fuel Injection and On-Board Diagnostics in 1980, four wheel Anti-lock Brakes on 1986 models and Traction Control in the fall of 1989.

The 1992 Seville STS was the first car ever to win all three major automotive awards: Car of the Year. Motor Trend; Ten Best List. Car & Driver; Car of the Year. Automobile Magazine.

The year 1993 saw the introduction of the Northstar system. The state of the art system includes the 32 valve, dual overhead camshaft, Northstar 4.6 liter V8 engine, 4T80-E electronically controlled automatic transaxle, road sensing suspension, speed sensitive steering, anti-lock brakes and traction control.

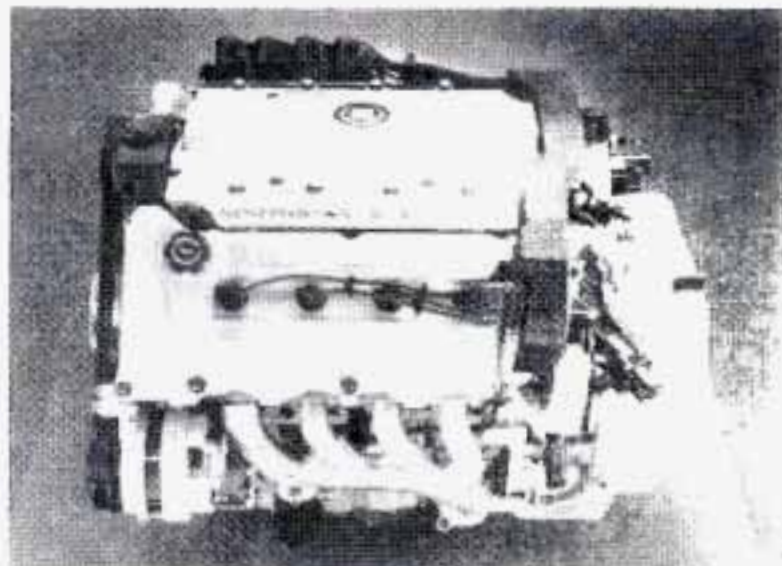

For more than nine decades Cadillac has been a leader in quality and technical innovation. Now more than ever, Cadillac is "Creating a Higher Standard."

How to Use this Manual

Many people read their owner's manual from beginning to end when they first receive their new vehicle. If you do this, it will help you learn about the features and controls for your vehicle. In this manual, you'll find that pictures and words work together to explain things quickly.

Index

A good place to look for what you need is the Index in back of the manual. It's an alphabetical list of what's in the manual, and the page number where you'll find it.

Safety Warnings and Symbols

You will find a number of safety cautions in this book. We use a box and the word CAUTION to tell you about things that could hurt you if you were to ignore the warning.



CAUTION:

These mean there is something that could hurt you or other people.

In the caution area, we tell you what the hazard is. Then we tell you what to do to help avoid or reduce the hazard. Please read these cautions. If you don't, you or others could be hurt.



You will also find a circle with a slash through it in this book. This safety symbol means "Don't," "Don't do this," or "Don't let this happen."

Vehicle Damage Warnings

Also, in this book you will find these notices:

NOTICE:
These mean there is something that could damage your vehicle.

In the notice area, we tell you about something that can damage your vehicle. Many times, this damage would not be covered by your warranty, and it could be costly. But the notice will tell you what to do to help avoid the damage.

When you read other manuals, you might see CAUTION and NOTICE warnings in different colors or in different words.

You'll also see warning labels on your vehicle. They use the same words, CAUTION or NOTICE.

Vehicle Symbols

These are some of the symbols you may find on your vehicle.

For example, these symbols are used on an original battery:

CAUTION
POSSIBLE
INJURY



PROTECT
EYES BY
SHIELDING



CAUSTIC
BATTERY
ACID COULD
CAUSE
BURNS



AVOID
SPARKS OR
FLAMES



SPARK OR
FLAME
COULD
EXPLODE
BATTERY



These symbols are important for you and your passengers whenever your vehicle is driven:

DOOR LOCK
UNLOCK



FASTEN
SEAT
BELTS



POWER
WINDOW



AIR BAG



These symbols have to do with your lamps:

MASTER
LIGHTING
SWITCH



TURN
SIGNALS



PARKING
LAMPS

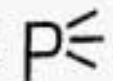

HAZARD
WARNING
FLASHER



DAYTIME
RUNNING
LAMPS



FOG LAMPS



These symbols are on some of your controls:

WINDSHIELD
WIPER



WINDSHIELD
WASHER



WINDSHIELD
DEFROSTER



REAR
WINDOW
DEFOGGER



VENTILATING
FAN



These symbols are used on warning and indicator lights:

ENGINE
COOLANT
TEMP

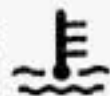

BATTERY
CHARGING
SYSTEM



BRAKE



COOLANT



ENGINE OIL
PRESSURE

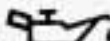

ANTI-LOCK
BRAKES



Here are some other symbols you may see:

FUSE



LIGHTER



HORN



SPEAKER



FUEL





Section 1 Seats and Restraint System

Here you'll find information about the seats in your Cadillac and how to use your safety belts properly. You can also learn about some things you should *not* do with air bags and safety belts.

1-2	Seats and Seat Controls	1-27	Rear Seat Passengers
1-6	Safety Belts: They're for Everyone	1-30	Center Passenger Position
1-11	Here Are Questions Many People Ask About Safety Belts -- and the Answers	1-31	Children
1-12	How to Wear Safety Belts Properly	1-33	Child Restraints
1-12	Driver Position	1-40	Larger Children
1-20	Safety Belt Use During Pregnancy	1-43	Safety Belt Extender
1-21	Right Front Passenger Position	1-43	Checking Your Restraint Systems
1-21	Supplemental Inflatable Restraint (SIR) System	1-43	Replacing Restraint System Parts After a Crash

Seats and Seat Controls

This section tells you about the power seats -- how to adjust them, and also about reclining front seatbacks, lumbar adjustments, heated seats and head restraints.

Power Seats

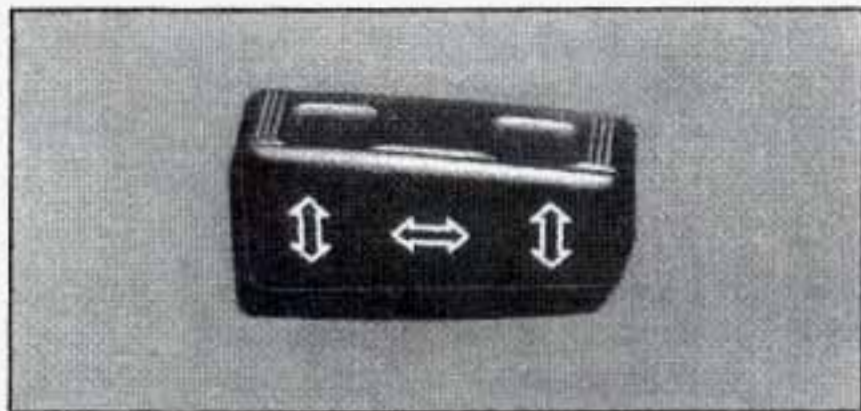

The power seat controls are located on the outboard side of the front seat cushion.

- Move the front of the control in the direction of the arrows to adjust the front portion of the cushion up or down.
- Move the rear of the control in the direction of the arrows to adjust the rear portion of the cushion up or down.

- Lift up or push down on both outer arrows at the same time to move the entire seat up or down.
- To move the whole seat forward or backward, slide the control in the direction of the center arrow.

Power Lumbar Control (If Equipped)



The lumbar control is located on the outboard side of each front seat. It provides additional support to your lower back and it works independently of the other seat controls. Use the power seat control first to get the proper position. Then proceed with the lumbar adjustment.

To reshape the lower seatback, press the lumbar control forward to increase support and rearward to decrease support. Press the control up or down to raise or lower the support mechanism.

Keep in mind that as your seating position changes, as it may during long trips, so should the position of your lumbar support. Adjust the seat as needed.

If you have the optional personalization package, the power lumbar control can be programmed for memory recall. For more information, see “Memory Seat and Mirrors” later in this section.

Memory Seat and Mirrors (If Equipped)



Adjust the driver's seat (including lumbar adjustments) and both outside mirrors to a comfortable position and then press the SET button. Within five seconds, press button “1.”

A second mirror and seating position may be programmed by repeating the above steps and pressing button “2” instead of button 1. Note that each time a memory button is pressed, a single beep will sound through the radio.

If your vehicle is in PARK (P), you can recall mirror and seating positions by briefly pressing button 1 or 2. This will adjust the seat and mirrors to where you have previously programmed them. If you have accidentally pressed one of the memory recall buttons and want to stop seat or mirror movement, press one of the manual seat or mirror control buttons. This cancels a memory recall.

You can also recall a seat and mirror position if your vehicle is not in PARK (P). Press and hold either the 1 or 2 button until seat and mirror movement is complete. Releasing the buttons will stop adjustment.

The EXIT button can be programmed to allow easy exit for up to two drivers. Adjust the seat to a comfortable “exit” position and then press the SET button followed by the EXIT button. While your vehicle is in PARK (P), briefly press the EXIT button to recall your programmed exit position.

Automatic seat and mirror movement will occur if the Remote Keyless Entry (RKE) transmitter is used to enter the vehicle. The number on the back of the transmitter corresponds to the 1 or 2 seat and mirror position. After the unlock button is pressed on the RKE transmitter or when the key is placed in the ignition, the seat and mirrors will automatically adjust to the appropriate position.

Automatic seat and mirror movement is programmed through the Driver Information Center (DIC) so that the driver can select whether or not movement will occur using the RKE transmitter or by placing the ignition key in the ignition. For more information, see "Remote Recall Memory" in the Index.

Heated Front Seat (Option)



The control is located in the center console. Move the switch to LO or HI to turn on the heating elements in the seat. The LO setting warms the seatback and cushion until the seat approximates body temperature. The HI setting heats the seat to a slightly higher temperature.

A telltale light in the control reminds you that the heating system is in use. The heated seats can only be used when the ignition is turned on.

Reclining Front Seatbacks



Press the control forward or rearward to adjust the seatback.



But don't have a seatback reclined if your vehicle is moving.

⚠ CAUTION:

Sitting in a reclined position when your vehicle is in motion can be dangerous. Even if you buckle up, your safety belts can't do their job when you're reclined like this.

The shoulder belt can't do its job because it won't be against your body. Instead, it will be in front of you. In a crash you could go into it, receiving neck or other injuries.

The lap belt can't do its job either. In a crash the belt could go up over your abdomen. The belt forces would be there, not at your pelvic bones. This could cause serious internal injuries.

For proper protection when the vehicle is in motion, have the seatback upright. Then sit well back in the seat and wear your safety belt properly.

Head Restraints

Slide the head restraint up or down so that the top of the restraint is closest to the top of your ears. This position reduces the chance of a neck injury in a crash.

The head restraints tilt forward and rearward also.

Safety Belts: They're for Everyone

This part of the manual tells you how to use safety belts properly. It also tells you some things you should not do with safety belts.

And it explains the Supplemental Inflatable Restraint (SIR), or air bag system.



CAUTION:

Don't let anyone ride where he or she can't wear a safety belt properly. If you are in a crash and you're not wearing a safety belt, your injuries can be much worse. You can hit things inside the vehicle or be ejected from it. You can be seriously injured or killed. In the same crash, you might not be if you are buckled up. Always fasten your safety belt, and check that your passengers' belts are fastened properly too.



CAUTION:

It is extremely dangerous to ride in a cargo area, inside or outside of a vehicle. In a collision, people riding in these areas are more likely to be seriously injured or killed. Do not allow people to ride in any area of your vehicle that is not equipped with seats and safety belts. Be sure everyone in your vehicle is in a seat and using a safety belt properly.



Your vehicle has a light that comes on as a reminder to buckle up. (See "Safety Belt Reminder Light" in the Index.)

In most states and Canadian provinces, the law says to wear safety belts. Here's why: *They work.*

You never know if you'll be in a crash. If you do have a crash, you don't know if it will be a bad one.

A few crashes are mild, and some crashes can be so serious that even buckled up a person wouldn't survive. But most crashes are in between. In many of them, people who buckle up can survive and sometimes walk away. Without belts they could have been badly hurt or killed.

After more than 25 years of safety belts in vehicles, the facts are clear. In most crashes buckling up does matter ... a lot!

Why Safety Belts Work

When you ride in or on anything, you go as fast as it goes.

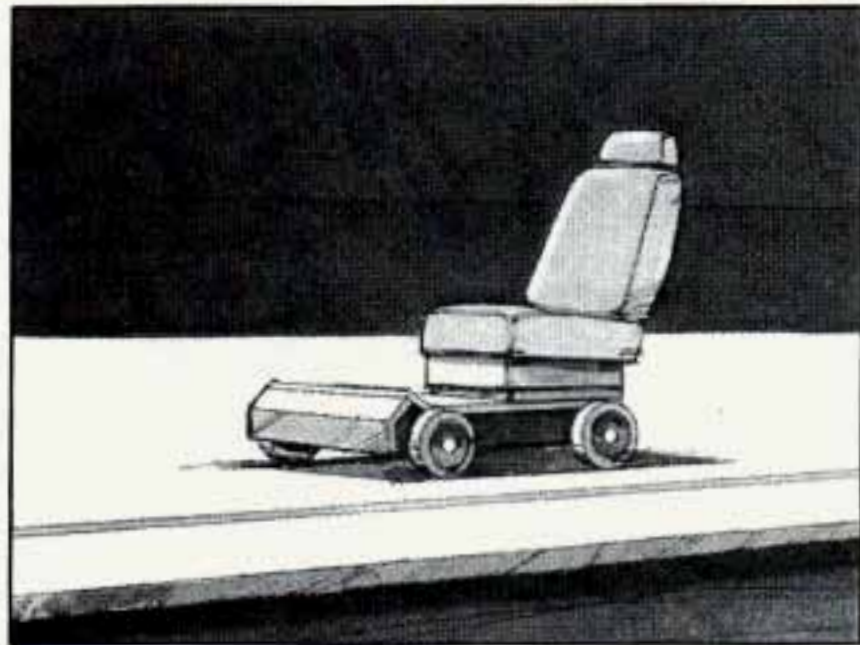

Take the simplest vehicle. Suppose it's just a seat on wheels.

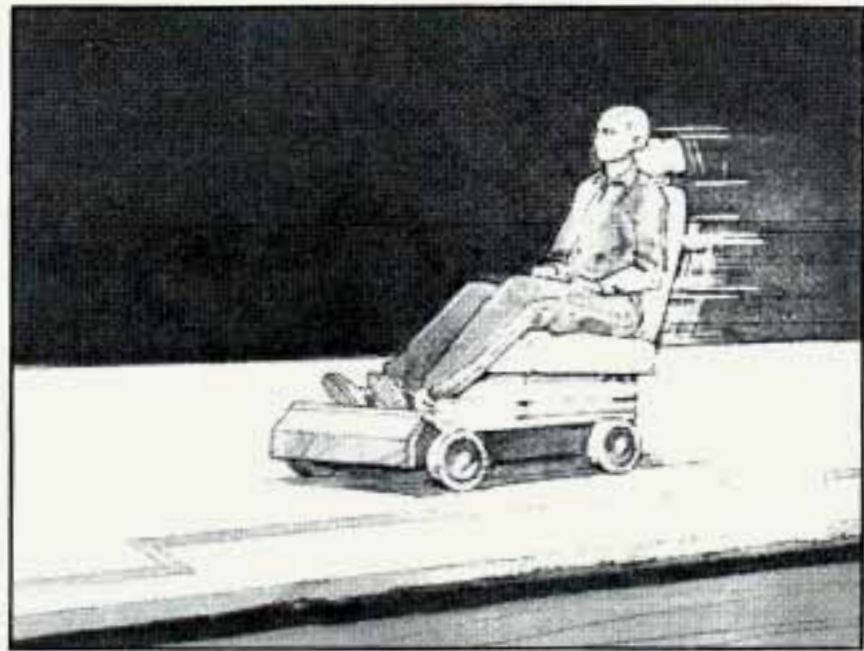

Put someone on it.

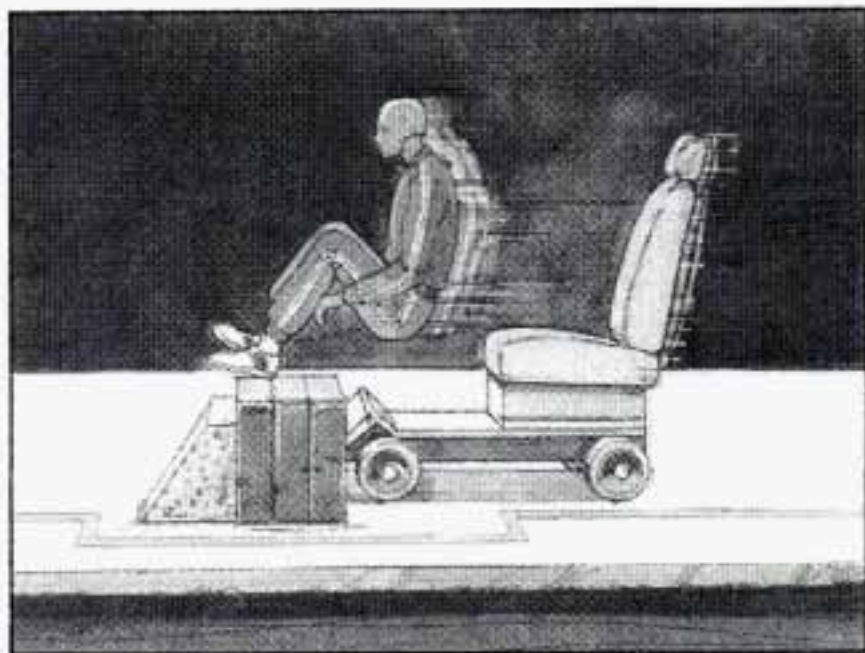

Get it up to speed. Then stop the vehicle. The rider doesn't stop.



The person keeps going until stopped by something. In a real vehicle, it could be the windshield ...

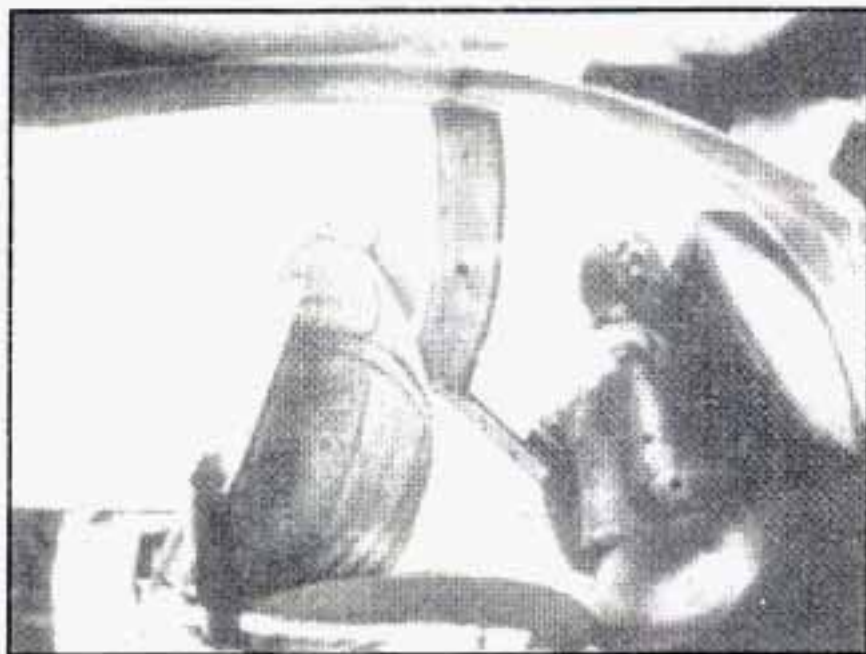

or the instrument panel ...

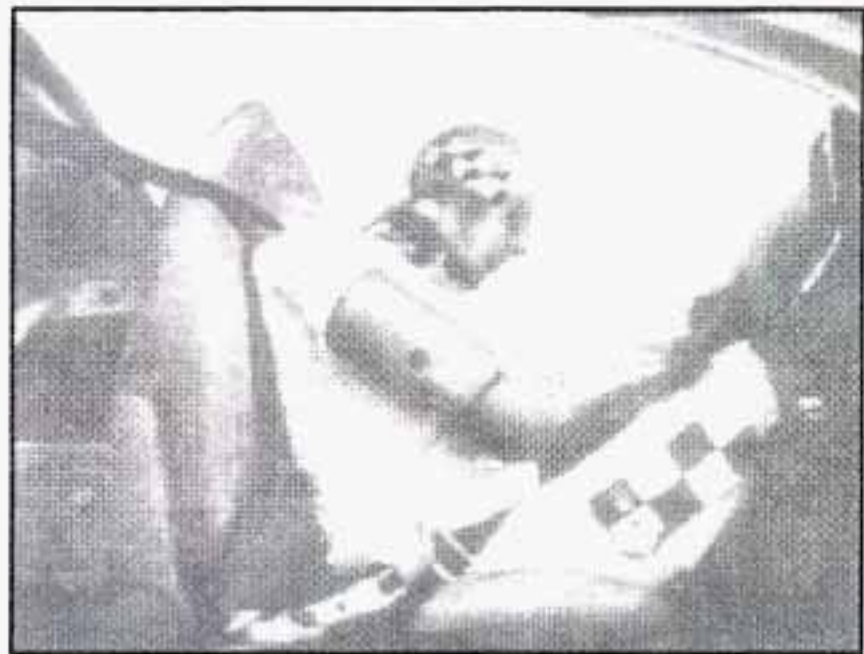

or the safety belts!

With safety belts, you slow down as the vehicle does. You get more time to stop. You stop over more distance, and your strongest bones take the forces. That's why safety belts make such good sense.

Here Are Questions Many People Ask About Safety Belts -- and the Answers

Q: Won't I be trapped in the vehicle after an accident if I'm wearing a safety belt?

A: You *could* be -- whether you're wearing a safety belt or not. But you can unbuckle a safety belt, even if you're upside down. And your chance of being conscious during and after an accident, so you *can* unbuckle and get out, is *much* greater if you are belted.

Q: If my vehicle has air bags, why should I have to wear safety belts?

A: Air bags are in many vehicles today and will be in most of them in the future. But they are supplemental systems only; so they work *with* safety belts -- not instead of them. Every air bag system ever offered for sale has required the use of safety belts. Even if you're in a vehicle that has air bags, you still have to buckle up to get the most protection. That's true not only in frontal collisions, but especially in side and other collisions.

Q: If I'm a good driver, and I never drive far from home, why should I wear safety belts?

A: You may be an excellent driver, but if you're in an accident -- even one that isn't your fault -- you and your passengers can be hurt. Being a good driver doesn't protect you from things beyond your control, such as bad drivers.

Most accidents occur within 25 miles (40 km) of home. And the greatest number of serious injuries and deaths occur at speeds of less than 40 mph (65 km/h).

Safety belts are for everyone.

How to Wear Safety Belts Properly

Adults

This part is only for people of adult size.

Be aware that there are special things to know about safety belts and children. And there are different rules for smaller children and babies. If a child will be riding in your Cadillac, see the part of this manual called "Children." Follow those rules for everyone's protection.

First, you'll want to know which restraint systems your vehicle has.

We'll start with the driver position.

Driver Position

This part describes the driver's restraint system.

Lap-Shoulder Belt

The driver has a lap-shoulder belt. Here's how to wear it properly.

1. Close and lock the door.
2. Adjust the seat (to see how, see "Seats" in the Index) so you can sit up straight.



3. Pick up the latch plate and pull the belt across you. Don't let it get twisted.
4. Push the latch plate into the buckle until it clicks.

Pull up on the latch plate to make sure it is secure. If the belt isn't long enough, see "Safety Belt Extender" at the end of this section.

Make sure the release button on the buckle is positioned so you would be able to unbuckle the safety belt quickly if you ever had to.

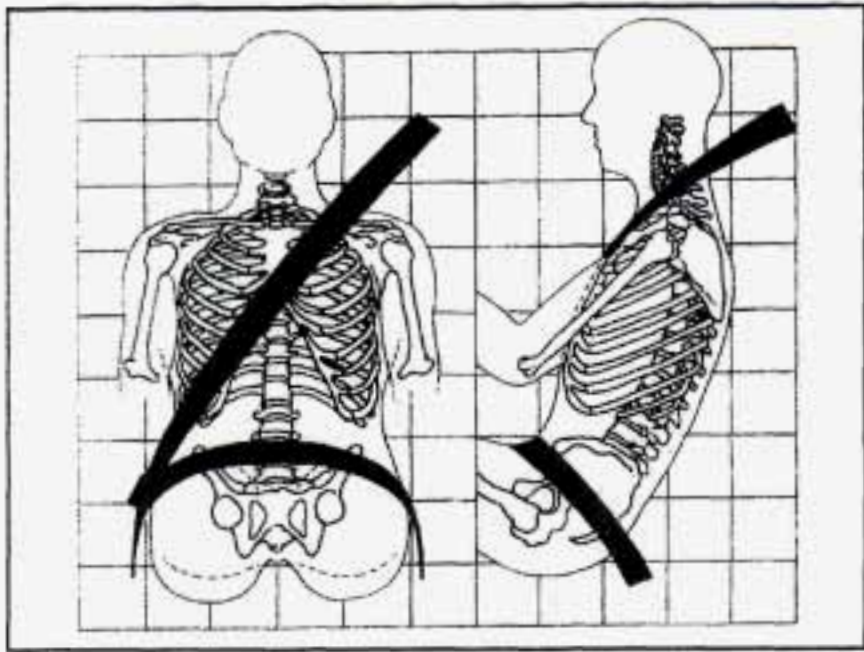

The lap part of the belt should be worn low and snug on the hips, just touching the thighs. In a crash, this applies force to the strong pelvic bones. And you'd be less likely to slide under the lap belt. If you slid under it, the belt would apply force at your abdomen. This could cause serious or even fatal injuries. The shoulder belt should go over the shoulder and across the chest. These parts of the body are best able to take belt restraining forces.

The safety belt locks if there's a sudden stop or crash.

Shoulder Belt Height Adjuster

Before you begin to drive, move the shoulder belt adjuster to the height that is right for you.



To move it down, squeeze the release handle and move the height adjuster to the desired position. You can move the adjuster up just by pushing up on the bottom of the release handle. After you move the adjuster to where you want it, try to move it down without squeezing the release handle to make sure it has locked into position.

Adjust the height so that the shoulder portion of the belt is centered on your shoulder. The belt should be away from your face and neck, but not falling off your shoulder.

Shoulder Belt Tightness Adjustment

Your car has a shoulder belt tightness adjustment feature. If the shoulder belt seems too tight, adjust it before you begin to drive.

1. Sit well back in the seat.
2. Start pulling the shoulder belt out.



3. Just before it reaches the end, give it a quick pull.
4. Let the belt go back all the way. You should hear a slight clicking sound. If you don't, the adjustment feature won't set, and you'll have to start again.



5. Now you can add a small amount of slack. Lean forward slightly, then sit back. If you've added more than 1 inch (25 mm) of slack, pull the shoulder belt out as you did before and start again.

If you move around in the vehicle enough, or if you pull out the shoulder belt, the belt will become tight again. If this happens, you can reset it.

Q: What's wrong with this?

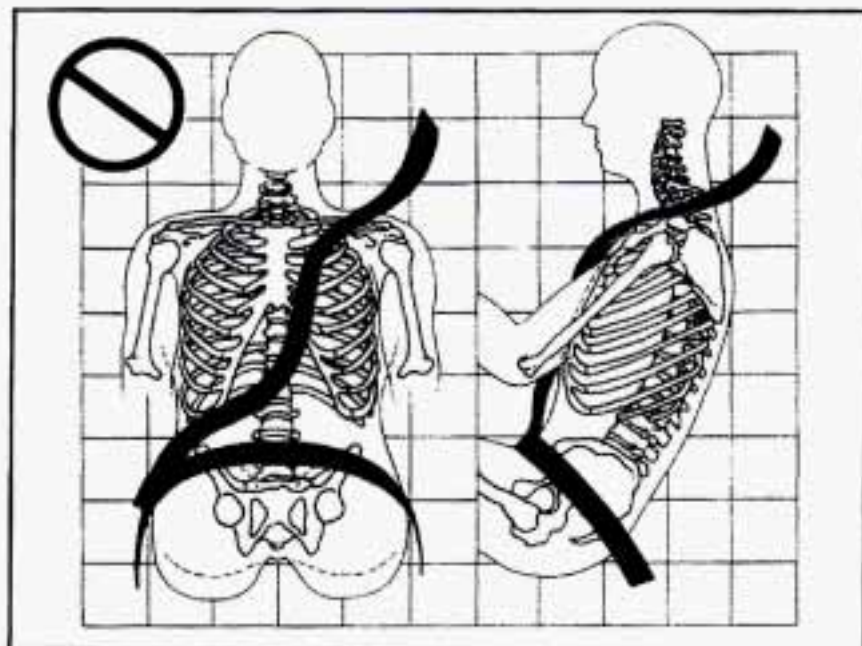

CAUTION:

You can be seriously hurt if your shoulder belt is too loose. In a crash, you would move forward too much, which could increase injury. The shoulder belt should fit against your body. Don't allow more than 1 inch (25 mm) of slack.

A: The shoulder belt is too loose. It won't give nearly as much protection this way.

Q: What's wrong with this?

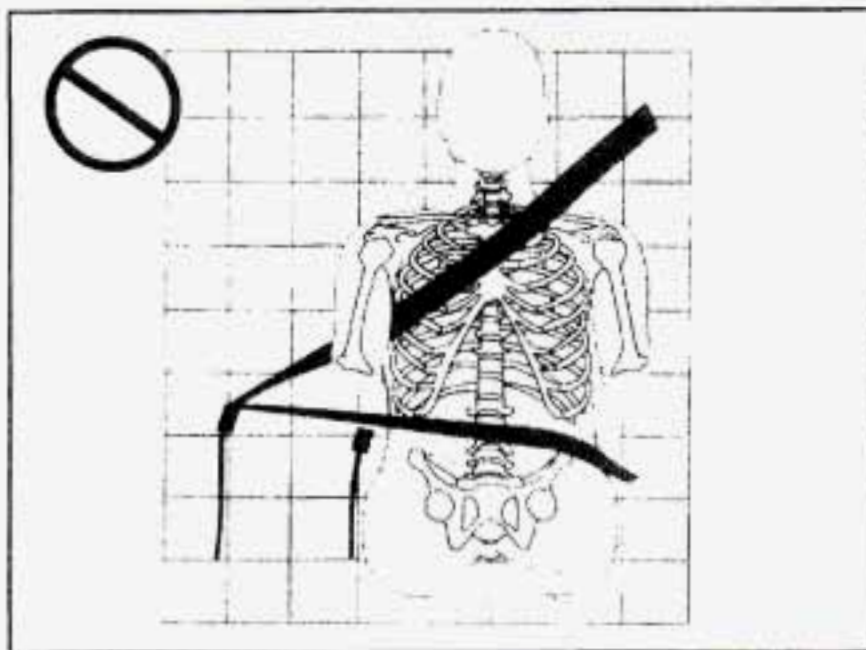

A: The belt is buckled in the wrong place.



CAUTION:

You can be seriously injured if your belt is buckled in the wrong place like this. In a crash, the belt would go up over your abdomen. The belt forces would be there, not at the pelvic bones. This could cause serious internal injuries. Always buckle your belt into the buckle nearest you.

Q: What's wrong with this?

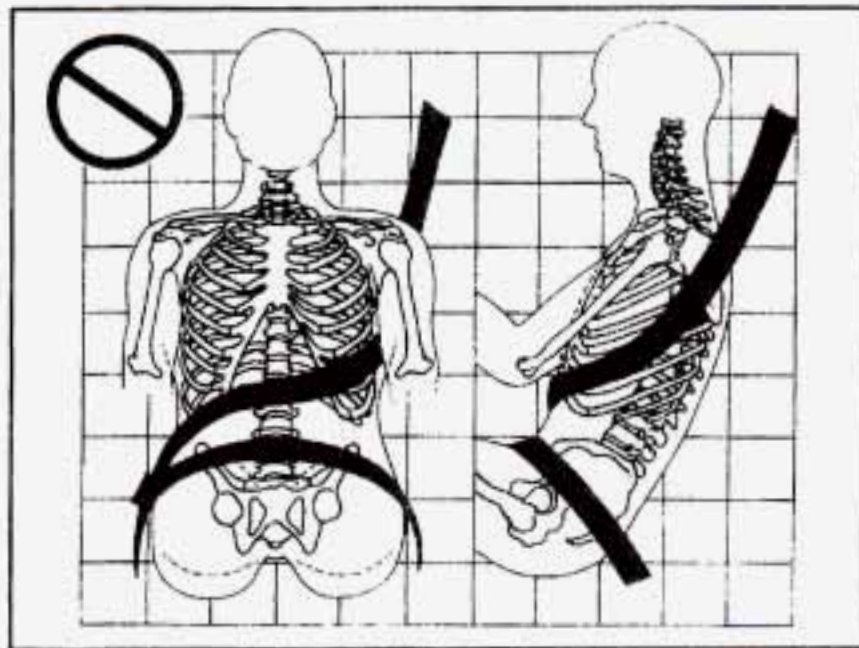

CAUTION:

You can be seriously injured if you wear the shoulder belt under your arm. In a crash, your body would move too far forward, which would increase the chance of head and neck injury. Also, the belt would apply too much force to the ribs, which aren't as strong as shoulder bones. You could also severely injure internal organs like your liver or spleen.

A: The shoulder belt is worn under the arm. It should be worn over the shoulder at all times.

Q: What's wrong with this?

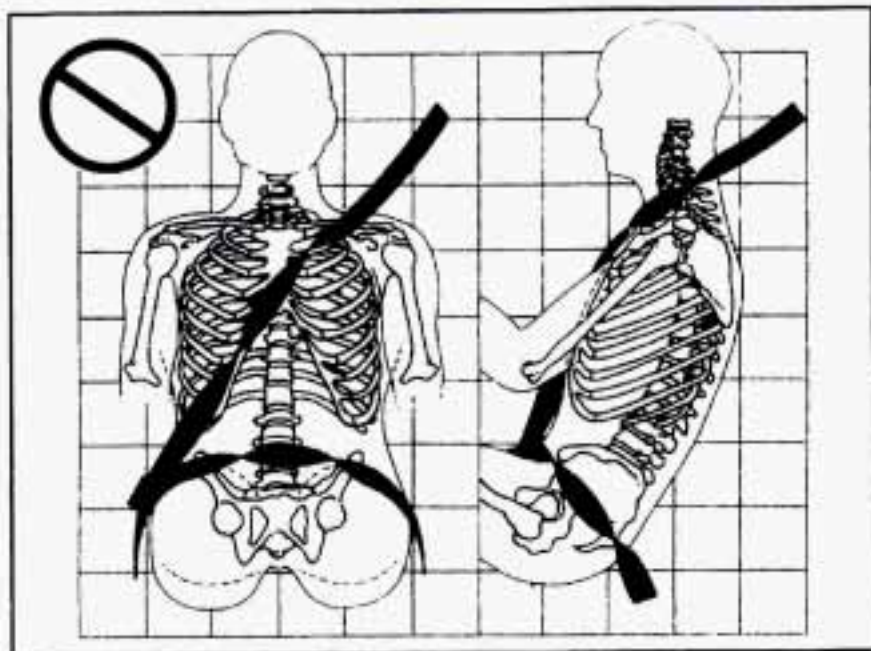

A: The belt is twisted across the body.

⚠ CAUTION:

You can be seriously injured by a twisted belt. In a crash, you wouldn't have the full width of the belt to spread impact forces. If a belt is twisted, make it straight so it can work properly, or ask your dealer to fix it.



To unfasten the belt, just push the button on the buckle. The belt should go back out of the way.

Before you close the door, be sure the belt is out of the way. If you slam the door on it, you can damage both the belt and your vehicle.

Safety Belt Use During Pregnancy

Safety belts work for everyone, including pregnant women. Like all occupants, they are more likely to be seriously injured if they don't wear safety belts.

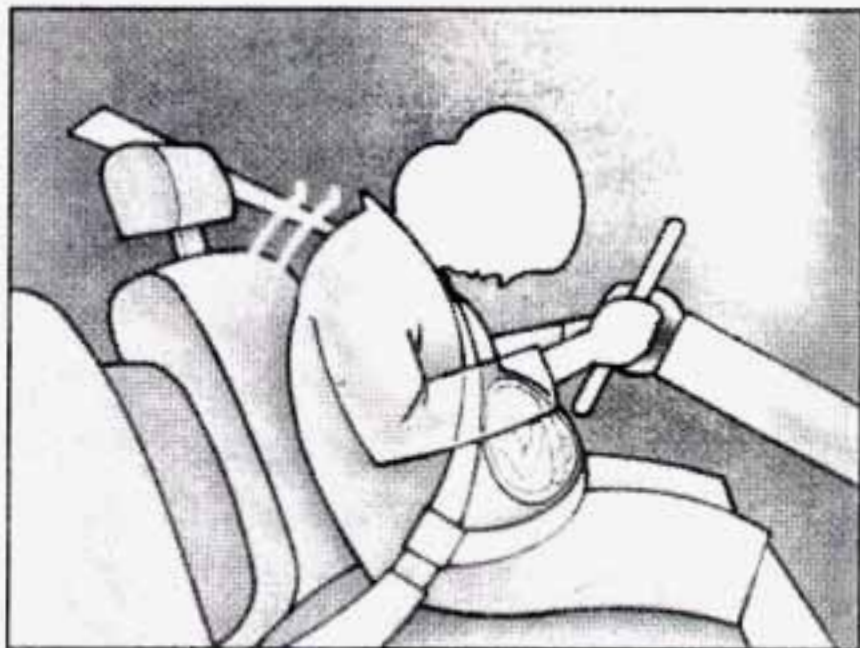

A pregnant woman should wear a lap-shoulder belt, and the lap portion should be worn as low as possible, below the rounding, throughout the pregnancy.

The best way to protect the fetus is to protect the mother. When a safety belt is worn properly, it's more likely that the fetus won't be hurt in a crash. For pregnant women, as for anyone, the key to making safety belts effective is wearing them properly.

Right Front Passenger Position

The right front passenger's safety belt works the same way as the driver's safety belt. See "Driver Position," earlier in this section.

When the lap portion of the belt is pulled out all the way, it will lock. If it does, let it go back all the way and start again.

Supplemental Inflatable Restraint (SIR) System

This part explains the Supplemental Inflatable Restraint (SIR) system or air bag system.

Your Cadillac has two air bags -- one air bag for the driver and another air bag for the right front passenger.

Here are the most important things to know about the air bag system:

CAUTION:

You can be severely injured or killed in a crash if you aren't wearing your safety belt -- even if you have air bags. Wearing your safety belt during a crash helps reduce your chance of hitting things inside the vehicle or being ejected from it. Air bags are "supplemental restraints" to the safety belts. All air bags are designed to work with safety belts, but don't replace them. Air bags are designed to work only in moderate to severe crashes where the front of your vehicle hits something. They aren't designed to inflate at all in rollover, rear, side or low-speed frontal crashes. Everyone in your vehicle should wear a safety belt properly -- whether or not there's an air bag for that person.

 **CAUTION:**

Air bags inflate with great force, faster than the blink of an eye. If you're too close to an inflating air bag, it could seriously injure you. Safety belts help keep you in position before and during a crash. Always wear your safety belt, even with air bags. The driver should sit as far back as possible while still maintaining control of the vehicle.

 **CAUTION:**

An inflating air bag can seriously injure small children. Always secure children properly in your vehicle. To read how, see the part of this manual called "Children" and the caution label on the right front passenger's safety belt.

AIR BAG

There is an air bag readiness light on the instrument panel, which shows AIR BAG.

The system checks the air bag electrical system for malfunctions. The light tells you if there is an electrical problem. See "Air Bag Readiness Light" in the Index for more information.

How the Air Bag System Works



Where are the air bags?

The driver's air bag is in the middle of the steering wheel.



The right front passenger's air bag is in the instrument panel on the passenger's side.



CAUTION:

If something is between an occupant and an air bag, the bag might not inflate properly or it might force the object into that person. The path of an inflating air bag must be kept clear. Don't put anything between an occupant and an air bag, and don't attach or put anything on the steering wheel hub or on or near any other air bag covering.

When should an air bag inflate?

An air bag is designed to inflate in a moderate to severe frontal or near-frontal crash. The air bag will inflate only if the impact speed is above the system's designed "threshold level." If your vehicle goes straight into a wall that doesn't move or deform, the threshold level is about 9 to 15 mph (14 to 24 km/h). The threshold level can vary, however, with specific vehicle design, so that

it can be somewhat above or below this range. If your vehicle strikes something that will move or deform, such as a parked car, the threshold level will be higher. The air bag is not designed to inflate in rollovers, side impacts or rear impacts, because inflation would not help the occupant.

In any particular crash, no one can say whether an air bag should have inflated simply because of the damage to a vehicle or because of what the repair costs were. Inflation is determined by the angle of the impact and how quickly the vehicle slows down in frontal or near-frontal impacts.

What makes an air bag inflate?

In an impact of sufficient severity, the air bag sensing system detects that the vehicle is in a crash. The sensing system triggers a release of gas from the inflator, which inflates the air bag. The inflator, air bag and related hardware are all part of the air bag modules inside the steering wheel and in the instrument panel in front of the right front passenger.

How does an air bag restrain?

In moderate to severe frontal or near-frontal collisions, even belted occupants can contact the steering wheel or the instrument panel. Air bags supplement the protection provided by safety belts. Air bags distribute the force of the impact more evenly over the occupant's upper body, stopping the occupant more gradually. But air bags would not help you in many types of collisions, including rollovers, rear impacts and side impacts, primarily because an occupant's motion is not toward those air bags. Air bags should never be regarded as anything more than a supplement to safety belts, and then only in moderate to severe frontal or near-frontal collisions.

What will you see after an air bag inflates?

After an air bag inflates, it quickly deflates, so quickly that some people may not even realize the air bag inflated. Some components of the air bag module -- the steering wheel hub for the driver's air bag, or the instrument panel for the right front passenger's bag -- will be hot for a short time. The parts of the bag that come into contact with you may be warm, but not too hot to touch. There will be some smoke and dust coming from vents in the deflated air bags. Air bag inflation doesn't prevent the driver from seeing or from being able to steer the vehicle, nor does it stop people from leaving the vehicle.



CAUTION:

When an air bag inflates, there is dust in the air. This dust could cause breathing problems for people with a history of asthma or other breathing trouble. To avoid this, everyone in the vehicle should get out as soon as it is safe to do so. If you have breathing problems but can't get out of the vehicle after an air bag inflates, then get fresh air by opening a window or door.

Your vehicle has a feature that will automatically unlock the doors and turn the interior lamps on when the air bags inflate (if battery power is available). You can lock the doors again and turn the interior lamps off by using the door lock and interior lamp controls.

In many crashes severe enough to inflate an air bag, windshields are broken by vehicle deformation. Additional windshield breakage may also occur from the right front passenger air bag.

- Air bags are designed to inflate only once. After they inflate, you'll need some new parts for your air bag system. If you don't get them, the air bag system won't be there to help protect you in another crash. A new system will include air bag modules and possibly other parts. The service manual for your vehicle covers the need to replace other parts.
- Your vehicle is equipped with a crash sensing and diagnostic module, which records information about the air bag system. The module records information about the readiness of the system, when the sensors are activated and driver's safety belt usage at deployment.
- Let only qualified technicians work on your air bag system. Improper service can mean that your air bag system won't work properly. See your dealer for service.

NOTICE:

If you damage the covering for the driver's air bag, it may not work properly. You may have to replace the air bag module. Do not open or break the air bag covering.

Servicing Your Air Bag-Equipped Cadillac

Air bags affect how your Cadillac should be serviced. There are parts of the air bag system in several places around your vehicle. You don't want the system to inflate while someone is working on your vehicle. Your Cadillac dealer and the Cadillac Service Manual have information about servicing your vehicle and the air bag system. To purchase a service manual, see "Service and Owner Publications" in the Index.



CAUTION:

For up to 10 seconds after the ignition key is turned off and the battery is disconnected, an air bag can still inflate during improper service. You can be injured if you are close to an air bag when it inflates. Avoid wires wrapped with yellow tape or yellow connectors. They are probably part of the air bag system. Be sure to follow proper service procedures, and make sure the person performing work for you is qualified to do so.

The air bag system does not need regular maintenance.

Rear Seat Passengers

It's very important for rear seat passengers to buckle up! Accident statistics show that unbelted people in the rear seat are hurt more often in crashes than those who are wearing safety belts.

Rear passengers who aren't safety belted can be thrown out of the vehicle in a crash. And they can strike others in the vehicle who are wearing safety belts.

Rear Seat Outside Passenger Positions

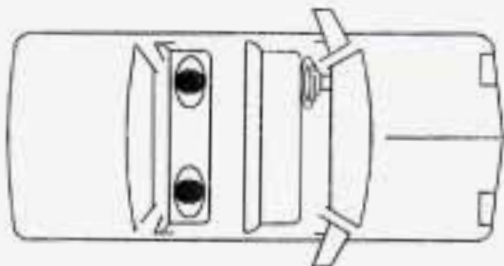

Lap-Shoulder Belt

The positions next to the windows have lap-shoulder belts. Here's how to wear one properly.



1. Pick up the latch plate and pull the belt across you. Don't let it get twisted.

The shoulder belt may lock if you pull the belt across you very quickly. If this happens, let the belt go back slightly to unlock it. Then pull the belt across you more slowly.

2. Push the latch plate into the buckle until it clicks.

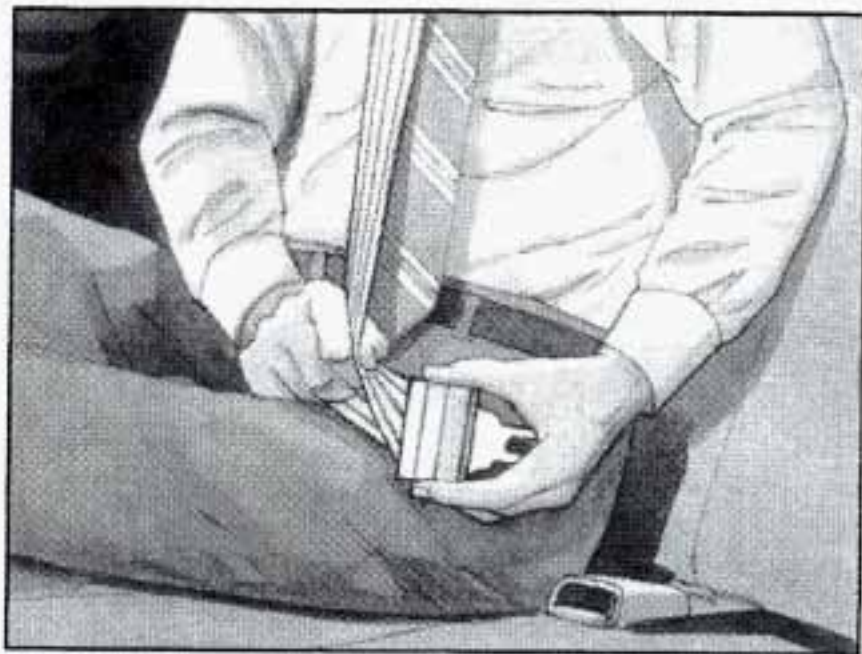

If the belt stops before it reaches the buckle, tilt the latch plate and keep pulling until you can buckle it.

Pull up on the latch plate to make sure it is secure.

If the belt is not long enough, see "Safety Belt Extender" at the end of this section. Make sure the release button on the buckle is positioned so you would be able to unbuckle the safety belt quickly if you ever had to.



3. To make the lap part tight, pull down on the buckle end of the belt as you pull up on the shoulder part.

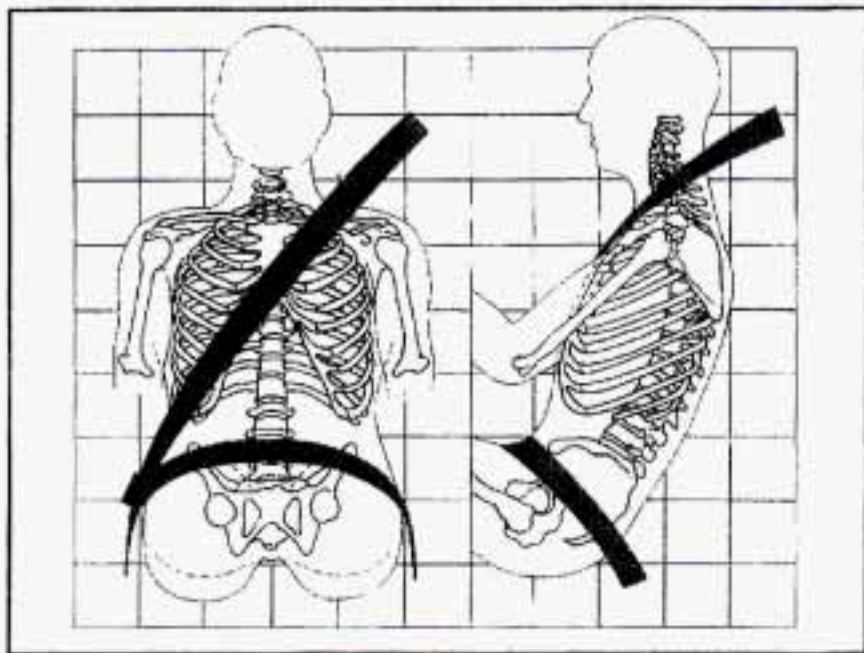

The lap part of the belt should be worn low and snug on the hips, just touching the thighs. In a crash, this applies force to the strong pelvic bones. And you'd be less likely to slide under the lap belt. If you slid under it, the belt would apply force at your abdomen. This could cause serious or even fatal injuries. The shoulder belt should go over the shoulder and across the chest. These parts of the body are best able to take belt restraining forces.

The safety belt locks if there's a sudden stop or a crash, or if you pull the belt very quickly out of the retractor.



CAUTION:

You can be seriously hurt if your shoulder belt is too loose. In a crash, you would move forward too much, which could increase injury. The shoulder belt should fit against your body.



To unlatch the belt, just push the button on the buckle.

Center Passenger Position

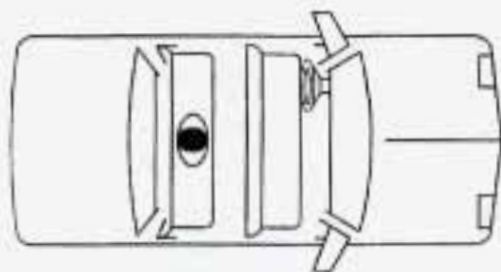

Lap Belt



When you sit in the center seating position, you have a lap safety belt, which has no retractor. To make the belt longer, tilt the latch plate and pull it along the belt.



To make the belt shorter, pull its free end as shown until the belt is snug.

Buckle, position and release it the same way as the lap part of a lap-shoulder belt. If the belt isn't long enough, see "Safety Belt Extender" at the end of this section.

Make sure the release button on the buckle is positioned so you would be able to unbuckle the safety belt quickly if you ever had to.

Children

Everyone in a vehicle needs protection! That includes infants and all children smaller than adult size. In fact, the law in every state in the United States and in every Canadian province says children up to some age must be restrained while in a vehicle.

Smaller Children and Babies

CAUTION:

Smaller children and babies should always be restrained in a child or infant restraint. The instructions for the restraint will say whether it is the right type and size for your child. A very young child's hip bones are so small that a regular belt might not stay low on the hips, as it should. Instead, the belt will likely be over the child's abdomen. In a crash, the belt would apply force right on the child's abdomen, which could cause serious or fatal injuries. So, be sure that any child small enough for one is always properly restrained in a child or infant restraint.



⚠ CAUTION:

Never hold a baby in your arms while riding in a vehicle. A baby doesn't weigh much -- until a crash. During a crash a baby will become so

CAUTION: (Continued)

CAUTION: (Continued)

heavy you can't hold it. For example, in a crash at only 25 mph (40 km/h), a 12-lb. (5.5 kg) baby will suddenly become a 240-lb. (110 kg) force on your arms. The baby would be almost impossible to hold.

Secure the baby in an infant restraint.



Child Restraints

Be sure the child restraint is designed to be used in a vehicle. If it is, it will have a label saying that it meets Federal Motor Vehicle Safety Standards.

Then follow the instructions for the restraint. You may find these instructions on the restraint itself or in a booklet, or both. These restraints use the belt system in your vehicle, but the child also has to be secured within the restraint to help reduce the chance of personal injury. The instructions that come with the infant or child restraint will show you how to do that.

Where to Put the Restraint

Accident statistics show that children are safer if they are restrained in the rear rather than the front seat. We at General Motors therefore recommend that you put your child restraint in the rear seat. *Never* put a rear-facing child restraint in the front passenger seat. Here's why:



CAUTION:

A child in a rear-facing child restraint can be seriously injured if the right front passenger's air bag inflates. This is because the back of a rear-facing child restraint would be very close to the inflating air bag. Always secure a rear-facing child restraint in the rear seat.

You may, however, secure a forward-facing child restraint in the right front seat. Before you secure a forward-facing child restraint, always move the front passenger seat as far back as it will go. Or, secure the child restraint in the rear seat.

Wherever you install it, be sure to secure the child restraint properly.

Keep in mind that an unsecured child restraint can move around in a collision or sudden stop and injure people in the vehicle. Be sure to properly secure any child restraint in your vehicle -- even when no child is in it.

Top Strap

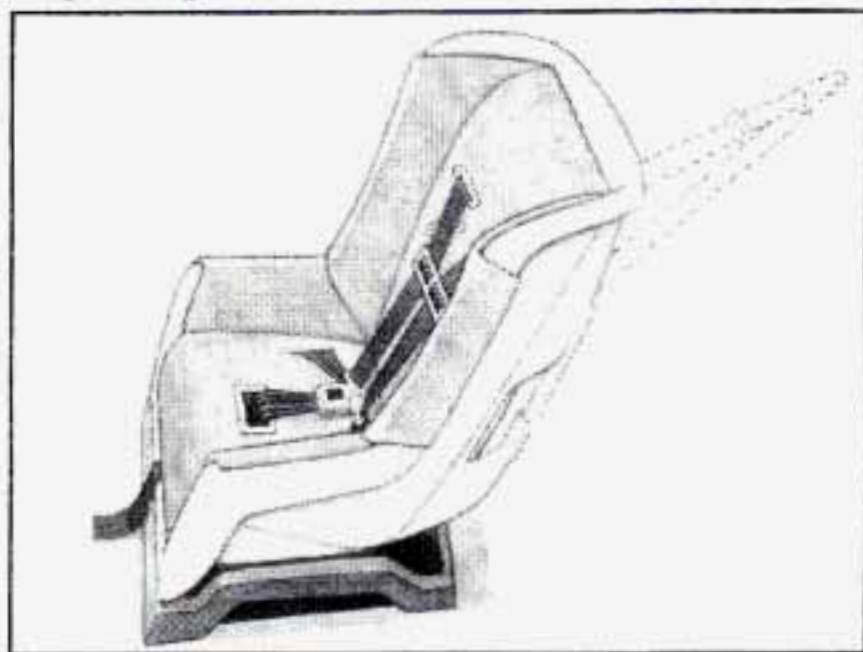

If your child restraint has a top strap, it should be anchored. If you need to have an anchor installed, you can ask your Cadillac dealer to put it in for you. If you want to install an anchor yourself, your dealer can tell you how to do it.

Canadian law requires that child restraints have a top strap, and that the strap be anchored.

If your child restraint has a top strap, your dealer can obtain a kit with anchor hardware and installation instructions specifically designed for this vehicle. The dealer can then install the anchor for you. In Canada, this work will be done for you free of charge. Or, you may install the anchor yourself using the instructions provided in the kit.

Securing a Child Restraint in a Rear Outside Seat Position

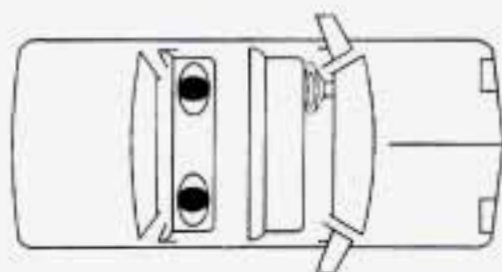

You'll be using the lap-shoulder belt. See the earlier part about the top strap if the child restraint has one.

1. Put the restraint on the seat. Follow the instructions for the child restraint.
2. Secure the child in the child restraint as the instructions say.

3. Pick up the latch plate, and run the lap and shoulder portions of the vehicle's safety belt through or around the restraint. The child restraint instructions will show you how.



Tilt the latch plate to adjust the belt if needed.

If the shoulder belt goes in front of the child's face or neck, put it behind the child restraint.



4. Buckle the belt. Make sure the release button is positioned so you would be able to unbuckle the safety belt quickly if you ever had to.



Securing a Child Restraint in the Center Rear Seat Position

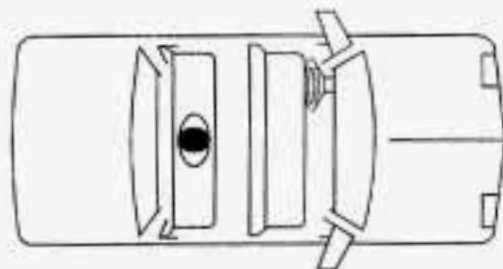

You'll be using the lap belt.

See the earlier part about the top strap if the child restraint has one.

5. To tighten the belt, pull up on the shoulder belt while you push down on the child restraint.
6. Push and pull the child restraint in different directions to be sure it is secure.

To remove the child restraint, just unbuckle the vehicle's safety belt and let it go back all the way. The safety belt will move freely again and be ready to work for an adult or larger child passenger.

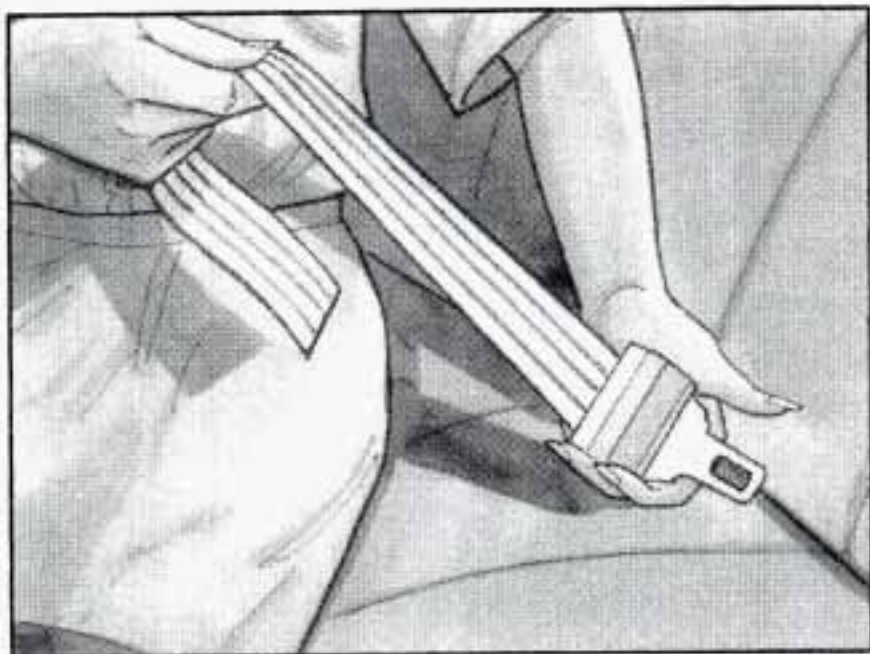

1. Make the belt as long as possible by tilting the latch plate and pulling it along the belt.
2. Put the restraint on the seat. Follow the instructions for the child restraint.
3. Secure the child in the child restraint as the instructions say.
4. Run the vehicle's safety belt through or around the restraint. The child restraint instructions will show you how.



5. Buckle the belt. Make sure the release button is positioned so you would be able to unbuckle the safety belt quickly if you ever had to.
6. To tighten the belt, pull its free end while you push down on the child restraint.
7. Push and pull the child restraint in different directions to be sure it is secure. If it isn't, secure the restraint in a different place in the vehicle and contact the child restraint maker for their advice about how to attach the child restraint properly.

To remove the child restraint, just unbuckle the vehicle's safety belt. It will be ready to work for an adult or larger child passenger.

Securing a Child Restraint in the Right Front Seat Position

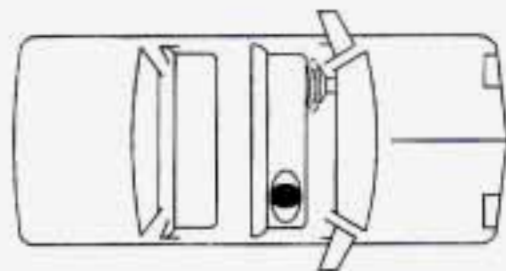

Your vehicle has a right front passenger air bag. *Never* put a rear-facing child restraint in this seat. Here's why:

CAUTION:

A child in a rear-facing child restraint can be seriously injured if the right front passenger's air bag inflates. This is because the back of a rear-facing child restraint would be very close to the inflating air bag. Always secure a rear-facing child restraint in the rear seat.

You'll be using the lap-shoulder belt. See the earlier part about the top strap if the child restraint has one.

1. Because your vehicle has a right front passenger air bag, always move the seat as far back as it will go before securing a forward-facing child restraint. (See "Seats" in the Index.)
2. Put the restraint on the seat. Follow the instructions for the child restraint.
3. Secure the child in the child restraint as the instructions say.
4. Pick up the latch plate, and run the lap and shoulder portions of the vehicle's safety belt through or around the restraint. The child restraint instructions will show you how.

If the shoulder belt goes in front of the child's face or neck, put it behind the child restraint.



5. Buckle the belt. Make sure the release button is positioned so you would be able to unbuckle the safety belt quickly if you ever had to.



6. Pull the rest of the lap belt all the way out of the retractor to set the lock.



7. To tighten the belt, feed the lap belt back into the retractor while you push down on the child restraint.
8. Push and pull the child restraint in different directions to be sure it is secure.

To remove the child restraint, just unbuckle the vehicle's safety belt and let it go back all the way. The safety belt will move freely again and be ready to work for an adult or larger child passenger.

Larger Children



Children who have outgrown child restraints should wear the vehicle's safety belts.

If you have the choice, a child should sit next to a window so the child can wear a lap-shoulder belt and get the additional restraint a shoulder belt can provide.

Accident statistics show that children are safer if they are restrained in the rear seat. But they need to use the safety belts properly.

- Children who aren't buckled up can be thrown out in a crash.
- Children who aren't buckled up can strike other people who are.



⚠ CAUTION:

Never do this.

Here two children are wearing the same belt. The belt can't properly spread the impact forces. In a crash, the two children can be crushed together and seriously injured. A belt must be used by only one person at a time.

Q: What if a child is wearing a lap-shoulder belt, but the child is so small that the shoulder belt is very close to the child's face or neck?

A: Move the child toward the center of the vehicle, but be sure that the shoulder belt still is on the child's shoulder, so that in a crash the child's upper body would have the restraint that belts provide. If the child is so small that the shoulder belt is still very close to the child's face or neck, you might want to place the child in the center seat position, the one that has only a lap belt.



⚠ CAUTION:

Never do this.

Here a child is sitting in a seat that has a lap-shoulder belt, but the shoulder part is behind the child. If the child wears the belt in this way, in a crash the child might slide under the belt. The belt's force would then be applied right on the child's abdomen. That could cause serious or fatal injuries.

Wherever the child sits, the lap portion of the belt should be worn low and snug on the hips, just touching the child's thighs. This applies belt force to the child's pelvic bones in a crash.

Safety Belt Extender

If the vehicle's safety belt will fasten around you, you should use it.

But if a safety belt isn't long enough to fasten, your dealer will order you an extender. It's free. When you go in to order it, take the heaviest coat you will wear, so the extender will be long enough for you. The extender will be just for you, and just for the seat in your vehicle that you choose. Don't let someone else use it, and use it only for the seat it is made to fit. To wear it, just attach it to the regular safety belt.

Checking Your Restraint Systems

Now and then, make sure the safety belt reminder light and all your belts, buckles, latch plates, retractors and anchorages are working properly. Look for any other loose or damaged safety belt system parts. If you see anything that might keep a safety belt system from doing its job, have it repaired.

Torn or frayed safety belts may not protect you in a crash. They can rip apart under impact forces. If a belt is torn or frayed, get a new one right away.

Also look for any opened or broken air bag covers, and have them repaired or replaced. (The air bag system does not need regular maintenance.)

Replacing Restraint System Parts After a Crash

If you've had a crash, do you need new belts?

After a very minor collision, nothing may be necessary. But if the belts were stretched, as they would be if worn during a more severe crash, then you need new belts.

If belts are cut or damaged, replace them. Collision damage also may mean you will need to have safety belt or seat parts repaired or replaced. New parts and repairs may be necessary even if the belt wasn't being used at the time of the collision.

If an air bag inflates, you'll need to replace air bag system parts. See the part on the air bag system earlier in this section.



Section 2 Features and Controls

Here you can learn about the many standard and optional features on your Cadillac, and information on starting, shifting and braking. Also explained are the instrument panel and the warning systems that tell you if everything is working properly -- and what to do if you have a problem.

2-2	Keys	2-34	Running Your Engine While You're Parked
2-4	Door Locks	2-35	Windows
2-7	Remote Keyless Entry (RKE) System	2-36	Tilt Wheel
2-12	Trunk	2-37	Turn Signal/Multifunction Lever
2-16	Theft	2-45	Lamps
2-16	Theft-Deterrent System	2-52	Mirrors
2-18	PASS-Key [®] II	2-57	Storage Compartments
2-19	New Vehicle "Break-In"	2-61	Cellular Telephone
2-20	Ignition Positions	2-63	Astrorooft (Option)
2-21	Starting Your Engine	2-64	Universal Transmitter
2-23	Engine Coolant Heater	2-68	The Instrument Panel: Your Information System
2-24	Automatic Transaxle Operation	2-70	Digital Cluster (SLS Only)
2-28	Parking Brake	2-71	Analog Cluster (If Equipped)
2-29	Shifting Into PARK (P)	2-74	Warning Lights, Gages and Indicators
2-32	Shifting Out of PARK (P)	2-85	Driver Information Center (DIC)
2-33	Parking Over Things That Burn		
2-33	Engine Exhaust		

Keys

CAUTION:

Leaving young children in a vehicle with the ignition key is dangerous for many reasons. A child or others could be badly injured or even killed.

They could operate power windows or other controls or even make the vehicle move. If they turned the ignition to ON and moved the shift lever out of PARK (P), that would release the parking brake. Don't leave the keys in a vehicle with young children.

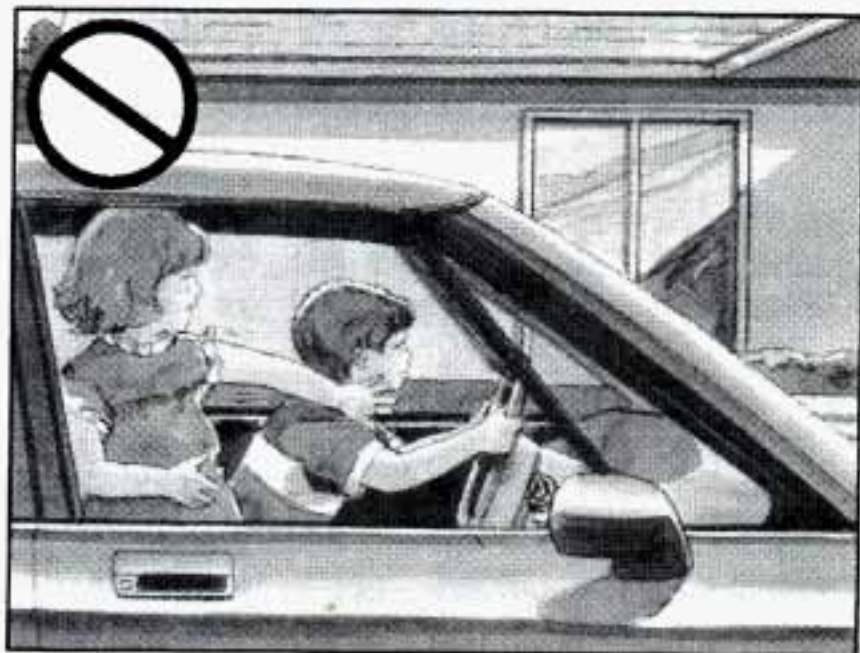



The square key is for the ignition only. It has a resistor pellet which is part of the vehicle's PASS-Key[®] II system.



The oval key is for the doors and all other locks.

When a new Cadillac is delivered, the dealer removes the plug from the door key. The plug has a code on it that tells the dealer or a qualified locksmith how to make extra keys. The ignition key has a bar code tag attached to it rather than a knock out plug. Your dealer or qualified locksmith can make extra ignition keys by reading the bar code tag.

Keep the bar code tag and the door key plugs in a safe place. If you lose your keys, you will be able to have new ones made using the plug or bar code tag.

NOTICE:

Your Cadillac has a number of new features that can help prevent theft. You can have a lot of trouble getting into your vehicle if you ever lock your keys inside and you may have to damage your vehicle to get in. Be sure you have extra keys.

Door Locks

CAUTION:

Unlocked doors can be dangerous.

Passengers -- especially children -- can easily open the doors and fall out. When a door is locked, the inside handle won't open it.

Outsiders can easily enter through an unlocked door when you slow down or stop your vehicle.

This may not be so obvious: You increase the chance of being thrown out of the vehicle in a crash if the doors aren't locked. Wear safety belts properly, lock your doors and you will be far better off whenever you drive your vehicle.

There are several ways to lock and unlock your vehicle. From the outside, use either the door key or the Remote Keyless Entry (RKE) transmitter.

If your vehicle has the optional theft-deterrent system, you must unlock the doors with the key or RKE transmitter to avoid setting off the alarm.

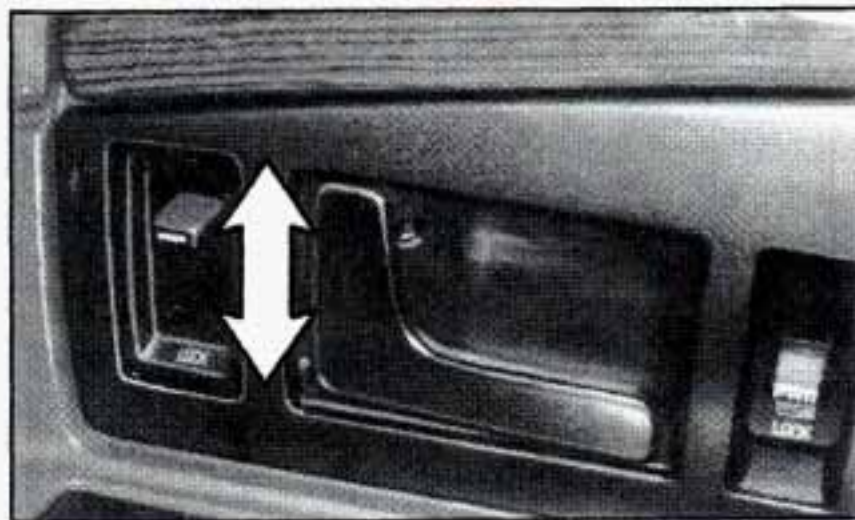

Slide the manual lock lever down to lock the door from the inside. To unlock the door, slide the lock lever up.

Central Door Unlocking System

Your vehicle will have this feature if it is equipped with the optional theft-deterrent system. When unlocking either front door, you can unlock the other doors by holding the key in the turned position for a few seconds or by quickly rotating the door key twice in the lock cylinder.

Power Door Locks

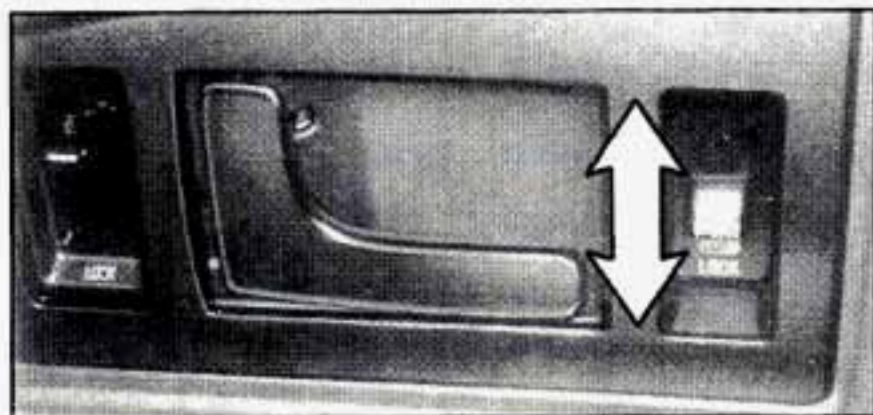

Press the power door lock to lock or unlock all the doors at once. The rear power door locks only provide a lock function as a safety feature. They will not unlock the doors.

Automatic Door Locks

Close your doors and turn on the ignition. Every time you move the shift lever out of PARK (P), all of the doors will lock. The doors will unlock every time you stop the vehicle and move the shift lever into PARK (P).

If someone needs to get out while your vehicle is not in PARK (P), have that person use the manual or power lock. When the door is closed again, it will not lock automatically. Use the manual or power lock to lock the door again. If you need to lock the doors before shifting out of PARK (P), use the manual or power lock button to lock the doors.

Programmable Automatic Door Locks (If Equipped)

With the ignition in the RUN position, the door locks can be programmed through prompts displayed by the Driver Information Center (DIC). These prompts allow the driver to choose various lock settings. If your vehicle has memory, press the appropriate driver (1 or 2), prior to programming.

To begin programming, press and hold the INFORMATION (INFO) and RESET (INFO RESET) buttons at the same time to display the following prompts.

DOORS LOCK IN GEAR: All doors automatically lock when shifted out of PARK (P). No automatic door unlock.

DOORS UNLOCK IN PARK: All doors automatically lock when shifted out of PARK (P). All doors automatically unlock when shifted into PARK (P).

DRIVR UNLOCK IN PARK: All doors automatically lock when shifted out of PARK (P). Only the driver's door automatically unlocks when shifted into PARK (P).

A "yes" or "no" response must be made after each prompt is displayed in order to continue on to the next prompt or personalization feature. Press the TRIP SET (TRIP RESET) button to choose yes, press the RESET (INFO RESET) button to choose no or press the INFORMATION (INFO) button to "skip" to the next personalization feature.

FEATURE ON appears when a yes response is made and FEATURE OFF appears with a no response.

If a no response is made after the DOORS LOCK IN GEAR prompt is displayed, FEATURE OFF will appear. The automatic door locking system has been disabled and no other door lock messages will be displayed. REMOTE FLASH LIGHTS, which is the next available personalization feature to display, will appear next. See "Remote Confirmation" in the Index for more information.

If a yes response is made after the DOORS LOCK IN GEAR prompt is displayed, FEATURE ON appears. The automatic door locking system is enabled and

allows the DOORS UNLOCK IN PARK prompt to appear. Choosing this prompt advances you to REMOTE FLASH LIGHTS whereas a no response will display the DRIVR UNLOCK IN PARK prompt. A yes or no response here automatically brings up the REMOTE FLASH LIGHTS feature.

Rear Door Security Lock



Your Cadillac is equipped with rear door security locks that help prevent passengers from opening the rear doors of your vehicle from the inside. To use this lock:

1. Move the lever on the door all the way up to the ENGAGED position.
2. Close the door.
3. Do the same thing to the other rear door lock.

The rear doors of your vehicle cannot be opened from the inside when this feature is in use.

When you want to open a rear door when the security lock is on:

1. Unlock the door from the inside.
2. Then open the door from the outside.

To cancel the rear door lock:

1. Unlock the door from the inside and open the door from the outside.
2. Move the lever all the way down.
3. Do the same for the other rear door.

The rear door locks will now work normally.

Anti-Lockout Feature

Leaving your key in any ignition position with any door open will disable the use of the power door lock switches. The anti-lockout feature is disabled when the ignition is on. If you close the doors, you can lock them using the RKE system. It is always recommended that you remove the ignition key when locking your vehicle.

Note that the anti-lockout feature can be overridden by holding the power door lock switch for three seconds or longer.

Leaving Your Vehicle

If you are leaving the vehicle, open the door, set the locks from the inside, get out and close the door.

Remote Keyless Entry (RKE) System



With this feature, you can lock and unlock the doors, unlock the trunk, open the fuel door and turn on your vehicle's interior lamps from about 10 feet (3 m) away using the RKE transmitter supplied with your vehicle.

Your RKE system operates on a radio frequency subject to Federal Communications Commission (FCC) Rules and with Industry and Science Canada.

This device complies with Part 15 of the FCC Rules. Operation is subject to the following two conditions: (1) this device may not cause harmful interference, and (2) this device must accept any interference received, including interference that may cause undesired operation.

This device complies with RSS-210 of Industry and Science Canada. Operation is subject to the following two conditions: (1) this device may not cause interference, and (2) this device must accept any interference received, including interference that may cause undesired operation of the device.

Changes or modifications to this system by other than an authorized service facility could void authorization to use this equipment.

The range of this system is about 10 feet (3 m). At times you may notice a decrease in range. This is normal for any remote keyless entry system. If the transmitter does not work or if you have to stand closer to your vehicle for the transmitter to work, try this:

- Check to determine if battery replacement is necessary. See the instructions that follow.
- Check the distance. You may be too far from your vehicle. You may need to stand closer during rainy or snowy weather.
- Check the location. Other vehicles or objects may be blocking the signal. Take a few steps to the left or right, hold the transmitter higher, and try again.
- If you're still having trouble, see your Cadillac dealer or a qualified technician for service.

Operation

 When you press this symbol to unlock the driver's door, the parking lamps on your vehicle will blink twice. (You can program your vehicle so the parking lamps will not flash. For more information, see "Remote Confirmation" later in this section.) Pressing it again within five seconds will unlock the other doors. Pressing this button will also disarm the optional theft-deterrent system and turn on the interior lamps at night.

 When you press this symbol to lock the doors, the parking lamps will blink once. (You can program your vehicle so the parking lamps will not flash. For more information, see "Remote Confirmation" later in this section.) This also arms the optional theft-deterrent system when the ignition is off.

 Press this symbol to open the trunk.

 Press this button to open the fuel door.

The RKE transmitter can also be used to recall the memory seats for up to two drivers. For more information, see “Memory Seat and Mirrors” in the Index.

Note that pressing the transmitter buttons numerous times (approximately 500 times) out of the vehicle’s operating range may cause the transmitter not to work. Replacing the battery and pressing the transmitter buttons 10 or more times out of range will also cause the transmitter not to work. To reset the transmitter, you must be within the vehicle’s operating range. Press and hold the trunk button, and within one second, press and hold the lock button. Continue to hold both buttons for approximately three seconds. See your Cadillac dealer for service if your transmitter still doesn’t work properly.

RKE Personalization Features

Remote Confirmation (If Equipped)

This personalization feature allows the driver to program the parking lamps to blink or to remain off when the lock or unlock buttons on the RKE

transmitter are pressed. Press the TRIP SET (TRIP RESET) button to answer “yes,” press the RESET (INFO RESET) button to indicate “no” or press the INFORMATION (INFO) button to “skip” to the next personalization feature.

To begin programming, press the unlock button of the RKE transmitter for the appropriate driver (1 or 2). The ignition must be in the RUN position. Press and hold the INFORMATION (INFO) and RESET (INFO RESET) buttons at the same time. The first message to appear refers to the programmable automatic door locks. To skip this prompt, press the INFORMATION (INFO) button.

When REMOTE FLASH LIGHTS appears on the DIC display, press the yes button to program the parking lamps to blink once when the lock button on the RKE transmitter is pressed and to blink twice when the unlock button is pressed. If you don’t want the parking lamps to blink when using the RKE transmitter, press the no button.

FEATURE ON will display if REMOTE FLASH LIGHTS was selected and FEATURE OFF will show if you answer no.

For a list of the other personalization features available, see “Memory and Personalization Features” later in this section.

Exterior Lighting (If Equipped)

This personalization feature enables the driver to program the exterior lamps to turn on or to remain off when using the RKE transmitter to unlock your vehicle.

If exterior lighting is selected, the parking lamps, taillamps, sidemarker lamps, license plate lamps, low-beam headlamps, etc. will turn on for about 20 seconds or until a door is opened or the key is placed in your vehicle's ignition.

To begin programming, press the INFORMATION (INFO) and RESET (INFO RESET) buttons at the same time for about two seconds. Exterior lighting is the third feature to display. Press the INFORMATION (INFO) button to "skip" past the first two features -- DOOR LOCKS IN GEAR and REMOTE FLASH LIGHTS.

When EXT LIGHTS AT UNLOCK appears, a "yes" or "no" response is required. Press the TRIP SET (TRIP RESET) button to answer yes or press the RESET (INFO RESET) button to indicate a no response.

FEATURE ON displays when a yes response is made and FEATURE OFF shows after a no response.

For a list of the other personalization features available, see "Memory and Personalization Features" later in this section.

Remote Recall Memory (If Equipped)

Your vehicle may have memory personalization. If it does, REMOTE RECALL MEMORY will be the fourth personalization feature to display on the DIC system.

Memory settings that have been previously programmed (HVAC settings, radio preset settings, exterior lighting choices, remote confirmation choices and programmable automatic door lock choices) can be recalled by using the RKE transmitter or by placing the key in your vehicle's ignition.

To begin programming, press the INFORMATION (INFO) and RESET (INFO RESET) buttons at the same time for about two seconds. As mentioned, memory recall is the fourth feature to appear. To "skip" past the first three personalization features, press the INFORMATION (INFO) button.

When REMOTE RECALL MEMORY appears, the driver is able to recall memory settings when the unlock button on the RKE transmitter is pressed. Press the TRIP SET (TRIP RESET) button to select or press the RESET (INFO RESET) button to answer no and to continue on to the next prompt. (FEATURE ON displays when a yes response is made and FEATURE OFF shows when a no response is made.)

If a no response was made, the KEY IN RECALL MEMORY prompt will show next. This choice recalls memory settings when the key is placed in your vehicle's ignition. A yes or no response is required.

For a list of the other personalization features available, see "Memory and Personalization Features" later in this section.

Matching Transmitter(s) To Your Vehicle

Each remote keyless entry transmitter is coded to prevent another transmitter from unlocking your vehicle. If a transmitter is lost or stolen, a replacement can be purchased through your dealer. Once your dealer has coded the new transmitter, the lost transmitter will not unlock your vehicle. Each vehicle can have only two transmitters matched to it.

Battery Replacement

Under normal use, the battery in your remote keyless entry transmitter should last about four years.

You can tell the battery is weak if the transmitter won't work at the normal range in any location. If you have to get close to your vehicle before the transmitter works, it's probably time to change the battery.

NOTICE:

When replacing the battery, use care not to touch any of the circuitry. Static from your body transferred to these surfaces may damage the transmitter.



1. Use the round end of the door key or a coin to pry open the transmitter.



2. Remove the battery and replace it with a CR2032 battery. Using the wrong size battery can damage the transmitter. Make sure the battery is positioned with the "plus" (+) facing down.
3. Align the internal pieces of the transmitter, including the cover. Snap together to reinstall.

Trunk

CAUTION:

It can be dangerous to drive with the trunk lid open because carbon monoxide (CO) gas can come into your vehicle. You can't see or smell CO. It can cause unconsciousness and even death. If you must drive with the trunk lid open or if electrical wiring or other cable connections must pass through the seal between the body and the trunk lid:

- Make sure all windows are shut.
- Turn the fan on your heating or cooling system to its highest speed with the setting on AUTO or ECON and the temperature between 65°F (18°C) and 85°F (29°C). That will force outside air into your vehicle. See "Comfort Controls" in the Index.
- If you have air outlets on or under the instrument panel, open them all the way. See "Engine Exhaust" in the Index.

Trunk Lock Release (If Equipped)



To use this feature, your vehicle must be in PARK (P). Press the TRUNK release button located above the radio on the DIC to open the trunk.

You can also press the trunk button on the RKE transmitter to access the trunk compartment. If you do not have the full console, then press the trunk button on the RKE transmitter.

Trunk Storage System (Option)

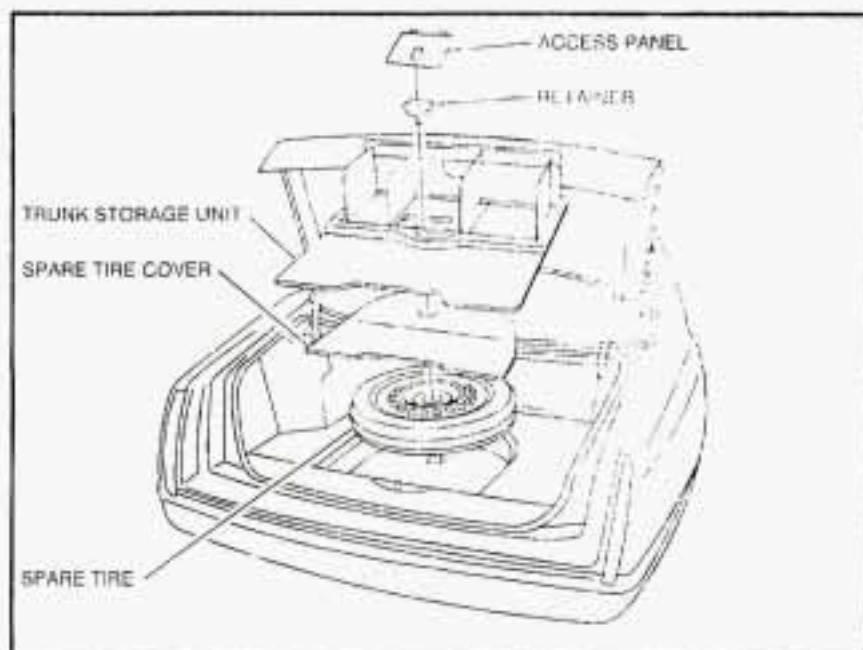

If equipped, the optional trunk storage system can be used to organize many different items inside the trunk.

To install the storage system:

1. Pull the carpeting from the floor of the trunk. Turn the retainer (center dial) on the compact spare tire cover counterclockwise to remove it.
2. Place the trunk storage system on the center of the trunk floor (the cut out portion of the storage system should be facing the rear of the vehicle).
3. Open the storage system by pulling up on the handle located in the carpeted area. This allows the unit to snap into place. Fold the divider walls open.
4. Remove the rectangular access panel from the floor of the storage system. The access panel should unsnap by hand.
5. Center the storage system access hole over the area where the spare tire is secured by the retainer. Position the storage system as needed and then secure it with the retainer.
6. Replace the access panel.
7. Attach the removable net to the slots located on the side and front of the divider walls.

Once in place, the storage system can be moved forward or rearward for convenience and easy accessing of stored items.

The following steps explain how to remove the trunk storage system for cleaning or in case you need to access the spare tire. Follow all of these steps if the storage system is in the closed position. Begin with Step 2 if the system is already open.

1. Open the storage system by pulling up on the handle located in the carpeted area. This allows the unit to snap into place. Fold the divider walls open.
2. Remove the rectangular access panel from the floor of the storage system. The access panel should unsnap by hand.
3. Center the storage system access hole over the area where the spare tire is secured by the retainer. Position the storage system as needed and then remove the retainer (turn the retainer counterclockwise to remove it).
4. Replace the access panel and remove the storage system.

Trunk Lid Automatic Pull-Down Feature

CAUTION:

Your car has an automatic pull-down feature that helps close the trunk electronically. Your fingers can be trapped under the trunk lid as it goes down. Your fingers could be injured, and you would need someone to help you free them. Keep your fingers away from the trunk lid as you close it and as it is going down.

With the automatic pull-down feature, you never have to slam the trunk lid in order to close the trunk. Instead, gently lower the trunk lid until it is nearly shut -- the automatic pull-down unit will take over and lock the trunk firmly.

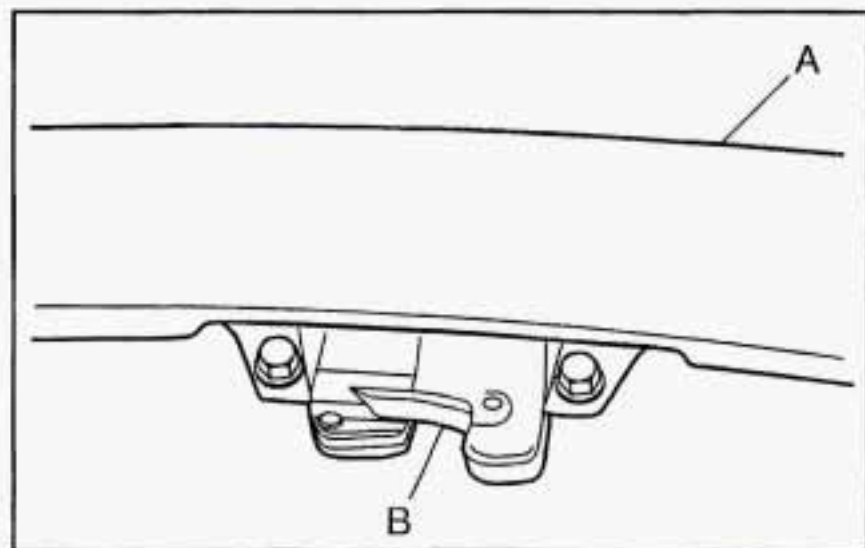

A. Trunk Lid

B. Lever

If for some reason the trunk lid (A) will not close, it may be because the trunk pull-down unit was accidentally bumped. Even though the trunk lid remains open, the motor from the pull-down unit has already cycled down. If this happens, press the lever (B) on the trunk lid. The pull-down unit motor will reset itself allowing the trunk lid to close when lowered.

Theft

Vehicle theft is big business, especially in some cities. Although your Cadillac has a number of theft-deterrent features, we know that nothing we put on it can make it impossible to steal. However, there are ways you can help.

Key in the Ignition

If you leave your vehicle with the keys inside, it's an easy target for joy riders or professional thieves -- so don't do it.

When you park your Cadillac and open the driver's door, you'll hear a chime reminding you to remove your key from the ignition and take it with you. Always do this. Your steering wheel will be locked, and so will your ignition and transaxle. And remember to lock the doors.

Parking at Night

Park in a lighted spot, close all windows and lock your vehicle. Remember to keep your valuables out of sight. Put them in a storage area, or take them with you.

Parking Lots

If you park in a lot where someone will be watching your vehicle, it's best to lock it up and take your keys. But what if you have to leave your ignition key? What if you have to leave something valuable in your vehicle?

- Put your valuables in a storage area, like your trunk or glove box.
- Lock the glove box.
- Lock all the doors except the driver's.
- Then take the door key and remote keyless entry transmitter with you.

Theft-Deterrent System (If Equipped)



If the ignition is off and any door is open, the SECURITY light will flash, reminding you to activate the system (the light will also flash if the battery has been disconnected and reconnected).

To arm the system, do the following:

1. Open the door.
2. Lock the door using the power door lock or the RKE system. The SECURITY light should come on and stay on.
3. Close all the doors. The SECURITY light should go off within approximately 30 seconds.

The horn will sound and the lamps will flash for about 30 seconds when the door or trunk is opened without the key or RKE system. The horn also sounds if the locks are damaged.

Remember, the theft-deterrent system won't activate if you lock the doors with a key or use the manual door lock. It activates only if you use a power door lock switch or the RKE system.

To avoid activating the alarm by accident:

- The vehicle should be locked with the door key or the manual door lock switch *after* the doors are closed if you don't want to activate the theft-deterrent system.
- Always unlock a door with a key or use the RKE system. (Pressing the unlock button on the RKE transmitter disables the theft-deterrent system.) Unlocking a door any other way will activate the

alarm. Turning the ignition key to RUN without disarming the theft-deterrent system will also activate the alarm.

If you activate the alarm by accident, unlock any door with your key. You can also turn off the alarm by using the unlock button of the RKE system. The alarm won't stop if you try to unlock a door any other way.

Testing the Alarm

1. From inside the vehicle, roll down the window, then get out of the vehicle, keeping the door open.
2. From outside of the vehicle, with the door open, lock the vehicle using the power door lock or the RKE system and close the door. Wait 30 seconds until the SECURITY lamp goes off.
3. Reach in and unlock the door using the manual lock and open the door. The horn will sound and the headlamps will flash.

If the alarm does not sound when it should, check to see if the horn works. The horn fuse may be blown. To replace the fuse, see "Fuses and Circuit Breakers" in the Index. If the fuse does not need to be replaced, you may need to have your Cadillac serviced.

To reduce the possibility of theft, always activate the optional theft-deterrent system when leaving your vehicle.

Security Override



Pressing the VALET button located inside the glove box will disable the use of the trunk, fuel door and garage door opener. Pressing this button again will make these features reusable. Locking the glove box with the door key will also help to secure your vehicle.

Note that the RKE transmitter can't be used to open the trunk or fuel door if the VALET button is pressed in.

PASS-Key® II



Your vehicle is equipped with the PASS-Key II theft-deterrent system. PASS-Key II is a passive system. The system is armed when the key is removed from the ignition.

PASS-Key II uses a resistor pellet in the ignition key that is read by the system in your vehicle. If the key resistor matches the code stored in the vehicle system, the vehicle's fuel and starting systems will be enabled. If an incorrect key is used, the vehicle's fuel and starting systems are disabled for three minutes. Additional attempts during this lockout period will not start the car, even with the correct key.

If the engine does not start and the “STARTING DISABLED DUE TO THEFT SYSTEM, REMOVE IGNITION KEY” message is displayed in the Driver Information Center, your key should be checked for damage. Starting may be attempted with an undamaged key immediately. See your Cadillac dealer or a locksmith for key service.

If the “STARTING DISABLED DUE TO THEFT SYSTEM, REMOVE IGNITION KEY” and “WAIT 3 MINUTES” messages are displayed, the key should be cleaned. After three minutes, try again. A “START CAR” message will appear at this time. If the engine still does not start, wait three minutes and try a duplicate key. At this time, fuses should be checked (see “Fuses and Circuit Breakers” in the Index). If the engine does not start with the duplicate key, your vehicle needs service. See your Cadillac dealer for service.

If the “THEFT SYSTEM PROBLEM” message is displayed during vehicle operation, your vehicle needs servicing. Your vehicle will restart if you turn it off, however, your vehicle may be unprotected. See your Cadillac dealer for service.

If an ignition key is lost or damaged, see your Cadillac dealer or a locksmith to have a new key made.

New Vehicle “Break-In”

NOTICE:

Your modern Cadillac doesn't need an elaborate “break-in.” But it will perform better in the long run if you follow these guidelines:

- **Don't drive at any one speed -- fast or slow -- for the first 500 miles (805 km). Don't make full-throttle starts.**
- **Avoid making hard stops for the first 200 miles (322 km) or so. During this time your new brake linings aren't yet broken in. Hard stops with new linings can mean premature wear and earlier replacement. Follow this breaking-in guideline every time you get new brake linings.**
- **Don't tow a trailer during break-in. See “Towing a Trailer” in the Index for more information.**

Ignition Positions

NOTICE:

If your key seems stuck in LOCK and you can't turn it, be sure you are using the correct key; if so, is it all the way in? If it is, then turn the steering wheel left and right while you turn the key hard. But turn the key only with your hand. Using a tool to force it could break the key or the ignition switch. If none of this works, then your vehicle needs service.

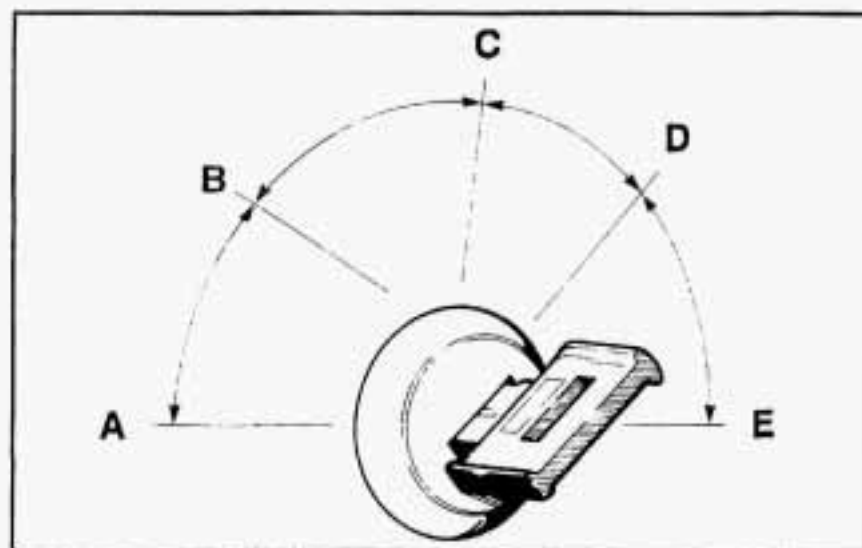

With the ignition key in the ignition switch, you can turn the switch to five different positions:

ACCESSORY (A): This position lets you use things like the radio and the windshield wipers when the engine is off. To get into ACCESSORY, push in the key and turn it toward you. The steering wheel will remain locked, just as it was before you inserted the key.

LOCK (B): Before you put the key in, the ignition will be in the LOCK position. This is the only position in which you can remove the key. This position locks the ignition, steering wheel and transaxle. It's a theft-deterrent feature.

OFF (C): This position lets you turn off the engine but still turn the steering wheel. It doesn't lock the steering wheel like LOCK. Use OFF if you must have your vehicle in motion while the engine is off (for example, if your vehicle is being pushed).

RUN (D): This is the position for driving.

START (E): This starts the engine.

Retained Accessory Power (RAP)

The following accessories on your Cadillac may be used for up to 10 minutes after the ignition key is turned from RUN to OFF:

- Radio
- Power Windows
- Astrorooftop

Power to these accessories stops after 10 minutes or if any door is opened. If you want power for another 10 minutes, turn the ignition key to RUN and then back to OFF.

Starting Your Engine

Move your shift lever to PARK (P) or NEUTRAL (N). Your engine won't start in any other position -- that's a safety feature. To restart when you're already moving, use NEUTRAL (N) only.

NOTICE:

Don't try to shift to PARK (P) if your Cadillac is moving. If you do, you could damage the transaxle. Shift to PARK (P) only when your vehicle is stopped.

1. Without pushing the accelerator pedal, turn your ignition key to START. When the engine starts, let go of the key. The idle speed will go down as your engine gets warm.

NOTICE:

Holding your key in START for longer than 15 seconds at a time will cause your battery to be drained much sooner. And the excessive heat can damage your starter motor.

2. If it doesn't start right away, hold your key in START for about three seconds at a time until your engine starts. Wait about 15 seconds between each try to help avoid draining your battery.

3. If your engine still won't start (or starts but then stops), it could be flooded with too much gasoline. Try pushing your accelerator pedal all the way to the floor and holding it there as you hold the key in START for about three seconds. If the vehicle starts briefly but then stops again, do the same thing.

NOTICE:

Your engine is designed to work with the electronics in your vehicle. If you add electrical parts or accessories, you could change the way the engine operates. Before adding electrical equipment, check with your dealer. If you don't, your engine might not perform properly.

If you ever have to have your vehicle towed, see the part of this manual that tells how to do it without damaging your vehicle. See "Towing Your Vehicle" in the Index.

Engine Coolant Heater (Option) (Canada Only)

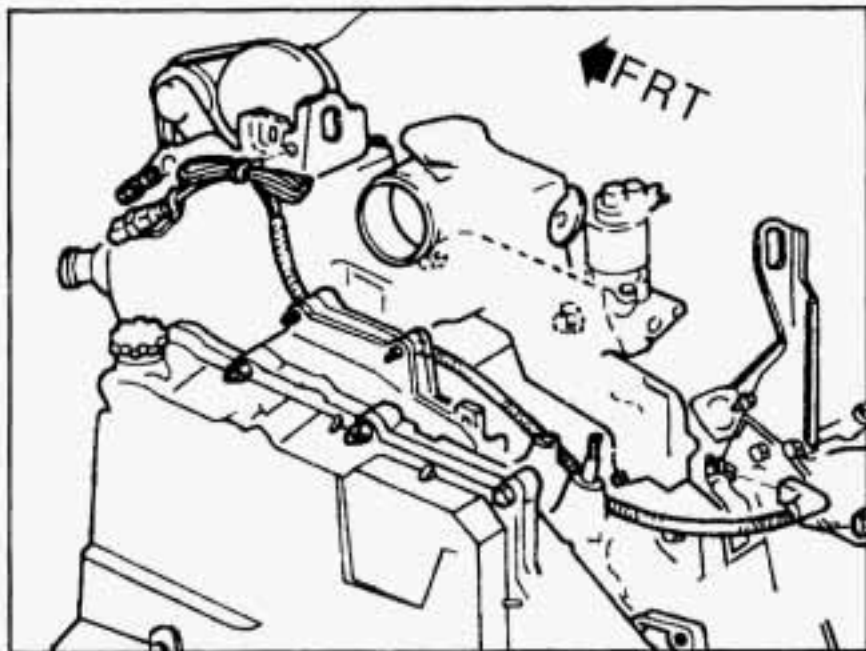

In very cold weather, 0°F (-18°C) or colder, the engine coolant heater can help. You'll get easier starting and better fuel economy during engine warm-up. Usually, the coolant heater should be plugged in a minimum of four hours prior to starting your vehicle.

To Use the Coolant Heater

1. Turn off the engine.
2. Open the hood and unwrap the electrical cord.
3. Plug it into a normal, grounded 110-volt AC outlet.

CAUTION:

Plugging the cord into an ungrounded outlet could cause an electrical shock. Also, the wrong kind of extension cord could overheat and cause a fire. You could be seriously injured. Plug the cord into a properly grounded three-prong 110-volt AC outlet. If the cord won't reach, use a heavy-duty three-prong extension cord rated for at least 15 amps.

4. Before starting the engine, be sure to unplug and store the cord as it was before to keep it away from moving engine parts. If you don't, it could be damaged.

How long should you keep the coolant heater plugged in? The answer depends on the outside temperature, the kind of oil you have, and some other things. Instead of trying to list everything here, we ask that you contact your Cadillac dealer in the area where you'll be parking your vehicle. The dealer can give you the best advice for that particular area.

Automatic Transaxle Operation

The automatic transaxle may have either a shift lever located on the steering column or on the console between the seats.

There are several different positions for the shift lever.

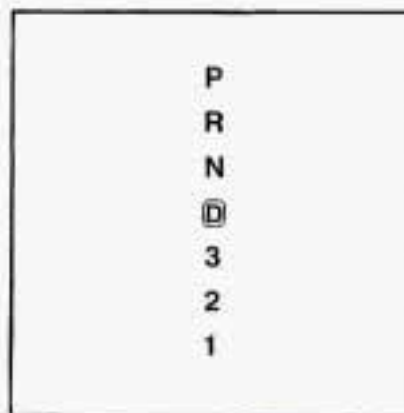

Console Shifter

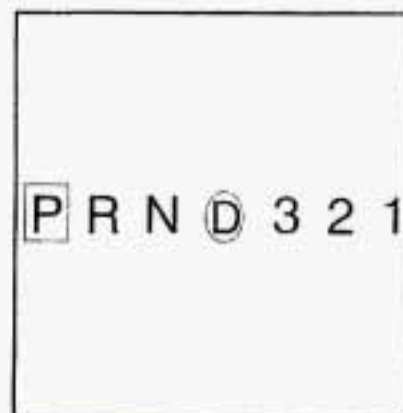

Column Shifter

PARK (P): This locks the front wheels. It's the best position to use when you start the engine because your vehicle can't move easily.



CAUTION:

It is dangerous to get out of your vehicle if the shift lever is not fully in PARK (P) with the parking brake firmly set. Your vehicle can roll. Don't leave your vehicle when the engine is running unless you have to. If you have left the engine running, the vehicle can move suddenly. You or others could be injured. To be sure your vehicle won't move, even when you're on fairly level ground, always set your parking brake and move the shift lever to PARK (P).

See "Shifting Into PARK (P)" in the Index. If you're pulling a trailer, see "Towing a Trailer" in the Index.

Ensure the shift lever is fully in PARK (P) range before starting the engine. Your Cadillac has a brake-transaxle shift interlock. You have to fully *apply* your regular brakes *before* you can shift from PARK (P) when the ignition key is in the RUN position. If you cannot shift out of PARK (P), ease pressure on the shift lever -- push the shift lever all the way into PARK (P) and release the shift lever button on the floor shift console models as you maintain brake application. Then move the shift lever into the gear you wish. (Press the shift lever button before moving the shift lever on floor shift console models.) See "Shifting Out of PARK (P)" in this section.

REVERSE (R): Use this gear to back up.

NOTICE:

Shifting to REVERSE (R) while your vehicle is moving forward could damage your transaxle. Shift to REVERSE (R) only after your vehicle has stopped.

Also use this gear to rock your vehicle back and forth to get out of snow, ice or sand without damaging your transaxle. See "If You're Stuck in Sand, Mud, Ice or Snow" in the Index for additional information.

NEUTRAL (N): In this position, the engine doesn't connect with the wheels. To restart when you're already moving, use NEUTRAL (N) only. Also, use NEUTRAL (N) when your vehicle is being towed.

 **CAUTION:**

Shifting out of PARK (P) or NEUTRAL (N) while your engine is "racing" (running at high speed) is dangerous. Unless your foot is firmly on the brake pedal, your vehicle could move very rapidly. You could lose control and hit people or objects. Don't shift out of PARK (P) or NEUTRAL (N) while your engine is racing.

NOTICE:

Damage to your transaxle caused by shifting out of PARK (P) or NEUTRAL (N) with the engine racing isn't covered by your warranty.

OVERDRIVE (Ⓢ): This position is for normal driving. If you need more power for passing, and you're:

- Going less than 35 mph (55 km/h), push the accelerator pedal about halfway down.
- Going about 35 mph (55 km/h) or more, push the accelerator all the way down.

The transaxle will shift down to the next gear and have more power.

NOTICE:

If your vehicle seems to start up rather slowly, or if it doesn't seem to shift gears as you accelerate, something may be wrong with a transaxle system sensor. If you drive very far that way, your vehicle can be damaged. So if this happens, have your vehicle serviced right away. Until then, you can use SECOND (2) when you are driving less than 35 mph (55 km/h) and OVERDRIVE (Ⓢ) for higher speeds.

THIRD (3): This position is also used for normal driving, however, it offers more power and lower fuel economy than OVERDRIVE (Ⓣ).

Here are examples for using THIRD (3) instead of OVERDRIVE (Ⓣ):

- When driving on hilly, winding roads.
- When towing a trailer, so there is less shifting between gears.
- When going down a steep hill.

SECOND (2): This position gives you more power. You can use SECOND (2) on hills. It can help control your speed as you go down steep mountain roads, but then you would also want to use your brakes off and on.

NOTICE:

Don't shift into SECOND (2) unless you are going slower than 65 mph (105 km/h), or you can damage your engine.

FIRST (1): This position gives you even more power than SECOND (2). You can use it on very steep hills, or in deep snow or mud. (If the shift lever is put in FIRST (1), the transaxle won't shift into gear until the vehicle is going slowly enough.)

NOTICE:

If your front wheels can't rotate, don't try to drive. This might happen if you were stuck in very deep sand or mud or were up against a solid object. You could damage your transaxle. Also, if you stop when going uphill, don't hold your vehicle there with only the accelerator pedal. This could cause overheating and damage the transaxle. Use your brakes to hold your vehicle in position on a hill.

Parking Brake

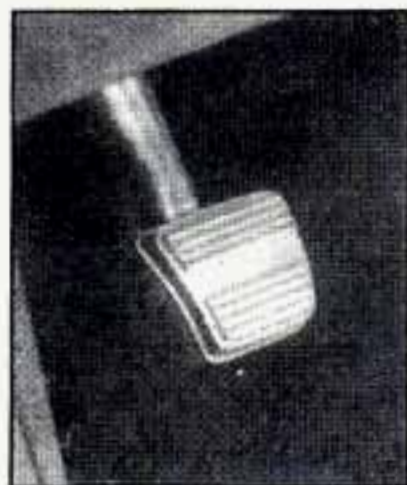

Hold the regular brake pedal down with your right foot and push down the parking brake pedal with your left foot to set the parking brake. If the ignition is on, the PARK BRAKE indicator light should come on. If it doesn't, you need to have your vehicle serviced.

If the parking brake has not been fully released and you try to drive off with the parking brake on, the PARK BRAKE indicator light comes on and stays on. See "Parking Brake Indicator Light" in the Index for more information.

When you move out of PARK (P) or NEUTRAL (N), if the engine is running, the parking brake should release. If it doesn't, you can manually release the parking brake.

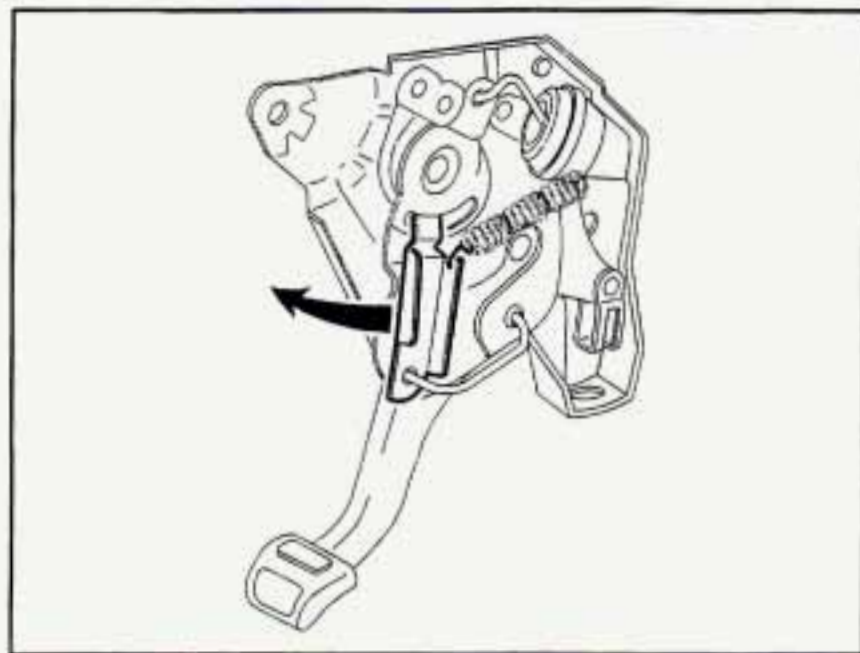

Reach under the driver's side of the instrument panel and pull on the manual release lever, which is located above the parking brake pedal. If the parking brake does not release, you should either drive to the nearest service station or have your vehicle towed.

 **CAUTION:**

If your hand or arm is in the way of the pedal, you could be hurt. The pedal springs back quickly. Keep your hand and arm away when you use the manual release lever.

NOTICE:

Driving with the parking brake on can cause your rear brakes to overheat. You may have to replace them and you could also damage other parts of your vehicle.

If you are towing a trailer and are parking on a hill, see “Towing a Trailer” in the Index. This section shows what to do first to keep the trailer from moving.

Shifting Into PARK (P)

 **CAUTION:**

It can be dangerous to get out of your vehicle if the shift lever is not fully in PARK (P) with the parking brake firmly set. Your vehicle can roll. If you have left the engine running, the vehicle can move suddenly. You or others could be injured. To be sure your vehicle won't move, even when you're on fairly level ground, use the steps that follow. If you're pulling a trailer, see “Towing a Trailer” in the Index.

Steering Column Shift Lever (SLS Only)

1. Hold the brake pedal down with your right foot.
2. Move the shift lever into the PARK (P) position like this:

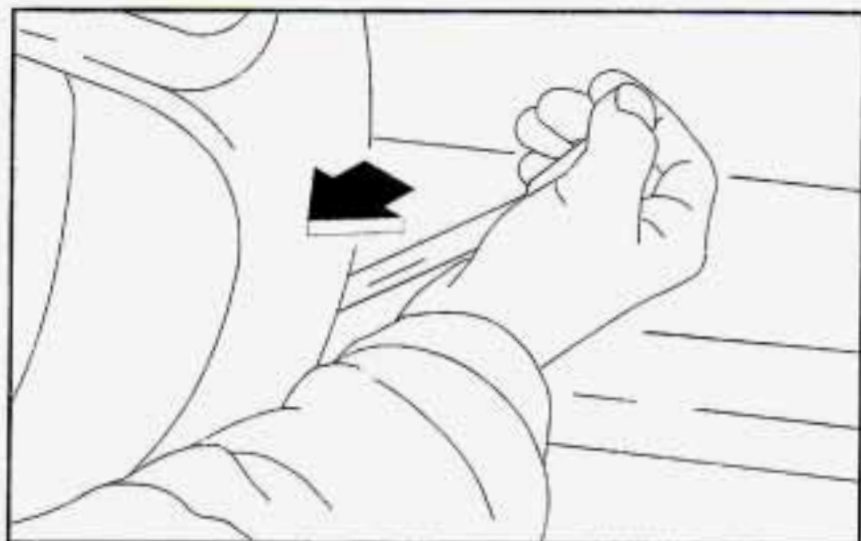

- Pull the lever toward you.

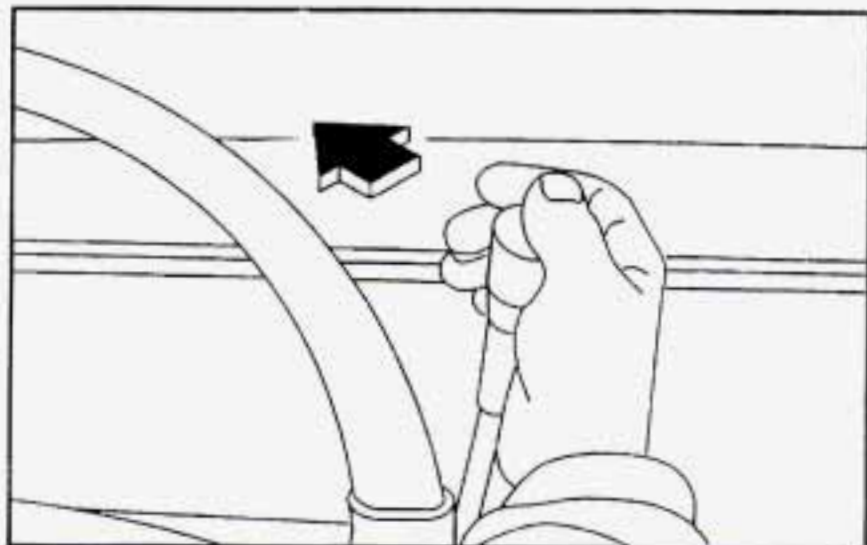

- Move the lever up as far as it will go.
1. With your right foot still holding the brake pedal down, set the parking brake.
 2. Move the ignition key to LOCK.
 3. Remove the key and take it with you. If you can leave your vehicle with the ignition key in your hand, your vehicle is in PARK (P).

Console Shift Lever (If Equipped)

1. Hold the brake pedal down with your right foot.

2. Move the shift lever into the PARK (P) position like this:



3. Hold in the button on the lever and push the lever all the way toward the front of your vehicle.
4. With your right foot still holding the brake pedal down, set the parking brake.
5. Move the ignition key to LOCK.
6. Remove the key and take it with you. If you can leave your vehicle with the ignition key in your hand, your vehicle is in PARK (P).

Leaving Your Vehicle With the Engine Running

CAUTION:

It can be dangerous to leave your vehicle with the engine running. Your vehicle could move suddenly if the shift lever is not fully in PARK (P) with the parking brake firmly set. And, if you leave the vehicle with the engine running, it could overheat and even catch fire. You or others could be injured. Don't leave your vehicle with the engine running unless you have to.

If you have to leave your vehicle with the engine running, be sure your vehicle is in PARK (P) and your parking brake is firmly set before you leave it. After you've moved the shift lever into the PARK (P) position, hold the regular brake pedal down. Then, see if you can move the shift lever away from PARK (P)

without first pulling it toward you (or, if you have the console shift lever, without first pushing the button). If you can, it means that the shift lever wasn't fully locked into PARK (P).

Torque Lock

If you are parking on a hill and you don't shift your transaxle into PARK (P) properly, the weight of the vehicle may put too much force on the parking pawl in the transaxle. You may find it difficult to pull the shift lever out of PARK (P). This is called "torque lock." To prevent torque lock, set the parking brake and then shift into PARK (P) properly before you leave the driver's seat. To find out how, see "Shifting Into PARK (P)" in the Index.

If torque lock does occur, you may need to have another vehicle push yours a little uphill to take some of the pressure from the parking pawl in the transaxle, so you can pull the shift lever out of PARK (P).

Shifting Out of PARK (P)

Your Cadillac has a Brake-Transaxle Shift Interlock (BTSI). You have to fully *apply* your regular brakes *before* you can shift from PARK (P) when the ignition is in the RUN position. See "Automatic Transaxle" in the Index.

If you cannot shift out of PARK (P), ease pressure on the shift lever -- push the shift lever all the way into PARK (P) and also release the shift lever button on floor shift models as you maintain brake application. Then move the shift lever into the gear you want. (Press the shift lever button before moving the shift lever.) If you ever hold the brake pedal down but still can't shift out of PARK (P), try this:

1. Turn the key to OFF. Open and close the driver's door to turn off the RAP feature.
2. Apply and hold the brake until the end of Step 4.
3. Shift to NEUTRAL (N).
4. Start the vehicle and then shift to the drive gear you want.
5. Have the vehicle fixed as soon as you can.

Parking Over Things That Burn

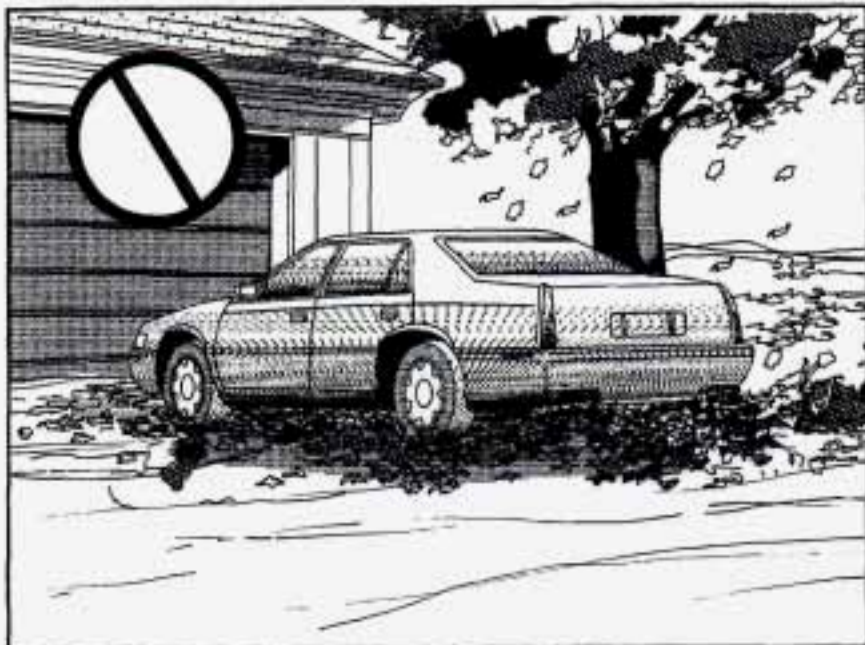

CAUTION:

Things that can burn could touch hot exhaust parts under your vehicle and ignite. Don't park over papers, leaves, dry grass or other things that can burn.

Engine Exhaust

CAUTION:

Engine exhaust can kill. It contains the gas carbon monoxide (CO), which you can't see or smell. It can cause unconsciousness and death.

You might have exhaust coming in if:

- Your exhaust system sounds strange or different.
- Your vehicle gets rusty underneath.
- Your vehicle was damaged in a collision.
- Your vehicle was damaged when driving over high points on the road or over road debris.
- Repairs weren't done correctly.
- Your vehicle or exhaust system had been modified improperly.

If you ever suspect exhaust is coming into your vehicle:

- Drive it only with all the windows down to blow out any CO; and
- Have your vehicle fixed immediately.

Running Your Engine While You're Parked

It's better not to park with the engine running. But if you ever have to, here are some things to know.

CAUTION:

Idling the engine with the climate control system off could allow dangerous exhaust into your vehicle (see the earlier Caution under "Engine Exhaust").

Also, idling in a closed-in place can let deadly carbon monoxide (CO) into your vehicle even if the fan switch is at the highest setting. One place this can happen is a garage. Exhaust -- with CO -- can come in easily. NEVER park in a garage with the engine running.

Another closed-in place can be a blizzard. (See "Blizzard" in the Index.)

CAUTION:

It can be dangerous to get out of your vehicle if the shift lever is not fully in PARK (P) with the parking brake firmly set. Your vehicle can roll. Don't leave your vehicle when the engine is running unless you have to. If you've left the engine running, the vehicle can move suddenly. You or others could be injured. To be sure your vehicle won't move, even when you're on fairly level ground, always set your parking brake after you move the shift lever to PARK (P).

Follow the proper steps to be sure your vehicle won't move. See "Shifting Into PARK (P)" in the Index.

If you are parking on a hill and if you're pulling a trailer, also see "Towing a Trailer" in the Index.

Windows

Power Windows



The controls are located near each window. Press the control forward to raise the window and press rearward to lower. Note that the second rearward position on the driver's control operates the express-down window feature.

Your vehicle has Retained Accessory Power (RAP). When you stop your vehicle and turn the ignition key to OFF, you can still use your power windows. The electrical power to operate the windows will not shut off until you open a door or 10 minutes have passed. If you want this power for another 10 minutes, turn the key to RUN and back to OFF.

Express-Down Window

This feature is present on the driver's power window. Pressing the control rearward into the second position then releasing it will lower the window completely. If you want to stop the window as it is lowering, press the control forward. Press the control forward to raise the window.

Note that the first position on the control operates the driver's power window in the non-express mode.

Rear Window Lockout



Pressing the button down will disable the rear passenger window controls. This is a useful feature if you have children as passengers. Press the button again to allow your passengers to reuse their window controls.

Horn

The horn can be sounded by pressing on the center of the steering wheel pad.

Tilt Wheel

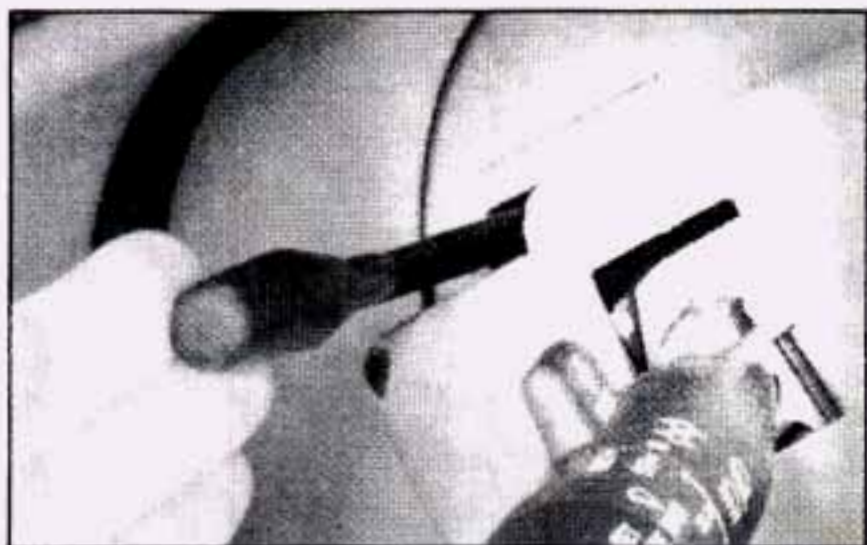

Tilt steering allows you to adjust the steering wheel before you drive. Raising the steering wheel to the highest level gives your legs more room when you enter and exit the vehicle.

Hold the steering wheel and pull the lever toward you to tilt the wheel. Adjust the steering wheel to a comfortable position and then release the lever to lock the wheel in place.

Turn Signal/Multifunction Lever

Turn and Lane Change Signals

To signal a turn, move the lever all the way up or down. The lever returns automatically when the turn is complete.

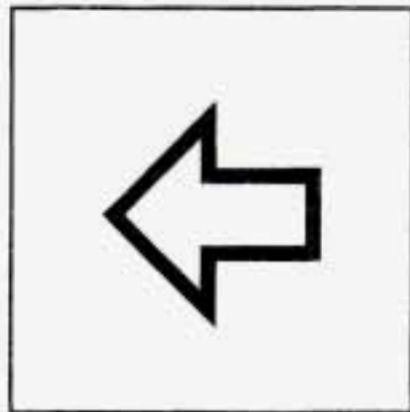

An arrow on the instrument panel will flash in the direction of the turn or lane change.

Raise or lower the lever until the arrow starts to flash to signal a lane change. Hold it there until the lane change is complete. The lever returns when it's released.

If the turn signal is left on, a warning chime will sound and the DIC will display **TURN SIGNAL ON** (after driving about a mile) to remind you to turn it off.

Arrows that flash rapidly when signaling for a turn or lane change may be caused by a burned-out signal bulb. Other drivers won't see the turn signal.

Replace burned-out bulbs to help avoid possible accidents. Check the fuse (see "Fuses and Circuit Breakers" in the Index) and for burned-out bulbs if the arrow fails to work when signaling a turn.

Headlamp High/Low Beam Indicator Light

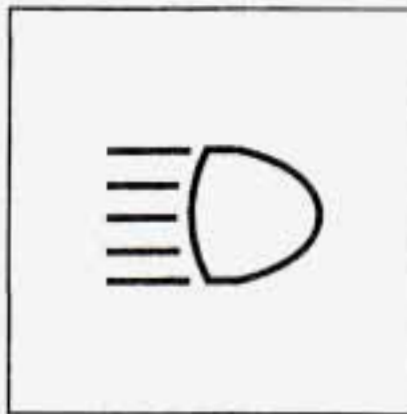

Pull the turn signal lever all the way toward you and then release it to change the headlamps from low beam to high or from high beam to low. This light on the instrument panel will be on, indicating high beam usage.

Flash-To-Pass

This lets you use the high-beam headlamps to signal the driver in front of you that you want to pass.

Pull the turn signal lever toward you to use. When you do:

- If the headlamps are either off or in the DRL mode, the high-beam headlamps will turn on. They'll stay on as long as you hold the lever there. Release the lever to turn them off.
- If the headlamps are on low beam, they will shift to high beam and stay there. Pull the lever toward you to return to low beam.
- If the headlamps are on high beam, they will switch to low beam. To return to high beam, pull the lever toward you.

Windshield Wipers

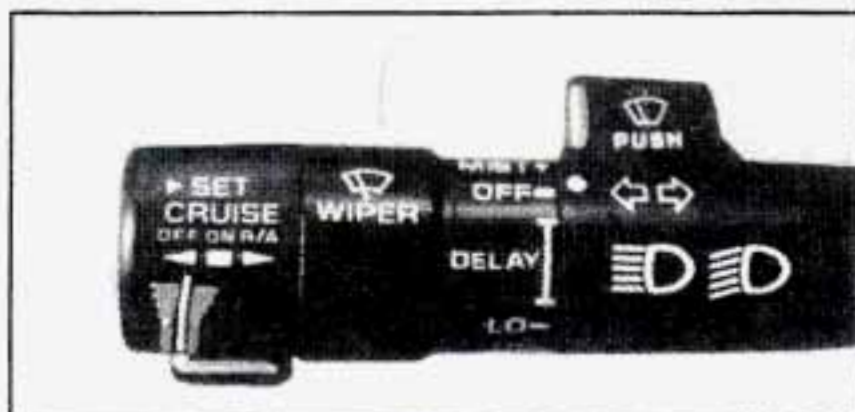

WIPER: Turn the band on the turn signal lever to control the wipers.

MIST: Turn the band toward you and then release it for a single wipe cycle. For more cycles hold the band on MIST longer.

LO or HI: Turn the band away from you to either LO (low speed) or to HI (high speed), depending on the wiper speed you want.

DELAY: You can set the wiper speed for a long or short delay between wipes with this setting. Move the band to the DELAY position. The closer you move it to LO the longer the delay. (SLS Only)

OFF: Turn the band to OFF to turn off the wipers.

Be sure to clear ice and snow from the wiper blades before using them. If they're frozen to the windshield, carefully loosen or thaw them. If the blades do become damaged, get new blades or blade inserts.

Heavy snow or ice can overload the wiper motor. A circuit breaker will stop the motor until it cools. Clear away snow or ice to prevent an overload.

Rainsense Wipers (STS Only)

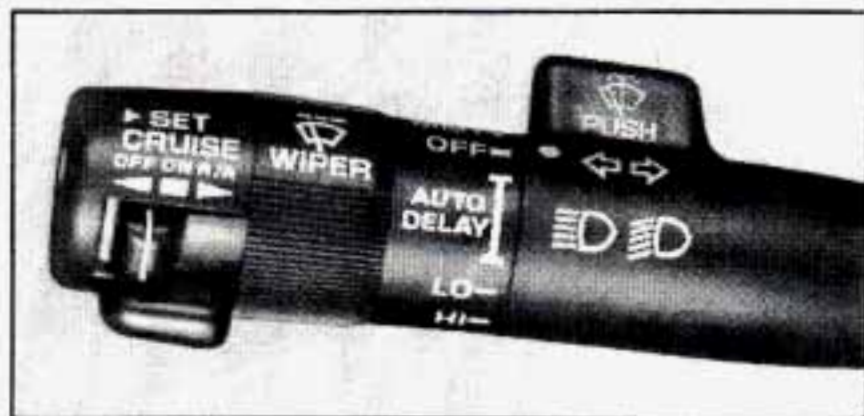

This moisture sensor is mounted on the passenger's interior side of the windshield behind the rearview mirror and is used to automatically operate the wipers by monitoring the amount of moisture that is on the windshield.

The Rainsense system can be activated by turning the wiper stalk to one of the five sensitivity levels within the AUTO DELAY area. The AUTO DELAY position closest to OFF is the lowest sensitivity setting. This allows more water to collect on the windshield between wipes. Rotating the stalk away from you to the other AUTO DELAY settings increases the sensitivity of the system and frequency of wipes. A single wipe will

occur each time you turn the wiper stalk to a higher sensitivity level. An initial wipe occurs when you turn the ignition on as a reminder that Rainsense is active. The windshield wipers also remain in a “high park” position, even when the ignition is turned off.

The Rainsense wipers operate in a delay mode as well as a continuous low or high speed depending on the amount of moisture and the sensitivity level. The MIST and “wash” cycles operate as normal and are not affected by the Rainsense function.

NOTICE:

The wipers must be turned off when going through a car wash to avoid damage.

It is important to note that the Rainsense wiping feature (AUTO DELAY) can be overridden at any time by manually changing the wiper control to LO or HI speed.

Note that if you ever need to replace the windshield, make sure it is Rainsense compatible.

Windshield Washer

CAUTION:

In freezing weather, don't use your washer until the windshield is warmed. Otherwise the washer fluid can form ice on the windshield, blocking your vision.

Press and hold the PUSH paddle to wash the windshield. Release the paddle when you have enough fluid. The wipers will clear the windshield and either stop or return to your preset speed.

LOW WASHER FLUID will be displayed on the DIC when the washer fluid reaches a low level.

Driving without washer fluid can be dangerous. A bad mud splash can block your vision and you could hit another vehicle or go off the road. Check the washer fluid level often.

Cruise Control

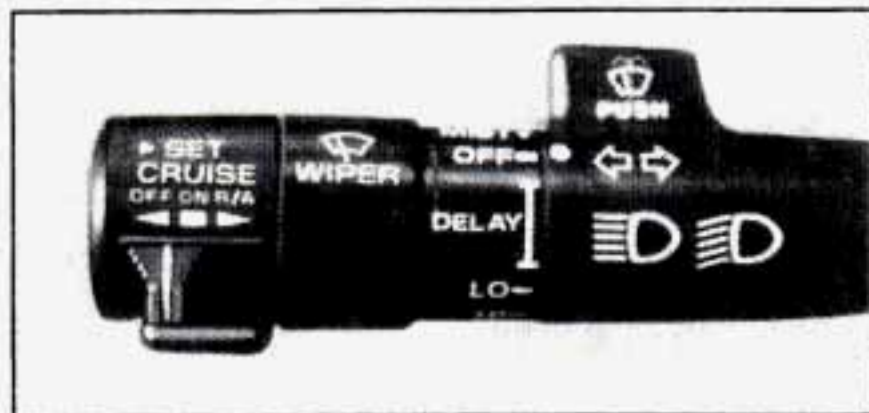

With cruise control, you can maintain a speed of about 25 mph (40 km/h) or more without keeping your foot on the accelerator. This can help on long trips. Cruise control does not work at speeds below about 25 mph (40 km/h).

Cruise control shuts off when you apply your brakes.

CAUTION:

- Cruise control can be dangerous where you can't drive safely at a steady speed. So, don't use your cruise control on winding roads or in heavy traffic.
- Cruise control can be dangerous on slippery roads. On such roads, fast changes in tire traction can cause needless wheel spinning, and you could lose control. Don't use cruise control on slippery roads.

If your vehicle is in cruise control when the traction control system begins to limit wheel spin, the cruise control will automatically disengage. (See "Traction Control System" in the Index.) When road conditions allow you to safely use it again, you may turn the cruise control back on.

Setting Cruise Control

CAUTION:

If you leave your cruise control switch on when you're not using cruise, you might hit a button and go into cruise when you don't want to. You could be startled and even lose control. Keep the cruise control switch off until you want to use it.



1. Move the cruise control switch to ON.

2. Accelerate to the speed you want.

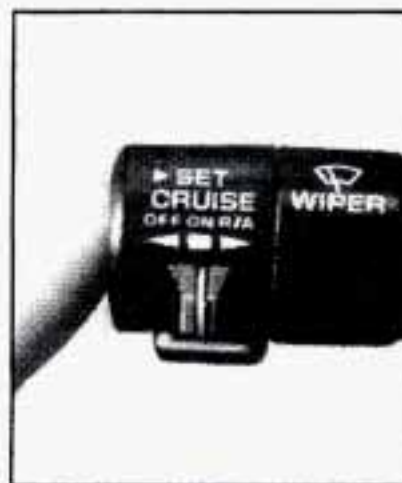

3. Press the SET CRUISE button at the end of the lever and release it. The CRUISE ENGAGED message will display on the DIC.

4. Remove your foot from the accelerator pedal.

Resuming a Set Speed

Setting the cruise control at a desired speed and then applying the brake will end the cruise function.



Once you're going about 25 mph (40 km/h) or more, you can move the cruise control switch from ON to R/A (Resume/Accelerate) for about half a second to reset. This returns you to your desired preset speed. Also note that the DIC will display the CRUISE ENGAGED message again.

Remember, if you hold the switch at R/A longer than half a second, the vehicle will accelerate until you release the switch or apply the brake. You could be startled and even lose control. So unless you want to go faster, don't hold the switch at R/A.

Increasing Speed While Using Cruise Control

There are two ways to go to a higher speed:

1. Use the accelerator pedal to go to a higher speed. Push the button at the end of the lever and then release the button and the accelerator pedal. You'll now cruise at the higher speed.
2. Move the cruise switch from ON to R/A. Hold it there until you reach a desired speed and then release the switch. (To increase your speed in very small amounts, move the switch to R/A. Each time you do this, your vehicle will go about 1 mph (1.6 km/h) faster.)

The accelerate feature will only work after you have set the cruise control speed by pushing the SET CRUISE button.

Reducing Speed While Using Cruise Control

There are two ways to reduce your speed while using cruise control:

- Push in the button at the end of the lever until you reach a desired lower speed, then release it. A CRUISE ENGAGED message will then display.
- To slow down in very small amounts, push the button for less than half a second. Each time you do this, you'll go 1 mph (1.6 km/h) slower.

Passing Another Vehicle While Using Cruise Control

Use the accelerator pedal to increase your speed. When you take your foot off the pedal, your vehicle will slow down to the cruise control speed you set earlier.

Using Cruise Control on Hills

How well your cruise control will work on hills depends upon your speed, load and the steepness of the hills. When going up steep hills, you may have to step on the accelerator pedal to maintain your speed. When going downhill, you may have to brake or shift to a lower gear to keep your speed down. Of course, applying the brakes or downshifting into FIRST (1) takes you out of cruise control. Many drivers find this to be too much trouble and don't use cruise control on steep hills.

Ending Cruise Control

There are two ways to end cruise control:

- Step lightly on the brake pedal.
- Move the CRUISE switch to OFF.

Erasing Speed Memory

The cruise control set speed memory is erased when you turn off the cruise control or the ignition.

Lamps



The control on the left side of the instrument panel controls these lamp systems:

- Headlamps
- Taillamps
- Parking Lamps
- Sidemarker Lamps
- License Plate Lamp
- Underhood Lamp
- Fog Lamps (STS Only)
- Instrument Panel Lights
- Interior Courtesy Lamps

Pull the lamp control knob out to the first stop to turn on the parking and taillamps, sidemarker lamps and instrument panel lights. Pull the knob out all the way to turn on the headlamps. Push the control knob all the way back in to turn the lamps and lights off.

Cluster lighting as well as instrument panel backlighting will dim only when it is dark outside.

Headlamps

The control for the headlamps is on the left side of the instrument panel. Pull the lamp control knob all the way out to turn the headlamps on. Push the control knob all the way back in to turn the headlamps off.

Wiper Activated Headlamps

This feature activates the headlamps and parking lamps after the windshield wipers have been in use for approximately 20 seconds.

In order to operate the wiper activated headlamps, the twilight sentinel must be in the on position. This feature lights the way in poor weather and it also makes your vehicle more visible to other drivers. If the wiper activated headlamps are on, and the ignition switch is turned off, the wiper activated headlamps will immediately turn off.

The wiper activated headlamps will deactivate if you turn off the twilight sentinel or if the windshield wipers have been turned off for a period of one or two seconds.

Lamps On Reminder

You will hear a warning chime if you open any door while leaving the lamps on, if the manual headlamp control is activated. An exception to this is when you're using twilight sentinel.

Daytime Running Lamps

Daytime Running Lamps (DRL) can make it easier for others to see the front of your vehicle during the day. DRL can be helpful in many different driving conditions, but they can be especially helpful in the short periods after dawn and before sunset.

The DRL system will make the high-beam headlamps come on at reduced brightness when:

- the ignition is on,
- the headlamp switch is off and
- the transaxle is not in PARK (P).

When DRL are on, only your high-beam headlamps (at reduced brightness) will be on. No other exterior lamps such as the parking lamps, taillamps, etc. will be on

when the DRL are being used. Your instrument panel won't be lit up either.

When the twilight sentinel switch is on and it's dark enough outside, the high-beam headlamps (at reduced intensity) will turn off and normal low-beam headlamp operation will occur. When the twilight sentinel switch is on and it's bright enough outside, the regular lamps will go off, and the high-beam headlamps at reduced brightness will take over for the DRL.

If it's dark enough outside and the twilight sentinel control is off, a HEADLAMPS SUGGESTED message will display on the DIC. This message informs the driver that turning on the exterior lamps is recommended even though the DRL are still illuminated (it's become dark enough outside to require the headlamps and/or other exterior lamps). Turning on the twilight sentinel, the headlamp switch or the fog lamp switch will remove the HEADLAMPS SUGGESTED message.

To idle your vehicle with the DRL off, turn off the twilight sentinel switch and shift the transaxle into PARK (P). Placing your vehicle in PARK (P) disables the DRL. The DRL will stay off until you shift out of PARK (P).

As with any vehicle, you should turn on the regular headlamp system when you need it.

Fog Lamps (STS Only)



Use the fog lamps for better vision in foggy or misty conditions. When you press the fog lamp button, a small indicator light will tell you that the fog lamps and the parking lamps are on. Press the button again to turn them off.

If you switch on the high-beam headlamps, the fog lamps will turn off. They'll turn back on again when you switch to low-beam headlamps.

When the twilight sentinel is on and the fog lamp switch is activated, the fog lamps will remain on as well as the headlamps and parking lamps.

Cornering Lamps

The cornering lamps come on when the headlamps or parking lamps are on and you signal a turn. They provide more light for cornering.

Twilight Sentinel



The control is next to the headlamp knob. It automatically switches the lamps on and off by sensing how dark it is outside.

To operate the twilight sentinel, leave the lamp knob off and move the TWILIGHT control to any position but OFF.

If you move the control all the way to the right, the lamps will remain on for approximately three minutes after the ignition has been turned to the OFF or LOCK position. If you move the control so it is just on, the lamps will go off quickly when you turn the ignition switch out of RUN. You can adjust the delay time from only a few seconds to three minutes.

If it's dark enough outside and the twilight sentinel control is off, a HEADLAMPS SUGGESTED message will display on the DIC. This message informs the driver that turning on the exterior lamps is recommended (it's become dark enough outside to require the headlamps and/or other exterior lamps). Turning on the twilight sentinel, the headlamp switch or the fog lamp switch will remove the HEADLAMPS SUGGESTED message.

The following chart shows what lamps are controlled by the twilight sentinel in various conditions:

	Light Outside	Dark Outside		
		Twilight Switch On		Twilight Switch Off
		Domestic & Canadian	Domestic	Canadian
Park and Low Beams (Automatic)	****	X		X
No Lamps or Message	X*		X*	
DRL**	X		X***	
DRL and Manual Park Lamps**	X			
Manual Park Lamps	X*		X***	
Manual Park and Fog Lamps	X*		X	
Manual Park, Fog and DRL**	X			
Manual Park Lamps and Low Beams	X		X	
Manual Low Beams, Park and Fog Lamps	X		X	

* Must be in PARK (P)

** Not in PARK (P)

*** Reminder message will be displayed if not in PARK (P)

**** Lamps turn on automatically if twilight switch is on and windshield wipers are activated

Light Sensor

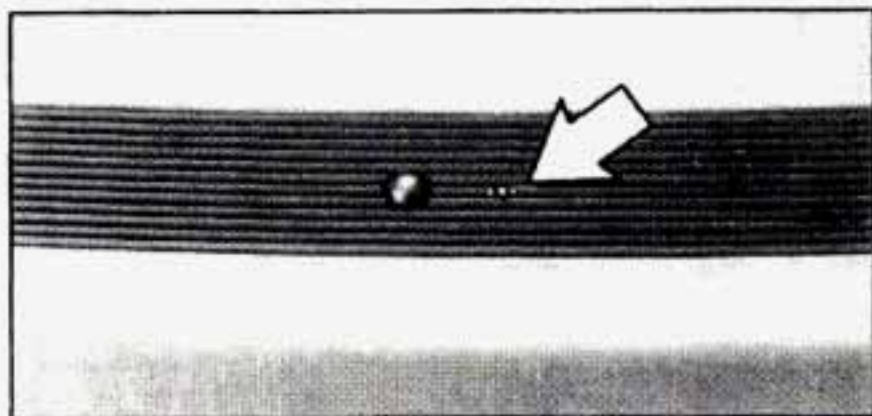

The light sensor for the DRL and the twilight sentinel is located in the center of the front defogger grille. If you cover the sensor, it will read “dark” and the lamps will come on.

Exterior Lighting Battery Saver

If the manual park lamp control has been left on, the exterior lamps will turn off approximately 10 minutes after the ignition is turned to LOCK or ACCESSORY. This protects draining the battery in case you have accidentally left the headlamps or parking lamps on. If you need to purposely leave the lamps on for more than 10 minutes, use the manual control knob to turn the lamps back on. To delay the lamps from turning off, see “Twilight Sentinel” earlier in this section.

Interior Lamps

Instrument Panel Brightness Control

Cluster lighting as well as instrument panel lighting automatically dims when it becomes dark outside. When it's dark, the brightness control can be manually adjusted. Cluster lighting and instrument panel lighting automatically brighten when it becomes light outside.

Illuminated Entry

The illuminated entry system turns on the courtesy lamps and the backlighting to the door switches and to the lamp control knob when a door is opened or if you press a RKE transmitter button. Since the illuminated entry system has a photocell, this means that it must be dark outside in order for the courtesy lamps or backlighting to turn on. The courtesy lamps turn off approximately 20 seconds after the last door is closed or after the ignition key is placed in the ignition.

Parade Dimming

This feature prohibits the dimming of the instrument panel lights during daylight while the headlamps are on. This feature operates with the light sensor for the twilight sentinel and is fully automatic. When the light sensor reads darkness outside, the instrument panel lights can be adjusted. Backlighting to the instrument panel will also turn on.

Reading Lamps

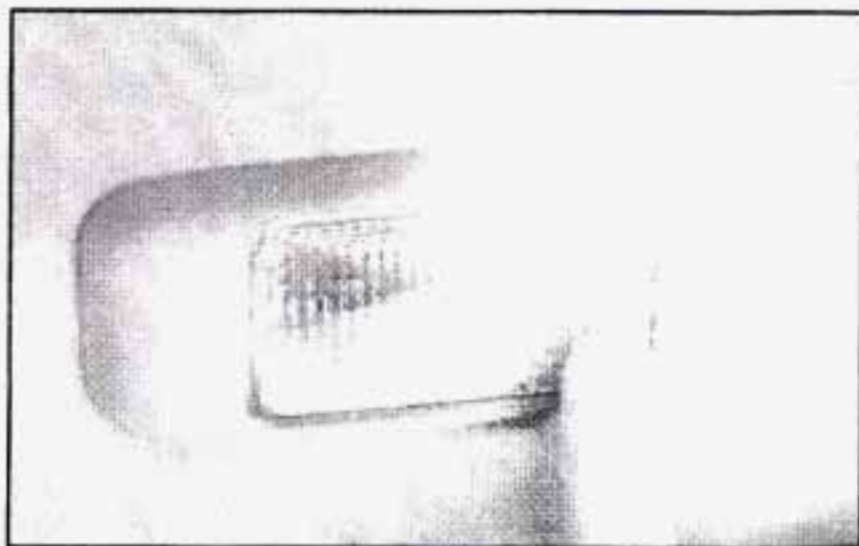

The reading lamps are located in the roof. These lamps and the interior courtesy lamps come on when any door is opened and it is dark outside. Press the button to turn them on. Press it again to turn them off.

If the reading lamps are left on, they automatically shut off 10 minutes after the ignition has been turned off.

Inadvertent Power Battery Saver

This feature is designed to protect your vehicle's battery against drainage from the interior lamps, trunk lamp, glove box lamp, cigarette lighters or the garage door opener. When the ignition is turned off, the power to these features will automatically turn off after 10 minutes (three minutes if a new car has 15 miles or less). Power will be restored for an additional 10 minutes if any door is opened, the trunk is opened or the courtesy lamp switch is turned on.

Battery Guard Storage

This feature is for long term use and must be programmed through the DIC while the ignition is in the RUN position. Battery guard storage protects the battery by placing the vehicle in a storage mode so that the radio, amplifiers, instrument cluster and RKE will not drain the battery over a long period of time.

To begin programming, press the INFORMATION (INFO) and RESET (INFO RESET) buttons at the same time for about two seconds. The first message to appear is DOORS LOCK IN GEAR. Press the INFORMATION

(INFO) button after this prompt is displayed until STORAGE MODE prompt appears on the DIC. Press the TRIP SET (TRIP RESET) button to answer "yes" or press the RESET (INFO RESET) button to indicate a "no" response.

FEATURE ON appears when a yes response is made and FEATURE OFF shows when a no response is made. Since this is the last personalization feature available, a yes or no response will end out of the DIC display.

Once the battery guard has been programmed, your vehicle will enter the storage mode about 20 minutes after the ignition key has been turned off. The RKE will also be disabled at this point. The RKE will reactivate when a door or the trunk is opened, however, if your vehicle is left inactive for another 20 minutes, the RKE will re-enter the storage mode.

Your vehicle will stay in the storage mode until the ignition key is turned out of LOCK. The system will "wake-up" when the door key is inserted into the door, however, your vehicle will remain in the storage mode. The ignition must be out of LOCK before the battery guard is disabled.

Mirrors

Electrochromic Day/Night Rearview Mirror

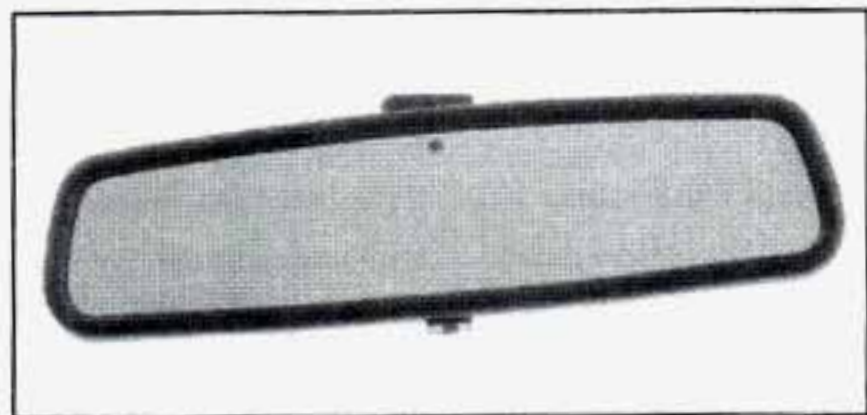

This mirror automatically changes to reduce glare from headlamps behind you. A photocell on the back of the mirror senses when it is becoming dark outside. Another photocell built into the mirror surface senses when headlamps are behind you.

At night, when the glare is too high, the mirror will gradually darken to reduce glare (this change may take a few seconds). The mirror will return to its clear daytime state when the glare is reduced.

On/Off Switch

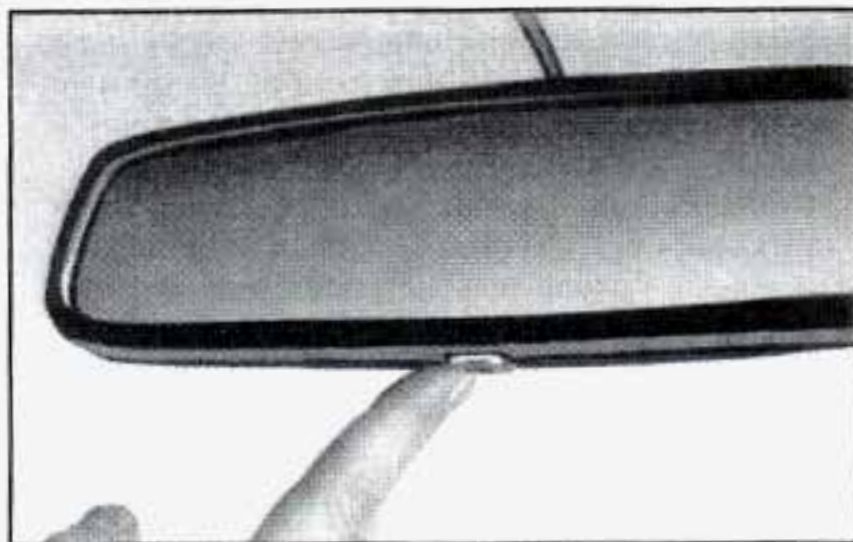

Press the button at the base of the mirror to turn on the automatic feature. The button has an indicator light to show it is on. Press the button to turn the automatic feature off.

Time Delay

This feature prevents rapid changing of the mirror from the night mode to the day mode as you drive under lights and through traffic.

Reverse Day Mode

The reverse mode is another important feature of the automatic mirror. When the shift lever is placed in REVERSE (R), the mirror changes to the day mode. This gives you a bright image in the mirror as you back up.

Cleaning the Photocells

Use a cotton swab and glass cleaner to clean the front and rear photocells that make the auto-dimming feature work.

Electrochromic Day/Night Rearview Mirror with Compass (Option)

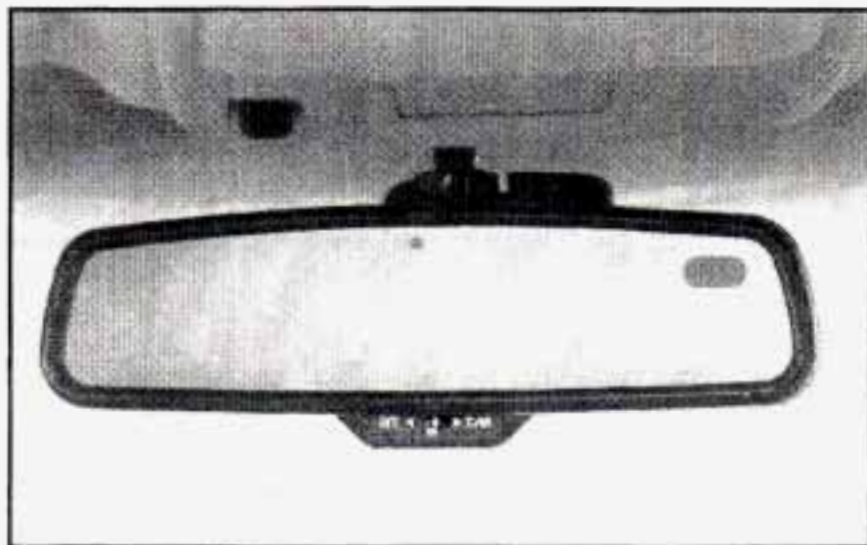

This mirror automatically changes to reduce glare when set in the M (Mirror) or C/M (Compass/Mirror) positions. One photocell on the back of the mirror senses when it is becoming dark outside. Another photocell is built into the mirror surface to sense headlamps behind you.

Mirror Settings

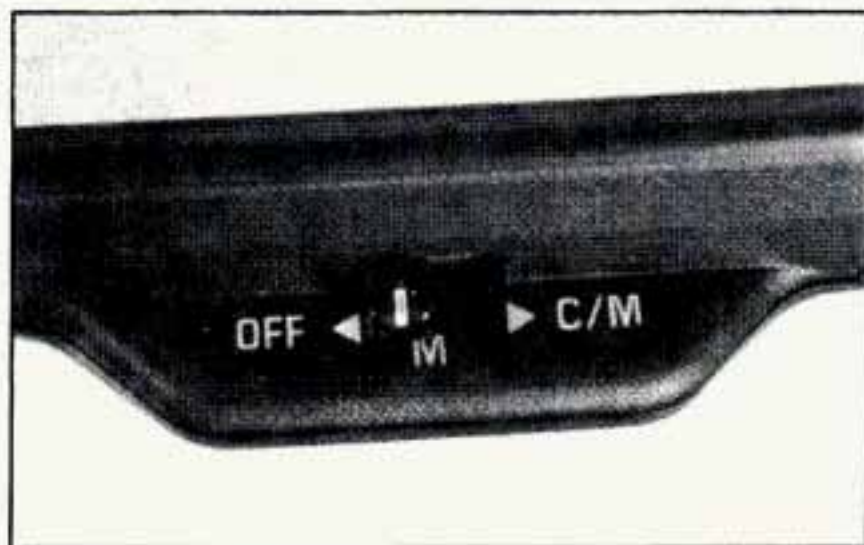

OFF: This setting turns off the day/night function and compass. The mirror will stay in the day mode.

M: This turns on the day/night portion of the mirror to automatically reduce glare.

C/M: This setting turns on the compass in addition to the day/night function. The letter or letters displayed in the top right corner of the mirror indicate the direction in which you are traveling.

Time Delay

This feature prevents rapid changing of the mirror from the night mode to the day mode as you drive under lights and through traffic.

Reverse Day Mode

The reverse mode is another important feature of the automatic mirror. When the shift lever is placed in REVERSE (R), the mirror changes to the day mode. This gives you a bright image in the mirror as you back up.

Cleaning the Photocells

Use a cotton swab and glass cleaner to clean the front and rear photocells that make the auto-dimming feature work.

Compass Calibration

Once the compass is calibrated, it does not need to be recalibrated. To calibrate the compass:

1. Set the switch on the mirror control to C/M.
2. Turn the vehicle ignition switch on. The letter C should be displayed in the mirror compass window. If not, hold the CAL switch (on the bottom of the mirror) for more than 10 seconds, and the letter C will appear. To hold in the CAL switch, insert a paper clip into the small hole on the bottom of the mirror housing. The display will show a number first, but keep holding until the letter C appears.
3. For quick calibration, drive the vehicle in a 360-degree circle at less than 5 mph (8 km/h) until the display reads a compass direction. For normal calibration, drive the vehicle on your everyday routine, and the compass will eventually calibrate.

Compass Variance

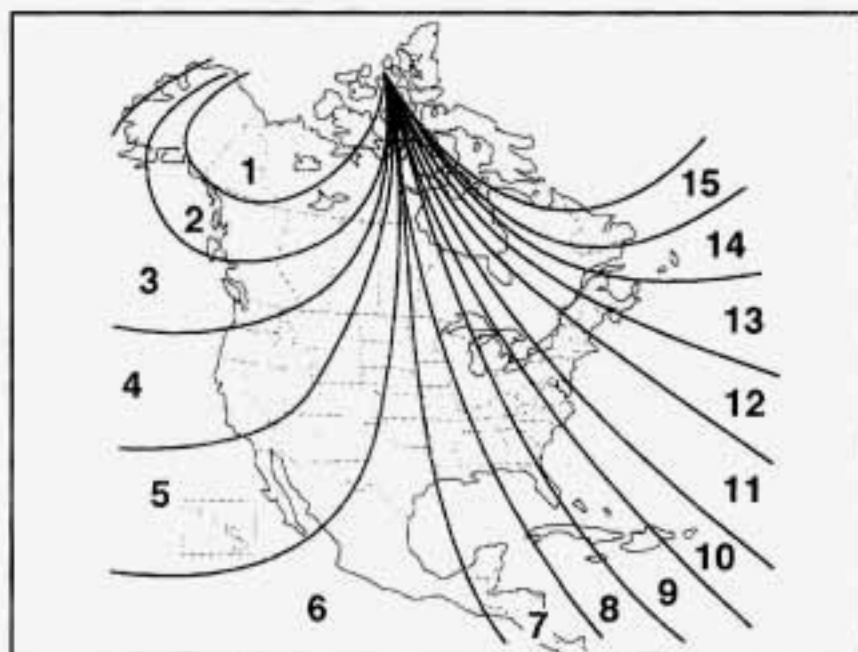

Variance is the difference between magnetic north and geographic north. In some areas, the difference between the two can be great enough to cause false compass readings. If this happens, follow these instructions to set the variance for your particular location:

1. Find your location on the zone map. Note the zone number.

2. Hold in the CAL switch (on the bottom of the mirror housing) for five seconds until the current zone entry number appears in the display. To hold in the CAL switch, insert a paper clip into the small hole on the bottom of the mirror housing.
3. Press the CAL switch until the number for the new zone entry is displayed.

Once the desired zone number is displayed, stop pressing the CAL switch and the display will show compass direction within a few seconds.

Power Remote Control Mirror (Heated)



Your Cadillac has an electric mirror control located on the driver's door armrest.

Move the switch in the middle of the control to choose the right or left mirror. To adjust the mirror, push the arrow control in the direction you want the mirror to go. Adjust each mirror so you can see the side of your vehicle and the area behind your vehicle.

The mirrors can also be programmed for personalization if you have the optional memory package. For more information, see "Memory Seat and Mirrors" in the Index.

Driver's Outside Auto-Dimming Rearview Mirror (If Equipped)

Only the driver's side outside mirror will adjust for the glare of headlamps behind you. This feature is controlled by the on and off settings on the electrochromic mirror. See "Electrochromic Day/Night Rearview Mirror" earlier in this section.

Convex Outside Mirror

Your passenger's side mirror is convex. A convex mirror's surface is curved so you can see more from the driver's seat. This mirror does not have a dimming feature.



CAUTION:

A convex mirror can make things (like other vehicles) look farther away than they really are. If you cut too sharply into the right lane, you could hit a vehicle on your right. Check your inside mirror or glance over your shoulder before changing lanes.

Storage Compartments

Glove Box

The glove box is located in front of the passenger's seat. To lock the glove box door, insert the oval key into the lock cylinder and turn it clockwise. Turn the key counterclockwise to unlock the door.

Overhead Console

Sunglasses Storage Compartment

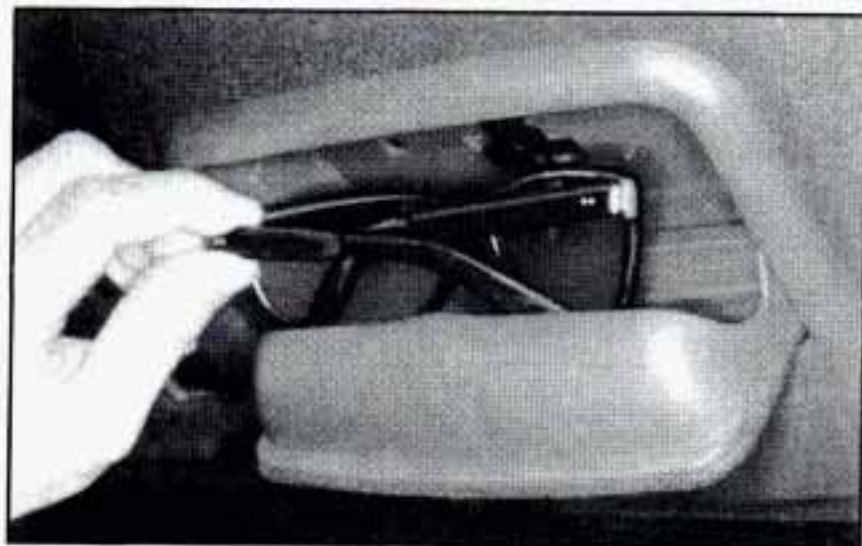

This feature is on vehicles without the optional astrorooftop. To gain access to this compartment, which is located directly above the inside rearview mirror in the headliner, push up and the storage area will open.

Map Pocket

The map/storage pockets are located on each front door as well as on the passenger's and driver's front seatbacks.

Center Console Storage Area (If Equipped)



Your vehicle is equipped with either the mini console, if you have the column shifter, or the optional full front console with shift lever.

The mini console comes with a storage tray, a storage compartment for CDs or tapes and a dual cupholder that unfolds for use. The full console includes a storage compartment for CDs or tapes and an optional phone, an armrest and a cupholder. The cupholder can be opened by pressing on the surface panel located in front of the armrest. Close the lid to secure.

Rear Storage Armrest (If Equipped)

Your vehicle may be equipped with a rear seat armrest which includes an open storage compartment and a dual cupholder that unfolds for use. To open, lift the front edge. This feature is available on vehicles with leather interiors only.

Convenience Net



The convenience net is inside the back wall of the trunk. Put small loads, like grocery bags, behind the net. It can help keep them from falling over during sharp turns or quick starts and stops.

The net is not for larger, heavier loads. Store them in the trunk as far forward as you can. When not using the net, hook the net to the tabs securing it to the sill plate.

Ashtrays and Cigarette Lighter

With the full center console, press on the cover, which is located below the climate control system, to reveal the front ashtray. To clean this ashtray, lift it out by gripping the sides. If you don't have a center console, pull the tray out to reveal the ashtray. The tray is located beneath the radio. To clean this ashtray, lift it out by pulling on the snuffer.

To use the rear ashtray, lift the lid.

NOTICE:

Don't put papers or other flammable items into your ashtrays. Hot cigarettes or other smoking materials could ignite them, causing a damaging fire.

The cigarette lighter is located near the ashtray. Press it all the way in and release. It will pop back by itself when it's ready to light. You may also have a lighter on the back of the center console near the rear seat air outlet.

Note that power to the cigarette lighter will shut off 10 minutes after the ignition is turned off. This helps to prevent battery drainage. For more information, see "Inadvertent Power Battery Saver" earlier in this section.

NOTICE:

Don't hold a cigarette lighter in with your hand while it is heating. If you do, it won't be able to back away from the heating element when it's ready. That can make it overheat, damaging the lighter and the heating element.

Sun Visors

Swing down the visor to block out glare. It can also be detached from the center mount and moved to the side. The driver's sunshade is also equipped with a storage flap that can be used for maps or toll tickets.

Illuminated Visor Vanity Mirror (If Equipped)

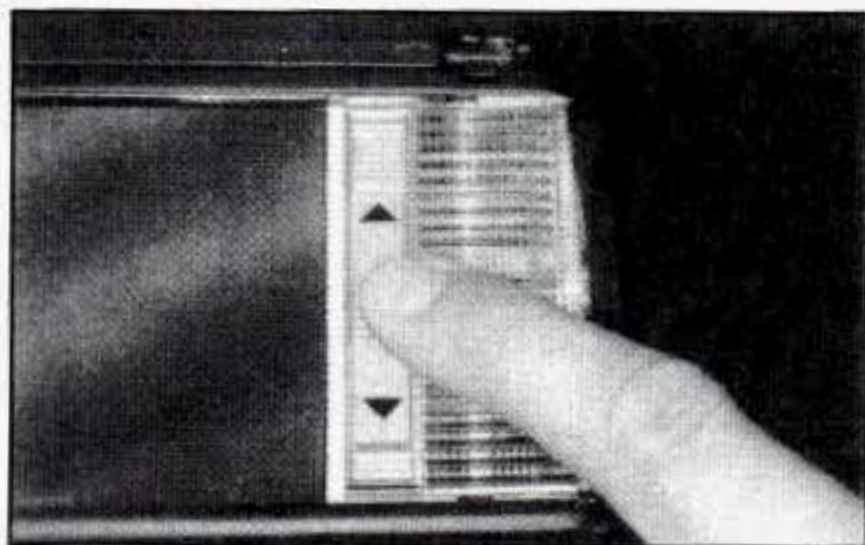

Turn the sunshade down and lift the cover to see the mirror. Move the slide switch up or down to brighten or dim the lamp.

Cellular Telephone (Option)

Your vehicle has been prewired for dealer installation of a Cadillac dual-mode (analog/digital) cellular telephone. A fixed mobile or a portable hand-held system are available. Either system has steering wheel telephone controls and information output through the DIC. Voice activation and hands-free operation are standard features. For more information, contact your Cadillac dealer. A user's guide is provided with the telephone.

OnStar System (Option)

This system may be ordered if you have the optional fixed cellular telephone. The following services are available 24 hours a day:

- Roadside Service with Location
- Emergency Services Button
- Remote Door Unlock
- Theft Detection/Notification and Stolen-Vehicle Tracking
- Automatic Notification of Air Bag Deployment
- Concierge/Customer Convenience Services

For more information, contact your Cadillac dealer.

Assist Handles

A folding handle above each rear door can be used when getting out of your vehicle.

Garment Hooks

For your convenience, a garment hook is attached to the rear reading lamp and assist handle.

Floor Mats

Your Cadillac is equipped with rubber-backed front and rear floor mats. Keep them clean by vacuuming and using a spot cleaner, if necessary. Do not machine wash.

Astroroof (Option)

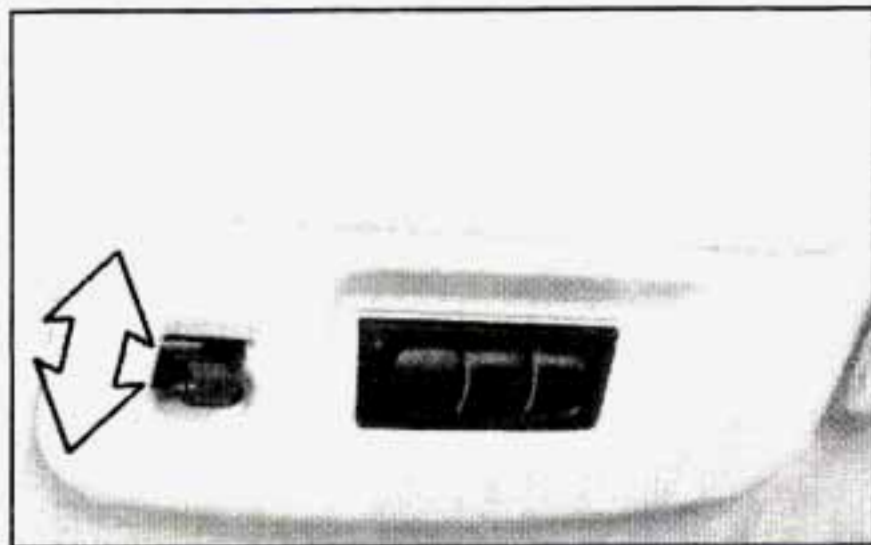

The express-open astroroof provides an airy, spacious feel to your vehicle's interior and can also increase ventilation. It includes a sliding glass panel and a sliding sunshade. The control switch only works when the ignition is on or when the RAP is active.

Press the switch rearward and release to express-open the glass panel and sunshade. The sunshade can also be opened by hand. If you want to stop the roof in a partially opened position, press the switch in either direction. Press and release the switch again to open it fully.

Press and hold the switch forward to close the glass panel. The sunshade can only be closed by hand.

To vent, press the switch forward when the glass panel is closed. Open the sunshade by hand. To close the vent, press the switch rearward.

Universal Transmitter (Option)

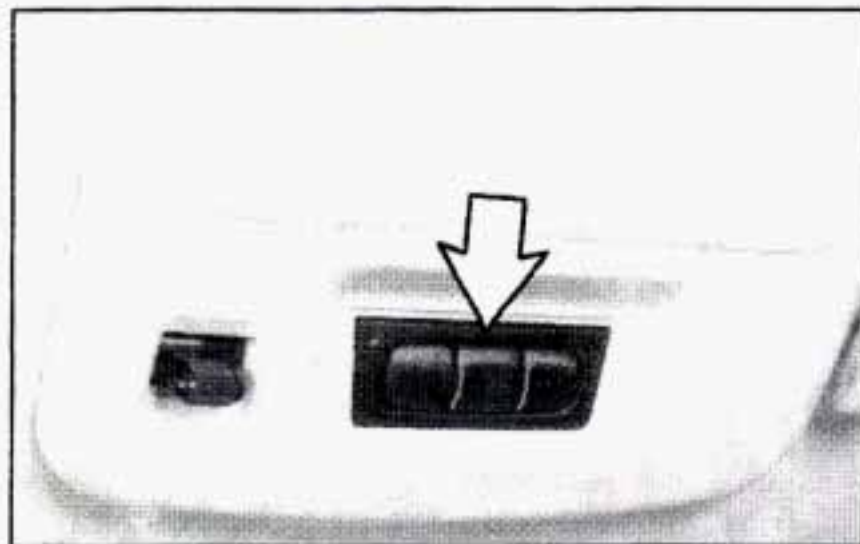

This transmitter allows you to consolidate the functions of up to three individual hand-held transmitters. It will operate garage doors and gates, or with the accessory package, other devices controlled by radio frequency such as home/office lighting systems.

The transmitter will learn and transmit the frequencies of most current transmitters and is powered by your vehicle's battery and charging system.

This device complies with Part 15 of the FCC Rules. Operation is subject to the following two conditions: (1) this device may not cause harmful interference, and (2) this device must accept any interference received, including interference that may cause undesired operation.

This device complies with RSS-210 of Industry and Science Canada. Operation is subject to the following two conditions: (1) this device may not cause interference, and (2) this device must accept any interference, including interference that may cause undesired operation of the device.

Changes or modification to this system by other than an authorized service facility could void authorization to use this equipment.

Programming the Transmitter

Do not use the universal transmitter with any garage door opener that does not have the "stop and reverse" safety feature. This includes any garage door opener model manufactured before April 1, 1982.

Be sure that people and objects are clear of the garage door you are programming.

Your vehicle's engine should be turned off while programming the transmitter. Follow these steps to program up to three channels:

1. If you have previously programmed a transmitter channel, proceed to Step 2. Otherwise, hold down the two outside buttons on the universal transmitter until the red light begins to flash rapidly (approximately 20 seconds). Then release the buttons. This procedure initializes the memory and erases any previous settings for all three channels.
2. Decide which one of the three channels you want to program.
3. Hold the end of the hand-held transmitter against the front surface of the universal transmitter so that you can still see the red light.

4. Using both hands, press the hand-held transmitter button and the desired button on the universal transmitter. Continue to press both buttons through Step 5.
5. Hold down both buttons until you see the red light on the universal transmitter flash slowly and then rapidly. The rapid flashing, which could take up to 90 seconds, indicates that the universal transmitter has been programmed. Release both buttons once the light starts to flash rapidly.

If you have trouble programming the universal transmitter, make sure that you have followed the directions exactly as described and that the battery in the hand-held transmitter is not dead. If you still cannot program it, rotate the hand-held transmitter end over end and try again. The universal transmitter may not work with older garage door openers that do not meet current Federal Consumer Safety Standards. If you cannot program the transmitter after repeated attempts, consult your Cadillac dealer.

Be sure to keep the original hand-held transmitter in case you need to erase and reprogram the universal transmitter.

Note to Canadian Owners: During programming, the hand-held transmitter may stop transmitting after one or two seconds. If you are programming from one of these transmitters, you should press and re-press the button on the hand-held transmitter every two seconds without ever releasing the button on the universal transmitter. Release both buttons when the red light on the universal transmitter begins to flash rapidly.

Operating the Transmitter

Press and hold the appropriate button on the universal transmitter. The red light comes on while the signal is being transmitted.

Note that the universal transmitter is disabled when the VALET button inside the glove box is activated. For more information, see "Security Override" earlier in this section.

Also note that if the hand-held transmitter appears to program the universal transmitter but does not open your garage door, and if the garage door opener was manufactured after 1995, the garage door opener may have a "rolling code" system. A rolling code system changes the code of the garage door opener every time you open or close the garage door.

To determine if you have this system, press the button on the universal transmitter that you have programmed already. If the red light on the universal transmitter flashes rapidly for one or two seconds and then stops flashing, the garage door opener has a rolling code system.

Training a Garage Door Opener with “Rolling Codes” (If Equipped)

If you have not previously programmed the hand-held transmitter to the universal transmitter, see “Programming the Transmitter” earlier in this section. If you have completed this programming already, you now need to train the garage door opener receiver to recognize the universal transmitter.

1. Remove the cover panel from the garage door opener receiver (the receiver should be located by the garage door opener motor).
2. Locate the training button on the garage door opener receiver. The exact location and color of the button may vary by garage door opener brand. If you have difficulty locating the training button, refer to your garage door opener manual.
3. Press the training button on the garage door opener receiver for one or two seconds.

4. Return to the universal transmitter in your vehicle and press the universal transmitter button you have already programmed for two to three seconds. Press the button again to make sure that the universal transmitter has been trained to the garage door opener receiver.

The garage door opener should now recognize the universal transmitter. You may either use the universal transmitter or the hand-held transmitter to open the garage door.

If after following these instructions you still have problems training the garage door opener, consult your Cadillac dealer.

Erasing Channels

To erase all three programmed channels, hold down the two outside buttons until the red light begins to flash. Individual channels cannot be erased, but can be reprogrammed using the procedure for programming the transmitter explained earlier.

The Instrument Panel: Your Information System

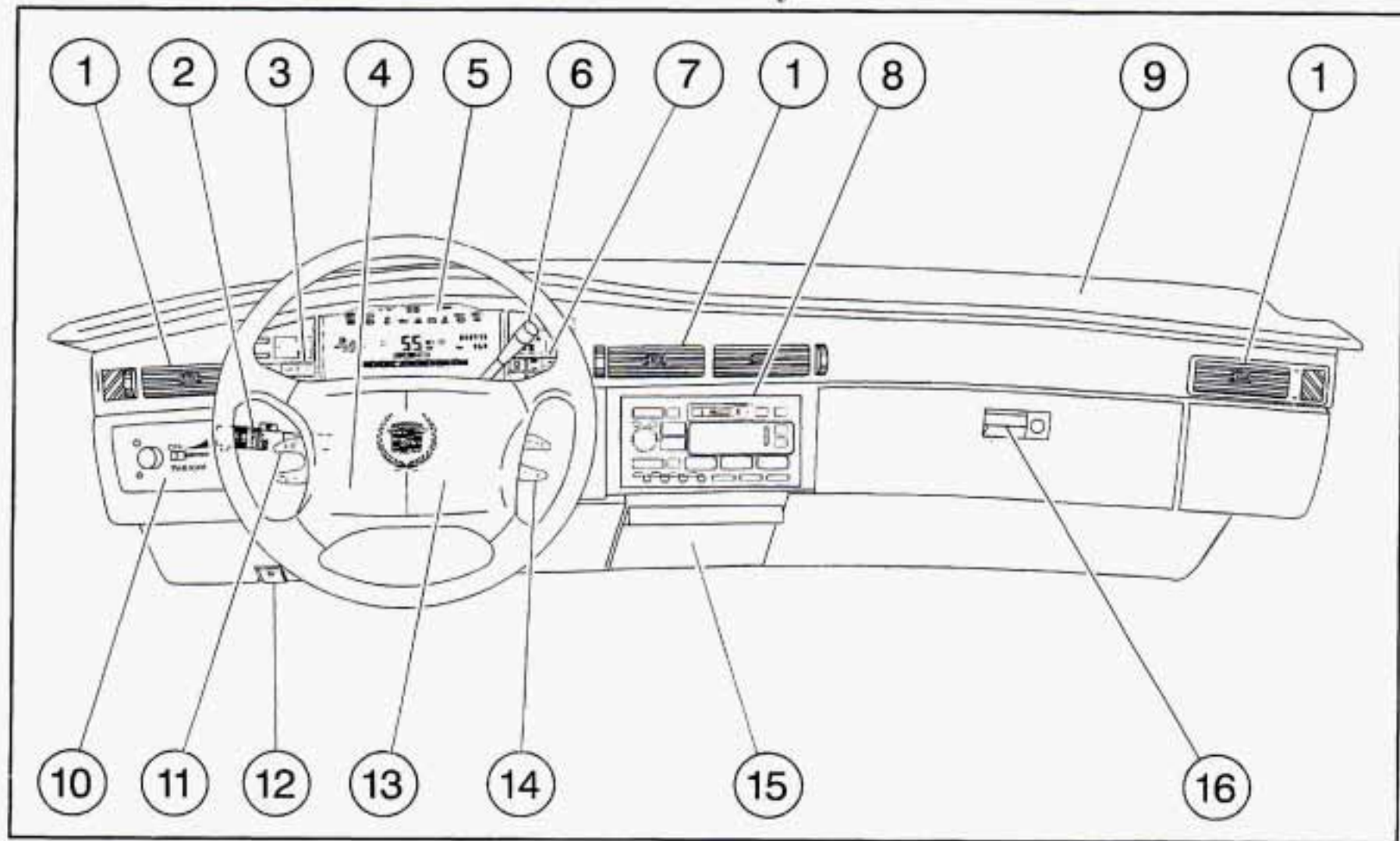

The instrument panel is designed to let you know at a glance how your Cadillac is running. You'll know how fast you're going, how much fuel you're using and many of the other things you'll need to know to drive safely and economically. The main components of the instrument panel are:

1. Air Outlets
2. Turn Signal/Multifunction Lever
3. Driver Information Center Control Buttons
4. Driver's Side Air Bag
5. Cluster
6. Steering Column Shift Lever
7. Electronic Climate Controls
8. Radio
9. Passenger's Side Air Bag
10. Lamp Controls
11. HVAC Steering Wheel Controls (or Cellular Telephone Controls, If Equipped)
12. Hood Release
13. Horn
14. Audio Steering Wheel Controls
15. Ashtray and Cigarette Lighter
16. Glove Box

Digital Cluster (SLS Only)

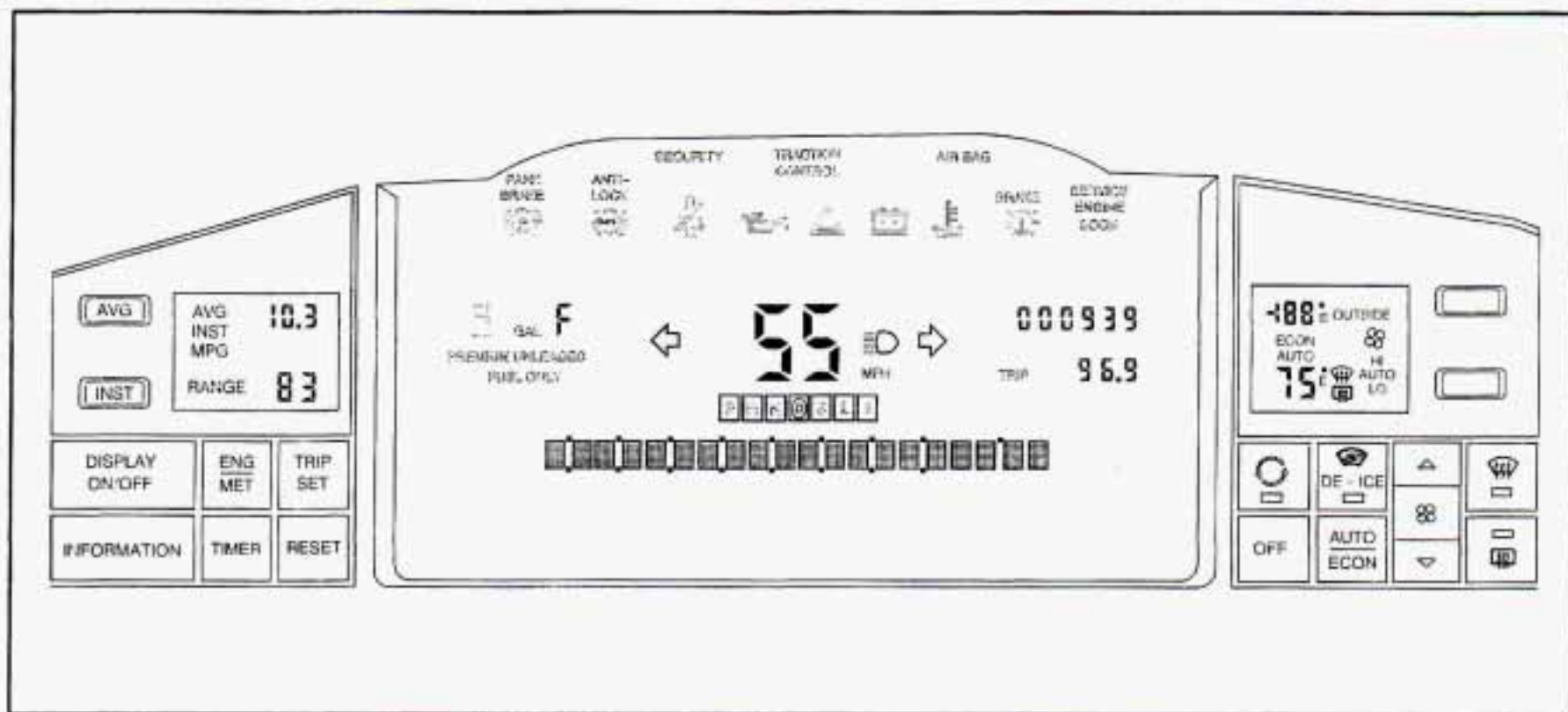

United States version shown, Canadian similar

Analog Cluster (If Equipped)

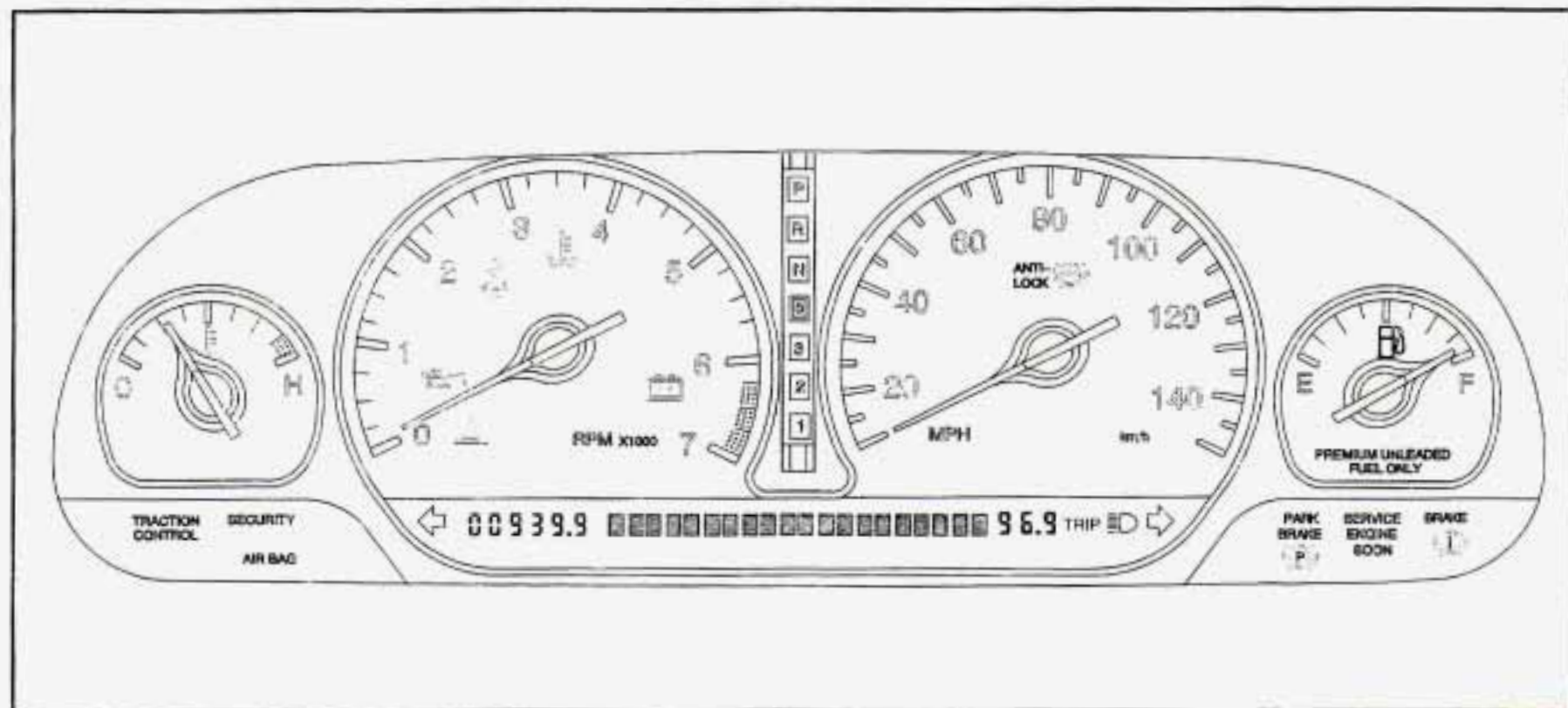

United States version shown, Canadian similar

Speedometer and Odometer

The speedometer lets you see your speed in both miles per hour (mph) and kilometers per hour (km/h). The odometer shows how far your vehicle has been driven, in either miles (used in the United States) or kilometers (used in Canada).

You may wonder what happens if a vehicle has to have a new odometer installed. The new one may read the correct mileage. This is because your vehicle's computer has stored the mileage in memory.

Trip Odometer

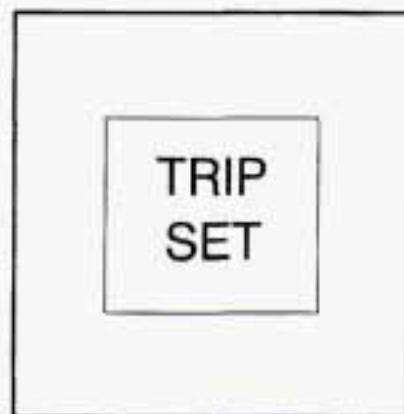

Digital Cluster

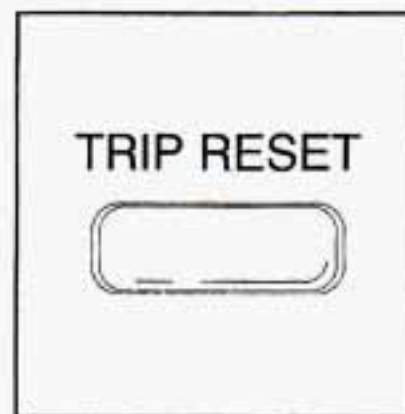

Analog Cluster

By pressing one of these buttons, you can tell how far you've traveled since you last set the trip odometer back to zero. For information on resetting these buttons, see "Digital or Analog Control Buttons" later in this section.

English/Metric Display



Digital Cluster

With the digital cluster, you can go back and forth from English (miles) to metric (kilometers) by pressing this button.

For analog clusters, press the INFO button until ENGLISH/METRIC RESET displays and then press INFO RESET to select.

Note that other readings such as temperature, fuel and trip odometer also go back and forth between English and metric.

Vehicle Speed Limiter

This feature prevents your vehicle from exceeding speeds that the tires are not rated for. When this happens, the engine's fuel supply is shut off. When the vehicle speed slows, the fuel supply will come on again.

Tachometer (Analog Cluster Only)

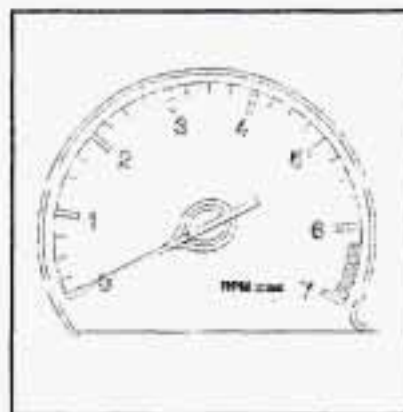

This gage indicates the engine speed in revolutions per minute (rpm).

NOTICE:

Do not operate the engine with the tachometer in the red area or engine damage may occur.

Engine Speed Limiter

This feature prevents the engine from operating at too many revolutions per minute (rpm). When the engine's rpm are critically high, the fuel supply to the engine is shut off. When the engine speed slows, the fuel supply will come on again. This helps prevent damage to the engine.

Warning Lights, Gages and Indicators

This part describes the warning lights and gages that may be on your vehicle. The pictures will help you locate them.

Warning lights and gages can signal that something is wrong before it becomes serious enough to cause an expensive repair or replacement. Paying attention to your warning lights and gages could also save you or others from injury.

Warning lights come on when there may be or is a problem with one of your vehicle's functions. As you will see in the details on the next few pages, some warning lights come on briefly when you start the engine just to let you know they're working. If you are familiar with this section, you should not be alarmed when this happens.

Gages can indicate when there may be or is a problem with one of your vehicle's functions. Often gages and warning lights work together to let you know when there's a problem with your vehicle.

When one of the warning lights comes on and stays on when you are driving, or when one of the gages shows there may be a problem, check the section that tells you what to do about it. Please follow this manual's advice. Waiting to do repairs can be costly -- and even dangerous. So please get to know your warning lights and gages. They're a big help.

Your vehicle also has a Driver Information Center that works along with the warning lights and gages. See "Driver Information Center" later in this section.

Safety Belt Reminder Light

When the key is turned to RUN or START, a chime will come on for about eight seconds to remind people to fasten their safety belts, unless the driver's safety belt is already buckled.



The safety belt light will also come on and stay on for about 20 seconds, then it will flash for about 70 seconds. If the driver's belt is already buckled, neither the chime nor the light will come on.

Air Bag Readiness Light

There is an air bag readiness light on the instrument panel, which shows AIR BAG. The system checks the air bag's electrical system for malfunctions. The light tells you if there is an electrical problem. The system check includes the air bag sensors, the air bag modules, the wiring and the crash sensing and diagnostic module. For more information on the air bag system, see "Air Bag" in the Index.



This light will come on when you start your engine, and it will flash for a few seconds. Then the light should go out. This means the system is ready.

If the air bag readiness light stays on after you start the engine or comes on when you are driving, your air bag system may not work properly. Have your vehicle serviced right away.

The air bag readiness light should flash for a few seconds when you turn the ignition key to RUN. If the light doesn't come on then, have it fixed so it will be ready to warn you if there is a problem.

Charging System Indicator Light

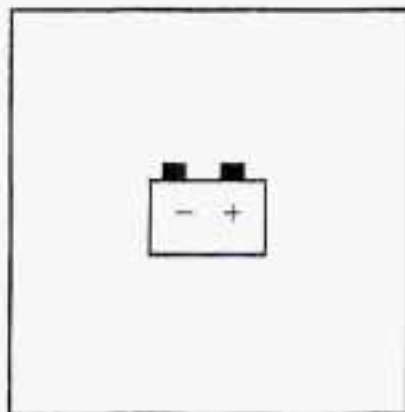

When you turn the key to RUN, this light will come on briefly to show that your generator and battery charging systems are working.

If this light stays on, you need service and you should take your Cadillac to the dealer at once. To save your battery until you get there, turn off all accessories.

Brake System Warning Light

Your Cadillac's hydraulic brake system is divided into two parts. If one part isn't working, the other part can still work and stop you. For good braking though, you need both parts working well.

If the warning light comes on, there could be a brake problem. Have your brake system inspected right away.

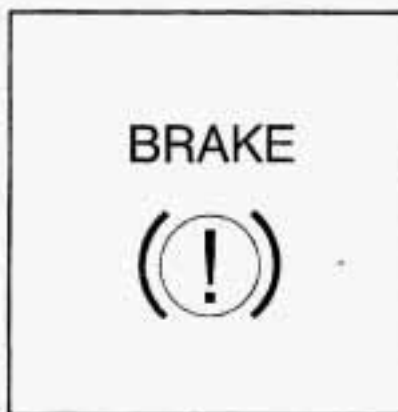

This light should come on briefly when you turn the ignition key to RUN. If it doesn't come on then, have it fixed so it will be ready to warn you if there's a problem.

If the light comes on while you are driving, pull off the road and stop carefully. You may notice that the pedal is harder to push. Or, the pedal may go closer to the floor. It may take longer to stop. If the light is still on, have the vehicle towed for service. (See "Towing Your Vehicle" in the Index.)

 **CAUTION:**

Your brake system may not be working properly if the brake system warning light is on. Driving with the brake system warning light on can lead to an accident. If the light is still on after you've pulled off the road and stopped carefully, have the vehicle towed for service.

When the ignition is on, the brake system warning light will also come on when you set your parking brake. The light will stay on if your parking brake doesn't release fully. If it stays on after your parking brake is fully released, it means you have a brake problem.

Parking Brake Indicator Light

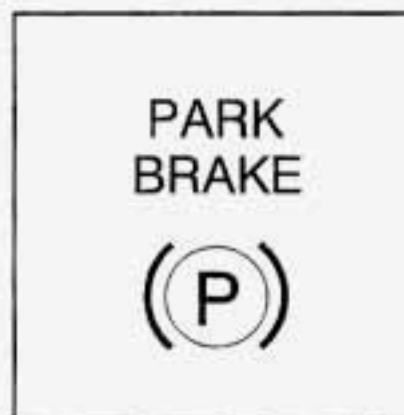

This light comes on when the parking brake is set, and it will stay on if the parking brake does not fully release. If you try to drive off with the parking brake set, this light will remain on.

This light should also come on briefly as you start the vehicle. If it doesn't, have the light fixed so it will be ready to remind you if the parking brake has not fully released. For more information on how to release the parking brake, see "Parking Brake" earlier in this section.

Anti-Lock Brake System Warning Light

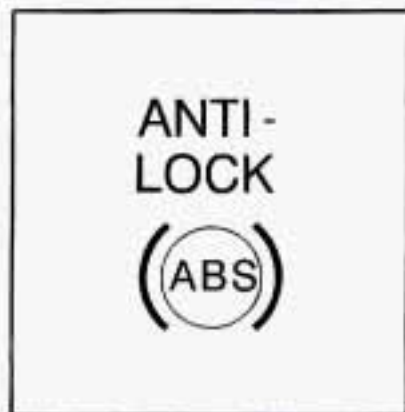

Digital Cluster

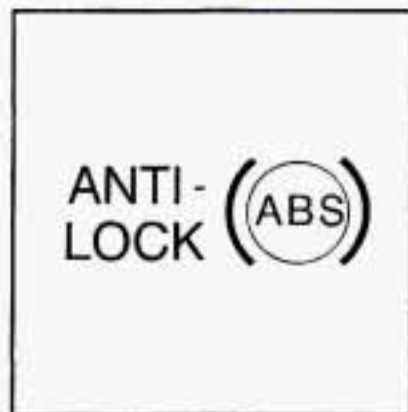

Analog Cluster

With the anti-lock brake system, the light(s) will come on when you start your engine and may stay on for several seconds. That's normal.

If the light stays on, turn the ignition to OFF. Or, if the light comes on when you're driving, stop as soon as possible and turn the ignition off. Then start the engine again to reset the system. If the light still stays on, or comes on again while you're driving, your Cadillac needs service. If the regular brake system warning light isn't on, you still have brakes, but you don't have anti-lock brakes. If the regular brake system warning light is also on, you don't have anti-lock brakes and there's a problem with your regular brakes. See "Brake System Warning Light" earlier in this section.

The anti-lock brake system warning light should come on briefly when you turn the ignition key to RUN. If the light doesn't come on then, have it fixed so it will be ready to warn you if there is a problem.

Traction Control System Warning Light



This warning light should come on briefly as you start the engine. If the warning light doesn't come on then, have it fixed so it will be ready to warn you if there's a problem.

If it stays on, or comes on when you're driving, there may be a problem with your traction control system and your vehicle may need service. When this warning light is on, the system will not limit wheel spin. Adjust your driving accordingly.

The traction control system warning light may come on for the following reasons:

- If there's a brake system problem that is specifically related to traction control, the traction control system will turn off and the warning light will come on.
- If the traction control system is affected by an engine related problem, the system will turn off and the warning light will come on.

If the traction control system warning light comes on and stays on for an extended period of time when the system is turned on, your vehicle needs service.

Engine Coolant Temperature Warning Light

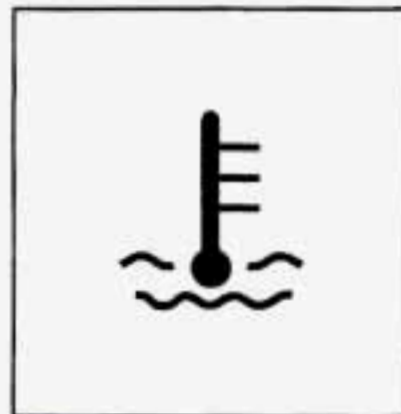

This light tells you that the engine has overheated. You should stop the car and turn the engine off as soon as possible. A warning chime should also sound if this light comes on.

As a check, the light should come on for a few seconds when you start your engine. In the section "Problems on the Road," this manual explains what to do. See "Engine Overheating" in the Index.

Engine Coolant Temperature Gage

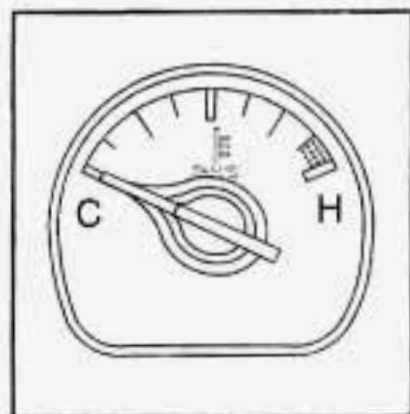

Analog Cluster

This gage shows the engine coolant temperature. If the gage pointer moves into the red area, the engine is too hot.

That reading means the same thing as the warning light -- the engine coolant has overheated. The section "Problems on the Road" in this manual explains what to do. See "Engine Overheating" in the Index.

Malfunction Indicator Lamp (Service Engine Soon Light)



Your Cadillac is equipped with a computer which monitors operation of the fuel, ignition and emission control systems.

This system is called OBD II (On-Board Diagnostics-Second Generation) and is intended to assure that emissions are at acceptable levels for the life of the vehicle, helping to produce a cleaner environment. (In Canada, OBD II is replaced by Enhanced Diagnostics.) The SERVICE ENGINE SOON light comes on and a chime will sound to indicate that there is a problem and service is required. Malfunctions often will be indicated by the system before any problem is apparent. This may prevent more serious damage to your vehicle. This system is also designed to assist your service technician in correctly diagnosing any malfunction.

NOTICE:

If you keep driving your vehicle with this light on, after a while, your emission controls may not work as well, your fuel economy may not be as good and your engine may not run as smoothly. This could lead to costly repairs that may not be covered by your warranty.

This light should come on, as a check to show you it is working, when the ignition is on and the engine is not running. If the light doesn't come on, have it repaired. This light will also come on during a malfunction in one of two ways:

- **Light Flashing** -- A misfire condition has been detected. A misfire increases vehicle emissions and may damage the emission control system on your vehicle. Dealer or qualified service center diagnosis and service is required.
- **Light On Steady** -- An emission control system malfunction has been detected on your vehicle. Dealer or qualified service center diagnosis and service may be required.

If the Light Is Flashing

The following may prevent more serious damage to your vehicle:

- Reducing vehicle speed.
- Avoiding hard accelerations.
- Avoiding steep uphill grades.
- If you are towing a trailer, reduce the amount of cargo being hauled as soon as it is possible.

If the light stops flashing and remains on steady, see "If the Light Is On Steady" following.

If the light continues to flash, when it is safe to do so, *stop the vehicle*. Find a safe place to park your vehicle. Turn the key off, wait at least 10 seconds and restart the engine. If the light remains on steady, see "If the Light Is On Steady" following. If the light is still flashing, follow the previous steps, and drive the vehicle to your dealer or qualified service center for service.

If the Light Is On Steady

You may be able to correct the emission system malfunction by considering the following:

Did you just drive through a deep puddle of water?

If so, your electrical system may be wet. The condition will usually be corrected when the electrical system dries out. A few driving trips should turn the light off.

Are you low on fuel?

As your engine starts to run out of fuel, your engine may not run as efficiently as designed since small amounts of air are sucked into the fuel line causing a misfire. The system can detect this. Adding fuel should correct this condition. Make sure to install the fuel cap properly. It will take a few driving trips to turn the light off.

Have you recently changed brands of fuel?

If so, be sure to fuel your vehicle with quality fuel (see "Fuel" in the Index). Poor fuel quality will cause your engine not to run as efficiently as designed. You may notice this as stalling after start-up, stalling when you put the vehicle into gear, misfiring, hesitation on acceleration or stumbling on acceleration. (These conditions may go away once the engine is warmed up.) This will be detected by the system and cause the light to turn on.

If you experience one or more of these conditions, change the fuel brand you use. It will require at least one full tank of the proper fuel to turn the light off.

If none of the above steps have made the light turn off, have your dealer or qualified service center check the vehicle. Your dealer has the proper test equipment and diagnostic tools to fix any mechanical or electrical problems that may have developed.

Oil Pressure Light



This light tells you if there could be a problem with your engine oil pressure.

The light goes on when you turn your key to RUN or START. It goes off once you start your engine. That's a check to be sure the light works. If it doesn't come on, be sure to have it fixed so it will be there to warn you if something goes wrong.

When the light *comes* on and *stays* on, it means that oil isn't flowing through your engine properly. You could be low on oil and you might have some other system problem.

⚠ CAUTION:

Don't keep driving if the oil pressure is low. If you do, your engine can become so hot that it catches fire. You or others could be burned. Check your oil as soon as possible and have your vehicle serviced.

NOTICE:

Damage to your engine from neglected oil problems can be costly and is not covered by your warranty.

Fuel Gage

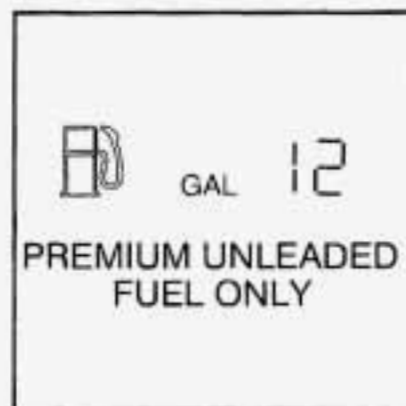

Digital Cluster

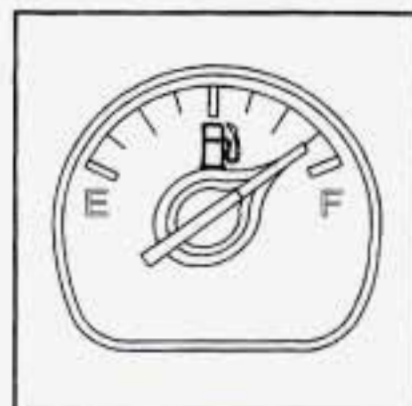

Analog Cluster

The fuel gage shows approximately how much fuel is in the tank. It works only when the ignition is in the RUN position.

On the digital cluster, if the fuel level is within approximately two gallons (7.6 L) of being full, the letter F is shown. If the fuel level is between one and three gallons (3.8 and 11.4 L) from being empty, the

letter E is shown. If the fuel supply gets down to approximately three gallons (11.4 L), the E will display and the FUEL LEVEL LOW message will appear on the DIC. (On the analog fuel gage, the FUEL LEVEL LOW message will also appear.) When the fuel supply gets down to about 1.2 gallons (4.5 L) from being empty, the letter E begins to flash indicating that fuel is needed soon.

Here are a few concerns some owners have had about the fuel gage. All of these situations are normal and do not indicate that anything is wrong with the fuel gage.

- At the gas station the gas pump shuts off before the gage reads F.
- It takes more (or less) gas to fill the tank than the gage said. For example, the gage read 8 GALLONS, but it took more (or less) than the tank's remaining capacity to fill it.
- The gage may change when you turn, stop or speed up.

Fuel Data Panel

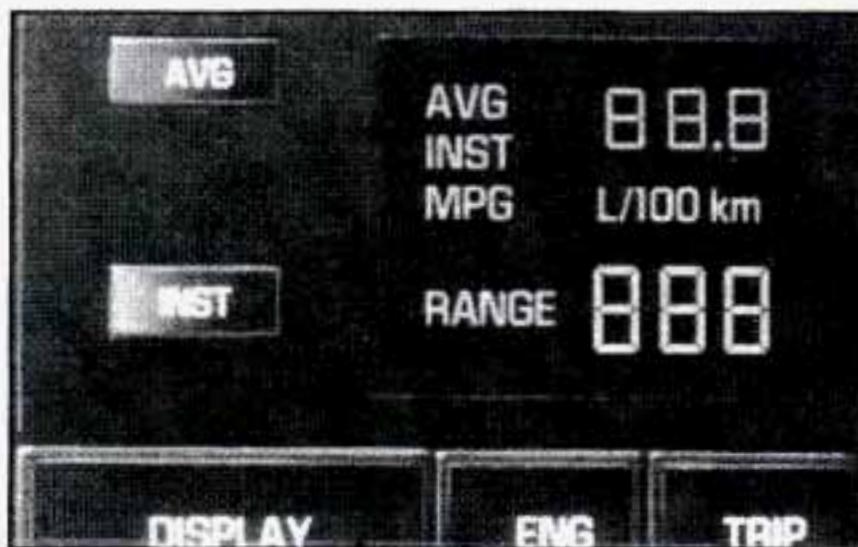

Digital Cluster

For vehicles equipped with an analog cluster (not shown), fuel data can be obtained by pressing the INFO button. See "Analog Control Buttons" later in this section.

The fuel data panel tells you all you need to know about the fuel economy and how far you can travel with the fuel remaining.

Press the AVG button to display the average mile-per-gallon (AVG MPG). You can also display it in metric units by pressing the ENG/MET button.

When AVG MPG is selected, the total distance is divided by the total fuel used.

When the INST button (Instantaneous Fuel Economy) is selected, you will see what the fuel economy is at that instant. The computer takes a new reading twice every second. It will show economy up to 70 miles-per-gallon (or 2 L per 100 km).

To reset the average fuel economy, press the INFORMATION button until the AVG MPG is displayed on the DIC. Press and hold the RESET button until both the fuel data center and DIC display reads 0.0.

The RANGE display shows how far the computer thinks you can travel with the fuel that is in the tank. The computer does not know what driving conditions will be like for the rest of your trip, so the range is estimated based on the recent fuel economy. Therefore, the range reading may change as your driving habits change. Going from city to highway driving may increase the range reading.

If the range display shows LO, you should stop for fuel as soon as possible. Your computer needs enough data for the RANGE reading to work.

Driver Information Center (DIC)

The DIC display gives you the status of many of your vehicle's systems. The DIC is also used to display driver personalization features and warning/status messages.

Memory and Personalization Features (If Equipped)

Your vehicle may be equipped with the following features that can be individually customized for up to two drivers.

- Programmable Automatic Door Locks
- Remote Confirmation (for RKE)
- Exterior Lighting (at Unlock)
- Remote Recall Memory (for RKE or Key in the Ignition)
- Battery Guard Storage
- Climate Control Personalization
- Memory Seat and Mirrors
- Radio Personalization

For detailed information, see each feature in the Index.

Digital Control Buttons (SLS Only)



DISPLAY ON/OFF: Pressing this button will turn off the DIC, Electronic Climate Control (ECC), fuel data center, the fuel gage, trip odometer and odometer. While the displays are off, pressing the INFORMATION button will only turn on the DIC. If the TRIP SET button is pressed or the fuel level falls below four gallons (15.2 L), all of the displays will come back on.

ENG/MET: You can change the display from English (miles) to metric (kilometers) by pressing this button. The same button also changes other readings (like temperature, fuel and odometer).

TRIP SET: By using this button, you can tell how far you've gone since you last set the TRIP SET back to zero. To reset, press and hold the button until zeros appear. If your vehicle is domestic, the trip odometer will return to zero after 999.9 miles (1 609 km). If your vehicle is Canadian, the trip odometer will return to zero after 1 999.9 km (1,242 miles).

INFORMATION: Pressing this button repeatedly will display the MPG AVG, MPG INST, GAL FUEL USED, AVG MPH, ENGINE RPM, BATTERY VOLTS, COOLANT TEMP and OIL LIFE LEFT.

TIMER: This feature is like a stopwatch, in that you can clock the time it takes to get from one point to another.

To operate, press the TIMER button until TIMER OFF 00:00:00 is displayed on the DIC. Each of the fields for the hours, minutes and seconds are two numeric digits.

Once **TIMER OFF 00:00:00** is displayed, press the **TIMER** button to start the timing feature. Press the **TIMER** button again to stop it. If you will be starting and stopping your Cadillac, during a trip for instance, the **TIMER** feature will automatically start timing where it left off when you last stopped. To reset it, press and hold the **RESET** button until the display reads **TIMER 00:00:00**. Press the **INFORMATION** button to exit from the **TIMER** function.

RESET: Pressing this button will reset the **MPG AVG**, **MPG INST**, **GAL FUEL USED**, **AVG MPH** and **OIL LIFE LEFT**. Pressing **RESET** when a non-resettable display appears will cause a "recall" mode to occur. When this happens, all **DIC** warning messages that have been displayed since the ignition key was turned to **RUN** will redisplay. If no messages were displayed, a **MONITORED SYSTEMS OK** message will appear.

MPG AVG (Reset): Press the **INFORMATION** button to display the **MPG AVG** (Average Fuel Economy), then press and hold the **RESET** button until **0.0 MPG AVG** is displayed.

FUEL USED (Reset): Press the **INFORMATION** button to display the **GAL FUEL USED** on the **DIC**, then press and hold the **RESET** button until **0.0 GAL FUEL USED** is displayed.

AVG MPH (Reset): Press the **INFORMATION** button to display the **AVG MPH** (Average Speed), then press and hold the **RESET** button until **0.0 AVG MPH** is displayed.

OIL LIFE LEFT (Reset): Press the **INFORMATION** button to display the **OIL LIFE LEFT**, then press and hold the **RESET** button until **100% OIL LIFE LEFT** is displayed. (This only needs to be reset after you have had the oil changed.)

Analog Control Buttons (If Equipped)



TRIP RESET: By using this button, you can tell how far you've gone since you last set the TRIP RESET back to zero. To reset, press and hold the button until zeros appear. If your vehicle is domestic, the trip odometer will return to zero after 999.9 miles (1 609 km). If your vehicle is Canadian, the trip odometer will return to zero after 1 999.9 km (1,242 miles).

INFO RESET: Pressing this button will reset the MPG AVG, GAL FUEL USED, AVG MPH, TIMER, OIL LIFE LEFT and ENGLISH/METRIC RESET. Pressing INFO RESET when a non-resettable display appears will cause a "recall" mode to occur. When this happens, all DIC warning messages that have been displayed since the ignition key was turned to RUN will redisplay. If no messages were displayed, a MONITORED SYSTEMS OK message will appear.

MPG AVG (Reset): Press the INFO button to display the MPG AVG (Average Fuel Economy), then press and hold the INFO RESET button until 0.0 MPG AVG is displayed.

GAL FUEL USED (Reset): Press the INFO button to display the FUEL USED on the DIC, then press and hold the INFO RESET button until 0.0 GAL FUEL USED is displayed.

AVG MPH (Reset): Press the INFO button to display the AVG MPH (Average Speed), then press and hold the INFO RESET button until 0.0 AVG MPH is displayed.

TIMER: This feature is like a stopwatch, in that you can clock the time it takes to get from one point to another.

To operate, press the INFO button to display TIMER. Each of the fields for the hours, minutes and seconds are two numeric digits.

Once TIMER OFF 00:00:00 is displayed, press the INFO RESET button to start the timing feature. Press the INFO RESET button again to stop it. If you will be starting and stopping your Cadillac, during a trip for instance, the TIMER feature will automatically start timing where it left off when you last stopped. To reset it, press and hold the INFO RESET button until the display reads TIMER 00:00:00. Press the INFO button to exit from the TIMER function.

OIL LIFE LEFT (Reset): Press the INFO button to display the OIL LIFE LEFT, then press and hold the INFO RESET button until 100% OIL LIFE LEFT is displayed. (This only needs to be reset after you have had the oil changed.)

ENGLISH/METRIC (Reset): Press the INFO button to display ENGLISH/METRIC RESET, then press the INFO RESET button to select. The display will change from English (miles) to metric (kilometers).

INFO: Pressing this button repeatedly will display the RANGE, MPG AVG, MPG INST, GAL FUEL USED, MPH, AVG MPH, TIMER, BATTERY VOLTS, COOLANT TEMP, OIL LIFE LEFT and ENGLISH/METRIC RESET.

FUEL DOOR: Press this button to open the fuel door. (This feature will work only when the shift lever is in PARK (P) regardless of whether or not the vehicle is running.)

TRUNK: Press this button to open the trunk. (This feature will work only when the shift lever is in PARK (P) regardless of whether or not the vehicle is running.)

Driver Information Center Messages

These messages will appear if there is a problem sensed in one of your vehicle's systems. Vehicles that are first sold in Canada will have a number after each message. This number helps to identify the message which is only displayed in English.

A/C OFF FOR ENGINE PROTECTION - 16: This message displays when the engine coolant becomes hotter than the normal operating temperature. To avoid added strain on a hot engine, the air conditioning compressor is automatically turned off so that air conditioned air is not delivered. If the coolant temperature returns to normal, you must select AC to return to a normal A/C compressor operation. If this message continues to appear, have the system repaired as soon as possible to avoid compressor damage.

APPLY BRAKE TO SHIFT - 46: This message will appear if your vehicle is in PARK (P) for about 15 seconds and the brake is not pressed in. To remove this message from the DIC display, hold the OFF and the blue (cooler) buttons on the digital cluster climate control panel for about five seconds. On the analog cluster climate control panel, press the OFF button (next to the MODE button) and the down arrow on the PASS TEMP button for about five seconds. Hold the same two buttons to display the message again.

BATTERY NO CHARGE - 07: This message will appear if the battery is not being charged. Have the electrical system checked by your Cadillac dealership at your earliest convenience.

BATTERY VOLTS HIGH - 08: This message shows that the electrical charging system is overcharging (more than 16 volts). To avoid being stranded, have the electrical system checked by your Cadillac dealership. You can reduce the charging overload by using the accessories. Turn on the lamps and radio, set the climate control on AUTO and the fan speed on HI, and turn the rear window defogger on. You can monitor battery voltage on the DIC by pressing the INFORMATION (INFO) button. The normal range is 11.5 to 15.5 volts when the engine is running.

BATTERY VOLTS LOW - 06: This message will appear when the electrical system is charging less than 10 volts or if the battery has been drained. If this message appears immediately after starting, it is possible that the generator can still recharge the battery. The battery should recharge after driving a few miles and the message should go out. If this message appears while driving or after starting your vehicle and stays on, have it checked immediately to determine the cause of this problem. To help the generator recharge the battery quickly, you can reduce the load on the electrical system

by turning off the accessories. You can monitor battery voltage on the DIC by pressing the INFORMATION (INFO) button. The normal range is 11.5 to 15.5 volts.

BRAKE VACUUM PROBLEM -108: The circuit in the brake booster vacuum has shorted or is loose when this message appears. Your vehicle may lose power brakes but you will still have the use of manual brakes. The power brakes will not be affected if the problem is caused by a failed sensor. Have your vehicle serviced immediately at your Cadillac dealership.

CHANGE ENGINE OIL - 82: This means that the life of the engine oil has expired and it should be changed within 200 miles. See "Engine Oil" and "Filter Recommendations" in the Maintenance Schedule booklet. After an oil change, the Oil Life Indicator must be reset. See "Oil Life Indicator" in the Index on how to reset it.

CHANGE TRANS FLUID - 47: This message will appear when it is time to replace the transaxle fluid. See the Maintenance Schedule booklet for the proper fluid and change intervals.

CHECK BRAKE FLUID LEVEL - 37: This message will display if the ignition is in the RUN position to inform the driver that the brake fluid level is low. Check the brake reservoir level and add fluid as needed. Have the brake system serviced by a Cadillac technician as

soon as possible. If the brake warning light is on, follow the directions in that part.

CHECK COOLANT LEVEL - 02: This message will appear when there is a low level of engine coolant. Have the cooling system serviced by a Cadillac technician as soon as possible.

CHECK FUEL GAGE - 39: This message will appear when the fuel supply is less than four gallons (15.2 L) and the display is turned off (digital clusters only). A single chime will also sound when this message is displayed.

CHECK OIL LEVEL - 36: For correct operation of the low oil sensing system, your vehicle should be on a level surface. A false CHECK OIL LEVEL message may appear if the vehicle is parked on grades. The oil level sensing system does not check for actual oil level if the engine has been off for a short period of time, and the oil level is never sensed while the engine is running. If the CHECK OIL LEVEL message appears, and your vehicle has been parked on level ground with the engine off for at least 30 minutes, the oil level should be checked by observing the oil dipstick. Prior to checking the oil level, be sure the engine has been off for five minutes and your vehicle is on a level surface. Then check the dipstick and add oil if necessary. See "Engine Oil" in the Index.

CHECK WASHER FLUID - 25: This message will appear for several seconds indicating that you need washer solvent.

CRUISE ENGAGED - 43: This message will appear for a few seconds when you select a speed at which to cruise.

DOOR OPEN - 141: The passenger's door or rear doors are open or ajar when this message appears. The vehicle's engine must be running and the transaxle not in PARK (P) for this message to display. A chime will also sound when the vehicle's speed is greater than 5 mph (8.1 km/h).

DRIVER DOOR OPEN - 140: This message will display when the vehicle is being shifted out of PARK (P) with the engine running to signal that the driver's door is open or ajar. A chime will also sound when the vehicle's speed is greater than 5 mph (8.1 km/h).

ENGINE COOLANT HOT-IDLE ENGINE - 44: This message will appear when the engine coolant temperature is over 248°F (126°C). To avoid added strain on a hot engine turn off the climate control system. Stop and allow your vehicle to idle until it cools down or the message is removed. If it does not cool down, turn off the engine and have it serviced before driving it again. Severe engine damage can result

from an overheated engine. See “Engine Overheating” in the Index.

ENGINE MISFIRE -- EASE OFF GAS

PEDAL - 114: An engine misfire has occurred. You'll need to ease off the gas pedal.

FUEL LEVEL LOW - 11: This message serves as a warning that the fuel level in the tank is critically low. Stop for fuel soon.

HEADLAMPS SUGGESTED - 23: If it's dark enough outside and the twilight sentinel control is off, a HEADLAMPS SUGGESTED message will display on the DIC. This message informs the driver that turning on the exterior lamps is recommended even though the DRL are still illuminated (it's become dark enough outside to require the headlamps and/or other exterior lamps).

ICE POSSIBLE - 13: This message appears when the outside air temperature is cold enough to create icy road conditions.

MONITORED SYSTEMS OK - 1: This message only appears in the “recall” mode by pressing the RESET button. It lets you know that no other messages are stored or currently active.

PASS KEY NOT PROGRAMMED - 31: This warning message displays when the PASS-Key pellet

information has not been programmed into your vehicle. See your Cadillac dealership for service.

PCM FAULT - 110: The circuit in the Powertrain Control Module (PCM) has shorted or is loose when this message appears. Have your Cadillac serviced by your dealership at once.

REDUCED ENGINE POWER - 41: This message informs the driver, that due to wheel slippage, your vehicle is reducing engine power to compensate for the loss of traction. Accelerating too fast, causing the tires to spin, is an example of when this message would display.

REMOVE KEY - 70: This message will appear when the Personalized Automotive Security System (PASS-Key II) is unable to read the pellet on the ignition key or an improper key pellet has been inserted. Wait for the DIC to display STARTING DISABLED DUE TO THEFT SYSTEM REMOVE IGNITION KEY. The instrument panel cluster will then run a timer and change the messages to WAIT 3 MINUTES, WAIT 2 MINUTES, WAIT 1 MINUTE and then START CAR. When the REMOVE KEY message is displayed, remove the ignition key. Check the ignition key for damage. If it is damaged, it may need to be replaced. If you see no damage, clean the pellet contacts with a soft cloth or napkin before inserting the key back into the ignition. Have your vehicle serviced if the message still appears.

SERVICE A/C SYSTEM A/C COMPRESSOR

OFF - 14: This message appears when the electronic sensors that control the air conditioning and heating systems are no longer working. Have the climate control system serviced if you notice a drop in heating and air conditioning efficiency.

SERVICE AIR BAG - 83: There is a problem with the Supplemental Inflatable Restraint (air bag) system when this message appears. Let only a qualified technician work on your vehicle. See your Cadillac dealership for service at once.

SERVICE BRAKE FLUID SWITCH - 37: A defect in the brake fluid detection circuit causes this message to display if the ignition is in the RUN position. Have the brake system serviced by a Cadillac technician as soon as possible. If the brake warning light is on, refer to the directions listed in that part.

SERVICE CHARGING SYSTEM - 102: This message will display when a problem with the charging system has been detected. Have your vehicle serviced at your Cadillac dealership.

SERVICE ELECTRICAL SYSTEM - 106: This message will display if an electrical problem has occurred within the PCM. Have your vehicle serviced by your Cadillac dealership.

SERVICE EMISSIONS SYSTEM - 104: A problem in the emissions system has occurred when this message appears. Have your Cadillac dealership service your vehicle.

SERVICE ENGINE COOLING SYSTEM - 103: A problem within the engine cooling system has been detected when this message displays. See your Cadillac dealership for service.

SERVICE FUEL SYSTEM - 101: The PCM has detected a problem within the fuel system when this message appears. See your Cadillac dealership for service.

SERVICE IDLE CONTROL SYSTEM - 107: A problem with the idle control has occurred when this message displays. Bring your vehicle to your Cadillac dealership for service.

SERVICE IGNITION SYSTEM - 105: This message displays when a failure in the ignition system has been detected. Have your vehicle serviced by your Cadillac dealership.

SERVICE RIDE CONTROL - 84: This message is displayed to indicate that the suspension system is not operating properly. To correct this problem, have your vehicle serviced at your Cadillac dealership.

SERVICE STEERING SYSTEM - 127: This message is displayed when a problem has been detected in the MAGNASTEER™ variable effort steering system. Service is required. A single chime will also sound when this message is displayed.

SERVICE TRANSMISSION - 100: If a problem is detected with the transaxle, this message will appear. Have your vehicle checked by your Cadillac dealership.

SPEED SENSOR FAULT - 109: A circuit problem with the vehicle speed sensor will trigger this message to appear. Have your Cadillac dealership service your vehicle.

STABILITY ENGAGED - 55: If you have the Seville STS, you may see the STABILITY ENGAGED message on the Driver Information Center. It means that an advanced, computer-controlled system has come on to help your Cadillac continue to go in the direction in which you're steering. This stability enhancement system activates when the computer senses that your Cadillac is just starting to spin, as it might if you hit a patch of ice or other slippery spot on the road. When the system is on, you may hear a noise or feel a vibration in the brake pedal. This is normal.

When the STABILITY ENGAGED message is on, you should continue to steer in the direction you want to go. The system is designed to help you in bad weather or other difficult driving situations by making the most of whatever road conditions will permit. If the STABILITY ENGAGED message comes on, you'll know that something has caused your Cadillac to start to spin, so you should consider slowing down.

STABILITY REDUCED - 54: If you ever see the STABILITY REDUCED message, it means there may be a problem with your stability enhancement system. If you see this message, try to reset the system (stop; turn off the engine; then start the engine again). If the STABILITY REDUCED message still comes on, however, it means there is a problem, so you should see your Cadillac dealer for service.

STARTING DISABLED DUE TO THEFT SYSTEM

REMOVE IGNITION KEY - 33: This message will appear when the Personalized Automotive Security System (PASS-Key II) senses that an improper ignition key is being used to try to start the vehicle. Check the ignition key for damage. If it is damaged, it may need to be replaced. If you see no damage, clean the pellet contacts with a soft cloth or napkin. Remove the ignition key and wait for the DIC to display WAIT 3 MINUTES. The instrument panel cluster will then run a timer and change the messages to WAIT 2 MINUTES, WAIT 1 MINUTE and then START CAR. When the START CAR message is displayed, try again to start the engine.

STOP ENGINE ENGINE OVERHEATED - 42: This message will appear when the engine has overheated. Stop and turn the engine off immediately to avoid severe engine damage. See "Engine Overheating" in the Index. A multiple chime will also sound when this message is displayed.

STOP ENGINE LOW OIL PRESSURE - 35: If this message appears while the engine is running, stop the engine and do not operate it until the cause of low oil pressure is corrected. Severe damage to the engine can result. A multiple chime will also sound when this message is displayed.

THEFT SYSTEM PROBLEM/CAR MAY NOT RESTART - 34: This message means there is a problem in the Personalized Automotive Security System (PASS-Key II). A fault has been detected in the system which means that the PASS-Key II system is disabled and is not protecting the vehicle. The vehicle usually restarts, however, you may want to take your vehicle to a proper service center before turning off the engine.

TOP SPEED FUEL CUT-OFF - 111: This message will appear when the PCM senses that the maximum speed for your Cadillac has been reached. The speed of your vehicle will decrease several mph as the fuel supply is cutoff. This allows your vehicle to stay in a stable operating range.

TRACTION ENGAGED - 91: When your traction control system is limiting wheel spin, the TRACTION ENGAGED message will be displayed. Slippery road conditions may exist if this message is displayed, so adjust your driving accordingly. This message will stay on for a few seconds after the traction control system stops limiting wheel spin.

TRACTION OFF - 89: This message will be displayed after the traction control has been turned off.

TRACTION READY - 91: This message informs the driver that the traction control system is available. This occurs when the traction on/off button in the glove box has been returned to an on position (pressing the button once turns the traction control system off; pressing the button again turns the system back on). This message also self cancels after five seconds.

TRACTION SUSPENDED - 56: This message displays when the traction control system has been temporarily shut off because your vehicle's brakes have overheated. This message does not indicate a problem with your vehicle's traction control system. After a few minutes, the traction control system will be available again and the TRACTION READY message will appear.

TRANS FLUID RESET - 48: With the engine not running and the ignition on, press and hold the OFF and rear defog buttons until the TRANS FLUID RESET message appears on the DIC (between five and 20 seconds).

TRANSMISSION HOT - 112: This messages indicates that the transaxle fluid in your vehicle is too hot. Stop and allow your vehicle to idle until it cools down or until this message is removed.

TRUNK OPEN - 24: This message indicates that the trunk is open when the ignition is in RUN.

TURN SIGNAL ON - 20: This message is a reminder, after driving about a mile, that you have the turn signal on. A multiple chime will also sound when this message is displayed.

VEHICLE SPEED LIMITED TO XXX MPH (KM/H) - 113: A failure in the suspension control system has occurred when this message appears. The PCM determines the speed your vehicle is limited to. Have your Cadillac serviced if this message appears.

VERY LOW REFRIGERANT A/C COMPRESSOR OFF - 12: This message means that the air conditioning system detects a refrigerant level that is low enough to cause damage to the air conditioning compressor. To avoid damage, the air conditioning compressor automatically turns off and the Electronic Climate Control will automatically switch from AUTO to ECON and remain there. Have the air conditioning system serviced if this message appears.

Continuous Variable - Real Time Damping (CV-RTD)

The CV-RTD automatically adjusts the ride of your vehicle. Automatic ride control is achieved through a computer used to control and monitor the suspension system. The controller receives inputs from various sensors to determine the proper system response. If the controller detects a problem within the system, the DIC will display a SERVICE RIDE CONTROL message. If this message appears, have your vehicle serviced at your Cadillac dealership.

Oil Life Indicator



This feature lets you know when to change the engine oil. It's based on the engine oil temperatures and your driving patterns. To see the display, press the INFORMATION (INFO) button several times until XX OIL LIFE LEFT appears. If you see 99% OIL LIFE LEFT, 99 percent of your current oil life remains.

The DIC may display a CHECK OIL LEVEL message. Always keep a written record of the mileage and date when you changed your oil. For more information, see the Cadillac Maintenance Schedule booklet. If you see CHECK OIL LEVEL, it means that you have less than 10 percent of the oil life left and you should consider changing your engine oil. If you see CHANGE ENGINE OIL, it means the oil life is gone and you should change the oil right away.

The system should indicate changing the oil between 3,000 miles (5 000 km) and 7,500 miles (12 500 km). It may indicate changing the oil before 3,000 miles (5 000 km) depending on your driving habits. If the vehicle has been driven 7,500 miles (12 500 km), it will indicate to change the oil. If you drive in a dusty area, you should change your oil every 3,000 miles (5 000 km) or three months (whichever comes first) unless the display indicates changing it sooner. The system doesn't check *how much* oil you have, so you'll still have to check for that. To see how, see "Engine Oil" in the Index.

When new oil is added, you'll need to reset the system. To reset, display the Oil Life Indicator by pressing the INFORMATION (INFO) button. Then press and hold the RESET (INFO RESET) button until the display shows 100% OIL LIFE LEFT.



Section 3 Comfort Controls and Audio Systems

In this section, you'll find out how to operate the comfort control and audio systems offered with your Cadillac. Be sure to read about the particular systems supplied with your vehicle.

3-2	Comfort Controls	3-14	Bose™ AM-FM Stereo with Cassette Tape and Compact Disc Player
3-2	Climate Control Panel	3-17	Bose™ AM-FM Stereo with Cassette Tape and Compact Disc Player with Digital Signal Processing
3-6	Electronic Solar Sensor	3-21	Trunk Mounted CD Changer
3-7	Air Conditioning	3-25	Radio Personalization
3-7	Heating	3-25	Theft-Deterrent Feature
3-7	Ventilation System	3-25	Audio Steering Wheel Controls
3-8	Defrosting	3-26	Understanding Radio Reception
3-9	Rear Window Defogger	3-26	Tips About Your Audio System
3-9	HVAC Steering Wheel Controls	3-27	Care of Your Cassette Tape Player
3-10	Climate Control Personalization	3-28	Care of Your Compact Discs
3-10	Audio Systems	3-28	Power Antenna Mast Care
3-10	Setting the Clock		
3-10	AM-FM Stereo with Cassette Tape Player and Optional Compact Disc Player		

Comfort Controls

This section tells you how to make your air system work for you. Your Electronic Climate Control (ECC) system uses ozone-friendly R-134a refrigerant.

With the ECC system, you can control the heating, cooling and ventilation in your Cadillac. Your vehicle also has a flow-through ventilation system described later in this section.

Climate Control Panel

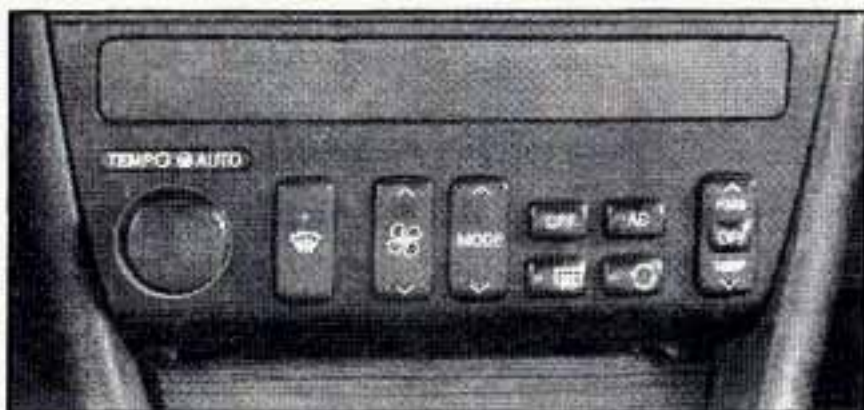

Fan Button

The button with the fan symbol adjusts the fan speed. Press the up arrow to increase fan speed and the down arrow to decrease fan speed.

Driver's Side Temperature Knob

The TEMP/AUTO knob adjusts the air temperature coming through the system. Turn the TEMP/AUTO knob clockwise to increase the temperature and counterclockwise to decrease the temperature. Press the TEMP/AUTO knob to put the system in the automatic mode.

Passenger's Side Temperature Button

With this dual-zone feature, the right front passenger can control the temperature of air for his/her own zone. The passenger can select a four degree warmer or cooler temperature from the driver's setting. To turn the system on, press the PASS/TEMP button. Press the up arrow to increase the temperature and press the down arrow to decrease the climate setting. Pressing the OFF button will turn off the dual-zone function.

Outside Temperature Display

The outside temperature is always displayed when your vehicle is running. You can change it from Fahrenheit to Celsius by pressing the INFO button (above the radio) until ENGLISH/METRIC RESET displays. Once displayed, press the INFO RESET button to select.

The outside temperature sensor is located near the front grille. The sensor can be affected by road or engine heat during idling, slow driving or when the engine is first started after a short trip. In order to ensure proper automatic climate control operation, the outside air temperature display may not update as quickly as expected. This is to allow the air surrounding the outside temperature sensor to be as close to the actual outside conditions as possible. This is determined by how much time has elapsed since the vehicle has been turned off and by vehicle speed.

Mode Button

Press this button to deliver air through the floor, middle or windshield outlets. The system will stay in the selected mode until the MODE button is pushed again. Press the up or down arrow to cycle through the available modes.

Automatic Operation

When the system is set for automatic operation, sensors will control the air delivery mode. Air will come from the floor, middle or windshield outlets. The fan speed will vary as the system maintains the selected temperature setting.

Be careful not to put anything over the solar sensor located in the middle of the instrument panel near the windshield. This sensor is used by the automatic system to regulate temperature.

To find your comfort zone, start with the 75°F (24°C) setting and allow about 20 minutes for the system to regulate. Turn the TEMP/AUTO knob to adjust the temperature if necessary. If you choose 60°F (16°C), the system will remain at that maximum cooling setting and will not regulate fan speed. If you choose the temperature of 90°F (32°C), the system will remain at that maximum heating setting and will not regulate fan speed. Choosing either maximum setting will not cause the system to heat or cool any faster.

With the automatic setting, the air conditioning compressor automatically cycles when needed to cool the air. In cold weather, when the system senses the need for heat, the airflow will be directed out the floor outlets. As the interior temperature approaches a desired setting, the blower speed will decrease. To maintain interior comfort, the airflow may move to the instrument panel air outlets and floor outlets (bi-level mode). On bright sunny days in cold weather, the airflow may come out of the air conditioning outlets (AC mode) to maintain comfort and prevent stuffiness.

If your vehicle is sitting out on a hot day and you have it set on AUTO, the air will first flow out the floor air outlets for a few seconds. That is normal. This is to expel hot air from the air outlets. As the air is cooled, the airflow will move through the air conditioning outlets. If you start your vehicle with the fan setting on HI, it will skip the air conditioning purge.

To avoid blowing cold air in cold weather, the system will delay turning on the fan until warm air is available. The length of delay depends on the outside air temperature, engine coolant temperature or the time since the engine was last started. As the coolant warms up, the blower fan speed will gradually increase and air will flow from the heater outlets, with some airflow to the windshield to prevent fogging under most normal conditions.

If you leave your vehicle, the system will remember the control setting the next time you start your engine, except for recirculation and defrost. Each ignition cycle cancels recirculation, whereas, DEFROST will change to automatic operation when the ignition is shut off and then turned back on.

Manual Operation

You may manually adjust the air delivery mode or fan speed.

 **AC:** This setting directs airflow through the middle instrument panel outlets.

 **BI-LEVEL:** This setting directs air into your vehicle in two ways. Cool air is directed to the upper portion of your body through the four instrument panel outlets while warmed air is directed to the floor.

 **HEATER/DEFROST:** This setting directs air to the floor outlets and toward the windshield.

 **HEATER:** This setting directs warmed air through the floor outlets. Some warm air is diverted to the windshield to minimize fogging.

 **DEFROST:** Press this button to quickly remove fog or frost from the windshield. This setting sends most of the airflow to the windshield with only a small amount to the floor outlets.

 **FAN SPEEDS:** Press the button with the fan symbol on it until AUTO is displayed on the screen. At this setting, the fan speed is automatically controlled. If it is cold outside, the blower may not run in the maximum high fan speed right away. The system checks the temperature of the engine coolant to assure it is warm enough to provide heat. When the engine coolant is warm, the controller allows the fan to gradually increase to a higher speed. This prevents cold air from blowing into the passenger compartment. If you want the blower fan at a high speed, press the up arrow button until you see HI on the display. If you want the fan speed to be automatic, but you like the fan speed to be higher than the AUTO setting, press the fan symbol button until HI AUTO is shown on the display. If you want the blower fan at a low speed, press the down arrow button until LO is shown on the display. If you want the fan speed to run lower than the AUTO setting, press the button until LO AUTO is shown on the display.

OFF: Press this button to turn the system off. Fresh air will continue to flow through the vehicle, and the system will try to maintain the previously set temperature. The outside temperature will show on the display when the system is OFF.

AC: Press this button to turn the air conditioning on and off. The system will cool and dehumidify the air inside the vehicle. In the AUTO mode, the display will show that AC is active, but the air conditioning compressor only operates when the system determines it is needed.

RECIRCULATION: Press this button to limit the amount of fresh air entering your vehicle. This is helpful when you are trying to cool the air quickly or limit odors entering your vehicle. In the AUTO mode, the system will use recirculation as necessary to cool the air. Pressing the recirculation button will change the operation to a manual mode and the air will recirculate non-stop. Press this button again to turn off the recirculation feature.

If you notice the windows fogging, press the recirculation button to exit the recirculation mode.

Electronic Solar Sensor

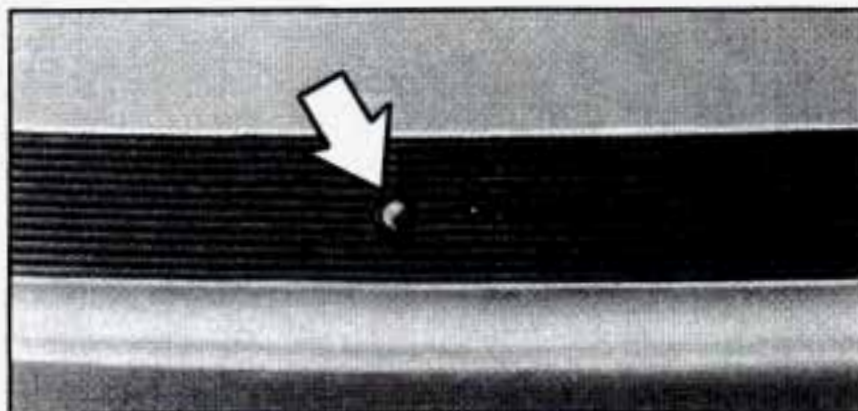

The sensor monitors the sun's solar radiation and is located on top of the instrument panel near the windshield. The ECC system uses this information to automatically make the necessary temperature and airflow adjustments to maintain your comfort.

Air Conditioning

On hot days, open the windows long enough to let hot inside air escape. This reduces the time it takes for your vehicle to cool down. Then keep your windows closed for the air conditioner to work its best.

Press the AC button or the TEMP/AUTO knob to turn the system on and then select the proper MODE to direct airflow. The system will cool and dehumidify the air inside the vehicle. Also while in the AUTO mode, the system will use recirculation as necessary to cool the air. You may also need to adjust the interior temperature and the fan speed as needed.

When the air conditioner is on, you may sometimes notice slight changes in your vehicle's engine speed and power. This is normal because the system is designed to cycle the compressor on and off to keep the desired temperature.

Heating

Press the MODE button to select heater. Adjust the interior temperature to a comfortable level and if the fan speed needs adjusting, press the up or down arrow.

With each system, outside air will be brought in and sent through the floor, air conditioning or bi-level outlets (depending on the condition). The heater works best if you keep your windows closed while using it.

Ventilation System

Your Cadillac's flow-through ventilation system supplies outside air into the vehicle when it is moving. Outside air will also enter the vehicle when the heater or the air conditioning fan is running.

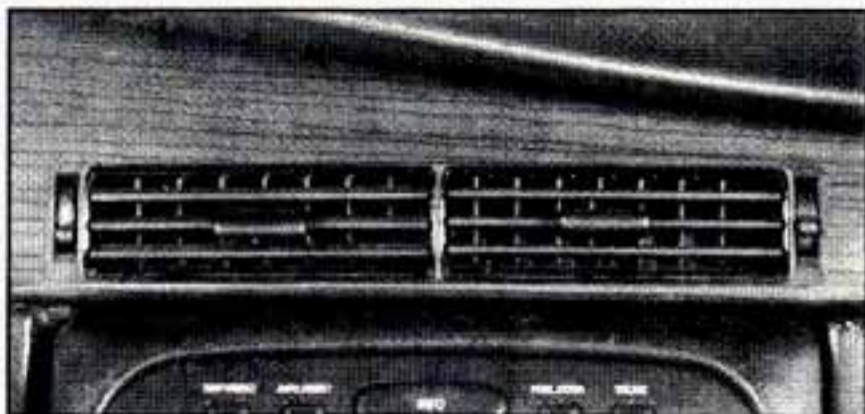

The front outlets are located in the center and at each side of the instrument panel. You can adjust the direction of airflow by moving the center control levers or you can stop the airflow by moving the lever located on each side of the outlets downward.

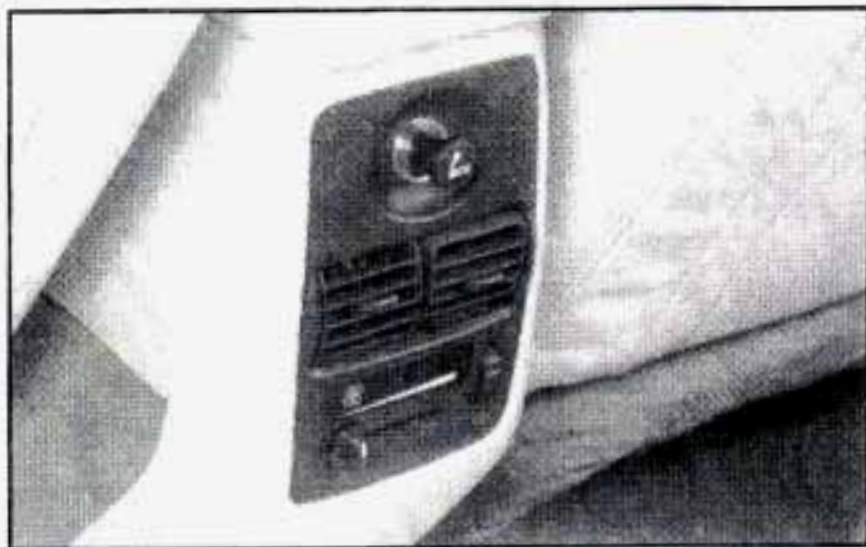

The direction of airflow for the rear seats can also be adjusted if you have the optional full console. Move the fan lever to adjust the blower speed from LO to HI. Move the vent lever to direct the airflow.

Ventilation Tips

- Keep the hood and front air inlet free of ice, snow or any other obstruction (such as leaves). The heater and defroster will work far better, reducing the chance of fogging the inside of the windows.
- When you enter a vehicle in cold weather, adjust the fan to the highest speed for a few moments before driving off. This helps clear the intake outlets of snow and moisture, and reduces the chance of fogging the inside of the windows.
- Keep the air path under the front seats clear of objects. This helps circulate air throughout your vehicle.

Defrosting

Use DEFROST to remove fog or ice from the windshield quickly in extremely humid or cold conditions.

Press the DEFROST button. If you select DEFROST, adjust the fan speed by pressing the fan button up or down. If you select DEFROST from AUTO, the system will control the fan speed. The temperature also needs to be adjusted by turning the TEMP/AUTO knob.

Note that recirculation is not available in the defrost or defog modes.

Rear Window Defogger

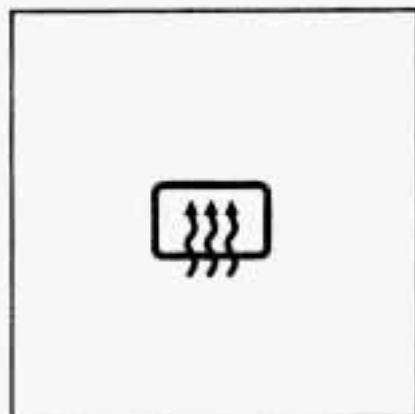

The lines you see on the rear window warm the glass. Press this button to turn on the rear defogger. With it, the rear window and both outside rearview mirrors are heated.

The system will automatically shut off after 10 minutes. If further defogging is desired, press the button again.

Do not attach a temporary vehicle license, tape or decals across the defogger grid on the rear window.

NOTICE:

Scraping the inside of your rear window could cut and damage the heating grids. Your warranty would not cover this damage. And don't put decals there; you might have to scrape them off.

HVAC Steering Wheel Controls

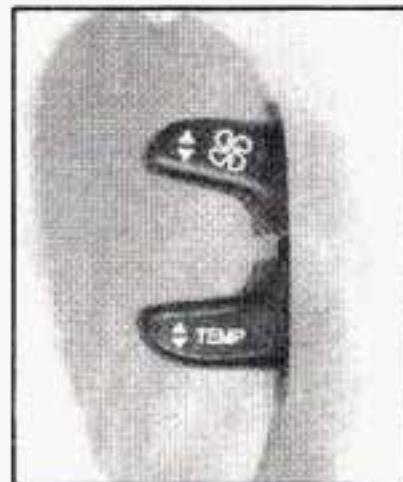

Some heating and cooling controls can be adjusted at the steering wheel. Other touch controls operate some audio controls. See "Audio Steering Wheel Controls" later in this section.

FAN SPEED: Press the up arrow lever to increase the fan speed and the down arrow lever to decrease fan speed.

TEMP: Press the up arrow lever to increase the temperature and the down arrow lever to decrease temperature.

Climate Control Personalization (If Equipped)

With this feature, your vehicle will recall the latest climate control settings as adjusted the last time your vehicle was operated. This feature allows two different drivers to store and recall their own climate control settings. The settings recalled by the climate control system are determined by which RKE transmitter ("1" or "2") was used to enter the vehicle. The number on the back of the RKE transmitter corresponds to driver 1 or to driver 2. After the unlock button is pressed on the RKE transmitter or the ignition key is placed in the ignition, the climate control settings will automatically adjust to where they were last set. The settings can also be changed by briefly pressing the memory seat buttons 1 or 2 located on the driver's door.

Audio Systems

Your Cadillac audio system has been designed to operate easily and give years of listening pleasure. You will get the most enjoyment out of it if you acquaint yourself with it first. Find out what your audio system can do and how to operate all its controls, to be sure you're getting the most out of the advanced engineering that went into it.

Setting the Clock

Press and hold HR or MN until the time display begins to change. Release the button as you get close to the correct time. The time may be set anytime the clock is displayed. There is a two-second delay before the clock goes into time-set mode.

AM-FM Stereo with Cassette Tape Player and Optional Compact Disc Player



For information on the compact disc player, see "Trunk Mounted CD Changer" later in this section.

Playing the Radio

PWR/VOL: Press this knob lightly to release it from its stored position. The system will turn on. Press the knob again to turn the system off. To increase volume, turn the knob clockwise. Turn it counterclockwise to decrease volume. The volume level will appear on the display.

DSPL: Press this button to display the station being played.

Finding a Station

BAND: Press this button to select AM, FM1 or FM2 and preset stations.

SEEK-TUNE: Press and release this button to seek to the next higher or lower radio station. Pressing and holding this button until a chime sounds puts the radio in a tune mode. In this mode, higher or lower radio stations are advanced to in small increments until the SEEK-TUNE button is released. Tuning stops when you release this button. If you press and hold the SEEK-TUNE button again within five seconds of being in the tune mode, tuning will continue. Waiting longer than five seconds places the radio back in the seek mode.

SCAN: Press this button and SCAN will appear on the display. Use SCAN to listen to stations for a few seconds. The radio will go to a station, stop for a few seconds, then go on to the next station. Press this button again to stop scanning.

PUSHBUTTONS: The six numbered pushbuttons let you return to your favorite stations. You can set up to 18 stations (six AM, six FM1 and six FM2). Just:

1. Turn the radio on.
2. Press BAND to select AM, FM1 or FM2.
3. Tune in the desired station.
4. Press and hold one of the six numbered buttons until you hear a chime. The sound will mute. When it returns, release the button. Whenever you press that numbered button, the station you set will return.
5. Repeat the steps for each pushbutton.

PRESET SCAN: Press and hold SCAN for two to three seconds until PRESET SCAN appears on the display to listen to each of your preset stations for a few seconds (factory presets which have not been reprogrammed with your stations will be ignored). The radio will go to the first preset station stored on your pushbuttons, stop for a few seconds, then go on to the next preset station. Press SCAN again to stop scanning. If a preset station has weak reception, the radio will not stop at the preset station.

Setting the Tone

BASS: Press this knob lightly so it extends. Turn the knob clockwise to increase and counterclockwise to decrease bass.

TREB: Press this knob lightly so it extends. Turn the knob clockwise to increase and counterclockwise to decrease treble. If a station is weak or noisy, you may want to decrease the treble.

Push these knobs back into their stored positions when you're not using them.

Adjusting the Speakers

BAL: Press this knob lightly so it extends. Turn the knob clockwise to adjust sound to the right speakers and counterclockwise for the left speakers. The middle position balances the sound between the speakers.

FADE: Press this knob lightly so it extends. Turn the knob clockwise to adjust the sound to the front speakers and counterclockwise for the rear speakers. The middle position balances the sound between the speakers.

Push these knobs back into their stored positions when you're not using them.

Playing a Cassette Tape

With the radio on, insert a cassette tape. The tape will begin playing as soon as it is inserted.

While the tape is playing, use the VOL, FADE, BAL, BASS and TREB controls just as you do for the radio. Other controls may have different functions when a tape is inserted. The display will show TAPE with an arrow to indicate which side of the tape is playing. PLAY will appear on the display temporarily when a tape is playing. The display will then revert back to showing the time.

If an error occurs while trying to play a cassette tape, it could be that:

- The cassette tape is tight and the cassette player cannot turn the hubs of the tape. Hold the cassette tape with the open end down and try turning the right hub counterclockwise with a pencil. Flip the tape over and repeat. If the hubs do not turn easily, your cassette tape may be damaged and should not be used in the player. Try a new tape to be sure your player is working properly.
- The cassette tape is broken. (Check to see if your tape is broken. Try a new tape.)

REV: Press the left arrow to reverse the tape rapidly. Press it again to return to playing speed. The radio will play while the tape reverses and REV will appear on the display. You may use your station pushbuttons to tune to another radio station while in REV mode.

FF: Press the right arrow to fast forward to another part of the tape. Press it again to return to playing speed. The radio will play while the tape advances and FF will appear on the display. You may use your station pushbuttons to tune to another radio station while in FF mode.

SEEK-TUNE: Press the right arrow to seek to the next selection on the tape. Press the left arrow to search for the previous selection on the tape (REP will appear on the display). Your tape must have at least three seconds of silence between each selection for SEEK-TUNE to work. The sound will mute while seeking.

SCAN: Press this button. SCAN FF will appear on the display until the next selection is found and then SCAN PLAY will appear on the display. Use SCAN to listen to selections for a few seconds. The tape will go to a selection, stop for a few seconds, then go on to the next selection. Press this button again to stop scanning.

SIDE: Press this button to change the side of the tape that is playing. (PLAY shows on the display.)

SOURCE: Press this button to switch from radio to cassette tape play. If no cassette tape is in the tape player, CASS appears on the display and then the radio station appears briefly. The display then reverts back to showing the time of day. Press this button again or BAND to switch back to the radio.

 **EJECT:** Press the upward triangle button to remove a tape. The radio will play. Eject may be activated with the radio off. Cassette tapes may be loaded with the radio off but they will not start playing until the PWR button is pressed. Press PWR or turn the ignition key off to stop the cassette tape player. The tape will stay in the player and resume play at the point where it stopped. If you leave a cassette tape in the player while listening to the radio, it may become warm.

CLN: If this message appears on the display, the cassette tape player needs to be cleaned. It will still play tapes, but you should clean it as soon as possible to prevent damage to the tapes and player. See "Care of Your Cassette Tape Player" in the Index. After you clean the player, press and hold EJECT for five seconds to reset the CLN indicator. The radio will display --- to show the indicator was reset.

Dolby[®] Noise Reduction is manufactured under a license from Dolby Laboratories Licensing Corporation. Dolby and the double-D symbol are trademarks of Dolby Laboratories Licensing Corporation.

Bose™ AM-FM Stereo with Cassette Tape and Compact Disc Player (If Equipped)



For information on the compact disc player, see “Trunk Mounted CD Changer” later in this section.

Playing the Radio

PWR/VOL: Press this knob lightly to release it from its stored position. The system will turn on. Press the knob again to turn the system off. To increase volume, turn the knob clockwise. Turn it counterclockwise to decrease volume. The volume level will appear on the display.

Finding a Station

BAND: Press this button to select AM, FM1 or FM2 and preset stations.

SEEK-TUNE: Press and release this button to seek to the next higher or lower radio station. Pressing and holding this button until a chime sounds puts the radio in a tune mode. In this mode, higher or lower radio stations are advanced to in small increments until the SEEK-TUNE button is released. Tuning stops when you release this button. If you press and hold the SEEK-TUNE button again within five seconds of being in the tune mode, tuning will continue. Waiting longer than five seconds places the radio back in the seek mode.

SCAN: Press this button and SCAN will appear on the display. Use SCAN to listen to stations for a few seconds. The radio will go to a station, stop for a few seconds, then go on to the next station. Press this button again to stop scanning.

PUSHBUTTONS: The six numbered pushbuttons let you return to your favorite stations. You can set up to 18 stations (six AM, six FM1 and six FM2). Just:

1. Turn the radio on.
2. Press BAND to select AM, FM1 or FM2.
3. Tune in the desired station.

4. Press and hold one of the six numbered buttons until you hear a chime. A preset number will appear on the display. The sound will mute. When it returns, release the button. Whenever you press that numbered button, the station you set will return.
5. Repeat the steps for each pushbutton.

PRESET SCAN: Press and hold SCAN for two to three seconds until PRESET SCAN appears on the display to listen to each of your preset stations for a few seconds (factory presets which have not been reprogrammed with your stations will be ignored). The radio will go to the first preset station stored on your pushbuttons, stop for a few seconds, then go on to the next preset station. Press SCAN again to stop scanning. If a preset station has weak reception, the radio will not stop at the preset station.

Setting the Tone

BASS: Press this knob lightly so it extends. Turn the knob clockwise to increase and counterclockwise to decrease bass.

TREB: Press this knob lightly so it extends. Turn the knob clockwise to increase and counterclockwise to decrease treble. If a station is weak or noisy, you may want to decrease the treble.

Push these knobs back into their stored positions when you're not using them.

Adjusting the Speakers

BAL: Press this knob lightly so it extends. Turn the knob clockwise to adjust sound to the right speakers and counterclockwise for the left speakers. The middle position balances the sound between the speakers.

FADE: Press this knob lightly so it extends. Turn the knob clockwise to adjust the sound to the front speakers and counterclockwise for the rear speakers. The middle position balances the sound between the speakers.

Push these knobs back into their stored positions when you're not using them.

Playing a Cassette Tape

With the radio on, insert a cassette tape. The tape will begin playing as soon as it is inserted.

While the tape is playing, use the VOL, FADE, BAL, BASS and TREB controls just as you do for the radio. Other controls may have different functions when a tape is inserted. The display will show TAPE with an arrow to indicate which side of the tape is playing. PLAY will appear on the display temporarily when a tape is playing. The display will then revert back to showing the time.

If an error occurs while trying to play a cassette tape, it could be that:

- The cassette tape is tight and the cassette player cannot turn the hubs of the tape. Hold the cassette tape with the open end down and try turning the right hub counterclockwise with a pencil. Flip the tape over and repeat. If the hubs do not turn easily, your cassette tape may be damaged and should not be used in the player. Try a new tape to be sure your player is working properly.
- The cassette tape is broken. (Check to see if your tape is broken. Try a new tape.)

REV: Press the left arrow to reverse the tape rapidly. Press it again to return to playing speed. The radio will play while the tape reverses and REV will appear on the display. You may use your station pushbuttons to tune to another radio station while in REV mode.

FF: Press the right arrow to fast forward to another part of the tape. Press it again to return to playing speed. The radio will play while the tape advances and FWD will appear on the display. You may use your station pushbuttons to tune to another radio station while in FF mode.

SEEK-TUNE: Press the right arrow to seek to the next selection on the tape. Press the left arrow to search for the previous selection on the tape (REP will appear on the display). Your tape must have at least three seconds of silence between each selection for SEEK-TUNE to work. The sound will mute while seeking.

SCAN: Press this button. SCAN will appear on the display until the next selection is found and then PLAY will appear on the display. Use SCAN to listen to selections for a few seconds. The tape will go to a selection, stop for a few seconds, then go on to the next station. Press this button again to stop scanning.

SIDE: Press this button to change the side of the tape that is playing. (PLAY shows on the display.)

SOURCE: Press this button to switch from radio to cassette tape play. If no cassette tape is in the tape player, CASS appears on the display and then the radio station appears briefly. The display then reverts back to showing the time of day. Press this button again or BAND to switch back to the radio.

△ **EJECT:** Press the upward triangle button to remove a tape. The radio will play. Eject may be activated with the radio off. Cassette tapes may be loaded with the radio off but they will not start playing until the PWR button is pressed. Press PWR or turn the ignition key off to stop the cassette tape player. The tape will stay in the player and resume play at the point where it stopped. If you leave a cassette tape in the player while listening to the radio, it may become warm.

CLN: If this message appears on the display, the cassette tape player needs to be cleaned. It will still play tapes, but you should clean it as soon as possible to prevent damage to the tapes and player. See “Care of Your Cassette Tape Player” in the Index. After you clean the player, press and hold EJECT for five seconds to reset the CLN indicator. The radio will display --- to show the indicator was reset.

Dolby[®] Noise Reduction is manufactured under a license from Dolby Laboratories Licensing Corporation. Dolby and the double-D symbol are trademarks of Dolby Laboratories Licensing Corporation.

Bose™ AM-FM Stereo with Cassette Tape and Compact Disc Player with Digital Signal Processing (If Equipped)



For information on the compact disc player, see “Trunk Mounted CD Changer” later in this section.

Playing the Radio

PWR/VOL: Press this knob lightly to release it from its stored position. The system will turn on. Press the knob again to turn the system off. To increase volume, turn the knob clockwise. Turn it counterclockwise to decrease volume. The volume level will appear on the display.

Finding a Station

BAND: Press this button to select AM, FM1 or FM2 and preset stations.

SEEK-TUNE: Press and release this button to seek to the next higher or lower radio station. Pressing and holding this button until a chime sounds puts the radio in a tune mode. In this mode, higher or lower radio stations are advanced to in small increments until the SEEK-TUNE button is released. Tuning stops when you release this button. If you press and hold the SEEK-TUNE button again within five seconds of being in the tune mode, tuning will continue. Waiting longer than five seconds places the radio back in the seek mode.

SCAN: Press this button and SCAN will appear on the display. Use SCAN to listen to stations for a few seconds. The radio will go to a station, stop for a few seconds, then go on to the next station. Press this button again to stop scanning.

PUSHBUTTONS: The six numbered pushbuttons let you return to your favorite stations. You can set up to 18 stations (six AM, six FM1 and six FM2). Just:

1. Turn the radio on.
2. Press BAND to select AM, FM1 or FM2.

3. Tune in the desired station.
4. Press and hold one of the six numbered buttons until you hear a chime. A preset number will appear on the display. The sound will mute. When it returns, release the button. Whenever you press that numbered button, the station you set will return.
5. Repeat the steps for each pushbutton.

PRESET SCAN: Press and hold SCAN for two to three seconds until PRESET SCAN appears on the display to listen to each of your preset stations for a few seconds (factory presets which have not been reprogrammed with your stations will be ignored). The radio will go to the first preset station stored on your pushbuttons, stop for a few seconds, then go on to the next preset station. Press SCAN again to stop scanning. If a preset station has weak reception, the radio will not stop at the preset station.

Setting the Tone

BASS: Press this knob lightly so it extends. Turn the knob clockwise to increase and counterclockwise to decrease bass.

TREB: Press this knob lightly so it extends. Turn the knob clockwise to increase and counterclockwise to decrease treble. If a station is weak or noisy, you may want to decrease the treble.

Push these knobs back into their stored positions when you're not using them.

DSP: The Digital Signal Processing (DSP) feature is used to produce four audio effects. These include TALK, DRIVER SEAT, LIVE and AUDITORIUM. DSP can be used while listening to the radio, the cassette tape player or the CD player. To activate DSP, press the DSP button. Press this button again to go through the four effects. To turn the DSP feature off, press OFF.

- **TALK:** This setting is used when listening to non-musical material such as baseball games, talk shows or news. TALK gives the best clarity of spoken words. The high and low frequencies are lowered, the mid-range is increased and the audio is moved more toward the front speakers.
- **DRIVER SEAT:** This setting adjusts the audio to give the driver the best possible sound qualities. This has been done by tailoring the sound arrival times and equalization for the driver seat. DRIVER SEAT can be used at any time for any material. Other passengers in the vehicle may not perceive the same effect.
- **LIVE:** This setting is used to imitate the sound of a live performance.

- **AUDITORIUM:** This setting is similar to LIVE, however, more echo is present. The LIVE and AUDITORIUM settings are best used for music.

LEVEL: Press the plus or minus symbol on this button to adjust the amount of effect desired when in DSP mode. Some experimenting with this button will help you determine the best sound.

Adjusting the Speakers

BAL: Press this knob lightly so it extends. Turn the knob clockwise to adjust sound to the right speakers and counterclockwise for the left speakers. The middle position balances the sound between the speakers.

FADE: Press this knob lightly so it extends. Turn the knob clockwise to adjust the sound to the front speakers and counterclockwise for the rear speakers. The middle position balances the sound between the speakers.

Push these knobs back into their stored positions when you're not using them.

Playing a Cassette Tape

With the radio on, insert a cassette tape. The tape will begin playing as soon as it is inserted.

While the tape is playing, use the VOL, FADE, BAL, BASS and TREB controls just as you do for the radio. Other controls may have different functions when a tape is inserted. The display will show TAPE with an arrow to indicate which side of the tape is playing. PLAY will appear on the display temporarily when a tape is playing. The display will then revert back to showing the time.

If an error occurs while trying to play a cassette tape, it could be that:

- The cassette tape is tight and the cassette player cannot turn the hubs of the tape. Hold the cassette tape with the open end down and try turning the right hub counterclockwise with a pencil. Flip the tape over and repeat. If the hubs do not turn easily, your cassette tape may be damaged and should not be used in the player. Try a new tape to be sure your player is working properly.
- The cassette tape is broken. (Check to see if your tape is broken. Try a new tape.)

REV: Press the left arrow to reverse the tape rapidly. Press it again to return to playing speed. The radio will play while the tape reverses and REV will appear on the display. You may use your station pushbuttons to tune to another radio station while in REV mode.

FF: Press the right arrow to fast forward to another part of the tape. Press it again to return to playing speed. The radio will play while the tape advances and FF will appear on the display. You may use your station pushbuttons to tune to another radio station while in FF mode.

SEEK-TUNE: Press the right arrow to seek to the next selection on the tape. Press the left arrow to search for the previous selection on the tape (REP will appear on the display). Your tape must have at least three seconds of silence between each selection for SEEK-TUNE to work. The sound will mute while seeking.

SCAN: Press this button. SCAN FF will appear on the display until the next selection is found and then SCAN PLAY will appear on the display. Use SCAN to listen to selections for a few seconds. The tape will go to a selection, stop for a few seconds, then go on to the next selection. Press this button again to stop scanning.

SIDE: Press this button to change the side of the tape that is playing. (PLAY shows on the display.)

SOURCE: Press this button to switch from radio to cassette tape play. If no cassette tape is in the tape player, CASS appears on the display and then the radio station appears briefly. The display then reverts back to showing the time of day. Press this button again or BAND to switch back to the radio.

EJECT: Press the upward triangle button to remove a tape. The radio will play. Eject may be activated with the radio off if the ignition is on. Cassette tapes may be loaded with the radio off but they will not start playing until the PWR button is pressed. Press PWR or turn the ignition key off to stop the cassette tape player. The tape will stay in the player and resume play at the point where it stopped. If you leave a cassette tape in the player while listening to the radio, it may become warm.

CLN: If this message appears on the display, the cassette tape player needs to be cleaned. It will still play tapes, but you should clean it as soon as possible to prevent damage to the tapes and player. See "Care of Your Cassette Tape Player" in the Index. After you clean the player, press and hold EJECT for five seconds to reset the CLN indicator. The radio will display --- to show the indicator was reset.

Dolby[®] Noise Reduction is manufactured under a license from Dolby Laboratories Licensing Corporation. Dolby and the double-D symbol are trademarks of Dolby Laboratories Licensing Corporation.

Trunk Mounted CD Changer (If Equipped)

With the compact disc changer, you can play up to 12 discs continuously. Normal size discs may be played using the trays supplied in the magazine. The small discs (8 cm) can be played only with specially designed trays.

NOTICE:

Objects in the trunk which may shift or slide during driving could damage your CD changer. Protect your CD changer by using the convenience net whenever possible. Place large objects in the trunk appropriately so that they will not come into contact with the CD changer.

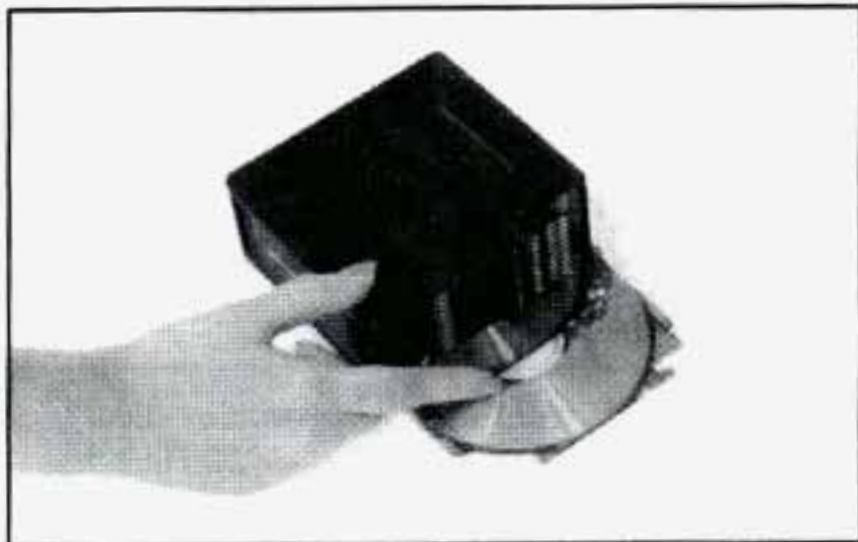

You must first load the magazine with discs before you can play a compact disc. Each of the 12 trays holds one disc. Press the button on the back of the magazine and pull gently on one of the trays. Load the trays from bottom to top, placing a disc on the tray label side down. If you load a disc label side up, the disc will not play and an error will occur. Gently push the tray back into the magazine slot. Repeat this procedure for loading up to 12 discs in the magazine.



Once you have loaded the discs in the magazine, slide open the door of the compact disc (CD) changer. Push the magazine into the changer in the direction of the arrow marked on top of the magazine.



Close the door by sliding it all the way to the left. If the door is left partially open, the changer will not operate and an error will occur. When the door is closed, the changer will begin checking for discs in the magazine. This will continue for up to one and a half minutes, depending on the number of discs loaded.

To eject the magazine from the player, slide the CD changer door all the way open. The magazine will automatically eject. Remember to keep the door closed whenever possible to keep dirt and dust from getting inside the changer.

Whenever a CD magazine with discs is loaded in the changer, the CD symbol will appear on the radio display. If the CD changer is checking the magazine for CDs, the CD symbol will flash on the display until the changer is ready to play. When a CD begins playing, a disc and track number will be displayed. The disc numbers are listed on the front of the magazine.

All of the CD functions are controlled by the radio buttons, except for ejecting the CD magazine.

PUSHBUTTONS: Press buttons one through six to go from one compact disc to another that is loaded in the changer. Press and hold one of the six pushbuttons until a beep sounds to use pushbuttons 7 through 12. These pushbuttons represent the order of the discs loaded in the changer.

DSPL: Press and hold this button to see the track elapsed time (available on all radios). Press DSPL again within five seconds to see how many compact discs are loaded in the changer and where they are loaded (not available on the standard AM-FM Stereo radio).

REV: Press and hold this button to reverse quickly through a track selection.

FF: Press and hold this button to advance quickly through a track selection.

SEEK-TUNE: Press the right arrow to seek to the next selection. Press the left arrow to search for the previous track selection. The sound will mute while seeking.

SCAN: When you press SCAN while playing a CD, you will hear the first few seconds of each track on a disc. Press SCAN again to stop on a CD. The CD will mute while scanning and SCAN will appear on the display.

RDM: Press this button to hear the tracks in random, rather than sequential, order. RDM will appear on the display. Press SEEK-TUNE while RDM is on the display to randomly seek through discs and tracks. Press RDM again to turn off random play. (This button is not available on the standard AM-FM Stereo radio.)

SIDE: Press this button to select the next disc in the changer. Each time you press this button, DISC LOADING will appear on the display (does not appear on the standard AM-FM Stereo radio) and the disc number on the radio display will move to the next available CD.

SOURCE: Press this button if you have a disc loaded in the changer and the radio is on, to play a compact disc. To return to playing the radio, press BAND. Pressing SOURCE also switches between a tape or compact disc if both are loaded.

EJECT: Slide the CD changer door all the way open and the disc holder will automatically eject.

Compact Disc Changer Errors

If ERR or ERROR appears on the display, an error has occurred and the compact disc temporarily cannot play.

CD CHANGER ERROR could be displayed for the following:

- The road is too rough. The disc should play when the road is smoother.
- The disc is dirty, scratched, wet or loaded label side up.
- The air is very humid. If so, wait about an hour and try again.

CHEK DOOR or CD CHANGER DOOR OPEN is displayed when the CD changer door is left open. Completely close the changer door to restore normal operation.

CD CHANGER NO DISCS is displayed when an empty magazine is inserted in the CD changer. Try the magazine again with a disc loaded on one of the trays. (This message does not appear in the display on the standard AM-FM Stereo radios.)

If any error occurs repeatedly or if an error cannot be corrected, please contact your dealer. If your radio displays an error number, write it down and provide it to your dealer when reporting the problem.

Radio Personalization (If Equipped)

With this feature, your vehicle will recall the latest radio settings as adjusted the last time your vehicle was operated. This feature allows two different drivers to store and recall their own radio settings. The settings recalled by the radio are determined by which RKE transmitter ("1" or "2") was used to enter the vehicle. The number on the back of the RKE transmitter corresponds to driver 1 or to driver 2. After the unlock button is pressed on the RKE transmitter or the ignition key is placed in the ignition, the radio settings will automatically adjust to where they were last set. The settings can also be changed by briefly pressing the memory seat buttons 1 or 2 located on the driver's door.

Theft-Deterrent Feature

Your Cadillac has a "built-in" theft-deterrent feature on each radio that is automatic -- there is no programming required. The radio in your Cadillac cannot be used in any other vehicle besides another Cadillac if it were to be removed.

Audio Steering Wheel Controls

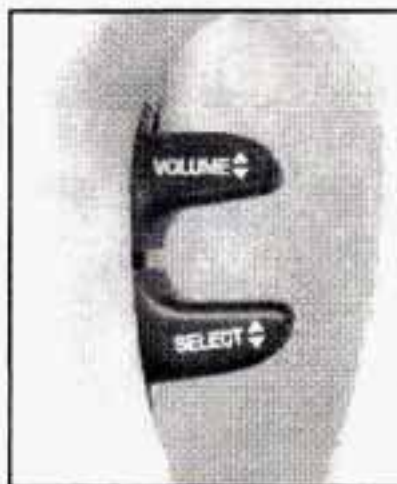

VOLUME: Press the up arrow lever to increase volume and the down arrow lever to decrease volume.

SELECT: When listening to the radio, press the up or down arrow lever to tune to the next or previous preset radio station (factory presets which have not been reprogrammed with your stations will be ignored). When listening to a cassette tape, the up or down arrow lever can be used to SEEK forward and rearward through the tape. Pressing the up or down arrow lever when listening to a CD will cause the player to go to the next or previous selection.

Understanding Radio Reception

FM Stereo

FM stereo will give you the best sound. But FM signals will reach only about 10 to 40 miles (16 to 65 km). Tall buildings or hills can interfere with FM signals, causing the sound to come and go.

AM

The range for most AM stations is greater than for FM, especially at night. The longer range, however, can cause stations to interfere with each other. AM can pick up noise from things like storms and power lines. Try reducing the treble to reduce this noise if you ever get it.

Tips About Your Audio System

Hearing damage from loud noise is almost undetectable until it is too late. Your hearing can adapt to higher volumes of sound. Sound that seems normal can be loud and harmful to your hearing. Take precautions by adjusting the volume control on your radio to a safe sound level before your hearing adapts to it.

To help avoid hearing loss or damage:

- Adjust the volume control to the lowest setting.
- Increase volume slowly until you hear comfortably and clearly.

NOTICE:

Before you add any sound equipment to your vehicle -- like a tape player, CB radio, mobile telephone or two-way radio -- be sure you can add what you want. If you can, it's very important to do it properly. Added sound equipment may interfere with the operation of your vehicle's engine, Cadillac radio or other systems, and even damage them. Your vehicle's systems may interfere with the operation of sound equipment that has been added improperly.

So, before adding sound equipment, check with your dealer and be sure to check Federal rules covering mobile radio and telephone units.

Care of Your Cassette Tape Player

A tape player that is not cleaned regularly can cause reduced sound quality, ruined cassettes or a damaged mechanism. Cassette tapes should be stored in their cases away from contaminants, direct sunlight and extreme heat. If they aren't, they may not operate properly or may cause failure of the tape player.

Your tape player should be cleaned regularly after every 50 hours of use. Your radio may display CLN or CLEAN TAPE to indicate that you have used your tape player for 50 hours without resetting the tape clean timer. Each time the cassette is cleaned, the 50 hour cassette timer should be reset. This is done by holding down the eject button for three seconds until the TAPE CLEAN message is displayed. If you notice a reduction in sound quality, try a known good cassette to see if it is the tape or the tape player at fault. If this other cassette has no improvement in sound quality, clean the tape player.

Cleaning may be done with a scrubbing action, non-abrasive cleaning cassette with pads which scrub the tape head as the hubs of the cleaner cassette turn. It is normal for the cassette to eject while cleaning. Insert the cassette at least six times to ensure thorough cleaning.

Some cleaning cassettes or CD adapter kits may appear as a broken tape. If the cleaning cassette is ejected immediately from the tape player, follow these steps for the TAPE CLEAN OVERRIDE feature:

1. Turn the ignition to RUN or ACC.
2. Turn the radio off.
3. Press and hold the SOURCE button for three seconds. After three seconds, the tape icon will flash indicating the cut tape feature is now turned off.
4. Turn the radio on and insert the cleaning cassette (or the CD adapter kit).
5. Eject the tape after the tape player has been cleaned.

When the cleaning cassette has been ejected, the broken tape detection feature is active again.

You may also choose a non-scrubbing action, wet-type cleaner which uses a cassette with a fabric belt to clean the tape head. This type of cleaning cassette will not eject and, it may not clean as thoroughly as the scrubbing type cleaner.

Cassettes are subject to wear and the sound quality may degrade over time. Always make sure the cassette tape is in good condition before you have your tape player serviced.

Care of Your Compact Discs

Handle discs carefully. Store them in their original cases or other protective cases and away from direct sunlight and dust. If the surface of a disc is soiled, dampen a clean, soft cloth in a mild, neutral detergent solution and clean it, wiping from the center to the edge.

Be sure never to touch the signal surface when handling discs. Pick up discs by grasping the outer edges or the edge of the hole and the outer edge.

Power Antenna Mast Care

Your power antenna will look its best and work well if it's cleaned from time to time. To clean the antenna mast:

1. Turn on the ignition and radio to raise the antenna.
2. Dampen a clean cloth with mineral spirits or equivalent solvent.
3. Wipe the cloth over the mast sections, removing any dirt.
4. Make the antenna go up and down by turning the radio or ignition off and on.
5. Repeat if necessary.

NOTICE:

Don't lubricate the power antenna. Lubrication could damage it.

NOTICE:

Before entering an automatic car wash, turn off your radio to make the power antenna go down. This will prevent the mast from possibly getting damaged. If the antenna does not go down when you turn the radio off, it may be damaged or need to be cleaned. In either case, lower the antenna by hand by carefully pressing the antenna down.

If the mast portion of your antenna is damaged, you can easily replace it. See your dealer for a replacement kit and follow the instructions in the kit.



Section 4 Your Driving and the Road

Here you'll find information about driving on different kinds of roads and in varying weather conditions. We've also included many other useful tips on driving.

4-2	Defensive Driving	4-18	Driving in Rain and on Wet Roads
4-3	Drunken Driving	4-21	City Driving
4-6	Control of a Vehicle	4-22	Freeway Driving
4-6	Braking	4-23	Before Leaving on a Long Trip
4-10	Steering	4-24	Highway Hypnosis
4-13	Off-Road Recovery	4-24	Hill and Mountain Roads
4-13	Passing	4-26	Winter Driving
4-14	Loss of Control	4-30	Loading Your Vehicle
4-16	Driving at Night	4-32	Towing a Trailer



Defensive Driving

The best advice anyone can give about driving is:
Drive defensively.

Please start with a very important safety device in your Cadillac: Buckle up. (See "Safety Belts" in the Index.)

Defensive driving really means "be ready for anything." On city streets, rural roads or freeways, it means "always expect the unexpected."

Assume that pedestrians or other drivers are going to be careless and make mistakes. Anticipate what they might do. Be ready for their mistakes.

Rear-end collisions are about the most preventable of accidents. Yet they are common. Allow enough following distance. It's the best defensive driving maneuver, in both city and rural driving. You never know when the vehicle in front of you is going to brake or turn suddenly.

Drunken Driving

Death and injury associated with drinking and driving is a national tragedy. It's the number one contributor to the highway death toll, claiming thousands of victims every year.

Alcohol affects four things that anyone needs to drive a vehicle:

- Judgment
- Muscular Coordination
- Vision
- Attentiveness.

Police records show that almost half of all motor vehicle-related deaths involve alcohol. In most cases, these deaths are the result of someone who was drinking and driving. In recent years, some 17,000 annual motor vehicle-related deaths have been associated with the use of alcohol, with more than 300,000 people injured.

Many adults -- by some estimates, nearly half the adult population -- choose never to drink alcohol, so they never drive after drinking. For persons under 21, it's against the law in every U.S. state to drink alcohol. There are good medical, psychological and developmental reasons for these laws.

The obvious way to solve this highway safety problem is for people never to drink alcohol and then drive. But what if people do? How much is "too much" if the driver plans to drive? It's a lot less than many might think. Although it depends on each person and situation, here is some general information on the problem.

The Blood Alcohol Concentration (BAC) of someone who is drinking depends upon four things:

- The amount of alcohol consumed
- The drinker's body weight
- The amount of food that is consumed before and during drinking
- The length of time it has taken the drinker to consume the alcohol.

According to the American Medical Association, a 180-lb. (82 kg) person who drinks three 12-ounce (355 ml) bottles of beer in an hour will end up with a BAC of about 0.06 percent. The person would reach the same BAC by drinking three 4-ounce (120 ml) glasses of wine or three mixed drinks if each had 1-1/2 ounces (45 ml) of a liquor like whiskey, gin or vodka.

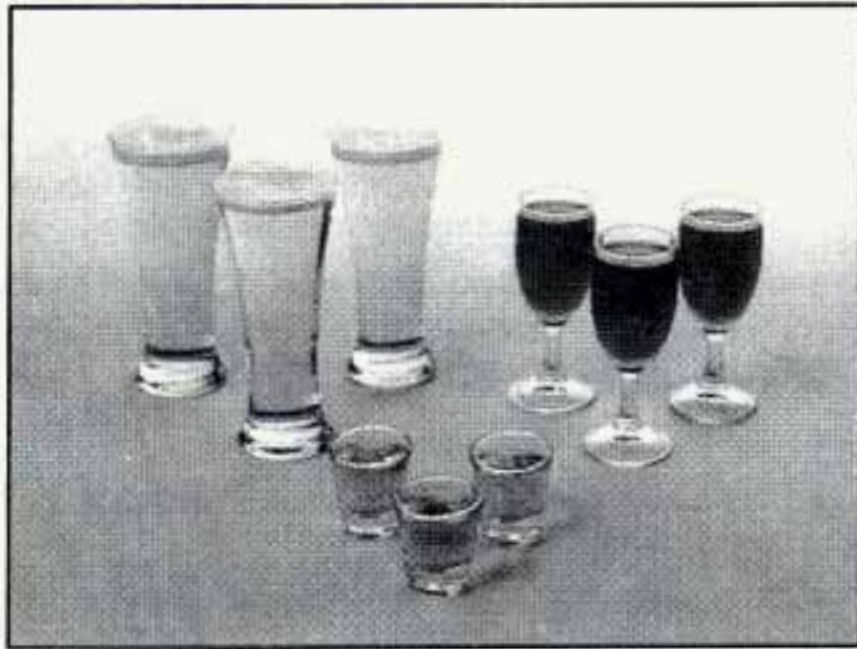

It's the amount of alcohol that counts. For example, if the same person drank three double martinis (3 ounces or 90 ml of liquor each) within an hour, the person's BAC would be close to 0.12 percent. A person who consumes food just before or during drinking will have a somewhat lower BAC level.

There is a gender difference, too. Women generally have a lower relative percentage of body water than men.

Since alcohol is carried in body water, this means that a woman generally will reach a higher BAC level than a man of her same body weight when each has the same number of drinks.

The law in many U.S. states sets the legal limit at a BAC of 0.10 percent. In a growing number of U.S. states, and throughout Canada, the limit is 0.08 percent. In some other countries, it's even lower. The BAC limit for all commercial drivers in the United States is 0.04 percent.

The BAC will be over 0.10 percent after three to six drinks (in one hour). Of course, as we've seen, it depends on how much alcohol is in the drinks, and how quickly the person drinks them.

But the ability to drive is affected well below a BAC of 0.10 percent. Research shows that the driving skills of many people are impaired at a BAC approaching 0.05 percent, and that the effects are worse at night. All drivers are impaired at BAC levels above 0.05 percent. Statistics show that the chance of being in a collision increases sharply for drivers who have a BAC of 0.05 percent or above. A driver with a BAC level of 0.06 percent has doubled his or her chance of having a collision. At a BAC level of 0.10 percent, the chance of this driver having a collision is 12 times greater; at a level of 0.15 percent, the chance is 25 times greater!

The body takes about an hour to rid itself of the alcohol in one drink. No amount of coffee or number of cold showers will speed that up. "I'll be careful" isn't the right answer. What if there's an emergency, a need to take sudden action, as when a child darts into the street? A person with even a moderate BAC might not be able to react quickly enough to avoid the collision.

There's something else about drinking and driving that many people don't know. Medical research shows that alcohol in a person's system can make crash injuries worse, especially injuries to the brain, spinal cord or heart. This means that when anyone who has been drinking -- driver or passenger -- is in a crash, that person's chance of being killed or permanently disabled is higher than if the person had not been drinking.



CAUTION:

Drinking and then driving is very dangerous. Your reflexes, perceptions, attentiveness and judgment can be affected by even a small amount of alcohol. You can have a serious -- or even fatal -- collision if you drive after drinking. Please don't drink and drive or ride with a driver who has been drinking. Ride home in a cab; or if you're with a group, designate a driver who will not drink.

Control of a Vehicle

You have three systems that make your vehicle go where you want it to go. They are the brakes, the steering and the accelerator. All three systems have to do their work at the places where the tires meet the road.

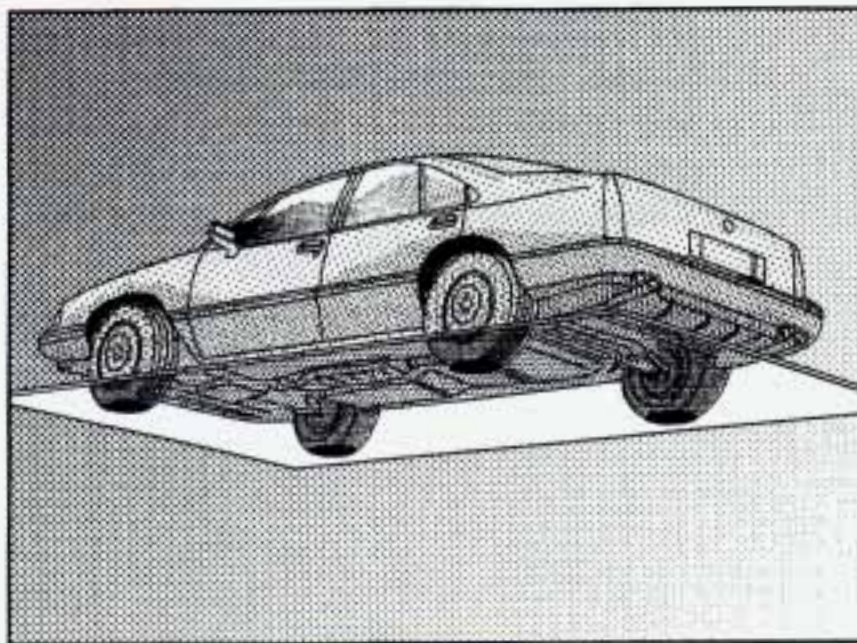

Sometimes, as when you're driving on snow or ice, it's easy to ask more of those control systems than the tires and road can provide. That means you can lose control of your vehicle.

Braking

Braking action involves *perception time* and *reaction time*.

First, you have to decide to push on the brake pedal. That's *perception time*. Then you have to bring up your foot and do it. That's *reaction time*.

Average *reaction time* is about $3/4$ of a second. But that's only an average. It might be less with one driver and as long as two or three seconds or more with another. Age, physical condition, alertness, coordination and eyesight all play a part. So do alcohol, drugs and frustration. But even in $3/4$ of a second, a vehicle moving at 60 mph (100 km/h) travels 66 feet (20 m). That could be a lot of distance in an emergency, so keeping enough space between your vehicle and others is important.

And, of course, actual stopping distances vary greatly with the surface of the road (whether it's pavement or gravel); the condition of the road (wet, dry, icy); tire tread; the condition of your brakes; the weight of the vehicle and the amount of brake force applied.

Avoid needless heavy braking. Some people drive in spurts -- heavy acceleration followed by heavy braking -- rather than keeping pace with traffic. This is a mistake. Your brakes may not have time to cool between hard stops. Your brakes will wear out much faster if you do a lot of heavy braking. If you keep pace with the traffic and allow realistic following distances, you will eliminate a lot of unnecessary braking. That means better braking and longer brake life.

If your engine ever stops while you're driving, brake normally but don't pump your brakes. If you do, the pedal may get harder to push down. If your engine stops, you will still have some power brake assist. But you will use it when you brake. Once the power assist is used up, it may take longer to stop and the brake pedal will be harder to push.

Anti-Lock Brakes (ABS)

Your vehicle has anti-lock brakes (ABS). ABS is an advanced electronic braking system that will help prevent a braking skid.

When you start your engine and begin to drive away, your anti-lock brake system will check itself. You may hear a momentary motor or clicking noise while this test is going on, and you may even notice that your brake pedal moves a little. This is normal.

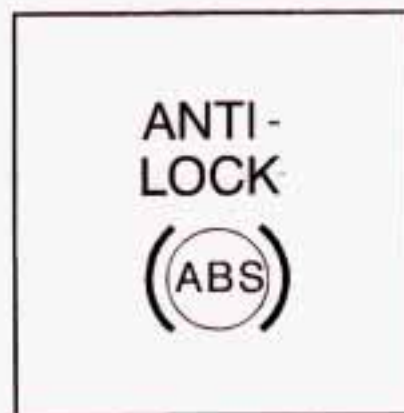

If there's a problem with the anti-lock brake system, this warning light will stay on. See "Anti-Lock Brake System Warning Light" in the Index.



Here's how anti-lock works. Let's say the road is wet. You're driving safely. Suddenly an animal jumps out in front of you.

You slam on the brakes. Here's what happens with ABS. A computer senses that wheels are slowing down. If one of the wheels is about to stop rolling, the computer will separately work the brakes at each front wheel and at the rear wheels.

The anti-lock system can change the brake pressure faster than any driver could. The computer is programmed to make the most of available tire and road conditions.



You can steer around the obstacle while braking hard.

As you brake, your computer keeps receiving updates on wheel speed and controls braking pressure accordingly.

Remember: Anti-lock doesn't change the time you need to get your foot up to the brake pedal or always decrease stopping distance. If you get too close to the vehicle in front of you, you won't have time to apply your brakes if that vehicle suddenly slows or stops. Always leave enough room up ahead to stop, even though you have anti-lock brakes.

Using Anti-Lock

Don't pump the brakes. Just hold the brake pedal down and let anti-lock work for you. You may hear the anti-lock pump or motor operate, and feel the brake pedal pulsate, but this is normal.

Traction Control System

Your vehicle has a traction control system that limits wheel spin. This is especially useful in slippery road conditions. The system operates only if it senses that one or both of the front wheels are spinning or beginning to lose traction. When this happens, the system works the front brakes and reduces engine power to limit wheel spin.

The TRACTION ENGAGED message will display on the Driver Information Center when the traction control system is limiting wheel spin. See "Driver Information Center Messages" in the Index. You may feel or hear the system working, but this is normal.

If your vehicle is in cruise control when the traction control system begins to limit wheel spin, the cruise control will automatically disengage. When road conditions allow you to safely use it again, you may re-engage the cruise control. (See "Cruise Control" in the Index.)



This warning light will come on to let you know if there's a problem with your traction control system.

See "Traction Control System Warning Light" in the Index. When this warning light is on, the system will not limit wheel spin. Adjust your driving accordingly.

The traction control system automatically comes on whenever you start your vehicle. To limit wheel spin, especially in slippery road conditions, you should always leave the system on. But you can turn the traction control system off if you ever need to. (You should turn the system off if your vehicle ever gets stuck

in sand, mud, ice or snow. See “Rocking Your Vehicle” in the Index.)



To turn the system off, press the TRAC OFF button located inside of the glove box.

The TRACTION OFF message will display on the Driver Information Center. If the system is limiting wheel spin when you press the button, the TRACTION OFF message will display -- but the system won't turn off right away. It will wait until there's no longer a current need to limit wheel spin.

You can turn the system back on at any time by pressing the button again. The TRACTION READY message should display briefly on the Driver Information Center.

Braking in Emergencies

With anti-lock, you can steer and brake at the same time. In many emergencies, steering can help you more than even the very best braking.

Steering

Power Steering

If you lose power steering assist because the engine stops or the system is not functioning, you can steer but it will take much more effort.

MAGNASTEER™

Your vehicle may be equipped with GM MAGNASTEER, a system that continuously adjusts the effort you feel when steering at all vehicle speeds. It provides ease when parking yet a firm, solid feel at highway speeds.

Steering Tips

Driving on Curves

It's important to take curves at a reasonable speed.

A lot of the "driver lost control" accidents mentioned on the news happen on curves. Here's why:

Experienced driver or beginner, each of us is subject to the same laws of physics when driving on curves. The traction of the tires against the road surface makes it possible for the vehicle to change its path when you turn the front wheels. If there's no traction, inertia will keep the vehicle going in the same direction. If you've ever tried to steer a vehicle on wet ice, you'll understand this.

The traction you can get in a curve depends on the condition of your tires and the road surface, the angle at which the curve is banked and your speed. While you're in a curve, speed is the one factor you can control.

Suppose you're steering through a sharp curve. Then you suddenly accelerate. Both control systems -- steering and acceleration -- have to do their work where the tires meet the road. Adding the sudden acceleration can demand too much of those places. You can lose control. Refer to "Traction Control System" in the Index.

What should you do if this ever happens? Ease up on the accelerator pedal, steer the vehicle the way you want it to go, and slow down.

If you have the Seville STS, you may see the STABILITY SYS ENGAGED message on the Driver Information Center. See "Stability Engaged Message" in the Index.

Speed limit signs near curves warn that you should adjust your speed. Of course, the posted speeds are based on good weather and road conditions. Under less favorable conditions you'll want to go slower.

If you need to reduce your speed as you approach a curve, do it before you enter the curve, while your front wheels are straight ahead.

Try to adjust your speed so you can "drive" through the curve. Maintain a reasonable, steady speed. Wait to accelerate until you are out of the curve, and then accelerate gently into the straightaway.

Steering in Emergencies

There are times when steering can be more effective than braking. For example, you come over a hill and find a truck stopped in your lane, or a car suddenly pulls out from nowhere, or a child darts out from between parked cars and stops right in front of you. You can avoid these problems by braking -- if you can stop in time. But sometimes you can't; there isn't room. That's the time for evasive action -- steering around the problem.

Your Cadillac can perform very well in emergencies like these. First apply your brakes. (See "Braking in Emergencies" earlier in this section.) It is better to remove as much speed as you can from a possible collision. Then steer around the problem, to the left or right depending on the space available.



An emergency like this requires close attention and a quick decision. If you are holding the steering wheel at the recommended 9 and 3 o'clock positions, you can turn it a full 180 degrees very quickly without removing either hand. But you have to act fast, steer quickly, and just as quickly straighten the wheel once you have avoided the object.

The fact that such emergency situations are always possible is a good reason to practice defensive driving at all times and wear safety belts properly.

Off-Road Recovery

You may find sometime that your right wheels have dropped off the edge of a road onto the shoulder while you're driving.



If the level of the shoulder is only slightly below the pavement, recovery should be fairly easy. Ease off the accelerator and then, if there is nothing in the way, steer so that your vehicle straddles the edge of the pavement. You can turn the steering wheel up to one-quarter turn until the right front tire contacts the pavement edge. Then turn your steering wheel to go straight down the roadway.

Passing

The driver of a vehicle about to pass another on a two-lane highway waits for just the right moment, accelerates, moves around the vehicle ahead, then goes back into the right lane again. A simple maneuver?

Not necessarily! Passing another vehicle on a two-lane highway is a potentially dangerous move, since the passing vehicle occupies the same lane as oncoming traffic for several seconds. A miscalculation, an error in judgment, or a brief surrender to frustration or anger can suddenly put the passing driver face to face with the worst of all traffic accidents -- the head-on collision.

So here are some tips for passing:

- "Drive ahead." Look down the road, to the sides and to crossroads for situations that might affect your passing patterns. If you have any doubt whatsoever about making a successful pass, wait for a better time.
- Watch for traffic signs, pavement markings and lines. If you can see a sign up ahead that might indicate a turn or an intersection, delay your pass. A broken center line usually indicates it's all right to pass (providing the road ahead is clear). Never cross a solid line on your side of the lane or a double solid line, even if the road seems empty of approaching traffic.

- Do not get too close to the vehicle you want to pass while you're awaiting an opportunity. For one thing, following too closely reduces your area of vision, especially if you're following a larger vehicle. Also, you won't have adequate space if the vehicle ahead suddenly slows or stops. Keep back a reasonable distance.
- When it looks like a chance to pass is coming up, start to accelerate but stay in the right lane and don't get too close. Time your move so you will be increasing speed as the time comes to move into the other lane. If the way is clear to pass, you will have a "running start" that more than makes up for the distance you would lose by dropping back. And if something happens to cause you to cancel your pass, you need only slow down and drop back again and wait for another opportunity.
- If other cars are lined up to pass a slow vehicle, wait your turn. But take care that someone isn't trying to pass you as you pull out to pass the slow vehicle. Remember to glance over your shoulder and check the blind spot.
- Check your mirrors, glance over your shoulder, and start your left lane change signal before moving out of the right lane to pass. When you are far enough ahead of the passed vehicle to see its front in your

inside mirror, activate your right lane change signal and move back into the right lane. (Remember that your right outside mirror is convex. The vehicle you just passed may seem to be farther away from you than it really is.)

- Try not to pass more than one vehicle at a time on two-lane roads. Reconsider before passing the next vehicle.
- Don't overtake a slowly moving vehicle too rapidly. Even though the brake lamps are not flashing, it may be slowing down or starting to turn.
- If you're being passed, make it easy for the following driver to get ahead of you. Perhaps you can ease a little to the right.

Loss of Control

Let's review what driving experts say about what happens when the three control systems (brakes, steering and acceleration) don't have enough friction where the tires meet the road to do what the driver has asked.

In any emergency, don't give up. Keep trying to steer and constantly seek an escape route or area of less danger.

Skidding

In a skid, a driver can lose control of the vehicle. Defensive drivers avoid most skids by taking reasonable care suited to existing conditions, and by not “overdriving” those conditions. But skids are always possible.

The three types of skids correspond to your Cadillac’s three control systems. In the braking skid, your wheels aren’t rolling. In the steering or cornering skid, too much speed or steering in a curve causes tires to slip and lose cornering force. And in the acceleration skid, too much throttle causes the driving wheels to spin.

A cornering skid is best handled by easing your foot off the accelerator pedal.

Remember: Any traction control system helps avoid only the acceleration skid.

If your traction control system is off, then an acceleration skid is also best handled by easing your foot off the accelerator pedal.

If your vehicle starts to slide, ease your foot off the accelerator pedal and quickly steer the way you want the vehicle to go. If you start steering quickly enough, your vehicle may straighten out. Always be ready for a second skid if it occurs.

If you have the Seville STS, you may see the STABILITY SYS ENGAGED message on the Driver Information Center. See “Stability Engaged Message” in the Index.

Of course, traction is reduced when water, snow, ice, gravel or other material is on the road. For safety, you’ll want to slow down and adjust your driving to these conditions. It is important to slow down on slippery surfaces because stopping distance will be longer and vehicle control more limited.

While driving on a surface with reduced traction, try your best to avoid sudden steering, acceleration or braking (including engine braking by shifting to a lower gear). Any sudden changes could cause the tires to slide. You may not realize the surface is slippery until your vehicle is skidding. Learn to recognize warning clues -- such as enough water, ice or packed snow on the road to make a “mirrored surface” -- and slow down when you have any doubt.

Remember: Any anti-lock brake system (ABS) helps avoid only the braking skid.

Driving at Night

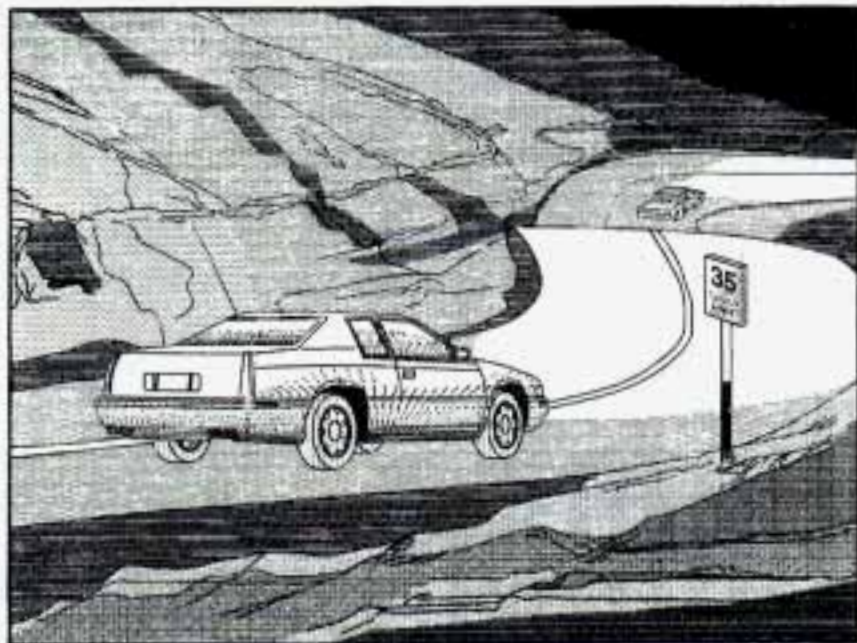

Night driving is more dangerous than day driving. One reason is that some drivers are likely to be impaired -- by alcohol or drugs, with night vision problems, or by fatigue.

Here are some tips on night driving.

- Drive defensively.
- Don't drink and drive.
- Since you can't see as well, you may need to slow down and keep more space between you and other vehicles.
- Slow down, especially on higher speed roads. Your headlamps can light up only so much road ahead.
- In remote areas, watch for animals.
- If you're tired, pull off the road in a safe place and rest.

Night Vision

No one can see as well at night as in the daytime. But as we get older these differences increase. A 50-year-old driver may require at least twice as much light to see the same thing at night as a 20-year-old.

What you do in the daytime can also affect your night vision. For example, if you spend the day in bright sunshine you are wise to wear sunglasses. Your eyes will have less trouble adjusting to night. But if you're driving, don't wear sunglasses at night. They may cut down on glare from headlamps, but they also make a lot of things invisible.

You can be temporarily blinded by approaching headlamps. It can take a second or two, or even several seconds, for your eyes to readjust to the dark. When you are faced with severe glare (as from a driver who doesn't lower the high beams, or a vehicle with misaimed headlamps), slow down a little. Avoid staring directly into the approaching headlamps.

Keep your windshield and all the glass on your vehicle clean -- inside and out. Glare at night is made much worse by dirt on the glass. Even the inside of the glass can build up a film caused by dust. Dirty glass makes lights dazzle and flash more than clean glass would, making the pupils of your eyes contract repeatedly.

Remember that your headlamps light up far less of a roadway when you are in a turn or curve. Keep your eyes moving; that way, it's easier to pick out dimly lighted objects. Just as your headlamps should be checked regularly for proper aim, so should your eyes be examined regularly. Some drivers suffer from night blindness -- the inability to see in dim light -- and aren't even aware of it.

Driving in Rain and on Wet Roads



Rain and wet roads can mean driving trouble. On a wet road, you can't stop, accelerate or turn as well because your tire-to-road traction isn't as good as on dry roads. And, if your tires don't have much tread left, you'll get even less traction. It's always wise to go slower and be cautious if rain starts to fall while you are driving. The surface may get wet suddenly when your reflexes are tuned for driving on dry pavement.

The heavier the rain, the harder it is to see. Even if your windshield wiper blades are in good shape, a heavy rain can make it harder to see road signs and traffic signals, pavement markings, the edge of the road and even people walking.

It's wise to keep your windshield wiping equipment in good shape and keep your windshield washer tank filled with washer fluid. Replace your windshield wiper inserts when they show signs of streaking or missing areas on the windshield, or when strips of rubber start to separate from the inserts.

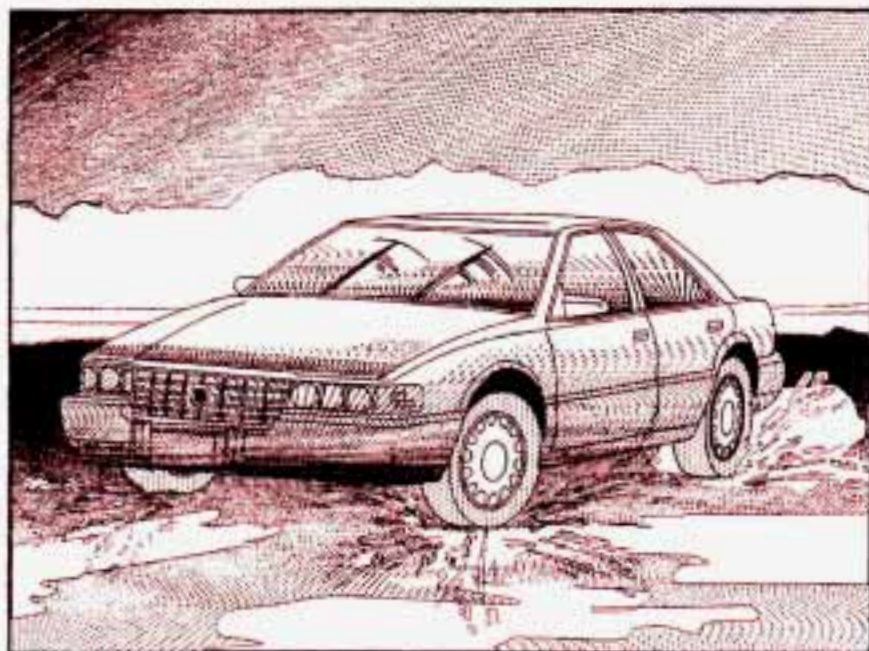

Driving too fast through large water puddles or even going through some car washes can cause problems, too. The water may affect your brakes. Try to avoid puddles. But if you can't, try to slow down before you hit them.

 **CAUTION:**

Wet brakes can cause accidents. They won't work as well in a quick stop and may cause pulling to one side. You could lose control of the vehicle.

After driving through a large puddle of water or a car wash, apply your brake pedal lightly until your brakes work normally.

Hydroplaning

Hydroplaning is dangerous. So much water can build up under your tires that they can actually ride on the water. This can happen if the road is wet enough and you're going fast enough. When your vehicle is hydroplaning, it has little or no contact with the road.

Hydroplaning doesn't happen often. But it can if your tires do not have much tread or if the pressure in one or more is low. It can happen if a lot of water is standing on the road. If you can see reflections from trees, telephone poles or other vehicles, and raindrops "dimple" the water's surface, there could be hydroplaning.

Hydroplaning usually happens at higher speeds. There just isn't a hard and fast rule about hydroplaning. The best advice is to slow down when it is raining.

Driving Through Deep Standing Water

NOTICE:

If you drive too quickly through deep puddles or standing water, water can come in through your engine's air intake and badly damage your engine. Never drive through water that is slightly lower than the underbody of your vehicle. If you can't avoid deep puddles or standing water, drive through them very slowly.

Some Other Rainy Weather Tips

- Besides slowing down, allow some extra following distance. And be especially careful when you pass another vehicle. Allow yourself more clear room ahead, and be prepared to have your view restricted by road spray.
- Have good tires with proper tread depth. (See "Tires" in the Index.)

City Driving

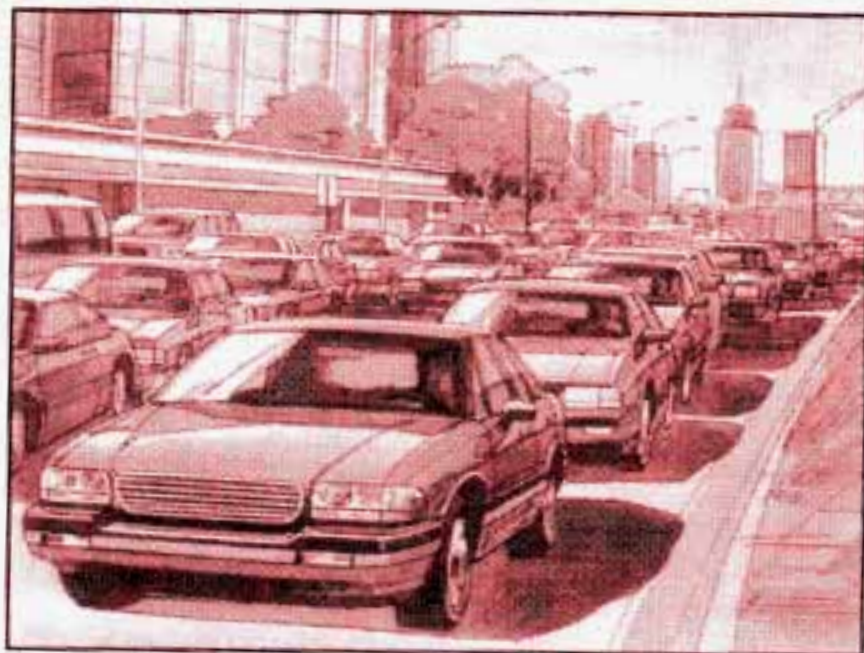

One of the biggest problems with city streets is the amount of traffic on them. You'll want to watch out for what the other drivers are doing and pay attention to traffic signals.

Here are ways to increase your safety in city driving:

- Know the best way to get to where you are going. Get a city map and plan your trip into an unknown part of the city just as you would for a cross-country trip.
- Try to use the freeways that rim and crisscross most large cities. You'll save time and energy. (See the next part, "Freeway Driving.")
- Treat a green light as a warning signal. A traffic light is there because the corner is busy enough to need it. When a light turns green, and just before you start to move, check both ways for vehicles that have not cleared the intersection or may be running the red light.

Freeway Driving

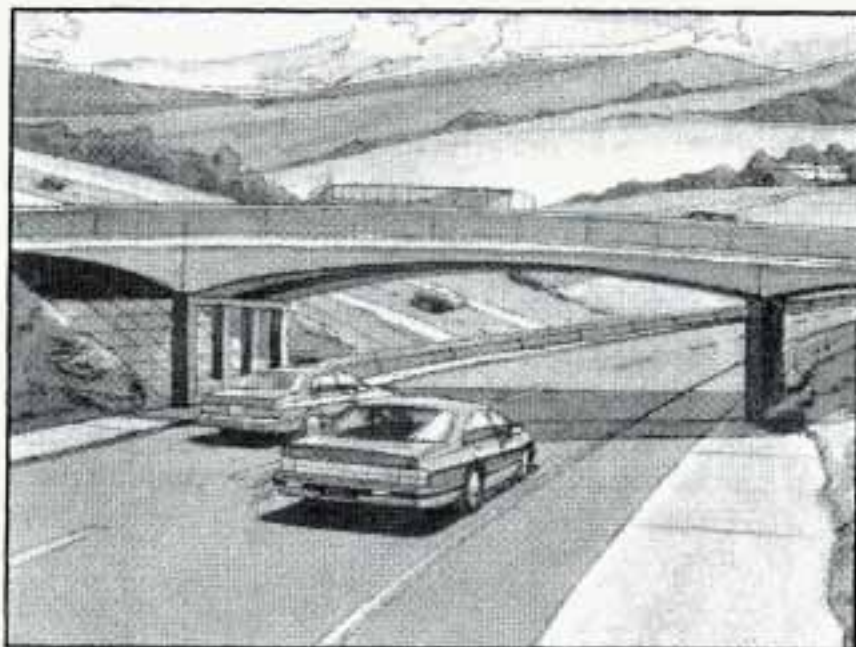

Mile for mile, freeways (also called thruways, parkways, expressways, turnpikes or superhighways) are the safest of all roads. But they have their own special rules.

The most important advice on freeway driving is: Keep up with traffic and keep to the right. Drive at the same speed most of the other drivers are driving. Too-fast or too-slow driving breaks a smooth traffic flow. Treat the left lane on a freeway as a passing lane.

At the entrance, there is usually a ramp that leads to the freeway. If you have a clear view of the freeway as you drive along the entrance ramp, you should begin to check traffic. Try to determine where you expect to blend with the flow. Try to merge into the gap at close to the prevailing speed. Switch on your turn signal, check your mirrors and glance over your shoulder as often as necessary. Try to blend smoothly with the traffic flow.

Once you are on the freeway, adjust your speed to the posted limit or to the prevailing rate if it's slower. Stay in the right lane unless you want to pass.

Before changing lanes, check your mirrors. Then use your turn signal.

Just before you leave the lane, glance quickly over your shoulder to make sure there isn't another vehicle in your "blind" spot.

Once you are moving on the freeway, make certain you allow a reasonable following distance. Expect to move slightly slower at night.

When you want to leave the freeway, move to the proper lane well in advance. If you miss your exit, do not, under any circumstances, stop and back up. Drive on to the next exit.

The exit ramp can be curved, sometimes quite sharply.

The exit speed is usually posted.

Reduce your speed according to your speedometer, not to your sense of motion. After driving for any distance at higher speeds, you may tend to think you are going slower than you actually are.

Before Leaving on a Long Trip

Make sure you're ready. Try to be well rested. If you must start when you're not fresh -- such as after a day's work -- don't plan to make too many miles that first part of the journey. Wear comfortable clothing and shoes you can easily drive in.

Is your vehicle ready for a long trip? If you keep it serviced and maintained, it's ready to go. If it needs service, have it done before starting out. Of course, you'll find experienced and able service experts in Cadillac dealerships all across North America. They'll be ready and willing to help if you need it.

Here are some things you can check before a trip:

- *Windshield Washer Fluid:* Is the reservoir full? Are all windows clean inside and outside?
- *Wiper Blades:* Are they in good shape?
- *Fuel, Engine Oil, Other Fluids:* Have you checked all levels?
- *Lamps:* Are they all working? Are the lenses clean?
- *Tires:* They are vitally important to a safe, trouble-free trip. Is the tread good enough for long-distance driving? Are the tires all inflated to the recommended pressure?
- *Weather Forecasts:* What's the weather outlook along your route? Should you delay your trip a short time to avoid a major storm system?
- *Maps:* Do you have up-to-date maps?

Highway Hypnosis

Is there actually such a condition as “highway hypnosis”? Or is it just plain falling asleep at the wheel? Call it highway hypnosis, lack of awareness, or whatever.

There is something about an easy stretch of road with the same scenery, along with the hum of the tires on the road, the drone of the engine, and the rush of the wind against the vehicle that can make you sleepy. Don't let it happen to you! If it does, your vehicle can leave the road in *less than a second*, and you could crash and be injured.

What can you do about highway hypnosis? First, be aware that it can happen.

Then here are some tips:

- Make sure your vehicle is well ventilated, with a comfortably cool interior.
- Keep your eyes moving. Scan the road ahead and to the sides. Check your rearview mirrors and your instruments frequently.
- If you get sleepy, pull off the road into a rest, service or parking area and take a nap, get some exercise, or both. For safety, treat drowsiness on the highway as an emergency.

Hill and Mountain Roads



Driving on steep hills or mountains is different from driving in flat or rolling terrain.

If you drive regularly in steep country, or if you're planning to visit there, here are some tips that can make your trips safer and more enjoyable.

- Keep your vehicle in good shape. Check all fluid levels and also the brakes, tires, cooling system and transaxle. These parts can work hard on mountain roads.
- Know how to go down hills. The most important thing to know is this: let your engine do some of the slowing down. Shift to a lower gear when you go down a steep or long hill.

 **CAUTION:**

If you don't shift down, your brakes could get so hot that they wouldn't work well. You would then have poor braking or even none going down a hill. You could crash. Shift down to let your engine assist your brakes on a steep downhill slope.

 **CAUTION:**

Coasting downhill in NEUTRAL (N) or with the ignition off is dangerous. Your brakes will have to do all the work of slowing down. They could get so hot that they wouldn't work well. You would then have poor braking or even none going down a hill. You could crash. Always have your engine running and your vehicle in gear when you go downhill.

- Know how to go uphill. You may want to shift down to a lower gear. The lower gears help cool your engine and transaxle, and you can climb the hill better.
- Stay in your own lane when driving on two-lane roads in hills or mountains. Don't swing wide or cut across the center of the road. Drive at speeds that let you stay in your own lane.
- As you go over the top of a hill, be alert. There could be something in your lane, like a stalled car or an accident.
- You may see highway signs on mountains that warn of special problems. Examples are long grades, passing or no-passing zones, a falling rocks area or winding roads. Be alert to these and take appropriate action.

Winter Driving

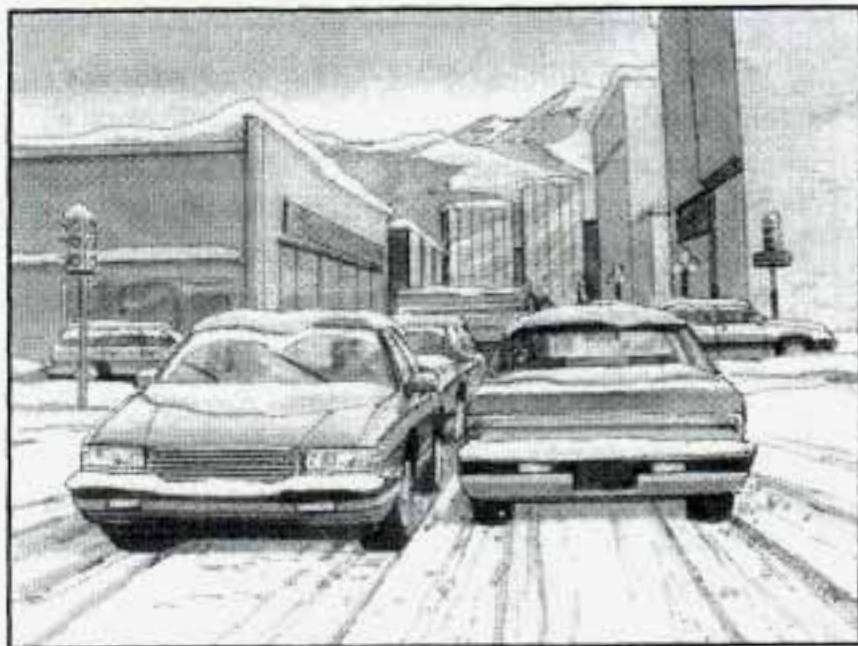

Here are some tips for winter driving:

- Have your vehicle in good shape for winter.
- You may want to put winter emergency supplies in your trunk.

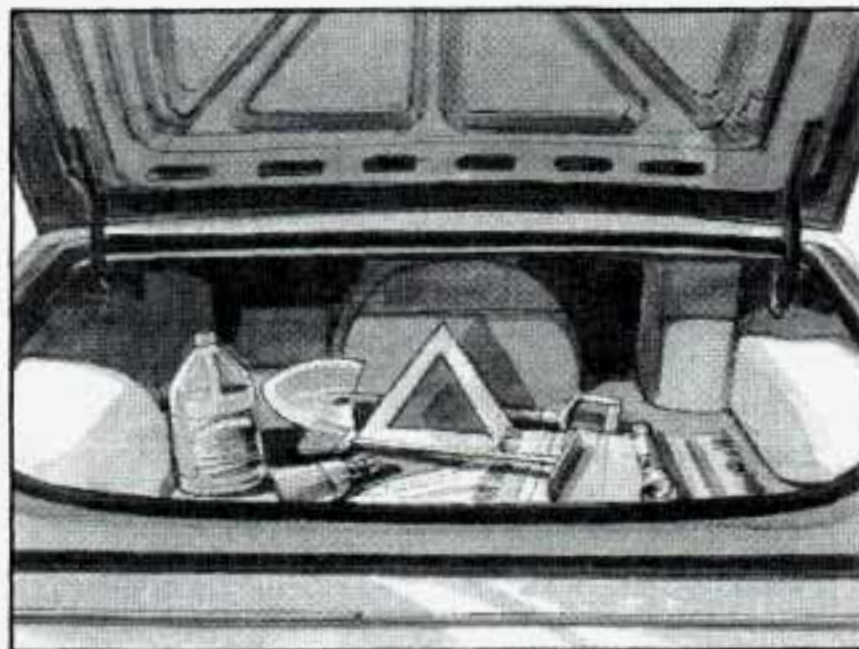

Include an ice scraper, a small brush or broom, a supply of windshield washer fluid, a rag, some winter outer clothing, a small shovel, a flashlight, a red cloth and a couple of reflective warning triangles. And, if you will be driving under severe conditions, include a small bag of sand, a piece of old carpet or a couple of burlap bags to help provide traction. Be sure you properly secure these items in your vehicle.

Driving on Snow or Ice

Most of the time, those places where your tires meet the road probably have good traction.

However, if there is snow or ice between your tires and the road, you can have a very slippery situation. You'll have a lot less traction or "grip" and will need to be very careful.

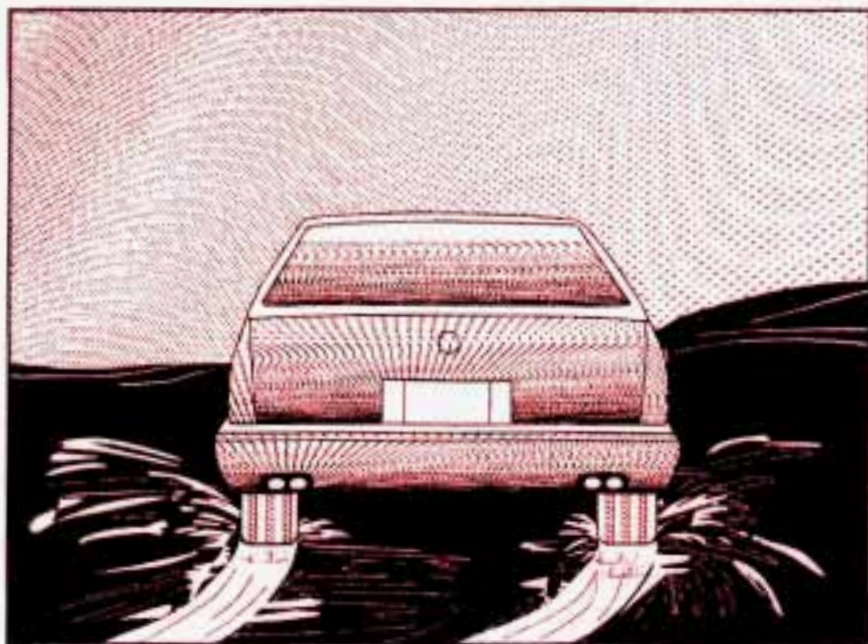

What's the worst time for this? "Wet ice." Very cold snow or ice can be slick and hard to drive on. But wet ice can be even more trouble because it may offer the least traction of all. You can get wet ice when it's about freezing (32°F; 0°C) and freezing rain begins to fall. Try to avoid driving on wet ice until salt and sand crews can get there.

Whatever the condition -- smooth ice, packed, blowing or loose snow -- drive with caution.

Keep your traction control system on. It improves your ability to accelerate when driving on a slippery road. Even though your vehicle has a traction control system, you'll want to slow down and adjust your driving to the road conditions. See "Traction Control System" in the Index.

Your anti-lock brakes improve your vehicle's stability when you make a hard stop on a slippery road. Even though you have the anti-lock braking system, you'll want to begin stopping sooner than you would on dry pavement. See "Anti-Lock" in the Index.

- Allow greater following distance on any slippery road.
- Watch for slippery spots. The road might be fine until you hit a spot that's covered with ice. On an otherwise clear road, ice patches may appear in shaded areas where the sun can't reach: around clumps of trees, behind buildings or under bridges. Sometimes the surface of a curve or an overpass may remain icy when the surrounding roads are clear. If you see a patch of ice ahead of you, brake before you are on it. Try not to brake while you're actually on the ice, and avoid sudden steering maneuvers.

If You're Caught in a Blizzard



If you are stopped by heavy snow, you could be in a serious situation. You should probably stay with your vehicle unless you know for sure that you are near help and you can hike through the snow. Here are some things to do to summon help and keep yourself and your passengers safe:

- Turn on your hazard flashers.

- Tie a red cloth to your vehicle to alert police that you've been stopped by the snow.
- Put on extra clothing or wrap a blanket around you. If you have no blankets or extra clothing, make body insulators from newspapers, burlap bags, rags, floor mats -- anything you can wrap around yourself or tuck under your clothing to keep warm.

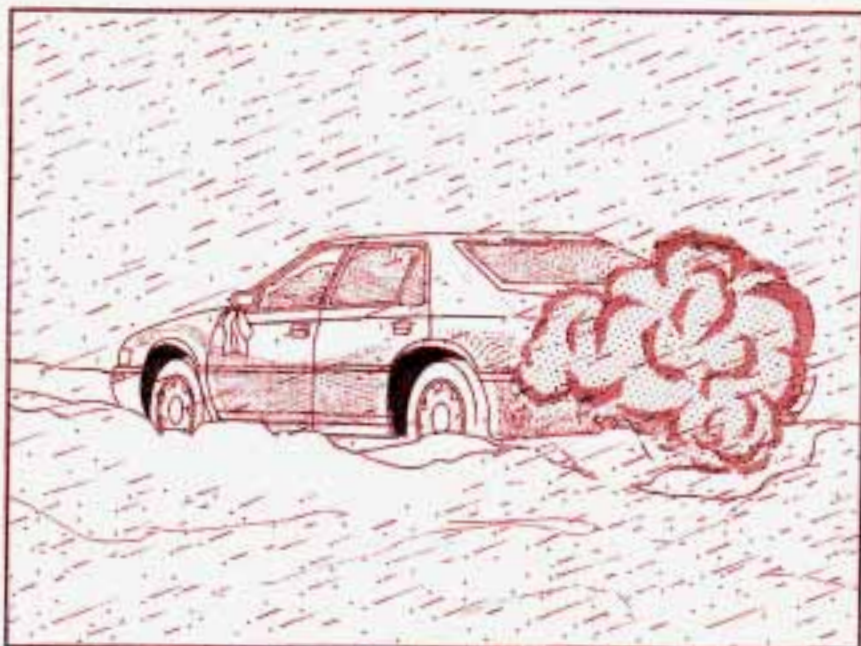

You can run the engine to keep warm, but be careful.

⚠ CAUTION:

Snow can trap exhaust gases under your vehicle. This can cause deadly CO (carbon monoxide) gas to get inside. CO could overcome you and kill you. You can't see it or smell it, so you might not know it is in your vehicle. Clear away snow from around the base of your vehicle, especially any that is blocking your exhaust pipe. And check around again from time to time to be sure snow doesn't collect there.

Open a window just a little on the side of the vehicle that's away from the wind. This will help keep CO out.

Run your engine only as long as you must. This saves fuel. When you run the engine, make it go a little faster than just idle. That is, push the accelerator slightly. This uses less fuel for the heat that you get and it keeps the battery charged. You will need a well-charged battery to restart the vehicle, and possibly for signaling later on with your headlamps. Let the heater run for awhile.

Then, shut the engine off and close the window almost all the way to preserve the heat. Start the engine again and repeat this only when you feel really uncomfortable from the cold. But do it as little as possible. Preserve the fuel as long as you can. To help keep warm, you can get out of the vehicle and do some fairly vigorous exercises every half hour or so until help comes.

Loading Your Vehicle

TIRE-LOADING INFORMATION					
OCCUPANTS			VEHICLE CAP. WT.		
FRT.	CTR.	RR.	TOTAL	LBS.	KG
MAX. LOADING & GVWR SAME AS VEHICLE					
CAPACITY WEIGHT		XXX	COLD TIRE		
TIRE SIZE			SPEED	PRESSURE	
			RTG	PSI/KPa	
FRT.					
RR.					
SPA.					
IF TIRES ARE HOT, ADD 4PSI / 28KPa					
SEE OWNER'S MANUAL FOR ADDITIONAL INFORMATION					

Two labels on your vehicle show how much weight it may properly carry. The Tire-Loading Information label found on the driver's door tells you the proper size, speed rating and recommended inflation pressures for the tires on your vehicle. It also gives you important information about the number of people that can be in your vehicle and the total weight that you can carry. This weight is called the Vehicle Capacity Weight and includes the weight of all occupants, cargo and all options not installed in the factory.



MFD BY GENERAL MOTORS CORP
DATE GVWR GAWR FRT GAWR RR

THIS VEHICLE CONFORMS TO ALL APPLICABLE U.S. FEDERAL MOTOR VEHICLE SAFETY, BUMPER, AND THEFT PREVENTION STANDARDS IN EFFECT ON THE DATE OF MANUFACTURE SHOWN ABOVE.

The other label is the Certification label, found on the rear edge of the driver's door. It tells you the gross weight capacity of your vehicle, called the GVWR (Gross Vehicle Weight Rating). The GVWR includes the weight of the vehicle, all occupants, fuel and cargo. Never exceed the GVWR for your vehicle, or the Gross Axle Weight Rating (GAWR) for either the front or rear axle.

If you do have a heavy load, you should spread it out. Don't carry more than 176 lbs. (80 kg) in your trunk.



CAUTION:

Do not load your vehicle any heavier than the GVWR, or either the maximum front or rear GAWR. If you do, parts on your vehicle can break, or it can change the way your vehicle handles. These could cause you to lose control. Also, overloading can shorten the life of your vehicle.

NOTICE:

Your warranty does not cover parts or components that fail because of overloading.

If you put things inside your vehicle -- like suitcases, tools, packages, or anything else -- they will go as fast as the vehicle goes. If you have to stop or turn quickly, or if there is a crash, they'll keep going.

 **CAUTION:**

Things you put inside your vehicle can strike and injure people in a sudden stop or turn, or in a crash.

- Put things in the trunk of your vehicle. In a trunk, put them as far forward as you can. Try to spread the weight evenly.
- Never stack heavier things, like suitcases, inside the vehicle so that some of them are above the tops of the seats.
- Don't leave an unsecured child restraint in your vehicle.
- When you carry something inside the vehicle, secure it whenever you can.

Electronic Level Control

This feature keeps the rear of your vehicle level as the load changes. It's automatic -- you don't need to adjust anything.

Towing a Trailer

 **CAUTION:**

If you don't use the correct equipment and drive properly, you can lose control when you pull a trailer. For example, if the trailer is too heavy, the brakes may not work well -- or even at all. You and your passengers could be seriously injured. Pull a trailer only if you have followed all the steps in this section. Ask your Cadillac dealer for advice and information about towing a trailer with your vehicle.

NOTICE:

Pulling a trailer improperly can damage your vehicle and result in costly repairs not covered by your warranty. To pull a trailer correctly, follow the advice in this part, and see your Cadillac dealer for important information about towing a trailer with your vehicle.

Your vehicle can tow a trailer if it is equipped with the proper trailer towing equipment. To identify what the vehicle trailering capacity is for your vehicle, you should read the information in “Weight of the Trailer” that appears later in this section. But trailering is different than just driving your vehicle by itself. Trailering means changes in handling, durability and fuel economy. Successful, safe trailering takes correct equipment, and it has to be used properly.

That’s the reason for this part. In it are many time-tested, important trailering tips and safety rules. Many of these are important for your safety and that of your passengers. So please read this section carefully before you pull a trailer.

Load-pulling components such as the engine, transaxle, wheel assemblies and tires are forced to work harder against the drag of the added weight. The engine is required to operate at relatively higher speeds and under greater loads, generating extra heat. What’s more, the trailer adds considerably to wind resistance, increasing the pulling requirements.

If You Do Decide To Pull A Trailer

If you do, here are some important points:

- There are many different laws, including speed limit restrictions, having to do with trailering. Make sure your rig will be legal, not only where you live but also where you’ll be driving. A good source for this information can be state or provincial police.
- Consider using a sway control. You can ask a hitch dealer about sway controls.
- Don’t tow a trailer at all during the first 1,000 miles (1 600 km) your new vehicle is driven. Your engine, axle or other parts could be damaged.
- Then, during the first 500 miles (800 km) that you tow a trailer, don’t drive over 50 mph (80 km/h) and don’t make starts at full throttle. This helps your engine and other parts of your vehicle wear in at the heavier loads.
- Obey speed limit restrictions when towing a trailer. Don’t drive faster than the maximum posted speed for trailers (or no more than 55 mph (90 km/h)) to save wear on your vehicle’s parts.

Three important considerations have to do with weight:

- the weight of the trailer,
- the weight of the trailer tongue
- and the total weight on your vehicle's tires.

Weight of the Trailer

How heavy can a trailer safely be?

It should never weigh more than 1,000 lbs. (450 kg) total, including the load. But even that can be too heavy.

It depends on how you plan to use your rig. For example, speed, altitude, road grades, outside temperature and how much your vehicle is used to pull a trailer are all important. And, it can also depend on any special equipment that you have on your vehicle.

You can ask your dealer for our trailering information or advice, or you can write us at:

Cadillac Customer Assistance Center
Cadillac Motor Car Division
30009 Van Dyke
P.O. Box 9025
Warren, MI 48090-9025

In Canada, write to:

General Motors of Canada Limited
Customer Communication Centre
1908 Colonel Sam Drive
Oshawa, Ontario L1H 8P7

Weight of the Trailer Tongue

The tongue load (A) of any trailer is an important weight to measure because it affects the total capacity weight of your vehicle. The capacity weight includes the curb weight of the vehicle, any cargo you may carry in it, and the people who will be riding in the vehicle. And if you will tow a trailer, you must subtract the tongue load from your vehicle's capacity weight because your vehicle will be carrying that weight, too. See "Loading Your Vehicle" in the Index for more information about your vehicle's maximum load capacity.

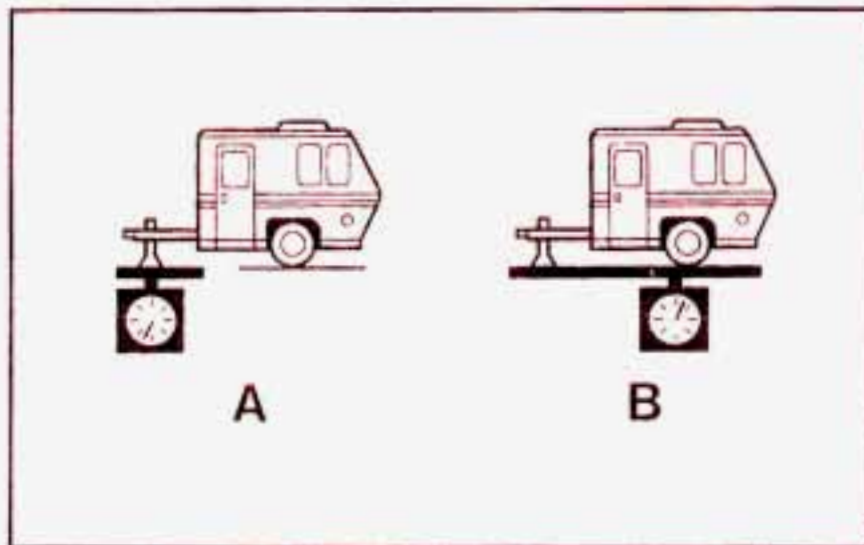

If you're using a weight-carrying hitch, the trailer tongue (A) should weigh 10 percent of the total loaded trailer weight (B). If you have a weight-distributing hitch, the trailer tongue (A) should weigh 12 percent of the total loaded trailer weight (B).

After you've loaded your trailer, weigh the trailer and then the tongue, separately, to see if the weights are proper. If they aren't, you may be able to get them right simply by moving some items around in the trailer.

Total Weight on Your Vehicle's Tires

Be sure your vehicle's tires are inflated to the upper limit for cold tires. You'll find these numbers on the Tire-Loading Information label at the rear edge of the driver's door or see "Loading Your Vehicle" in the Index. Then be sure you don't go over the GVW limit for your vehicle, including the weight of the trailer tongue.

Hitches

It's important to have the correct hitch equipment. Crosswinds, large trucks going by and rough roads are a few reasons why you'll need the right hitch. Here are some rules to follow:

- The bumpers on your vehicle are not intended for hitches. Do not attach rental hitches or other bumper-type hitches to them. Use only a frame-mounted hitch that does not attach to the bumper.
- Will you have to make any holes in the body of your vehicle when you install a trailer hitch? If you do, then be sure to seal the holes later when you remove the hitch. If you don't seal them, deadly carbon monoxide (CO) from your exhaust can get into your vehicle (see "Carbon Monoxide" in the Index). Dirt and water can, too.

Safety Chains

You should always attach chains between your vehicle and your trailer. Cross the safety chains under the tongue of the trailer so that the tongue will not drop to the road if it becomes separated from the hitch. Instructions about safety chains may be provided by the hitch manufacturer or by the trailer manufacturer. Follow the manufacturer's recommendation for attaching safety chains and do not attach them to the bumper. Always leave just enough slack so you can turn with your rig. And, never allow safety chains to drag on the ground.

Trailer Brakes

Because you have anti-lock brakes, don't try to tap into your vehicle's hydraulic brake system. If you do, both brake systems won't work well, or at all.

Be sure to read and follow the instructions for the trailer brakes so you'll be able to install, adjust and maintain them properly.

Driving with a Trailer

Towing a trailer requires a certain amount of experience. Before setting out for the open road, you'll want to get to know your rig. Acquaint yourself with the feel of handling and braking with the added weight of the trailer. And always keep in mind that the vehicle you are

driving is now a good deal longer and not nearly as responsive as your vehicle is by itself.

Before you start, check the trailer hitch and platform (and attachments), safety chains, electrical connector, lamps, tires and mirror adjustment. If the trailer has electric brakes, start your vehicle and trailer moving and then apply the trailer brake controller by hand to be sure the brakes are working. This lets you check your electrical connection at the same time.

During your trip, check occasionally to be sure that the load is secure, and that the lamps and any trailer brakes are still working.

Following Distance

Stay at least twice as far behind the vehicle ahead as you would when driving your vehicle without a trailer. This can help you avoid situations that require heavy braking and sudden turns.

Passing

You'll need more passing distance up ahead when you're towing a trailer. And, because you're a good deal longer, you'll need to go much farther beyond the passed vehicle before you can return to your lane.

Backing Up

Hold the bottom of the steering wheel with one hand. Then, to move the trailer to the left, just move that hand to the left. To move the trailer to the right, move your hand to the right. Always back up slowly and, if possible, have someone guide you.

Making Turns

NOTICE:

Making very sharp turns while trailering could cause the trailer to come in contact with the vehicle. Your vehicle could be damaged. Avoid making very sharp turns while trailering.

When you're turning with a trailer, make wider turns than normal. Do this so your trailer won't strike soft shoulders, curbs, road signs, trees or other objects. Avoid jerky or sudden maneuvers. Signal well in advance.

Turn Signals When Towing a Trailer

When you tow a trailer, your vehicle may need a different turn signal flasher and/or extra wiring. Check with your Cadillac dealer. The green arrows on your instrument panel will flash whenever you signal a turn or lane change. Properly hooked up, the trailer lamps will also flash, telling other drivers you're about to turn, change lanes or stop.

When towing a trailer, the green arrows on your instrument panel will flash for turns even if the bulbs on the trailer are burned out. Thus, you may think drivers behind you are seeing your signal when they are not. It's important to check occasionally to be sure the trailer bulbs are still working.

Driving On Grades

Reduce speed and shift to a lower gear *before* you start down a long or steep downgrade. If you don't shift down, you might have to use your brakes so much that they would get hot and no longer work well.

On a long uphill grade, shift down and reduce your speed to around 45 mph (70 km/h) or less to reduce the possibility of engine and transaxle overheating.

Parking on Hills

You really should not park your vehicle, with a trailer attached, on a hill. If something goes wrong, your rig could start to move. People can be injured, and both your vehicle and the trailer can be damaged.

But if you ever have to park your rig on a hill, here's how to do it:

1. Apply your regular brakes, but do not shift into PARK (P).
2. Have someone place chocks under the trailer wheels.
3. When the wheel chocks are in place, release the regular brakes until the chocks absorb the load.
4. Reapply the regular brakes. Then shift into PARK (P) firmly and apply your parking brake.
5. Release the regular brakes.

When You Are Ready to Leave After Parking on a Hill

1. Apply your regular brakes and hold the pedal down while you:
 - Start your engine;
 - Shift into a gear; and
 - Be sure the parking brake has released.
2. Let up on the brake pedal.
3. Drive slowly until the trailer is clear of the chocks.
4. Stop and have someone pick up and store the chocks.

Maintenance When Trailer Towing

Your vehicle will need service more often when you're pulling a trailer. See the Maintenance Schedule for more on this. Things that are especially important in trailer operation are automatic transaxle fluid (don't overfill), engine oil, belt, cooling system and brake adjustment. Each of these is covered in this manual, and the Index will help you find them quickly. If you're trailering, it's a good idea to review these sections before you start your trip.

Check periodically to see that all hitch nuts and bolts are tight.



Section 5 Problems on the Road

Here you'll find what to do about some problems that can occur on the road.

5-2 Hazard Warning Flashers
5-4 Other Warning Devices
5-4 Jump Starting
5-9 Towing Your Vehicle
5-16 Engine Overheating

5-26 If a Tire Goes Flat
5-26 Changing a Flat Tire
5-36 Compact Spare Tire
5-37 If You're Stuck: In Sand, Mud,
Ice or Snow

Hazard Warning Flashers

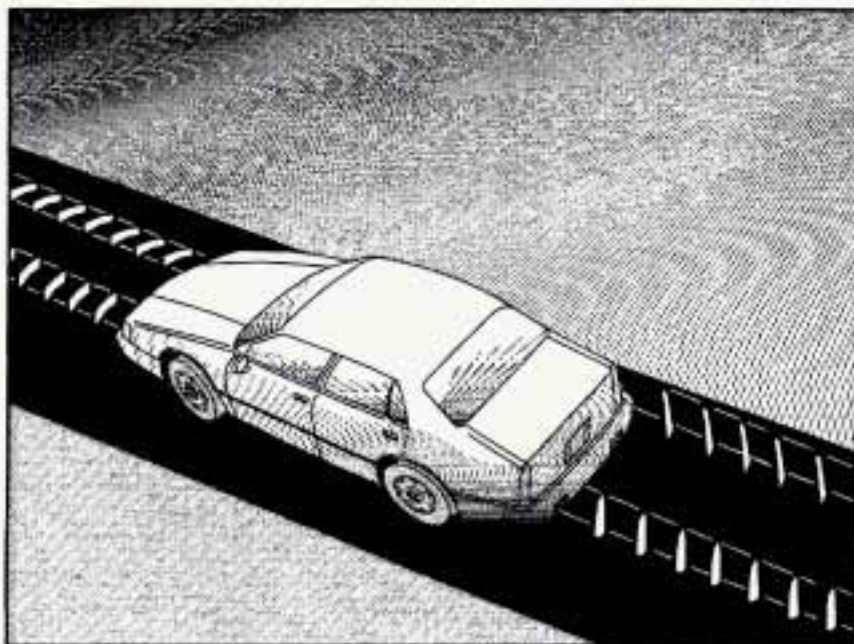

Your hazard warning flashers let you warn others. They also let police know you have a problem. Your front and rear turn signal lamps will flash on and off.



Press the button in to make the front and rear turn signal lamps flash on and off.

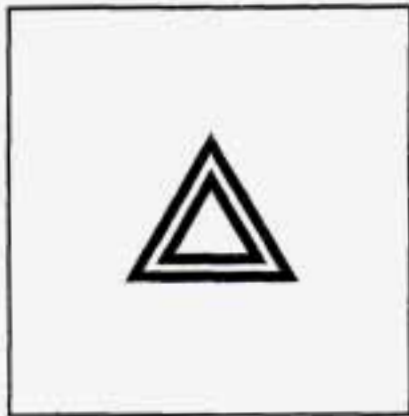

This light on the instrument panel will flash, indicating that the hazard warning flashers are on.

The hazard warning flashers will work once the button is pressed in regardless of the key position.



Pull out on the collar to turn the flashers off. When the hazard warning flashers are on, the turn signals won't work since they are already flashing.

Other Warning Devices

If you carry reflective triangles, you can set one up at the side of the road about 300 feet (100 m) behind your vehicle.

Jump Starting

If your battery has run down, you may want to use another vehicle and some jumper cables to start your Cadillac. Please follow the steps below to do it safely.

NOTICE:

Ignoring these steps could result in costly damage to your vehicle that wouldn't be covered by your warranty.

Trying to start your Cadillac by pushing or pulling it won't work and it could damage your vehicle.



CAUTION:

Batteries can hurt you. They can be dangerous because:

- They contain acid that can burn you.
- They contain gas that can explode or ignite.
- They contain enough electricity to burn you.

If you don't follow these steps exactly, some or all of these things can hurt you.

1. Check the other vehicle. It must have a 12-volt battery with a negative ground system.

NOTICE:

If the other system isn't a 12-volt system with a negative ground, both vehicles can be damaged.

2. Get the vehicles close enough so the jumper cables can reach, but be sure the vehicles aren't touching each other. If they are, it could cause a ground connection you don't want. You wouldn't be able to start your Cadillac and the bad grounding could damage the electrical systems.
3. Turn off the ignition on both vehicles. Unplug unnecessary accessories plugged into the cigarette lighter. Turn off all lamps that aren't needed as well as radios. This will avoid sparks and help save both batteries. In addition, it could save your radio!
4. Open the hoods and locate the batteries. Find the positive (+) and negative (-) terminals on each battery.

 **CAUTION:**

An electric fan can start up even when the engine is not running and can injure you. Keep hands, clothing and tools away from any underhood electric fan.



5. Start by removing the red positive (+) terminal cover.



CAUTION:

Using a match near a battery can cause battery gas to explode. People have been hurt doing this, and some have been blinded. Use a flashlight if you need more light.

Be sure the battery has enough water. You don't need to add water to the Delco Freedom[®] battery installed in every new GM vehicle. But if a battery has filler caps, be sure the right amount of fluid is there. If it is low, add water to take care of that first. If you don't, explosive gas could be present.

Battery fluid contains acid that can burn you. Don't get it on you. If you accidentally get it in your eyes or on your skin, flush the place with water and get medical help immediately.

6. Check that the jumper cables don't have loose or missing insulation. If they do, you could get a shock. The vehicles could also be damaged.

Before you connect the cables, here are some basic things you should know. Positive (+) will go to positive (+) and negative (-) will go to an unpainted metal engine part or a body metal surface. Don't connect positive (+) to negative (-) or you will get a short that would damage the battery and maybe other parts, too. Also don't connect negative (-) to negative (-).



CAUTION:

Fans or other moving engine parts can injure you badly. Keep your hands away from moving parts once the engines are running.

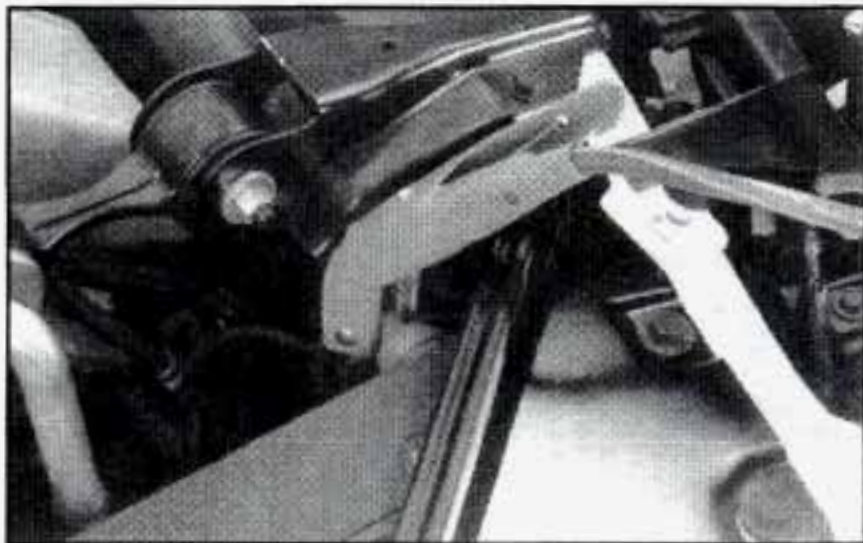

7. Connect the red positive (+) cable to the positive (+) terminal of the vehicle with the dead battery.



8. Don't let the other end of the positive cable touch metal. Connect it to the positive (+) terminal of the good battery.



9. Now connect the black negative (-) cable to the good battery's negative (-) terminal.

Don't let the other end of the negative (-) cable touch anything until the next step. The other end of the negative (-) cable *doesn't* go to the dead battery. It goes to a heavy unpainted metal part on the engine of the vehicle with the dead battery.



10. Attach the cable at least 18 inches (46 cm) away from the dead battery, but not near engine parts that move. The electrical connection is just as good there, but the chance of sparks getting back to the battery is much less.

11. Now start the vehicle with the good battery and run the engine for awhile.
12. Try to start the vehicle with the dead battery. If it won't start after a few tries, it probably needs service.

13. Remove the cables in reverse order to prevent electrical shorting. Take care that they don't touch each other or any other metal.

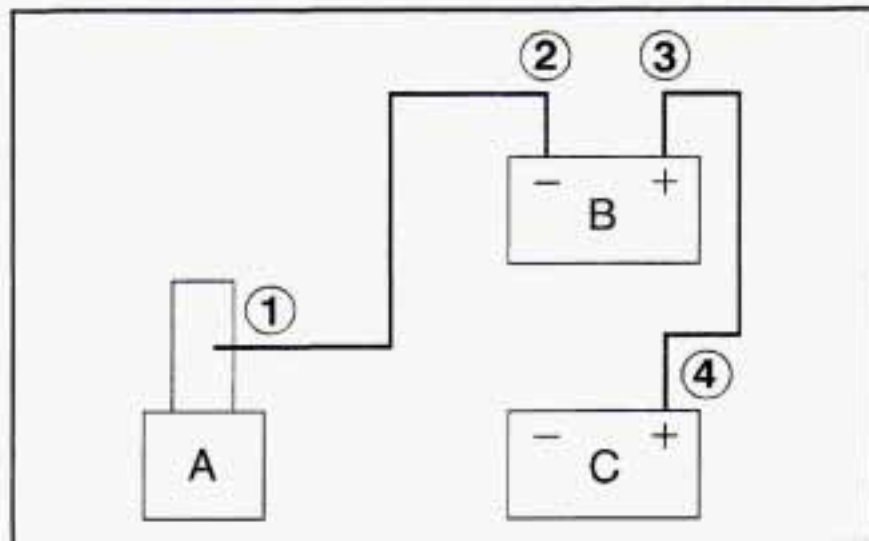

- A. Heavy Metal Engine Part
B. Good Battery
C. Dead Battery

Towing Your Vehicle

Try to have a Cadillac dealer or a professional towing service tow your Seville. See "Roadside Service" in the Index.

If your vehicle has been changed or modified since it was factory-new by adding aftermarket items like fog lamps, aero skirting or special tires and wheels, these instructions may not be correct.

Before you do anything, turn on the hazard warning flashers.

When you call, tell the towing service:

- That your vehicle has front-wheel drive.
- The make, model and year of your vehicle.
- Whether you can still move the shift lever.
- If there was an accident, what was damaged.

When the towing service arrives, let the tow operator know that this manual contains towing instructions and illustrations. The operator may want to see them.

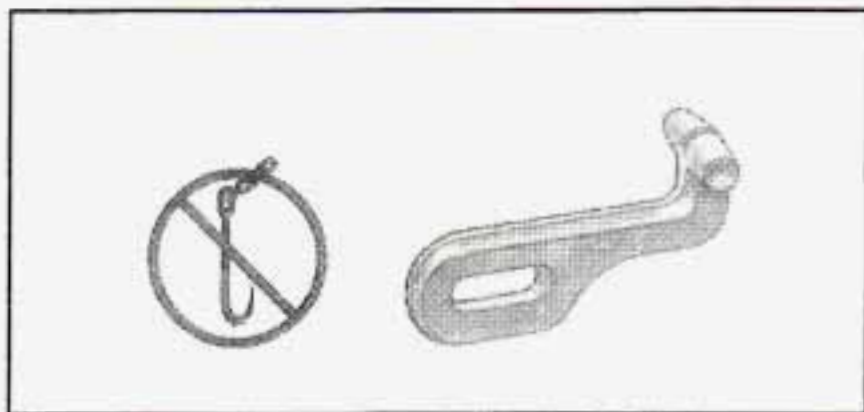

Front Towing



Rear Towing

⚠ CAUTION:

To help avoid injury to you or others:

- Never let passengers ride in a vehicle that is being towed.
- Never tow faster than safe or posted speeds.
- Never tow with damaged parts not fully secured.
- Never get under your vehicle after it has been lifted by the tow truck.
- Always secure the vehicle on each side with separate safety chains when towing it.
- Never use J-hooks. Use only T-hooks in the front T-hook slots and only R-hooks in the rear R-hook slots.



CAUTION:

A vehicle can fall from a car-carrier if it isn't adequately secured. This can cause a collision, serious personal injury and vehicle damage. The vehicle should be tightly secured with chains or steel cables before it is transported.

Don't use substitutes (ropes, leather straps, canvas webbing, etc.) that can be cut by sharp edges underneath the towed vehicle. Always use T-hooks inserted in the front T-hook slots or R-hooks inserted in the rear R-hook slots. Never use J-hooks. They will damage drivetrain and suspension components.

When your vehicle is being towed, have the ignition key turned to the OFF position. The steering wheel should be clamped in a straight-ahead position, with a clamping device designed for towing service. Do not use the vehicle's steering column lock for this. The transaxle should be in NEUTRAL (N) and the parking brake released.

Don't have your vehicle towed on the drive wheels unless you must. If the vehicle must be towed on the drive wheels, be sure to follow the speed and distance restrictions later in this section or your transaxle will be damaged. If these limitations must be exceeded, then the drive wheels have to be supported on a dolly.

Front Towing

Tow Limits -- 35 mph (56 kph), 25 miles (40 km)

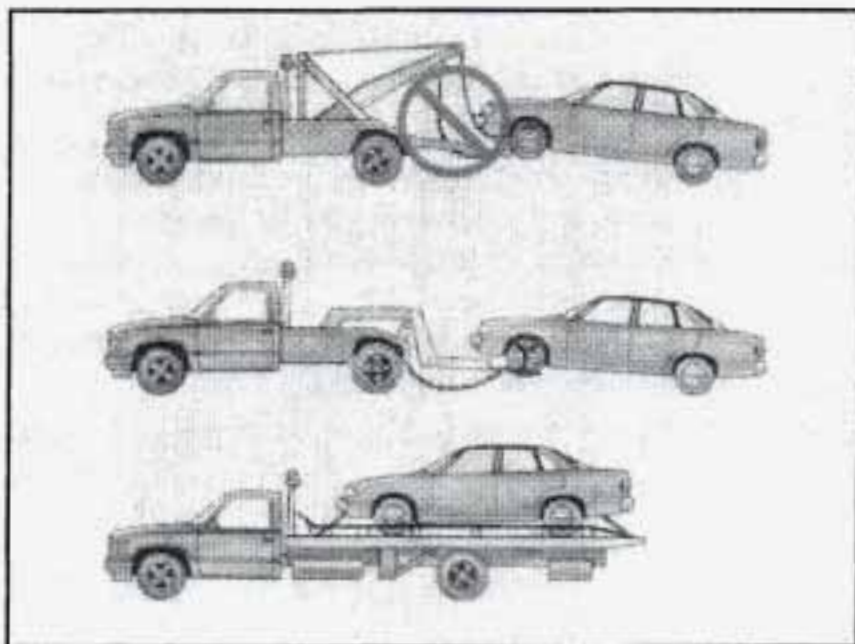

NOTICE:

Do not tow with sling type equipment or fascia/fog lamp damage will occur. Use wheel-lift or car-carrier equipment. Additional ramping may be required for car-carrier equipment. Use safety chains and wheel straps.

Towing a vehicle over rough surfaces could damage a vehicle. Damage can occur from vehicle to ground or vehicle to wheel-lift equipment. To help avoid damage, install a towing dolly and raise the vehicle until adequate clearance is obtained between the ground and/or wheel-lift equipment.

Do not attach winch cables or J-hooks to suspension components when using car-carrier equipment. Always use T-hooks inserted in the T-hook slots.

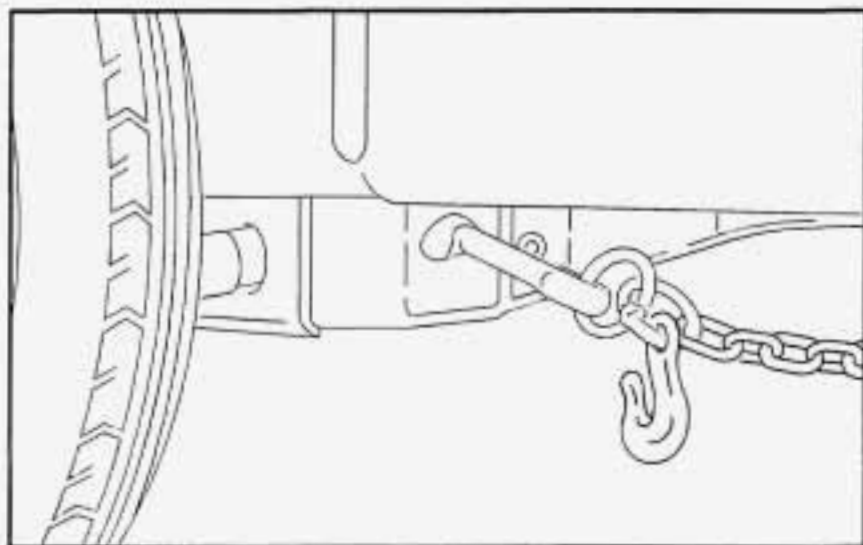

Attach T-hook chains on both sides, in the slotted holes in the bottom of the frame rails, behind the front wheels. These slots are to be used when loading and securing to car-carrier equipment.

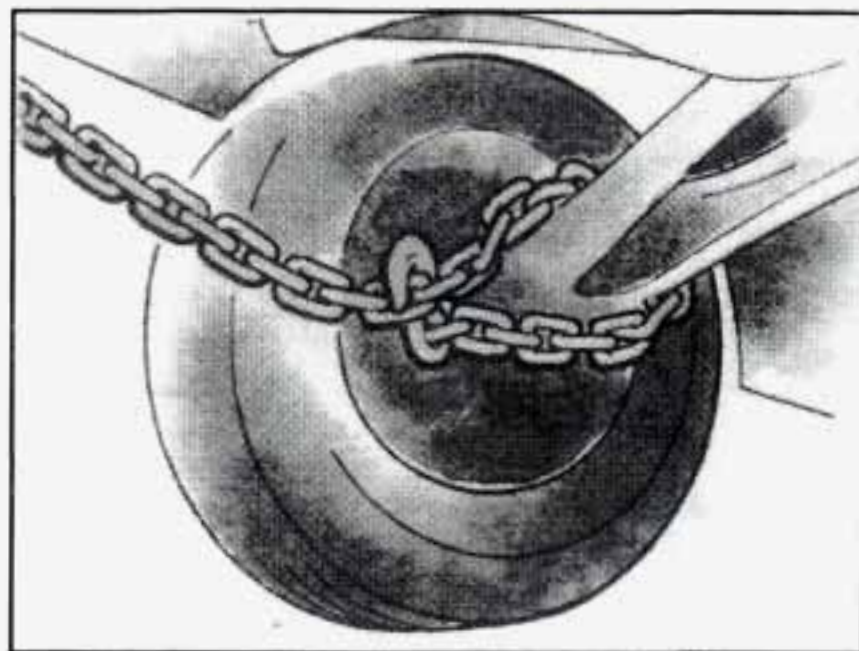

Attach a separate safety chain around the outboard end of each lower control arm.

Rear Towing

Tow Limits -- 35 mph (56 kph), 25 miles (40 km)

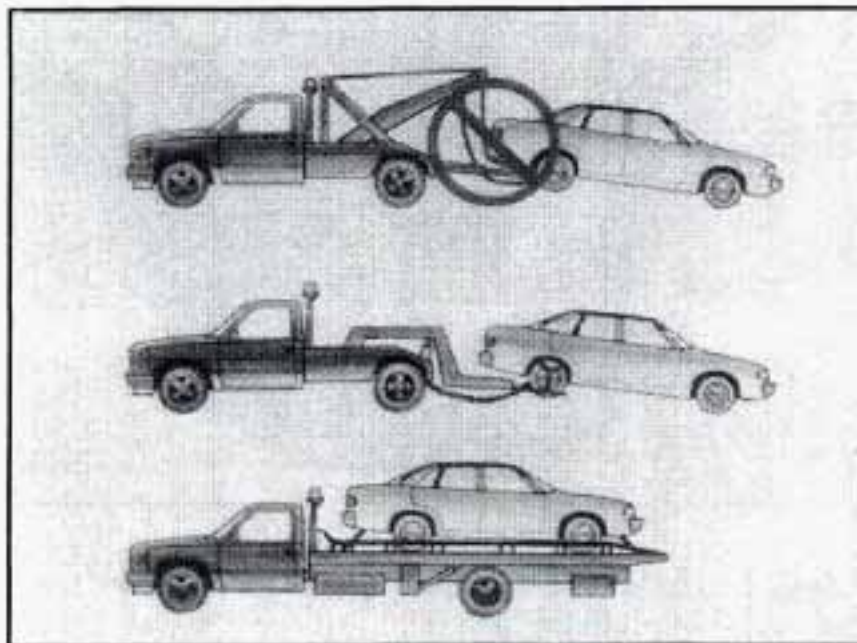

NOTICE:

Do not tow with sling type equipment or rear bumper valance damage will occur. Use wheel-lift or car-carrier equipment. Additional ramping may be required for car-carrier equipment. Use safety chains and wheel straps.

Towing a vehicle over rough surfaces could damage a vehicle. Damage can occur from vehicle to ground or vehicle to wheel-lift equipment. To help avoid damage, install a towing dolly and raise the vehicle until adequate clearance is obtained between the ground and/or wheel-lift equipment.

Do not attach winch cables or J-hooks to suspension components when using car-carrier equipment. Always use R-hooks inserted in the R-hook slots.

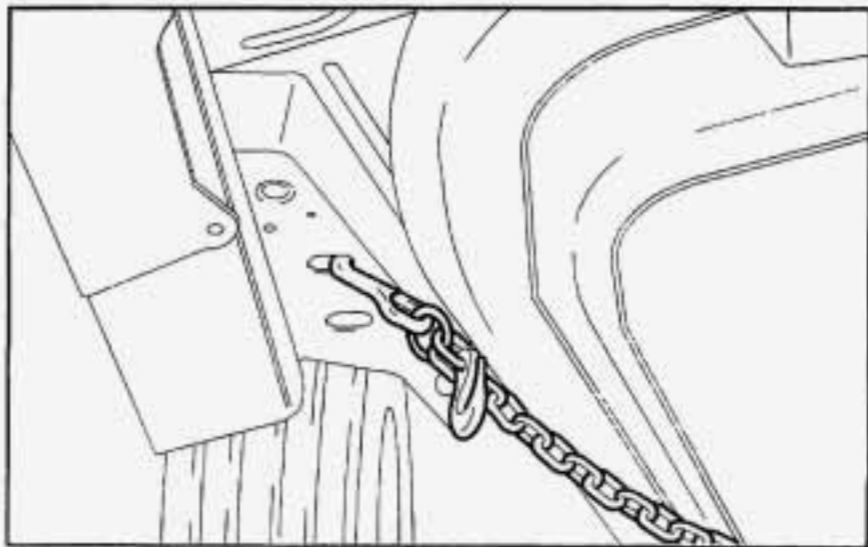

Attach R-hook chains to the R-hook slots in the frame rails just ahead of the rear wheels on both sides. These slots are to be used when loading and securing to car-carrier equipment.

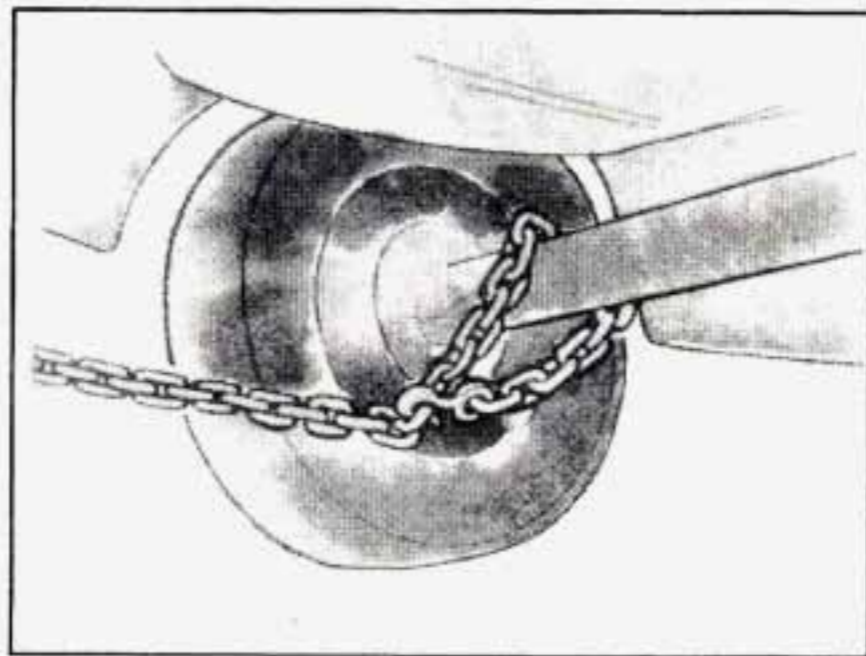

Attach a separate safety chain around the end of each axle inboard of the spring.

Engine Overheating

You will find an ENGINE COOLANT HOT-IDLE ENGINE message or a STOP ENGINE ENGINE OVERHEATED message on the Driver Information Center (DIC). There is also an engine temperature warning light and/or gage on the instrument panel. See “Engine Coolant Temperature Warning Light” or “Engine Coolant Temperature Gage” in the Index.

Overheated Engine Protection Operating Mode

Should a low coolant condition exist and the message STOP ENGINE ENGINE OVERHEATED is displayed, an overheat protection mode which alternates firing groups of four cylinders helps prevent engine damage. In this mode, you will notice a loss in power and engine performance. This operating mode allows your vehicle to be driven to a safe place in an emergency; you may drive up to 50 miles (80 km). Towing a trailer in the overheat protection mode should be avoided.

NOTICE:

After driving in the overheated engine protection operating mode, to avoid engine damage, allow the engine to cool before attempting any repair. The engine oil will be severely degraded. Repair the cause of coolant loss, change the oil and reset the oil life indicator. See “Engine Oil, When to Change” in the Index.

If Steam Is Coming From Your Engine



CAUTION:

Steam from an overheated engine can burn you badly, even if you just open the hood. Stay away from the engine if you see or hear steam coming from it. Just turn it off and get everyone away from the vehicle until it cools down. Wait until there is no sign of steam or coolant before you open the hood.

If you keep driving when your engine is overheated, the liquids in it can catch fire. You or others could be badly burned. Stop your engine if it overheats, and get out of the vehicle until the engine is cool.

NOTICE:

If your engine catches fire because you keep driving with no coolant, your vehicle can be badly damaged. The costly repairs would not be covered by your warranty. See “Overheated Engine Protection Operating Mode” in the Index.

If No Steam Is Coming From Your Engine

If you get the overheat warning but see or hear no steam, the problem may not be too serious. Sometimes the engine can get a little too hot when you:

- Climb a long hill on a hot day.
- Stop after high-speed driving.
- Idle for long periods in traffic.
- Tow a trailer.

If you get the overheat warning with no sign of steam, try this for a minute or so:

1. Turn off your air conditioner.
2. Dial temperature control to the highest heat setting and open the window, as necessary.
3. If you're in a traffic jam, shift to NEUTRAL (N); otherwise, shift to the highest gear while driving -- OVERDRIVE (Ⓢ) or THIRD (3).

If you no longer have the overheat warning, you can drive. Just to be safe, drive slower for about 10 minutes. If the warning doesn't come back on, you can drive normally.

If the warning continues, pull over, stop and park your vehicle right away.

If there's still no sign of steam, you can idle the engine for two or three minutes while you're parked, to see if the warning stops. But then, if you still have the warning, *turn off the engine and get everyone out of the vehicle* until it cools down. Also, see "Overheated Engine Protection Operating Mode" listed previously in this section.

You may decide not to lift the hood but to get service help right away.

When you decide it's safe to lift the hood, here's what you'll see:

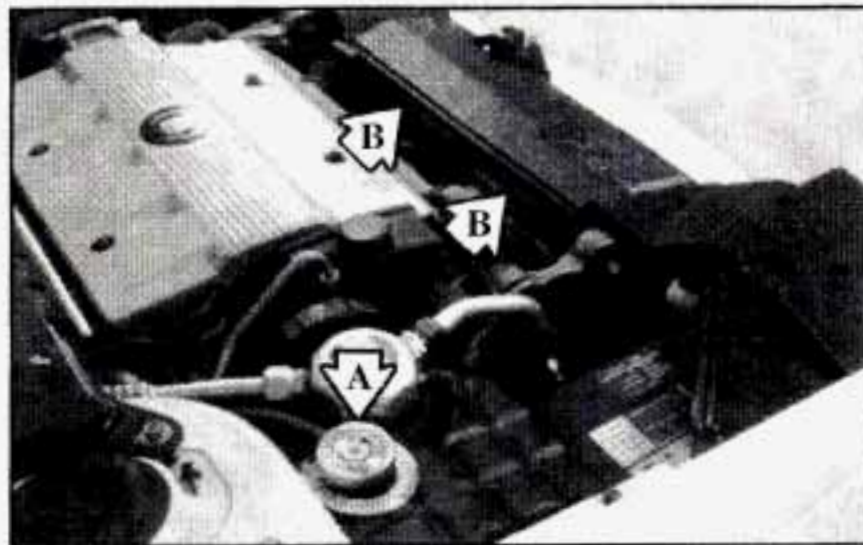

- A. Coolant Surge Tank with Pressure Cap
- B. Electric Engine Fans

⚠ CAUTION:

An electric fan under the hood can start up even when the engine is not running and can injure you. Keep hands, clothing and tools away from any underhood electric fan.

If the coolant inside the coolant surge tank is boiling, don't do anything else until it cools down.



If it isn't, the coolant level should be indicated by a **CHECK COOLANT LEVEL** message on the Driver Information Center. If it is, you may have a leak in the radiator hoses, heater hoses, radiator, water pump or somewhere else in the cooling system.

CAUTION:

Heater and radiator hoses, and other engine parts, can be very hot. Don't touch them. If you do, you can be burned.

Don't run the engine if there is a leak. If you run the engine, it could lose all coolant. That could cause an engine fire, and you could be burned. Get any leak fixed before you drive the vehicle.

NOTICE:

Engine damage if you keep running your engine without coolant isn't covered by your warranty. See "Overheated Engine Protection Operating Mode" in the Index.

If there seems to be no leak, with the engine on, check to see if the electric engine fans are running. If the engine is overheating, both fans should be running. If they aren't, your vehicle needs service.

How to Add Coolant to the Coolant Surge Tank

If you haven't found a problem yet, but the coolant level isn't at the proper level (2.5 inches (6.4 cm) below the base of the fill neck), add a 50/50 mixture of *clean water* (preferably distilled) and DEX-COOL[®] coolant at the coolant surge tank, but be sure the cooling system, including the coolant surge tank pressure cap, is cool before you do it. (See "Engine Coolant" in the Index for more information.)



CAUTION:

Steam and scalding liquids from a hot cooling system can blow out and burn you badly. They are under pressure, and if you turn the coolant surge tank pressure cap -- even a little -- they can come out at high speed. Never turn the cap when the cooling system, including the coolant surge tank pressure cap, is hot. Wait for the cooling system and coolant surge tank pressure cap to cool if you ever have to turn the pressure cap.

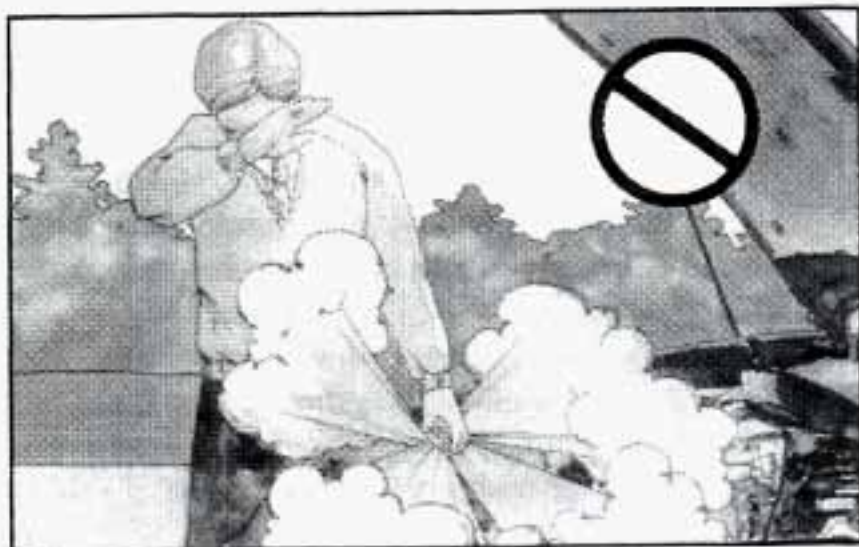

 **CAUTION:**

Adding only plain water to your cooling system can be dangerous. Plain water, or some other liquid like alcohol, can boil before the proper coolant mix will. Your vehicle's coolant warning system is set for the proper coolant mix. With plain water or the wrong mix, your engine could get too hot but you wouldn't get the overheat warning. Your engine could catch fire and you or others could be burned. Use a 50/50 mix of clean water and DEX-COOL[®] coolant.

NOTICE:

In cold weather, water can freeze and crack the engine, radiator, heater core and other parts. So use the recommended coolant.

⚠ CAUTION:

You can be burned if you spill coolant on hot engine parts. Coolant contains ethylene glycol and it will burn if the engine parts are hot enough. Don't spill coolant on a hot engine.



1. You can remove the coolant surge tank pressure cap when the cooling system, including the coolant surge tank pressure cap and upper radiator hose, is no longer hot. Turn the pressure cap slowly counterclockwise until it first stops. (Don't press down while turning the pressure cap.)

If you hear a hiss, wait for that to stop. A hiss means there is still some pressure left.



2. Then keep turning the cap, but now push down as you turn it. Remove the pressure cap.



3. Then fill the coolant surge tank with the proper mix, up to the base of the filler neck.

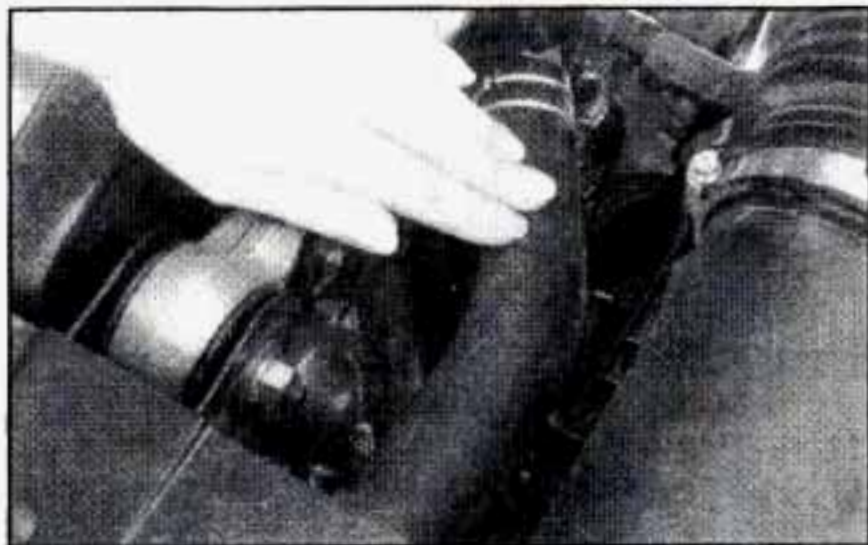

4. With the coolant surge tank pressure cap off, start the engine and let it run until you can feel the upper radiator hose getting hot. Watch out for the engine fans.

By this time, the coolant level inside the coolant surge tank may be lower. If the level is lower, add more of the proper mix to the coolant surge tank until the level reaches about 2.5 inches (6.4 cm) below the base of the filler neck.



5. Then replace the pressure cap. Be sure the arrows on the pressure cap line up like this.

Start the engine and allow it to warm up. If the CHECK COOLANT LEVEL message does not appear on the Driver Information Center, coolant is at the proper fill level. If a CHECK COOLANT LEVEL message does appear, repeat Steps 1 through 3 or see your dealer.

If a Tire Goes Flat

It's unusual for a tire to "blow out" while you're driving, especially if you maintain your tires properly. If air goes out of a tire, it's much more likely to leak out slowly. But if you should ever have a "blowout," here are a few tips about what to expect and what to do:

If a front tire fails, the flat tire will create a drag that pulls the vehicle toward that side. Take your foot off the accelerator pedal and grip the steering wheel firmly. Steer to maintain lane position, and then gently brake to a stop well out of the traffic lane.

A rear blowout, particularly on a curve, acts much like a skid and may require the same correction you'd use in a skid. In any rear blowout, remove your foot from the accelerator pedal. Get the vehicle under control by steering the way you want the vehicle to go. It may be very bumpy and noisy, but you can still steer. Gently brake to a stop -- well off the road if possible.

If a tire goes flat, the next part shows how to use your jacking equipment to change a flat tire safely.

Changing a Flat Tire

If a tire goes flat, avoid further tire and wheel damage by driving slowly to a level place. Turn on your hazard warning flashers.



CAUTION:

Changing a tire can cause an injury. The vehicle can slip off the jack and roll over you or other people. You and they could be badly injured. Find a level place to change your tire. To help prevent the vehicle from moving:

- 1. Put the shift lever in PARK (P).**
- 2. Set the parking brake firmly.**
- 3. Turn off the engine.**

To be even more certain the vehicle won't move, you can put blocks at the front and rear of the tire farthest away from the one being changed. That would be the tire on the other side of the vehicle, at the opposite end.

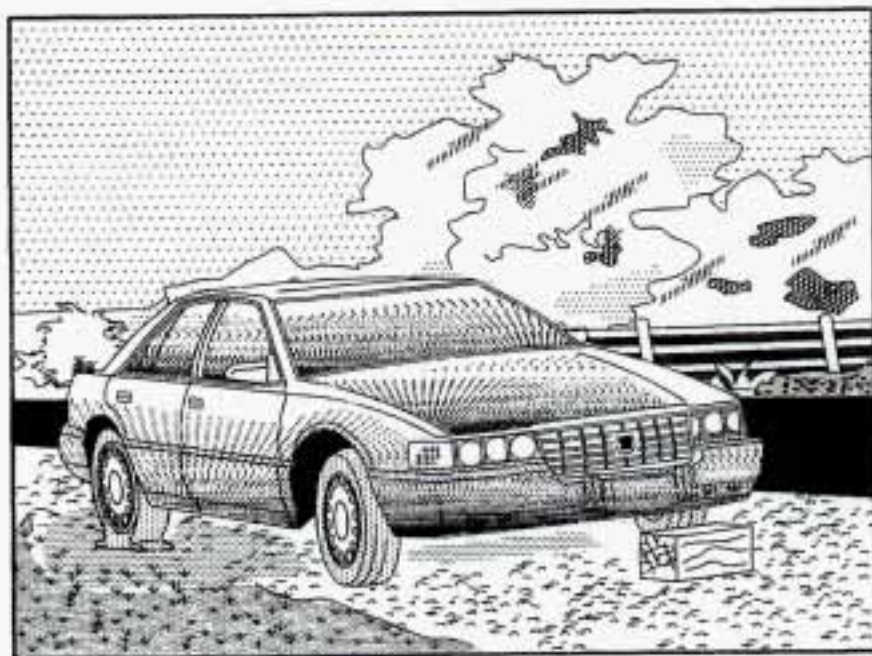

The following steps will tell you how to use the jack and change a tire.

Removing the Spare Tire and Tools



The equipment you'll need is in the trunk. Pull the carpeting from the floor of the trunk. Turn the retainer (center dial) on the compact spare cover counterclockwise to remove it. Lift and remove the cover. (See "Compact Spare Tire" later in this section for more information about the compact spare.)



Lift up the tire to remove it from the trunk.

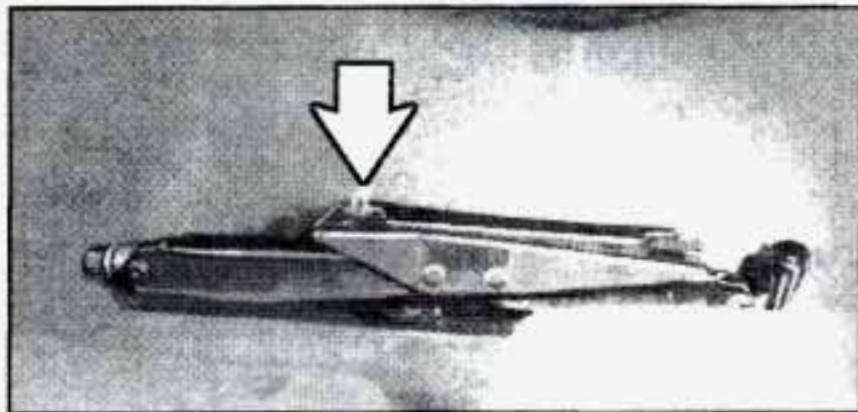

Turn the nut holding the jack and wheel wrench counterclockwise and remove it. Then remove the jack and wrench.

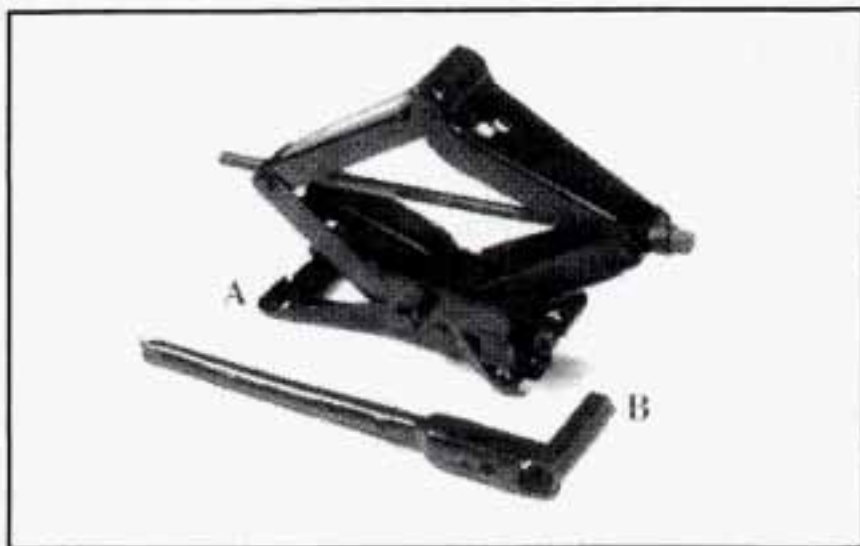

The tools you'll be using include the jack (A) and the wheel wrench (B).

Removing the Wheel Cover

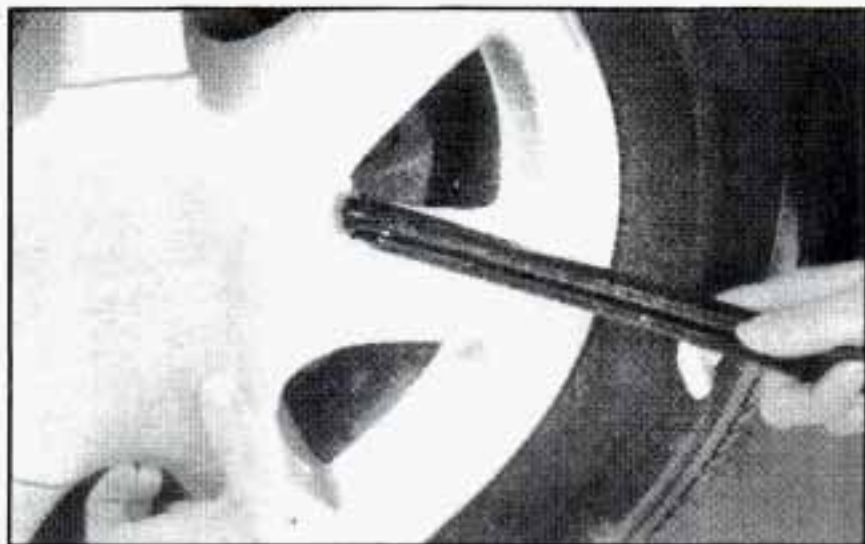

There is a center wheel cover on the aluminum wheel. Using the flat end of the wheel wrench, gently pry the wheel cover off. Be careful not to scratch the aluminum wheel edge and don't try to remove it with your hands.

Removing the Flat Tire and Installing the Spare Tire

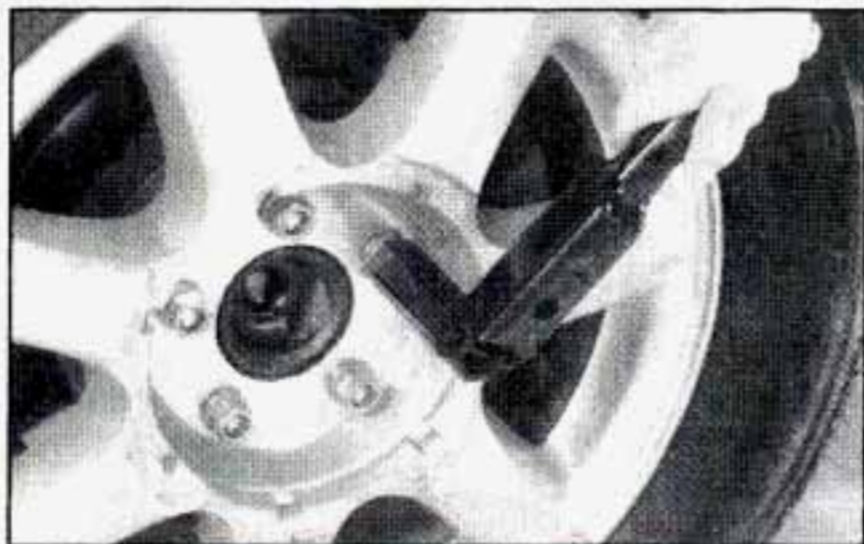

1. Using the wheel wrench, loosen all the wheel nuts. Don't remove them yet.
2. Turn the jack handle clockwise to raise the jack lift head a few inches.

CAUTION:

Getting under a vehicle when it is jacked up is dangerous. If the vehicle slips off the jack, you could be badly injured or killed. Never get under a vehicle when it is supported only by a jack.

NOTICE:

Raising your vehicle with the jack improperly positioned can damage the vehicle and even make the vehicle fall. To help avoid personal injury and vehicle damage, be sure to fit the jack lift head into the proper location before raising your vehicle.

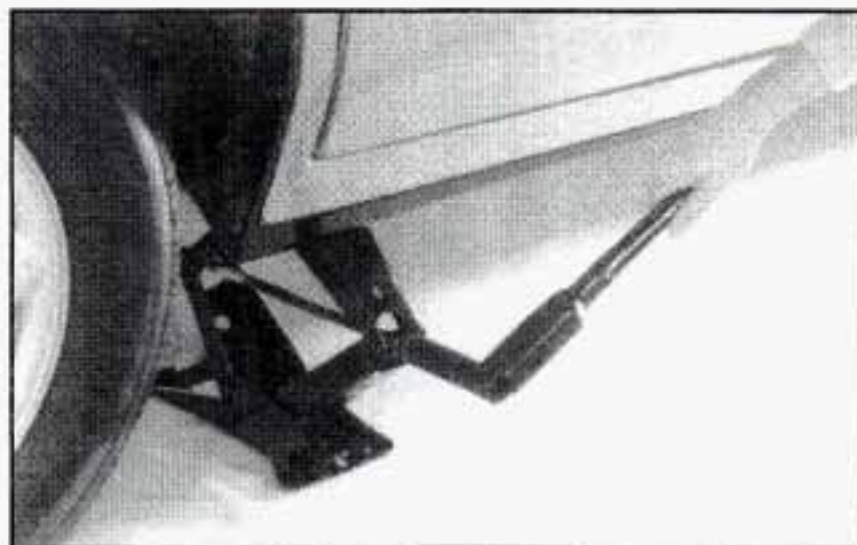
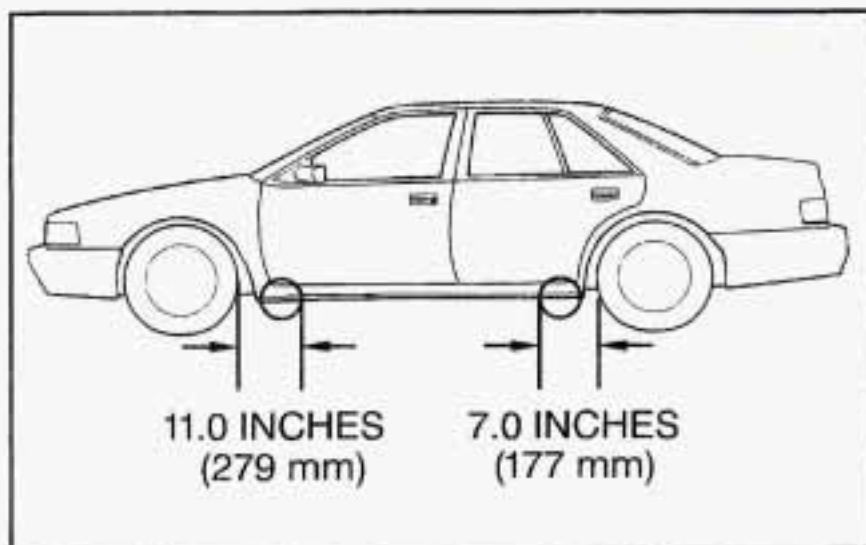

3. Position the jack under the vehicle and raise the jack lift head until it fits firmly into the notch in the vehicle's frame nearest the flat tire.

Put the compact spare tire near you.

4. Raise the vehicle by turning the jack handle clockwise. Raise the vehicle far enough off the ground for the spare tire to fit under the vehicle.
5. Remove all wheel nuts and take off the flat tire.

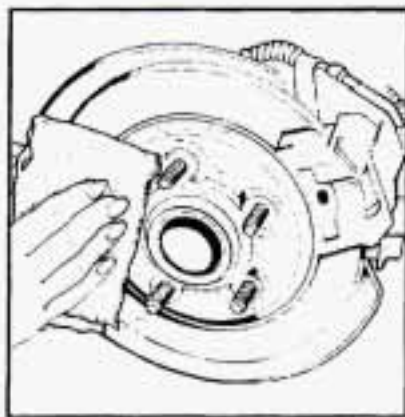

6. Remove any rust or dirt from the wheel bolts, mounting surfaces and spare wheel.

⚠ CAUTION:

Rust or dirt on the wheel, or on the parts to which it is fastened, can make the wheel nuts become loose after a time. The wheel could come off and cause an accident. When you change a wheel, remove any rust or dirt from the places where the wheel attaches to the vehicle. In an emergency, you can use a cloth or a paper towel to do this; but be sure to use a scraper or wire brush later, if you need to, to get all the rust or dirt off.

⚠ CAUTION:

Never use oil or grease on studs or nuts. If you do, the nuts might come loose. Your wheel could fall off, causing a serious accident.



7. Replace the wheel nuts with the rounded end of the nuts toward the wheel. Tighten each nut by hand until the wheel is held against the hub.



8. Lower the vehicle by turning the jack handle counterclockwise. Lower the jack completely.

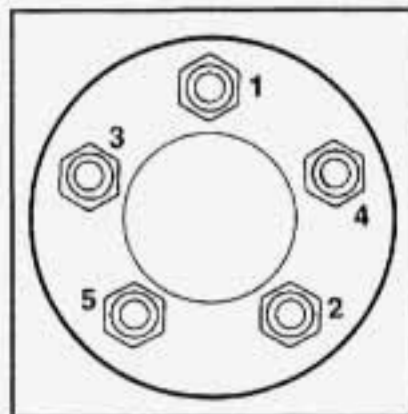

9. Tighten the wheel nuts firmly in a criss-cross sequence as shown.

⚠ CAUTION:

Incorrect wheel nuts or improperly tightened wheel nuts can cause the wheel to become loose and even come off. This could lead to an accident. Be sure to use the correct wheel nuts. If you have to replace them, be sure to get new GM original equipment wheel nuts.

Stop somewhere as soon as you can and have the nuts tightened with a torque wrench to 100 lb-ft (140 N·m).

NOTICE:

Improperly tightened wheel nuts can lead to brake pulsation and rotor damage. To avoid expensive brake repairs, evenly tighten the wheel nuts in the proper sequence and to the proper torque specification.

Don't try to put a wheel cover on your compact spare tire. It won't fit. Store the wheel cover in the trunk until you have the flat tire repaired or replaced.

NOTICE:

Wheel covers won't fit on your compact spare. If you try to put a wheel cover on your compact spare, you could damage the cover or the spare.

Storing the Flat Tire and Tools **CAUTION:**

Storing a jack, a tire or other equipment in the passenger compartment of the vehicle could cause injury. In a sudden stop or collision, loose equipment could strike someone. Store all these in the proper place.

After you've put the compact spare tire on your vehicle, you'll need to store the flat tire in your trunk. Use the following procedure to secure the flat tire in the trunk.

Put the flat tire in the trunk so the side that faces out when it is on the vehicle is facing down. The full-size tire will not fit down into the well. Place it so the front is in the well and the rear is out of the well.

Secure the tire with the retainer that was used to hold the compact spare in place. Store the cover as far forward as possible.

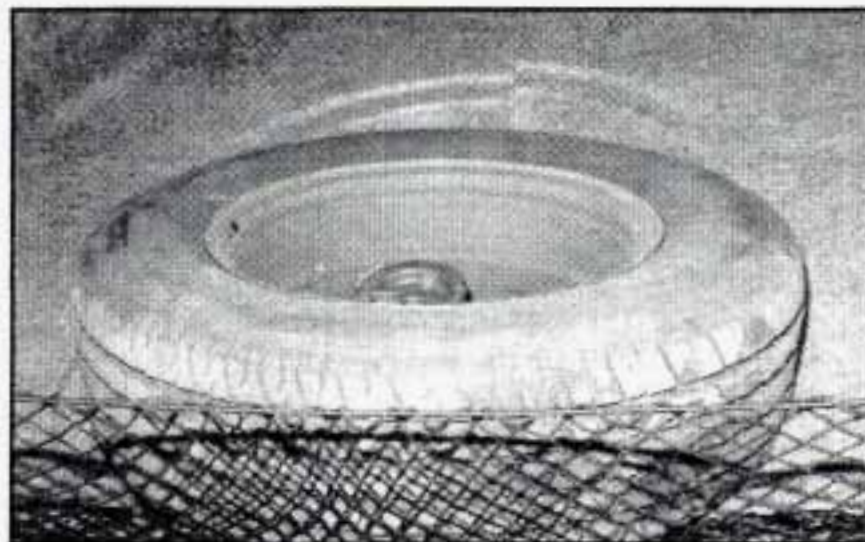

Storing the Spare Tire and Tools

⚠ CAUTION:

Storing a jack, a tire or other equipment in the passenger compartment of the vehicle could cause injury. In a sudden stop or collision, loose equipment could strike someone. Store all these in the proper place.

The compact spare is for temporary use only. Replace the compact spare tire with a full-size tire as soon as you can. See the storage instructions label to replace your compact spare into your trunk properly.

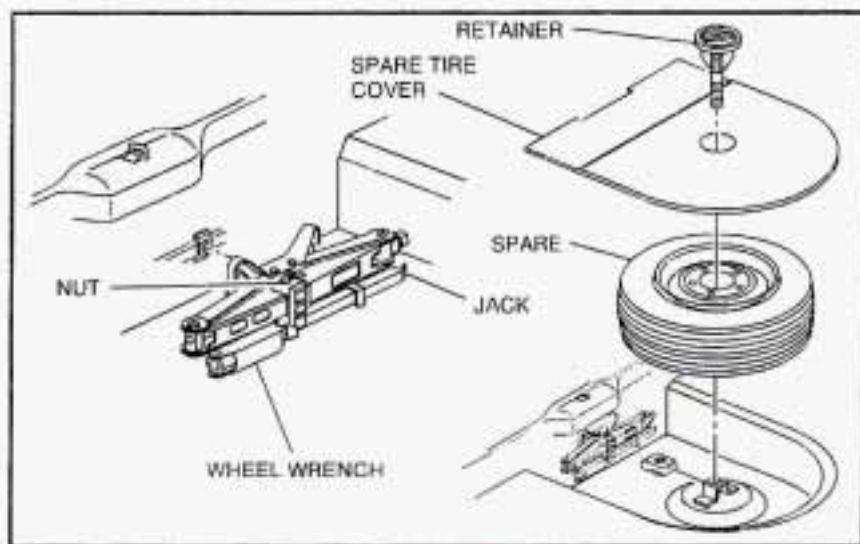

Compact Spare Tire

Although the compact spare tire was fully inflated when your vehicle was new, it can lose air after a time. Check the inflation pressure regularly. It should be 60 psi (420 kPa).

After installing the compact spare on your vehicle, you should stop as soon as possible and make sure your spare tire is correctly inflated. The compact spare is made to perform well at speeds up to 65 mph (105 km/h) for distances up to 3,000 miles (5 000 km), so you can finish your trip and have your full-size tire repaired or replaced where you want. Of course, it's best to replace your spare with a full-size tire as soon as you can. Your spare will last longer and be in good shape in case you need it again.

NOTICE:

When the compact spare is installed, don't take your vehicle through an automatic car wash with guide rails. The compact spare can get caught on the rails. That can damage the tire and wheel, and maybe other parts of your vehicle.

Don't use your compact spare on other vehicles.

And don't mix your compact spare tire or wheel with other wheels or tires. They won't fit. Keep your spare tire and its wheel together.

NOTICE:

Tire chains won't fit your compact spare. Using them can damage your vehicle and can damage the chains too. Don't use tire chains on your compact spare.

If You're Stuck: In Sand, Mud, Ice or Snow

What you don't want to do when your vehicle is stuck is to spin your wheels too fast. The method known as "rocking" can help you get out when you're stuck, but you must use caution.



CAUTION:

If you let your tires spin at high speed, they can explode, and you or others could be injured. And, the transaxle or other parts of the vehicle can overheat. That could cause an engine compartment fire or other damage. When you're stuck, spin the wheels as little as possible. Don't spin the wheels above 35 mph (55 km/h) as shown on the speedometer.

NOTICE:

Spinning your wheels can destroy parts of your vehicle as well as the tires. If you spin the wheels too fast while shifting your transaxle back and forth, you can destroy your transaxle.

For information about using tire chains on your vehicle, see "Tire Chains" in the Index.

Rocking Your Vehicle To Get It Out

First, turn your steering wheel left and right. That will clear the area around your front wheels. You should turn your traction control system off. (See "Traction Control System" in the Index.) Then shift back and forth between REVERSE (R) and a forward gear, spinning the wheels as little as possible. Release the accelerator pedal while you shift, and press lightly on the accelerator pedal when the transaxle is in gear. If that doesn't get you out after a few tries, you may need to be towed out. If you do need to be towed out, see "Towing Your Vehicle" in the Index.

 NOTES



Section 6 Service and Appearance Care

Here you will find information about the care of your Cadillac. This section begins with service and fuel information, and then it shows how to check important fluid and lubricant levels. There is also technical information about your vehicle, and a part devoted to its appearance care.

6-2	Service	6-50	Cleaning the Outside of the Windshield and Wiper Blades
6-3	Fuel	6-50	Weatherstrips
6-4	Fuels in Foreign Countries	6-50	Cleaning the Outside of Your Cadillac
6-5	Filling Your Tank	6-51	Cleaning Aluminum or Chrome Wheels (If Equipped)
6-7	Checking Things Under the Hood	6-52	Cleaning Tires
6-10	Engine Oil	6-52	Sheet Metal Damage
6-14	Air Cleaner	6-52	Underbody Maintenance
6-17	Automatic Transaxle Fluid	6-52	Chemical Paint Spotting
6-21	Engine Coolant	6-53	Appearance Care Materials Chart
6-26	Windshield Washer Fluid	6-54	Vehicle Identification Number (VIN)
6-27	Brakes	6-54	Service Parts Identification Label
6-30	Battery	6-55	Electrical System
6-31	Bulb Replacement	6-64	Replacement Bulbs
6-36	Windshield Wiper Blade Replacement	6-64	Capacities and Specifications
6-37	Tires	6-65	Air Conditioning Refrigerants
6-45	Appearance Care	6-65	Normal Maintenance Replacement Parts
6-46	Cleaning the Inside of Your Cadillac		
6-49	Care of Safety Belts		
6-49	Cleaning Glass Surfaces		

Service

Your Cadillac dealer knows your vehicle best and wants you to be happy with it. We hope you'll go to your dealer for all your service needs. You'll get genuine GM parts and GM-trained and supported service people.

We hope you'll want to keep your GM vehicle all GM. Genuine GM parts have one of these marks:



Doing Your Own Service Work

If you want to do some of your own service work, you'll want to get the proper Cadillac Service Manual. It tells you much more about how to service your Cadillac than this manual can. To order the proper service manual, see "Service and Owner Publications" in the Index.

Your vehicle has an air bag system. Before attempting to do your own service work, see "Servicing Your Air Bag-Equipped Cadillac" in the Index.

You should keep a record with all parts receipts and list the mileage and the date of any service work you perform. See "Maintenance Record" in the Maintenance Schedule booklet.

CAUTION:

You can be injured and your vehicle could be damaged if you try to do service work on a vehicle without knowing enough about it.

- **Be sure you have sufficient knowledge, experience, the proper replacement parts and tools before you attempt any vehicle maintenance task.**
- **Be sure to use the proper nuts, bolts and other fasteners. "English" and "metric" fasteners can be easily confused. If you use the wrong fasteners, parts can later break or fall off. You could be hurt.**

Adding Equipment to the Outside of Your Vehicle

Things you might add to the outside of your vehicle can affect the airflow around it. This may cause wind noise and affect windshield washer performance. Check with your Cadillac dealer before adding equipment to the outside of your vehicle.

Fuel

Use premium unleaded gasoline rated at 91 octane or higher. At a minimum, it should meet specifications ASTM D4814 in the United States and CGSB 3.5-M93 in Canada. Improved gasoline specifications have been developed by the American Automobile Manufacturers Association (AAMA) for better vehicle performance and engine protection. Gasolines meeting the AAMA specification could provide improved driveability and emission control system protection compared to other gasolines.

Be sure the posted octane for premium is at least 91. If the octane is less than 91, you may get a heavy knocking noise when you drive. (In an emergency, you may be able to use a lower octane -- as low as 87 -- if heavy knocking does not occur.) If you're using 91 or higher octane unleaded gasoline and you hear heavy knocking, your engine needs service.

If your vehicle is certified to meet California Emission Standards (indicated on the underhood tune-up label), it is designed to operate on fuels that meet California specifications. If such fuels are not available in states adopting California emissions standards, your vehicle will operate satisfactorily on fuels meeting federal specifications, but emission control system performance may be affected. The malfunction indicator lamp on your instrument panel may turn on and/or your vehicle may fail a smog-check test. If this occurs, return to your authorized Cadillac dealer for diagnosis to determine the cause of failure. In the event it is determined that the cause of the condition is the type of fuels used, repairs may not be covered by your warranty.

Some gasolines that are not reformulated for low emissions contain an octane-enhancing additive called methylcyclopentadienyl manganese tricarbonyl (MMT); ask your service station operator whether or not this fuel contains MMT. General Motors does not recommend the use of such gasolines. If fuels containing MMT are used, spark plug life may be reduced and your emission control system performance may be affected. The malfunction indicator lamp on your instrument panel may turn on. If this occurs, return to your authorized Cadillac dealer for service.

To provide cleaner air, all gasolines in the United States are now required to contain additives that will help prevent deposits from forming in your engine and fuel system, allowing your emission control system to function properly. Therefore, you should not have to add anything to the fuel. In addition, gasolines containing oxygenates, such as ethers and ethanol, and reformulated gasolines may be available in your area to help clean the air. General Motors recommends that you use these gasolines if they comply with the specifications described earlier.

NOTICE:

Your vehicle was not designed for fuel that contains methanol. Don't use it. It can corrode metal parts in your fuel system and also damage plastic and rubber parts. That damage wouldn't be covered under your warranty.

Fuels in Foreign Countries

If you plan on driving in another country outside the United States or Canada, the proper fuel may be hard to find. Never use leaded gasoline or any other fuel not recommended in the previous text on fuel. Costly repairs caused by use of improper fuel wouldn't be covered by your warranty.

To check on fuel availability, ask an auto club, or contact a major oil company that does business in the country where you'll be driving.

You can also write us at the following address for advice. Just tell us where you're going and give your Vehicle Identification Number (VIN).

General Motors International Product Center
1908 Colonel Sam Drive
Oshawa, Ontario L1H 8P7

Filling Your Tank

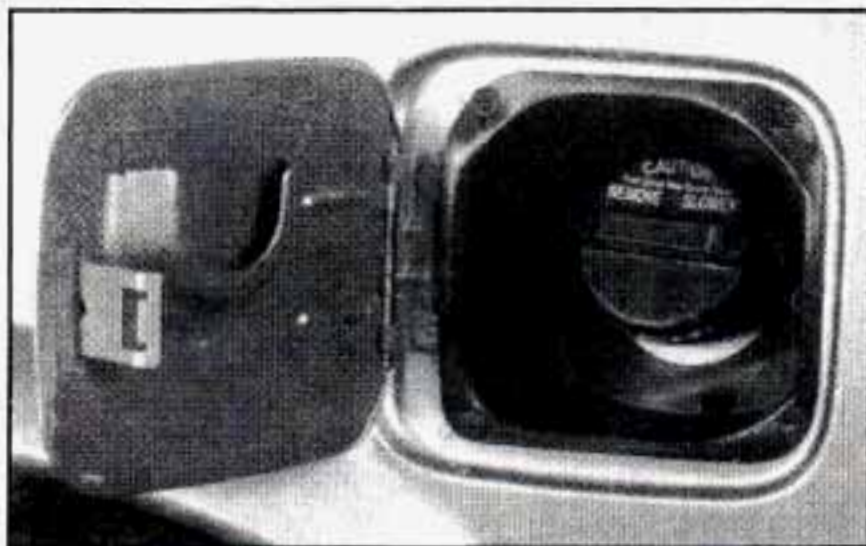

The cap is behind a hinged door on the driver's side of your vehicle.



The fuel door release is located on the optional full console and on the Remote Keyless Entry (RKE) transmitter. If your vehicle is not equipped with the full console, then you must use the RKE transmitter to open the fuel door.

CAUTION:

Gasoline vapor is highly flammable. It burns violently, and that can cause very bad injuries. Don't smoke if you're near gasoline or refueling your vehicle. Keep sparks, flames and smoking materials away from gasoline.



An alternate fuel door release is located inside of the trunk on the left hand side. Pull it to release the fuel door.

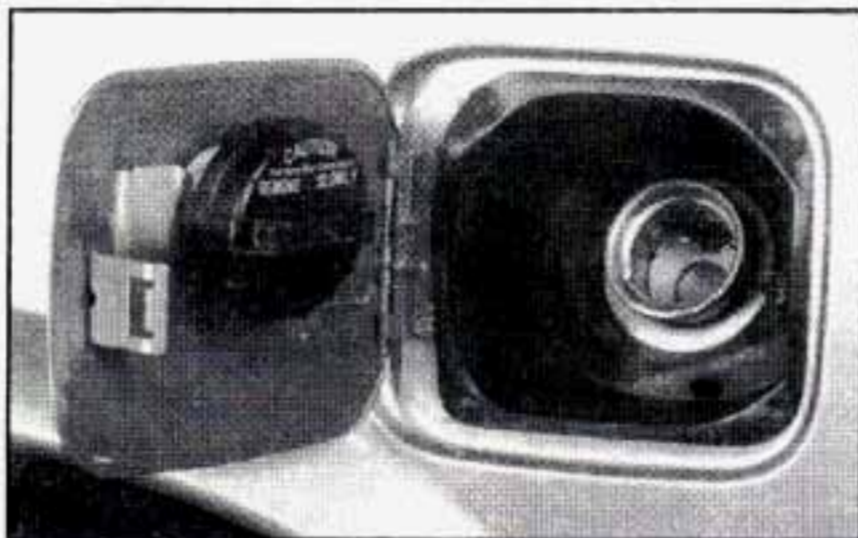

Hang the cap inside the fuel door while refueling.

To take off the cap, turn it slowly to the left (counterclockwise).

⚠ CAUTION:

If you get gasoline on yourself and then something ignites it, you could be badly burned. Gasoline can spray out on you if you open the fuel filler cap too quickly. This spray can happen if your tank is nearly full, and is more likely in hot weather. Open the fuel filler cap slowly and wait for any "hiss" noise to stop. Then unscrew the cap all the way.

Be careful not to spill gasoline. Clean gasoline from painted surfaces as soon as possible. See "Cleaning the Outside of Your Cadillac" in the Index.

When you put the cap back on, turn it to the right (clockwise) until you hear a clicking sound. Make sure you fully install the cap.

NOTICE:

If you need a new cap, be sure to get the right type. Your dealer can get one for you. If you get the wrong type, it may not fit or have proper venting, and your fuel tank and emissions system might be damaged.

Checking Things Under the Hood

 **CAUTION:**

An electric fan under the hood can start up and injure you even when the engine is not running. Keep hands, clothing and tools away from any underhood electric fan.

 **CAUTION:**

Things that burn can get on hot engine parts and start a fire. These include liquids like gasoline, oil, coolant, brake fluid, windshield washer and other fluids, and plastic or rubber. You or others could be burned. Be careful not to drop or spill things that will burn onto a hot engine.

Hood Release

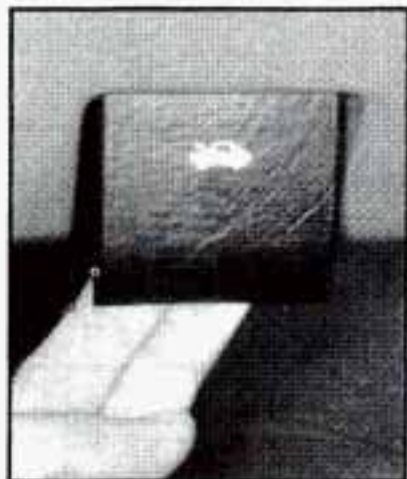

Pull the lever inside the vehicle to open the hood. It is located on the lower left side of the instrument panel.



Then go to the front of the vehicle and find the secondary hood release which is located above the front grille. Lift up on the release lever as you raise the hood.

When you open the hood, you'll see:

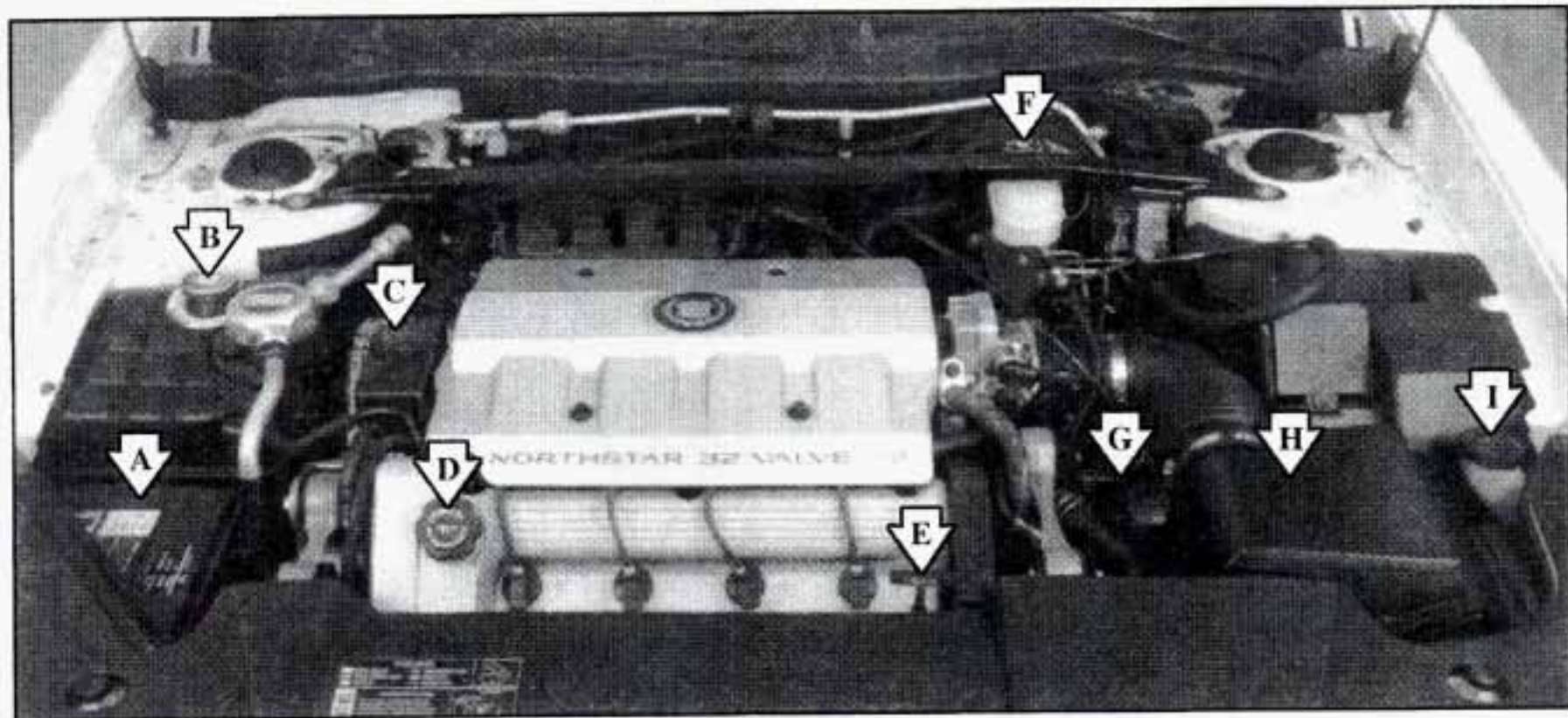

A. Battery

B. Coolant Fill Location

C. Power Steering Fluid

D. Oil Fill Location

E. Engine Oil Dipstick Location

F. Brake Master Cylinder

G. Transaxle Dipstick/Fill

H. Air Cleaner

I. Windshield Washer Fluid

Before closing the hood, be sure all filler caps are on properly. Then pull the hood down and close it firmly.

Underhood Lamp

Turn the parking lamps on to operate the underhood lamp. The underhood lamp will come on when the hood is opened.

Engine Oil

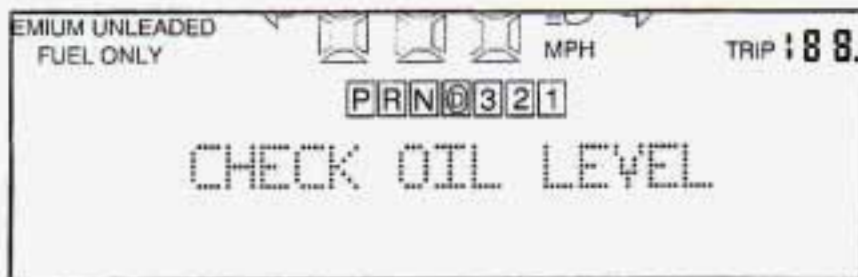

If you have the Driver Information Center (DIC), a CHECK OIL LEVEL message will appear when the engine oil is approximately 1 quart (1 L) low. If the message is displayed, check the dipstick level and add oil as needed.

It's a good idea to check your engine oil every time you get fuel. In order to get an accurate reading, the oil must be warm and the vehicle must be on level ground.



The engine oil dipstick is located behind the radiator on the driver's side of the engine. The black handle says ENGINE OIL on it.

Turn off the engine and give the oil a few minutes to drain back into the oil pan. If you don't, the oil dipstick might not show the actual level.

Checking Engine Oil

Pull out the dipstick and clean it with a paper towel or cloth, then push it back in all the way. Remove it again, keeping the tip down, and check the level.

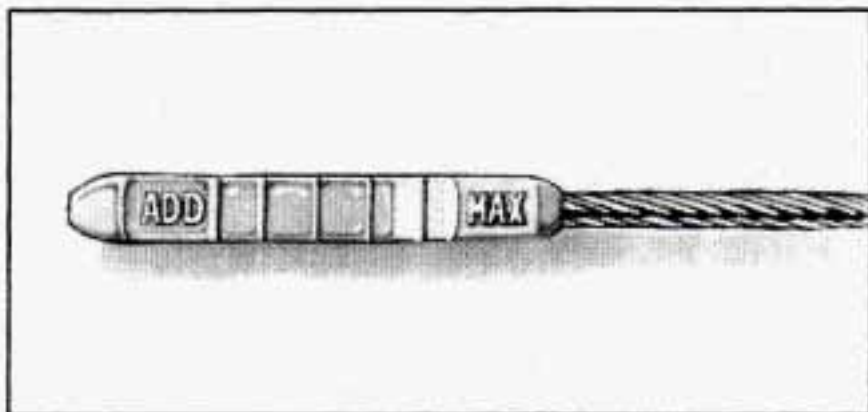

When to Add Oil

If the oil is at or below the ADD line, then you'll need to add at least one quart of oil. But you must use the right kind. This part explains what kind of oil to use. For crankcase capacity, see "Capacities and Specifications" in the Index.

NOTICE:

Don't add too much oil. If your engine has so much oil that the oil level gets above the upper mark that shows the proper operating range, your engine could be damaged.



The oil fill cap is located behind the radiator on the passenger's side of the engine. Turn the cap counterclockwise to remove it.

Be sure to fill it enough to put the level somewhere in the proper operating range. Push the dipstick all the way back in when you're through.

What Kind of Oil to Use

Oils recommended for your vehicle can be identified by looking for the "Starburst" symbol. This symbol indicates that the oil has been certified by the American Petroleum Institute (API). Do not use any oil which does not carry this Starburst symbol.



If you change your own oil, be sure you use oil that has the Starburst symbol on the front of the oil container. If you have your oil changed for you, be sure the oil put into your engine is American Petroleum Institute certified for gasoline engines.

You should also use the proper viscosity oil for your vehicle, as shown in the following chart:

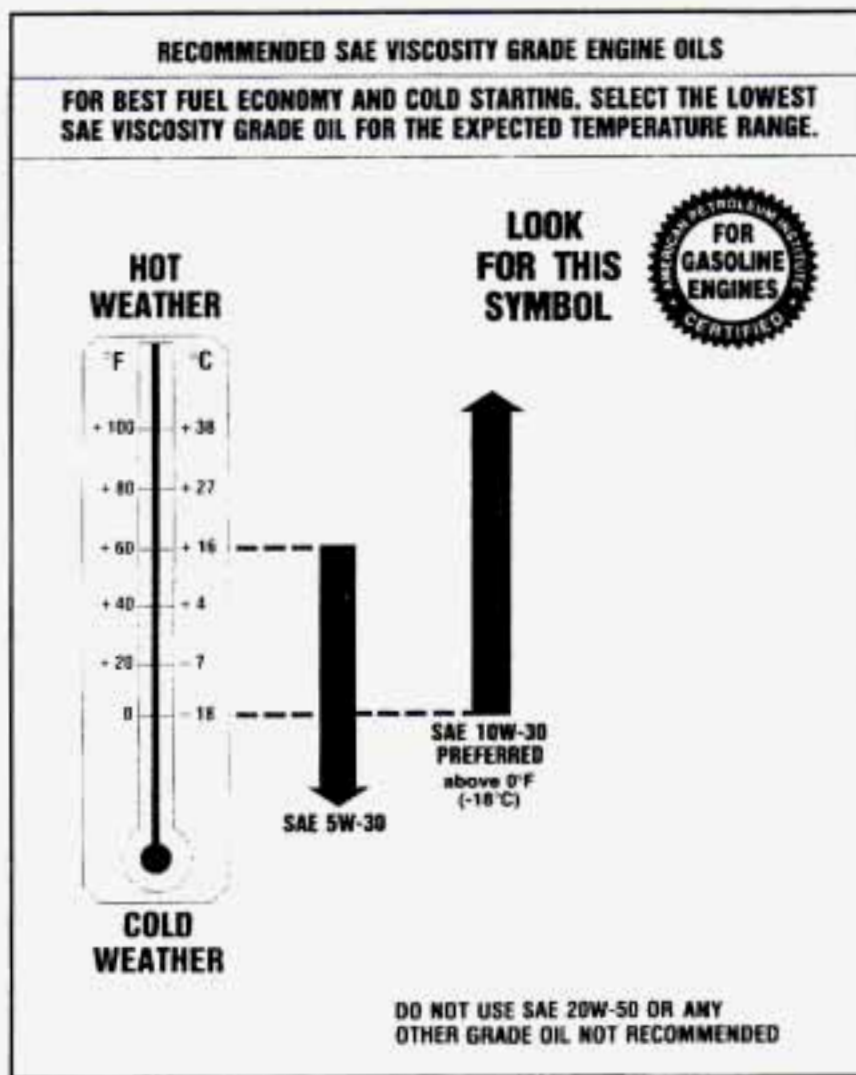

As shown in the chart, SAE 10W-30 is best for your vehicle. However, you can use SAE 5W-30 if it's going to be colder than 60°F (16°C) before your next oil change. When it's very cold, you should use SAE 5W-30. These numbers on an oil container show its viscosity, or thickness. Do not use other viscosity oils, such as SAE 20W-50.

NOTICE:

Use only engine oil with the American Petroleum Institute Certified For Gasoline Engines "Starburst" symbol. Failure to use the recommended oil can result in engine damage not covered by your warranty.

GM Goodwrench[®] oil meets all the requirements for your vehicle.

If you are in an area where the temperature falls below -20°F (-29°C), consider using either an SAE 5W-30 synthetic oil or an SAE 0W-30 oil. Both will provide easier cold starting and better protection for your engine at extremely low temperatures.

Engine Oil Additives

Don't add anything to your oil. Your Cadillac dealer is ready to advise if you think something should be added.

When to Change Engine Oil

Your Cadillac has an Oil Life Indicator. This feature will let you know when to change your oil and filter -- usually between 3,000 miles (5 000 km) and 7,500 miles (12 500 km) since your last oil change. Under severe conditions, the indicator may come on before 3,000 miles (5 000 km). Never drive your vehicle more than 7,500 miles (12 500 km) or 12 months (whichever occurs first) without an oil change.

The system won't detect dust in the oil. So, if you drive in a dusty area, be sure to change your oil every 3,000 miles (5 000 km) or sooner if the CHANGE ENGINE OIL message comes on. Remember to reset the Oil Life Indicator when the oil has been changed. For more information, see "Oil Life Indicator" in the Index.

How to Reset the Oil Life Indicator

After the oil has been changed, display the OIL LIFE LEFT message by pressing the INFORMATION (INFO) button. Then press and hold the RESET (INFO RESET) button until the display shows "100." This resets the oil life index. The message will remain off until the next oil change is needed. The percentage of oil life remaining may be checked at any time by pressing the INFORMATION (INFO) button several times until the OIL LIFE LEFT message appears. For more information on the Oil Life feature, see "Oil Life Indicator" in the Index.

What to Do with Used Oil

Did you know that used engine oil contains certain elements that may be unhealthy for your skin and could even cause cancer? Don't let used oil stay on your skin for very long. Clean your skin and nails with soap and water, or a good hand cleaner. Wash or properly throw away clothing or rags containing used engine oil. (See the manufacturer's warnings about the use and disposal of oil products.)

Used oil can be a real threat to the environment. If you change your own oil, be sure to drain all free-flowing oil from the filter before disposal. Don't ever dispose of oil by putting it in the trash, pouring it on the ground, into

sewers, or into streams or bodies of water. Instead, recycle it by taking it to a place that collects used oil. If you have a problem properly disposing of your used oil, ask your dealer, a service station or a local recycling center for help.

Air Cleaner

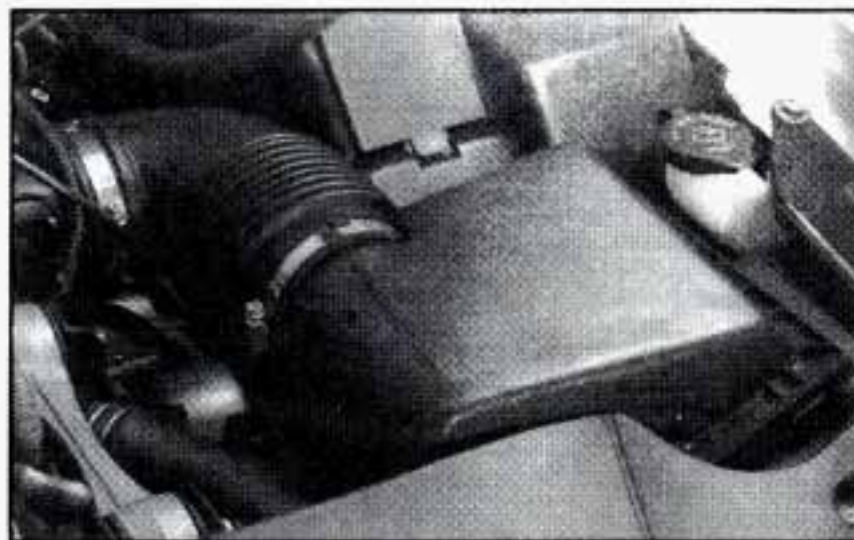

The air cleaner is located next to the windshield washer fluid reservoir on the driver's side of the engine. Be sure the engine has cooled before following these steps to replace the air cleaner filter:



1. Disconnect the Intake Air Temperature (IAT) sensor from the base of the air cleaner.



2. With a screwdriver, loosen the air duct clamp, which is located at the mass airflow sensor end of the air duct.

3. Disconnect the air duct from the mass airflow sensor.



4. Unhook both air cleaner cover latches. One latch is located near the radiator hose (not shown) and the other latch is located next to the IAT sensor.
5. Pivot the air cleaner and air duct assembly toward the front of the vehicle. Remove the cover.



6. Take out the air cleaner filter and remove any loose debris that may be found laying in the air cleaner base.
7. Install a new air filter element. See "Normal Maintenance Replacement Parts" in the Index.

Follow these steps to reinstall the air cleaner assembly:

1. Slide the air cleaner lid into the slots in the front edge of the air cleaner base.
2. Pivot the air cleaner cover and the air duct assembly downward. Make sure that both latches are secure and fully engaged.
3. Reinstall the clean air duct over the mass airflow sensor. Make sure that the duct is secure around the entire outer edge of the sensor.
4. Tighten the air duct clamp.
5. Reconnect the IAT sensor.

Refer to the Maintenance Schedule to determine when to replace the air filter.

See "Scheduled Maintenance Services" in the Maintenance Schedule booklet.



CAUTION:

Operating the engine with the air cleaner off can cause you or others to be burned. The air cleaner not only cleans the air, it stops flames if the engine backfires. If it isn't there, and the engine backfires, you could be burned. Don't drive with it off, and be careful working on the engine with the air cleaner off.

NOTICE:

If the air cleaner is off, a backfire can cause a damaging engine fire. And, dirt can easily get into your engine, which will damage it. Always have the air cleaner in place when you're driving.

Automatic Transaxle Fluid

When to Check and Change

A good time to check your automatic transaxle fluid level is when the engine oil is changed.

Change both the fluid and filter every 50,000 miles (83 000 km) if the vehicle is mainly driven under one or more of these conditions:

- In heavy city traffic where the outside temperature regularly reaches 90°F (32°C) or higher.
- In hilly or mountainous terrain.
- When doing frequent trailer towing.
- Uses such as found in taxi, police or delivery service.

If you do not use your vehicle under any of these conditions, the fluid and filter do not require changing.

See "Scheduled Maintenance Services" in the Maintenance Schedule booklet.

How to Check

Because this operation can be a little difficult, you may choose to have this done at your Cadillac dealership service department.

If you do it yourself, be sure to follow all the instructions here, or you could get a false reading on the dipstick.

NOTICE:

Too much or too little fluid can damage your transaxle. Too much can mean that some of the fluid could come out and fall on hot engine parts or exhaust system parts, starting a fire. Be sure to get an accurate reading if you check your transaxle fluid.

Wait at least 30 minutes before checking the transaxle fluid level if you have been driving:

- When outside temperatures are above 90°F (32°C).
- At high speed for quite a while.
- In heavy traffic -- especially in hot weather.
- While pulling a trailer.

To get the right reading, the fluid should be at normal operating temperature, which is 180°F to 200°F (82°C to 93°C).

Get the vehicle warmed up by driving about 15 miles (24 km) when outside temperatures are above 50°F (10°C). If it's colder than 50°F (10°C), you may have to drive longer.

Checking the Fluid Level

- Park your vehicle on a level place. Keep the engine running.
- With the parking brake applied, place the shift lever in PARK (P).
- With your foot on the brake pedal, move the shift lever through each gear range, pausing for about three seconds in each range. Then, position the shift lever in PARK (P).
- Let the engine run at idle for three to five minutes.

Then, without shutting off the engine, follow these steps:



1. The black transaxle fluid cap is located next to the radiator hose and below the air cleaner assembly on the driver's side of the engine. Remove the air cleaner assembly so you can reach the transaxle fluid cap. The assembly is attached to the vehicle by two fasteners. Simply lift up on the air cleaner assembly to remove it. Find the transaxle fluid cap and turn it counterclockwise to remove. Pull out the dipstick and wipe it with a clean rag or paper towel.

2. Push it back in all the way, wait three seconds and then pull it back out again.

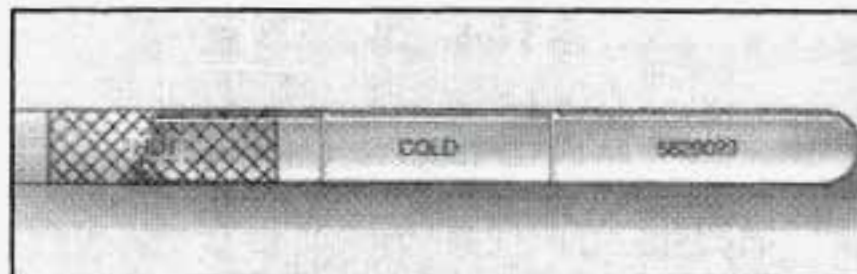

3. Check both sides of the dipstick, and read the lower level. The fluid level must be in the cross-hatched area.
4. If the fluid level is in the acceptable range, push the dipstick back in all the way. Replace the air cleaner assembly.

How to Add Fluid

Refer to the Maintenance Schedule to determine what kind of transaxle fluid to use. See “Recommended Fluids and Lubricants” in the Maintenance Schedule booklet.

If the fluid level is low, add only enough of the proper fluid to bring the level into the cross-hatched area on the dipstick.

1. Pull out the dipstick.
2. Using a long-neck funnel, add enough fluid at the dipstick hole to bring it to the proper level.

It doesn't take much fluid, generally less than one pint (0.5 L). *Don't overfill.*

NOTICE:

We recommend you use only fluid labeled DEXRON[®]-III, because fluid with that label is made especially for your automatic transmission. Damage caused by fluid other than DEXRON-III is not covered by your new vehicle warranty.

3. After adding fluid, recheck the fluid level as described under “How to Check.”
4. When the correct fluid level is obtained, push the dipstick back in all the way.

How to Reset Transaxle Fluid Change Indicator

Your vehicle is equipped with a transaxle fluid change indicator. A CHANGE TRANS FLUID message will display on the Driver Information Center (DIC) when the powertrain computer determines that the transaxle fluid needs to be changed or at each 100,000 miles (160 000 km) interval, whichever occurs first. See your Maintenance Schedule booklet for more information. When this message appears, change the transaxle fluid and reset the transaxle fluid life indicator as follows:

1. Turn the ignition on but do not start the engine.
2. Press and hold the OFF and rear defog buttons on the climate control at the same time until the TRANS FLUID RESET message appears on the DIC.

Engine Coolant

The cooling system in your vehicle is filled with DEX-COOL[®] engine coolant. This coolant is designed to remain in your vehicle for 5 years or 150,000 miles (240 000 km), whichever occurs first, if you add only DEX-COOL[®] extended life coolant.

The following explains your cooling system and how to add coolant when it is low. If you have a problem with engine overheating, see "Engine Overheating" in the Index.

A 50/50 mixture of water and DEX-COOL[®] coolant will:

- Give freezing protection down to -34°F (-37°C).
- Give boiling protection up to 265°F (129°C).
- Protect against rust and corrosion.
- Help keep the proper engine temperature.
- Let the warning lights and gages work as they should.

NOTICE:

When adding coolant, it is important that you use only DEX-COOL[®] (silicate-free) coolant. If coolant other than DEX-COOL[®] is added to the system, premature engine, heater core or radiator corrosion may result. In addition, the engine coolant will require change sooner -- at 30,000 miles (50 000 km) or 24 months, whichever occurs first. Damage caused by the use of coolant other than DEX-COOL[®] is not covered by your new vehicle warranty.

What to Use

Use a mixture of one-half *clean water* (preferably distilled) and one-half DEX-COOL[®] coolant which won't damage aluminum parts. If you use this mixture, you don't need to add anything else.



CAUTION:

Adding only plain water to your cooling system can be dangerous. Plain water, or some other liquid like alcohol, can boil before the proper coolant mix will. Your vehicle's coolant warning system is set for the proper coolant mix. With plain water or the wrong mix, your engine could get too hot but you wouldn't get the overheat warning. Your engine could catch fire and you or others could be burned. Use a 50/50 mix of clean water and DEX-COOL[®] coolant.

NOTICE:

If you use an improper coolant mix, your engine could overheat and be badly damaged. The repair cost wouldn't be covered by your warranty. Too much water in the mix can freeze and crack the engine, radiator, heater core and other parts.

If you have to add coolant more than four times a year, have your dealer check your cooling system.

NOTICE:

If you use the proper coolant, you don't have to add extra inhibitors or additives which claim to improve the system. These can be harmful.

Checking Coolant



The surge tank is located next to the engine block on the passenger's side of the engine.

The cooling system is under a lot of pressure when it is hot. If the CHECK COOLANT LEVEL message appears on the DIC, you will need to add coolant.

CAUTION:

Turning the surge tank pressure cap when the engine and radiator are hot can allow steam and scalding liquids to blow out and burn you badly. Never turn the surge tank pressure cap -- even a little -- when the engine and radiator are hot.

When your engine is cold, the coolant level should be at the FULL COLD mark, which is 2.5 inches (6.4 cm) below the base of the fill neck. Use a flashlight as necessary to see into the tank.



If this message comes on, it means you're low on engine coolant.

Adding Coolant

If you need more coolant, add the proper DEX-COOL[®] coolant mixture *at the surge tank*, but only when the engine is cool.

CAUTION:

You can be burned if you spill coolant on hot engine parts. Coolant contains ethylene glycol, and it will burn if the engine parts are hot enough. Don't spill coolant on a hot engine.

When replacing the pressure cap, make sure it is tight.

Surge Tank Pressure Cap

NOTICE:

The surge tank cap is a 15 psi (105 kPa) pressure-type cap and must be tightly installed to prevent coolant loss and possible engine damage from overheating. Be sure the arrows on the cap line up.

If the surge tank pressure cap needs to be replaced, a General Motors cap is recommended.

Thermostat

Engine coolant temperature is controlled by a thermostat in the engine coolant system. The thermostat stops the flow of coolant through the radiator until the coolant reaches a preset temperature.

If your thermostat needs to be replaced, a General Motors thermostat is recommended.

Power Steering Fluid



The power steering fluid reservoir is located next to the coolant surge tank on the passenger's side of the engine.

When to Check Power Steering Fluid

It is not necessary to regularly check power steering fluid unless you suspect there is a leak in the system or you hear an unusual noise. A fluid loss in this system could indicate a problem. Have the system inspected and repaired.

How To Check Power Steering Fluid

When the engine compartment is cool, wipe the cap and the top of the reservoir clean, then unscrew the cap and wipe the dipstick with a clean rag. Replace the cap and completely tighten it. Then remove the cap again and look at the fluid level on the dipstick.

The level should be at the FULL COLD mark. If necessary, add only enough fluid to bring the level up to the mark.

What to Use

To determine what kind of fluid to use, see "Recommended Fluids and Lubricants" in the Index. Always use the proper fluid. Failure to use the proper fluid can cause leaks and damage hoses and seals.

Windshield Washer Fluid

What to Use

When you need windshield washer fluid, be sure to read the manufacturer's instructions before use. If you will be operating your vehicle in an area where the temperature may fall below freezing, use a fluid that has sufficient protection against freezing.

Adding Washer Fluid

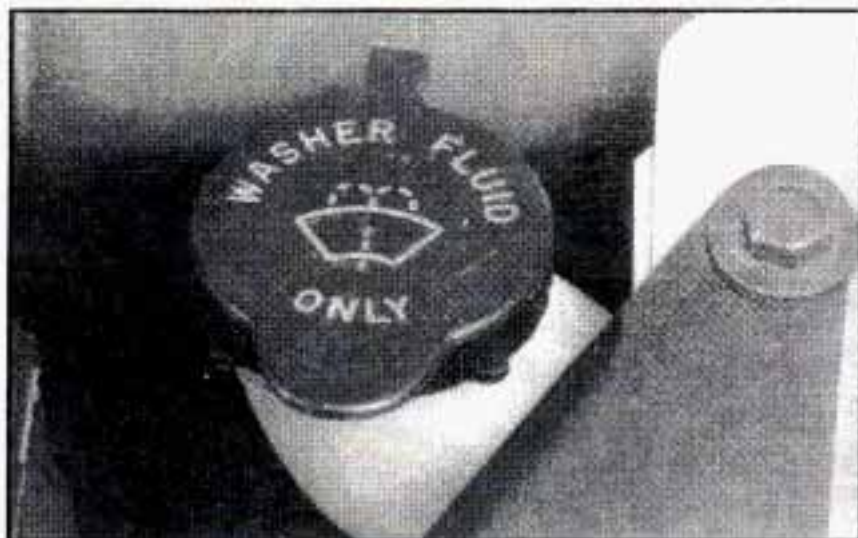

The windshield washer fluid reservoir is located next to the air cleaner on the driver's side of the engine.

Open the cap labeled WASHER FLUID ONLY. Add washer fluid until the tank is full.

NOTICE:

- **When using concentrated washer fluid, follow the manufacturer's instructions for adding water.**
- **Don't mix water with ready-to-use washer fluid. Water can cause the solution to freeze and damage your washer fluid tank and other parts of the washer system. Also, water doesn't clean as well as washer fluid.**
- **Fill your washer fluid tank only three-quarters full when it's very cold. This allows for expansion if freezing occurs, which could damage the tank if it is completely full.**
- **Don't use radiator antifreeze in your windshield washer. It can damage your washer system and paint.**

Brakes

Brake Fluid

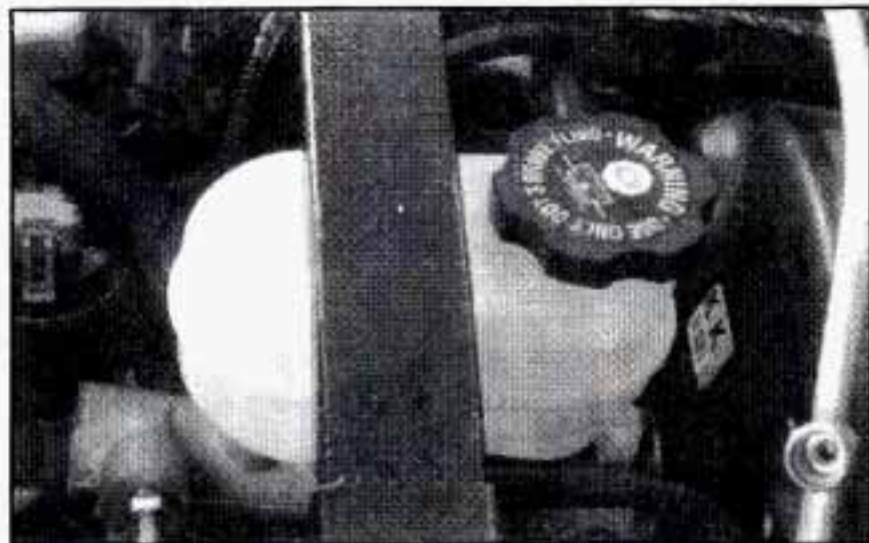

Your brake master cylinder reservoir is here. It is filled with DOT-3 brake fluid.

There are only two reasons why the brake fluid level in the reservoir might go down. The first is that the brake fluid goes down to an acceptable level during normal brake lining wear. When new linings are put in, the fluid level goes back up. The other reason is that fluid is leaking out

of the brake system. If it is, you should have your brake system fixed, since a leak means that sooner or later your brakes won't work well, or won't work at all.

So, it isn't a good idea to "top off" your brake fluid. Adding brake fluid won't correct a leak. If you add fluid when your linings are worn, then you'll have too much fluid when you get new brake linings. You should add (or remove) brake fluid, as necessary, only when work is done on the brake hydraulic system.

CAUTION:

If you have too much brake fluid, it can spill on the engine. The fluid will burn if the engine is hot enough. You or others could be burned, and your vehicle could be damaged. Add brake fluid only when work is done on the brake hydraulic system.

When your brake fluid falls to a low level, your brake warning light will come on. See "Brake System Warning Light" in the Index.

What to Add

When you do need brake fluid, use only DOT-3 brake fluid -- such as Delco Supreme 11[®] (GM Part No. 12377967). Use new brake fluid from a sealed container only.

Always clean the brake fluid reservoir cap and the area around the cap before removing it. This will help keep dirt from entering the reservoir.



CAUTION:

With the wrong kind of fluid in your brake system, your brakes may not work well, or they may not even work at all. This could cause a crash. Always use the proper brake fluid.

NOTICE:

- **Using the wrong fluid can badly damage brake system parts. For example, just a few drops of mineral-based oil, such as engine oil, in your brake system can damage brake system parts so badly that they'll have to be replaced. Don't let someone put in the wrong kind of fluid.**
- **If you spill brake fluid on your vehicle's painted surfaces, the paint finish can be damaged. Be careful not to spill brake fluid on your vehicle. If you do, wash it off immediately. See "Appearance Care" in the Index.**

Brake Wear

Your Cadillac has four-wheel disc brakes.

Disc brake pads have built-in wear indicators that make a high-pitched warning sound when the brake pads are worn and new pads are needed. The sound may come and go or be heard all the time your vehicle is moving (except when you are pushing on the brake pedal firmly).



CAUTION:

The brake wear warning sound means that soon your brakes won't work well. That could lead to an accident. When you hear the brake wear warning sound, have your vehicle serviced.

NOTICE:

Continuing to drive with worn-out brake pads could result in costly brake repair.

Some driving conditions or climates may cause a brake squeal when the brakes are first applied or lightly applied. This does not mean something is wrong with your brakes.

Properly torqued wheel nuts are necessary to help prevent brake pulsation. When tires are rotated, inspect brake pads for wear and evenly torque wheel nuts in the proper sequence to GM specifications.

Brake linings should always be replaced as complete axle sets.

See "Brake System Inspection" in the Maintenance Schedule booklet under Part C "Periodic Maintenance Inspections".

Brake Pedal Travel

See your dealer if the brake pedal does not return to normal height, or if there is a rapid increase in pedal travel. This could be a sign of brake trouble.

Brake Adjustment

Every time you apply the brakes, with or without the vehicle moving, your brakes adjust for wear.

Replacing Brake System Parts

The braking system on a modern vehicle is complex. Its many parts have to be of top quality and work well together if the vehicle is to have really good braking. Your vehicle was designed and tested with top-quality GM brake parts. When you replace parts of your braking system -- for example, when your brake linings wear down and you have to have new ones put in -- be sure you get new approved GM replacement parts. If you don't, your brakes may no longer work properly. For example, if someone puts in brake linings that are wrong for your vehicle, the balance between your front and rear brakes can change -- for the worse. The braking performance you've come to expect can change in many other ways if someone puts in the wrong replacement brake parts.

Battery

Every new Cadillac has a Delco Freedom[®] battery. You never have to add water to one of these. When it's time for a new battery, we recommend a Delco Freedom battery. Get one that has the replacement number shown on the original battery's label.

Vehicle Storage

If you're not going to drive your vehicle for 25 days or more, take off the black, negative (-) cable from the battery. This will help keep your battery from running down.

CAUTION:

Batteries have acid that can burn you and gas that can explode. You can be badly hurt if you aren't careful. See "Jump Starting" in the Index for tips on working around a battery without getting hurt.

Contact your dealer to learn how to prepare your vehicle for longer storage periods.

Also, for your audio system, see "Theft-Deterrent Feature" in the Index.

Bulb Replacement

For any bulb changing procedure not listed in this section, contact your Cadillac dealer service department.

Halogen Bulbs

CAUTION:

Halogen bulbs have pressurized gas inside and can burst if you drop or scratch the bulb. You or others could be injured. Be sure to read and follow the instructions on the bulb package.

Headlamps

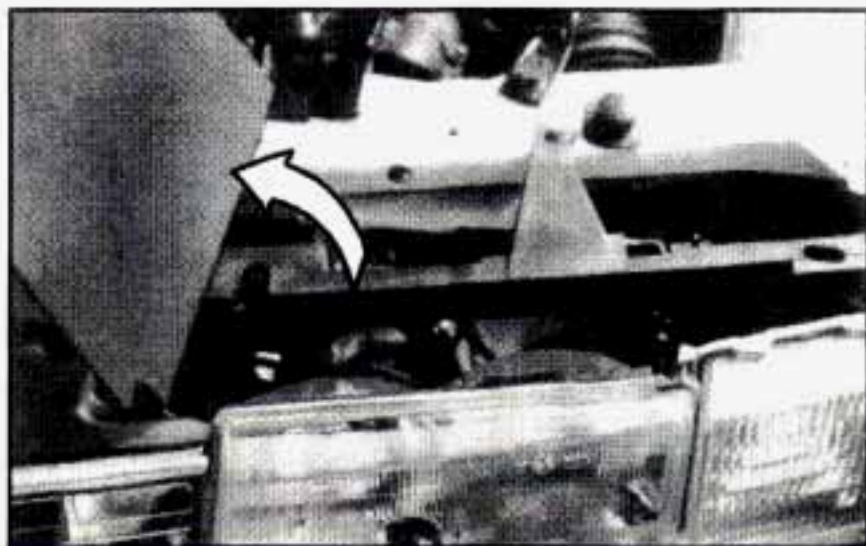

1. To access the headlamps, lift the cover off as shown.



2. Turn the headlamp housing socket counterclockwise to unlock the socket from the lamp housing.



3. Remove the headlamp housing socket.



4. After removing the wiring harness from the headlamp housing socket, replace the bulb and socket. Reconnect it to the wiring harness and reinstall the headlamp housing socket back into the headlamp assembly.

Front Turn Signal Lamps

1. The turn signal lamps are located on the outboard side of the headlamps. To access, lift off the headlamp cover (see Step 1 under "Headlamps").



2. Turn the housing socket clockwise to unlock the socket from the lamp housing.



3. Remove the turn signal lamp housing socket and replace the bulb.

Center High-Mounted Stoplamp (CHMSL)

The individual bulbs in the CHMSL are not replaceable. See your dealer for assistance.

Rear Turn Signal Lamps and Taillamps

1. Open the trunk to gain access to the lamp housing.



2. Remove the convenience net and pull trim away to access the wing nuts.

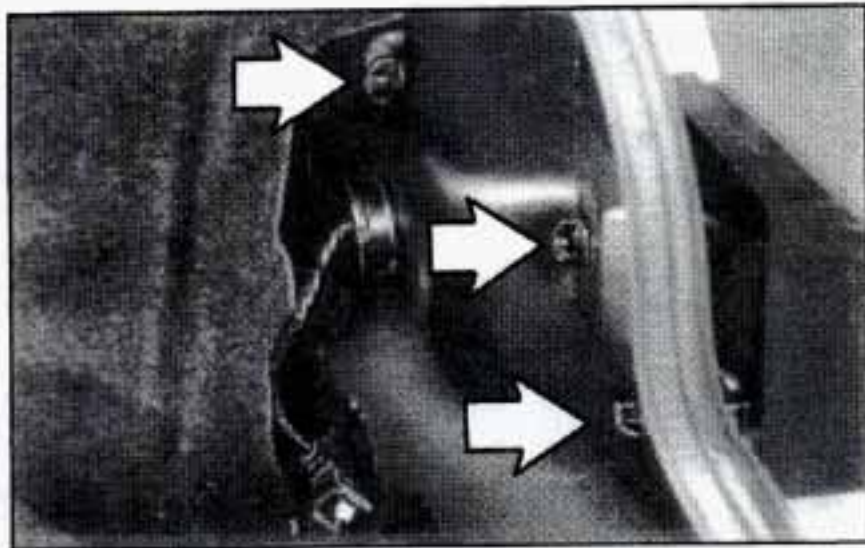

3. Remove the three wing nuts.
4. Gently remove the lamp housing. The taillamp is on the inboard side of the housing and the rear turn signal lamp is on the outboard side.

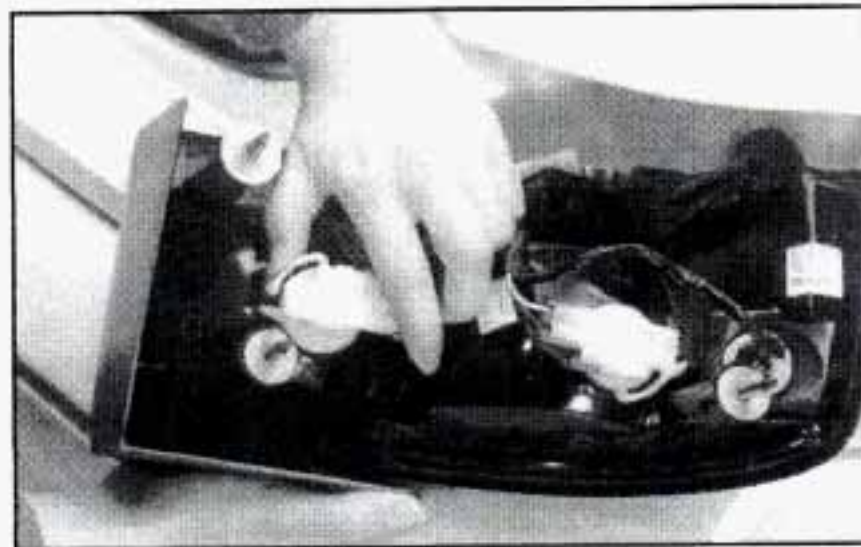

5. Press the bulb housing lever and rotate the housing counterclockwise to remove it. To remove the bulb, push and rotate it counterclockwise.

Once you have replaced the burned-out bulb, reverse the steps to reassemble the lamp assembly.

Windshield Wiper Blade Replacement

It's a good idea to clean or replace the wiper blade assembly on a regular basis or when worn. For proper windshield wiper blade length and type, see "Normal Maintenance Replacement Parts" later in this section. To replace the wiper blade assembly:

1. Turn the ignition key to **ACCESSORY** and turn the wipers on. Position the wipers on the windshield in the "mid" wipe position. Then with the door open, turn the key to **OFF**.



2. Insert a screwdriver into the slot as shown and press down to release the wiper blade assembly.
3. Align the wiper arm pin with the hole on the wiper blade assembly and snap it into place to install.

Tires

Your new Cadillac comes with high-quality tires made by a leading tire manufacturer. If you ever have questions about your tire warranty and where to obtain service, see your Cadillac Warranty booklet for details.



CAUTION:

Poorly maintained and improperly used tires are dangerous.

- **Overloading your tires can cause overheating as a result of too much friction. You could have an air-out and a serious accident. See “Loading Your Vehicle” in the Index.**
- **Underinflated tires pose the same danger as overloaded tires. The resulting accident could cause serious injury. Check all tires frequently to maintain the recommended pressure. Tire pressure should be checked when your tires are cold.**

CAUTION: (Continued)

CAUTION: (Continued)

- **Overinflated tires are more likely to be cut, punctured or broken by a sudden impact -- such as when you hit a pothole. Keep tires at the recommended pressure.**
- **Worn, old tires can cause accidents. If your tread is badly worn, or if your tires have been damaged, replace them.**

See “Inflation -- Tire Pressure” in this section for inflation pressure adjustment for higher speed driving.

Inflation -- Tire Pressure

The Tire-Loading Information label, which is located on the rear edge of the driver's door, shows the correct inflation pressures for your tires when they're cold. "Cold" means your vehicle has been sitting for at least three hours or driven no more than 1 mile (1.6 km).

If you'll be driving at speeds higher than 100 mph (160 km/h) where it is legal, raise the cold inflation pressure of each tire to 35 psi (240 kPa). When you end this very high-speed driving, reduce the cold inflation pressures to those listed on the Tire-Loading Information label.

NOTICE:

Don't let anyone tell you that underinflation or overinflation is all right. It's not. If your tires don't have enough air (underinflation), you can get the following:

- Too much flexing
- Too much heat
- Tire overloading
- Bad wear
- Bad handling
- Bad fuel economy.

If your tires have too much air (overinflation), you can get the following:

- Unusual wear
- Bad handling
- Rough ride
- Needless damage from road hazards.

When to Check

Check your tires once a month or more.

Don't forget your compact spare tire. It should be at 60 psi (420 kPa).

How to Check

Use a good quality pocket-type gage to check tire pressure. You can't tell if your tires are properly inflated simply by looking at them. Radial tires may look properly inflated even when they're underinflated.

Be sure to put the valve caps back on the valve stems. They help prevent leaks by keeping out dirt and moisture.

Tire Inspection and Rotation

Tires should be rotated every 6,000 to 8,000 miles (10 000 to 13 000 km). Any time you notice unusual wear, rotate your tires as soon as possible and check wheel alignment. Also check for damaged tires or wheels. See "When It's Time for New Tires" and "Wheel Replacement" later in this section for more information.

The purpose of regular rotation is to achieve more uniform wear for all tires on the vehicle. The first rotation is the most important. See "Scheduled Maintenance Services" in the Maintenance Schedule booklet for scheduled rotation intervals.

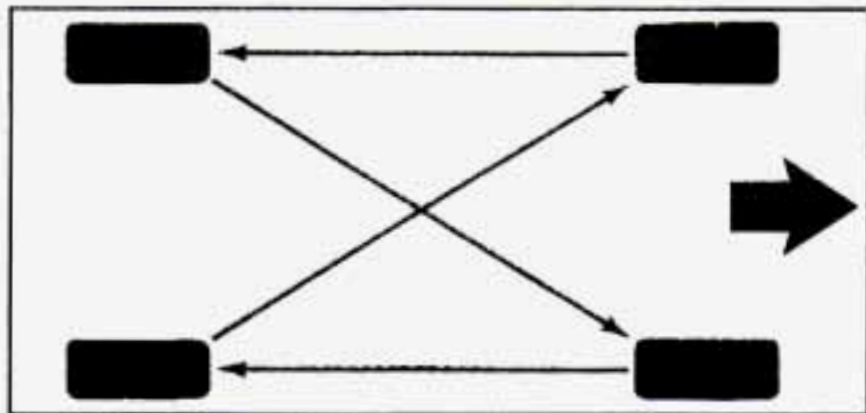

When rotating your tires, always use the correct rotation pattern shown here.

Don't include the compact spare tire in your tire rotation.

After the tires have been rotated, adjust the front and rear inflation pressures as shown on the Tire-Loading Information label. Make certain that all wheel nuts are properly tightened. See "Wheel Nut Torque" in the Index.

⚠ CAUTION:

Rust or dirt on a wheel, or on the parts to which it is fastened, can make wheel nuts become loose after a time. The wheel could come off and cause an accident. When you change a wheel, remove any rust or dirt from places where the wheel attaches to the vehicle. In an emergency, you can use a cloth or a paper towel to do this; but be sure to use a scraper or wire brush later, if you need to, to get all the rust or dirt off. (See “Changing a Flat Tire” in the Index.)

When It's Time for New Tires

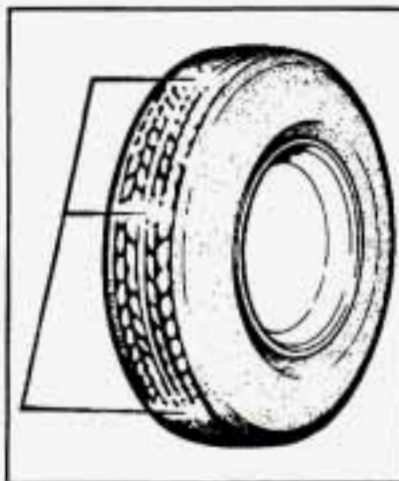

One way to tell when it's time for new tires is to check the treadwear indicators, which will appear when your tires have only 1/16 inch (1.6 mm) or less of tread remaining.

You need a new tire if any of the following statements are true:

- You can see the indicators at three or more places around the tire.
- You can see cord or fabric showing through the tire's rubber.
- The tread or sidewall is cracked, cut or snagged deep enough to show cord or fabric.
- The tire has a bump, bulge or split.
- The tire has a puncture, cut or other damage that can't be repaired well because of the size or location of the damage.

Buying New Tires

To find out what kind and size of tires you need, look at the Tire-Loading Information label.

The tires installed on your vehicle when it was new had a Tire Performance Criteria Specification (TPC Spec) number on each tire's sidewall. When you get new tires, get ones with that same TPC Spec number. That way your vehicle will continue to have tires that are designed to give proper endurance, handling, speed rating, traction, ride and other things during normal service on your vehicle. If your tires have an all-season tread design, the TPC number will be followed by an "MS" (for mud and snow).

If you ever replace your tires with those not having a TPC Spec number, make sure they are the same size, load range, speed rating and construction type (bias, bias-belted or radial) as your original tires.



CAUTION:

Mixing tires could cause you to lose control while driving. If you mix tires of different sizes or types (radial and bias-belted tires), the vehicle may not handle properly, and you could have a crash.

Using tires of different sizes may also cause damage to your vehicle. Be sure to use the same size and type tires on all wheels.

It's all right to drive with your compact spare, though. It was developed for use on your vehicle.

Uniform Tire Quality Grading

The following information relates to the system developed by the United States National Highway Traffic Safety Administration, which grades tires by treadwear, traction and temperature performance. (This applies only to vehicles sold in the United States.) The grades are molded on the sidewalls of most passenger car tires. The Uniform Tire Quality Grading system does not apply to deep tread, winter-type snow tires, space-saver or temporary use spare tires, tires with nominal rim diameters of 10 to 12 inches (25 to 30 cm), or to some limited-production tires.

While the tires available on General Motors passenger cars and light trucks may vary with respect to these grades, they must also conform to Federal safety requirements and additional General Motors Tire Performance Criteria (TPC) standards.

Treadwear

The treadwear grade is a comparative rating based on the wear rate of the tire when tested under controlled conditions on a specified government test course. For example, a tire graded 150 would wear one and a half (1 1/2) times as well on the government course as a tire graded 100. The relative performance of tires depends upon the actual conditions of their use, however, and may depart significantly from the norm due to variations in driving habits, service practices and differences in road characteristics and climate.

Traction -- A, B, C

The traction grades, from highest to lowest, are A, B and C, and they represent the tire's ability to stop on wet pavement as measured under controlled conditions on specified government test surfaces of asphalt and concrete. A tire marked C may have poor traction performance.

Warning: The traction grade assigned to this tire is based on braking (straightahead) traction tests and does not include cornering (turning) traction.

Temperature -- A, B, C

The temperature grades are A (the highest), B and C, representing the tire's resistance to the generation of heat and its ability to dissipate heat when tested under controlled conditions on a specified indoor laboratory test wheel. Sustained high temperature can cause the material of the tire to degenerate and reduce tire life, and excessive temperature can lead to sudden tire failure. The grade C corresponds to a level of performance which all passenger car tires must meet under the Federal Motor Vehicle Safety Standard No. 109. Grades A and B represent higher levels of performance on the laboratory test wheel than the minimum required by law.

Warning: The temperature grade for this tire is established for a tire that is properly inflated and not overloaded. Excessive speed, underinflation or excessive loading, either separately or in combination, can cause heat buildup and possible tire failure.

Wheel Alignment and Tire Balance

The wheels on your vehicle were aligned and balanced carefully at the factory to give you the longest tire life and best overall performance.

Scheduled wheel alignment and wheel balancing are not needed. However, if you notice unusual tire wear or your vehicle pulling one way or the other, the alignment may need to be reset. If you notice your vehicle vibrating when driving on a smooth road, your wheels may need to be rebalanced.

Wheel Replacement

Replace any wheel that is bent, cracked or badly rusted or corroded. If wheel nuts keep coming loose, the wheel, wheel bolts and wheel nuts should be replaced. If the wheel leaks air, replace it (except some aluminum wheels, which can sometimes be repaired). See your Cadillac dealer if any of these conditions exist.

Your dealer will know the kind of wheel you need.

Each new wheel should have the same load-carrying capacity, diameter, width, offset and be mounted the same way as the one it replaces.

If you need to replace any of your wheels, wheel bolts or wheel nuts, replace them only with new GM original equipment parts. This way, you will be sure to have the right wheel, wheel bolts and wheel nuts for your Cadillac model.

 **CAUTION:**

Using the wrong replacement wheels, wheel bolts or wheel nuts on your vehicle can be dangerous. It could affect the braking and handling of your vehicle, make your tires lose air and make you lose control. You could have a collision in which you or others could be injured. Always use the correct wheel, wheel bolts and wheel nuts for replacement.

NOTICE:

The wrong wheel can also cause problems with bearing life, brake cooling, speedometer or odometer calibration, headlamp aim, bumper height, vehicle ground clearance and tire or tire chain clearance to the body and chassis.

See "Changing a Flat Tire" in the Index for more information.

Used Replacement Wheels

 **CAUTION:**

Putting a used wheel on your vehicle is dangerous. You can't know how it's been used or how far it's been driven. It could fail suddenly and cause an accident. If you have to replace a wheel, use a new GM original equipment wheel.

Tire Chains

NOTICE:

Use tire chains only where legal and only when you must. Use only SAE Class “S” type chains that are the proper size for your tires. Install them on the front tires and tighten them as tightly as possible with the ends securely fastened. Drive slowly and follow the chain manufacturer’s instructions. If you can hear the chains contacting your vehicle, stop and retighten them. If the contact continues, slow down until it stops. Driving too fast or spinning the wheels with chains on will damage your vehicle.

Appearance Care

Remember, cleaning products can be hazardous. Some are toxic. Others can burst into flames if you strike a match or get them on a hot part of the vehicle. Some are dangerous if you breathe their fumes in a closed space. When you use anything from a container to clean your Cadillac, be sure to follow the manufacturer’s warnings

and instructions. And always open your doors or windows when you’re cleaning the inside.

Never use these to clean your vehicle:

- Gasoline
- Benzene
- Naphtha
- Carbon Tetrachloride
- Acetone
- Paint Thinner
- Turpentine
- Lacquer Thinner
- Nail Polish Remover

They can all be hazardous -- some more than others -- and they can all damage your vehicle, too.

Don’t use any of these unless this manual says you can. In many uses, these will damage your vehicle:

- Alcohol
- Laundry Soap
- Bleach
- Reducing Agents

Cleaning the Inside of Your Cadillac

Use a vacuum cleaner often to get rid of dust and loose dirt. Wipe vinyl or leather with a clean, damp cloth.

Your Cadillac dealer has two cleaners, a solvent-type spot lifter and a foam-type powdered cleaner. They will clean normal spots and stains very well. Do not use them on vinyl or leather.

Here are some cleaning tips:

1. Always read the instructions on the cleaner label.
2. Clean up stains as soon as you can -- before they set.
3. Use a clean cloth or sponge, and change to a clean area often. A soft brush may be used if stains are stubborn.
4. Use solvent-type cleaners in a well-ventilated area only. If you use them, don't saturate the stained area.
5. If a ring forms after spot cleaning, clean the entire area immediately or it will set.

Using Foam-Type Cleaner on Fabric

1. Vacuum and brush the area to remove any loose dirt.
2. Always clean a whole trim panel or section. Mask surrounding trim along stitch or welt lines.
3. Mix Multi-Purpose Powdered Cleaner following the directions on the container label.
4. Use suds only and apply with a clean sponge. Don't saturate the material and don't rub it roughly.
5. As soon as you've cleaned the section, use a sponge to remove the suds.
6. Rinse the section with a clean, wet sponge.
7. Wipe off what's left with a slightly damp paper towel or cloth.
8. Dry it immediately with a blow dryer.
9. Wipe with a clean cloth.

Using Solvent-Type Cleaner on Fabric

First, see if you have to use solvent-type cleaner at all. Some spots and stains will clean off better with just water and mild soap.

If you need to use a solvent:

1. Gently scrape excess soil from the trim material with a clean, dull knife or scraper.
2. Use very little cleaner, light pressure and clean cloths (preferably cheesecloth). Cleaning should start at the outside of the stain, "feathering" toward the center.
3. Keep changing to a clean section of the cloth.
4. When you clean a stain from fabric, immediately dry the area with a blow dryer to help prevent a cleaning ring.

Special Cleaning Problems

Greasy or Oily Stains

Stains caused by grease, oil, butter, margarine, shoe polish, coffee with cream, chewing gum, cosmetic creams, vegetable oils, wax crayon, tar and asphalt can be removed as follows:

1. Carefully scrape off excess stain.

2. Follow the solvent-type instructions described earlier.

Shoe polish, wax crayon, tar and asphalt will stain if left on a vehicle's seat fabric. They should be removed as soon as possible. Be careful, because the cleaner will dissolve them and may cause them to spread.

Non-Greasy Stains

Stains caused by catsup, coffee (black), egg, fruit, fruit juice, milk, soft drinks, wine, vomit, urine and blood can be removed as follows:

1. Carefully scrape off excess stain, then sponge the soiled area with cool water.
2. If a stain remains, follow the foam-type instructions described earlier.
3. If an odor lingers after cleaning vomit or urine, treat the area with a water/baking soda solution: 1 teaspoon (5 ml) of baking soda to 1 cup (250 ml) of lukewarm water.
4. If needed, clean lightly with solvent-type cleaner.

Combination Stains

Stains caused by candy, ice cream, mayonnaise, chili sauce and unknown stains can be removed as follows:

1. Carefully scrape off excess stain.
2. Clean with cool water and allow to dry.
3. If a stain remains, clean it with solvent-type cleaner.

Cleaning Vinyl

Use warm water and a clean cloth.

- Rub with a clean, damp cloth to remove dirt. You may have to do it more than once.
- Things like tar, asphalt and shoe polish will stain if you don't get them off quickly. Use a clean cloth and a vinyl/leather cleaner. See your dealer for this product.

Cleaning Leather

Use a soft cloth with lukewarm water and a mild soap or saddle soap and wipe dry with a soft cloth. Then, let the leather dry naturally. Do not use heat to dry.

- For stubborn stains, use a leather cleaner. See your dealer for this product.
- *Never* use oils, varnishes, solvent-based or abrasive cleaners, furniture polish or shoe polish on leather.
- Soiled or stained leather should be cleaned immediately. If dirt is allowed to work into the finish, it can harm the leather.

Cleaning the Top of the Instrument Panel

Use only mild soap and water to clean the top surfaces of the instrument panel. Sprays containing silicones or waxes may cause annoying reflections in the windshield and even make it difficult to see through the windshield under certain conditions.

Cleaning Wood Panels

Use a clean cloth moistened in warm, soapy water (use mild dish washing soap). Dry the wood immediately with a clean cloth.

Cleaning Speaker Covers

Vacuum around a speaker cover gently, so that the speaker won't be damaged. Some spots and stains will clean off better with just water and mild soap. If something gets on one of them and you need to use a solvent, follow these steps:

1. Gently scrape excess soil from the trim material with a clean, dull knife or scraper.
2. Use very little cleaner, light pressure and clean cloths (preferably cheesecloth). Cleaning should start at the outside of the stain, "feathering" toward the center.
3. Keep changing to a clean section of the cloth.
4. When you clean a stain from fabric, immediately dry the area with a blow dryer to help prevent a cleaning ring.

Care of Safety Belts

Keep belts clean and dry.

CAUTION:

Do not bleach or dye safety belts. If you do, it may severely weaken them. In a crash, they might not be able to provide adequate protection. Clean safety belts only with mild soap and lukewarm water.

Cleaning Glass Surfaces

Glass should be cleaned often. GM Glass Cleaner (GM Part No. 1050427) or a liquid household glass cleaner will remove normal tobacco smoke and dust films on interior glass.

Don't use abrasive cleaners on glass, because they may cause scratches. Avoid placing decals on the inside rear window, since they may have to be scraped off later. If abrasive cleaners are used on the inside of the rear window, an electric defogger element may be damaged. Any temporary license should not be attached across the defogger grid.

Cleaning the Outside of the Windshield and Wiper Blades

If the windshield is not clear after using the windshield washer, or if the wiper blade chatters when running, wax, sap or other material may be on the blade or windshield.

Clean the outside of the windshield with GM Windshield Cleaner, Bon Ami[®] Powder (non-scratching glass cleaning powder), GM Part No. 1050011. The windshield is clean if beads do not form when you rinse it with water.

Grime from the windshield will stick to the wiper blades and affect their performance. Clean the blade by wiping vigorously with a cloth soaked in full-strength windshield washer solvent. Then rinse the blade with water.

Check the wiper blades and clean them as necessary; replace blades that look worn.

Weatherstrips

Silicone grease on weatherstrips will make them last longer, seal better, and not stick or squeak. Apply silicone grease with a clean cloth at least every six months. During very cold, damp weather more frequent application may be required. (See "Recommended Fluids and Lubricants" in the Maintenance Schedule booklet.)

Cleaning the Outside of Your Cadillac

The paint finish on your vehicle provides beauty, depth of color, gloss retention and durability.

Washing Your Vehicle

The best way to preserve your vehicle's finish is to keep it clean by washing it often with lukewarm or cold water.

Don't wash your vehicle in the direct rays of the sun. Don't use strong soaps or chemical detergents. Use liquid hand, dish or car washing (mild detergent) soaps. Don't use cleaning agents that are petroleum based, or that contain acid or abrasives. All cleaning agents should be flushed promptly and not allowed to dry on the surface, or they could stain. Dry the finish with a soft, clean chamois or an all-cotton towel to avoid surface scratches and water spotting.

High pressure car washes may cause water to enter your vehicle.

Cleaning Exterior Lamps/Lenses

Use lukewarm or cold water, a soft cloth and a liquid hand, dish or car washing (mild detergent) soap to clean exterior lamps and lenses. Follow instructions under "Washing Your Vehicle."

Finish Care

Occasional waxing or mild polishing of your Cadillac by hand may be necessary to remove residue from the paint finish. You can get GM-approved cleaning products from your dealer. (See "Appearance Care and Materials" in the Index.)

Your Cadillac has a "basecoat/clearcoat" paint finish. The clearcoat gives more depth and gloss to the colored basecoat. Always use waxes and polishes that are non-abrasive and made for a basecoat/clearcoat paint finish.

NOTICE:

Machine compounding or aggressive polishing on a basecoat/clearcoat paint finish may dull the finish or leave swirl marks.

Foreign materials such as calcium chloride and other salts, ice melting agents, road oil and tar, tree sap, bird droppings, chemicals from industrial chimneys, etc., can damage your vehicle's finish if they remain on painted surfaces. Wash the vehicle as soon as possible.

If necessary, use non-abrasive cleaners that are marked safe for painted surfaces to remove foreign matter.

Exterior painted surfaces are subject to aging, weather and chemical fallout that can take their toll over a period of years. You can help to keep the paint finish looking new by keeping your Cadillac garaged or covered whenever possible.

Cleaning Aluminum or Chrome Wheels (If Equipped)

Keep your wheels clean using a soft clean cloth with mild soap and water. Rinse with clean water. After rinsing thoroughly, dry with a soft clean towel. A wax may then be applied.

The surface of these wheels is similar to the painted surface of your vehicle. Don't use strong soaps, chemicals, abrasive polishes, abrasive cleaners or abrasive cleaning brushes on them because you could damage the surface. You may use chrome polish on chrome wheels, but avoid any painted surface of the wheel, and buff off immediately after application.

Don't take your vehicle through an automatic car wash that has silicon carbide tire cleaning brushes. These brushes can also damage the surface of these wheels.

Cleaning Tires

To clean your tires, use a stiff brush with a tire cleaner.

NOTICE:

When applying a tire dressing always take care to wipe off any overspray or splash from all painted surfaces on the body or wheels of the vehicle. Petroleum-based products may damage the paint finish.

Sheet Metal Damage

If your vehicle is damaged and requires sheet metal repair or replacement, make sure the body repair shop applies anti-corrosion material to the parts repaired or replaced to restore corrosion protection.

Finish Damage

Any stone chips, fractures or deep scratches in the finish should be repaired right away. Bare metal will corrode quickly and may develop into a major repair expense.

Minor chips and scratches can be repaired with touch-up materials available from your dealer or other service outlets. Larger areas of finish damage can be corrected in your dealer's body and paint shop.

Underbody Maintenance

Chemicals used for ice and snow removal and dust control can collect on the underbody. If these are not removed, accelerated corrosion (rust) can occur on the underbody parts such as fuel lines, frame, floor pan and exhaust system even though they have corrosion protection.

At least every spring, flush these materials from the underbody with plain water. Clean any areas where mud and other debris can collect. Dirt packed in closed areas of the frame should be loosened before being flushed. Your dealer or an underbody car washing system can do this for you.

Chemical Paint Spotting

Some weather and atmospheric conditions can create a chemical fallout. Airborne pollutants can fall upon and attack painted surfaces on your vehicle. This damage can take two forms: blotchy, ringlet-shaped discolorations, and small irregular dark spots etched into the paint surface.

Although no defect in the paint job causes this, Cadillac will repair, at no charge to the owner, the surfaces of new vehicles damaged by this fallout condition within 12 months or 12,000 miles (20 000 km) of purchase, whichever occurs first.

Appearance Care Materials Chart

PART NUMBER	SIZE	DESCRIPTION	USAGE
994954	23 in. x 25 in.	Polishing Cloth – Wax Treated	Exterior Polish
1050004	2.75 sq. ft.	Chamois	Shines vehicle without scratching
1050172	16 oz. (0.473 L)	Tar and Road Oil Remover	Also removes old waxes and polishes
1050173	16 oz. (0.473 L)	Chrome Cleaner and Polish	Removes rust and corrosion
1050174	16 oz. (0.473 L)	White Sidewall Tire Cleaner	Removes soil and black marks
1050200	1 gal. (3.785 L)	Magic Mirror Cleaner Polish	Exterior cleaner and polish
1050214	32 oz. (0.946 L)	Vinyl Cleaner	Spot and stain removal
1050427	23 oz. (0.680 L)	Glass Cleaner	Cleans grease, grime and smoke film
1052870	16 oz. (0.473 L)	Wash and Wax Concentrate	Exterior wash
1052918**	8 oz. (0.237 L)	Armor All™ Protector	Protects vinyl, leather and rubber
1052925	16 oz. (0.473 L)	Multi-Purpose Powdered Cleaner	Cleans vinyl, cloth, tires and mats
1052929	16 oz. (0.473 L)	Wheel Cleaner	Spray on wheel cleaner
1052930	8 oz. (0.237 L)	Capture Dry Spot Remover	Attracts and absorbs soils
12345002**	16 oz. (0.473 L)	Armor All™ Cleaner	Cleans vinyl, leather and rubber
12345725	12 oz. (0.354 L)	Silicone Tire Shine	Shines tires
12377964	16 oz. (0.473 L)	Cleaning Wax	Protects finish and removes fine scratches
12377966	16 oz. (0.473 L)	Finish Enhancer	Spot cleans paint and gives high luster
See your General Motors Parts Department for these products. See "Fluids and Lubricants" in the Index.			** Not recommended for use on instrument panel vinyl.

Vehicle Identification Number (VIN)

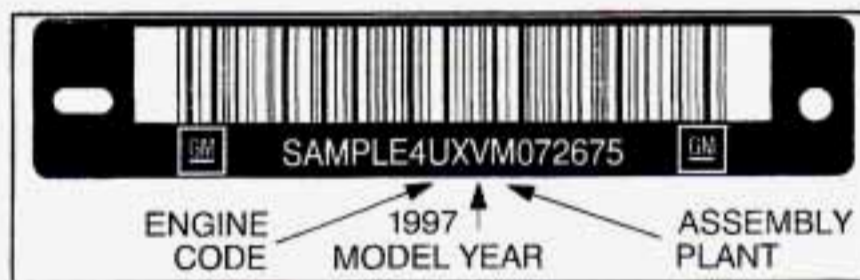

This is the legal identifier for your Cadillac. It appears on a plate in the front corner of the instrument panel, on the driver's side. You can see it if you look through the windshield from outside your vehicle. The VIN also appears on the Vehicle Certification and Service Parts labels and the certificates of title and registration.

Engine Identification

The 8th character in your VIN is the engine code. This code will help you identify your engine, specifications and replacement parts.

Service Parts Identification Label

You'll find this label on the rear wall of the trunk on the passenger's side. It's very helpful if you ever need to order parts. On this label is:

- your VIN.
- the model designation.
- paint information and
- a list of all production options and special equipment.

Be sure that this label is not removed from the vehicle.

Electrical System

Add-On Electrical Equipment

NOTICE:

Don't add anything electrical to your Cadillac unless you check with your dealer first. Some electrical equipment can damage your vehicle and the damage wouldn't be covered by your warranty. Some add-on electrical equipment can keep other components from working as they should.

Your vehicle has an air bag system. Before attempting to add anything electrical to your Cadillac, see "Servicing Your Air Bag-Equipped Cadillac" in the Index.

Headlamp Wiring

The headlamp wiring has an individual fuse which is powered by a MaxiFuse[®]. An electrical overload will cause the lamps to go on and off, or in some cases to

remain off. If this happens, have the headlamp wiring checked right away.

MaxiFuse is a registered trademark of Little Fuse Incorporated.

Windshield Wiper Fuses

The windshield wiper motor is powered by a MaxiFuse. If the motor overheats due to heavy snow, etc., the wipers will stop until the motor cools. If the overload is caused by some electrical problem, be sure to have it fixed.

Power Windows and Other Power Options

Circuit breakers protect the power windows and other power accessories. When the current load is too heavy, the circuit breaker opens and closes, protecting the circuit until the problem is fixed or goes away.

MaxiFuses/Relay Center

The MaxiFuses and relays are located next to the engine compartment fuse block on the driver's side of the engine. If a MaxiFuse should blow, have your vehicle serviced by your Cadillac dealer immediately.

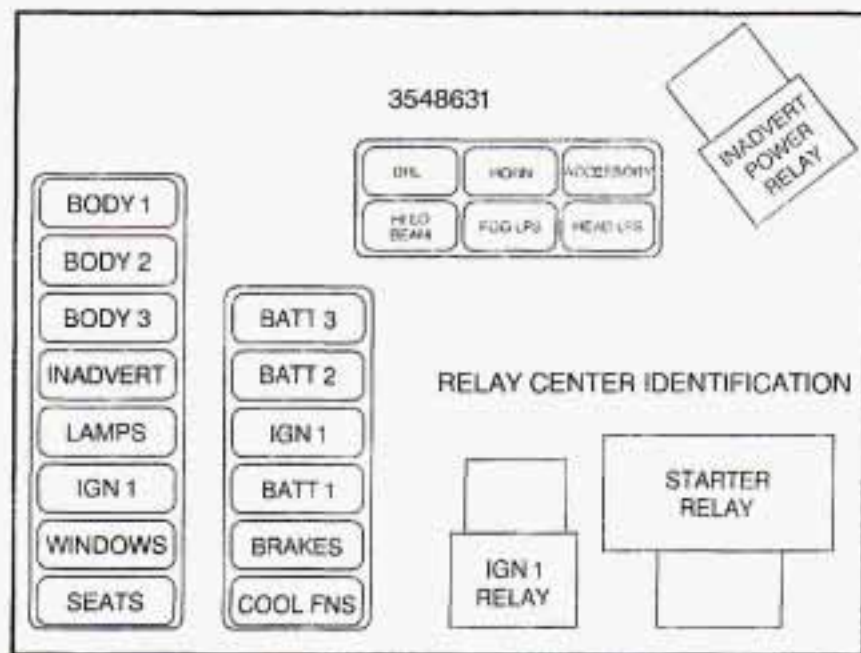

Fuse	Usage
BODY 1	Real Time Dampening (RTD) Fuse, Convenience Fuse, BATT Fuse, Passenger and Driver Seat Belt Comfort Solenoids, Trunk and Fuel Door Release Solenoids and Relays, Door Lock/Unlock Relays, DPR Relay (STS Only), Park Lamp Relay, Right and Left Park Fuse, Rear Fog Lamp Relay

Fuse	Usage
BODY 2	Defog Relay, Pull-Down Fuse, Right and Left Heated Seat Fuse, Electronic Level Control (ELC) Fuse/Relay, Antenna Fuse, Heated Mirror Fuse
BODY 3	Controlled Power Relay, Controlled Power Back-Up Relay, Cluster Fuse, Platform Zone Module (PZM) Fuse, Radio Fuse, DAB Relay, Trunk and Fuel Door Release Relay, High Beam Relay, Comfort Fuse, Controlled Power Relay, AMP Bose Only Fuse, Right and Left Bose Relay
INADVERT	Inadvertent Power Relay, Interior Lamps Fuse, Cigarette Lighter-1 Fuse, Cigarette Lighter-2 Fuse

Fuse	Usage
LAMPS	Headlamp Wash Relay (Export), Headlamps Fuse/Relay, High/Low Beam Control Relay, Fog Lamp/DRL Fuse, Hazard Fuse, Mirror Fuse, Inadvertent Power Relay, Right and Left High Beam Fuse, Right and Left Low Beam Fuse, Stop Fuse, Fog Lamp Relay (STS Only), DRL Relay
IGN 1	Rear Ignition-1 Relay, Wiper Fuse, Relay Ignition-1 Fuse, Supplemental Inflatable Restraint (SIR) Fuse, Accessory Relay
WINDOWS	Delayed Accessory Bus (DAB) Relay
SEATS	Horn Relay, Driver and Passenger Lumbar In/Out Relays, Driver and Passenger Up/Down Relays

Fuse	Usage
BATT 3	Steering Column Ignition Switch
BATT 2	Steering Column Ignition Switch
IGN 1*	Front and Rear Ignition-1 Relay, Oxygen Sensor 1 and 2 Fuse, Fuel Fuse, Cruise Fuse, DRL Relay, Front and Rear Fog Lamp Relay, Control Power Back-Up Relay, Ignition-1 Fuse
BATT 1	Starter Relay and Solenoid, Park/Rev Fuse, Park Relay, PCM Fuse, AC Compressor Fuse and Relay, Fan Relay
BRAKES	ABS Brake Modulator
COOL FNS	Cooling Fan Relays 1 and 3

* Do not alter OBD II related fuses or circuit breakers.

Fuses and Circuit Breakers

The wiring circuits in your vehicle are protected from short circuits by a combination of fuses and circuit breakers. This greatly reduces the chance of fires caused by electrical problems.

Look at the silver-colored band inside the fuse. If the band is broken or melted, replace the fuse. Be sure you replace a bad fuse with a new one of the identical size and rating.

If you ever have a problem on the road and don't have a spare fuse, you can "borrow" one that has the same amperage. Pick some feature of your vehicle that you can get along without -- like the radio or cigarette lighter -- and use its fuse, if it is the correct amperage. Replace it as soon as you can.

There are two fuse blocks in your vehicle: the engine compartment fuse block and the rear compartment fuse block.

Engine Compartment Fuse Block



The fuse block is located next to the air cleaner on the driver's side of the engine. Lift the cover to gain access.

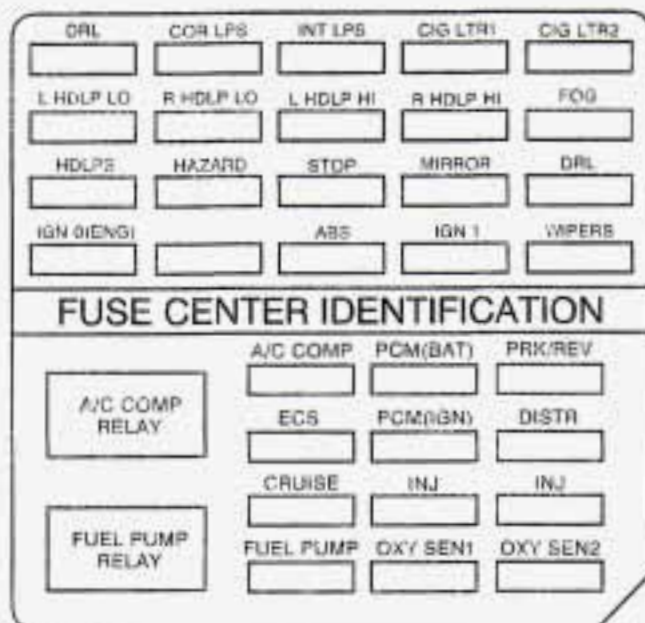

Fuse	Usage
DRL	Daytime Running Lamps (DRL)
COR LPS	Cornering Lamp Switch, Right and Left Cornering Lamps
INT LPS	Trunk Lamp, Courtesy Lamps, Front Vanity Lamps, Glove Box Lamp, Garage Door Opener, Courtesy Lamp Relay

Fuse	Usage
CIG LTR1	Front and Rear Cigarette Lighters (Full Console Only)
CIG LTR2	Right and Left Rear Cigarette Lighters
L HDLP LO	Left Low-Beam Headlamp
R HDLP LO	Right Low-Beam Headlamp
L HDLP HI	Left High-Beam Headlamp
R HDLP HI	Right High-Beam Headlamp
FOG	Right and Left Front Fog Lamp Relay
HDLPS	Headlamp Relay, High/Low Beam Control Relay, Right and Left Low/High Beam Fuses
HAZARD	Electronic Flasher Module, Turn/Hazard Switch, Right and Left Front Turn Lamps, Right and Left Rear Turn Lamps, Right and Left Repeater Lamps (Export), Cluster

Fuse	Usage
STOP	Stoplamp Switch, Centered High-Mounted Stoplamp (CHMSL), Turn Hazard Switch, ABS Controller, Stepper Motor Cruise Control, Right and Left Rear Stoplamps (Export)
MIRROR	Inadvertent Power Relay, Left Outside Rearview Mirror Switch, ALDL, Memory Mirror Module Dimmer Switch, Cluster
DRL	Daytime Running Lamps (DRL) Relay, (STS Only) Left and Right Low Beam in DRL Mode, DRL Switch
IGN 0 (ENG)*	Powertrain Control Module (PCM)
ABS	Anti-Lock Brake System (ABS)/Traction Control System

Fuse	Usage
IGN-1	Rear Ignition-1 Relay, Front and Rear Fog Lamp Relays, Control Power Back-Up, DRL Relay
WIPERS	Accessory Relay, Wiper Switch
A/C COMP	AC Compressor Relay, Cooling Fan Relays 1, 2, 3, Compressor Clutch
A/C COMP	AC Compressor
PCM (BAT)*	PCM
PRK/REV	TCC and Exterior Travel Brake Switch, Reverse Relay, Right and Left Back-Up Lamps, Electrochromatic Mirror (in Header), Park Relay, Brake Transaxle-Shift Interlock (BTSI) Switch, BTSI, PZM

Fuse	Usage
ECS*	Transaxle Shift Solenoids, Mass Airflow, Canister Purge, PCM, Linear Exhaust Gas Recirculation (EGR), Front Ignition-1 Relay, Torque Converter
PCM (IGN)*	Powertrain Control Module (PCM)
DISTR*	Electronic Ignition Control Module
CRUISE	Stepper Motor Cruise Control, Power Steering Pressure Switch, Low Refrigerant Pressure Cutoff Switch, Park Relay

Fuse	Usage
INJ*	Injectors 1, 4, 6, 7
INJ*	Injectors 2, 3, 5, 8
FUEL PUMP*	PCM, Fuel Pump Relay, Fuel Pump
FUEL PUMP	Fuel Pump
OXY SEN1*	Oxygen Sensor Front, CAT Front Oxygen Sensor
OXY SEN2*	Oxygen Sensor Rear, Catalytic Converter (CAT) Rear Oxygen Sensor

* Do not alter OBD II related fuses or circuit breakers.

Rear Compartment Fuse Block

The fuse block is located on the front wall of the trunk (behind the rear seat) on the driver's side. Loosen the four trunk trim fasteners and pull the trim away from the fuse block to gain access.

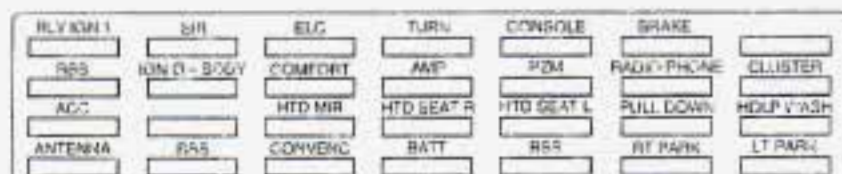

Fuse	Usage
RLY IGN1*	Cluster, Cruise in Stalk, PZM, Catalytic Converter Overtemp Amplifier (Export), TCC Switches
SIR	SDM, Left and Right Door Sensor
ELC	ELC Relay, Vacuum Pump, ALC Sensor
TURN	Electronic Flasher, Turn/Hazard Switch
CONSOLE	Rear Zone Blower, Right and Left Heated Seat Switches (Optional)

Fuse	Usage
BRAKE	Vacuum Pump (VP) Relay, VP Motor, VP Pressure Switch
RSS	CV-RTD (CV-RSS)
IGN 0-BODY	PRNDL, Dual Zone Switch, PZM, Cluster, Air Control Module (ACM), Upper Zone Motor, Lower Zone Motor (Optional), HVAC Solenoids, Climate Control Panel Analog Cluster (Console Shift Only), Rear Defog Relay, ELC Relay
COMFORT	CD Player, Remote Keyless Entry (RKE), Controlled Power Relay, Air Control Module (ACM), PZM
AMP (Bose Only)(Optional)	Right and Left Hand Bose Relay, Right and Left Front Speakers (On Door), Right and Left Rear Speakers
PZM	PZM

Fuse	Usage
RADIO/PHONE	Radio Receiver, Radio Interface Module (RIM)(Bose Only), Phone, DAB Relay, Trunk Release Relay, Fuel Door Release Relay, High/Low Beam Relay
CLUSTER	Steering Wheel Controls, Cluster
ACC	PZM, Electrochromic Mirror, Rain Sensor (Optional), Accessory Relay
HTD MIR	Right and Left Outside Heated Mirror
HTD SEAT R	Passenger Heated Seat Relay (Optional)
HTD SEAT L	Driver Heated Seat Relay (Optional)
PULL DOWN	Trunk Pull-Down Motor
HDLP WASH	Headlamp Wash Relay (Export), Headlamp Wash Motor
ANTENNA	Power Mast Antenna
RSS	CV-RTD Module (CV-RSS)

Fuse	Usage
CONVENC	Trunk Release Relay, Trunk Release Solenoid, Fuel Door Release Relay, Fuel Filler Door Release Solenoid, Door Lock Relay, Left Front Door Motors, PZM, Door Unlock Relay
BATT	Driver and Passenger Seat Lumbar Switch (Optional), Memory Seat Module
RSS	CV-RTD (CV-RSS)
RT PARK	Headlamp Switches, Rear Fog Lamp Relay, Right Front and Rear Sidemarker Lamps, Right Rear Back-Up Lamp (Export), Park Position Lamp (Export), Rear Park/Turn Lamps
LT PARK	Left Front and Rear Sidemarker Lamps, Front Parking Lamps, Left Turn/Stop/Tail Lamps, Right and Left License Plate Lamps, Park Position Lamp (Export)

* Do not alter OBD II related fuses or circuit breakers.

Replacement Bulbs

Application	Number
Headlamps Composite	
Inner High Beam	9005
Outer Low Beam	9006
Front Turn Signal	2357 NA
Rear Turn Signal and Taillamp	2057

Capacities and Specifications

Engine Specifications

Displacement	279 cubic inches (4.565 cc)
Type	4.6 L DOHC V8
VIN Engine Code	
SLS	Y
STS	9
Horsepower	
SLS	275 (bhp) @ 5600 rpm 205 (kW) @ 5600 rpm
STS	300 (bhp) @ 6000 rpm 224 (kW) @ 6000 rpm

Torque

SLS	300 (lb-ft) @ 4000 rpm 407 (N·m) @ 4000 rpm
STS	295 (lb-ft) @ 4400 rpm 400 (N·m) @ 4400 rpm

Firing Order

1-2-7-3-4-5-6-8

Thermostat Starts To Open ... 177-184° F (81-85° C)

Capacities

Please refer to "Recommended Fluids and Lubricants" in your Maintenance Schedule booklet for more information.

Transaxle (4T80-E)	15 quarts (14.2 L)
Crankcase (Engine Oil with Filter Change)	7.0 quarts (6.62 L)
Engine Cooling System	12.5 quarts (11.8 L)
Fuel Tank	20 gallons (75.7 L)
R-134a Refrigerant	2.0 lbs. (0.91 kg)

Vehicle Dimensions

Wheel Base	111 inches (281.9 cm)
Length	204.1 inches (518.3 cm)
Height	54.5 inches (138.4 cm)
Width	74.2 inches (188.5 cm)
Front Tread	60.9 inches (154.6 cm)
Rear Tread	60.9 inches (154.6 cm)
Wheel Nut Torque	100 lb-ft (140 N·m)

Air Conditioning Refrigerants

Not all air conditioning refrigerants are the same. If the air conditioning system in your vehicle needs refrigerant, be sure the proper refrigerant is used. If you're not sure, ask your Cadillac dealer.

Normal Maintenance Replacement Parts

Air Filter Element	AC Type A1096C 25096932
Fuel Filter Element	AC Type GF-580 25121468
Engine Oil Filter	AC Type PF-58 25014377
PCV Valve	AC Type CV-774C 06487779
Spark Plugs	AC Type 41-900 5614236
Thermostat	AC Type 131-66 3531407
Windshield Wiper Blade (Pin Type)	22 inches (56.5 cm)



Section 7 Customer Assistance Information

Here you will find out how to contact Cadillac if you need assistance. This section also tells you how to obtain service publications and how to report any safety defects.

7-2	Customer Satisfaction Procedure	7-11	BBB Autoline Information
7-4	Address for Writing to Cadillac	7-12	Warranty Information
7-4	Assistance for Text Telephone (TTY) Users	7-12	Reporting Safety Defects to the United States
7-5	Cadillac Roadside Service	7-13	Reporting Safety Defects to Canada
7-7	Roadside Service for the Hearing or Speech Impaired	7-13	Reporting Safety Defects to General Motors
7-8	Gold Key Courtesy Transportation	7-13	Ordering Service Publications in Canada
7-9	Transportation Options	7-14	How to Order Service Publications
		7-15	Order Form for Service Publications

Customer Satisfaction Procedure



Cadillac dealers have the facilities, trained technicians and up-to-date information to promptly address any concerns you may have. However, if a concern has not been resolved to your complete satisfaction, take the following steps:

STEP ONE -- Discuss your concern with a member of dealership management. Normally, concerns can be quickly resolved at that level. If the matter has already been reviewed with the Sales, Service or Parts Manager, contact the owner of the dealership or the General Manager.

STEP TWO -- If after contacting a member of dealership management, it appears your concern cannot be resolved by the dealership without further help, contact the Cadillac Customer Assistance Center, 24 hours a day, by calling 1-800-458-8006. In Canada, contact GM of Canada Customer Communication Centre in Oshawa by calling 1-800-263-3777 (English) or 1-800-263-7854 (French).

For help outside of the United States and Canada, call the following numbers as appropriate:

- In Mexico: (525) 625-3256
- In Puerto Rico: 1-800-496-9992 (English) or 1-800-496-9993 (Spanish)

- In the U.S. Virgin Islands: 1-800-496-9994
- In the Dominican Republic: 1-800-751-4135 (English) or 1-800-751-4136 (Spanish)
- In the Bahamas: 1-800-389-0009
- In Bermuda, Barbados, Antigua and the British Virgin Islands: 1-800-534-0122
- In all other Caribbean countries: (809) 763-1315
- In other overseas locations, call GM International Product Center in Canada at (905) 644-4112.

For prompt assistance, please have the following information available to give the Customer Assistance Representative:

- Your name, address, home and business telephone numbers
- Vehicle Identification Number (This is available from the vehicle registration or title, or the plate at the top left of the instrument panel and visible through the windshield.)
- Dealership name and location
- Vehicle delivery date and present mileage
- Nature of concern

We encourage you to call us so we can give your inquiry prompt attention. However, if you wish to write Cadillac, address your inquiry to:

Cadillac Customer Assistance Center
Cadillac Motor Car Division
30009 Van Dyke
P.O. Box 9025
Warren, MI 48090-9025

In Canada, write to:

General Motors of Canada Limited
Customer Communication Centre, 163-005
1908 Colonel Sam Drive
Oshawa, Ontario L1H 8P7

Refer to your Warranty and Owner Assistance Information booklet for addresses of GM Overseas offices.

When contacting Cadillac, please remember that your concern will likely be resolved in the dealership, using the dealer's facilities, equipment and personnel. That is why we suggest you follow Step One first if you have a concern.

Customer Assistance for Text Telephone (TTY) Users

To assist customers who are deaf, hard of hearing, or speech-impaired and who use Text Telephones (TTYs), Cadillac has TTY equipment available at its Customer Assistance Center. Any TTY user can communicate with Cadillac by dialing: 1-800-833-CMCC. (TTY users in Canada can dial 1-800-263-3830.)

Roadside Service



Cadillac's exceptional Roadside Service is more than an auto club or towing service. It provides every Cadillac owner with the advantage of contacting a Cadillac advisor and, when appropriate, a Cadillac trained dealer technician who can provide on-site service.

Each technician travels with a specially equipped service vehicle complete with the necessary Cadillac parts and tools required to handle most roadside repairs.

Cadillac Roadside Service can be reached by dialing 1-800-882-1112, 24 hours a day, 365 days a year. This service is provided at no charge for any warranty-covered situation and for a nominal charge if the Cadillac is no longer under warranty. Roadside Service is available only in the United States and Canada.

Cadillac Owner Privileges™

Roadside Service provides several Cadillac Owner Privileges™ at "no charge," throughout your *1997 Cadillac Warranty Period -- 48 Months/ 50,000 miles (80 000 km).*



Emergency Road Service is performed on site for the following situations:

- Towing Service
- Battery Jump Starting
- Lock Out Assistance
- Fuel Delivery
- Flat Tire Change (Covers change only)
- Trip Interruption -- If your trip is interrupted due to a warranty failure, incidental expenses may be reimbursed during the 48 months/50,000 miles (80 000 km) warranty period. Items covered are hotel, meals and rental car.

Roadside Service Availability

Wherever you drive in the United States or Canada, an advisor is available to assist you over the phone. A dealer technician, if available, can travel to your location within a 30 mile (50 km) radius, of a participating Cadillac dealership. If beyond this radius, we will arrange to have your car towed to the nearest Cadillac dealership.

Reaching Roadside Service

Dial the toll-free Roadside Service number: 1-800-882-1112. An experienced Roadside Service Advisor will assist you and request the following information:

- A description of the problem
- Name, home address, home telephone number
- Location of your Cadillac and number you are calling from
- The model year, Vehicle Identification Number (VIN), mileage and date of delivery



Roadside Service for the Hearing or Speech Impaired

Roadside Service is prepared to assist owners who have hearing difficulties or are speech impaired. Cadillac has installed special telecommunication devices called Text Telephone (TTY) in the Roadside Service Center.

Any customer who has access to a (TTY) or a conventional teletypewriter can communicate with Cadillac by dialing from the United States or Canada 1-800-833-CMCC -- daily, 24 hours.



Our Cadillac Dealer Technician network is ready and able to assist Cadillac customers at roadside.



Gold Key Courtesy Transportation

One of your Cadillac Owner Privileges is Gold Key Courtesy Transportation. It is just one more example of Cadillac's commitment to provide the services you expect and deserve as a Cadillac owner.

Gold Key Courtesy Transportation helps you get where you need to be when your Cadillac is in the dealership for warranty service.*

In Canada, please consult your GM dealer for information on Courtesy Transportation.

Transportation Options*

Warranty work can frequently be handled in one day, but there is often no reason for you to wait at the dealership. Cadillac helps minimize inconvenience to you by providing several transportation options. Depending on the circumstances, your dealership can offer you one of the following options:

Shuttle Service*

Your dealership can provide you with shuttle service to get you to your destination with minimal interruption of your daily schedule when your Cadillac is unavailable due to a warranty repair.

Courtesy Vehicle*

For repairs that require your vehicle to be unavailable to you for an extended period of time, your dealer may arrange to provide you with a courtesy vehicle from the dealership, or one obtained from a local rental agency.

Miscellaneous Service*

Should the situation necessitate making your own arrangements, Gold Key Courtesy Transportation provides for reimbursement of personally arranged transportation such as cab fare, reasonable fuel expenses for a ride provided by another individual or a rental vehicle obtained from an independent source.

**Some restrictions may apply. Please consult your Cadillac dealer concerning specific Gold Key Courtesy Transportation benefits offered by the dealership.*

Plan Ahead When Possible

Whenever possible, scheduling an appointment for your vehicle's warranty service and advising your service consultant that you wish to take advantage of Gold Key Courtesy Transportation can help minimize your inconvenience by allowing your dealer to prepare arrangements to fulfill your transportation needs in advance of your visit.

Owner Responsibilities

You are responsible for primary insurance coverage of the vehicle provided. In many cases, your own auto insurance policy may provide this coverage under provisions for rental car agreements. Please consult your insurance carrier to be certain of what's covered.

While your dealership will cover the rental expense of a vehicle provided under the provisions of Gold Key Courtesy Transportation, you are responsible for charges incurred for such items as fuel used, additional insurance coverage and any taxes or fees levied by state or local governmental agencies.

It is important that your vehicle be picked up from the dealership promptly following the completion of your repairs. If your vehicle is not picked up from the dealership within a reasonable amount of time following notification from the dealer, you may be responsible for any additional rental charges incurred as a result of this delay.

For Canadian Vehicles

In Canada, for warranty repairs during the Complete Vehicle Coverage period in the New Vehicle Limited Warranty, interim transportation may be available under the Courtesy Transportation Program. Please consult your dealer for details.

GM Participation in an Alternative Dispute Resolution Program

This program is available in all 50 states and the District of Columbia. Canadian owners refer to your Warranty and Owner Assistance Information booklet for information on the Canadian Motor Vehicle Arbitration Plan (CAMVAP). General Motors reserves the right to change eligibility limitations and/or to discontinue its participation in this program.

Both Cadillac and your Cadillac dealer are committed to making sure you are completely satisfied with your new vehicle. Our experience has shown that, if a situation arises where you feel your concern has not been adequately addressed, the Customer Satisfaction Procedure described earlier in this section is very successful.

There may be instances where an impartial third party can assist in arriving at a solution to a disagreement regarding vehicle repairs or interpretation of the New Vehicle Limited Warranty. To assist in resolving these disagreements, Cadillac voluntarily participates in BBB AUTO LINE.

BBB AUTO LINE is an out-of-court program administered by the Better Business Bureau system to settle automotive disputes. This program is available free of charge to customers who currently own or lease a GM vehicle.

If you are not satisfied after following the Customer Satisfaction Procedure, you may contact the BBB using the toll-free telephone number, or write them at the following address:

BBB AUTO LINE
Council of Better Business Bureaus, Inc.
4200 Wilson Boulevard
Suite 800
Arlington, VA 22203-1804
Telephone: 1-800-955-5100

To file a claim, you will be asked to provide your name and address, your Vehicle Identification Number (VIN) and a statement of the nature of your complaint. Eligibility is limited by vehicle age and mileage, and other factors.

We prefer you utilize the Customer Satisfaction Procedure before you resort to AUTO LINE, but you may contact the BBB at any time. The BBB will attempt to resolve the complaint serving as an intermediary. If this mediation is unsuccessful, an informal hearing will be scheduled where eligible customers may present their case to an impartial third-party arbitrator.

The arbitrator will make a decision which you may accept or reject. If you accept the decision, GM will be bound by that decision. The entire dispute resolution procedure should ordinarily take about 40 days from the time you file a claim until a decision is made.

Some state laws may require you to use this program before filing a claim with a state-run arbitration program or in the courts. For further information, contact the BBB at 1-800-955-5100 or the Cadillac Customer Assistance Center at 1-800-458-8006.

Warranty Information

Your vehicle comes with a separate warranty booklet that contains detailed warranty information.

REPORTING SAFETY DEFECTS TO THE UNITED STATES GOVERNMENT

If you believe that your vehicle has a defect which could cause a crash or could cause injury or death, you should immediately inform the National Highway Traffic Safety Administration (NHTSA), in addition to notifying General Motors.

If NHTSA receives similar complaints, it may open an investigation, and if it finds that a safety defect exists in a group of vehicles, it may order a recall and remedy campaign. However, NHTSA cannot become involved in individual problems between you, your dealer or General Motors.

To contact NHTSA, you may either call the Auto Safety Hotline toll-free at 1-800-424-9393 (or 366-0123 in the Washington, D.C. area) or write to:

NHTSA, U.S. Department of Transportation
Washington, D.C. 20590

You can also obtain other information about motor vehicle safety from the Hotline.

REPORTING SAFETY DEFECTS TO THE CANADIAN GOVERNMENT

If you live in Canada, and you believe that your vehicle has a safety defect, you should immediately notify Transport Canada, in addition to notifying General Motors of Canada Limited. You may write to:

Transport Canada
Box 8880
Ottawa, Ontario K1G 3J2

REPORTING SAFETY DEFECTS TO GENERAL MOTORS

In addition to notifying NHTSA (or Transport Canada) in a situation like this, we certainly hope you'll notify us. Please call us at 1-800-458-8006 or write:

Cadillac Customer Assistance Center
Cadillac Motor Car Division
30009 Van Dyke
P.O. Box 9025
Warren, MI 48090-9025

In Canada, please call us at 1-800-263-3777 (English) or 1-800-263-7854 (French). Or, write:

General Motors of Canada Limited
Customer Communication Centre, 163-005
1908 Colonel Sam Drive
Oshawa, Ontario L1H 8P7

Ordering Service and Owner Publications in Canada

Service manuals, service bulletins, owner's manuals and other service literature are available for purchase for all current and past model General Motors vehicles.

The toll-free telephone number for ordering information in Canada is 1-800-668-5539.

1997 CADILLAC SERVICE PUBLICATIONS ORDERING INFORMATION

The following publications covering the operation and servicing of your vehicle can be purchased by filling out the Service Publication Order Form in this book and mailing it in with your check, money order, or credit card information to Helm, Incorporated (address below.)

CURRENT PUBLICATIONS FOR 1997 CADILLAC

SERVICE MANUALS

Service Manuals have the diagnosis and repair information on engines, transmission, axle, suspension, brakes, electrical, steering, body, etc.

RETAIL SELL PRICE: \$90.00

TRANSMISSION, TRANSAXLE, TRANSFER CASE UNIT REPAIR MANUAL

This manual provides information on unit repair service procedures, adjustments and specifications for the 1997 GM transmissions, transaxles and transfer cases.

RETAIL SELL PRICE: \$40.00

SERVICE BULLETINS

Service Bulletins give technical service information needed to knowledgeably service General Motors cars and trucks. Each bulletin contains instructions to assist in the diagnosis and service of your vehicle.

PLEASE COMPLETE THE ORDER FORM SHOWN ON THE FOLLOWING PAGE AND MAIL TO:

Helm, Incorporated • P.O. Box 07130 • Detroit, MI 48207

OWNER'S INFORMATION

Owner publications are written directly for Owners and intended to provide basic operational information about the vehicle. The owner's manual will include the Maintenance Schedule for all models.

In-Portfolio: Includes a Portfolio, Owner's Manual and Warranty Booklet.

RETAIL SELL PRICE: \$15.00

Without Portfolio: Owner's Manual only.

RETAIL SELL PRICE: \$10.00

CURRENT & PAST MODEL ORDER FORMS

Service Publications are available for current and past model GM vehicles. To request an order form, please specify year and model name of the vehicle.

OR ORDER TOLL FREE: 1-800-782-4356

Monday-Friday 8:00 AM – 6:00 PM Eastern Time

For Credit Card Orders Only (VISA–MasterCard–Discover)

ORDER TOLL FREE*(NOTE: For Credit Card Holders Only)***1-800-782-4356***(Monday-Friday 8:00 AM - 6:00 PM EST)**FAX Orders Only 1-313-865-5927*

Orders will be mailed within 10 days of receipt. Please allow adequate time for postal service. If further information is needed, write to the address shown below or call 1-800-782-4356. Material cannot be returned for credit without packing slip with return information within 30 days of delivery. On returns, a re-stocking fee may be applied against the original order.

1 9 9 7 G M	PUBLICATION FORM NUMBER	ITEM DESCRIPTION	VEHICLE MODEL		QTY.	PRICE EACH*	TOTAL PRICE
			NAME	YEAR			
		Service Manual		1997		\$90.00	
		Car & Light Truck Transmission Unit Repair		1997		\$40.00	
		Owner's Manual In Portfolio		1997		\$15.00	
		Owner's Manual Without Portfolio		1997		\$10.00	

NOTE: Dealers and Companies please provide dealer or company name, and also the name of the person to whose attention the shipment should be sent.
Mail completed order form to:
HELM, INCORPORATED • P.O. Box 07130 • Detroit, MI 46207
For purchases outside U.S.A. please write to the above address for quotation.

(CUSTOMER'S NAME) (ATTENTION)

(STREET ADDRESS—NO P.O. BOX NUMBERS)

(CITY) (STATE) (ZIP CODE)

DAYTIME TELEPHONE NO. () _____
AREA CODE

**P
A
Y
M
E
N
T**
 Check or Money
Order payable to
Helm, Inc. (USA funds
only — *do not send cash.*)

 MasterCard

 VISA

 Discover

 Account Number

 Expiration Date month Check here if your billing address is different from your shipping address shown.

CUSTOMER SIGNATURE**TOTAL MATERIAL**Michigan Purchasers
add 6% sales tax

U.S. Order Processing

\$5.00Canadian Postage
(See Note Below)**GRAND TOTAL**

GM-CAD-ORD97

*(Prices are subject to change without notice and without incurring obligation. Allow ample time for delivery.)

Note to Canadian Customers: All listed prices are quoted in U.S. funds. Canadian residents are to make checks payable in U.S. funds. To cover Canadian postage, add \$11.50 plus the U.S. order processing.

 NOTES

 NOTES



Section 8 Index

A BS	4-7	Appearance Care Materials	6-53
A/C Off For Engine Protection Message	2-89	Apply Brake To Shift Message	2-89
Adding Equipment to the Outside of Your Vehicle	6-3	Arbitration Program	7-11
Air Bag	1-21	Armrest, Storage	2-58, 2-59
How Does it Restrain	1-25	Ashtrays	2-60
How it Works	1-23	Assist Handles	2-62
Location	1-23	Astrorooft	2-63
Readiness Light	1-22, 2-75	Audio Equipment, Adding	3-26
Servicing	1-26	Audio Steering Wheel Controls	3-25
What Makes it Inflate	1-24	Audio Systems	3-10
What Will You See After it Inflates	1-25	Automatic Door Locks	2-5
When Should it Inflate	1-24	Automatic Overdrive	2-26
Air Cleaner	6-14	Automatic Pull-Down Feature	2-15
Air Conditioning	3-7	Automatic Transaxle	
Air Conditioning Refrigerants	6-65	Operation	2-24
Air Control, Climate Control System	3-2	Shifting	2-24
Alarm, Theft-Deterrent	2-16	Starting Your Engine	2-21
Alignment and Balance, Tire	6-43	Fluid	6-17
Aluminum Wheels, Cleaning	6-51		
Analog Control Buttons	2-88	B attery	6-30
Antenna, Power	3-28	Charging System Indicator Light	2-76
Antifreeze	6-21	Jump Starting	5-4
Anti-Lock		No Charge Message	2-90
Brake System Warning Light	2-78, 4-7	Replacement, Remote Keyless Entry	2-11
Brakes	4-7	Volts High Message	2-90
Anti-Lockout Feature	2-7	Volts Low Message	2-90
Anti-Theft, Radio	3-25	Warnings	5-4, 5-6
Appearance Care	6-45	Battery Guard Storage	2-51

Battery Saver	2-49	Central Door Unlocking System	2-4
Exterior Lighting	2-49	Certification Label	4-31
Inadvertent Power	2-51	Chains, Safety	4-36
BBB Auto Line	7-11	Chains, Tire	6-45
Better Business Bureau Mediation	7-11	Change Engine Oil Message	2-90
Brake		Change Trans Fluid Message	2-90
Adjustment	6-29	Changing a Flat Tire	5-26
Fluid	6-27	Charging System Indicator Light	2-76
Master Cylinder	6-27	Check Brake Fluid Level Message	2-90
Parking	2-28	Check Coolant Level Message	2-91
Pedal Travel	6-29	Check Fuel Gage Message	2-91
Replacing System Parts	6-30	Check Oil Level Message	2-91
System Warning Light	2-76	Check Washer Fluid Message	2-91
Trailer	4-36	Checking Your Restraint Systems	1-43
Transaxle Shift Interlock	2-32	Chemical Paint Spotting	6-52
Vacuum Problem Message	2-90	Child Restraints	1-33
Wear	6-29	Securing in a Rear Outside Seat Position	1-34
Brakes, Anti-Lock	4-7	Securing in the Center Rear Seat Position	1-36
Braking	4-6	Securing in the Right Front Seat Position	1-38
Braking in Emergencies	4-10	Top Strap	1-34
Break-In, New Vehicle	2-19	Where to Put	1-33
Brightness Control	2-49	CHMSL	6-34
BTSI	2-32	Chrome Wheels, Cleaning	6-51
Bulb Replacement	6-31	Cigarette Lighter	2-60
		Circuit Breakers and Fuses	6-58
C apacities and Specifications	6-64	Cleaner, Air	6-14
Carbon Monoxide	2-33, 4-29, 4-35	Cleaning	
Cassette Tape Player	3-10, 3-14, 3-17	Aluminum or Chrome Wheels	6-51
Cassette Tape Player Care	3-27	Fabric	6-46, 6-47
Cellular Telephone	2-61	Glass	6-49
Center Console Storage Area	2-58	Inside of Your Cadillac	6-46
Center High-Mounted Stoplamp, Bulb Replacement	6-34	Instrument Panel	6-48
Center Passenger Position	1-30	Leather	6-48
		Outside of Your Cadillac	6-50

Speaker Covers	6-49	Cruise Engaged Message	2-91
Special Problems	6-47	Cupholders	2-59
Stains	6-47, 6-48	Customer Assistance for Text Telephone Users	7-4
Tires	6-52	Customer Assistance Information	7-1
Vinyl	6-48	Customer Satisfaction Procedure	7-2
Wheels	6-51	CV-RTD (CV-RSS)	2-96
Windshield and Wiper Blades	6-50		
Wood Panels	6-48	D amage, Finish	6-52
Climate Control Personalization	3-10	Damage, Sheet Metal	6-52
Climate Control, Steering Wheel Controls	3-9	Daytime Running Lamps	2-46
Climate Control System	3-2	Dead Battery	5-4
Climate Control Panel	3-2	Defects, Reporting Safety	7-12, 7-13
Clock, Setting the	3-10	Defensive Driving	4-2
Comfort Controls	3-2	Defogger, Rear Window	3-9
Compact Disc Care	3-28	Defrosting	3-8
Compact Disc Player	3-21	DIC	2-85
Compact Disc Player Errors	3-24	Digital Control Buttons	2-86
Compact Spare Tire	5-36	Dimensions, Vehicle	6-65
Compass, Rearview Mirror with	2-53	Dolby [®] B Noise Reduction	3-13, 3-17, 3-21
Console Shift Lever	2-30	Door	
Continuous Variable - Real Time Damping	2-96	Central Unlocking System	2-4
Control of a Vehicle	4-6	Locks	2-4
Convenience Net	2-59	Map Pocket	2-58
Convex Outside Mirror	2-57	Open Message	2-91
Coolant	6-21	Driver Door Open Message	2-91
Heater, Engine	2-23	Driver Information Center	2-85
Surge Tank	5-21	Driver Information Center Messages	2-89
Cooling System	5-19	Driver Position	1-12
Cornering Lamps	2-47	Driver's Outside Auto-Dimming Rearview Mirror	2-57
Cruise Control	2-41		

Driving	
City	4-21
Defensive	4-2
Drunken	4-3
Freeway	4-22
In a Blizzard	4-28
In Foreign Countries	6-4
In the Rain	4-18
Night	4-16
On Curves	4-11
On Grades While Towing a Trailer	4-37
On Hill and Mountain Roads	4-24
On Snow and Ice	4-27
Through Water	4-20
Wet Roads	4-18
Winter	4-26
With a Trailer	4-36
DRL	2-46
Drunken Driving	4-3
ECC	3-2
Electrical Equipment, Adding	2-22, 3-26, 6-55
Electrical System	6-55
Electrochromic Day/Night Rearview Mirror	2-52, 2-53
Electronic Climate Control	3-2
Electronic Level Control	4-32
Electronic Solar Sensor	3-6
Engine	6-9
Compartment Fuse Block	6-58
Coolant	6-21
Coolant Heater	2-23
Coolant Hot-Idle Engine Message	2-91
Coolant Temperature Gage	2-80
Coolant Temperature Warning Light	2-79
Exhaust	2-33
Identification	6-54
Misfire -- Ease Off Gas Pedal Message	2-92
Overheating	5-16
Running While Parked	2-34
Specifications	6-64
Starting Your	2-21
Engine Oil	6-10
Adding	6-11
Additives	6-13
Checking	6-11
Used	6-14
What Kind of Oil to Use	6-12
When to Change	6-13
Engine Speed Limiter	2-74
English/Metric Display	2-73
Ethanol	6-4
Exhaust, Engine	2-33
Express-Down Window	2-35
Exterior Lighting	2-10
Exterior Lighting Battery Saver	2-49
F abric Cleaning	6-46, 6-47
Fan Button	3-2
Filling Your Tank	6-5
Filter, Air	6-14
Finish Care	6-51
Finish Damage	6-52
First Gear, Automatic Transaxle	2-27
Flash-To-Pass Feature	2-38
Flashers, Hazard Warning	5-2
Flat Tire, Changing	5-26
Floor Mats	2-62
Fluid Capacities	6-64

Fog Lamps	2-47	On Reminder	2-46
Foreign Countries, Fuel	6-4	Suggested Message	2-46, 2-47
French Language Manual	ii	Wiper Activated	2-45
Front Towing	5-10, 5-12	Wiring	6-55
Front Turn Signal Lamps, Bulb Replacement	6-33	Hearing Impaired, Customer Assistance	7-4
Fuel	6-3	Heated Seats	1-4
Data Panel	2-84	Heating	3-7
Door Lock Release	6-5	High-Beam Headlamps	2-37
Filling Your Tank	6-5	Highway Hypnosis	4-24
Gage	2-83	Hill and Mountain Roads	4-24
In Foreign Countries	6-4	Hitches, Trailer	4-35
Level Low Message	2-92	Hood	
Fuses and Circuit Breakers	6-58	Checking Things Under	6-7
G ages		Release	6-8
Engine Coolant Temperature	2-80	Hooks, Garment	2-62
Fuel	2-83	Horn	2-36
Tachometer	2-73	How to Reset the Oil Life Indicator	6-14
Garment Hooks	2-62	HVAC Steering Wheel Controls	3-9
GAWR	4-31	Hydraulic Brake Warning Lights	2-76
Gear Positions, Automatic Transaxle	2-24	Hydroplaning	4-20
Glove Box	2-57	I ce Possible Message	2-92
Gold Key Courtesy Transportation	7-8	Ignition Positions	2-20
Gross Axle Weight Rating	4-31	Illuminated Entry	2-50
Gross Vehicle Weight Rating	4-31	Illuminated Visor Vanity Mirror	2-61
Guide en Français	ii	Inflation, Tire	6-38
GVWR	4-31	Instrument Panel	2-68
H alogen Bulbs	6-31	Brightness Control	2-49
Handles, Assist	2-62	Cleaning the Top	6-48
Hazard Warning Flashers	5-2	Clusters	2-70, 2-71
Head Restraints	1-6	Interior Lamps	2-49
Headlamps	2-45	J ack, Tire	5-29
Bulb Replacement	6-31	Jump Starting	5-4
High/Low Beam Changer	2-37		

K eyless Entry System, Remote	2-7	Fuel Door Release	6-5
Keys	2-2	Power Door	2-5
L abels		Programmable Automatic Door	2-5
Certification	4-31	Rear Door Security	2-6
Service Parts Identification	6-54	Trunk Release	2-13
Tire-Loading Information	4-30	Lumbar Controls	1-2
Vehicle Identification Number	6-54	M agnasteer™	4-10
Lamps	2-45	Maintenance, Normal Replacement Parts	6-65
Interior	2-49	Maintenance, Underbody	6-52
On Reminder	2-46	Maintenance When Trailer Towing	4-38
Panel	2-49	Malfunction Indicator Lamp	2-80
Underhood	6-10	Map Pocket	2-58
Leaving Your Vehicle	2-7	Matching Transmitters To Your Vehicle	2-11
Leaving Your Vehicle with the Engine Running	2-31	MaxiFuses/Relay Center	6-55
Light Sensor, Twilight Sentinel	2-49	Memory and Personalization Features	2-85
Lighter	2-60	Memory Seat and Mirrors	1-3
Lights		Methanol	6-4
Air Bag Readiness	1-22, 2-75	Mirrors	2-52, 2-53
Anti-Lock Brake System Warning	2-78, 4-7	Convex Outside	2-57
Brake System Warning	2-76	Driver's Outside Auto-Dimming Rearview	2-57
Charging System Indicator	2-76	Illuminated Visor Vanity	2-61
Engine Coolant Temperature Warning	2-79	Memory Seat and Mirrors	1-3
Interior	2-49	Power Remote Control	2-56
Oil Pressure	2-82	MMT	6-3
Parking Brake Indicator	2-77	Model Reference	ii
Safety Belt Reminder	1-7, 2-75	Monitored Systems OK Message	2-92
Service Engine Soon	2-80	Mountain Roads	4-24
Traction Control System Warning	2-78, 4-9	Multifunction Lever	2-37
Loading Your Vehicle	4-30	N et, Convenience	2-59
Locks	2-4	Neutral, Automatic Transaxle	2-26
Anti-Lockout Feature	2-7	New Vehicle "Break-In"	2-19
Automatic Door	2-5	Night Vision	4-17
Door	2-4		

O dometer	2-72	Door Locks	2-5
Odometer, Trip	2-72	Remote Control Mirror	2-56
Off-Road Recovery	4-13	Seat	1-2
Oil, Engine	6-10	Steering	4-10
Oil Life Indicator	2-97	Steering Fluid	6-25
Oil Life Indicator, How to Reset	6-14	Windows	2-35
Oil Pressure Light	2-82	Windows and Other Power Options	6-55
OnStar System	2-62	Power Seat	1-2
Overdrive, Automatic Transaxle	2-26	Lumbar Controls	1-2
Overheated Engine Protection Operating Mode	5-16	Memory Function	1-3
Overheating Engine	5-16	Pregnancy, Use of Safety Belts	1-20
Owner Publications, Ordering	7-13, 7-14	Problems on the Road	5-1
P aint Spotting, Chemical	6-52	Programable Automatic Door Locks	2-5
Parade Dimming	2-50	Publications, Service and Owner	7-13, 7-14
P ARK (P)		Pull-Down Feature, Automatic	2-15
Automatic Transaxle	2-24	R adio Personalization	3-25
Shifting Into	2-29	Radio Reception	3-26
Shifting Out of	2-32	Radio Theft-Deterrent Feature	3-25
P arking		Radios	3-10, 3-14, 3-17
At Night	2-16	Rain, Driving In	4-18
Brake	2-28	Rainsense Wipers	2-39
Brake Indicator Light	2-77	RAP	2-21
Lots	2-16	Reading Lamps	2-50
Over Things That Burn	2-33	R ear	
With a Trailer	4-38	Compartment Fuse Block	6-62
Pass Key Not Programmed Message	2-92	Door Security Locks	2-6
Passenger's Side Temperature Button	3-2	Outside Seat Position	1-27
Passing	4-13	Seat Passengers	1-27
PASS-Key [®] II	2-18	Storage Armrest	2-59
PCM Fault Message	2-92	Towing	5-10, 5-14
P ower		Window Defogger	3-9
Accessory, Retained	2-21	Rear Turn Signal Lamps, Bulb Replacement	6-34
Antenna Mast Care	3-28	Rearview Mirrors	2-52, 2-53

Recirculation	3-6	Adults	1-12
Reclining Front Seatbacks	1-4	Care	6-49
Reduced Engine Power Message	2-92	Center Passenger Position	1-30
Refrigerants, Air Conditioning	6-65	Children	1-31
Remote		Driver Position	1-12
Confirmation	2-9	Extender	1-43
Fuel Door Release	6-5	How to Wear Properly	1-12
Keyless Entry	2-7	Incorrect Usage	1-16, 1-41, 1-42
Recall Memory	2-10	Lap Belt	1-30
Trunk Release	2-13	Lap-Shoulder	1-12, 1-27
Remove Key Message	2-92	Larger Children	1-40
Replacement		Questions and Answers	1-11
Bulbs	6-64	Rear Seat Outside Passenger Positions	1-27
Normal Maintenance Parts	6-65	Rear Seat Passengers	1-27
Wheel	6-43	Reminder Light	1-7, 2-75
Replacing Safety Belts	1-43	Replacing After a Crash	1-43
Reporting Safety Defects	7-12, 7-13	Right Front Passenger Position	1-21
Restraints		Shoulder Belt Height Adjuster	1-14
Checking	1-43	Shoulder Belt Tightness Adjustment	1-14
Child	1-33	Smaller Children and Babies	1-31
Head	1-6	Use During Pregnancy	1-20
Replacing Parts After a Crash	1-43	Why They Work	1-8
Retained Accessory Power	2-21	Safety Chains	4-36
Reverse, Automatic Transaxle	2-25	Safety Defects, Reporting	7-12, 7-13
Right Front Passenger Position	1-21	Safety Warnings and Symbols	xi
RKE	2-7	Seatback, Reclining Front	1-4
RKE Personalization Features	2-9	Seats	
Roadside Service	7-5	Heated	1-4
Rocking Your Vehicle	5-38	Lumbar Control	1-2
Rotation, Tires	6-39	Memory Function	1-3
		Power	1-2
		Restraint Systems	1-1
		Seat Controls	1-2
		Securing a Child Restraint	1-34, 1-36, 1-38
S afety Belt Extender	1-43		
Safety Belts	1-6		

Second Gear, Automatic Transaxle	2-27	Signaling Turns	2-37
Security Override	2-18	SIR	1-21
Security System	2-18	Skidding	4-15
Service	6-2	Sound Equipment, Adding	3-26
A/C System A/C Compressor Off Message	2-93	Spare Tire, Compact	5-36
Air Bag System Message	2-93	Speaker Covers, Cleaning	6-49
Brake Fluid Switch Message	2-93	Specifications and Capacities	6-64
Bulletins, Ordering	7-13, 7-14	Speech Impaired, Customer Assistance	7-4
Charging System Message	2-93	Speed Sensor Fault Message	2-94
Electrical System Message	2-93	Speedometer	2-72
Emissions System Message	2-93	Stability Engaged Message	2-94
Engine Cooling System Message	2-93	Stability Reduced Message	2-94
Engine Soon Light	2-80	Stains, Cleaning	6-47, 6-48
Fuel System Message	2-93	Starting Disabled Due to Theft System Remove	
Idle Control System Message	2-93	Ignition Key Message	2-94
Ignition System Message	2-93	Starting Your Engine	2-21
Manuals, Ordering	7-13, 7-14	Steam	5-17
Parts Identification Label	6-54	Steering	4-10
Publications, Ordering	7-13, 7-14	Column Shift Lever	2-30
Ride Control Message	2-93	In Emergencies	4-12
Steering System Message	2-93	Magnasteer™	4-10
Transmission Message	2-94	Power	4-10
Work, Doing Your Own	6-2	Tips	4-11
Service and Appearance Care	6-1	Wheel Controls	3-9, 3-26
Service and Owner Publications	7-13, 7-14	Wheel, Tilt	2-36
Servicing Your Air Bag-Equipped Cadillac	1-26	Stop Engine - Engine Overheated Message	2-94
Sheet Metal Damage	6-52	Stop Engine Low Oil Pressure Message	2-95
Shift Lever Positions	2-30	Storage Compartments	2-57
Shifting		Storage, Vehicle	6-30
Automatic Transaxle	2-24	Stuck: In Sand, Mud, Ice or Snow	5-37
Into PARK (P)	2-29	Sun Visors	2-60
Out of PARK (P)	2-32	Sunglasses Storage Compartment	2-58
Shoulder Belt Height Adjuster	1-14	Sunroof	2-63
Shoulder Belt Tightness Adjustment	1-14	Supplemental Inflatable Restraint	1-21

Surge Tank, Coolant	5-21	Treadwear	6-42
Surge Tank Pressure Cap	6-24	Uniform Quality Grading	6-42
Symbols, Vehicle	xiii	Wear Indicators	6-40
T achometer	2-73	Wheel Replacement	6-43
Taillamps, Bulb Replacement	6-34	When It's Time for New	6-40
Tape Player Care	3-27	Top Speed Fuel Cut-Off Message	2-95
Telephone, Cellular	2-61	Top Strap	1-34
Temperature Button, Passenger's Side	3-2	Torque Lock	2-32
Temperature Controls	3-2	Torque, Wheel Nut	5-33, 6-65
Theft	2-16	Towing a Trailer	4-32
Theft-Deterrent Alarm System	2-16	Towing Your Vehicle	5-9
Theft Security Override	2-18	Traction	
Theft System Problem/Car May Not Restart Message ..	2-95	Control System	4-9
Thermostat	6-24	Control System Warning Light	2-78, 4-9
Third Gear, Automatic Transaxle	2-27	Engaged Message	2-95
Tilt Steering Wheel	2-36	Off Message	2-95
Time, Setting the	3-10	Ready Message	2-95
Tire Loading	4-30	Suspended Message	2-95
Tire-Loading Information Label	4-30	Trailer	
Tires	6-37	Brakes	4-36
Alignment and Balance	6-43	Driving on Grades	4-37
Buying New	6-41	Driving with	4-36
Chains	6-45	Hitches	4-35
Changing a Flat	5-26	Maintenance When Towing	4-38
Cleaning	6-52	Parking on Hills	4-38
Compact Spare	5-36	Safety Chains	4-36
Inflation	6-38	Tongue Weight	4-34
Inspection and Rotation	6-39	Total Weight on Tires	4-35
Loading	4-30	Towing	4-32
Pressure	6-38	Turn Signals	4-37
Temperature	6-43	Weight	4-34
Traction	6-42	Trans Fluid Reset Message	2-95
		Transaxle Fluid, Automatic	6-17
		Transmission Hot Message	2-95

Transmitter, Universal	2-64	Ventilation System	3-7
Transmitters, Remote Keyless Entry	2-7	Very Low Refrigerant A/C Compressor Off Message ...	2-96
Transportation, Gold Key Courtesy	7-8	Visors, Sun	2-60
Trip Odometer	2-72		
Trunk		W arning Devices	5-4
Automatic Pull-Down Feature	2-15	Warning Lights, Gages and Indicators	2-74
Lock Release	2-13	Warranty Information	7-12
Mounted CD Changer	3-21	Washer Fluid, Windshield	6-26
Open Message	2-96	Washing Your Vehicle	6-50
Storage System	2-13	Weatherstrips	6-50
TTY Users	7-4	Wheel	
Turn and Lane Change Signals	2-37	Alignment	6-43
Turn Signal On Chime	2-37	Nut Torque	5-33, 6-65
Turn Signal On Message	2-37, 2-96	Replacement	6-43
Turn Signal/Multifunction Lever	2-37	Wrench	5-29
Turn Signals When Towing a Trailer	4-37	Windows	2-35
Twilight Sentinel	2-47	Express-Down	2-35
		Power	2-35
U nderbody Maintenance	6-52	Rear Lockout Switch	2-36
Underhood Lamp	6-10	Windshield Washer	2-40
Universal Transmitter	2-64	Fluid	2-40, 6-26
		Windshield Wipers	2-38
V ehicle		Blade Replacement	6-36
Control	4-6	Fuses	6-55
Damage Warnings	xii	Rainsense	2-39
Dimensions	6-65	Winter Driving	4-26
Identification Number	6-54	Wiper Activated Headlamps	2-45
Loading	4-30	Wiring, Headlamp	6-55
Speed Limited to XXX MPH AND YYY MPH	2-96	Wood Panels, Cleaning	6-48
Storage	6-31	Wrecker Towing	5-9
Vehicle Speed Limiter	2-73	Wrench, Wheel	5-29



Service Station Checkpoints

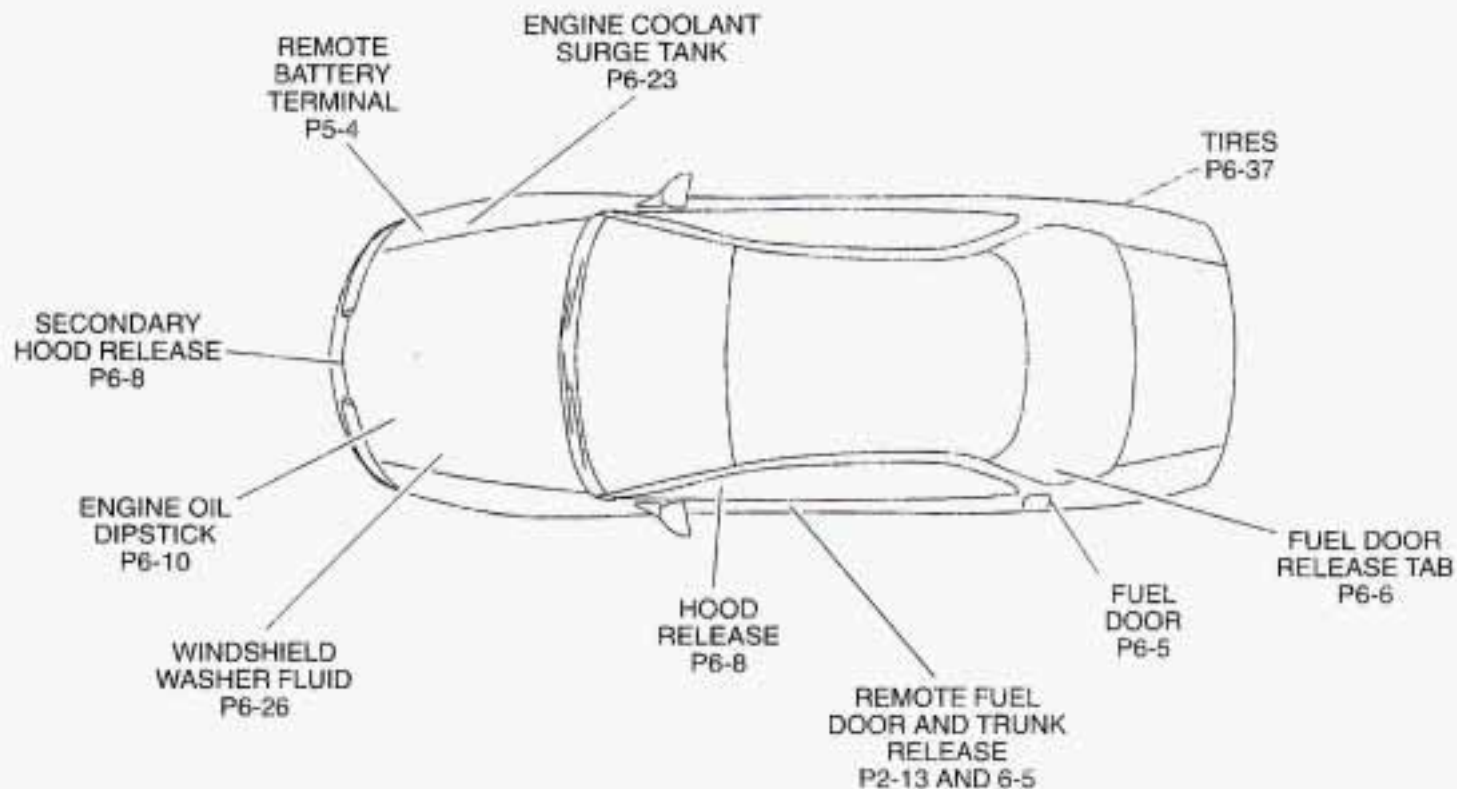

For detailed information, refer to the page number listed, or see the Index in the back of the owner's manual.



25649945B