



1997 RIVIERA



The 1997 Buick Riviera Owner's Manual

1-1 Seats and Restraint Systems

This section tells you how to use your seats and safety belts properly. It also explains the "SRS" system.

2-1 Features and Controls

This section explains how to start and operate your Buick.

3-1 Comfort Controls and Audio Systems

This section tells you how to adjust the ventilation and comfort controls and how to operate your audio system.

4-1 Your Driving and the Road

Here you'll find helpful information and tips about the road and how to drive under different conditions.

5-1 Problems on the Road

This section tells what to do if you have a problem while driving, such as a flat tire or overheated engine, etc.

6-1 Service and Appearance Care

Here the manual tells you how to keep your Buick running properly and looking good.

7-1 Maintenance Schedule

This section tells you when to perform vehicle maintenance and what fluids and lubricants to use.

8-1 Customer Assistance Information

This section tells you how to contact Buick for assistance and how to get service and owner publications. It also gives you information on "Reporting Safety Defects" on page 8-8.

9-1 Index

Here's an alphabetical listing of almost every subject in this manual. You can use it to quickly find something you want to read.



GENERAL MOTORS, GM, the GM Emblem, BUICK, the BUICK Emblem and the name RIVIERA are registered trademarks of General Motors Corporation.

This manual includes the latest information at the time it was printed. We reserve the right to make changes in the product after that time without further notice. For vehicles first sold in Canada, substitute the name "General Motors of Canada Limited" for Buick Motor Division whenever it appears in this manual.

Please keep this manual in your Buick, so it will be there if you ever need it when you're on the road. If you sell the vehicle, please leave this manual in it so the new owner can use it.

Litho in U.S.A.
Part No. 25645980 B First Edition



We support voluntary technician certification.

For Canadian Owners Who Prefer a French Language Manual:

Aux propriétaires canadiens: Vous pouvez vous procurer un exemplaire de ce guide en français chez votre concessionnaire ou au:

DGN Marketing Services Ltd.
1500 Bonhill Rd.
Mississauga, Ontario L5T 1C7

© Copyright General Motors Corporation 1996
All Rights Reserved

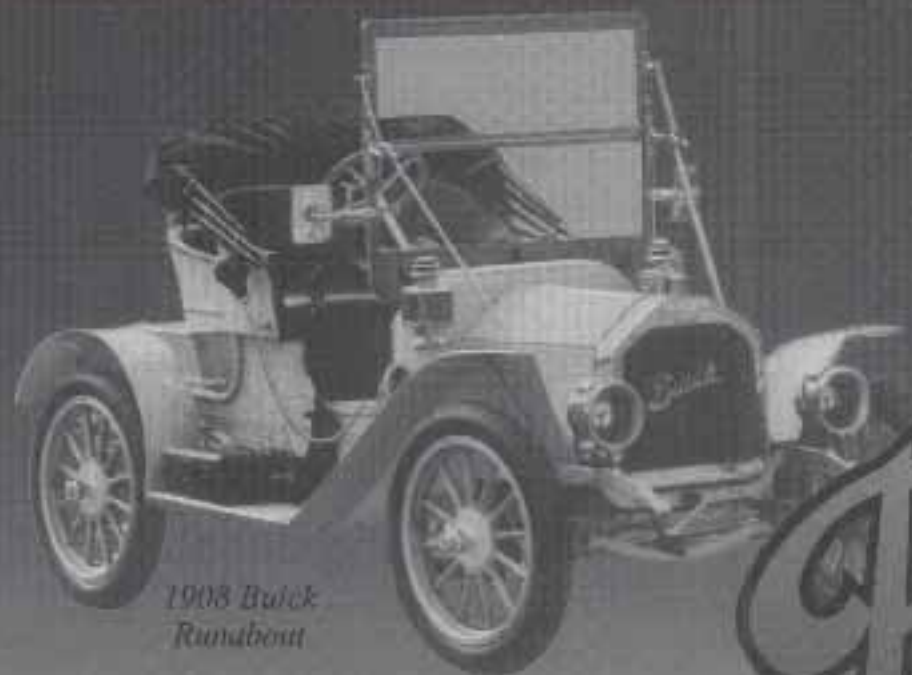

*1908 Buick
Runabout*

*Buick Motor Division
provides one of the most dramatic
and important chapters in the history
of the American automobile*

Buick



David Dunbar Buick



Walter Marr and Thomas Buick

Buick's chief engineer, Walter L. Marr (left), and Thomas D. Buick, son of founder David Dunbar Buick, drove the first Flint Buick in a successful Flint-Detroit round trip in July 1904.

David Buick was building gasoline engines by 1899, and Marr, his engineer, apparently built the first auto to be called a Buick in 1900. However, Buick traditionally dates its beginnings to 1903. That was the year the company was reorganized, refinanced and moved from Detroit to Flint. Buick has always been a product innovator. Buick engineers developed the

“valve-in-head” engine, a light, powerful and reliable engine which would eventually influence the entire automotive industry.

William C. Durant was instrumental in promoting Buicks across the country using his Durant-Dort Carriage Co. outlets and salespeople as the nucleus of a giant distribution system. He knew the Buick as a “self-seller.” If automobiles could be this good, he thought, maybe it was time to switch from the horse and buggy business to automobiles.



William C. (Billy) Durant

At the 1905 New York Auto Show, Durant took orders for 1,000 Buicks before the company had built 40. On Buick's success, Durant created a holding company, September 16, 1908. He called it General Motors.

Durant also created a racing team that won 500 racing trophies in 1909 and 1910, including successes at Indianapolis two years before the Indy 500 began.

The success of Buick engines was visible not only on the race track, but in endurance tests across the country and around the world. Buick was the only car to complete a 1,000-mile Chicago-to-New York race in 1906. And a Buick was the first car to travel across South America, driven from Buenos Aires, Argentina, over the Andes to Santiago, Chile in 1914.



1911 Model 21 Touring Car on Buick's Test Hill

Buick drew plenty of attention because it could climb hills and run through mud like no other car. Buick's endurance and reliability were world famous.

During World War I, Buick built Liberty aircraft engines as well as Red Cross ambulances so successfully that one Buick ambulance was awarded the Croix de Guerre by the French government.

As a builder of premier automobiles, Buick was hard hit by the Great Depression. However, new General Manager Harlow H. Curtice created popular new models including the Special and the Roadmaster. Buick sales soon flourished.



First Buick Factory

In World War II, Buick built aircraft engines, tanks and other military hardware. This post-war period brought great styling and engineering changes which resulted in increased sales. The torque converter automatic transmission, Dynaflo, was introduced in the 1948 Roadmaster. Buick's famous "portholes" came along in 1949.



1949 Roadmaster

A high-compression V-8 engine was introduced in 1953. And Buick's famous vertical pillar "toothy" grille (introduced in 1942) became more massive in the post-war era.



1953 Skylark

Motor Trend magazine named the 1962 Buick Special "Car of the Year." The first production V-6 engine was used in the Special.



1962 Buick Special

Built inside the walls of the old buildings in Buick's former Flint complex, which formed the cornerstone of General Motors, Buick City is a state-of-the-art assembly facility with more than 200 robots and other high-tech equipment. It was completed in the fall of 1985.

Buicks are, and will continue to be, premium American motorcars with smooth power, high performance, rich detail and comfortable accommodation.



Ed Mertz, General Manager, Buick Motor Division

Our mission is simple:

“Buick will provide Premium American Motorcars backed with services that exceed our customers' expectations, throughout the purchase, ownership, service and repurchase experience.”

Buicks are **SUBSTANTIAL**.

Buicks are **DISTINCTIVE**.

Buicks are **POWERFUL**.

Buicks are **PREMIUM**.

How to Use this Manual

Many people read their owner's manual from beginning to end when they first receive their new vehicle. If you do this, it will help you learn about the features and controls for your vehicle. In this manual, you'll find that pictures and words work together to explain things quickly.

Index

A good place to look for what you need is the Index in the back of the manual. It's an alphabetical list of all that's in the manual, and the page number where you'll find it.

Safety Warnings and Symbols

You will find a number of safety cautions in this book. We use a box and the word **CAUTION** to tell you about things that could hurt you if you were to ignore the warning.



CAUTION:

These mean there is something that could hurt you or other people.

In the caution area, we tell you what the hazard is. Then we tell you what to do to help avoid or reduce the hazard. Please read these cautions. If you don't, you or others could be hurt.



You will also find a circle with a slash through it in this book. This safety symbol means "Don't," "Don't do this," or "Don't let this happen."

Vehicle Damage Warnings

Also, in this book you will find these notices:

NOTICE:

These mean there is something that could damage your vehicle.

In the notice area, we tell you about something that can damage your vehicle. Many times, this damage would not be covered by your warranty, and it could be costly. But the notice will tell you what to do to help avoid the damage.

When you read other manuals, you might see CAUTION and NOTICE warnings in different colors or in different words.

You'll also see warning labels on your vehicle. They use the same words, CAUTION or NOTICE.

Vehicle Symbols

These are some of the symbols you may find on your vehicle.

For example, these symbols are used on an original battery:

CAUTION
POSSIBLE
INJURY



PROTECT
EYES BY
SHIELDING



CAUSTIC
BATTERY
ACID COULD
CAUSE
BURNS



AVOID
SPARKS OR
FLAMES



SPARK OR
FLAME
COULD
EXPLODE
BATTERY



These symbols are important for you and your passengers whenever your vehicle is driven:

DOOR LOCK
UNLOCK



FASTEN
SEAT
BELTS



POWER
WINDOW



AIR BAG



These symbols have to do with your lamps:

MASTER
LIGHTING
SWITCH



TURN
SIGNALS



PARKING
LAMPS



HAZARD
WARNING
FLASHER



DAYTIME
RUNNING
LAMPS



FOG LAMPS

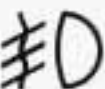

These symbols are on some of your controls:

WINDSHIELD
WIPER



WINDSHIELD
WASHER



WINDSHIELD
DEFROSTER



REAR
WINDOW
DEFOGGER



VENTILATING
FAN



These symbols are used on warning and indicator lights:

ENGINE
COOLANT
TEMP



BATTERY
CHARGING
SYSTEM



BRAKE



COOLANT



ENGINE OIL
PRESSURE



ANTI-LOCK
BRAKES



Here are some other symbols you may see:

FUSE



LIGHTER



HORN



SPEAKER



FUEL





Section 1 Seats and Restraint Systems

Here you'll find information about the seats in your Buick and how to use your safety belts properly. You can also learn about some things you should *not* do with air bags and safety belts.

1-2	Seats and Seat Controls	1-28	Rear Seat Passengers
1-6	Safety Belts: They're for Everyone	1-32	Rear Safety Belt Comfort Guides for Children and Small Adults
1-11	Here Are Questions Many People Ask About Safety Belts -- and the Answers	1-34	Children
1-12	How to Wear Safety Belts Properly	1-36	Child Restraints
1-13	Driver Position	1-44	Larger Children
1-20	Safety Belt Use During Pregnancy	1-47	Safety Belt Extender
1-21	Right Front Passenger Position	1-47	Checking Your Restraint Systems
1-21	Supplemental Restraint System (SRS)	1-48	Replacing Restraint System Parts After a Crash
1-27	Center Passenger Position		

Seats and Seat Controls

This section tells you about the seats -- how to adjust them, and also about memory seats, reclining seatbacks and head restraints.

Power Seats



The power seat controls are located on the side of the driver's and passenger's seats.

- Raise or lower the front of the seat by holding the front part of the horizontal control up or down.
- Raise or lower the rear of the seat by holding the rear part of the horizontal control up or down.
- Raise or lower the entire seat by holding the whole control up or down.
- Move the seat forward or back by holding the control to the front or back.

Power Lumbar Control (Option)

If you have this option, the driver's seatback lumbar support can be adjusted by moving the single switch located on the side of the seat. To increase or decrease support, hold the switch forward or rearward.

Memory Seat and Mirrors (Option)



The memory function controls the driver's seat cushion and outside mirror positions. It does not store the lumbar or recline positions.

To set your memory seat and mirrors:

1. Adjust the driver's seat to your desired position. Adjust both outside mirrors to suit you. See "Mirrors" in the Index.
2. Press the SET button and then press the 1 or 2 side of the MEMORY switch within five seconds. You will hear one beep when you press the SET button and two beeps when you press the MEMORY button to confirm that the mirror and seat positions are entered into memory.

When your Buick is in PARK (P) with the ignition on or OFF, press the same side of the MEMORY switch to recall the seat and mirror setting.

To do the same thing for a second driver, follow the preceding steps, but press the other side of the MEMORY switch.

The EXIT button allows you to get out of the car easily. When the gear shift selector is in PARK (P) with the ignition on or OFF, push EXIT and the seat will go all the way down and back.

Remote Keyless Entry Personal Choice Feature

Each remote keyless entry transmitter can be programmed to move the driver's seat and outside mirrors to a set memory position when the transmitter's UNLOCK button is pressed. For programming instructions, see "Personal Choice Features" in the Index.

Heated Front Seat (Option)



If your vehicle has this option, the switch is on the driver's armrest. With the ignition in ACCESSORY or RUN, press the button once and the seat will warm up. The HI light on the button will come on.

Press the button a second time and the LO light will come on. The seat will warm to a lower temperature.

Press the button a third time to turn off the heated seat. The heater will also turn off automatically when the ignition is turned off.

Reclining Front Seatbacks



The front seatbacks can be adjusted by pressing the vertical control located on the side of the seat. Push it forward to bring the seat to a more upright position. Push it rearward to recline the seatback.



But don't have a seatback reclined if your vehicle is moving.

CAUTION:

Sitting in a reclined position when your vehicle is in motion can be dangerous. Even if you buckle up, your safety belts can't do their job when you're reclined like this.

The shoulder belt can't do its job. In a crash you could go into it, receiving neck or other injuries.

The lap belt can't do its job either. In a crash the belt could go up over your abdomen. The belt forces would be there, not at your pelvic bones. This could cause serious internal injuries.

For proper protection when the vehicle is in motion, have the seatback upright. Then sit well back in the seat and wear your safety belt properly.

Head Restraints

Slide the head restraint up or down so that the top of the restraint is closest to the top of your ears. This position reduces the chance of a neck injury in a crash.

Seatback Latches

CAUTION:

If the seatback isn't locked, it could move forward in a sudden stop or crash. That could cause injury to the person sitting there. Always press rearward on the seatback to be sure it is locked.

The front seatback folds forward to let people get into the back seat. Your seatback will move back and forth freely, unless you come to a sudden stop. Then it will lock in place.

There's one time the seatback may not fold without some help from you. That's if your vehicle is parked going down a fairly steep hill.



To fold a seatback forward if it does lock in place, push the seatback toward the rear as you lift this latch. Then the seatback will fold forward. The latch must be down for the seat to work properly.

Safety Belts: They're for Everyone

This part of the manual tells you how to use safety belts properly. It also tells you some things you should not do with safety belts.

And it explains the Supplemental Restraint System (SRS), or air bag system.

⚠ CAUTION:

Don't let anyone ride where he or she can't wear a safety belt properly. If you are in a crash and you're not wearing a safety belt, your injuries can be much worse. You can hit things inside the vehicle or be ejected from it. You can be seriously injured or killed. In the same crash, you might not be if you are buckled up. Always fasten your safety belt, and check that your passengers' belts are fastened properly too.

⚠ CAUTION:

It is extremely dangerous to ride in a cargo area, inside or outside of a vehicle. In a collision, people riding in these areas are more likely to be seriously injured or killed. Do not allow people to ride in any area of your vehicle that is not equipped with seats and safety belts. Be sure everyone in your vehicle is in a seat and using a safety belt properly.



Your vehicle has a light that comes on as a reminder to buckle up. (See "Safety Belt Reminder Light" in the Index.)

In most states and Canadian provinces, the law says to wear safety belts. Here's why: *They work.*

You never know if you'll be in a crash. If you do have a crash, you don't know if it will be a bad one.

A few crashes are mild, and some crashes can be so serious that even buckled up a person wouldn't survive. But most crashes are in between. In many of them, people who buckle up can survive and sometimes walk away. Without belts they could have been badly hurt or killed.

After more than 25 years of safety belts in vehicles, the facts are clear. In most crashes buckling up does matter ... a lot!

Why Safety Belts Work

When you ride in or on anything, you go as fast as it goes.

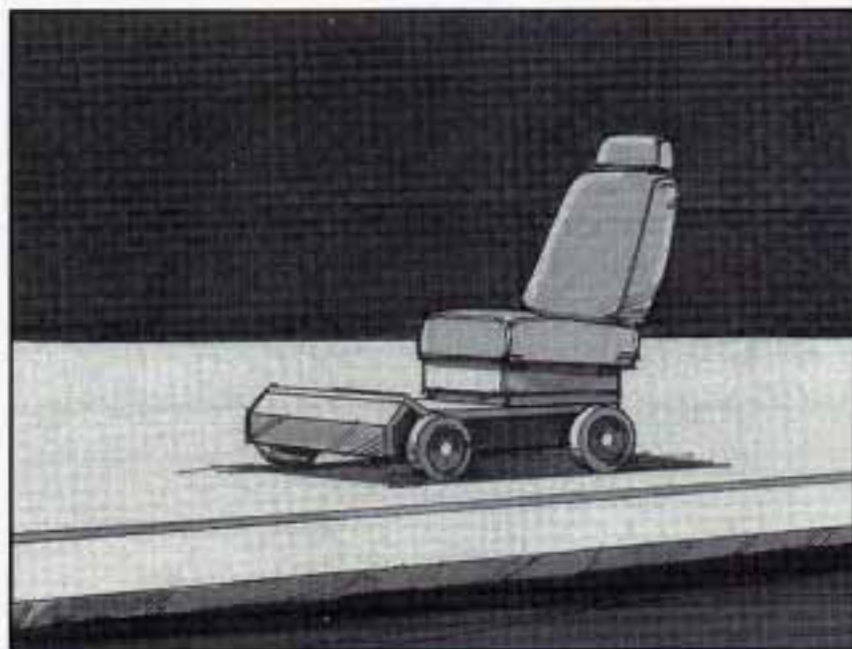

Take the simplest vehicle. Suppose it's just a seat on wheels.

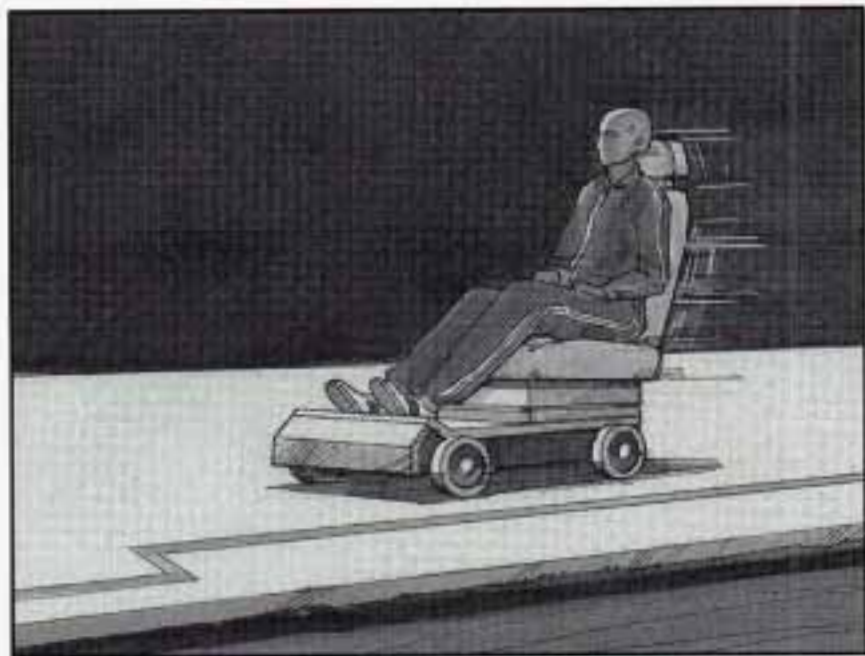

Put someone on it.

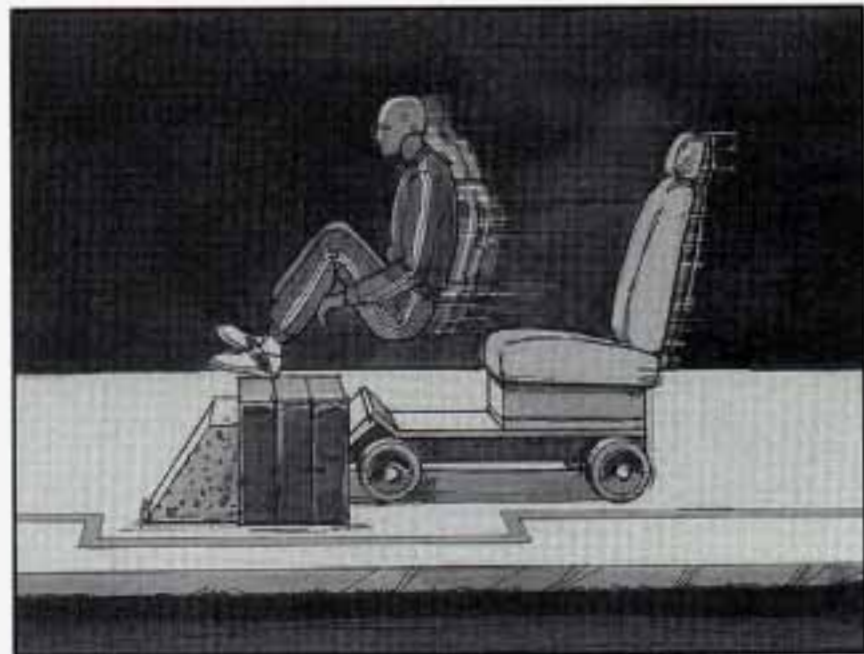

Get it up to speed. Then stop the vehicle. The rider doesn't stop.



The person keeps going until stopped by something.
In a real vehicle, it could be the windshield ...



or the instrument panel ...



or the safety belts!

With safety belts, you slow down as the vehicle does. You get more time to stop. You stop over more distance, and your strongest bones take the forces. That's why safety belts make such good sense.

Here Are Questions Many People Ask About Safety Belts -- and the Answers

Q: Won't I be trapped in the vehicle after an accident if I'm wearing a safety belt?

A: You *could* be -- whether you're wearing a safety belt or not. But you can unbuckle a safety belt, even if you're upside down. And your chance of being conscious during and after an accident, so you *can* unbuckle and get out, is *much* greater if you are belted.

Q: If my vehicle has air bags, why should I have to wear safety belts?

A: Air bags are in many vehicles today and will be in most of them in the future. But they are supplemental systems only; so they work *with* safety belts -- not instead of them. Every air bag system ever offered for sale has required the use of safety belts. Even if you're in a vehicle that has air bags, you still have to buckle up to get the most protection. That's true not only in frontal collisions, but especially in side and other collisions.

Q: If I'm a good driver, and I never drive far from home, why should I wear safety belts?

A: You may be an excellent driver, but if you're in an accident -- even one that isn't your fault -- you and your passengers can be hurt. Being a good driver doesn't protect you from things beyond your control, such as bad drivers.

Most accidents occur within 25 miles (40 km) of home. And the greatest number of serious injuries and deaths occur at speeds of less than 40 mph (65 km/h).

Safety belts are for everyone.

How to Wear Safety Belts Properly

Adults

This part is only for people of adult size.

Be aware that there are special things to know about safety belts and children. And there are different rules for smaller children and babies. If a child will be riding in your Buick, see the part of this manual called "Children." Follow those rules for everyone's protection.

First, you'll want to know which restraint systems your vehicle has.

We'll start with the driver position.

Driver Position

This part describes the driver's restraint system.

Lap-Shoulder Belt

The driver has a lap-shoulder belt. The shoulder portion of the belt has an energy management loop. It is designed to open and help protect you in certain crashes. If it opens, you will see a label on the safety belt that says to replace the belt. Be sure to do so. If you don't, the safety belt won't work properly and won't protect you in another crash. For more information on replacing safety belts after a crash, see "Replacing Safety Belts" in the Index.

Here's how to wear the lap-shoulder belt properly.

1. Close and lock the door.
2. Adjust the seat (to see how, see "Seats" in the Index) so you can sit up straight.
3. Pick up the latch plate and pull the belt across you. Don't let it get twisted.
4. Push the latch plate into the buckle until it clicks. Pull up on the latch plate to make sure it is secure. If the belt isn't long enough, see "Safety Belt Extender" at the end of this section. Make sure the release button on the buckle is positioned so you would be able to unbuckle the safety belt quickly if you ever had to.



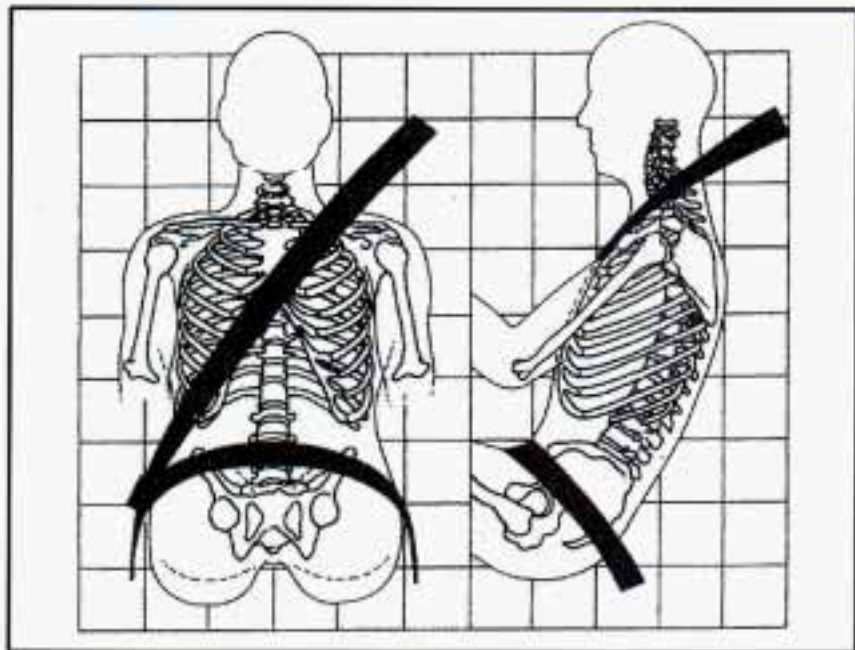

The lap part of the belt should be worn low and snug on the hips, just touching the thighs. In a crash, this applies force to the strong pelvic bones. And you'd be less likely to slide under the lap belt. If you slid under it, the belt would apply force at your abdomen. This could cause serious or even fatal injuries. The shoulder belt should go over the shoulder and across the chest. These parts of the body are best able to take belt restraining forces.

The safety belt locks if there's a sudden stop or crash.

Shoulder Belt Tightness Adjustment

Your car has a shoulder belt tightness adjustment feature. If the shoulder belt seems too tight, adjust it before you begin to drive.

1. Sit well back in the seat.
2. Start pulling the shoulder belt out.



3. Just before it reaches the end, give it a quick pull.
4. Let the belt go back all the way. You should hear a slight clicking sound. If you don't, the adjustment feature won't set, and you'll have to start again.



5. Now you can add a small amount of slack. Lean forward slightly, then sit back. If you've added more than 1 inch (25 mm) of slack, pull the shoulder belt out as you did before and start again.

If you move around in the vehicle enough, pull out the shoulder belt, or open your door, the belt will become tight again. If this happens, you can reset it.

Q: What's wrong with this?

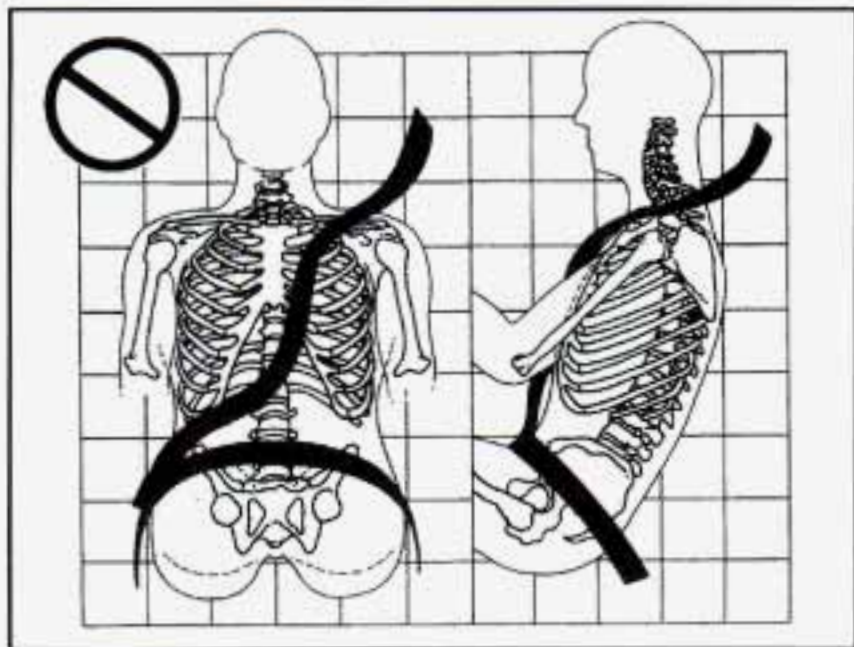

A: The shoulder belt is too loose. It won't give nearly as much protection this way.

⚠ CAUTION:

You can be seriously hurt if your shoulder belt is too loose. In a crash, you would move forward too much, which could increase injury. The shoulder belt should fit against your body. Don't allow more than 1 inch (25 mm) of slack.

Q: What's wrong with this?

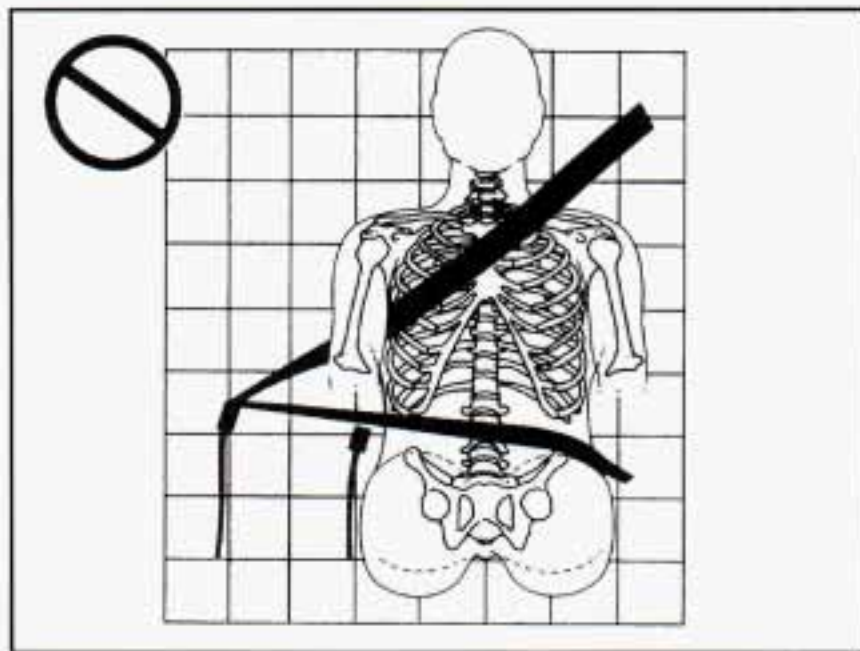

A: The belt is buckled in the wrong place.



CAUTION:

You can be seriously injured if your belt is buckled in the wrong place like this. In a crash, the belt would go up over your abdomen. The belt forces would be there, not at the pelvic bones. This could cause serious internal injuries. Always buckle your belt into the buckle nearest you.

Q: What's wrong with this?

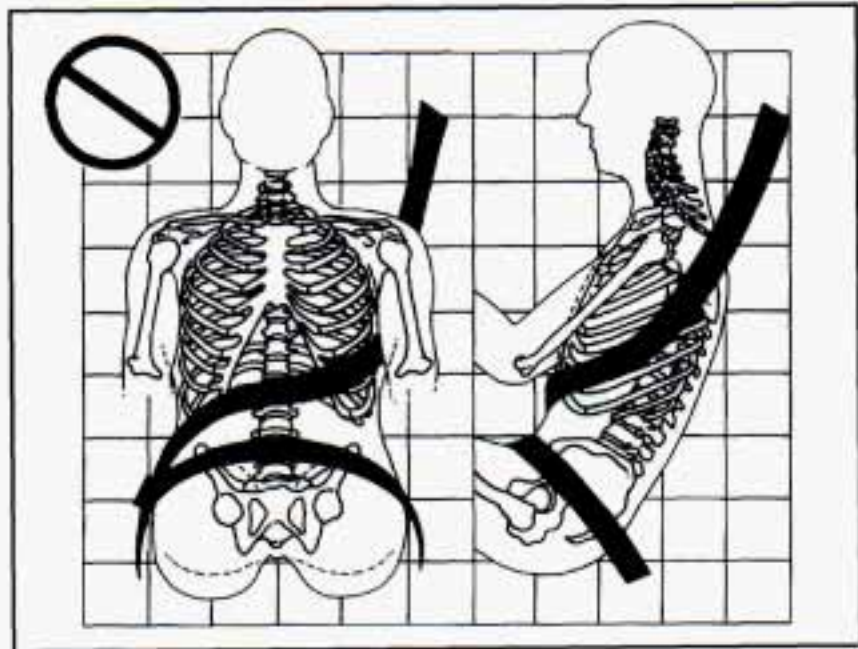

A: The shoulder belt is worn under the arm. It should be worn over the shoulder at all times.

⚠ CAUTION:

You can be seriously injured if you wear the shoulder belt under your arm. In a crash, your body would move too far forward, which would increase the chance of head and neck injury. Also, the belt would apply too much force to the ribs, which aren't as strong as shoulder bones. You could also severely injure internal organs like your liver or spleen.

Q: What's wrong with this?

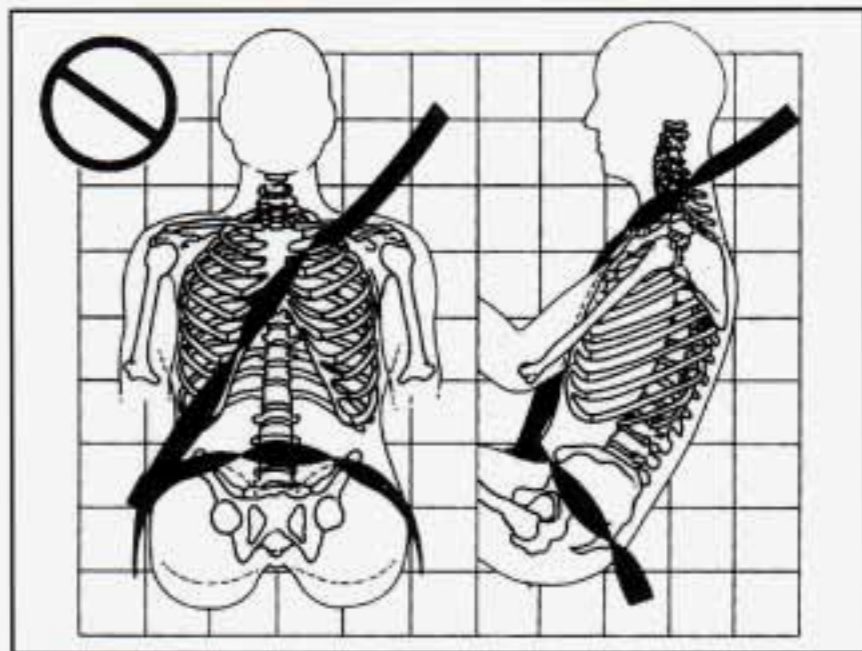

A: The belt is twisted across the body.

⚠ CAUTION:

You can be seriously injured by a twisted belt. In a crash, you wouldn't have the full width of the belt to spread impact forces. If a belt is twisted, make it straight so it can work properly, or ask your dealer to fix it.



To unfasten the belt, just push the button on the buckle. The belt should go back out of the way.

Before you close the door, be sure the belt is out of the way. If you slam the door on it, you can damage both the belt and your vehicle.

Safety Belt Use During Pregnancy

Safety belts work for everyone, including pregnant women. Like all occupants, they are more likely to be seriously injured if they don't wear safety belts.

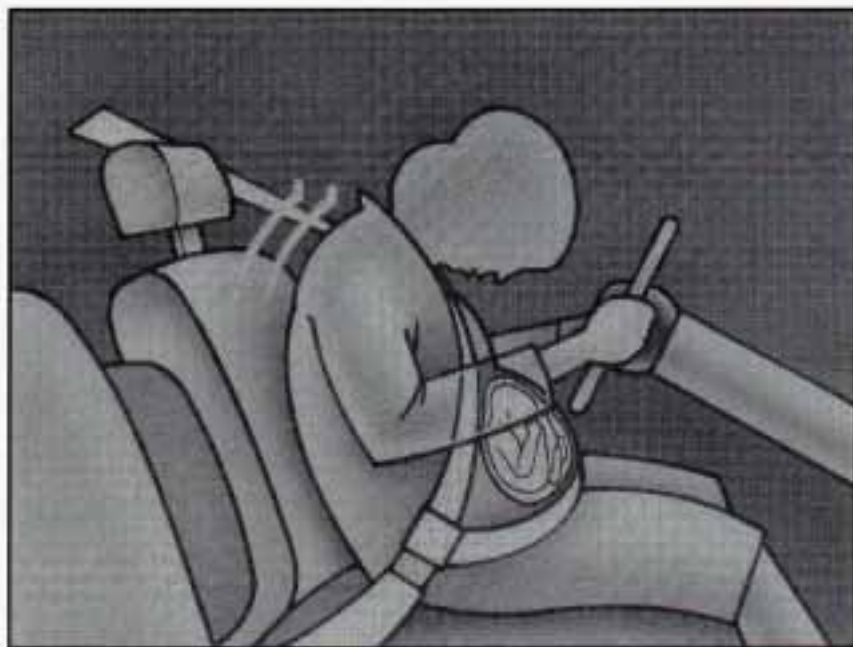

A pregnant woman should wear a lap-shoulder belt, and the lap portion should be worn as low as possible, below the rounding, throughout the pregnancy.

The best way to protect the fetus is to protect the mother. When a safety belt is worn properly, it's more likely that the fetus won't be hurt in a crash. For pregnant women, as for anyone, the key to making safety belts effective is wearing them properly.

Right Front Passenger Position

The right front passenger's safety belt works the same way as the driver's safety belt. See "Driver Position," earlier in this section.

When the lap portion of the belt is pulled out all the way, it will lock. If it does, let it go back all the way and start again.

If your vehicle has a center passenger position, be sure to use the correct buckle when buckling your lap-shoulder belt. If you find that the latch plate will not go fully into the buckle, see if you are using the buckle for the center passenger position.

Supplemental Restraint System (SRS)

This part explains the Supplemental Restraint System (SRS) or air bag system.

Your Buick has two air bags -- one air bag for the driver and another air bag for the right front passenger.

Here are the most important things to know about the air bag system:

CAUTION:

You can be severely injured or killed in a crash if you aren't wearing your safety belt -- even if you have air bags. Wearing your safety belt during a crash helps reduce your chance of hitting things inside the vehicle or being ejected from it. Air bags are "supplemental restraints" to the safety belts. All air bags are designed to work with safety belts, but don't replace them. Air bags are designed to work only in moderate to severe crashes where the front of your vehicle hits something. They aren't designed to inflate at all in rollover, rear, side or low-speed frontal crashes. Everyone in your vehicle should wear a safety belt properly -- whether or not there's an air bag for that person.

⚠ CAUTION:

Air bags inflate with great force, faster than the blink of an eye. If you're too close to an inflating air bag, it could seriously injure you. Safety belts help keep you in position before and during a crash. Always wear your safety belt, even with air bags. The driver should sit as far back as possible while still maintaining control of the vehicle.

⚠ CAUTION:

An inflating air bag can seriously injure small children. Always secure children properly in your vehicle. To read how, see the part of this manual called "Children" and the caution label on the right front passenger's safety belt.



There is an air bag readiness light on the instrument panel, which shows AIR BAG.

The system checks the air bag electrical system for malfunctions. The light tells you if there is an electrical problem. See "Air Bag Readiness Light" in the Index for more information.

How the Air Bag System Works



Where are the air bags?

The driver's air bag is in the middle of the steering wheel.



The right front passenger's air bag is in the instrument panel on the passenger's side.



CAUTION:

If something is between an occupant and an air bag, the bag may not inflate properly or it might force the object into that person. The path of an inflating air bag must be kept clear. Don't put anything between an occupant and an air bag, and don't attach or put anything on the steering wheel hub or on or near any other air bag covering.

When should an air bag inflate?

An air bag is designed to inflate in a moderate to severe frontal or near-frontal crash. The air bag will inflate only if the impact speed is above the system's designed "threshold level." If your vehicle goes straight into a wall that doesn't move or deform, the threshold level is about 8 to 11 mph (13 to 18 km/h). The threshold level can vary, however, with specific vehicle design, so that

it can be somewhat above or below this range. If your vehicle strikes something that will move or deform, such as a parked car, the threshold level will be higher. The air bag is not designed to inflate in rollovers, side impacts or rear impacts, because inflation would not help the occupant.

In any particular crash, no one can say whether an air bag should have inflated simply because of the damage to a vehicle or because of what the repair costs were. Inflation is determined by the angle of the impact and how quickly the vehicle slows down in frontal or near-frontal impacts.

What makes an air bag inflate?

In an impact of sufficient severity, the air bag sensing system detects that the vehicle is in a crash. The sensing system triggers a release of gas from the inflator, which inflates the air bag. The inflator, air bag and related hardware are all part of the air bag modules inside the steering wheel and in the instrument panel in front of the right front passenger.

How does an air bag restrain?

In moderate to severe frontal or near-frontal collisions, even belted occupants can contact the steering wheel or the instrument panel. Air bags supplement the protection provided by safety belts. Air bags distribute the force of the impact more evenly over the occupant's upper body, stopping the occupant more gradually. But air bags would not help you in many types of collisions, including rollovers, rear impacts and side impacts, primarily because an occupant's motion is not toward those air bags. Air bags should never be regarded as anything more than a supplement to safety belts, and then only in moderate to severe frontal or near-frontal collisions.

What will you see after an air bag inflates?

After an air bag inflates, it quickly deflates, so quickly that some people may not even realize the air bag inflated. Some components of the air bag module in the steering wheel hub for the driver's air bag, or the instrument panel for the right front passenger's bag, will be hot for a short time. The parts of the bag that come into contact with you may be warm, but not too hot to touch. There will be some smoke and dust coming from vents in the deflated air bags. Air bag inflation doesn't prevent the driver from seeing or from being able to steer the vehicle, nor does it stop people from leaving the vehicle.



CAUTION:

When an air bag inflates, there is dust in the air. This dust could cause breathing problems for people with a history of asthma or other breathing trouble. To avoid this, everyone in the vehicle should get out as soon as it is safe to do so. If you have breathing problems but can't get out of the vehicle after an air bag inflates, then get fresh air by opening a window or door.

In many crashes severe enough to inflate an air bag, windshields are broken by vehicle deformation. Additional windshield breakage may also occur from the right front passenger air bag.

- Air bags are designed to inflate only once. After they inflate, you'll need some new parts for your air bag system. If you don't get them, the air bag system won't be there to help protect you in another crash. A new system will include air bag modules and possibly other parts. The service manual for your vehicle covers the need to replace other parts.

- Your vehicle is equipped with a crash sensing and diagnostic module, which records information about the air bag system. The module records information about the readiness of the system, when the sensors are activated and driver's safety belt usage at deployment.
- Let only qualified technicians work on your air bag system. Improper service can mean that your air bag system won't work properly. See your dealer for service.

NOTICE:

If you damage the covering for the driver's or the right front passenger's air bag, the bag may not work properly. You may have to replace the air bag module in the steering wheel or both the air bag module and the instrument panel for the right front passenger's air bag. Do not open or break the air bag coverings.

Servicing Your Air Bag-Equipped Buick

Air bags affect how your Buick should be serviced. There are parts of the air bag system in several places around your vehicle. You don't want the system to inflate while someone is working on your vehicle. Your Buick dealer and the Riviera Service Manual have information about servicing your vehicle and the air bag system. To purchase a service manual, see "Service and Owner Publications" in the Index.



CAUTION:

For up to 10 minutes after the ignition key is turned off and the battery is disconnected, an air bag can still inflate during improper service. You can be injured if you are close to an air bag when it inflates. Avoid wires wrapped with yellow tape or yellow connectors. They are probably part of the air bag system. Be sure to follow proper service procedures, and make sure the person performing work for you is qualified to do so.

The air bag system does not need regular maintenance.

Center Passenger Position

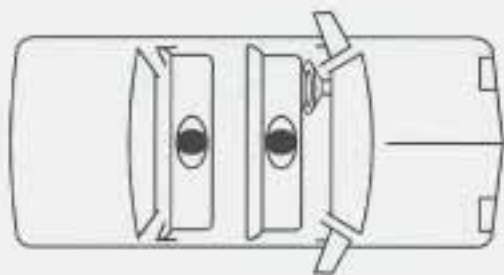

Lap Belt

If your vehicle has a front split seat and a rear bench seat, someone can sit in the center positions.



When you sit in a center seating position, you have a lap safety belt, which has no retractor. To make the belt longer, tilt the latch plate and pull it along the belt.



To make the belt shorter, pull its free end as shown until the belt is snug.

Buckle, position and release it the same way as the lap part of a lap-shoulder belt. If the belt isn't long enough, see "Safety Belt Extender" at the end of this section.

Make sure the release button on the buckle is positioned so you would be able to unbuckle the safety belt quickly if you ever had to.

Rear Seat Passengers

It's very important for rear seat passengers to buckle up! Accident statistics show that unbelted people in the rear seat are hurt more often in crashes than those who are wearing safety belts.

Rear passengers who aren't safety belted can be thrown out of the vehicle in a crash. And they can strike others in the vehicle who are wearing safety belts.

Rear Seat Outside Passenger Positions

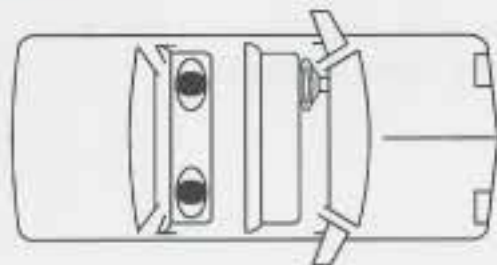

Lap-Shoulder Belt

The positions next to the windows have lap-shoulder belts. Here's how to wear one properly.



1. Pick up the latch plate and pull the belt across you. Don't let it get twisted.
2. Push the latch plate into the buckle until it clicks.

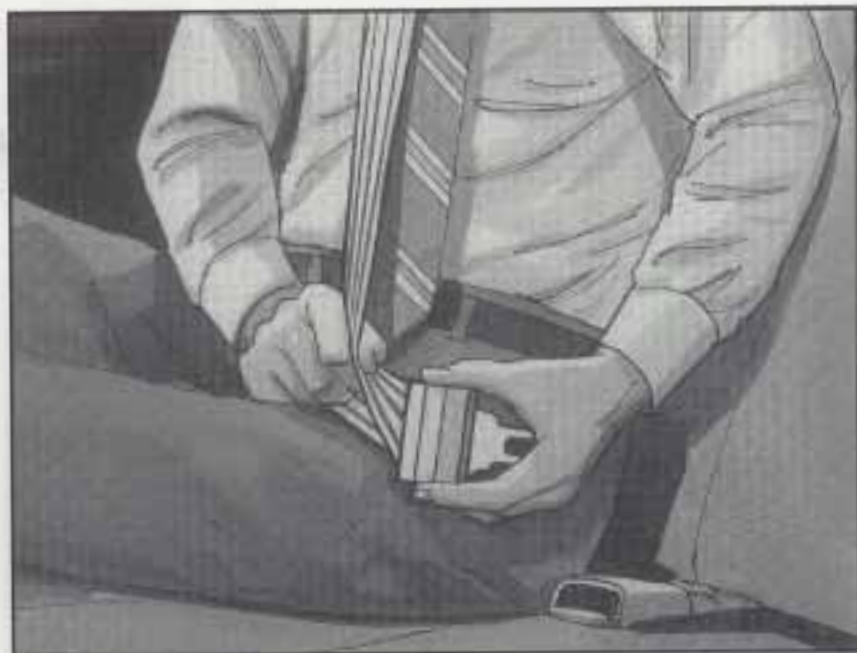

If the belt stops before it reaches the buckle, tilt the latch plate and keep pulling until you can buckle it.

Pull up on the latch plate to make sure it is secure.

If the belt is not long enough, see "Safety Belt Extender" at the end of this section. Make sure the release button on the buckle is positioned so you would be able to unbuckle the safety belt quickly if you ever had to.



3. To make the lap part tight, pull down on the buckle end of the belt as you pull up on the shoulder part.

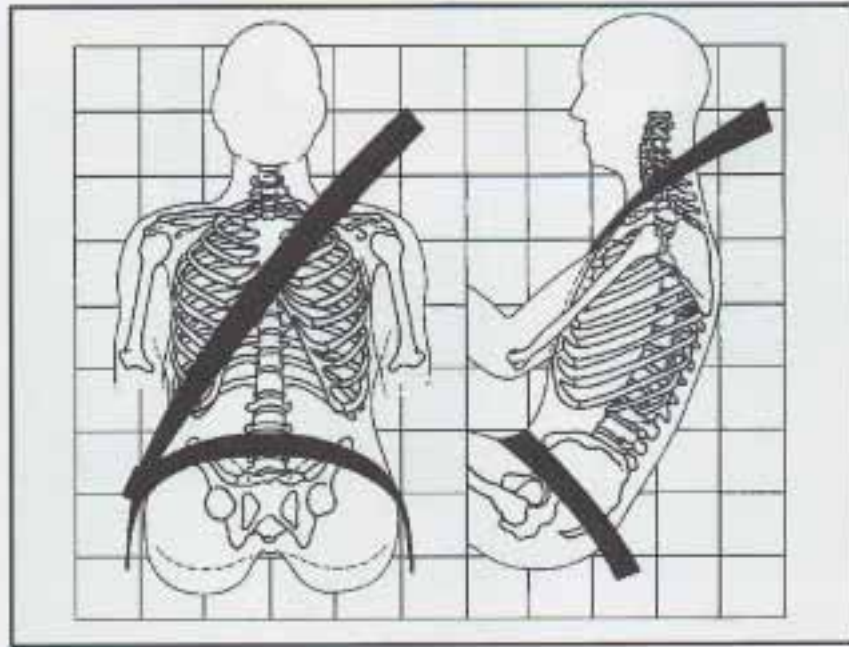

The lap part of the belt should be worn low and snug on the hips, just touching the thighs. In a crash, this applies force to the strong pelvic bones. And you'd be less likely to slide under the lap belt. If you slid under it, the belt would apply force at your abdomen. This could cause serious or even fatal injuries. The shoulder belt should go over the shoulder and across the chest. These parts of the body are best able to take belt restraining forces.

The safety belt locks if there's a sudden stop or a crash.

⚠ CAUTION:

You can be seriously hurt if your shoulder belt is too loose. In a crash, you would move forward too much, which could increase injury. The shoulder belt should fit against your body.



To unlatch the belt, just push the button on the buckle.

Rear Safety Belt Comfort Guides for Children and Small Adults

Rear shoulder belt comfort guides will provide added safety belt comfort for children who have outgrown child restraints and for small adults. When installed on a shoulder belt, the comfort guide pulls the belt away from the neck and head.

There is one guide for each outside passenger position in the rear seat. To provide added safety belt comfort for children who have outgrown child restraints and for smaller adults, the comfort guides may be installed on the shoulder belts. Here's how to install a comfort guide and use the safety belt:

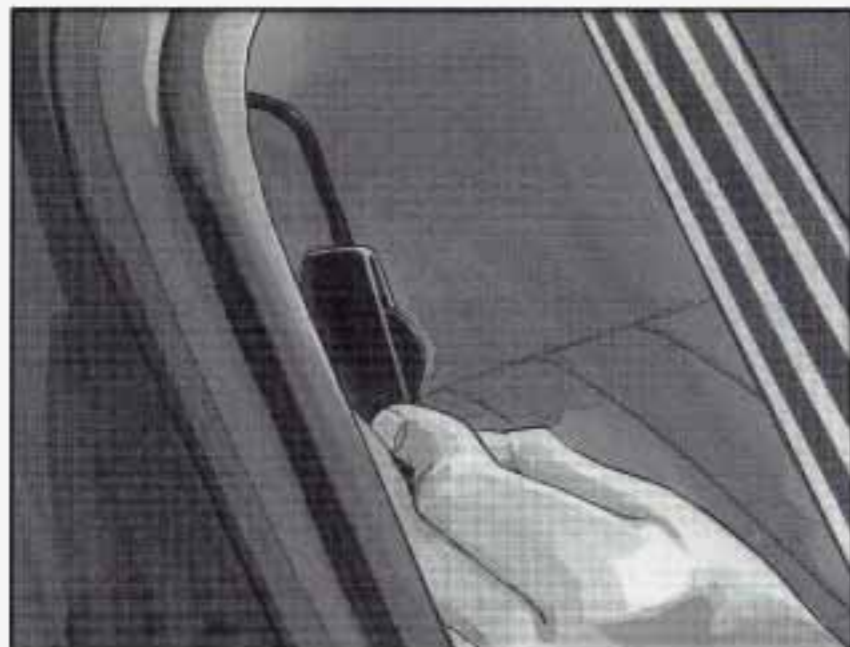

1. Pull the elastic cord out from between the edge of the seatback and the interior body to remove the guide from its storage clip.



2. Slide the guide under and past the belt. The elastic cord must be under the belt. Then, place the guide over the belt, and insert the two edges of the belt into the slots of the guide.

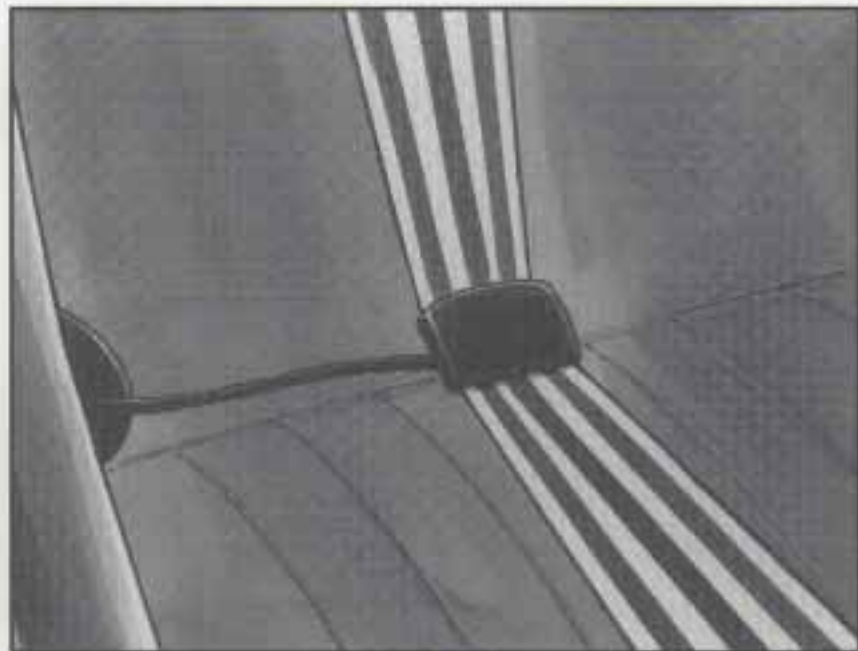

3. Be sure that the belt is not twisted and it lies flat. The elastic cord must be under the belt and the guide on top.



4. Buckle, position and release the safety belt as described in "Rear Seat Outside Passenger Positions" earlier in this section. Make sure that the shoulder belt crosses the shoulder.

To remove and store the comfort guides, squeeze the belt edges together so that you can take them out from the guides. Pull the guide upward to expose its storage clip, and then slide the guide onto the clip. Rotate the guide and clip inward and in between the seatback and the interior body, leaving only the loop of elastic cord exposed.

Children

Everyone in a vehicle needs protection! That includes infants and all children smaller than adult size. In fact, the law in every state in the United States and in every Canadian province says children up to some age must be restrained while in a vehicle.

Smaller Children and Babies

CAUTION:

Smaller children and babies should always be restrained in a child or infant restraint. The instructions for the restraint will say whether it is the right type and size for your child. A very young child's hip bones are so small that a regular belt might not stay low on the hips, as it should. Instead, the belt will likely be over the child's abdomen. In a crash, the belt would apply force right on the child's abdomen, which could cause serious or fatal injuries. So, be sure that any child small enough for one is always properly restrained in a child or infant restraint.



⚠ CAUTION:

Never hold a baby in your arms while riding in a vehicle. A baby doesn't weigh much -- until a crash. During a crash a baby will become so heavy you can't hold it. For example, in a crash

CAUTION: (Continued)

CAUTION: (Continued)

at only 25 mph (40 km/h), a 12-lb. (5.5 kg) baby will suddenly become a 240-lb. (110 kg) force on your arms. The baby would be almost impossible to hold.

Secure the baby in an infant restraint.



Child Restraints

Be sure the child restraint is designed to be used in a vehicle. If it is, it will have a label saying that it meets Federal Motor Vehicle Safety Standards.

Then follow the instructions for the restraint. You may find these instructions on the restraint itself or in a booklet, or both. These restraints use the belt system in your vehicle, but the child also has to be secured within the restraint to help reduce the chance of personal injury. The instructions that come with the infant or child restraint will show you how to do that.

Where to Put the Restraint

Accident statistics show that children are safer if they are restrained in the rear rather than the front seat. We at General Motors therefore recommend that you put your child restraint in the rear seat. *Never* put a rear-facing child restraint in the front passenger seat. Here's why:



CAUTION:

A child in a rear-facing child restraint can be seriously injured if the right front passenger's air bag inflates. This is because the back of a rear-facing child restraint would be very close to the inflating air bag. Always secure a rear-facing child restraint in the rear seat.

You may, however, secure a forward-facing child restraint in the right front seat. Before you secure a forward-facing child restraint, always move the front passenger seat as far back as it will go. Or, secure the child restraint in the rear seat.

⚠ CAUTION:

A child in a child restraint in the center front seat can be badly injured by the right front passenger air bag if it inflates. Never secure a child restraint in the center front seat. It's always better to secure a child restraint in the rear seat. You may, however, secure a forward-facing child restraint in the right front passenger seat, but only with the seat moved all the way back.

Wherever you install it, be sure to secure the child restraint properly.

Keep in mind that an unsecured child restraint can move around in a collision or sudden stop and injure people in the vehicle. Be sure to properly secure any child restraint in your vehicle -- even when no child is in it.

Top Strap

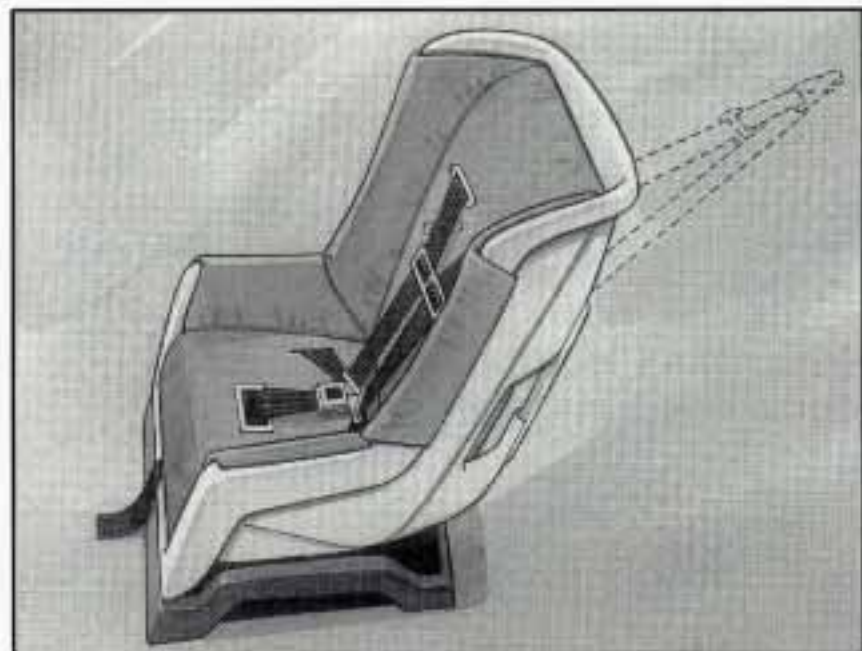

If your child restraint has a top strap, it should be anchored. If you need to have an anchor installed, you can ask your Buick dealer to put it in for you. If you want to install an anchor yourself, your dealer can tell you how to do it.

Canadian law requires that child restraints have a top strap, and that the strap be anchored.

If your child restraint has a top strap, your dealer can obtain a kit with anchor hardware and installation instructions specifically designed for this vehicle. The retailer can then install the anchor for you. In Canada, this work will be done for you free of charge. Or, you may install the anchor yourself using the instructions provided in the kit.

Securing a Child Restraint in a Rear Outside Seat Position

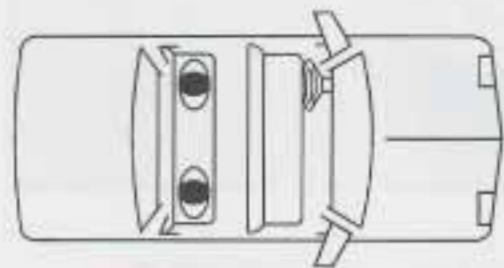

You'll be using the lap-shoulder belt. See the earlier part about the top strap if the child restraint has one.

1. Put the restraint on the seat. Follow the instructions for the child restraint.

2. Secure the child in the child restraint as the instructions say.
3. Pick up the latch plate, and run the lap and shoulder portions of the vehicle's safety belt through or around the restraint. The child restraint instructions will show you how.



4. Tilt the latch plate to adjust the belt if needed.

If the shoulder belt goes in front of the child's face or neck, put it behind the child restraint.



5. Buckle the belt. Make sure the release button is positioned so you would be able to unbuckle the safety belt quickly if you ever had to.

6. To tighten the belt, pull up on the shoulder belt while you push down on the child restraint.
7. Push and pull the child restraint in different directions to be sure it is secure.

To remove the child restraint, just unbuckle the vehicle's safety belt and let it go back all the way. The safety belt will move freely again and be ready to work for an adult or larger child passenger.

Securing a Child Restraint in the Center Rear Seat Position

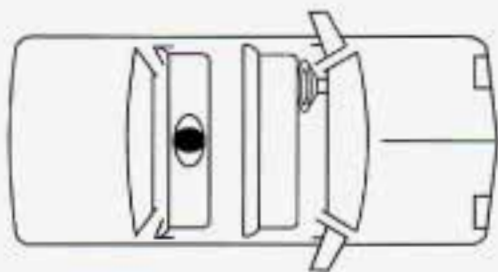

You'll be using the lap belt.

CAUTION:

A child in a child restraint in the center front seat can be badly injured by the right front passenger air bag if it inflates. Never secure a child restraint in the center front seat. It's always better to secure a child restraint in the rear seat. You may, however, secure a forward-facing child restraint in the right front passenger seat, but only with the seat moved all the way back.

See the earlier part about the top strap if the child restraint has one.



1. Make the belt as long as possible by tilting the latch plate and pulling it along the belt.
2. Put the restraint on the seat. Follow the instructions for the child restraint.
3. Secure the child in the child restraint as the instructions say.
4. Run the vehicle's safety belt through or around the restraint. The child restraint instructions will show you how.



5. Buckle the belt. Make sure the release button is positioned so you would be able to unbuckle the safety belt quickly if you ever had to.
6. To tighten the belt, pull its free end while you push down on the child restraint.

7. Push and pull the child restraint in different directions to be sure it is secure. If it isn't, secure the restraint in a different place in the vehicle and contact the child restraint maker for their advice about how to attach the child restraint properly.

To remove the child restraint, just unbuckle the vehicle's safety belt. It will be ready to work for an adult or larger child passenger.

Securing a Child Restraint in the Right Front Seat Position

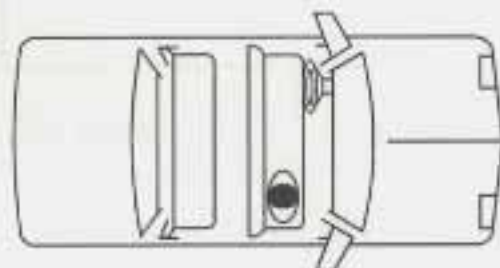

Your vehicle has a right front passenger air bag. *Never* put a rear-facing child restraint in this seat. Here's why:

⚠ CAUTION:

A child in a rear-facing child restraint can be seriously injured if the right front passenger's air bag inflates. This is because the back of a rear-facing child restraint would be very close to the inflating air bag. Always secure a rear-facing child restraint in the rear seat.

You'll be using the lap-shoulder belt. See the earlier part about the top strap if the child restraint has one.

1. Because your vehicle has a right front passenger air bag, always move the seat as far back as it will go before securing a forward-facing child restraint. (See "Seats" in the Index.)
2. Put the restraint on the seat. Follow the instructions for the child restraint.
3. Secure the child in the child restraint as the instructions say.

4. Pick up the latch plate, and run the lap and shoulder portions of the vehicle's safety belt through or around the restraint. The child restraint instructions will show you how.

If the shoulder belt goes in front of the child's face or neck, put it behind the child restraint.



5. Buckle the belt. Make sure the release button is positioned so you would be able to unbuckle the safety belt quickly if you ever had to.



6. Pull the rest of the lap belt all the way out of the retractor to set the lock.



7. To tighten the belt, feed the lap belt back into the retractor while you push down on the child restraint.
8. Push and pull the child restraint in different directions to be sure it is secure.

To remove the child restraint, just unbuckle the vehicle's safety belt and let it go back all the way. The safety belt will move freely again and be ready to work for an adult or larger child passenger.

Larger Children



Children who have outgrown child restraints should wear the vehicle's safety belts.

If you have the choice, a child should sit next to a window so the child can wear a lap-shoulder belt and get the additional restraint a shoulder belt can provide.

Accident statistics show that children are safer if they are restrained in the rear seat. But they need to use the safety belts properly.

- Children who aren't buckled up can be thrown out in a crash.
- Children who aren't buckled up can strike other people who are.



⚠ CAUTION:

Never do this.

Here two children are wearing the same belt. The belt can't properly spread the impact forces. In a crash, the two children can be crushed together and seriously injured. A belt must be used by only one person at a time.

Q: What if a child is wearing a lap-shoulder belt, but the child is so small that the shoulder belt is very close to the child's face or neck?

A: Move the child toward the center of the vehicle, but be sure that the shoulder belt still is on the child's shoulder, so that in a crash the child's upper body would have the restraint that belts provide. If the child is sitting in a rear seat outside position, see "Rear Safety Belt Comfort Guides" in the Index. If the child is so small that the shoulder belt is still very close to the child's face or neck, you might want to place the child in the center seat position, the one that has only a lap belt.

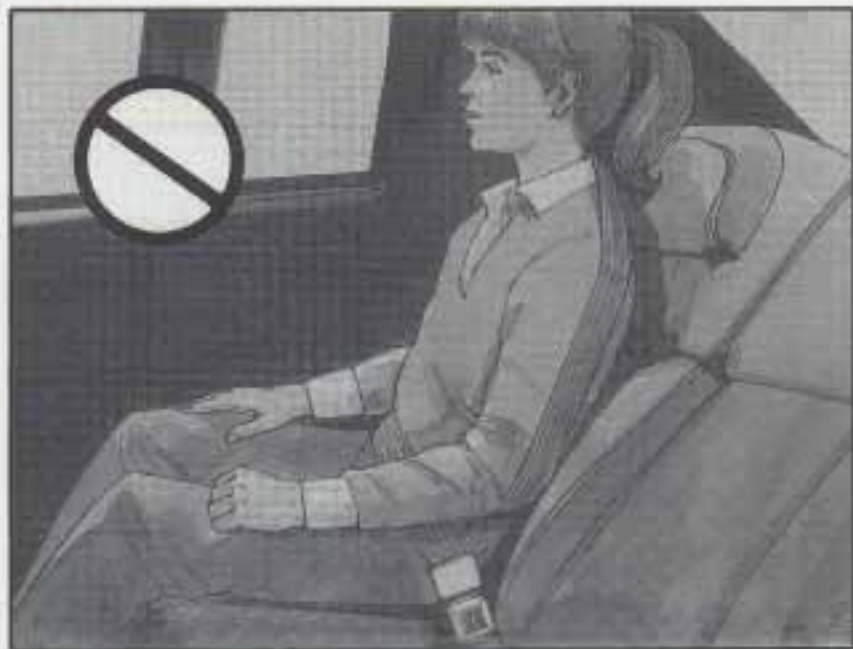

⚠ CAUTION:

Never do this.

Here a child is sitting in a seat that has a lap-shoulder belt, but the shoulder part is behind the child. If the child wears the belt in this way, in a crash the child might slide under the belt. The belt's force would then be applied right on the child's abdomen. That could cause serious or fatal injuries.

Wherever the child sits, the lap portion of the belt should be worn low and snug on the hips, just touching the child's thighs. This applies belt force to the child's pelvic bones in a crash.

Safety Belt Extender

If the vehicle's safety belt will fasten around you, you should use it.

But if a safety belt isn't long enough to fasten, your dealer will order you an extender. It's free. When you go in to order it, take the heaviest coat you will wear, so the extender will be long enough for you. The extender will be just for you, and just for the seat in your vehicle that you choose. Don't let someone else use it, and use it only for the seat it is made to fit. To wear it, just attach it to the regular safety belt.

Checking Your Restraint Systems

Now and then, make sure the safety belt reminder light and all your belts, buckles, latch plates, retractors and anchorages are working properly. Look for any other loose or damaged safety belt system parts. If you see anything that might keep a safety belt system from doing its job, have it repaired.

Torn or frayed safety belts may not protect you in a crash. They can rip apart under impact forces. If a belt is torn or frayed, get a new one right away.

Also look for any opened or broken air bag covers, and have them repaired or replaced. (The air bag system does not need regular maintenance.)

Replacing Restraint System Parts After a Crash

If you've had a crash, do you need new belts?

After a very minor collision, nothing may be necessary. But if the belts were stretched, as they would be if worn during a more severe crash, then you need new belts.



If you ever see a label on the driver's or the right front passenger's safety belt that says to replace the belt, be sure to do so. Then the new belt will be there to help protect you in a collision. You would see this label on the belt near the latch plate.

If belts are cut or damaged, replace them. Collision damage also may mean you will need to have safety belt or seat parts repaired or replaced. New parts and repairs may be necessary even if the belt wasn't being used at the time of the collision.

If your seat adjuster won't work after a crash, the special part of the safety belt that goes through the seat to the adjuster may need to be replaced.

If an air bag inflates, you'll need to replace air bag system parts. See the part on the air bag system earlier in this section.

 **NOTES**

 NOTES



Section 2 Features and Controls

Here you can learn about the many standard and optional features on your Buick, and information on starting, shifting and braking. Also explained are the instrument panel and the warning systems that tell you if everything is working properly -- and what to do if you have a problem.

2-2	Keys	2-32	Engine Exhaust
2-4	Door Locks	2-33	Running Your Engine While You're Parked
2-7	Remote Keyless Entry System	2-34	Windows
2-14	Trunk	2-34	Horn
2-15	Theft	2-35	Tilt Wheel
2-16	Universal Theft-Deterrent	2-35	Turn Signal/Multifunction Lever
2-18	PASS-Key [®] II	2-44	Lamps
2-19	New Vehicle "Break-In"	2-46	Interior Lamps
2-19	Ignition Positions	2-50	Mirrors
2-21	Starting Your Engine	2-52	Storage Compartments
2-22	Engine Coolant Heater	2-60	Accessory Power Outlet
2-24	Automatic Transaxle Operation	2-60	Cellular Telephone
2-27	Parking Brake	2-60	Astrorooft
2-28	Shifting Into PARK (P)	2-61	Universal Transmitter
2-31	Shifting Out of PARK (P)	2-64	The Instrument Panel
2-32	Parking Over Things That Burn	2-68	Warning Lights, Gages and Indicators

Keys

CAUTION:

Leaving young children in a vehicle with the ignition key is dangerous for many reasons. A child or others could be badly injured or even killed.

They could operate power windows or other controls or even make the vehicle move. Don't leave the keys in a vehicle with young children.





The ignition key is for the ignition only.

When a new Riviera is delivered, the dealer removes the plugs from the keys, and gives them to the first owner. However, if the ignition key does not have a plug, there may be a bar-coded key tag instead.

Each plug or bar-coded key tag has a code on it that tells your dealer or a qualified locksmith how to make extra keys. Keep the tags or plugs in a safe place. If you lose your keys, you'll be able to have new ones made easily using these tags or plugs. If your ignition keys don't have tags or plugs, go to your Buick dealer for the correct key code if you need a new ignition key.



The door key is for the doors and all other locks.

NOTICE:

Your Buick has a number of features that can help prevent theft. But you can have a lot of trouble getting into your vehicle if you ever lock your keys inside. You may even have to damage your vehicle to get in. So be sure you have extra keys.

Door Locks

CAUTION:

Unlocked doors can be dangerous.

Passengers -- especially children -- can easily open the doors and fall out. When a door is locked, the inside handle won't open it.

Outsiders can easily enter through an unlocked door when you slow down or stop your vehicle.

This may not be so obvious: You increase the chance of being thrown out of the vehicle in a crash if the doors aren't locked. Wear safety belts properly, lock your doors, and you will be far better off whenever you drive your vehicle.

There are several ways to lock and unlock your vehicle.

From the outside, use your door key.

If your vehicle has a theft-deterrent system and it is activated, unlock the doors only with the key or Remote Keyless Entry System. This will avoid setting off the alarm.



To lock the door from the inside, move the lock control on the door forward.

To unlock the door, move the lock control toward the rear of the vehicle. There is a red mark on the lock control which shows when the door is unlocked.

Central Door Unlocking System (Option)

If the driver's door key is held in the unlock position for more than one second, all doors will electronically unlock.

Power Door Locks



Press the power DOOR LOCK/UNLOCK switch to lock or unlock both doors at once.

Door Ajar Reminder

If one of the doors on your vehicle is not closed properly, a door ajar light on the instrument panel will come on and stay on until the doors are closed and completely latched.

Memory Door Locks

This is a Personal Choice feature that programs your door locks to automatically lock or unlock.

Close your doors and turn on the ignition. Every time you move your shift lever out of PARK (P), all of the doors will lock. And, every time you stop and move your shift lever into PARK (P), your doors will unlock. If someone needs to get out while you're not in PARK (P), have that person use the manual or power lock. When the door is closed again, it will not lock automatically. Just use the manual or power lock to lock the door again. If you need to lock your doors before shifting out of PARK (P), use the manual or power lock button to lock the doors.

Customizing Your Memory Door Locks Feature

You can program the memory door locks feature to change to the following modes:

Mode	Operation
0	No automatic door lock or unlock.
1	All doors automatically lock when shifted out of PARK (P). No automatic door unlock.
2	All doors automatically lock when shifted out of PARK (P). Only the driver's door automatically unlocks when shifted into PARK (P).
3	All doors automatically lock when shifted out of PARK (P). All doors automatically unlock when shifted into PARK (P).

Vehicles are delivered programmed in Mode 3.

To change modes:

1. Close all doors and turn the ignition on. Keep all doors closed throughout this procedure.
2. Press and hold the driver's power door lock switch through Step 4.
3. Press the LOCK button on the Remote Keyless Entry transmitter. The memory door locks will remain in the current mode.
4. Press the LOCK button on the transmitter again. Each time the transmitter's LOCK button is pressed, the mode will advance by one, going from Mode 3 to 0 to 1, etc.

NOTE: The door locks will cycle according to the mode entered while customizing memory door locks. (Mode "0" has no feedback.)

5. Release the power door lock switch. The memory door locks will remain in the most recent mode selected.

NOTE: This procedure changes the mode for only the transmitter used to change this setting. The procedure will need to be repeated for the second transmitter.

Lockout Protection

The power door locks will not work if the key is left in the ignition with the driver's door open. You can override this feature by holding the power door lock switch for more than three seconds, unless the engine is running.

Leaving Your Vehicle

If you are leaving the vehicle, take your keys, open your door and set the locks from the inside. Then get out and close the door.

If your vehicle has a theft-deterrent system, see "Universal Theft-Deterrent" in the Index.

Remote Keyless Entry System



You can lock and unlock your doors or unlock your trunk from about 3 feet (1 m) up to 30 feet (9 m) away using the remote keyless entry transmitter supplied with your vehicle.

Your Remote Keyless Entry System operates on a radio frequency subject to Federal Communications Commission (FCC) Rules and with Industry and Science Canada.

This device complies with Part 15 of the FCC Rules. Operation is subject to the following two conditions: (1) this device may not cause harmful interference, and (2) this device must accept any interference received, including interference that may cause undesired operation.

This device complies with RSS-210 of Industry and Science Canada. Operation is subject to the following two conditions: (1) this device may not cause interference, and (2) this device must accept any interference received, including interference that may cause undesired operation of the device.

Changes or modifications to this system by other than an authorized service facility could void authorization to use this equipment.

This system has a range of about 3 feet (1 m) up to 30 feet (9 m). At times you may notice a decrease in range. This is normal for any remote keyless entry system. If the transmitter does not work or if you have to stand closer to your vehicle for the transmitter to work, try this:

- Check to determine if battery replacement or resynchronization is necessary. See the instructions that follow.

- Check the distance. You may be too far from your vehicle. You may need to stand closer during rainy or snowy weather.
- Check the location. Other vehicles or objects may be blocking the signal. Take a few steps to the left or right, hold the transmitter higher, and try again.
- If you're still having trouble, see your Buick dealer or a qualified technician for service.

Operation

The driver's door will unlock when UNLOCK is pressed.

If UNLOCK is pressed again within five seconds, both doors will unlock. Pressing the UNLOCK button will also illuminate the interior lamps. See "Illuminated Entry" in the index.

Both doors will lock when LOCK is pressed.

The trunk will unlock when the opened trunk symbol is pressed when the ignition is off. The trunk symbol will also work when the ignition is on, but only while the vehicle is in PARK (P) or NEUTRAL (N).

Instant Alarm

When the button with the horn symbol on the remote keyless entry transmitter is pressed, the horn will sound and the headlamps and taillamps will flash for up to two minutes. This can be turned off by pressing the instant alarm button again or by turning the ignition on. If your vehicle is equipped with the Universal Theft Deterrent feature, you may also turn off the instant alarm by unlocking the vehicle with a key.

Resynchronization

If only the instant alarm button works, the transmitter needs to be resynchronized to the receiver. Do this by pressing and holding both the LOCK and UNLOCK buttons for about eight seconds. You must be within range of the vehicle.

Once the transmitter has been resynchronized, the horn will chirp and the exterior lamps will flash once. The system should now operate properly.

Security Feedback

This Personal Choice feature provides feedback to the driver when the vehicle receives a command from the key transmitter. The following modes may be selected:

Mode	Transmitter Response
0	No transmitter response when locking or unlocking vehicle.
1	No transmitter response when locking; exterior lamps flash when unlocking vehicle.
2	Exterior lamps flash when locking; no transmitter response when unlocking vehicle.
3	Exterior lamps flash when locking and when unlocking vehicle.
4	Exterior lamps flash and horn chirps when locking; no transmitter response when unlocking vehicle.
5	Exterior lamps flash and horn chirps when locking; exterior lamps flash when unlocking.

Vehicles are delivered programmed in Mode 5. To change to another mode, the ignition must be off. Then:

1. Press and hold the driver's power door lock switch (located on the driver's side door).
2. Press the opened trunk button on the transmitter to enter the programming mode. The transmitter will remain in its current mode.
3. Press the opened trunk button again. Each time the opened trunk button is pressed, the horn will chirp and the transmitter will advance to the next mode.
4. Release the power door lock switch.

This procedure changes the mode for only the transmitter used to change this setting. The procedure will need to be repeated for the second transmitter.

Personal Choice Features

The following list of features that are available on your Riviera can be programmed to the driver's preference for each key chain transmitter.

- **Memory Door Locks:** This feature programs your door locks to automatically lock or unlock when shifting in and out of PARK (P).
- **Security Feedback:** This feature provides feedback to the driver when the vehicle receives a command from the key chain transmitter.
- **Delayed Locking:** This feature lets the driver delay the actual locking of the vehicle. When all doors have been closed, the doors will lock automatically after five seconds.
- **Perimeter Lighting:** When the UNLOCK button on the key chain transmitter is pressed, the headlamps, parking lamps, back-up lamps and cornering lamps will turn on in dark conditions.

For more detailed information and programming instructions, refer to the Index for each individual feature listed above.

Memory Seat and Mirrors

This is another Personal Choice feature of your Riviera.

The transmitters can also be programmed to move the driver's seat and outside mirrors to a set memory position when the key chain transmitter's UNLOCK button is pressed.

To program the system:

1. Adjust the driver's seat to a comfortable position. Adjust both outside mirrors to suit you. See "Power Remote Control Mirror" in the Index.
2. Press the SET button on the driver's door armrest. You will hear one beep.
3. Within five seconds, press one of the two memory buttons on the armrest. You will hear two beeps to confirm that the mirror and the seat positions are entered into memory.
4. Press the UNLOCK button on the appropriate transmitter within five seconds. You will hear two beeps.

The second key chain transmitter can be programmed to record a different seat and mirror position by following the same steps.

If you prefer to program the exit seat position, which moves the seat completely down and back, follow these steps:

1. Press the SET button on the driver's door armrest. You will hear one beep.
2. Press the EXIT button on the armrest. You will hear one beep, but the seat will not move at this time.
3. Press the UNLOCK button on the appropriate transmitter within five seconds. You will hear two beeps.

This personal choice feature will work only when the vehicle is in PARK (P). A beep will sound inside the vehicle when the UNLOCK button on the transmitter is pressed to move the seat and mirrors.

To turn this feature off, press SET and then UNLOCK within five seconds.

Delayed Locking

This Personal Choice feature lets the driver delay the actual locking of the vehicle. When the power door lock switch is pressed with the key out of the ignition and the driver's door open, a chime will sound three times to signal that the lock delay mode is active. When all doors have been closed, the doors will lock automatically after five seconds. If any door is opened before this, the five-second timer will reset itself once all the doors have been closed again.

Pressing the door lock switch twice within two seconds will override this feature.

The delayed locking feature can be turned on or off for each remote transmitter.

To turn the feature on:

1. Press and hold the power door lock switch throughout this procedure. Both doors will lock.
2. Press the UNLOCK button on the remote transmitter. The lock delay is still off and both doors will remain locked.
3. Press the UNLOCK button on the remote transmitter again. Lock delay is now active and both doors will unlock.
4. Release the power door lock switch.

To turn the feature off, repeat the previous procedure.

Matching Transmitter(s) To Your Vehicle

Each remote keyless entry transmitter is coded to prevent another transmitter from unlocking your vehicle. If a transmitter is lost or stolen, a replacement can be purchased through your dealer. Remember to bring any remaining transmitters with you when you go to your dealer. When the dealer matches the replacement transmitter to your vehicle, any remaining transmitters must also be matched. Once your dealer has coded the new transmitter, the lost transmitter will not unlock your vehicle. Each vehicle can have only four transmitters matched to it.

See your Buick dealer to match transmitters to another vehicle.

Battery Replacement

Under normal use, the battery in your remote keyless entry transmitter should last about two years.

You can tell the battery is weak if the transmitter won't work at the normal range in any location. If you have to get close to your vehicle before the transmitter works, it's probably time to change the battery.



For battery replacement, use a Duracell® battery, type DL-2032, or a similar type.

NOTICE:

When replacing the battery, use care not to touch any of the circuitry. Static from your body transferred to these surfaces may damage the transmitter.

To replace the battery:

1. Insert a coin into the notch near the key ring. Turn coin counterclockwise to separate the two halves of the transmitter.
2. Once the transmitter is separated, use a pencil to remove the old battery. Do not use a metal object.
3. Remove and replace the battery. Insert the new battery as the instructions under the cover indicate.
4. Snap the transmitter back together tightly to be sure no moisture can enter.
5. Resynchronize the transmitter by pressing and holding the LOCK and UNLOCK buttons for about eight seconds within range of the vehicle. Once the transmitter is resynchronized, the horn will chirp and the exterior lamps will flash once.

Trunk

CAUTION:

It can be dangerous to drive with the trunk lid open because carbon monoxide (CO) gas can come into your vehicle. You can't see or smell CO. It can cause unconsciousness and even death.

If you must drive with the trunk lid open or if electrical wiring or other cable connections must pass through the seal between the body and the trunk lid:

- Make sure all windows are shut.
- Turn the fan on your heating or cooling system to its highest speed with the setting on VENT. That will force outside air into your vehicle. See "Comfort Controls" in the Index.
- If you have air outlets on or under the instrument panel, open them all the way. See "Engine Exhaust" in the Index.

Trunk Lock Release

To unlock the trunk from the outside, turn the lock cover to expose the key hole. Insert the door key and turn it.

Remote Trunk Release



Press the TRUNK release button located below the driver's door handle to release the trunk lid. The trunk will open if the transaxle is in PARK (P) and if the trunk security release is not in the off position.

If you have the Remote Keyless Entry System, it also will unlock your trunk if the ignition is off, or if the ignition is on and the transaxle is in PARK (P).

Remote Trunk Release Lockout

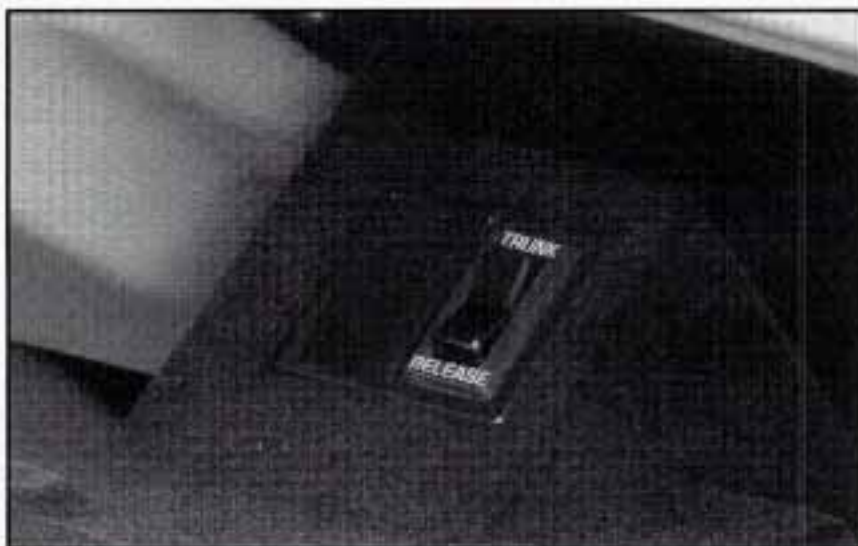

The trunk release lockout switch in the glove box allows you to secure items in the trunk. Move the trunk release switch off, lock the glove box and take the key with you. Now the trunk release on the driver's door will not open the trunk.

Trunk Security Override

The remote transmitter will open the trunk even if the override switch is in the off position.

Theft

Vehicle theft is big business, especially in some cities. Although your Buick has a number of theft-deterrent features, we know that nothing we put on it can make it impossible to steal. However, there are ways you can help.

Key in the Ignition

If you leave your vehicle with the keys inside, it's an easy target for joy riders or professional thieves -- so don't do it.

With the ignition OFF and the driver's door open, you'll hear a chime reminding you to remove your key from the ignition and take it with you. Always do this. Your steering wheel will be locked, and so will your ignition and transaxle. And remember to lock the doors.

Parking at Night

Park in a lighted spot, close all windows and lock your vehicle. Remember to keep your valuables out of sight. Put them in a storage area, or take them with you.

Parking Lots

If you park in a lot where someone will be watching your vehicle, it's best to lock it up and take your keys. But what if you have to leave your ignition key? What if you have to leave something valuable in your vehicle?

- Put your valuables in a storage area, like your trunk or glove box.
- Lock the glove box.
- Lock all the doors except the driver's.
- Then take the door key and remote keyless entry transmitter with you.

Universal Theft-Deterrent (Option)

If your Buick has this option, it has a theft-deterrent alarm system. With this system, if your ignition is off, the SECURITY light will flash as you open the door.



This light reminds you to activate the theft-deterrent system. Here's how to do it:

1. Open the door.
2. Lock the door with the power door lock switch or Remote Keyless Entry System. The SECURITY light should come on and stay on.
3. Close all doors. The SECURITY light should go off after about 30 seconds. The security system is not armed until the SECURITY light is off. If the SECURITY light stays on or flashes when the ignition is turned on, there is a problem with the system and the vehicle should be serviced.

If a door or the trunk is opened without the key or Remote Keyless Entry System, the alarm will go off. It will also go off if the trunk lock or door locks are damaged. Your vehicle's lamps will flash and the horn will sound for several minutes, then will go off to save battery power.

Remember, the theft-deterrent system won't be activated if you lock the doors with a key or manual door lock. It only activates if you use a power door lock switch or Remote Keyless Entry System. You should also remember that you can start your vehicle with the correct ignition key if the alarm has been set off, but this does not shut off the alarm.

Here's how to avoid setting off the alarm by accident:

- If you don't want to activate the theft-deterrent system, lock the door either using a key or the manual door lock switch.
- Always unlock a door with a key, or use the Remote Keyless Entry System. Unlocking a door any other way will set off the alarm.

If you set off the alarm by accident, unlock any door with your key.

You can also turn off the alarm by using the Keyless Entry System. The alarm won't stop if you try to unlock a door any other way.

Testing the Alarm

The alarm can be tested by first having the driver's window down. Activate the system by locking the doors with the power door lock switch or the Remote Keyless Entry System. Get out of the car and close the door and wait for the SECURITY light to go out. Then reach in through the window, unlock the door with the manual door lock, and open the door. This should set off the alarm.

If the alarm does not sound when it should, check to see if the horn works. The horn fuse may be blown. To replace the fuse, see "Fuses and Circuit Breakers" in the Index.

To reduce the possibility of theft, always activate the theft-deterrent system when leaving your vehicle.

PASS-Key® II



Your vehicle is equipped with the PASS-Key II (Personalized Automotive Security System) theft-deterrent system. PASS-Key II is a passive theft-deterrent system. It works when you insert or remove the key from the ignition.

PASS-Key II uses a resistor pellet in the ignition key that matches a decoder in your vehicle.

When the PASS-Key II system senses that someone is using the wrong key, it shuts down the vehicle's starter and fuel systems. For about three minutes, the starter won't work and fuel won't go to the engine. If someone tries to start your vehicle again or uses another key during this time, the vehicle will not start. This discourages someone from randomly trying different keys with different resistor pellets in an attempt to make a match.

The ignition key must be clean and dry before it's inserted in the ignition or the engine may not start. If the engine does not start and the SECURITY light comes on, the key may be dirty or wet. Turn the ignition off.

Clean and dry the key. Wait about three minutes and try again. The SECURITY light may remain on during this time. If the starter still won't work, and the key appears to be clean and dry, wait about three minutes and try another ignition key. At this time, you may also want to check the fuse (see "Fuses and Circuit Breakers" in the Index). If the starter won't work with the other key, your vehicle needs service. If your vehicle does start, the first ignition key may be faulty. See your Buick dealer or a locksmith who can service the PASS-Key II.

If you accidentally use a key that has a damaged or missing resistor pellet, the starter won't work. The SECURITY light will flash. But you don't have to wait three minutes before trying another ignition key.

See your Buick dealer or a locksmith who can service the PASS-Key II to have a new key made.

If you're ever driving and the SECURITY light comes on, you will be able to restart your engine if you turn it off. Your PASS-Key II system, however, is not working properly and must be serviced by your Buick dealer. Your vehicle is not protected by the PASS-Key II system.

If you lose or damage a PASS-Key II ignition key, see your Buick dealer or a locksmith who can service PASS-Key II to have a new key made.

New Vehicle “Break-In”

NOTICE:

Your modern Buick doesn't need an elaborate “break-in.” But it will perform better in the long run if you follow these guidelines:

- Don't drive at any one speed -- fast or slow -- for the first 500 miles (805 km). Don't make full-throttle starts.
- Avoid making hard stops for the first 200 miles (322 km) or so. During this time your new brake linings aren't yet broken in. Hard stops with new linings can mean premature wear and earlier replacement. Follow this breaking-in guideline every time you get new brake linings.
- Don't tow a trailer during break-in. See “Towing a Trailer” in the Index for more information.

Ignition Positions

The key with the black plastic head operates the ignition lock.

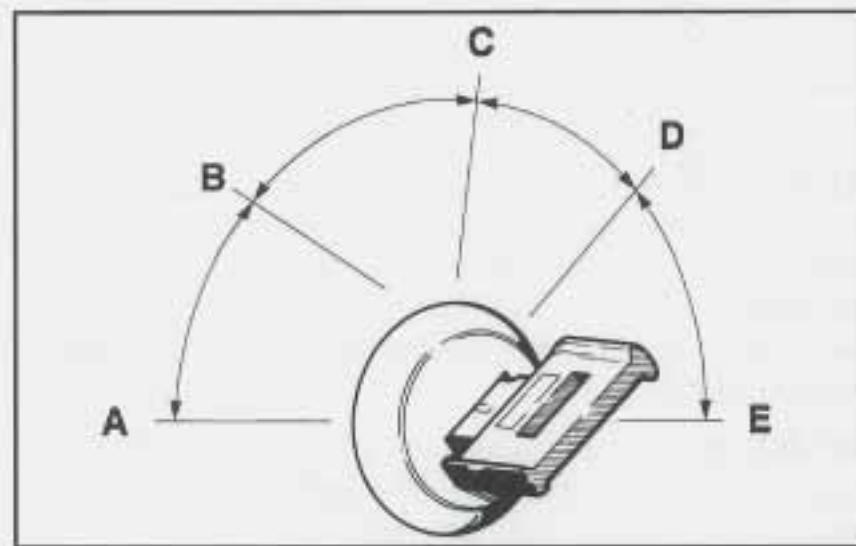

With the ignition key in the ignition switch, you can turn the switch to five different positions:

ACCESSORY (A): This is an on position in which you can operate your electrical power accessories. Press the ignition key in as you turn the top of it toward you.

LOCK (B): This is the only position in which you can remove the key. This position locks your ignition, steering wheel and transaxle. It's a theft-deterrent feature.

OFF (C): This position lets you turn off the engine but still turn the steering wheel. It doesn't lock the steering wheel like LOCK and it doesn't send any electrical power to the accessories. Use OFF if you must have your vehicle in motion while the engine is not running.

RUN (D): This is an on position that the switch returns to after you start your engine and release the switch. This is the position for driving. Even when the engine is not running, you can use RUN to operate your electrical power accessories and to display some instrument panel warning lights.

START (E): This position starts your engine. When the engine starts, release the key. The ignition switch will return to RUN for normal driving.

NOTICE:

If your key seems stuck in LOCK and you can't turn it, be sure you are using the correct key; if so, is it all the way in? If it is, then turn the steering wheel left and right while you turn the key hard. But turn the key only with your hand. Using a tool to force it could break the key or the ignition switch. If none of this works, then your vehicle needs service.

Retained Accessory Power

After you turn your ignition to OFF and remove the key, for about 10 minutes, you will have electrical power to such accessories as the radio, power windows and astroroof (if equipped). If you open a door, the retained accessory power is shut off.

Starting Your Engine

Move your shift lever to PARK (P) or NEUTRAL (N). Your engine won't start in any other position -- that's a safety feature. To restart when you're already moving, use NEUTRAL (N) only.

NOTICE:

Don't try to shift to PARK (P) if your Buick is moving. If you do, you could damage the transaxle. Shift to PARK (P) only when your vehicle is stopped.

1. Without pushing the accelerator pedal, turn your ignition key to START. When the engine starts, let go of the key. The idle speed will go down as your engine gets warm.

NOTICE:

Holding your key in START for longer than 15 seconds at a time will cause your battery to be drained much sooner. And the excessive heat can damage your starter motor.

2. If it doesn't start right away, hold your key in START for about three to five seconds at a time until your engine starts. Wait about 15 seconds between each try to help avoid draining your battery.
3. If your engine still won't start (or starts but then stops), it could be flooded with too much gasoline. Try pushing your accelerator pedal all the way to the floor and holding it there as you hold the key in START for about three seconds. If the vehicle starts briefly but then stops again, do the same thing, but this time keep the pedal down for five or six seconds. This clears the extra gasoline from the engine. After waiting about 15 seconds, repeat the normal starting procedure.

NOTICE:

Your engine is designed to work with the electronics in your vehicle. If you add electrical parts or accessories, you could change the way the engine operates. Before adding electrical equipment, check with your dealer. If you don't, your engine might not perform properly.

If you ever have to have your vehicle towed, see the part of this manual that tells how to do it without damaging your vehicle. See "Towing Your Vehicle" in the Index.

Engine Coolant Heater (Option)

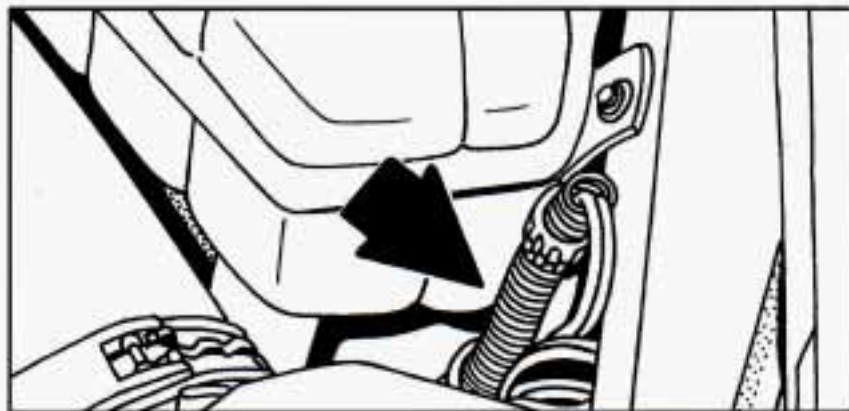

In very cold weather, 0°F (-18°C) or colder, the engine coolant heater can help. You'll get easier starting and better fuel economy during engine warm-up. Usually, the coolant heater should be plugged in a minimum of four hours prior to starting your vehicle.

To Use the Coolant Heater

1. Turn off the engine.
2. Open the hood and unwrap the electrical cord.
3. Plug it into a normal, grounded 110-volt AC outlet.

CAUTION:

Plugging the cord into an ungrounded outlet could cause an electrical shock. Also, the wrong kind of extension cord could overheat and cause a fire. You could be seriously injured. Plug the cord into a properly grounded three-prong 110-volt AC outlet. If the cord won't reach, use a heavy-duty three-prong extension cord rated for at least 15 amps.

4. Before starting the engine, be sure to unplug and store the cord as it was before to keep it away from moving engine parts. If you don't, it could be damaged.

How long should you keep the coolant heater plugged in? The answer depends on the outside temperature, the kind of oil you have, and some other things. Instead of trying to list everything here, we ask that you contact your Buick dealer in the area where you'll be parking your vehicle. The dealer can give you the best advice for that particular area.

Automatic Transaxle Operation



There are several different positions for your shift lever.

PARK (P): This locks your front wheels. It's the best position to use when you start your engine because your vehicle can't move easily.

CAUTION:

It is dangerous to get out of your vehicle if the shift lever is not fully in **PARK (P)** with the parking brake firmly set. Your vehicle can roll. Don't leave your vehicle when the engine is running unless you have to. If you have left the engine running, the vehicle can move suddenly. You or others could be injured. To be sure your vehicle won't move, even when you're on fairly level ground, always set your parking brake and move the shift lever to **PARK (P)**.

See "Shifting Into **PARK (P)**" in the Index. If you're pulling a trailer, see "Towing a Trailer" in the Index.

Ensure the shift lever is fully in PARK (P) range before starting the engine. Your Buick has a brake-transaxle shift interlock. You have to fully *apply* your regular brakes *before* you can shift from PARK (P) when the ignition key is in RUN. If you cannot shift out of PARK (P), ease pressure on the shift lever -- push the shift lever all the way into PARK (P) and also release the shift lever button on floor shift console models as you maintain brake application. Then move the shift lever into the gear you wish. (Press the shift lever button before moving the shift lever on floor shift console models.) See "Shifting Out of PARK (P)" in this section.

REVERSE (R): Use this gear to back up.

NOTICE:

Shifting to REVERSE (R) while your vehicle is moving forward could damage your transaxle. Shift to REVERSE (R) only after your vehicle is stopped.

To rock your vehicle back and forth to get out of snow, ice or sand without damaging your transaxle, see "Stuck: In Sand, Mud, Ice or Snow" in the Index.

NEUTRAL (N): In this position, your engine doesn't connect with the wheels. To restart when you're already moving, use NEUTRAL (N) only. Also, use NEUTRAL (N) when your vehicle is being towed.

CAUTION:

Shifting out of PARK (P) or NEUTRAL (N) while your engine is "racing" (running at high speed) is dangerous. Unless your foot is firmly on the brake pedal, your vehicle could move very rapidly. You could lose control and hit people or objects. Don't shift out of PARK (P) or NEUTRAL (N) while your engine is racing.

NOTICE:

Damage to your transaxle caused by shifting out of PARK (P) or NEUTRAL (N) with the engine racing isn't covered by your warranty.

AUTOMATIC OVERDRIVE (Ⓢ): This position is for normal driving. If you need more power for passing, and you're:

- Going less than approximately 35 mph (56 km/h), push your accelerator pedal about halfway down.
- Going about 35 mph (56 km/h) or more, push the accelerator all the way down.

You'll shift down to the next gear and have more power.

THIRD (3): This position is also used for normal driving, however, it offers more power and lower fuel economy than AUTOMATIC OVERDRIVE (Ⓢ). Here are some times you might choose THIRD (3) instead of AUTOMATIC OVERDRIVE (Ⓢ):

- When driving on hilly, winding roads,
- When towing a trailer, so there is less shifting between gears, or
- When going down a steep hill.

SECOND (2): This position gives you more power but lower fuel economy than AUTOMATIC OVERDRIVE (Ⓢ) or THIRD (3). You can use SECOND (2) on hills. It can help control your speed as you go down steep mountain roads, but then you would also want to use your brakes off and on.

NOTICE:

Don't drive in SECOND (2) for more than 25 miles (41 km), or at speeds over 55 mph (88 km/h), or you can damage your transaxle. Use AUTOMATIC OVERDRIVE (Ⓢ) or THIRD (3) as much as possible.

Don't shift into SECOND (2) unless you are going slower than 65 mph (105 km/h), or you can damage your engine.

FIRST (1): This position gives you even more power but lower fuel economy than **SECOND (2)**. You can use it on very steep hills, or in deep snow or mud. If the selector lever is put in **FIRST (1)**, the transaxle won't shift into **FIRST (1)** until the vehicle is going slowly enough.

NOTICE:

If your front wheels can't rotate, don't try to drive. This might happen if you were stuck in very deep sand or mud or were up against a solid object. You could damage your transaxle.

Also, if you stop when going uphill, don't hold your vehicle there with only the accelerator pedal. This could overheat and damage the transaxle. Use your brakes or shift into **PARK (P) to hold your vehicle in position on a hill.**

Parking Brake



Setting the parking brake: Hold the regular brake pedal down with your right foot. Push down the parking brake pedal with your left foot. If the ignition is on, the brake system warning light will come on and a single chime will be heard.

The parking brake uses the brakes on the rear wheels.

Releasing the parking brake: You will need to use the **PUSH TO RELEASE** parking brake pedal. Hold the regular brake pedal down and push the parking brake pedal with your left foot. This will unlock the pedal. When you lift your left foot, the parking brake pedal will follow it to the release position.

If you try to drive off with the parking brake on, the brake light stays on and a chime sounds until you release the parking brake or recycle the ignition.

NOTICE:

Driving with the parking brake on can cause your rear brakes to overheat. You may have to replace them, and you could also damage other parts of your vehicle.

If you are towing a trailer and are parking on a hill, see “Towing a Trailer” in the Index. That section shows what to do first to keep the trailer from moving.

Shifting Into PARK (P)



CAUTION:

It can be dangerous to get out of your vehicle if the shift lever is not fully in PARK (P) with the parking brake firmly set. Your vehicle can roll. If you have left the engine running, the vehicle can move suddenly. You or others could be injured. To be sure your vehicle won't move, even when you're on fairly level ground, use the steps that follow. If you're pulling a trailer, see “Towing a Trailer” in the Index.

Steering Column Shift Lever

1. Hold the brake pedal down with your right foot and set the parking brake by pushing down the parking brake pedal with your left foot.
2. Move the shift lever into PARK (P) like this:

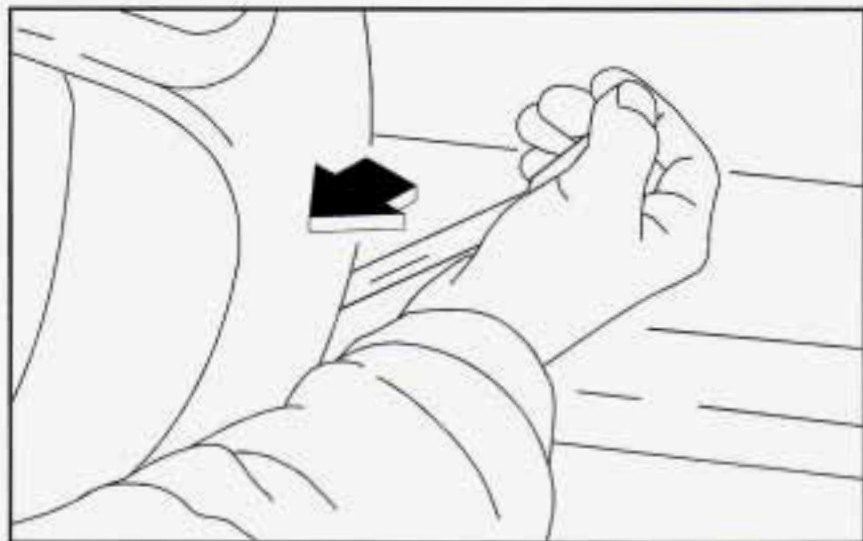

- Pull the lever toward you.

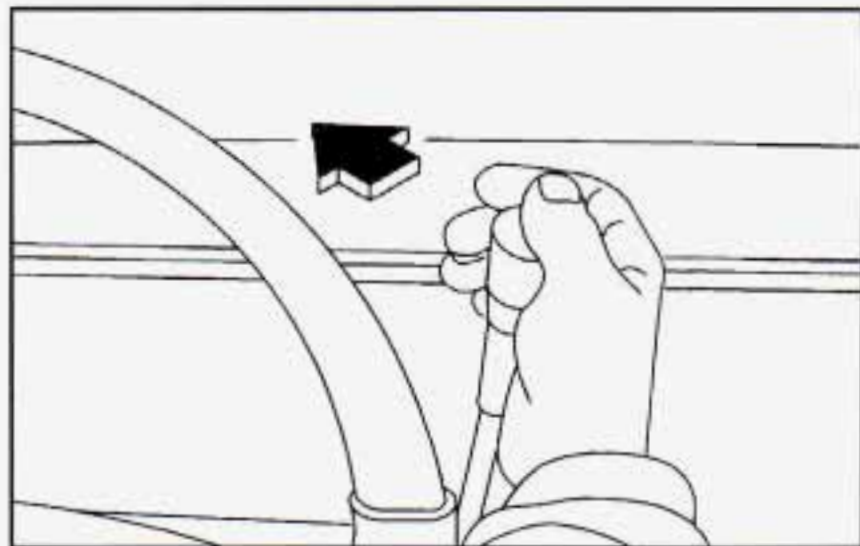

- Move the lever up as far as it will go.
3. Move the ignition key to LOCK.
 4. Remove the key and take it with you. If you can leave your vehicle with the ignition key in your hand, your vehicle is in PARK (P).

Console Shift Lever

1. Hold the brake pedal down with your right foot and set the parking brake.
2. Move the shift lever into PARK (P) like this:
 - Hold in the button on the lever.
 - Push the lever all the way toward the front of your vehicle.



3. Move the ignition key to LOCK.
4. Remove the key and take it with you. If you can leave your vehicle with the ignition key in your hand, your vehicle is in PARK (P).

Leaving Your Vehicle With the Engine Running

CAUTION:

It can be dangerous to leave your vehicle with the engine running. Your vehicle could move suddenly if the shift lever is not fully in PARK (P) with the parking brake firmly set. And, if you leave the vehicle with the engine running, it could overheat and even catch fire. You or others could be injured. Don't leave your vehicle with the engine running unless you have to.

If you have to leave your vehicle with the engine running, be sure your vehicle is in PARK (P) and your parking brake is firmly set before you leave it. After you've moved the shift lever into PARK (P), hold the regular brake pedal down. Then, see if you can move the shift lever away from PARK (P) without first pushing the button. If you can, it means that the shift lever wasn't fully locked into PARK (P).

Torque Lock

If you are parking on a hill and you don't shift your transaxle into PARK (P) properly, the weight of the vehicle may put too much force on the parking pawl in the transaxle. You may find it difficult to pull the shift lever out of PARK (P). This is called "torque lock." To prevent torque lock, set the parking brake and then shift into PARK (P) properly before you leave the driver's seat. To find out how, see "Shifting Into PARK (P)" in the Index.

When you are ready to drive, move the shift lever out of PARK (P) *before* you release the parking brake.

If torque lock does occur, you may need to have another vehicle push yours a little uphill to take some of the pressure from the parking pawl in the transaxle, so you can pull the shift lever out of PARK (P).

Shifting Out of PARK (P)

Your Buick has a brake-transaxle shift interlock. You have to fully *apply* your regular brake *before* you can shift from PARK (P) when the ignition is in RUN. See "Automatic Transaxle" in the Index.

Your vehicle has a BRAKE TO SHIFT reminder light. This light comes on to remind you to apply the brake pedal before you can shift from PARK (P).

If you cannot shift out of PARK (P), ease pressure on the shift lever -- push the shift lever all the way into PARK (P) and also release the shift lever button on floor shift models as you maintain brake application. Then move the shift lever into the gear you want. (Press the shift lever button before moving the shift lever.) If you ever hold the brake pedal down but still can't shift out of PARK (P), try this:

1. Turn the ignition key to OFF. Open and close the driver's door to turn off the retained accessory power feature.
2. Apply and hold the brake until the end of Step 4.
3. Shift to NEUTRAL (N).
4. Start the vehicle and then shift to the drive gear you want.
5. Have the vehicle fixed as soon as you can.

Parking Over Things That Burn



CAUTION:

Things that can burn could touch hot exhaust parts under your vehicle and ignite. Don't park over papers, leaves, dry grass or other things that can burn.

Engine Exhaust

CAUTION:

Engine exhaust can kill. It contains the gas carbon monoxide (CO), which you can't see or smell. It can cause unconsciousness and death.

You might have exhaust coming in if:

- Your exhaust system sounds strange or different.
- Your vehicle gets rusty underneath.
- Your vehicle was damaged in a collision.
- Your vehicle was damaged when driving over high points on the road or over road debris.
- Repairs weren't done correctly.
- Your vehicle or exhaust system had been modified improperly.

If you ever suspect exhaust is coming into your vehicle:

- Drive it only with all the windows down to blow out any CO; and
- Have your vehicle fixed immediately.

Running Your Engine While You're Parked

It's better not to park with the engine running. But if you ever have to, here are some things to know.

CAUTION:

Idling the engine with the climate control system off could allow dangerous exhaust into your vehicle (see the earlier Caution under "Engine Exhaust").

Also, idling in a closed-in place can let deadly carbon monoxide (CO) into your vehicle even if the fan switch is at the highest setting. One place this can happen is a garage. Exhaust -- with CO -- can come in easily. **NEVER** park in a garage with the engine running.

Another closed-in place can be a blizzard. (See "Blizzard" in the Index.)

CAUTION:

It can be dangerous to get out of your vehicle if the shift lever is not fully in **PARK (P)** with the parking brake firmly set. Your vehicle can roll. Don't leave your vehicle when the engine is running unless you have to. If you've left the engine running, the vehicle can move suddenly. You or others could be injured. To be sure your vehicle won't move, even when you're on fairly level ground, always set your parking brake and move the shift lever to **PARK (P)**.

Follow the proper steps to be sure your vehicle won't move. See "Shifting Into **PARK (P)**" in the Index.

If you are parking on a hill and if you're pulling a trailer, also see "Towing a Trailer" in the Index.

Windows

Power Windows



Switches on the driver's armrest control each of the windows while the ignition is on or retained accessory power is active. In addition, the passenger's door armrest has a switch for its own window.

To lower the passenger's window, pull back on the right switch. The window will lower as long as the switch is held. To raise either window, push the switch forward.

Express-Down Window

The switch for the driver's window has an express-down feature. When the driver's AUTO switch is held rearward for more than half a second, the window will automatically lower completely. To stop the window while it is lowering, press the switch again and then release. The window can be opened in smaller amounts by pressing the switch rearward and releasing it immediately. To raise the window, hold the switch forward.

Horn

Nearly the entire surface of the center pad of the steering wheel is an active horn switch. Press anywhere on the pad to sound the horn.

Tilt Wheel

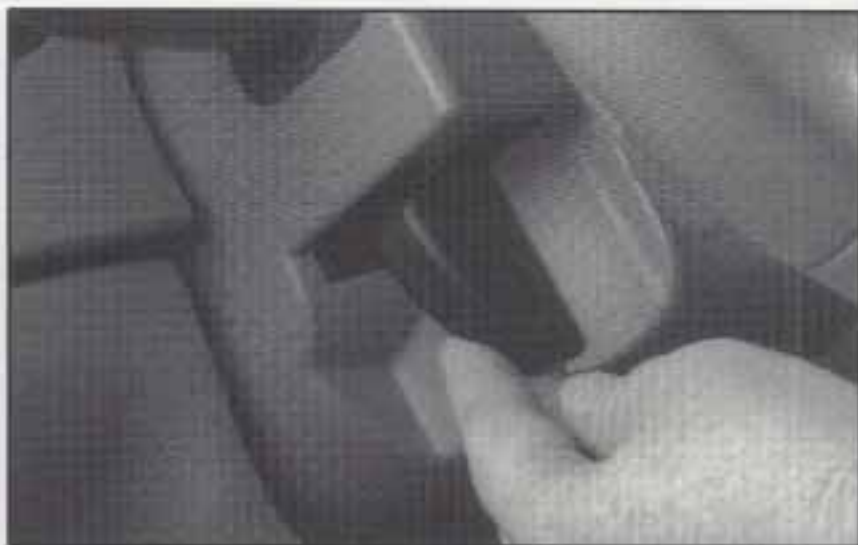

A tilt steering wheel allows you to adjust the steering wheel before you drive.

You can also raise it to the highest level to give your legs more room when you exit and enter the vehicle.

To tilt the wheel, hold the steering wheel and pull the lever toward you. Move the steering wheel to a comfortable level, then release the lever to lock the wheel in place.

Turn Signal/Multifunction Lever

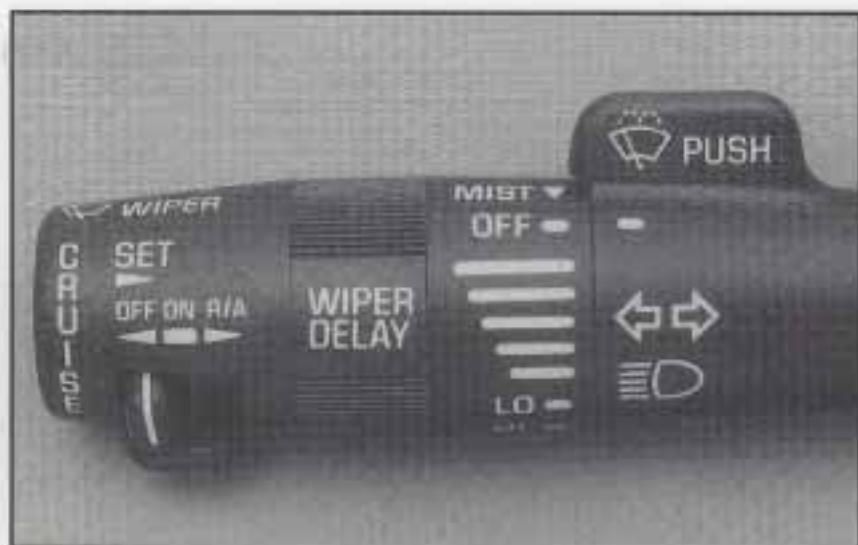

The lever on the left side of the steering column includes your:

- Turn Signal and Lane Change Indicator
- Headlamp High/Low Beam
- Flash-To-Pass Feature
- Windshield Wipers
- Windshield Washer
- Cruise Control

Turn Signal and Lane Change Indicator

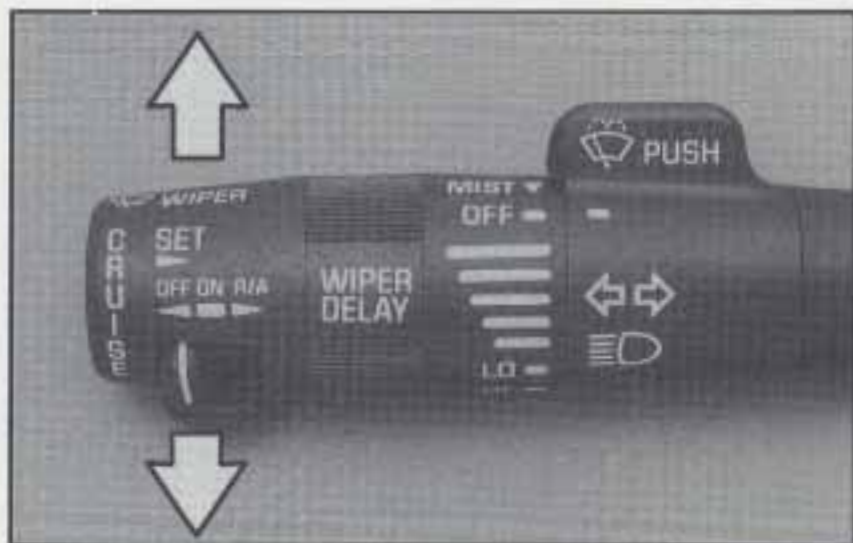

The turn signal has two upward (for right) and two downward (for left) positions. These positions allow you to signal a turn or a lane change.

To signal a turn, move the lever all the way up or down. When the turn is finished, the lever will return automatically.

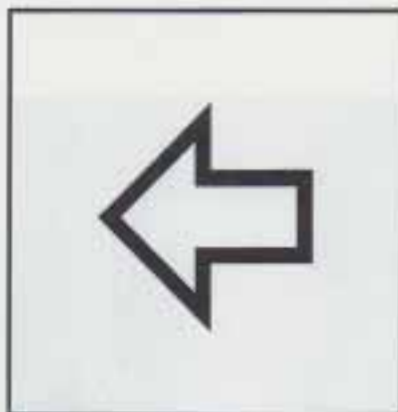

An arrow on the instrument panel will flash in the direction of the turn or lane change.

To signal a lane change, just raise or lower the lever until the arrow starts to flash. Hold it there until you complete your lane change. The lever will return by itself when you release it.

As you signal a turn or a lane change, if the arrows don't flash but just stay on, a signal bulb may be burned out and other drivers won't see your turn signal.

If a bulb is burned out, replace it to help avoid an accident. If the arrows don't go on at all when you signal a turn, check the fuse and check for burned-out bulbs. See "Fuses and Circuit Breakers" in the Index.

Turn Signal Reminder

If your turn signal is left on for more than 3/4 of a mile, a chime will sound. To turn off the chime, move the turn signal lever to the off position.

Headlamp High/Low Beam

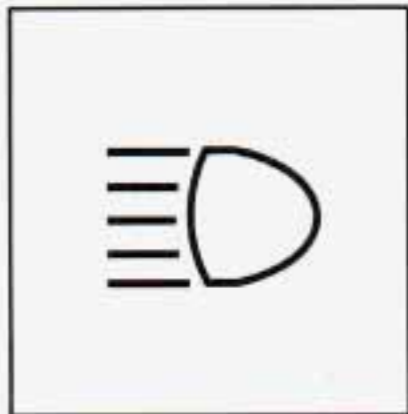

To change the headlamps from low beam to high or high to low, pull the turn signal lever toward you. Then release it. When the high beams are on, this light on the instrument panel will also be on.

Flash-To-Pass Feature

This feature lets you use your high-beam headlamps to signal a driver in front of you that you want to pass. It works even if your headlamps are off.

To use it, pull the turn signal lever toward you a little, but not so far that you hear a click.

If your headlamps are off or on low beam, your high-beam headlamps will turn on. They'll stay on as long as you hold the lever toward you and the high beam indicator on the dash will come on. Release the lever to turn the high-beam headlamps off.

Windshield Wipers

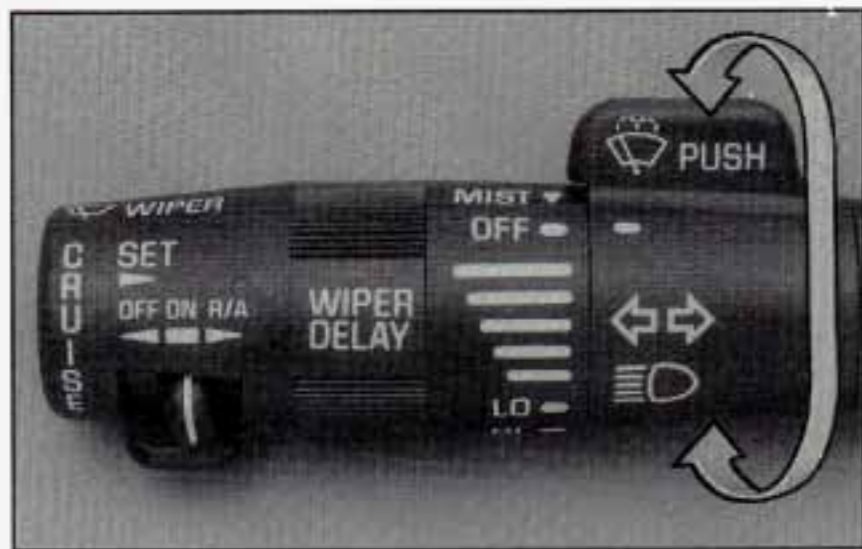

You control the windshield wipers by turning the band marked WIPER DELAY.

For a single wiping cycle, turn the band to MIST. Hold it there until the wipers start, then let go. The wipers will stop after one cycle. If you want more cycles, hold the band on MIST longer.

You can set the wiper speed for a long or short delay between wipes. This can be very useful in light rain or snow. Turn the band to choose the delay time. The closer to LO, the shorter the delay.

For steady wiping at low speed, turn the band away from you to the LO position. For high-speed wiping, turn the band further, to HI. To stop the wipers, move the band to OFF.

Remember that damaged wiper blades may prevent you from seeing well enough to drive safely. To avoid damage, be sure to clear ice and snow from the wiper blades before using them. If they're frozen to the windshield, carefully loosen or thaw them. If your blades do become damaged, get new blades or blade inserts.

Heavy snow or ice can overload your wiper motor. A circuit breaker will stop the motor until it cools. Clear away snow or ice to prevent an overload.

Windshield Washer

At the top of the turn signal lever there's a paddle with the word PUSH on it. To spray washer fluid on the windshield, just push the paddle for less than a second. The washer will spray several times, then stop. Unless they are already turned on, the wipers will operate at low speed for several sweeps, then turn off.



CAUTION:

In freezing weather, don't use your washer until the windshield is warmed. Otherwise the washer fluid can form ice on the windshield, blocking your vision.

To get more fluid on the windshield, push and hold the paddle. Spraying will continue as long as the paddle is held.

**WASHER
FLUID LOW**

When you get to a low fluid condition, the LOW WASHER FLUID light will come on to remind you to get more washer fluid soon.

Cruise Control



With cruise control, you can maintain a speed of about 25 mph (40 km/h) or more without keeping your foot on the accelerator. This can really help on long trips.

Cruise control does not work at speeds below about 25 mph (40 km/h).

When you apply your brakes, the cruise control shuts off.

CAUTION:

- Cruise control can be dangerous where you can't drive safely at a steady speed. So, don't use your cruise control on winding roads or in heavy traffic.
- Cruise control can be dangerous on slippery roads. On such roads, fast changes in tire traction can cause needless wheel spinning, and you could lose control. Don't use cruise control on slippery roads.

If your vehicle is in cruise control when the optional traction control system begins to limit wheel spin, the cruise control will automatically disengage. (See "Traction Control System" in the Index.) When road conditions allow you to safely use it again, you may turn the cruise control back on.

Setting Cruise Control

CAUTION:

If you leave your cruise control switch on when you're not using cruise, you might hit a button and go into cruise when you don't want to. You could be startled and even lose control. Keep the cruise control switch OFF until you want to use it.

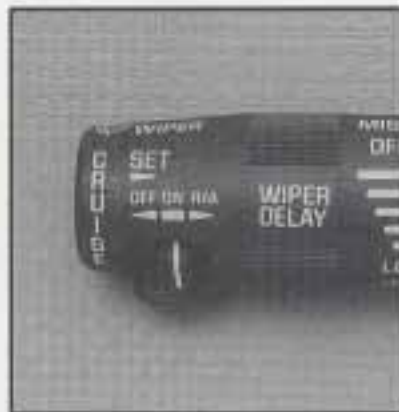

1. Move the cruise control switch to ON.
2. Get up to the speed you want.

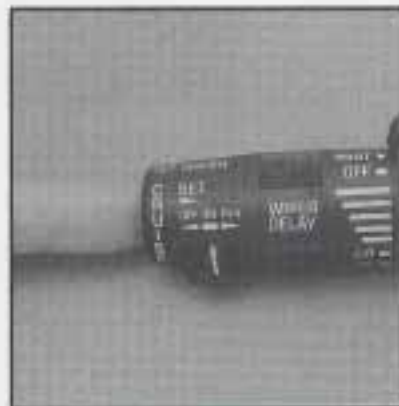

3. Push in the SET button at the end of the lever and release it. The CRUISE light on the instrument panel will come on.
4. Take your foot off the accelerator pedal.

Resuming a Set Speed

Setting the cruise control at a desired speed and then applying the brake will end the cruise control function.

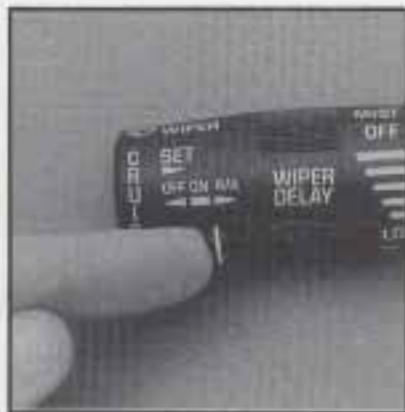

Once you're going about 25 mph (40 km/h) or more, you can move the cruise control switch from ON to R/A (Resume/Accelerate) for about half a second to reset. This returns you to your desired preset speed.

Remember, if you hold the switch at R/A longer than half a second, the vehicle will accelerate until you release the switch or apply the brake. So unless you want to go faster, don't hold the switch at R/A.

Increasing Speed While Using Cruise Control

There are two ways to go to a higher speed:

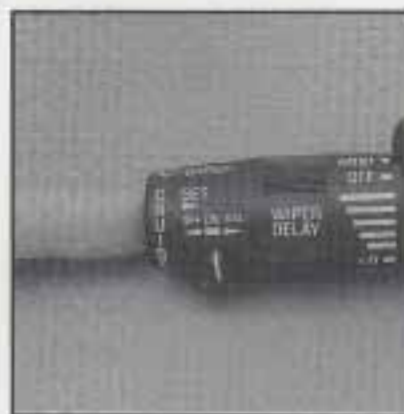

- Use the accelerator pedal to go to a higher speed. Push the SET button at the end of the lever, then release the button and the accelerator pedal. You'll now cruise at the higher speed. *Or,*

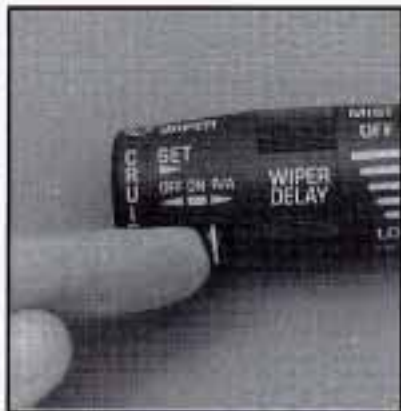

- Move the cruise switch from ON to R/A. Hold it there until you reach a desired speed and then release the switch.

To increase your speed in very small amounts, move the switch to R/A for less than half a second and then release it. Each time you do this, your vehicle will go about 1 mph (1.6 km/h) faster.

The accelerate feature will only work after you have set the cruise control speed by pushing the SET button.

Reducing Speed While Using Cruise Control

There are two ways to reduce your speed while using cruise control:

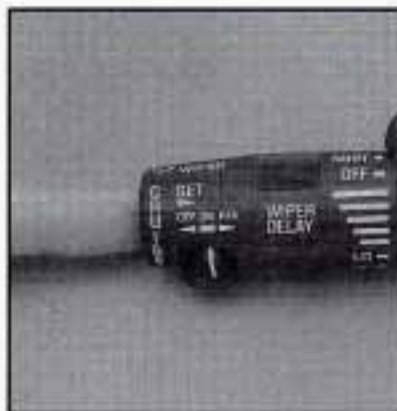

- Push in the button at the end of the lever until you reach a desired lower speed then release it.
- To slow down in very small amounts, push the button for less than half a second. Each time you do this, you'll go 1 mph (1.6 km/h) slower.

Passing Another Vehicle While Using Cruise Control

Use the accelerator pedal to increase your speed. When you take your foot off the pedal, your vehicle will slow down to the cruise control speed you set earlier.

Using Cruise Control on Hills

How well your cruise control will work on hills depends upon your speed, load and the steepness of the hills.

When going up steep hills, you may have to step on the accelerator pedal to maintain your speed. When going downhill, you may have to brake or shift to a lower gear to keep your speed down. Of course, applying the brake takes you out of cruise control. Many drivers find this to be too much trouble and don't use cruise control on steep hills.

Ending Cruise Control

There are two ways to turn off the cruise control:

- Step lightly on the brake pedal, *or*
- Move the cruise switch to OFF. The CRUISE light will also go out.

Erasing Speed Memory

When you turn off the cruise control or the ignition, your cruise control set speed memory is erased.

Lamps



Headlamps

 This switch controls these systems:

- Headlamps
- Taillamps
- Parking Lamps
- License Plate Lamps

- Sidemarkers Lamps
- Instrument Panel Lights
- Interior Courtesy Lamps

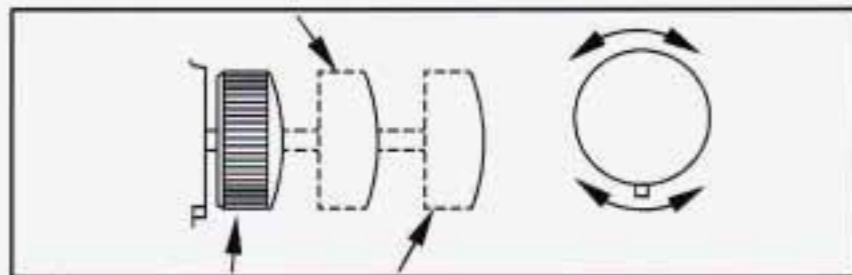

Pull the knob toward you to the first setting to turn on the parking lamps and other operating lamps without the headlamps. Pull the knob toward you to the second setting to turn on the headlamps as well as the other operating lamps.

Rotate the knob from left to right to control brightness of the instrument panel lights.

Lamps On Reminder

If the headlamp switch is left on, you'll hear a warning chime when you turn the ignition off, remove the key from the ignition and open the driver's door.

Daytime Running Lamps

Daytime Running Lamps (DRL) can make it easier for others to see the front of your vehicle during the day. DRL can be helpful in many different driving conditions, but they can be especially helpful in the short periods after dawn and before sunset.

A light sensor on top of the instrument panel makes the DRL work, so be sure it isn't covered.

The DRL system will make your high-beam headlamps come on at reduced brightness in daylight when:

- The ignition is on,
- The headlamp switch is off and
- The transaxle is not in PARK (P).

When DRL are on, only your high-beam headlamps will be on. The parking lamps, taillamps, sidemarker and other lamps won't be on. Your instrument panel won't be lit up either.

When it's dark enough outside, your high-beam headlamps will turn off and your low-beam and parking lamps will become active. The other lamps that come on with your headlamps will also come on. When it's bright enough outside, the regular lamps will go off, and your high-beam headlamps change to the reduced brightness of DRL.

To idle your vehicle with the DRL off, shift the transaxle into PARK (P). The DRL will stay off until you shift out of PARK (P).

To turn off all exterior lamps at night when you are in PARK (P), turn off the headlamps and move the twilight sentinel control, located on the lower area of the headlamp switch, all the way toward AUTO MIN. When released, the spring control will return to the twilight sentinel minimum delay position, and all exterior lamps will turn off.

As with any vehicle, you should turn on the regular headlamp system when you need it.

Cornering Lamps (Option)

The cornering lamps are designed to come on when you signal a turn. This will provide more light for cornering at night.

Twilight Sentinel

Twilight sentinel turns your headlamps, taillamps and parking lamps on and off by sensing how dark it is outside. The control is located on the lower area of the headlamp switch.

To operate it, leave the headlamp switch off. The vehicle's twilight sentinel is always enabled.

Twenty-three seconds after entering a darkened environment, the headlamps and parking lamps will turn on. If the ignition is turned on at night, the exterior lamps will come on.

To turn off all exterior lamps at night when you are in PARK (P), turn off the headlamps and move the twilight sentinel control, located on the lower area of the headlamp switch, all the way toward AUTO MIN. When released, the spring control will return to the twilight sentinel minimum delay position, and all exterior lamps will turn off.

If you move the control all the way to AUTO MAX, your lamps will remain on for three minutes after you turn off your engine. If you move the control toward AUTO MIN, the lamps will go off quickly when you turn off your engine. You can set this delay time for only a few seconds or up to three minutes.

Light Sensor

Your twilight sentinel and daytime running lamps work with the light sensor on top of the instrument panel. Don't cover it up. If you do, it will read "dark" and the headlamps will come on.

Interior Lamps

Instrument Panel Brightness

By rotating the headlamp knob you can make the instrument panel lights bright or dim. See "Headlamps" in the Index.

Time Out Feature

The interior lamps will automatically shut off after 10 minutes if a door is left open. This feature is designed to help eliminate battery wear down.

Courtesy Lamps

When any door is opened, several lamps go on. They make it easy for you to enter and leave the car. To turn on these lamps without opening the door, rotate the headlamp knob.

Delayed Entry Lighting

When you open the door to enter your vehicle, the interior lamps will come on. When you close the door with the ignition off, the interior lamps will stay on for 25 seconds or until the ignition is turned to an on position. Please note that locking the doors will override the delayed entry lighting feature and the lamps will turn off right away.

Theater Dimming

This feature allows for a three to five-second fade out of the courtesy lamps instead of immediate turn off.

Parade Dimming

This feature prohibits the dimming of your instrument panel displays during daylight while your headlamps are on. This feature operates with the light sensor for the twilight sentinel and is fully automatic. When the light sensor reads darkness outside, you will be able to dim your instrument panel displays once again.

Delayed Exit Lighting

With this feature, the interior lamps will come on for 25 seconds after you remove the key from the ignition. This will give you time to find the door pull handle or lock switches when you exit the vehicle.

Illuminated Entry

Press the UNLOCK button on the key chain transmitter and the interior courtesy lamps will come on and stay on for up to a minute. The lamps will turn off immediately when pressing the LOCK button on the key chain transmitter, starting the ignition or activating the power door locks.

Perimeter Lighting

This is a Personal Choice feature of your Riviera.

When the UNLOCK button on the key chain transmitter is pressed, the headlamps, parking lamps, back-up lamps and cornering lamps will come on if it is dark enough outside according to the twilight sentinel.

This option can be programmed on or off for each transmitter when the ignition is off.

To turn the feature off:

1. Press and hold the door lock switch throughout this procedure. All doors will lock.
2. Press the instant alarm button on the transmitter. Perimeter lighting remains on at this time and the horn will chirp two times.
3. Press the instant alarm button on the key chain transmitter again. Perimeter lighting is disabled and the horn will chirp one time.
4. Release the door lock switch. The perimeter lighting option is now off.

To turn the feature on:

1. Press and hold the door lock switch throughout this procedure. All doors will lock.
2. Press the instant alarm button on the key chain transmitter. Perimeter lighting remains off at this time and the horn will chirp one time.
3. Press the instant alarm button on the transmitter again. Perimeter lighting is now enabled and the horn will chirp two times.
4. Release the door lock switch. The perimeter lighting option is now on.

Front Reading Lamps



These lamps and the interior courtesy lamps will come on when you open a door, and turn off when you turn the ignition on. To turn on the reading lamps when the doors are closed, press the button behind the lamp you want on. Press it again to turn the lamp off.

Trunk Lamp

When you open the trunk to its full open position, a lamp will come on inside the trunk. This lamp will automatically turn off when the trunk is closed.

Battery Rundown Protection

This feature shuts off the courtesy, reading, trunk, glove box and visor vanity mirror lamps if any are left on for more than 10 minutes when the ignition is OFF. This will keep your battery from running down.

This feature also shuts off the exterior lamps if they are left on for more than 10 minutes when the ignition is OFF. You may override this feature for the exterior lamps by turning the lamps off and then back on after the ignition is turned to OFF. If you do this, the exterior lamps will stay on until you manually turn them off.

If the feature is enabled for the interior and exterior lamps, all lamps should turn off at approximately the same time.

Mirrors

Inside Day/Night Rearview Mirror

When you are sitting in a comfortable driving position, adjust the mirror so you can see clearly behind your vehicle. Grip the mirror in the center to move it up or down and side to side. The day/night adjustment allows you to adjust the mirror to avoid glare from the lights behind you. Pull the tab forward for daytime use; push it back for night use.



Electrochromic Day/Night Rearview Mirror (Option)

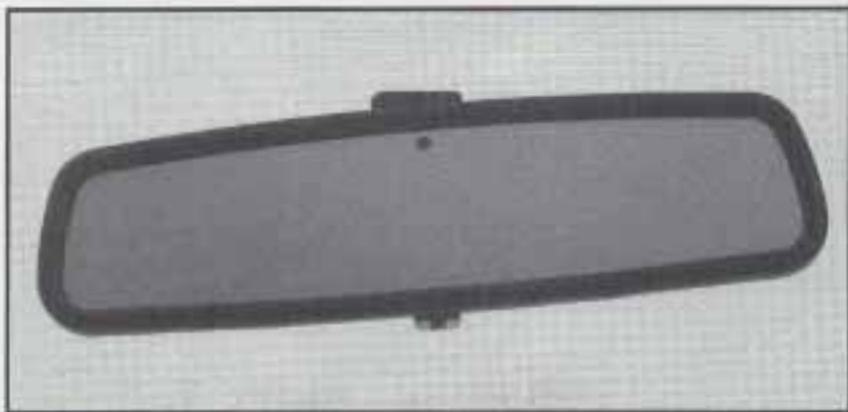

Your Buick may have an automatic electrochromic day/night rearview mirror.

This mirror automatically changes to reduce glare from headlamps behind you. A photocell on the back of the mirror senses when it is becoming dark outside. Another photocell built into the mirror surface, senses when headlamps are behind you.

At night, when the glare is too high, the mirror will gradually darken to reduce glare (this change may take a few seconds). The mirror will return to its clear daytime state when the glare is reduced.

Press the button at the base of the mirror to turn on the automatic feature. The button has an indicator light to show it is on. Press the button again to turn the automatic feature off.

Time Delay

The automatic mirror has a time delay feature which prevents unnecessary switching from the night back to the day position. This delay prevents rapid changing of the mirror as you drive under lights and through traffic.

Reverse Gear Day Mode

The reverse day mode is another important feature of the electrochromic mirror. When you shift into REVERSE (R), the mirror changes to the day mode. This gives you a bright image in the mirror as you back up.

Cleaning the Photocells

Use a cotton swab and glass cleaner to clean the photocells when necessary.

Electrochromic Day/Night Rearview Mirror with Compass (Option)



This mirror automatically changes to reduce glare when set in the M (Mirror) or C/M (Compass/Mirror) position.

This mirror automatically changes to reduce glare from headlamps behind you. One photocell on the back of the mirror senses when it is becoming dark outside. Another photocell is built into the mirror surface to sense headlamps behind you.

At night, when the glare is too high, the mirror will gradually darken to reduce glare (this change may take a few seconds). The mirror will return to its clear daytime state when the glare is reduced.

Setting the Mirror

OFF: This setting turns off the day/night function and compass. The mirror will stay in the day mode.

M: This turns on the day/night portion of the mirror to automatically reduce glare.

C/M: This setting turns on the compass in addition to the day/night function. The letter or letters displayed in the top right corner of the mirror indicate the direction in which you are traveling.

Time Delay

This feature prevents rapid changing of the mirror from the night mode to the day mode as you drive under lights and through traffic.

Reverse Gear Day Mode

The reverse mode is another important feature of the electrochromic mirror. When the shift lever is placed in REVERSE (R), the mirror changes to the day mode. This gives you a bright image in the mirror as you back up.

Cleaning the Photocells

Use a cotton swab and glass cleaner to clean the photocells when necessary.

Compass Calibration

Once the compass is calibrated, it does not need to be recalibrated as long as the mirror is left in your vehicle and the vehicle remains in the same geographical zone. To calibrate the compass:

1. Set the switch on the mirror control to C/M.
2. Turn the vehicle ignition switch on. If the letter C is not displayed in the mirror compass window, hold the CAL switch (on the bottom of the mirror) for more than 10 seconds. To hold in the CAL switch, insert a paper clip into the small hole on the bottom of the mirror housing. The display will show a number first, but keep holding until the letter C appears.
3. For quick calibration, drive the vehicle in a 360-degree circle at less than 5 mph (8 km/h) until the display reads a compass direction.

For normal calibration, drive the vehicle on your everyday routine, and the compass will eventually calibrate.

Compass Variance

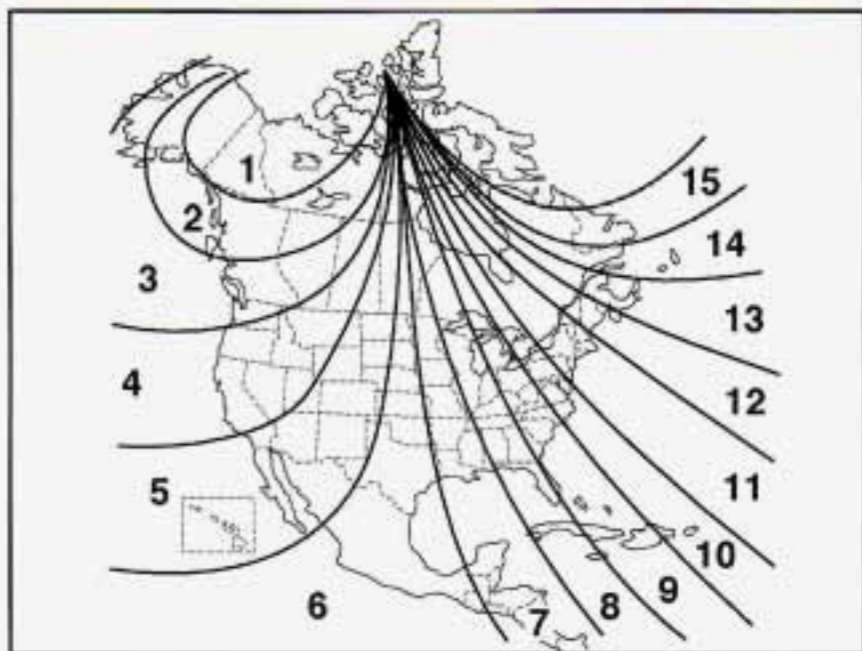

Variance is the difference between magnetic north and geographic north. In some areas, the difference between the two can be great enough to cause false compass readings. If this happens, follow these instructions to set the variance for your particular location:

1. Find your location on the zone map. Note your zone number.
2. Hold in the CAL switch (on the bottom of the mirror housing) for five seconds until the current zone entry number appears on the display. To hold in the CAL switch, insert a paper clip into the small hole on the bottom of the mirror housing.
3. Repeatedly press the CAL switch until the number for the new zone entry is displayed.

Once the desired zone number is displayed, stop pressing the CAL switch and the display will show compass direction within a few seconds.

Power Remote Control Mirror



Your Buick has an electric mirror control located on the driver's door armrest.

Move the inner switch to the right (R) or left (L) to choose either the driver's or passenger's side mirror. Press any of the four arrow buttons to move the mirror in the direction desired.

Adjust each mirror so you can just see the side of your vehicle and the area behind your vehicle. When the inner switch is in the center position, the mirrors cannot be adjusted.

Automatic Dimming Outside Rearview Mirror (Option)

If you have this option, the driver's side outside mirror will adjust for the glare of headlamps behind you. This feature is controlled by the on and off settings on the automatic electrochromic day/night rearview mirror. See "Automatic Electrochromic Day/Night Rearview Mirror" earlier in this section.

Parallel Park Assist Mirror (Option)

The passenger's outside rearview mirror also includes a tilt-down feature that operates when the shift lever is in reverse. This feature assists the driver with improved rear obstacle detection.

To enable this feature, move the power remote mirror switch to the left (L) or center position. Move the switch to the right (R) to turn this feature off.

Convex Outside Mirror

Your passenger's side mirror is convex. A convex mirror's surface is curved so you can see more from the driver's seat.



CAUTION:

A convex mirror can make things (like other vehicles) look farther away than they really are. If you cut too sharply into the right lane, you could hit a vehicle on your right. Check your inside mirror or glance over your shoulder before changing lanes.

Storage Compartments

Glove Box

Use the door key to lock and unlock the glove box. To open, pull the latch on the front of the glove box door.

Installing a Garage Door Opener



The garage door opener storage area is located in the headliner near the reading lamps. The following chart and instructions will help you install your garage door opener in the overhead storage area.

1. Push the extended tab (above the GARAGE button) or insert a screwdriver between the tab and outer edge of the cover. The garage door opener cover will flip down.



- Remove the square height adapters from the cover. Refer to the chart to determine the number and location of the height adapters for your garage door opener. If your unit does not appear on the chart, you will have to try different adapter number and location combinations.

Your Garage Door Transmitter			Vehicle Console Door	
Name	Model	Button	Position For Adapter(s)	Number Of Adapter(s)
CHAMBERLAIN	G-3684	1	5	4
CRUSADER	1-BUTTON	1	9	3
GENIE	AT85P	1	3	3
GENIE	AT85	1	5	4
GENIE	AT90	1	5	4
GENIE	MAT85	1	6	4
GENIE	MAT90	1	6	4
GENIE	AT285P	1	10	3
		2	1	3
GENIE	AT95	1	10	3
		2	3	3
		3	1	3
LIFTMASTER	G3446	1	2	3
LIFTMASTER	G3456	1	2	3
LINEAR	DT2A	1	6	3
		2	6	3
LINEAR	D22A	1	4	3
LINEAR	EK-11/H	1	4	2
LINEAR	ET-2	1	6	4
LINEAR	D22B	1	6	3
		2	6	3

Your Garage Door Transmitter			Vehicle Console Door	
Name	Model	Button	Position For Adapter(s)	Number Of Adapter(s)
LINEAR	DT4	1	10	3
		2	8	3
		3	3	3
		4	1	3
LINEAR	D4B	1	10	3
		2	8	3
		3	3	3
		4	1	3
MICOM	ESP-T-9R	1	6	3
MICOM	ESP-T-9	1	6	3
MULTIELMAC	3010	1	6	3
MULTIELMAC	3089	1	4	3
MULTIELMAC	3070	1	6	4
MULTIELMAC	3032	1	6	3
		2	6	3
MULTIELMAC	1054	1	6	3
MULTIELMAC	3034	1	—	—
		2	6	3
		3	6	3
		4	—	—

Your Garage Door Transmitter			Vehicle Console Door	
Name	Model	Button	Position For Adapter(s)	Number Of Adapter(s)
MULTIELMAC	3033	1	—	—
		2	6	3
		3	6	3
		4	—	—
MULTIELMAC	1048	1	4	2
MULTIELMAC	1087	1	5	2
MULTIELMAC	3060	1	6	4
		2	7	2
MULTIELMAC	1098	1	5	2
		2	7	2
OVERHEAD DOOR	1-BTN 223	1	1 OR 10	3
OVERHEAD DOOR	2-BTN 265	1	10	3
		2	1	3
OVERHEAD DOOR	3-BTN 242	1	10	3
		2	10	3
		3	1	3
OVERHEAD DOOR	4-BTN 232	1	10	3
		2	10	3
		3	1	3
		4	1	3
PULSAR	921	1	4	3
PULSAR	931	1	4	3

Your Garage Door Transmitter			Vehicle Console Door	
Name	Model	Button	Position For Adapter(s)	Number Of Adapter(s)
PULSAR	832	1	9	3
		2	3	3
PULSAR	833	1	9	3
		2	3	3
PULSAR	832C	1	4	3
		2	3	3
		3	1	3
PULSAR	833B	1	5	4
PULSAR	PDX-9921	1	4	3
SEARS	9B53738	1	6	4
SEARS	9B53708	1	2	2
SHIMA	RT-18	1	4	3
STANLEY	1047	1	5	3
STANLEY	1050	1	6	3
		2	6	3
STANLEY	1076	1	6	3
		2	6	3
STANLEY	1079	1	6	3
		2	6	3
STANLEY	1075	1	6	3
		2	6	3
STANLEY	331-1052	1	6	4

- Place the height adapters on the proper peg using the suggested combinations or by lining up the height adapters and the transmitter button on your garage door opener.

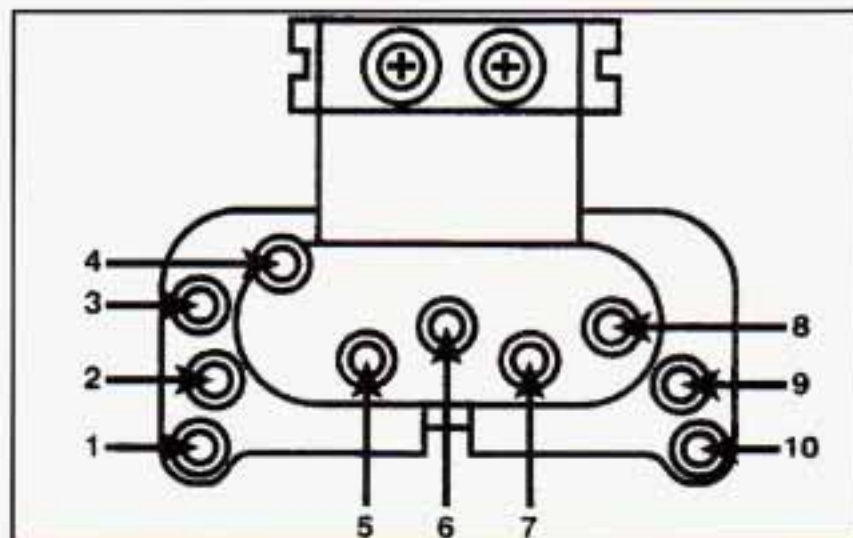

- Use the Velcro[®] found in the storage area and attach the garage door opener securely inside the console. Line up the transmitter button with the height adapters.
 - Close the cover and test the GARAGE button.
- If your garage door opener doesn't work after it is installed, try another combination.

Front Storage Armrest



The front storage armrest has space for compact disc and cassette storage, and a removable coinholder. To raise the armrest cover, press the latch in front of the armrest cover and lift the front edge.

Center Console Cupholder



The center console has a dual cupholder in front of the shift lever. To use the cupholder, push forward on the covered area and it will open. Press the cover and it will close.

Compact Disc Storage



The area between the ashtray and cupholder is additional storage space for your compact discs. Push on the raised portion of the slot, and your compact disc will extend from the storage space. Push the dropped door back in to store your compact disc.

Convenience Net



Your vehicle has a convenience net. You'll see it just inside the back wall of the trunk.

Put small loads, like grocery bags, behind the net. It can help keep them from falling over during sharp turns or quick starts and stops. For heavier loads, store them in the trunk as far forward as you can.

There are six retainers to secure the convenience net, allowing two different placements for the net. You can unhook the net so that it will lie flat when you're not using it. When reinstalling the net, make sure the label points toward the upper retainer.

Ashtrays and Cigarette Lighter

Front Ashtray

The front ashtray is behind a panel above the compact disc storage area. Press on the panel door to reveal the ashtray and cigarette lighter.

The front center ashtray may be lifted out for cleaning. Press the tabs on each side of the ashtray and pull up to remove. It snaps back into place.

Rear Ashtray

To remove the rear ashtray for cleaning, open the lid and ease the ashtray upward until the edge can be grasped to pull the ashtray up and out.

Cigarette Lighter

To use the cigarette lighter, push it all the way in and let it go. When it is hot, it will pop back by itself.

NOTICE:

If you hold a cigarette lighter in with your hand while it is heating, it won't be able to back away from the heating element when it's ready. This can make it overheat, damaging the lighter and the heating element.

Sun Visors

To block out glare, you can swing down the visors. You can also remove them from the center mount and swing them to the side, while the auxiliary visor remains to block out glare from the front.

Illuminated Visor Vanity Mirror



This mirror is on the larger of the passenger's sun visors. It may also be on the larger of the driver's sun visors. When you open it, the lamps turn on. The brightness of the lamps can be adjusted by sliding the switch up or down.

Accessory Power Outlet

An auxiliary power receptacle is located on the lower right side of the console. When the ignition is on, you can plug in accessories requiring electrical power.

If your Riviera has no console, the auxiliary power receptacle is opposite the cigarette lighter in the ashtray area.

Garment Hooks

Rear garment hooks are available for your convenience. Garment hooks are not designed to support clothing bars. Use assist straps for this if possible.

Rear License Plate Holder

To use it, open the trunk lid and slide your license plate into the slot. Always close the trunk to prevent theft of the plate.

Cellular Telephone (Option)

If your vehicle is equipped with the cellular telephone readiness package, your Riviera has been pre-wired for installation of a cellular telephone. If you choose to install a cellular telephone, contact your Buick dealer.

Assist Handles

An assist handle above each door can be used to help you get in or out of your vehicle.

Astrorooft (Option)



If your vehicle has the astrorooft option, the switch is on the roof between the sun visors. It will open the astrorooft when the ignition is on, or when retained accessory power is active.

To fully open the glass panel and sunshade, press the switch rearward and release. To stop the panel in a partially open position, press the switch again at the desired point. To continue to open fully, press the switch rearward again and release. The sunshade can be opened manually.

To close the glass panel, press and hold the switch forward. The sunshade must be manually closed.

Once the astrorooft is closed, it can be opened to a vent position. Press the switch forward to vent. To close, press the switch rearward.

Universal Transmitter (Option)



This transmitter allows you to consolidate the functions of up to three individual hand-held transmitters. It will operate garage doors and gates, or other devices controlled by radio frequency such as home/office lighting systems.

The transmitter will learn and transmit the frequencies of most current transmitters and is powered by your vehicle's battery and charging system.

This device complies with Part 15 of the FCC Rules. Operation is subject to the following two conditions:

(1) This device may not cause harmful interference, and

(2) This device must accept any interference received, including interference that may cause undesired operation.

This device complies with RSS-210 of Industry and Science Canada. Operation is subject to the following two conditions: (1) this device may not cause interference, and (2) this device must accept any interference, including interference that may cause undesired operation of the device.

Changes or modifications to this system by other than an authorized service facility could void authorization to use this equipment.

Programming the Transmitter

Do not use the universal transmitter with any garage door opener that does not have the "stop and reverse" safety feature. This includes any garage door opener model manufactured before April 1, 1982.

Be sure that people and objects are clear of the garage door you are programming.

Your vehicle's engine should be turned off while programming your transmitter. Follow these steps to program up to three channels:

1. If you have not previously programmed a universal transmitter channel, proceed to Step 2. Otherwise, hold down the two outside buttons on the universal

transmitter until the red light begins to flash rapidly (approximately 20 seconds). Then release the buttons. This procedure initializes the memory and erases any previous settings for all three channels.

2. Hold the end of your hand-held transmitter against the bottom surface of the universal transmitter so that you can still see the red light.
3. Decide which one of the three channels you want to program. Using both hands, press the hand-held transmitter button and the desired button on the universal transmitter. Continue to hold both buttons through Step 4.
4. Hold down both buttons until you see the red light on the universal transmitter flash slowly then rapidly. The rapid flashing, which could take up to 90 seconds, indicates that the universal transmitter has been programmed. Release both buttons three seconds after the light starts to flash rapidly.

If you have trouble programming the universal transmitter, make sure that you have followed the directions exactly as described and that the batteries in the hand-held transmitter are not dead. If you still cannot program it, rotate your hand-held transmitter end over end and try again. The universal transmitter may not be

compatible with a limited number of older installations due to legislated changes in transmission frequencies. If you cannot program the transmitter after repeated attempts, consult your Buick dealer.

Be sure to keep your original hand-held transmitter in case you need to erase and reprogram the universal transmitter.

Note to Canadian Owners: During programming, your hand-held transmitter may stop transmitting after one or two seconds. If you are programming from one of these transmitters, you should press and repress the button on the hand-held transmitter every two seconds without ever releasing the button on the universal transmitter. Release both buttons three seconds after the red light on the universal transmitter begins to flash rapidly.

Operating the Transmitter

Press and hold the appropriate button on the universal transmitter. The red light comes on while the signal is being transmitted.

Note that the effective transmission range of the universal transmitter may differ from your hand-held transmitter and also from one channel to another.

Training a Garage Door Opener Equipped with “Rolling Codes”

If you programmed the universal transmitter, but the garage door will not open, and if your garage door opener was manufactured after 1995, your garage door may have a security feature that changes the “code” of your garage door opener every time it is opened or closed.

To determine if your garage door opener has this rolling code feature, press the appropriate button on the universal transmitter that was programmed. If the red light flashes rapidly for one to two seconds, then turns solid, your garage door opener has this feature.

To program a garage door opener with the rolling code feature, do the following:

1. Program your hand-held transmitter to the universal transmitter by following the steps provided under “Programming the Transmitter” earlier.
2. Remove the cover panel from the garage door opener receiver. It is located near the garage door opener motor.
3. Locate the training button on the garage door opener receiver. The exact location and color will vary among brands.

4. Press the training button on the garage door opener receiver for one to two seconds.
5. Return to your vehicle and press the programmed button on the universal transmitter until the red light flashes rapidly (about two seconds).
6. Release the button, then press it again to confirm it was programmed to the garage door opener receiver.

You may now use either the universal transmitter or the hand-held transmitter to open your garage door. If you still have difficulty in programming and require assistance, please call your Buick dealer.

Erasing Channels

To erase all three programmed channels, hold down the two outside buttons until the red light begins to flash. Individual channels cannot be erased, but can be reprogrammed using the procedure for programming the transmitter explained earlier.

Accessories

Accessories for your universal transmitter are available from the manufacturer of the unit. If you would like additional information, please call 1-800-355-3515.

The Instrument Panel

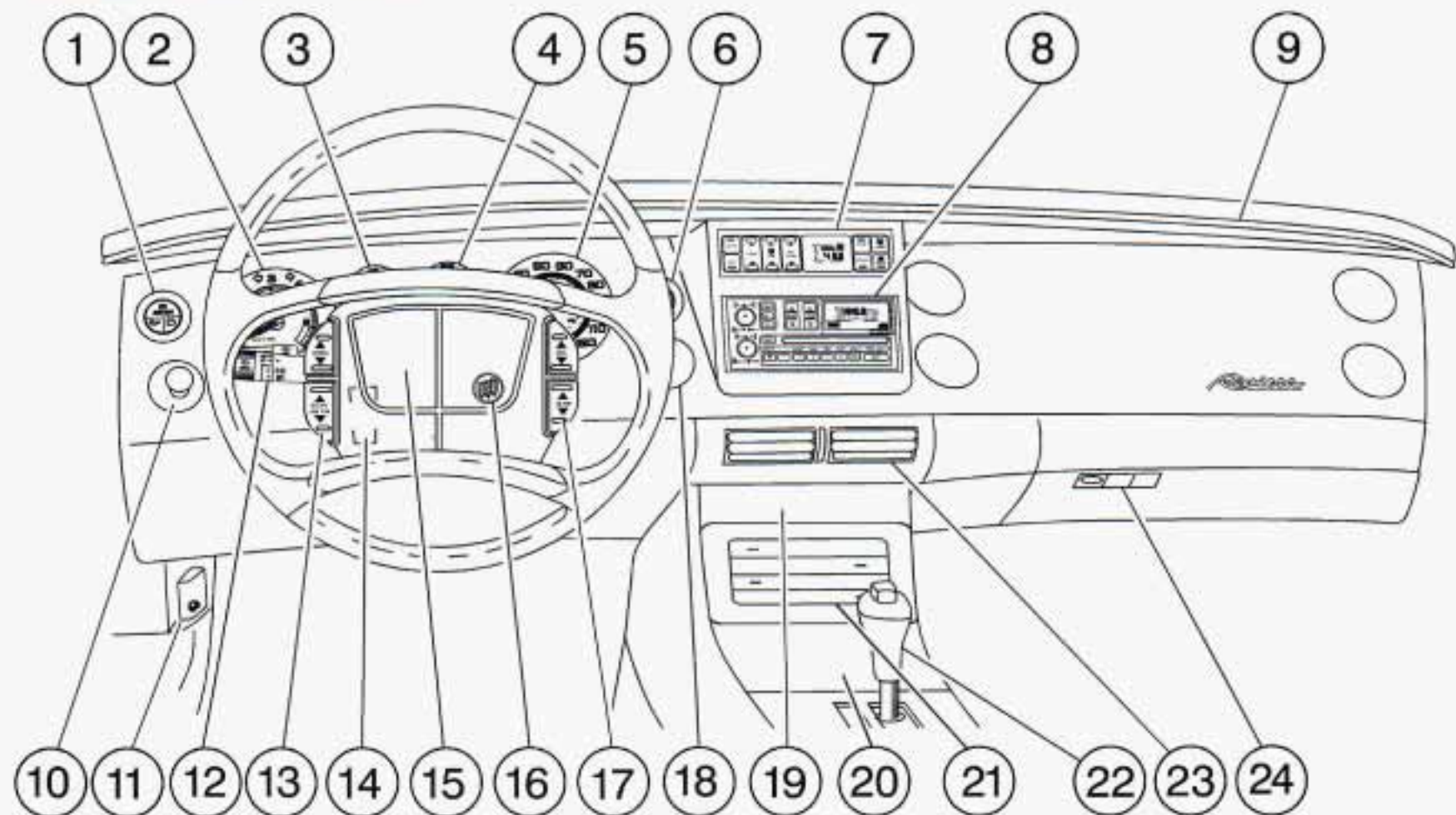

Your instrument panel is designed to let you know at a glance how your car is running. You'll know how fast you're going, how much fuel you're using, and many other things you'll need to know to drive safely and economically.

The main components of your instrument panel are:

1. Warning Lights
2. Tachometer
3. Fuel Gage
4. Engine Temperature Gage
5. Speedometer
6. Warning Lights
7. Climate Controls
8. Audio System
9. Passenger's Side Air Bag
10. Headlamp/Instrument Panel Intensity Control/Twilight Sentinel
11. Hood Release
12. Turn Signal/Multifunction Lever
13. Steering Wheel Touch Controls for Audio System
14. Tilt Steering Wheel Lever
15. Horn
16. Driver's Side Air Bag
17. Steering Wheel Touch Controls for Audio/Climate Control System
18. Traction Control/Trip Reset Button
19. Ashtray and Cigarette Lighter
20. Dual Cupholder
21. Compact Disc Storage Compartment
22. Gearshift Lever
23. Air Outlets
24. Glove Box

Instrument Panel Cluster

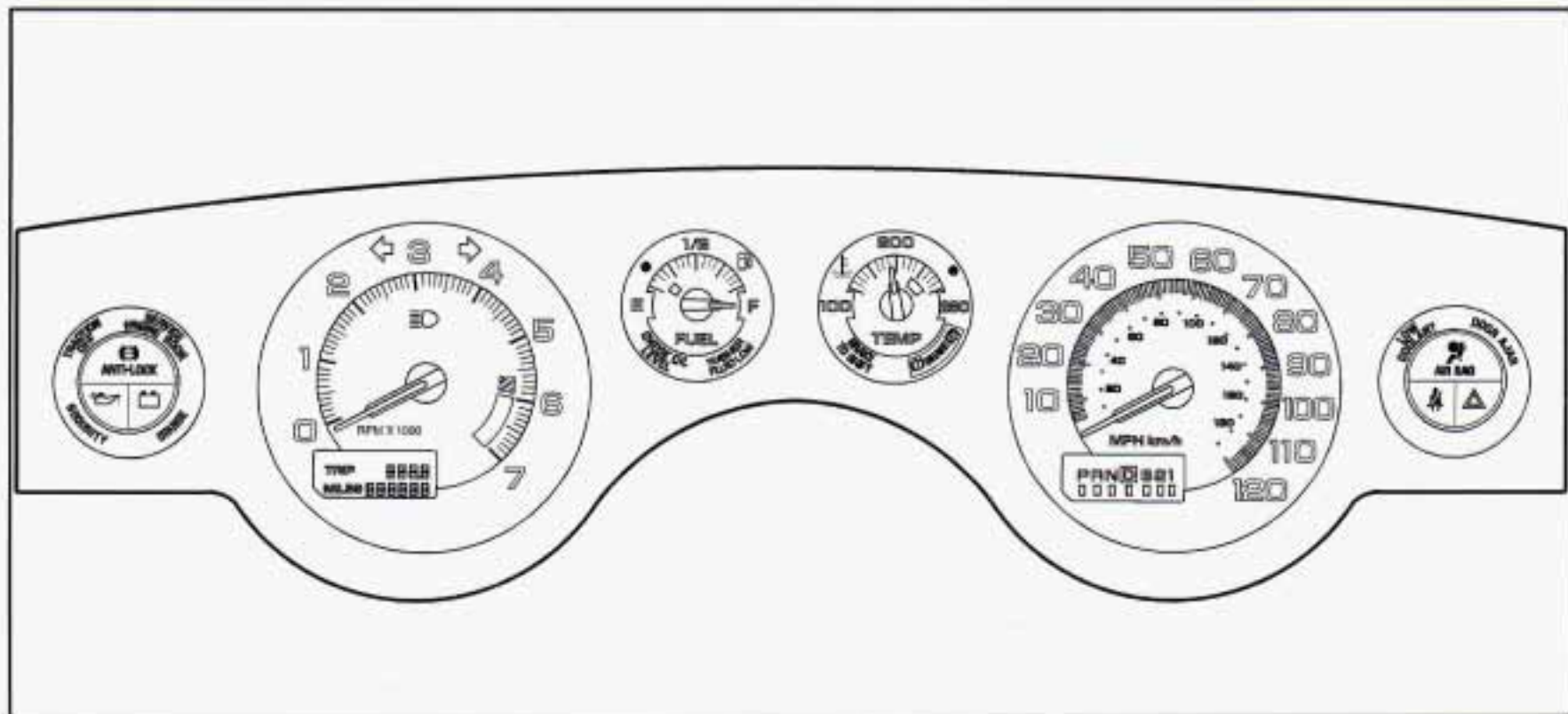

Your Buick is equipped with this instrument panel cluster. It includes indicator warning lights and gages that are explained on the following pages.

Speedometer and Odometer

Your speedometer lets you see your speed in both miles per hour (mph) and kilometers per hour (km/h). Your odometer shows how far your vehicle has been driven, in either miles (used in the United States) or kilometers (used in Canada).

Trip Odometer

A trip odometer can tell you how many miles you have driven since you last reset it back to zero.



To reset the trip odometer, push the TRIP RESET button.

Tachometer



The tachometer tells you how fast the engine is running. It displays engine speed in revolutions per minute (rpm).

NOTICE:

Do not operate the engine with the tachometer in the red area, or engine damage may occur.

Warning Lights, Gages and Indicators

This part describes the warning lights and gages that may be on your vehicle. The pictures will help you locate them.

Warning lights and gages can signal that something is wrong before it becomes serious enough to cause an expensive repair or replacement. Paying attention to your warning lights and gages could also save you or others from injury.

Warning lights come on when there may be or is a problem with one of your vehicle's functions. As you will see in the details on the next few pages, some warning lights come on briefly when you start the engine just to let you know they're working. If you are familiar with this section, you should not be alarmed when this happens.

Gages can indicate when there may be or is a problem with one of your vehicle's functions. Often gages and warning lights work together to let you know when there's a problem with your vehicle.

When one of the warning lights comes on and stays on when you are driving, or when one of the gages shows there may be a problem, check the section that tells you what to do about it. Please follow this manual's advice. Waiting to do repairs can be costly -- and even dangerous. So please get to know your warning lights and gages. They're a big help.

Safety Belt Reminder Light

When the key is turned to RUN or START, a chime will come on for about eight seconds to remind people to fasten their safety belts.



The safety belt light will also come on and stay on for about 70 seconds. If the driver's belt is already buckled, neither the chime nor the light will come on.

Air Bag Readiness Light

There is an air bag readiness light on the instrument panel, which shows AIR BAG. The system checks the air bag's electrical system for malfunctions. The light tells you if there is an electrical problem. The system check includes the air bag sensors, the air bag modules, the wiring and the crash sensing and diagnostic module. For more information on the air bag system, see "Air Bag" in the Index.



This light will come on when you start your engine, and it will flash for a few seconds. Then the light should go out. This means the system is ready.

If the air bag readiness light stays on after you start the engine or comes on when you are driving, your air bag system may not work properly. Have your vehicle serviced right away.

The air bag readiness light should flash for a few seconds when you turn the ignition key to RUN. If the light doesn't come on then, have it fixed so it will be ready to warn you if there is a problem.

Battery Light

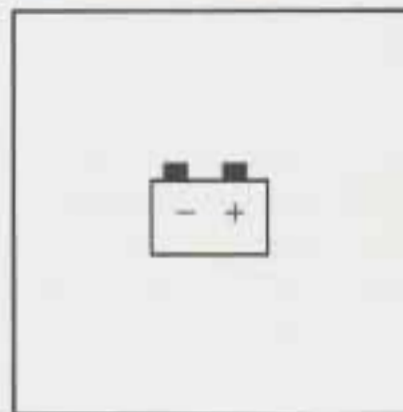

When you turn the key to RUN, this light will come on briefly, to show that your generator and battery charging systems are working.

If the light stays on, your vehicle needs service and you should take your Buick to the dealer at once. To save your battery until you get there, turn off all accessories, and set your air system to OFF.

Brake System Warning Light

Your Buick's hydraulic brake system is divided into two parts. If one part isn't working, the other part can still work and stop you. For good braking, though, you need both parts working well.

If the warning light comes on, there could be a brake problem. Have your brake system inspected right away.

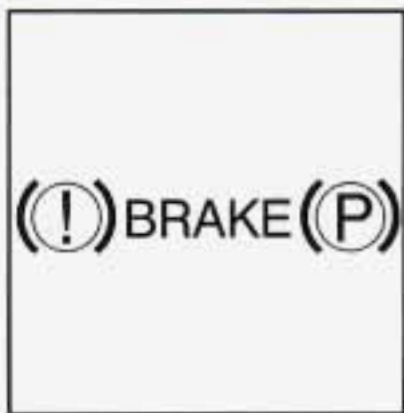

This light should come on when you turn the key to START. If it doesn't come on then, have it fixed so it will be ready to warn you if there's a problem.

If the light and chime come on while you are driving, pull off the road and stop carefully. You may notice that the pedal is harder to push. Or, the pedal may go closer to the floor. It may take longer to stop. If the light is still on, have the vehicle towed for service. (See "Towing Your Vehicle" in the Index.)



CAUTION:

Your brake system may not be working properly if the brake system warning light is on. Driving with the brake system warning light on can lead to an accident. If the light is still on after you've pulled off the road and stopped carefully, have the vehicle towed for service.

When the ignition is on, the brake system warning light will also come on when you set your parking brake. The light will stay on if your parking brake doesn't release fully. If you try to drive off with the parking brake set, a chime will also come on until you release the parking brake. If the light and chime stay on after your parking brake is fully released, it means you have a brake problem.

Anti-Lock Brake System Warning Light

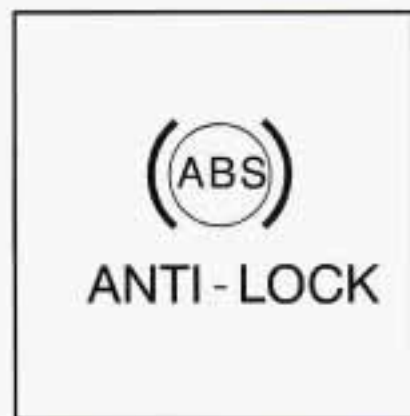

With the anti-lock brake system, this light will come on when you start your engine and may stay on for several seconds. That's normal.

If the light stays on, turn the ignition to OFF. Or, if the light comes on when you're driving, stop as soon as possible and turn the ignition off. Then start the engine again to reset the system. If the light still stays on, or comes on again while you're driving, your Buick needs service. If the regular brake system warning light isn't on, you still have brakes, but you don't have anti-lock brakes. If the regular brake system warning light is also on, you don't have anti-lock brakes and there's a problem with your regular brakes. See "Brake System Warning Light" earlier in this section.

The anti-lock brake system warning light should come on briefly when you turn the ignition key to RUN. If the light doesn't come on then, have it fixed so it will be ready to warn you if there is a problem.

Traction Control System Warning Light (Option)



This warning light should come on briefly as you start the engine. If the warning light doesn't come on then, have it fixed so it will be ready to warn you if there's a problem.

If it stays on, or comes on when you're driving, there may be a problem with your traction control system and your vehicle may need service. When this warning light is on, the system will not limit wheel spin. Adjust your driving accordingly.

The traction control system warning light may come on for the following reasons:

- If you turn the system off by pressing the TRAC CONT button located on the instrument panel, the warning light will come on and stay on. To turn the system back on, press the button again. The warning light should go off. (See “Traction Control System” in the Index for more information.)
- If there’s a brake system problem that is specifically related to traction control, the traction control system will turn off and the warning light will come on. If your brakes begin to overheat, the traction control system will turn off and the warning light will come on until your brakes cool down.
- If the traction control system is affected by an engine-related problem, the system will turn off and the warning light will come on.

If the traction control system warning light comes on and stays on for an extended period of time when the system is turned on, your vehicle needs service.

Engine Coolant Temperature Warning Light

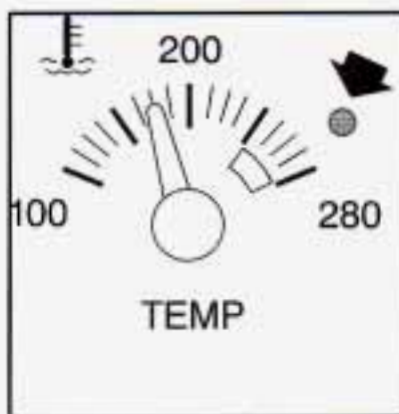

This light tells you that your engine coolant has overheated or your radiator cooling fan is not working. If you have been operating your vehicle under normal driving conditions, you should pull off the road, stop your vehicle and turn the engine off as soon as possible.

The section “Problems on the Road” in this manual explains what to do. See “Engine Overheating” in the Index.

Engine Coolant Temperature Gage

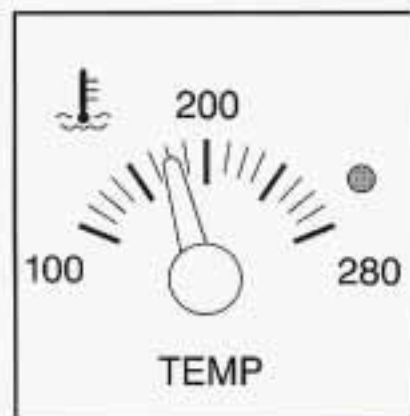

Your vehicle has a gage that shows the engine coolant temperature. If the gage pointer moves into the red area, your engine is too hot!

This reading means the same thing as the warning light. It means that your engine coolant has overheated. If you have been operating your vehicle under normal driving conditions, you should pull off the road, stop your vehicle and turn off the engine as soon as possible.

The section “Problems on the Road” in this manual explains what to do. See “Engine Overheating” in the Index.

Low Coolant Warning Light

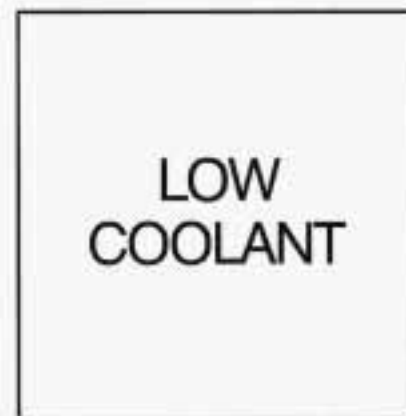

When this light comes on, the cooling system is low on coolant. As a bulb check, it will come on for two to four seconds and then go off when the ignition is in RUN. If the light doesn't come on, have the vehicle serviced.

If the coolant level is low, the light will come back on and a warning chime will sound. If this happens, see “Engine Coolant” in the Index for proper cooling system fill.

After the coolant level is returned to its proper level, the LOW COOLANT light will go off after 20 seconds or remain off during the next ignition cycle.

Malfunction Indicator Lamp (Service Engine Soon Light)



SERVICE
ENGINE SOON

Your Buick is equipped with a computer which monitors operation of the fuel, ignition and emission control systems.

This system is called OBD II (On-Board Diagnostics-Second Generation) and is intended to assure that emissions are at acceptable levels for the life of the vehicle, helping to produce a cleaner environment. (In Canada, OBD II is replaced by Enhanced Diagnostics.) The SERVICE ENGINE SOON light comes on to indicate that there is a problem and service is required. Malfunctions often will be indicated by the system before any problem is apparent. This may prevent more serious damage to your vehicle. This system is also designed to assist your service technician in correctly diagnosing any malfunction.

NOTICE:

If you keep driving your vehicle with this light on, after a while, your emission controls may not work as well, your fuel economy may not be as good and your engine may not run as smoothly. This could lead to costly repairs that may not be covered by your warranty.

This light should come on, as a check to show you it is working, when the ignition is on and the engine is not running. If the light doesn't come on, have it repaired. This light will also come on during a malfunction in one of two ways:

- **Light Flashing** -- A misfire condition has been detected. A misfire increases vehicle emissions and may damage the emission control system on your vehicle. Dealer or qualified service center diagnosis and service is required.
- **Light On Steady** -- An emission control system malfunction has been detected on your vehicle. Dealer or qualified service center diagnosis and service may be required.

If the Light Is Flashing

The following may prevent more serious damage to your vehicle:

- Reducing vehicle speed.
- Avoiding hard accelerations.
- Avoiding steep uphill grades.
- If you are towing a trailer, reduce the amount of cargo being hauled as soon as it is possible.

If the light stops flashing and remains on steady, see “If the Light Is On Steady” following.

If the light continues to flash, when it is safe to do so, *stop the vehicle*. Find a safe place to park your vehicle. Turn the key off, wait at least 10 seconds and restart the engine. If the light remains on steady, see “If the Light Is On Steady” following. If the light is still flashing, follow the previous steps, and drive the vehicle to your dealer or qualified service center for service.

If the Light Is On Steady

You may be able to correct the emission system malfunction by considering the following:

Did you just drive through a deep puddle of water?

If so, your electrical system may be wet. The condition will usually be corrected when the electrical system dries out. A few driving trips should turn the light off.

Are you low on fuel?

As your engine starts to run out of fuel, your engine may not run as efficiently as designed since small amounts of air are sucked into the fuel line causing a misfire. The system can detect this. Adding fuel should correct this condition. Make sure to install the fuel cap properly. It will take a few driving trips to turn the light off.

Have you recently changed brands of fuel?

If so, be sure to fuel your vehicle with quality fuel (see “Fuel” in the Index). Poor fuel quality will cause your engine not to run as efficiently as designed. You may notice this as stalling after start-up, stalling when you put the vehicle into gear, misfiring, hesitation on acceleration or stumbling on acceleration. (These conditions may go away once the engine is warmed up.) This will be detected by the system and cause the light to turn on.

If you experience one or more of these conditions, change the fuel brand you use. It will require at least one full tank of the proper fuel to turn the light off.

If none of the above steps have made the light turn off, have your dealer or qualified service center check the vehicle. Your dealer has the proper test equipment and diagnostic tools to fix any mechanical or electrical problems that may have developed.

Oil Pressure Light

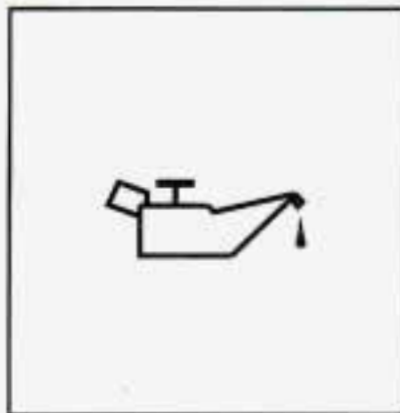

This light tells you if there could be a problem with your engine oil pressure.

When this light *comes* on and *stays* on, it means oil isn't going through your engine properly. You could be low on oil, or you might have some other oil problem.



CAUTION:

Don't keep driving if the oil pressure is low. If you do, your engine can become so hot that it catches fire. You or others could be burned. Check your oil as soon as possible and have your vehicle serviced.

NOTICE:

Damage to your engine from neglected oil problems can be costly and is not covered by your warranty.

Check Oil Level Light

A square box containing the text "CHECK OIL LEVEL" in all caps, centered.

CHECK OIL
LEVEL

The CHECK OIL LEVEL light is lit for two to four seconds as a bulb check each time the ignition key is turned to RUN. If the light doesn't come on, have your vehicle serviced.

If the engine oil is more than one quart (0.95 L) low, this light will turn on for about one minute and then will remain off until the next time you start the vehicle only if the vehicle has been shut off for at least eight minutes.

If the CHECK OIL LEVEL light comes back on, the engine oil should be checked at the dipstick then brought up to the proper level if necessary. See "Engine Oil" in the Index.

Door Ajar Light

A square box containing the text "DOOR AJAR" in all caps, centered.

DOOR AJAR

When the ignition is on, this light will stay on until both doors are closed and completely latched.

Fuel Gage

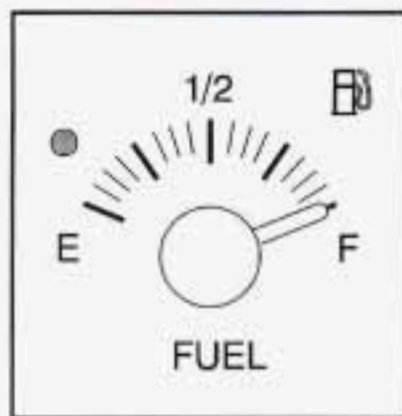

The fuel gage shows about how much fuel is in your tank.

It works only when the ignition is on. When the indicator nears Empty (E) you still have a little fuel left. You need to get more fuel right away.

Here are some concerns some owners have had about the fuel gage. All these situations are normal and indicate nothing wrong with the fuel gage.

- At the gas station, the gas pump shuts off before the gage reads Full (F).

- It takes more (or less) gas to fill up than the gage indicated. For example, the gage may have indicated half full, but it took more (or less) than half of the tank's capacity to fill it.
- The gage moves a little when you turn a corner, speed up or stop your vehicle.
- When you turn the engine off, the gage doesn't go all the way back to Empty (E).

Low Fuel Light

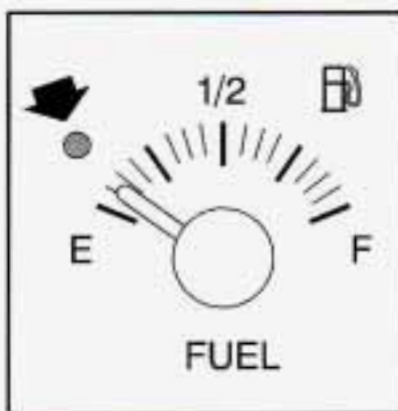

A yellow light near the Empty (E) mark on the fuel gage comes on when your vehicle is low on fuel. You should get more fuel as soon as you can.



Section 3 Comfort Controls and Audio Systems

In this section, you'll find out how to operate the comfort control and audio systems offered with your Buick. Be sure to read about the particular systems supplied with your vehicle.

3-2	Comfort Controls	3-10	AM-FM Stereo with Cassette Tape and Compact Disc Player and Automatic Tone Control
3-2	Dual Automatic ComforTemp Climate Control	3-15	Theft-Deterrent Feature
3-5	Air Conditioning	3-18	Steering Wheel Controls
3-5	Heating	3-19	Understanding Radio Reception
3-6	Ventilation System	3-19	Tips About Your Audio System
3-7	Defogging and Defrosting	3-20	Care of Your Cassette Tape Player
3-8	Rear Window Defogger	3-20	Care of Your Compact Discs
3-9	Steering Wheel Controls for Climate Control	3-21	Power Antenna Mast Care
3-9	Passenger Zone Comfort Control		
3-10	Setting the Clock		

Comfort Controls

This section describes how to operate your climate control system. Your climate control system uses ozone-friendly R-134a refrigerant.

Dual Automatic ComforTemp Climate Control

Your vehicle has the Dual Automatic ComforTemp Climate Control system. The following information tells you how it works.

You will hear a beep each time a button is pushed and a small light on the button will indicate which buttons are active. The lights are on all buttons except TEMP, FAN and AIR FLOW. The display will show fan speed, comfort level setting and airflow direction for a few seconds whenever AUTO is selected, and then it will display the outside temperature. The outside temperature reading is most accurate when the vehicle is moving. During stops, the display shows the previous temperature for best accuracy and system control.



If the display is flashing after the climate control system is started, there is a problem with the system and you should see your dealer for service.

Sun and temperature sensors automatically adjust the air temperature, the airflow direction and the fan speed to maintain your comfort setting. The system may supply cooler air to the side toward the sun. Be careful not to put anything over the sensors on top of the dash.

Temperature Button

To adjust the comfort level you want maintained inside the car, push the TEMP button. If you want a warmer comfort level, push the red arrow. If you want a cooler comfort level, push the blue arrow. Your comfort setting is shown in the display.

Fan Button

The speed of the blower fan is controlled automatically if you have the system set for AUTO. Pressing the FAN button will display and hold the current blower fan setting.

If you want the blower fan to run at a lower speed, push the bottom of the FAN button. The fan speed will decrease with every push of the button until the lowest speed is reached. If you want to increase the fan speed, push the top of the FAN button. Notice the fan indicators in the display.

Mode Controls

Press the AIR FLOW button to deliver air through the floor, middle or windshield outlets. The system will stay in the selected mode until the AUTO button is pushed. Press the up arrow on the AIR FLOW button to cycle through the available modes.

Automatic Operation

Press the AUTO button when you want the system to automatically adjust the interior temperature to your preference. When the system is set for automatic operation, air will come from the floor, middle or windshield outlets depending on the temperature inside the vehicle, the outside temperature and sun load. Fan speed will vary as the system gets to and maintains the comfort setting you have selected through the use of the TEMP button.

To find your comfort setting, start with the system in AUTO mode and the TEMP button adjusted to a display of 75°F (24°C), give the vehicle about 20 minutes to stabilize, then readjust your comfort setting if necessary. The display will show the comfort setting for a few seconds and then it will display the outside temperature. If you want to see your current automatic fan speed, airflow direction and comfort setting, press the AUTO button.

In cold weather, the system will delay turning on the fan, to avoid blowing cold air. The length of the delay depends on the engine coolant temperature and the outside temperature. Pushing the FAN, AIR FLOW or FRONT buttons will override this delay, turn off the AUTO setting and change the fan speed.

Manual Operation

You may also manually adjust the air delivery or fan speed.

AIR FLOW: This button is used to change the direction of the airflow. The airflow choices available are FLOOR, FLOOR-MID, MID and WINDSHIELD-FLOOR. If the system is set for AUTO, pressing the AIR FLOW button will display the current airflow direction and the comfort setting. Press the AIR FLOW up or down button again to change the direction of the airflow.

If the AIR FLOW up button is selected while in the FRONT defrost mode, the system will direct the air toward the WINDSHIELD-FLOOR. If the AIR FLOW down button is selected while in the FRONT defrost mode, the system will direct the air toward the FLOOR, and the FRONT defrost mode will cancel. Notice the arrows in the display.

OFF: If the passenger's comfort control is turned on, it can be turned off by pressing the OFF button once. Pressing the OFF button a second time will turn off the main system. Turning off the main system causes the fan to turn off and the airflow to be directed to the FLOOR. The system will still try to keep the interior of the

vehicle at the previously chosen comfort setting. The outside temperature will show on the display when the system is set to OFF.

The ventilation system always allows fresh air to flow through your Buick when the vehicle is moving even with the system in the OFF mode.

VENT: The VENT button allows outside air to flow through your Buick without the air conditioning compressor working. Selecting VENT and the AUTO button at the same time allows the system to control automatically without the use of the air conditioning compressor or the use of the RECIRC mode. To turn off the VENT selection, push the VENT button again.

RECIRC: When RECIRC is selected, the system will limit the amount of outside air entering your vehicle. This is helpful when you are trying to cool the interior of the vehicle quickly or limit the amount of outside air entering your vehicle for some other reason. RECIRC and AUTO may be selected at the same time. The system will remain in RECIRC until the ignition is turned off, then the system will return back to the previously selected mode. RECIRC can be selected in all manual airflow modes except FRONT defrost. RECIRC cannot be selected with the VENT button.

Operating RECIRC in cold temperature or under high humidity conditions may cause moisture to form on the inside of the windshield. If this condition occurs, deselect the RECIRC button.



FRONT: This selection is used to defrost the windshield by directing the airflow toward the windshield.

If FRONT is selected while in the AUTO mode, the fan speed and the air temperature from the front defroster will vary. If a manual fan speed setting is selected, the fan speed will remain at that selection until another fan speed selection is made or the AUTO mode is selected. To turn off FRONT, press the AUTO or AIR FLOW button.

FRONT defrost will work better if any ice or snow is cleared from the hood and the air inlet area between the base of the windshield and the hood.

Air Conditioning

On very hot days, open the windows long enough to let the hot air out. This reduces the time required to cool the interior of the vehicle to a comfortable level. If the system is in the AUTO mode on very hot days, the system will automatically enter the RECIRC mode and the temperature door will be positioned at the full cold position for maximum cooling. If the system is not in the AUTO mode, RECIRC should be selected to provide maximum cooling. You can choose the extreme comfort setting of 60°F (16°C), but the system will not cool any faster by choosing the extreme comfort setting.

Heating

On cold days, if the AUTO mode is selected, the system will automatically direct the air toward the floor and the temperature door will be positioned at the full hot position. You can choose the extreme comfort setting of 90°F (32°C) but the system will not warm up any faster by selecting the extreme comfort setting. If the outside temperature is cold, the fan will be delayed to avoid blowing cold air. Pushing the FAN, AIR FLOW or FRONT buttons will override this delay, turn off the AUTO mode and change the fan speed.

Ventilation System

When the vehicle is moving, fresh air flows through the air outlets. When the vehicle is not moving, you can get fresh air by selecting any airflow choice (except the rear window defogger) and any fan speed.



Adjust the direction of airflow by moving the louvered air outlets.



You can also adjust the direction of the airflow to the rear seating area.

Ventilation Tips

- Keep the hood and front air inlet free of ice, snow or any other obstruction such as leaves. The heater and defroster will work better, reducing the chance of fogging your windows.
- Keep the air path under the front seats clear of objects. This helps air to circulate throughout your vehicle.
- When the engine idles for a long time, the exterior temperature sensor retains the temperature setting that was present when the vehicle was last moving. The system will try to maintain the set temperature inside your vehicle.

Defogging and Defrosting

Use the **FRONT** button to quickly remove fog, frost or ice from the windshield in extremely humid or cold conditions.

Select the **FRONT** button to defrost the windshield. By choosing this button, the airflow will be directed at the windshield. Adjust your comfort level by pressing the **TEMP** up or down arrow. The fan speed will be controlled by the system. You can change the fan speed by pressing the top of the **FAN** button to increase speed, and the bottom of the button to decrease speed.

Rear Window Defogger



The lines you see on the rear window warm the glass. Press the button to start warming your window. An indicator light in the button will glow while the rear window defogger is operating.

At speeds above 30 mph (48 km/h), the rear defogger will stay on until you press the REAR defogger button again. At speeds below 30 mph (48 km/h), the rear window defogger will turn off automatically after about 10 minutes of use. If you press it again, the defogger will operate for about five minutes only. You can also turn the defogger off by turning off the ignition.

NOTICE:

Scraping the inside of your rear window could cut and damage the heater. Your warranty would not cover this damage. Don't put decals there because you might have to scrape them off.

Steering Wheel Controls for Climate Control (Option)



If your Buick has this feature, you can control the temperature comfort setting by using the control button on your steering wheel.

TEMP: Press either arrow once and the current comfort setting will be displayed. Press the up arrow again to choose a warmer comfort setting and press the down arrow again to choose a cooler comfort setting.

Passenger Zone Comfort Control



The front seat passenger can control the air temperature in their seating area.

This system can be activated by turning the COMFORT CONTROL knob on the passenger's door.

Adjust the temperature using the COMFORT CONTROL knob. Turn the control toward COOLER or WARMER. This control can be set up to 5°F (-15°C) cooler or warmer than the primary setting. Notice the lighted display above the control which indicates the difference from the main temperature setting.

Push the OFF button on the main control panel once to turn off this part of the system.

Audio Systems

Your Delco® audio system has been designed to operate easily and give years of listening pleasure. You will get the most enjoyment out of it if you acquaint yourself with it first. Find out what your Delco system can do and how to operate all its controls, to be sure you're getting the most out of the advanced engineering that went into it.

Setting the Clock

Press and hold HRS until the correct hour appears. Press and hold MIN until the correct minute appears.

You may set the clock with the ignition off if you press RECALL first and follow the same procedure described above.

AM-FM Stereo with Cassette Tape and Compact Disc Player and Automatic Tone Control



Playing the Radio

VOLUME: Press this knob to turn the system on and off. To increase volume, turn the knob clockwise. Turn it counterclockwise to decrease volume.

RECALL: Press this button briefly to recall the station being played or to display the clock. To change what is normally shown on the display (station or time), press the RECALL button until you see the display you want, then hold the RECALL button until the display flashes. If you press the button when the ignition is off, the clock will show for a few seconds.

Finding a Station

AM-FM: Press this button to switch between AM, FM1 and FM2. The display shows your selection.

TUNE: Press the up or down arrow to choose radio stations.

SEEK: Press the up or down arrow to go to the next higher or lower station and stay there. The sound will mute while seeking.

SCAN: Press one of the SEEK arrows for two seconds and SCAN will appear on the display. Use SCAN to listen to stations for a few seconds. The radio will go to a station, stop for a few seconds, then go on to the next station. Press one of the SEEK arrows again to stop scanning. The sound will mute while scanning.

PUSHBUTTONS: The six numbered pushbuttons let you return to your favorite stations. You can set up to 18 stations (six AM, six FM1 and six FM2). Just:

1. Turn the radio on.
2. Press AM-FM to select the band.
3. Tune in the desired station.
4. Press TONE to select the setting you prefer.
5. Press and hold one of the six numbered buttons. The sound will mute. When it returns, release the button. Whenever you press that numbered button, the station you set will return and the tone you selected will be automatically selected for that button.
6. Repeat the steps for each pushbutton.

P SCAN: Press this button to listen to each of your preset stations for a few seconds. The radio will go to the first preset station, stop for a few seconds, then go on to the next preset station. Press P SCAN again to stop scanning. If a preset station has weak reception, the radio will not stop at the preset station.

AUTO SET: Press this button and the system will seek and set the 12 strongest FM or the 6 strongest AM stations on your preset buttons. AUTO SET will flash while seeking and will remain on until this function is complete. To return to the stations you manually set, press AUTO SET again.

Setting the Tone

BASS: Press this knob lightly so it extends. Turn the knob to increase or decrease bass.

TREB: Press this knob lightly so it extends. Turn the knob to increase or decrease treble. If a station is weak or noisy, you may want to decrease the treble.

Push these knobs back into their stored positions when you're not using them.

TONE: This feature allows you to choose preset bass and treble equalization settings designed for classical, pop, rock, jazz, talk and country/western stations. CLASS will appear on the display when you first press TONE. Each time you press it, another setting will appear on the display. Press it again after C & W appears and MANUAL will appear. Tone control will return to the BASS and TREB knobs. Also, if you use the BASS and TREB knobs, control will return to them and MANUAL will appear.

Adjusting the Speakers

BAL: Press this knob lightly so it extends. Turn the knob to move the sound to the left or right speakers. The middle position balances the sound between the speakers.

FADE: Press this knob lightly so it extends. Turn the knob to move the sound to the front or rear speakers. The middle position balances the sound between the speakers.

Push these knobs back into their stored positions when you're not using them.

Playing a Cassette Tape

The longer side with the tape visible should face to the right. If the ignition and the radio are on, the tape can be inserted and will begin playing. If you hear nothing or hear a garbled sound the tape may not be in squarely. Press EJECT to remove the tape and start over.

While the tape is playing, use the VOLUME, FADE, BAL, BASS and TREB controls just as you do for the radio. Other controls may have different functions when a tape is inserted. The display will show an arrow to show which side of the tape is playing.

If you want to insert a tape when the ignition or radio is off, first press EJECT or RECALL.

Your tape bias is set automatically.

If E and a number appear on the radio display, the tape won't play because of an error.

- **E10:** The tape is tight and the player can't turn the tape hubs. Remove the tape. Hold the tape with the open end down and try to turn the right hub counterclockwise with a pencil. Turn the tape over and repeat. If the hubs do not turn easily, your tape may be damaged and should not be used in the player. Try a new tape to make sure your player is working properly.
- **E11:** The tape is broken. Try a new tape.

If any error occurs repeatedly or if an error can't be corrected, please contact your dealer. If your radio displays an error number, write it down and provide it to your dealer when reporting the problem.

PREV (1): Press this button to search for the previous selection on the tape. Your tape must have at least three seconds of silence between each selection for PREV to work. The sound will mute while seeking.

NEXT (2): Press this button to search for the next selection on the tape. Your tape must have at least three seconds of silence between each selection for NEXT to work. The sound will mute while seeking.

The SEEK down and up arrows will also find the previous and next selections on the tape.

◀◀ **(3):** Press this button to reverse the tape rapidly. Press it again to return to playing speed. The radio will play while the tape reverses.

▶▶ **(4):** Press this button to advance quickly to another part of the tape. Press the button again to return to playing speed. The radio will play while the tape advances.

SIDE (5): Press this button to change the side of the tape that is playing.

RAND (6): Press this button to reduce background noise when playing a cassette tape. The double-D symbol will appear in the display.

SOURCE: Press this button to change to the tape or disc function when the radio is on. If both a tape and a disc are installed, the system will first go to tape play; TAPE SIDE and an arrow will appear on the display. If SOURCE is pressed again, the system will go to disc play; CD PLAY will appear on the display.

EJECT: The system has two EJECT buttons. Press the button near the CD slot to remove a disc. Press the button near the tape slot to remove a tape and the radio will play. If you leave a cassette tape in the player while listening to the radio, it may become warm.

CLN: If this message appears on the display, the cassette tape player needs to be cleaned. It will still play tapes, but you should clean it as soon as possible to prevent damage to the tapes and player. See “Care of Your Cassette Tape Player” in the Index. After you clean the player, press and hold EJECT for five seconds to reset the CLN indicator. The radio will display --- to show the indicator was reset.

Your cassette tape player automatically reduces background noise from tapes encoded with Dolby NR. You may turn Dolby off by pressing the number six preset.

Dolby Noise Reduction is manufactured under a license from Dolby Laboratories Licensing Corporation. Dolby and the double-D symbol are trademarks of Dolby Laboratories Licensing Corporation.

Playing a Compact Disc

Insert a disc partway into the slot, label side up. The player will pull it in. The disc should begin playing.

If you want to insert a CD while the ignition or the radio is off, first press EJECT or RECALL.

If you're driving on a very rough road or if it's very hot, the disc may not play and an error code may appear on the display. When things get back to normal, the disc should play. If the disc comes out, it could be that:

- **E20:** The disc is upside down.
- **E20:** It is dirty, scratched or wet.
- **E20:** There's too much moisture in the air.
(Wait about an hour and try again.)

If any error occurs repeatedly or if an error can't be corrected, please contact your dealer. If your radio displays an error number, write it down and provide it to your dealer when reporting the problem.

PREV (1): Press this button to go to the start of the current track, if more than eight seconds have played. If you hold the button or press it more than once, the player will continue moving back through the disc. The sound will mute while seeking.

NEXT (2): Press this button to go to the next track. If you hold the button or press it more than once, the player will continue moving forward through the disc. The sound will mute while seeking.

The SEEK down and up arrows will also find the previous and next selections on the disc.

◀◀ (3): Press and hold this button to quickly reverse within a track. You will hear sound.

▶▶ (4): Press and hold this button to quickly advance within a track. You will hear sound.

RAND (6): Press this button to hear the tracks in random, rather than sequential, order. Press RAND again to turn off random play.

RECALL: Press this button to see which track is playing. Press it again within five seconds to see how long it has been playing. To change what is normally shown on the display (track or elapsed time), press the RECALL button until you see the display you want, then hold the RECALL button until the display flashes.

AM-FM: Press this button to play the radio when a disc is in the player.

SOURCE: Press this button to change to the disc function when the radio is on. When a disc is inserted, the disc will play until you press AM-FM. Then the disc will stop playing and the radio will play. Press SOURCE again to play a disc again. CD PLAY will show on the display.

EJECT: Press this button to remove the disc. The radio will play.

If you turn off the ignition or radio with a disc in the player, it will stay in the player. When you turn on the ignition or system, the disc will start playing where it stopped, if it was the last-selected audio source.

Also, as a protection feature, if a CD is ejected and left in the player, it will be pulled back in the player with the ignition on or off. If you leave a compact disc in the player while listening to the radio, it may become warm.

Theft-Deterrent Feature

THEFTLOCK™ is designed to discourage theft of your radio. It works by using a secret code to disable all radio functions whenever battery power is removed.

If THEFTLOCK is active, the THEFTLOCK indicator will flash when the ignition is off.

The THEFTLOCK feature for the radio may be used or ignored. If ignored, the system plays normally and the radio is not protected by the feature. If THEFTLOCK is activated, your radio will not operate if stolen.

When THEFTLOCK is activated, the radio will display LOC to indicate a locked condition anytime battery power is removed. If your battery loses power for any reason, you must unlock the radio with the secret code before it will operate.

Activating the Theft-Deterrent Feature

The instructions which follow, explain how to enter your secret code to activate the THEFTLOCK system. It is recommended that you read through all nine steps before starting the procedure.

NOTE: If you allow more than 15 seconds to elapse between any steps, the radio automatically reverts to time and you must start the procedure over at Step 4.

1. Write down any three or four-digit number from 000 to 1999 and keep it in a safe place separate from the vehicle.
2. Turn the ignition to ACCESSORY or RUN.
3. Turn the radio off.
4. Press the 1 and 4 buttons together. Hold them down until --- shows on the display. Next you will use the secret code number which you have written down.
5. Press MIN and 000 will appear on the display.
6. Press MIN again to make the last two digits agree with your code.
7. Press HRS to make the first one or two digits agree with your code.

8. Press AM-FM after you have confirmed that the code matches the secret code you have written down. The display will show REP to let you know that you need to repeat Steps 5 through 7 to confirm your secret code.
9. Press AM-FM and this time the display will show SEC to let you know that your radio is secure.

Unlocking the Theft-Deterrent Feature After a Power Loss

Enter your secret code as follows; pause no more than 15 seconds between steps:

1. LOC appears when the ignition is on.
2. Press MIN and 000 will appear on the display.
3. Press MIN again to make the last two digits agree with your code.
4. Press HRS to make the first one or two digits agree with your code.
5. Press AM-FM after you have confirmed that the code matches the secret code you have written down. The display will show SEC, indicating the radio is now operable and secure.

If you enter the wrong code eight times, INOP will appear on the display. You will have to wait an hour with the ignition on before you can try again. When you try again, you will only have three more chances (eight tries per chance) to enter the correct code before INOP appears.

If you lose or forget your code, contact your dealer.

Disabling the Theft-Deterrent Feature

Enter your secret code as follows; pause no more than 15 seconds between steps:

1. Turn the ignition to ACCESSORY or RUN.
2. Turn the radio off.
3. Press the 1 and 4 buttons together. Hold them down until SEC shows on the display.
4. Press MIN and 000 will appear on the display.

5. Press MIN again to make the last two digits agree with your code.
6. Press HRS to make the first one or two digits agree with your code.
7. Press AM-FM after you have confirmed that the code matches the secret code you have written down. The display will show ---, indicating that the radio is no longer secured.

If the code entered is incorrect, SEC will appear on the display. The radio will remain secured until the correct code is entered.

When battery power is removed and later applied to a secured radio, the radio won't turn on and LOC will appear on the display.

To unlock a secured radio see "Unlocking the Theft-Deterrent Feature After a Power Loss" earlier in this section.

Steering Wheel Controls (Option)

If your vehicle has this feature, you can control certain radio and comfort control functions using the buttons on your steering wheel.



VOL: Press the up or down arrow to increase or decrease volume.

TEMP: Press the up arrow to increase the set temperature on your comfort control system or the down arrow to decrease the temperature.



SEEK: Press the SEEK down arrow to go to a lower frequency station and the SEEK up arrow to go to a higher frequency station.

If you press and hold the SEEK button for two seconds, SCAN will appear on the display. It will go to a station, stop for a few seconds and go on to the next station. Press the SEEK button to stop scanning. SEEK also functions as PREV and NEXT when playing a cassette tape or compact disc.

SCAN/AM-FM: Press the SCAN button and SCAN will appear on the display. SCAN works as the PSCAN button on your radio. It will scan through each of the preset radio stations. If a preset radio station has weak reception, the radio will not stop at the preset station. Press SCAN again to stop scanning. Press the AM-FM button to choose the AM, FM1 or FM2 band.

Understanding Radio Reception

FM Stereo

FM stereo will give you the best sound. But FM signals will reach only about 10 to 40 miles (16 to 65 km). Tall buildings or hills can interfere with FM signals, causing the sound to come and go.

AM

The range for most AM stations is greater than for FM, especially at night. The longer range, however, can cause stations to interfere with each other. AM can pick up noise from things like storms and power lines. Try reducing the treble to reduce this noise if you ever get it.

Tips About Your Audio System

Hearing damage from loud noise is almost undetectable until it is too late. Your hearing can adapt to higher volumes of sound. Sound that seems normal can be loud and harmful to your hearing. Take precautions by adjusting the volume control on your radio to a safe sound level before your hearing adapts to it.

To help avoid hearing loss or damage:

- Adjust the volume control to the lowest setting.
- Increase volume slowly until you hear comfortably and clearly.

NOTICE:

Before you add any sound equipment to your vehicle -- like a tape player, CB radio, mobile telephone or two-way radio -- be sure you can add what you want. If you can, it's very important to do it properly. Added sound equipment may interfere with the operation of your vehicle's engine, Delco radio or other systems, and even damage them. Your vehicle's systems may interfere with the operation of sound equipment that has been added improperly.

So, before adding sound equipment, check with your dealer and be sure to check Federal rules covering mobile radio and telephone units.

Care of Your Cassette Tape Player

A tape player that is not cleaned regularly can cause reduced sound quality, ruined cassettes or a damaged mechanism. Cassette tapes should be stored in their cases away from contaminants, direct sunlight and extreme heat. If they aren't, they may not operate properly or may cause failure of the tape player.

Your tape player should be cleaned regularly after every 50 hours of use. Your radio may display CLN to indicate that you have used your tape player for 50 hours without resetting the tape clean timer. If this message appears on the display, your cassette tape player needs to be cleaned. It will still play tapes, but you should clean it as soon as possible to prevent damage to your tapes and player. If you notice a reduction in sound quality, try a known good cassette to see if it is the tape or the tape player at fault. If this other cassette has no improvement in sound quality, clean the tape player.

Cleaning may be done with a scrubbing action, non-abrasive cleaning cassette with pads which scrub the tape head as the hubs of the cleaner cassette turn. A scrubbing action cleaning cassette is available through your Buick dealership.

You may also choose a non-scrubbing action, wet-type cleaner which uses a cassette with a fabric belt to clean the tape head. This type of cleaning cassette may not clean as thoroughly as the scrubbing type cleaner.

After you clean the player, press and hold EJECT for five seconds to reset the CLN indicator. The radio will display --- to show the indicator was reset.

Cassettes are subject to wear and the sound quality may degrade over time. Always make sure the cassette tape is in good condition before you have your tape player serviced.

Care of Your Compact Discs

Handle discs carefully. Store them in their original cases or other protective cases and away from direct sunlight and dust. If the surface of a disc is soiled, dampen a clean, soft cloth in a mild, neutral detergent solution and clean it, wiping from the center to the edge.

Be sure never to touch the signal surface when handling discs. Pick up discs by grasping the outer edges or the edge of the hole and the outer edge.

Power Antenna Mast Care

Your power antenna will look its best and work well if it's cleaned from time to time. To clean the antenna mast:

1. Turn on the ignition and radio to raise the antenna.
2. Dampen a clean cloth with mineral spirits or equivalent solvent.
3. Wipe the cloth over the mast sections, removing any dirt.
4. Wipe dry with a clean cloth.
5. Make the antenna go up and down by turning the radio or ignition off and on.
6. Repeat if necessary.

NOTICE:

Don't lubricate the power antenna. Lubrication could damage it.

NOTICE:

Before entering an automatic car wash, turn off your radio to make the power antenna go down. This will prevent the mast from possibly getting damaged. If the antenna does not go down when you turn the radio off, it may be damaged or need to be cleaned. In either case, lower the antenna by hand by carefully pressing the antenna down.

If the mast portion of your antenna is damaged, you can easily replace it. See your dealer for a replacement kit and follow the instructions in the kit.

 **NOTES**



Section 4 Your Driving and the Road

Here you'll find information about driving on different kinds of roads and in varying weather conditions. We've also included many other useful tips on driving.

4-2	Defensive Driving	4-17	Driving in Rain and on Wet Roads
4-3	Drunken Driving	4-20	City Driving
4-6	Control of a Vehicle	4-21	Freeway Driving
4-6	Braking	4-22	Before Leaving on a Long Trip
4-10	Steering	4-23	Highway Hypnosis
4-12	Off-Road Recovery	4-23	Hill and Mountain Roads
4-13	Passing	4-25	Winter Driving
4-14	Loss of Control	4-30	Loading Your Vehicle
4-15	Driving at Night	4-32	Towing a Trailer



Defensive Driving

The best advice anyone can give about driving is:
Drive defensively.

Please start with a very important safety device in your Buick: Buckle up. (See "Safety Belts" in the Index.)

Defensive driving really means "be ready for anything." On city streets, rural roads or freeways, it means "always expect the unexpected."

Assume that pedestrians or other drivers are going to be careless and make mistakes. Anticipate what they might do. Be ready for their mistakes.

Rear-end collisions are about the most preventable of accidents. Yet they are common. Allow enough following distance. It's the best defensive driving maneuver, in both city and rural driving. You never know when the vehicle in front of you is going to brake or turn suddenly.

Drunken Driving

Death and injury associated with drinking and driving is a national tragedy. It's the number one contributor to the highway death toll, claiming thousands of victims every year.

Alcohol affects four things that anyone needs to drive a vehicle:

- Judgment
- Muscular Coordination
- Vision
- Attentiveness.

Police records show that almost half of all motor vehicle-related deaths involve alcohol. In most cases, these deaths are the result of someone who was drinking and driving. In recent years, some 17,000 annual motor vehicle-related deaths have been associated with the use of alcohol, with more than 300,000 people injured.

Many adults -- by some estimates, nearly half the adult population -- choose never to drink alcohol, so they never drive after drinking. For persons under 21, it's against the law in every U.S. state to drink alcohol. There are good medical, psychological and developmental reasons for these laws.

The obvious way to solve this highway safety problem is for people never to drink alcohol and then drive. But what if people do? How much is "too much" if the driver plans to drive? It's a lot less than many might think. Although it depends on each person and situation, here is some general information on the problem.

The Blood Alcohol Concentration (BAC) of someone who is drinking depends upon four things:

- The amount of alcohol consumed
- The drinker's body weight
- The amount of food that is consumed before and during drinking
- The length of time it has taken the drinker to consume the alcohol.

According to the American Medical Association, a 180-lb. (82 kg) person who drinks three 12-ounce (355 ml) bottles of beer in an hour will end up with a BAC of about 0.06 percent. The person would reach the same BAC by drinking three 4-ounce (120 ml) glasses of wine or three mixed drinks if each had 1-1/2 ounces (45 ml) of a liquor like whiskey, gin or vodka.

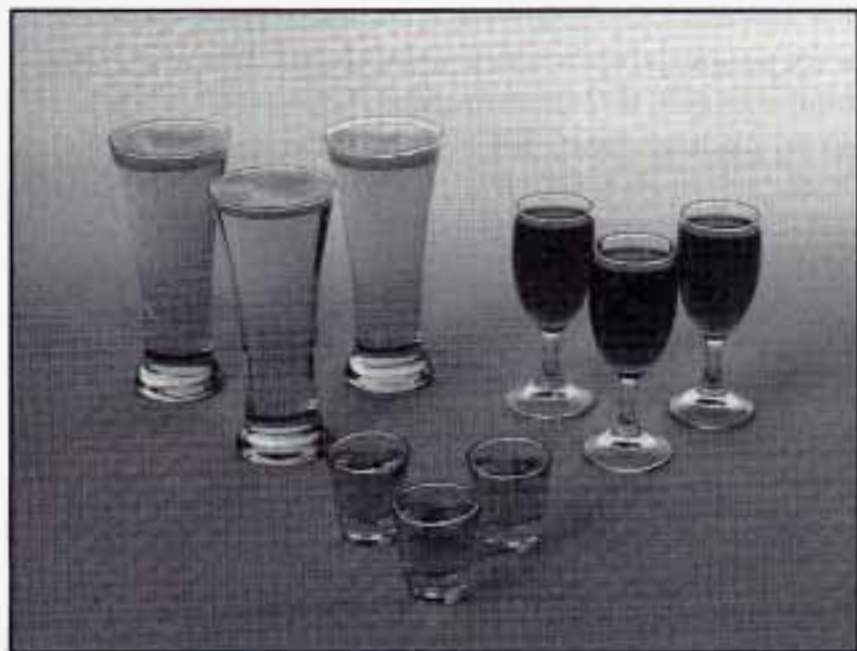

It's the amount of alcohol that counts. For example, if the same person drank three double martinis (3 ounces or 90 ml of liquor each) within an hour, the person's BAC would be close to 0.12 percent. A person who consumes food just before or during drinking will have a somewhat lower BAC level.

There is a gender difference, too. Women generally have a lower relative percentage of body water than men.

Since alcohol is carried in body water, this means that a woman generally will reach a higher BAC level than a man of her same body weight when each has the same number of drinks.

The law in many U.S. states sets the legal limit at a BAC of 0.10 percent. In a growing number of U.S. states, and throughout Canada, the limit is 0.08 percent. In some other countries, it's even lower. The BAC limit for all commercial drivers in the United States is 0.04 percent.

The BAC will be over 0.10 percent after three to six drinks (in one hour). Of course, as we've seen, it depends on how much alcohol is in the drinks, and how quickly the person drinks them.

But the ability to drive is affected well below a BAC of 0.10 percent. Research shows that the driving skills of many people are impaired at a BAC approaching 0.05 percent, and that the effects are worse at night. All drivers are impaired at BAC levels above 0.05 percent. Statistics show that the chance of being in a collision increases sharply for drivers who have a BAC of 0.05 percent or above. A driver with a BAC level of 0.06 percent has doubled his or her chance of having a collision. At a BAC level of 0.10 percent, the chance of this driver having a collision is 12 times greater; at a level of 0.15 percent, the chance is 25 times greater!

The body takes about an hour to rid itself of the alcohol in one drink. No amount of coffee or number of cold showers will speed that up. "I'll be careful" isn't the right answer. What if there's an emergency, a need to take sudden action, as when a child darts into the street? A person with even a moderate BAC might not be able to react quickly enough to avoid the collision.

There's something else about drinking and driving that many people don't know. Medical research shows that alcohol in a person's system can make crash injuries worse, especially injuries to the brain, spinal cord or heart. This means that when anyone who has been drinking -- driver or passenger -- is in a crash, that person's chance of being killed or permanently disabled is higher than if the person had not been drinking.



CAUTION:

Drinking and then driving is very dangerous. Your reflexes, perceptions, attentiveness and judgment can be affected by even a small amount of alcohol. You can have a serious -- or even fatal -- collision if you drive after drinking. Please don't drink and drive or ride with a driver who has been drinking. Ride home in a cab; or if you're with a group, designate a driver who will not drink.

Control of a Vehicle

You have three systems that make your vehicle go where you want it to go. They are the brakes, the steering and the accelerator. All three systems have to do their work at the places where the tires meet the road.

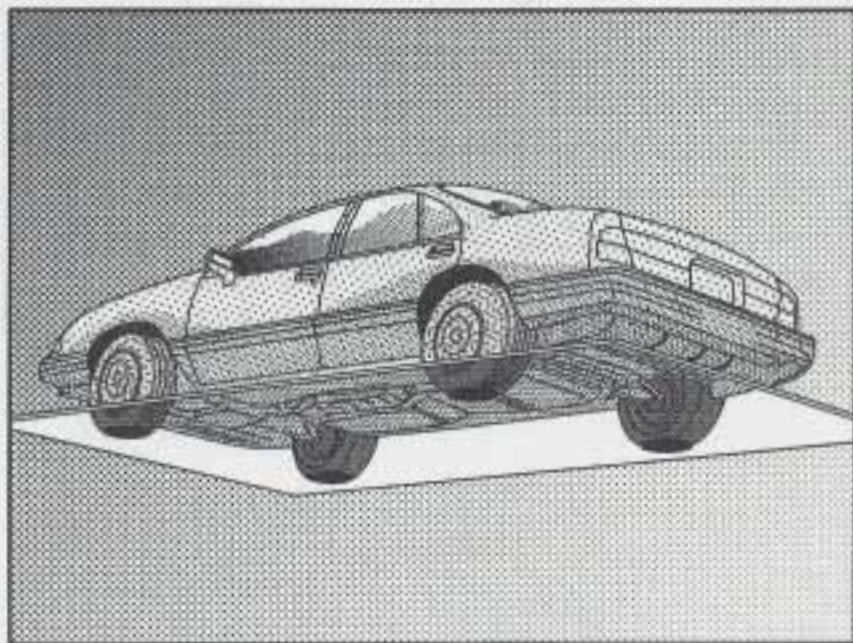

Sometimes, as when you're driving on snow or ice, it's easy to ask more of those control systems than the tires and road can provide. That means you can lose control of your vehicle.

Braking

Braking action involves *perception time* and *reaction time*.

First, you have to decide to push on the brake pedal. That's *perception time*. Then you have to bring up your foot and do it. That's *reaction time*.

Average *reaction time* is about $3/4$ of a second. But that's only an average. It might be less with one driver and as long as two or three seconds or more with another. Age, physical condition, alertness, coordination and eyesight all play a part. So do alcohol, drugs and frustration. But even in $3/4$ of a second, a vehicle moving at 60 mph (100 km/h) travels 66 feet (20 m). That could be a lot of distance in an emergency, so keeping enough space between your vehicle and others is important.

And, of course, actual stopping distances vary greatly with the surface of the road (whether it's pavement or gravel); the condition of the road (wet, dry, icy); tire tread; the condition of your brakes; the weight of the vehicle and the amount of brake force applied.

Avoid needless heavy braking. Some people drive in spurts -- heavy acceleration followed by heavy braking -- rather than keeping pace with traffic. This is a mistake. Your brakes may not have time to cool between hard stops. Your brakes will wear out much faster if you do a lot of heavy braking. If you keep pace with the traffic and allow realistic following distances, you will eliminate a lot of unnecessary braking. That means better braking and longer brake life.

If your engine ever stops while you're driving, brake normally but don't pump your brakes. If you do, the pedal may get harder to push down. If your engine stops, you will still have some power brake assist. But you will use it when you brake. Once the power assist is used up, it may take longer to stop and the brake pedal will be harder to push.

Anti-Lock Brakes

Your vehicle has anti-lock brakes (ABS). ABS is an advanced electronic braking system that will help prevent a braking skid.

When you start your engine and begin to drive away, your anti-lock brake system will check itself. You may hear a momentary motor or clicking noise while this test is going on, and you may even notice that your brake pedal moves a little. This is normal.

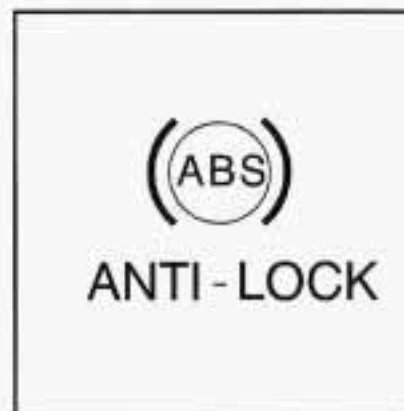

If there's a problem with the anti-lock brake system, this warning light will stay on. See "Anti-Lock Brake System Warning Light" in the Index.



Here's how anti-lock works. Let's say the road is wet. You're driving safely. Suddenly an animal jumps out in front of you.

You slam on the brakes. Here's what happens with ABS.

A computer senses that wheels are slowing down. If one of the wheels is about to stop rolling, the computer will separately work the brakes at each front wheel and at the rear wheels.

The anti-lock system can change the brake pressure faster than any driver could. The computer is programmed to make the most of available tire and road conditions.



You can steer around the obstacle while braking hard.

As you brake, your computer keeps receiving updates on wheel speed and controls braking pressure accordingly.

Remember: Anti-lock doesn't change the time you need to get your foot up to the brake pedal or always decrease stopping distance. If you get too close to the vehicle in front of you, you won't have time to apply your brakes if that vehicle suddenly slows or stops. Always leave enough room up ahead to stop, even though you have anti-lock brakes.

Using Anti-Lock

Don't pump the brakes. Just hold the brake pedal down and let anti-lock work for you. You may hear a motor or clicking noise during a hard stop, but this is normal.

Traction Control System (Option)

Your vehicle may have a traction control system that limits wheel spin. This is especially useful in slippery road conditions. The system operates only if it senses that one or both of the front wheels are spinning or beginning to lose traction. When this happens, the system works the front brakes and reduces engine power to limit wheel spin.

You may feel or hear the system working, but this is normal.

If your vehicle is in cruise control when the traction control system begins to limit wheel spin, the cruise control will automatically disengage. When road

conditions allow you to safely use it again, you may re-engage the cruise control. (See "Cruise Control" in the Index.)



When the system is on, this warning light will come on to let you know if there's a problem with your traction control system.

See "Traction Control System Warning Light" in the Index. When this warning light is on, the system will not limit wheel spin. Adjust your driving accordingly.

The traction control system automatically comes on whenever you start your vehicle. To limit wheel spin, especially in slippery road conditions, you should always leave the system on. But you can turn the traction control system off if you ever need to. (You should turn the system off if your vehicle ever gets stuck in sand, mud, ice or snow. See "Rocking Your Vehicle" in the Index.)



To turn the system off, press the TRAC CONT button located on the instrument panel.

The traction control system warning light will come on and stay on. If the system is limiting wheel spin when you press the button, the warning light will come on -- but the system won't turn off right away. It will wait until there's no longer a current need to limit wheel spin.

You can turn the system back on at any time by pressing the button again. The traction control system warning light should go off.

Braking in Emergencies

With anti-lock, you can steer and brake at the same time. In many emergencies, steering can help you more than even the very best braking.

Steering

Power Steering

If you lose power steering assist because the engine stops or the system is not functioning, you can steer but it will take much more effort.

Magnasteer™

Your vehicle is equipped with GM Magnasteer, a steering system that continuously adjusts the effort you feel when steering at all vehicle speeds. It provides ease when parking yet a firm, solid feel at highway speeds.

Steering Tips

Driving on Curves

It's important to take curves at a reasonable speed.

A lot of the "driver lost control" accidents mentioned on the news happen on curves. Here's why:

Experienced driver or beginner, each of us is subject to the same laws of physics when driving on curves. The traction of the tires against the road surface makes it possible for the vehicle to change its path when you turn the front wheels. If there's no traction, inertia will keep the vehicle going in the same direction. If you've ever tried to steer a vehicle on wet ice, you'll understand this.

The traction you can get in a curve depends on the condition of your tires and the road surface, the angle at which the curve is banked, and your speed. While you're in a curve, speed is the one factor you can control.

Suppose you're steering through a sharp curve. Then you suddenly accelerate. Both control systems -- steering and acceleration -- have to do their work where the tires meet the road. Adding the sudden acceleration can demand too much of those places. You can lose control. Refer to "Traction Control" in the Index.

What should you do if this ever happens? Ease up on the accelerator pedal, steer the vehicle the way you want it to go, and slow down.

Speed limit signs near curves warn that you should adjust your speed. Of course, the posted speeds are based on good weather and road conditions. Under less favorable conditions you'll want to go slower.

If you need to reduce your speed as you approach a curve, do it before you enter the curve, while your front wheels are straight ahead.

Try to adjust your speed so you can "drive" through the curve. Maintain a reasonable, steady speed. Wait to accelerate until you are out of the curve, and then accelerate gently into the straightaway.

Steering in Emergencies

There are times when steering can be more effective than braking. For example, you come over a hill and find a truck stopped in your lane, or a car suddenly pulls out from nowhere, or a child darts out from between parked cars and stops right in front of you. You can avoid these problems by braking -- if you can stop in time. But sometimes you can't; there isn't room. That's the time for evasive action -- steering around the problem.

Your Buick can perform very well in emergencies like these. First apply your brakes. (See "Braking in Emergencies" earlier in this section.) It is better to remove as much speed as you can from a possible collision. Then steer around the problem, to the left or right depending on the space available.



An emergency like this requires close attention and a quick decision. If you are holding the steering wheel at the recommended 9 and 3 o'clock positions, you can turn it a full 180 degrees very quickly without removing either hand. But you have to act fast, steer quickly, and just as quickly straighten the wheel once you have avoided the object.

The fact that such emergency situations are always possible is a good reason to practice defensive driving at all times and wear safety belts properly.

Off-Road Recovery

You may find sometime that your right wheels have dropped off the edge of a road onto the shoulder while you're driving.

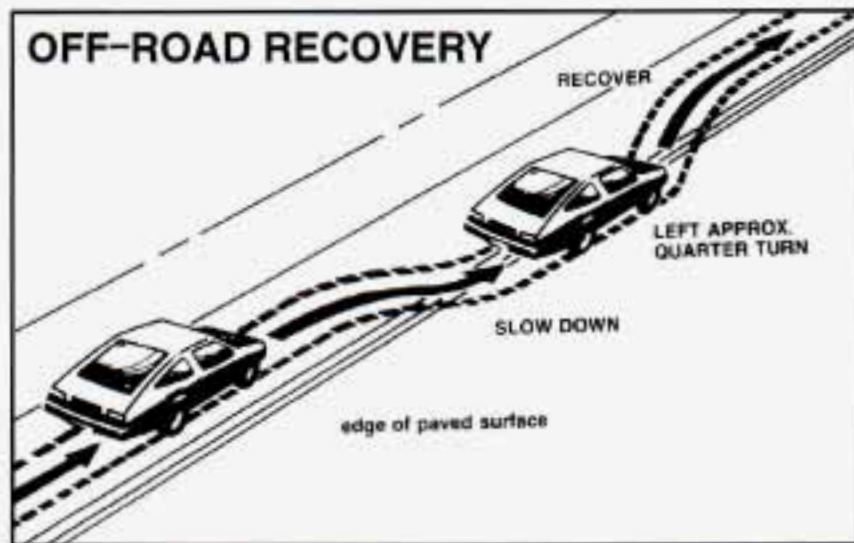

If the level of the shoulder is only slightly below the pavement, recovery should be fairly easy. Ease off the accelerator and then, if there is nothing in the way, steer so that your vehicle straddles the edge of the pavement. You can turn the steering wheel up to one-quarter turn until the right front tire contacts the pavement edge. Then turn your steering wheel to go straight down the roadway.

Passing

The driver of a vehicle about to pass another on a two-lane highway waits for just the right moment, accelerates, moves around the vehicle ahead, then goes back into the right lane again. A simple maneuver?

Not necessarily! Passing another vehicle on a two-lane highway is a potentially dangerous move, since the passing vehicle occupies the same lane as oncoming traffic for several seconds. A miscalculation, an error in judgment, or a brief surrender to frustration or anger can suddenly put the passing driver face to face with the worst of all traffic accidents -- the head-on collision.

So here are some tips for passing:

- “Drive ahead.” Look down the road, to the sides and to crossroads for situations that might affect your passing patterns. If you have any doubt whatsoever about making a successful pass, wait for a better time.
- Watch for traffic signs, pavement markings and lines. If you can see a sign up ahead that might indicate a turn or an intersection, delay your pass. A broken center line usually indicates it’s all right to pass (providing the road ahead is clear). Never cross a solid line on your side of the lane or a double solid line, even if the road seems empty of approaching traffic.
- Do not get too close to the vehicle you want to pass while you’re awaiting an opportunity. For one thing, following too closely reduces your area of vision, especially if you’re following a larger vehicle. Also, you won’t have adequate space if the vehicle ahead suddenly slows or stops. Keep back a reasonable distance.
- When it looks like a chance to pass is coming up, start to accelerate but stay in the right lane and don’t get too close. Time your move so you will be increasing speed as the time comes to move into the other lane. If the way is clear to pass, you will have a “running start” that more than makes up for the distance you would lose by dropping back. And if something happens to cause you to cancel your pass, you need only slow down and drop back again and wait for another opportunity.
- If other cars are lined up to pass a slow vehicle, wait your turn. But take care that someone isn’t trying to pass you as you pull out to pass the slow vehicle. Remember to glance over your shoulder and check the blind spot.

- Check your mirrors, glance over your shoulder, and start your left lane change signal before moving out of the right lane to pass. When you are far enough ahead of the passed vehicle to see its front in your inside mirror, activate your right lane change signal and move back into the right lane. (Remember that your right outside mirror is convex. The vehicle you just passed may seem to be farther away from you than it really is.)
- Try not to pass more than one vehicle at a time on two-lane roads. Reconsider before passing the next vehicle.
- Don't overtake a slowly moving vehicle too rapidly. Even though the brake lamps are not flashing, it may be slowing down or starting to turn.
- If you're being passed, make it easy for the following driver to get ahead of you. Perhaps you can ease a little to the right.

Loss of Control

Let's review what driving experts say about what happens when the three control systems (brakes, steering and acceleration) don't have enough friction where the tires meet the road to do what the driver has asked.

In any emergency, don't give up. Keep trying to steer and constantly seek an escape route or area of less danger.

Skidding

In a skid, a driver can lose control of the vehicle. Defensive drivers avoid most skids by taking reasonable care suited to existing conditions, and by not "overdriving" those conditions. But skids are always possible.

The three types of skids correspond to your Buick's three control systems. In the braking skid, your wheels aren't rolling. In the steering or cornering skid, too much speed or steering in a curve causes tires to slip and lose cornering force. And in the acceleration skid, too much throttle causes the driving wheels to spin.

A cornering skid is best handled by easing your foot off the accelerator pedal.

If you have the traction control system, remember: It helps avoid only the acceleration skid.

If you do not have traction control, or if the system is off, then an acceleration skid is also best handled by easing your foot off the accelerator pedal.

If your vehicle starts to slide, ease your foot off the accelerator pedal and quickly steer the way you want the vehicle to go. If you start steering quickly enough, your vehicle may straighten out. Always be ready for a second skid if it occurs.

Of course, traction is reduced when water, snow, ice, gravel or other material is on the road. For safety, you'll want to slow down and adjust your driving to these conditions. It is important to slow down on slippery surfaces because stopping distance will be longer and vehicle control more limited.

While driving on a surface with reduced traction, try your best to avoid sudden steering, acceleration or braking (including engine braking by shifting to a lower gear). Any sudden changes could cause the tires to slide. You may not realize the surface is slippery until your vehicle is skidding. Learn to recognize warning clues -- such as enough water, ice or packed snow on the road to make a "mirrored surface" -- and slow down when you have any doubt.

Remember: Any anti-lock brake system (ABS) helps avoid only the braking skid.

Driving at Night

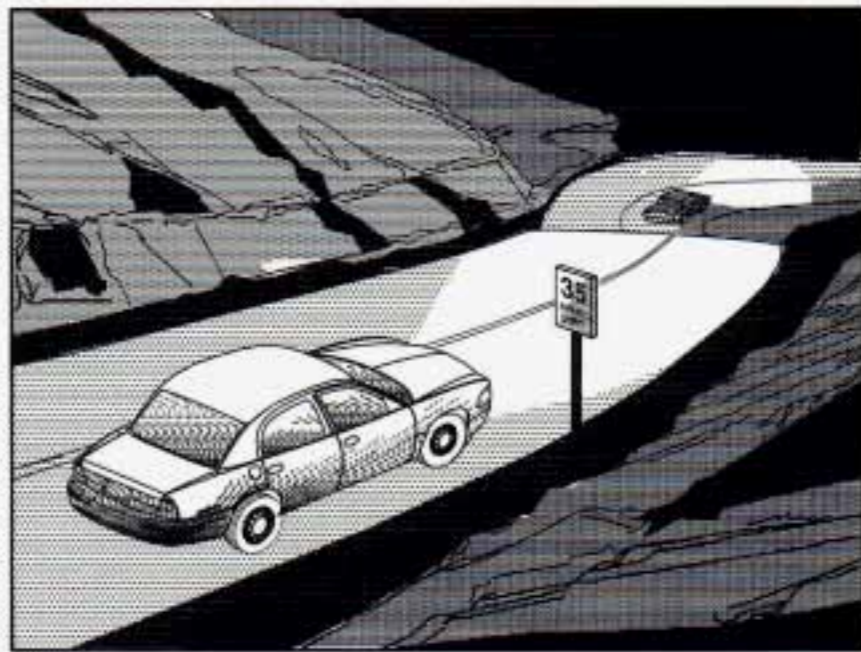

Night driving is more dangerous than day driving. One reason is that some drivers are likely to be impaired -- by alcohol or drugs, with night vision problems, or by fatigue.

Here are some tips on night driving.

- Drive defensively.
- Don't drink and drive.
- Adjust your inside rearview mirror to reduce the glare from headlamps behind you.
- Since you can't see as well, you may need to slow down and keep more space between you and other vehicles.
- Slow down, especially on higher speed roads. Your headlamps can light up only so much road ahead.
- In remote areas, watch for animals.
- If you're tired, pull off the road in a safe place and rest.

Night Vision

No one can see as well at night as in the daytime. But as we get older these differences increase. A 50-year-old driver may require at least twice as much light to see the same thing at night as a 20-year-old.

What you do in the daytime can also affect your night vision. For example, if you spend the day in bright sunshine you are wise to wear sunglasses. Your eyes will have less trouble adjusting to night. But if you're

driving, don't wear sunglasses at night. They may cut down on glare from headlamps, but they also make a lot of things invisible.

You can be temporarily blinded by approaching headlamps. It can take a second or two, or even several seconds, for your eyes to readjust to the dark. When you are faced with severe glare (as from a driver who doesn't lower the high beams, or a vehicle with misaimed headlamps), slow down a little. Avoid staring directly into the approaching headlamps.

Keep your windshield and all the glass on your vehicle clean -- inside and out. Glare at night is made much worse by dirt on the glass. Even the inside of the glass can build up a film caused by dust. Dirty glass makes lights dazzle and flash more than clean glass would, making the pupils of your eyes contract repeatedly.

Remember that your headlamps light up far less of a roadway when you are in a turn or curve. Keep your eyes moving; that way, it's easier to pick out dimly lighted objects. Just as your headlamps should be checked regularly for proper aim, so should your eyes be examined regularly. Some drivers suffer from night blindness -- the inability to see in dim light -- and aren't even aware of it.

Driving in Rain and on Wet Roads



Rain and wet roads can mean driving trouble. On a wet road, you can't stop, accelerate or turn as well because your tire-to-road traction isn't as good as on dry roads. And, if your tires don't have much tread left, you'll get even less traction. It's always wise to go slower and be cautious if rain starts to fall while you are driving. The surface may get wet suddenly when your reflexes are tuned for driving on dry pavement.

The heavier the rain, the harder it is to see. Even if your windshield wiper blades are in good shape, a heavy rain can make it harder to see road signs and traffic signals, pavement markings, the edge of the road and even people walking.

It's wise to keep your windshield wiping equipment in good shape and keep your windshield washer tank filled with washer fluid. Replace your windshield wiper inserts when they show signs of streaking or missing areas on the windshield, or when strips of rubber start to separate from the inserts.

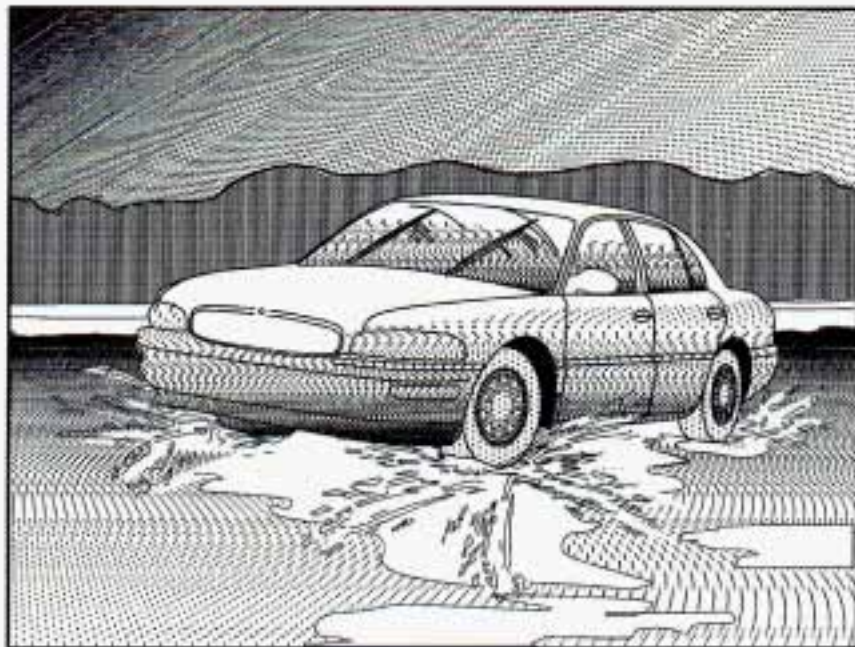

CAUTION:

Wet brakes can cause accidents. They won't work as well in a quick stop and may cause pulling to one side. You could lose control of the vehicle.

After driving through a large puddle of water or a car wash, apply your brake pedal lightly until your brakes work normally.

Driving too fast through large water puddles or even going through some car washes can cause problems, too. The water may affect your brakes. Try to avoid puddles. But if you can't, try to slow down before you hit them.

Hydroplaning

Hydroplaning is dangerous. So much water can build up under your tires that they can actually ride on the water. This can happen if the road is wet enough and you're going fast enough. When your vehicle is hydroplaning, it has little or no contact with the road.

Hydroplaning doesn't happen often. But it can if your tires do not have much tread or if the pressure in one or more is low. It can happen if a lot of water is standing on the road. If you can see reflections from trees, telephone poles or other vehicles, and raindrops "dimple" the water's surface, there could be hydroplaning.

Hydroplaning usually happens at higher speeds. There just isn't a hard and fast rule about hydroplaning. The best advice is to slow down when it is raining.

Driving Through Deep Standing Water

NOTICE:

If you drive too quickly through deep puddles or standing water, water can come in through your engine's air intake and badly damage your engine. Never drive through water that is slightly lower than the underbody of your vehicle. If you can't avoid deep puddles or standing water, drive through them very slowly.

Some Other Rainy Weather Tips

- Besides slowing down, allow some extra following distance. And be especially careful when you pass another vehicle. Allow yourself more clear room ahead, and be prepared to have your view restricted by road spray.
- Have good tires with proper tread depth. (See "Tires" in the Index.)

City Driving



One of the biggest problems with city streets is the amount of traffic on them. You'll want to watch out for what the other drivers are doing and pay attention to traffic signals.

Here are ways to increase your safety in city driving:

- Know the best way to get to where you are going. Get a city map and plan your trip into an unknown part of the city just as you would for a cross-country trip.
- Try to use the freeways that rim and crisscross most large cities. You'll save time and energy. (See the next part, "Freeway Driving.")
- Treat a green light as a warning signal. A traffic light is there because the corner is busy enough to need it. When a light turns green, and just before you start to move, check both ways for vehicles that have not cleared the intersection or may be running the red light.

Freeway Driving

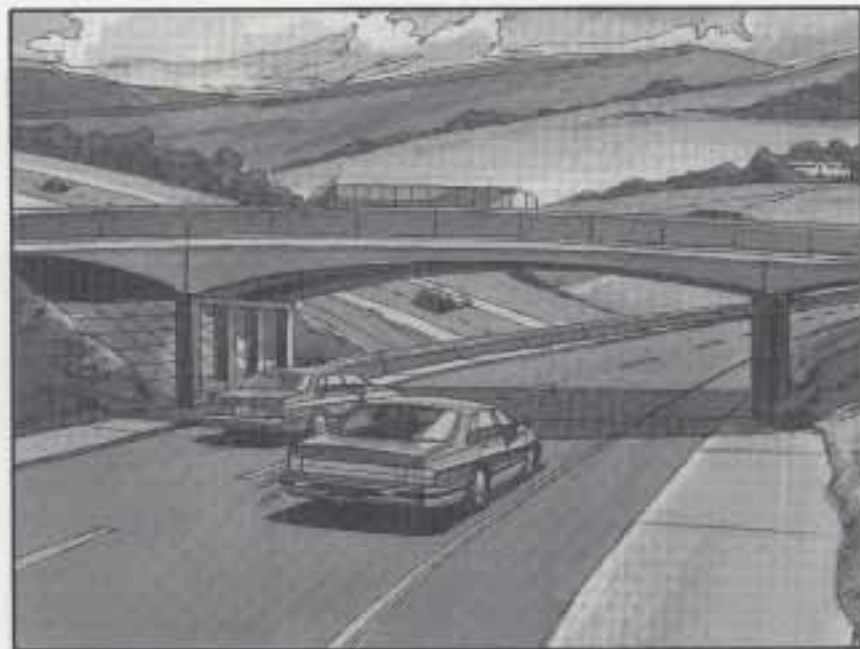

Mile for mile, freeways (also called thruways, parkways, expressways, turnpikes or superhighways) are the safest of all roads. But they have their own special rules.

The most important advice on freeway driving is: Keep up with traffic and keep to the right. Drive at the same speed most of the other drivers are driving. Too-fast or too-slow driving breaks a smooth traffic flow. Treat the left lane on a freeway as a passing lane.

At the entrance, there is usually a ramp that leads to the freeway. If you have a clear view of the freeway as you drive along the entrance ramp, you should begin to check traffic. Try to determine where you expect to blend with the flow. Try to merge into the gap at close to the prevailing speed. Switch on your turn signal, check your mirrors and glance over your shoulder as often as necessary. Try to blend smoothly with the traffic flow.

Once you are on the freeway, adjust your speed to the posted limit or to the prevailing rate if it's slower. Stay in the right lane unless you want to pass.

Before changing lanes, check your mirrors. Then use your turn signal.

Just before you leave the lane, glance quickly over your shoulder to make sure there isn't another vehicle in your "blind" spot.

Once you are moving on the freeway, make certain you allow a reasonable following distance. Expect to move slightly slower at night.

When you want to leave the freeway, move to the proper lane well in advance. If you miss your exit, do not, under any circumstances, stop and back up. Drive on to the next exit.

The exit ramp can be curved, sometimes quite sharply. The exit speed is usually posted.

Reduce your speed according to your speedometer, not to your sense of motion. After driving for any distance at higher speeds, you may tend to think you are going slower than you actually are.

Before Leaving on a Long Trip

Make sure you're ready. Try to be well rested. If you must start when you're not fresh -- such as after a day's work -- don't plan to make too many miles that first part of the journey. Wear comfortable clothing and shoes you can easily drive in.

Is your vehicle ready for a long trip? If you keep it serviced and maintained, it's ready to go. If it needs service, have it done before starting out. Of course, you'll find experienced and able service experts in Buick dealerships all across North America. They'll be ready and willing to help if you need it.

Here are some things you can check before a trip:

- *Windshield Washer Fluid:* Is the reservoir full? Are all windows clean inside and outside?
- *Wiper Blades:* Are they in good shape?
- *Fuel, Engine Oil, Other Fluids:* Have you checked all levels?
- *Lamps:* Are they all working? Are the lenses clean?
- *Tires:* They are vitally important to a safe, trouble-free trip. Is the tread good enough for long-distance driving? Are the tires all inflated to the recommended pressure?
- *Weather Forecasts:* What's the weather outlook along your route? Should you delay your trip a short time to avoid a major storm system?
- *Maps:* Do you have up-to-date maps?

Highway Hypnosis

Is there actually such a condition as “highway hypnosis”? Or is it just plain falling asleep at the wheel? Call it highway hypnosis, lack of awareness, or whatever.

There is something about an easy stretch of road with the same scenery, along with the hum of the tires on the road, the drone of the engine, and the rush of the wind against the vehicle that can make you sleepy. Don't let it happen to you! If it does, your vehicle can leave the road in *less than a second*, and you could crash and be injured.

What can you do about highway hypnosis? First, be aware that it can happen.

Then here are some tips:

- Make sure your vehicle is well ventilated, with a comfortably cool interior.
- Keep your eyes moving. Scan the road ahead and to the sides. Check your rearview mirrors and your instruments frequently.
- If you get sleepy, pull off the road into a rest, service or parking area and take a nap, get some exercise, or both. For safety, treat drowsiness on the highway as an emergency.

Hill and Mountain Roads



Driving on steep hills or mountains is different from driving in flat or rolling terrain.

If you drive regularly in steep country, or if you're planning to visit there, here are some tips that can make your trips safer and more enjoyable.

- Keep your vehicle in good shape. Check all fluid levels and also the brakes, tires, cooling system and transaxle. These parts can work hard on mountain roads.
- Know how to go down hills. The most important thing to know is this: let your engine do some of the slowing down. Shift to a lower gear when you go down a steep or long hill.

 **CAUTION:**

If you don't shift down, your brakes could get so hot that they wouldn't work well. You would then have poor braking or even none going down a hill. You could crash. Shift down to let your engine assist your brakes on a steep downhill slope.

 **CAUTION:**

Coasting downhill in NEUTRAL (N) or with the ignition off is dangerous. Your brakes will have to do all the work of slowing down. They could get so hot that they wouldn't work well. You would then have poor braking or even none going down a hill. You could crash. Always have your engine running and your vehicle in gear when you go downhill.

- Know how to go uphill. Drive in the highest gear possible.
- Stay in your own lane when driving on two-lane roads in hills or mountains. Don't swing wide or cut across the center of the road. Drive at speeds that let you stay in your own lane.
- As you go over the top of a hill, be alert. There could be something in your lane, like a stalled car or an accident.
- You may see highway signs on mountains that warn of special problems. Examples are long grades, passing or no-passing zones, a falling rocks area or winding roads. Be alert to these and take appropriate action.

Winter Driving



Here are some tips for winter driving:

- Have your Buick in good shape for winter.
- You may want to put winter emergency supplies in your trunk.

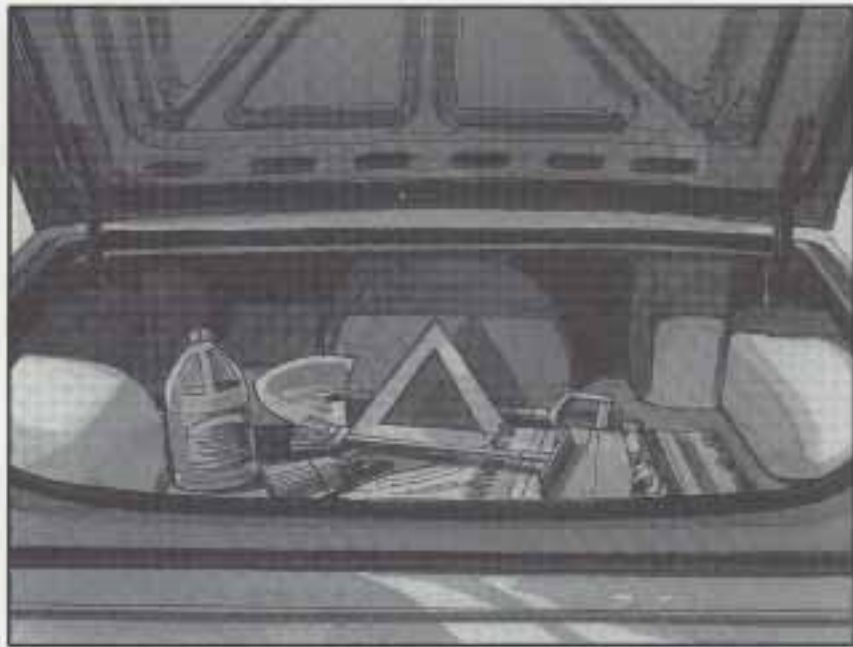

Include an ice scraper, a small brush or broom, a supply of windshield washer fluid, a rag, some winter outer clothing, a small shovel, a flashlight, a red cloth and a couple of reflective warning triangles. And, if you will be driving under severe conditions, include a small bag of sand, a piece of old carpet or a couple of burlap bags to help provide traction. Be sure you properly secure these items in your vehicle.

Driving on Snow or Ice

Most of the time, those places where your tires meet the road probably have good traction.

However, if there is snow or ice between your tires and the road, you can have a very slippery situation. You'll have a lot less traction or "grip" and will need to be very careful.

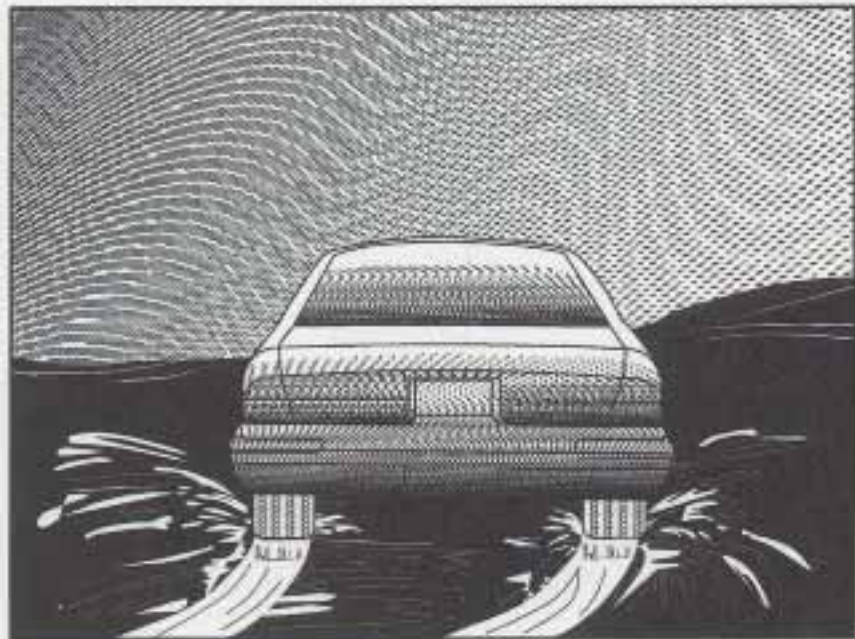

What's the worst time for this? "Wet ice." Very cold snow or ice can be slick and hard to drive on. But wet ice can be even more trouble because it may offer the least traction of all. You can get wet ice when it's about freezing (32°F; 0°C) and freezing rain begins to fall. Try to avoid driving on wet ice until salt and sand crews can get there.

Whatever the condition -- smooth ice, packed, blowing or loose snow -- drive with caution.

If you have traction control, keep the system on. It will improve your ability to accelerate when driving on a slippery road. Even though your vehicle has a traction control system, you'll want to slow down and adjust your driving to the road conditions. See "Traction Control System" in the Index.

If you don't have the traction control system, accelerate gently. Try not to break the fragile traction. If you accelerate too fast, the drive wheels will spin and polish the surface under the tires even more.

Your anti-lock brakes improve your vehicle's stability when you make a hard stop on a slippery road. Even though you have the anti-lock braking system, you'll want to begin stopping sooner than you would on dry pavement. See "Anti-Lock" in the Index.

- Allow greater following distance on any slippery road.
- Watch for slippery spots. The road might be fine until you hit a spot that's covered with ice. On an otherwise clear road, ice patches may appear in shaded areas where the sun can't reach: around clumps of trees, behind buildings or under bridges. Sometimes the surface of a curve or an overpass may remain icy when the surrounding roads are clear. If you see a patch of ice ahead of you, brake before you are on it. Try not to brake while you're actually on the ice, and avoid sudden steering maneuvers.

If You're Caught in a Blizzard



If you are stopped by heavy snow, you could be in a serious situation. You should probably stay with your vehicle unless you know for sure that you are near help and you can hike through the snow. Here are some things to do to summon help and keep yourself and your passengers safe:

- Turn on your hazard flashers.

- Tie a red cloth to your vehicle to alert police that you've been stopped by the snow.
- Put on extra clothing or wrap a blanket around you. If you have no blankets or extra clothing, make body insulators from newspapers, burlap bags, rags, floor mats -- anything you can wrap around yourself or tuck under your clothing to keep warm.



You can run the engine to keep warm, but be careful.



CAUTION:

Snow can trap exhaust gases under your vehicle. This can cause deadly CO (carbon monoxide) gas to get inside. CO could overcome you and kill you. You can't see it or smell it, so you might not know it is in your vehicle. Clear away snow from around the base of your vehicle, especially any that is blocking your exhaust pipe. And check around again from time to time to be sure snow doesn't collect there.

Open a window just a little on the side of the vehicle that's away from the wind. This will help keep CO out.

Run your engine only as long as you must. This saves fuel. When you run the engine, make it go a little faster than just idle. That is, push the accelerator slightly. This uses less fuel for the heat that you get and it keeps the battery charged. You will need a well-charged battery to restart the vehicle, and possibly for signaling later on with your headlamps. Let the heater run for awhile.

Then, shut the engine off and close the window almost all the way to preserve the heat. Start the engine again and repeat this only when you feel really uncomfortable from the cold. But do it as little as possible. Preserve the fuel as long as you can. To help keep warm, you can get out of the vehicle and do some fairly vigorous exercises every half hour or so until help comes.

Loading Your Vehicle



TIRE-LOADING INFORMATION

OCCUPANTS		VEHICLE CAP. WT.	
FRT.	CTR. RR.	TOTAL	LBS. KG

MAX. LOADING & GVWR SAME AS VEHICLE CAPACITY WEIGHT		
TIRE SIZE	XXX	COLD TIRE PRESSURE
	SPEED RTG	PSI/KPa

FRT.

RR.

SPA.

IF TIRES ARE HOT, ADD 4PSI/28KPa
SEE OWNER'S MANUAL FOR ADDITIONAL INFORMATION



MFD BY GENERAL MOTORS CORP
DATE GVWR GAWR FRT GAWR RR

THIS VEHICLE CONFORMS TO ALL APPLICABLE U.S. FEDERAL MOTOR VEHICLE SAFETY, BUMPER, AND THEFT PREVENTION STANDARDS IN EFFECT ON THE DATE OF MANUFACTURE SHOWN ABOVE.

Two labels on your vehicle show how much weight it may properly carry. The Tire Loading Information label found on the rear edge of the driver's door tells you the proper size, speed rating and recommended inflation pressures for the tires on your vehicle. It also gives you important information about the number of people that can be in your vehicle and the total weight that you can carry. This weight is called the Vehicle Capacity Weight and includes the weight of all occupants, cargo, and all nonfactory-installed options.

The other label is the Certification label, also found on the rear edge of the driver's door. It tells you the gross weight capacity of your vehicle, called the GVWR (Gross Vehicle Weight Rating). The GVWR includes the weight of the vehicle, all occupants, fuel and cargo. Never exceed the GVWR for your vehicle, or the Gross Axle Weight Rating (GAWR) for either the front or rear axle.

And, if you do have a heavy load, you should spread it out. Don't carry more than 176 pounds (80 kilograms) in your trunk.

 **CAUTION:**

Do not load your vehicle any heavier than the GVWR, or either the maximum front or rear GAWR. If you do, parts on your vehicle can break, or it can change the way your vehicle handles. These could cause you to lose control. Also, overloading can shorten the life of your vehicle.

NOTICE:

Your warranty does not cover parts or components that fail because of overloading.

If you put things inside your vehicle -- like suitcases, tools, packages, or anything else -- they will go as fast as the vehicle goes. If you have to stop or turn quickly, or if there is a crash, they'll keep going.

 **CAUTION:**

Things you put inside your vehicle can strike and injure people in a sudden stop or turn, or in a crash.

- Put things in the trunk of your vehicle. In a trunk, put them as far forward as you can. Try to spread the weight evenly.
- Never stack heavier things, like suitcases, inside the vehicle so that some of them are above the tops of the seats.
- Don't leave an unsecured child restraint in your vehicle.
- When you carry something inside the vehicle, secure it whenever you can.

Electronic Level Control

This feature keeps the rear of your vehicle level as the load changes. It's automatic -- you don't need to adjust anything.

Towing a Trailer

CAUTION:

If you don't use the correct equipment and drive properly, you can lose control when you pull a trailer. For example, if the trailer is too heavy, the brakes may not work well -- or even at all. You and your passengers could be seriously injured. **Pull a trailer only if you have followed all the steps in this section. Ask your Buick dealer for advice and information about towing a trailer with your vehicle.**

NOTICE:

Pulling a trailer improperly can damage your vehicle and result in costly repairs not covered by your warranty. To pull a trailer correctly, follow the advice in this part, and see your Buick dealer for important information about towing a trailer with your vehicle.

Your vehicle can tow a trailer if it is equipped with proper towing equipment. To identify what the vehicle trailering capacity is for your vehicle, you should read the information in "Weight of the Trailer" that appears later in this section. But trailering is different than just driving your vehicle by itself. Trailering means changes in handling, durability and fuel economy. Successful, safe trailering takes correct equipment, and it has to be used properly.

That's the reason for this part. In it are many time-tested, important trailering tips and safety rules. Many of these are important for your safety and that of your passengers. So please read this section carefully before you pull a trailer.

Load-pulling components such as the engine, transaxle, wheel assemblies and tires are forced to work harder against the drag of the added weight. The engine is required to operate at relatively higher speeds and under greater loads, generating extra heat. What's more, the trailer adds considerably to wind resistance, increasing the pulling requirements.

If You Do Decide To Pull A Trailer

If you do, here are some important points:

- There are many different laws, including speed limit restrictions, having to do with trailering. Make sure your rig will be legal, not only where you live but also where you'll be driving. A good source for this information can be state or provincial police.

- Consider using a sway control. You can ask a hitch dealer about sway controls.
- Don't tow a trailer at all during the first 1,000 miles (1 600 km) your new vehicle is driven. Your engine, axle or other parts could be damaged.
- Then, during the first 500 miles (800 km) that you tow a trailer, don't drive over 50 mph (80 km/h) and don't make starts at full throttle. This helps your engine and other parts of your vehicle wear in at the heavier loads.
- Obey speed limit restrictions when towing a trailer. Don't drive faster than the maximum posted speed for trailers (or no more than 55 mph (90 km/h)) to save wear on your vehicle's parts.

Three important considerations have to do with weight:

- the weight of the trailer,
- the weight of the trailer tongue
- and the total weight on your vehicle's tires.

Weight of the Trailer

How heavy can a trailer safely be?

It should never weigh more than 1,000 pounds (450 kg). But even that can be too heavy.

It depends on how you plan to use your rig. For example, speed, altitude, road grades, outside temperature and how much your vehicle is used to pull a trailer are all important. And, it can also depend on any special equipment that you have on your vehicle.

You can ask your dealer for our trailering information or advice, or you can write us at:

Buick Motor Division
Customer Relations Center
902 E. Hamilton Avenue
Flint, MI 48550

In Canada, write to:

General Motors of Canada Limited
Customer Communication Centre
1908 Colonel Sam Drive
Oshawa, Ontario L1H 8P7

Weight of the Trailer Tongue

The tongue load (A) of any trailer is an important weight to measure because it affects the total capacity weight of your vehicle. The capacity weight includes the curb weight of the vehicle, any cargo you may carry in it, and the people who will be riding in the vehicle. And if you will tow a trailer, you must subtract the tongue load from your vehicle's capacity weight because your vehicle will be carrying that weight, too. See "Loading Your Vehicle" in the Index for more information about your vehicle's maximum load capacity.

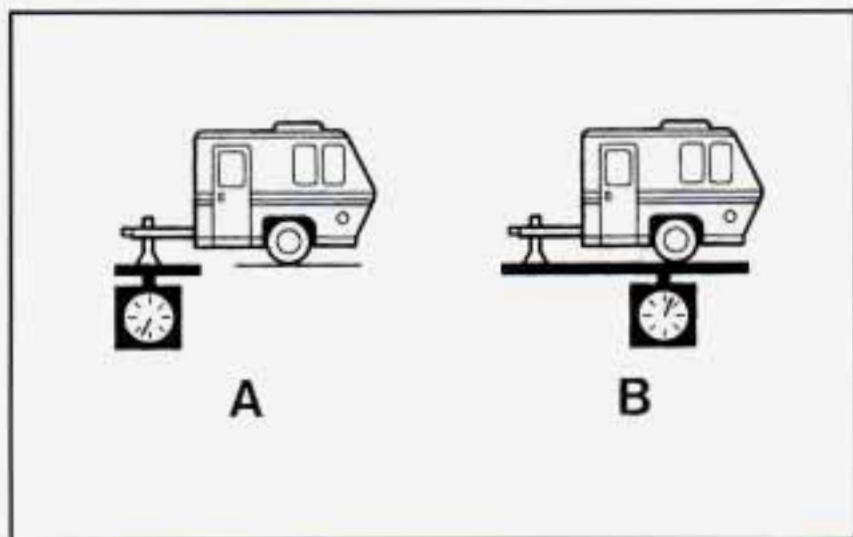

If you're using a weight-carrying hitch, the trailer tongue (A) should weigh 10 percent of the total loaded trailer weight (B). If you have a weight-distributing hitch, the trailer tongue (A) should weigh 12 percent of the total loaded trailer weight (B).

After you've loaded your trailer, weigh the trailer and then the tongue, separately, to see if the weights are proper. If they aren't, you may be able to get them right simply by moving some items around in the trailer.

Total Weight on Your Vehicle's Tires

Be sure your vehicle's tires are inflated to the upper limit for cold tires. You'll find these numbers on the Tire-Loading Information label at the rear edge of the driver's door or see "Loading Your Vehicle" in the Index. Then be sure you don't go over the GVW limit for your vehicle, including the weight of the trailer tongue.

Hitches

It's important to have the correct hitch equipment. Crosswinds, large trucks going by and rough roads are a few reasons why you'll need the right hitch. Here are some rules to follow:

- The bumpers on your vehicle are not intended for hitches. Do not attach rental hitches or other bumper-type hitches to them. Use only a frame-mounted hitch that does not attach to the bumper.
- Will you have to make any holes in the body of your vehicle when you install a trailer hitch? If you do, then be sure to seal the holes later when you remove the hitch. If you don't seal them, deadly carbon monoxide (CO) from your exhaust can get into your vehicle (see "Carbon Monoxide" in the Index). Dirt and water can, too.

Safety Chains

You should always attach chains between your vehicle and your trailer. Cross the safety chains under the tongue of the trailer so that the tongue will not drop to the road if it becomes separated from the hitch. Instructions about safety chains may be provided by the hitch manufacturer or by the trailer manufacturer. Follow the manufacturer's recommendation for attaching safety chains and do not attach them to the bumper. Always leave just enough slack so you can turn with your rig. And, never allow safety chains to drag on the ground.

Trailer Brakes

Does your trailer have its own brakes? Be sure to read and follow the instructions for the trailer brakes so you'll be able to install, adjust and maintain them properly. Because you have anti-lock brakes, do not try to tap into your vehicle's brake system. If you do, both brake systems won't work well, or at all.

Driving with a Trailer

Towing a trailer requires a certain amount of experience. Before setting out for the open road, you'll want to get to know your rig. Acquaint yourself with the feel of handling and braking with the added weight of the trailer. And always keep in mind that the vehicle you are

driving is now a good deal longer and not nearly as responsive as your vehicle is by itself.

Before you start, check the trailer hitch and platform (and attachments), safety chains, electrical connector, lamps, tires and mirror adjustment. If the trailer has electric brakes, start your vehicle and trailer moving and then apply the trailer brake controller by hand to be sure the brakes are working. This lets you check your electrical connection at the same time.

During your trip, check occasionally to be sure that the load is secure, and that the lamps and any trailer brakes are still working.

Following Distance

Stay at least twice as far behind the vehicle ahead as you would when driving your vehicle without a trailer. This can help you avoid situations that require heavy braking and sudden turns.

Passing

You'll need more passing distance up ahead when you're towing a trailer. And, because you're a good deal longer, you'll need to go much farther beyond the passed vehicle before you can return to your lane.

Backing Up

Hold the bottom of the steering wheel with one hand. Then, to move the trailer to the left, just move that hand to the left. To move the trailer to the right, move your hand to the right. Always back up slowly and, if possible, have someone guide you.

Making Turns

NOTICE:

Making very sharp turns while trailering could cause the trailer to come in contact with the vehicle. Your vehicle could be damaged. Avoid making very sharp turns while trailering.

When you're turning with a trailer, make wider turns than normal. Do this so your trailer won't strike soft shoulders, curbs, road signs, trees or other objects. Avoid jerky or sudden maneuvers. Signal well in advance.

Turn Signals When Towing a Trailer

The green arrows on your instrument panel will flash whenever you signal a turn or lane change. Properly hooked up, the trailer lamps will also flash, telling other drivers you're about to turn, change lanes or stop.

When towing a trailer, the green arrows on your instrument panel will flash for turns even if the bulbs on the trailer are burned out. Thus, you may think drivers behind you are seeing your signal when they are not. It's important to check occasionally to be sure the trailer bulbs are still working.

Your vehicle has bulb warning lights. When you plug a trailer lighting system into your vehicle's lighting system, its bulb warning lights may not let you know if one of your lamps goes out. So, when you have a trailer lighting system plugged in, be sure to check your vehicle and trailer lamps from time to time to be sure they're all working. Once you disconnect the trailer lamps, the bulb warning lights again can tell you if one of your vehicle lamps is out.

Driving On Grades

Reduce speed and shift to a lower gear *before* you start down a long or steep downgrade. If you don't shift down, you might have to use your brakes so much that they would get hot and no longer work well.

On a long uphill grade, use the highest gear possible. If you cannot maintain posted speeds, driving at a lower speed may help avoid overheating your engine and transaxle.

Parking on Hills

You really should not park your vehicle, with a trailer attached, on a hill. If something goes wrong, your rig could start to move. People can be injured, and both your vehicle and the trailer can be damaged.

But if you ever have to park your rig on a hill, here's how to do it:

1. Apply your regular brakes, but don't shift into PARK (P) yet.
2. Have someone place chocks under the trailer wheels.
3. When the wheel chocks are in place, release the regular brake until the chocks absorb the load.
4. Reapply the regular brakes. Then apply your parking brake, and then shift to PARK (P).
5. Release the regular brakes.

When You Are Ready to Leave After Parking on a Hill

1. Apply your regular brakes and hold the pedal down while you:
 - Start your engine;
 - Shift into a gear; and
 - Release the parking brake.
2. Let up on the brake pedal.
3. Drive slowly until the trailer is clear of the chocks.
4. Stop and have someone pick up and store the chocks.

Maintenance When Trailer Towing

Your vehicle will need service more often when you're pulling a trailer. See the Maintenance Schedule for more on this. Things that are especially important in trailer operation are automatic transaxle fluid (don't overfill), engine oil, belts, cooling system and brake adjustment. Each of these is covered in this manual, and the Index will help you find them quickly. If you're trailering, it's a good idea to review these sections before you start your trip.

Check periodically to see that all hitch nuts and bolts are tight.



Section 5 Problems on the Road

Here you'll find what to do about some problems that can occur on the road.

5-2 Hazard Warning Flashers
5-3 Other Warning Devices
5-3 Jump Starting
5-8 Towing Your Vehicle
5-14 Engine Overheating

5-24 If a Tire Goes Flat
5-24 Changing a Flat Tire
5-34 Compact Spare Tire
5-35 If You're Stuck: In Sand, Mud,
Ice or Snow

Hazard Warning Flashers

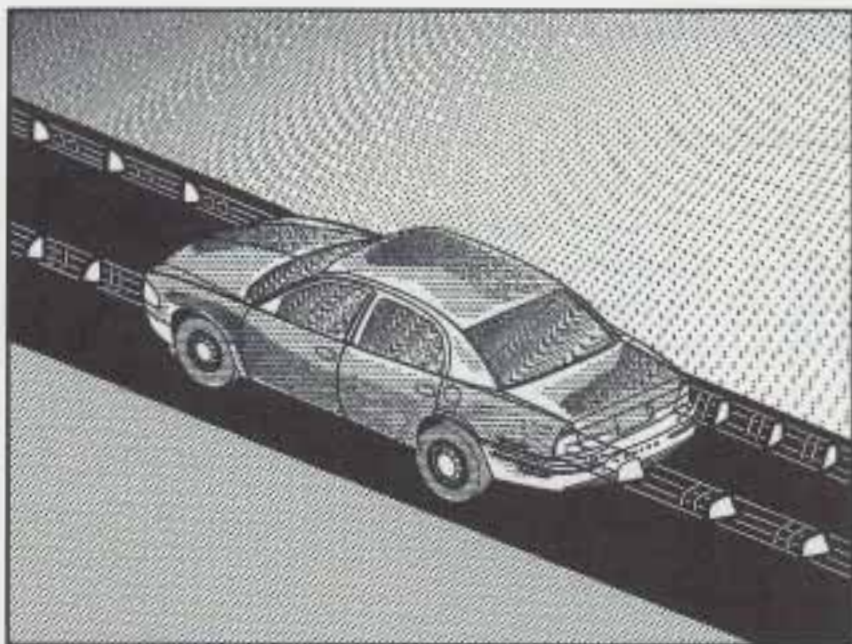

Your hazard warning flashers let you warn others. They also let police know you have a problem. Your front and rear turn signal lamps will flash on and off.



Press down on the button located on top of the steering column to make your front and rear turn signal lamps flash on and off.



The hazard light on the instrument panel will also come on.

Your hazard warning flashers work no matter what position your key is in, and even if the key isn't in.

To turn off the flashers, press down on the button again. When the hazard warning flashers are on, your turn signals won't work.

Other Warning Devices

If you carry reflective triangles, you can set one up at the side of the road about 300 feet (100 m) behind your vehicle.

Jump Starting

If your battery has run down, you may want to use another vehicle and some jumper cables to start your Buick. But please use the following steps to do it safely.

NOTICE:

Ignoring these steps could result in costly damage to your vehicle that wouldn't be covered by your warranty.

Trying to start your Buick by pushing or pulling it won't work, and it could damage your vehicle.



CAUTION:

Batteries can hurt you. They can be dangerous because:

- They contain acid that can burn you.
- They contain gas that can explode or ignite.
- They contain enough electricity to burn you.

If you don't follow these steps exactly, some or all of these things can hurt you.

1. Check the other vehicle. It must have a 12-volt battery with a negative ground system.

NOTICE:

If the other system isn't a 12-volt system with a negative ground, both vehicles can be damaged.

2. Get the vehicles close enough so the jumper cables can reach, but be sure the vehicles aren't touching each other. If they are, it could cause a ground connection you don't want. You wouldn't be able to start your Buick, and the bad grounding could damage the electrical systems.

To avoid the possibility of the vehicles rolling, set the parking brake firmly on both vehicles involved in the jump start procedure. Put an automatic transaxle in PARK (P) before setting the parking brake.

 **CAUTION:**

An electric fan can start up even when the engine is not running and can injure you. Keep hands, clothing and tools away from any underhood electric fan.

3. Turn off the ignition on both vehicles. Unplug unnecessary accessories plugged into the cigarette lighter or accessory power outlet. Turn off all lamps that aren't needed as well as radios. This will avoid sparks and help save both batteries. In addition, it could save your radio.

NOTICE:

If you leave your radio on, it could be badly damaged. The repairs wouldn't be covered by your warranty.

4. Open the hoods and locate the batteries. Find the positive (+) and negative (-) terminals on each battery. Your Riviera has a remote positive (+) terminal for this purpose. (The battery is under the back seat.)

 **CAUTION:**

Using a match near a battery can cause battery gas to explode. People have been hurt doing this, and some have been blinded. Use a flashlight if you need more light.

Be sure the battery has enough water. You don't need to add water to the Delco Freedom[®] battery installed in every new GM vehicle. But if a battery has filler caps, be sure the right amount of fluid is there. If it is low, add water to take care of that first. If you don't, explosive gas could be present.

Battery fluid contains acid that can burn you. Don't get it on you. If you accidentally get it in your eyes or on your skin, flush the place with water and get medical help immediately.

5. Check that the jumper cables don't have loose or missing insulation. If they do, you could get a shock. The vehicles could be damaged too.

Before you connect the cables, here are some basic things you should know. Positive (+) will go to positive (+) and negative (-) will go to negative (-) or a metal engine part. Don't connect positive (+) to negative (-) or you'll get a short that would damage the battery and maybe other parts too.

 **CAUTION:**

Fans or other moving engine parts can injure you badly. Keep your hands away from moving parts once the engines are running.



6. Connect the red positive (+) cable to the remote positive (+) terminal of the vehicle with the dead battery.



7. Don't let the other end touch metal. Connect it to the positive (+) terminal of the good battery. Use a remote positive (+) terminal if the vehicle has one.



8. Now connect the black negative (-) cable to the good battery's negative (-) terminal.

Don't let the other end touch anything until the next step. The other end of the negative cable *doesn't* go to the dead battery.

It goes to a heavy unpainted metal part on the engine of the vehicle with the dead battery.



9. Attach the cable at least 18 inches (45 cm) away from the dead battery, but not near engine parts that move. The electrical connection is just as good there, but the chance of sparks getting back to the battery is much less.
10. Now start the vehicle with the good battery and run the engine for a while.
11. Try to start the vehicle with the dead battery. If it won't start after a few tries, it probably needs service.

12. Remove the cables in reverse order to prevent electrical shorting. Take care that they don't touch each other or any other metal.

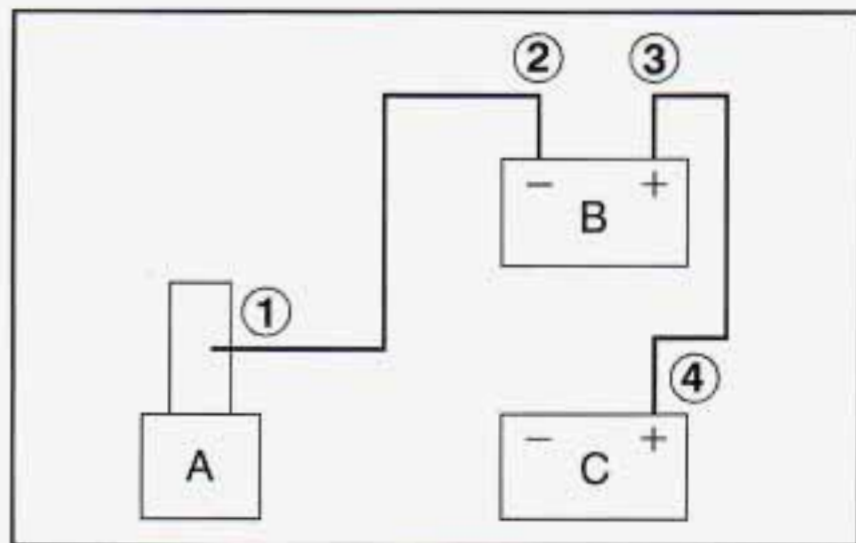

- A. Heavy Metal Engine Part
B. Good Battery
C. Dead Battery

Towing Your Vehicle

Try to have a Buick dealer or a professional towing service tow your Riviera. See "Roadside Assistance" in the Index.

If your vehicle has been changed or modified since it was factory-new by adding aftermarket items like fog lamps, aero-skirting, or special tires and wheels, these instructions and illustrations may not be correct.

Before you do anything, turn on the hazard warning flashers.

When you call, tell the towing service:

- That your vehicle cannot be towed from the front with sling-type equipment.
- That your vehicle has front-wheel drive.
- The make, model and year of your vehicle.
- Whether you can still move the shift lever.
- If there was an accident, what was damaged.

When the towing service arrives, let the tow operator know that this manual contains detailed towing instructions and illustrations. The operator may want to see them.



⚠ CAUTION:

To help avoid injury to you or others:

- Never let passengers ride in a vehicle that is being towed.
- Never tow faster than safe or posted speeds.
- Never tow with damaged parts not fully secured.
- Never get under your vehicle after it has been lifted by the tow truck.
- Always secure the vehicle on each side with separate safety chains when towing it.
- Never use J-hooks. Use T-hooks instead.

⚠ CAUTION:

A vehicle can fall from a car carrier if it isn't adequately secured. This can cause a collision, serious personal injury and vehicle damage. The vehicle should be tightly secured with chains or steel cables before it is transported.

Don't use substitutes (ropes, leather straps, canvas webbing, etc.) that can be cut by sharp edges underneath the towed vehicle. Always use T-hooks inserted in the T-hook slots. Never use J-hooks. They will damage drivetrain and suspension components.

When your vehicle is being towed, have the ignition key turned to OFF. The steering wheel should be clamped in a straight-ahead position, with a clamping device designed for towing service. Do not use the vehicle's steering column lock for this. The transaxle should be in NEUTRAL (N) and the parking brake released.

Don't have your vehicle towed on the drive wheels, unless you must. If the vehicle must be towed on the drive wheels, be sure to follow the speed and distance restrictions later in this section or your transaxle will be damaged. If these limits must be exceeded, then the drive wheels have to be supported on a dolly.

Front Towing

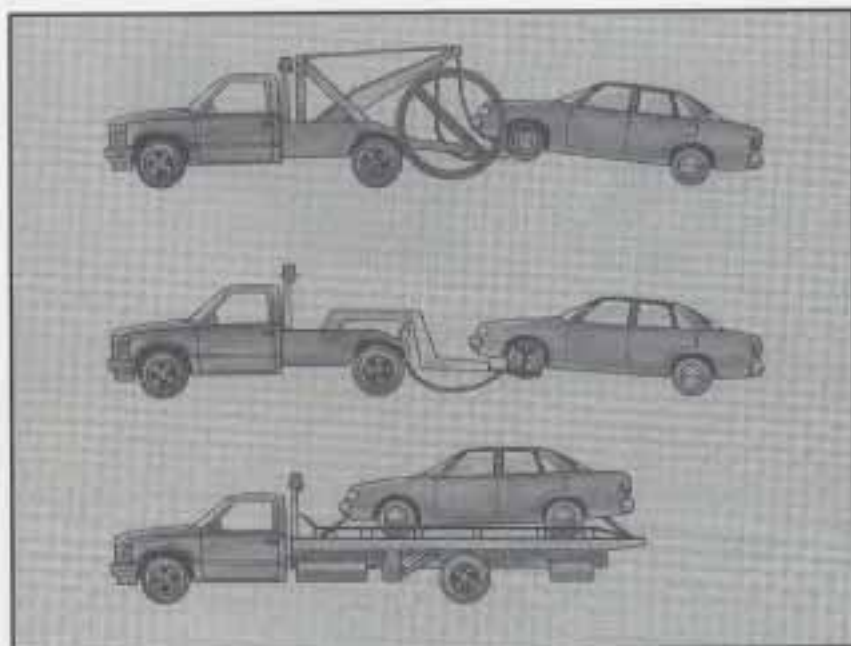

NOTICE:

Do not tow with sling-type equipment or fascia/fog lamp damage will occur. Use wheel-lift or car-carrier equipment. Additional ramping may be required for car-carrier equipment. Use safety chains and wheel straps.

Towing a vehicle over rough surfaces could damage a vehicle. Damage can occur from vehicle to ground or vehicle to wheel-lift equipment. To help avoid damage, install a towing dolly and raise the vehicle until adequate clearance is obtained between the ground and/or wheel-lift equipment.

Do not attach winch cables or J-hooks to suspension components when using car-carrier equipment. Always use T-hooks inserted in the T-hook slots.

These slots are to be used when loading and securing to car-carrier equipment.

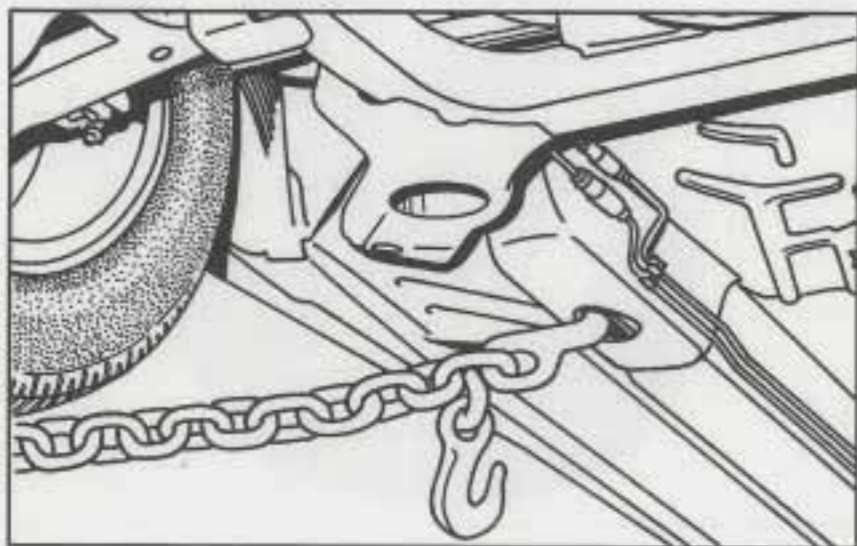

Attach T-hook chains on both sides, in the slotted holes in the bottom of the body rail, behind the front wheels and cradle.

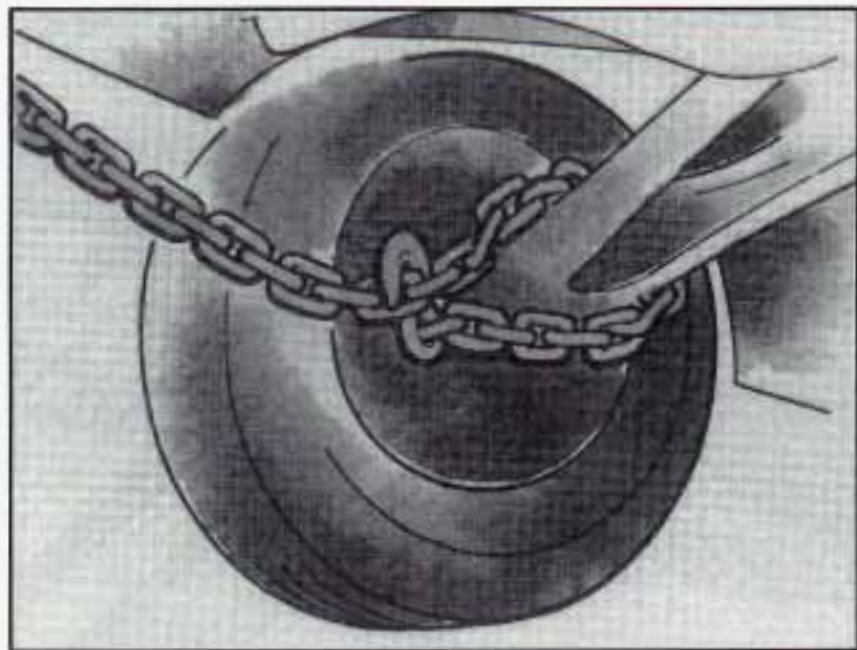

Attach a separate safety chain around the outboard end of each lower control arm.

NOTICE:

Be sure not to attach the safety chain to the drive axle. This could cause damage to the drive axle boot.

Rear Towing

Tow Limits -- 55 mph (88 km/h), 500 miles (800 km)

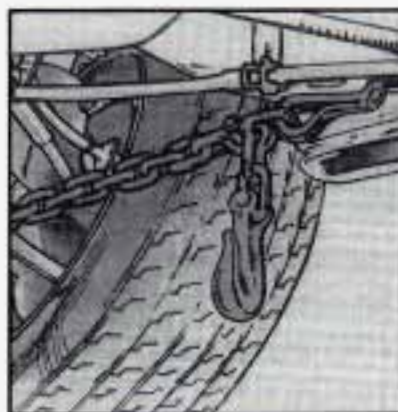

Attach T-hook chains to the T-hook slots in the bottom of the floor pan just ahead of the rear wheels on both sides.

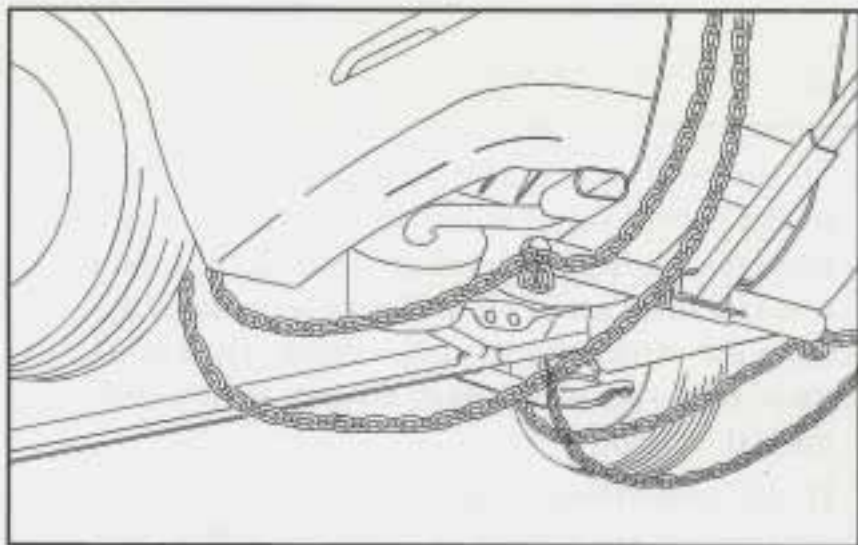

Position the lower-sling crossbar directly under the fascia.

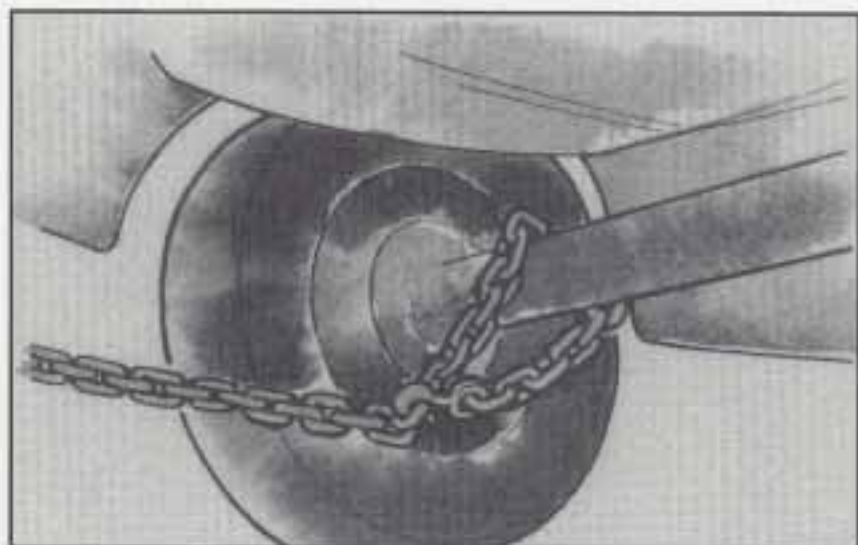

Attach a separate safety chain around the outboard end of each lower control arm.

Engine Overheating

You will find a coolant temperature gage and the warning light about a hot engine on your instrument panel.

If Steam Is Coming From Your Engine



CAUTION:

Steam from an overheated engine can burn you badly, even if you just open the hood. Stay away from the engine if you see or hear steam coming from it. Just turn it off and get everyone away from the vehicle until it cools down. Wait until there is no sign of steam or coolant before you open the hood.

If you keep driving when your engine is overheated, the liquids in it can catch fire. You or others could be badly burned. Stop your engine if it overheats, and get out of the vehicle until the engine is cool.

NOTICE:

If your engine catches fire because you keep driving with no coolant, your vehicle can be badly damaged. The costly repairs would not be covered by your warranty.

If No Steam Is Coming From Your Engine

If you get the overheat warning but see or hear no steam, the problem may not be too serious. Sometimes the engine can get a little too hot when you:

- Climb a long hill on a hot day.
- Stop after high-speed driving.
- Idle for long periods in traffic.
- Tow a trailer.

If you get the overheat warning with no sign of steam, try this for a minute or so:

1. Turn off your air conditioner.
2. Turn on your heater to full hot at the highest fan speed and open the window as necessary.
3. If you're in a traffic jam, shift to NEUTRAL (N); otherwise, shift to the highest gear while driving -- AUTOMATIC OVERDRIVE (Ⓢ) or THIRD (3).

If you no longer have the overheat warning, you can drive. Just to be safe, drive slower for about 10 minutes. If the warning doesn't come back on, you can drive normally.

If the warning continues, pull over, stop, and park your vehicle right away.

If there's still no sign of steam, you can idle the engine for two or three minutes while you're parked, to see if the warning stops. But then, if you still have the warning, *turn off the engine and get everyone out of the vehicle* until it cools down.

You may decide not to lift the hood but to get service help right away.

When you decide it's safe to lift the hood, here's what you'll see:



- A. Radiator Pressure Cap
- B. Two Electric Engine Cooling Fans
- C. Coolant Recovery Tank



CAUTION:

An electric fan under the hood can start up even when the engine is not running and can injure you. Keep hands, clothing and tools away from any underhood electric fan.

If the coolant inside the coolant recovery tank is boiling, don't do anything else until it cools down.

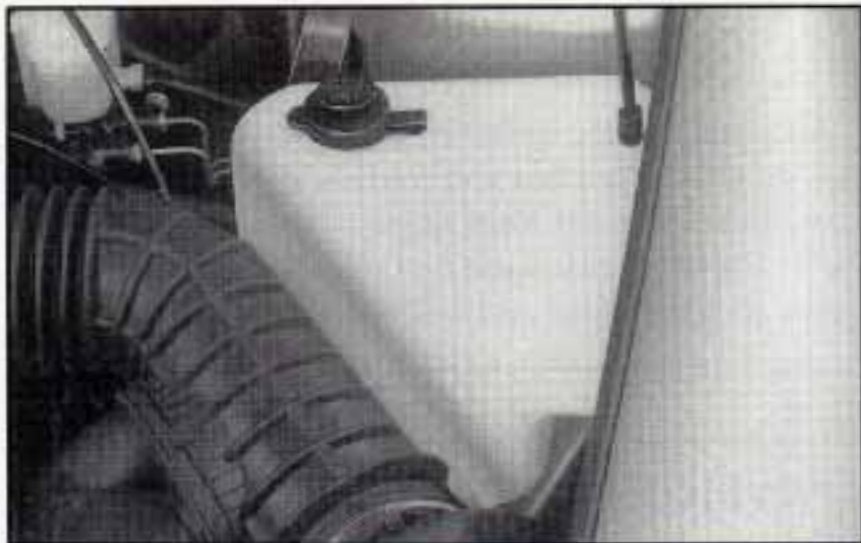

The coolant level should be at or above FULL COLD.

If it isn't, you may have a leak in the radiator hoses, heater hoses, radiator, water pump or somewhere else in the cooling system.

CAUTION:

Heater and radiator hoses, and other engine parts, can be very hot. Don't touch them. If you do, you can be burned.

Don't run the engine if there is a leak. If you run the engine, it could lose all coolant. That could cause an engine fire, and you could be burned. Get any leak fixed before you drive the vehicle.

NOTICE:

Engine damage from running your engine without coolant isn't covered by your warranty.

If there seems to be no leak, with the engine on, check to see if the electric engine fans are running. If the engine is overheating, both fans should be running. If they aren't, your vehicle needs service.

How to Add Coolant to the Coolant Recovery Tank

If you haven't found a problem yet, but the coolant level isn't at FULL COLD, add a 50/50 mixture of *clean water* (preferably distilled) and DEX-COOL[®] (silicate-free) antifreeze at the coolant recovery tank. (See "Engine Coolant" in the Index for more information.)



CAUTION:

Adding only plain water to your cooling system can be dangerous. Plain water, or some other liquid like alcohol, can boil before the proper coolant mix will. Your vehicle's coolant warning system is set for the proper coolant mix.

CAUTION: (Continued)

CAUTION: (Continued)

With plain water or the wrong mix, your engine could get too hot but you wouldn't get the overheat warning. Your engine could catch fire and you or others could be burned. Use a 50/50 mix of clean water and DEX-COOL[®] coolant.

NOTICE:

In cold weather, water can freeze and crack the engine, radiator, heater core and other parts. Use the recommended coolant and the proper coolant mix.



⚠ CAUTION:

You can be burned if you spill coolant on hot engine parts. Coolant contains ethylene glycol and it will burn if the engine parts are hot enough. Don't spill coolant on a hot engine.

When the coolant in the coolant recovery tank is at FULL COLD, start your vehicle.

If the overheat warning continues, there's one more thing you can try. You can add the proper coolant mix directly to the radiator but be sure the cooling system is cool before you do it.

⚠ CAUTION:

Steam and scalding liquids from a hot cooling system can blow out and burn you badly. They are under pressure, and if you turn the radiator pressure cap -- even a little -- they can come out at high speed. Never turn the cap when the cooling system, including the radiator pressure cap, is hot. Wait for the cooling system and radiator pressure cap to cool if you ever have to turn the pressure cap.



How to Add Coolant to the Radiator



1. You can remove the radiator pressure cap when the cooling system, including the radiator pressure cap and upper radiator hose, is no longer hot.



2. Then keep turning the pressure cap, but now push down as you turn it. Remove the pressure cap.

Turn the pressure cap slowly counterclockwise until it first stops. (Don't press down while turning the pressure cap.)

If you hear a hiss, wait for that to stop. A hiss means there is still some pressure left.



3. Fill the radiator with the proper DEX-COOL[®] coolant mixture, up to the base of the filler neck.



4. Then fill the coolant recovery tank to FULL COLD.
5. Put the cap back on the coolant recovery tank, but leave the radiator pressure cap off.



6. Start the engine and let it run until you can feel the upper radiator hose getting hot. Watch out for the engine fans.
7. By this time, the coolant level inside the radiator filler neck may be lower. If the level is lower, add more of the proper DEX-COOL[®] coolant mixture through the filler neck until the level reaches the base of the filler neck.

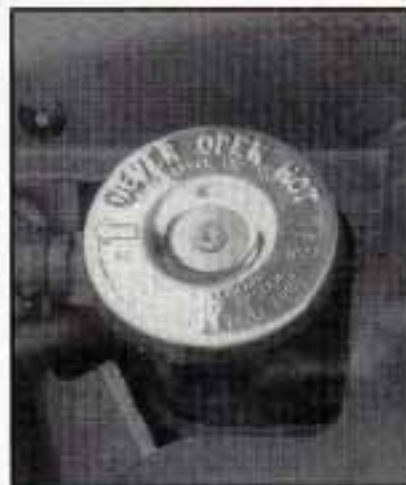

8. Then replace the pressure cap. At any time during this procedure if coolant begins to flow out of the filler neck, reinstall the pressure cap. Be sure the arrows on the pressure cap line up like this.

If a Tire Goes Flat

It's unusual for a tire to "blow out" while you're driving, especially if you maintain your tires properly. If air goes out of a tire, it's much more likely to leak out slowly. But if you should ever have a "blowout," here are a few tips about what to expect and what to do:

If a front tire fails, the flat tire will create a drag that pulls the vehicle toward that side. Take your foot off the accelerator pedal and grip the steering wheel firmly. Steer to maintain lane position, and then gently brake to a stop well out of the traffic lane.

A rear blowout, particularly on a curve, acts much like a skid and may require the same correction you'd use in a skid. In any rear blowout, remove your foot from the accelerator pedal. Get the vehicle under control by steering the way you want the vehicle to go. It may be very bumpy and noisy, but you can still steer. Gently brake to a stop -- well off the road if possible.

If a tire goes flat, the next part shows how to use your jacking equipment to change a flat tire safely.

Changing a Flat Tire

If a tire goes flat, avoid further tire and wheel damage by driving slowly to a level place. Turn on your hazard warning flashers.



CAUTION:

Changing a tire can cause an injury. The vehicle can slip off the jack and roll over you or other people. You and they could be badly injured. Find a level place to change your tire. To help prevent the vehicle from moving:

- 1. Set the parking brake firmly.**
- 2. Put the shift lever in PARK (P).**
- 3. Turn off the engine.**

To be even more certain the vehicle won't move, you can put blocks at the front and rear of the tire farthest away from the one being changed. That would be the tire on the other side of the vehicle, at the opposite end.

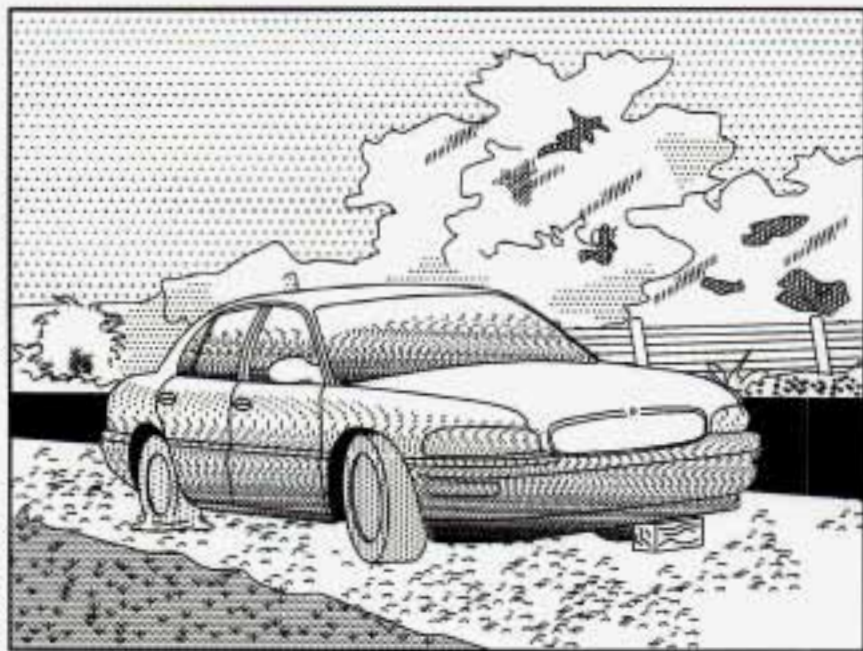

The following steps will tell you how to use the jack and change a tire.

Removing the Spare Tire and Tools



The equipment you'll need is in the trunk.

Instructions for changing your tires are on the inside of the tire cover. You can rest the cover near you for easy reference while you change the tire.

Lift and remove the spare tire cover for access to the spare tire and jack.

Remove the wheel wrench and jack from the jack container. Turn the spare tire retainer bolt counterclockwise and remove the retainer assembly.

Remove the spare tire from the trunk.

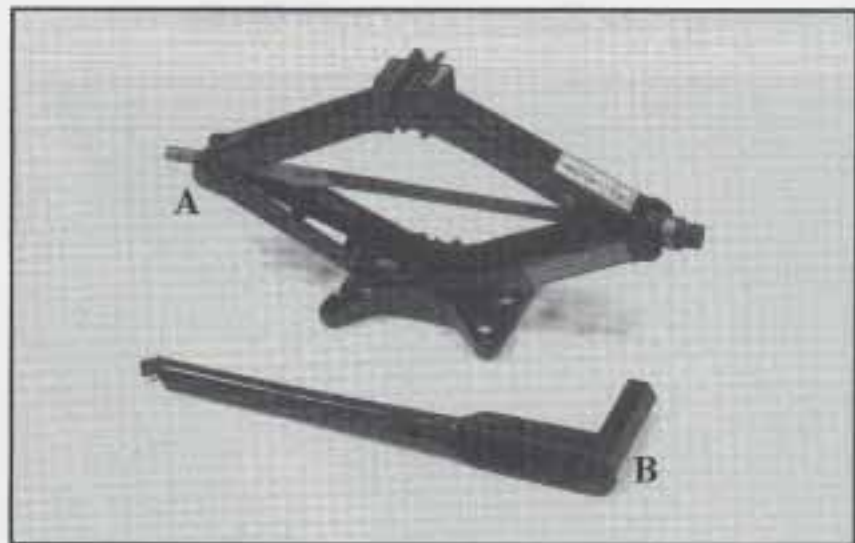

The tools you'll be using include the jack (A) and wheel wrench (B).



Your Buick has a wheel cover which must be taken off to reach the wheel nuts. Insert the flat end of the wrench into the notch in the center cover. Pry carefully, so the center cover is not scratched.

Removing the Flat Tire and Installing the Spare Tire



1. Position the wheel wrench securely over the wheel nuts to loosen, but don't remove them yet.
2. Attach the wheel wrench to the bolt on the end of the jack to create a jack handle.

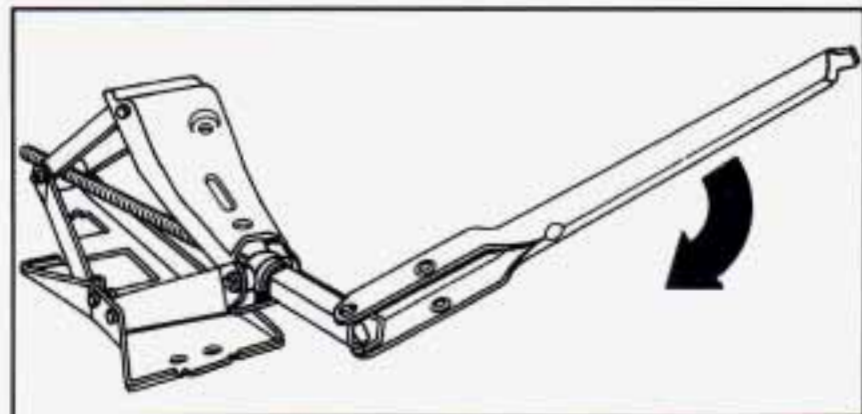

3. Rotate the wheel wrench clockwise to raise the jack lift head a few inches.

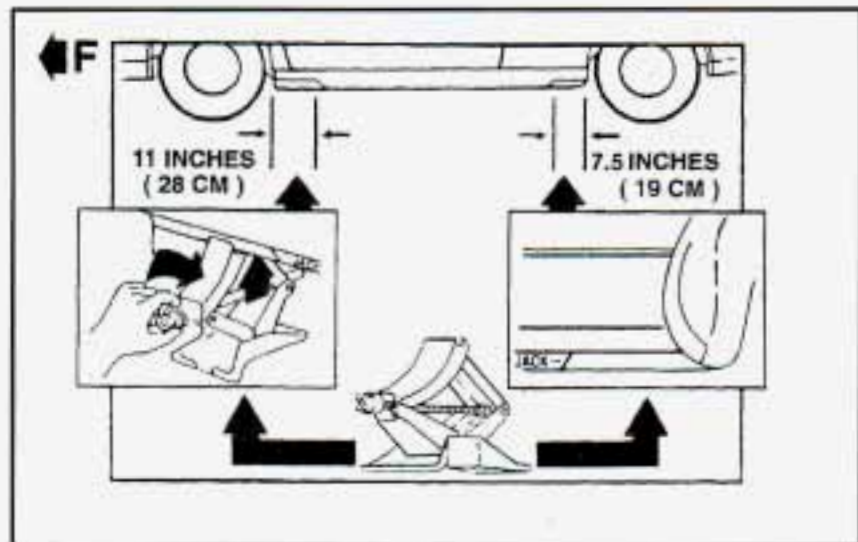

4. Near each wheel well is a notch in the frame to position the jack head. You'll find the word **JACK** and an arrow stamped into the plastic near each notch. Position the jack under the vehicle and raise the jack head until it fits firmly against the sheet metal next to the word **JACK**. Do not raise the vehicle yet. Put the compact spare near you.

⚠ CAUTION:

Getting under a vehicle when it is jacked up is dangerous. If the vehicle slips off the jack, you could be badly injured or killed. Never get under a vehicle when it is supported only by a jack.

⚠ CAUTION:

Raising your vehicle with the jack improperly positioned can damage the vehicle and even make the vehicle fall. To help avoid personal injury and vehicle damage, be sure to fit the jack lift head into the proper location before raising the vehicle.

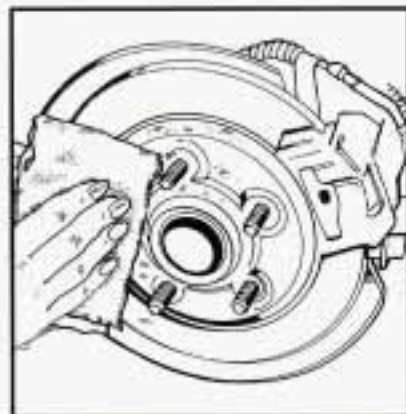

7. Remove any rust or dirt from the wheel bolts, mounting surfaces and spare wheel.

5. Raise the vehicle by rotating the wheel wrench clockwise. Raise the vehicle far enough off the ground so there is enough room for the spare tire to fit.
6. Remove all the wheel nuts and take off the flat tire.

⚠ CAUTION:

Rust or dirt on the wheel, or on the parts to which it is fastened, can make the wheel nuts become loose after a time. The wheel could come off and cause an accident. When you change a wheel, remove any rust or dirt from the places where the wheel attaches to the vehicle. In an emergency, you can use a cloth or a paper towel to do this; but be sure to use a scraper or wire brush later, if you need to, to get all the rust or dirt off.

⚠ CAUTION:

Never use oil or grease on studs or nuts. If you do, the nuts might come loose. Your wheel could fall off, causing a serious accident.



8. Place the spare on the wheel-mounting surface.



9. Replace the wheel nuts with the rounded end of the nuts toward the wheel. Tighten each nut by hand until the wheel is held against the hub.

If a nut cannot be tightened by hand, use the wrench and see your dealer right away.



10. Lower the vehicle by rotating the wheel wrench counterclockwise. Lower the jack completely.

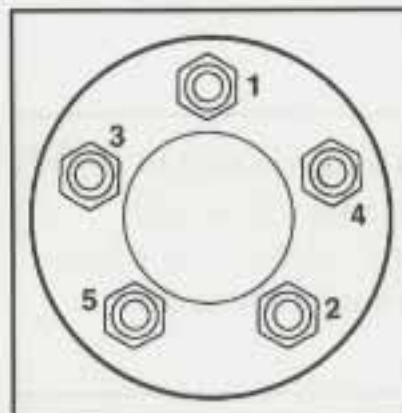

11. Using the wheel wrench, tighten the wheel nuts firmly in a crisscross sequence as shown.



CAUTION:

Incorrect wheel nuts or improperly tightened wheel nuts can cause the wheel to become loose and even come off. This could lead to an accident. Be sure to use the correct wheel nuts. If you have to replace them, be sure to get new GM original equipment wheel nuts.

Stop somewhere as soon as you can and have the nuts tightened with a torque wrench to 100 lb-ft (140 N·m).

NOTICE:

Improperly tightened wheel nuts can lead to brake pulsation and rotor damage. To avoid expensive brake repairs, evenly tighten the wheel nuts in the proper sequence and to the proper torque specification.

12. Then replace the wheel cover. Be sure to position the alignment pin on the cover with the notch in the wheel. Apply pressure around the edge of the cap to snap it in place.

NOTICE:

Wheel covers won't fit on your compact spare. If you try to put a wheel cover on your compact spare, you could damage the cover or the spare.

Don't try to put a wheel cover on your compact spare tire. It won't fit. Store the wheel cover in the trunk until you have the flat tire repaired or replaced.

Storing the Flat Tire and Tools



CAUTION:

Storing a jack, a tire or other equipment in the passenger compartment of the vehicle could cause injury. In a sudden stop or collision, loose equipment could strike someone. Store all these in the proper place.

Store the flat tire as far forward in the trunk as possible. Store the jack and wheel wrench in their compartment in the trunk. For storage, the jack must be raised until the screw end is flush with the edge of the jack.

Storing the Spare Tire and Tools

CAUTION:

Storing a jack, a tire or other equipment in the passenger compartment of the vehicle could cause injury. In a sudden stop or collision, loose equipment could strike someone. Store all these in the proper place.

The compact spare is for temporary use only. Replace the compact spare tire with a full size tire as soon as you can. See "Compact Spare Tire" in the Index. See the storage instructions label to replace your compact spare into your trunk properly.

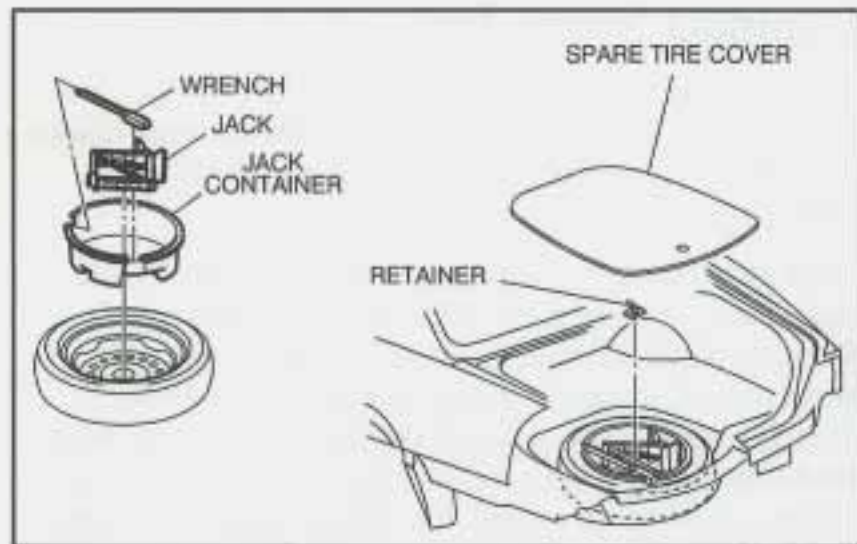

Compact Spare Tire

Although the compact spare tire was fully inflated when your vehicle was new, it can lose air after a time. Check the inflation pressure regularly. It should be 60 psi (420 kPa).

After installing the compact spare on your vehicle, you should stop as soon as possible and make sure your spare tire is correctly inflated. The compact spare is made to perform well at speeds up to 65 mph (105 km/h) for distances up to 3,000 miles (5 000 km), so you can finish your trip and have your full-size tire repaired or replaced where you want. Of course, it's best to replace your spare with a full-size tire as soon as you can. Your spare will last longer and be in good shape in case you need it again.

NOTICE:

When the compact spare is installed, don't take your vehicle through an automatic car wash with guide rails. The compact spare can get caught on the rails. That can damage the tire and wheel, and maybe other parts of your vehicle.

Don't use your compact spare on other vehicles.

And don't mix your compact spare tire or wheel with other wheels or tires. They won't fit. Keep your spare tire and its wheel together.

NOTICE:

Tire chains won't fit your compact spare. Using them can damage your vehicle and can damage the chains too. Don't use tire chains on your compact spare.

If You're Stuck: In Sand, Mud, Ice or Snow

What you don't want to do when your vehicle is stuck is to spin your wheels too fast. The method known as "rocking" can help you get out when you're stuck, but you must use caution.



CAUTION:

If you let your tires spin at high speed, they can explode, and you or others could be injured. And, the transaxle or other parts of the vehicle can overheat. That could cause an engine compartment fire or other damage. When you're stuck, spin the wheels as little as possible. Don't spin the wheels above 35 mph (55 km/h) as shown on the speedometer.

NOTICE:

Spinning your wheels can destroy parts of your vehicle as well as the tires. If you spin the wheels too fast while shifting your transaxle back and forth, you can destroy your transaxle.

For information about using tire chains on your vehicle, see "Tire Chains" in the Index.

Rocking Your Vehicle To Get It Out

First, turn your steering wheel left and right. That will clear the area around your front wheels. If your vehicle has traction control, you should turn the system off. (See "Traction Control System" in the Index.) Then shift back and forth between REVERSE (R) and a forward gear, spinning the wheels as little as possible. Release the accelerator pedal while you shift, and press lightly on the accelerator pedal when the transaxle is in gear. If that doesn't get you out after a few tries, you may need to be towed out. If you do need to be towed out, see "Towing Your Vehicle" in the Index.



Section 6 Service and Appearance Care

Here you will find information about the care of your Buick. This section begins with service and fuel information, and then it shows how to check important fluid and lubricant levels. There is also technical information about your vehicle, and a part devoted to its appearance care.

6-2	Service	6-51	Appearance Care
6-3	Fuel	6-51	Cleaning the Inside of Your Buick
6-8	Checking Things Under the Hood	6-55	Cleaning the Outside of Your Buick
6-11	Engine Oil	6-58	Underbody Maintenance
6-16	Air Cleaner	6-58	Chemical Paint Spotting
6-17	Supercharger Oil	6-59	Appearance Care Materials Chart
6-18	Automatic Transaxle Fluid	6-60	Vehicle Identification Number (VIN)
6-21	Engine Coolant	6-61	Electrical System
6-25	Radiator Pressure Cap	6-67	Removing the Rear Seat Cushion
6-26	Windshield Washer Fluid	6-69	Replacement Bulbs
6-28	Brakes	6-70	Capacities and Specifications
6-31	Battery	6-72	Air Conditioning Refrigerants
6-33	Bulb Replacement	6-72	Engine Specifications
6-36	Headlamp Aiming	6-72	Normal Maintenance Replacement Parts
6-43	Tires	6-72	Vehicle Dimensions

Service

Your Buick dealer knows your vehicle best and wants you to be happy with it. We hope you'll go to your dealer for all your service needs. You'll get genuine GM parts and GM-trained and supported service people.

We hope you'll want to keep your GM vehicle all GM. Genuine GM parts have one of these marks:



Doing Your Own Service Work

If you want to do some of your own service work, you'll want to get the proper Buick Service Manual. It tells you much more about how to service your Buick than this manual can. To order the proper service manual, see "Service and Owner Publications" in the Index.

Your vehicle has an air bag system. Before attempting to do your own service work, see "Servicing Your Air Bag-Equipped Buick" in the Index.

You should keep a record with all parts receipts and list the mileage and the date of any service work you perform. See "Maintenance Record" in the Index.

 **CAUTION:**

You can be injured and your vehicle could be damaged if you try to do service work on a vehicle without knowing enough about it.

- **Be sure you have sufficient knowledge, experience, the proper replacement parts and tools before you attempt any vehicle maintenance task.**
- **Be sure to use the proper nuts, bolts and other fasteners. “English” and “metric” fasteners can be easily confused. If you use the wrong fasteners, parts can later break or fall off. You could be hurt.**

Adding Equipment to the Outside of Your Vehicle

Things you might add to the outside of your vehicle can affect the airflow around it. This may cause wind noise and affect windshield washer performance. Check with your Buick dealer before adding equipment to the outside of your vehicle.

Fuel

The 8th digit of your vehicle identification number (VIN) shows the code letter for your engine. You will find the VIN at the top left of your instrument panel. (See “Vehicle Identification Number” in the Index.)

If you have the 3800 engine (VIN Code K), use regular unleaded gasoline rated at 87 octane or higher. If you're using fuel rated at the recommended octane or higher and you still hear heavy knocking, your engine needs service. But don't worry if you hear a little pinging noise when you're accelerating or driving up a hill. That's normal, and you don't have to buy a higher octane fuel to get rid of pinging. It's the heavy, constant knock that means you have a problem.

If you have the 3800 Supercharged engine (VIN Code 1), use premium unleaded gasoline rated at 91 octane or higher. With the 3800 Supercharged engine, in an emergency, you may be able to use a lower octane -- as low as 87 -- if heavy knocking does not occur. If you are using 91 or higher octane unleaded gasoline and you hear heavy knocking, your engine needs service.

At a minimum, the gasoline you use should meet specifications ASTM D4814 in the United States and CGSB 3.5-M93 in Canada. Improved gasoline specifications have been developed by the American Automobile Manufacturers Association (AAMA) for better vehicle performance and engine protection. Gasolines meeting the AAMA specification could provide improved driveability and emission control system protection compared to other gasolines.

Be sure the posted octane for premium is at least 91 (at least 89 for middle grade and 87 for regular). If the octane is less than 87, you may get a heavy knocking noise when you drive. If it's bad enough, it can damage your engine.

If your vehicle is certified to meet California Emission Standards (indicated on the underhood tune-up label), it is designed to operate on fuels that meet California specifications. If such fuels are not available in states adopting California emissions standards, your vehicle will operate satisfactorily on fuels meeting federal specifications, but emission control system performance may be affected. The malfunction indicator lamp on your instrument panel may turn on and/or your vehicle may fail a smog-check test. If this occurs, return to your authorized Buick dealer for diagnosis to determine the cause of failure. In the event it is determined that the cause of the condition is the type of fuels used, repairs may not be covered by your warranty.

Some gasolines that are not reformulated for low emissions contain an octane-enhancing additive called methylcyclopentadienyl manganese tricarbonyl (MMT); ask your service station operator whether or not his fuel contains MMT. General Motors does not recommend the use of such gasolines. If fuels containing MMT are used, spark plug life may be reduced and your emission control system performance may be affected. The malfunction indicator lamp on your instrument panel may turn on. If this occurs, return to your authorized Buick dealer for service.

To provide cleaner air, all gasolines in the United States are now required to contain additives that will help prevent deposits from forming in your engine and fuel system, allowing your emission control system to function properly. Therefore, you should not have to add anything to the fuel. In addition, gasolines containing oxygenates, such as ethers and ethanol, and reformulated gasolines may be available in your area to help clean the air. General Motors recommends that you use these gasolines if they comply with the specifications described earlier.

NOTICE:

Your vehicle was not designed for fuel that contains methanol. Don't use it. It can corrode metal parts in your fuel system and also damage plastic and rubber parts. That damage wouldn't be covered under your warranty.

Fuels in Foreign Countries

If you plan on driving in another country outside the United States or Canada, the proper fuel may be hard to find. Never use leaded gasoline or any other fuel not recommended in the previous text on fuel. Costly repairs caused by use of improper fuel wouldn't be covered by your warranty.

To check on fuel availability, ask an auto club, or contact a major oil company that does business in the country where you'll be driving.

You can also write us at the following address for advice. Just tell us where you're going and give your Vehicle Identification Number (VIN).

General Motors International Product Center
1908 Colonel Sam Drive
Oshawa, Ontario L1H 8P7

Filling Your Tank

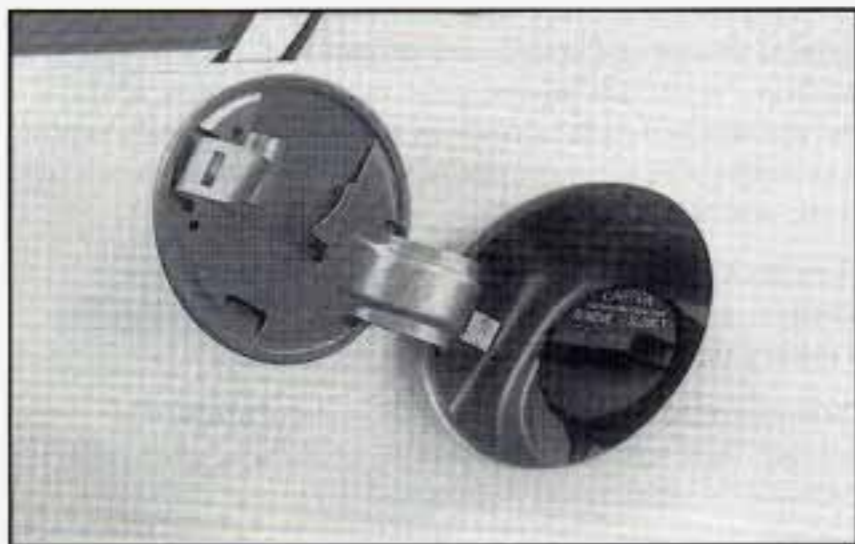

The cap is behind a hinged door on the left side of your vehicle.



CAUTION:

Gasoline vapor is highly flammable. It burns violently, and that can cause very bad injuries. Don't smoke if you're near gasoline or refueling your vehicle. Keep sparks, flames and smoking materials away from gasoline.



The release button is on the driver's door below the inside door handle.



The fuel door can also be opened by using the release in the trunk compartment, on the driver's side of the vehicle.



While refueling, hang the cap inside the fuel door. To take off the cap, turn it slowly to the left (counterclockwise).

 **CAUTION:**

If you get gasoline on yourself and then something ignites it, you could be badly burned. Gasoline can spray out on you if you open the fuel filler cap

CAUTION: (Continued)

CAUTION: (Continued)

too quickly. This spray can happen if your tank is nearly full, and is more likely in hot weather. Open the fuel filler cap slowly and wait for any “hiss” noise to stop. Then unscrew the cap all the way.

Be careful not to spill gasoline. Clean gasoline from painted surfaces as soon as possible. See “Cleaning the Outside of Your Buick” in the Index.

When you put the cap back on, turn it to the right (clockwise) until you hear a clicking sound. Make sure you fully install the cap.

NOTICE:

If you need a new cap, be sure to get the right type. Your dealer can get one for you. If you get the wrong type, it may not fit or have proper venting, and your fuel tank and emissions system might be damaged.

Checking Things Under the Hood

 **CAUTION:**

An electric fan under the hood can start up and injure you even when the engine is not running. Keep hands, clothing and tools away from any underhood electric fan.

 **CAUTION:**

Things that burn can get on hot engine parts and start a fire. These include liquids like gasoline, oil, coolant, brake fluid, windshield washer and other fluids, and plastic or rubber. You or others could be burned. Be careful not to drop or spill things that will burn onto a hot engine.

Hood Release



Pull the handle inside the vehicle to open the hood. The handle is located on the lower left side of the instrument panel, next to the parking brake release.

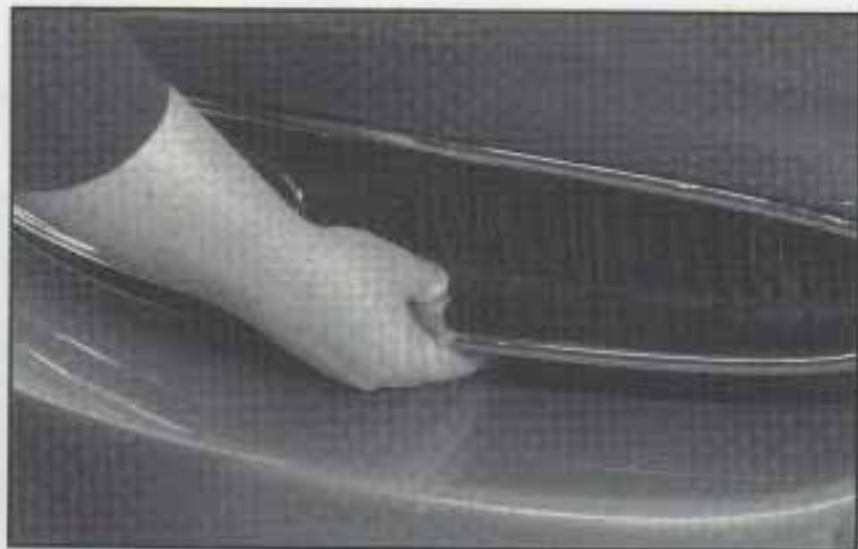

Then go to the front of the vehicle and locate the secondary hood release. It is under the front edge of the grille, slightly right of center as you face the vehicle.

Push up on the secondary hood release lever as you lift up the hood.

3800 Supercharged (L67) Engine (Option)

When you open the hood on the 3800 Supercharged engine, here's what you will see (the 3800 Non-Supercharged (L36) engine is similar):

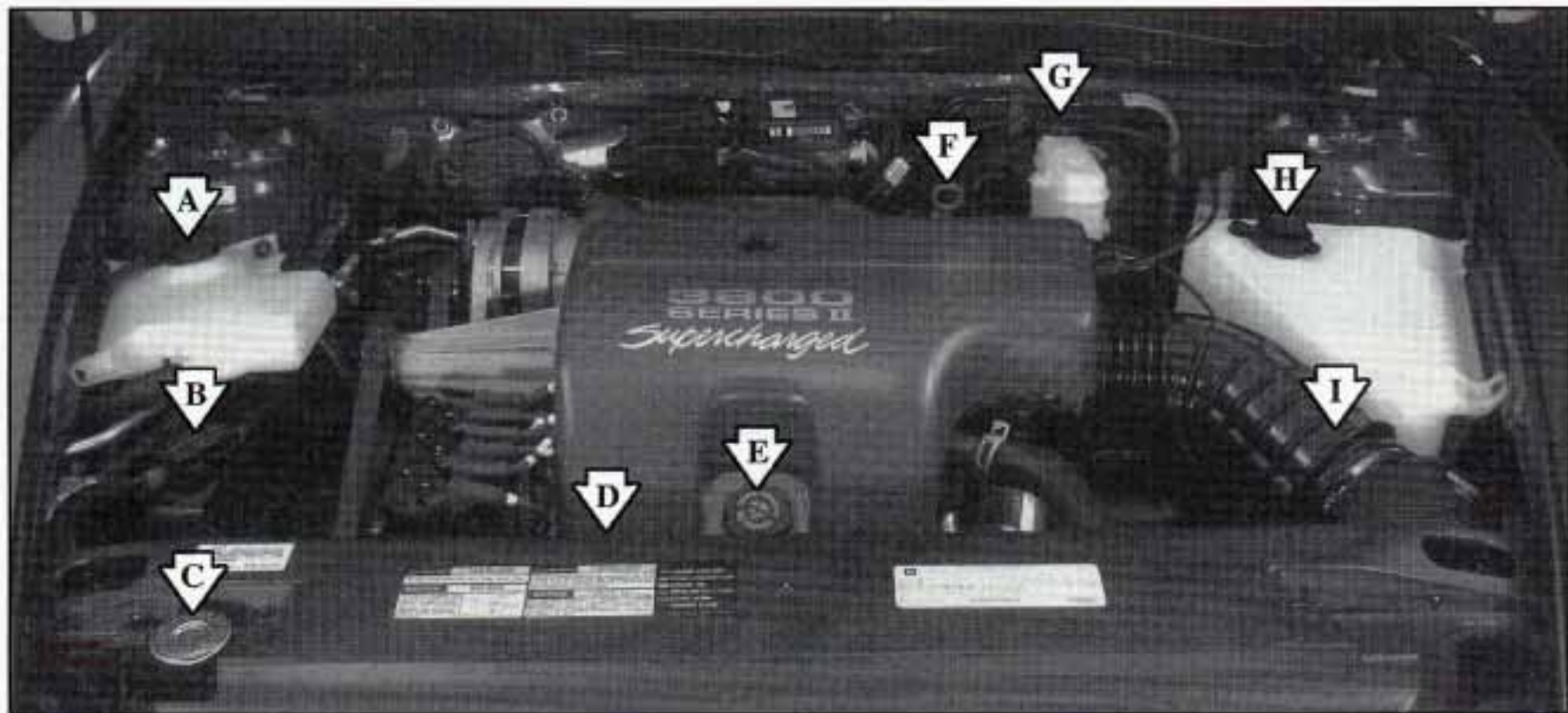

- A. Windshield Washer Fluid Reservoir
- B. Remote Positive Battery Terminal
- C. Radiator Pressure Cap
- D. Supercharged Engine Oil Dipstick
- E. Supercharged Oil Fill Cap
- F. Automatic Transaxle Fluid Dipstick
- G. Brake Master Cylinder
- H. Supercharged Engine Coolant Recovery Tank
- I. Air Cleaner

Your vehicle may have a 3800 Supercharged engine. Buick chose supercharging rather than turbocharging because Buick emphasizes smooth, refined power.

The supercharger is a device which is designed to pump more air into the engine than it would normally use. This air, mixed with fuel, creates increased engine power. Since the supercharger is a pump and is driven from an engine accessory drive belt, increased pressure is available at all driving conditions.

The Powertrain Control Module (PCM), works with a vacuum control to regulate the increased pressure required during specific driving conditions. When this increased pressure or boost is not desired, such as during idling and light throttle cruising, the excess air that the supercharger is pumping is routed through a bypass. All of these controls working together provide high performance, character and fuel efficiency in the 3800 V6 Supercharged Buick engine.

Engine Oil

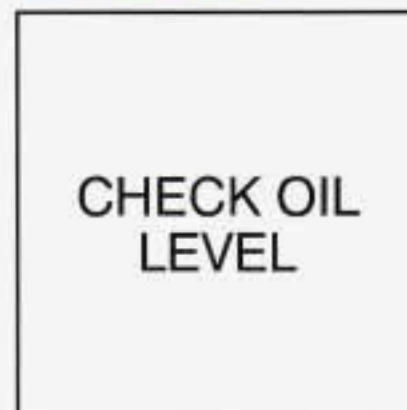

If the CHECK OIL LEVEL light on the instrument panel comes on, it means you need to check your engine oil level right away.

For more information, see "Check Oil Level Light" in the Index. You should check your engine oil level regularly; this is an added reminder.

It's a good idea to check your engine oil every time you get fuel. In order to get an accurate reading, the oil must be warm and the vehicle must be on level ground.



The engine oil dipstick is a round, yellow loop located directly behind the engine fan.

Turn off the engine and give the oil a few minutes to drain back into the oil pan. If you don't, the oil dipstick might not show the actual level.

Checking Engine Oil

Pull out the dipstick and clean it with a paper towel or cloth, then push it back in all the way. Remove it again, keeping the tip down, and check the level.



When to Add Oil

If the oil is at or below the ADD mark, then you'll need to add at least one quart of oil. But you must use the right kind. This part explains what kind of oil to use. For crankcase capacity, see "Capacities and Specifications" in the Index.

NOTICE:

Don't add too much oil. If your engine has so much oil that the oil level gets above the cross-hatched area that shows the proper operating range, your engine could be damaged.

Add engine oil at the engine oil fill cap next to the oil dipstick.

Be sure to fill it enough to put the level somewhere in the proper operating range. Push the dipstick all the way back in when you're through.

What Kind of Oil to Use

Oils recommended for your vehicle can be identified by looking for the "Starburst" symbol. This symbol indicates that the oil has been certified by the American Petroleum Institute (API). Do not use any oil which does not carry this Starburst symbol.



If you change your own oil, be sure you use oil that has the Starburst symbol on the front of the oil container. If you have your oil changed for you, be sure the oil put into your engine is American Petroleum Institute certified for gasoline engines.

You should also use the proper viscosity oil for your vehicle, as shown in the following chart:

RECOMMENDED SAE VISCOSITY GRADE ENGINE OILS

FOR BEST FUEL ECONOMY AND COLD STARTING, SELECT THE LOWEST SAE VISCOSITY GRADE OIL FOR THE EXPECTED TEMPERATURE RANGE.

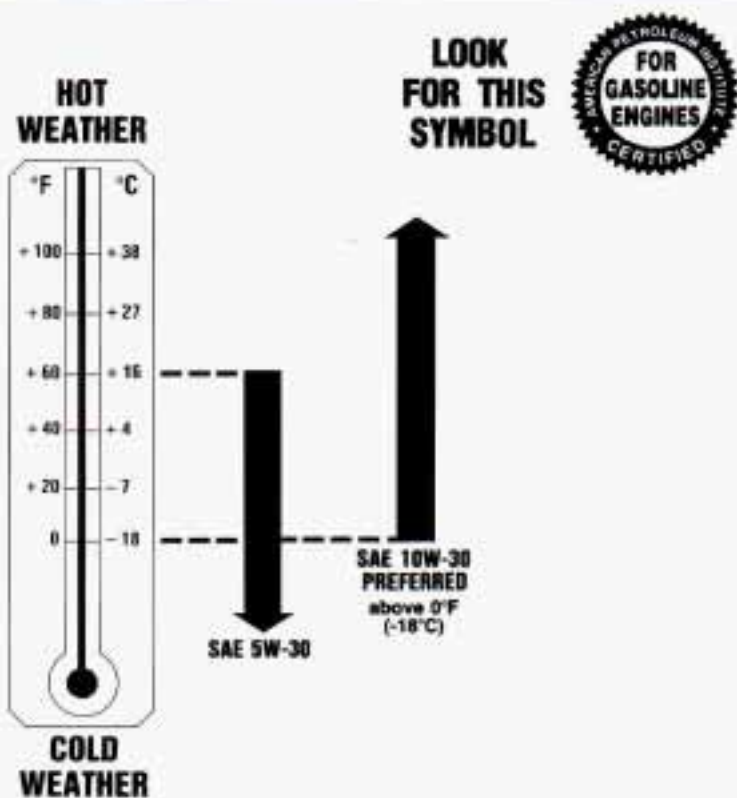

DO NOT USE SAE 20W-50 OR ANY
OTHER GRADE OIL NOT RECOMMENDED

As shown in the chart, SAE 10W-30 is best for your vehicle. However, you can use SAE 5W-30 if it's going to be colder than 60°F (16°C) before your next oil change. When it's very cold, you should use SAE 5W-30. These numbers on an oil container show its viscosity, or thickness. Do not use other viscosity oils, such as SAE 20W-50.

NOTICE:

Use only engine oil with the American Petroleum Institute Certified For Gasoline Engines "Starburst" symbol. Failure to use the recommended oil can result in engine damage not covered by your warranty.

GM Goodwrench[®] oil meets all the requirements for your vehicle.

If you are in an area where the temperature falls below -20°F (-29°C), consider using either an SAE 5W-30 synthetic oil or an SAE 0W-30 oil. Both will provide easier cold starting and better protection for your engine at extremely low temperatures.

Engine Oil Additives

Don't add anything to your oil. Your Buick dealer is ready to advise if you think something should be added.

When to Change Engine Oil

If any one of these is true for you, use the short trip/city maintenance schedule:

- Most trips are less than 5 to 10 miles (8 to 16 km). This is particularly important when outside temperatures are below freezing.
- Most trips include extensive idling (such as frequent driving in stop-and-go traffic).
- Most trips are through dusty areas.
- You frequently tow a trailer or use a carrier on top of your vehicle.
- The vehicle is used for delivery service, police, taxi or other commercial application.

Driving under these conditions causes engine oil to break down sooner. If any one of these is true for your vehicle, then you need to change your oil and filter every 3,000 miles (5 000 km) or 3 months -- whichever occurs first.

If none of them is true, use the long trip/highway maintenance schedule. Change the oil and filter every 7,500 miles (12 500 km) or 12 months -- whichever occurs first. Driving a vehicle with a fully warmed engine under highway conditions causes engine oil to break down slower.

What to Do with Used Oil

Did you know that used engine oil contains certain elements that may be unhealthy for your skin and could even cause cancer? Don't let used oil stay on your skin for very long. Clean your skin and nails with soap and water, or a good hand cleaner. Wash or properly throw away clothing or rags containing used engine oil. (See the manufacturer's warnings about the use and disposal of oil products.)

Used oil can be a real threat to the environment. If you change your own oil, be sure to drain all free-flowing oil from the filter before disposal. Don't ever dispose of oil by putting it in the trash, pouring it on the ground, into sewers, or into streams or bodies of water. Instead, recycle it by taking it to a place that collects used oil. If you have a problem properly disposing of your used oil, ask your dealer, a service station or a local recycling center for help.

Air Cleaner

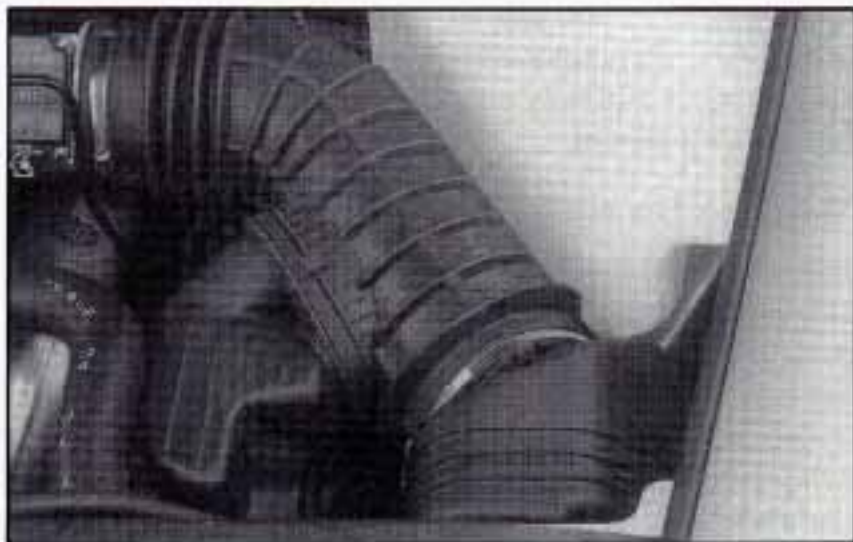

As you face the front of the vehicle, the air cleaner is in the front right section of the engine compartment. There is a filter inside the air cleaner.

Remove the air cleaner assembly as follows:

1. Remove the air duct clamp and separate the duct from the air cleaner cover. Rotate the duct on the throttle body upward so it is out of the way.
2. Detach the electrical connector and remove the air cleaner cover by flipping the two latches on the bottom inboard side of the cover.
3. Tilt and pull the cover toward the engine to disengage it from the assembly.
4. Remove the old filter and install the new one.
5. Reinstall the air cleaner cover by sliding the tabs into the base of the air cleaner and locking the two latches. Reinstall the electrical connector.
6. Rotate the inlet duct into position and slide it onto the air cleaner outlet, then tighten the clamp.

Refer to the Maintenance Schedule to determine when to replace the air filter.

See "Scheduled Maintenance Services" in the Index.

CAUTION:

Operating the engine with the air cleaner off can cause you or others to be burned. The air cleaner not only cleans the air, it stops flame if the engine backfires. If it isn't there, and the engine backfires, you could be burned. Don't drive with it off, and be careful working on the engine with the air cleaner off.

NOTICE:

If the air cleaner is off, a backfire can cause a damaging engine fire. And, dirt can easily get into your engine, which will damage it. Always have the air cleaner in place when you're driving.

Supercharger Oil



Unless you are technically qualified and have the proper tools, you should let your dealer or a qualified service center perform this maintenance.

When to Check

Check oil level every 30,000 miles (50 000 km) or every 36 months, whichever occurs first.

What Kind of Oil to Use

See "Recommended Fluids and Lubricants" in the Index and use only the recommended oil.

How to Check and Add Oil

Check oil only when the engine is cold. Allow the engine to cool two to three hours after running.

CAUTION:

If you remove the supercharger oil fill plug while the engine is hot, pressure may cause hot oil to blow out of the oil fill hole. You may be burned. Do not remove the plug until the engine cools.

1. Clean the area around the oil fill plug before removing it.
2. Remove the oil fill plug using a 3/16 inch Allen wrench.
3. The oil level is correct when it just reaches the bottom of the threads of the inspection hole.
4. Replace the oil plug with the O-ring in place. Torque to 88 lb-in (10 N·m).

Automatic Transaxle Fluid

When to Check and Change

A good time to check your automatic transaxle fluid level is when the engine oil is changed.

Change both the fluid and filter every 50,000 miles (83 000 km) if the vehicle is mainly driven under one or more of these conditions:

- In heavy city traffic where the outside temperature regularly reaches 90°F (32°C) or higher.
- In hilly or mountainous terrain.
- When doing frequent trailer towing.
- Uses such as found in taxi, police or delivery service.

If you do not use your vehicle under any of these conditions, the fluid and filter do not require changing.

See “Scheduled Maintenance Services” in the Index.

How to Check

Because this operation can be a little difficult, you may choose to have this done at your Buick dealership Service Department.

If you do it yourself, be sure to follow all the instructions here, or you could get a false reading on the dipstick.

NOTICE:

Too much or too little fluid can damage your transaxle. Too much can mean that some of the fluid could come out and fall on hot engine parts or exhaust system parts, starting a fire. Be sure to get an accurate reading if you check your transaxle fluid.

Wait at least 30 minutes before checking the transaxle fluid level if you have been driving:

- When outside temperatures are above 90°F (32°C).
- At high speed for quite a while.
- In heavy traffic -- especially in hot weather.
- While pulling a trailer.

To get the right reading, the fluid should be at normal operating temperature, which is 180°F to 200°F (82°C to 93°C).

Get the vehicle warmed up by driving about 15 miles (24 km) when outside temperatures are above 50°F (10°C). If it's colder than 50°F (10°C), you may have to drive longer.

Checking the Fluid Level

- Park your vehicle on a level place. Keep the engine running.
- With the parking brake applied, place the shift lever in PARK (P).
- With your foot on the brake pedal, move the shift lever through each gear range, pausing for about three seconds in each range. Then, position the shift lever in PARK (P).
- Let the engine run at idle for three to five minutes.

Then, without shutting off the engine, follow these steps:



1. The transaxle fluid dipstick is a round, red loop located next to the brake master cylinder. Pull out the dipstick and wipe it with a clean rag or paper towel.

2. Push it back in all the way, wait three seconds and then pull it back out again.

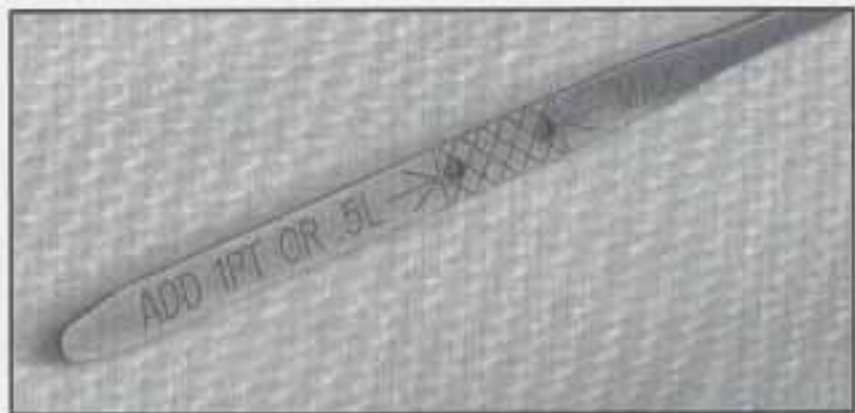

3. Check both sides of the dipstick, and read the lower level. The fluid level must be in the cross-hatched area.
4. If the fluid level is in the acceptable range, push the dipstick back in all the way.

How to Add Fluid

Refer to the Maintenance Schedule to determine what kind of transaxle fluid to use. See “Recommended Fluids and Lubricants” in the Index.

If the fluid level is low, add only enough of the proper fluid to bring the level into the cross-hatched area on the dipstick.

1. Pull out the dipstick.
2. Using a long-neck funnel, add enough fluid at the dipstick hole to bring it to the proper level.

It doesn't take much fluid, generally less than one pint (0.5 L). *Don't overfill.*

NOTICE:

We recommend you use only fluid labeled DEXRON®-III, because fluid with that label is made especially for your automatic transaxle. Damage caused by fluid other than DEXRON®-III is not covered by your new vehicle warranty.

3. After adding fluid, recheck the fluid level as described under “How to Check.”
4. When the correct fluid level is obtained, push the dipstick back in all the way.

Engine Coolant

The cooling system in your vehicle is filled with DEX-COOL® engine coolant. This coolant is designed to remain in your vehicle for 5 years or 150,000 miles (240 000 km), whichever occurs first, if you add only DEX-COOL® extended life coolant.

The following explains your cooling system and how to add coolant when it is low. If you have a problem with engine overheating, see “Engine Overheating” in the Index.

A 50/50 mixture of water and DEX-COOL® coolant will:

- Give freezing protection down to -34°F (-37°C).
- Give boiling protection up to 265°F (129°C).
- Protect against rust and corrosion.
- Help keep the proper engine temperature.
- Let the warning lights and gages work as they should.

NOTICE:

When adding coolant, it is important that you use only DEX-COOL[®] (silicate-free) coolant.

If coolant other than DEX-COOL[®] is added to the system, premature engine, heater core or radiator corrosion may result. In addition, the engine coolant will require change sooner -- at 30,000 miles (50 000 km) or 24 months, whichever occurs first. Damage caused by the use of coolant other than DEX-COOL[®] is not covered by your new vehicle warranty.

What to Use

Use a mixture of one-half *clean water* (preferably distilled) and one-half DEX-COOL[®] coolant which won't damage aluminum parts. If you use this mixture, you don't need to add anything else.



CAUTION:

Adding only plain water to your cooling system can be dangerous. Plain water, or some other liquid like alcohol, can boil before the proper coolant mix will. Your vehicle's coolant warning system is set for the proper coolant mix. With plain water or the wrong mix, your engine could get too hot but you wouldn't get the overheat warning. Your engine could catch fire and you or others could be burned. Use a 50/50 mix of clean water and DEX-COOL[®] coolant.

NOTICE:

If you use an improper coolant mix, your engine could overheat and be badly damaged. The repair cost wouldn't be covered by your warranty. Too much water in the mix can freeze and crack the engine, radiator, heater core and other parts.

If you have to add coolant more than four times a year, have your dealer check your cooling system.

NOTICE:

If you use the proper coolant, you don't have to add extra inhibitors or additives which claim to improve the system. These can be harmful.

Checking Coolant



The engine coolant recovery tank is located on the driver's side of the engine compartment.

When your engine is cold, the coolant level should be at **FULL COLD** or a little higher. When your engine is warm, the level should be up to **FULL HOT** or a little higher.

LOW COOLANT LEVEL

If this light comes on, it means you're low on engine coolant.

Adding Coolant

If you need more coolant, add the proper DEX-COOL[®] coolant mixture *at the coolant recovery tank*, but be careful not to spill it.



CAUTION:

Turning the radiator pressure cap when the engine and radiator are hot can allow steam and scalding liquids to blow out and burn you badly. With the coolant recovery tank, you will almost never have to add coolant at the radiator. Never turn the radiator pressure cap -- even a little -- when the engine and radiator are hot.



CAUTION:

You can be burned if you spill coolant on hot engine parts. Coolant contains ethylene glycol, and it will burn if the engine parts are hot enough. Don't spill coolant on a hot engine.

Radiator Pressure Cap

NOTICE:

Your radiator cap is a 15 psi (105 kPa) pressure-type cap and must be tightly installed to prevent coolant loss and possible engine damage from overheating. Be sure the arrows on the cap line up with the overflow tube on the radiator filler neck.

When you replace your radiator pressure cap, a GM cap is recommended.

Thermostat

Engine coolant temperature is controlled by a thermostat in the engine coolant system. The thermostat stops the flow of coolant through the radiator until the coolant reaches a preset temperature.

When you replace your thermostat, a GM thermostat is recommended.

Power Steering Fluid



When to Check Power Steering Fluid

It is not necessary to regularly check power steering fluid unless you suspect there is a leak in the system or you hear an unusual noise. A fluid loss in this system could indicate a problem. Have the system inspected and repaired.

The power steering fluid reservoir on the L36 and L67 engine is located below the generator and behind the accessory drive belt.

How To Check Power Steering Fluid

When the engine compartment is cool, wipe the cap and the top of the reservoir clean, then unscrew the cap and wipe the dipstick with a clean rag. Replace the cap and completely tighten it. Then remove the cap again and look at the fluid level on the dipstick.

The level should be at the FULL COLD mark. If necessary, add only enough fluid to bring the level up to the mark.

What to Use

To determine what kind of fluid to use, see “Recommended Fluids and Lubricants” in the Index. Always use the proper fluid. Failure to use the proper fluid can cause leaks and damage hoses and seals.

Windshield Washer Fluid

What to Use

When you need windshield washer fluid, be sure to read the manufacturer’s instructions before use. If you will be operating your vehicle in an area where the temperature may fall below freezing, use a fluid that has sufficient protection against freezing.

Adding Washer Fluid



Open the cap labeled **WASHER FLUID ONLY**. Add washer fluid until the tank is full.

NOTICE:

- When using concentrated washer fluid, follow the manufacturer's instructions for adding water.
- Don't mix water with ready-to-use washer fluid. Water can cause the solution to freeze and damage your washer fluid tank and other parts of the washer system. Also, water doesn't clean as well as washer fluid.
- Fill your washer fluid tank only three-quarters full when it's very cold. This allows for expansion if freezing occurs, which could damage the tank if it is completely full.
- Don't use radiator antifreeze in your windshield washer. It can damage your washer system and paint.

Brakes

Brake Fluid



Your brake master cylinder reservoir is here. It is filled with DOT-3 brake fluid.

There are only two reasons why the brake fluid level in the reservoir might go down. The first is that the brake fluid goes down to an acceptable level during normal brake lining wear. When new linings are put in, the fluid level goes back up. The other reason is that fluid is leaking out of the brake system. If it is, you should have your brake

system fixed, since a leak means that sooner or later your brakes won't work well, or won't work at all.

So, it isn't a good idea to "top off" your brake fluid. Adding brake fluid won't correct a leak. If you add fluid when your linings are worn, then you'll have too much fluid when you get new brake linings. You should add (or remove) brake fluid, as necessary, only when work is done on the brake hydraulic system.



CAUTION:

If you have too much brake fluid, it can spill on the engine. The fluid will burn if the engine is hot enough. You or others could be burned, and your vehicle could be damaged. Add brake fluid only when work is done on the brake hydraulic system.

When your brake fluid falls to a low level, your brake warning light will come on. A chime will sound if you try to drive with this warning light on. See "Brake System Warning Light" in the Index.

What to Add

When you do need brake fluid, use only DOT-3 brake fluid -- such as Delco Supreme 11[®] (GM Part No. 12377967). Use new brake fluid from a sealed container only.

Always clean the brake fluid reservoir cap and the area around the cap before removing it. This will help keep dirt from entering the reservoir.

CAUTION:

With the wrong kind of fluid in your brake system, your brakes may not work well, or they may not even work at all. This could cause a crash. Always use the proper brake fluid.

NOTICE:

- Using the wrong fluid can badly damage brake system parts. For example, just a few drops of mineral-based oil, such as engine oil, in your brake system can damage brake system parts so badly that they'll have to be replaced. Don't let someone put in the wrong kind of fluid.
- If you spill brake fluid on your vehicle's painted surfaces, the paint finish can be damaged. Be careful not to spill brake fluid on your vehicle. If you do, wash it off immediately. See "Appearance Care" in the Index.

Brake Wear

Your Buick has four-wheel disc brakes.

Disc brake pads have built-in wear indicators that make a high-pitched warning sound when the brake pads are worn and new pads are needed. The sound may come and go or be heard all the time your vehicle is moving (except when you are pushing on the brake pedal firmly).

CAUTION:

The brake wear warning sound means that soon your brakes won't work well. That could lead to an accident. When you hear the brake wear warning sound, have your vehicle serviced.

NOTICE:

Continuing to drive with worn-out brake pads could result in costly brake repair.

Some driving conditions or climates may cause a brake squeal when the brakes are first applied or lightly applied. This does not mean something is wrong with your brakes.

Properly torqued wheel nuts are necessary to help prevent brake pulsation. When tires are rotated, inspect brake pads for wear and evenly torque wheel nuts in the proper sequence to GM specifications.

Brake linings should always be replaced as complete axle sets.

See "Brake System Inspection" in Section 7 of this manual under Part C "Periodic Maintenance Inspections."

Brake Pedal Travel

See your dealer if the brake pedal does not return to normal height, or if there is a rapid increase in pedal travel. This could be a sign of brake trouble.

Brake Adjustment

Every time you apply the brakes, with or without the vehicle moving, your brakes adjust for wear.

Replacing Brake System Parts

The braking system on a modern vehicle is complex. Its many parts have to be of top quality and work well together if the vehicle is to have really good braking. Your vehicle was designed and tested with top-quality GM brake parts. When you replace parts of your braking system -- for example, when your brake linings wear down and you have to have new ones put in -- be sure you get new approved GM replacement parts. If you don't, your brakes may no longer work properly. For example, if someone puts in brake linings that are wrong for your vehicle, the balance between your front and rear brakes can change -- for the worse. The braking performance you've come to expect can change in many other ways if someone puts in the wrong replacement brake parts.

Battery

Every new Buick has a Delco Freedom[®] battery. You never have to add water to one of these. When it's time for a new battery, we recommend a Delco Freedom battery. Get one that has the replacement number shown on the original battery's label.

The battery is located under the rear seat cushion. To access the battery, see "Removing the Rear Seat Cushion" in the Index. You don't need to access the battery to jump start your vehicle. See "Jump Starting" in the Index.



CAUTION:

A battery that isn't properly vented can let sulfuric acid fumes into the area under the rear seat cushion. These fumes can damage your rear seat safety belt systems. You may not be able to see this damage, and the safety belts might not provide the protection needed in a crash. If a replacement battery is ever needed, it must be vented in the same manner as the original battery. Always make sure that the vent hose is properly reattached before reinstalling the seat cushion.

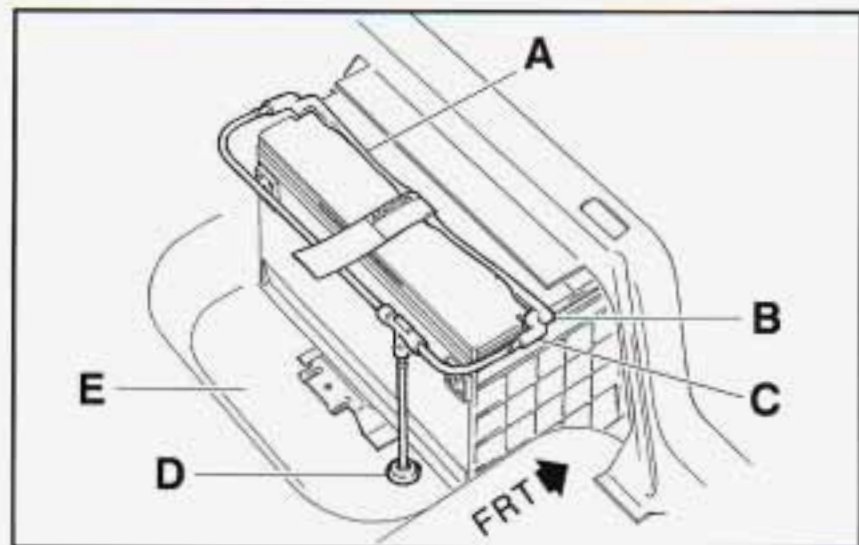

To be sure the vent hose (A) is properly attached, the vent hose connectors (B) must be securely reattached to the vent outlets (C) on each side of the battery, and the vent assembly grommet (D) must be secured to the floor pan (E).

Vehicle Storage

If you're not going to drive your vehicle for 25 days or more, take off the black, negative (-) cable from the battery. This will help keep your battery from running down.

CAUTION:

Batteries have acid that can burn you and gas that can explode. You can be badly hurt if you aren't careful. See "Jump Starting" in the Index for tips on working around a battery without getting hurt.

Contact your dealer to learn how to prepare your vehicle for longer storage periods.

Also, for your audio system, see "Theft-Deterrent Feature" in the Index.

Bulb Replacement

The following procedure tells you how to replace your headlamp bulbs.

For any bulb changing procedure not listed in this section, contact your Buick dealer's service department.

Halogen Bulbs

CAUTION:

Halogen bulbs have pressurized gas inside and can burst if you drop or scratch the bulb. You or others could be injured. Be sure to read and follow the instructions on the bulb package.

Exterior Front Bulbs

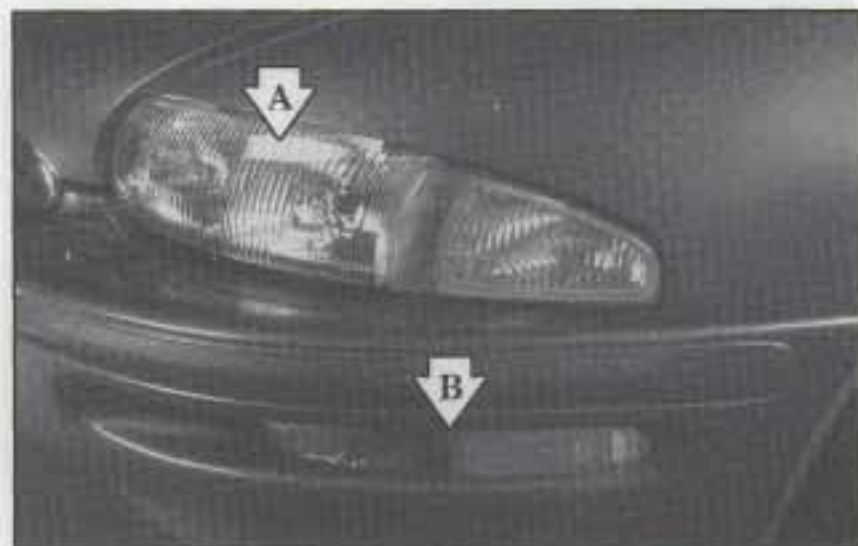

- A. Headlamp
- B. Front Turn Signal

The entire front headlamp assembly must be removed to replace the headlamps. You may find it easier to remove the air cleaner assembly when replacing bulbs on the driver's side.

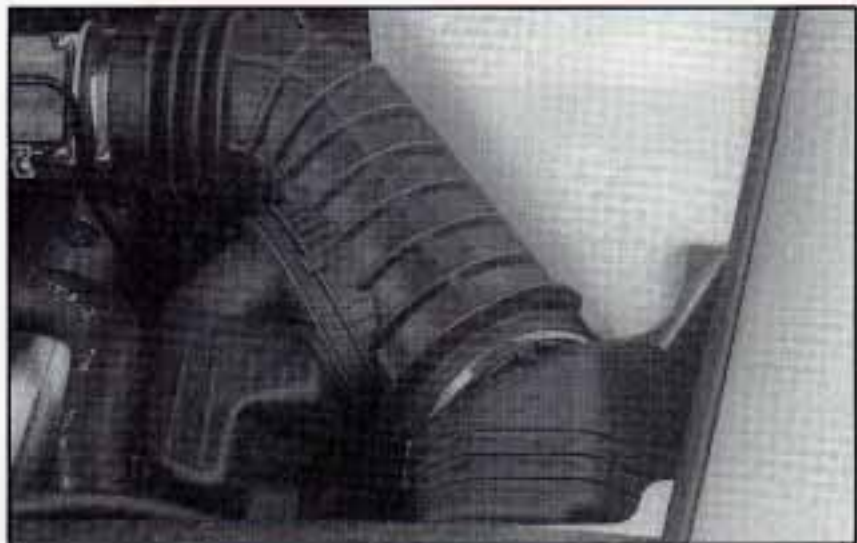

If more hand clearance is required, remove the air cleaner assembly as follows:

1. Remove the air duct clamp and separate the duct from the air cleaner cover. Rotate the duct on the throttle body upward so it is out of the way.

2. Detach the electrical connector and remove the air cleaner cover by flipping the two latches on the bottom inboard side of the cover.
3. Tilt and pull the cover toward the engine to disengage it from the assembly.
4. Remove the filter and install the new one.
5. Reinstall the air cleaner cover by sliding the tabs into the base of the air cleaner and locking the two latches. Reinstall the electrical connector.
6. Rotate the inlet duct into position and slide onto the air cleaner outlet, then tighten the clamp.

Headlamps

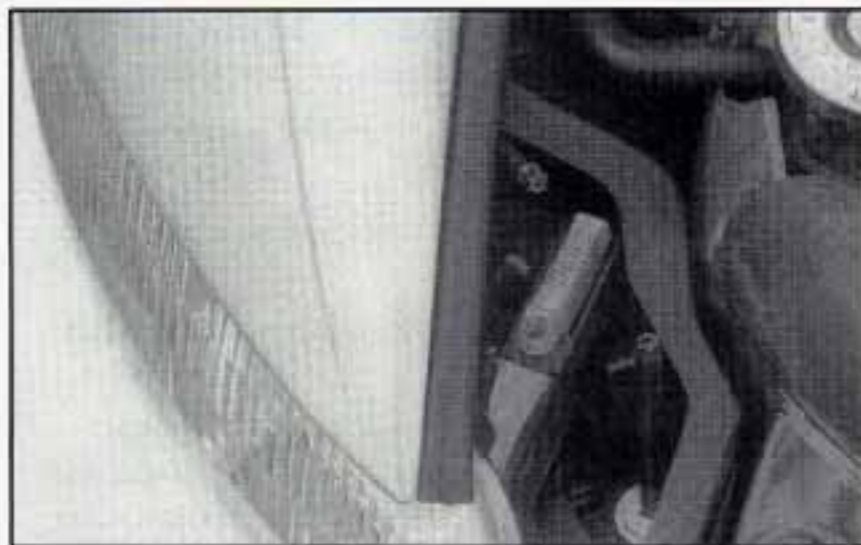

The right high-beam headlamp access area is next to the radiator pressure cap.

The right low-beam headlamp access area is to the right and slightly behind the high beam area.

The left high-beam headlamp access area is located near the air cleaner.

The left low-beam headlamp access area is behind and between the high-beam area and the air cleaner.

1. Loosen the two bolts on the inboard edge of the headlamp assembly. This allows you to pull out the assembly for more hand clearance when changing bulbs.

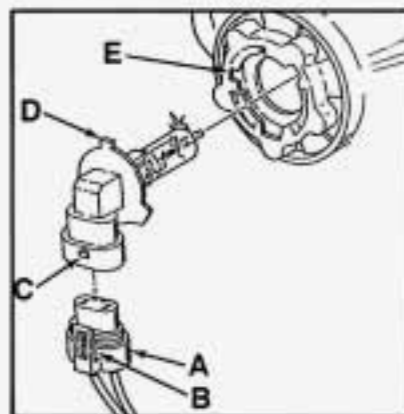

2. Reach into the assembly and turn the bulb socket one-quarter of a turn toward the center of the engine compartment, while pressing it firmly.
3. Remove the wire connector from the bulb by lifting the lock tab and pulling it away from the plastic base.
4. Install the bulb by putting the small tab (D) into the small notch in the lamp (E).
5. Turn the bulb socket one-quarter of a turn making sure the tab is properly engaged in the panel slot.
6. To reassemble, attach the wire connector (A) to the plastic base making sure the lock tab (B) is over the lock (C).

Front Turn Signal Lamps

The turn signal bulb is located in the front fascia.

1. Remove the panel on the underside of the bulb assembly by pulling the two fasteners that hold it in place.
2. Reach in to press the locking tab and twist the bulb socket one-quarter of a turn counterclockwise.
3. Replace the bulb, then reassemble by reversing Steps 1 and 2.

Headlamp Aiming

Your vehicle has the composite headlamp system. These headlamps have horizontal and vertical aim indicators. The aim has been pre-set at the factory and should need no further adjustment.

If your vehicle is damaged in an accident and the headlamp aim seems to be affected, see your Buick dealer. Headlamps on damaged vehicles may require recalibration of the horizontal aim by your Buick dealer.

To check the aim, the vehicle should be properly prepared as follows:

- The vehicle must have all four tires on a perfectly level surface.
- The vehicle should not have any snow, ice or mud attached to it.
- There should not be any cargo or loading of the vehicle, except it should have a full tank of gas and one person or 160 lbs. (75 kg) on the driver's seat.
- Tires should be properly inflated.

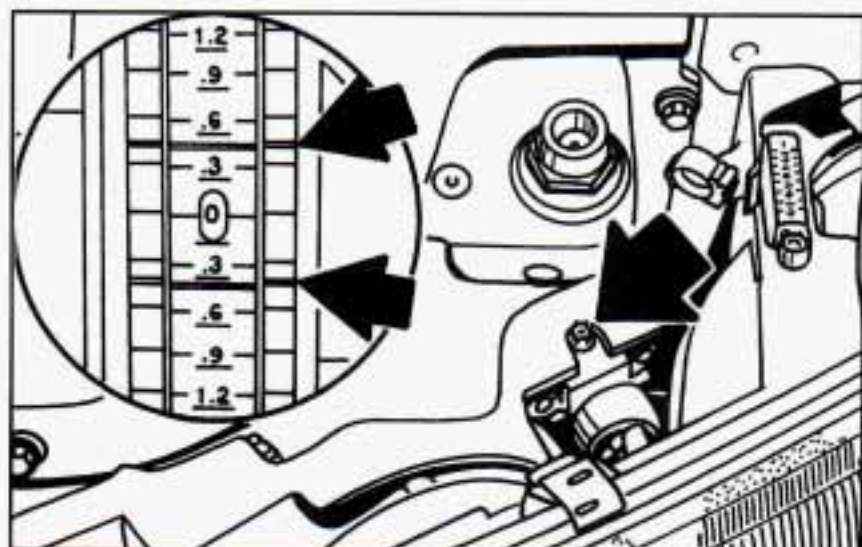
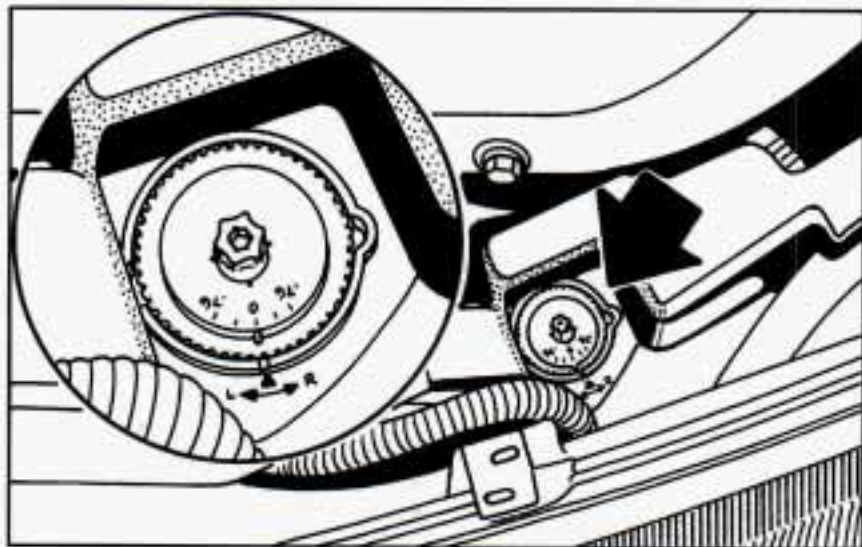

NOTICE:

To make sure your headlamps are aimed properly, read all the instructions before beginning. Failure to follow these instructions could cause damage to headlamp parts.

State inspection stations will allow a vertical reading of plus 0.76 degrees or minus 0.76 degrees from the center of the bubble.

It is recommended that the upper limit not exceed plus 0.4 degrees from the center of the bubble. Other drivers may flash their high beams at you if your adjustment is much above plus 0.4 degrees.

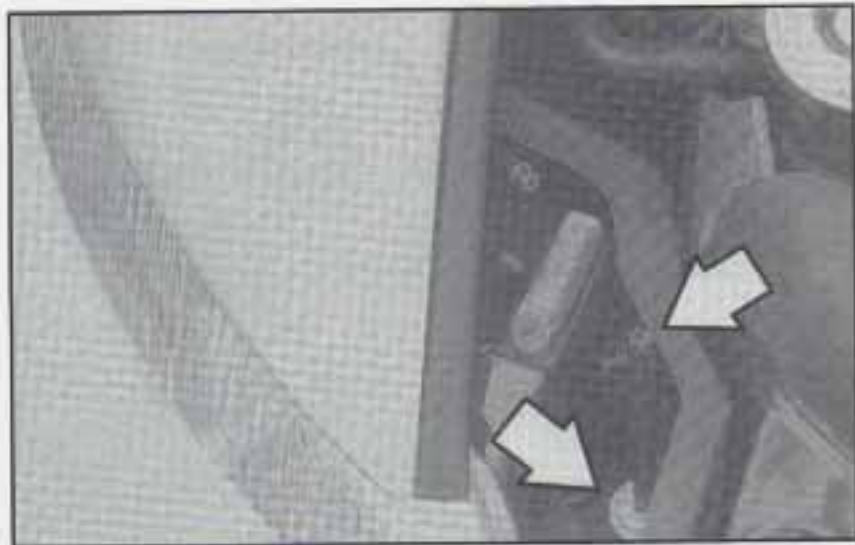

The headlamp aiming device is under the hood, directly behind the headlamps.

If you find that the headlamp aiming needs adjustment, follow these steps:

1. Start by checking the vertical headlamp aim first. The vehicle must be parked on a level surface. Turn the vertical aiming screw until the bubble inside the level is centered at 0 (zero).

2. After the vertical aim is correct, check the horizontal aim for each headlamp and adjust as necessary. Turn the horizontal aiming screw until the pointer is lined up with the 0 (zero).
3. Visually, re-check the vertical aim to make sure it remains correct after the horizontal aim adjustment. Adjust as necessary.

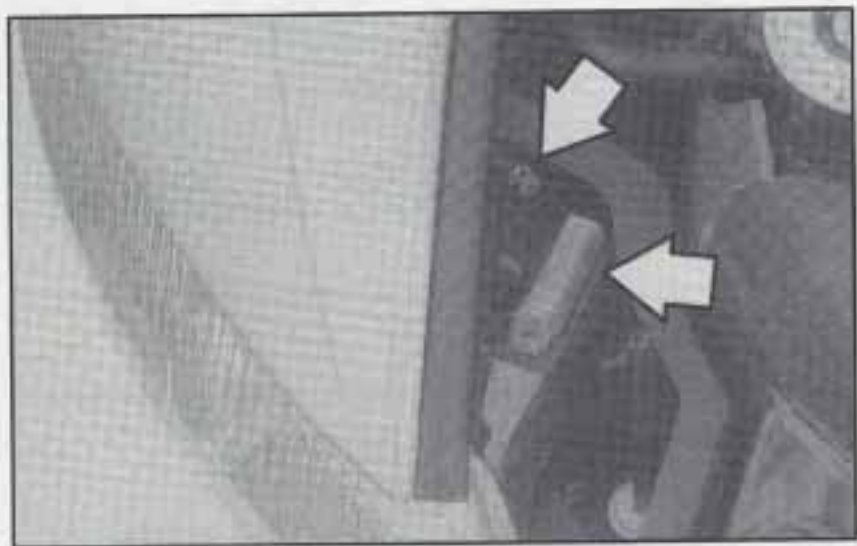

Exterior Rear Bulbs

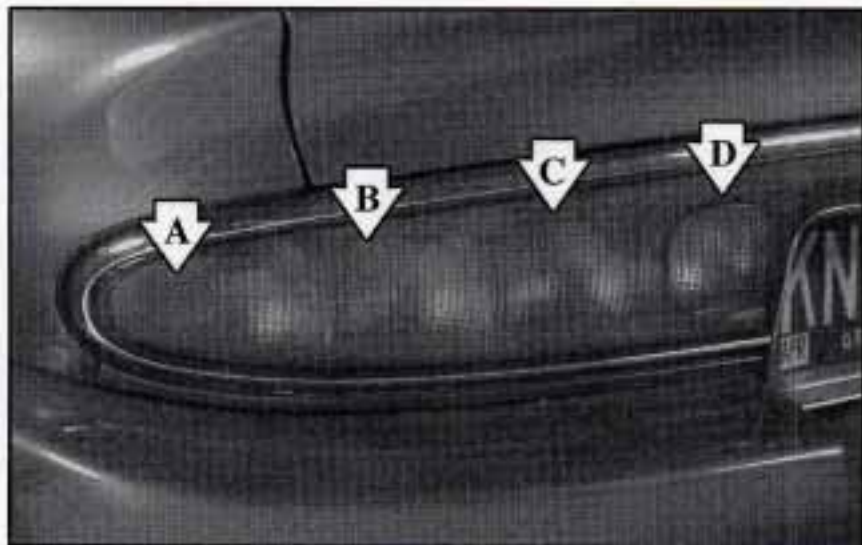

Taillamps: A, B and C
Rear Turn Signal: A and C
Back-Up Lamps: D

The entire taillamp assembly must be removed to change any of these bulbs. To access them, do the following:



1. Remove the screws that secure the trunk trim over the taillamp area.

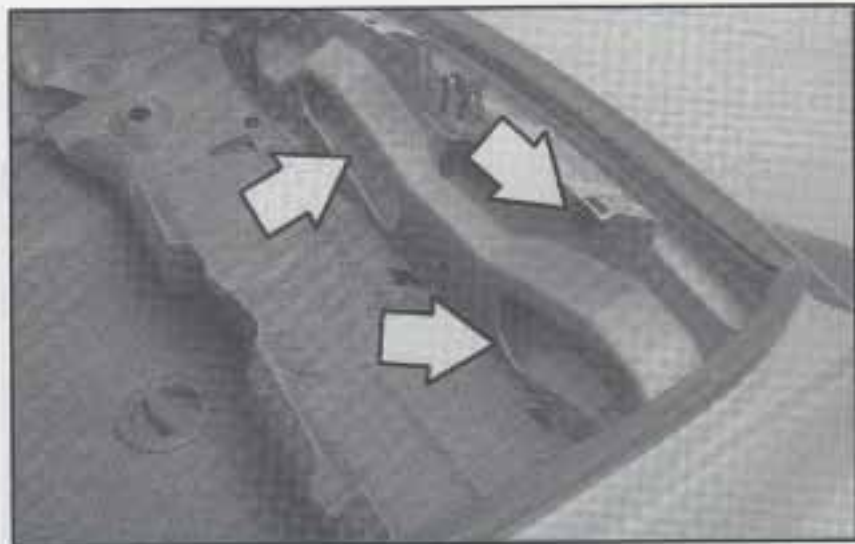

2. Remove the plastic wing nuts that hold the taillamp assembly in place.

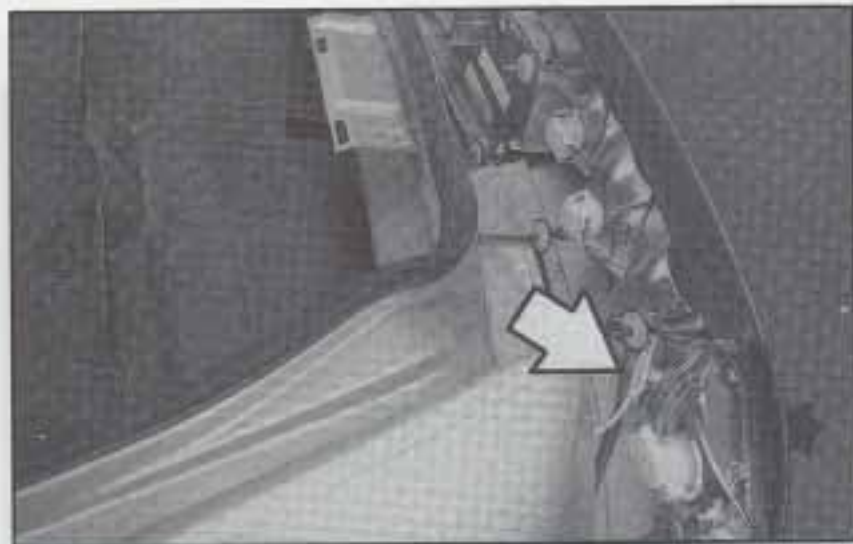

3. Pull the taillamp assembly away from the vehicle carefully, to avoid scratching the paint. The taillamp has safety straps to help you hold the assembly while replacing the bulbs.

Taillamps/Rear Turn Signal/Back-Up Lamps

The following instructions explain how to change each bulb.



1. Remove the bulb socket assembly by squeezing the plastic lock and turning it one-quarter of a turn counterclockwise.



2. Pull the bulb straight out to remove it from the socket.
3. Install a new bulb into the socket. Reverse the instructions to replace the taillamp assembly.

Interior Lamps

Front and Rear Reading Lamps

To change the bulbs in the front and rear reading lamps, do the following:

1. Carefully insert a flat head screwdriver in the slot between the lens cover and molding.
2. Gently pry the lens cover away to expose the reading lamp bulb. The lens cover should pop off.
3. Twist or pull the bulb from its assembly and install a new bulb.
4. Snap the lens cover back in place.

Windshield Wiper Blade Replacement

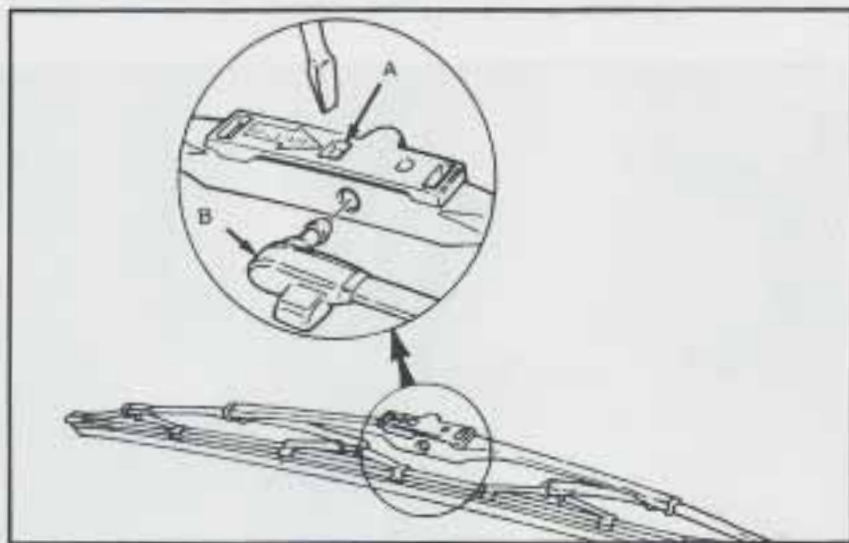

Replacement blades come in different types and are removed in different ways. Here's how to remove the type with a release hole:

1. Pull the windshield wiper arm away from the windshield.
2. Insert a small screwdriver into the hole (A) and pull the blade assembly off the wiper arm (B).
3. Push the new wiper blade securely on the wiper arm.

For the proper windshield wiper blade length and type, see "Normal Maintenance Replacement Parts" in the Index.

Tires

Your new Buick comes with high-quality tires made by a leading tire manufacturer. If you ever have questions about your tire warranty and where to obtain service, see your Buick Warranty booklet for details.

CAUTION:

Poorly maintained and improperly used tires are dangerous.

- Overloading your tires can cause overheating as a result of too much friction. You could have an air-out and a serious accident. See “Loading Your Vehicle” in the Index.

CAUTION: (Continued)

CAUTION: (Continued)

- Underinflated tires pose the same danger as overloaded tires. The resulting accident could cause serious injury. Check all tires frequently to maintain the recommended pressure. Tire pressure should be checked when your tires are cold.
- Overinflated tires are more likely to be cut, punctured or broken by a sudden impact -- such as when you hit a pothole. Keep tires at the recommended pressure.
- Worn, old tires can cause accidents. If your tread is badly worn, or if your tires have been damaged, replace them.

Inflation -- Tire Pressure

The Tire-Loading Information label, which is located on the rear edge of the driver's door shows the correct inflation pressures for your tires when they're cold. "Cold" means your vehicle has been sitting for at least three hours or driven no more than 1 mile (1.6 km).

NOTICE:

Don't let anyone tell you that underinflation or overinflation is all right. It's not. If your tires don't have enough air (underinflation), you can get the following:

- Too much flexing
- Too much heat
- Tire overloading
- Bad wear
- Bad handling
- Bad fuel economy.

NOTICE: (Continued)

NOTICE: (Continued)

If your tires have too much air (overinflation), you can get the following:

- Unusual wear
- Bad handling
- Rough ride
- Needless damage from road hazards.

When to Check

Check your tires once a month or more.

Don't forget your compact spare tire. It should be at 60 psi (420 kPa).

How to Check

Use a good quality pocket-type gage to check tire pressure. You can't tell if your tires are properly inflated simply by looking at them. Radial tires may look properly inflated even when they're underinflated.

Be sure to put the valve caps back on the valve stems. They help prevent leaks by keeping out dirt and moisture.

Tire Inspection and Rotation

Tires should be rotated every 6,000 to 8,000 miles (10 000 to 13 000 km). Any time you notice unusual wear, rotate your tires as soon as possible and check wheel alignment. Also check for damaged tires or wheels. See “When It’s Time for New Tires” and “Wheel Replacement” later in this section for more information.

The purpose of regular rotation is to achieve more uniform wear for all tires on the vehicle. The first rotation is the most important. See “Scheduled Maintenance Services” in the Index for scheduled rotation intervals.

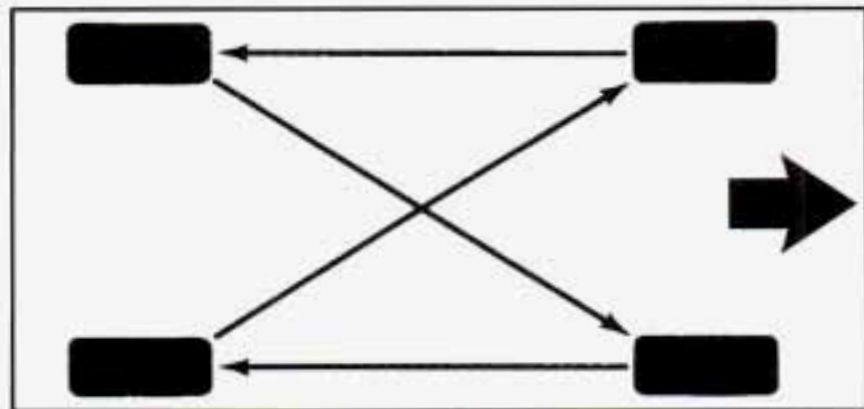

When rotating your tires, always use the correct rotation pattern shown here.

Don't include the compact spare tire in your tire rotation.

After the tires have been rotated, adjust the front and rear inflation pressures as shown on the Tire-Loading Information label. Make certain that all wheel nuts are properly tightened. See “Wheel Nut Torque” in the Index.

CAUTION:

Rust or dirt on a wheel, or on the parts to which it is fastened, can make wheel nuts become loose after a time. The wheel could come off and cause an accident. When you change a wheel, remove any rust or dirt from places where the wheel attaches to the vehicle. In an emergency, you can use a cloth or a paper towel to do this; but be sure to use a scraper or wire brush later, if you need to, to get all the rust or dirt off. (See “Changing a Flat Tire” in the Index.)

When It's Time for New Tires

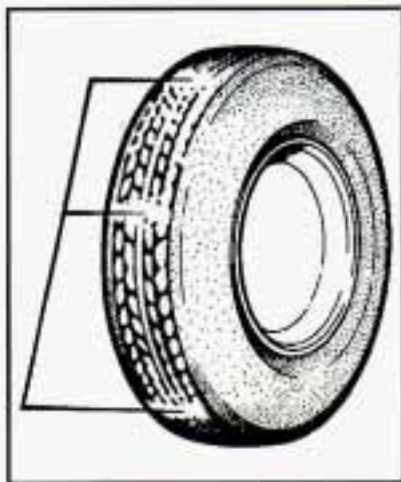

One way to tell when it's time for new tires is to check the treadwear indicators, which will appear when your tires have only 1/16 inch (1.6 mm) or less of tread remaining.

You need a new tire if any of the following statements are true:

- You can see the indicators at three or more places around the tire.
- You can see cord or fabric showing through the tire's rubber.
- The tread or sidewall is cracked, cut or snagged deep enough to show cord or fabric.
- The tire has a bump, bulge or split.

- The tire has a puncture, cut or other damage that can't be repaired well because of the size or location of the damage.

Buying New Tires

To find out what kind and size of tires you need, look at the Tire-Loading Information label.

The tires installed on your vehicle when it was new had a Tire Performance Criteria Specification (TPC Spec) number on each tire's sidewall. When you get new tires, get ones with that same TPC Spec number. That way your vehicle will continue to have tires that are designed to give proper endurance, handling, speed rating, traction, ride and other things during normal service on your vehicle. If your tires have an all-season tread design, the TPC number will be followed by an "MS" (for mud and snow).

If you ever replace your tires with those not having a TPC Spec number, make sure they are the same size, load range, speed rating and construction type (bias, bias-belted or radial) as your original tires.

 **CAUTION:**

Mixing tires could cause you to lose control while driving. If you mix tires of different sizes or types (radial and bias-belted tires), the vehicle may not handle properly, and you could have a crash. Using tires of different sizes may also cause damage to your vehicle. Be sure to use the same size and type tires on all wheels.

It's all right to drive with your compact spare, though. It was developed for use on your vehicle.

Uniform Tire Quality Grading

The following information relates to the system developed by the United States National Highway Traffic Safety Administration, which grades tires by treadwear, traction and temperature performance. (This applies only to vehicles sold in the United States.) The grades are molded on the sidewalls of most passenger

car tires. The Uniform Tire Quality Grading system does not apply to deep tread, winter-type snow tires, space-saver or temporary use spare tires, tires with nominal rim diameters of 10 to 12 inches (25 to 30 cm), or to some limited-production tires.

While the tires available on General Motors passenger cars and light trucks may vary with respect to these grades, they must also conform to Federal safety requirements and additional General Motors Tire Performance Criteria (TPC) standards.

Treadwear

The treadwear grade is a comparative rating based on the wear rate of the tire when tested under controlled conditions on a specified government test course. For example, a tire graded 150 would wear one and a half (1 1/2) times as well on the government course as a tire graded 100. The relative performance of tires depends upon the actual conditions of their use, however, and may depart significantly from the norm due to variations in driving habits, service practices and differences in road characteristics and climate.

Traction -- A, B, C

The traction grades, from highest to lowest, are A, B, and C, and they represent the tire's ability to stop on wet pavement as measured under controlled conditions on specified government test surfaces of asphalt and concrete. A tire marked C may have poor traction performance.

Warning: The traction grade assigned to this tire is based on braking (straightahead) traction tests and does not include cornering (turning) traction.

Temperature -- A, B, C

The temperature grades are A (the highest), B, and C, representing the tire's resistance to the generation of heat and its ability to dissipate heat when tested under controlled conditions on a specified indoor laboratory test wheel. Sustained high temperature can cause the material of the tire to degenerate and reduce tire life, and excessive temperature can lead to sudden tire failure. The grade C corresponds to a level of performance which all passenger car tires must meet under the Federal Motor Vehicle Safety Standard No. 109. Grades B and A represent higher levels of performance on the laboratory test wheel than the minimum required by law.

Warning: The temperature grade for this tire is established for a tire that is properly inflated and not overloaded. Excessive speed, underinflation, or excessive loading, either separately or in combination, can cause heat buildup and possible tire failure.

Wheel Alignment and Tire Balance

The wheels on your vehicle were aligned and balanced carefully at the factory to give you the longest tire life and best overall performance.

Scheduled wheel alignment and wheel balancing are not needed. However, if you notice unusual tire wear or your vehicle pulling one way or the other, the alignment may need to be reset. If you notice your vehicle vibrating when driving on a smooth road, your wheels may need to be rebalanced.

Wheel Replacement

Replace any wheel that is bent, cracked, or badly rusted or corroded. If wheel nuts keep coming loose, the wheel, wheel bolts and wheel nuts should be replaced. If the wheel leaks air, replace it (except some aluminum wheels, which can sometimes be repaired). See your Buick dealer if any of these conditions exist.

Your dealer will know the kind of wheel you need.

Each new wheel should have the same load-carrying capacity, diameter, width, offset and be mounted the same way as the one it replaces.

If you need to replace any of your wheels, wheel bolts or wheel nuts, replace them only with new GM original equipment parts. This way, you will be sure to have the right wheel, wheel bolts and wheel nuts for your Buick model.



CAUTION:

Using the wrong replacement wheels, wheel bolts or wheel nuts on your vehicle can be dangerous. It could affect the braking and handling of your vehicle, make your tires lose air and make you lose control. You could have a collision in which you or others could be injured. Always use the correct wheel, wheel bolts and wheel nuts for replacement.

NOTICE:

The wrong wheel can also cause problems with bearing life, brake cooling, speedometer or odometer calibration, headlamp aim, bumper height, vehicle ground clearance and tire or tire chain clearance to the body and chassis.

See "Changing a Flat Tire" in the Index for more information.

Used Replacement Wheels

CAUTION:

Putting a used wheel on your vehicle is dangerous. You can't know how it's been used or how far it's been driven. It could fail suddenly and cause an accident. If you have to replace a wheel, use a new GM original equipment wheel.

Tire Chains

NOTICE:

Use tire chains only where legal and only when you must. Use only SAE Class "S" type chains that are the proper size for your tires. Install them on the front tires and tighten them as tightly as possible with the ends securely fastened. Drive slowly and follow the chain manufacturer's instructions. If you can hear the chains contacting your vehicle, stop and retighten them. If the contact continues, slow down until it stops. Driving too fast or spinning the wheels with chains on will damage your vehicle.

Appearance Care

Remember, cleaning products can be hazardous. Some are toxic. Others can burst into flame if you strike a match or get them on a hot part of the vehicle. Some are dangerous if you breathe their fumes in a closed space. When you use anything from a container to clean your Buick, be sure to follow the manufacturer's warnings and instructions. And always open your doors or windows when you're cleaning the inside.

Never use these to clean your vehicle:

- Gasoline
- Benzene
- Naphtha
- Carbon Tetrachloride
- Acetone
- Paint Thinner
- Turpentine
- Lacquer Thinner
- Nail Polish Remover

They can all be hazardous -- some more than others -- and they can all damage your vehicle, too.

Don't use any of these unless this manual says you can. In many uses, these will damage your vehicle:

- Alcohol
- Laundry Soap
- Bleach
- Reducing Agents

Cleaning the Inside of Your Buick

Use a vacuum cleaner often to get rid of dust and loose dirt. Wipe vinyl or leather with a clean, damp cloth.

Your Buick dealer has two cleaners, a solvent-type spot lifter and a foam-type powdered cleaner. They will clean normal spots and stains very well. Do not use them on vinyl or leather.

Here are some cleaning tips:

1. Always read the instructions on the cleaner label.
2. Clean up stains as soon as you can -- before they set.
3. Use a clean cloth or sponge, and change to a clean area often. A soft brush may be used if stains are stubborn.
4. Use solvent-type cleaners in a well-ventilated area only. If you use them, don't saturate the stained area.
5. If a ring forms after spot cleaning, clean the entire area immediately or it will set.

Using Foam-Type Cleaner on Fabric

1. Vacuum and brush the area to remove any loose dirt.
2. Always clean a whole trim panel or section. Mask surrounding trim along stitch or welt lines.
3. Mix Multi-Purpose Powdered Cleaner following the directions on the container label.
4. Use suds only and apply with a clean sponge. Don't saturate the material and don't rub it roughly.
5. As soon as you've cleaned the section, use a sponge to remove the suds.
6. Rinse the section with a clean, wet sponge.
7. Wipe off what's left with a slightly damp paper towel or cloth.
8. Dry it immediately with a blow dryer.
9. Wipe with a clean cloth.

Using Solvent-Type Cleaner on Fabric

First, see if you have to use solvent-type cleaner at all. Some spots and stains will clean off better with just water and mild soap.

If you need to use a solvent:

1. Gently scrape excess soil from the trim material with a clean, dull knife or scraper.
2. Use very little cleaner, light pressure and clean cloths (preferably cheesecloth). Cleaning should start at the outside of the stain, "feathering" toward the center.
3. Keep changing to a clean section of the cloth.
4. When you clean a stain from fabric, immediately dry the area with a blow dryer to help prevent a cleaning ring.

Special Cleaning Problems

Greasy or Oily Stains

Stains caused by grease, oil, butter, margarine, shoe polish, coffee with cream, chewing gum, cosmetic creams, vegetable oils, wax crayon, tar and asphalt can be removed as follows:

1. Carefully scrape off excess stain.
2. Follow the solvent-type instructions described earlier.

Shoe polish, wax crayon, tar and asphalt will stain if left on a vehicle's seat fabric. They should be removed as soon as possible. Be careful, because the cleaner will dissolve them and may cause them to spread.

Non-Greasy Stains

Stains caused by catsup, coffee (black), egg, fruit, fruit juice, milk, soft drinks, wine, vomit, urine and blood can be removed as follows:

1. Carefully scrape off excess stain, then sponge the soiled area with cool water.
2. If a stain remains, follow the foam-type instructions described earlier.
3. If an odor lingers after cleaning vomit or urine, treat the area with a water/baking soda solution: 1 teaspoon (5 ml) of baking soda to 1 cup (250 ml) of lukewarm water.
4. If needed, clean lightly with solvent-type cleaner.

Combination Stains

Stains caused by candy, ice cream, mayonnaise, chili sauce and unknown stains can be removed as follows:

1. Carefully scrape off excess stain.
2. Clean with cool water and allow to dry.
3. If a stain remains, clean it with solvent-type cleaner.

Cleaning Vinyl

Use warm water and a clean cloth.

- Rub with a clean, damp cloth to remove dirt. You may have to do it more than once.
- Things like tar, asphalt and shoe polish will stain if you don't get them off quickly. Use a clean cloth and a vinyl/leather cleaner. See your dealer for this product.

Cleaning Leather

Use a soft cloth with lukewarm water and a mild soap or saddle soap and wipe dry with a soft cloth. Then, let the leather dry naturally. Do not use heat to dry.

- For stubborn stains, use a leather cleaner. See your dealer for this product.
- *Never* use oils, varnishes, solvent-based or abrasive cleaners, furniture polish or shoe polish on leather.
- Soiled or stained leather should be cleaned immediately. If dirt is allowed to work into the finish, it can harm the leather.

Cleaning the Top of the Instrument Panel

Use only mild soap and water to clean the top surfaces of the instrument panel. Sprays containing silicones or waxes may cause annoying reflections in the windshield and even make it difficult to see through the windshield under certain conditions.

Cleaning Wood Panels

Use a clean cloth moistened in warm, soapy water (use mild dish washing soap). Dry the wood immediately with a clean cloth.

Cleaning Speaker Covers

Vacuum around a speaker cover gently, so that the speaker won't be damaged. Some spots and stains will clean off better with just water and mild soap. If something gets on one of them and you need to use a solvent, follow these steps:

1. Gently scrape excess soil from the trim material with a clean, dull knife or scraper.
2. Use very little cleaner, light pressure and clean cloths (preferably cheesecloth). Cleaning should start at the outside of the stain, "feathering" toward the center.
3. Keep changing to a clean section of the cloth.
4. When you clean a stain from fabric, immediately dry the area with a blow dryer to help prevent a cleaning ring.

Care of Safety Belts

Keep belts clean and dry.



CAUTION:

Do not bleach or dye safety belts. If you do, it may severely weaken them. In a crash, they might not be able to provide adequate protection. Clean safety belts only with mild soap and lukewarm water.

Glass

Glass should be cleaned often. GM Glass Cleaner (GM Part No. 1050427) or a liquid household glass cleaner will remove normal tobacco smoke and dust films on interior glass.

Don't use abrasive cleaners on glass, because they may cause scratches. Avoid placing decals on the inside rear window, since they may have to be scraped off later. If abrasive cleaners are used on the inside of the rear window, an electric defogger element may be damaged. Any temporary license should not be attached across the defogger grid.

Cleaning the Outside of the Windshield and Wiper Blades

If the windshield is not clear after using the windshield washer, or if the wiper blade chatters when running, wax, sap or other material may be on the blade or windshield.

Clean the outside of the windshield with GM Windshield Cleaner, Bon Ami[®] Powder (non-scratching glass cleaning powder), GM Part No. 1050011. The windshield is clean if beads do not form when you rinse it with water.

Grime from the windshield will stick to the wiper blades and affect their performance. Clean the blade by wiping vigorously with a cloth soaked in full-strength windshield washer solvent. Then rinse the blade with water.

Check the wiper blades and clean them as necessary; replace blades that look worn.

Weatherstrips

Silicone grease on weatherstrips will make them last longer, seal better, and not stick or squeak. Apply silicone grease with a clean cloth at least every six months. During very cold, damp weather more frequent application may be required. (See "Recommended Fluids and Lubricants" in the Index.)

Cleaning the Outside of Your Buick

The paint finish on your vehicle provides beauty, depth of color, gloss retention and durability.

Washing Your Vehicle

The best way to preserve your vehicle's finish is to keep it clean by washing it often with lukewarm or cold water.

Don't wash your vehicle in the direct rays of the sun. Don't use strong soaps or chemical detergents. Use liquid hand, dish or car washing (mild detergent) soaps. Don't use cleaning agents that are petroleum based, or that contain acid or abrasives. All cleaning agents should be flushed promptly and not allowed to dry on the surface, or they could stain. Dry the finish with a soft, clean chamois or an all-cotton towel to avoid surface scratches and water spotting.

High pressure car washes may cause water to enter your vehicle.

Cleaning Exterior Lamps/Lenses

Use lukewarm or cold water, a soft cloth and a liquid hand, dish or vehicle washing (mild detergent) soap to clean exterior lamps and lenses. Follow instructions under "Washing Your Vehicle."

Finish Care

Occasional waxing or mild polishing of your Buick by hand may be necessary to remove residue from the paint finish. You can get GM-approved cleaning products from your dealer. (See “Appearance Care and Materials” in the Index.)

Your Buick has a “basecoat/clearcoat” paint finish. The clearcoat gives more depth and gloss to the colored basecoat. Always use waxes and polishes that are non-abrasive and made for a basecoat/clearcoat paint finish.

NOTICE:

Machine compounding or aggressive polishing on a basecoat/clearcoat paint finish may dull the finish or leave swirl marks.

Foreign materials such as calcium chloride and other salts, ice melting agents, road oil and tar, tree sap, bird droppings, chemicals from industrial chimneys, etc., can damage your vehicle’s finish if they remain on painted surfaces. Wash the vehicle as soon as possible. If

necessary, use non-abrasive cleaners that are marked safe for painted surfaces to remove foreign matter.

Exterior painted surfaces are subject to aging, weather and chemical fallout that can take their toll over a period of years. You can help to keep the paint finish looking new by keeping your Buick garaged or covered whenever possible.

Aluminum or Chrome Wheels

Keep your wheels clean using a soft clean cloth with mild soap and water. Rinse with clean water. After rinsing thoroughly, dry with a soft clean towel. A wax may then be applied.

The surface of these wheels is similar to the painted surface of your vehicle. Don’t use strong soaps, chemicals, abrasive polishes, abrasive cleaners or abrasive cleaning brushes on them because you could damage the surface. You may use chrome polish on chrome wheels, but avoid any painted surface of the wheel, and buff off immediately after application.

Don’t take your vehicle through an automatic car wash that has silicon carbide tire cleaning brushes. These brushes can also damage the surface of these wheels.

Tires

To clean your tires, use a stiff brush with a tire cleaner.

NOTICE:

When applying a tire dressing always take care to wipe off any overspray or splash from all painted surfaces on the body or wheels of the vehicle. Petroleum-based products may damage the paint finish.

Sheet Metal Damage

If your vehicle is damaged and requires sheet metal repair or replacement, make sure the body repair shop applies anti-corrosion material to the parts repaired or replaced to restore corrosion protection.

Finish Damage

Any stone chips, fractures or deep scratches in the finish should be repaired right away. Bare metal will corrode quickly and may develop into a major repair expense.

Minor chips and scratches can be repaired with touch-up materials available from your dealer or other service outlets. Larger areas of finish damage can be corrected in your dealer's body and paint shop.

Underbody Maintenance

Chemicals used for ice and snow removal and dust control can collect on the underbody. If these are not removed, accelerated corrosion (rust) can occur on the underbody parts such as fuel lines, frame, floor pan and exhaust system even though they have corrosion protection.

At least every spring, flush these materials from the underbody with plain water. Clean any areas where mud and other debris can collect. Dirt packed in closed areas of the frame should be loosened before being flushed. Your dealer or an underbody car washing system can do this for you.

Chemical Paint Spotting

Some weather and atmospheric conditions can create a chemical fallout. Airborne pollutants can fall upon and attack painted surfaces on your vehicle. This damage can take two forms: blotchy, ringlet-shaped discolorations, and small irregular dark spots etched into the paint surface.

Although no defect in the paint job causes this, Buick will repair, at no charge to the owner, the surfaces of new vehicles damaged by this fallout condition within 12 months or 12,000 miles (20 000 km) of purchase, whichever occurs first.

Appearance Care Materials Chart

PART NUMBER	SIZE	DESCRIPTION	USAGE
994954	23 in. x 25 in.	Polishing Cloth – Wax Treated	Exterior Polish
1050004	2.75 sq. ft.	Chamois	Shines vehicle without scratching
1050172	16 oz. (0.473 L)	Tar and Road Oil Remover	Also removes old waxes and polishes
1050173	16 oz. (0.473 L)	Chrome Cleaner and Polish	Removes rust and corrosion
1050174	16 oz. (0.473 L)	White Sidewall Tire Cleaner	Removes soil and black marks
1050200	1 gal. (3.785 L)	Magic Mirror Cleaner Polish	Exterior cleaner and polish
1050214	32 oz. (0.946 L)	Vinyl Cleaner	Spot and stain removal
1050427	23 oz. (0.680 L)	Glass Cleaner	Cleans grease, grime and smoke film
1052870	16 oz. (0.473 L)	Wash and Wax Concentrate	Exterior wash
1052918**	8 oz. (0.237 L)	Armor All™ Protector	Protects vinyl, leather and rubber
1052925	16 oz. (0.473 L)	Multi-Purpose Powdered Cleaner	Cleans vinyl, cloth, tires and mats
1052929	16 oz. (0.473 L)	Wheel Cleaner	Spray on wheel cleaner
1052930	8 oz. (0.237 L)	Capture Dry Spot Remover	Attracts and absorbs soils
12345002**	16 oz. (0.473 L)	Armor All™ Cleaner	Cleans vinyl, leather and rubber
12345725	12 oz. (0.354 L)	Silicone Tire Shine	Shines tires
12377964	16 oz. (0.473 L)	Cleaning Wax	Protects finish and removes fine scratches
12377966	16 oz. (0.473 L)	Finish Enhancer	Spot cleans paint and gives high luster
See your General Motors Parts Department for these products. See "Fluids and Lubricants" in the Index.			**Not recommended for use on instrument panel vinyl.

Vehicle Identification Number (VIN)

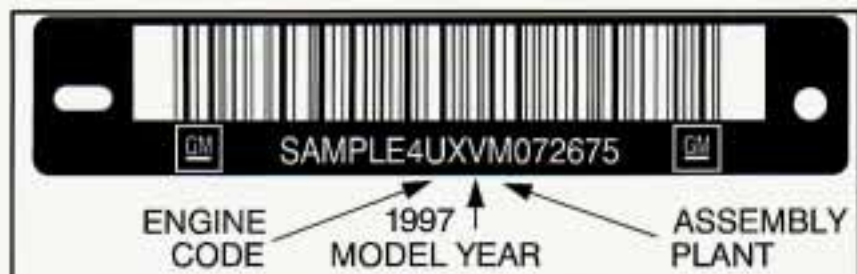

This is the legal identifier for your Buick. It appears on a plate in the front corner of the instrument panel, on the driver's side. You can see it if you look through the windshield from outside your vehicle. The VIN also appears on the Vehicle Certification and Service Parts labels and the certificates of title and registration.

Engine Identification

The 8th character in your VIN is the engine code. This code will help you identify your engine, specifications and replacement parts.

Service Parts Identification Label

You'll find this label on the underside of the spare tire cover. It's very helpful if you ever need to order parts. On this label is:

- your VIN,
- the model designation,
- paint information and
- a list of all production options and special equipment.

Be sure that this label is not removed from the vehicle.

Electrical System

Add-On Electrical Equipment

NOTICE:

Don't add anything electrical to your Buick unless you check with your dealer first. Some electrical equipment can damage your vehicle and the damage wouldn't be covered by your warranty. Some add-on electrical equipment can keep other components from working as they should.

Your vehicle has an air bag system. Before attempting to add anything electrical to your Buick, see "Servicing Your Air Bag-Equipped Buick" in the Index.

Headlamp Wiring

The headlamp wiring is protected by a circuit breaker. An electrical overload will cause the lamps to go on and off, or in some cases to remain off. If this happens, have your headlamp wiring checked right away.

Windshield Wiper Fuses

The windshield wiper motor is protected by a circuit breaker and a fuse. If the motor overheats due to heavy snow, etc., the wiper will stop until the motor cools. If the overload is caused by some electrical problem and not snow, etc., be sure to get it fixed.

Power Windows and Other Power Options

Circuit breakers in the fuse panel protect the power windows and other power accessories. When the current load is too heavy, the circuit breaker opens and closes, protecting the circuit until the problem is fixed or goes away.

Fuses and Circuit Breakers

The wiring circuits in your vehicle are protected from short circuits by a combination of fuses and circuit breakers.

Look at the silver-colored band inside the fuse. If the band is broken or melted, replace the fuse. Be sure you replace a bad fuse with a new one of the identical size and rating.

If you ever have a problem on the road and don't have a spare fuse, you can "borrow" one that has the same amperage. Just pick some feature of your vehicle that you can get along without -- like the radio or cigarette lighter -- and use its fuse if it is the correct amperage. Replace it as soon as you can.



There is a fuse panel located at the end of the instrument panel near the driver's door.

There is an underhood electrical center and two other fuse panels located under the rear seat.

Instrument Panel Fuse Block

AIR BAG	INJ	ABS	LH EXT LPS
TURN LPS	OXYGEN SENSOR	HVAC CONT	RH EXT LPS
HVAC RELAY	MAF	AUX PWR	INT LPS
CHIME	TMNSS	CRUISE CNTRL	PERIM LIGHTS
		RADIO	CLNG FAN
		WSW	FLAT PACK MTR
PCM	C/LTR	CRANK	HVAC BLOWER

Fuse	Usage	Fuse	Usage
1	Air Bag	15	Cruise Control
2	Injectors	16	Perimeter Lights
3	Anti-Lock Brake System	17	Not Used
4	Left Exterior Lamps	18	Not Used
5	Turn Signal Lamps	19	Radio
6	Oxygen Sensor	20	Cooling Fan
7	Climate Control	21	Not Used
8	Right Exterior Lamps	22	Not Used
9	HVAC Relay	23	Windshield Wipers
10	MAF	24	Flat Pack Motor
11	Auxiliary Power	25	PCM
12	Interior Lamps	26	Cigarette Lighter
13	Chime	27	Crank
14	TMNSS	28	HVAC Blower

Engine Compartment Fuse Block

AIR CONDITIONING CENTER		
HORN		
COOLING FAN #2		COOLING FAN #3
COOLING FAN	ABS MAIN	ABS PUMP MOTOR
	HORN	

Fuse	Usage
1	Air Conditioning Compressor
2	Not Used
3	Not Used
4	Horn
5	Not Used
6	Not Used
7	Cooling Fan #2
8	Cooling Fan #3
9	Cooling Fan
10	ABS Main
11	ABS Pump Motor
12	Not Used
13	Horn
14	Not Used

Under Rear Seat Fuse Block

OPEN	ELC	TRUNK REL			
OPEN	F/PMP	D/DOOR UNLOCK			
OPEN	DEFG - RR #2	DEFG - RR #1			
OPEN					
OPEN					
OPEN					
OPEN	SPARE	SPARE	SPARE	OPEN	OPEN
OPEN	DAP ACSRY	OPEN			
OPEN					
OPEN					
OPEN					

Fuse	Usage
1	Open
2	Electronic Level Control
3	Trunk Release Relay
4	Not Used
5	Fuel Pump Relay
6	Driver Door Unlock Relay
7-10	Not Used
11	Rear Defogger Relay (Upper Zone)
12	Rear Defogger Relay (Lower Zone)
13	Not Used
14	Spare
15	Spare
16	Spare
17-22	Not Used
23	Direct Accessory Power - Accessory
24	Open

Under Rear Seat Fuse Block

SPARE	SPARE	OPEN	PWR WDO/SUNRF CB		
SPARE	SPARE	OPEN			
SPARE	SPARE	OPEN	PWR ST CB		
SPARE	SPARE	OPEN			
PWR ST	HDLP CB	HVAC BLO MTR	PCM/ VATS	IGN 3	IGN 1
DEFOG RR	TRUNK FDR REL	ELC	HTD ST/ IP	EXT LP	OPEN
PWR DR LK	INTR LP	HZRD/STOP	PARK LP		
OPEN	OPEN	F/DR REL	TRUNK REL		
BATT THER	LP 2	LP 1	HTD ST		
F/PMP	OPEN	DEFOG 2	DEFOG 1		

Fuse	Usage
1-2	Spare
3	Open
4	Breaker - Power Windows/Sunroof
5-6	Spare
7	Open
8-9	Spare
10	Open
11	Breaker - Power Seats
12-13	Spare
14	Open
15	Power Steering
16	Breaker-Headlamps
17	HVAC Blower Motor
18	Powertrain Control Module/PASS-Key II
19	Ignition 3
20	Ignition 1
21	Rear Defogger
22	Trunk and Fuel Door Releases
23	Electronic Level Control

Fuse	Usage
24	Heated Seats/Instrument Panel
25	Exterior Lamps
26	Open
27	Power Door Locks
28	Interior Lamps
29	Hazard Lamps/Stoplamps
30	Parking Lamps
31	Open
32	Open
33	Fuel Door Release
34	Trunk Release
35	Battery Thermistor
36	Instrument Panel #2
37	Instrument Panel #1
38	Heated Seats
39	Fuel Pump
40	Open
41	Defog 2
42	Defog 1

Removing the Rear Seat Cushion

To access the battery and main fuse boxes, the rear seat cushion must be removed. You may wish to have your dealer do this for you.

NOTICE:

The battery and main fuse boxes are located under the rear seat cushion. The battery's ground terminal and some relay wires are exposed. To help avoid damage to the battery and wires, be careful when removing or reinstalling the seat cushion. Do not remove covers from covered parts. Do not store anything under the seat, as objects could touch exposed wires and cause a short.

To Remove the Rear Seat Cushion

1. Pull up on the front of the cushion to release the front hooks.
2. Pull the cushion up and out toward the front of the vehicle.

To Reinstall the Rear Seat Cushion

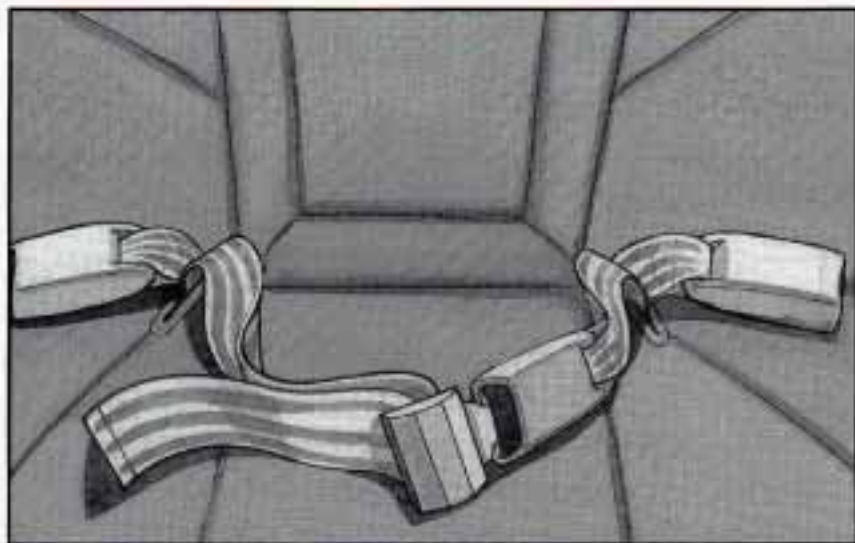

CAUTION:

A safety belt that isn't properly routed through the seat cushion or is twisted won't provide the protection needed in a crash. If the safety belt

CAUTION: (Continued)

CAUTION: (Continued)

hasn't been routed through the seat cushion at all, it won't be there to work for the next passenger. The person sitting in that position could be badly injured. After reinstalling the seat cushion, always check to be sure that the safety belts are properly routed and are not twisted.

1. Buckle the center passenger position safety belt, then route the safety belts through the proper slots in the seat cushion. Don't let the safety belts get twisted.
2. Slide the rear of the cushion up and under the seatback so the rear locating guides hook into the wire loops on the back frame.
3. With the seat cushion lowered, push rearward and then press down on the seat cushion until the spring locks on both ends engage.
4. Check to make sure the safety belts are properly routed and that no portion of any safety belt is trapped under the seat. Also make sure the seat cushion is secured.

Replacement Bulbs

Application	Number
Exterior	
Headlamp	
High-Beam	9005
Low-Beam	9006
Parking/Turn	3057
Back-Up	3057
Tail	194
Tail/Turn	3057

Interior

Rail Courtesy, Reading	PC168
Front Overhead Reading	PC168

Capacities and Specifications

The following approximate capacities are given in English and metric conversions. Please refer to "Recommended Fluids and Lubricants" in the Index for more information.

Engine Code 1 (L67) 3.8L V-6 SFI

Belt Tensions

Automatically controlled by a Self-Tension idler pulley. Tension adjustment should never be necessary.

Cooling System Capacity 13 quarts (12.5 L)

**Crankcase Capacity (oil change
with filter change)** 4.5 quarts (4.26 L)

Fuel Tank Capacity 19.4 gallons (73.4 L)

Automatic Transaxle

Drain and Refill 6 quarts (5.6 L)

Complete Overhaul 10 quarts (9.5 L)

When performing either transaxle procedure, check fluid level when done. More fluid may be needed.

Wheel Nut Torque 100 lb-ft (140 N-m)

Tire Pressure

The Tire-Loading Information label, which is located on the rear edge of the driver's door, shows the correct inflation pressures for your tires.

R-134a Air Conditioning Capacity See refrigerant charge label under the hood.

Capacities and Specifications

The following approximate capacities are given in English and metric conversions. Please refer to “Recommended Fluids and Lubricants” in the Index for more information.

Engine Code K (L36) 3.8L V-6 MFI

Belt Tensions

Automatically controlled by a Self-Tension idler pulley. Tension adjustment should never be necessary.

Cooling System Capacity 13 quarts (12.5 L)

Crankcase Capacity (oil change with filter change) 4.5 quarts (4.26 L)

Fuel Tank Capacity 19.4 gallons (73.4 L)

Automatic Transaxle

Drain and Refill 6 quarts (5.6 L)

Complete Overhaul 10 quarts (9.5 L)

When performing either transaxle procedure, check fluid level when done. More fluid may be needed.

Wheel Nut Torque 100 lb-ft (140 N·m)

Tire Pressure

The Tire-Loading Information label, which is located on the rear edge of the driver’s door, shows the correct inflation pressures for your tires.

R-134a Air Conditioning Capacity See refrigerant charge label under the hood.

Air Conditioning Refrigerants

Not all air conditioning refrigerants are the same. If the air conditioning system in your vehicle needs refrigerant, be sure the proper refrigerant is used. If you're not sure, ask your Buick dealer.

Engine Specifications

Engine	L67	L36
VIN Engine Code	1	K
Type	V6	V6
Displacement	3.8L	3.8L
Horsepower	240-hp	205-hp
Firing Order	1-6-5-4-3-2	1-6-5-4-3-2
Thermostat Temperature	195°F (91°C)	195°F (91°C)

Normal Maintenance Replacement Parts

Air Cleaner Filter	A1096C
Engine Oil Filter	PF47
Radiator Cap	RC27
Spark Plugs	41-921, Gap 0.060 inch (1.52 mm)
Windshield Wiper Blades	
Type	6.32 pin
Length	22 inches (56 cm)

Vehicle Dimensions

Length	207.2 inches (526.3 cm)
Width	75.0 inches (190.5 cm)
Height	55.2 inches (140 cm)
Wheelbase	113.8 inches (289 cm)
Front Tread	62.5 inches (158.8 cm)
Rear Tread	62.6 inches (159 cm)

Engine Accessory Belt (L36)

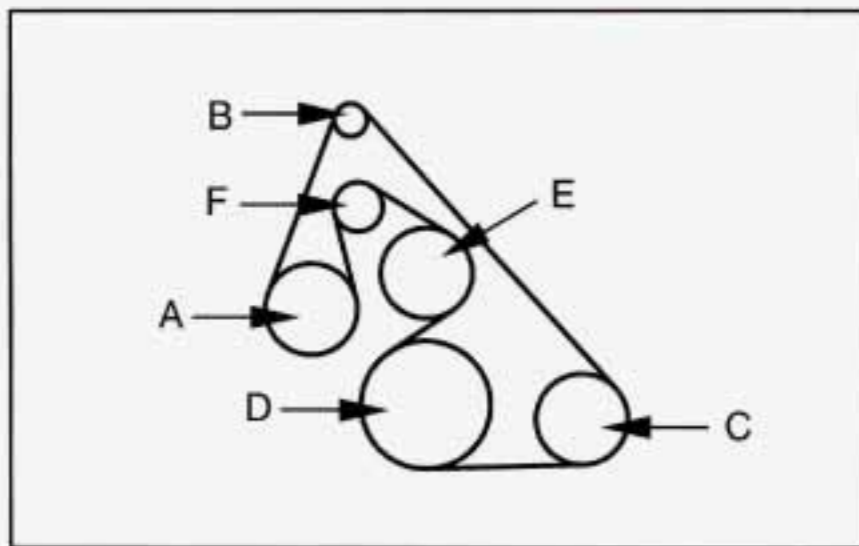

The 3800 (L36) engine uses an engine accessory belt. This diagram shows the features connected by the belt routing. See "Maintenance Schedule" in the Index for when to check the belt.

- A. Power Steering
- B. Generator
- C. Air Conditioning
- D. Crank
- E. Coolant Pump
- F. Tensioner

Supercharged Engine Accessory Belt (L67)

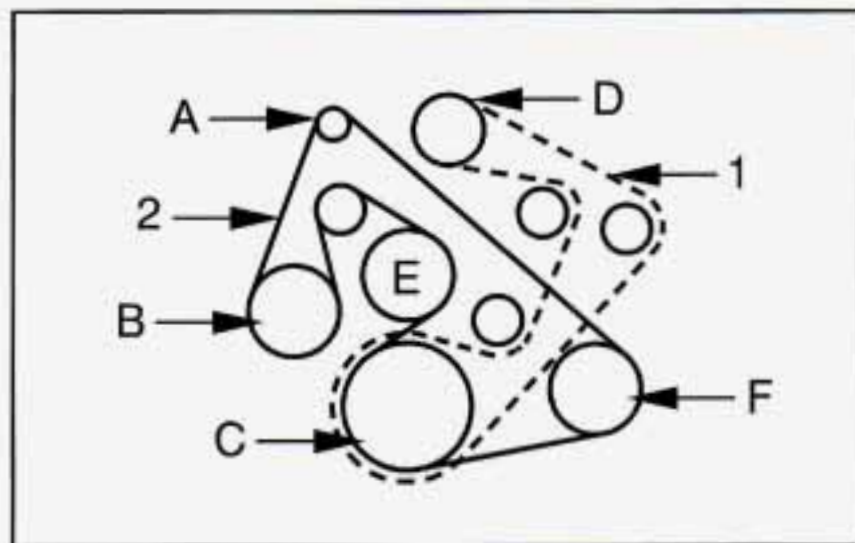

1. Front Belt
2. Back Belt
- A. Generator
- B. Power Steering
- C. Crank
- D. Supercharger
- E. Coolant Pump
- F. Air Conditioning

The Supercharged 3800 engine uses two accessory drive belts. One belt drives the generator, power steering pump, coolant pump and air conditioning compressor. The second belt drives the supercharger. Each belt has its own tensioner and idler pulley.



Section 7 Maintenance Schedule

This section covers the maintenance required for your Buick. Your vehicle needs these services to retain its safety, dependability and emission control performance.

7-2	Introduction	7-40	At Least Once a Year
7-2	Your Vehicle and the Environment	7-43	Part C: Periodic Maintenance Inspections
7-2	How This Section is Organized	7-43	Steering, Suspension and Front Drive
7-4	Part A: Scheduled Maintenance Services		Axle Boot and Seal Inspection
7-4	Using Your Maintenance Schedule	7-43	Exhaust System Inspection
7-4	Selecting the Right Schedule	7-43	Radiator and Heater Hose Inspection
7-39	Part B: Owner Checks and Services	7-43	Throttle Linkage Inspection
7-39	At Each Fuel Fill	7-43	Brake System Inspection
7-39	At Least Once a Month	7-44	Part D: Recommended Fluids and Lubricants
7-40	At Least Twice a Year	7-46	Part E: Maintenance Record

IMPORTANT:
KEEP ENGINE OIL
AT THE PROPER
LEVEL AND CHANGE AS
RECOMMENDED



***Protection
Plan***

Have you purchased the GM Protection Plan? The Plan supplements your new vehicle warranties. See your Warranty and Owner Assistance booklet, or your Buick dealer for details.

Introduction

Your Vehicle and the Environment

Proper vehicle maintenance not only helps to keep your vehicle in good working condition, but also helps the environment. All recommended maintenance procedures are important. Improper vehicle maintenance can even affect the quality of the air we breathe. Improper fluid levels or the wrong tire inflation can increase the level of emissions from your vehicle. To help protect our environment, and to keep your vehicle in good condition, please maintain your vehicle properly.

How This Section is Organized

The remainder of this section is divided into five parts:

“Part A: Scheduled Maintenance Services” shows what to have done and how often. Some of these services can be complex, so unless you are technically qualified and have the necessary equipment, you should let your dealer’s service department or another qualified service center do these jobs.

 **CAUTION:**

Performing maintenance work on a vehicle can be dangerous. In trying to do some jobs, you can be seriously injured. Do your own maintenance work only if you have the required know-how and the proper tools and equipment for the job. If you have any doubt, have a qualified technician do the work.

If you are skilled enough to do some work on your vehicle, you will probably want to get the service information GM publishes. See “Service and Owner Publications” in the Index.

“**Part B: Owner Checks and Services**” tells you what should be checked and when. It also explains what you can easily do to help keep your vehicle in good condition.

“**Part C: Periodic Maintenance Inspections**” explains important inspections that your Buick dealer’s service department or another qualified service center should perform.

“**Part D: Recommended Fluids and Lubricants**” lists some products GM recommends to help keep your vehicle properly maintained. These products, or their equivalents, should be used whether you do the work yourself or have it done.

“**Part E: Maintenance Record**” provides a place for you to record the maintenance performed on your vehicle. Whenever any maintenance is performed, be sure to write it down in this part. This will help you determine when your next maintenance should be done. In addition, it is a good idea to keep your maintenance receipts. They may be needed to qualify your vehicle for warranty repairs.

Part A: Scheduled Maintenance Services

Using Your Maintenance Schedule

We at General Motors want to help you keep your vehicle in good working condition. But we don't know exactly how you'll drive it. You may drive very short distances only a few times a week. Or you may drive long distances all the time in very hot, dusty weather. You may use your vehicle in making deliveries. Or you may drive it to work, to do errands or in many other ways.

Because of all the different ways people use their GM vehicles, maintenance needs vary. You may even need more frequent checks and replacements than you'll find in the schedules in this section. So please read this section and note how you drive. If you have any questions on how to keep your vehicle in good condition, see your Buick dealer.

This part tells you the maintenance services you should have done and when you should schedule them. If you go to your dealer for your service needs, you'll know that GM-trained and supported service people will perform the work using genuine GM parts.

The proper fluids and lubricants to use are listed in Part D. Make sure whoever services your vehicle uses these. All parts should be replaced and all necessary repairs done before you or anyone else drives the vehicle.

These schedules are for vehicles that:

- carry passengers and cargo within recommended limits. You will find these limits on your vehicle's Tire-Loading Information label. See "Loading Your Vehicle" in the Index.
- are driven on reasonable road surfaces within legal driving limits.
- use the recommended fuel. See "Fuel" in the Index.

Selecting the Right Schedule

First you'll need to decide which of the two schedules is right for your vehicle. Here's how to decide which schedule to follow:

Maintenance Schedule

Short Trip/City Definition

Follow the Short Trip/City Maintenance Schedule if any one of these conditions is true for your vehicle:

- Most trips are less than 5 to 10 miles (8 to 16 km). This is particularly important when outside temperatures are below freezing.
- Most trips include extensive idling (such as frequent driving in stop-and-go traffic).
- Most trips are through dusty areas.
- You frequently tow a trailer or use a carrier on top of your vehicle.
- If the vehicle is used for delivery service, police, taxi or other commercial application.

One of the reasons you should follow this schedule if you operate your vehicle under any of these conditions is that these conditions cause engine oil to break down sooner.

Short Trip/City Intervals

Every 3,000 Miles (5 000 km): Engine Oil and Filter Change (or 3 months, whichever occurs first).

Every 6,000 Miles (10 000 km): Chassis Lubrication (or 6 months, whichever occurs first). Tire Rotation.

Every 15,000 Miles (25 000 km): Air Cleaner Filter Inspection, if driving in dusty conditions.

Every 30,000 Miles (50 000 km): Air Cleaner Filter Replacement. Fuel Tank, Cap and Lines Inspection. Supercharger Oil Check (or every 36 months, whichever occurs first) (3.8L Code 1 engine only).

Every 50,000 Miles (83 000 km): Automatic Transaxle Service (severe conditions only).

Every 60,000 Miles (100 000 km): Engine Accessory Drive Belt Inspection.

Every 100,000 Miles (166 000 km): Spark Plug Wire Inspection. Spark Plug Replacement.

Every 150,000 Miles (240 000 km): Cooling System Service (or every 60 months, whichever occurs first).

These intervals only summarize maintenance services. Be sure to follow the complete maintenance schedule on the following pages.

Maintenance Schedule

Long Trip/Highway Definition

Follow this maintenance schedule *only* if none of the conditions from the Short Trip/City Maintenance Schedule is true. Do not use this schedule if the vehicle is used for trailer towing, driven in a dusty area or used off paved roads. Use the Short Trip/City schedule for these conditions.

Driving a vehicle with a fully warmed engine under highway conditions causes engine oil to break down slower.

Long Trip/Highway Intervals

Every 7,500 Miles (12 500 km): Engine Oil and Filter Change (or every 12 months, whichever occurs first). Chassis Lubrication (or every 12 months, whichever occurs first). Tire Rotation.

Every 30,000 Miles (50 000 km): Supercharger Oil Check (or every 36 months, whichever occurs first) (3.8L Code 1 engine only). Air Cleaner Filter Replacement. Fuel Tank, Cap and Lines Inspection.

Every 50,000 Miles (83 000 km): Automatic Transaxle Service (severe conditions only).

Every 60,000 Miles (100 000 km): Engine Accessory Drive Belt Inspection.

Every 100,000 Miles (166 000 km): Spark Plug Wire Inspection. Spark Plug Replacement.

Every 150,000 Miles (240 000 km): Cooling System Service (or every 60 months, whichever occurs first).

These intervals only summarize maintenance services. Be sure to follow the complete maintenance schedule on the following pages.

Short Trip/City Maintenance Schedule

The services shown in this schedule up to 100,000 miles (166 000 km) should be performed after 100,000 miles (166 000 km) at the same intervals. The services shown at 150,000 miles (240 000 km) should be performed at the same interval after 150,000 miles (240 000 km). See "Owner Checks and Services" and "Periodic Maintenance Inspections" following.

Footnotes

† The U.S. Environmental Protection Agency or the California Air Resources Board has determined that the failure to perform this maintenance item will not nullify the emission warranty or limit recall liability prior to the completion of the vehicle's useful life. We, however, urge that all recommended maintenance services be performed at the indicated intervals and the maintenance be recorded.

Lubricate the suspension and steering linkage, transaxle shift linkage, parking brake cable guides and the underbody contact points and linkage.

+ A good time to check your brakes is during tire rotation. See "Brake System Inspection" under "Periodic Maintenance Inspection" in Part C of this schedule.

3,000 Miles (5 000 km)

- Change engine oil and filter (or every 3 months, whichever occurs first).

An Emission Control Service.

DATE	ACTUAL MILEAGE	SERVICED BY:

Short Trip/City Maintenance Schedule

6,000 Miles (10 000 km)

- Change engine oil and filter (or every 3 months, whichever occurs first).
An Emission Control Service.
- Lubricate chassis components (or every 6 months, whichever occurs first).
(See footnote #.)
- Rotate tires. See "Tire Inspection and Rotation" in the Index for proper rotation pattern and additional information.
(See footnote +.)

DATE	ACTUAL MILEAGE	SERVICED BY:

9,000 Miles (15 000 km)

- Change engine oil and filter (or every 3 months, whichever occurs first).
An Emission Control Service.

DATE	ACTUAL MILEAGE	SERVICED BY:

Short Trip/City Maintenance Schedule

12,000 Miles (20 000 km)

- Change engine oil and filter (or every 3 months, whichever occurs first).
An Emission Control Service.
- Lubricate chassis components (or every 6 months, whichever occurs first).
(See footnote #.)
- Rotate tires. See "Tire Inspection and Rotation" in the Index for proper rotation pattern and additional information.
(See footnote +.)

DATE	ACTUAL MILEAGE	SERVICED BY:

15,000 Miles (25 000 km)

- Change engine oil and filter (or every 3 months, whichever occurs first).
An Emission Control Service.
- Inspect air cleaner filter if you are driving in dusty conditions. Replace filter if necessary. *An Emission Control Service.*
(See footnote †.)

DATE	ACTUAL MILEAGE	SERVICED BY:

Short Trip/City Maintenance Schedule

18,000 Miles (30 000 km)

- Change engine oil and filter (or every 3 months, whichever occurs first).
An Emission Control Service.
- Lubricate chassis components (or every 6 months, whichever occurs first).
(See footnote #.)
- Rotate tires. See "Tire Inspection and Rotation" in the Index for proper rotation pattern and additional information.
(See footnote +.)

DATE	ACTUAL MILEAGE	SERVICED BY:

21,000 Miles (35 000 km)

- Change engine oil and filter (or every 3 months, whichever occurs first).
An Emission Control Service.

DATE	ACTUAL MILEAGE	SERVICED BY:

Short Trip/City Maintenance Schedule

24,000 Miles (40 000 km)

- Change engine oil and filter (or every 3 months, whichever occurs first).
An Emission Control Service.
- Lubricate chassis components (or every 6 months, whichever occurs first).
(See footnote #.)
- Rotate tires. See "Tire Inspection and Rotation" in the Index for proper rotation pattern and additional information.
(See footnote +.)

DATE	ACTUAL MILEAGE	SERVICED BY:

27,000 Miles (45 000 km)

- Change engine oil and filter (or every 3 months, whichever occurs first).
An Emission Control Service.

DATE	ACTUAL MILEAGE	SERVICED BY:

Short Trip/City Maintenance Schedule

30,000 Miles (50 000 km)

- Change engine oil and filter (or every 3 months, whichever occurs first).
An Emission Control Service.
- Lubricate chassis components (or every 6 months, whichever occurs first).
(See footnote #.)
- Replace air cleaner filter.
An Emission Control Service.
- Inspect fuel tank, cap and lines for damage or leaks. Inspect fuel cap gasket for any damage. Replace parts as needed.
An Emission Control Service. (See footnote †.)

- For supercharged engines only: Check the supercharger oil level and add oil as needed (or every 36 months, whichever occurs first). See "Recommended Fluids and Lubricants" in this section.
An Emission Control Service. (See footnote †.)
- Rotate tires. See "Tire Inspection and Rotation" in the Index for proper rotation pattern and additional information.
(See footnote +.)

DATE	ACTUAL MILEAGE	SERVICED BY:

Short Trip/City Maintenance Schedule

33,000 Miles (55 000 km)

- Change engine oil and filter (or every 3 months, whichever occurs first).
An Emission Control Service.

DATE	ACTUAL MILEAGE	SERVICED BY:

36,000 Miles (60 000 km)

- Change engine oil and filter (or every 3 months, whichever occurs first).
An Emission Control Service.
- Lubricate chassis components (or every 6 months, whichever occurs first).
(See footnote #.)
- Rotate tires. See "Tire Inspection and Rotation" in the Index for proper rotation pattern and additional information.
(See footnote +.)

DATE	ACTUAL MILEAGE	SERVICED BY:

Short Trip/City Maintenance Schedule

39,000 Miles (65 000 km)

- Change engine oil and filter (or every 3 months, whichever occurs first).

An Emission Control Service.

42,000 Miles (70 000 km)

- Change engine oil and filter (or every 3 months, whichever occurs first).
An Emission Control Service.
- Lubricate chassis components (or every 6 months, whichever occurs first).
(See footnote #.)
- Rotate tires. See "Tire Inspection and Rotation" in the Index for proper rotation pattern and additional information.
(See footnote +.)

DATE	ACTUAL MILEAGE	SERVICED BY:

DATE	ACTUAL MILEAGE	SERVICED BY:

Short Trip/City Maintenance Schedule

45,000 Miles (75 000 km)

- Change engine oil and filter (or every 3 months, whichever occurs first).
An Emission Control Service.
- Inspect air cleaner filter if you are driving in dusty conditions. Replace filter if necessary. *An Emission Control Service.* (See footnote†.)

DATE	ACTUAL MILEAGE	SERVICED BY:

48,000 Miles (80 000 km)

- Change engine oil and filter (or every 3 months, whichever occurs first).
An Emission Control Service.
- Lubricate chassis components (or every 6 months, whichever occurs first). (See footnote #.)
- Rotate tires. See “Tire Inspection and Rotation” in the Index for proper rotation pattern and additional information. (See footnote +.)

DATE	ACTUAL MILEAGE	SERVICED BY:

Short Trip/City Maintenance Schedule

50,000 Miles (83 000 km)

- Change automatic transaxle fluid and filter if the vehicle is mainly driven under one or more of these conditions:
- In heavy city traffic where the outside temperature regularly reaches 90°F (32°C) or higher.
 - In hilly or mountainous terrain.

- When doing frequent trailer towing.
- Uses such as found in taxi, police or delivery service.

If you do not use your vehicle under any of these conditions, the fluid and filter do not require changing.

DATE	ACTUAL MILEAGE	SERVICED BY:

Short Trip/City Maintenance Schedule

51,000 Miles (85 000 km)

- Change engine oil and filter (or every 3 months, whichever occurs first).
An Emission Control Service.

DATE	ACTUAL MILEAGE	SERVICED BY:

54,000 Miles (90 000 km)

- Change engine oil and filter (or every 3 months, whichever occurs first).
An Emission Control Service.
- Lubricate chassis components (or every 6 months, whichever occurs first).
(See footnote #.)
- Rotate tires. See "Tire Inspection and Rotation" in the Index for proper rotation pattern and additional information.
(See footnote +.)

DATE	ACTUAL MILEAGE	SERVICED BY:

Short Trip/City Maintenance Schedule

57,000 Miles (95 000 km)

- Change engine oil and filter (or every 3 months, whichever occurs first).

An Emission Control Service.

60,000 Miles (100 000 km)

- Change engine oil and filter (or every 3 months, whichever occurs first).
An Emission Control Service.
- Lubricate chassis components (or every 6 months, whichever occurs first).
(See footnote #.)
- Inspect engine accessory drive belt.
An Emission Control Service.
- Replace air cleaner filter.
An Emission Control Service.
- Inspect fuel tank, cap and lines for damage or leaks. Inspect fuel cap gasket for any damage. Replace parts as needed.
An Emission Control Service. (See footnote †.)

DATE	ACTUAL MILEAGE	SERVICED BY:

Short Trip/City Maintenance Schedule

- For supercharged engines only: Check the supercharger oil level and add oil as needed (or every 36 months, whichever occurs first). See “Recommended Fluids and Lubricants” in this section.

An Emission Control Service. (See footnote †.)

- Rotate tires. See “Tire Inspection and Rotation” in the Index for proper rotation pattern and additional information. (See footnote +.)

63,000 Miles (105 000 km)

- Change engine oil and filter (or every 3 months, whichever occurs first).

An Emission Control Service.

DATE	ACTUAL MILEAGE	SERVICED BY:

DATE	ACTUAL MILEAGE	SERVICED BY:

Short Trip/City Maintenance Schedule

66,000 Miles (110 000 km)

- Change engine oil and filter (or every 3 months, whichever occurs first).
An Emission Control Service.
- Lubricate chassis components (or every 6 months, whichever occurs first).
(See footnote #.)
- Rotate tires. See "Tire Inspection and Rotation" in the Index for proper rotation pattern and additional information.
(See footnote +.)

DATE	ACTUAL MILEAGE	SERVICED BY:

69,000 Miles (115 000 km)

- Change engine oil and filter (or every 3 months, whichever occurs first).
An Emission Control Service.

DATE	ACTUAL MILEAGE	SERVICED BY:

Short Trip/City Maintenance Schedule

72,000 Miles (120 000 km)

- Change engine oil and filter (or every 3 months, whichever occurs first).
An Emission Control Service.
- Lubricate chassis components (or every 6 months, whichever occurs first).
(See footnote #.)
- Rotate tires. See "Tire Inspection and Rotation" in the Index for proper rotation pattern and additional information.
(See footnote +.)

DATE	ACTUAL MILEAGE	SERVICED BY:

75,000 Miles (125 000 km)

- Change engine oil and filter (or every 3 months, whichever occurs first).
An Emission Control Service.
- Inspect air cleaner filter if you are driving in dusty conditions. Replace filter if necessary. *An Emission Control Service.*
(See footnote †.)

DATE	ACTUAL MILEAGE	SERVICED BY:

Short Trip/City Maintenance Schedule

78,000 Miles (130 000 km)

- Change engine oil and filter (or every 3 months, whichever occurs first).
An Emission Control Service.
- Lubricate chassis components (or every 6 months, whichever occurs first).
(See footnote #.)
- Rotate tires. See "Tire Inspection and Rotation" in the Index for proper rotation pattern and additional information.
(See footnote +.)

DATE	ACTUAL MILEAGE	SERVICED BY:

81,000 Miles (135 000 km)

- Change engine oil and filter (or every 3 months, whichever occurs first).
An Emission Control Service.

DATE	ACTUAL MILEAGE	SERVICED BY:

Short Trip/City Maintenance Schedule

84,000 Miles (140 000 km)

- Change engine oil and filter (or every 3 months, whichever occurs first).
An Emission Control Service.
- Lubricate chassis components (or every 6 months, whichever occurs first).
(See footnote #.)
- Rotate tires. See "Tire Inspection and Rotation" in the Index for proper rotation pattern and additional information.
(See footnote +.)

DATE	ACTUAL MILEAGE	SERVICED BY:

87,000 Miles (145 000 km)

- Change engine oil and filter (or every 3 months, whichever occurs first).
An Emission Control Service.

DATE	ACTUAL MILEAGE	SERVICED BY:

Short Trip/City Maintenance Schedule

90,000 Miles (150 000 km)

- Change engine oil and filter (or every 3 months, whichever occurs first).
An Emission Control Service.
- Lubricate chassis components (or every 6 months, whichever occurs first).
(See footnote #.)
- Replace air cleaner filter.
An Emission Control Service.
- Inspect fuel tank, cap and lines for damage or leaks. Inspect fuel cap gasket for any damage. Replace parts as needed.
An Emission Control Service. (See footnote †.)

- For supercharged engines only: Check the supercharger oil level and add oil as needed (or every 36 months, whichever occurs first). See “Recommended Fluids and Lubricants” in this section.
An Emission Control Service. (See footnote †.)
- Rotate tires. See “Tire Inspection and Rotation” in the Index for proper rotation pattern and additional information.
(See footnote +.)

DATE	ACTUAL MILEAGE	SERVICED BY:

Short Trip/City Maintenance Schedule

93,000 Miles (155 000 km)

- Change engine oil and filter (or every 3 months, whichever occurs first).

An Emission Control Service.

96,000 Miles (160 000 km)

- Change engine oil and filter (or every 3 months, whichever occurs first).
An Emission Control Service.
- Lubricate chassis components (or every 6 months, whichever occurs first).
(See footnote #.)
- Rotate tires. See "Tire Inspection and Rotation" in the Index for proper rotation pattern and additional information.
(See footnote +.)

DATE	ACTUAL MILEAGE	SERVICED BY:

DATE	ACTUAL MILEAGE	SERVICED BY:

Short Trip/City Maintenance Schedule

99,000 Miles (165 000 km)

- Change engine oil and filter (or every 3 months, whichever occurs first).
An Emission Control Service.

DATE	ACTUAL MILEAGE	SERVICED BY:

100,000 Miles (166 000 km)

- Inspect spark plug wires.
An Emission Control Service.
- Replace spark plugs.
An Emission Control Service.
- Change automatic transaxle fluid and filter if the vehicle is mainly driven under one or more of these conditions:
- In heavy city traffic where the outside temperature regularly reaches 90°F (32°C) or higher.
 - In hilly or mountainous terrain.

DATE	ACTUAL MILEAGE	SERVICED BY:

Short Trip/City Maintenance Schedule

- When doing frequent trailer towing.
- Uses such as found in taxi, police or delivery service.

If you do not use your vehicle under any of these conditions, the fluid and filter do not require changing.

DATE	ACTUAL MILEAGE	SERVICED BY:

150,000 Miles (240 000 km)

- Drain, flush and refill cooling system (or every 60 months since last service, whichever occurs first). See "Engine Coolant" in the Index for what to use. Inspect hoses. Clean radiator, condenser, pressure cap and neck. Pressure test cooling system and pressure cap. *An Emission Control Service.*

DATE	ACTUAL MILEAGE	SERVICED BY:

Long Trip/Highway Maintenance Schedule

The services shown in this schedule up to 100,000 miles (166 000 km) should be performed after 100,000 miles (166 000 km) at the same intervals. The services shown at 150,000 miles (240 000 km) should be performed at the same interval after 150,000 miles (240 000 km). See "Owner Checks and Services" and "Periodic Maintenance Inspections" following.

Footnotes

† The U.S. Environmental Protection Agency or the California Air Resources Board has determined that the failure to perform this maintenance item will not nullify the emission warranty or limit recall liability prior to the completion of the vehicle's useful life. We, however, urge that all recommended maintenance services be performed at the indicated intervals and the maintenance be recorded.

Lubricate the suspension and steering linkage, transaxle shift linkage, parking brake cable guides and the underbody contact points and linkage.

+ A good time to check your brakes is during tire rotation. See "Brake System Inspection" under "Periodic Maintenance Inspections" in Part C of this schedule.

7,500 Miles (12 500 km)

- Change engine oil and filter (or every 12 months, whichever occurs first).
An Emission Control Service.
- Lubricate chassis components (or every 12 months, whichever occurs first).
(See footnote #.)
- Rotate tires. See "Tire Inspection and Rotation" in the Index for proper rotation pattern and additional information.
(See footnote +.)

DATE	ACTUAL MILEAGE	SERVICED BY:

Long Trip/Highway Maintenance Schedule

15,000 Miles (25 000 km)

- Change engine oil and filter (or every 12 months, whichever occurs first).
An Emission Control Service.
- Lubricate chassis components (or every 12 months, whichever occurs first).
(See footnote #.)
- Rotate tires. See "Tire Inspection and Rotation" in the Index for proper rotation pattern and additional information.
(See footnote +.)

DATE	ACTUAL MILEAGE	SERVICED BY:

22,500 Miles (37 500 km)

- Change engine oil and filter (or every 12 months, whichever occurs first).
An Emission Control Service.
- Lubricate chassis components (or every 12 months, whichever occurs first).
(See footnote #.)
- Rotate tires. See "Tire Inspection and Rotation" in the Index for proper rotation pattern and additional information.
(See footnote +.)

DATE	ACTUAL MILEAGE	SERVICED BY:

Long Trip/Highway Maintenance Schedule

30,000 Miles (50 000 km)

- Change engine oil and filter (or every 12 months, whichever occurs first).
An Emission Control Service.
- Lubricate chassis components (or every 12 months, whichever occurs first).
(See footnote #.)
- Rotate tires. See "Tire Inspection and Rotation" in the Index for proper rotation pattern and additional information.
(See footnote +.)
- Replace air cleaner filter.
An Emission Control Service.

- Inspect fuel tank, cap and lines for damage or leaks. Inspect fuel cap gasket for any damage. Replace parts as needed.
An Emission Control Service. (See footnote †.)
- For supercharged engines only: Check the supercharger oil level and add oil as needed (or every 36 months, whichever occurs first). See "Recommended Fluids and Lubricants" in this section.
An Emission Control Service. (See footnote †.)

DATE	ACTUAL MILEAGE	SERVICED BY:

Long Trip/Highway Maintenance Schedule

37,500 Miles (62 500 km)

- Change engine oil and filter (or every 12 months, whichever occurs first).
An Emission Control Service.
- Lubricate chassis components (or every 12 months, whichever occurs first).
(See footnote #.)
- Rotate tires. See "Tire Inspection and Rotation" in the Index for proper rotation pattern and additional information.
(See footnote +.)

DATE	ACTUAL MILEAGE	SERVICED BY:

45,000 Miles (75 000 km)

- Change engine oil and filter (or every 12 months, whichever occurs first).
An Emission Control Service.
- Lubricate chassis components (or every 12 months, whichever occurs first).
(See footnote #.)
- Rotate tires. See "Tire Inspection and Rotation" in the Index for proper rotation pattern and additional information.
(See footnote +.)

DATE	ACTUAL MILEAGE	SERVICED BY:

Long Trip/Highway Maintenance Schedule

50,000 Miles (83 000 km)

- Change automatic transaxle fluid and filter if the vehicle is mainly driven under one or more of these conditions:
- In heavy city traffic where the outside temperature regularly reaches 90°F (32°C) or higher.
 - In hilly or mountainous terrain.

- When doing frequent trailer towing.
- Uses such as found in taxi, police or delivery service.

If you do not use your vehicle under any of these conditions, the fluid and filter do not require changing.

DATE	ACTUAL MILEAGE	SERVICED BY:

Long Trip/Highway Maintenance Schedule

52,500 Miles (87 500 km)

- Change engine oil and filter (or every 12 months, whichever occurs first).
An Emission Control Service.
- Lubricate chassis components (or every 12 months, whichever occurs first).
(See footnote #.)
- Rotate tires. See "Tire Inspection and Rotation" in the Index for proper rotation pattern and additional information.
(See footnote +.)

DATE	ACTUAL MILEAGE	SERVICED BY:

60,000 Miles (100 000 km)

- Change engine oil and filter (or every 12 months, whichever occurs first).
An Emission Control Service.
- Lubricate chassis components (or every 12 months, whichever occurs first).
(See footnote #.)
- For supercharged engines only: Check the supercharger oil level and add oil as needed (or every 36 months, whichever occurs first). See "Recommended Fluids and Lubricants" in this section.
An Emission Control Service. (See footnote †.)

(Continued)

Long Trip/Highway Maintenance Schedule

60,000 Miles (100 000 km) (Continued)

- Rotate tires. See “Tire Inspection and Rotation” in the Index for proper rotation pattern and additional information. (See footnote +.)
- Inspect engine accessory drive belt.
An Emission Control Service.
- Replace air cleaner filter.
An Emission Control Service.
- Inspect fuel tank, cap and lines for damage or leaks. Inspect fuel cap gasket for any damage. Replace parts as needed.
An Emission Control Service. (See footnote †.)

DATE	ACTUAL MILEAGE	SERVICED BY:

67,500 Miles (112 500 km)

- Change engine oil and filter (or every 12 months, whichever occurs first).
An Emission Control Service.
- Lubricate chassis components (or every 12 months, whichever occurs first). (See footnote #.)
- Rotate tires. See “Tire Inspection and Rotation” in the Index for proper rotation pattern and additional information. (See footnote +.)

DATE	ACTUAL MILEAGE	SERVICED BY:

Long Trip/Highway Maintenance Schedule

75,000 Miles (125 000 km)

- Change engine oil and filter (or every 12 months, whichever occurs first).
An Emission Control Service.
- Lubricate chassis components (or every 12 months, whichever occurs first).
(See footnote #.)
- Rotate tires. See “Tire Inspection and Rotation” in the Index for proper rotation pattern and additional information.
(See footnote +.)

DATE	ACTUAL MILEAGE	SERVICED BY:

82,500 Miles (137 500 km)

- Change engine oil and filter (or every 12 months, whichever occurs first).
An Emission Control Service.
- Lubricate chassis components (or every 12 months, whichever occurs first).
(See footnote #.)
- Rotate tires. See “Tire Inspection and Rotation” in the Index for proper rotation pattern and additional information.
(See footnote +.)

DATE	ACTUAL MILEAGE	SERVICED BY:

Long Trip/Highway Maintenance Schedule

90,000 Miles (150 000 km)

- Change engine oil and filter (or every 12 months, whichever occurs first).
An Emission Control Service.
- Lubricate chassis components (or every 12 months, whichever occurs first).
(See footnote #.)
- Replace air cleaner filter.
An Emission Control Service.
- Inspect fuel tank, cap and lines for damage or leaks. Inspect fuel cap gasket for any damage. Replace parts as needed.
An Emission Control Service. (See footnote †.)

- For supercharged engines only: Check the supercharger oil level and add oil as needed (or every 36 months, whichever occurs first). See “Recommended Fluids and Lubricants” in this section.
An Emission Control Service. (See footnote †.)
- Rotate tires. See “Tire Inspection and Rotation” in the Index for proper rotation pattern and additional information.
(See footnote +.)

DATE	ACTUAL MILEAGE	SERVICED BY:

Long Trip/Highway Maintenance Schedule

97,500 Miles (162 500 km)

- Change engine oil and filter (or every 12 months, whichever occurs first).
An Emission Control Service.
- Lubricate chassis components (or every 12 months, whichever occurs first).
(See footnote #.)
- Rotate tires. See "Tire Inspection and Rotation" in the Index for proper rotation pattern and additional information.
(See footnote +.)

DATE	ACTUAL MILEAGE	SERVICED BY:

100,000 Miles (166 000 km)

- Inspect spark plug wires.
An Emission Control Service.
- Replace spark plugs.
An Emission Control Service.
- Change automatic transaxle fluid and filter if the vehicle is mainly driven under one or more of these conditions:
 - In heavy city traffic where the outside temperature regularly reaches 90°F (32°C) or higher.
 - In hilly or mountainous terrain.

(Continued)

Long Trip/Highway Maintenance Schedule

100,000 Miles (166 000 km) (Continued)

- When doing frequent trailer towing.
- Uses such as found in taxi, police or delivery service.

If you do not use your vehicle under any of these conditions, the fluid and filter do not require changing.

DATE	ACTUAL MILEAGE	SERVICED BY:

150,000 Miles (240 000 km)

- Drain, flush and refill cooling system (or every 60 months since last service, whichever occurs first). See "Engine Coolant" in the Index for what to use. Inspect hoses. Clean radiator, condenser, pressure cap and neck. Pressure test the cooling system and pressure cap.
An Emission Control Service.

DATE	ACTUAL MILEAGE	SERVICED BY:

Part B: Owner Checks and Services

Listed below are owner checks and services which should be performed at the intervals specified to help ensure the safety, dependability and emission control performance of your vehicle.

Be sure any necessary repairs are completed at once. Whenever any fluids or lubricants are added to your vehicle, make sure they are the proper ones, as shown in Part D.

At Each Fuel Fill

It is important for you or a service station attendant to perform these underhood checks at each fuel fill.

Engine Oil Level Check

Check the engine oil level and add the proper oil if necessary. See “Engine Oil” in the Index for further details.

Engine Coolant Level Check

Check the engine coolant level and add DEX-COOL[®] coolant mixture if necessary. See “Engine Coolant” in the Index for further details.

Windshield Washer Fluid Level Check

Check the windshield washer fluid level in the windshield washer tank and add the proper fluid if necessary. See “Windshield Washer Fluid” in the Index for further details.

At Least Once a Month

Tire Inflation Check

Make sure tires are inflated to the correct pressures. See “Tires” in the Index for further details.

Cassette Deck Service

Clean cassette deck. Cleaning should be done every 50 hours of tape play. See “Audio Systems” in the Index for further details.

Power Antenna Service

Clean power antenna mast. See “Audio Systems” in the Index for further details.

At Least Twice a Year

Restraint System Check

Make sure the safety belt reminder light and all your belts, buckles, latch plates, retractors and anchorages are working properly. Look for any other loose or damaged safety belt system parts. If you see anything that might keep a safety belt system from doing its job, have it repaired. Have any torn or frayed safety belts replaced.

Also look for any opened or broken air bag covers, and have them repaired or replaced. (The air bag system does not need regular maintenance.)

Wiper Blade Check

Inspect wiper blades for wear or cracking. Replace blade inserts that appear worn or damaged or that streak or miss areas of the windshield. Also see "Wiper Blades, Cleaning" in the Index.

Automatic Transaxle Check

Check the transaxle fluid level; add if needed. See "Automatic Transaxle" in the Index. A fluid loss may indicate a problem. Check the system and repair if needed.

At Least Once a Year

Key Lock Cylinders Service

Lubricate the key lock cylinders with the lubricant specified in Part D.

Body Lubrication Service

Lubricate all body door hinges. Also lubricate all hinges and latches, including those for the hood, glove box door, console door and any folding seat hardware. Part D tells you what to use. More frequent lubrication may be required when exposed to a corrosive environment.

Starter Switch Check

CAUTION:

When you are doing this check, the vehicle could move suddenly. If it does, you or others could be injured. Follow the steps below.

1. Before you start, be sure you have enough room around the vehicle.
2. Firmly apply both the parking brake (see “Parking Brake” in the Index if necessary) and the regular brake.

NOTE: Do not use the accelerator pedal, and be ready to turn off the engine immediately if it starts.

3. Try to start the engine in each gear. The starter should work only in PARK (P) or NEUTRAL (N). If the starter works in any other position, your vehicle needs service.

Brake-Transaxle Shift Interlock (BTSI) Check (Automatic Transaxle)

CAUTION:

When you are doing this check, the vehicle could move suddenly. If it does, you or others could be injured. Follow the steps below.

1. Before you start, be sure you have enough room around the vehicle. It should be parked on a level surface.
2. Firmly apply the parking brake (see “Parking Brake” in the Index if necessary).

NOTE: Be ready to apply the regular brake immediately if the vehicle begins to move.

3. With the engine off, turn the key to the RUN position, but don't start the engine. Without applying the regular brake, try to move the shift lever out of PARK (P) with normal effort. If the shift lever moves out of PARK (P), your vehicle's BTSI needs service.

Ignition Transaxle Lock Check

While parked, and with the parking brake set, try to turn the ignition key to LOCK in each shift lever position.

- The key should turn to LOCK only when the shift lever is in PARK (P).
- The key should come out only in LOCK.

Parking Brake and Automatic Transaxle PARK (P) Mechanism Check

CAUTION:

When you are doing this check, your vehicle could begin to move. You or others could be injured and property could be damaged. Make sure there is room in front of your vehicle in case it begins to roll. Be ready to apply the regular brake at once should the vehicle begin to move.

Park on a fairly steep hill, with the vehicle facing downhill. Keeping your foot on the regular brake, set the parking brake.

- To check the parking brake's holding ability: With the engine running and transaxle in NEUTRAL (N), slowly remove foot pressure from the regular brake pedal. Do this until the vehicle is held by the parking brake only.
- To check the PARK (P) mechanism's holding ability: With the engine running, shift to PARK (P). Then release all brakes.

Underbody Flushing Service

At least every spring, use plain water to flush any corrosive materials from the underbody. Take care to clean thoroughly any areas where mud and other debris can collect.

Part C: Periodic Maintenance Inspections

Listed below are inspections and services which should be performed at least twice a year (for instance, each spring and fall). You should let your GM dealer's service department or other qualified service center do these jobs. Make sure any necessary repairs are completed at once.

Proper procedures to perform these services may be found in a GM service manual. See "Service and Owner Publications" in the Index.

Steering, Suspension and Front Drive Axle Boot and Seal Inspection

Inspect the front and rear suspension and steering system for damaged, loose or missing parts, signs of wear or lack of lubrication. Inspect the power steering lines and hoses for proper hook-up, binding, leaks, cracks, chafing, etc. Clean and then inspect the drive axle boot seals for damage, tears or leakage. Replace seals if necessary.

Exhaust System Inspection

Inspect the complete exhaust system. Inspect the body near the exhaust system. Look for broken, damaged, missing or out-of-position parts as well as open seams, holes, loose

connections or other conditions which could cause a heat build-up in the floor pan or could let exhaust fumes into the vehicle. See "Engine Exhaust" in the Index.

Radiator and Heater Hose Inspection

Inspect the hoses and have them replaced if they are cracked, swollen or deteriorated. Inspect all pipes, fittings and clamps; replace as needed.

Throttle Linkage Inspection

Inspect the throttle linkage for interference or binding, and for damage or missing parts. Replace parts as needed. Replace any cables that have high effort or excessive wear. Do not lubricate accelerator and cruise control cables.

Brake System Inspection

Inspect the complete system. Inspect brake lines and hoses for proper hook-up, binding, leaks, cracks, chafing, etc. Inspect disc brake pads for wear and rotors for surface condition. Inspect other brake parts, including calipers, parking brake, etc. You may need to have your brakes inspected more often if your driving habits or conditions result in frequent braking.

Part D: Recommended Fluids and Lubricants

NOTE: Fluids and lubricants identified below by name, part number or specification may be obtained from your GM dealer.

USAGE	FLUID/LUBRICANT
Engine Oil	Engine oil with the American Petroleum Institute Certified For Gasoline Engines "Starburst" symbol of the proper viscosity. To determine the preferred viscosity for your vehicle's engine, see "Engine Oil" in the Index.
Engine Coolant	50/50 mixture of clean water (preferably distilled) and use only GM Goodwrench [®] DEX-COOL [™] or Havoline [®] DEX-COOL [®] coolant. See "Engine Coolant" in the Index.

USAGE	FLUID/LUBRICANT
Hydraulic Brake System	Delco Supreme 11 [™] Brake Fluid (GM Part No. 12377967 or equivalent DOT-3 brake fluid).
Parking Brake Cable Guides	Chassis lubricant (GM Part No. 12377985 or equivalent) or lubricant meeting requirements of NLGI # 2, Category LB or GC-LB.
Power Steering System	GM Power Steering Fluid (GM Part No. 1052884 - 1 pint, 1050017 - 1 quart, or equivalent).
Automatic Transaxle	DEXRON [™] -III Automatic Transmission Fluid.

USAGE	FLUID/LUBRICANT
Key Lock Cylinders	Multi-Purpose lubricant, Superlube [®] (GM Part No. 12346241 or equivalent).
Supercharger	Supercharger Oil (GM Part No. 12345982). See "Supercharger Oil" in the Index.
Chassis Lubrication	Chassis lubricant (GM Part No. 12377985 or equivalent) or lubricant meeting requirements of NLGI # 2, Category LB or GC-LB.
Windshield Washer Solvent	GM Optikleen [®] Washer Solvent (GM Part No. 1051515) or equivalent.

USAGE	FLUID/LUBRICANT
Hood Latch Assembly, Pivots, Spring Anchor and Release Pawl	Lubriplate lubricant aerosol (GM Part No. 12346293 or equivalent) or lubricant meeting requirements of NLGI # 2, Category LB or GC-LB.
Hood and Door Hinges	Multi-purpose lubricant, Superlube [®] (GM Part No. 12346241 or equivalent).
Weatherstrip Conditioning	Dielectric Silicone Grease (GM Part No. 12345579 or equivalent).

See "Replacement Parts" in the Index for recommended replacement filters and spark plugs.

Part E: Maintenance Record

After the scheduled services are performed, record the date, odometer reading and who performed the service in the boxes provided after the maintenance interval. Any additional information from "Owner Checks and

Services" or "Periodic Maintenance" can be added on the following record pages. Also, you should retain all maintenance receipts. Your owner information portfolio is a convenient place to store them.

Maintenance Record			
DATE	ODOMETER READING	SERVICED BY	MAINTENANCE PERFORMED



Section 8 Customer Assistance Information

Here you will find out how to contact Buick if you need assistance. This section also tells you how to obtain service publications and how to report any safety defects.

- 8-2 Customer Satisfaction Procedure
- 8-4 Customer Assistance for Text Telephone (TTY) Users
- 8-5 Roadside Assistance
- 8-5 Canadian Roadside Assistance
- 8-6 Courtesy Transportation
- 8-7 GM Participation in an Alternative Dispute Resolution Program

- 8-8 Warranty Information
- 8-8 Reporting Safety Defects to the United States Government
- 8-9 Reporting Safety Defects to the Canadian Government
- 8-9 Reporting Safety Defects to General Motors
- 8-9 Ordering Service and Owner Publications in Canada

Customer Satisfaction Procedure



Buick dealers have the facilities, trained technicians and up-to-date information to promptly address any concerns you may have. However, if a concern has not been resolved to your complete satisfaction, take the following steps:

STEP ONE -- Discuss your concern with a member of dealership management. Normally, concerns can be quickly resolved at that level. If the matter has already been reviewed with the Sales, Service or Parts Manager, contact the owner of the dealership or the General Manager.

STEP TWO -- If after contacting a member of dealership management, it appears your concern cannot be resolved by the dealership without further help, contact the Buick Customer Relations Center by calling 1-800-521-7300. In Canada, contact GM of Canada Customer Communication Centre in Oshawa by calling 1-800-263-3777 (English) or 1-800-263-7854 (French).

For help outside of the United States and Canada, call the following numbers as appropriate:

- In Mexico: (525) 625-3256
- In Puerto Rico: 1-800-496-9992 (English) or 1-800-496-9993 (Spanish)
- In the U.S. Virgin Islands: 1-800-496-9994
- In the Dominican Republic: 1-800-751-4135 (English) or 1-800-751-4136 (Spanish)
- In the Bahamas: 1-800-389-0009
- In Bermuda, Barbados, Antigua and the British Virgin Islands: 1-800-534-0122
- In all other Caribbean countries: (809) 763-1315
- In other overseas locations, call GM International Product Center in Canada at (905) 644-4112.

For prompt assistance, please have the following information available to give the Customer Assistance Representative:

- Your name, address, home and business telephone numbers
- Vehicle Identification Number (This is available from the vehicle registration or title, or the plate at the top left of the instrument panel and visible through the windshield.)
- Dealership name and location
- Vehicle delivery date and present mileage
- Nature of concern

We encourage you to call us so we can give your inquiry prompt attention. However, if you wish to write Buick, address your inquiry to:

Buick Motor Division
Customer Relations Center
902 E. Hamilton Avenue
Flint, MI 48550

In Canada, write to:

General Motors of Canada Limited
Customer Communication Centre, 163-005
1908 Colonel Sam Drive
Oshawa, Ontario L1H 8P7

Refer to your Warranty and Owner Assistance Information booklet for addresses of GM Overseas offices.

When contacting Buick, please remember that your concern will likely be resolved in the dealership, using the dealer's facilities, equipment and personnel. That is why we suggest you follow Step One first if you have a concern.

Customer Assistance for Text Telephone (TTY) Users

To assist customers who are deaf, hard of hearing, or speech-impaired and who use Text Telephones (TTYs), Buick has TTY equipment available at its Customer Assistance Center. Any TTY user can communicate with Buick by dialing: 1-800-83-BUICK. (TTY users in Canada can dial 1-800-263-3830.)

Roadside Assistance

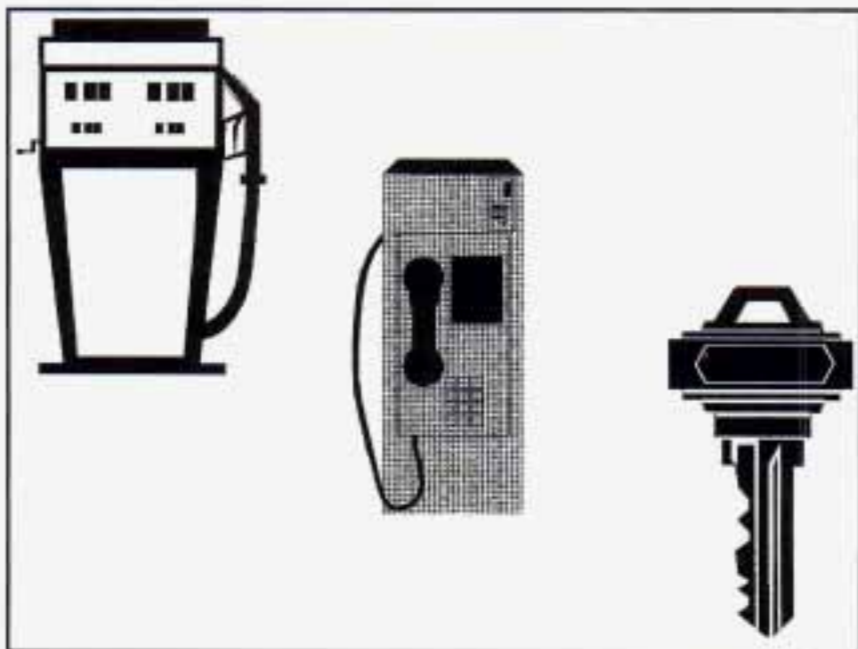

Buick Motor Division is proud to offer Buick Premium Roadside Assistance to customers for vehicles covered under the 3 year/36,000 mile (60 000 km) new car warranty (whichever occurs first).

Our commitment to Buick owners has always included superior service through our network of 3,000 Buick dealers. Buick Premium Roadside Assistance provides an extra measure of convenience and security.

Buick Premium Roadside Assistance:

- Provides owners with access to minor repairs or towing for disabled vehicles.
- Takes the anxiety out of uncertain situations by providing easy access to service professionals trained to work with Buick owners, 24 hours a day, 365 days a year, including weekends and holidays.

For details on Buick Premium Roadside Assistance, please consult your Buick Premium Roadside Assistance owner booklet included with your owner's manual. For needed assistance, call the Buick Premium Roadside Assistance toll-free hotline: 1-800-252-1112.

Canadian Roadside Assistance

Vehicles purchased in Canada have an extensive Roadside Assistance program accessible from anywhere in Canada or the United States. Please refer to the separate brochure provided by the dealer or call 1-800-268-6800 for emergency services.

Courtesy Transportation

To Buick Motor Division, Quality Means Service -- and service means "keeping you on the road."

Included with your Buick new car warranty (3 years/36,000 miles (60 000 km), whichever occurs first), is Courtesy Transportation, a program which will provide Buick retail customers with:

- Reimbursement toward a loaner vehicle, courtesy of Buick Motor Division, for up to five days for vehicles requiring overnight warranty repairs. Also, reimbursement up to \$30 a day (five days maximum) may be available for the cost of a rental car, bus or even a cab.
- A free one-way shuttle ride up to 10 miles (16 km) from the dealership is available for customers whose vehicles require same-day warranty repairs.

Courtesy Transportation is Buick's way of extending the Premium Service you've come to expect from Buick and its 3,000 dealers. Please review the Courtesy Transportation glove box card contained in your vehicle, or consult your Buick dealer for details.

Some state insurance regulations make it impractical to rent vehicles to people under 21 years of age. If you are under 21 and have difficulty renting a vehicle, Buick will reimburse you up to \$30/day, for any documented transportation you receive. Please consult your dealer for details.

For warranty repairs during the Complete Vehicle Coverage period in the New Vehicle Limited Warranty, interim transportation may be available under the Courtesy Transportation program. Please consult your dealer for details. The Courtesy Transportation program is available only in the United States and Canada.

In Canada, please consult your GM dealer for information on Courtesy Transportation.

GM Participation in an Alternative Dispute Resolution Program

This program is available in all 50 states and the District of Columbia. Canadian owners refer to your Warranty and Owner Assistance Information booklet for information on the Canadian Motor Vehicle Arbitration Plan (CAMVAP). General Motors reserves the right to change eligibility limitations and/or to discontinue its participation in this program.

Both Buick and your Buick dealer are committed to making sure you are completely satisfied with your new vehicle. Our experience has shown that, if a situation arises where you feel your concern has not been adequately addressed, the Customer Satisfaction Procedure described earlier in this section is very successful.

There may be instances where an impartial third party can assist in arriving at a solution to a disagreement regarding vehicle repairs or interpretation of the New Vehicle Limited Warranty. To assist in resolving these disagreements, Buick voluntarily participates in BBB AUTO LINE.

BBB AUTO LINE is an out-of-court program administered by the Better Business Bureau system to settle automotive disputes. This program is available free of charge to customers who currently own or lease a GM vehicle.

If you are not satisfied after following the Customer Satisfaction Procedure, you may contact the BBB using the toll-free telephone number, or write them at the following address:

BBB AUTO LINE
Council of Better Business Bureaus, Inc.
4200 Wilson Boulevard
Suite 800
Arlington, VA 22203-1804
Telephone: 1-800-955-5100

To file a claim, you will be asked to provide your name and address, your Vehicle Identification Number (VIN) and a statement of the nature of your complaint. Eligibility is limited by vehicle age and mileage, and other factors.

We prefer you utilize the Customer Satisfaction Procedure before you resort to AUTO LINE, but you may contact the BBB at any time. The BBB will attempt to resolve the complaint serving as an intermediary. If this mediation is unsuccessful, an informal hearing will be scheduled where eligible customers may present their case to an impartial third-party arbitrator.

The arbitrator will make a decision which you may accept or reject. If you accept the decision, GM will be bound by that decision. The entire dispute resolution procedure should ordinarily take about 40 days from the time you file a claim until a decision is made.

Some state laws may require you to use this program before filing a claim with a state-run arbitration program or in the courts. For further information, contact the BBB at 1-800-955-5100 or the Buick Customer Assistance Center at 1-800-955-7300.

Warranty Information

Your vehicle comes with a separate warranty booklet that contains detailed warranty information.

REPORTING SAFETY DEFECTS TO THE UNITED STATES GOVERNMENT

If you believe that your vehicle has a defect which could cause a crash or could cause injury or death, you should immediately inform the National Highway Traffic Safety Administration (NHTSA), in addition to notifying General Motors.

If NHTSA receives similar complaints, it may open an investigation, and if it finds that a safety defect exists in a group of vehicles, it may order a recall and remedy campaign. However, NHTSA cannot become involved in individual problems between you, your dealer or General Motors.

To contact NHTSA, you may either call the Auto Safety Hotline toll-free at 1-800-424-9393 (or 366-0123 in the Washington, D.C. area) or write to:

NHTSA, U.S. Department of Transportation
Washington, D.C. 20590

You can also obtain other information about motor vehicle safety from the Hotline.

REPORTING SAFETY DEFECTS TO THE CANADIAN GOVERNMENT

If you live in Canada, and you believe that your vehicle has a safety defect, you should immediately notify Transport Canada, in addition to notifying General Motors of Canada Limited. You may write to:

Transport Canada
Box 8880
Ottawa, Ontario K1G 3J2

REPORTING SAFETY DEFECTS TO GENERAL MOTORS

In addition to notifying NHTSA (or Transport Canada) in a situation like this, we certainly hope you'll notify us. Please call us at 1-800-521-7300, or write:

Buick Motor Division
Customer Relations Center
902 E. Hamilton Avenue
Flint, MI 48550

In Canada, please call us at 1-800-263-3777 (English) or 1-800-263-7854 (French). Or, write:

General Motors of Canada Limited
Customer Communication Centre
1908 Colonel Sam Drive
Oshawa, Ontario L1H 8P7

Ordering Service and Owner Publications in Canada

Service manuals, service bulletins, owner's manuals and other service literature are available for purchase for all current and past model General Motors vehicles.

The toll-free telephone number for ordering information in Canada is 1-800-668-5539.

1997 BUICK SERVICE PUBLICATIONS ORDERING INFORMATION

The following publications covering the operation and servicing of your vehicle can be purchased by filling out the Service Publication Order Form in this book and mailing it in with your check, money order, or credit card information to Helm, Incorporated (address below.)

CURRENT PUBLICATIONS FOR 1997 BUICK

SERVICE MANUALS

Service Manuals have the diagnosis and repair information on engines, transmission, axle, suspension, brakes, electrical, steering, body, etc.

RETAIL SELL PRICE: \$90.00

TRANSMISSION, TRANSAXLE, TRANSFER CASE UNIT REPAIR MANUAL

This manual provides information on unit repair service procedures, adjustments and specifications for the 1997 GM transmissions, transaxles and transfer cases.

RETAIL SELL PRICE: \$40.00

SERVICE BULLETINS

Service Bulletins give technical service information needed to knowledgeably service General Motors cars and trucks. Each bulletin contains instructions to assist in the diagnosis and service of your vehicle.

OWNER'S INFORMATION

Owner publications are written directly for Owners and intended to provide basic operational information about the vehicle. The owner's manual will include the Maintenance Schedule for all models.

In-Portfolio: Includes a Portfolio, Owner's Manual and Warranty Booklet.

RETAIL SELL PRICE: \$15.00

Without Portfolio: Owner's Manual only.

RETAIL SELL PRICE: \$10.00

CURRENT & PAST MODEL ORDER FORMS

Service Publications are available for current and past model GM vehicles. To request an order form, please specify year and model name of the vehicle.

PLEASE COMPLETE THE ORDER FORM SHOWN ON THE FOLLOWING PAGE AND MAIL TO:

Helm, Incorporated • P.O. Box 07130 • Detroit, MI 48207

OR ORDER TOLL FREE: 1-800-782-4356

Monday-Friday 8:00 AM – 6:00 PM Eastern Time

For Credit Card Orders Only (VISA–MasterCard–Discover)

ORDER TOLL FREE*(NOTE: For Credit Card Holders Only)***1-800-782-4356**

(Monday-Friday 8:00 AM - 6:00 PM EST)

FAX Orders Only 1-313-865-5927

Orders will be mailed within 10 days of receipt. Please allow adequate time for postal service. If further information is needed, write to the address shown below or call 1-800-782-4356. Material cannot be returned for credit without packing slip with return information within 30 days of delivery. On returns, a re-stocking fee may be applied against the original order.

1
9
9
7
G
M

PUBLICATION FORM NUMBER	ITEM DESCRIPTION	VEHICLE MODEL		QTY.	PRICE EACH*	TOTAL PRICE
		NAME	YEAR			
	Service Manual		1997		\$90.00	
	Car & Light Truck Transmission Unit Repair		1997		\$40.00	
	Owner's Manual In Portfolio		1997		\$15.00	
	Owner's Manual Without Portfolio		1997		\$10.00	

S
H
I
P
T
O

NOTE: Dealers and Companies please provide dealer or company name, and also the name of the person to whose attention the shipment should be sent.

Mail completed order form to:

HELM, INCORPORATED • P.O. Box 07130 • Detroit, MI 48207

For purchases outside U.S.A. please write to the above address for quotation.

(CUSTOMER'S NAME) (ATTENTION)_____
(STREET ADDRESS—NO P.O. BOX NUMBERS)_____
(CITY) (STATE) (ZIP CODE)_____
DAYTIME TELEPHONE NO.()
AREA CODEP
A
Y
M
E
N
T
 Check or Money
Order payable to
Helm, Inc. (USA funds
only — *do not send cash.*)
 MasterCard VISA DiscoverAccount Number: Expiration Date mo/yr: Check here if your billing address is different from your shipping address shown. _____
CUSTOMER SIGNATURE**TOTAL MATERIAL**Michigan Purchasers
add 6% sales tax

U.S. Order Processing

\$5.00Canadian Postage
(See Note Below)**GRAND TOTAL**

GM-BUI-ORD97

*(Prices are subject to change without notice and without incurring obligation. Allow ample time for delivery.)

Note to Canadian Customers: All listed prices are quoted in U.S. funds. Canadian residents are to make checks payable in U.S. funds. To cover Canadian postage, add \$11.50 plus the U.S. order processing.



Section 9 Index

- A**ccessory Power Outlet 2-62
- Air Bag 1-21
- How Does it Restrain 1-25
 - How it Works 1-23
 - Location 1-23
 - Readiness Light 1-22, 2-71
 - Servicing 1-26
 - What Makes it Inflate 1-24
 - What Will You See After it Inflates 1-25
 - When Should it Inflate 1-24
- Air Cleaner 6-16
- Air Conditioning 3-5
- Air Conditioning Refrigerants 6-72
- Air Control, Climate Control System 3-3, 3-4
- Alarm, Universal Theft-Deterrent 2-16
- Alignment and Balance, Tire 6-48
- Aluminum Wheels, Cleaning 6-56
- Antenna, Power 3-21
- Antifreeze 6-21
- Anti-Lock
- Brake System Warning Light 2-73, 4-7
 - Brakes 4-6
- Anti-Theft, Radio 3-15
- Appearance Care 6-51
- Appearance Care Materials 6-59
- Arbitration Program 8-7
- Ashtrays 2-61
- Astrorooft 2-62
- Audio Controls, Steering Wheel Control 3-18
- Audio Equipment, Adding 3-19
- Audio Systems 3-10
- Automatic Dimming Outside Rearview Mirror 2-54
- Automatic Transaxle 6-18
- Check 7-40
 - Fluid 6-18
 - Operation 2-24
 - Park Mechanism Check 7-42
- B**ack-Up Lamp Bulb Replacement 6-39, 6-41
- Battery 6-31
- Jump Starting 5-3
 - Replacement, Remote Keyless Entry 2-12
 - Rundown Protection 2-49
 - Warning Light 2-71
 - Warnings 5-3
- BBB Auto Line 8-7
- Belt, Engine Accessory 6-73, 6-74
- Better Business Bureau Mediation 8-7
- Blizzard 4-28

Brake		
Adjustment	6-30	
Fluid	6-28	
Master Cylinder	6-28	
Parking	2-27	
Pedal Travel	6-30	
Replacing System Parts	6-31	
System Warning Light	2-72	
Trailer	4-36	
Transaxle Shift Interlock Check	7-41	
Wear	6-30	
Brakes, Anti-Lock	4-7	
Braking	4-6	
Braking in Emergencies	4-10	
Break-In, New Vehicle	2-19	
Brightness Control	2-46	
BTSI Check	7-41	
Bulb Replacement	6-33	
Exterior Front	6-33	
Exterior Rear	6-39	
Reading Lamps	6-42	
C anadian Roadside Assistance	8-5	
Capacities and Specifications	6-70, 6-71	
Carbon Monoxide	2-14, 2-32, 4-29, 4-35	
Care of Your Cassette Tape Player	3-20	
Cassette Deck Service	7-39	
Cassette Tape Player	3-12	
Cassette Tape Player Care	3-20	
Cellular Telephone Package	2-62	
Center Passenger Position	1-27	
Central Door Unlocking System	2-5	
Certification Label	4-30	
Chains, Safety	4-36	
Chains, Tire	6-50	
Changing a Flat Tire	5-24	
Check Oil Level Light	2-79	
Checking Your Restraint Systems	1-47	
Chemical Paint Spotting	6-58	
Child Restraints	1-36	
Securing in a Rear Outside Seat Position	1-38	
Securing in the Center Rear Seat Position	1-40	
Securing in the Right Front Seat Position	1-41	
Top Strap	1-37	
Where to Put	1-36	
Chrome Wheels, Cleaning	6-56	
Cigarette Lighter	2-61	
Circuit Breakers and Fuses	6-61	
Cleaner, Air	6-16	
Cleaning		
Aluminum or Chrome Wheels	6-56	
Fabric	6-52	
Glass	6-54	
Inside of Your Buick	6-51	
Instrument Panel	6-53	
Lamps/Lenses	6-55	
Leather	6-53	
Outside of Your Buick	6-55	
Speaker Covers	6-54	
Special Problems	6-52	
Stains	6-52	
Tires	6-57	
Vinyl	6-53	
Wheels	6-57	
Windshield and Wiper Blades	6-55	

Climate Control System	3-2	Defensive Driving	4-2
Steering Wheel Control	3-9	Defogger, Rear Window	3-8
Clock, Setting the	3-10	Defogging	3-7
Comfort Controls	3-2	Defrosting	3-7
Passenger Zone	3-9	Delayed Entry Lighting	2-47
Steering Wheel Control	3-9	Delayed Exit Lighting	2-47
Compact Disc Care	3-20	Delayed Locking	2-12
Compact Disc Player	3-14	Dimensions, Vehicle	6-72
Compact Disc Storage	2-60	Door	
Compact Spare Tire	5-34	Ajar Light	2-79
Console Storage	2-59	Ajar Reminder	2-5
Control of a Vehicle	4-6	Central Unlocking System	2-5
Convenience Net	2-60	Locks	2-4
Convex Outside Mirror	2-55	Locks, Delayed Locking	2-12
Coolant	6-21	Memory Locks	2-5
Heater, Engine	2-22	Driver Position	1-13
Recovery Tank	5-18	Driving	
Cooling System	5-16	City	4-20
Cornering Lamps	2-46	Defensive	4-2
Courtesy Lamps	2-47	Drunken	4-3
Courtesy Transportation	8-6	Freeway	4-21
Cruise Control	2-39	In a Blizzard	4-28
Cupholders	2-59	In the Rain	4-17
Customer Assistance for Text Telephone Users	8-4	Night	4-15
Customer Assistance Information	8-1	On Curves	4-10
Customer Satisfaction Procedure	8-2	On Grades While Towing a Trailer	4-38
D amage, Finish	6-57	On Hill and Mountain Roads	4-23
Damage, Sheet Metal	6-57	On Snow and Ice	4-26
Daytime Running Lamps	2-45	Through Water	4-19
Dead Battery	5-3	Wet Roads	4-17
Defects, Reporting Safety	8-8	Winter	4-25
		With a Trailer	4-36

Drunken Driving	4-3
Dual Automatic ComforTemp Climate Control	3-2

E lectrical Equipment, Adding	3-19, 6-61
Electrical System	6-61
Electrochromic Day/Night Rearview Mirror	2-50
With Compass	2-51
Electronic Level Control	4-31
Engine	6-10
Accessory Belt	6-73, 6-74
Coolant	6-21
Coolant Heater	2-22
Coolant Level Check	7-39
Coolant Temperature Gage	2-75
Coolant Temperature Warning Light	2-74
Exhaust	2-32
Fuse Block	6-64
Identification	6-60
Oil Level Check	7-39
Overheating	5-14
Running While Parked	2-33
Specifications	6-72
Starting Your	2-21
Supercharged	6-10
Engine Oil	6-11
Adding	6-13
Additives	6-15
Checking	6-12
Pressure Light	2-78
Used	6-15
When to Change	6-15
Exhaust, Engine	2-32

Exit Lighting, Delayed	2-47
Express-Down Window	2-34

F abric Cleaning	6-52
Fan Button, Climate Control System	3-3
Filling Your Tank	6-6
Filter, Air	6-16
Finish Care	6-56
Finish Damage	6-57
Flashers, Hazard Warning	5-2
Flash-to-Pass Feature	2-37
Flat Tire, Changing	5-24
Fluids and Lubricants	7-44
French Language Manual	ii
Front Towing	5-10
Fuel	6-3
Filling Your Tank	6-6
Gage	2-80
In Foreign Countries	6-5
Fuse Block, Under Rear Seat	6-65, 6-66
Fuses and Circuit Breakers	6-61

G ages	
Engine Coolant Temperature	2-75
Fuel	2-80
Garage Door Opener	2-55, 2-63
GAWR	4-30
Glove Box	2-55
Gross Axle Weight Rating	4-30
Gross Vehicle Weight Rating	4-30
Guide en Français	ii
GVWR	4-30

H alogen Bulbs	6-33	Suspension	7-43
Hazard Warning Flashers	5-2	Throttle Linkage	7-43
Head Restraints	1-5	Instrument Panel	2-66
Headlamps	2-44	Brightness Control	2-46
Aiming	6-36	Cleaning	6-53
Bulb Replacement	6-33	Cluster	2-68
High/Low Beam Changer	2-37	Fuse Block	6-62
Wiring	6-61	Interior Lamps	2-46
Hearing Impaired, Customer Assistance	8-4	Bulb Replacement	6-42
Heated Seats	1-4		
Heating	3-5	J ack, Tire	5-26
High-Beam Headlamps	2-37	Jump Starting	5-3
Highway Hypnosis	4-23		
Hill and Mountain Roads	4-23	K ey Lock Cylinders Service	7-40
Hitches, Trailer	4-35	Key Reminder Warning	2-15
Hood		Keys	2-2
Checking Things Under	6-8		
Release	6-9	L abels	
Horn	2-34	Certification	4-30
Hydroplaning	4-19	Service Parts Identification	6-60
		Tire-Loading Information	4-30
I gnition Key Positions	2-19	Vehicle Identification Number	6-60
Ignition Transaxle Lock Check	7-42	Lamp, Trunk	2-49
Illuminated Entry	2-47	Lamps	2-44
Inflation, Tire	6-44	Cornering	2-46
Inside Day/Night Rearview Mirror	2-50	Courtesy	2-47
Inspections	7-43	Instrument Panel	2-46
Brake System	7-43	Interior	2-46
Exhaust Systems	7-43	On Reminder	2-44
Front-Wheel-Drive Axle Boot and Seal	7-43	Latches, Seatback	1-6
Radiator and Heater Hose	7-43		
Steering	7-43		

Leaving Your Vehicle	2-7	Lubricants and Fluids	7-44
Leaving Your Vehicle with the Engine Running	2-30	Lubrication Service, Body	7-40
License Plate Holder	2-62	Lumbar Controls	1-2
Light Sensor, Twilight Sentinel	2-46	M agnasteer™	4-10
Lighter	2-61	Maintenance, Normal Replacement Parts	6-72
Lights		Maintenance Record	7-46
Air Bag Readiness	1-22, 2-71	Maintenance Schedule	7-1
Anti-Lock Brake System Warning	2-73, 4-7	Long Trip/Highway Definition	7-6
Battery Warning	2-71	Long Trip/Highway Intervals	7-6
Brake System Warning	2-72	Owner Checks and Services	7-39
Check Oil	2-79	Periodic Maintenance Inspections	7-43
Door Ajar	2-79	Recommended Fluids and Lubricants	7-44
Engine Coolant Temperature Warning	2-74	Short Trip/City Definition	7-5
Interior	2-46	Short Trip/City Intervals	7-5
Low Coolant Warning	2-75	Maintenance, Underbody	6-58
Low Fuel	2-80	Maintenance When Trailer Towing	4-38
Oil Pressure	2-78	Malfunction Indicator Lamp	2-76
Safety Belt Reminder	1-7, 2-70	Memory	
Service Engine Soon	2-76	Door Locks	2-5
Traction Control System Warning	2-73, 4-9	Seats and Mirrors	1-3, 2-11
Loading Your Vehicle	4-30	Mirrors	2-50
Locks	2-4	Automatic Dimming Outside Rearview	2-54
Door	2-4	Convex Outside	2-55
Door, Delayed Locking	2-12	Electrochromic Day/Night Rearview	2-50
Ignition Transaxle Lock Check	7-42	Inside Day/Night Rearview	2-50
Key Lock Cylinder Service	7-40	Memory	1-3, 2-11
Lockout Protection	2-7	Parallel Park Assist	2-54
Memory Door	2-5	Power Remote Control	2-54
Power Door	2-5	Visor Vanity	2-61
Trunk	2-14	With Compass	2-51
Low Coolant Warning Light	2-75	Mountain Roads	4-23
Low Fuel Light	2-80	Multifunction Lever	2-35

N et, Convenience	2-60
New Vehicle Break-In	2-19
Night Vision	4-16
Normal Maintenance Replacement Parts	6-72

O dometer	2-69
Odometer, Trip	2-69
Off-Road Recovery	4-12
Oil, Engine	6-11
Oil Pressure Light	2-78
Oil, Supercharger	6-17
Opener, Garage Door	2-55, 2-63
Outside Rearview Mirrors	2-50
Overheating Engine	5-14
Owner Checks and Services	7-39
Owner Publications, Ordering	8-9

P aint Spotting, Chemical	6-58
Parade Dimming	2-47
Parallel Park Assist Mirror	2-54

P ark	
Shifting Into	2-28
Shifting Out of	2-31

P arking	
At Night	2-15
Brake	2-27
Brake Mechanism Check	7-42
Lots	2-16
Over Things That Burn	2-32
With a Trailer	4-38

Passenger Zone Comfort Control	3-9
Passing	4-13
PASS-Key [®] II	2-18
Perimeter Lighting	2-48
Periodic Maintenance Inspections	7-43
Personal Choice Features	2-10

P ower	
Accessory Outlet	2-62
Antenna Mast Care	3-21
Antenna Service	7-39
Door Locks	2-5
Remote Control Mirror	2-54
Seat	1-2
Seatback Recliner	1-4
Steering	4-10
Steering Fluid	6-25
Windows	2-34
Power, Retained Accessory	2-20

P ower Seat	
Lumbar Controls	1-2
Memory Seats and Mirrors	1-3, 2-11
Pregnancy, Use of Safety Belts	1-20
Problems on the Road	5-1
Publications, Service and Owner	8-9

R adiator	5-21
Radiator Pressure Cap	6-25
Radio Reception	3-19
Radios	3-10
Rain, Driving In	4-17
Reading Lamps	2-49

Rear		Replacing Parts After a Crash	1-48
Outside Seat Position	1-28	System Check	7-40
Safety Belt Comfort Guides	1-32	Retained Accessory Power	2-20
Seat Passengers	1-28	Right Front Passenger Position	1-21
Towing	5-12	Roadside Assistance	8-5
Window Defogger	3-8	Roadside Assistance, Canadian	8-5
Rear Turn Signal Bulb Replacement	6-39, 6-41	Rocking Your Vehicle	5-35
Rearview Mirror		Rotation, Tires	6-45
Electrochromic Day/Night	2-50	S afety Belts	1-6
Inside Day/Night	2-50	Adults	1-12
With Compass	2-51	Care	6-54
Reclining Front Seatbacks	1-4	Center Passenger Position	1-27
Recommended Fluids and Lubricants	7-44	Children	1-34
Recovery Tank, Coolant	5-18	Driver Position	1-13
Refrigerants, Air Conditioning	6-72	Extender	1-47
Remote		How to Wear Properly	1-12
Fuel Door Release	6-7	Incorrect Usage	1-16, 1-45, 1-46
Keyless Entry	2-7	Lap Belt	1-27
Trunk Release	2-14	Lap-Shoulder	1-13, 1-28
Trunk Release Lockout	2-15	Larger Children	1-44
Removing the Rear Seat Cushion	6-67	Passenger Position	1-21, 1-27, 1-28
Replacement		Questions and Answers	1-11
Bulbs	6-69	Rear Comfort Guides	1-32
Parts	6-72	Rear Seat Outside Passenger Positions	1-28
Wheel	6-49	Rear Seat Passengers	1-28
Replacing Safety Belts	1-48	Reminder Light	1-7, 2-70
Reporting Safety Defects	8-8	Replacing After a Crash	1-48
Restraints		Right Front Passenger Position	1-21
Checking	1-47	Shoulder Belt Tightness Adjustment	1-14
Child	1-36	Smaller Children and Babies	1-34
Head	1-5	Use During Pregnancy	1-20
		Why They Work	1-8

Safety Chains	4-36	Shifting	
Safety Defects, Reporting	8-8	Into Park (P)	2-28
Safety Warnings and Symbols	viii	Out of Park (P)	2-31
Scheduled Maintenance Services	7-4	Shoulder Belt Tightness Adjustment	1-14
Seat Cushion, Removing the Rear	6-67	Signaling Turns	2-36
Seatback		Skidding	4-14
Latches	1-6	Sound Equipment, Adding	3-19
Power Recliner	1-4	Spare Tire, Compact	5-34
Reclining Front	1-4	Speaker Covers, Cleaning	6-54
Seats		Specifications and Capacities	6-70, 6-71
Controls	1-2	Specifications, Engine	6-72
Heated	1-4	Speech Impaired, Customer Assistance	8-4
Lumbar Control	1-2	Speedometer	2-69
Memory	1-3, 2-11	SRS	1-21
Power	1-2	Stains, Cleaning	6-52
Restraint Systems	1-1	Starter Switch Check	7-41
Securing a Child Restraint	1-38, 1-40, 1-41	Starting Your Engine	2-21
Security Feedback	2-9	Steam	5-14
Security System, PASS-Key [®] II	2-18	Steering	4-10
Service	6-2	In Emergencies	4-11
Bulletins, Ordering	8-9	Magnasteer [™]	4-10
Engine Soon Light	2-76	Power	4-10
Manuals, Ordering	8-9	Tips	4-10
Parts Identification Label	6-60	Wheel, Tilt	2-35
Publications, Ordering	8-9	Steering Wheel Touch Controls	3-9, 3-18
Work, Doing Your Own	6-2	Storage Compartments	2-55
Service and Appearance Care	6-1	Storage, Vehicle	6-32
Service and Owner Publications	8-9	Stuck: In Sand, Mud, Ice or Snow	5-35
Service Publications	8-9	Sun Visors	2-61
Servicing Your Air Bag-Equipped Buick	1-26	Sunroof (Astrorooft)	2-62
Sheet Metal Damage	6-57	Supercharged Engine	6-10
		Supercharger Oil	6-17

Supplemental Restraint System	1-21
Symbols, Vehicle	x

T achometer	2-69
Taillamp Bulb Replacement	6-39, 6-41
Tape Player Care	3-20
Temperature Button, Climate Control System	3-3
Theater Dimming	2-47
Theft	2-15
Theft-Deterrent Feature	3-15
THEFTLOCK™	3-15
Thermostat	6-25
Tilt Steering Wheel	2-35
Time Out Feature	2-47
Time, Setting the	3-10
Tire Chains	6-50
Tire Loading	4-30
Tire-Loading Information Label	4-30
Tires	6-43
Alignment and Balance	6-48
Buying New	6-46
Chains	6-50
Changing a Flat	5-24
Cleaning	6-57
Compact Spare	5-34
Inflation	6-44
Inflation Check	7-39
Inspection and Rotation	6-45
Loading Your Vehicle	4-30
Pressure	6-44
Temperature	6-48
Traction	6-48

Treadwear	6-47
Uniform Quality Grading	6-47
Wear Indicators	6-46
Wheel Replacement	6-49
When It's Time for New	6-46
Top Strap	1-37
Torque Lock	2-31
Torque, Wheel Nut	5-31, 6-70, 6-71
Towing a Trailer	4-32
Towing Your Vehicle	5-8
Traction	
Control System	4-8
Control System Warning Light	2-73, 4-9
Trailer	
Brakes	4-36
Driving on Grades	4-38
Driving with	4-36
Hitches	4-35
Maintenance When Towing	4-38
Parking on Hills	4-38
Safety Chains	4-36
Tongue Weight	4-34
Total Weight on Tires	4-35
Towing	4-32
Turn Signals	4-37
Weight	4-34
Transaxle Fluid, Automatic	6-18
Transmitter, Universal	2-63
Transmitters, Remote Keyless Entry	2-7
Transportation, Courtesy	8-6
Trip Odometer	2-69

Trunk		
Lock	2-14	
Release Lockout, Remote	2-15	
Release, Remote	2-14	
Security Override	2-15	
TTY Users	8-4	
Turn Signal and Lane Change Indicator	2-36	
Turn Signal Reminder	2-36	
Turn Signal/Multifunction Lever	2-35	
Turn Signals When Towing a Trailer	4-37	
Twilight Sentinel	2-46	
U nderbody Flushing Service	7-42	
Underbody Maintenance	6-58	
Universal Theft-Deterrent System	2-16	
Universal Transmitter	2-63	
V ehicle		
Control	4-6	
Damage Warnings	ix	
Dimensions	6-72	
Identification Number	6-60	
Loading	4-30	
Storage	6-32	
Ventilation System	3-6	
Visor Vanity Mirrors, Illuminated	2-61	
Visors, Sun	2-61	
W arning Devices	5-3	
Warning Lights, Gages and Indicators	2-70	
Warranty Information	8-8	
Washer Fluid, Windshield	6-26	
Washing Your Vehicle	6-55	
Weatherstrips	6-55	
Wheel		
Alignment	6-48	
Nut Torque	5-31, 6-70, 6-71	
Replacement	6-49	
Wrench	5-26	
Windows	2-34	
Express-Down	2-34	
Power	2-34	
Windshield Washer	2-38	
Fluid	2-38, 6-26	
Fluid Level Check	7-39	
Windshield Wiper	2-37	
Blade Check	7-40	
Blade Replacement	6-42, 6-72	
Cleaning the Blade	2-38, 6-55	
Fuses	6-61	
Winter Driving	4-25	
Wiper Blades, Cleaning	2-38, 6-55	
Wiring, Headlamp	6-61	
Wrecker Towing	5-8	
Wrench, Wheel	5-26	



Service Station Checkpoints

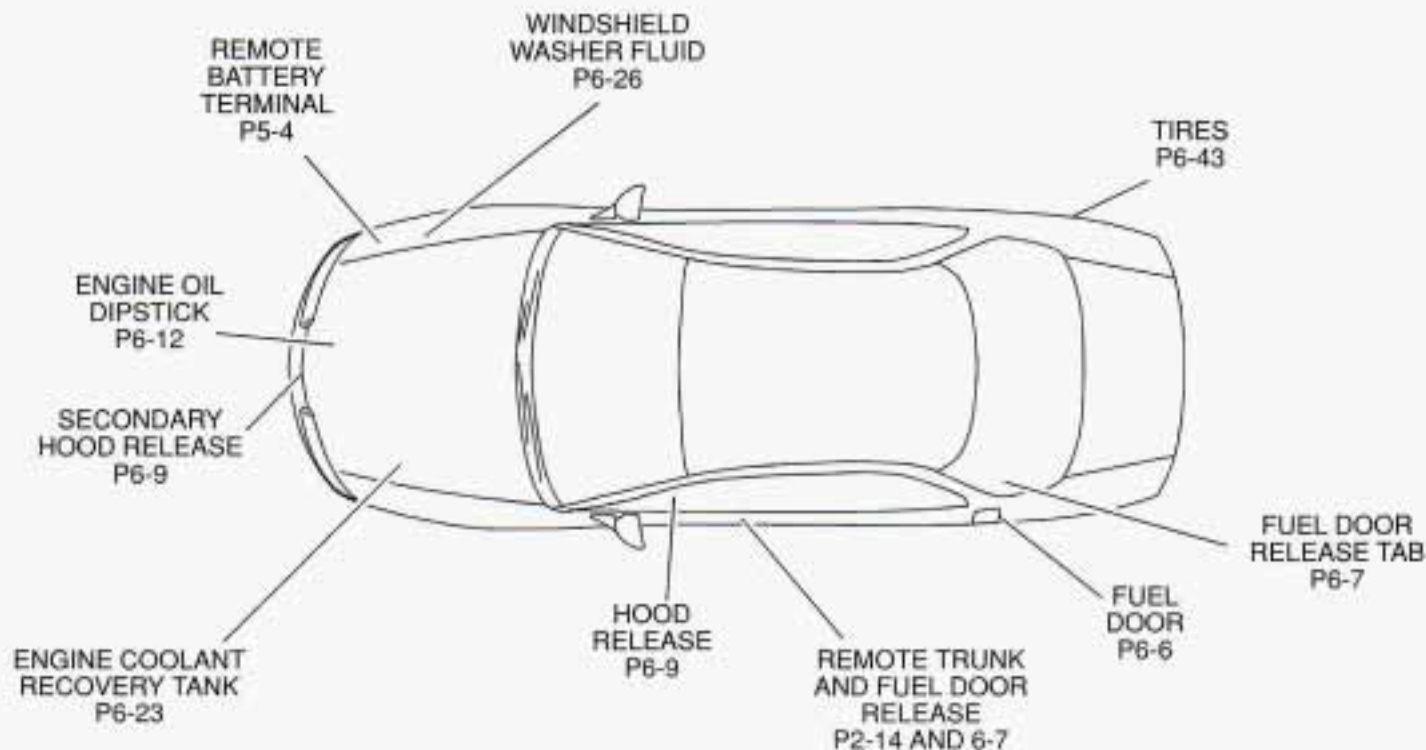

For detailed information, refer to the page number listed, or see the Index in the back of the owner's manual.



BUICK

The New Symbol For Quality
In America.