

1996

Silhouette



by Oldsmobile



The 1996 Oldsmobile Silhouette Owner's Manual

Seats and Restraint Systems	1-1
This section tells you how to use your seats and safety belts properly. It also explains the "SIR" system.	
Features and Controls	2-1
This section explains how to start and operate your Oldsmobile.	
Comfort Controls and Audio Systems	3-1
This section tells you how to adjust the ventilation and comfort controls and how to operate your audio system.	
Your Driving and the Road	4-1
Here you'll find helpful information and tips about the road and how to drive under different conditions.	
Problems on the Road	5-1
This section tells you what to do if you have a problem while driving, such as a flat tire or overheated engine, etc.	
Service and Appearance Care	6-1
Here the manual tells you how to keep your Oldsmobile running properly and looking good.	
Maintenance Schedule	7-1
This section tells you when to perform vehicle maintenance and what fluids and lubricants to use.	
Customer Assistance Information	8-1
This section tells you how to contact Oldsmobile for assistance and how to get service and owner publications. It also gives you information on "Reporting Safety Defects" on page 8-7.	
Index	9-1
Here's an alphabetical listing of almost every subject in this manual. You can use it to quickly find something you want to read.	



GENERAL MOTORS, GM, the GM Emblem, OLDSMOBILE, the OLDSMOBILE Rocket Emblem and the name SILHOUETTE are registered trademarks of General Motors Corporation.

This manual includes the latest information at the time it was printed. We reserve the right to make changes in the product after that time without further notice.

Please keep this manual in your Oldsmobile, so it will be there if you ever need it when you're on the road. If you sell the vehicle, please leave this manual in it so the new owner can use it.



We support voluntary technician certification.

How to Use this Manual

Many people read their owner's manual from beginning to end when they first receive their new vehicle. If you do this, it will help you learn about the features and controls for your vehicle. In this manual, you'll find that pictures and words work together to explain things quickly.

Index

A good place to look for what you need is the Index in the back of the manual. It's an alphabetical list of all that's in the manual, and the page number where you'll find it.

Safety Warnings and Symbols

You will find a number of safety cautions in this book. We use a box and the word CAUTION to tell you about things that could hurt you if you were to ignore the warning.



CAUTION:

These mean there is something that could hurt you or other people.

In the caution area, we tell you what the hazard is. Then we tell you what to do to help avoid or reduce the hazard. Please read these cautions. If you don't, you or others could be hurt.



You will also find a circle with a slash through it in this book. This safety symbol means "Don't," "Don't do this," or "Don't let this happen."

Vehicle Damage Warnings

Also in this book you will find these notices:

NOTICE:

These mean there is something that could damage your vehicle.

In the notice area, we tell you about something that can damage your vehicle. Many times, this damage would not be covered by your warranty, and it could be costly. But the notice will tell you what to do to help avoid the damage.

When you read other manuals, you might see CAUTION and NOTICE warnings in different colors or in different words.

You'll also see warning labels on your vehicle. They use the same words, CAUTION or NOTICE.

Vehicle Symbols

These are some of the symbols you may find on your vehicle.

For example, these symbols are used on an original battery:

CAUTION
POSSIBLE
INJURY



PROTECT
EYES BY
SHIELDING



CAUSTIC
BATTERY
ACID COULD
CAUSE
BURNS



AVOID
SPARKS OR
FLAMES



SPARK OR
FLAME
COULD
EXPLODE
BATTERY



These symbols are important for you and your passengers whenever your vehicle is driven:

DOOR LOCK
UNLOCK



FASTEN
SEAT
BELTS



POWER
WINDOW



AIR BAG



These symbols have to do with your lights:

MASTER
LIGHTING
SWITCH



TURN
SIGNALS

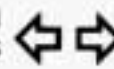

PARKING
LAMPS

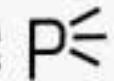

HAZARD
WARNING
FLASHER



DAYTIME
RUNNING
LAMPS

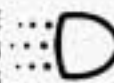

FOG LAMPS



These symbols are on some of your controls:

WINDSHIELD
WIPER



WINDSHIELD
WASHER



WINDSHIELD
DEFROSTER



REAR
WINDOW
DEFOGGER



VENTILATING
FAN



These symbols are used on warning and indicator lights:

ENGINE
COOLANT
TEMP



BATTERY
CHARGING
SYSTEM



BRAKE



COOLANT



ENGINE OIL
PRESSURE



ANTI-LOCK
BRAKES



Here are some other symbols you may see:

FUSE



LIGHTER



HORN



SPEAKER



FUEL



NOTES



Section 1 Seats and Restraint Systems

Here you'll find information about the seats in your Oldsmobile and how to use your safety belts properly. You can also learn about some things you should *not* do with air bags and safety belts.

Seats and Seat Controls

This section tells you about the seats -- how to adjust them, take them out, put them back in, and fold them up and down.

Driver's 4-Way Manual Seat

 **CAUTION:**

You can lose control of the vehicle if you try to adjust a manual driver's seat while the vehicle is moving. The sudden movement could startle and confuse you, or make you push a pedal when you don't want to. Adjust the driver's seat only when the vehicle is not moving.

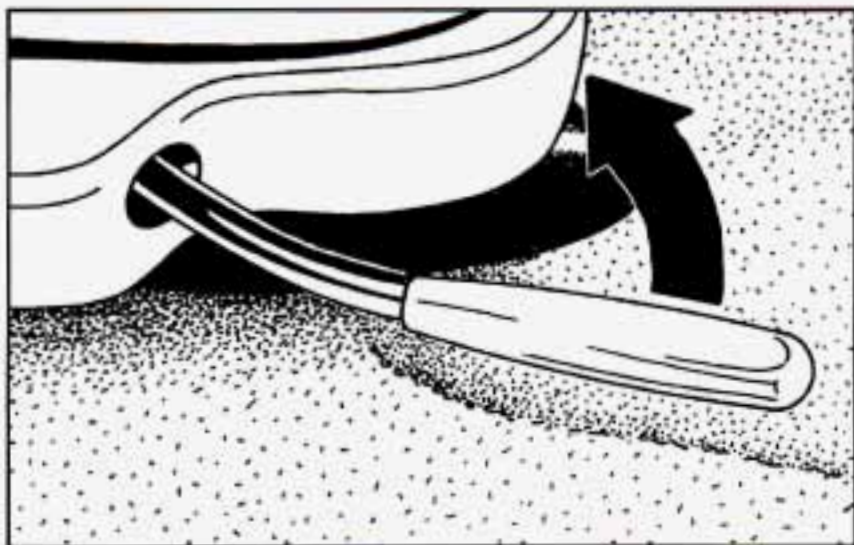

Manual Front Passenger Seat

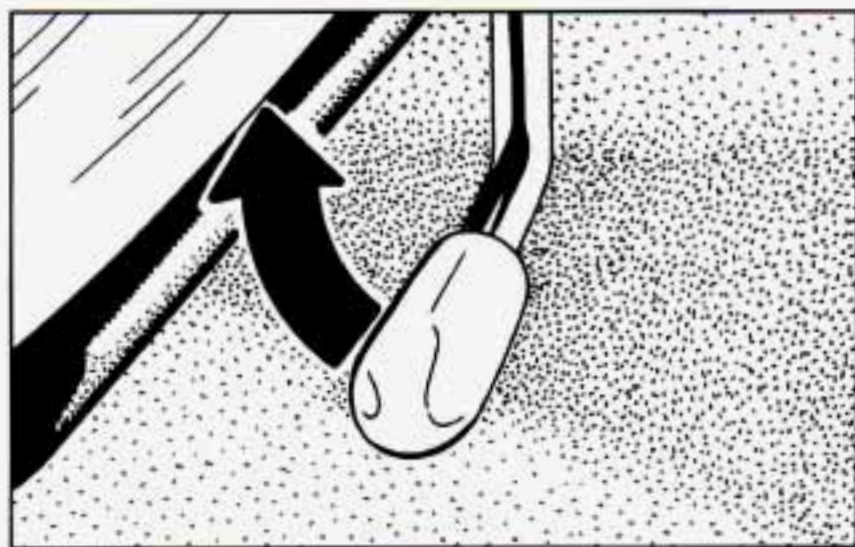

The driver's seat can be adjusted four ways.

Use the lever on the front of the seat to adjust the seat forward or backward. Pull up on the lever on the front of the seat to unlock it. Slide the seat to where you want it. To make sure the seat is locked into place, release the lever and try to move the seat with your body.

To raise the seat, pull up on the lever on the right side of the seat. To lower the seat, push the lever down.

This seat is used in the right front passenger position.

To use, pull up the lever on the front of the seat to unlock it. Slide the seat to where you want it. To make sure the seat is locked into place, release the lever and try to move the seat with your body.

Driver's 6-Way Power Seat (Option)

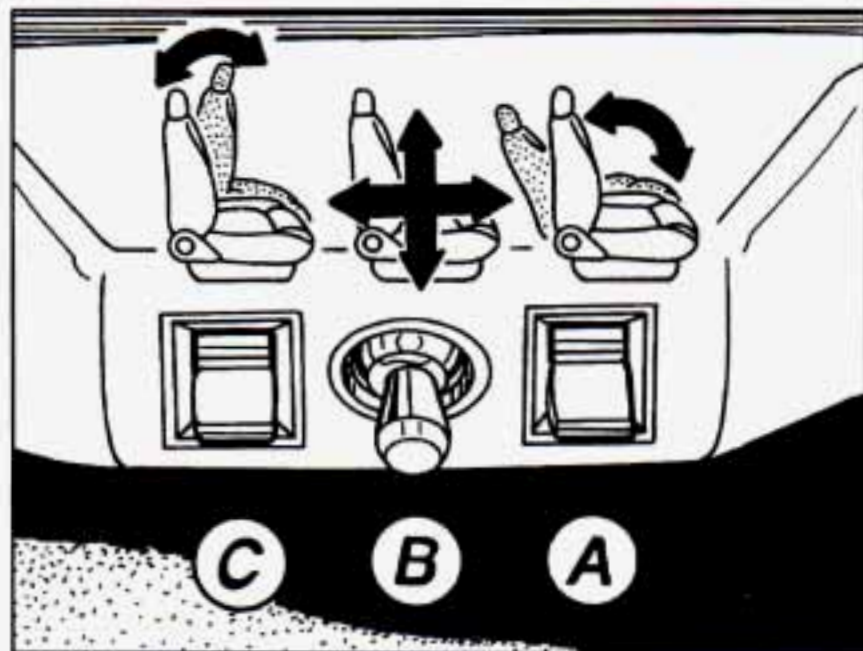

To adjust the driver's six-way power seat:

Front Control (A): Raise the front of the seat by holding the switch up. Hold the switch down to lower the front of the seat.

Center Control (B): Move the seat forward or backward by holding the control to the front or back. Raise or lower the seat by holding the control up or down.

Rear Control (C): Raise the rear of the seat by holding the switch up. Hold the switch down to lower the rear of the seat.

Reclining Front Seatbacks

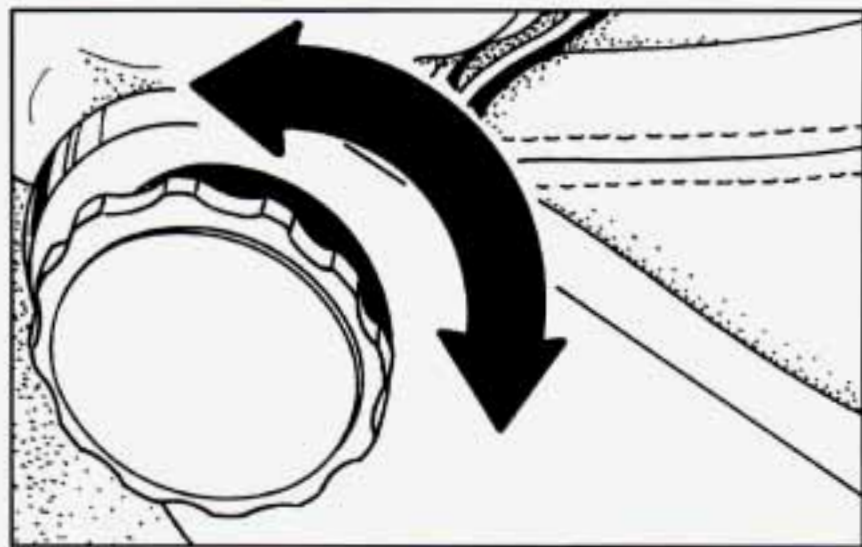

To adjust the seatback, rotate this knob. It is easier to recline the seat if you lean forward, taking your weight off of the seatback.



But don't have a seatback reclined if your vehicle is moving.

CAUTION:

Sitting in a reclined position when your vehicle is in motion can be dangerous. Even if you buckle up, your safety belts can't do their job when you're reclined like this.

The shoulder belt can't do its job because it won't be against your body. Instead, it will be in front of you. In a crash you could go into it, receiving neck or other injuries.

The lap belt can't do its job either. In a crash the belt could go up over your abdomen. The belt forces would be there, not at your pelvic bones. This could cause serious internal injuries.

For proper protection when the vehicle is in motion, have the seatback upright. Then sit well back in the seat and wear your safety belt properly.

Head Restraints

Slide the head restraint up or down so that the top of the restraint is closest to the top of your ears. This position reduces the chance of a neck injury in a crash.

Removable Rear Bucket Seats

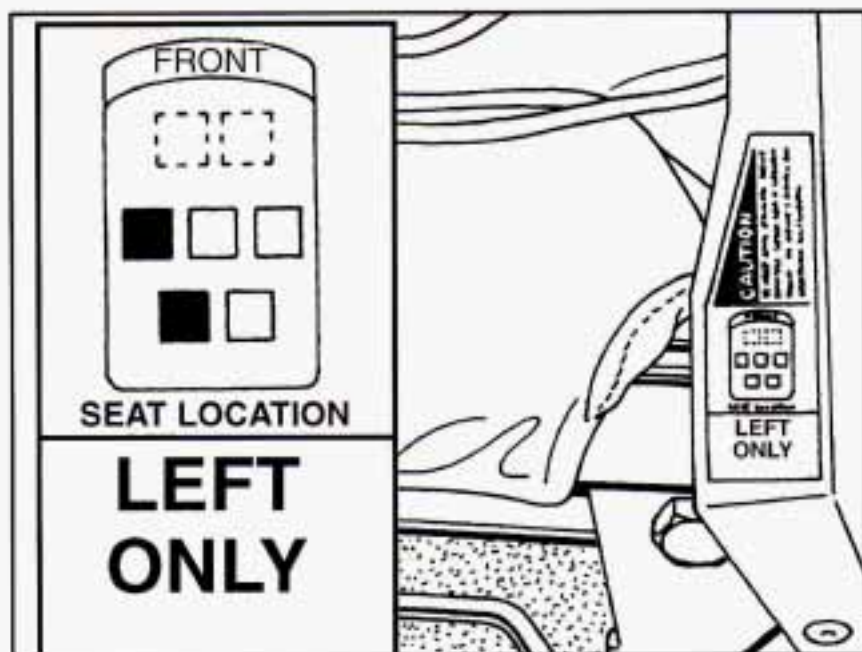

There are three types of rear bucket seats: **RIGHT ONLY**, **CENTER OR LEFT** and **LEFT ONLY**. **RIGHT ONLY** and **LEFT ONLY** seats may be equipped with the built-in child restraint option.

The rear bucket seats can be removed to provide extra storage. Each seat that has the built-in child restraint option fits in only one location in your vehicle. Seats that don't have the built-in child restraint can be moved to different floor locations. The back of each seat has a diagram (similar to the one pictured) that shows where the seat must be located in your vehicle.

RIGHT ONLY seats that don't have the built-in child restraint fit only in the right locations. **LEFT ONLY** seats that don't have the built-in child restraint fit only in the left locations. The **CENTER OR LEFT** seat fits in the center location and in either left location.

RIGHT ONLY seats that have the built-in child restraint option fit only in the rear set of floor pins in the right location of the second row. **LEFT ONLY** seats that have the built-in child restraint option fit only in the rear set of floor pins in the left location of the second row.

Dump and Stow Feature



The second and third row bucket seats have been designed to allow them to fold fully upward and forward when the seats are anchored in the rear-most position. This design improves both luggage/cargo capacity and rear seat entry/exit.

To use this feature on **RIGHT ONLY** seats: Lift the upper lever to fold the seatback forward. Push the lower lever back and tilt the entire seat and seatback forward.

To use this feature on **CENTER OR LEFT** or **LEFT ONLY** seats: Lift the upper lever to fold the seatback forward. Push down on the rear release bar (located behind the seat), and tilt the entire seat and seatback forward.

To release the **RIGHT ONLY** seat from this position: Pull the entire seat back to the upright position. Lift the upper lever to lift the seatback up again. Push and pull on the seat and the seatback to be sure both are locked into position.

To release the **CENTER OR LEFT** or **LEFT ONLY** seat from this position: Push the rear release bar while you pull the entire seat back to the upright position. Lift the upper lever to lift the seatback up again. Push and pull on the seat and the seatback to be sure both are locked into position.

Entry to Third Row Bucket Seats

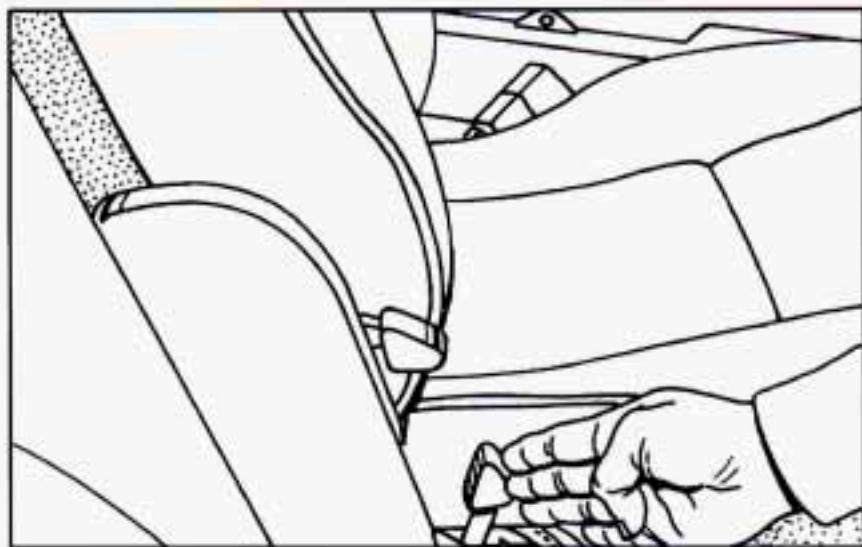

The **RIGHT ONLY** seats have a lower lever to tilt the seat forward. To get into third row seats, push back the lower lever on the **RIGHT ONLY** seat (nearest the sliding door) and tilt the seat forward completely. To return the seat to its normal position, pull the seat back, holding the lower lever back. Once the seat is in place, release the lower lever. Push and pull on the seatback to be sure that it is locked.

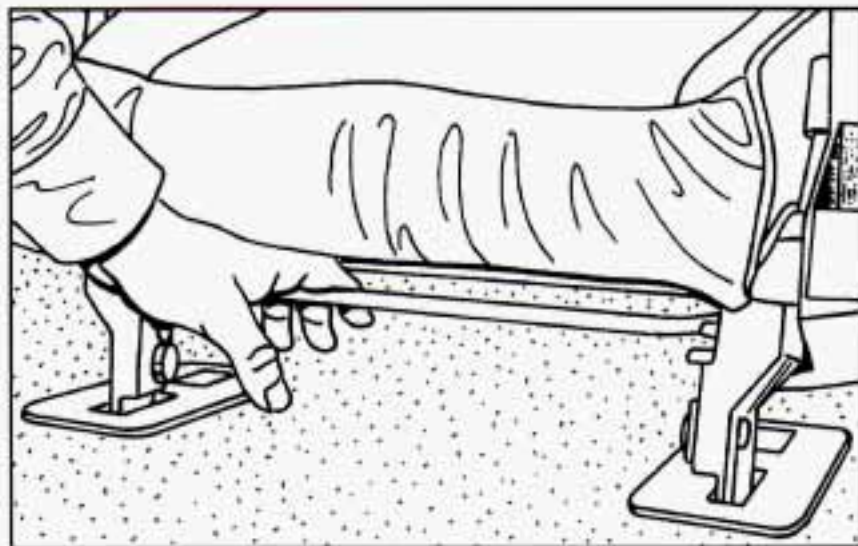

To get out of the third row seats, first lift the upper lever on the seat ahead of you to fold the seatback forward. Push down on the rear release bar under the seat ahead of you to tilt the entire seat forward.

Removing Rear Bucket Seats

Removing the RIGHT ONLY Seats

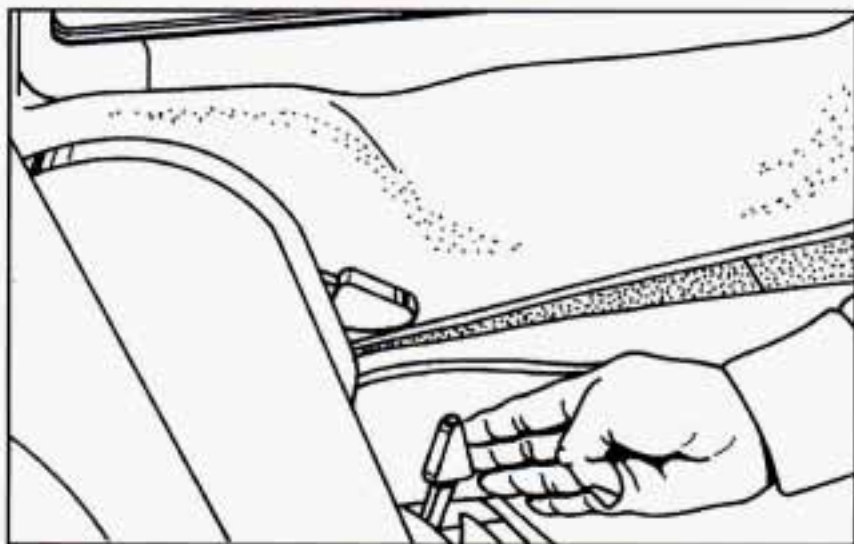

1. Lift the upper lever to fold the seatback forward.
2. Push the lower lever back and tilt the entire seat and seatback forward.

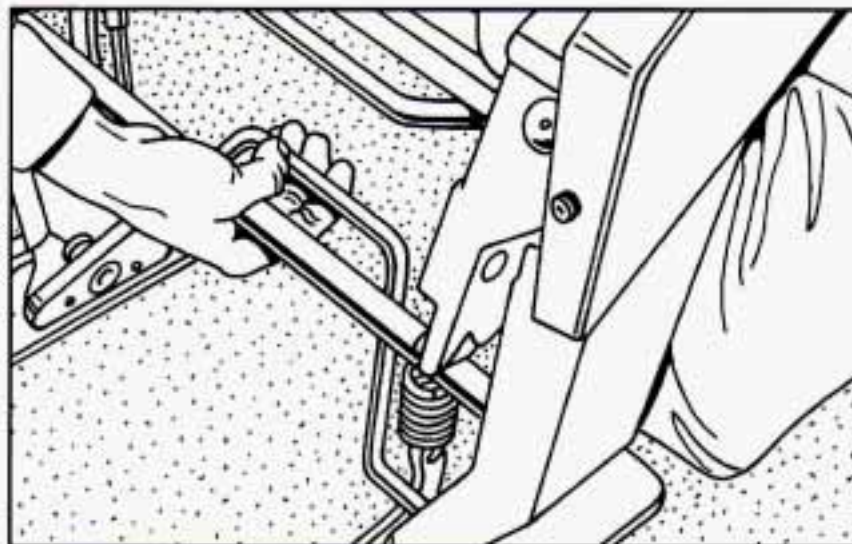

3. From behind the seat, support the top portion of the seat with one hand as you squeeze the front release bar toward the crossbar. The seat will release from the floor pins.

**Removing LEFT ONLY and
CENTER OR LEFT Seats**

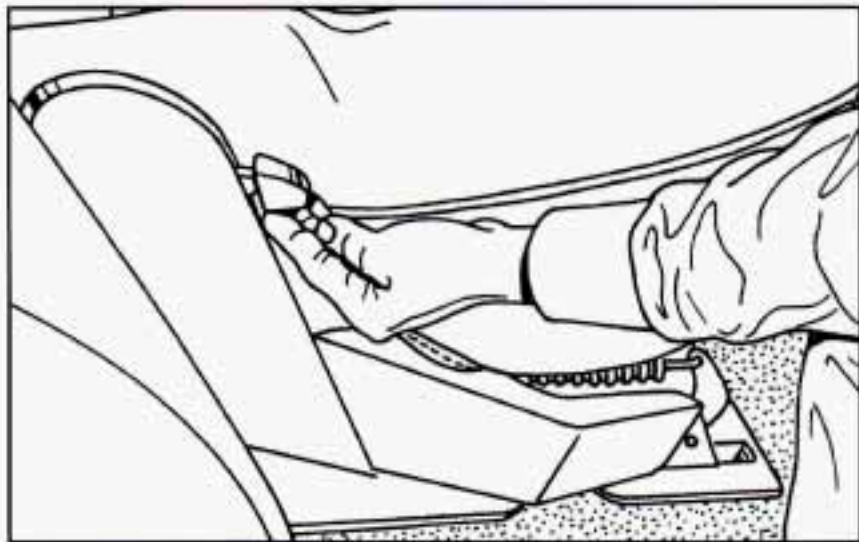

1. Lift the upper lever to fold the seatback forward.

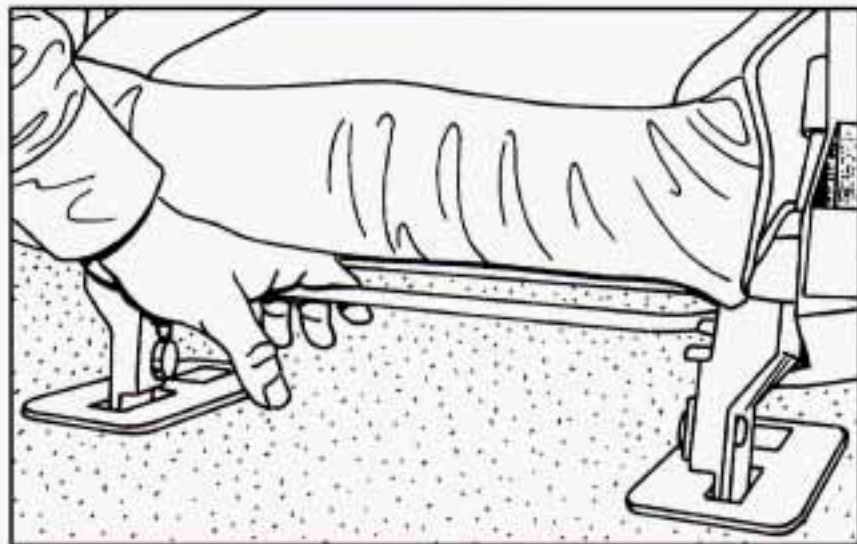

2. Push down on the rear release bar (located behind the seat) and tilt the entire seat forward.

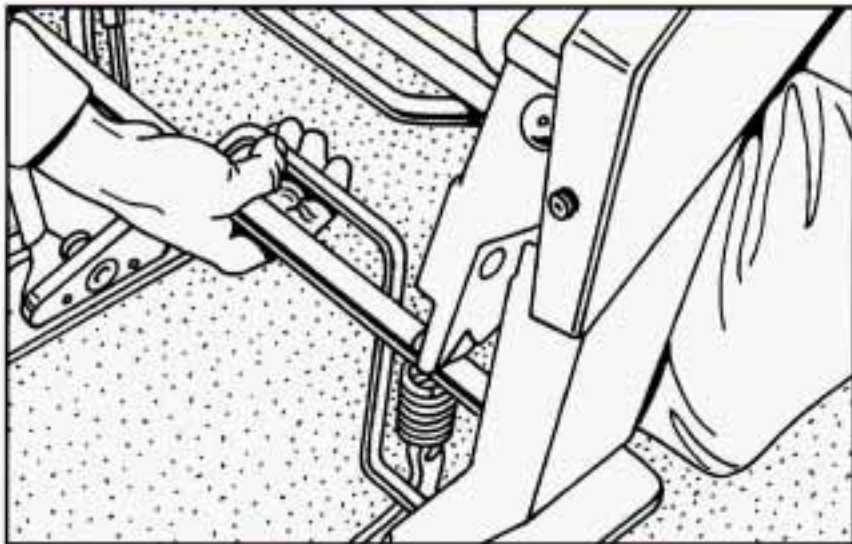

3. From behind the seat, support the top portion of the seat with one hand as you squeeze the front release bar toward the crossbar. The seat will release from the floor pins.

Adjusting Rear Seats

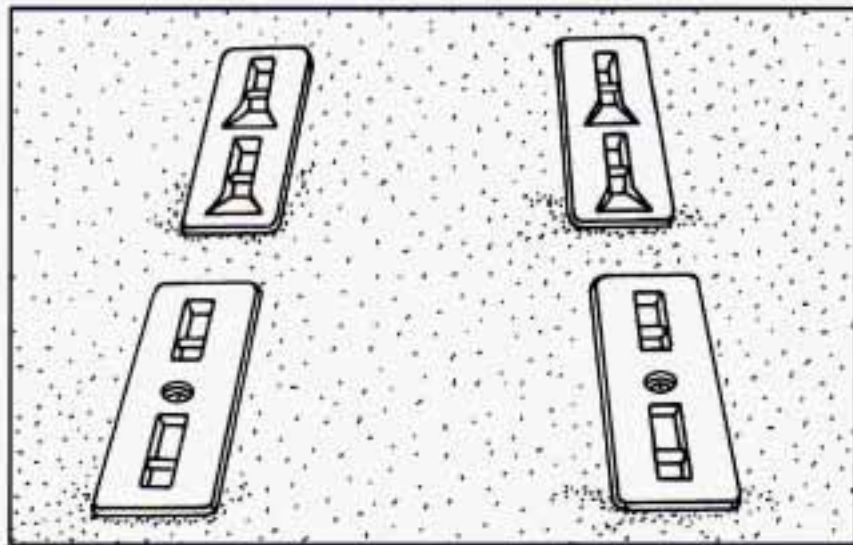

Each rear seat location has two sets of floor pins. Seats equipped with the built-in child restraint option must be secured in the rear set of floor pins. Seats that don't have the built-in child restraint can be secured in either set of floor pins. Move the position of these seats up or back to provide a little more room behind or in front of a seat.

Replacing Rear Bucket Seats

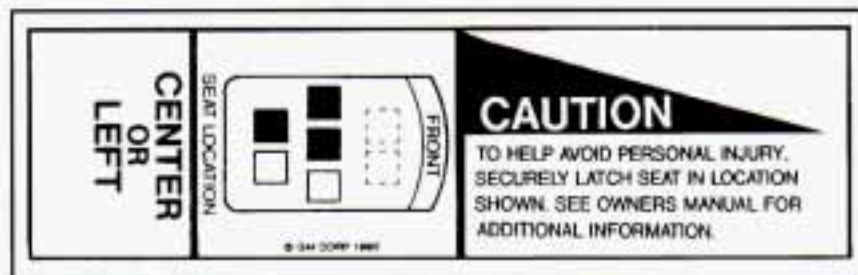

Follow the diagram on the back of the seats to replace the seats in their proper location.

The LEFT ONLY seats fit only in the left positions. The RIGHT ONLY seats fit only in the right positions. The CENTER OR LEFT seat fits in the center position and in either left position.

Don't try to place the seats in backward, because they won't latch that way.

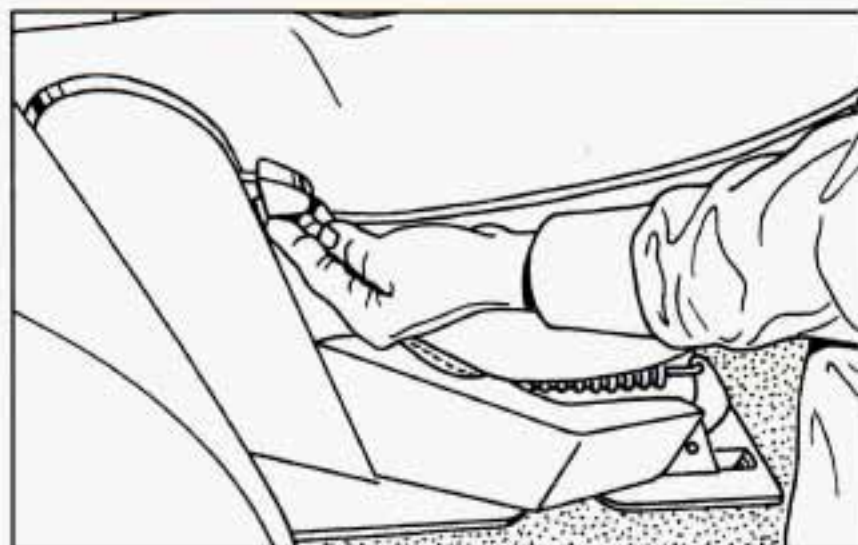

1. With the entire seat tilted forward, place the front hooks of the seat latch onto the front floor pins.
2. Firmly press the rear hooks onto the rear floor pins. The seat should lock into position.
3. Push and pull on the seat to check that it is locked.
4. Lift the upper lever and pull up on the seatback until it locks upright. Push and pull on the seatback to be sure that it is locked.

CAUTION:

A seat that isn't locked into place properly can move around in a collision or sudden stop. People in the vehicle could be injured. Be sure to lock the seat into place properly when installing it.

 **CAUTION:**

If the seatback isn't locked, it could move forward in a sudden stop or crash. That could cause injury to the person sitting there. Always press rearward on the seatback to be sure it is locked.

5. Check to see that you have put the seats into the proper location, according to the label on each seat. If not, the seats may not latch properly, and your passengers may not have the proper safety belt.

Safety Belts: They're for Everyone

This part of the manual tells you how to use safety belts properly. It also tells you some things you should not do with safety belts.

And it explains the Supplemental Restraint System (SRS), or air bag system.

 **CAUTION:**

Don't let anyone ride where he or she can't wear a safety belt properly. If you are in a crash and you're not wearing a safety belt, your injuries can be much worse. You can hit things inside the vehicle or be ejected from it. You can be seriously injured or killed. In the same crash, you might not be if you are buckled up. Always fasten your safety belt, and check that your passengers' belts are fastened properly too.



Your vehicle has a light that comes on as a reminder to buckle up. (See “Safety Belt Reminder Light” in the Index.)

In most states and Canadian provinces, the law says to wear safety belts. Here’s why: *They work.*

You never know if you’ll be in a crash. If you do have a crash, you don’t know if it will be a bad one.

A few crashes are mild, and some crashes can be so serious that even buckled up a person wouldn’t survive. But most crashes are in between. In many of them, people who buckle up can survive and sometimes walk away. Without belts they could have been badly hurt or killed.

After more than 25 years of safety belts in vehicles, the facts are clear. In most crashes buckling up does matter ... a lot!

Why Safety Belts Work

When you ride in or on anything, you go as fast as it goes.

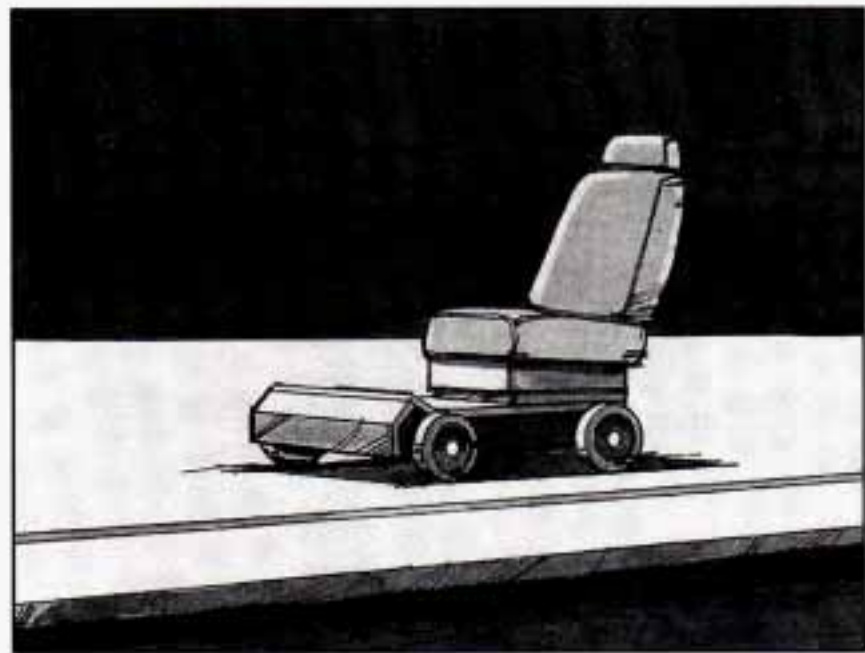

Take the simplest vehicle. Suppose it’s just a seat on wheels.

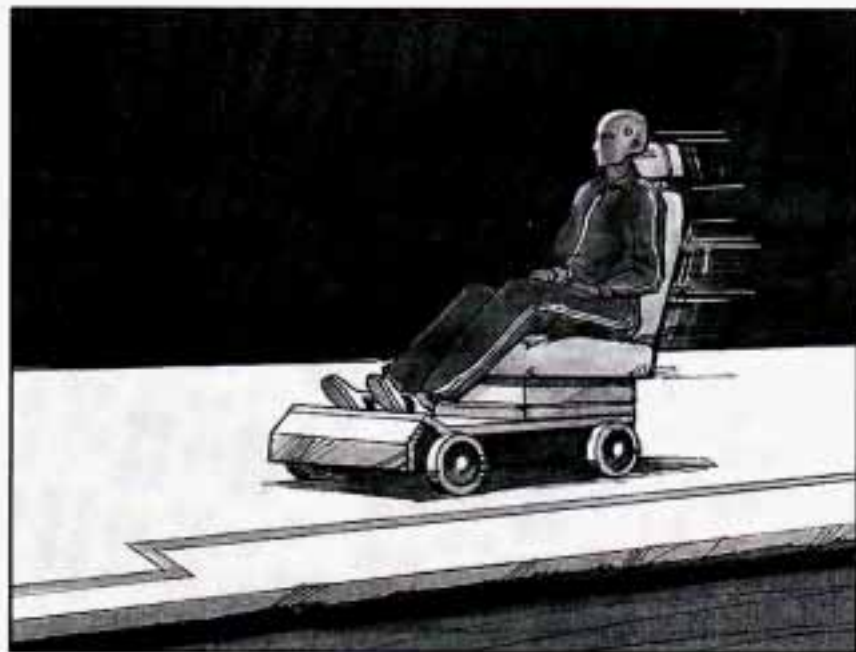

Put someone on it.



Get it up to speed. Then stop the vehicle. The rider doesn't stop.



The person keeps going until stopped by something.
In a real vehicle, it could be the windshield ...

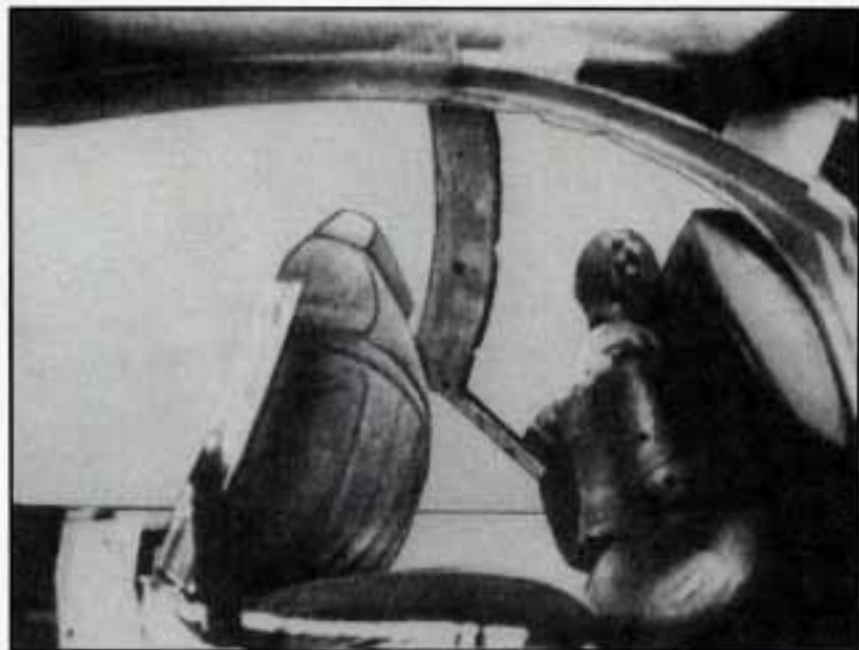

or the instrument panel ...



or the safety belts!

With safety belts, you slow down as the vehicle does. You get more time to stop. You stop over more distance, and your strongest bones take the forces. That's why safety belts make such good sense.

Here Are Questions Many People Ask About Safety Belts -- and the Answers

Q: Won't I be trapped in the vehicle after an accident if I'm wearing a safety belt?

A: You *could* be -- whether you're wearing a safety belt or not. But you can unbuckle a safety belt, even if you're upside down. And your chance of being conscious during and after an accident, so you *can* unbuckle and get out, is *much* greater if you are belted.

Q: If my vehicle has air bags, why should I have to wear safety belts?

A: Air bags are in many vehicles today and will be in most of them in the future. But they are supplemental systems only; so they work *with* safety belts -- not instead of them. Every air bag system ever offered for sale has required the use of safety belts. Even if you're in a vehicle that has air bags, you still have to buckle up to get the most protection. That's true not only in frontal collisions, but especially in side and other collisions.

Q: If I'm a good driver, and I never drive far from home, why should I wear safety belts?

A: You may be an excellent driver, but if you're in an accident -- even one that isn't your fault -- you and your passengers can be hurt. Being a good driver doesn't protect you from things beyond your control, such as bad drivers.

Most accidents occur within 25 miles (40 km) of home. And the greatest number of serious injuries and deaths occur at speeds of less than 40 mph (65 km/h).

Safety belts are for everyone.

How to Wear Safety Belts Properly

Adults

This part is only for people of adult size.

Be aware that there are special things to know about safety belts and children. And there are different rules for smaller children and babies. If a child will be riding in your Oldsmobile, see the part of this manual called "Children." Follow those rules for everyone's protection.

First, you'll want to know which restraint systems your vehicle has.

We'll start with the driver position.

Driver Position

This part describes the driver's restraint system.

Lap-Shoulder Belt

The driver has a lap-shoulder belt. Here's how to wear it properly.

1. Close and lock the door.
2. Adjust the seat (to see how, see "Seats" in the Index) so you can sit up straight.



3. Pick up the latch plate and pull the belt across you. Don't let it get twisted.

The shoulder belt may lock if you pull the belt across you very quickly. If this happens, let the belt go back slightly to unlock it. Then pull the belt across you more slowly.

4. Push the latch plate into the buckle until it clicks.



If the belt stops before it reaches the buckle, tilt the latch plate and keep pulling until you can buckle the belt.

Pull up on the latch plate to make sure it is secure. If the belt isn't long enough, see "Safety Belt Extender" at the end of this section.

Make sure the release button on the buckle is positioned so you would be able to unbuckle the safety belt quickly if you ever had to.



5. To make the lap part tight, pull down on the buckle end of the belt as you pull up on the shoulder belt.

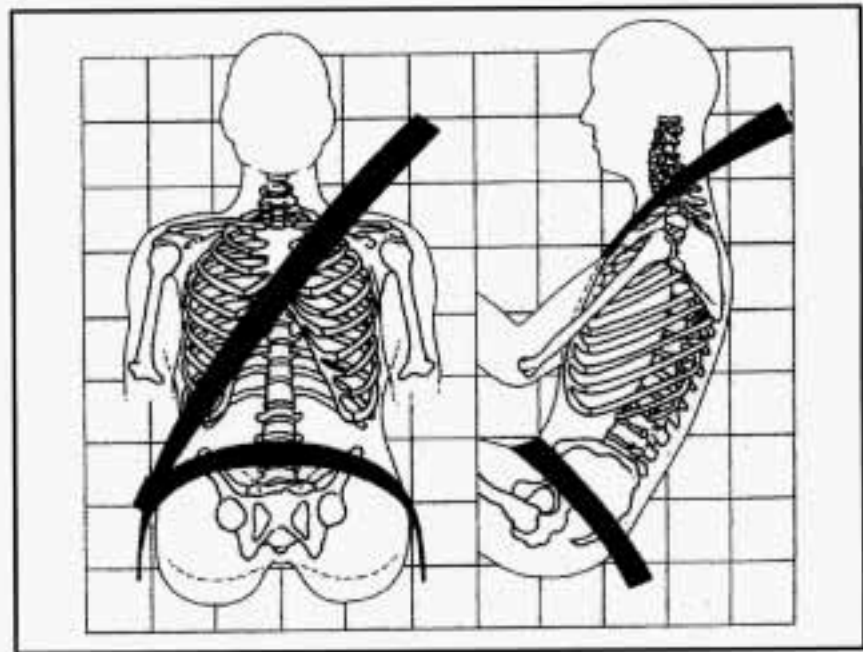

The lap part of the belt should be worn low and snug on the hips, just touching the thighs. In a crash, this applies force to the strong pelvic bones. And you'd be less likely to slide under the lap belt. If you slid under it, the belt would apply force at your abdomen. This could cause serious or even fatal injuries. The shoulder belt should go over the shoulder and across the chest. These parts of the body are best able to take belt restraining forces.

The safety belt locks if there's a sudden stop or crash, or if you pull the belt very quickly out of the retractor.

Q: What's wrong with this?

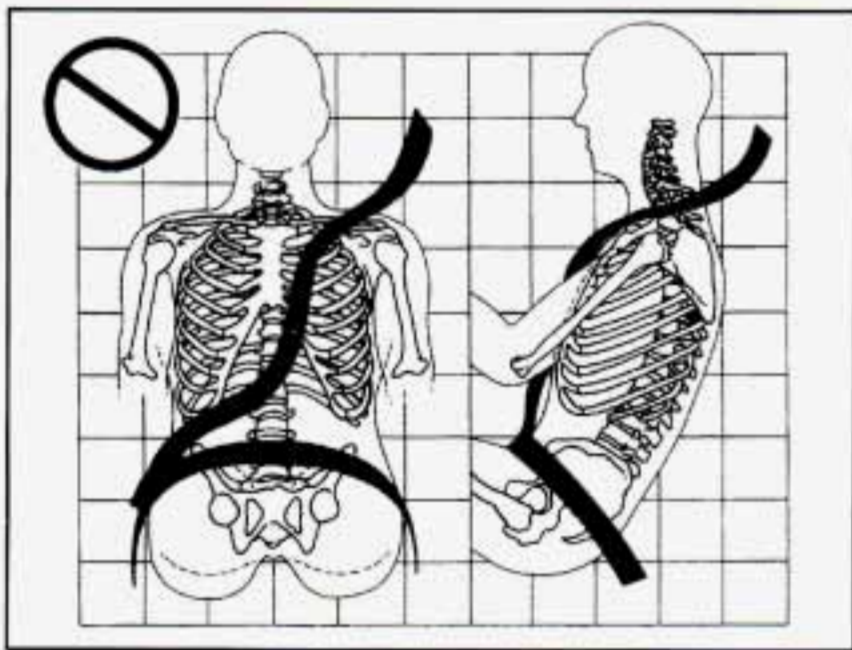

⚠ CAUTION:

You can be seriously hurt if your shoulder belt is too loose. In a crash, you would move forward too much, which could increase injury. The shoulder belt should fit against your body.

A: The shoulder belt is too loose. It won't give nearly as much protection this way.

Q: What's wrong with this?

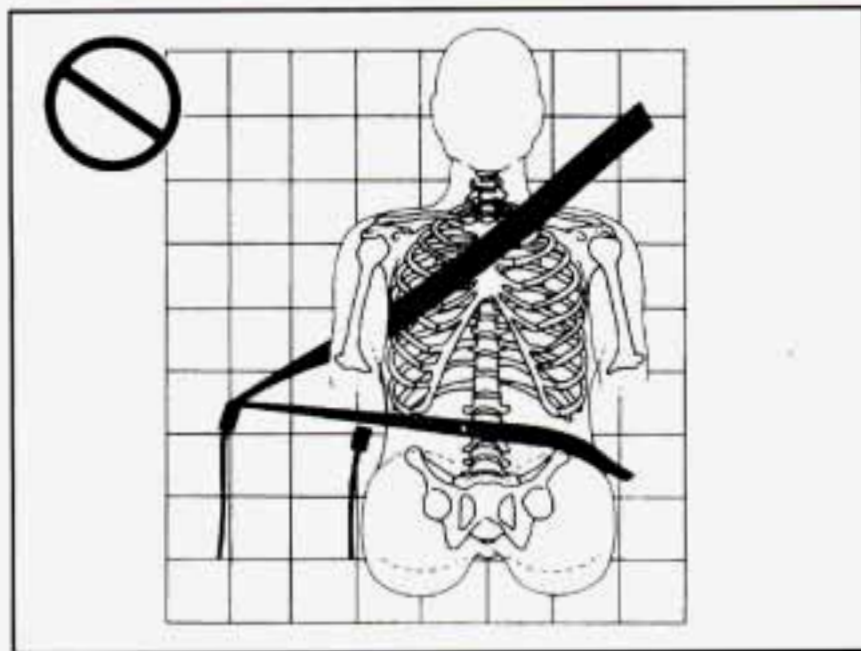

A: The belt is buckled in the wrong place.

⚠ CAUTION:

You can be seriously injured if your belt is buckled in the wrong place like this. In a crash, the belt would go up over your abdomen. The belt forces would be there, not at the pelvic bones. This could cause serious internal injuries. Always buckle your belt into the buckle nearest you.

Q: What's wrong with this?

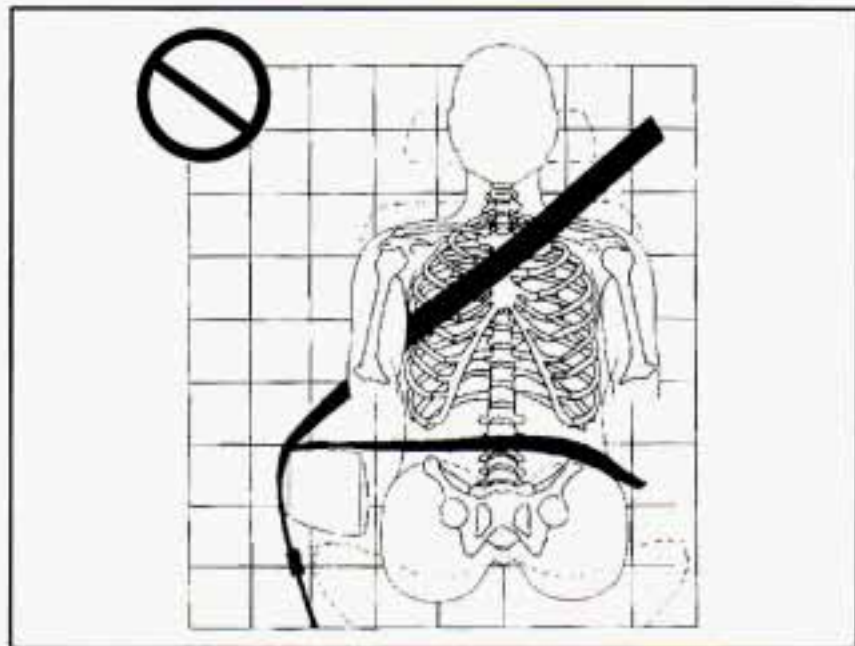

A: The belt is over an armrest.

⚠ CAUTION:

You can be seriously injured if your belt goes over an armrest like this. The belt would be much too high. In a crash, you can slide under the belt. The belt force would then be applied at the abdomen, not at the pelvic bones, and that could cause serious or fatal injuries. Be sure the belt goes under the armrests.

Q: What's wrong with this?

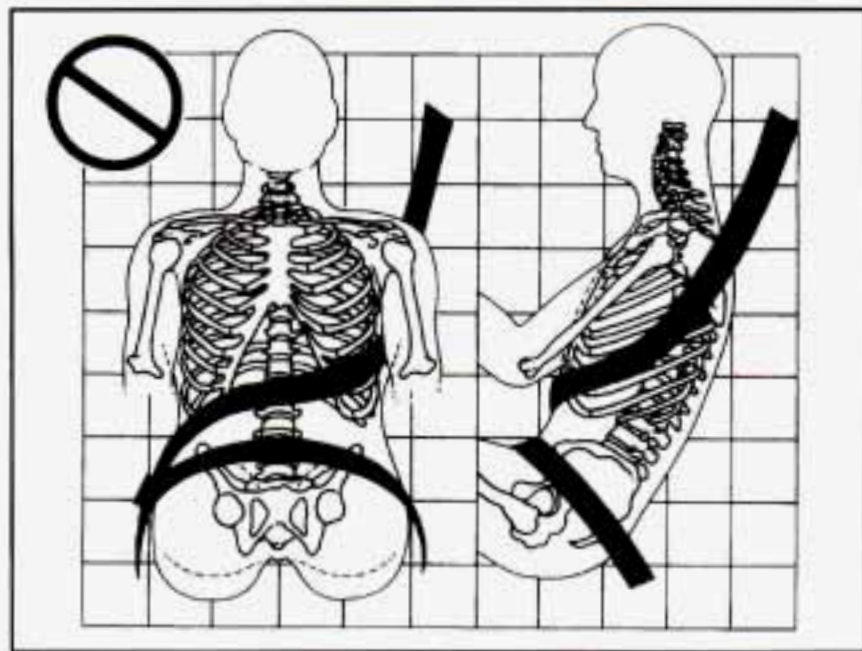

A: The shoulder belt is worn under the arm. It should be worn over the shoulder at all times.

⚠ CAUTION:

You can be seriously injured if you wear the shoulder belt under your arm. In a crash, your body would move too far forward, which would increase the chance of head and neck injury. Also, the belt would apply too much force to the ribs, which aren't as strong as shoulder bones. You could also severely injure internal organs like your liver or spleen.

Q: What's wrong with this?

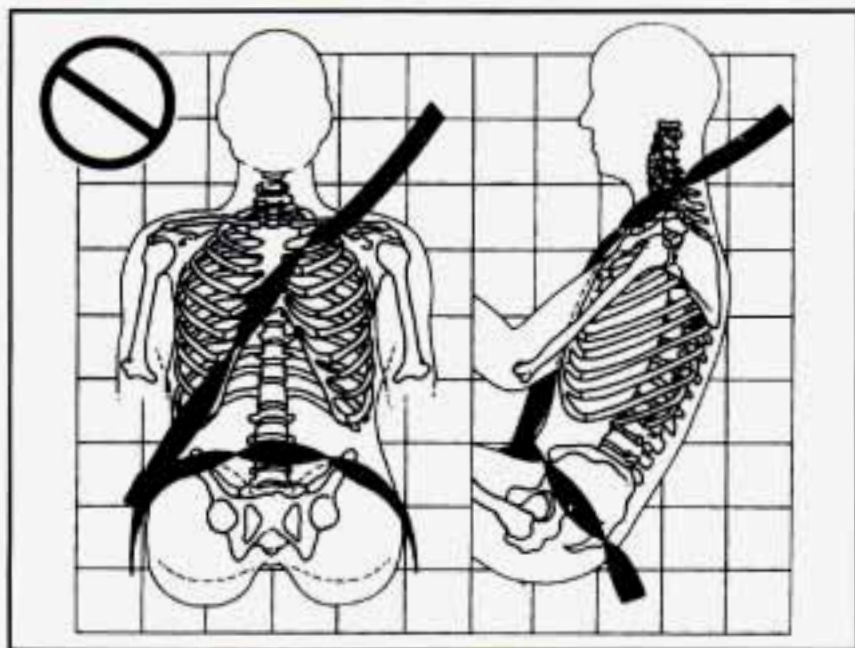

A: The belt is twisted across the body.

⚠ CAUTION:

You can be seriously injured by a twisted belt. In a crash, you wouldn't have the full width of the belt to spread impact forces. If a belt is twisted, make it straight so it can work properly, or ask your retailer to fix it.



To unlatch the belt, just push the button on the buckle. The belt should go back out of the way.

Before you close the door, be sure the belt is out of the way. If you slam the door on it, you can damage both the belt and your vehicle.

Supplemental Restraint System (SRS)

This part explains the Supplemental Restraint System (SRS) or air bag system.

Your Oldsmobile has an air bag for the driver.

Here are the most important things to know about the air bag system:

CAUTION:

You can be severely injured or killed in a crash if you aren't wearing your safety belt -- even if you have an air bag. Wearing your safety belt during a crash helps reduce your chance of hitting things inside the vehicle or being ejected from it. The air bag is only a "supplemental restraint." That is, it works with safety belts but doesn't replace them. Air bags are designed to work only in moderate to severe crashes where the front of your vehicle hits something. They aren't designed to inflate at all in rollover, rear, side or low-speed frontal crashes. Everyone in your vehicle, including the driver, should wear a safety belt properly -- whether or not there's an air bag for that person.

 **CAUTION:**

Air bags inflate with great force, faster than the blink of an eye. If you're too close to an inflating air bag, it could seriously injure you. Safety belts help keep you in position for an air bag inflation in a crash. Always wear your safety belt, even with an air bag, and sit as far back as you can while still maintaining control of your vehicle.

AIR BAG



There is an air bag readiness light on the instrument panel, which shows the words AIR BAG.

The system checks the air bag's electrical system for malfunctions. The light tells you if there is an electrical problem. See "Air Bag Readiness Light" in the Index for more information.

How the Air Bag System Works



Where is the air bag?

The driver's air bag is in the middle of the steering wheel.

CAUTION:

Don't put anything on, or attach anything to, the steering wheel. Also, don't put anything (such as pets or objects) between the driver and the steering wheel. If something is between an occupant and an air bag, it could affect the performance of the air bag -- or worse, it could cause injury.

When should an air bag inflate?

The air bag is designed to inflate in moderate to severe frontal or near-frontal crashes. The air bag will inflate only if the impact speed is above the system's designed "threshold level." If your vehicle goes straight into a wall that doesn't move or deform, the threshold level is about 9 to 15 mph (14 to 24 km/h). The threshold level can vary, however, with specific vehicle design, so that it can be somewhat above or below this range. If your vehicle strikes something that will move or deform, such as a parked car, the threshold level will be higher. The air bag is not designed to inflate in rollovers, side impacts or rear impacts, because inflation would not help the occupant.

In any particular crash, no one can say whether an air bag should have inflated simply because of the damage to a vehicle or because of what the repair costs were. Inflation is determined by the angle of the impact and the vehicle's deceleration. Vehicle damage is only one indication of this.

What makes an air bag inflate?

In a frontal or near-frontal impact of sufficient severity, the air bag sensing system detects that the vehicle is suddenly stopping as a result of a crash. The sensing system triggers a chemical reaction of the sodium azide sealed in the inflator. The reaction produces nitrogen gas, which inflates the air bag. The inflator, air bag and related hardware are all part of the air bag module packed inside the steering wheel.

How does an air bag restrain?

In moderate to severe frontal or near-frontal collisions, even belted occupants can contact the steering wheel. The air bag supplements the protection provided by safety belts. Air bags distribute the force of the impact more evenly over the occupant's upper body, stopping the occupant more gradually. But air bags would not help you in many types of collisions, including rollovers, rear impacts and side impacts, primarily because an occupant's motion is not toward the air bag. Air bags should never be regarded as anything more than a supplement to safety belts, and then only in moderate to severe frontal or near-frontal collisions.

What will you see after an air bag inflates?

After the air bag inflates, it quickly deflates. This occurs so quickly that some people may not even realize the air bag inflated. Some components of the air bag module in the steering wheel hub will be hot for a short time. The part of the bag that comes into contact with you may be warm, but it will never be too hot to touch. There will be some smoke and dust coming from vents in the deflated air bag. Air bag inflation will not prevent the driver from seeing or from being able to steer the vehicle, nor will it stop people from leaving the vehicle.

 **CAUTION:**

When an air bag inflates, there is dust in the air. This dust could cause breathing problems for people with a history of asthma or other breathing trouble. To avoid this, everyone in the vehicle should get out as soon as it is safe to do so. If you have breathing problems but can't get out of the vehicle after an air bag inflates, then get fresh air by opening a window or door.

- The air bag is designed to inflate only once. After it inflates, you'll need some new parts for your air bag system. If you don't get them, the air bag system won't be there to help protect you in another crash. A new system will include the air bag module and possibly other parts. The service manual for your vehicle covers the need to replace other parts.
- Your vehicle is equipped with a diagnostic module, which records information about the air bag system. The module records information about the readiness of the system, when the sensors are activated and driver's safety belt usage at deployment.
- Let only qualified technicians work on your air bag system. Improper service can mean that your air bag system won't work properly. See your retailer for service.

NOTICE:

If you damage the cover for the driver's air bag, it may not work properly. You may have to replace the air bag module. Do not open or break the air bag cover.

Servicing Your Air Bag-Equipped Oldsmobile

The air bag affects how your Oldsmobile should be serviced. There are parts of the air bag system in several places around your vehicle. You don't want the system to inflate while someone is working on your vehicle. Your Oldsmobile retailer and the Silhouette Service Manual have information about servicing your vehicle and the air bag system. To purchase a service manual, see "Service and Owner Publications" in the Index.

CAUTION:

For up to two minutes after the ignition key is turned off and the battery is disconnected, an air bag can still inflate during improper service. You can be injured if you are close to an air bag when it inflates. Avoid wires wrapped with yellow tape, or yellow connectors. They are probably part of the air bag system. Be sure to follow proper service procedures, and make sure the person performing work for you is qualified to do so.

The air bag system does not need regular maintenance.

Safety Belt Use During Pregnancy

Safety belts work for everyone, including pregnant women. Like all occupants, they are more likely to be seriously injured if they don't wear safety belts.

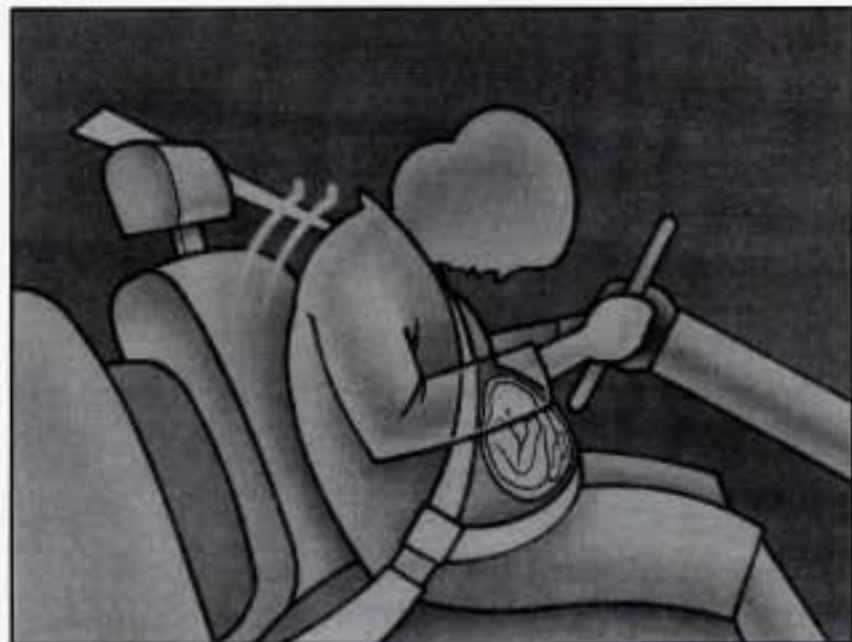

A pregnant woman should wear a lap-shoulder belt, and the lap portion should be worn as low as possible, below the rounding, throughout the pregnancy.

The best way to protect the fetus is to protect the mother. When a safety belt is worn properly, it's more likely that the fetus won't be hurt in a crash. For pregnant women, as for anyone, the key to making safety belts effective is wearing them properly.

Right Front Passenger Position

The right front passenger's safety belt works the same way as the driver's safety belt. See "Driver Position" earlier in this section.

Rear Seat Passengers

It's very important for rear seat passengers to buckle up! Accident statistics show that unbelted people in the rear seat are hurt more often in crashes than those who are wearing safety belts.

Rear passengers who aren't safety belted can be thrown out of the vehicle in a crash. And they can strike others in the vehicle who are wearing safety belts.

Rear Seat Outside Passenger Positions

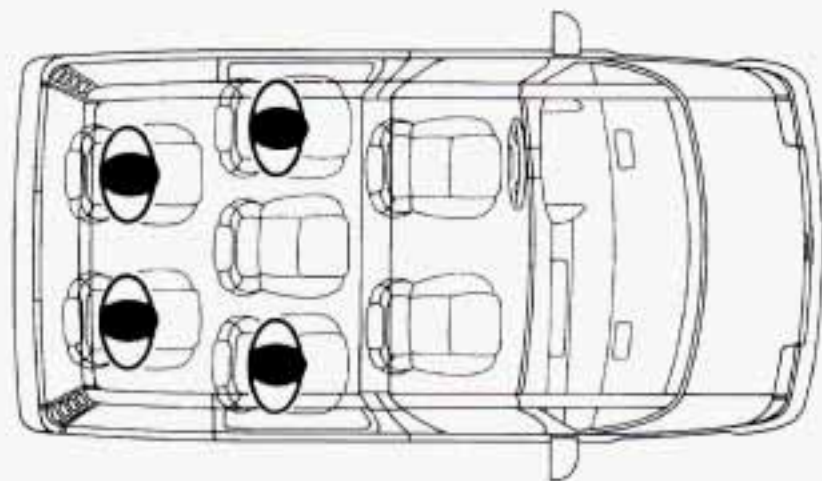

Lap-Shoulder Belt

The positions next to the windows have lap-shoulder belts. Here's how to wear one properly.



1. Pick up the latch plate and pull the belt across you. Don't let it get twisted.

The shoulder belt may lock if you pull the belt across you very quickly. If this happens, let the belt go back slightly to unlock it. Then pull the belt across you more slowly.

2. Push the latch plate into the buckle until it clicks.



If the belt stops before it reaches the buckle, tilt the latch plate and keep pulling until you can buckle it.

Pull up on the latch plate to make sure it is secure.

If the belt is not long enough, see "Safety Belt Extender" at the end of this section. Make sure the release button on the buckle is positioned so you would be able to unbuckle the safety belt quickly if you ever had to.



3. To make the lap part tight, pull down on the buckle end of the belt as you pull up on the shoulder part.

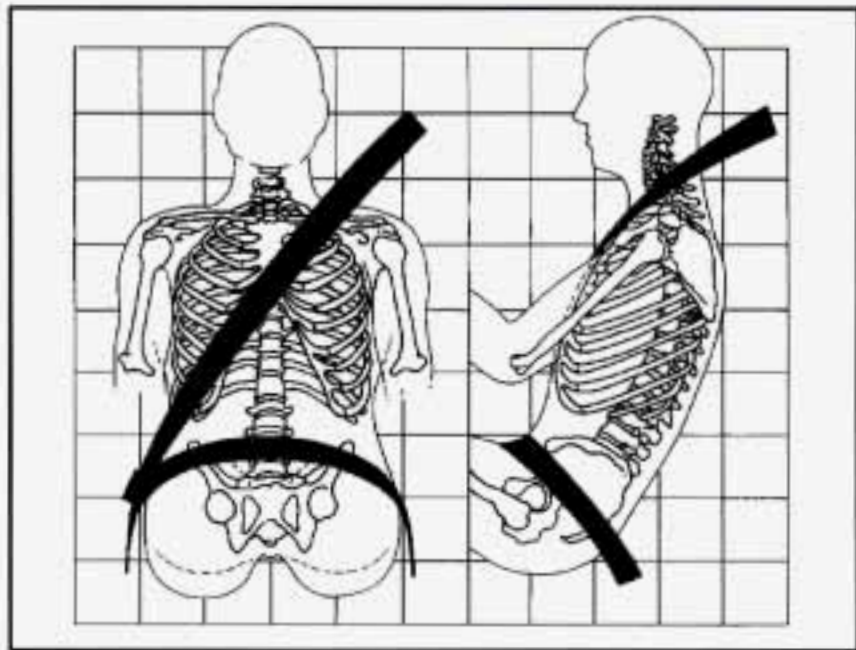

The lap part of the belt should be worn low and snug on the hips, just touching the thighs. In a crash, this applies force to the strong pelvic bones. And you'd be less likely to slide under the lap belt. If you slid under it, the belt would apply force at your abdomen. This could cause serious or even fatal injuries. The shoulder belt should go over the shoulder and across the chest. These parts of the body are best able to take belt restraining forces.

The safety belt locks if there's a sudden stop or a crash, or if you pull the belt very quickly out of the retractor.

⚠ CAUTION:

You can be seriously hurt if your shoulder belt is too loose. In a crash, you would move forward too much, which could increase injury. The shoulder belt should fit against your body.



To unlatch the belt, just push the button on the buckle.

Center Passenger Position

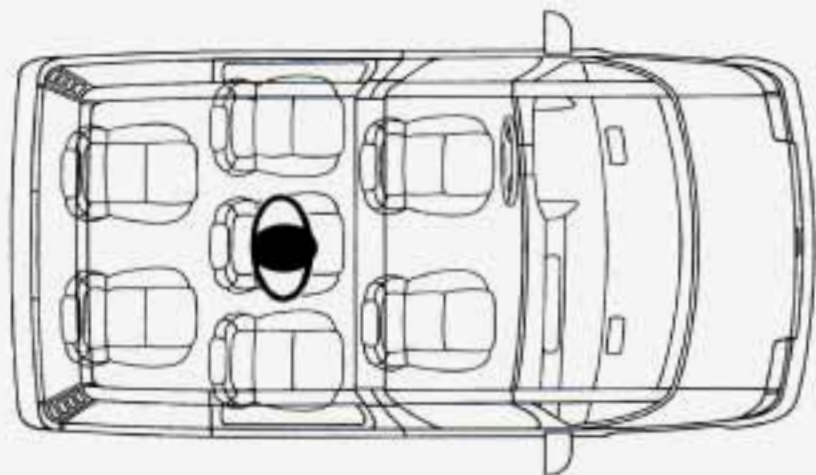

Lap Belt

Someone can sit in the center position bucket seat.

When you sit in the center position bucket seat, you have a lap safety belt which has a retractor.

1. Pick up the latch plate and, in a single motion, pull the belt across you. Don't let it get twisted.
2. Push the latch plate into the buckle until it clicks. If the belt stops before it reaches the buckle, let it go back into the retractor all the way and start again. Pull up on the latch plate to make sure it is secure.
3. Feed the lap belt into the retractor to tighten it.



The center position bucket seat is a **CENTER OR LEFT** type seat. Because it is the only bucket seat with a lap belt, and has a buckle on only one side, there are certain places a **CENTER OR LEFT** type bucket seat should, and should not, be used. See "Seats" in the Index. If the **CENTER OR LEFT** bucket seat is used on the left side of the vehicle, the person sitting there should use the lap-shoulder belt. It works the same way as the driver's safety belt. See "Driver Position" in the Index.

4. Position and release it the same way as the lap part of a lap-shoulder belt.

If the belt isn't long enough, see "Safety Belt Extender" at the end of this section. Make sure the release button on the buckle is positioned so you would be able to unbuckle the safety belt quickly if you ever had to.

Children

Everyone in a vehicle needs protection! That includes infants and all children smaller than adult size. In fact, the law in every state in the United States and in every Canadian province says children up to some age must be restrained while in a vehicle.

Smaller Children and Babies

CAUTION:

Smaller children and babies should always be restrained in a child or infant restraint. The instructions for the restraint will say whether it is the right type and size for your child. A very young child's hip bones are so small that a regular belt might not stay low on the hips, as it should. Instead, the belt will likely be over the child's abdomen. In a crash, the belt would apply force right on the child's abdomen, which could cause serious or fatal injuries. So, be sure that any child small enough for one is always properly restrained in a child or infant restraint.



⚠ CAUTION:

Never hold a baby in your arms while riding in a vehicle. A baby doesn't weigh much -- until a crash. During a crash a baby will become so heavy you can't hold it. For example, in a crash

CAUTION: (Continued)

CAUTION: (Continued)

at only 25 mph (40 km/h), a 12-lb. (5.5 kg) baby will suddenly become a 240-lb. (110 kg) force on your arms. The baby would be almost impossible to hold.

Secure the baby in an infant restraint.



Built-in Child Restraint (Option)

Each seat that has the built-in child restraint option fits in only one location in your vehicle. To find out where a seat that has a built-in child restraint must be located in your vehicle, see “Removable Rear Bucket Seats” in the Index.

If you have a rear seat with the optional built-in child restraint, refer to this picture to become familiar with the parts of each child seat and five-point harness listed below.

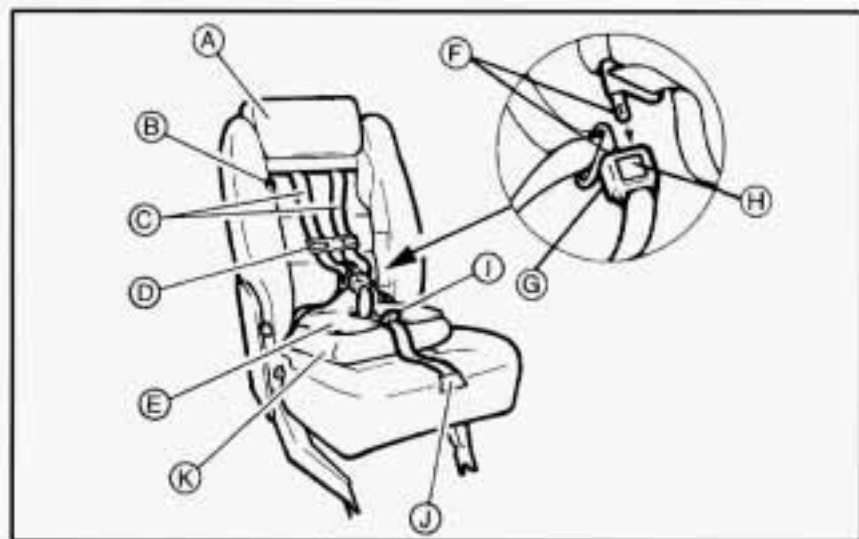

- A. Child Head Restraint
- B. Head Restraint Release Strap
- C. Shoulder Harness Straps
- D. Shoulder Harness Clip
- E. Removable Pad
- F. Seat Belt Latch Plates
- G. Buckle
- H. Seat Belt Buckle Release Button (Red)
- I. Shoulder Harness Release Strap (Black)
- J. Shoulder Harness Adjustment Strap (Grey)
- K. Child Restraint Cushion

This child restraint system conforms to all applicable Federal Motor Vehicle Safety Standards.

This child restraint is designed for use only by children who weigh between 20 and 40 pounds (9 and 18 kg) and whose height is 40 inches (102 cm) or less and who are capable of sitting upright alone.

In addition, the child should be one year old or more and at least 28 inches (71 cm) in height. It is important to use an approved, rear-facing infant restraint for a full year to allow the neck and spine to develop enough to support the weight of the child's head in the event of a collision.

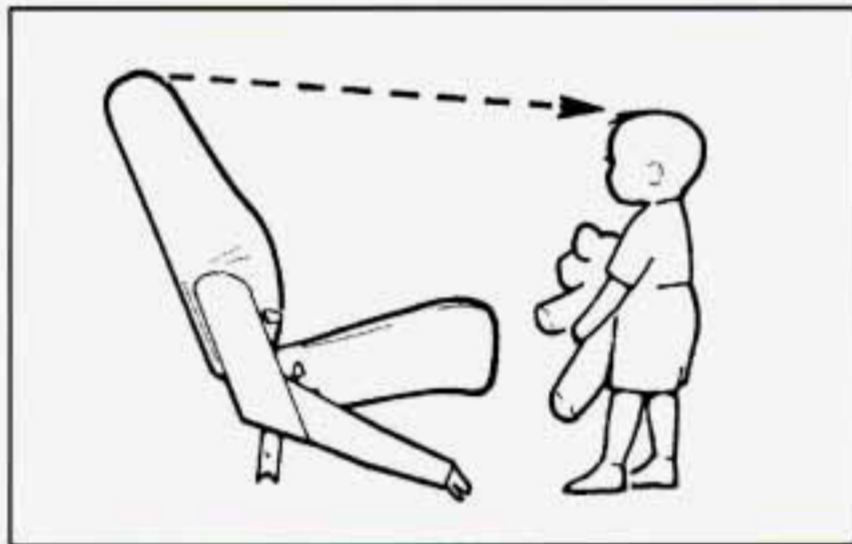

To make sure that the child is tall enough, compare the child's standing height to the top surface of the bucket seat, which is about 29 inches (74 cm) from the floor.



The booster seat can be used by children over 40 lbs. (18 kg) or whose shoulders are above the shoulder belt anchorages of the five-point child restraint harness. The vehicle's lap-shoulder belt is used instead of the five-point harness system. If a child's shoulders are higher than the shoulder belt anchorages while using the five-point harness, the spine could be injured in a collision.

WARNING! FAILURE TO FOLLOW THE MANUFACTURER'S INSTRUCTIONS ON THE USE OF THIS CHILD RESTRAINT SYSTEM CAN RESULT IN YOUR CHILD STRIKING THE VEHICLE'S INTERIOR DURING A SUDDEN STOP OR CRASH. SNUGLY ADJUST THE BELTS PROVIDED WITH THIS CHILD RESTRAINT AROUND YOUR CHILD.

Just like the other restraint systems in your vehicle, your built-in child restraint needs to be periodically checked and may need to have parts replaced after a crash. See "Checking Your Restraint Systems" and "Replacing Seat and Restraint System Parts After a Crash" in the Index.

Using the Built-in Child Restraint



1. Pull the child head restraint release strap and raise the head restraint until you hear the latch click.

CAUTION:

The child head restraint is not for use by an adult. Use of this head restraint by an adult could result in injury in the event of a collision.

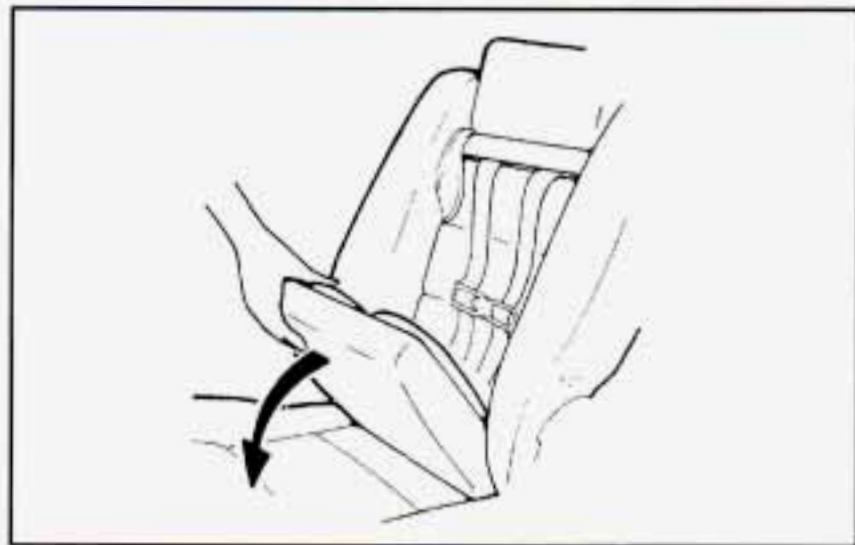

2. Lower the child restraint cushion.

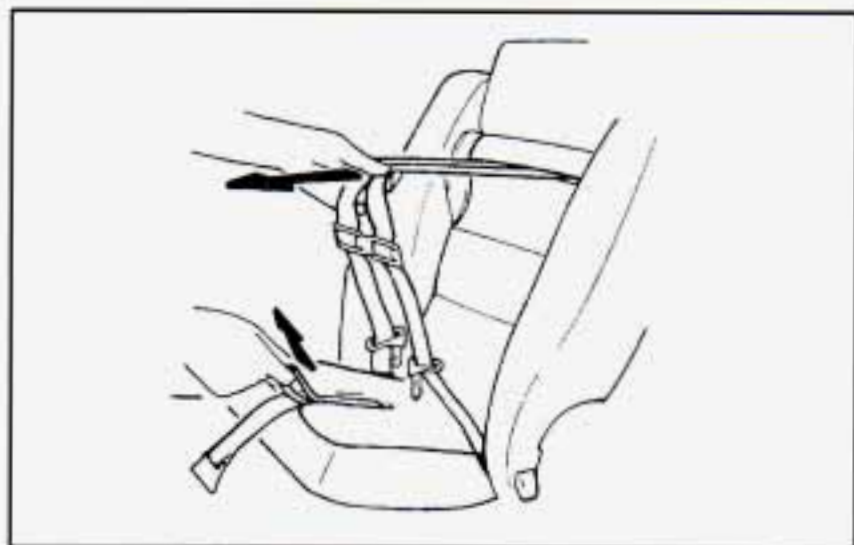

3. Before placing the child in the child restraint, add slack to the shoulder harness. Pull the black shoulder harness release strap firmly. At the same time pull both shoulder harness straps through the slots in the seatback as shown.

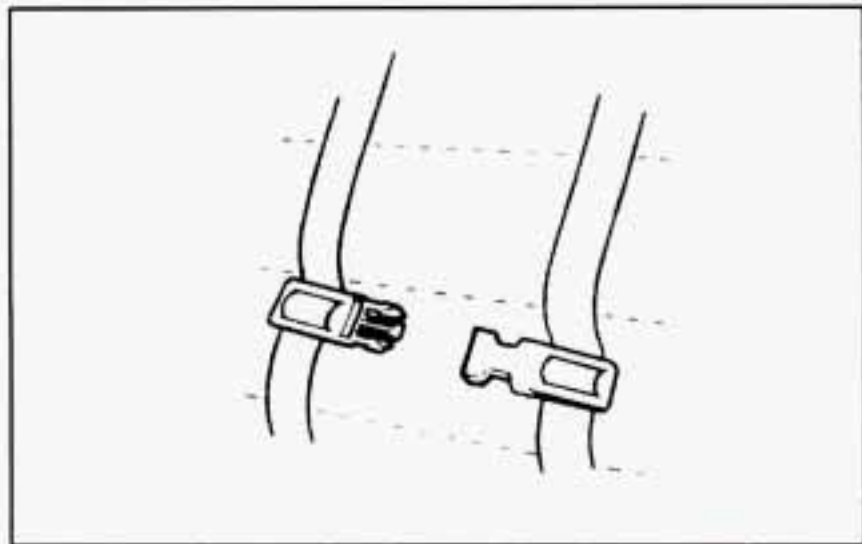

4. Separate the halves of the shoulder harness clip.



5. Place the child in the child restraint and put a shoulder harness strap over each shoulder. Insert both seat belt latch plates into the buckle and pull up on them to make sure they are firmly latched.

Be sure that the seat belt buckle is free of foreign objects that may prevent you from properly latching the latch plates. If an object is in the opening, see your Oldsmobile retailer for service before using the child restraint.

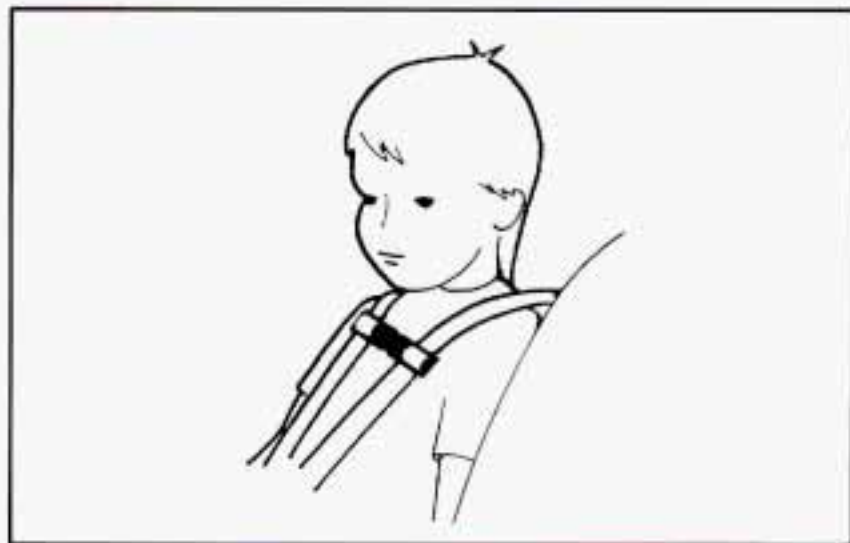

6. Fasten the two halves of the shoulder harness clip together and put it two to three inches (5 to 8 cm) below the child's chin. The purpose of the clip is to keep the shoulder harness straps positioned correctly on the shoulders.

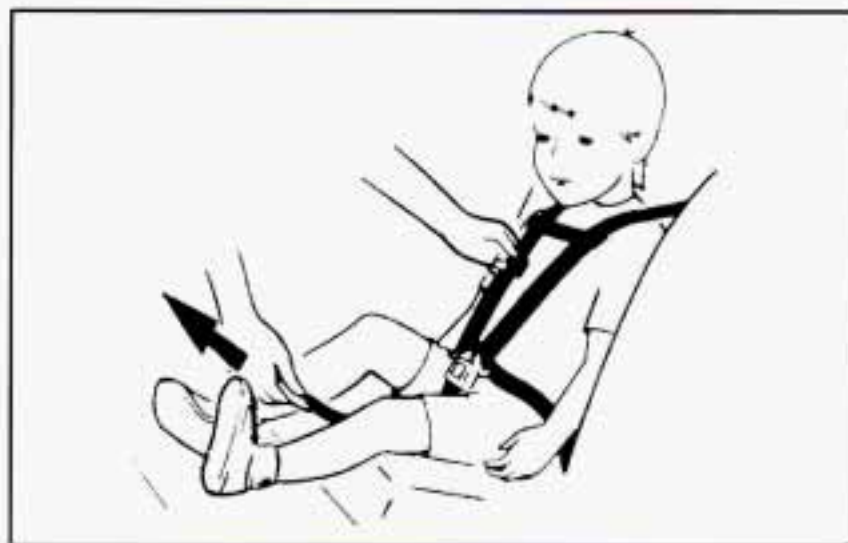

7. Pull the shoulder harness adjustment strap (grey) firmly until the shoulder harness straps are snug against the child's shoulders.
8. To release the child from the harness, separate the halves of the shoulder harness clip. Then push the red release button in the buckle. Move the shoulder harness straps to the side and remove the child.

If you expect that the child will sleep while riding, a U-shaped pillow that supports the child's chin may be helpful in providing additional comfort. Such devices may be found in the child restraint section of major toy stores or other stores where children's accessories are sold.

Storing the Built-in Child Restraint

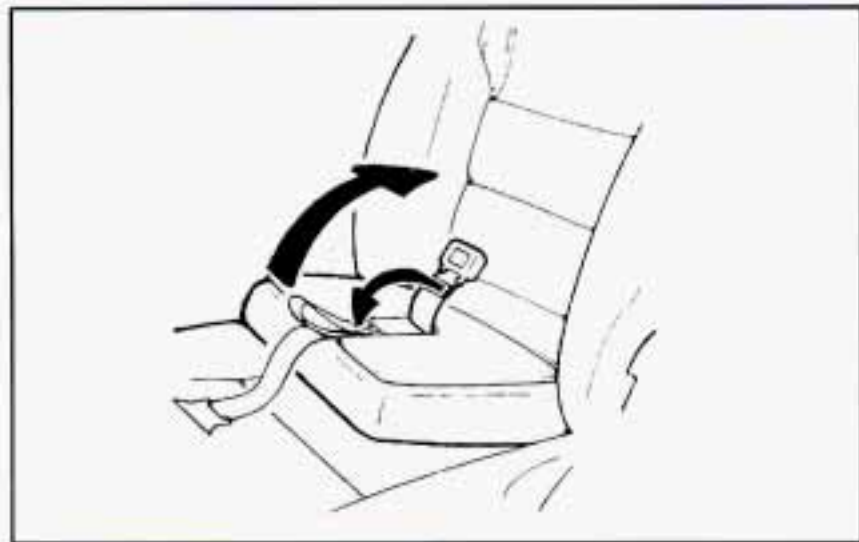

1. Make sure that the crotch strap is held flush to the child restraint cushion with the fastener strip. Also be sure the shoulder harness adjustment strap (grey) is folded up in the seat. This will allow the cushion to fold completely into the seatback. Raise the cushion.

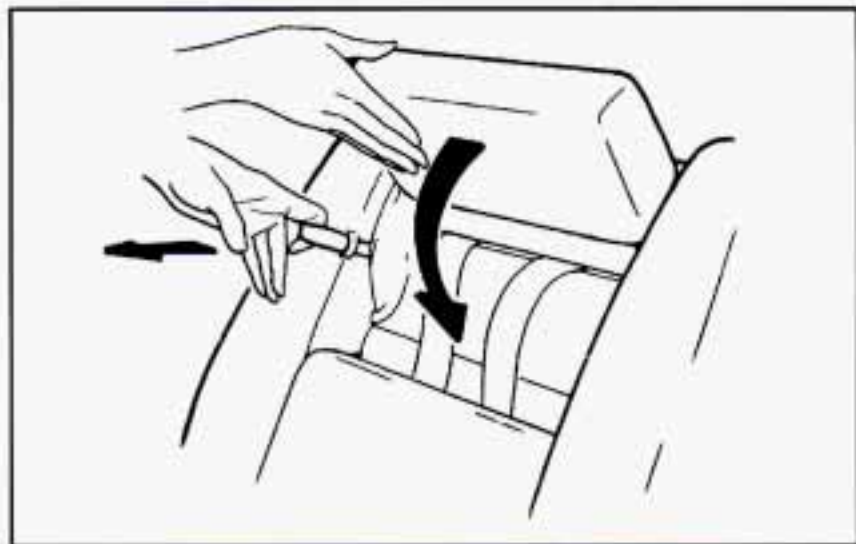

2. Unlatch the child head restraint by pulling the release strap. Lower the head restraint and press it firmly into the seatback until you hear the latch click.

Using as a Booster Seat

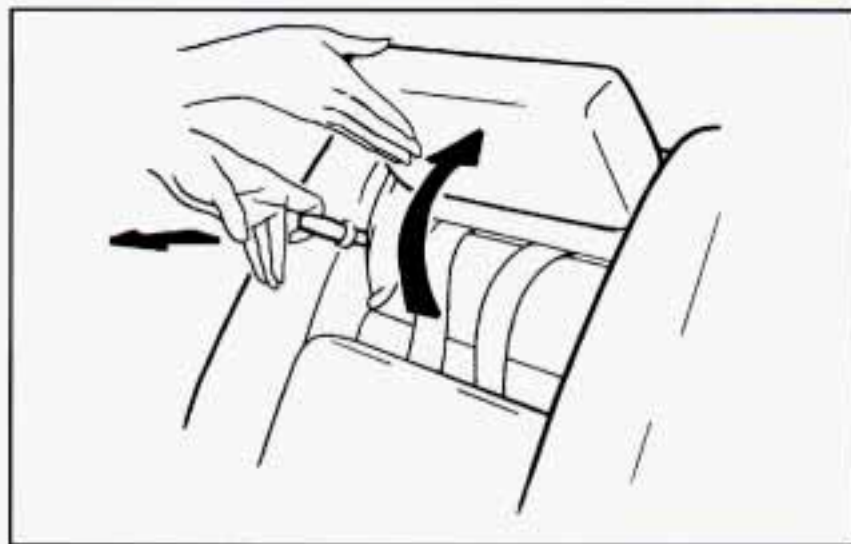

1. Pull the head restraint release strap and raise the head restraint until you hear the latch click.



2. Lower the child restraint cushion.

CAUTION:

The child head restraint is not for use by an adult. Use of this head restraint by an adult could result in injury in the event of a collision.



3. Store the five-point child restraint harness behind the removable pad. The pad is held in place by fastener strips.



4. Place the child on the cushion and fasten the vehicle lap-shoulder belt around the child.
5. To release the child from the vehicle lap-shoulder belt, push the red button on the buckle.

Child Restraints

Be sure the child restraint is designed to be used in a vehicle. If it is, it will have a label saying that it meets Federal Motor Vehicle Safety Standards.

Then follow the instructions for the restraint. You may find these instructions on the restraint itself or in a booklet, or both. These restraints use the belt system in your vehicle, but the child also has to be secured within the restraint to help reduce the chance of personal injury. The instructions that come with the infant or child restraint will show you how to do that.

Where to Put the Restraint

Accident statistics show that children are safer if they are restrained in the rear rather than the front seat. We at General Motors therefore recommend that you put your child restraint in the rear seat unless the child is an infant and you're the only adult in the vehicle. In that case, you might want to secure the restraint in the front seat where you can keep an eye on the baby.

Wherever you install it, be sure to secure the child restraint properly.

Keep in mind that an unsecured child restraint can move around in a collision or sudden stop and injure people in the vehicle. Be sure to properly secure any child restraint in your vehicle -- even when no child is in it.

Top Strap

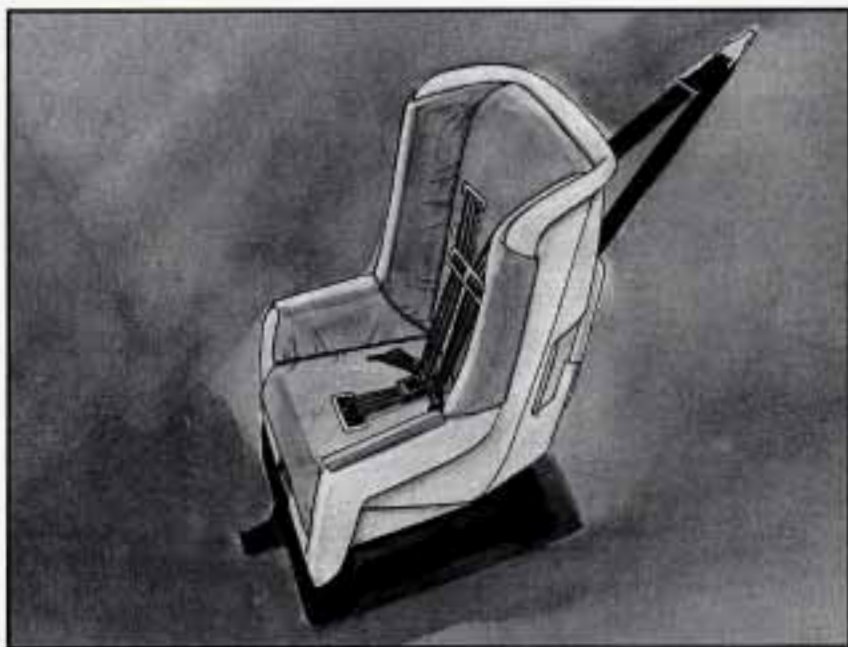

If your child restraint has a top strap, it should be anchored. Anchor brackets for the second row outside positions are located just above the place where the third row lap-shoulder belts meet the floor.



There's a vinyl sleeve there; to get to the bracket, push this vinyl sleeve aside slightly. Anchor the top strap to the bracket. If you need to have an anchor bracket installed for any additional passenger seat position, you can ask your Oldsmobile retailer to put it in for you. If you want to install an anchor bracket yourself, your retailer can tell you how to do it.

Once you have the top strap anchored, you'll be ready to secure the child restraint itself.

Securing a Child Restraint in an Outside Seat Position

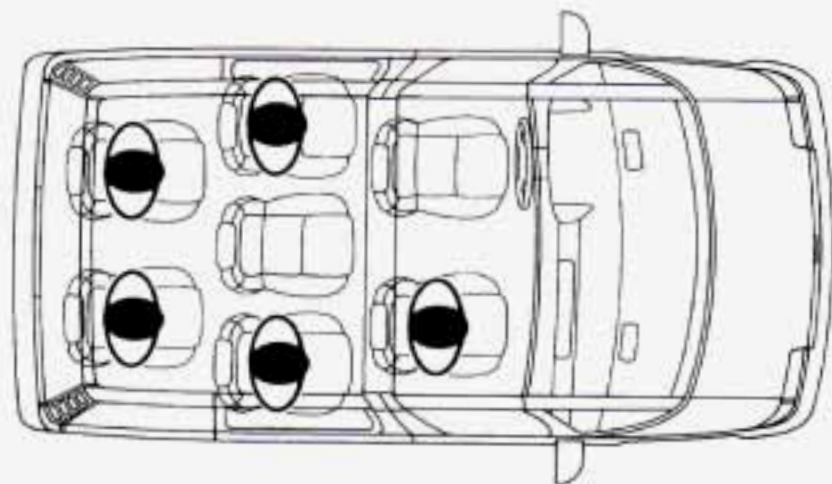

You'll be using the lap-shoulder belt. See the earlier part about the top strap if the child restraint has one.

1. Put the restraint on the seat. Follow the instructions for the child restraint.
2. Secure the child in the child restraint as the instructions say.
3. Pick up the latch plate, and run the lap and shoulder portions of the vehicle's safety belt through or around the restraint. The child restraint instructions will show you how.



Tilt the latch plate to adjust the belt if needed.
If the shoulder belt goes in front of the child's face or neck, put it behind the child restraint.



4. Buckle the belt. Make sure the release button is positioned so you would be able to unbuckle the safety belt quickly if you ever had to.



Securing a Child Restraint in the Center Seat Position

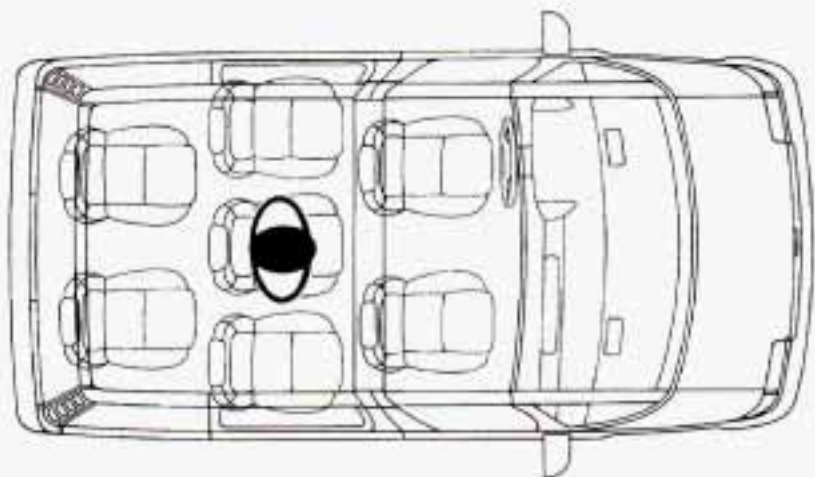

5. To tighten the belt, pull up on the shoulder belt while you push down on the child restraint.
6. Push and pull the child restraint in different directions to be sure it is secure.

To remove the child restraint, just unbuckle the vehicle's safety belt and let it go back all the way. The safety belt will move freely again and be ready to work for an adult or larger child passenger.

You'll be using the lap belt. See the earlier part about the top strap if the child restraint has one.

1. Put the restraint on the seat. Follow the instructions for the child restraint.
2. Secure the child in the child restraint as the instructions say.



3. Pull the lap belt all the way out without stopping.
4. While holding it out, run the belt through or around the child restraint. The child restraint instructions will show you how.



5. Buckle the belt. Make sure the release button is positioned so you would be able to unbuckle the safety belt quickly if you ever had to.



6. To tighten the belt, feed it back into the retractor while you push down on the child restraint.
7. Push and pull the child restraint in different directions to be sure it is secure.

To remove the child restraint, just unbuckle the vehicle's safety belt and let it go back all the way. The safety belt will move freely again and be ready to work for an adult or larger child passenger.

Larger Children



Children who have outgrown child restraints should wear the vehicle's safety belts.

If you have the choice, a child should sit next to a window so the child can wear a lap-shoulder belt and get the additional restraint a shoulder belt can provide.

Accident statistics show that children are safer if they are restrained in the rear seat. But they need to use the safety belts properly.

- Children who aren't buckled up can be thrown out in a crash.
- Children who aren't buckled up can strike other people who are.



CAUTION:

Never do this.

Here two children are wearing the same belt. The belt can't properly spread the impact forces. In a crash, the two children can be crushed together and seriously injured. A belt must be used by only one person at a time.

- Q:** What if a child is wearing a lap-shoulder belt, but the child is so small that the shoulder belt is very close to the child's face or neck?
- A:** Move the child toward the center of the vehicle, but be sure that the shoulder belt still is on the child's shoulder, so that in a crash the child's upper body would have the restraint that belts provide. If the child is so small that the shoulder belt is still very close to the child's face or neck, you might want to place the child in the center seat position, the one that has only a lap belt.



⚠ CAUTION:

Never do this.

Here a child is sitting in a seat that has a lap-shoulder belt, but the shoulder part is behind the child. If the child wears the belt in this way, in a crash the child might slide under the belt. The belt's force would then be applied right on the child's abdomen. That could cause serious or fatal injuries.

Wherever the child sits, the lap portion of the belt should be worn low and snug on the hips, just touching the child's thighs. This applies belt force to the child's pelvic bones in a crash.

Safety Belt Extender

If the vehicle's safety belt will fasten around you, you should use it.

But if a safety belt isn't long enough to fasten, your retailer will order you an extender. It's free. When you go in to order it, take the heaviest coat you will wear, so the extender will be long enough for you. The extender will be just for you, and just for the seat in your vehicle that you choose. Don't let someone else use it, and use it only for the seat it is made to fit. To wear it, just attach it to the regular safety belt.

Checking Your Restraint Systems

Now and then, make sure the safety belt reminder light and all your belts, buckles, latch plates, retractors and anchorages are working properly. If your vehicle has a built-in child restraint, also periodically make sure the harness straps, latch plates, buckle, clip, child head restraint and anchorages are working properly. Look for any other loose or damaged safety belt and built-in child restraint system parts. If you see anything that might keep a safety belt or built-in child restraint system from doing its job, have it repaired.

Torn or frayed safety belts may not protect you in a crash. They can rip apart under impact forces. If a belt is torn or frayed, get a new one right away.

If your vehicle has the built-in child restraint, torn or frayed harness straps can rip apart under impact forces just like torn or frayed safety belts can. They may not protect a child in a crash. If a harness strap is torn or frayed, get a new harness right away.

Also look for any opened or broken air bag covers, and have them repaired or replaced. (The air bag system does not need regular maintenance.)

Replacing Restraint System Parts After a Crash

If you've had a crash, do you need new safety belts or built-in child restraint parts?

After a very minor collision, nothing may be necessary. But if the safety belts or built-in child restraint harness straps were stretched, as they would be if worn during a more severe crash, then you need new safety belts or harness straps.

If safety belts or built-in child restraint harness straps are cut or damaged, replace them. Collision damage also may mean you will need to have safety belt, built-in child restraint or seat parts repaired or replaced. New parts and repairs may be necessary even if the safety belt or built-in child restraint wasn't being used at the time of the collision.

If an air bag inflates, you'll need to replace air bag system parts. See the part on the air bag system earlier in this section.



Section 2 Features and Controls

Here you can learn about the many standard and optional features on your Oldsmobile, and information on starting, shifting and braking. Also explained are the instrument panel and the warning systems that tell you if everything is working properly -- and what to do if you have a problem.

Keys

CAUTION:

Leaving young children in a vehicle with the ignition key is dangerous for many reasons. A child or others could be badly injured or even killed.

They could operate power windows or other controls or even make the vehicle move. Don't leave the keys in a vehicle with young children.





The ignition keys are for the ignition only.

When a new vehicle is delivered, the retailer removes the plugs from the keys and gives them to the first owner.

Each plug has a code on it that tells your retailer or a qualified locksmith how to make extra keys. Keep the plugs in a safe place. If you lose your keys, you'll be able to have new ones made easily using these plugs.

NOTICE:

Your Oldsmobile has a number of new features that can help prevent theft. But you can have a lot of trouble getting into your vehicle if you ever lock your keys inside. You may even have to damage your vehicle to get in. So be sure you have extra keys.



The door keys are for the doors and all other locks.

Front Doors

⚠ CAUTION:

Pay attention when you open or close these doors from the outside. Stay clear of the upper rear corner to avoid hitting your head.



Door Locks

CAUTION:

Unlocked doors can be dangerous.

Passengers -- especially children -- can easily open the doors and fall out. When a door is locked, the inside handle won't open it.

Outsiders can easily enter through an unlocked door when you slow down or stop your vehicle.

This may not be so obvious: You increase the chance of being thrown out of the vehicle in a crash if the doors aren't locked. Wear safety belts properly, lock your doors, and you will be far better off whenever you drive your vehicle.

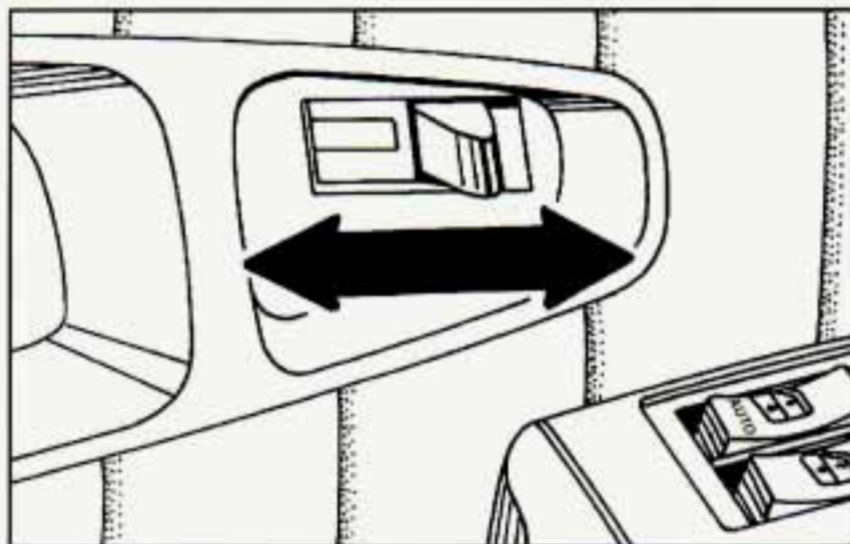

To lock the door from the inside, slide the locking lever rearward.

To unlock the door, slide the locking lever forward.

There are several ways to lock and unlock your vehicle.

From the outside, use your door key or the Remote Lock Control transmitter (if your vehicle has this option).

Power Door Locks (Option)

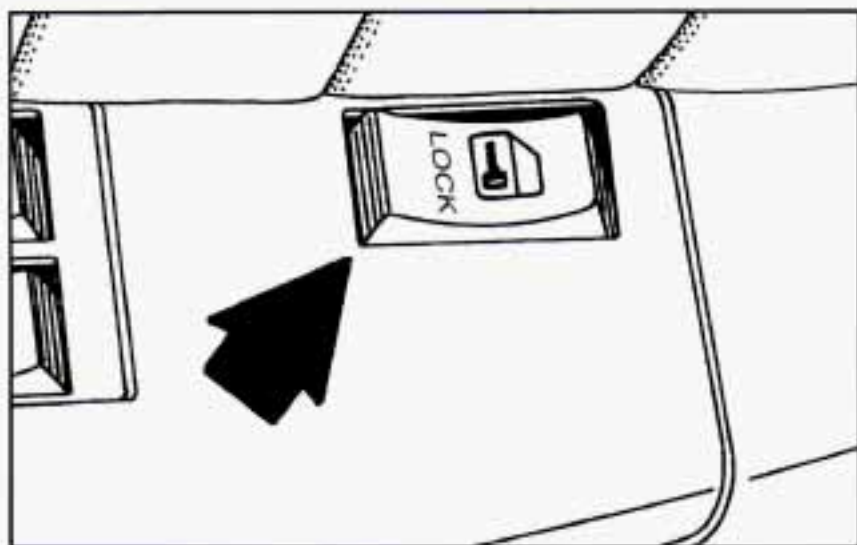

From the inside, press the front of the power door lock switch (on either front door), to unlock all doors and the liftgate.

You can lock all doors and the liftgate from the inside, by pressing the rear of the power lock switch on either front door.

If you have the optional Remote Lock Control system, your vehicle has a special security feature. If the driver's door is open and your key is in the ignition in the OFF position, you won't be able to set the door locks with the

power door lock switch or the remote transmitter. This feature is designed to help keep you from locking your keys in your vehicle.

If the sliding door is open when you press the power door lock switch, it will lock automatically within five seconds after you close it.

If you have the optional Remote Lock Control system, this feature will be replaced by a different lock delay system. See "Remote Lock Control" later in this section.

With power locks, when the doors are locked, the inside as well as the outside door latch release cannot open the doors. This safety feature prevents a door from being accidentally opened from the inside by moving the handle.

To override this safety feature, slide the locking lever to the unlock position on the door you want to open.

When the liftgate has been unlocked with the power door locks, you won't need the key to open it. Simply turn the lock clockwise until the latch releases. This is also true if you use the optional Remote Lock Control transmitter. See "Remote Lock Control" later in this section.

To lock the liftgate, use either the power door lock switch or the optional Remote Lock Control transmitter. You may also lock it manually by turning the lock counterclockwise.

Automatic Door Locks (Option)

With this feature, you can unlock all of the doors from the outside by holding the key in the unlock position for one second. To unlock only the driver's or passenger's door, turn the key to the unlock position and release.

From the inside, when the ignition is on and the driver's door is closed, all doors will lock each time you move the shift lever out of PARK (P). If the passenger's door or the liftgate is open when you move the shift lever out of PARK (P), they will lock when closed.

If the sliding door is open when you move the shift lever out of PARK (P) or manually lock the doors using the power door lock switches, a lock delay feature allows the sliding door to lock five seconds after it is closed.

With the automatic door locks feature, you can still lock or unlock the doors at any time, either manually or with the power door lock switches.

Overriding Lock Delay

To override the lock delay feature, press the front of the power door lock switch (the unlock position) while the shift lever is in PARK (P).

If you have the Remote Lock Control system, there are three additional ways you can disable the lock delay feature (see "Remote Lock Control" later in this section):

- Press the unlock symbol on your remote transmitter.
- Return the shift lever to PARK (P), or
- Turn the ignition off.

Customizing Your Automatic Door Locks Feature

With the Remote Lock Control system, you can customize your automatic door locks feature to suit your individual needs. (See "Remote Lock Control" later in this section.)

With the doors closed and the ignition on, press and hold the driver's side power door lock switch in the lock position for 10 seconds. The doors will lock, then unlock, indicating that you have 10 seconds in which to program one of four custom modes:

Unlock the Driver's Door Only: To program the automatic door locks system to unlock only the driver's door when the shift lever is returned to PARK (P), press the unlock symbol on your remote transmitter once. The driver's door will unlock, indicating that this mode has been successfully programmed.

Unlock All Doors: To program the automatic door locks system to unlock all doors when the shift lever is returned to PARK (P), press the unlock symbol on your remote transmitter once (the driver's door will unlock), then press the unlock symbol again. All doors will unlock, indicating that this mode has been successfully programmed.

All Doors Remain Locked: To program the automatic door locks system to leave all doors locked when the shift lever is returned to PARK (P), press the lock symbol on your remote transmitter once. All doors will lock, indicating that this mode has been successfully programmed.

Disengage the Automatic Door Locks System: To disengage the automatic door locks system, press the lock symbol on your remote transmitter once (all doors will lock). Press the lock symbol again. All doors will lock again, indicating that this mode has been successfully programmed.

You can reprogram the automatic door locks system at any time. If you do not program the automatic door locks system, all doors will remain locked when the shift lever is returned to PARK (P).

If you have more than one remote transmitter for your vehicle, your automatic door locks system will operate as programmed with any of them. There is no need to program each one individually.

Leaving Your Vehicle

If you are leaving the vehicle, take your keys, open your door and set the locks from inside. Then get out and close the door.

Remote Lock Control (Option)

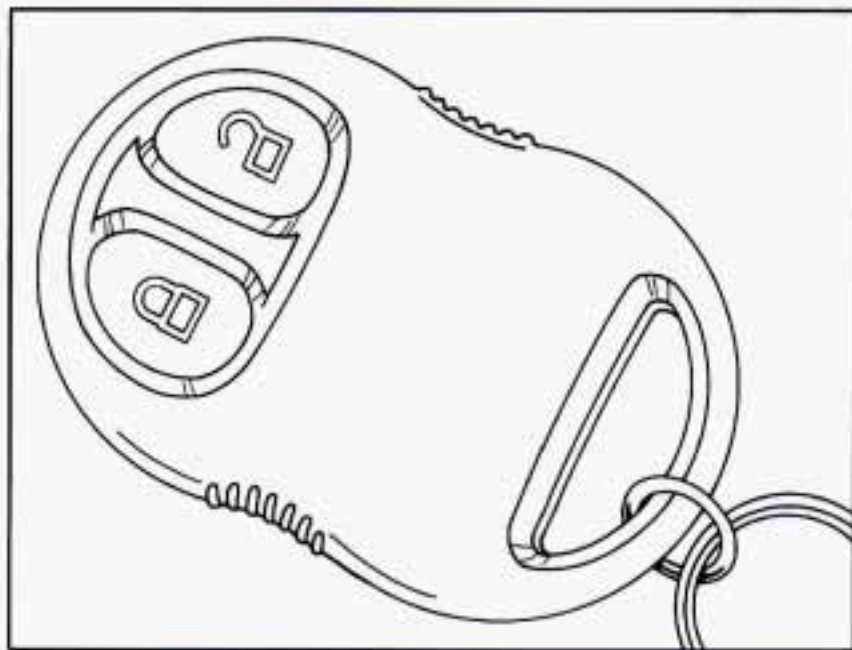

If your Oldsmobile has this option, you can lock and unlock your doors and liftgate from up to 30 feet (9 m) away using the key chain transmitter supplied with your vehicle.

Your Remote Lock Control operates on a radio frequency subject to Federal Communications Commission (FCC) Rules.

This device complies with Part 15 of the FCC Rules. Operation is subject to the following two conditions:
(1) This device may not cause harmful interference, and
(2) This device must accept any interference received, including interference that may cause undesired operation.

Should interference to this system occur, try this:

- Check to determine if battery replacement is necessary. See the instructions on battery replacement.
- Check the distance. You may be too far from your vehicle. This product has a maximum range.
- Check the location. Other vehicles or objects may be blocking the signal.
- See your Oldsmobile retailer or a qualified technician for service.

Changes or modifications to this system by other than an authorized service facility could void authorization to use this equipment.

Operation

The driver's door will unlock and the interior lamps will go on when the unlock symbol is pressed (see "Illuminated Entry System" later in this section). If pressed again within five seconds, all doors and the liftgate will unlock. All doors and the liftgate will lock when the lock symbol is pressed.

If the driver's door is open and your key is in the ignition in the OFF position, you won't be able to set the door lock with the power door lock switch or the remote transmitter. This security feature is designed to help keep you from locking your keys in your vehicle.

Lock Delay

The lock delay feature can be operated using either the remote key chain transmitter or the power door lock switch (see "Power Door Locks" earlier in this section).

For the lock delay feature to work, the ignition and the interior lamps control (located to the left of the instrument panel cluster) must be off. If you wish to lock the doors with the interior lamps on, press the lock symbol or the rear of either power door lock switch twice.

If any door is open when you press the lock symbol or the rear of either power door lock switch, a chime will sound three times. This indicates that all doors and the liftgate will lock about five seconds after the last door has been closed.

To override the lock delay feature, press the lock symbol or the rear of either power door lock switch again, and the doors and liftgate will lock immediately. If the sliding door is open, it will lock automatically within five seconds after it is closed.

To cancel the lock delay feature, press the unlock symbol or the front of either power door lock switch.

Remote Operation of the Power Sliding Door (Option)



If you have the optional power sliding door (see “Power Sliding Door” later in this section), your remote transmitter will have a third button that has a van symbol on it. Press it to open or close the sliding door.

If the sliding door is locked, first press the unlock symbol twice to unlock all doors, then press the van symbol to open the sliding door.

You can operate the power sliding door with the remote transmitter only when the power sliding door ON/OFF switch on the overhead console is in the ON position.

Matching Transmitter(s) To Your Vehicle

Each key chain transmitter is coded to prevent another transmitter from unlocking your vehicle. If a transmitter is lost or stolen, a replacement can be purchased through your retailer. Remember to bring any remaining transmitters with you when you go to your retailer.

When the retailer matches the replacement transmitter to your vehicle, any remaining transmitters must also be matched. Once the new transmitter is coded, the lost transmitter will not unlock your vehicle. Each vehicle can have only four transmitters matched to it.

Battery Replacement

Under normal use, the battery in your key chain transmitter should last about two years.

You can tell the battery is weak if the transmitter won't work at the normal range in any location. If you have to get close to your vehicle before the transmitter works, it's probably time to change the battery.

Replacing the Battery in the Remote Transmitter

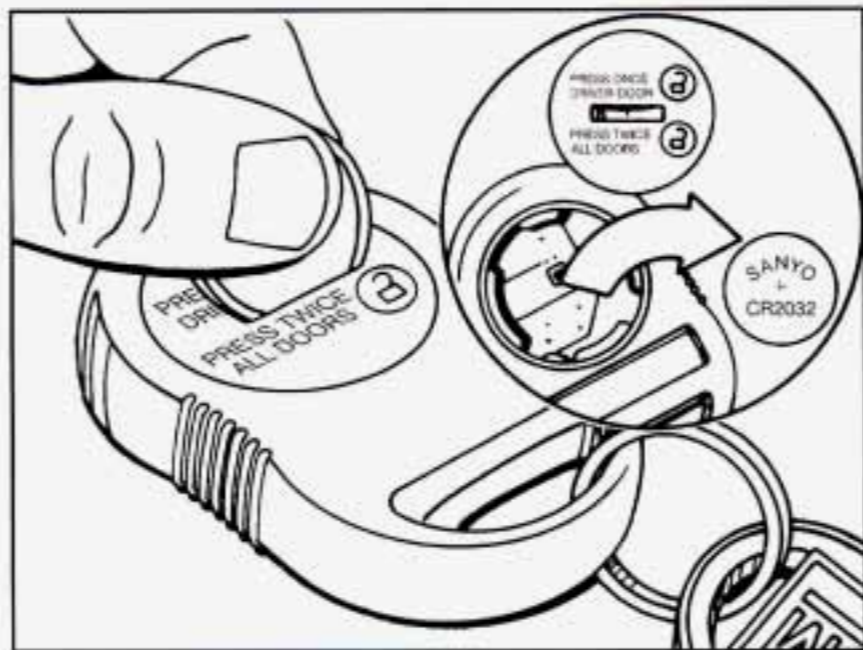

1. Insert a coin into the slot in the back of the transmitter, and turn it counterclockwise to open the cover.
2. Remove the cover.

3. Remove and replace the 3-volt battery (CR2032).
4. Reassemble the transmitter.
5. Check the transmitter operation.

Illuminated Entry System (Option)

This option comes with the optional Remote Lock Control system.

When you open the driver's door (by itself or in combination with any passenger door or the liftgate) the interior lamps will come on and then gradually dim to off, 10 seconds after the last door is closed. (If the driver's door has not been opened, the interior lamps will immediately dim to off.)

When you press the unlock symbol on your remote transmitter, the lamps inside your vehicle will go on, then gradually dim to off after about 40 seconds, unless a door or the liftgate is opened.

When you turn on the ignition, the interior lamps will immediately dim to off.

Sliding Door

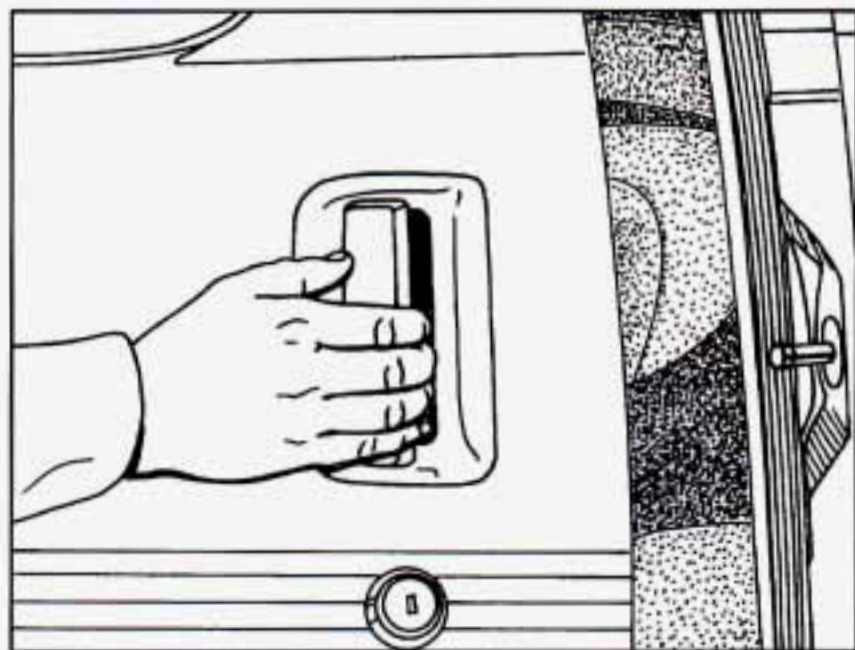

To open the sliding door from outside the vehicle, pull the front of the latch release out and then toward the rear. If you slide the door all the way back, it will latch in the open position.

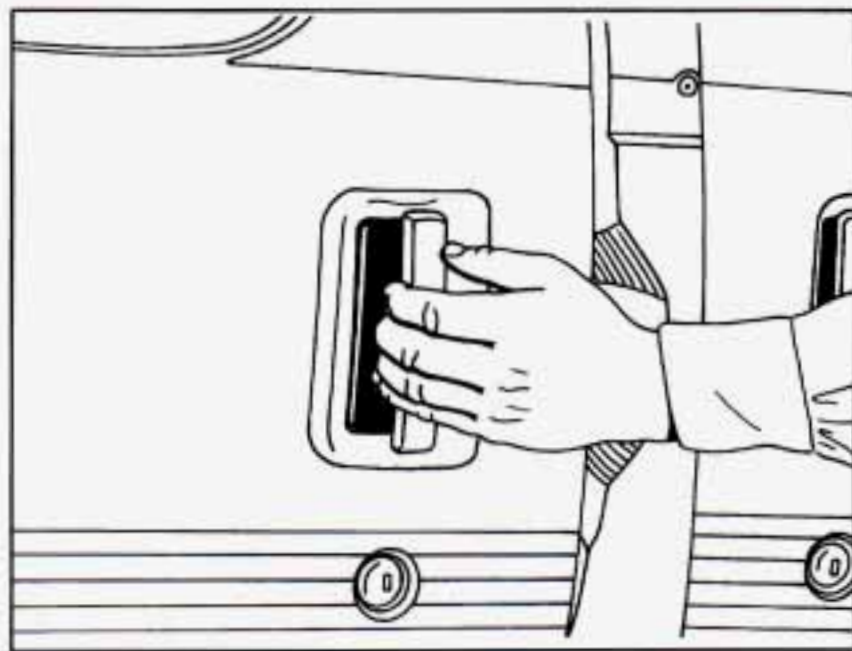

To move the door forward, you must first pull the inside or outside latch release out and then forward, or the door will remain latched in the open position.

Sliding Door Lock

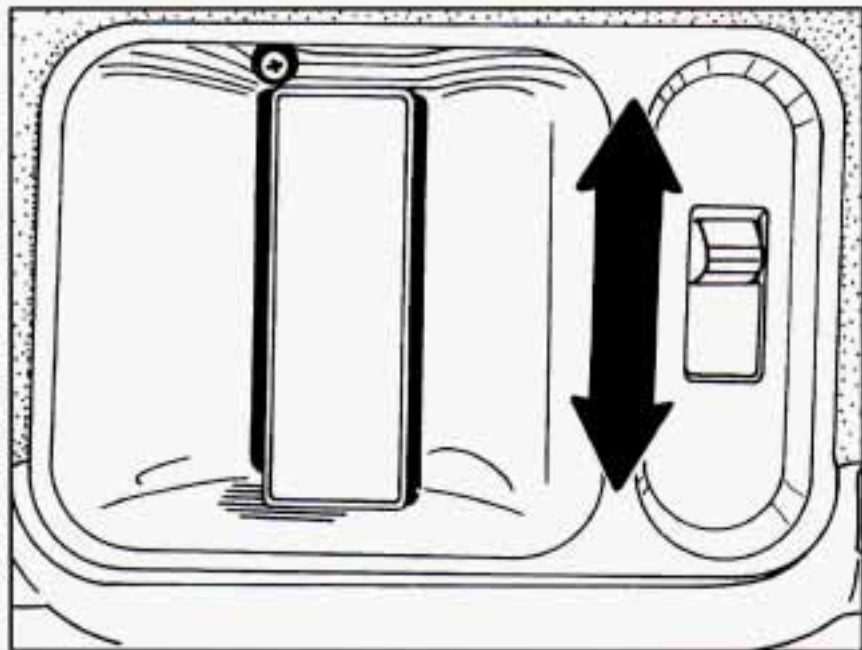

Lock the sliding door from the inside by sliding the manual locking lever down. Unlock it by sliding the lever up.

If you have the optional power door locks, the sliding door lock has a delay feature. See "Power Door Locks" or "Automatic Door Locks" in the Index.

Power Sliding Door (Option)

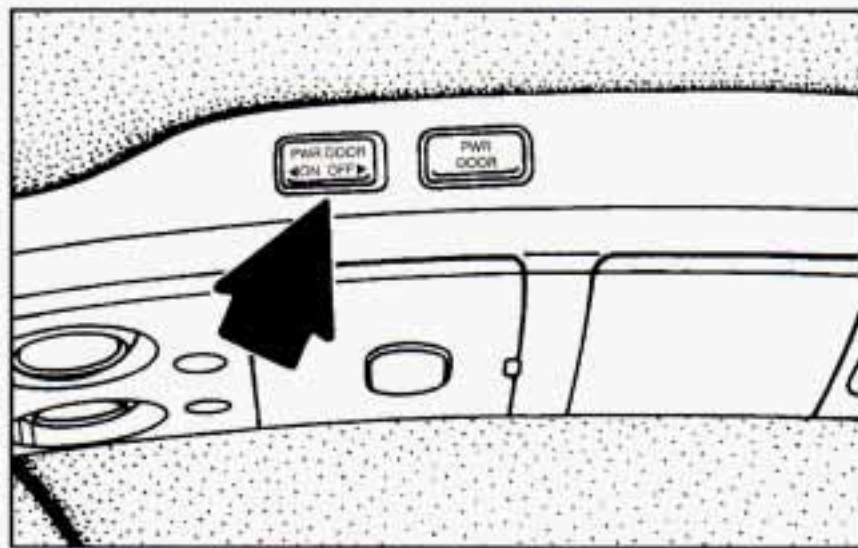

With this option, you can open and close the sliding door with switches inside your vehicle. If you have the optional Remote Lock Control system, you can also operate the sliding door with your remote transmitter. See "Remote Lock Control" in the Index.

⚠ CAUTION:

Leaving young children or pets unattended in your vehicle can be dangerous. They could operate the power sliding door. A child or others could be injured. Do not leave children or pets unattended in your vehicle.

To operate the power sliding door, the power sliding door ON/OFF switch must be in the ON position. This switch is the forward-most of two power door switches located on the side of the overhead console. (If you have the compact overhead console, this switch is located between the reading lamps.) To disable the power sliding door feature, slide the switch to OFF.

When your vehicle goes through an automatic car wash, be sure the power sliding door ON/OFF switch is in the OFF position.

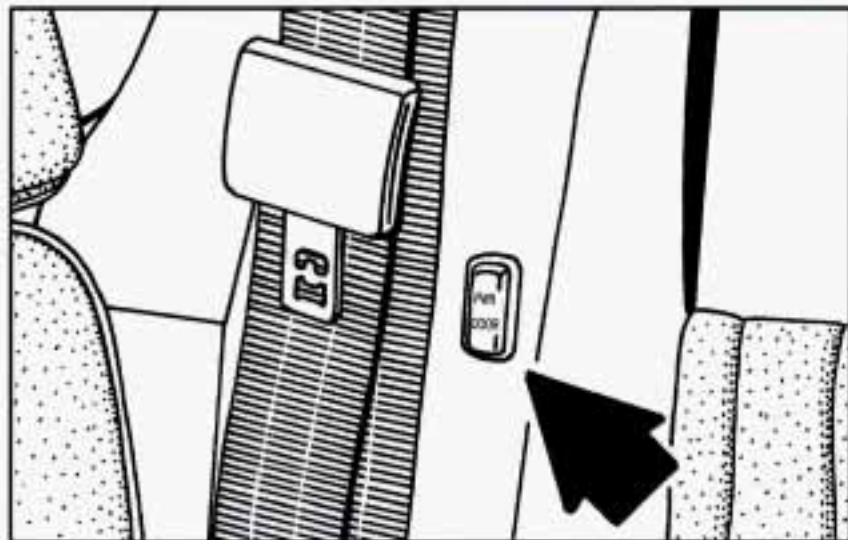

To open or close the sliding door, press and release one of two PWR DOOR switches. There is one mounted on the wall, just in front of the sliding door; the other is the rear-most switch on the side of the overhead console. (If you have the compact overhead console, this switch is located between the reading lamps.)

The sliding door must be unlocked for the power sliding door to operate. The ignition does not have to be on and the key does not have to be in the ignition. To prevent accidental operation of the sliding door, disable the power sliding door by placing the power sliding door ON/OFF switch in the OFF position.

When the key is in the ignition in the RUN position, the power sliding door will only open if the transaxle is in PARK (P). The transaxle does not have to be in PARK (P) to close the door. If the ON/OFF switch is in the ON position and the power sliding door is open or in the process of closing when you shift out of PARK (P), a tone will sound and the power sliding door warning light on your instrument panel will flash (see “Power Sliding Door Warning Light” in the Index). This is a warning light that the sliding door is not completely closed.

⚠ CAUTION:

If you shift the transaxle out of PARK (P) and accelerate before the power sliding door latches closed, the door may reverse to the open position. A child or others could fall out of the vehicle and be injured. Always make sure the power sliding door is closed and latched before you drive away.

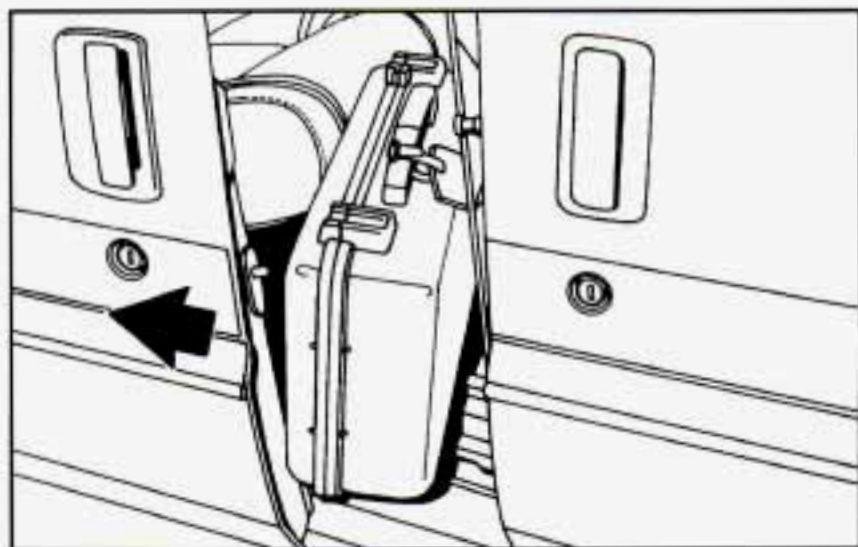

If anything obstructs the power sliding door while it is closing, the door will automatically reverse to the open position, provided it meets sufficient resistance. Resistance must be as strong as the force of the closing door, or stronger. The force of the closing door increases significantly as the door approaches the latch position.

 **CAUTION:**

You or others could be injured if caught in the path of the sliding door. Make sure the door path is clear before closing the door.

Objects caught in the path of the sliding door may be damaged. Make sure the door path is clear before closing the door.

To manually open the power sliding door when the sliding door ON/OFF switch is in the ON position, pull the inside or outside latch release and let go; the door will open fully and remain latched in the open position.

To manually open the power sliding door when the ON/OFF switch is in the OFF position, pull the inside or outside latch release and slide the door all the way back to the latch position.

 **CAUTION:**

If your vehicle is facing downward on a steep grade (20% or more), the door may not stay open and could slam shut, possibly injuring someone. To make sure the door does not slam shut, turn the ON/OFF switch ON. Then if the door closes, it will close under the control of the power door system.



To manually close the power sliding door when the sliding door ON/OFF switch is in the ON position, pull the inside or outside latch release or the edge of the door. Move the door about 4 inches (10 cm) toward the closed position and release. The door will close completely and latch for you.

To manually close the power sliding door when the ON/OFF switch is in the OFF position, pull the inside or outside latch release and slide the door all the way forward to the latch position.

Resetting the Power Sliding Door

The power sliding door may operate incorrectly or not at all because of the following conditions:

- A low voltage or dead battery
- Disconnecting the battery
- If the GUAGES, TAIL or TURN B/U fuse is removed or blown.

See "Fuse Panel" in the Index for more information about your fuse panel.

If any of these conditions occur, the power sliding door will need to be reset. To do this, follow the directions listed here. It will be easier if you read through them once before beginning this procedure.

1. Check to be sure the power sliding door is unlocked and securely closed.
2. Turn the ignition switch to the OFF position.
3. Turn the power sliding door ON/OFF switch to OFF.
4. Remove the TAIL fuse from the fuse panel. Leave it out for 30 seconds.
5. Reinstall the fuse and wait 10 seconds.
6. Move the ON/OFF switch to the ON position.

7. Push either of the PWR DOOR buttons to open the power sliding door.
8. Wait five seconds and close the door by pushing either PWR DOOR button.
9. Wait five seconds and repeat Steps 7 and 8.

If the door does not rest in the fully open position after repeating Step 7, repeat Steps 7 and 8 again. If the door still does not operate correctly, see your retailer for service.

Sliding Door Security Lock

Your Oldsmobile is equipped with a sliding door security lock that helps prevent passengers from opening the sliding door from the inside.

If you have the optional power sliding door, you can override the security lock by pressing the PWR DOOR switch when the power sliding door ON/OFF switch is in the ON position. See “Power Sliding Door” earlier in this section.

The security lock lever is located on the inside of the sliding door, near the rear edge of the door. To access the lever, open the sliding door. Use the security lock label on the rear edge of the door as a guide. Reach around the inside rear corner of the sliding door to access the lever.

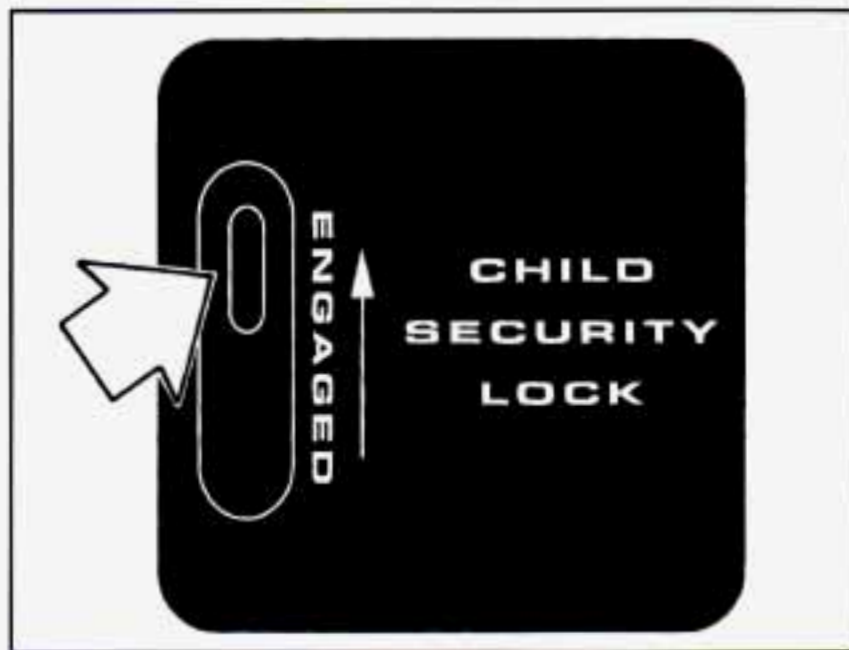

To use the security lock, move the security lock lever all the way up and close the door.

If you have the optional power sliding door, slide the power sliding door ON/OFF switch on the overhead console to the OFF position. The sliding door cannot be opened from the inside when this feature is in use.

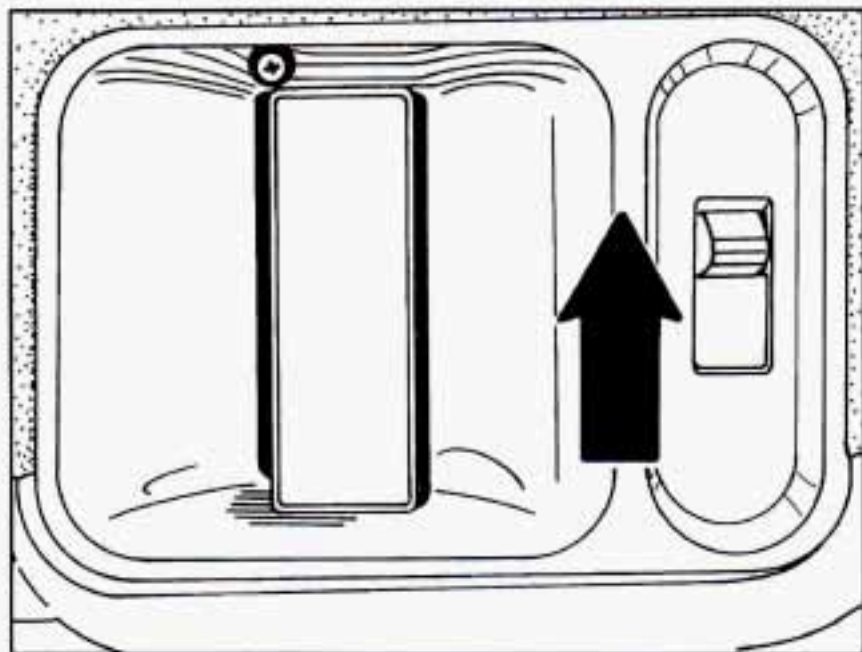

If you want to open the sliding door when the security lock is on, unlock the sliding door from the inside and open the door from the outside.

If you have the optional power sliding door, slide the power sliding door ON/OFF switch to the ON position. Press either PWR DOOR switch.

You should let adults and older children know how the security lock works, and how to cancel the lock. If you don't, adults or older children who ride in the rear won't be able to open the sliding door from the inside when the security lock feature is in use.

To Cancel the Sliding Door Lock

1. Unlock the sliding door from the inside and open the door from the outside.
2. Move the security lock lever all the way down.

The sliding door lock will now work normally.

Liftgate

Open the liftgate using the handle above the license plate. Once slightly opened, the liftgate will rise by itself. Lamps in the liftgate will come on, illuminating the rear cargo area (see "Rear Interior Lamps" in the Index).

NOTICE:

Be sure there are no overhead obstructions, such as a garage door, before you open the liftgate. You could slam the liftgate into something and break the glass.



To close the liftgate, pull down on the handle, then firmly shut the liftgate. Don't drive with the liftgate open, even slightly. See "Engine Exhaust" in the Index.

A light on your instrument panel will warn you if the liftgate is not completely closed (see "Liftgate Ajar Warning Light" in the Index).

⚠ CAUTION:

It can be dangerous to drive with the liftgate open because carbon monoxide (CO) gas can come into your vehicle. You can't see or smell CO. It can cause unconsciousness and even death. If you must drive with the liftgate open or if electrical wiring or other cable connections must pass through the seal between the body and the liftgate:

- Make sure all windows are shut.
- Turn the fan on your heating or cooling system to its highest speed with the setting on BI-LEV (Bi-Level) or UPPER. That will force outside air into your vehicle. See "Comfort Controls" in the Index.
- If you have air outlets on or under the instrument panel, open them all the way. See "Engine Exhaust" in the Index.

Liftgate Lock

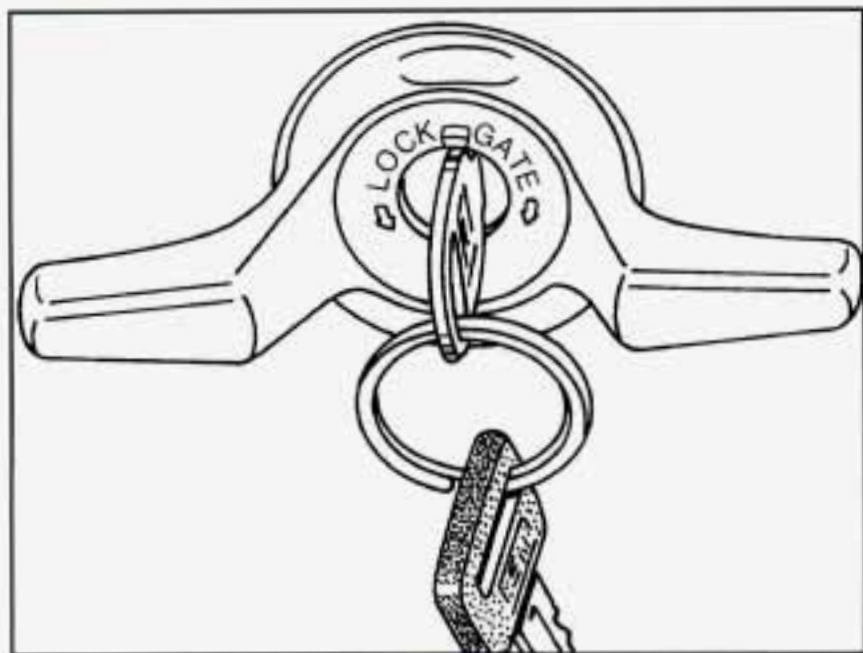

To unlock the liftgate, insert the door key and turn the lock clockwise. The liftgate will automatically lock when you close it.

If you have the optional power door locks or the Remote Lock Control system, the liftgate will lock and unlock differently. See "Power Door Locks" in the Index.

Theft

Vehicle theft is big business, especially in some cities. Although your Oldsmobile has a number of theft-deterrent features, we know that nothing we put on it can make it impossible to steal. However, there are ways you can help.

Key in the Ignition

If you leave your vehicle with the keys inside, it's an easy target for joy riders or professional thieves -- so don't do it.

When you park your Oldsmobile and open the driver's door, you'll hear a chime reminding you to remove your key from the ignition and take it with you. Always do this. Your steering wheel will be locked, and so will your ignition and transaxle. And remember to lock the doors.

Parking at Night

Park in a lighted spot, close all windows and lock your vehicle. Remember to keep your valuables out of sight. Put them in a storage area, or take them with you.

Parking Lots

If you park in a lot where someone will be watching your vehicle, it's best to lock it up and take your keys. But what if you have to leave your ignition key? What if you have to leave something valuable in your vehicle?

- Put your valuables in a storage area, like your glove box or locking storage bin.
- Lock the storage bin.
- Lock all the doors except the driver's.
- Then take the door key with you.

New Vehicle “Break-In”

NOTICE:

Your modern Oldsmobile doesn't need an elaborate “break-in.” But it will perform better in the long run if you follow these guidelines:

- **Don't drive at any one speed -- fast or slow -- for the first 500 miles (804 km). Don't make full-throttle starts.**
- **Avoid making hard stops for the first 200 miles (322 km) or so. During this time your new brake linings aren't yet broken in. Hard stops with new linings can mean premature wear and earlier replacement. Follow this breaking-in guideline every time you get new brake linings.**
- **Don't tow a trailer during break-in. See “Towing a Trailer” in the Index for more information.**

Ignition Positions

With the ignition key in the ignition switch, you can turn the switch to five positions.

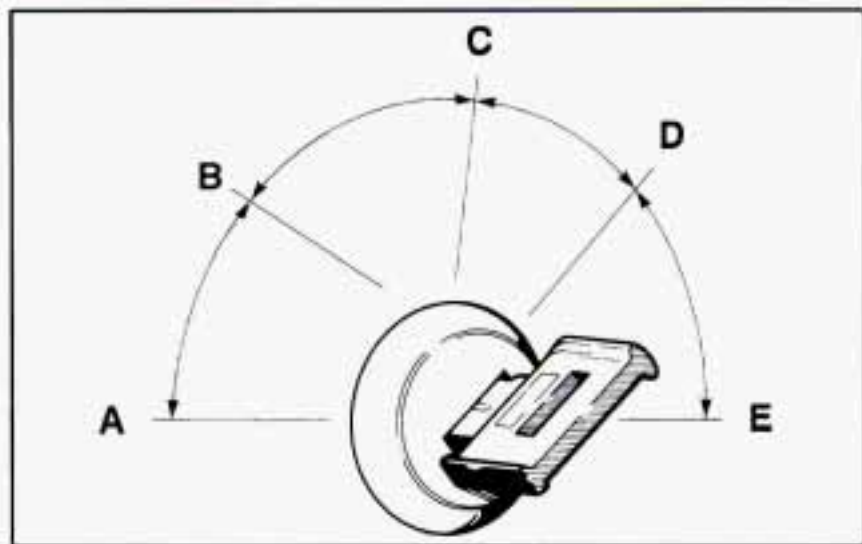

ACCESSORY (A): An on position in which you can operate your electrical power accessories. Press in the ignition switch as you turn the top of it toward you.

LOCK (B): This is the only position in which you can remove the key. This locks your steering wheel, ignition and transaxle.

OFF (C): This position unlocks the steering wheel, ignition and transaxle, but does not send electrical power to any accessories. Use this position if your vehicle must be pushed or towed, but never try to push-start your vehicle. A warning chime will sound if you open the driver's door when the ignition is OFF and the key is in the ignition.

RUN (D): An on position to which the switch returns after you start your engine and release the switch. The switch stays in the RUN position when the engine is running. But even when the engine is not running, you can use the RUN position to operate your electrical power accessories, and to display some instrument panel warning lights.

START (E): This position starts the engine. When the engine starts, release the key. The ignition switch will return to the RUN position for normal driving.

Note that even if the engine is not running, the positions ACCESSORY and RUN are on positions that allow you to operate your electrical accessories, such as the radio.

NOTICE:

If your key seems stuck in LOCK and you can't turn it, be sure it is all the way in. If it is, then turn the steering wheel left and right while you turn the key hard. But turn the key only with your hand. Using a tool to force it could break the key or the ignition switch. If none of this works, then your vehicle needs service.

Starting Your Engine

Move your shift lever to PARK (P) or NEUTRAL (N). Your engine won't start in any other position -- that's a safety feature. To restart when you're already moving, use NEUTRAL (N) only.

NOTICE:

Don't try to shift to PARK (P) if your Oldsmobile is moving. If you do, you could damage the transaxle. Shift to PARK (P) only when your vehicle is stopped.

1. Without pushing the accelerator pedal, turn your ignition key to START. When the engine starts, let go of the key. The idle speed will go down as your engine gets warm.

NOTICE:

Holding your key in START for longer than 15 seconds at a time will cause your battery to be drained much sooner. And the excessive heat can damage your starter motor.

2. If it doesn't start right away, hold your key in START. If it doesn't start in three seconds (or starts but then stops), push the accelerator pedal about one-quarter of the way down for 12 more seconds, or until it starts.
3. If your engine still won't start (or starts but then stops), it could be flooded with too much gasoline. Try this:
Wait 15 seconds to let the starter motor cool down. Then push your accelerator pedal all the way to the floor. Hold it there. Then hold the key in START.

This clears the extra gasoline from the engine. When the engine starts, let go of the key and the accelerator pedal. If the engine still doesn't start, wait another 15 seconds and repeat this step.

NOTICE:

Your engine is designed to work with the electronics in your vehicle. If you add electrical parts or accessories, you could change the way the engine operates. Before adding electrical equipment, check with your retailer. If you don't, your engine might not perform properly.
If you ever have to have your vehicle towed, see the part of this manual that tells how to do it without damaging your vehicle. See "Towing Your Vehicle" in the Index.

Engine Coolant Heater (Option)

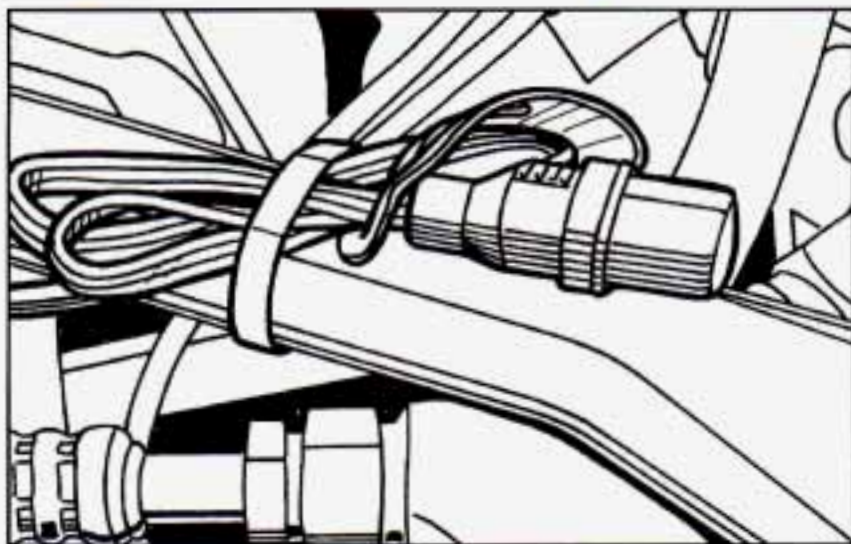

In very cold weather, 0°F (-18°C) or colder, the engine coolant heater can help. You'll get easier starting and better fuel economy during engine warm-up. Usually, the coolant heater should be plugged in a minimum of four hours prior to starting your vehicle.

To use the coolant heater:

1. Turn off the engine.
2. Open the hood and unwrap the electrical cord.
3. Plug it into a normal, grounded 110-volt AC outlet.

CAUTION:

Plugging the cord into an ungrounded outlet could cause an electrical shock. Also, the wrong kind of extension cord could overheat and cause a fire. You could be seriously injured. Plug the cord into a properly grounded three-prong 110-volt AC outlet. If the cord won't reach, use a heavy-duty three-prong extension cord rated for at least 15 amps.

4. After you've used the coolant heater, be sure to store the cord as it was before to keep it away from moving engine parts. If you don't, it could be damaged.

How long should you keep the coolant heater plugged in? The answer depends on the outside temperature, the kind of oil you have, and some other things. Instead of trying to list everything here, we ask that you contact your Oldsmobile retailer in the area where you'll be parking your vehicle. The retailer can give you the best advice for that particular area.

Automatic Transaxle Operation

There are several different positions for your shift lever.



PARK (P): This position locks your front wheels. It's the best position to use when you start your engine because your vehicle can't move easily.

Ensure the shift lever is fully in PARK (P) before starting the engine. Your Oldsmobile has Brake-Transaxle Shift Interlock (BTSI). You must fully *apply* your regular brakes *before* you can shift from PARK (P) when the ignition key is in the RUN position. As you step on the brake pedal, while in PARK (P), you may hear a click from the solenoid of the BTSI. This ensures that the BTSI is operating properly.

If you cannot shift out of PARK (P), ease pressure on the shift lever -- push the shift lever all the way into PARK (P) as you maintain brake application. Then move the shift lever into the gear you wish. See "Shifting Out of PARK (P)" in this section.

 **CAUTION:**

It is dangerous to get out of your vehicle if the shift lever is not fully in PARK (P) with the parking brake firmly set. Your vehicle can roll. Don't leave your vehicle when the engine is running unless you have to. If you have left the engine running, the vehicle can move suddenly. You or others could be injured. To be sure your vehicle won't move, even when you're on fairly level ground, always set your parking brake and move the shift lever to PARK (P). See "Shifting Into PARK (P)" in the Index. If you're pulling a trailer, see "Towing a Trailer" in the Index.

REVERSE (R): Use this gear to back up.

NOTICE:

Shifting to REVERSE (R) while your vehicle is moving forward could damage your transaxle. Shift to REVERSE (R) only after your vehicle is stopped.

To rock your vehicle back and forth to get out of snow, ice or sand without damaging your transaxle, see "Stuck: In Sand, Mud, Ice or Snow" in the Index.

NEUTRAL (N): In this position, your engine doesn't connect with the wheels. To restart when you're already moving, use NEUTRAL (N) only. Also, use NEUTRAL (N) when your vehicle is being towed.

NOTICE:

Damage to your transaxle caused by shifting out of PARK (P) or NEUTRAL (N) with the engine racing isn't covered by your warranty.

CAUTION:

Shifting out of PARK (P) or NEUTRAL (N) while your engine is "racing" (running at high speed) is dangerous. Unless your foot is firmly on the brake pedal, your vehicle could move very rapidly. You could lose control and hit people or objects. Don't shift out of PARK (P) or NEUTRAL (N) while your engine is racing.

AUTOMATIC OVERDRIVE (Ⓢ): This position is for normal driving. If you need more power for passing, and you're:

- Going less than about 35 mph (56 km/h), push your accelerator pedal about halfway down.
- Going about 35 mph (56 km/h) or more, push the accelerator all the way down.

You'll shift down to the next gear and have more power.

THIRD (D): This position is also used for normal driving but it offers more power and lower fuel economy than AUTOMATIC OVERDRIVE (Ⓢ).

Here are some times you might choose THIRD (D) instead of AUTOMATIC OVERDRIVE (Ⓢ):

- When driving on hilly, winding roads.
- When towing a trailer, so there is less shifting between gears.
- When going down a steep hill.

SECOND (2): This position gives you more power, but lower fuel economy. You can use SECOND (2) on hills. It can help control your speed as you go down steep mountain roads, but then you would also want to use your brakes off and on.

NOTICE:

Don't drive in SECOND (2) for more than 25 miles (41 km), or at speeds over 55 mph (88 km/h), or you can damage your transaxle. Use THIRD (D) or AUTOMATIC OVERDRIVE (Ⓢ) as much as possible. Don't shift into SECOND (2) unless you are going slower than 65 mph (105 km/h) or you can damage your engine.

NOTICE:

If your vehicle seems to start up rather slowly, or if it seems not to shift gears as you go faster, something may be wrong with a transaxle system sensor. If you drive very far that way, your vehicle can be damaged. So, if this happens, have your vehicle serviced right away. Until then, you can use SECOND (2) when you are driving less than 35 mph (55 km/h) and THIRD (D) for higher speeds.

FIRST (1): This position gives you even more power (but lower fuel economy) than **SECOND (2)**. You can use it on very steep hills, or in deep snow or mud. If the selector lever is put in **FIRST (1)**, the transaxle won't shift into first gear until the vehicle is going slowly enough.

NOTICE:

If your front wheels can't rotate, don't try to drive. This might happen if you were stuck in very deep sand or mud or were up against a solid object. You could damage your transaxle.

Also, if you stop when going uphill, don't hold your vehicle there with only the accelerator pedal. This could overheat and damage the transaxle. Use your brakes or shift into **PARK (P) to hold your vehicle in position on a hill.**

Parking Brake

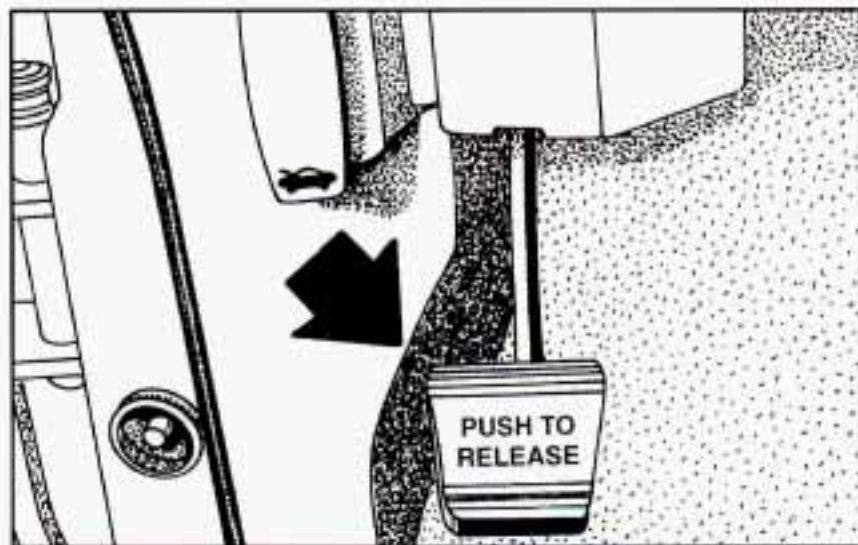

To set the parking brake, hold the regular brake pedal down with your right foot and push down the parking brake pedal with your left foot. If the ignition is on, the brake system warning light will come on. See "Brake System Warning Light" in the Index.

To release the parking brake, hold the regular brake pedal down with your right foot while you push down on the parking brake pedal with your left foot. (To release the tension on the parking brake cable, you will need to apply about the same amount of pressure to the parking brake pedal as you did when you set the parking brake.) When you remove your foot from the parking brake pedal, it will pop up to the release position.

NOTICE:

Driving with the parking brake on can cause your rear brakes to overheat. You may have to replace them, and you could also damage other parts of your vehicle.

If you are towing a trailer and are parking on any hill, see “Towing a Trailer” in the Index. That section shows what to do first to keep the trailer from moving.

Shifting Into PARK (P)



CAUTION:

It can be dangerous to get out of your vehicle if the shift lever is not fully in PARK (P) with the parking brake firmly set. Your vehicle can roll. If you have left the engine running, the vehicle can move suddenly. You or others could be injured. To be sure your vehicle won't move, even when you're on fairly level ground, use the steps that follow. If you're pulling a trailer, see “Towing a Trailer” in the Index.

1. Hold the brake pedal down with your right foot and set the parking brake with your left foot.

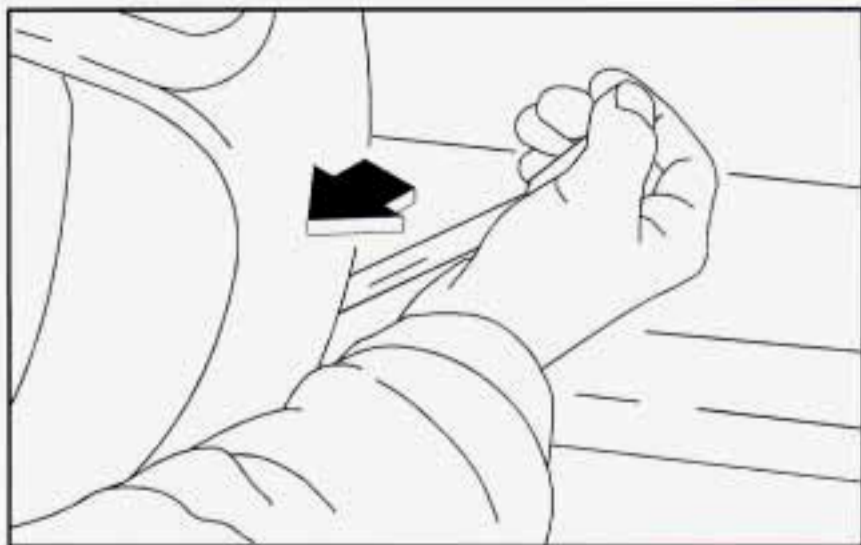

2. Move the shift lever into the PARK (P) position like this:

- Pull the lever toward you.

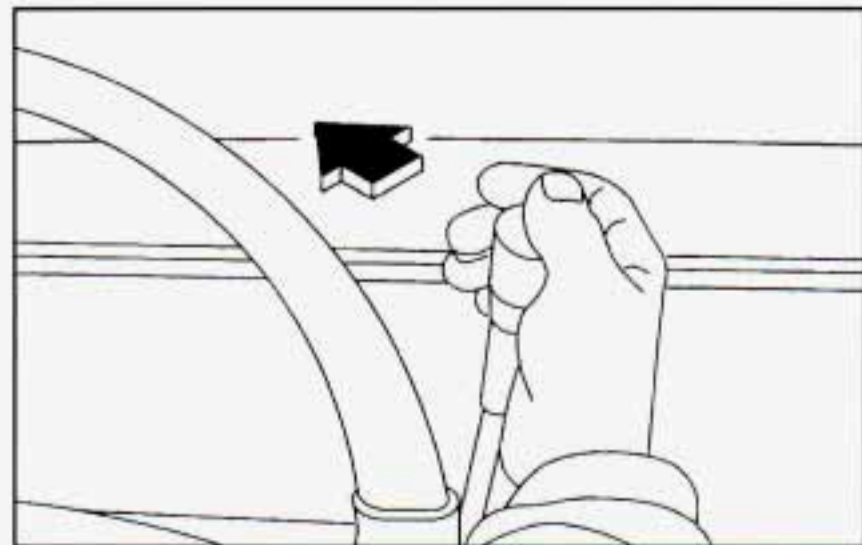

- Move the lever up as far as it will go.

3. Move the ignition key to the LOCK position.

4. Remove the key and take it with you. If you can leave your vehicle with the ignition key in your hand, your vehicle is in PARK (P).

Leaving Your Vehicle With the Engine Running

CAUTION:

It can be dangerous to leave your vehicle with the engine running. Your vehicle could move suddenly if the shift lever is not fully in PARK (P) with the parking brake firmly set. And, if you leave the vehicle with the engine running, it could overheat and even catch fire. You or others could be injured. Don't leave your vehicle with the engine running unless you have to.

If you have to leave your vehicle with the engine running, be sure your vehicle is in PARK (P) and your parking brake is firmly set before you leave it. After you've moved the shift lever into the PARK (P) position, hold the regular brake pedal down. Then, see if you can move the shift lever away from PARK (P) without first pulling it toward you.

If you can, it means that the shift lever wasn't fully locked into PARK (P).

Torque Lock

If you are parking on a hill and you don't shift your transaxle into PARK (P) properly, the weight of the vehicle may put too much force on the parking pawl in the transaxle. You may find it difficult to pull the shift lever out of PARK (P). This is called "torque lock." To prevent torque lock, set the parking brake and then shift into PARK (P) properly before you leave the driver's seat. To find out how, see "Shifting Into PARK (P)" in the Index.

When you are ready to drive, move the shift lever out of PARK (P) *before* you release the parking brake.

If torque lock does occur, you may need to have another vehicle push yours a little uphill to take some of the pressure from the transaxle, so you can pull the shift lever out of PARK (P).

Shifting Out of PARK (P)

Your Oldsmobile has Brake-Transaxle Shift Interlock (BTSI). You have to fully *apply* your regular brakes *before* you can shift from PARK (P), when the ignition is in the RUN position. See "Automatic Transaxle Operation" in the Index.

As you step on the brake pedal, while in PARK (P), you may hear a click from the solenoid of the BTSI. This ensures that the BTSI is operating properly.

If you cannot shift out of PARK (P), ease pressure on the shift lever -- push the shift lever all the way into PARK (P) as you maintain brake application. Then move the shift lever into the gear you want. If you ever hold the brake pedal down but still can't shift out of PARK (P), try this:

1. Turn the key to the OFF position.
2. Apply and hold the brake until the end of Step 4.
3. Shift to NEUTRAL (N).
4. Start the vehicle and then shift to the drive gear you want.
5. Have the vehicle fixed as soon as you can.

Parking Over Things That Burn



CAUTION:

Things that can burn could touch hot exhaust parts under your vehicle and ignite. Don't park over papers, leaves, dry grass or other things that can burn.

Engine Exhaust

CAUTION:

Engine exhaust can kill. It contains the gas carbon monoxide (CO), which you can't see or smell. It can cause unconsciousness and death.

You might have exhaust coming in if:

- Your exhaust system sounds strange or different.
- Your vehicle gets rusty underneath.
- Your vehicle was damaged in a collision.
- Your vehicle was damaged when driving over high points on the road or over road debris.
- Repairs weren't done correctly.
- Your vehicle or exhaust system had been modified improperly.

If you ever suspect exhaust is coming into your vehicle:

- Drive it only with all the windows down to blow out any CO; and
- Have your vehicle fixed immediately.

Running Your Engine While You're Parked

It's better not to park with the engine running. But if you ever have to, here are some things to know.

CAUTION:

Idling the engine with the air system control off could allow dangerous exhaust into your vehicle (see the earlier Caution under "Engine Exhaust").

Also, idling in a closed-in place can let deadly carbon monoxide (CO) into your vehicle even if the fan switch is at the highest setting. One place this can happen is a garage. Exhaust -- with CO -- can come in easily. NEVER park in a garage with the engine running.

Another closed-in place can be a blizzard. (See "Blizzard" in the Index.)

CAUTION:

It can be dangerous to get out of your vehicle if the shift lever is not fully in PARK (P) with the parking brake firmly set. Your vehicle can roll. Don't leave your vehicle when the engine is running unless you have to. If you've left the engine running, the vehicle can move suddenly. You or others could be injured. To be sure your vehicle won't move, even when you're on fairly level ground, always set your parking brake and move the shift lever to PARK (P).

Follow the proper steps to be sure your vehicle won't move. See "Shifting Into PARK (P)" in the Index.

If you're pulling a trailer, see "Towing a Trailer" in the Index.

Windows

Manual Windows

Use the manual crank to open and close the front windows.

Power Windows (Option)

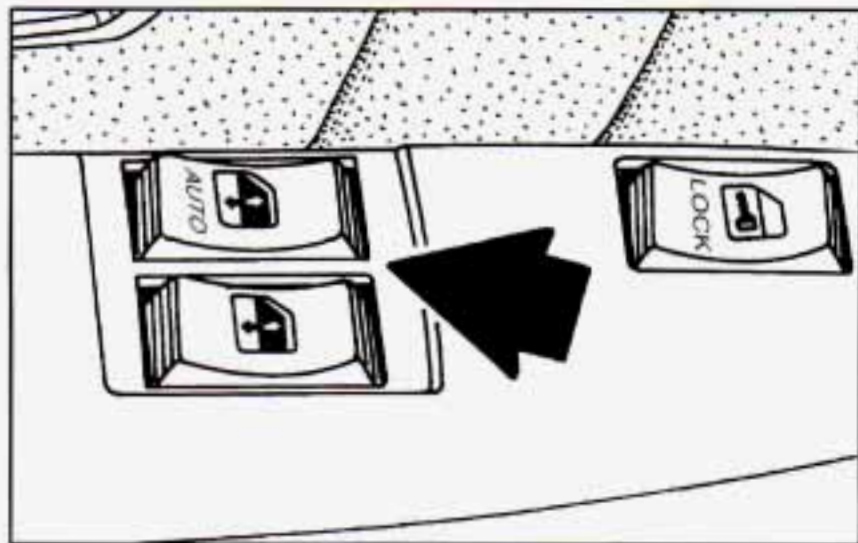

If you have power windows, the switches on the driver's door armrest control the front windows (when the ignition is on). The left switch controls the driver's window. The right switch controls the passenger's window.

The driver's power window switch has two down positions. Hold the rear of the switch in the first position to lower the window normally.

To activate the auto-down feature, fully press the rear of the switch, then release. The window will lower completely. To stop the window from lowering all the way, press the front of the switch.

To raise the window, press and hold the front of the switch.

Side Window Latches

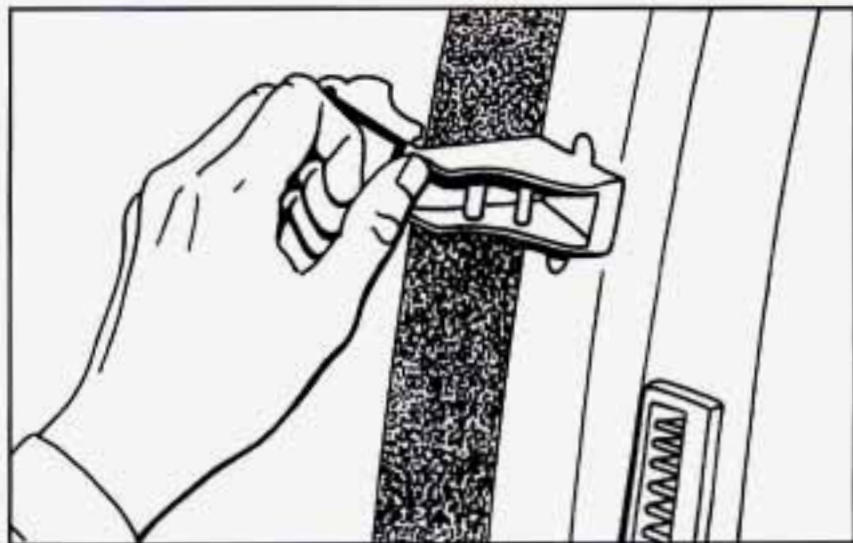

The rear of the side windows swings open.

To open, pull the latch forward to release it, then swing the window outward. Press the center of the latch to secure the window in the open position.

To close, pull the center of the latch forward and then close the latch.

Horn

You can sound the horn by pressing the horn symbols on your steering wheel.

Tilt Steering Wheel

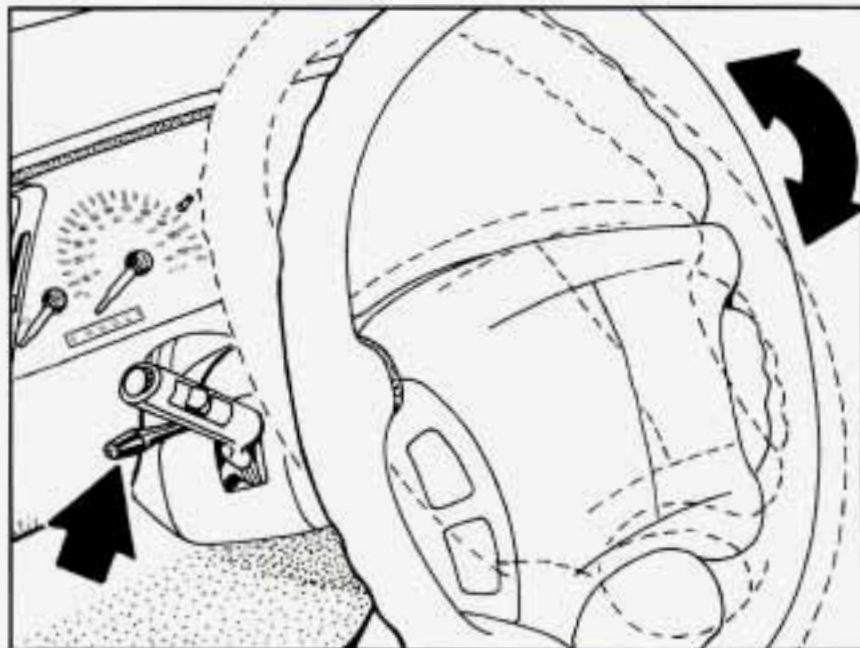

A tilt steering wheel allows you to adjust the steering wheel before you drive. You can also raise it to the highest level to give your legs more room when you exit and enter the vehicle.

To tilt the wheel, hold the steering wheel and pull the lever. Move the steering wheel to a comfortable level, then release the lever to lock the wheel in place.

Turn Signal/Multifunction Lever

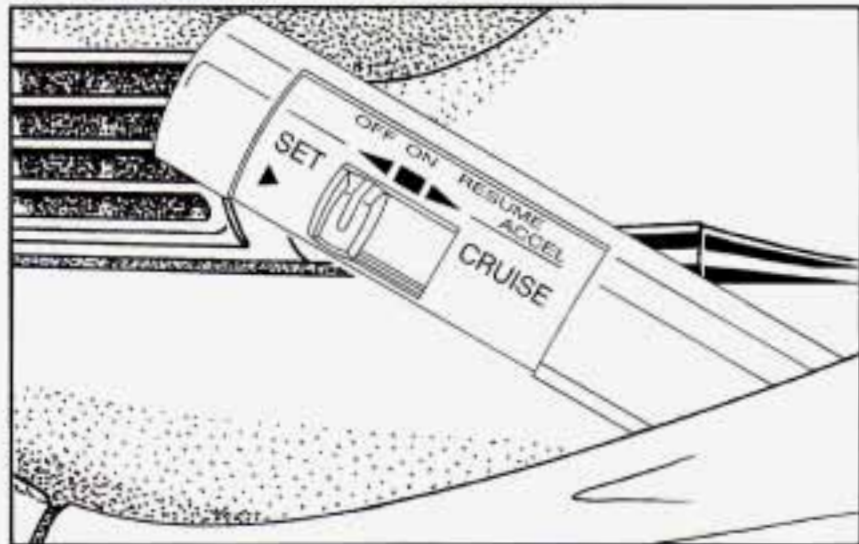

The lever on the left side of the steering column includes your:

- Turn Signal and Lane Change Indicator
- Headlamp High/Low Beam Changer
- Cruise Control (Option)

Turn Signal and Lane Change Indicator

The turn signal has two upward (for right) and two downward (for left) positions. These positions allow you to signal a turn or a lane change.

To signal a turn, move the lever all the way up or down. When the turn is finished, the lever will return automatically.

An arrow on the instrument panel will flash in the direction of the turn or lane change.

To signal a lane change, just raise or lower the lever until the arrow starts to flash. Hold it there until you complete your lane change. The lever will return by itself when you release it.

As you signal a turn or a lane change, if the arrows don't flash but just stay on, a signal bulb may be burned out and other drivers won't see your turn signal.

If a bulb is burned out, replace it to help avoid an accident. If the arrows don't go on at all when you signal a turn, check for burned-out bulbs and check the fuse (see "Fuses and Circuit Breakers" in the Index).

If you have a trailer towing option with added wiring for the trailer lamps, a different turn signal flasher is used. With this flasher installed, the signal indicator will flash even if a turn signal bulb is burned out. Check the front and rear turn signal lamps regularly to make sure they are working.

Headlamp High/Low Beam Changer

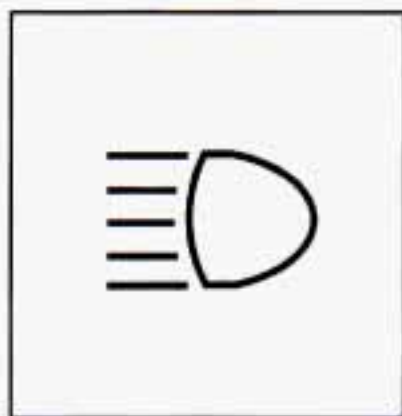

To change the headlamps from high to low beam, or low to high, simply pull the turn signal lever all the way toward you. Then release it.

When the high beams are on, a light on the instrument cluster will also be on.

Windshield Wipers

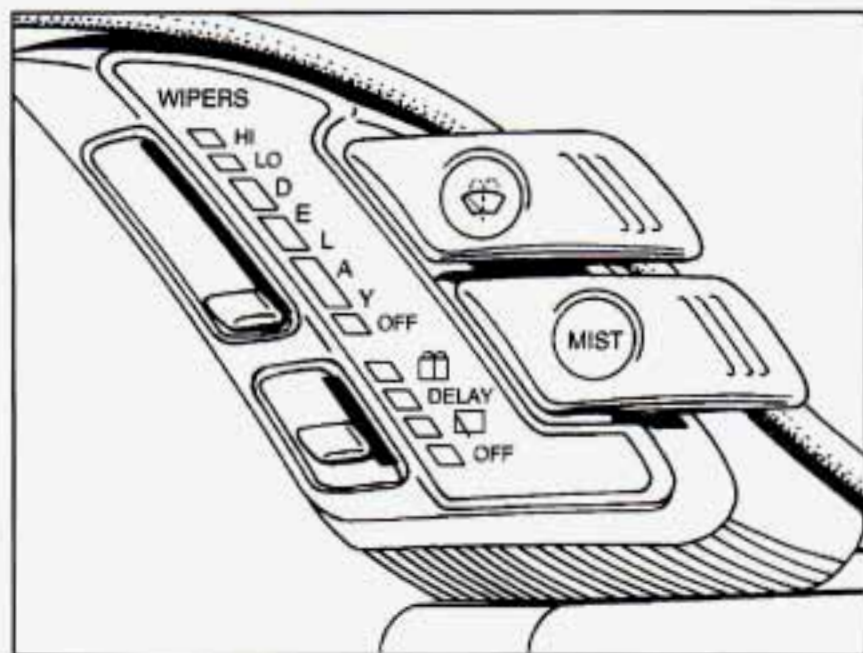

The windshield wiper and washer controls are located to the right of the instrument cluster.

For a single wiper cycle: Press the switch marked MIST and release. For more cycles, press and hold the switch.

For pulse delay wiper cycles: The pulse delay cycle system allows you to set the wiper speed as slow as 20 seconds between cycles, or faster. Pulse delay cycles are very useful in light rain or snow. Slide the upper control to the DELAY area. The lower the position, the slower the cycle; the higher the position, the faster the cycle.

For steady wiper cycles: Slide the upper control either to the LO or HI position, depending on the wiper speed you want.

To turn the wipers off: Slide the upper control to the OFF position.

Remember that damaged wiper blades may prevent you from seeing well enough to drive safely. To avoid damage, be sure to clear ice and snow from the wiper blades before using them. If they're frozen to the windshield, carefully loosen or thaw them. If your blades do become damaged, get new blades or blade inserts.

Heavy snow or ice can overload your wipers. A circuit breaker will stop them until the motor cools. Clear away snow or ice to prevent an overload.

Windshield Washer

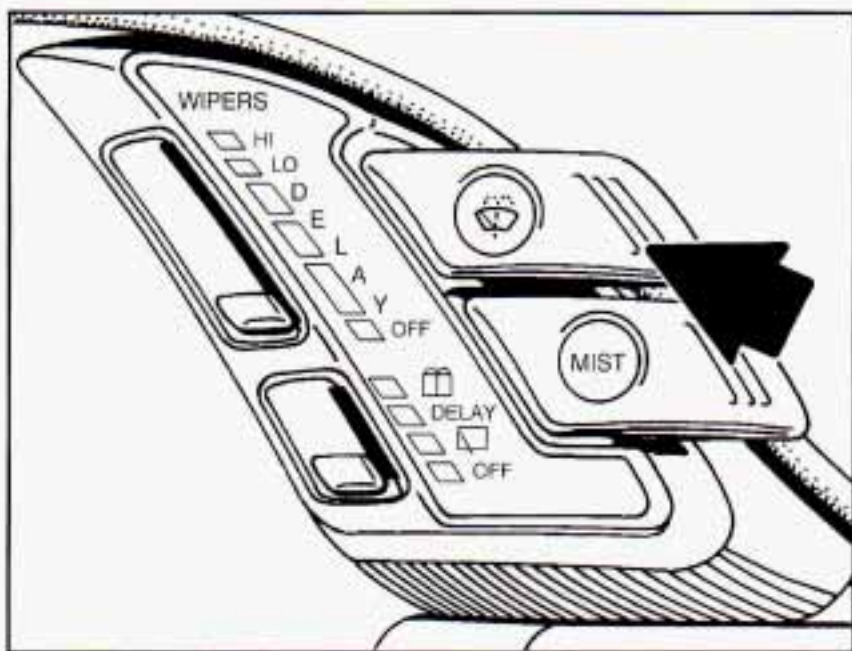

To wash your windshield, press and hold the windshield washer switch. The washers and wipers will operate. When you release the switch, the washers will stop, and the wipers will continue to operate for two cycles, unless your wipers had already been on. In that case, the wipers will resume the wiper speed you had selected earlier.

Driving without washer fluid can be dangerous. A bad mud splash can block your vision. You could hit another vehicle or go off the road. Check your washer fluid level often.

CAUTION:

In freezing weather, don't use your washer until the windshield is warmed. Otherwise the washer fluid can form ice on the windshield, blocking your vision.

Rear Window Wiper and Washer

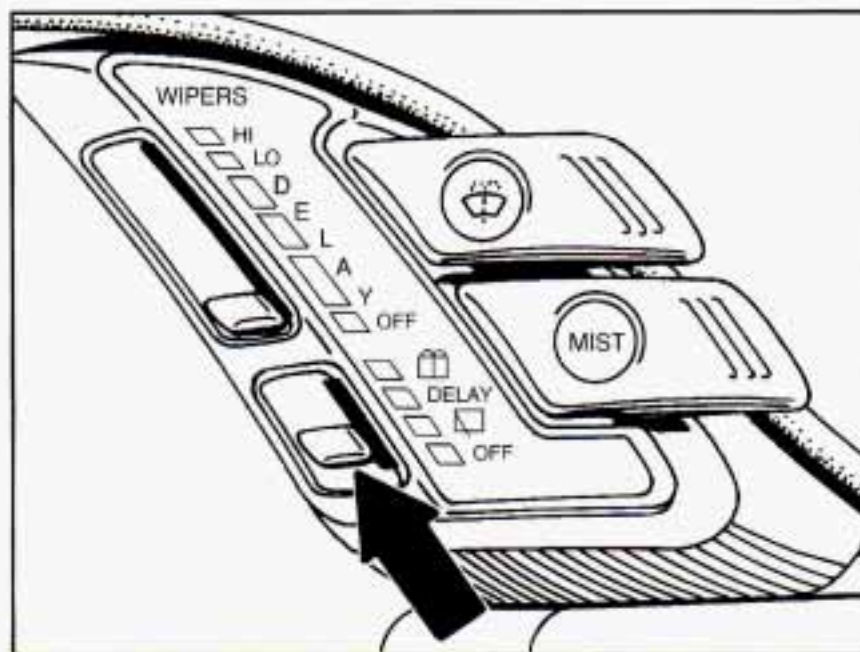

To use your rear wiper, slide the lower control to the rear window wiper symbol.

For a delayed wiper cycle, slide the lower control to DELAY.

To wash the rear window, slide the lower control to the rear window washer symbol and hold it. The washer and wiper will operate only as long as the control is held in that position. Then the wiper will return to DELAY.

Cruise Control (Option)

With cruise control, you can maintain a speed of about 25 mph (40 km/h) or more without keeping your foot on the accelerator. This can really help on long trips.

Cruise control does not work at speeds below about 25 mph (40 km/h).

When you apply your brakes, the cruise control shuts off.

CAUTION:

- Cruise control can be dangerous where you can't drive safely at a steady speed. So, don't use your cruise control on winding roads or in heavy traffic.
- Cruise control can be dangerous on slippery roads. On such roads, fast changes in tire traction can cause needless wheel spinning, and you could lose control. Don't use cruise control on slippery roads.

Setting Cruise Control

CAUTION:

If you leave your cruise control switch on when you're not using cruise, you might hit a button and go into cruise when you don't want to. You could be startled and even lose control. Keep the cruise control switch OFF until you want to use it.

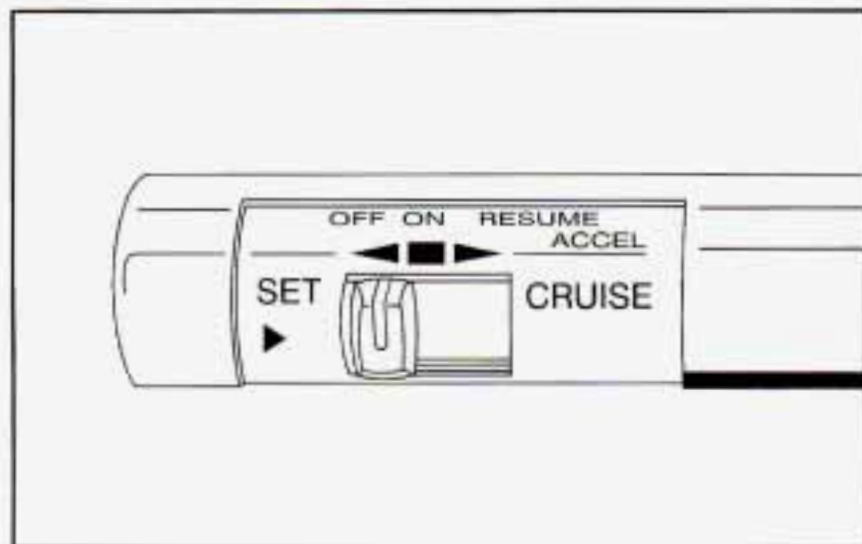

1. Move the cruise control switch to ON.
2. Get up to the speed you want.

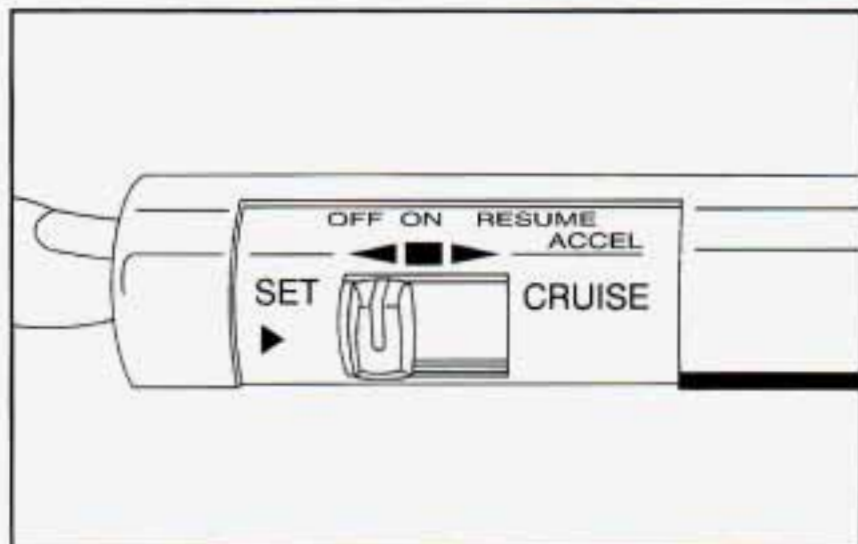

3. Push in the SET button at the end of the lever and release it.
4. Take your foot off the accelerator pedal.

Resuming a Set Speed

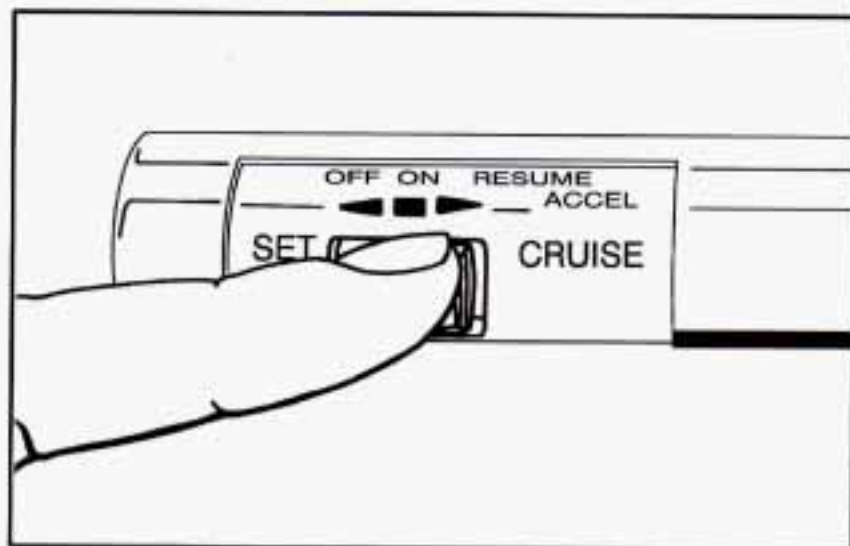

Suppose you set your cruise control at a desired speed and then you apply the brake. This, of course, shuts off the cruise control. But you don't need to reset it. Once you're going about 25 mph (40 km/h) or more, you can move the cruise control switch from ON to RESUME/ACCEL (R/A) for about half a second.

You'll go right back up to your chosen speed and stay there.

Use the SET button to reset cruise (see "Setting Cruise Control" earlier in this section).

If you hold the switch at R/A longer than half a second, the vehicle will keep going faster until you release the switch or apply the brake. You could be startled and even lose control. So unless you want to go faster, don't hold the switch at R/A.

Increasing Speed While Using Cruise Control

There are two ways to go to a higher speed:

- Use the accelerator pedal to get to the higher speed. Push the SET button at the end of the lever, then release the button and the accelerator pedal. You'll now cruise at the higher speed.
- Move the cruise switch from ON to R/A. Hold it there until you get up to the speed you want, and then release the switch. (To increase your speed in very small amounts, move the switch to R/A for less than half a second and then release it. Each time you do this, your vehicle will go about 1 mph (1.6 km/h) faster.)

The accelerate feature will work whether or not you have set an initial cruise control speed.

Reducing Speed While Using Cruise Control

- Push in the button at the end of the lever until you reach the lower speed you want, then release it.
- To slow down in very small amounts, push the button for less than half a second. Each time you do this, you'll go 1 mph (1.6 km/h) slower.

Passing Another Vehicle While Using Cruise Control

Use the accelerator pedal to increase your speed. When you take your foot off the pedal, your vehicle will slow down to the cruise control speed you set earlier.

Using Cruise Control on Hills

How well your cruise control will work on hills depends upon your speed, load and the steepness of the hills. When going up steep hills, you may have to step on the accelerator pedal to maintain your speed. When going

downhill, you may have to brake or shift to a lower gear to keep your speed down. Of course, applying the brake takes you out of cruise control. Many drivers find this to be too much trouble and don't use cruise control on steep hills.

Ending Cruise Control

There are two ways to turn off the cruise control:

- Step lightly on the brake pedal; OR
- Move the cruise switch to OFF.

Erasing Cruise Speed Memory

When you turn off the cruise control or the ignition, your cruise control set speed memory is erased.

Lamps

Headlamps

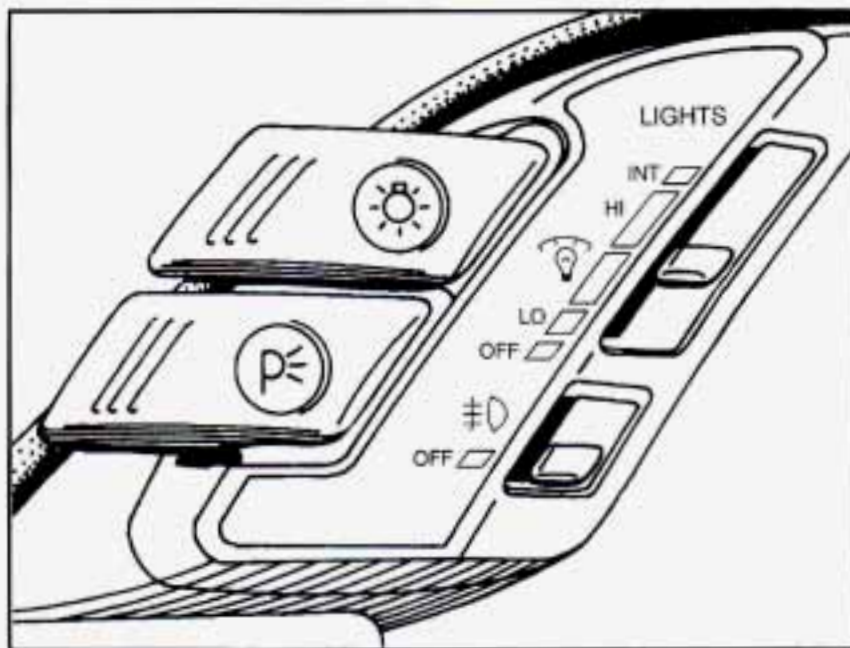

: Push this switch to turn on:

- Parking Lamps
- Sidemarker Lamps
- Taillamps
- Instrument Panel Lights

Pull the switch to turn off the lamps.

: Push this switch to turn on the headlamps, together with:

- Parking Lamps
- Sidemarker Lamps
- Taillamps
- Instrument Panel Lights

Pull the switch to turn off the lamps.

Lamps On Reminder

If you turn the ignition key to the OFF or LOCK position while leaving the lamps on, you will hear a warning chime.

Fog Lamps

Slide the lower lever on the lights control panel up to turn on the fog lamps, down to turn them off. An indicator light next to the control will glow when the fog lamps are on.

Your headlamps must be on for your fog lamps to go on.

Although your fog lamps will go off when your high beams are on, high beams are not recommended for driving in fog.

Interior Lamps

Instrument Panel Intensity Control

Slide the upper lights control all the way up to increase the brightness of the instrument panel lights, down to decrease the brightness. Slide the control all the way down to turn them off.

Interior Lights Control

Slide the upper lights control (located to the left of the instrument panel cluster) all the way up to turn on the interior lamps.

Interior Lights Override Switch

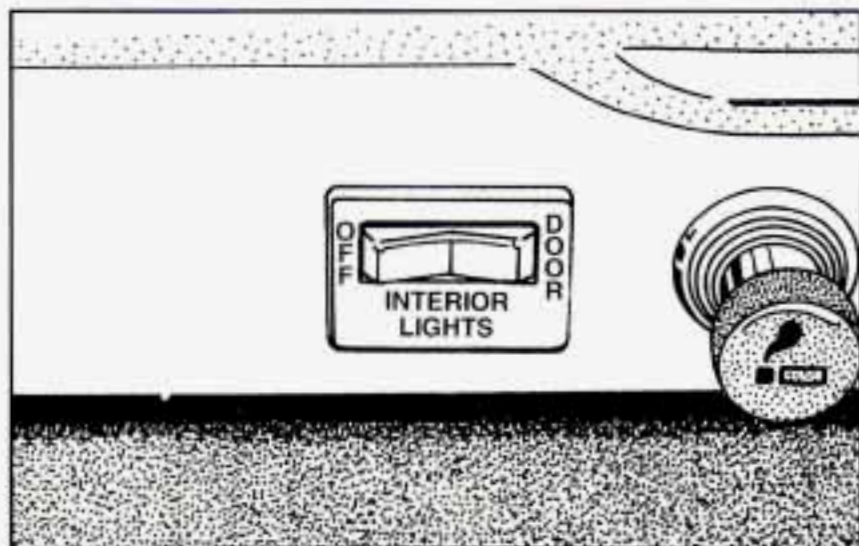

This switch is located to the left of the cigarette lighter in the center instrument panel console. It has two positions, DOOR (on) and OFF, and overrides all interior lamps except the reading lamps.

The interior lamps go on each time you open the doors. You can turn off these lamps so that the doors may be left open without running down the battery by turning the interior lights override switch to OFF.

Illuminated Entry System (Option)

This option comes with the optional Remote Lock Control system.

When you open the driver's door (by itself or in combination with any passenger door or the liftgate) the interior lamps will come on and then gradually dim to off 10 seconds after the last door is closed. (If the driver's door has not been opened, the interior lamps will immediately dim to off.)

When you press the unlock symbol on your remote transmitter, the lamps inside your vehicle will go on, then gradually dim to off after about 40 seconds, unless a door or the liftgate is opened.

When you turn on the ignition, the interior lamps will immediately dim to off.

Overhead Console Reading Lamps

To turn on or off either reading lamp, press the switch next to it. To adjust the aim of the lamps, pivot the lamps in their sockets.

Center Dome Lamp

This lamp is located in the center of your vehicle and has no switch of its own. It will go on each time you open the doors, unless you turn the interior lights override switch in the center instrument panel console to OFF.

If you have the optional rear climate control, you will not have a center dome lamp.

Rear Interior Lamps

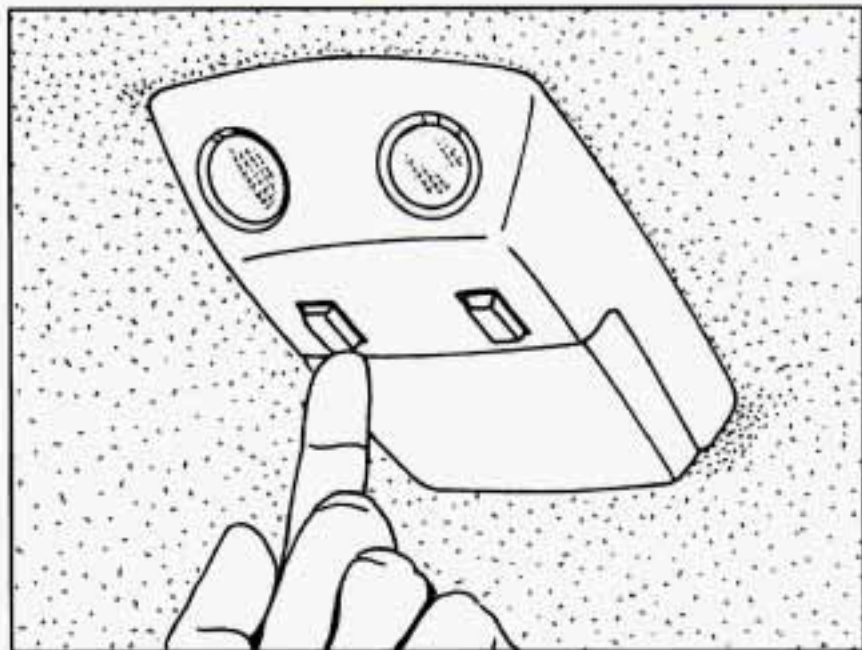

The rear dome lamp also has two reading lamps.

The dome lamp will go on each time you open the doors, unless you turn the interior lights override switch in the center instrument panel console to OFF.

To turn on either reading lamp, press the switch next to it.

Rear Compartment Lamps

There are two lamps in the liftgate to light the rear cargo area. These will come on each time you open the liftgate, unless the interior lights override switch is in the OFF position.

Mirrors

Inside Day/Night Rearview Mirror

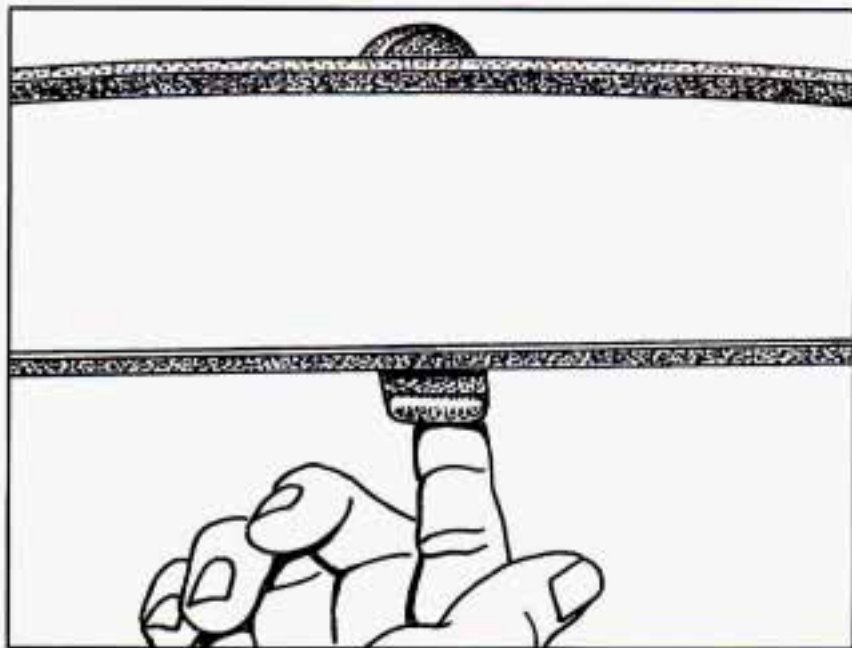

To reduce glare from lights behind you, pull the lever toward you to the night position. To return the mirror to the day position, push the lever away from you.

Power Remote Control Mirrors

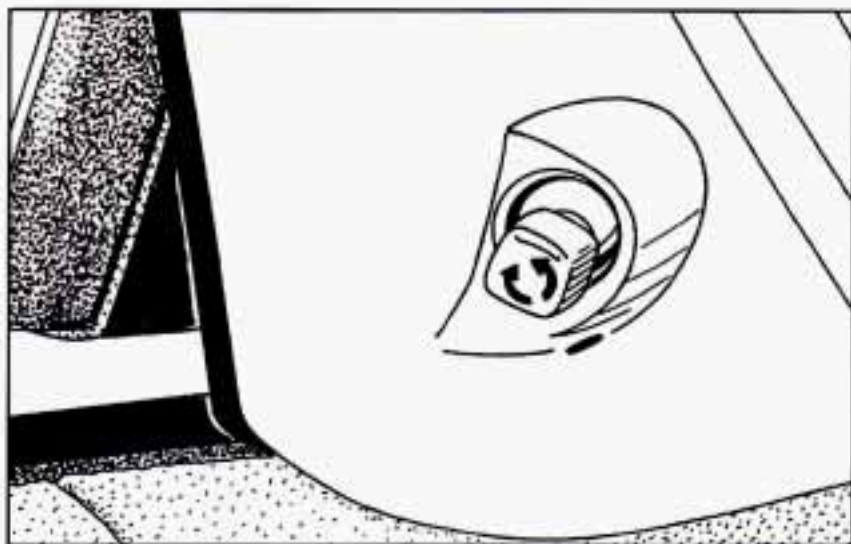

The control on the driver's door controls both outside rearview mirrors. Turn the control to the left to select the driver's side rearview mirror, or to the right to select the passenger's side rearview mirror. Then use the control to adjust each mirror so that you can just see the side of your vehicle when you are sitting in a comfortable driving position.

Both outside mirrors can be folded forward or rearward. In the rearward position, they will fold flush with the vehicle. This feature is particularly useful in automatic car washes and when maneuvering your vehicle in narrow spaces.

Convex Outside Mirror

Your passenger's side mirror is convex. A convex mirror's surface is curved so you can see more from the driver's seat.

CAUTION:

A convex mirror can make things (like other vehicles) look farther away than they really are. If you cut too sharply into the right lane, you could hit a vehicle on your right. Check your inside mirror or glance over your shoulder before changing lanes.

Storage Compartments

Extended Overhead Console (Option)

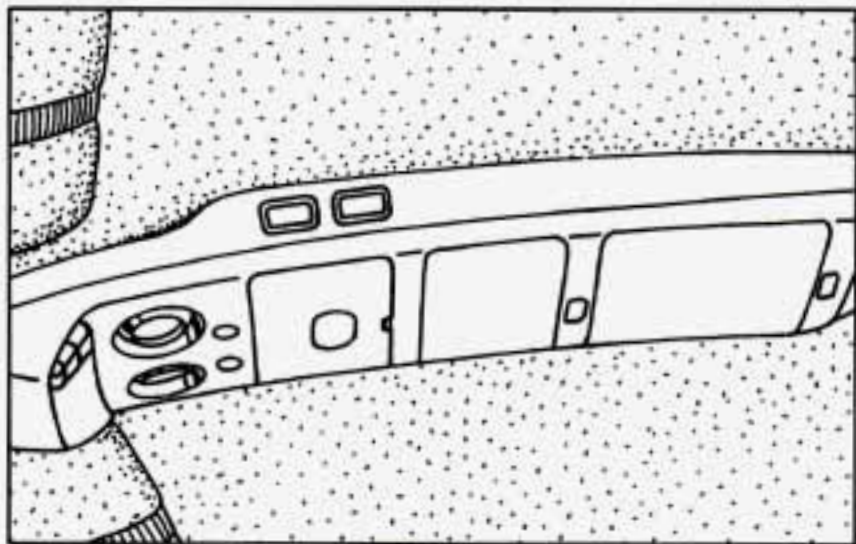

The front overhead console has the front reading lamps, two switches for the optional power sliding door, storage compartments (including one for your garage door opener and one for sunglasses), a compass and an outside temperature display. The features of the overhead console are explained on the following pages.

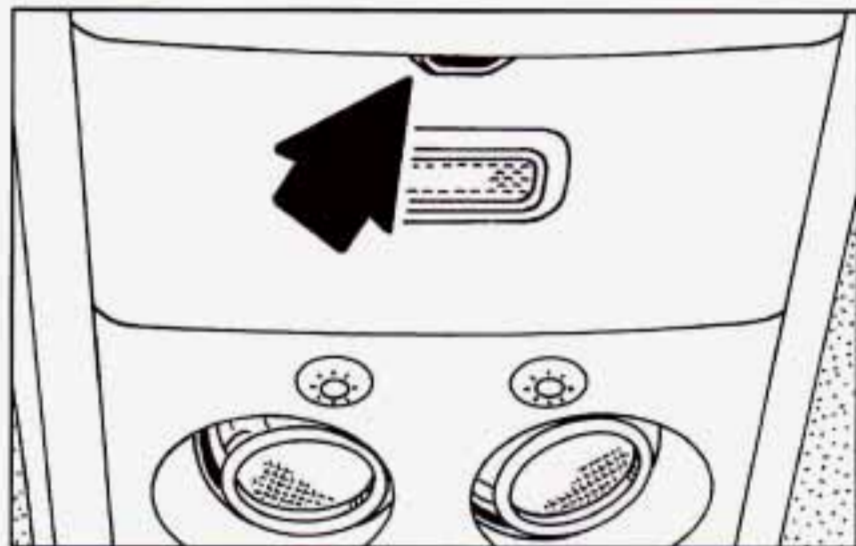

Garage Door Opener Compartment

You can store your garage door opener in the front compartment of your overhead console, and operate it from this position. To install your garage door opener, follow these instructions:

1. Open the compartment by pressing the latch forward. Remove the piece of self-sticking Velcro®.
2. Peel the protective backing from the Velcro and press it firmly to the back of your garage door opener.

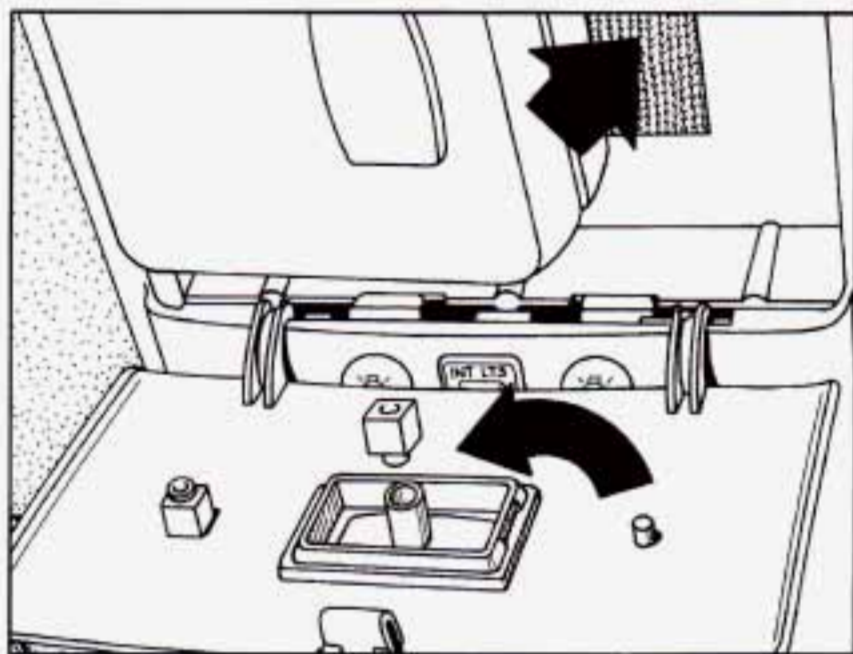

3. To make sure the button on your garage door opener is centered above the button on the compartment door, use the intersecting lines on the Velcro inside the compartment as a guide. Center the control button of your garage door opener over the point where the lines intersect, and press the opener firmly into place. Make sure the button is facing down.

- Once the opener is installed, use the pegs inside the compartment door to make sure the button on the compartment door will contact the control button on your garage door opener when pressed.

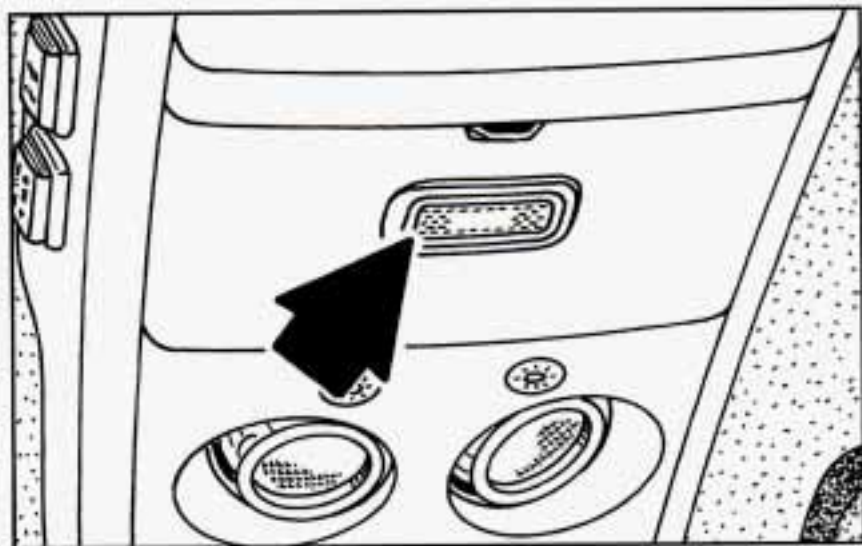

- Add one peg at a time until your garage door opener operates with the compartment door closed when you press the button.

Temperature and Compass Display

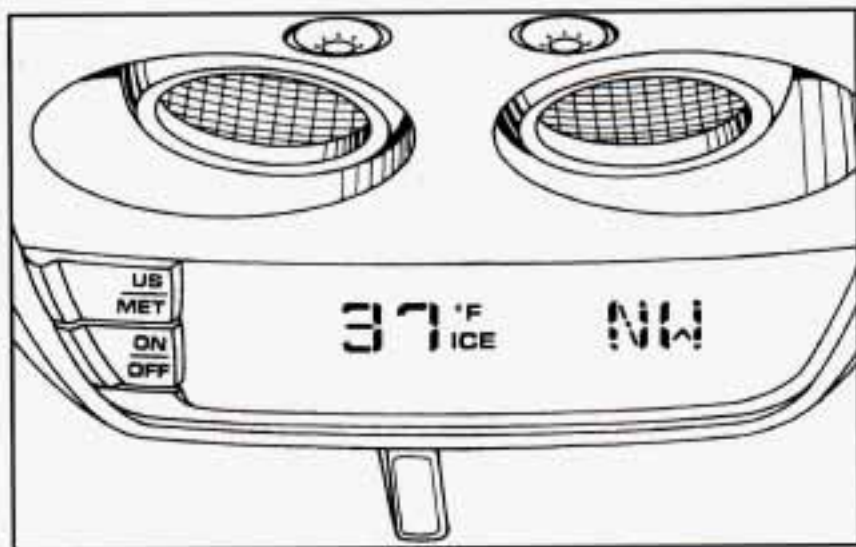

The outside air temperature and the compass are displayed at the front of the overhead console. The control switches are located to the left of the display.

Turn the display on or off by pressing the ON/OFF switch. Display the temperature in either degrees Fahrenheit (English) or Celsius (metric) by pressing the US/MET switch.

If the vehicle has been shut off for *less* than four hours, the display will show the temperature reading at the time the vehicle was turned off.

If the vehicle has been shut off for *more* than four hours, an immediate reading will be displayed when the vehicle is started.

The temperature display will be updated once the vehicle has reached 10 mph (16 km/h).

If the outside temperature is 37°F (3°C) or lower when you turn on the ignition, ICE will appear briefly on the display. It's there to caution the driver that road conditions may be icy and that appropriate precautions should be taken.

Compass Calibration

The compass is self-calibrating, so it does not need to be manually set. However, when your Silhouette is new, the compass may function erratically. If it does, CAL (calibration) will appear on the display. To correct the problem, drive in a complete 360° circle three times, and the compass will function normally.

Compass Variance

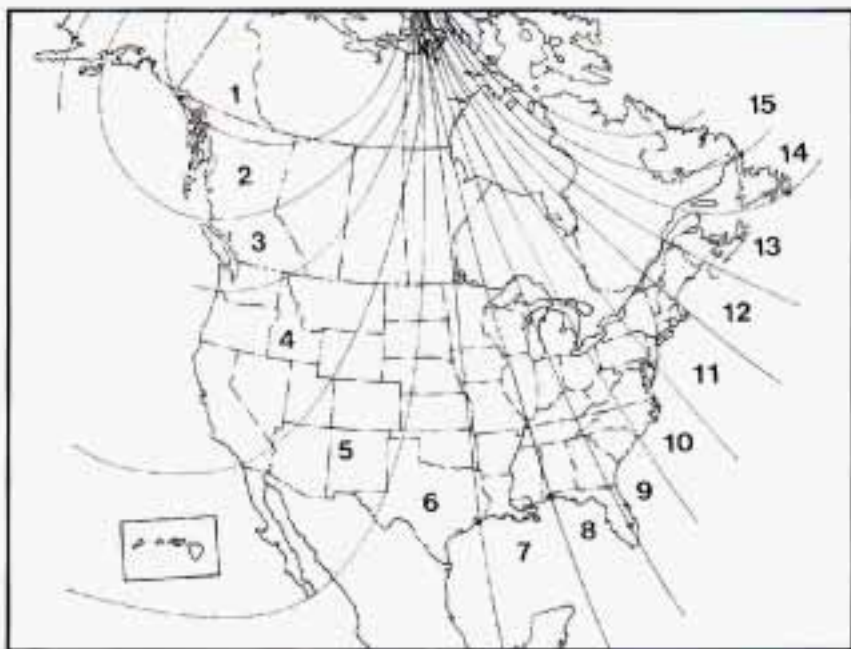

Variance is the difference between magnetic north and geographic north. In some areas, the difference between the two can be great enough to cause false compass readings. If this happens, follow these instructions to set the variance for your particular location:

1. Determine your location on the zone map. Note your zone number.

2. Press and hold both the ON/OFF and the US/MET switches. The display will go off.
3. After five seconds, VAR CAL will appear on the display. When it does, release both buttons.
4. Press US/MET until your zone number appears on the display.
5. Press ON/OFF to enter your zone number. Your variance is now set.

Storage Compartment

To open the rear storage compartment in the overhead console, press the release button.

Sunglasses Storage Compartment

To open the sunglasses storage compartment in the overhead console, press the release button. Pull the compartment down to the full open position.

Glove Box

Your vehicle has a glove box below the dash.

To open the glove box, pinch the latch release.

The fuse panel is located inside the glove box door. See “Fuses and Circuit Breakers” in the Index.

Compact Overhead Console

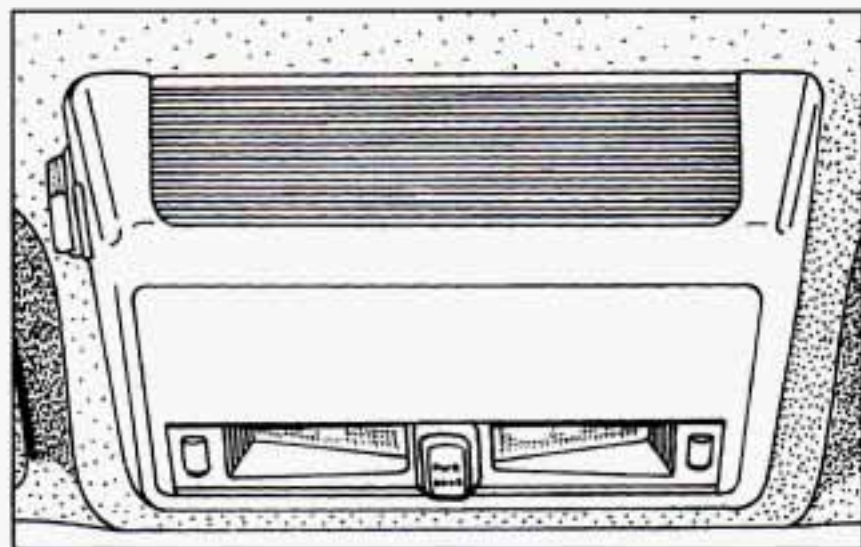

The overhead console includes two reading lamps and a storage compartment.

To turn either reading lamp on or off, press the switch next to it.

If you have the optional power sliding door, your overhead console will also have two power sliding door switches. To operate these switches, see “Power Sliding Door” in the Index.

Cupholders/Ashtray/Lighter

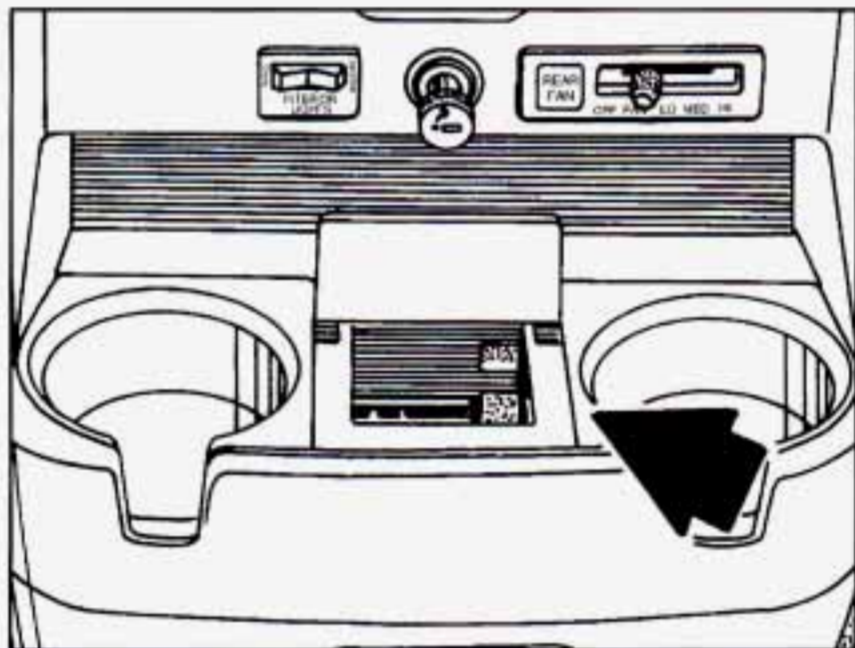

Two cupholders, an ashtray and a lighter are located in the center instrument panel console.

The foam cupholder liners can be removed for cleaning. Should the liners ever become damaged, see your retailer for replacements.

To use the ashtray, lift the lid.

To remove the ashtray for cleaning, close the lid, then grasp the rear edge of the ashtray with your fingertips and pull up and out, in a rocking motion.

To use the lighter, push it in all the way and let go. When it's ready, it will pop back by itself.

NOTICE:

Don't hold a cigarette lighter in with your hand while it is heating. If you do, it won't be able to back away from the heating element when it's ready. That can make it overheat, damaging the lighter and the heating element.

NOTICE:

Don't put papers and other things that burn into your ashtrays. If you do, cigarettes or other smoking materials could set them on fire, causing damage.

Side Ashtrays

To open the ashtray, press the right side and turn it open.

To remove the ashtray for cleaning, press the snuffer as you lift up the bottom of the ashtray.

If you have the optional rear climate control, your side ashtray will have a flip-up cover.

To remove the ashtray for cleaning, pull up on the snuffer or the cover.

Locking Storage Bin

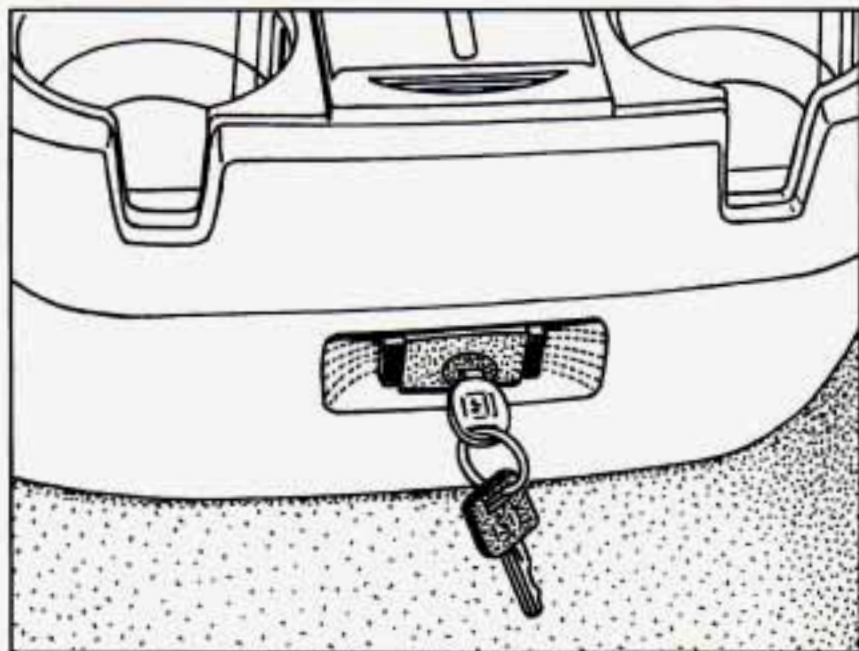

At the base of the center instrument panel console is a storage bin. Use the door key to lock and unlock it. To open the bin, pinch the latch release. Inside the storage bin, you will find a coinholder.

To remove the bin for cleaning, open it part way, then pull out and slightly up.

To clean the inside of the bin, vacuum or wipe with a slightly damp cloth.

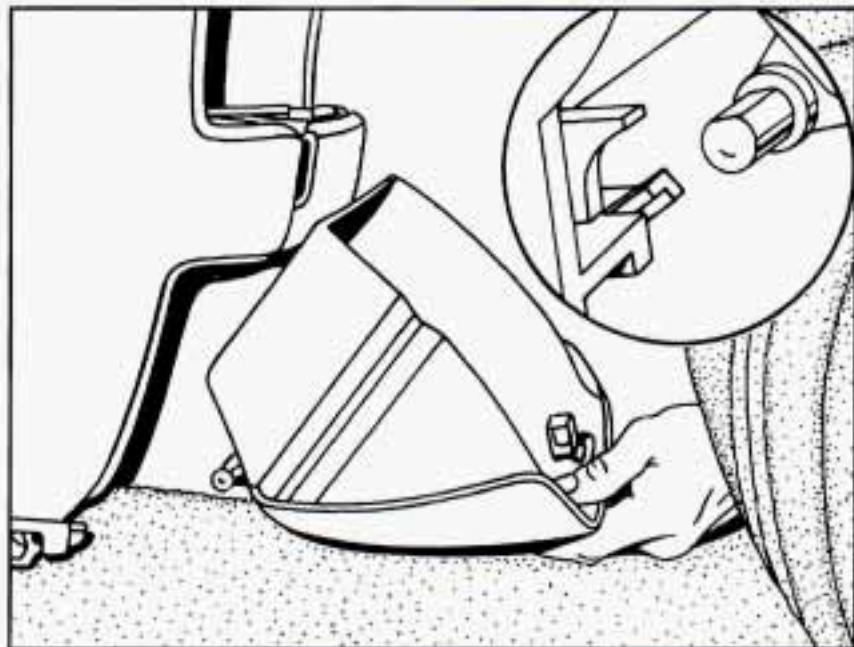

To replace the bin, set the hinge pins (one on each side of the bin, at the bottom) into the hinge guides (one at each side of the console opening, at the base), then close the bin. If the hinge pins are placed properly in the guides, the bin will close easily.

Center Dash Storage Compartment

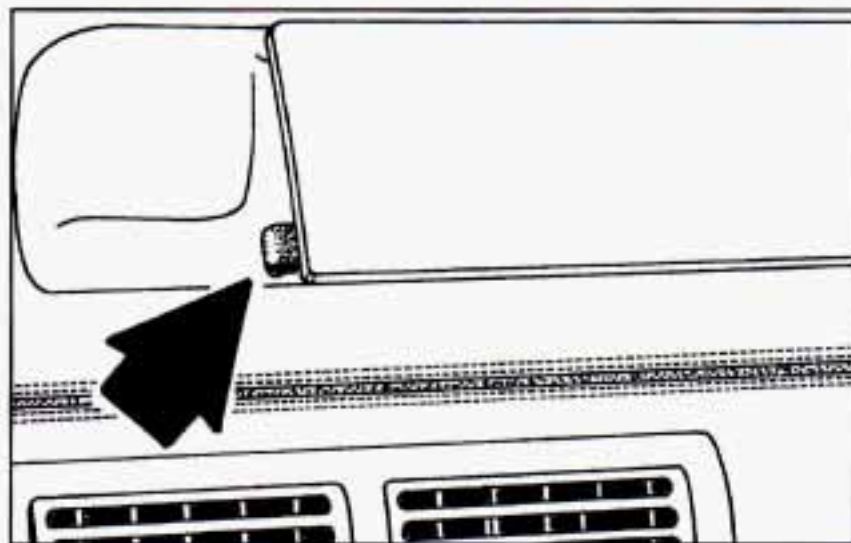

To open the storage compartment, push in the latch release, then lift the lid.

Rear Storage Compartment and Cupholder

Your vehicle will have an open storage compartment and cupholder on either side of the third row.

Convenience Net (Option)

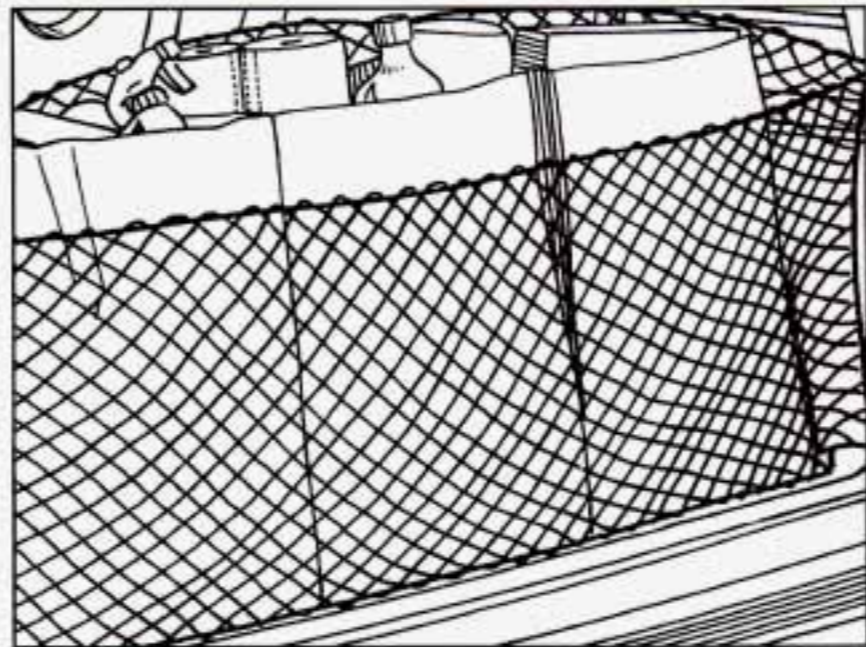

The optional convenience net is designed to help keep small loads, like grocery bags, from falling over during sharp turns or quick stops and starts.

Install the convenience net at the rear of your vehicle, just inside the liftgate. Attach the upper loops to the posts on either side of the liftgate opening (the label on the net should be in the upper right-hand corner). Attach the lower loops to the hooks on the floor.

The side of the convenience net closest to the front of the vehicle is higher than the side closest to the liftgate. Once you've loaded items into the net, stretch the higher side of the net up and over the top of the load to hold it firmly in place.

The convenience net has a maximum capacity of 100 lbs. (45 kg). It is not designed to hold larger, heavier loads. Store such loads on the floor of your vehicle, as far forward as you can.

When not in use, we recommend that you take down the convenience net to extend its life and retain its elasticity, and to keep the rear exit clear. Store the net in the pouch behind either front seat.

Luggage Carrier (Option)

CAUTION:

If you try to carry something on top of your vehicle that is longer or wider than the luggage carrier -- like paneling, plywood, a mattress, and so forth -- the wind can catch it as you drive along. This can cause you to lose control. What you are carrying could be violently torn off, and this could cause you or other drivers to have a collision, and of course damage your vehicle. You may be able to carry something like this inside. But, never carry something longer or wider than the luggage carrier on top of your vehicle.

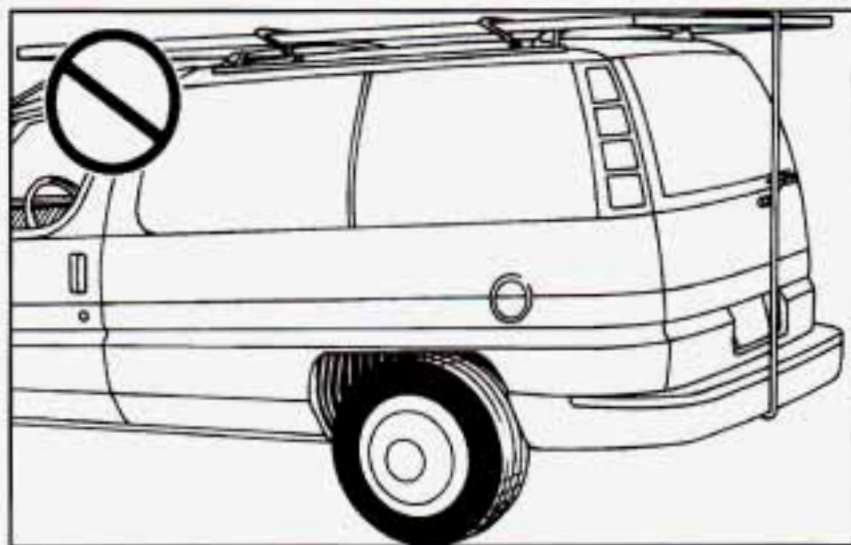

If you have the optional luggage carrier, you can load things on top of your vehicle. The luggage carrier has slats and side rails attached to the roof, as well as sliding crossrails and places to use for tying things down. These let you load some things on top of your vehicle, as long as they are not wider or longer than the luggage carrier.

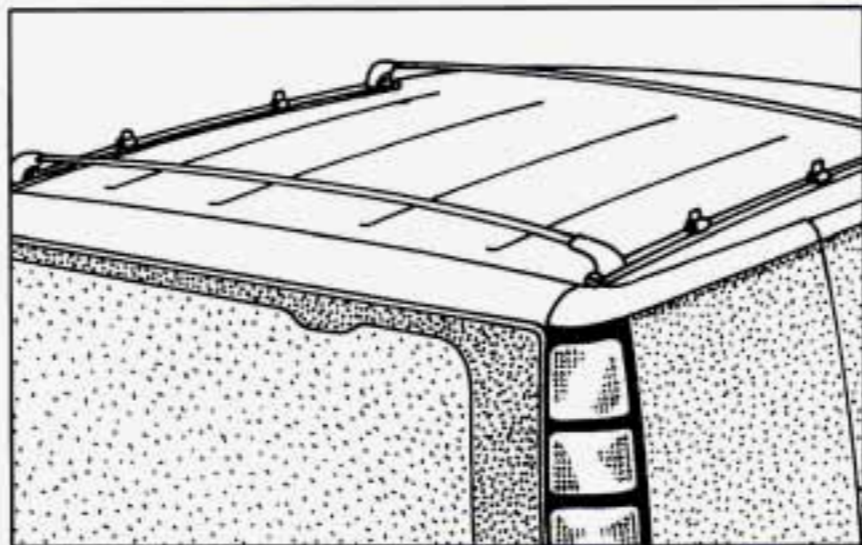

NOTICE:

Loading cargo that weighs more than 125 lbs. (56 kg) on the luggage carrier may damage your vehicle.

When you carry cargo on the luggage carrier of a proper size and weight, put it on the slats, as far forward as you can. Then slide the crossrail up against the rear of the load, to help keep it from moving. You can then tie it down.

Don't exceed the maximum vehicle capacity when loading your Oldsmobile. For more information on vehicle capacity and loading, see "Loading Your Vehicle" in the Index.

To prevent damage or loss of cargo as you're driving, check now and then to make sure the luggage carrier and cargo are still securely fastened.

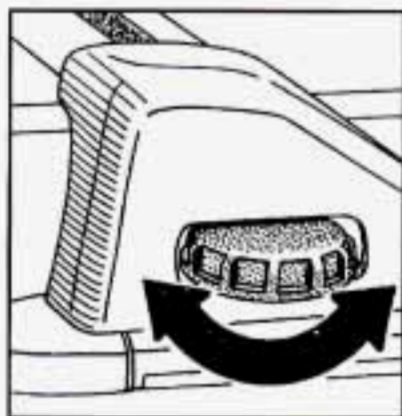

Your luggage carrier has release knobs set in the ends of each crossrail.

Turn the release knobs counterclockwise to unlock the crossrails. Slide the crossrails forward or back, as needed, to accommodate loads of varying size.

After repositioning the crossrails, be sure to tighten the release knobs by turning them clockwise, locking the crossrails in place.

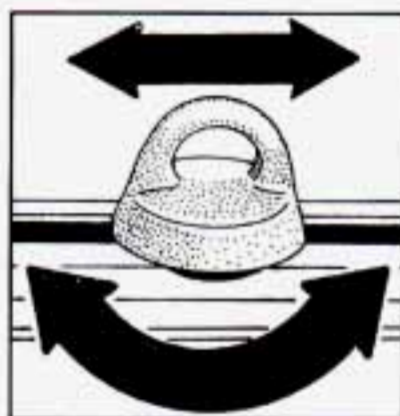

Use the adjustable tie-down loops in the side rails to help secure large loads.

Reposition the tie-downs by turning them counterclockwise, then slide them along the side rail. Turn the tie-downs clockwise to tighten them in place.

Tiedowns may be removed and used in the adjustable tapped plates in the crossrails. You may also use these tapped plates to secure bicycle or ski racks.

Outboard bumper strips on the luggage carrier crossrails help ensure a quieter ride.

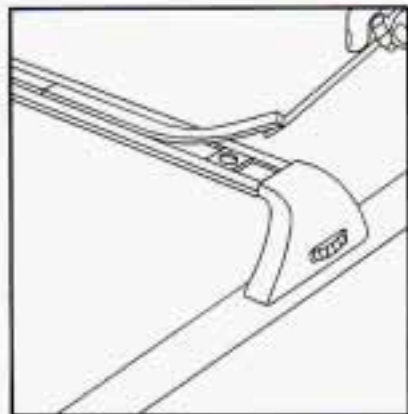

If you wish to attach the luggage tiedowns or other equipment, you will need to remove the outboard bumper strips to access the tapped plates on the crossbar.

After the tiedowns or other equipment is removed, be sure to reinstall the bumper strips.

Sun Visors

To block out glare, you can swing down the visors. You can also remove them from the center mount and swing them to the side.

Visor Vanity Mirrors

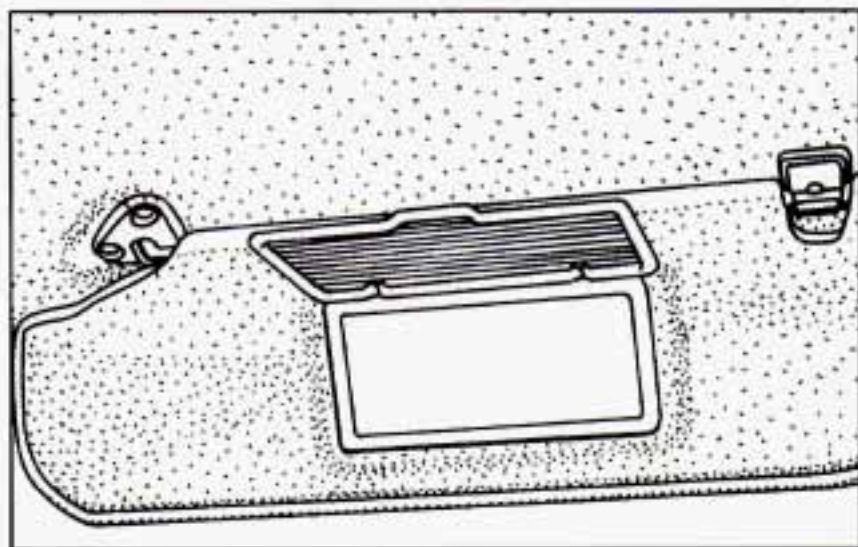

Lift the cover to expose the vanity mirror.

Accessory Power Outlet

The power outlet is located in the rear compartment on the driver's side. To open, slide the latch down and remove the cover.

The power outlet can be used to plug in electrical equipment such as a cellular telephone, CB radio, etc. Follow the proper installation instructions that are included with any electrical equipment you install.

When not in use, always cover the outlet with the protective cap.

NOTICE:

When using the accessory power outlet:

- **Maximum load of any electrical equipment should not exceed 20 amps.**
- **Be sure to turn off any electrical equipment when not in use. Leaving electrical equipment on for extended periods can drain your battery.**

Air Inflator System (Option)

Your vehicle may be equipped with an air inflator. It will be located in the rear compartment on the driver's side along with the accessory power outlet. With it, you can inflate things like air mattresses and basketballs, and you can also use it to bring your tires up to the proper pressure.

To open, slide the latch down and remove the cover.

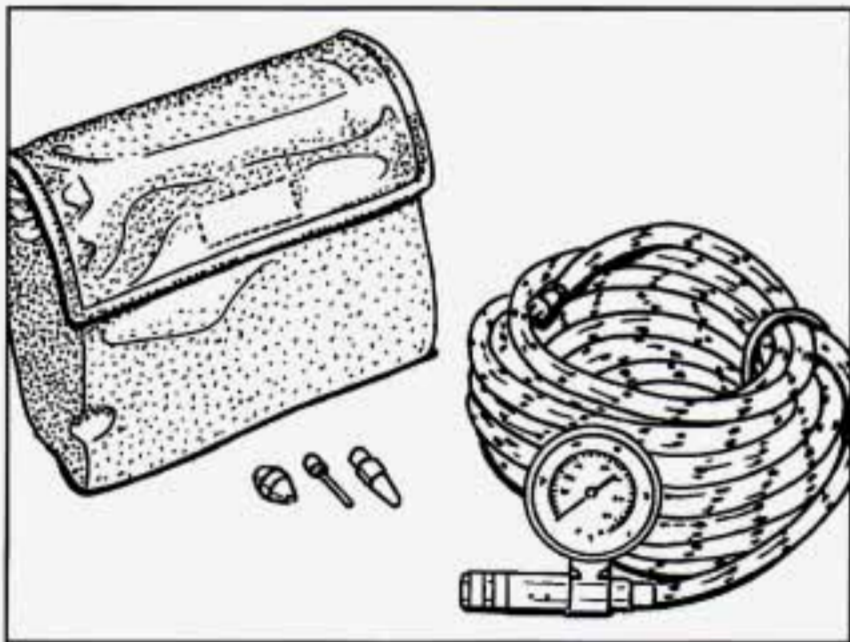

The air inflator kit is stored in a pouch in the glove box. It includes a 20-foot (6 m) hose with an air pressure gage and nozzle adapters.

⚠ CAUTION:

Inflating something too much can make it explode, and you or others could be injured. Be sure to read the inflator instructions, and inflate any object only to its recommended pressure.

To use your air inflator system, attach the appropriate nozzle adapter, if required, to the end of the hose that has the pressure gage. Then attach that end of the hose to the object you wish to inflate. Attach the other end of the hose to the outlet. Press the ON switch. The ON switch will work even with the ignition off. If the air inflator does not operate, a fuse may be blown or installed incorrectly. See your retailer for service.

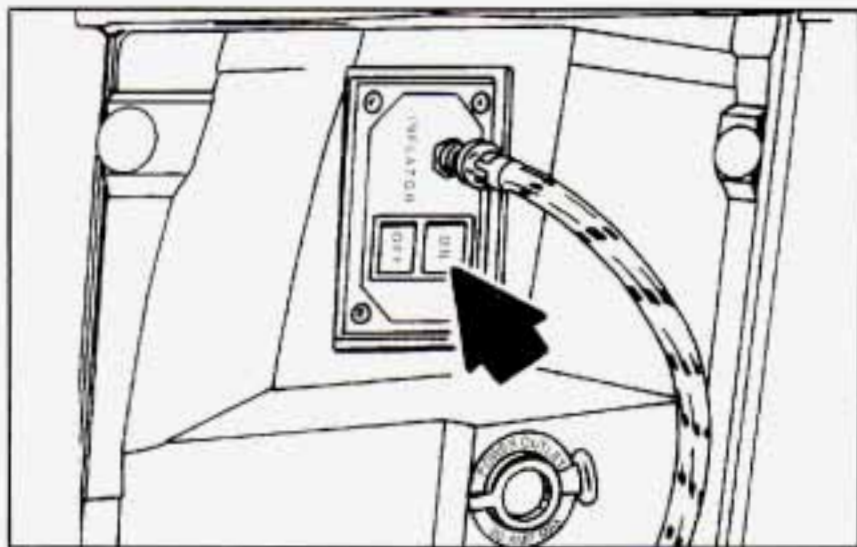

Your air inflator will automatically shut off after about 10 minutes. To reset it, press the ON switch again.

Don't run your air inflator for longer than 30 minutes at one time. If you do, you may damage the system. After 30 minutes, wait at least 10 minutes before restarting the air inflator.

To turn off the inflator, press OFF and detach the hose, first from the inflated object, then from the outlet. Place the inflator kit tools in the pouch and store it in the glove box.

The Instrument Panel -- Your Information System

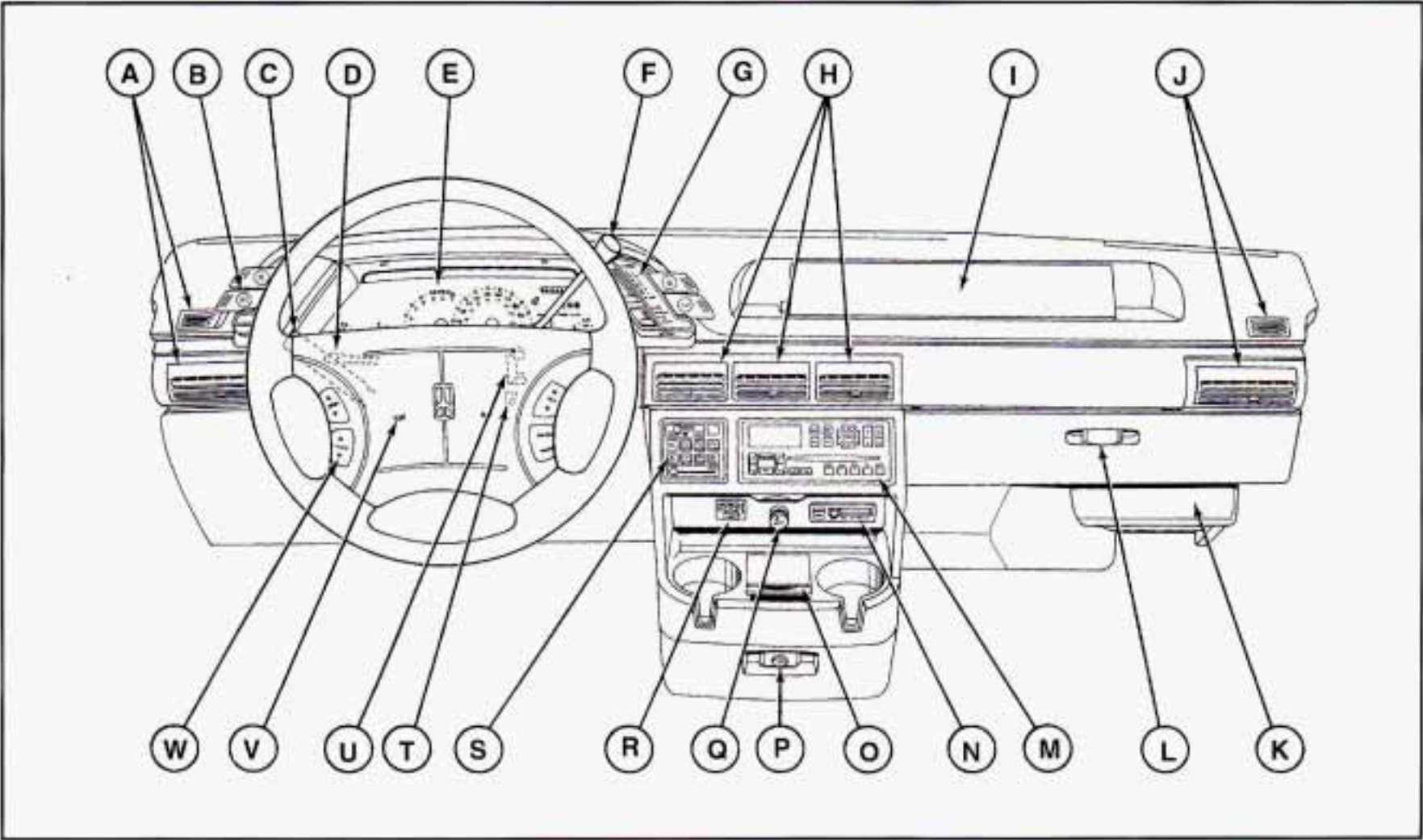

Your instrument panel is designed to let you know at a glance how your vehicle is running. You'll know how fast you're going, how much fuel you're using, and many other things you'll need to drive safely and economically.

Refer to the accompanying diagram of your instrument panel to locate the components listed below.

1. Side Vents
2. Lamp Controls
3. Turn Signal/Multifunction Lever
4. Tilt Steering Wheel Lever
5. Instrument Cluster
6. Gearshift Lever
7. Wiper/Washer Controls
8. Center Vents
9. Storage Compartment
10. Side Vents
11. Circuit Breaker/Relay Panel
12. Glove Box/Fuse Panel
13. Audio System
14. Rear Fan Controls
15. Cupholders/Ashtray
16. Locking Storage Bin
17. Lighter
18. Interior Lights Override Switch
19. Climate Controls
20. Hazard Warning Flashers Switch
21. Ignition Switch
22. Horn
23. Steering Wheel Touch Controls (Option)

Instrument Panel Cluster

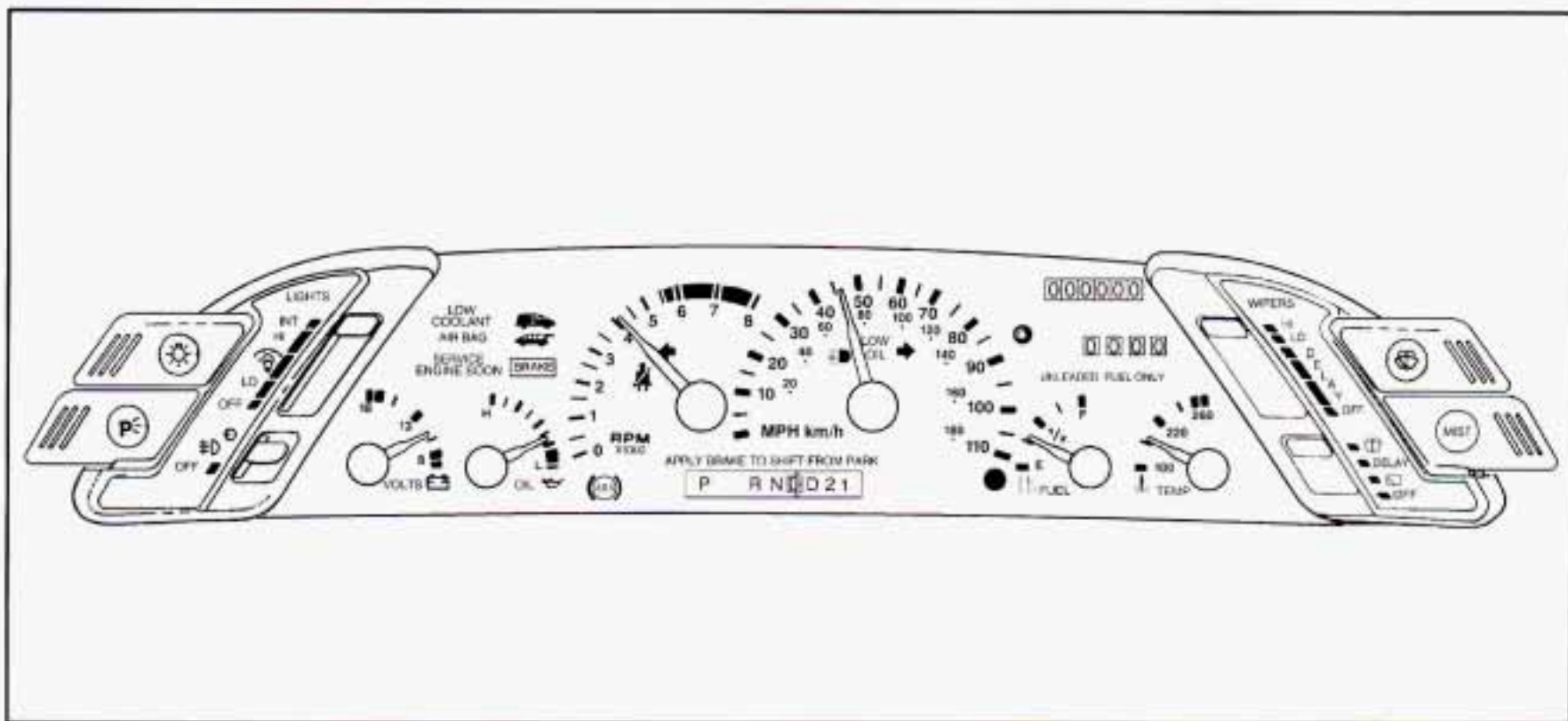

Your cluster includes indicator warning lights and gages that are explained on the following pages.

Speedometer and Tamper Resistant Odometer

Your speedometer lets you see your speed in both miles per hour (mph) and kilometers per hour (km/h). Your odometer shows how far your vehicle has been driven, in either miles (used in the United States) or kilometers (used in Canada).

Your Oldsmobile has a tamper resistant odometer. If you see silver lines between the numbers, you'll know that someone has probably tried to turn it back, so the numbers may not be true.

You may wonder what happens if your vehicle needs a new odometer installed. If the new one can be set to the mileage total of the old odometer, then that will be done. If it can't, then it's set at zero and a label must be put on the driver's door to show the old mileage reading when the new odometer was installed.

Tachometer

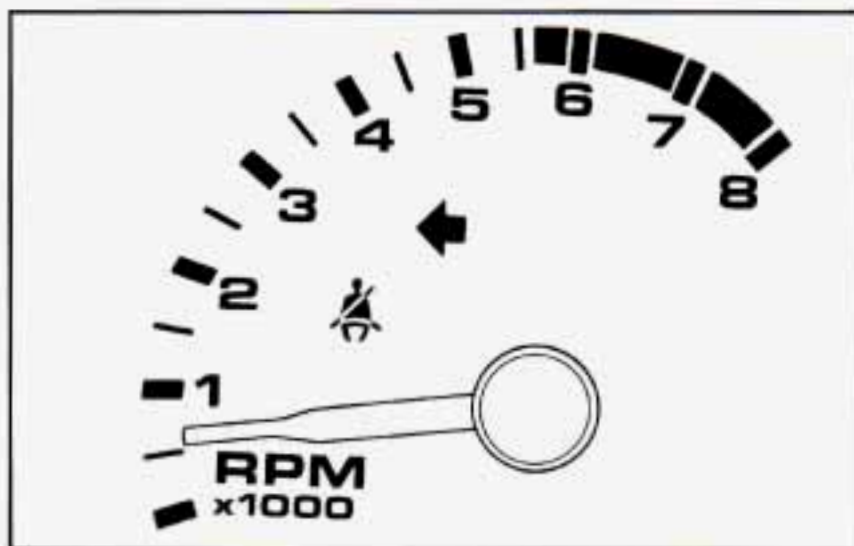

The tachometer displays the engine speed in revolutions per minute (rpm).

NOTICE:

Do not operate the engine with the tachometer in the red area, or engine damage may occur.

Trip Odometer

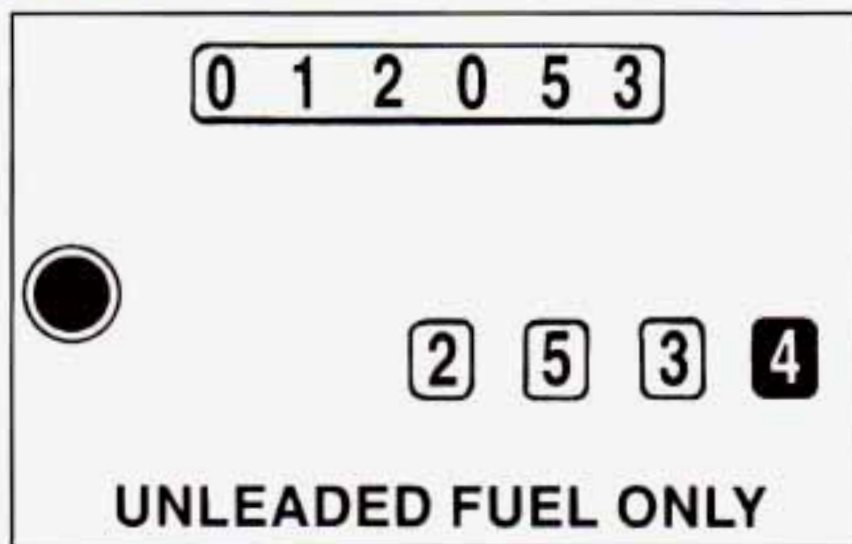

The trip odometer can tell you how far your vehicle has been driven since you last set it to zero. To set it to zero, push the reset button located above the fuel gage.

Warning Lights, Gages and Indicators

This part describes the warning lights and gages that may be on your vehicle. The pictures will help you locate them.

Warning lights and gages can signal that something is wrong before it becomes serious enough to cause an expensive repair or replacement. Paying attention to your warning lights and gages could also save you or others from injury.

Warning lights come on when there may be or is a problem with one of your vehicle's functions. As you will see in the details on the next few pages, some warning lights come on briefly when you start the engine just to let you know they're working. If you are familiar with this section, you should not be alarmed when this happens.

Gages can indicate when there may be or is a problem with one of your vehicle's functions. Often gages and warning lights work together to let you know when there's a problem with your vehicle.

When one of the warning lights comes on and stays on when you are driving, or when one of the gages shows there may be a problem, check the section that tells you what to do about it. Please follow this manual's advice. Waiting to do repairs can be costly -- and even dangerous. So please get to know your warning lights and gages. They're a big help.

Safety Belt Reminder Light

When the key is turned to RUN or START, a chime will come on for about eight seconds to remind people to fasten their safety belts, unless the driver's safety belt is already buckled.



The safety belt light will also come on and stay on until the driver's belt is buckled.

Air Bag Readiness Light

There is an air bag readiness light on the instrument panel, which shows the words AIR BAG. The system checks the air bag's electrical system for malfunctions. The light tells you if there is an electrical problem. The system check includes the air bag sensors, the air bag module, the wiring and the diagnostic module. For more information on the air bag system, see "Air Bag" in the Index.



You will see this light flash for a few seconds when you turn your ignition to RUN or START. Then the light should go out. This means the system is ready.

If the air bag readiness light doesn't come on when you start your vehicle, or stays on, or comes on when you are driving, your air bag system may not work properly. Have your vehicle serviced right away.

Voltmeter

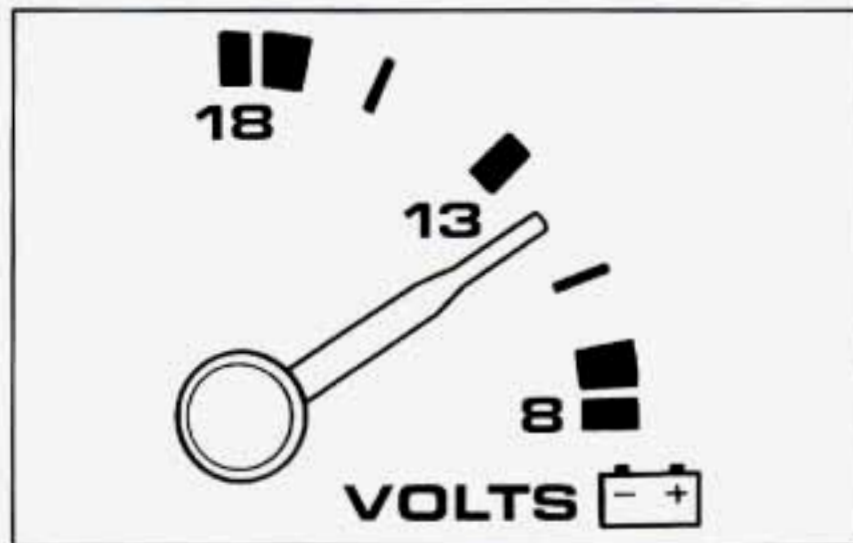

Your charging system gage will show the rate of charge when the engine is running.

The reading will change as the rate of charge changes (with the engine speed, etc.), but readings between the red warning zones indicate the normal operating range. Readings in either red zone indicate a possible problem with your charging system. Have your Oldsmobile serviced immediately.

When the engine is not running, but the ignition is on (in the RUN position), the display measures the voltage output of your battery.

Brake System Warning Light

Your Oldsmobile's hydraulic brake system is divided into two parts. If one part isn't working, the other part can still work and stop you. For good braking, though, you need both parts working well.

If the warning light comes on, there could be a brake problem. Have your brake system inspected right away.

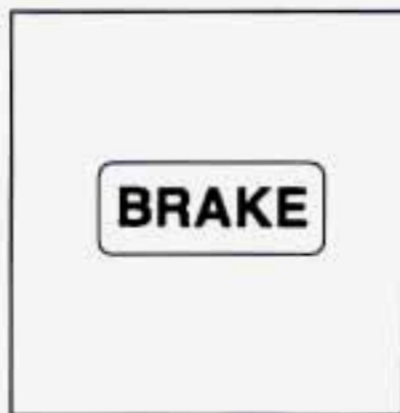

This light should come on briefly when you turn the ignition key to RUN. If it doesn't come on then, have it fixed so it will be ready to warn you if there's a problem.

If the light comes on while you are driving, pull off the road and stop carefully. You may notice that the pedal is harder to push. Or, the pedal may go closer to the floor. It may take longer to stop. If the light is still on, or if the anti-lock brake system warning light is flashing, have the vehicle towed for service. (See "Anti-Lock Brake System Warning Light" and "Towing Your Vehicle" in the Index.)

CAUTION:

Your brake system may not be working properly if the brake system warning light is on. Driving with the brake system warning light on can lead to an accident. If the light is still on or if the anti-lock brake system warning light is flashing after you've pulled off the road and stopped carefully, have the vehicle towed for service.

When the ignition is on, the brake system warning light will also come on when you set your parking brake. The light will stay on if your parking brake doesn't release fully. If it stays on after your parking brake is fully released, it means you have a brake problem.

Anti-Lock Brake System Warning Light

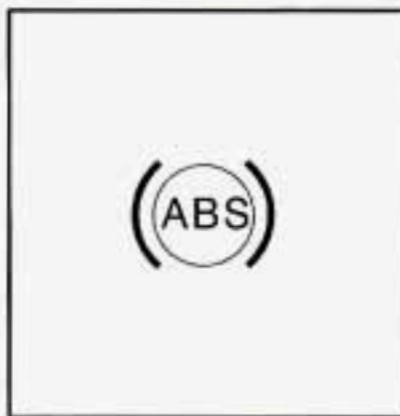

With the anti-lock brake system, this light will come on when you start your engine and it will stay on for three seconds. That's normal.

If the light flashes when you're driving, you don't have anti-lock brakes and there could be a problem with your regular brakes. Pull off the road and stop carefully. You may notice that the pedal is harder to push. Or, the pedal may go closer to the floor. It may take longer to stop. Have the vehicle towed for service. (See "Towing Your Vehicle" in the Index.)

CAUTION:

Your regular brake system may not be working properly if the anti-lock brake system warning light is flashing. Driving with the anti-lock brake system warning light flashing can lead to an accident. After you've pulled off the road and stopped carefully, have the vehicle towed for service.

If the anti-lock brake system warning light stays on longer than normal after you've started your engine, turn the ignition off. Or, if the light comes on and stays on when you're driving, stop as soon as possible and turn the ignition off. Then start the engine again to reset the system. If the light still stays on, or comes on again while you're driving, your Oldsmobile needs service. If the light is on but not flashing and the regular brake system warning light isn't on, you still have brakes, but you don't have anti-lock brakes.

The anti-lock brake system warning light should come on briefly when you turn the ignition key to RUN. If the light doesn't come on then, have it fixed so it will be ready to warn you if there is a problem.

Engine Coolant Temperature Gage

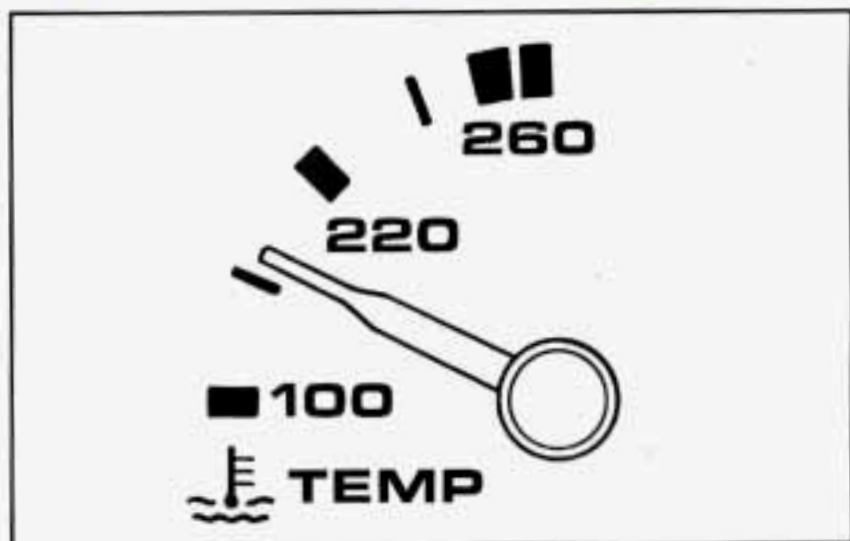

This gage shows the engine coolant temperature. If the gage pointer moves into the red area, your engine is too hot! It means that your engine coolant has overheated. If you have been operating your vehicle under normal driving conditions, you should pull off the road, stop your vehicle and turn off the engine as soon as possible.

In "Problems on the Road," this manual shows what to do. See "Engine Overheating" in the Index.

Low Coolant Light

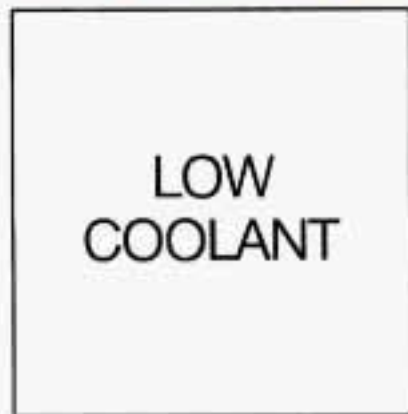

If this light comes on, your system is low on coolant and the engine may overheat.

To prevent damage to your engine, immediate action is required.

See "Engine Coolant" in the Index and have your vehicle serviced as soon as possible.

Malfunction Indicator Lamp (Service Engine Soon Light)



Your Oldsmobile is equipped with a computer which monitors operation of the fuel, ignition and emission control systems.

This system is called OBD II (On-Board Diagnostics-Second Generation) and is intended to assure that emissions are at acceptable levels for the life of the vehicle, helping to produce a cleaner environment. The SERVICE ENGINE SOON light comes on to indicate that there is a problem and service is required. Malfunctions often will be indicated by the system before any problem is apparent, which may prevent more serious damage to your vehicle. This system is also designed to assist your service technician in correctly diagnosing any malfunction.

NOTICE:

If you keep driving your vehicle with this light on, after a while, your emission controls may not work as well, your fuel economy may not be as good and your engine may not run as smoothly. This could lead to costly repairs that may not be covered by your warranty.

This light should come on, as a check to show you it is working, when the ignition is on and the engine is not running. If the light doesn't come on, have it repaired. This light will also come on during a malfunction in one of two ways:

- **Light Flashing** -- A misfire condition has been detected. A misfire increases vehicle emissions and may damage the emission control system on your vehicle. Retailer or qualified service center diagnosis and service is required.
- **Light On Steady** -- An emission control system malfunction has been detected on your vehicle. Retailer or qualified service center diagnosis and service may be required.

If the Light Is Flashing

The following may prevent more serious damage to your vehicle:

- Reduce vehicle speed.
- Avoid hard accelerations.
- Avoid steep uphill grades.
- If towing a trailer, reduce the amount of cargo being hauled as soon as it is possible.

If the light stops flashing and remains on steady, see "If the Light Is On Steady" following.

If the light continues to flash, when it is safe to do so, *stop the vehicle*. Put your vehicle in PARK (P). Turn the key off, wait at least 10 seconds and restart the engine. If the light remains on steady, see "If the Light Is On Steady" following. If the light is still flashing follow the previous steps, and drive the vehicle to your retailer or qualified service center for service.

If the Light Is On Steady

You may be able to correct the emission system malfunction by considering the following:

Did you just put fuel into your vehicle?

If so, reinstall the fuel cap, making sure to fully install the cap. The diagnostic system can determine if the fuel cap has been left off or improperly installed. This will allow fuel to evaporate into the atmosphere. A few driving trips should turn the light off.

Did you just drive through a deep puddle of water?

If so, your electrical system may be wet. The condition will usually be corrected when the electrical system dries out. A few driving trips should turn the light off.

Are you low on fuel?

As your engine starts to run out of fuel, your engine may not run as efficiently as designed since small amounts of air are sucked into the fuel line causing a misfire. The system can detect this. Adding fuel should correct this condition. Make sure to install the fuel cap properly. It will take a few driving trips to turn the light off.

Have you recently changed brands of fuel?

If so, be sure to fuel your vehicle with quality fuel (see "Fuel" in the Index). Poor fuel quality will cause your engine not to run as efficiently as designed. You may notice this as stalling after start-up, stalling when you put the vehicle into gear, misfiring, hesitation on acceleration or stumbling on acceleration. (These conditions may go away once the engine is warmed up.) This will be detected by the system and cause the light to turn on.

If you experience this condition, change the fuel brand you use. It will require at least one full tank of the proper fuel to turn the light off.

If none of the above steps have made the light turn off, have your retailer or qualified service center check the vehicle. Your retailer has the proper test equipment and diagnostic tools to fix any mechanical or electrical problems that may have developed.

Oil Pressure Indicator

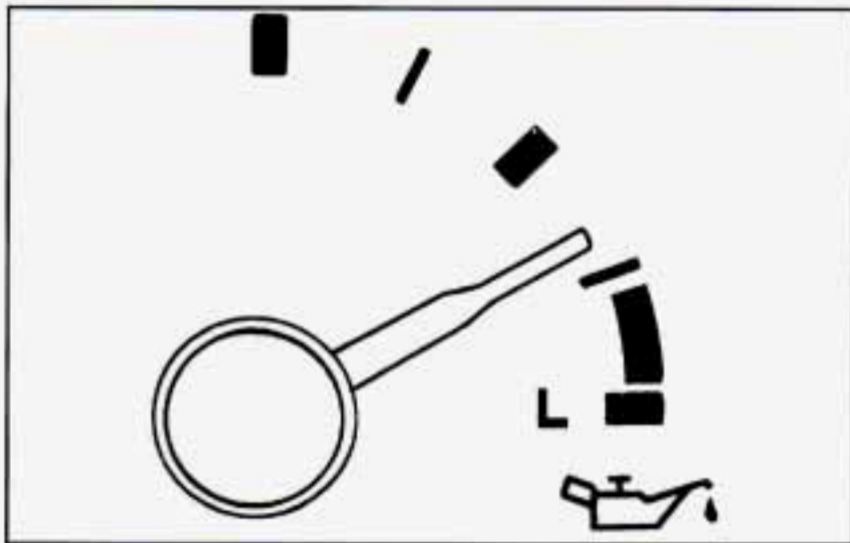

Your vehicle is equipped with an oil pressure indicator. Your oil pressure indicator lets you know when you may have a problem with your engine oil pressure.

When the engine is running, readings within the white area indicate the normal operating range. Readings in or below the red area indicate that the engine's oil level may be dangerously low, or there may be another problem causing low oil pressure.

Driving your vehicle with low oil pressure can cause extensive engine damage. Have your vehicle serviced immediately.

CAUTION:

Don't keep driving if the oil pressure is low. If you do, your engine can become so hot that it catches fire. You or others could be burned. Check your oil as soon as possible and have your vehicle serviced.

NOTICE:

Damage to your engine from neglected oil problems can be costly and is not covered by your warranty.

Low Oil Light

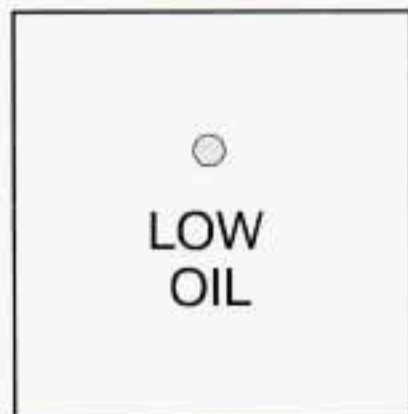

If this light comes on, it means your engine is low on oil.

You need to check the oil level right away. Driving your vehicle without enough oil can cause extensive engine damage. Have your vehicle serviced immediately.

Power Sliding Door Warning Light



With the optional power sliding door, the sliding door ajar symbol on your instrument panel will come on if your sliding door is not completely closed.

If you shift the transaxle out of PARK (P) while the sliding door is open or in the process of closing, and the power sliding door ON/OFF switch is in the ON position, the power sliding door warning light will flash and a buzzer will sound. This is a warning that the sliding door is not completely closed.



CAUTION:

If you shift the transaxle out of PARK (P) and accelerate before the power sliding door latches closed, the door may reverse to the open position. A child or others could fall out of the vehicle and be injured. Always make sure the power sliding door is closed and latched before you drive away.

If you manually slam the power sliding door shut when the ignition is on, the power sliding door warning light may come on and stay on. To turn the light off, reopen and close the door using either power door switch, or manually open and close the door again more slowly.

Liftgate Ajar Warning Light



The liftgate ajar symbol on your instrument panel will come on if your liftgate is not completely closed.

Fuel Gage

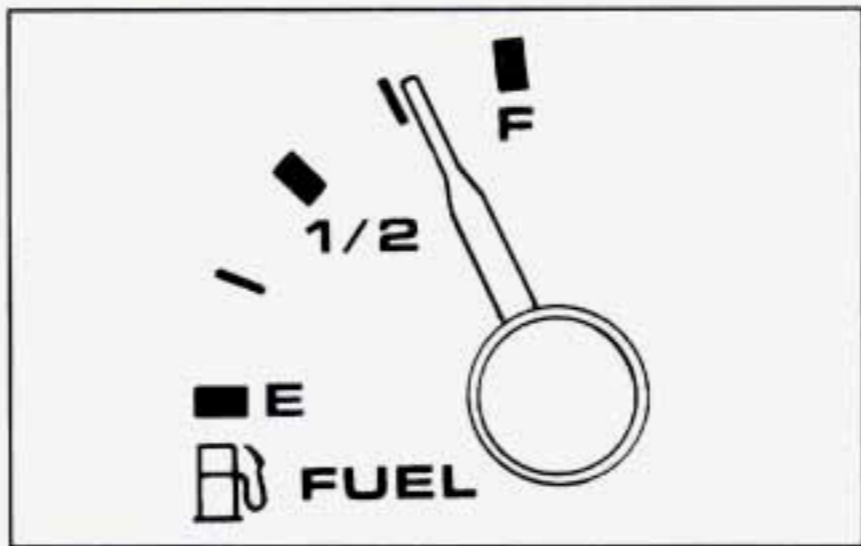

Your fuel gage tells you about how much fuel you have left (when the ignition is on). When the gage first indicates EMPTY (E), you still have a little fuel left, but you should get more soon.

Here are four things that some owners ask about. None of these show a problem with your fuel gage:

- At the service station, the gas pump shuts off before the gage reads FULL (F).
- It takes a little more or less fuel to fill up than the gage indicated. For example, the gage may have indicated the tank was half full, but it actually took a little more or less than half the tank's capacity to fill the tank.
- The gage moves a little when you turn a corner, brake or speed up.
- The gage doesn't go back to EMPTY (E) when you turn off the ignition.

Low Fuel Warning Light

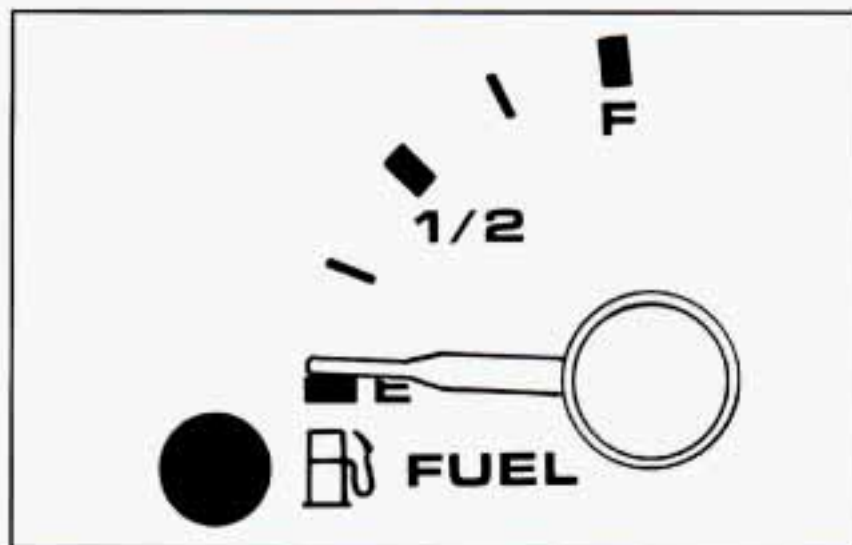

This light will also come on when you turn on the ignition, but the engine is not running, to show you it is working. If it doesn't come on as you start your vehicle, have it fixed right away.

When there is between 3 gallons (11 L) and 0.5 gallon (1.8 L) of fuel left in the tank, the warning light next to the fuel symbol will go on.



Section 3 Comfort Controls and Audio Systems

In this section you'll find out how to operate the comfort control and audio systems offered with your Oldsmobile. Be sure to read about the particular systems supplied with your vehicle.

Comfort Controls

This section tells you how to make your air system work for you. Your comfort control system uses ozone-friendly R-134a refrigerant.

With these systems you can control the heating, cooling and ventilation in your Oldsmobile. Your vehicle also has a flow-through ventilation system described later in this section.

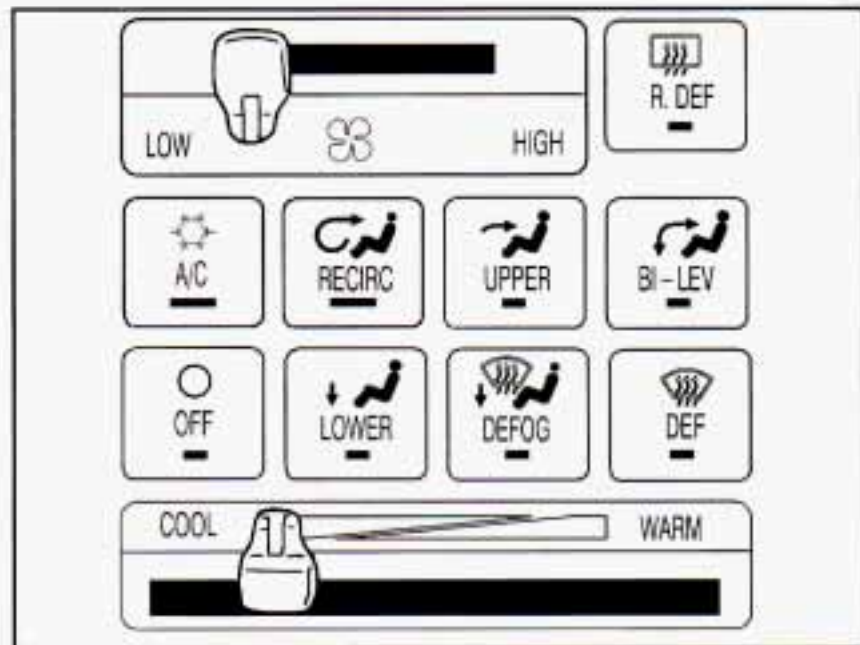

Your vehicle's heater and air conditioner will work best if you keep your windows closed.

Fan Lever

Slide the lever to the right to increase fan speed. To decrease fan speed, slide this lever to the left.

Temperature Control Lever

Slide this lever to the right for warmer, heated air. For cooled air, slide this lever to the left.

Mode Buttons

OFF: Press this button to turn the system off. Press any climate control setting to turn the system on.

A/C: This setting cools the air entering your vehicle and directs it through the instrument panel outlets. The air conditioning compressor operates in all air conditioner positions.

RECIRC: Press this button to limit the amount of fresh air entering your vehicle by recirculating much of the air inside your vehicle. You may use this setting to limit odors entering your vehicle.

UPPER: This setting directs outside air through the instrument panel outlets. Adjust the temperature of the air with the temperature control lever.

BI-LEV: The BI-LEV setting directs outside air into your vehicle in two ways. Cooler air is directed toward your upper body through the front instrument panel outlets, while warmed air is directed through the heater ducts at your feet. At times, this temperature difference may be more apparent than others.

LOWER: This setting brings in most of the air through the floor ducts and some through the defroster vents.

DEFOG: This mode is particularly useful during cold or inclement weather, because of your Oldsmobile Silhouette's larger windshield area. Press this button to direct air to the windshield and through the floor ducts.

DEF: Press this button to direct most of the air to the windshield and side window vents.

Air Conditioning

On very hot days, your vehicle will cool down more quickly and economically if you open the windows long enough to let hot, inside air escape. For all settings, adjust the temperature control lever and fan speed as desired.

Press the RECIRC button to get maximum cooling or quick cool-down on very hot days. It should not be used for long periods of time because the air may become too cold and dry.

When the temperature outside is above freezing, the air conditioner compressor will automatically condition the air when you press RECIRC (the A/C indicator light will glow), DEFOG or DEF (the A/C indicator light will not glow).

Press A/C (the A/C indicator light will glow) to condition the air when you press UPPER, BI-LEV or LOWER. To turn off the air conditioner compressor in these settings, press A/C again (the indicator light will go off).

Each time you turn on the ignition, the air conditioner will default to the setting you had selected before last turning off the ignition.

When the air conditioner compressor is on, you may sometimes notice slight changes in your vehicle's engine performance and power. This is normal. The system is designed to help fuel economy while it maintains the desired cooling level.

The air conditioner removes moisture from the air, so you may sometimes notice water dripping from under your vehicle when it is idling or after it has been turned off. This is normal.

Heating

Slide the temperature lever to the right to warm the air.

In the LOWER mode, outside air will be brought in and sent through the floor outlets. The heater works best if you keep your windows closed while using it.

The BI-LEV setting is designed for use on sunny days when the air is only moderately warm or cool. On days like these, the sun may adequately warm your upper body, but your lower body may not be warm enough. For the best results, slide the temperature control lever to the middle position, and then adjust it for comfort.

If you have the optional engine coolant heater and use it during cold weather, 0°F (-18°C) or lower, your heating system will provide heat more quickly because the engine coolant is already warmed. See “Engine Coolant Heater” in the Index.

Ventilation System

Your vehicle’s flow-through ventilation system supplies outside air into the vehicle when it is moving. Outside air will also enter the vehicle when the heater or the air conditioning fan is running.

Your vehicle has air outlets that allow you to adjust the direction and amount of airflow inside the vehicle. Push the outlet up or down to direct airflow to your preference. Increase or reduce the amount of airflow by opening and closing the louvers. Opening and closing the louvers will also direct airflow from side to side.

Rear Fan

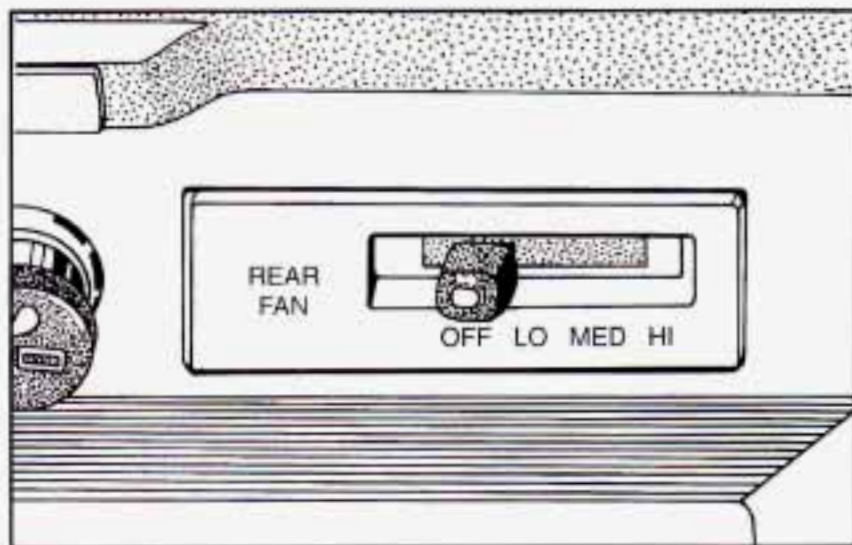

If your vehicle is equipped with seats in the third row, you will have a rear air outlet and a rear fan. To maximize airflow to the rear of your vehicle, place the left bucket seat in the second row in the forward position (see “Adjusting Rear Seats” in the Index). This uncovers the rear air outlet.

Please keep the area around the base of the center instrument panel console and the area between and under the front seats free of objects that could obstruct airflow to the rear.

The control for the rear fan is located below the audio system. Select LOWER, BI-LEV or DEFOG to direct airflow to the rear air outlet and to the rear side windows.

Use the temperature control lever to adjust the temperature setting. Select the force of air you want, from LO to HI, by sliding the rear fan control to the desired setting.

To maintain a comfortable temperature in the rear area without making the front passengers uncomfortable, adjust the front fan speed first, then adjust the temperature setting.

To turn off the rear fan, slide the control to OFF.

Ventilation Tips

- Keep the hood and front air inlet free of ice, snow or any other obstruction (such as leaves). This will allow the heater and defroster to work much better, reducing the chance of fogging the inside of your windows.
- When you enter a vehicle in cold weather, turn the blower fan to HIGH for a few moments before driving off. This helps clear the intake ducts of snow and moisture, and reduces the chance of fogging the inside of your windows.
- Keep the area around the base of the center instrument panel console and the air path under the front seats clear of objects. This helps air to circulate throughout your vehicle.

Rear Climate Control (Option)

If you have this option, you will have a master control for the rear fan on the center instrument panel console, and a rear control next to the second row seat, on the driver's side of the vehicle.

To maintain a comfortable temperature in the rear, use either rear fan control to adjust the force of air coming through the rear outlets. See "Rear Fan -- Master Control" and "Rear Fan -- Rear Control" later in this section.

Select the desired climate control mode using the directional controls on the instrument panel (see "Mode Buttons" earlier in the section). The mode you choose will regulate both the front and rear climate control systems. The temperature of heated or cooled air directed to the rear of the vehicle cannot be adjusted with the temperature control lever.

Select RECIRC, UPPER, BI-LEV or LOWER when outside temperatures are warm or moderate.

In the RECIRC mode, or if you press A/C when the system is in the UPPER or BI-LEV modes, cooled air will be directed to the rear of the vehicle through the overhead and third-row air conditioning outlets. If you select A/C in the LOWER mode, cooled air will be directed through the rear floor vent (see "Rear Air Vents" later in this section) unless the temperature control lever is set approximately 30 percent from the full cold setting. Heated air will result with the temperature control lever setting above 30 percent from the full cold setting. Temperature adjustment of the heated air is not possible. Cooled air will again return when the temperature control lever setting is returned to approximately 25 percent from the full cold setting.

If you do not select A/C in the UPPER or BI-LEV modes, air directed to the rear of the vehicle will be cabin temperature.

Select LOWER, DEFOG or DEF when outside temperatures are cool. In these modes, heated air will be directed to the rear of the vehicle through the rear side window vents and the rear floor heater vent.

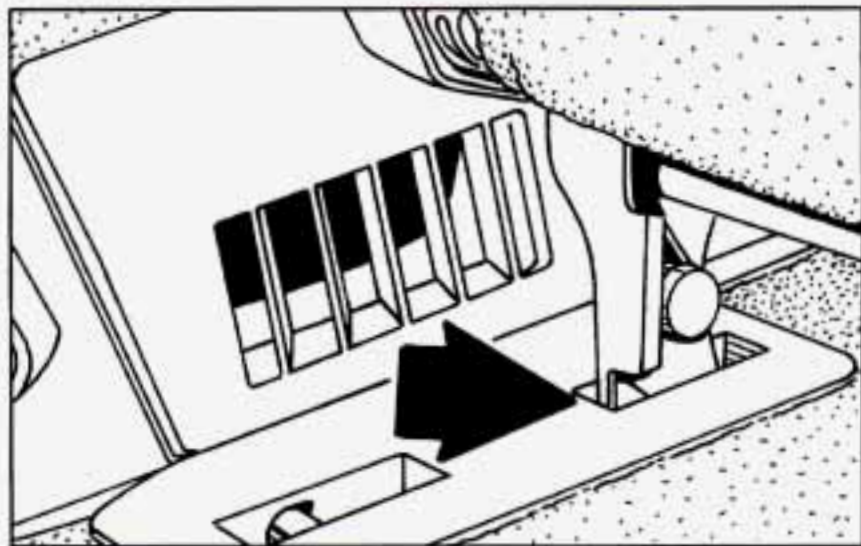

Rear Air Vents: To maximize airflow through the rear heater outlet, place the left bucket seat in the second row in the forward position (see “Adjusting Rear Seats” in the Index).

The vent forward of the rear heater outlet is the cold air return vent. Be sure to keep it free of obstructions.

Please keep the area around the base of the center instrument panel console and between and under the front seats free of objects that could obstruct airflow to the rear.

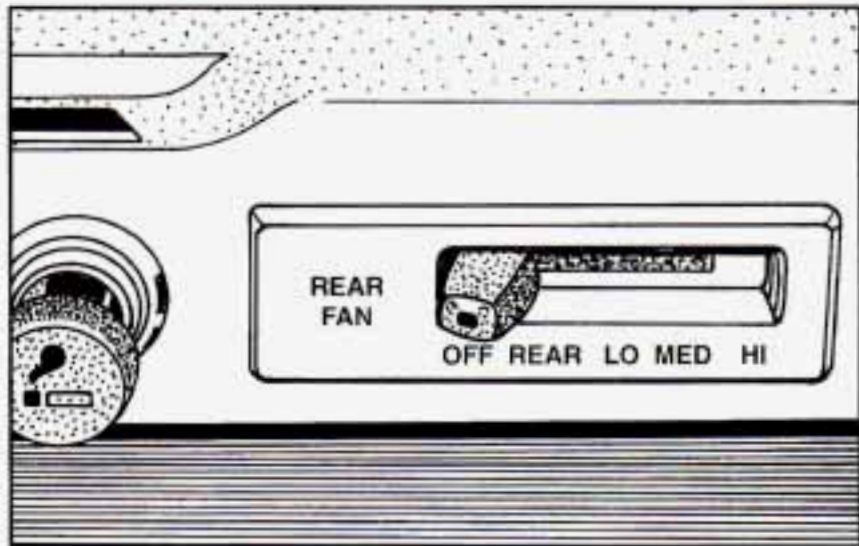

Rear Fan -- Master Control: The master control for the rear fan is located below the audio system.

To maintain a comfortable temperature in the rear area, select the force of air you want, from LO to HI, by sliding the control to the desired setting.

To transfer control of the rear fan to the rear control switch, slide the master control to REAR. The rear control switch will not operate when the master control is in any other position.

To turn off the rear fan, slide the control to OFF.

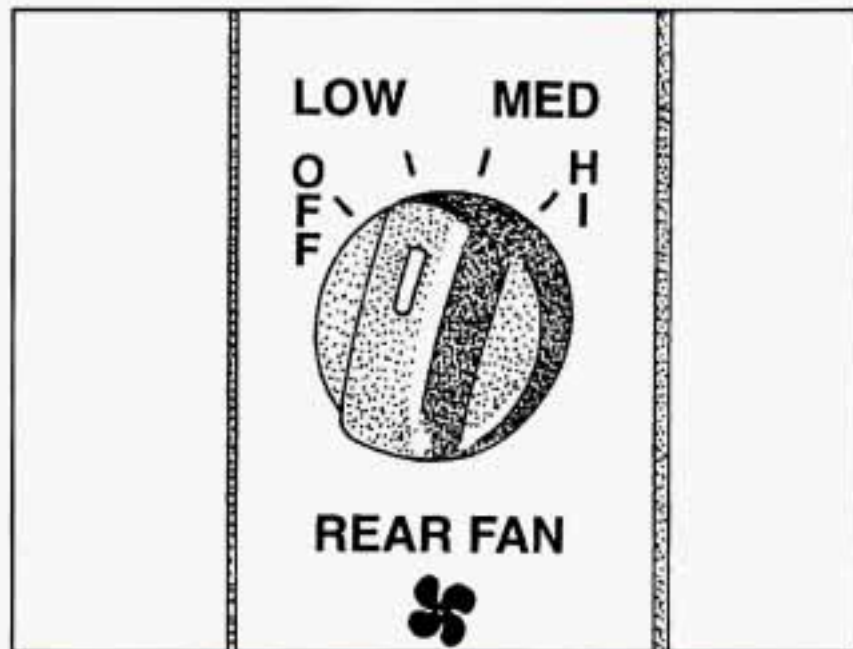

Rear Fan -- Rear Control: This feature allows passengers riding in the rear seats to control the flow of air to the rear area of the vehicle.

The rear control is located on the armrest next to the second row seat, left position. The rear fan master control on the instrument panel must be in the REAR position for the rear control to operate.

Select the force of air you want, from LOW to HI, by turning the control to the desired setting. To turn the rear fan off, turn the control to OFF. The rear fan can also be turned off at the master control.

Defogging and Defrosting

To rapidly defrost the windshield, slide the temperature control lever all the way to WARM and press DEF.

Adjust the fan to the highest speed.

To keep the windshield clear and bring in heated air through the heater ducts, press DEFOG.

When the temperature outside is above freezing, the air conditioner compressor will run in these settings to help remove moisture from the air.

Your vehicle is equipped with side window defogger vents located on the top of the instrument panel. For additional side window defogging, press the BI-LEV button and adjust the fan to the highest speed. Aim the side vents on the instrument panel toward the side windows. For increased airflow to the side vents, close the center vents.

Rear Window Defogger

Press R. DEF (Rear Defog) to warm the defogger grid on the rear window. The indicator light will glow while the rear window defogger is operating. The rear window defogger will turn off automatically after about 10 minutes of use. If you turn it on again, the defogger will operate for about five minutes only. You can also turn the defogger off by turning off the ignition or pressing the switch again.

Do not attach a temporary vehicle license across the defogger grid on the rear window.

NOTICE:

Don't use a razor blade or something else sharp on the inside of the rear window. If you do, you could cut or damage the warming grid, and the repairs wouldn't be covered by your warranty.

Audio Systems

Your Delco[®] audio system has been designed to operate easily and give years of listening pleasure. You will get the most enjoyment out of it if you acquaint yourself with it first. Find out what your Delco system can do and how to operate all its controls, to be sure you're getting the most out of the advanced engineering that went into it.

Setting the Clock for AM-FM Stereo

Press SET. Within five seconds, press and hold SEEK down arrow until the correct hour appears. Press and hold SEEK up arrow until the correct minute appears.

Setting the Clock for AM-FM Stereo with Cassette Tape Player

Press SET. Within five seconds, press and hold SEEK left arrow until the correct hour appears. Press and hold SEEK right arrow until the correct minute appears.

Setting the Clock for AM-FM Stereo with Compact Disc Player

Press SET. Within five seconds, press and hold SEEK until the correct hour appears. Press and hold SCAN until the correct minute appears.

AM-FM Stereo



Playing the Radio

VOL: Turn this knob clockwise to increase volume. Turn it counterclockwise to decrease volume.

RECALL: Press this button briefly to recall the station being played or to display the clock.

Finding a Station

AM-FM: Press this button to get AM or FM.

TUNE: Turn this knob to choose radio stations.

SEEK: Press the up or down arrow to go to the next higher or lower station.

PUSHBUTTONS: The four numbered pushbuttons let you return to your favorite stations. You can set up to 14 stations (seven AM and seven FM).

1. Find the station you want by using TUNE or SEEK.
2. Press SET. (The SET indicator will appear briefly on the display.)
3. Press one of the four pushbuttons, within five seconds. Whenever you press that numbered button, the station you set will return.
4. Repeat the steps for each pushbutton.

In addition to the four stations set as above, up to three additional stations may be preset on each band by pressing two adjoining buttons at the same time. Just:

1. Tune in the desired station.
2. Press SET. (The SET indicator will appear on the display.)
3. Press any two adjoining pushbuttons at the same time (within five seconds).
4. Whenever you press the same buttons, the station you set will return.

Setting the Tone

BASS: Slide this lever up to increase bass and down to decrease it.

TREB: Slide this lever up to increase treble and down to decrease it. If a station is weak or noisy, slide the lever down to reduce the noise.

Adjusting the Speakers

BAL: This control behind the upper knob adjusts the sound between the right and left speakers.

FADE: This control behind the lower knob adjusts the sound between your front and rear speakers.

AM-FM Stereo with Cassette Tape Player (Option)



Playing the Radio

VOL-BAL-PROG-RCL: This knob turns the system on and off and controls the volume. Turn the upper knob clockwise to increase volume. Turn it counterclockwise to decrease volume. Press the upper knob briefly to recall the station being played or to display the clock. If you press the button when the ignition is off, the clock will show for a few seconds.

Finding a Station

AM-FM: Press the lower knob to get AM, FM1 or FM2. The display shows your selection.

TUNE: Turn the lower knob to choose radio stations.

SEEK: Press the up or down arrow to go to the next higher or lower station.

PUSHBUTTONS: The four pushbuttons let you return to your favorite stations. You can set up to 21 stations (seven AM, seven FM1 and seven FM2).

1. Press AM-FM to select the band.
2. Find the station you want by using TUNE or SEEK.
3. Press SET until the word SET appears on the display.
4. Press and hold one of the four buttons, within five seconds.
5. The sound will mute. When it returns, release the button. Whenever you press that button, the station you set will return.
6. Repeat the steps for each pushbutton.

In addition to the four stations set as above, up to three additional stations may be preset on each band by pressing two adjoining buttons at the same time. Just:

1. Tune in the desired station.

2. Press SET. (The SET indicator will appear on the display.)
3. Press any two adjoining pushbuttons at the same time (within five seconds).
4. The sound will mute. When it returns, release the buttons. Whenever you press the same buttons, the station you set will return.

PSCAN: Press both SEEK arrows and PSCAN will appear on the display. Use PSCAN to listen to each of your preset stations for a few seconds. The radio will go to the first preset station, stop for a few seconds, then go on to the next preset station. (If a preset station has weak reception, it will not stop.) Press either SEEK arrow or the upper knob to stop scanning.

Setting the Tone

BASS: Slide the lever up or down to increase or decrease bass. The middle position is a detent.

TREB: Slide the lever up or down to increase or decrease treble. The middle position is a detent. If a station is weak or noisy, slide the lever down to reduce the noise.

Adjusting the Speakers

BAL: Turn the control behind the upper knob to move the sound to the left or right speakers. The middle position is a detent and balances the speakers.

FADE: Turn the control behind the lower knob to move the sound to the front or rear speakers. The middle position is a detent and balances the speakers.

Playing a Cassette Tape

Your tape player is built to work best with tapes that are 30 to 45 minutes long on each side. Tapes longer than that are so thin they may not work well in this player.

The longer side with the tape visible goes in first. If you hear nothing or hear just a garbled sound, it may not be in squarely. Press STOP-EJECT to remove the tape and start over.

While the tape is playing, use the VOL, FADE, BAL, TREB and BASS controls just as you do for the radio. Other controls may have different functions when a tape is inserted. The display will show an arrow to show which side of the tape is playing.

Note that cassette tape adapter kits for portable compact disc players will not work in your cassette player. These adapters will cause an error message to show on the display, and the adapter cassette will be ejected.

FORWARD: Press the right arrow to rapidly advance the tape. It will continue forwarding until you press the right arrow again lightly.

REVERSE: Press the left arrow to rapidly reverse the tape. It will continue reversing until you press the left arrow again lightly.

PROG-RCL: Press this knob to hear the other side of a tape that is playing.

STOP-EJECT: Press this button to remove the tape or stop playing the tape and switch to the radio.

CLN: This message may appear on the display. If it does, your cassette tape player needs to be cleaned. It will still play tapes, but you should clean it as soon as possible to prevent damage to your tapes and player. See "Care of Your Cassette Tape Player" in the Index. After you clean the player, press and hold STOP-EJECT for five seconds to reset the CLN indicator. The radio will display --- to show the indicator was reset.

AM-FM Stereo with Cassette Tape Player (Option)



Playing the Radio

PWR: Press this button to turn the radio on.

VOL: Turn the upper knob clockwise to increase volume and counterclockwise to decrease volume. VOL graphics will show on the display.

MUTE: Press the upper knob to mute the radio or cassette tape player. Press the button again to resume the sound.

RCL: Press this button briefly to recall the station being played or to display the clock. If you press the knob when the ignition is off, the clock will show for a few seconds.

Finding a Station

AM/FM: Press the lower knob to get AM, FM1 or FM2. Your selection will show on the display.

TUNE: Turn the lower knob to choose radio stations.

SEEK: Press the right arrow to go to the next higher station and the left arrow to go to the next lower station.

SCAN: Press the SCAN button to listen to stations for a few seconds. The radio will go to a station, stop for a few seconds, then go on to the next station. Press the SCAN button again to stop scanning.

PUSHBUTTONS: The five numbered pushbuttons let you return to your favorite stations. You can set up to 15 stations (five AM, five FM1 and five FM2).

1. Press AM-FM to select the band.
2. Find the station you want by using TUNE or SEEK.
3. Press SET. (The SET indicator will appear briefly on the display.)
4. Press one of the five pushbuttons, within five seconds. Whenever you press that numbered button for that band, the station you set will return.
5. Repeat the steps for each pushbutton.

Setting the Tone

BASS: Press this button up to increase bass and down to decrease it. Press the center of the control to get the factory preset midpoint.

TREB: Press this button up to increase treble and down to decrease it. If a station is weak or noisy, press the button down to reduce the noise. Press the center of the control to get the factory preset midpoint.

Adjusting the Speakers

BALANCE: Turn the control behind the upper knob to adjust the sound between the right and left speakers.

FADE: Turn the control behind the lower knob to move the sound between the front and rear speakers.

Playing a Cassette Tape

Your tape player is built to work best with tapes that are 30 to 45 minutes long on each side. Tapes longer than that are so thin they may not work well in this player.

While the tape is playing, use the VOL, FADE, TREB and BASS controls just as you do for the radio. The display will show an arrow to show which side of the tape is playing. When the down indicator arrow is lit, selections listed on the bottom side of the cassette are playing. When the up arrow is lit, selections listed on the

top side of the cassette are playing. The tape player automatically begins playing the other side when it reaches the end of the tape.

This system has automatic Dolby Noise Reduction to reduce background noise on tapes encoded with Dolby NR. Dolby Noise Reduction is manufactured under a license from Dolby Laboratories Licensing Corporation. Dolby and the double-D symbol are trademarks of Dolby Laboratories Licensing Corporation.

PROG (1): Press this button to play the other side of the tape.

CrO₂ (2): This button sets the tape bias. When playing high-bias chrome or metal tapes, press the CrO₂ button to turn the CrO₂ display on. When playing standard bias tapes, press again to turn the light off.

REV (5): Press this button to reverse the tape rapidly. Press REV or PROG to return to playing speed. The radio will play the last-selected station while the tape reverses.

FWD: Press the SCAN button to advance quickly to another part of the tape. Press FWD or PROG to return to playing speed. The radio will play the last-selected station while the tape advances.

PREV: Press the SEEK left arrow to search for the previous selection on the tape. A four-second quiet interval must be present for the tape to stop. The tape will also stop when PROG or the SEEK right arrow is pressed.

NEXT: Press the SEEK right arrow to search for the next selection on the tape. Your tape must have at least four seconds of silence between each selection for NEXT or SEEK to work. Press PREV or the SEEK right arrow to stop searching.

ST-PL: To switch from tape to radio immediately, press the ST-PL button and the radio will resume playing the station that was tuned in when you inserted a tape. Pressing the button again will allow the tape to resume playing.

EJECT: Press this button to remove the tape. The radio will play. EJECT may be activated with either the ignition or the radio off.

AM-FM Stereo with Compact Disc Player (Option)



Playing the Radio

POWER: Press this button to turn the system on or off when the ignition is on.

VOL: Press the up arrow to increase volume and the down arrow to decrease volume. The bottom of the digital screen displays the setting. For a normal listening level preset at the factory, press the center of the button.

RCL: Press this button to recall the station being played or to display the clock. RCL may be pressed with the ignition off to display the time.

Finding a Station

AM-FM: Press this button to get AM or FM. Your selection will show on the display. If the station is in stereo, ST will show on the display.

Your radio has AMAX. With an AMAX-certified receiver, your radio can produce quality AM sound comparable to FM stereo. AMAX reduces noise without reducing the high frequencies you need for the best sound. In addition to improved sound quality, AMAX includes more stations on the AM band. You don't have to do anything to your Delco/GM radio because AMAX is automatic.

TUNE: Press the up arrow to tune in radio stations higher on the AM or FM band. Press the down arrow to tune in radio stations lower on the band.

SEEK: Press this button to tune to the next higher station and stay there.

SCAN: Press this button to hear each station for a few seconds. The radio will go to a station, stop for a few seconds, then go on to the next station. Press SCAN again if you hear something you like and want to stay there. SCAN will appear on the display while scanning.

PUSHBUTTONS: The five pushbuttons let you return to your previously played stations. You can set up to 10 stations (five AM and five FM).

1. Find the station you want by using TUNE.
2. Press SET. (The SET indicator will appear briefly on the display.)
3. Press one of the five pushbuttons, within five seconds. Whenever you press that button, the station you set will return.
4. Repeat the steps for each pushbutton.

Setting the Tone

BASS: Press the top of the button to hear more bass and the down arrow to hear less bass. Press the center of the button for the factory-preset position.

TREB: Press the up arrow to hear more treble and the down arrow to hear less treble. Press the center of the button for the factory-preset position. TREB will appear briefly on the display whenever TREB is pressed.

Adjusting the Speakers

BAL: This four-way control adjusts the left/right and front/rear speaker balance to your individual taste. When you change either adjustment, the bottom of the digital screen will display the point of balance you have selected. Press the left and right or front and rear buttons at the same time to select the factory-preset position.

Playing a Compact Disc

Press **POWER** to turn the radio on. Insert a disc partway into the slot, label side up. The player will pull it in. The disc should begin playing.

If you're driving on a very rough road or if it's very hot, the disc may not play and may come back out of the slot. When things get back to normal, the disc should play. If the disc comes out, it could be that:

- The disc is upside down.
- It is dirty, scratched or wet.
- It is very humid. (If so, wait about an hour and try again.)

While a compact disc is playing, **CD** will appear on the display.

RCL: Press this button to see which track is playing. Press it again within five seconds to see how long it has been playing. The track number will also appear on the display when you change volume or when a new track starts playing.

COMP: Press this button to make loud and soft passages more nearly equal in volume. Press **COMP** again to resume normal play.

REV: Press and hold this button to return to a previously played passage rapidly. Release the button to play the passage.

FF: Press and hold this button to fast forward or advance through passages. Release the button to play the passage.

PREV: Press this button to hear a track again. If you press and hold this button or press it more than once, the disc will return to previous tracks.

NEXT: Press this button to hear the next track now instead of waiting until the current track is finished playing. If you press and hold this button or press it more than once, the disc will keep advancing to other tracks.

Stopping the Disc Player

Turn the power off or turn the ignition key off. The disc stays in the player and will resume playing at the point where it stopped.

ST-PL: Press this button to stop playing the disc and switch to the radio. Press it again to restart the disc at the point where it stopped.

EJCT: Press this button to eject the disc and switch to the radio. The disc will start playing track one when you reinsert it.

Theft-Deterrent Feature

Delco-Loc II[®] is a security feature for the compact disc player. It may be used or ignored. If ignored, the system plays normally and the radio is not protected by the feature. If Delco-Loc II is activated, your radio will not operate if stolen.

If your vehicle loses battery power for any reason, you must enter your secret code again before the system will turn on.

Activating the Theft-Deterrent Feature

The instructions which follow, explain how to enter your secret code to activate the Delco-Loc II system. It is recommended that you read through all of the steps before starting the procedure.

NOTE: If you allow more than 15 seconds to elapse between any steps, the radio automatically reverts to time and you must start the procedure over at Step 4.

1. Write down any six-digit number and keep it in a safe place separate from the vehicle.
2. Turn the ignition to the ACC or RUN position.
3. Press the PREV and FF buttons together. Hold them down until --- shows on the display. Next you will use the secret code number which you have written down.
4. Press SET and 000 will appear on the display.
5. Press SCAN to make the first digit of your code appear.

6. Press SEEK to make the second and third digits of your code appear.
 7. Press AM-FM and 000 will appear on the display again. Now you are ready to enter the last three digits of your code.
 8. Press SEEK to make the fourth digit of your code appear.
 9. Press SCAN to make the last two digits of your code appear.
 10. Press AM-FM and REP will appear on the display for five seconds, and then 000 will appear on the display.
 11. For verification, repeat Steps 6 through 11. If SEC appears on the display, your audio system is secured. If --- shows on the display, your system is not secured. You must restart the entire procedure again from Step 4.
2. Press SET and 000 will appear on the display.
 3. Press SCAN to make the first digit of your code appear.
 4. Press SEEK to make the second and third digits of your code appear.
 5. Press AM-FM and 000 will appear on the display again. Now you are ready to enter the last three digits of your code.
 6. Press SCAN to make the fourth digit of your code appear.
 7. Press SEEK to make the last two digits of your code appear.
 8. Press AM-FM. If the time appears, the unlocking sequence was successful. If the display shows SEC, the digits did not match and the unit is still secured.
 9. Press AM-FM after you have confirmed that the code matches the secret code you have written down. The display will show SEC, indicating the radio is now operable and secure.

Unlocking the Theft-Deterrent Feature After a Power Loss

Enter your secret code as follows; pause no more than 15 seconds between steps:

1. Turn the ignition on. (The radio should be off. LOC will appear on the display.)

If you lose or forget your code, contact your retailer.

Disabling the Theft-Deterrent Feature

1. Turn the ignition on.
2. Turn the radio off.
3. Press the PREV and FF buttons together. Hold them down until SEC shows on the display.
4. Press SET and 000 will appear on the display.
5. Press SCAN to make the first digit of your code appear.
6. Press SEEK to make the second and third digits of your code appear.
7. Press AM-FM and 000 will appear on the display again. Now you are ready to enter the last three digits of your code.

8. Enter the last three digits of your code. The display will show the numbers as entered.
9. Press AM-FM after you have confirmed that the code matches the secret code you have written down. The display will show ---, indicating that the radio is no longer secured.

If the code entered is incorrect, SEC will appear on the display. The radio will remain secured until the correct code is entered.

When battery power is disconnected from a secured radio, the radio won't turn on and LOC will appear on the display.

To unlock a secured radio, see "Unlocking the Theft-Deterrent Feature After a Power Loss" earlier in this section.

Steering Wheel Controls (Option)

If your vehicle has this feature, you can control certain radio functions using the buttons on your steering wheel.

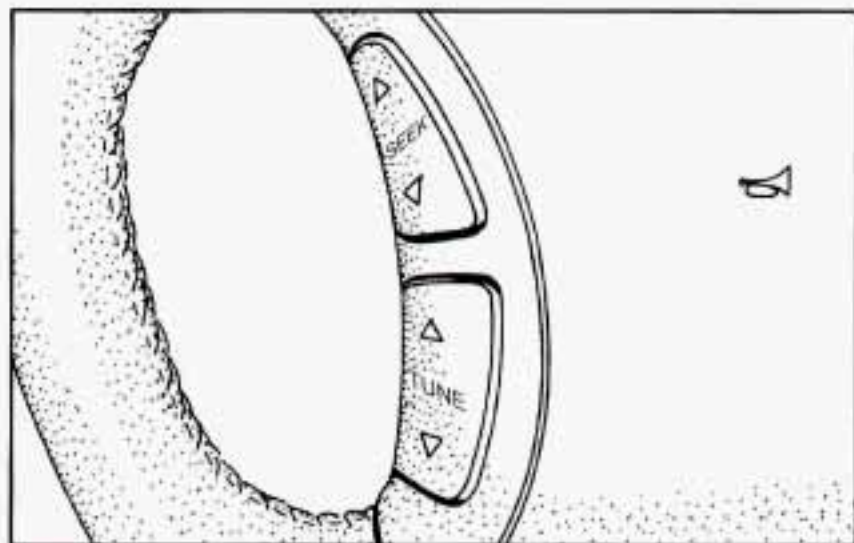

SEEK: Press this button to tune to a higher or lower radio station. The sound will be muted while seeking. When playing a cassette tape or compact disc, press SEEK to hear the next selection.

TUNE: Press the up arrow to tune to a higher radio station. Press the down arrow to tune to a lower radio station.

VOLUME: Press the up arrow to increase the volume and the down arrow to decrease volume.

AM-FM: Press this button to choose AM or FM.

MUTE: Press this button to silence the system. Press it again to turn on the sound. This button may be used when listening to the radio, a cassette tape or a compact disc.

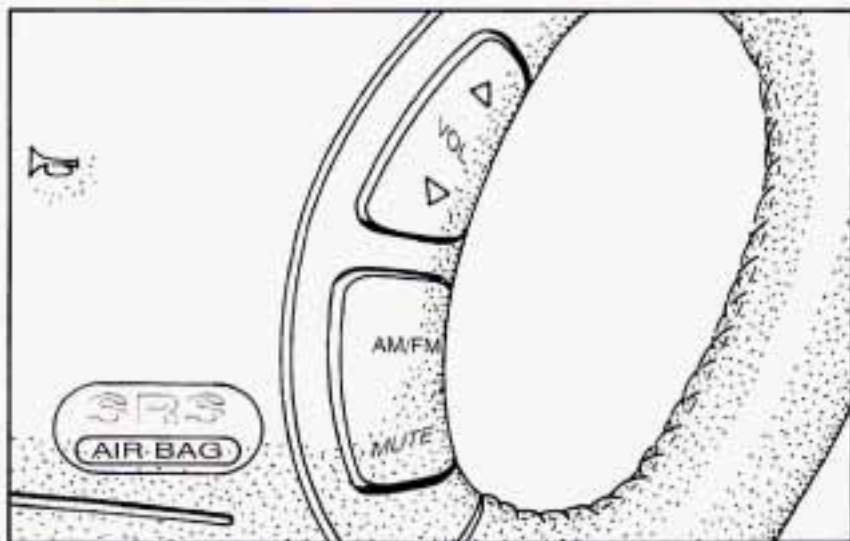

Understanding Radio Reception

FM Stereo

FM stereo will give you the best sound. But FM signals will reach only about 10 to 40 miles (16 to 65 km). Tall buildings or hills can interfere with FM signals, causing the sound to come and go.

AM

The range for most AM stations is greater than for FM, especially at night. The longer range, however, can cause stations to interfere with each other. AM can pick up noise from things like storms and power lines. Try reducing the treble to reduce this noise if you ever get it.

Tips About Your Audio System

Hearing damage from loud noise is almost undetectable until it is too late. Your hearing can adapt to higher volumes of sound. Sound that seems normal can be loud and harmful to your hearing. Take precautions by adjusting the volume control on your radio to a safe sound level before your hearing adapts to it.

To help avoid hearing loss or damage:

- Adjust the volume control to the lowest setting.
- Increase volume slowly until you hear comfortably and clearly.

NOTICE:

Before you add any sound equipment to your vehicle -- like a tape player, CB radio, mobile telephone or two-way radio -- be sure you can add what you want. If you can, it's very important to do it properly. Added sound equipment may interfere with the operation of your vehicle's engine, Delco radio or other systems, and even damage them. Your vehicle's systems may interfere with the operation of sound equipment that has been added improperly.

So, before adding sound equipment, check with your retailer and be sure to check Federal rules covering mobile radio and telephone units.

Care of Your Cassette Tape Player

A tape player that is not cleaned regularly can cause reduced sound quality, ruined cassettes or a damaged mechanism. Cassette tapes should be stored in their cases away from contaminants, direct sunlight and extreme heat. If they aren't, they may not operate properly or may cause failure of the tape player.

Your tape player should be cleaned regularly after every 50 hours of use. Your radio may display CLN to indicate that you have used your tape player for 50 hours without resetting the tape clean timer. If you notice a reduction in sound quality, try a known good cassette to see if the tape or the tape player is at fault. If this other cassette has no improvement in sound quality, clean the tape player.

Cleaning may be done with a scrubbing action, non-abrasive cleaning cassette with pads which scrub the tape head as the hubs of the cleaner cassette turn. A scrubbing action cleaning cassette is available through your Oldsmobile retailer.

You may also choose a non-scrubbing action, wet-type cleaner which uses a cassette with a fabric belt to clean the tape head. It may not clean as thoroughly as the scrubbing type cleaner.

Cassettes are subject to wear and the sound quality may degrade over time. Always make sure that the cassette tape is in good condition before you have your tape player serviced.

Care of Your Compact Discs

Handle discs carefully. Store them in their original cases or other protective cases and away from direct sunlight and dust. If the surface of a disc is soiled, dampen a clean, soft cloth in a mild, neutral detergent solution and clean it, wiping from the center to the edge.

Be sure never to touch the signal surface when handling discs. Pick up discs by grasping the outer edges or the edge of the hole and the outer edge.

Integrated Roof Antenna

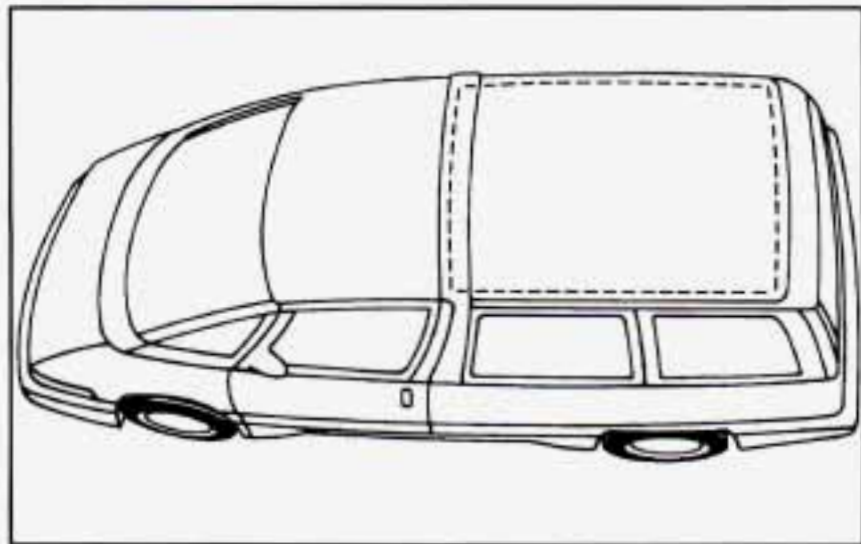

Your state-of-the-art integrated roof antenna is not visible. It is located between the roof and headliner of your vehicle, covering the entire roof area from the rear edge of the front doors to the liftgate.

NOTICE:

Don't mount anything to your roof or headliner, such as an antenna or a luggage carrier. If you puncture the roof or headliner, you could damage or destroy your integrated roof antenna. Have any work of this type done by your retailer.

If you want to add a mobile phone or two-way radio to your vehicle, there are special precautions you'll need to take because of your integrated roof antenna. See "Adding Sound Equipment" in the Index.

NOTES



Section 4 Your Driving and the Road



Here you'll find information about driving on different kinds of roads and in varying weather conditions. We've also included many other useful tips on driving.

Defensive Driving

The best advice anyone can give about driving is: Drive defensively.

Please start with a very important safety device in your Oldsmobile: Buckle up. (See "Safety Belts" in the Index.)

Defensive driving really means "be ready for anything." On city streets, rural roads or freeways, it means "always expect the unexpected."

Assume that pedestrians or other drivers are going to be careless and make mistakes. Anticipate what they might do. Be ready for their mistakes.

Rear-end collisions are about the most preventable of accidents. Yet they are common. Allow enough following distance. It's the best defensive driving maneuver, in both city and rural driving. You never know when the vehicle in front of you is going to brake or turn suddenly.

Drunken Driving

Death and injury associated with drinking and driving is a national tragedy. It's the number one contributor to the highway death toll, claiming thousands of victims every year.

Alcohol affects four things that anyone needs to drive a vehicle:

- Judgment
- Muscular Coordination
- Vision
- Attentiveness.

Police records show that almost half of all motor vehicle-related deaths involve alcohol. In most cases, these deaths are the result of someone who was drinking and driving. In recent years, some 18,000 annual motor vehicle-related deaths have been associated with the use of alcohol, with more than 300,000 people injured.

Many adults -- by some estimates, nearly half the adult population -- choose never to drink alcohol, so they never drive after drinking. For persons under 21, it's against the law in every U.S. state to drink alcohol. There are good medical, psychological and developmental reasons for these laws.

The obvious way to solve this highway safety problem is for people never to drink alcohol and then drive. But what if people do? How much is "too much" if the driver plans to drive? It's a lot less than many might think. Although it depends on each person and situation, here is some general information on the problem.

The Blood Alcohol Concentration (BAC) of someone who is drinking depends upon four things:

- The amount of alcohol consumed
- The drinker's body weight
- The amount of food that is consumed before and during drinking
- The length of time it has taken the drinker to consume the alcohol.

According to the American Medical Association, a 180-lb. (82 kg) person who drinks three 12-ounce (355 ml) bottles of beer in an hour will end up with a BAC of about 0.06 percent. The person would reach the same BAC by drinking three 4-ounce (120 ml) glasses of wine or three mixed drinks if each had 1-1/2 ounces (45 ml) of a liquor like whiskey, gin or vodka.

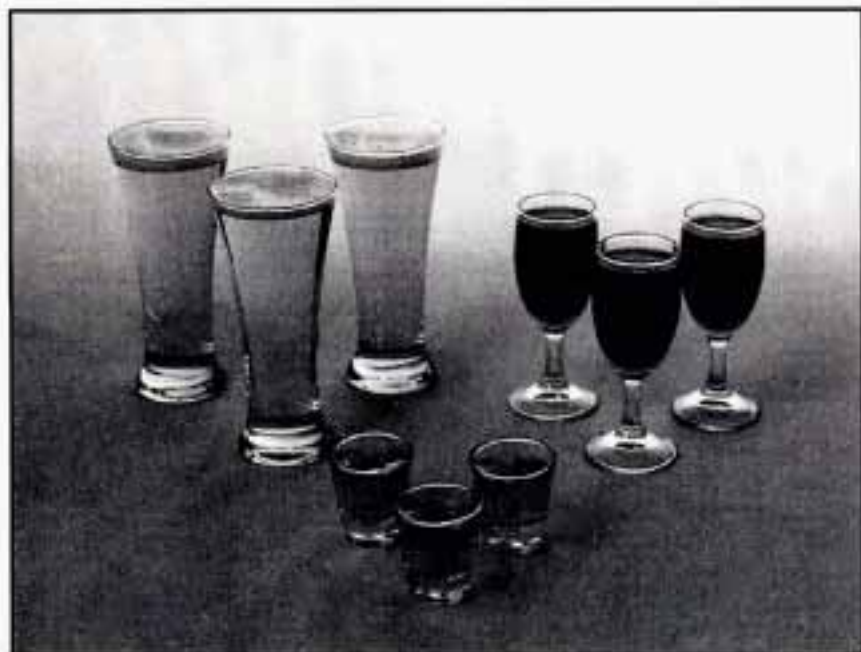

It's the amount of alcohol that counts. For example, if the same person drank three double martinis (3 ounces or 90 ml of liquor each) within an hour, the person's BAC would be close to 0.12 percent. A person who consumes food just before or during drinking will have a somewhat lower BAC level.

There is a gender difference, too. Women generally have a lower relative percentage of body water than men.

Since alcohol is carried in body water, this means that a woman generally will reach a higher BAC level than a man of her same body weight when each has the same number of drinks.

The law in many U.S. states sets the legal limit at a BAC of 0.10 percent. In a growing number of U.S. states, and throughout Canada, the limit is 0.08 percent. In some other countries, it's even lower. The BAC limit for all commercial drivers in the United States is 0.04 percent.

The BAC will be over 0.10 percent after three to six drinks (in one hour). Of course, as we've seen, it depends on how much alcohol is in the drinks, and how quickly the person drinks them.

But the ability to drive is affected well below a BAC of 0.10 percent. Research shows that the driving skills of many people are impaired at a BAC approaching 0.05 percent, and that the effects are worse at night. All drivers are impaired at BAC levels above 0.05 percent. Statistics show that the chance of being in a collision increases sharply for drivers who have a BAC of 0.05 percent or above. A driver with a BAC level of 0.06 percent has doubled his or her chance of having a collision. At a BAC level of 0.10 percent, the chance of this driver having a collision is 12 times greater; at a level of 0.15 percent, the chance is 25 times greater!

The body takes about an hour to rid itself of the alcohol in one drink. No amount of coffee or number of cold showers will speed that up. "I'll be careful" isn't the right answer. What if there's an emergency, a need to take sudden action, as when a child darts into the street? A person with even a moderate BAC might not be able to react quickly enough to avoid the collision.

There's something else about drinking and driving that many people don't know. Medical research shows that alcohol in a person's system can make crash injuries worse, especially injuries to the brain, spinal cord or heart. This means that when anyone who has been drinking -- driver or passenger -- is in a crash, that person's chance of being killed or permanently disabled is higher than if the person had not been drinking.



CAUTION:

Drinking and then driving is very dangerous. Your reflexes, perceptions, attentiveness and judgment can be affected by even a small amount of alcohol. You can have a serious -- or even fatal -- collision if you drive after drinking. Please don't drink and drive or ride with a driver who has been drinking. Ride home in a cab; or if you're with a group, designate a driver who will not drink.

Control of a Vehicle

You have three systems that make your vehicle go where you want it to go. They are the brakes, the steering and the accelerator. All three systems have to do their work at the places where the tires meet the road.



Sometimes, as when you're driving on snow or ice, it's easy to ask more of those control systems than the tires and road can provide. That means you can lose control of your vehicle.

Braking

Braking action involves *perception time* and *reaction time*.

First, you have to decide to push on the brake pedal. That's *perception time*. Then you have to bring up your foot and do it. That's *reaction time*.

Average *reaction time* is about 3/4 of a second. But that's only an average. It might be less with one driver and as long as two or three seconds or more with another. Age, physical condition, alertness, coordination and eyesight all play a part. So do alcohol, drugs and frustration. But even in 3/4 of a second, a vehicle moving at 60 mph (100 km/h) travels 66 feet (20 m). That could be a lot of distance in an emergency, so keeping enough space between your vehicle and others is important.

And, of course, actual stopping distances vary greatly with the surface of the road (whether it's pavement or gravel); the condition of the road (wet, dry, icy); tire tread; and the condition of your brakes.

Avoid needless heavy braking. Some people drive in spurts -- heavy acceleration followed by heavy braking -- rather than keeping pace with traffic. This is a mistake. Your brakes may not have time to cool between hard stops. Your brakes will wear out much faster if you do a lot of heavy braking. If you keep pace with the traffic and allow realistic following distances, you will eliminate a lot of unnecessary braking. That means better braking and longer brake life.

If your engine ever stops while you're driving, brake normally but don't pump your brakes. If you do, the pedal may get harder to push down. If your engine stops, you will still have some power brake assist. But you will use it when you brake. Once the power assist is used up, it may take longer to stop and the brake pedal will be harder to push.

Anti-Lock Brakes

Your vehicle has anti-lock brakes (ABS). ABS is an advanced electronic braking system that will help prevent a braking skid.

When you start your engine, or when you begin to drive away, your anti-lock brake system will check itself. You may hear a momentary motor or clicking noise while this test is going on, and you may even notice that your brake pedal moves a little. (You may also hear a clicking noise if you leave the ignition in the RUN position for about four seconds before starting the vehicle.) This is normal.

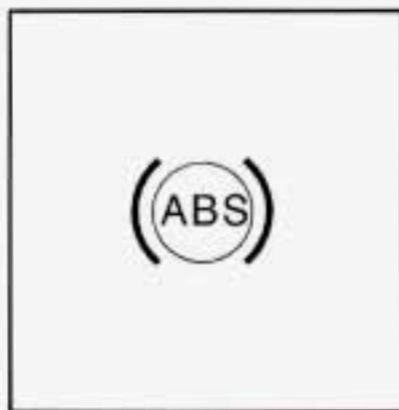

If there's a problem with the anti-lock brake system, this warning light will stay on or flash. See "Anti-Lock Brake System Warning Light" in the Index.



Here's how anti-lock works. Let's say the road is wet. You're driving safely. Suddenly an animal jumps out in front of you.

You slam on the brakes. Here's what happens with ABS. A computer senses that wheels are slowing down. If one of the wheels is about to stop rolling, the computer will separately work the brakes at each front wheel and at the rear wheels.

The anti-lock system can change the brake pressure faster than any driver could. The computer is programmed to make the most of available tire and road conditions.



You can steer around the obstacle while braking hard. As you brake, your computer keeps receiving updates on wheel speed and controls braking pressure accordingly.

Remember: Anti-lock doesn't change the time you need to get your foot up to the brake pedal or always decrease stopping distance. If you get too close to the vehicle in front of you, you won't have time to apply your brakes if that vehicle suddenly slows or stops. Always leave enough room up ahead to stop, even though you have anti-lock brakes.

Using Anti-Lock

Don't pump the brakes. Just hold the brake pedal down and let anti-lock work for you. You may feel the system working, or you may notice some noise, but this is normal.

Braking in Emergencies

Use your anti-lock braking system when you need to. With anti-lock, you can steer and brake at the same time. In many emergencies, steering can help you more than even the very best braking.

Steering

Power Steering

If you lose power steering assist because the engine stops or the system is not functioning, you can steer but it will take much more effort.

Steering Tips

Driving on Curves

It's important to take curves at a reasonable speed.

A lot of the "driver lost control" accidents mentioned on the news happen on curves. Here's why:

Experienced driver or beginner, each of us is subject to the same laws of physics when driving on curves. The traction of the tires against the road surface makes it possible for the vehicle to change its path when you turn the front wheels. If there's no traction, inertia will keep the vehicle going in the same direction. If you've ever tried to steer a vehicle on wet ice, you'll understand this.

The traction you can get in a curve depends on the condition of your tires and the road surface, the angle at which the curve is banked, and your speed. While you're in a curve, speed is the one factor you can control.

Suppose you're steering through a sharp curve. Then you suddenly accelerate. Both control systems -- steering and acceleration -- have to do their work where the tires meet the road. Adding the sudden acceleration can demand too much of those places. You can lose control.

What should you do if this ever happens? Ease up on the accelerator pedal, steer the vehicle the way you want it to go, and slow down.

Speed limit signs near curves warn that you should adjust your speed. Of course, the posted speeds are based on good weather and road conditions. Under less favorable conditions you'll want to go slower.

If you need to reduce your speed as you approach a curve, do it before you enter the curve, while your front wheels are straight ahead.

Try to adjust your speed so you can "drive" through the curve. Maintain a reasonable, steady speed. Wait to accelerate until you are out of the curve, and then accelerate gently into the straightaway.

Steering in Emergencies

There are times when steering can be more effective than braking. For example, you come over a hill and find a truck stopped in your lane, or a car suddenly pulls out from nowhere, or a child darts out from between parked cars and stops right in front of you. You can avoid these problems by braking -- if you can stop in time. But sometimes you can't; there isn't room. That's the time for evasive action -- steering around the problem.

Your Oldsmobile can perform very well in emergencies like these. First apply your brakes. (See "Braking in Emergencies" earlier in this section.) It is better to remove as much speed as you can from a possible collision. Then steer around the problem, to the left or right depending on the space available.



An emergency like this requires close attention and a quick decision. If you are holding the steering wheel at the recommended 9 and 3 o'clock positions, you can turn it a full 180 degrees very quickly without removing either hand. But you have to act fast, steer quickly, and just as quickly straighten the wheel once you have avoided the object.

The fact that such emergency situations are always possible is a good reason to practice defensive driving at all times and wear safety belts properly.

Off-Road Recovery

You may find sometime that your right wheels have dropped off the edge of a road onto the shoulder while you're driving.

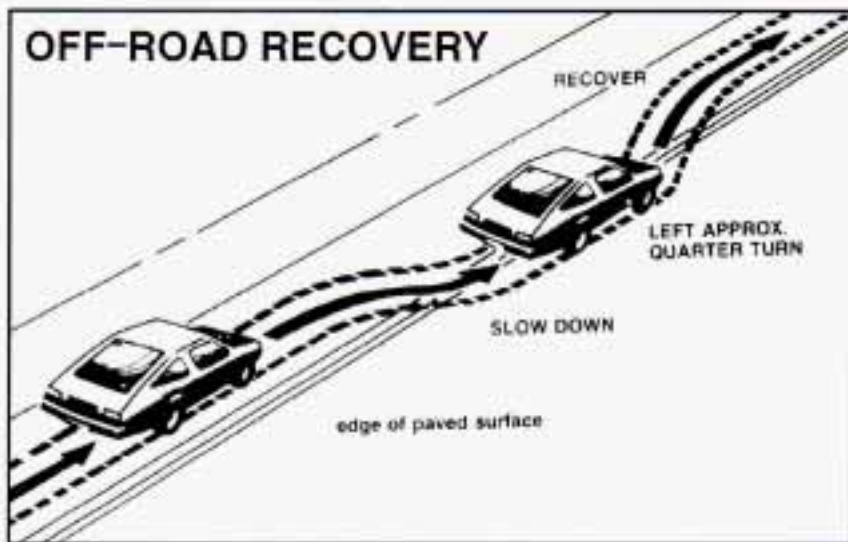

If the level of the shoulder is only slightly below the pavement, recovery should be fairly easy. Ease off the accelerator and then, if there is nothing in the way, steer so that your vehicle straddles the edge of the pavement. You can turn the steering wheel up to one-quarter turn until the right front tire contacts the pavement edge. Then turn your steering wheel to go straight down the roadway.

Passing

The driver of a vehicle about to pass another on a two-lane highway waits for just the right moment, accelerates, moves around the vehicle ahead, then goes back into the right lane again. A simple maneuver?

Not necessarily! Passing another vehicle on a two-lane highway is a potentially dangerous move, since the passing vehicle occupies the same lane as oncoming traffic for several seconds. A miscalculation, an error in judgment, or a brief surrender to frustration or anger can suddenly put the passing driver face to face with the worst of all traffic accidents -- the head-on collision.

So here are some tips for passing:

- “Drive ahead.” Look down the road, to the sides and to crossroads for situations that might affect your passing patterns. If you have any doubt whatsoever about making a successful pass, wait for a better time.
- Watch for traffic signs, pavement markings and lines. If you can see a sign up ahead that might indicate a turn or an intersection, delay your pass. A broken center line usually indicates it’s all right to pass (providing the road ahead is clear). Never cross a solid line on your side of the lane or a double solid line, even if the road seems empty of approaching traffic.
- Do not get too close to the vehicle you want to pass while you’re awaiting an opportunity. For one thing, following too closely reduces your area of vision, especially if you’re following a larger vehicle. Also, you won’t have adequate space if the vehicle ahead suddenly slows or stops. Keep back a reasonable distance.
- When it looks like a chance to pass is coming up, start to accelerate but stay in the right lane and don’t get too close. Time your move so you will be increasing speed as the time comes to move into the other lane. If the way is clear to pass, you will have a “running start” that more than makes up for the distance you would lose by dropping back. And if something happens to cause you to cancel your pass, you need only slow down and drop back again and wait for another opportunity.
- If other cars are lined up to pass a slow vehicle, wait your turn. But take care that someone isn’t trying to pass you as you pull out to pass the slow vehicle. Remember to glance over your shoulder and check the blind spot.

- Check your mirrors, glance over your shoulder and start your left lane change signal before moving out of the right lane to pass. When you are far enough ahead of the passed vehicle to see its front in your inside mirror, activate your right lane change signal and move back into the right lane. (Remember that your right outside mirror is convex. The vehicle you just passed may seem to be farther away from you than it really is.)
- Try not to pass more than one vehicle at a time on two-lane roads. Reconsider before passing the next vehicle.
- Don't overtake a slowly moving vehicle too rapidly. Even though the brake lamps are not flashing, it may be slowing down or starting to turn.
- If you're being passed, make it easy for the following driver to get ahead of you. Perhaps you can ease a little to the right.

Loss of Control

Let's review what driving experts say about what happens when the three control systems (brakes, steering and acceleration) don't have enough friction where the tires meet the road to do what the driver has asked.

In any emergency, don't give up. Keep trying to steer and constantly seek an escape route or area of less danger.

Skidding

In a skid, a driver can lose control of the vehicle. Defensive drivers avoid most skids by taking reasonable care suited to existing conditions, and by not "overdriving" those conditions. But skids are always possible.

The three types of skids correspond to your Oldsmobile's three control systems. In the braking skid, your wheels aren't rolling. In the steering or cornering skid, too much speed or steering in a curve causes tires to slip and lose cornering force. And in the acceleration skid, too much throttle causes the driving wheels to spin.

A cornering skid and an acceleration skid are best handled by easing your foot off the accelerator pedal.

If your vehicle starts to slide, ease your foot off the accelerator pedal and quickly steer the way you want the vehicle to go. If you start steering quickly enough, your vehicle may straighten out. Always be ready for a second skid if it occurs.

Of course, traction is reduced when water, snow, ice, gravel or other material is on the road. For safety, you'll want to slow down and adjust your driving to these conditions. It is important to slow down on slippery surfaces because stopping distance will be longer and vehicle control more limited.

While driving on a surface with reduced traction, try your best to avoid sudden steering, acceleration or braking (including engine braking by shifting to a lower gear). Any sudden changes could cause the tires to slide. You may not realize the surface is slippery until your vehicle is skidding. Learn to recognize warning clues -- such as enough water, ice or packed snow on the road to make a "mirrored surface" -- and slow down when you have any doubt.

Remember: Any anti-lock brake system (ABS) helps avoid only the braking skid.

Driving at Night



Night driving is more dangerous than day driving. One reason is that some drivers are likely to be impaired -- by alcohol or drugs, with night vision problems, or by fatigue.

Here are some tips on night driving.

- Drive defensively.
- Don't drink and drive.
- Adjust your inside rearview mirror to reduce the glare from headlamps behind you.
- Since you can't see as well, you may need to slow down and keep more space between you and other vehicles.
- Slow down, especially on higher speed roads. Your headlamps can light up only so much road ahead.
- In remote areas, watch for animals.
- If you're tired, pull off the road in a safe place and rest.

Night Vision

No one can see as well at night as in the daytime. But as we get older these differences increase. A 50-year-old driver may require at least twice as much light to see the same thing at night as a 20-year-old.

What you do in the daytime can also affect your night vision. For example, if you spend the day in bright sunshine you are wise to wear sunglasses. Your eyes will have less trouble adjusting to night. But if you're driving, don't wear sunglasses at night. They may cut

down on glare from headlamps, but they also make a lot of things invisible.

You can be temporarily blinded by approaching headlamps. It can take a second or two, or even several seconds, for your eyes to readjust to the dark. When you are faced with severe glare (as from a driver who doesn't lower the high beams, or a vehicle with misaimed headlamps), slow down a little. Avoid staring directly into the approaching headlamps.

Keep your windshield and all the glass on your vehicle clean -- inside and out. Glare at night is made much worse by dirt on the glass. Even the inside of the glass can build up a film caused by dust. Dirty glass makes lights dazzle and flash more than clean glass would, making the pupils of your eyes contract repeatedly.

Remember that your headlamps light up far less of a roadway when you are in a turn or curve. Keep your eyes moving; that way, it's easier to pick out dimly lighted objects. Just as your headlamps should be checked regularly for proper aim, so should your eyes be examined regularly. Some drivers suffer from night blindness -- the inability to see in dim light -- and aren't even aware of it.

Driving in Rain and on Wet Roads



Rain and wet roads can mean driving trouble. On a wet road, you can't stop, accelerate or turn as well because your tire-to-road traction isn't as good as on dry roads. And, if your tires don't have much tread left, you'll get even less traction. It's always wise to go slower and be cautious if rain starts to fall while you are driving. The surface may get wet suddenly when your reflexes are tuned for driving on dry pavement.

The heavier the rain, the harder it is to see. Even if your windshield wiper blades are in good shape, a heavy rain can make it harder to see road signs and traffic signals, pavement markings, the edge of the road and even people walking.

It's wise to keep your wiping equipment in good shape and keep your windshield washer tank filled with washer fluid. Replace your windshield wiper inserts when they show signs of streaking or missing areas on the windshield, or when strips of rubber start to separate from the inserts.



Driving too fast through large water puddles or even going through some car washes can cause problems, too. The water may affect your brakes. Try to avoid puddles. But if you can't, try to slow down before you hit them.



CAUTION:

Wet brakes can cause accidents. They won't work well in a quick stop and may cause pulling to one side. You could lose control of the vehicle.

After driving through a large puddle of water or a car wash, apply your brake pedal lightly until your brakes work normally.

Hydroplaning

Hydroplaning is dangerous. So much water can build up under your tires that they can actually ride on the water. This can happen if the road is wet enough and you're going fast enough. When your vehicle is hydroplaning, it has little or no contact with the road.

Hydroplaning doesn't happen often. But it can if your tires haven't much tread or if the pressure in one or more is low. It can happen if a lot of water is standing on the road. If you can see reflections from trees, telephone poles or other vehicles, and raindrops "dimple" the water's surface, there could be hydroplaning.

Hydroplaning usually happens at higher speeds. There just isn't a hard and fast rule about hydroplaning. The best advice is to slow down when it is raining.

Driving Through Deep Standing Water

NOTICE:

If you drive too quickly through deep puddles or standing water, water can come in through your engine's air intake and badly damage your engine. Never drive through water that is slightly lower than the underbody of your vehicle. If you can't avoid deep puddles or standing water, drive through them very slowly.

Some Other Rainy Weather Tips

- Turn on your low-beam headlamps -- not just your parking lamps -- to help make you more visible to others.
- Besides slowing down, allow some extra following distance. And be especially careful when you pass another vehicle. Allow yourself more clear room ahead, and be prepared to have your view restricted by road spray.
- Have good tires with proper tread depth. (See "Tires" in the Index.)

City Driving



One of the biggest problems with city streets is the amount of traffic on them. You'll want to watch out for what the other drivers are doing and pay attention to traffic signals.

Here are ways to increase your safety in city driving:

- Know the best way to get to where you are going. Get a city map and plan your trip into an unknown part of the city just as you would for a cross-country trip.
- Try to use the freeways that rim and crisscross most large cities. You'll save time and energy. (See the next part, "Freeway Driving.")
- Treat a green light as a warning signal. A traffic light is there because the corner is busy enough to need it. When a light turns green, and just before you start to move, check both ways for vehicles that have not cleared the intersection or may be running the red light.

Freeway Driving

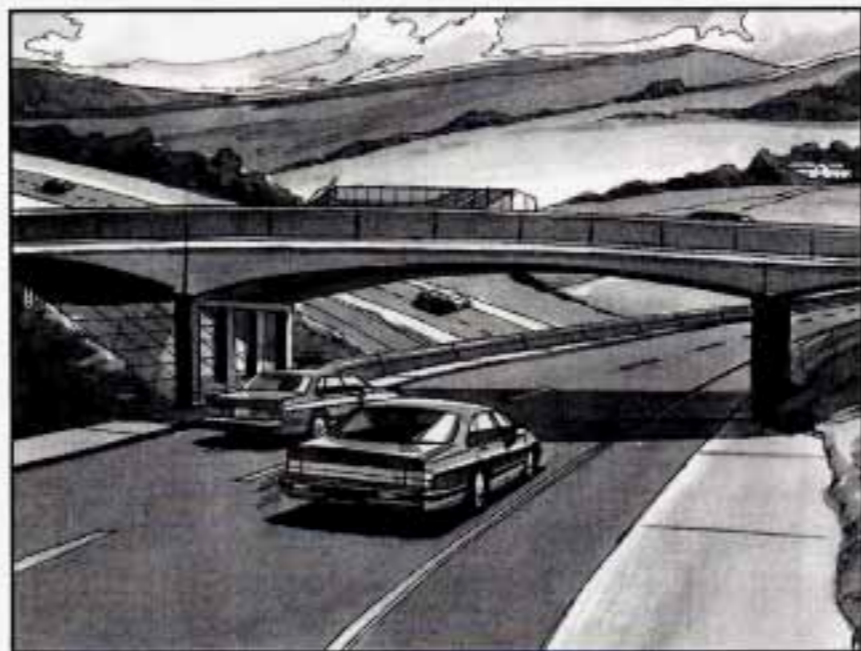

Mile for mile, freeways (also called thruways, parkways, expressways, turnpikes or superhighways) are the safest of all roads. But they have their own special rules.

The most important advice on freeway driving is: Keep up with traffic and keep to the right. Drive at the same speed most of the other drivers are driving. Too-fast or too-slow driving breaks a smooth traffic flow. Treat the left lane on a freeway as a passing lane.

At the entrance, there is usually a ramp that leads to the freeway. If you have a clear view of the freeway as you drive along the entrance ramp, you should begin to check traffic. Try to determine where you expect to blend with the flow. Try to merge into the gap at close to the prevailing speed. Switch on your turn signal, check your mirrors and glance over your shoulder as often as necessary. Try to blend smoothly with the traffic flow.

Once you are on the freeway, adjust your speed to the posted limit or to the prevailing rate if it's slower. Stay in the right lane unless you want to pass.

Before changing lanes, check your mirrors. Then use your turn signal.

Just before you leave the lane, glance quickly over your shoulder to make sure there isn't another vehicle in your "blind" spot.

Once you are moving on the freeway, make certain you allow a reasonable following distance. Expect to move slightly slower at night.

When you want to leave the freeway, move to the proper lane well in advance. If you miss your exit, do not, under any circumstances, stop and back up. Drive on to the next exit.

The exit ramp can be curved, sometimes quite sharply.

The exit speed is usually posted.

Reduce your speed according to your speedometer, not to your sense of motion. After driving for any distance at higher speeds, you may tend to think you are going slower than you actually are.

Before Leaving on a Long Trip

Make sure you're ready. Try to be well rested. If you must start when you're not fresh -- such as after a day's work -- don't plan to make too many miles that first part of the journey. Wear comfortable clothing and shoes you can easily drive in.

Is your vehicle ready for a long trip? If you keep it serviced and maintained, it's ready to go. If it needs service, have it done before starting out. Of course, you'll find experienced and able service experts in Oldsmobile retail facilities all across North America. They'll be ready and willing to help if you need it.

Here are some things you can check before a trip:

- *Windshield Washer Fluid:* Is the reservoir full? Are all windows clean inside and outside?
- *Wiper Blades:* Are they in good shape?
- *Fuel, Engine Oil, Other Fluids:* Have you checked all levels?
- *Lamps:* Are they all working? Are the lenses clean?
- *Tires:* They are vitally important to a safe, trouble-free trip. Is the tread good enough for long-distance driving? Are the tires all inflated to the recommended pressure?
- *Weather Forecasts:* What's the weather outlook along your route? Should you delay your trip a short time to avoid a major storm system?
- *Maps:* Do you have up-to-date maps?

Highway Hypnosis

Is there actually such a condition as “highway hypnosis”? Or is it just plain falling asleep at the wheel? Call it highway hypnosis, lack of awareness, or whatever.

There is something about an easy stretch of road with the same scenery, along with the hum of the tires on the road, the drone of the engine, and the rush of the wind against the vehicle that can make you sleepy. Don't let it happen to you! If it does, your vehicle can leave the road in *less than a second*, and you could crash and be injured.

What can you do about highway hypnosis? First, be aware that it can happen.

Then here are some tips:

- Make sure your vehicle is well ventilated, with a comfortably cool interior.
- Keep your eyes moving. Scan the road ahead and to the sides. Check your mirrors and your instruments frequently.
- If you get sleepy, pull off the road into a rest, service or parking area and take a nap, get some exercise, or both. For safety, treat drowsiness on the highway as an emergency.

Hill and Mountain Roads



Driving on steep hills or mountains is different from driving in flat or rolling terrain.

If you drive regularly in steep country, or if you're planning to visit there, here are some tips that can make your trips safer and more enjoyable.

- Keep your vehicle in good shape. Check all fluid levels and also the brakes, tires, cooling system and transaxle. These parts can work hard on mountain roads.
- Know how to go down hills. The most important thing to know is this: let your engine do some of the slowing down. Shift to a lower gear when you go down a steep or long hill.

 **CAUTION:**

If you don't shift down, your brakes could get so hot that they wouldn't work well. You would then have poor braking or even none going down a hill. You could crash. Shift down to let your engine assist your brakes on a steep downhill slope.

 **CAUTION:**

Coasting downhill in NEUTRAL (N) or with the ignition off is dangerous. Your brakes will have to do all the work of slowing down. They could get so hot that they wouldn't work well. You would then have poor braking or even none going down a hill. You could crash. Always have your engine running and your vehicle in gear when you go downhill.

- Know how to go uphill. You may want to shift down to a lower gear. The lower gears help cool your engine and transaxle, and you can climb the hill better.
- Stay in your own lane when driving on two-lane roads in hills or mountains. Don't swing wide or cut across the center of the road. Drive at speeds that let you stay in your own lane.
- As you go over the top of a hill, be alert. There could be something in your lane, like a stalled car or an accident.
- You may see highway signs on mountains that warn of special problems. Examples are long grades, passing or no-passing zones, a falling rocks area or winding roads. Be alert to these and take appropriate action.

Winter Driving



Here are some tips for winter driving:

- Have your Oldsmobile in good shape for winter.
- You may want to put winter emergency supplies in your vehicle.

Include an ice scraper, a small brush or broom, a supply of windshield washer fluid, a rag, some winter outer clothing, a small shovel, a flashlight, a red cloth and a couple of reflective warning triangles. And, if you will be driving under severe conditions, include a small bag of sand, a piece of old carpet or a couple of burlap bags to help provide traction. Be sure you properly secure these items in your vehicle.

Driving on Snow or Ice

Most of the time, those places where your tires meet the road probably have good traction.

However, if there is snow or ice between your tires and the road, you can have a very slippery situation. You'll have a lot less traction or "grip" and will need to be very careful.



What's the worst time for this? "Wet ice." Very cold snow or ice can be slick and hard to drive on. But wet ice can be even more trouble because it may offer the least traction of all. You can get wet ice when it's about freezing (32°F; 0°C) and freezing rain begins to fall. Try to avoid driving on wet ice until salt and sand crews can get there.

Whatever the condition -- smooth ice, packed, blowing or loose snow -- drive with caution.

Accelerate gently. Try not to break the fragile traction. If you accelerate too fast, the drive wheels will spin and polish the surface under the tires even more.

Your anti-lock brakes improve your vehicle's stability when you make a hard stop on a slippery road. Even though you have an anti-lock braking system, you'll want to begin stopping sooner than you would on dry pavement. See "Anti-Lock" in the Index.

- Allow greater following distance on any slippery road.
- Watch for slippery spots. The road might be fine until you hit a spot that's covered with ice. On an otherwise clear road, ice patches may appear in shaded areas where the sun can't reach: around clumps of trees, behind buildings or under bridges. Sometimes the surface of a curve or an overpass may remain icy when the surrounding roads are clear. If you see a patch of ice ahead of you, brake before you are on it. Try not to brake while you're actually on the ice, and avoid sudden steering maneuvers.

If You're Caught in a Blizzard



If you are stopped by heavy snow, you could be in a serious situation. You should probably stay with your vehicle unless you know for sure that you are near help and you can hike through the snow. Here are some things to do to summon help and keep yourself and your passengers safe:

- Turn on your hazard flashers.

- Tie a red cloth to your vehicle to alert police that you've been stopped by the snow.
- Put on extra clothing or wrap a blanket around you. If you have no blankets or extra clothing, make body insulators from newspapers, burlap bags, rags, floor mats -- anything you can wrap around yourself or tuck under your clothing to keep warm.



You can run the engine to keep warm, but be careful.

 **CAUTION:**

Snow can trap exhaust gases under your vehicle. This can cause deadly CO (carbon monoxide) gas to get inside. CO could overcome you and kill you. You can't see it or smell it, so you might not know it is in your vehicle. Clear away snow from around the base of your vehicle, especially any that is blocking your exhaust pipe. And check around again from time to time to be sure snow doesn't collect there.

Open a window just a little on the side of the vehicle that's away from the wind. This will help keep CO out.

Run your engine only as long as you must. This saves fuel. When you run the engine, make it go a little faster than just idle. That is, push the accelerator slightly. This uses less fuel for the heat that you get and it keeps the battery charged. You will need a well-charged battery to restart the vehicle, and possibly for signaling later on with your headlamps. Let the heater run for awhile.

Then, shut the engine off and close the window almost all the way to preserve the heat. Start the engine again and repeat this only when you feel really uncomfortable from the cold. But do it as little as possible. Preserve the fuel as long as you can. To help keep warm, you can get out of the vehicle and do some fairly vigorous exercises every half hour or so until help comes.

Loading Your Vehicle

				
MFD BY GENERAL MOTORS CORP XX/XX				
GVWR	GAWR FRT	GAWR RR		LB/KG
THIS VEHICLE CONFORMS TO ALL APPLICABLE U.S. FEDERAL MOTOR VEHICLE SAFETY STANDARDS IN EFFECT ON THE DATE OF MANUFACTURE SHOWN ABOVE.				
SERIAL NUMBER		M.P.V.		
MODEL:		SPEED		
MPBY	TIRE SIZE	RTG	RIM	PSI/KPA (COLD)
FRT				
RR				
SPA				
SEE OWNERS MANUAL FOR ADDITIONAL INFORMATION				

The Certification/Tire label is found on the rear edge of the driver's door.

The label shows the size of your original tires and the inflation pressures needed to obtain the gross weight capacity of your vehicle. This is called the GVWR (Gross Vehicle Weight Rating). The GVWR includes the weight of the vehicle, all occupants, fuel and cargo.

The Certification/Tire label also tells you the maximum weights for the front and rear axles, called the Gross Axle Weight Rating (GAWR). To find out the actual loads on your front and rear axles, you need to go to a weigh station and weigh your vehicle. Your retailer can help you with this. Be sure to spread out your load equally on both sides of the centerline.

Never exceed the GVWR for your vehicle, or the Gross Axle Weight Rating (GAWR) for either the front or rear axle.

Electronic Level Control (Option)

On vehicles equipped with the optional electronic level control, the rear of the vehicle is automatically kept level as you load or unload your vehicle. However, you should still not exceed the GVWR or the GAWR.

You may hear the compressor operating when you load or unload your vehicle, and periodically as the system self-adjusts. This is normal.

The compressor should operate for brief periods of time. If the sound continues for an extended period of time, your vehicle needs service. To keep your battery from being drained, you may want to remove the ELC fuse in the fuse control panel until you can have your vehicle serviced (see “Fuses and Circuit Breakers” in the Index.)

Using heavier suspension components to get added durability might not change your weight ratings. Ask your retailer to help you load your vehicle the right way.

CAUTION:

Do not load your vehicle any heavier than the GVWR, or either the maximum front or rear GAWR. If you do, parts on your vehicle can break, or it can change the way your vehicle handles. These could cause you to lose control. Also, overloading can shorten the life of your vehicle.

NOTICE:

Your warranty does not cover parts or components that fail because of overloading.

If you put things inside your vehicle -- like suitcases, tools, packages, or anything else -- they will go as fast as the vehicle goes. If you have to stop or turn quickly, or if there is a crash, they'll keep going.

CAUTION:

Things you put inside your vehicle can strike and injure people in a sudden stop or turn, or in a crash.

- Put things in the cargo area of your vehicle. Try to spread the weight evenly.
- Never stack heavier things, like suitcases, inside the vehicle so that some of them are above the tops of the seats.
- Don't leave an unsecured child restraint in your vehicle.
- When you carry something inside the vehicle, secure it whenever you can.
- Don't leave a seat folded down unless you need to.

Towing a Trailer

CAUTION:

If you don't use the correct equipment and drive properly, you can lose control when you pull a trailer. For example, if the trailer is too heavy, the brakes may not work well -- or even at all. You and your passengers could be seriously injured. Pull a trailer only if you have followed all the steps in this section. Ask your Oldsmobile retailer for advice and information about towing a trailer with your vehicle.

NOTICE:

Pulling a trailer improperly can damage your vehicle and result in costly repairs not covered by your warranty. To pull a trailer correctly, follow the advice in this part, and see your Oldsmobile retailer for important information about towing a trailer with your vehicle.

Your vehicle can tow a trailer. To identify what the vehicle trailering capacity is for your vehicle, you should read the information in “Weight of the Trailer” that appears later in this section. But trailering is different than just driving your vehicle by itself. Trailering means changes in handling, durability and fuel economy. Successful, safe trailering takes correct equipment, and it has to be used properly.

That’s the reason for this section. In it are many time-tested, important trailering tips and safety rules. Many of these are important for your safety and that of your passengers. So please read this section carefully before you pull a trailer.

Load-pulling components such as the engine, transaxle, wheel assemblies and tires are forced to work harder against the drag of the added weight. The engine is required to operate at relatively higher speeds and under greater loads, generating extra heat. What’s more, the trailer adds considerably to wind resistance, increasing the pulling requirements.

If You Do Decide To Pull A Trailer

If you do, here are some important points:

- There are many different laws, including speed limit restrictions, having to do with trailering. Make sure your rig will be legal, not only where you live but also where you’ll be driving. A good source for this information can be state or provincial police.
- Consider using a sway control if your trailer will weigh 2,000 lbs. (900 kg) or less. You should always use a sway control if your trailer will weigh more than 2,000 lbs. (900 kg). You can ask a hitch dealer about sway controls.
- Don’t tow a trailer at all during the first 500 miles (800 km) your new vehicle is driven. Your engine, axle or other parts could be damaged.
- Then, during the first 500 miles (800 km) that you tow a trailer, don’t drive over 50 mph (80 km/h) and don’t make starts at full throttle. This helps your engine and other parts of your vehicle wear in at the heavier loads.
- You should use THIRD (D) (or, as you need to, a lower gear) when towing a trailer. Operating your vehicle in THIRD (D) when towing a trailer will minimize heat buildup and extend the life of your transaxle.

Three important considerations have to do with weight: the weight of the trailer, the weight of the trailer tongue and the weight on your vehicle's tires.

Weight of the Trailer

How heavy can a trailer safely be?

It should never weigh more than 1,400 lbs. (630 kg) with up to six occupants or more than 2,000 lbs. (900 kg) with up to two occupants. If you have the optional trailer towing package, your vehicle can tow up to 2,400 lbs. (1 090 kg) with up to six occupants or up to 3,000 lbs. (1 360 kg) with up to two occupants. But even that can be too heavy.

It depends on how you plan to use your rig. For example, speed, altitude, road grades, outside temperature and how much your vehicle is used to pull a trailer are all important. And, it can also depend on any special equipment that you have on your vehicle.

You can ask your retailer for our trailering information or advice, or you can write us at:

Oldsmobile Customer Assistance
P.O. Box 30095
Lansing, MI 48909

In Canada, write to:

General Motors of Canada Limited
Customer Communication Centre
1908 Colonel Sam Drive
Oshawa, Ontario L1H 8P7

Weight of the Trailer Tongue

The tongue load (A) of any trailer is an important weight to measure because it affects the total or gross weight of your vehicle. The Gross Vehicle Weight (GVW) includes the curb weight of the vehicle, any cargo you may carry in it, and the people who will be riding in the vehicle. And if you will tow a trailer, you must add the tongue load to the GVW because your vehicle will be carrying that weight, too. See “Loading Your Vehicle” in the Index for more information about your vehicle’s maximum load capacity.

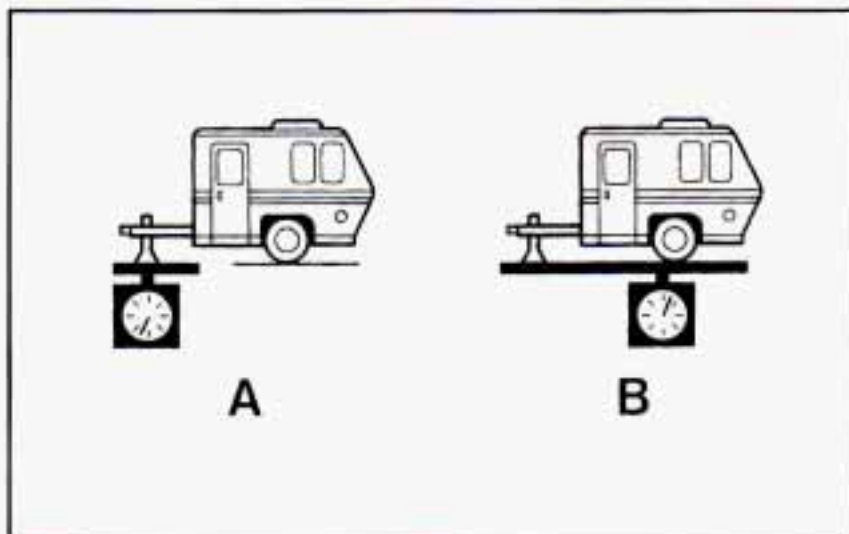

If you're using a weight-carrying hitch, the trailer tongue (A) should weigh 10 percent of the total loaded trailer weight (B). If you're using a weight-distributing hitch, the trailer tongue (A) should weigh 12 percent of the total loaded trailer weight (B).

After you've loaded your trailer, weigh the trailer and then the tongue, separately, to see if the weights are proper. If they aren't, you may be able to get them right simply by moving some items around in the trailer.

Total Weight on Your Vehicle's Tires

Be sure your vehicle's tires are inflated to the limit for cold tires. You'll find these numbers on the Certification/Tire label at the rear edge of the driver's door or see “Tire Loading” in the Index. Then be sure you don't go over the GVW limit for your vehicle, including the weight of the trailer tongue.

Hitches

It's important to have the correct hitch equipment. Crosswinds, large trucks going by and rough roads are a few reasons why you'll need the right hitch. Here are some rules to follow:

- The bumpers on your vehicle are not intended for hitches. Do not attach rental hitches or other bumper-type hitches to them. Use only a frame-mounted hitch that does not attach to the bumper.
- If you'll be pulling a trailer that, when loaded, will weigh more than 2,000 lbs. (900 kg), be sure to use a properly mounted, weight-distributing hitch and sway control of the proper size. This equipment is very important for proper vehicle loading and good handling when you're driving.
- Will you have to make any holes in the body of your vehicle when you install a trailer hitch?

If you do, then be sure to seal the holes later when you remove the hitch. If you don't seal them, deadly carbon monoxide (CO) from your exhaust can get into your vehicle (see "Carbon Monoxide" in the Index). Dirt and water can, too.

Safety Chains

You should always attach chains between your vehicle and your trailer. Cross the safety chains under the tongue of the trailer so that the tongue will not drop to the road if it becomes separated from the hitch. Instructions about safety chains may be provided by the hitch manufacturer or by the trailer manufacturer. Follow the manufacturer's recommendation for attaching safety chains and do not attach them to the bumper. Always leave just enough slack so you can turn with your rig. And, never allow safety chains to drag on the ground.

Trailer Brakes

If your trailer weighs more than 1,000 lbs. (450 kg) loaded, then it needs its own brakes -- and they must be adequate. Be sure to read and follow the instructions for the trailer brakes so you'll be able to install, adjust and maintain them properly.

Because you have anti-lock brakes, do not try to tap into your vehicle's brake system. If you do, both brake systems won't work well, or at all.

CAUTION:

If you have a rear-most window open and you pull a trailer with your vehicle, carbon monoxide (CO) could come into your vehicle. You can't see or smell CO. It can cause unconsciousness or death. (See "Engine Exhaust" in the Index.) To maximize your safety when towing a trailer:

- Have your exhaust system inspected for leaks, and make necessary repairs before starting on your trip.
- Keep the rear-most windows closed.
- If exhaust does come into your vehicle through a window in the rear or another opening, drive with your front, main heating or cooling system on and with the fan on any speed. This will bring fresh, outside air into your vehicle. Do not use RECIRC because it only recirculates the air inside your vehicle. (See "Comfort Controls" in the Index.)

Towing a trailer requires a certain amount of experience. Before setting out for the open road, you'll want to get to know your rig. Acquaint yourself with the feel of handling and braking with the added weight of the trailer. And always keep in mind that the vehicle you are driving is now a good deal longer and not nearly as responsive as your vehicle is by itself.

Before you start, check the trailer hitch and platform (and attachments), safety chains, electrical connector, lamps, tires and mirror adjustment. If the trailer has electric brakes, start your vehicle and trailer moving and then apply the trailer brake controller by hand to be sure the brakes are working. This lets you check your electrical connection at the same time.

During your trip, check occasionally to be sure that the load is secure, and that the lamps and any trailer brakes are still working.

Following Distance

Stay at least twice as far behind the vehicle ahead as you would when driving your vehicle without a trailer. This can help you avoid situations that require heavy braking and sudden turns.

Passing

You'll need more passing distance up ahead when you're towing a trailer. And, because you're a good deal longer, you'll need to go much farther beyond the passed vehicle before you can return to your lane.

Backing Up

Hold the bottom of the steering wheel with one hand. Then, to move the trailer to the left, just move that hand to the left. To move the trailer to the right, move your hand to the right. Always back up slowly and, if possible, have someone guide you.

Making Turns

NOTICE:

Making very sharp turns while trailering could cause the trailer to come in contact with the vehicle. Your vehicle could be damaged. Avoid making very sharp turns while trailering.

When you're turning with a trailer, make wider turns than normal. Do this so your trailer won't strike soft shoulders, curbs, road signs, trees or other objects. Avoid jerky or sudden maneuvers. Signal well in advance.

Turn Signals When Towing a Trailer

When you tow a trailer, your vehicle has to have extra wiring and a different turn signal flasher (included in the optional trailering package).

The arrows on your instrument panel will flash whenever you signal a turn or lane change. Properly hooked up, the trailer lamps will also flash, telling other drivers you're about to turn, change lanes or stop.

When towing a trailer, the arrows on your instrument panel will flash for turns even if the bulbs on the trailer are burned out. Thus, you may think drivers behind you are seeing your signal when they are not. It's important to check occasionally to be sure the trailer bulbs are still working.

Driving On Grades

Reduce speed and shift to a lower gear *before* you start down a long or steep downgrade. If you don't shift down, you might have to use your brakes so much that they would get hot and no longer work well.

On a long uphill grade, shift down and reduce your speed to around 45 mph (70 km/h) to reduce the possibility of engine and transaxle overheating.

If you are towing a trailer that weighs more than 1,000 lbs. (454 kg), and you have an automatic transaxle with AUTOMATIC OVERDRIVE (Ⓢ), you may prefer to drive in THIRD (D) instead of AUTOMATIC OVERDRIVE (Ⓢ) (or, as you need to, a lower gear). This will minimize heat build-up and extend the life of your transaxle.

Parking on Hills

You really should not park your vehicle, with a trailer attached, on a hill. If something goes wrong, your rig could start to move. People can be injured, and both your vehicle and the trailer can be damaged.

But if you ever have to park your rig on a hill, here's how to do it:

1. Apply your regular brakes, but don't shift into PARK (P) yet.
2. Have someone place chocks under the trailer wheels.
3. When the wheel chocks are in place, release the regular brakes until the chocks absorb the load.
4. Reapply the regular brakes. Then apply your parking brake, and then shift to PARK (P).
5. Release the regular brakes.

When You Are Ready to Leave After Parking on a Hill

1. Apply your regular brakes and hold the pedal down while you:
 - Start your engine;
 - Shift into a gear; and
 - Release the parking brake.
2. Let up on the brake pedal.
3. Drive slowly until the trailer is clear of the chocks.
4. Stop and have someone pick up and store the chocks.

Maintenance When Trailer Towing

Your vehicle will need service more often when you're pulling a trailer. See the Maintenance Schedule for more on this. Things that are especially important in trailer operation are automatic transaxle fluid (don't overfill), engine oil, belts, cooling system and brake adjustment. Each of these is covered in this manual, and the Index will help you find them quickly. If you're trailering, it's a good idea to review these sections before you start your trip.

Check periodically to see that all hitch nuts and bolts are tight.



Section 5 Problems on the Road

Here you'll find what to do about some problems that can occur on the road.

Hazard Warning Flashers



Your hazard warning flashers let you warn others.

They also let police know you have a problem. Your front and rear turn signal lamps will flash on and off.

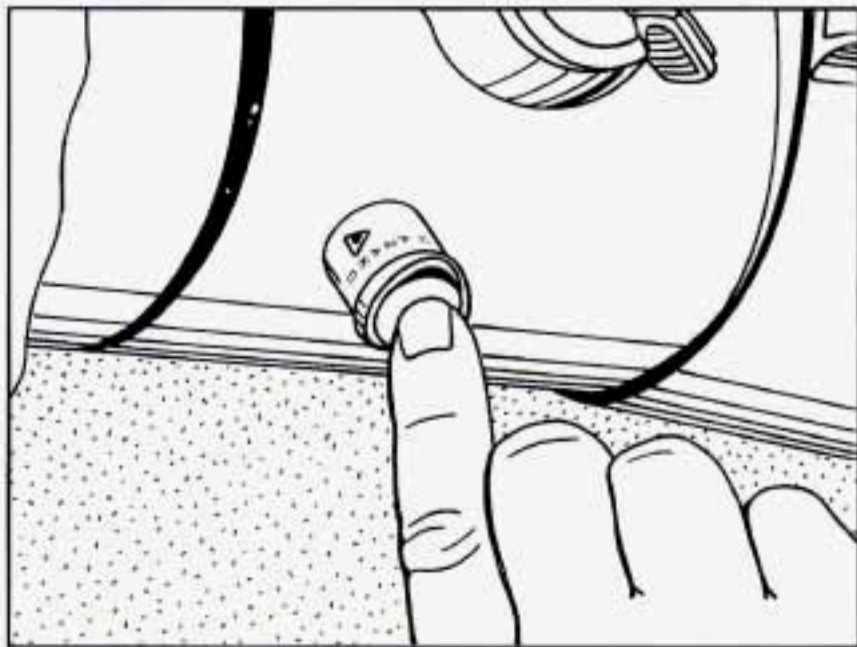

Your hazard warning flashers switch is on the steering column, below the ignition switch. Press the button in to turn on your flashers.

Your hazard warning flashers work no matter what position your key is in, and even if the key isn't in.

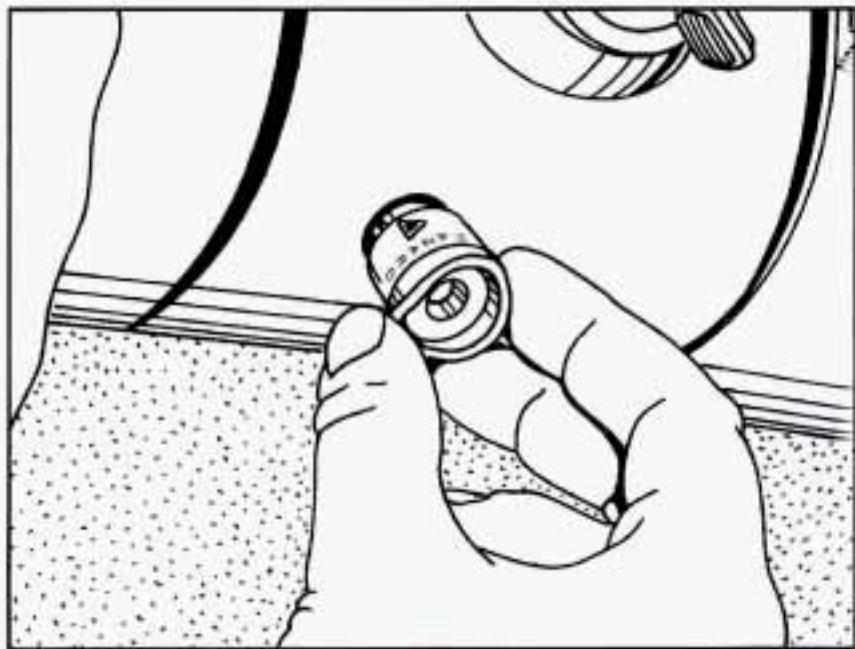

To turn off the flashers, pull out on the collar.

When the hazard warning flashers are on, your turn signals won't work.

Other Warning Devices

If you carry reflective triangles, you can set one up at the side of the road about 300 feet (100 m) behind your vehicle.

Jump Starting

If your battery has run down, you may want to use another vehicle and some jumper cables to start your Oldsmobile. But please use the following steps listed to do it safely.

On vehicles equipped with the optional power sliding door, a low voltage battery or replacing a battery may cause the system to become inoperative. See "Power Sliding Door" in the Index for more information.

NOTICE:

Ignoring these steps could result in costly damage to your vehicle that wouldn't be covered by your warranty. Trying to start your Oldsmobile by pushing or pulling it won't work, and it could damage your vehicle.

 **CAUTION:**

Batteries can hurt you. They can be dangerous because:

- They contain acid that can burn you.
- They contain gas that can explode or ignite.
- They contain enough electricity to burn you.

If you don't follow these steps exactly, some or all of these things can hurt you.

1. Check the other vehicle. It must have a 12-volt battery with a negative ground system.

NOTICE:

If the other system isn't a 12-volt system with a negative ground, both vehicles can be damaged.

2. Get the vehicles close enough so the jumper cables can reach, but be sure the vehicles aren't touching each other. If they are, it could cause a ground connection you don't want. You wouldn't be able to start your Oldsmobile, and the bad grounding could damage the electrical systems.

NOTICE:

You could be injured if the vehicles roll. Set the parking brake firmly on each vehicle. Put an automatic transaxle in PARK (P) or a manual transmission in NEUTRAL (N).

3. Turn off the ignition on both vehicles. Unplug unnecessary accessories plugged into the cigarette lighter or the accessory power outlet. Turn off all lamps that aren't needed as well as radios. This will avoid sparks and help save both batteries. In addition, it could save your radio!

NOTICE:

If you leave your radio on, it could be badly damaged. The repairs wouldn't be covered by your warranty.

4. Open the hoods and locate the batteries.

⚠ CAUTION:

An electric fan can start up even when the engine is not running and can injure you. Keep hands, clothing and tools away from any underhood electric fan.

5. Find the positive (+) and negative (-) terminals on each battery.

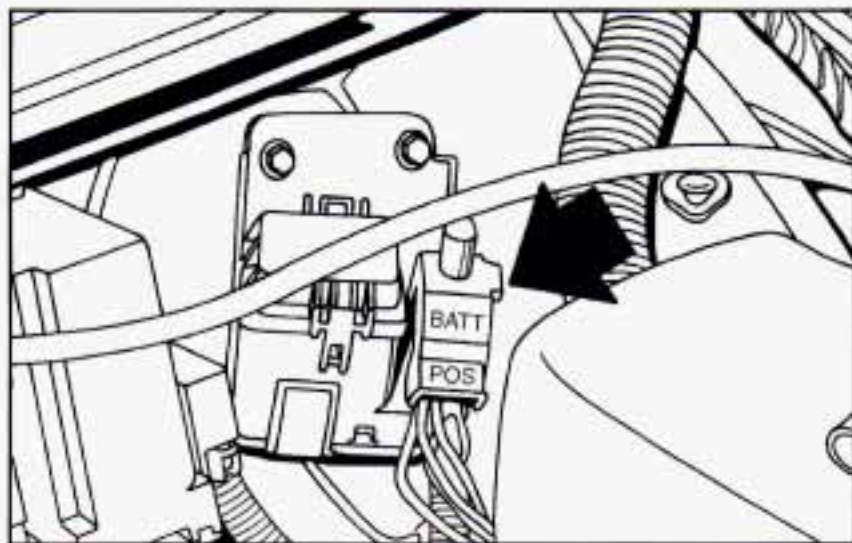

Your Oldsmobile has a remote positive (+) jump starting terminal. The terminal is in the red box on the same side of the engine compartment as your battery. You should always use the remote positive (+) terminal instead of the positive (+) terminal on your battery.

To open the remote positive (+) terminal box, pull the tab and open the cover.

 **CAUTION:**

Using a match near a battery can cause battery gas to explode. People have been hurt doing this, and some have been blinded. Use a flashlight if you need more light.

Be sure the battery has enough water. You don't need to add water to the Delco Freedom[®] battery (or batteries) installed in every new GM vehicle. But if a battery has filler caps, be sure the right amount of fluid is there. If it is low, add water to take care of that first. If you don't, explosive gas could be present.

Battery fluid contains acid that can burn you. Don't get it on you. If you accidentally get it in your eyes or on your skin, flush the place with water and get medical help immediately.

6. Check that the jumper cables don't have loose or missing insulation. If they do, you could get a shock. The vehicles could be damaged, too.

Before you connect the cables, here are some things you should know. Positive (+) will go to positive (+) and negative (-) will go to negative (-) or a metal engine part. Don't connect positive (+) to negative (-) or you'll get a short that would damage the battery and maybe other parts, too.

 **CAUTION:**

Fans or other moving engine parts can injure you badly. Keep your hands away from moving parts once the engines are running.

7. Connect the red positive (+) cable to the positive (+) terminal of the vehicle with the dead battery. Use a remote positive (+) terminal if the vehicle has one.



8. Don't let the other end touch metal. Connect it to the positive (+) terminal of the good battery. Use a remote positive (+) terminal if the vehicle has one.



9. Now connect the black negative (-) cable to the good battery's negative (-) terminal. Don't let the other end touch anything until the next step. The other end of the negative (-) cable *doesn't* go to the dead battery. It goes to a heavy unpainted metal part on the engine of the vehicle with the dead battery.



10. Attach the cable at least 18 inches (45 cm) away from the dead battery, but not near engine parts that move.

The electrical connection is just as good there, but the chance of sparks getting back to the battery is much less.

11. Now start the vehicle with the good battery and run the engine for a while.
12. Try to start the vehicle with the dead battery. If it won't start after a few tries, it probably needs service.

13. Remove the cables in reverse order to prevent electrical shorting. Take care that they don't touch each other or any other metal.

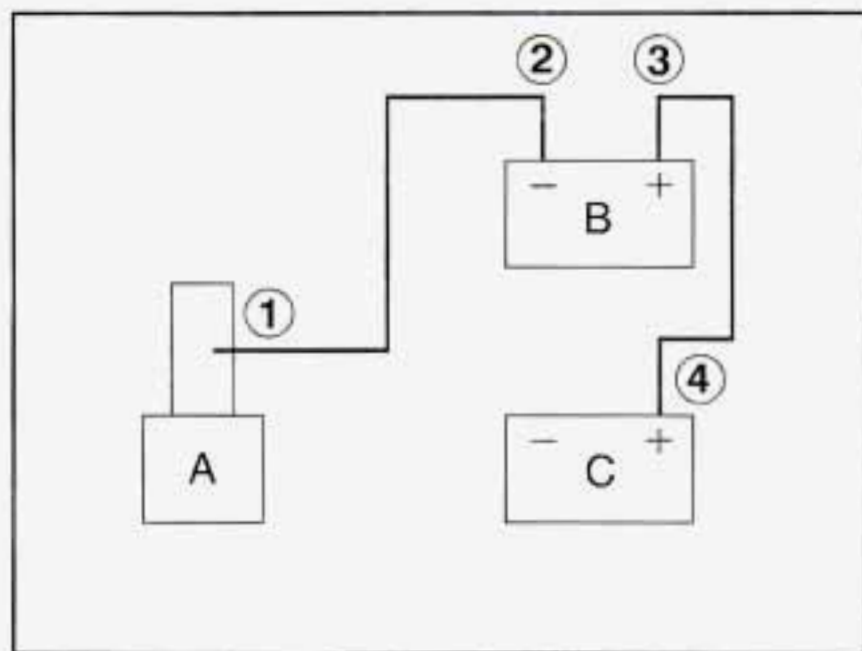

- A. Heavy Metal Engine Part
B. Good Battery
C. Dead Battery

Towing Your Vehicle

Try to have a GM retailer or a professional towing service tow your Silhouette. They can provide the right equipment and know how to tow your vehicle without damage. See "Roadside Assistance" in the Index.

If your vehicle has been changed or modified since it was factory-new by adding aftermarket items like fog lamps, aero skirting, or special tires and wheels, these instructions and illustrations may not be correct.

Before you do anything, turn on the hazard warning flashers.

When you call, tell the towing service:

- That your vehicle cannot be towed from the front with sling-type equipment.
- That your vehicle has front-wheel drive.
- The make, model, and year of your vehicle.
- Whether you can still move the shift lever.
- If there was an accident, what was damaged.

When the towing service arrives, let the tow operator know that this manual contains detailed towing instructions and illustrations. The operator may want to see them.



CAUTION:

To help avoid injury to you or others:

- Never let passengers ride in a vehicle that is being towed.
- Never tow faster than safe or posted speeds.
- Never tow with damaged parts not fully secured.
- Never get under your vehicle after it has been lifted by the tow truck.
- Always use separate safety chains on each side when towing a vehicle.
- Never use J-hooks. Use T-hooks instead.

When your vehicle is being towed, have the ignition key in the OFF position. The steering wheel should be clamped in a straight-ahead position, with a clamping device designed for towing service. Do not use the vehicle's steering column lock for this. The transaxle should be in NEUTRAL (N) and the parking brake released.

CAUTION:

A vehicle can fall from a car-carrier if it isn't adequately secured. This can cause a collision, serious personal injury and vehicle damage. The vehicle should be tightly secured with chains or steel cables before it is transported.

Don't use substitutes (ropes, leather straps, canvas webbing, etc.) that can be cut by sharp edges underneath the towed vehicle. Always use T-hooks inserted in the T-hook slots. Never use J-hooks. They will damage drivetrain and suspension components.

Front Towing

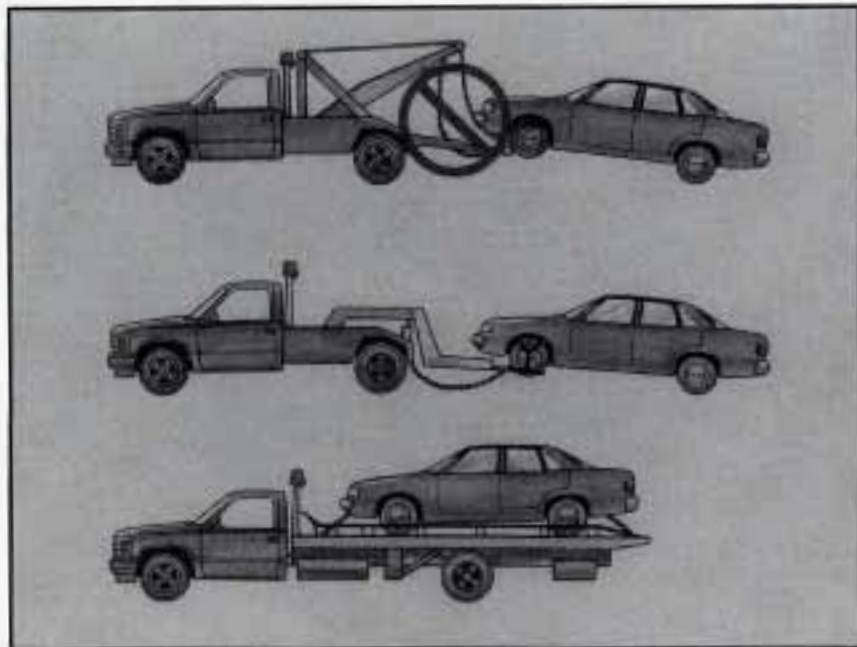

NOTICE:

Do not tow with sling-type equipment or fascia damage will occur. Use wheel-lift or car-carrier equipment. Additional ramping may be required for car-carrier equipment. Use safety chains and wheel straps.

Towing a vehicle over rough surfaces could damage a vehicle. Damage can occur from vehicle to ground or vehicle to wheel-lift equipment. To help avoid damage, install a towing dolly and raise the vehicle until adequate clearance is obtained between the ground and/or wheel-lift equipment.

Do not attach winch cables or J-hooks to suspension components when using car-carrier equipment. Always use T-hooks inserted in the T-hook slots.

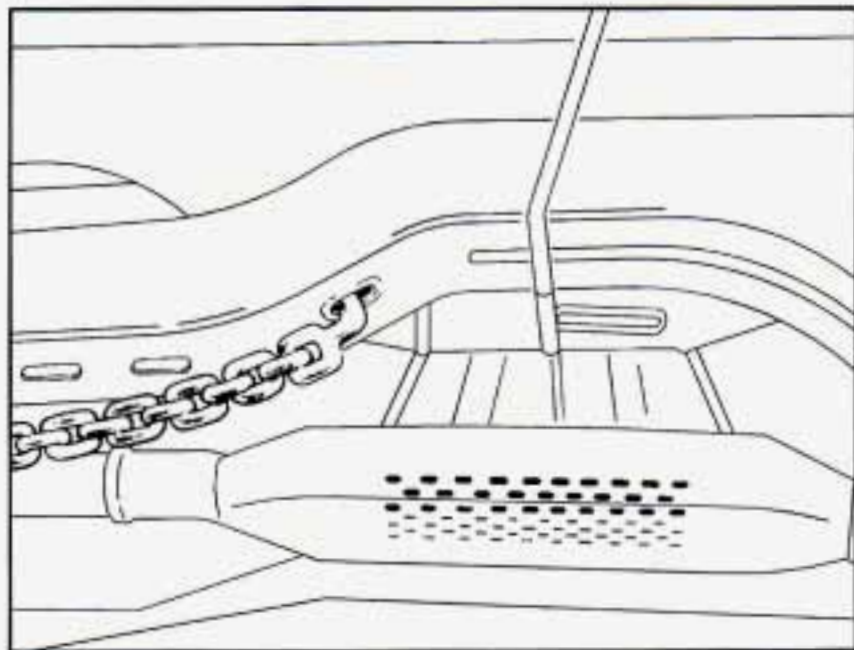

Attach T-hook chains on both sides, in the slotted holes in the bottom of the frame rails behind the front wheels.

These slots are to be used when loading and securing to car-carrier equipment.

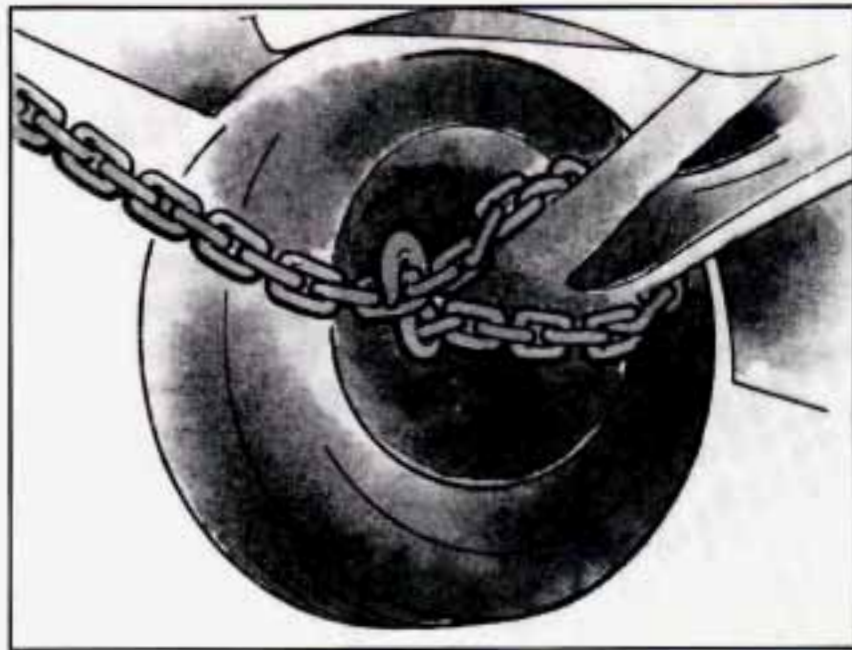

Attach a separate safety chain around the outboard end of each control arm.

Rear Towing

Tow Limits 55 mph (88 km/h) -- 500 miles (800 km)

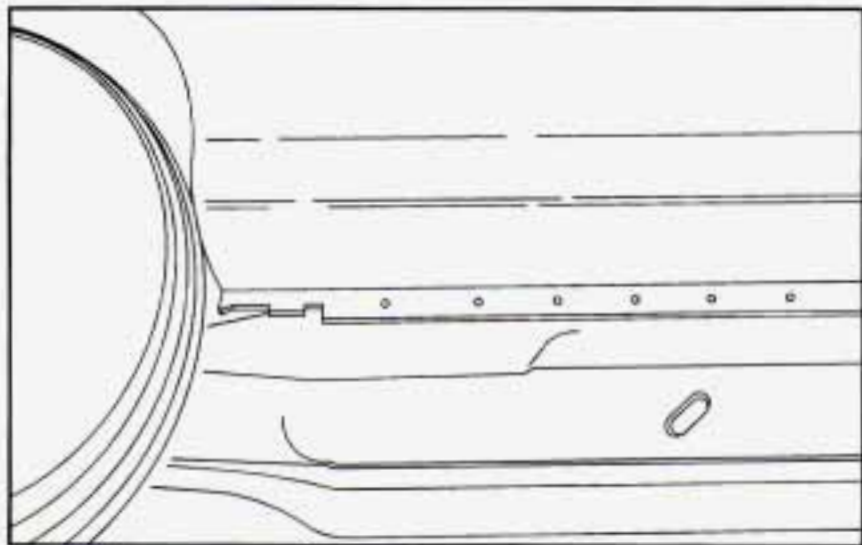

Attach T-hook chains on both sides, in the slotted holes in the frame rails, just ahead of the rear wheels.

These slots are to be used when using sling type equipment or when loading and securing to car-carrier equipment.

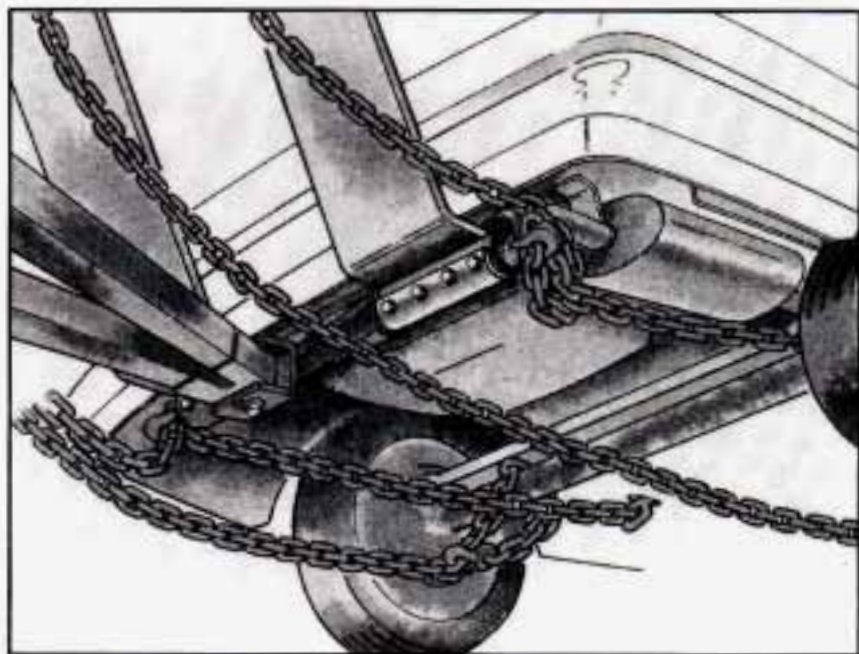

Position the lower sling crossbar directly under the rear bumper.

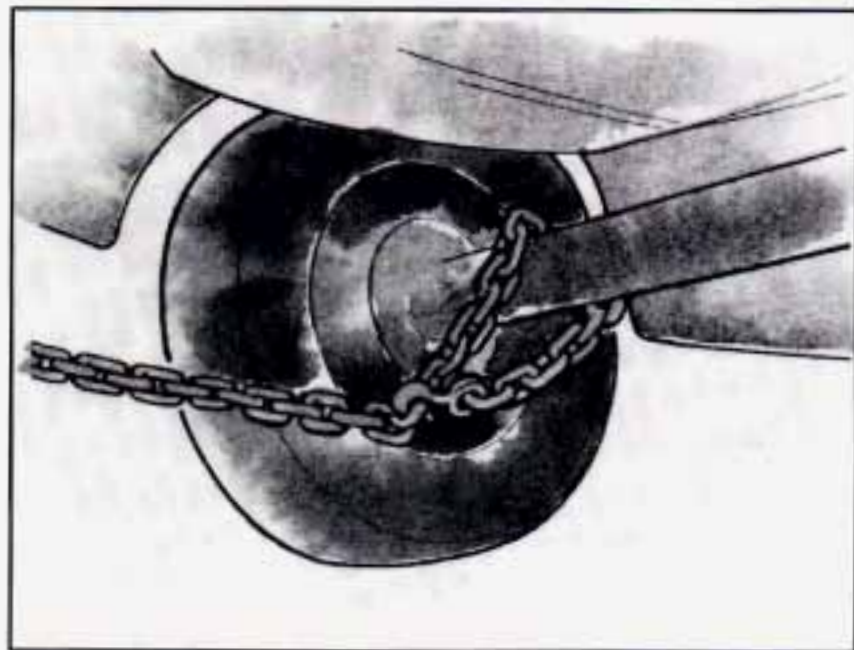

Attach a separate safety chain around the end of each axle inboard of the spring.

Engine Overheating

You will find a coolant temperature gage on your Oldsmobile's instrument panel. See "Engine Coolant Temperature Gage" in the Index. You also have a low coolant level light on your instrument panel. See "Low Coolant Light" in the Index.

If Steam Is Coming From Your Engine



 **CAUTION:**

Steam from an overheated engine can burn you badly, even if you just open the hood. Stay away from the engine if you see or hear steam coming from it. Just turn it off and get everyone away from the vehicle until it cools down. Wait until there is no sign of steam or coolant before opening the hood.

If you keep driving when your engine is overheated, the liquids in it can catch fire. You or others could be badly burned. Stop your engine if it overheats, and get out of the vehicle until the engine is cool.

NOTICE:

If your engine catches fire because you keep driving with no coolant, your vehicle can be badly damaged. The costly repairs would not be covered by your warranty.

If No Steam Is Coming From Your Engine

If you get the overheat warning but see or hear no steam, the problem may not be too serious. Sometimes the engine can get a little too hot when you:

- Climb a long hill on a hot day.
- Stop after high-speed driving.
- Idle for long periods in traffic.
- Tow a trailer.

If you get the overheat warning with no sign of steam, try this for a minute or so:

1. Turn off your air conditioner.
2. Turn on your heater to full hot at the highest fan speed and open the window as necessary.
3. If you're in a traffic jam, shift to NEUTRAL (N); otherwise, shift to the highest gear while driving -- AUTOMATIC OVERDRIVE (Ⓢ) or THIRD (D).

If you no longer have the overheat warning, you can drive. Just to be safe, drive slower for about 10 minutes. If the warning doesn't come back on, you can drive normally.

If the warning continues, pull over, stop, and park your vehicle right away.

If there's still no sign of steam, you can idle the engine for two or three minutes while you're parked, to see if the warning stops. But then, if you still have the warning, *turn off the engine and get everyone out of the vehicle* until it cools down.

You may decide not to lift the hood but to get service help right away.

When you decide it's safe to lift the hood, here's what you'll see:

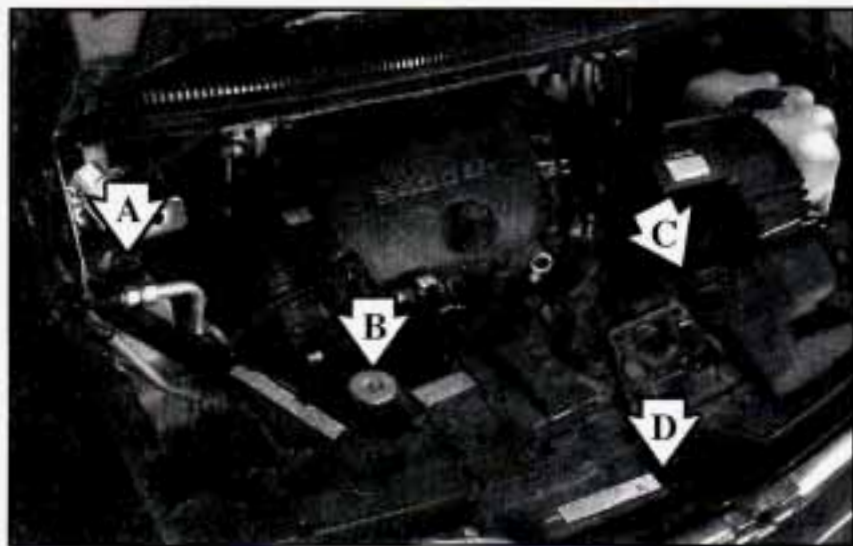

- A. Coolant Recovery Tank
- B. Radiator Pressure Cap
- C. Electric Engine Fan
- D. Electric Engine Fan

⚠ CAUTION:

An electric fan under the hood can start up even when the engine is not running and can injure you. Keep hands, clothing and tools away from any underhood electric fan.

If the coolant inside the coolant recovery tank is boiling, don't do anything else until it cools down.

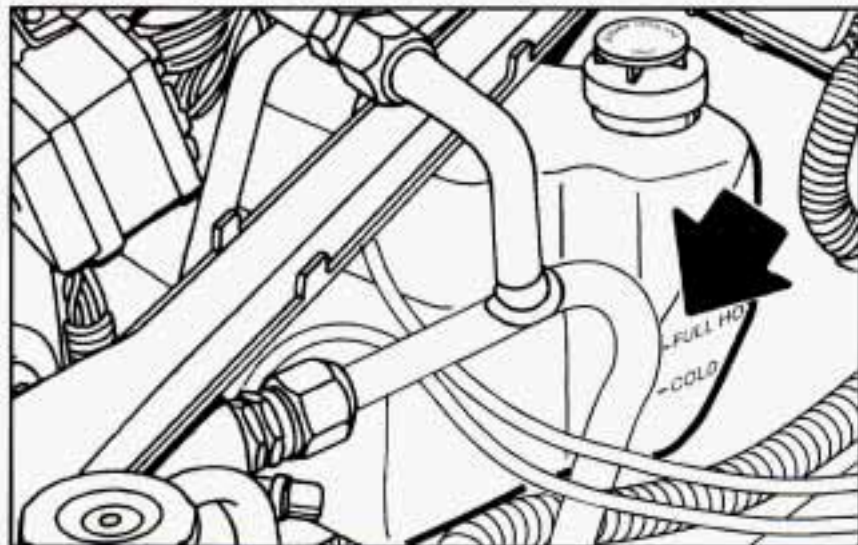

The coolant level should be at or above the FULL HOT mark. If it isn't, you may have a leak in the radiator hoses, heater hoses, radiator, water pump or somewhere else in the cooling system.

 **CAUTION:**

Heater and radiator hoses, and other engine parts, can be very hot. Don't touch them. If you do, you can be burned.

Don't run the engine if there is a leak. If you run the engine, it could lose all coolant. That could cause an engine fire, and you could be burned. Get any leak fixed before you drive the vehicle.

NOTICE:

Engine damage from running your engine without coolant isn't covered by your warranty.

If there seems to be no leak, with the engine on, check to see if the electric engine fan(s) are running. If the engine is overheating, both fan(s) should be running. If they aren't, your vehicle needs service.

How to Add Coolant to the Coolant Recovery Tank

If you haven't found a problem yet, but the coolant level isn't at or above the FULL HOT mark, add a 50/50 mixture of *clean water* (preferably distilled) and DEX-COOL™ (orange-colored, silicate-free) antifreeze at the coolant recovery tank. (See "Engine Coolant" in the Index for more information.)

 **CAUTION:**

Adding only plain water to your cooling system can be dangerous. Plain water, or some other liquid like alcohol, can boil before the proper coolant mix will. Your vehicle's coolant warning system is set for the proper coolant mix. With plain water or the wrong mix, your engine could get too hot but you wouldn't get the overheat warning. Your engine could catch fire and you or others could be burned. Use a 50/50 mix of clean water and DEX-COOL™ antifreeze.

NOTICE:

In cold weather, water can freeze and crack the engine, radiator, heater core and other parts. Use the recommended coolant and the proper coolant mix.



⚠ CAUTION:

You can be burned if you spill coolant on hot engine parts. Coolant contains ethylene glycol and it will burn if the engine parts are hot enough. Don't spill coolant on a hot engine.

When the coolant in the coolant recovery tank is at or above the FULL HOT mark, start your vehicle.

If the overheat warning continues, there's one more thing you can try. You can add the proper coolant mix directly to the radiator but be sure the cooling system is cool before you do it.

⚠ CAUTION:

Steam and scalding liquids from a hot cooling system can blow out and burn you badly. They are under pressure, and if you turn the radiator pressure cap -- even a little -- they can come out at high speed. Never turn the cap when the cooling system, including the radiator pressure cap, is hot. Wait for the cooling system and radiator pressure cap to cool if you ever have to turn the pressure cap.



How to Add Coolant to the Radiator



1. You can remove the radiator pressure cap when the cooling system, including the radiator pressure cap and upper radiator hose, is no longer hot. Turn the pressure cap slowly counterclockwise until it first stops. (Don't press down while turning the pressure cap.)

If you hear a hiss, wait for that to stop. A hiss means there is still some pressure left.

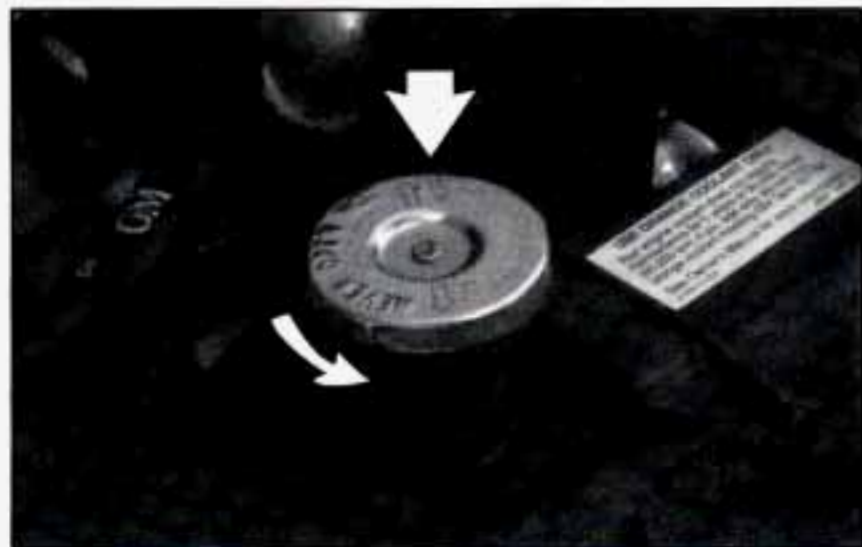

2. Then keep turning the pressure cap, but now push down as you turn it. Remove the pressure cap.



3. Fill the radiator with the proper mix, up to the base of the filler neck.

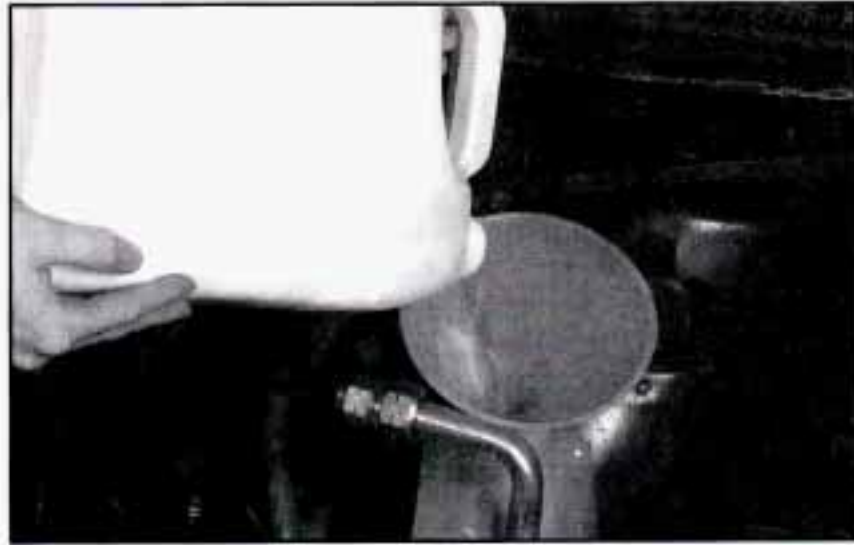

4. Then fill the coolant recovery tank to the FULL HOT mark.
5. Put the cap back on the coolant recovery tank, but leave the radiator pressure cap off.

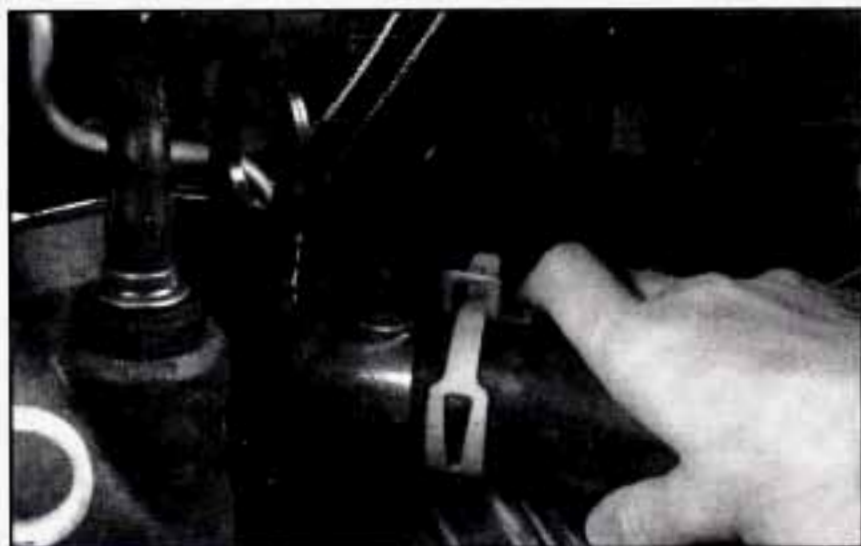

6. Start the engine and let it run until you can feel the upper radiator hose getting hot. Watch out for the engine fans.
7. By this time the coolant level inside the radiator filler neck may be lower. If the level is lower, add more of the proper mix through the filler neck until the level reaches the base of the filler neck.



8. Then replace the pressure cap. At any time during this procedure if coolant begins to flow out of the filler neck, reinstall the pressure cap. Be sure the arrows on the pressure cap line up like this.

If a Tire Goes Flat

It's unusual for a tire to "blow out" while you're driving, especially if you maintain your tires properly. If air goes out of a tire, it's much more likely to leak out slowly. But if you should ever have a "blowout," here are a few tips about what to expect and what to do:

If a front tire fails, the flat tire will create a drag that pulls the vehicle toward that side. Take your foot off the accelerator pedal and grip the steering wheel firmly. Steer to maintain lane position, and then gently brake to a stop well out of the traffic lane.

A rear blowout, particularly on a curve, acts much like a skid and may require the same correction you'd use in a skid. In any rear blowout, remove your foot from the accelerator pedal. Get the vehicle under control by steering the way you want the vehicle to go. It may be very bumpy and noisy, but you can still steer. Gently brake to a stop -- well off the road if possible.

If a tire goes flat, the next part shows how to use your jacking equipment to change a flat tire safely.

Air Inflator (Option)

Your vehicle may have an air inflator used to bring tires up to the proper pressure. See "Air Inflator System" in the Index for more details.

Changing a Flat Tire

If a tire goes flat, avoid further tire and wheel damage by driving slowly to a level place. Turn on your hazard warning flashers.



CAUTION:

Changing a tire can cause an injury. The vehicle can slip off the jack and roll over you or other people. You and they could be badly injured. Find a level place to change your tire. To help prevent the vehicle from moving:

- 1. Set the parking brake firmly.**
- 2. Put the shift lever in PARK (P).**
- 3. Turn off the engine.**

To be even more certain the vehicle won't move, you can put blocks at the front and rear of the tire farthest away from the one being changed. That would be the tire on the other side of the vehicle, at the opposite end.



The following steps will tell you how to use the jack and change a tire.

Removing the Spare Tire and Tools

The equipment you'll need is in the storage compartment at the rear of the vehicle, on the passenger's side.

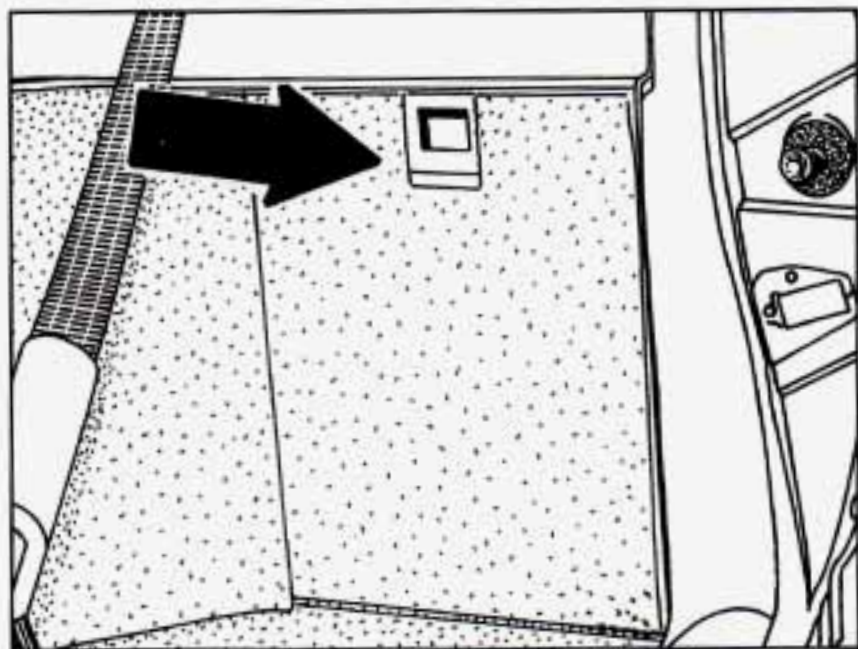

Open the jack storage compartment by sliding the latch down and removing the compartment cover.

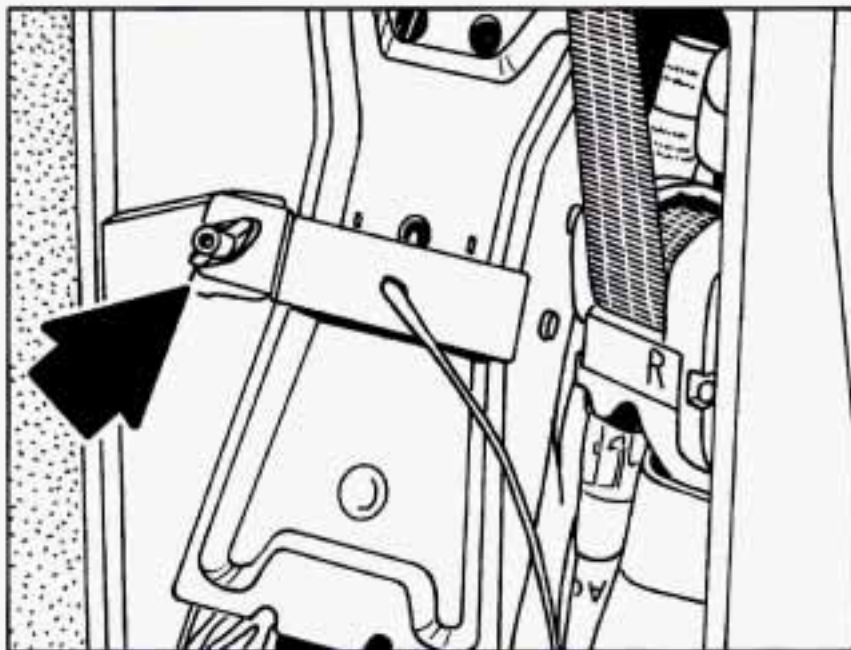

Remove the jack and jacking tools by loosening the wing nut and retainer bar.

Separate the plastic pouch from the jack and remove the jacking tools (folding wrench and shaft) from the pouch.

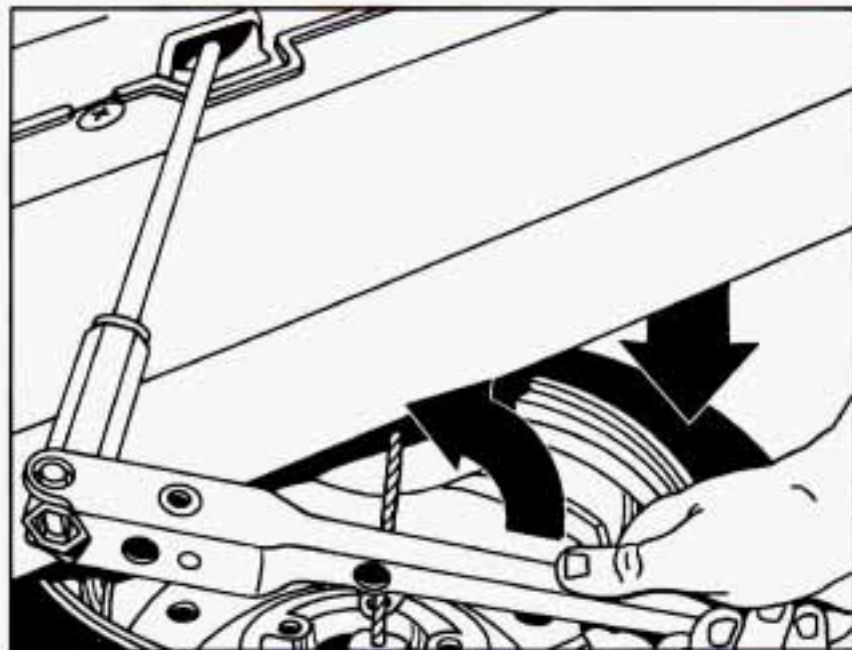

The compact spare tire is located under the vehicle, behind the rear bumper. Insert the narrow end of the shaft into the hole above the rear bumper. Then attach the folding wrench to the shaft.

Rotate the folding wrench counterclockwise to lower the compact spare tire until it can be pulled from under the vehicle.

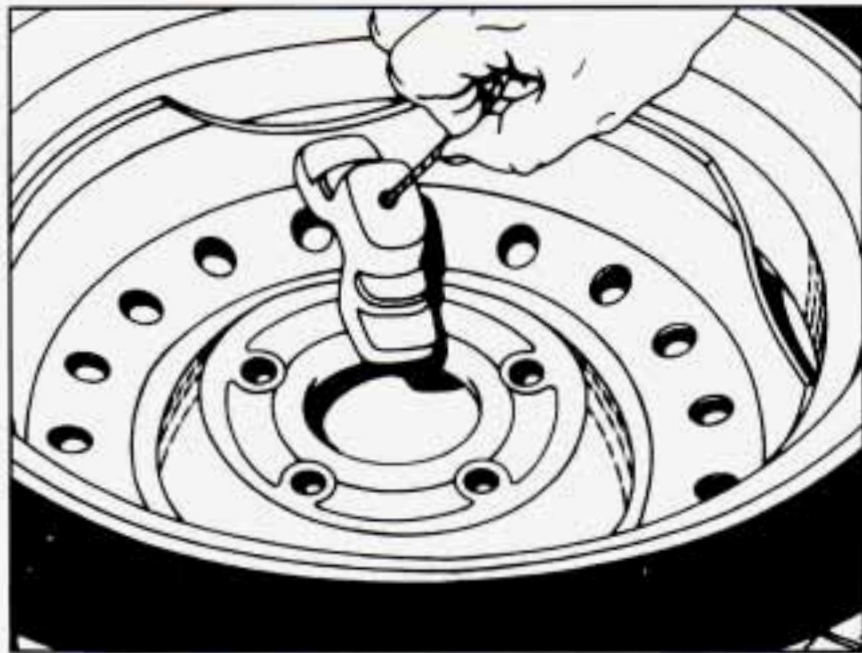

Slide the cable retainer through the center of the spare, then place the compact spare tire near the flat tire.



The tools you'll be using include the jack (A), folding wrench (B) and shaft (C).

Removing the Flat Tire and Installing the Spare Tire

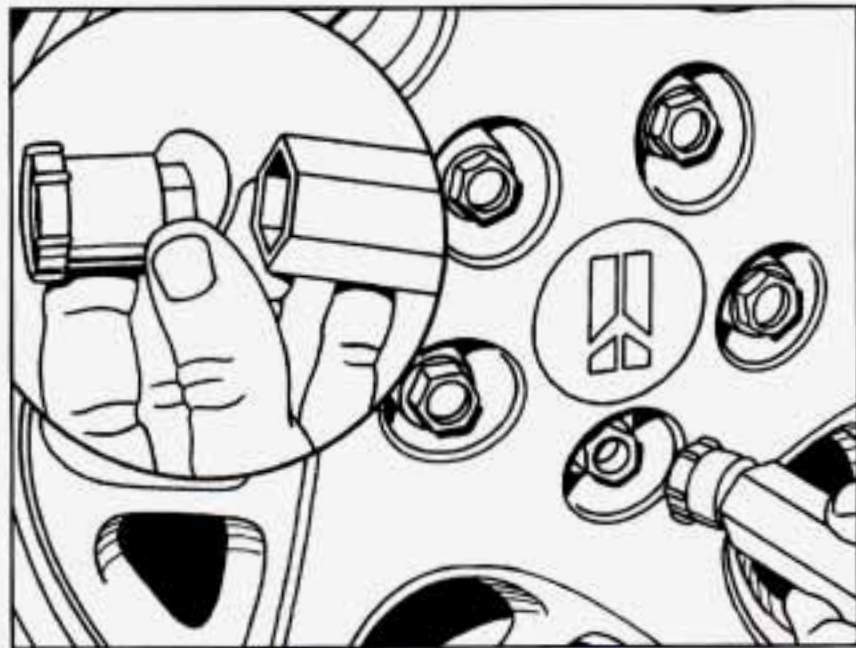

1. Each wheel nut is covered with a nylon cap. Use the folding wrench to remove the nylon caps from the wheel nuts before you loosen the nuts.

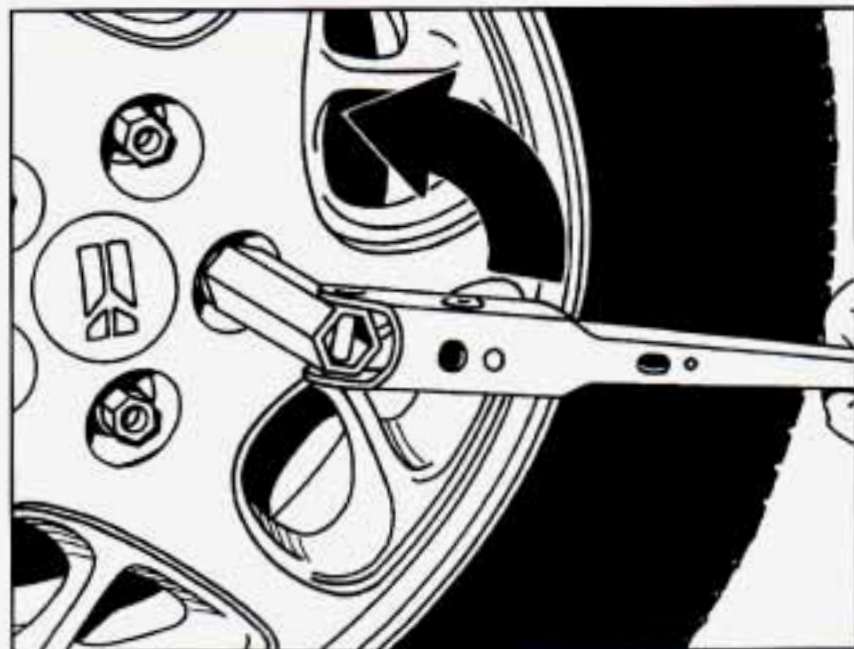

2. Loosen the wheel nuts -- but do not remove them -- using the folding wrench.

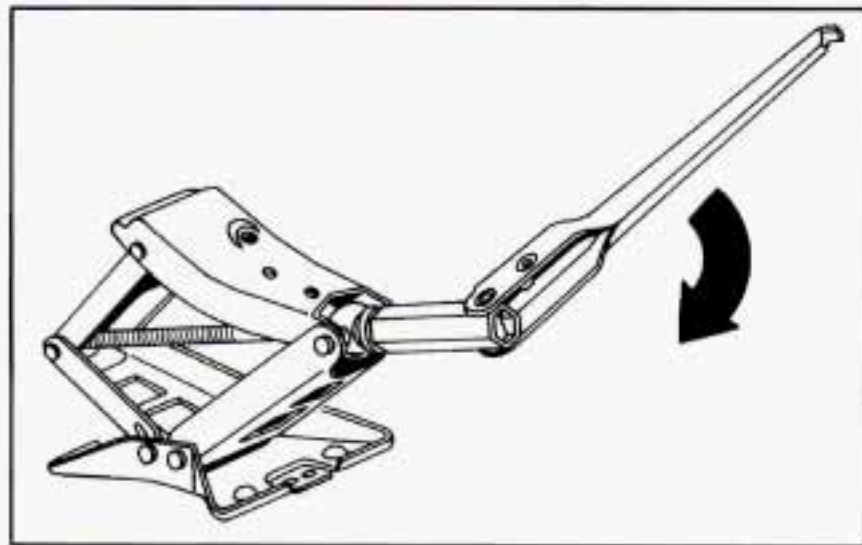

3. Attach the folding wrench to the jack, and rotate the wrench clockwise to raise the jack head a few inches.

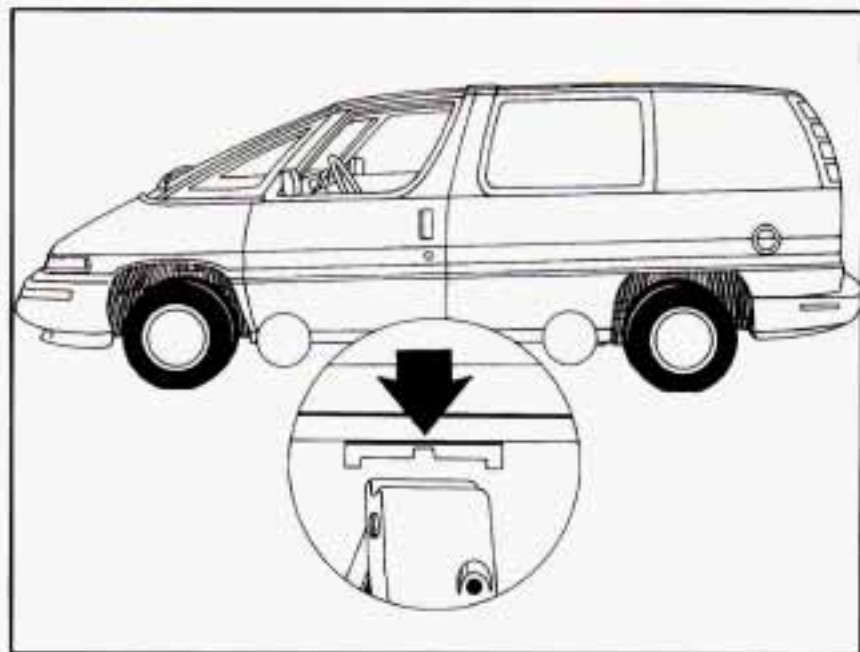

4. Near each wheel, there is a notch in the vehicle's frame. Position the jack and raise the jack head until it fits firmly into the notch in the vehicle's frame (nearest the flat tire). Do not raise the vehicle yet. Put the compact spare tire near you.

⚠ CAUTION:

Getting under a vehicle when it is jacked up is dangerous. If the vehicle slips off the jack, you could be badly injured or killed. Never get under a vehicle when it is supported only by a jack.

NOTICE:

Raising your vehicle with the jack improperly positioned will damage the vehicle or may allow the vehicle to fall off the jack. Be sure to fit the jack lift head into the proper location before raising your vehicle.

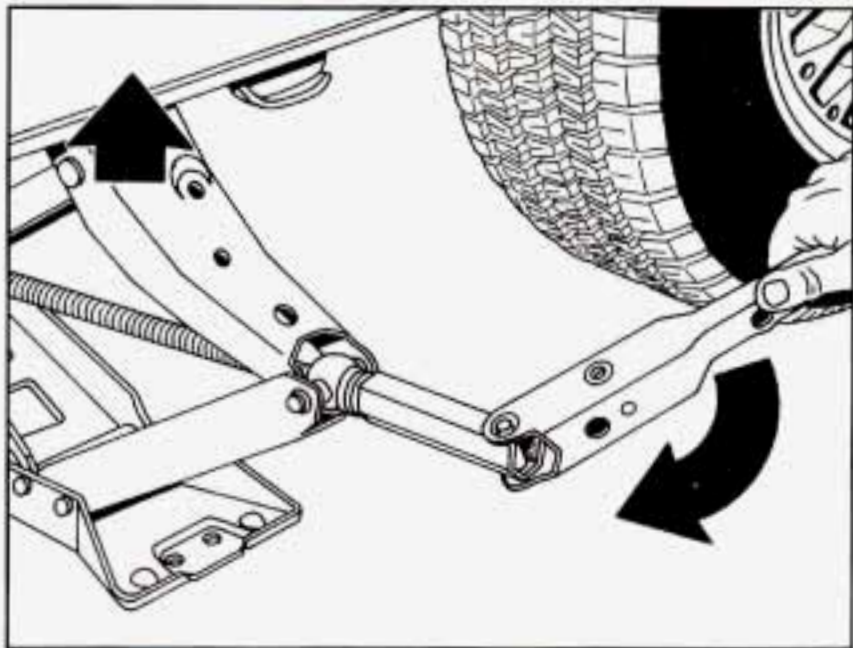

5. Raise the vehicle by rotating the folding wrench clockwise in the jack. Raise the vehicle far enough off the ground so there is enough room for the spare tire to fit.
6. Remove all the wheel nuts and take off the flat tire.

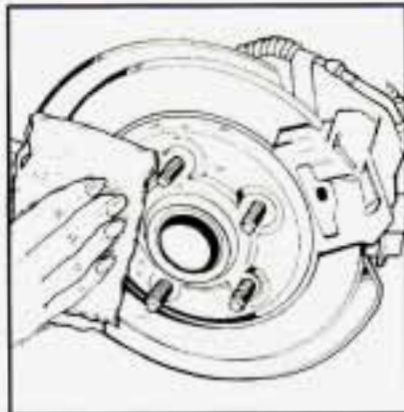

7. Remove any rust or dirt from the wheel bolts, mounting surfaces and spare wheel.

⚠ CAUTION:

Never use oil or grease on studs or nuts. If you do, the nuts might come loose. Your wheel could fall off, causing a serious accident.

8. Replace the wheel nuts with the rounded end of the nuts toward the wheel. Tighten each nut by hand until the wheel is held against the hub.

⚠ CAUTION:

Rust or dirt on the wheel, or on the parts to which it is fastened, can make the wheel nuts become loose after a time. The wheel could come off and cause an accident. When you change a wheel, remove any rust or dirt from the places where the wheel attaches to the vehicle. In an emergency, you can use a cloth or a paper towel to do this; but be sure to use a scraper or wire brush later, if you need to, to get all the rust or dirt off.

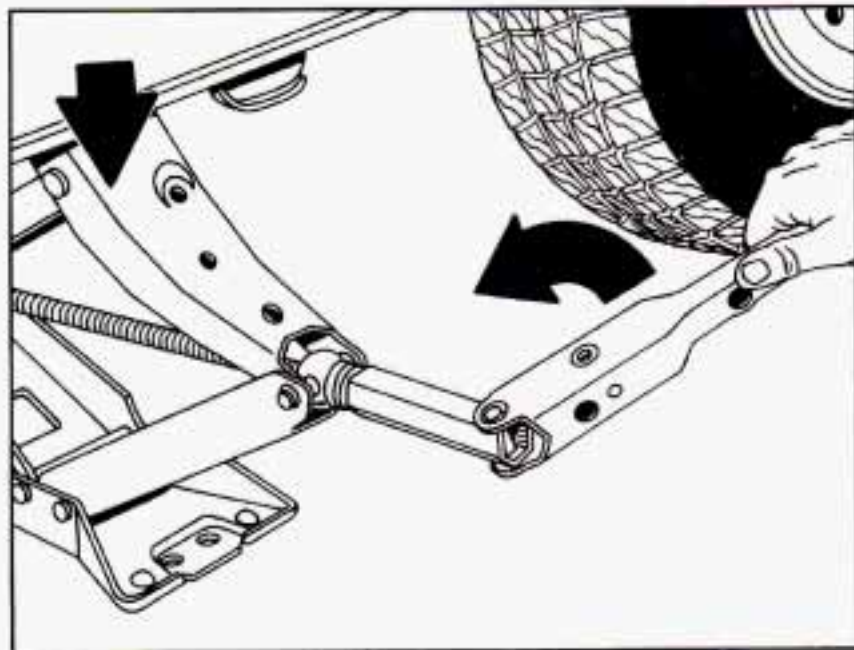

9. Lower the vehicle by attaching the folding wrench to the jack and rotating the wrench counterclockwise. Lower the jack completely.

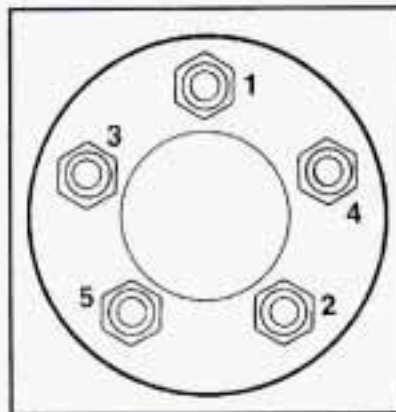

10. Tighten the wheel nuts firmly in a crisscross sequence as shown.

⚠ CAUTION:

Incorrect wheel nuts or improperly tightened wheel nuts can cause the wheel to become loose and even come off. This could lead to an accident. Be sure to use the correct wheel nuts. If you have to replace them, be sure to get new GM original equipment wheel nuts.

Stop somewhere as soon as you can and have the nuts tightened with a torque wrench to 100 lb-ft (140 N·m).

NOTICE:

Improperly tightened wheel nuts can lead to brake pulsation and rotor damage. To avoid expensive brake repairs, evenly tighten the wheel nuts in the proper sequence and to the proper torque specification.

Don't try to put a wheel cover on the compact spare tire. It won't fit.

NOTICE:

Wheel covers won't fit on your compact spare. If you try to put a wheel cover on your compact spare, you could damage the cover or the spare.

Storing a Flat or Spare Tire and Tools

CAUTION:

Storing a jack, a tire or other equipment in the passenger compartment of the vehicle could cause injury. In a sudden stop or collision, loose equipment could strike someone. Store all these in the proper place.

Lay the flat tire near the rear of the vehicle with the valve stem down. Slide the cable retainer through the center of the wheel and raise the flat tire until you hear the hoist mechanism click twice. This means that the wheel is firmly stored against the underside of the vehicle. When storing the spare tire, be certain to turn the spare so the valve stem is near the rear of the vehicle. This will help you to check and maintain tire pressure in the spare.

Push against the tire to be certain it is stored firmly.

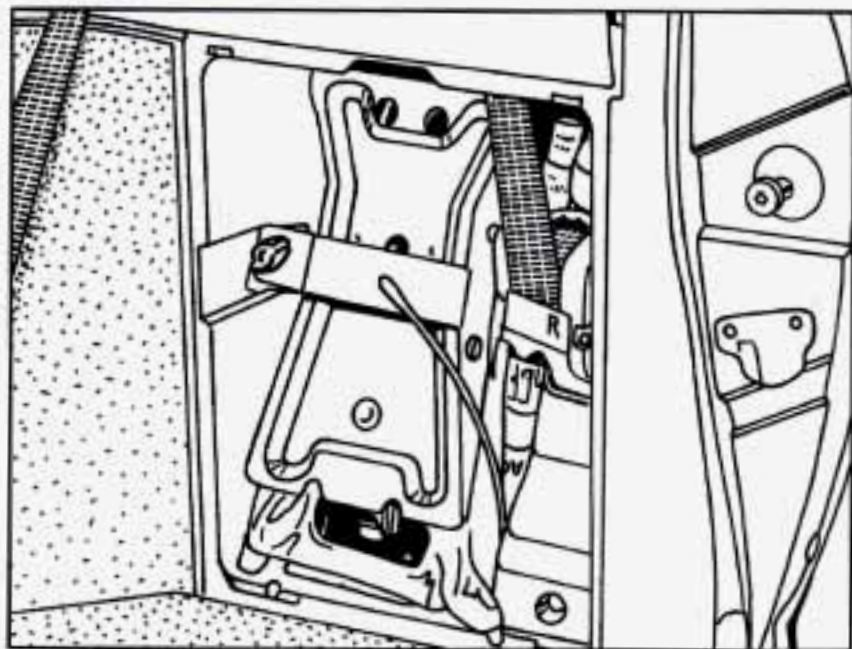

Replace all jacking tools as they were stored in the storage compartment and replace the compartment cover. Be sure to also store the nylon nut caps.

When you replace the compact spare tire with a full-size tire, replace the nylon nut caps over the wheel nuts. Tighten them "hand tight" using the folding wrench.

Compact Spare Tire

Although the compact spare tire was fully inflated when your vehicle was new, it can lose air after a time. Check the inflation pressure regularly. It should be 60 psi (420 kPa).

After installing the compact spare on your vehicle, you should stop as soon as possible and make sure your spare tire is correctly inflated. The compact spare is made to perform well at posted speed limits for distances up to 3,000 miles (5 000 km), so you can finish your trip and have your full-size tire repaired or replaced where you want. Of course, it's best to replace your spare with a full-size tire as soon as you can. Your spare will last longer and be in good shape in case you need it again.

NOTICE:

When the compact spare is installed, don't take your vehicle through an automatic vehicle wash with guide rails. The compact spare can get caught on the rails. That can damage the tire and wheel, and maybe other parts of your vehicle.

Don't use your compact spare on other vehicles.

And don't mix your compact spare tire or wheel with other wheels or tires. They won't fit. Keep your spare tire and its wheel together.

NOTICE:

Tire chains won't fit your compact spare. Using them can damage your vehicle and can damage the chains too. Don't use tire chains on your compact spare.

If You're Stuck: In Sand, Mud, Ice or Snow

What you don't want to do when your vehicle is stuck is to spin your wheels too fast. The method known as "rocking" can help you get out when you're stuck, but you must use caution.



CAUTION:

If you let your tires spin at high speed, they can explode, and you or others could be injured. And, the transaxle or other parts of the vehicle can overheat. That could cause an engine compartment fire or other damage. When you're stuck, spin the wheels as little as possible. Don't spin the wheels above 35 mph (55 km/h) as shown on the speedometer.

NOTICE:

Spinning your wheels can destroy parts of your vehicle as well as the tires. If you spin the wheels too fast while shifting your transaxle back and forth, you can destroy your transaxle.

For information about using tire chains on your vehicle, see “Tire Chains” in the Index.

Rocking your vehicle to get it out:

First, turn your steering wheel left and right. That will clear the area around your front wheels. Then shift back and forth between REVERSE (R) and a forward gear, spinning the wheels as little as possible. Release the accelerator pedal while you shift, and press lightly on the accelerator pedal when the transaxle is in gear. If that doesn't get you out after a few tries, you may need to be towed out. If you do need to be towed out, see “Towing Your Vehicle” in the Index.



Section 6 Service and Appearance Care

Here you will find information about the care of your Oldsmobile. This section begins with service and fuel information, and then it shows how to check important fluid and lubricant levels. There is also technical information about your vehicle, and a part devoted to its appearance care.

Service

Your Oldsmobile retailer knows your vehicle best and wants you to be happy with it. We hope you'll go to your retailer for all your service needs. You'll get genuine GM parts and GM-trained and supported service people.

We hope you'll want to keep your GM vehicle all GM. Genuine GM parts have one of these marks:



Doing Your Own Service Work

If you want to do some of your own service work, you'll want to get the proper Oldsmobile Service Manual. It tells you much more about how to service your Oldsmobile than this manual can. To order the proper service manual, see "Service and Owner Publications" in the Index.

Your vehicle has an air bag system. Before attempting to do your own service work, see "Servicing Your Air Bag-Equipped Oldsmobile" in the Index.

You should keep a record with all parts receipts and list the mileage and the date of any service work you perform. See "Maintenance Record" in the Index.

CAUTION:

You can be injured and your vehicle could be damaged if you try to do service work on a vehicle without knowing enough about it.

- **Be sure you have sufficient knowledge, experience, and the proper replacement parts and tools before you attempt any vehicle maintenance task.**
- **Be sure to use the proper nuts, bolts and other fasteners. “English” and “metric” fasteners can be easily confused. If you use the wrong fasteners, parts can later break or fall off. You could be hurt.**

Fuel

Use regular unleaded gasoline rated at 87 octane or higher. At a minimum, it should meet specifications ASTM D4814 in the United States and CGSB 3.5-M93 in Canada. Improved gasoline specifications have been developed by the American Automobile Manufacturers Association (AAMA) for better vehicle performance and engine protection. Gasolines meeting the AAMA

specification could provide improved driveability and emission control system protection compared to other gasolines.

Be sure the posted octane is at least 87. If the octane is less than 87, you may get a heavy knocking noise when you drive. If it's bad enough, it can damage your engine.

If you're using fuel rated at 87 octane or higher and you still hear heavy knocking, your engine needs service. But don't worry if you hear a little pinging noise when you're accelerating or driving up a hill. That's normal, and you don't have to buy a higher octane fuel to get rid of pinging. It's the heavy, constant knock that means you have a problem.

If your vehicle is certified to meet California Emission Standards (indicated on the underhood tune-up label), it is designed to operate on fuels that meet California specifications. If such fuels are not available in states adopting California emissions standards, your vehicle will operate satisfactorily on fuels meeting federal specifications, but emission control system performance may be affected. The malfunction indicator lamp on your instrument panel may turn on and/or your vehicle may fail a smog-check test. If this occurs, return to your authorized Oldsmobile retailer for diagnosis to determine the cause of failure. In the event it is determined that the cause of the condition is the type of fuels used, repairs may not be covered by your warranty.

In Canada, some gasolines contain an octane-enhancing additive called MMT. If you use such fuels, your emission control system performance may deteriorate and the malfunction indicator lamp on your instrument panel may turn on. If this happens, return to your authorized Oldsmobile retailer for service.

To provide cleaner air, all gasolines in the United States are now required to contain additives that will help prevent deposits from forming in your engine and fuel system, allowing your emission control system to function properly. Therefore, you should not have to add anything to the fuel. In addition, gasolines containing oxygenates, such as ethers and ethanol, and reformulated gasolines may be available in your area to help clean the air. General Motors recommends that you use these gasolines if they comply with the specifications described earlier.

Fuels in Foreign Countries

If you plan on driving in another country outside the United States or Canada, the proper fuel may be hard to find. Never use leaded gasoline or any other fuel not recommended in the previous text on fuel. Costly repairs caused by use of improper fuel wouldn't be covered by your warranty.

To check on fuel availability, ask an auto club, or contact a major oil company that does business in the country where you'll be driving.

You can also write us at the following address for advice. Just tell us where you're going and give your Vehicle Identification Number (VIN).

General Motors Overseas Distribution Corporation,
North American Export Sales (NAES)
1908 Colonel Sam Drive
Oshawa, Ontario L1H 8P7

NOTICE:

Your vehicle was not designed for fuel that contains methanol. Don't use it. It can corrode metal parts in your fuel system and also damage plastic and rubber parts. That damage wouldn't be covered under your warranty.

Filling Your Tank

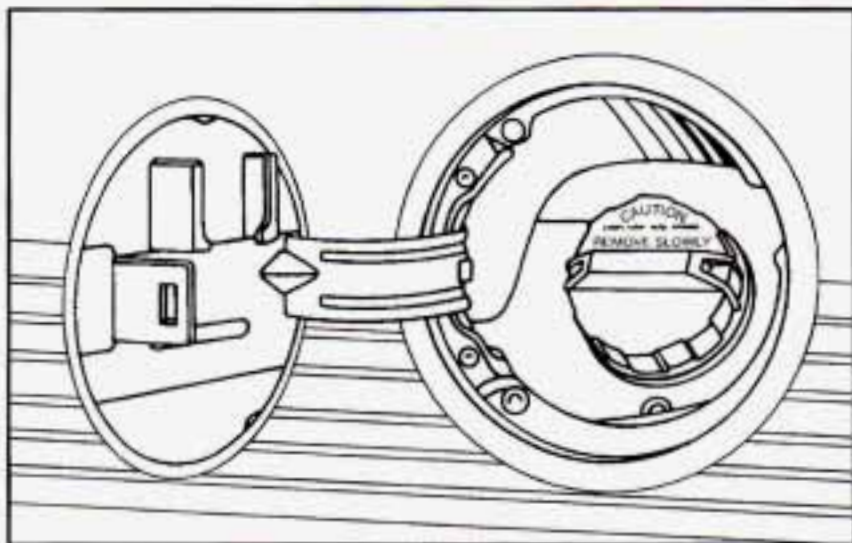

The cap is behind a hinged door on the driver's side of your vehicle. You will notice that on the inside of the hinged door there is a place to hold the gas cap while you are adding fuel.

CAUTION:

Gasoline vapor is highly flammable. It burns violently, and that can cause very bad injuries. Don't smoke if you're near gasoline or refueling your vehicle. Keep sparks, flames and smoking materials away from gasoline.

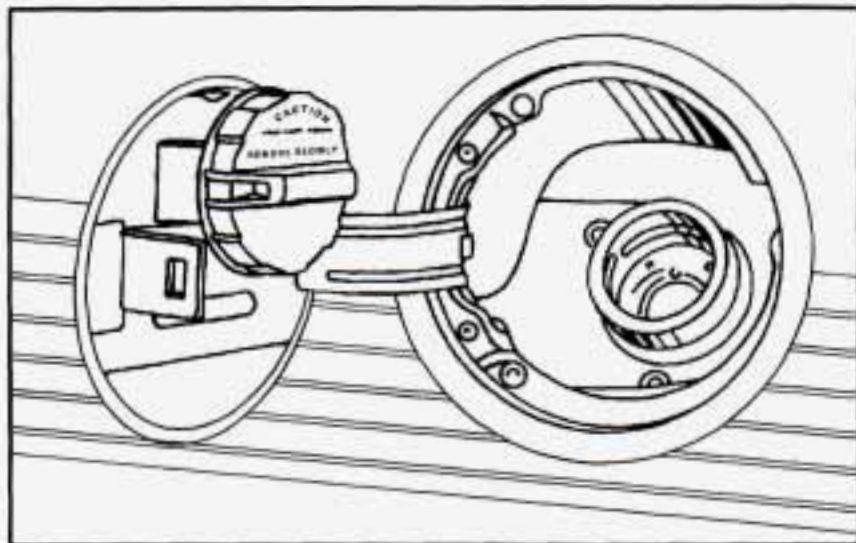

While refueling, hang the cap inside the fuel door.

To take off the cap, turn it slowly to the left (counterclockwise).

⚠ CAUTION:

If you get gasoline on yourself and then something ignites it, you could be badly burned. Gasoline can spray out on you if you open the fuel filler cap too quickly. This spray can happen if your tank is nearly full, and is more likely in hot weather. Open the fuel filler cap slowly and wait for any “hiss” noise to stop. Then unscrew the cap all the way.

Be careful not to spill gasoline. Clean gasoline from painted surfaces as soon as possible. See “Cleaning the Outside of Your Oldsmobile” in the Index.

When you put the cap back on, turn it to the right until you hear at least three clicks. Make sure you fully install the cap. The diagnostic system can determine if the fuel cap has been left off or improperly installed. This would allow fuel to evaporate into the atmosphere. See “Malfunction Indicator Lamp” in the Index.

NOTICE:

If you need a new cap, be sure to get the right type. Your retailer can get one for you. If you get the wrong type, it may not fit or have proper venting, and your fuel tank and emissions system might be damaged.

Checking Things Under the Hood

CAUTION:

An electric fan under the hood can start up and injure you even when the engine is not running. Keep hands, clothing and tools away from any underhood electric fan.

Hood Release

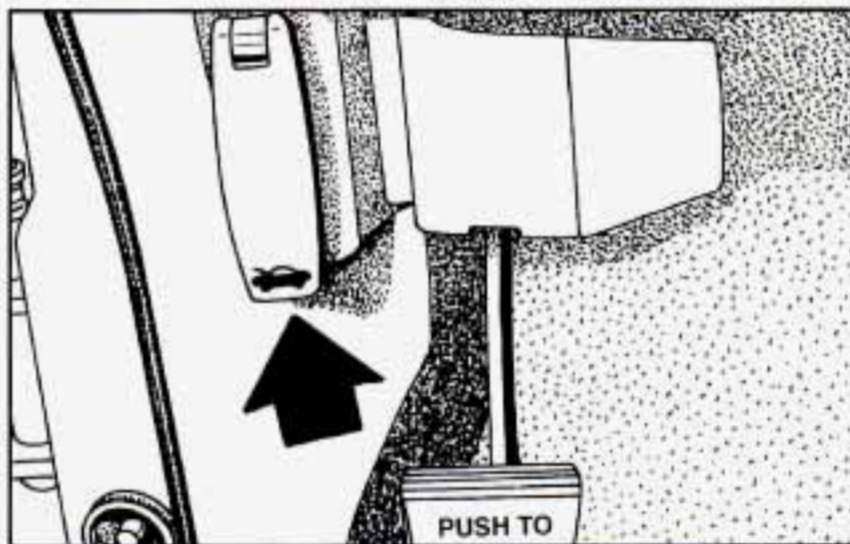

CAUTION:

Things that burn can get on hot engine parts and start a fire. These include liquids like gasoline, oil, coolant, brake fluid, windshield washer and other fluids, and plastic or rubber. You or others could be burned. Be careful not to drop or spill things that will burn onto a hot engine.

To open the hood, first pull the hood release handle inside the vehicle.

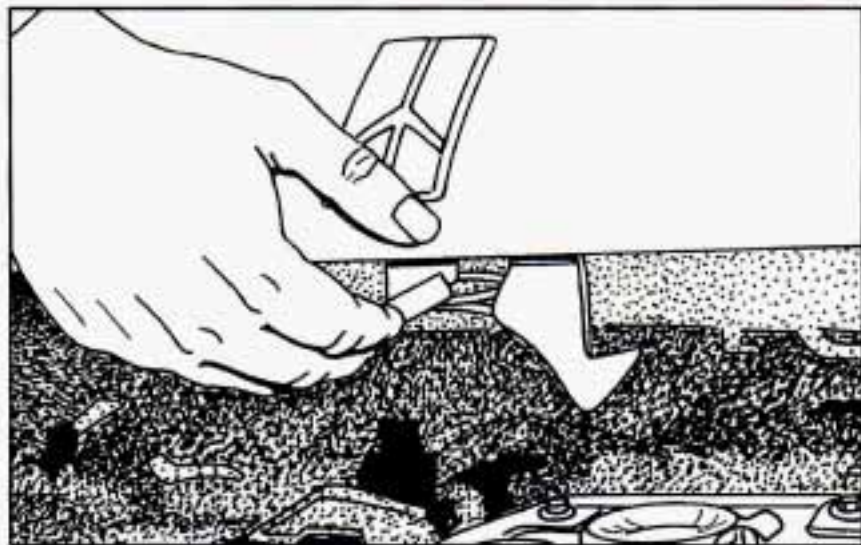

Next, go to the front of the vehicle and pull up on the underhood release.

Lift the hood.

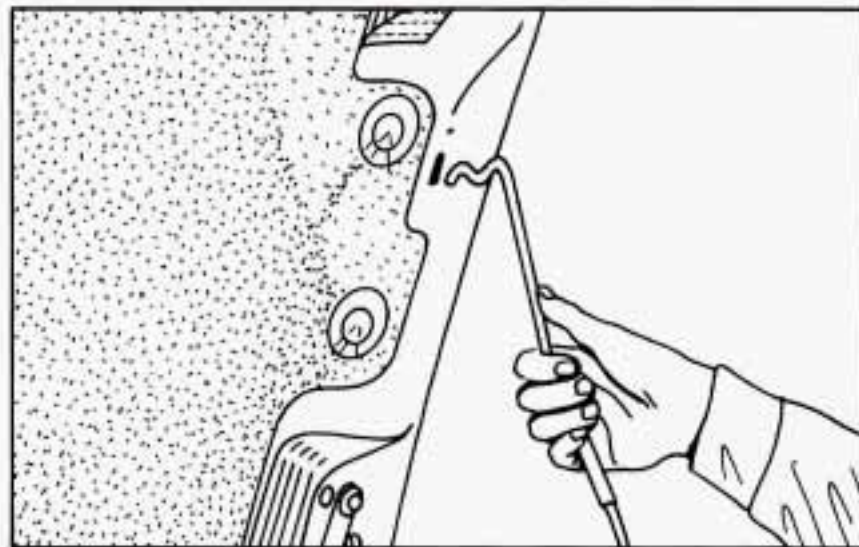

The hood prop rod may be hot due to increased engine temperatures under the hood, so be careful when handling it. Use your hood prop sleeve when handling the hood prop.

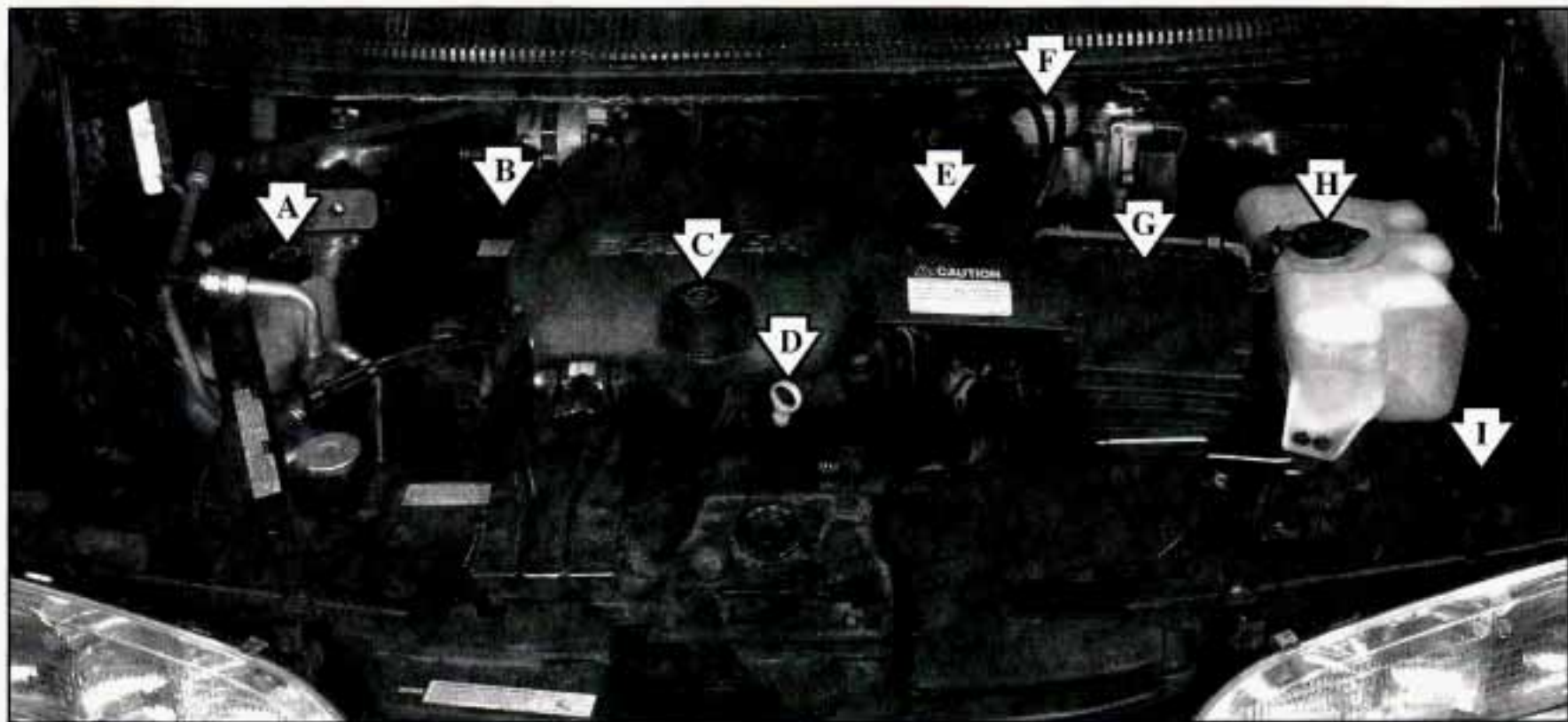

A. Coolant Recovery Tank

B. Power Steering Fluid Reservoir

C. Engine Oil Fill

D. Engine Oil Dipstick

E. Transaxle Fluid Dipstick

F. Brake Master Cylinder

G. Air Cleaner

H. Windshield Washer Fluid Reservoir

I. Battery

Pull forward on the hood prop to release it from its storage clip. Put the end of the hood prop into the slot in the underside of the hood.

Before closing the hood, be sure all the filler caps are on properly. Lift the hood to relieve the pressure on the hood prop. Remove the hood prop from the slot in the hood and return the prop to its retainer. Let the hood down and close it firmly.

Underhood Lamp

Your underhood lamp will go on when you open the hood.

Engine Oil



If the LOW OIL light on the instrument panel comes on, it means you need to check your engine oil level right away. For more information, see “LOW OIL Light” in the Index. You should check your engine oil level regularly; this is an added reminder.

It's a good idea to check your engine oil every time you get fuel. In order to get an accurate reading, the oil must be warm and the vehicle must be on level ground.



The engine oil dipstick is located at the front of the engine compartment, near the center. The dipstick handle has a bright, yellow loop design for easier identification.

Turn off the engine and give the oil a few minutes to drain back into the oil pan. If you don't, the oil dipstick might not show the actual level.

Checking Engine Oil

Pull out the dipstick and clean it with a paper towel or cloth, then push it back in all the way. Remove it again, keeping the tip down, and check the level.

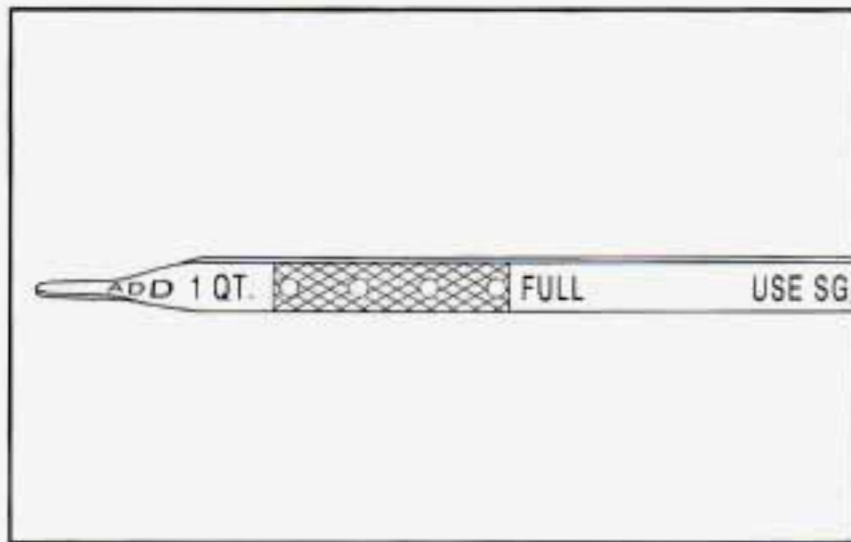

When to Add Oil

If the oil is at or below the ADD mark, then you'll need to add some oil. But you must use the right kind. This part explains what kind of oil to use. For crankcase capacity, see "Capacities and Specifications" in the Index.

NOTICE:

Don't add too much oil. If your engine has so much oil that the oil level gets above the cross-hatched area that shows the proper operating range, your engine could be damaged.



The engine oil fill cap is located just behind the engine oil dipstick.

Just fill it enough to put the level somewhere in the proper operating range. Push the dipstick all the way back in when you're through.

What Kind of Oil to Use

Oils recommended for your vehicle can be identified by looking for the "Starburst" symbol. This symbol indicates that the oil has been certified by the American Petroleum Institute (API). Do not use any oil which does not carry this Starburst symbol.



If you change your own oil, be sure you use oil that has the Starburst symbol on the front of the oil container. If you have your oil changed for you, be sure the oil put into your engine is American Petroleum Institute certified for gasoline engines.

You should also use the proper viscosity oil for your vehicle, as shown in the following chart:

RECOMMENDED SAE VISCOSITY GRADE ENGINE OILS

FOR BEST FUEL ECONOMY AND COLD STARTING, SELECT THE LOWEST SAE VISCOSITY GRADE OIL FOR THE EXPECTED TEMPERATURE RANGE.

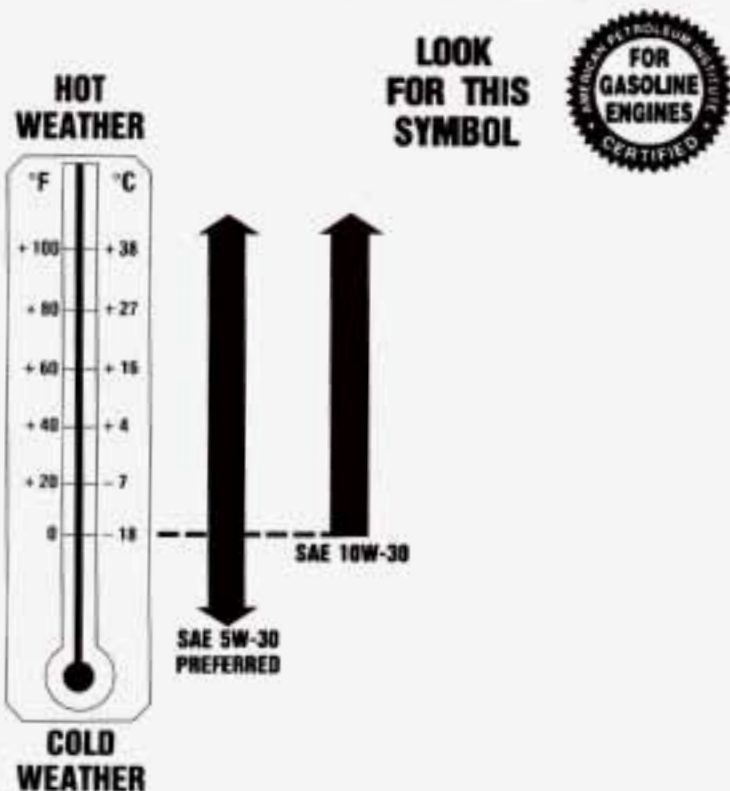

DO NOT USE SAE 20W-50 OR ANY OTHER GRADE OIL NOT RECOMMENDED

As shown in the chart, SAE 5W-30 is best for your vehicle. However, you can use SAE 10W-30 if it's going to be 0°F (-18°C) or above. These numbers on an oil container show its viscosity, or thickness. Do not use other viscosity oils, such as SAE 20W-50.

NOTICE:

Use only engine oil with the American Petroleum Institute Certified For Gasoline Engines "Starburst" symbol. Failure to use the recommended oil can result in engine damage not covered by your warranty.

GM Goodwrench[®] oil meets all the requirements for your vehicle.

Engine Oil Additives

Don't add anything to your oil. Your Oldsmobile retailer is ready to advise if you think something should be added.

When to Change Engine Oil

See if any one of these is true for you:

- Most trips are less than 5 to 10 miles (8 to 16 km). This is particularly important when outside temperatures are below freezing.
- Most trips include extensive idling (such as frequent driving in stop-and-go traffic).
- Most trips are through dusty areas.
- You frequently tow a trailer or use a carrier on top of your vehicle.
- The vehicle is used for delivery service, police, taxi or other commercial application.

Driving under these conditions causes engine oil to break down sooner. If any one of these is true for your vehicle, then you need to change your oil and filter every 3,000 miles (5 000 km) or 3 months -- whichever occurs first.

If none of them is true, change the oil and filter every 7,500 miles (12 500 km) or 12 months -- whichever occurs first. Driving a vehicle with a fully warmed engine under highway conditions causes engine oil to break down slower.

What to Do with Used Oil

Did you know that used engine oil contains certain elements that may be unhealthy for your skin and could even cause cancer? Don't let used oil stay on your skin for very long. Clean your skin and nails with soap and water, or a good hand cleaner. Wash or properly throw away clothing or rags containing used engine oil. (See the manufacturer's warnings about the use and disposal of oil products.)

Used oil can be a real threat to the environment. If you change your own oil, be sure to drain all free-flowing oil from the filter before disposal. Don't ever dispose of oil by putting it in the trash, pouring it on the ground, into sewers, or into streams or bodies of water. Instead, recycle it by taking it to a place that collects used oil. If you have a problem properly disposing of your used oil, ask your retailer, a service station or a local recycling center for help.

Air Cleaner



The air cleaner is located at the front of the engine compartment (on the driver's side of the vehicle), to the left of the windshield washer fluid reservoir.

Refer to the Maintenance Schedule to determine when to replace the air filter and the crankcase ventilation filter.

See "Scheduled Maintenance Services" in the Index.

CAUTION:

Operating the engine with the air cleaner off can cause you or others to be burned. The air cleaner not only cleans the air, it stops flame if the engine backfires. If it isn't there, and the engine backfires, you could be burned. Don't drive with it off, and be careful working on the engine with the air cleaner off.

NOTICE:

If the air cleaner is off, a backfire can cause a damaging engine fire. And, dirt can easily get into your engine, which will damage it. Always have the air cleaner in place when you're driving.

Checking or Replacing the Air Cleaner



1. Loosen the four wing nuts.
2. Pull the top of the air cleaner toward the front of the vehicle and remove the air cleaner filter.
3. Be sure to install the air cleaner filter, replace the cover and tighten the wing nuts securely.

Automatic Transaxle Fluid

When to Check and Change

A good time to check your automatic transaxle fluid level is when the engine oil is changed.

Change both the fluid and filter every 50,000 miles (83 000 km) if the vehicle is mainly driven under one or more of these conditions:

- In heavy city traffic where the outside temperature regularly reaches 90°F (32°C) or higher.
- In hilly or mountainous terrain.
- When doing frequent trailer towing.
- Uses such as found in taxi, police or delivery service.

If you do not use your vehicle under any of these conditions, the fluid and filter do not require changing.

See “Scheduled Maintenance Services” in the Index.

How to Check

Because this operation can be a little difficult, you may choose to have this done at your Oldsmobile retail facility Service Department.

If you do it yourself, be sure to follow all the instructions here, or you could get a false reading on the dipstick.

NOTICE:

Too much or too little fluid can damage your transaxle. Too much can mean that some of the fluid could come out and fall on hot engine parts or exhaust system parts, starting a fire. Be sure to get an accurate reading if you check your transaxle fluid.

Wait at least 30 minutes before checking the transaxle fluid level if you have been driving:

- When outside temperatures are above 90°F (32°C).
- At high speed for quite a while.
- In heavy traffic -- especially in hot weather.
- While pulling a trailer.

To get the right reading, the fluid should be at normal operating temperature, which is 180°F to 200°F (82°C to 93°C).

Get the vehicle warmed up by driving about 15 miles (24 km) when outside temperatures are above 50°F (10°C). If it's colder than 50°F (10°C), you may have to drive longer.

Checking the Fluid Level

- Park your vehicle on a level place. Keep the engine running.
- With the parking brake applied, place the shift lever in PARK (P).
- With your foot on the brake pedal, move the shift lever through each gear range, pausing for about three seconds in each range. Then, position the shift lever in PARK (P).
- Let the engine run at idle for three to five minutes.

Then, without shutting off the engine, follow these steps:



1. The dipstick is located toward the back of the engine compartment, near the center. The dipstick handle has a bright red loop design for easier identification. Pull out the dipstick and wipe it with a clean rag or paper towel.
2. Push it back in all the way, wait three seconds and then pull it back out again.

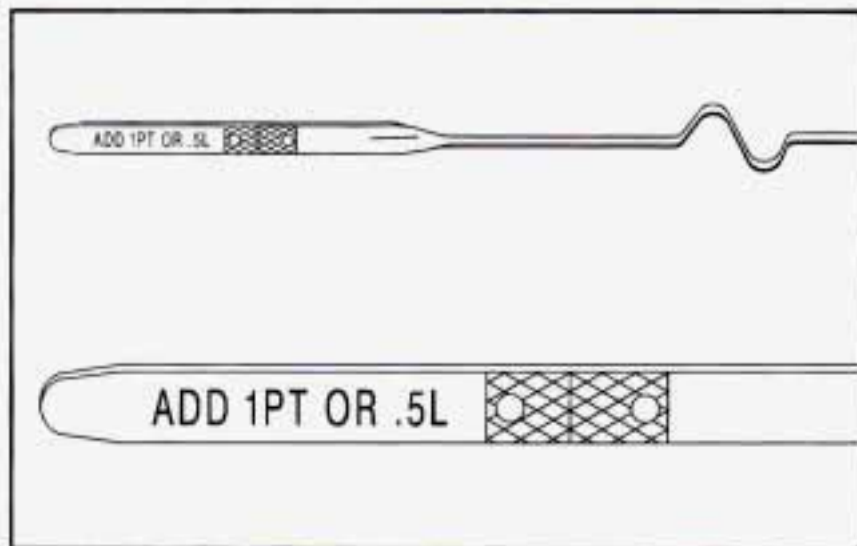

3. Check both sides of the dipstick, and read the lower level. The fluid level must be in the cross-hatched area.
4. If the fluid level is in the acceptable range, push the dipstick back in all the way.

How to Add Fluid

Refer to the Maintenance Schedule to determine what kind of transaxle fluid to use. See “Recommended Fluids and Lubricants” in the Index.

If the fluid level is low, add only enough of the proper fluid to bring the level into the cross-hatched area on the dipstick.

1. Pull out the dipstick.
 2. Using a long-neck funnel, add enough fluid at the dipstick hole to bring it to the proper level. It doesn't take much fluid, generally less than a pint (0.5 L). *Don't overfill.* We recommend you use only fluid labeled DEXRON[®]-III, because fluid with that label is made especially for your automatic transaxle. Damage caused by fluid other than DEXRON-III is not covered by your new vehicle warranty.
- After adding fluid, recheck the fluid level as described under “How to Check.”
 - When the correct fluid level is obtained, push the dipstick back in all the way.

Engine Coolant

The cooling system in your vehicle is filled with new DEX-COOL[™] (orange-colored, silicate-free) engine coolant. This coolant is designed to remain in your vehicle for 5 years or 100,000 miles (166 000 km), whichever occurs first.

The following explains your cooling system and how to add coolant when it is low. If you have a problem with engine overheating, see “Engine Overheating” in the Index.

A 50/50 mixture of water and the proper coolant for your Oldsmobile will:

- Give freezing protection down to -34°F (-37°C).
- Give boiling protection up to 265°F (129°C).
- Protect against rust and corrosion.
- Help keep the proper engine temperature.
- Let the warning lights and gages work as they should.

NOTICE:

When adding coolant it is important that you use DEX-COOL (orange-colored, silicate-free) coolant meeting GM Specification 6277M. If *silicated* coolant is added to the system, premature engine, heater core or radiator corrosion may result. In addition, the engine coolant will require change sooner -- at 30,000 miles (50 000 km) or 24 months, whichever occurs first.

What to Use

Use a mixture of one-half *clean water* (preferably distilled) and one-half DEX-COOL (orange-colored, silicate-free) antifreeze that meets GM Specification 6277M, which won't damage aluminum parts. Use GM Engine Coolant Supplement (sealer) (GM Part No. 3634621) with any complete coolant change. If you use this mixture, you don't need to add anything else.



CAUTION:

Adding only plain water to your cooling system can be dangerous. Plain water, or some other liquid like alcohol, can boil before the proper coolant mix will. Your vehicle's coolant warning system is set for the proper coolant mix. With plain water or the wrong mix, your engine could get too hot but you wouldn't get the overheat warning. Your engine could catch fire and you or others could be burned. Use a 50/50 mix of clean water and DEX-COOL (orange-colored, silicate-free) antifreeze.

NOTICE:

If you use an improper coolant mix, your engine could overheat and be badly damaged. The repair cost wouldn't be covered by your warranty. Too much water in the mix can freeze and crack the engine, radiator, heater core and other parts.

If you have to add coolant more than four times a year, have your retailer check your cooling system.

NOTICE:

If you use the proper coolant, you don't have to add extra inhibitors or additives which claim to improve the system. These can be harmful.

Checking Coolant

The engine coolant reservoir is located on the passenger's side of the vehicle towards the middle of the engine compartment.



When your engine is cold, the coolant level should be at **FULL COLD**, or a little higher. When your engine is warm, the level should be up to **FULL HOT**, or a little higher.

LOW
COOLANT

If this light comes on, it means you're low on engine coolant.

Adding Coolant

If you need more coolant, add the proper mix *at the coolant recovery tank*.



CAUTION:

Turning the radiator pressure cap when the engine and radiator are hot can allow steam and scalding liquids to blow out and burn you badly. With the coolant recovery tank, you will almost never have to add coolant at the radiator. Never turn the radiator pressure cap -- even a little -- when the engine and radiator are hot.

Add coolant mix at the recovery tank, but be careful not to spill it.



CAUTION:

You can be burned if you spill coolant on hot engine parts. Coolant contains ethylene glycol, and it will burn if the engine parts are hot enough. Don't spill coolant on a hot engine.

Radiator Pressure Cap

NOTICE:

Your radiator cap is a 15 psi (105 kPa) pressure-type cap and must be tightly installed to prevent coolant loss and possible engine damage from overheating. Be sure the arrows on the cap line up with the overflow tube on the radiator filler neck.

When you replace your radiator pressure cap, an AC[®] cap is recommended.

Thermostat

Engine coolant temperature is controlled by a thermostat in the engine coolant system. The thermostat stops the flow of coolant through the radiator until the coolant reaches a preset temperature.

When you replace your thermostat, an AC[®] thermostat is recommended.

Power Steering Fluid



The power steering fluid reservoir is located to the right of the engine coolant reservoir, at the back of the engine compartment.

When to Check Power Steering Fluid

It is not necessary to regularly check power steering fluid unless you suspect there is a leak in the system or you hear an unusual noise. A fluid loss in this system could indicate a problem. Have the system inspected and repaired.

How To Check Power Steering Fluid

When the engine compartment is cool, unscrew the cap and wipe the dipstick with a clean rag. Replace the cap and completely tighten it. Then remove the cap again and look at the fluid level on the dipstick.

When the engine compartment is hot, the level should be at the H mark. When it's cold, the level should be at the C mark. If the fluid is at the ADD mark, you should add fluid.

What to Use

Refer to the Maintenance Schedule to determine what kind of fluid to use. See "Recommended Fluids and Lubricants" in the Index. Always use the proper fluid. Failure to use the proper fluid can cause leaks and damage hoses and seals.

Windshield Washer Fluid

What to Use

When you need windshield washer fluid, be sure to read the manufacturer's instructions before use. If you will be operating your vehicle in an area where the temperature may fall below freezing, use a fluid that has sufficient protection against freezing.

Adding Washer Fluid

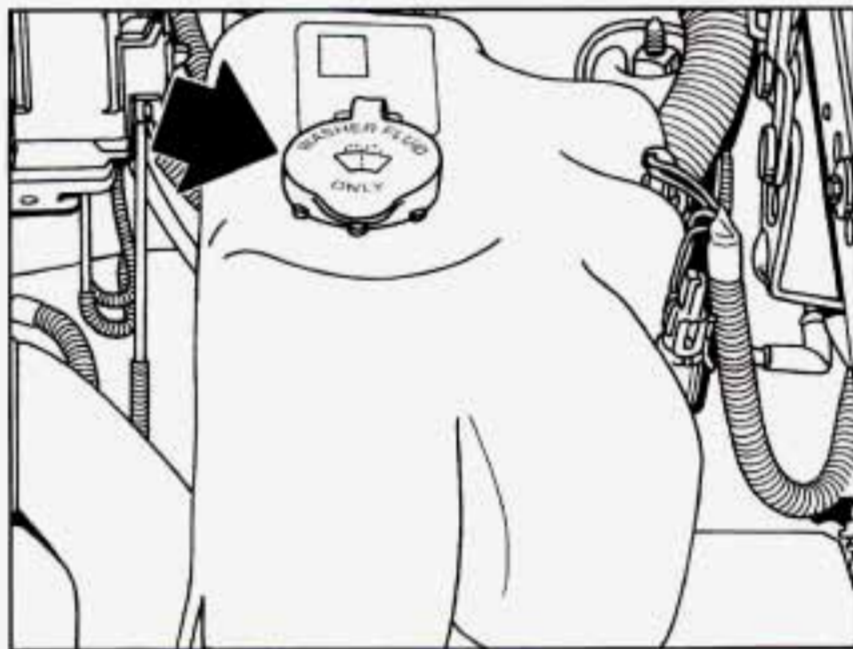

The windshield washer fluid reservoir is located on the driver's side of the vehicle, toward the front of the engine compartment.

Open the cap labeled WASHER FLUID ONLY. Add washer fluid until the tank is full.

NOTICE:

- When using concentrated washer fluid, follow the manufacturer's instructions for adding water.
- Don't mix water with ready-to-use washer fluid. Water can cause the solution to freeze and damage your washer fluid tank and other parts of the washer system. Also, water doesn't clean as well as washer fluid.
- Fill your washer fluid tank only three-quarters full when it's very cold. This allows for expansion, which could damage the tank if it is completely full.
- Don't use radiator antifreeze in your windshield washer. It can damage your washer system and paint.

Brakes

Brake Fluid

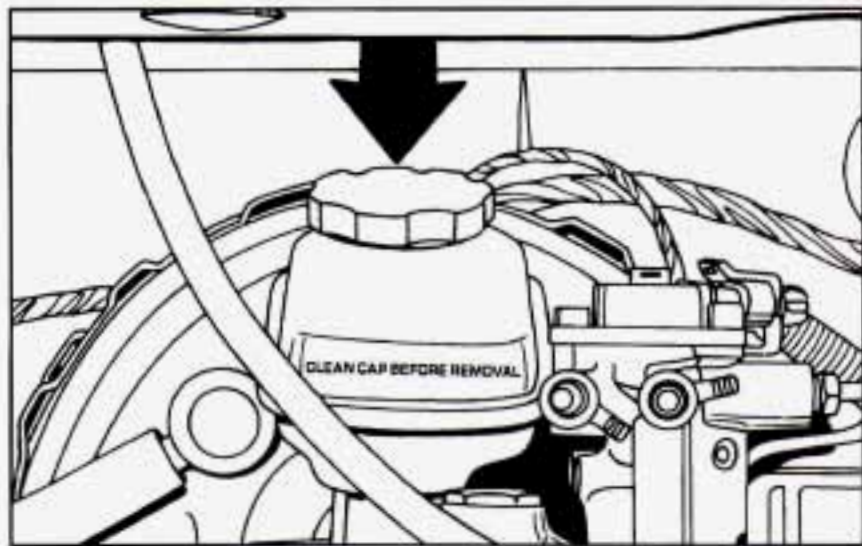

Your brake master cylinder reservoir is here. It is filled with DOT-3 brake fluid.

There are only two reasons why the brake fluid level in the reservoir might go down. The first is that the brake fluid goes down to an acceptable level during normal

brake lining wear. When new linings are put in, the fluid level goes back up. The other reason is that fluid is leaking out of the brake system. If it is, you should have your brake system fixed, since a leak means that sooner or later your brakes won't work well, or won't work at all.

So, it isn't a good idea to "top off" your brake fluid. Adding brake fluid won't correct a leak. If you add fluid when your linings are worn, then you'll have too much fluid when you get new brake linings. You should add (or remove) brake fluid, as necessary, only when work is done on the brake hydraulic system.

CAUTION:

If you have too much brake fluid, it can spill on the engine. The fluid will burn if the engine is hot enough. You or others could be burned, and your vehicle could be damaged. Add brake fluid only when work is done on the brake hydraulic system.

BRAKE

When your brake fluid falls to a low level, your brake warning light will come on. See “Brake System Warning Light” in the Index.

What to Add

When you do need brake fluid, use only DOT-3 brake fluid -- such as Delco Supreme 11[®] (GM Part No. 1052535). Use new brake fluid from a sealed container only, and always clean the brake fluid reservoir cap before removing it.

CAUTION:

With the wrong kind of fluid in your brake system, your brakes may not work well, or they may not even work at all. This could cause a crash. Always use the proper brake fluid.

NOTICE:

- **Using the wrong fluid can badly damage brake system parts. For example, just a few drops of mineral-based oil, such as engine oil, in your brake system can damage brake system parts so badly that they'll have to be replaced. Don't let someone put in the wrong kind of fluid.**
- **If you spill brake fluid on your vehicle's painted surfaces, the paint finish can be damaged. Be careful not to spill brake fluid on your vehicle. If you do, wash it off immediately. See “Appearance Care” in the Index.**

Brake Wear

Your Oldsmobile has front disc brakes and rear drum brakes.

Disc brake pads have built-in wear indicators that make a high-pitched warning sound when the brake pads are worn and new pads are needed. The sound may come and go or be heard all the time your vehicle is moving (except when you are pushing on the brake pedal firmly).

CAUTION:

The brake wear warning sound means that sooner or later your brakes won't work well. That could lead to an accident. When you hear the brake wear warning sound, have your vehicle serviced.

NOTICE:

Continuing to drive with worn-out brake pads could result in costly brake repair.

Some driving conditions or climates may cause a brake squeal when the brakes are first applied or lightly applied. This does not mean something is wrong with your brakes.

Free movement of brake calipers and properly torqued wheel nuts are necessary to help prevent brake pulsation. When tires are rotated, inspect brake calipers for movement, brake pads for wear, and evenly torque wheel nuts in the proper sequence to GM specifications.

Your rear drum brakes don't have wear indicators, but if you ever hear a rear brake rubbing noise, have the rear brake linings inspected. Also, the rear brake drums should be removed and inspected each time the tires are removed for rotation or changing. When you have the front brakes replaced, have the rear brakes inspected, too.

Brake linings should always be replaced as complete axle sets.

Brake Pedal Travel

See your retailer if the brake pedal does not return to normal height, or if there is a rapid increase in pedal travel. This could be a sign of brake trouble.

Brake Adjustment

Every time you apply the brakes, with or without the vehicle moving, your brakes adjust for wear.

Replacing Brake System Parts

The braking system on a modern vehicle is complex. Its many parts have to be of top quality and work well together if the vehicle is to have really good braking. Vehicles we design and test have top-quality GM brake parts in them, as your Oldsmobile does when it is new. When you replace parts of your braking system -- for example, when your brake linings wear down and you have to have new ones put in -- be sure you get new genuine GM replacement parts. If you don't, your brakes may no longer work properly. For example, if someone puts in brake linings that are wrong for your vehicle, the balance between your front and rear brakes can change -- for the worse. The braking performance you've come to expect can change in many other ways if someone puts in the wrong replacement brake parts.

Battery

Every new Oldsmobile has a Delco Freedom[®] battery. You never have to add water to one of these. When it's time for a new battery, we recommend a Delco Freedom battery. Get one that has the replacement number shown on the original battery's label.

Vehicle Storage

If you're not going to drive your vehicle for 25 days or more, take off the black, negative (-) cable from the battery. This will help keep your battery from running down.



CAUTION:

Batteries have acid that can burn you and gas that can explode. You can be badly hurt if you aren't careful. See "Jump Starting" in the Index for tips on working around a battery without getting hurt.

Contact your retailer to learn how to prepare your vehicle for longer storage periods.

Also, for your audio system, see "Theft-Deterrent Feature" in the Index.

Jump Starting

For jump starting instructions, see “Jump Starting” in the Index.

Bulb Replacement

For the type of bulb, see “Replacement Bulbs” in the Index.

Halogen Bulbs

CAUTION:

Halogen bulbs have pressurized gas inside and can burst if you drop or scratch the bulb. You or others could be injured. Be sure to read and follow the instructions on the bulb package.

Headlamps

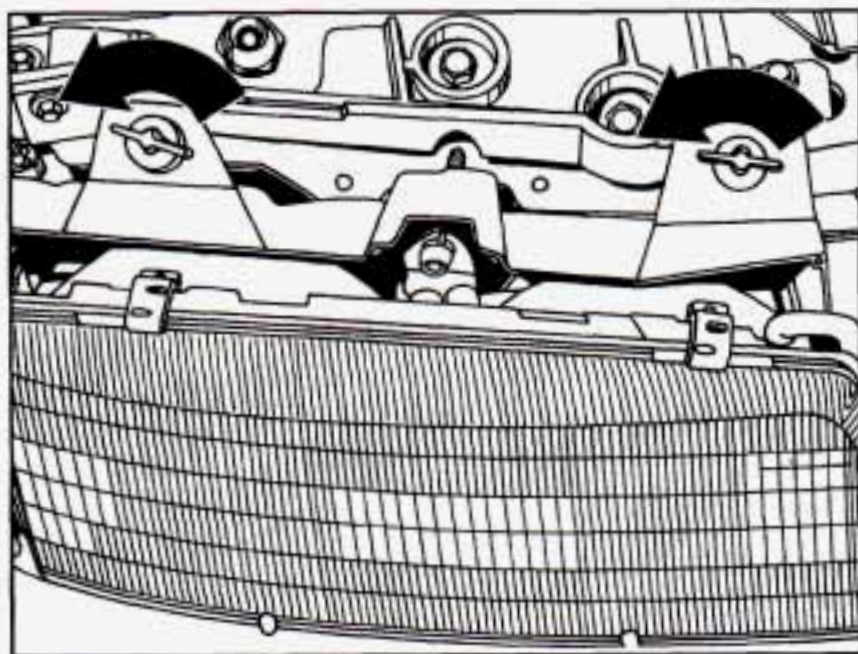

1. Remove the two black knobs.
2. Tilt the bulb housing forward.

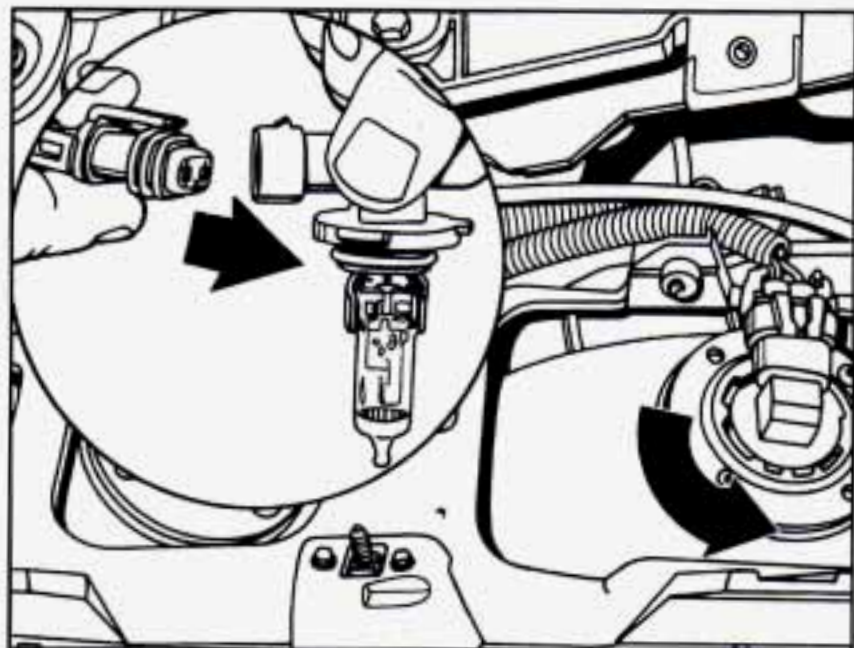

3. Twist the L-shaped bulb assembly counterclockwise one-sixth of a turn until the flanges align with the slots in the retainer ring.
4. Pull out the bulb assembly.
5. Disconnect the bulb wiring harness from the bulb assembly by lifting the plastic locking tab.

6. Snap a new bulb assembly into the wiring harness.
7. Replace the bulb assembly by reversing Step 3.
8. Replace the bulb housing and the two black knobs.

Front Parking/Turn Signal Lamps

1. Remove the headlamp assembly as described in "Headlamps."
2. Remove the lamp socket furthest inboard by pinching the lever and turning counterclockwise.
3. After replacing the bulb, line up the flanges on the socket with the slots in the headlamp capsule.
4. Push and turn the socket one-sixth of a turn clockwise.

Front Sidemarker

1. From behind the front bumper, remove the lamp socket from the lamp assembly by twisting counterclockwise.
2. With the bulb replaced, insert the lamp socket into the lamp assembly and turn clockwise.

License Plate Lamp

1. Remove the two screws from the lamp lens.

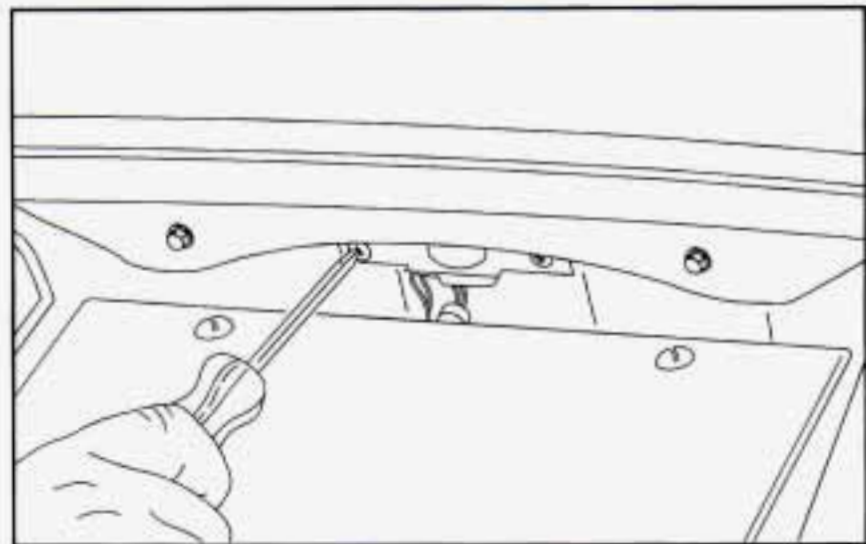

2. Remove the lamp lens from the liftgate.

3. Twist the lamp socket counterclockwise to remove it from the lamp lens.
4. Replace with the new bulb and twist the lamp socket clockwise in the lamp lens.
5. Replace the lamp lens in the liftgate and tighten with screws.

Back-up Lamp

1. Remove the license plate.
2. Unscrew the two bolts and pull the housing away from the tailgate.
3. Remove the bulb from the lamp socket.
4. Replace with the new bulb and twist the lamp socket clockwise in the lamp assembly.
5. Reinstall the entire back-up lamp housing and secure with the screws.
6. Replace the license plate.

Center High-Mounted Stoplamp

1. Remove the two screws from the lamp assembly.

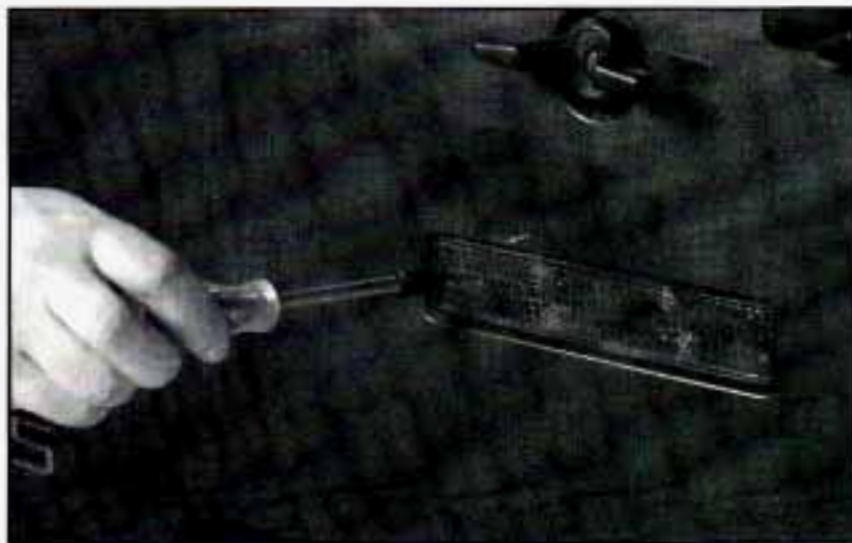

2. Pull the assembly out and away from the liftgate.
3. Remove the bulbs from the lamp socket.

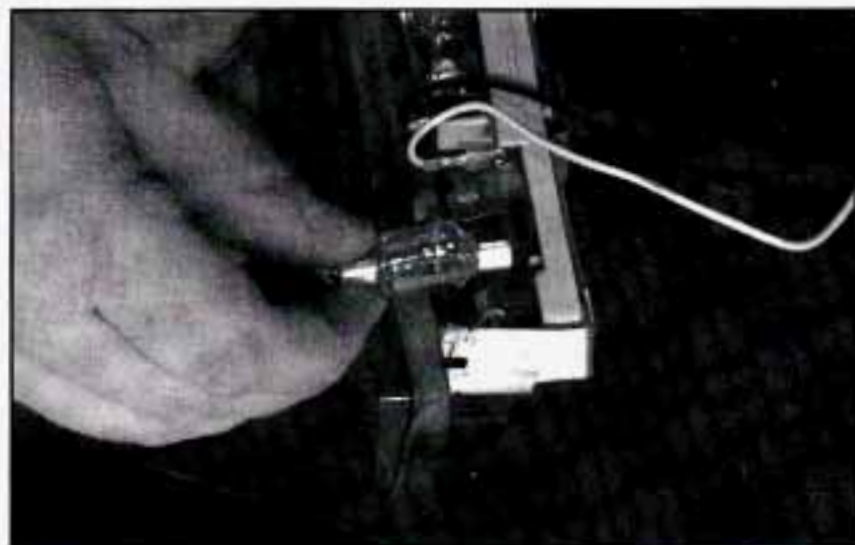

4. Reinstall the lamp assembly into the liftgate and secure with the screws.

Taillamps

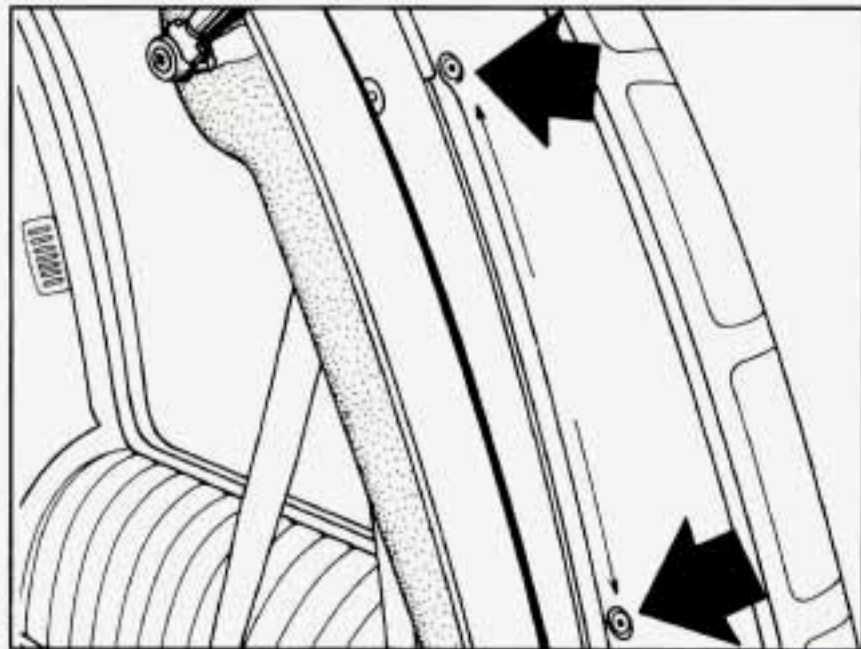

For the type of bulb, see “Replacement Bulbs” in the Index.

1. Open the rear side windows and liftgate.
2. Remove the two screws from the taillamp housing.
3. Undo the spring clips under the weatherstrip at the rear of the side window.

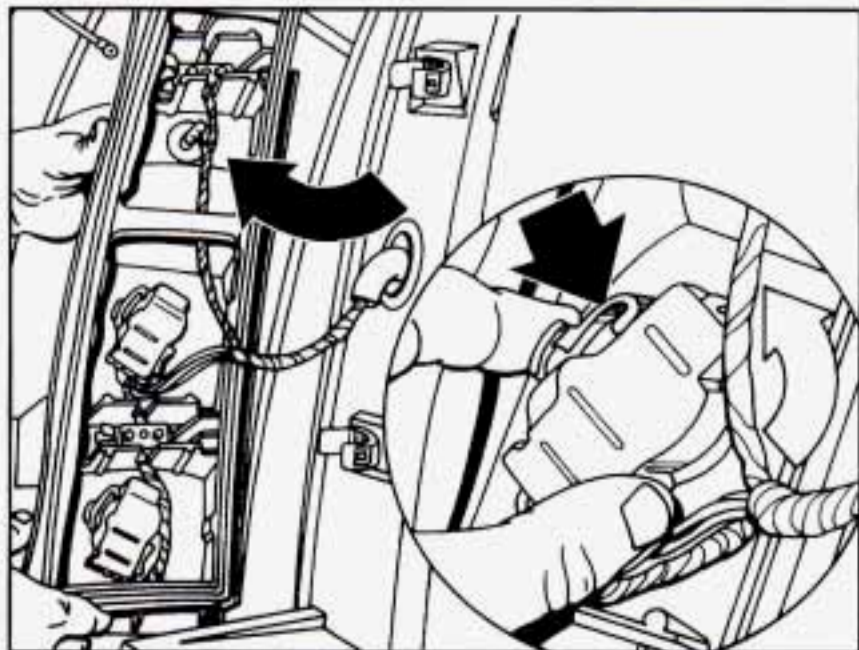

4. Pull off the entire taillamp housing.
5. Pinch the lever and twist the bulb assembly one-sixth of a turn counterclockwise to remove.
6. Remove the bulb by pressing in and turning one-eighth of a turn counterclockwise.
7. Line up the small retainer bumps on the replacement bulb so that the lower bump slides into the deepest slot in the housing. Press in and twist the bulb one-eighth of a turn clockwise. Reposition the bulb assembly in the taillamp housing. Turn the assembly one-sixth of a turn clockwise to lock in place.

8. Replace the entire taillamp housing and screws.

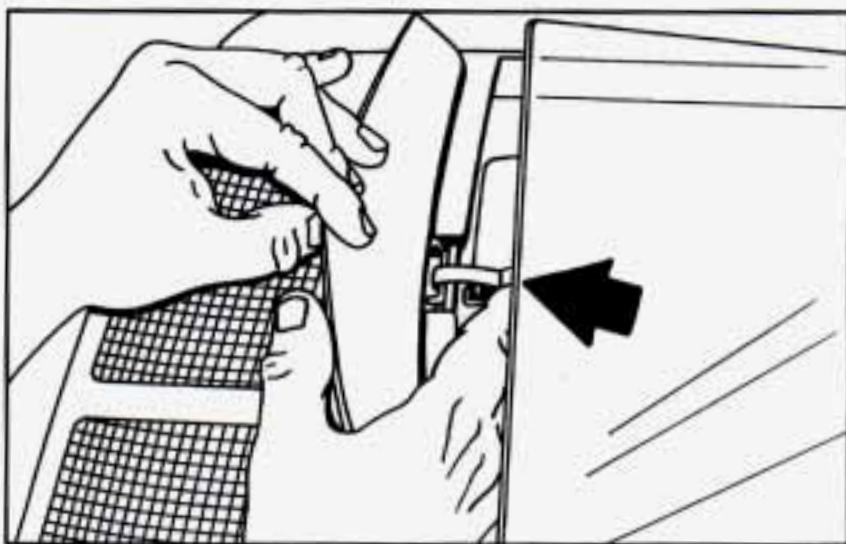

9. Attach the spring clips to the taillamp housing and secure them.
10. Close the rear side windows and liftgate.
11. Test the bulbs by using your turn signals and taillamps.
- For any bulb changing procedure not listed in this section, contact your Oldsmobile retailer service department.

Windshield Wiper Blade Replacement

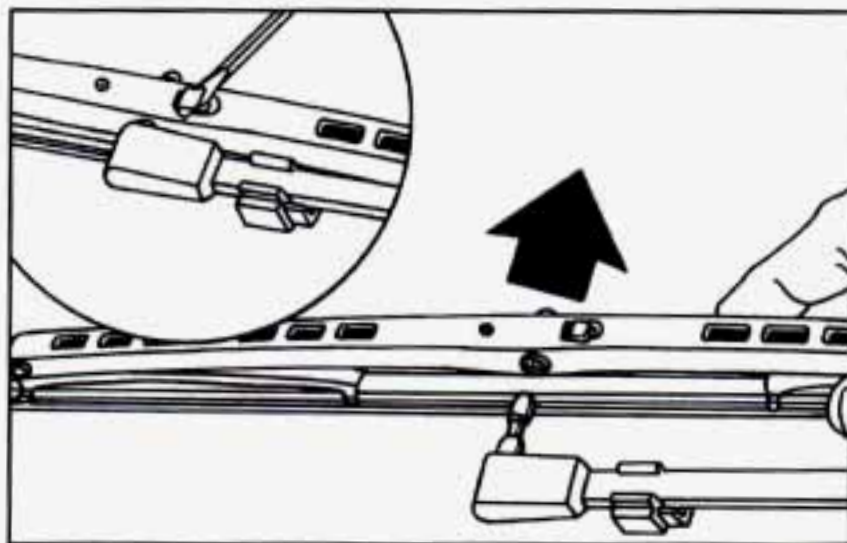

Replacement blades for your vehicle are 24 inches (61 cm) in length. They come in different types and are removed in different ways. Here's how to remove the type with a release clip:

1. Pull the windshield wiper arm away from the windshield.
2. Lift the release clip with a screwdriver and pull the blade assembly off the wiper arm.
3. Push the new wiper blade securely on the wiper arm.

Tires

We don't make tires. Your new Oldsmobile comes with high-quality tires made by a leading tire manufacturer. If you ever have questions about your tire warranty and where to obtain service, see your Oldsmobile Warranty booklet for details.

CAUTION:

Poorly maintained and improperly used tires are dangerous.

- **Overloading your tires can cause overheating as a result of too much friction. You could have an air-out and a serious accident. See "Loading Your Vehicle" in the Index.**

CAUTION: (Continued)

CAUTION: (Continued)

- **Underinflated tires pose the same danger as overloaded tires. The resulting accident could cause serious injury. Check all tires frequently to maintain the recommended pressure. Tire pressure should be checked when your tires are cold.**
- **Overinflated tires are more likely to be cut, punctured or broken by a sudden impact -- such as when you hit a pothole. Keep tires at the recommended pressure.**
- **Worn, old tires can cause accidents. If your tread is badly worn, or if your tires have been damaged, replace them.**

Inflation -- Tire Pressure

The Certification/Tire label, which is on the rear edge of the driver's door, shows the correct inflation pressures for your tires when they're cold. "Cold" means your vehicle has been sitting for at least three hours or driven no more than 1 mile (1.6 km).

NOTICE:

Don't let anyone tell you that underinflation or overinflation is all right. It's not. If your tires don't have enough air (underinflation), you can get the following:

- Too much flexing
- Too much heat
- Tire overloading
- Bad wear
- Bad handling
- Bad fuel economy.

NOTICE: (Continued)

NOTICE: (Continued)

If your tires have too much air (overinflation), you can get the following:

- Unusual wear
- Bad handling
- Rough ride
- Needless damage from road hazards.

When to Check

Check your tires once a month or more.

Don't forget your compact spare tire. It should be at 60 psi (420 kPa).

How to Check

Use a good quality pocket-type gage to check tire pressure. You can't tell if your tires are properly inflated simply by looking at them. Radial tires may look properly inflated even when they're underinflated.

Be sure to put the valve caps back on the valve stems. They help prevent leaks by keeping out dirt and moisture.

Tire Inspection and Rotation

Tires should be inspected every 6,000 to 8,000 miles (10 000 to 13 000 km) for any signs of unusual wear. If unusual wear is present, rotate your tires as soon as possible and check wheel alignment. Also check for damaged tires or wheels. See “When It’s Time for New Tires” and “Wheel Replacement” later in this section for more information.

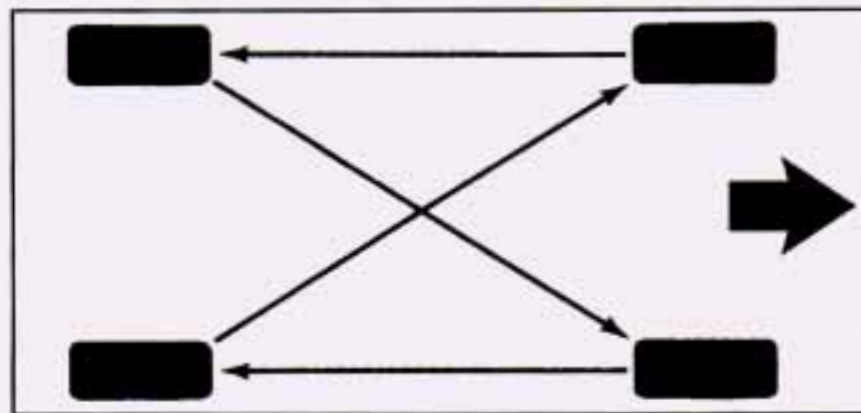

The purpose of regular rotation is to achieve more uniform wear for all tires on the vehicle. The first rotation is the most important. See “Scheduled Maintenance Services” in the Index for scheduled rotation intervals.

When rotating your tires, always use the correct rotation pattern shown here.

Don’t include the compact spare tire in your tire rotation.

After the tires have been rotated, adjust the front and rear inflation pressures as shown on the Certification/Tire label. Make certain that all wheel nuts are properly tightened. See “Wheel Nut Torque” in the Index.

CAUTION:

Rust or dirt on a wheel, or on the parts to which it is fastened, can make wheel nuts become loose after a time. The wheel could come off and cause an accident. When you change a wheel, remove any rust or dirt from places where the wheel attaches to the vehicle. In an emergency, you can use a cloth or a paper towel to do this; but be sure to use a scraper or wire brush later, if you need to, to get all the rust or dirt off. (See “Changing a Flat Tire” in the Index.)

When It's Time for New Tires

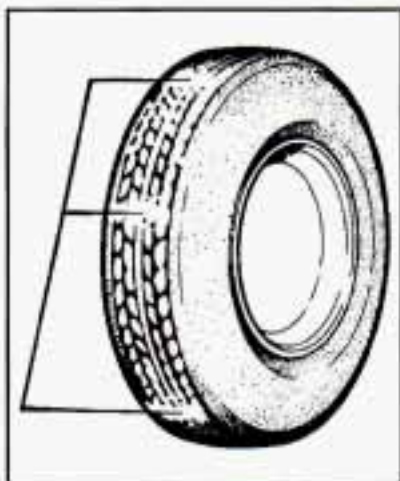

One way to tell when it's time for new tires is to check the treadwear indicators, which will appear when your tires have only 1/16 inch (1.6 mm) or less of tread remaining.

You need a new tire if any of the following statements are true:

- You can see the indicators at three or more places around the tire.
- You can see cord or fabric showing through the tire's rubber.
- The tread or sidewall is cracked, cut or snagged deep enough to show cord or fabric.

- The tire has a bump, bulge or split.
- The tire has a puncture, cut or other damage that can't be repaired well because of the size or location of the damage.

Buying New Tires

To find out what kind and size of tires you need, look at the Certification/Tire label.

The tires installed on your vehicle when it was new had a Tire Performance Criteria Specification (TPC Spec) number on each tire's sidewall. When you get new tires, get ones with that same TPC Spec number. That way your vehicle will continue to have tires that are designed to give proper endurance, handling, speed rating, traction, ride and other things during normal service on your vehicle. If your tires have an all-season tread design, the TPC number will be followed by an "MS" (for mud and snow).

If you ever replace your tires with those not having a TPC Spec number, make sure they are the same size, load range, speed rating and construction type (bias, bias-belted or radial) as your original tires.

CAUTION:

Mixing tires could cause you to lose control while driving. If you mix tires of different sizes or types (radial and bias-belted tires), the vehicle may not handle properly, and you could have a crash. Using tires of different sizes may also cause damage to your vehicle. Be sure to use the same size and type tires on all wheels.

It's all right to drive with your compact spare, though. It was developed for use on your vehicle.

Uniform Tire Quality Grading

The following information relates to the system developed by the United States National Highway Traffic Safety Administration, which grades tires by treadwear, traction and temperature performance. (This applies only to vehicles sold in the United States.) The grades are molded on the sidewalls of most passenger car tires. The Uniform Tire Quality Grading system does not apply to deep tread, winter-type snow tires, space-saver or temporary use spare tires, tires with nominal rim diameters of 10 to 12 inches (25 to 30 cm), or to some limited-production tires.

While the tires available on General Motors passenger cars and light trucks may vary with respect to these grades, they must also conform to Federal safety requirements and additional General Motors Tire Performance Criteria (TPC) standards.

Treadwear

The treadwear grade is a comparative rating based on the wear rate of the tire when tested under controlled conditions on a specified government test course. For example, a tire graded 150 would wear one and a half (1 1/2) times as well on the government course as a tire graded 100. The relative performance of tires depends upon the actual conditions of their use, however, and may depart significantly from the norm due to variations in driving habits, service practices and differences in road characteristics and climate.

Traction -- A, B, C

The traction grades, from highest to lowest, are A, B, and C, and they represent the tire's ability to stop on wet pavement as measured under controlled conditions on specified government test surfaces of asphalt and concrete. A tire marked C may have poor traction performance.

Warning: The traction grade assigned to this tire is based on braking (straightahead) traction tests and does not include cornering (turning) traction.

Temperature -- A, B, C

The temperature grades are A (the highest), B, and C, representing the tire's resistance to the generation of heat and its ability to dissipate heat when tested under controlled conditions on a specified indoor laboratory test wheel. Sustained high temperature can cause the material of the tire to degenerate and reduce tire life, and excessive temperature can lead to sudden tire failure.

The grade C corresponds to a level of performance which all passenger car tires must meet under the Federal Motor Vehicle Safety Standard No. 109. Grades B and A represent higher levels of performance on the laboratory test wheel than the minimum required by law.

Warning: The temperature grade for this tire is established for a tire that is properly inflated and not overloaded. Excessive speed, underinflation, or excessive loading, either separately or in combination, can cause heat buildup and possible tire failure.

Wheel Alignment and Tire Balance

The wheels on your vehicle were aligned and balanced carefully at the factory to give you the longest tire life and best overall performance.

In most cases, you will not need to have your wheels aligned again. However, if you notice unusual tire wear or your vehicle pulling one way or the other, the alignment may need to be reset. If you notice your vehicle vibrating when driving on a smooth road, your wheels may need to be rebalanced.

Wheel Replacement

Replace any wheel that is bent, cracked, or badly rusted or corroded. If wheel nuts keep coming loose, the wheel, wheel bolts and wheel nuts should be replaced. If the wheel leaks air, replace it (except some aluminum wheels, which can sometimes be repaired). See your Oldsmobile retailer if any of these conditions exist.

Your retailer will know the kind of wheel you need.

Each new wheel should have the same load-carrying capacity, diameter, width, offset and be mounted the same way as the one it replaces.

If you need to replace any of your wheels, wheel bolts or wheel nuts, replace them only with new GM original equipment parts. This way, you will be sure to have the right wheel, wheel bolts and wheel nuts for your Oldsmobile model.

 **CAUTION:**

Using the wrong replacement wheels, wheel bolts or wheel nuts on your vehicle can be dangerous. It could affect the braking and handling of your vehicle, make your tires lose air and make you lose control. You could have a collision in which you or others could be injured. Always use the correct wheel, wheel bolts and wheel nuts for replacement.

NOTICE:

The wrong wheel can also cause problems with bearing life, brake cooling, speedometer or odometer calibration, headlamp aim, bumper height, vehicle ground clearance and tire or tire chain clearance to the body and chassis.

See “Changing a Flat Tire” in the Index for more information.

Used Replacement Wheels

 **CAUTION:**

Putting a used wheel on your vehicle is dangerous. You can't know how it's been used or how many miles it's been driven. It could fail suddenly and cause an accident. If you have to replace a wheel, use a new GM original equipment wheel.

Tire Chains

NOTICE:

Use tire chains only where legal and only when you must. Use only SAE Class "S" type chains that are the proper size for your tires. Install them on the front tires and tighten them as tightly as possible with the ends securely fastened. Drive slowly and follow the chain manufacturer's instructions. If you can hear the chains contacting your vehicle, stop and retighten them. If the contact continues, slow down until it stops. Driving too fast or spinning the wheels with chains on will damage your vehicle.

Appearance Care

Remember, cleaning products can be hazardous. Some are toxic. Others can burst into flame if you strike a match or get them on a hot part of the vehicle. Some are dangerous if you breathe their fumes in a closed space. When you use anything from a container to clean your Oldsmobile, be sure to follow the manufacturer's

warnings and instructions. And always open your doors or windows when you're cleaning the inside.

Never use these to clean your vehicle:

- Gasoline
- Benzene
- Naphtha
- Carbon Tetrachloride
- Acetone
- Paint Thinner
- Turpentine
- Lacquer Thinner
- Nail Polish Remover

They can all be hazardous -- some more than others -- and they can all damage your vehicle, too.

Don't use any of these unless this manual says you can. In many uses, these will damage your vehicle:

- Alcohol
- Laundry Soap
- Bleach
- Reducing Agents

Cleaning the Inside of Your Oldsmobile

Use a vacuum cleaner often to get rid of dust and loose dirt. Wipe vinyl or leather with a clean, damp cloth.

Your Oldsmobile retailer has two GM cleaners, a solvent-type spot lifter and a foam-type powdered cleaner. They will clean normal spots and stains very well. Do not use them on vinyl or leather.

Here are some cleaning tips:

- Always read the instructions on the cleaner label.
- Clean up stains as soon as you can -- before they set.
- Use a clean cloth or sponge, and change to a clean area often. A soft brush may be used if stains are stubborn.
- Use solvent-type cleaners in a well-ventilated area only. If you use them, don't saturate the stained area.
- If a ring forms after spot cleaning, clean the entire area immediately or it will set.

Using Foam-Type Cleaner on Fabric

1. Vacuum and brush the area to remove any loose dirt.
2. Always clean a whole trim panel or section. Mask surrounding trim along stitch or welt lines.
3. Mix Multi-Purpose Powdered Cleaner following the directions on the container label.
4. Use suds only and apply with a clean sponge.
5. Don't saturate the material.
6. Don't rub it roughly.
7. As soon as you've cleaned the section, use a sponge to remove the suds.
8. Rinse the section with a clean, wet sponge.
9. Wipe off what's left with a slightly damp paper towel or cloth.
10. Then dry it immediately with a blow dryer.
11. Wipe with a clean cloth.

Using Solvent-Type Cleaner on Fabric

First, see if you have to use solvent-type cleaner at all. Some spots and stains will clean off better with just water and mild soap.

If you need to use a solvent:

- Gently scrape excess soil from the trim material with a clean, dull knife or scraper. Use very little cleaner, light pressure and clean cloths (preferably cheesecloth). Cleaning should start at the outside of the stain, “feathering” toward the center. Keep changing to a clean section of the cloth.
- When you clean a stain from fabric, immediately dry the area with a blow dryer to help prevent a cleaning ring.

Special Cleaning Problems

Greasy or Oily Stains

Stains caused by grease, oil, butter, margarine, shoe polish, coffee with cream, chewing gum, cosmetic creams, vegetable oils, wax crayon, tar and asphalt can be removed as follows:

1. Carefully scrape off excess stain.
2. Follow the solvent-type instructions described earlier.

3. Shoe polish, wax crayon, tar and asphalt will stain if left on a vehicle’s seat fabric. They should be removed as soon as possible. Be careful, because the cleaner will dissolve them and may cause them to spread.

Non-Greasy Stains

Stains caused by catsup, coffee (black), egg, fruit, fruit juice, milk, soft drinks, wine, vomit, urine and blood can be removed as follows:

1. Carefully scrape off excess stain, then sponge the soiled area with cool water.
2. If a stain remains, follow the foam-type instructions described earlier.
3. If an odor lingers after cleaning vomit or urine, treat the area with a water/baking soda solution: 1 teaspoon (5 ml) of baking soda to 1 cup (250 ml) of lukewarm water.
4. If needed, clean lightly with solvent-type cleaner.

Combination Stains

Stains caused by candy, ice cream, mayonnaise, chili sauce and unknown stains can be removed as follows:

- Carefully scrape off excess stain, then clean with cool water and allow to dry.
- If a stain remains, clean it with solvent-type cleaner.

Cleaning Vinyl

Use warm water and a clean cloth.

- Rub with a clean, damp cloth to remove dirt. You may have to do it more than once.
- Things like tar, asphalt and shoe polish will stain if you don't get them off quickly. Use a clean cloth and a GM Vinyl/Leather Cleaner or equivalent product.

Cleaning Leather

Use a soft cloth with lukewarm water and a mild soap or saddle soap.

- For stubborn stains, use a GM Vinyl/Leather Cleaner or equivalent product.
- *Never* use oils, varnishes, solvent-based or abrasive cleaners, furniture polish or shoe polish on leather.
- Soiled leather should be cleaned immediately. If dirt is allowed to work into the finish, it can harm the leather.

Cleaning the Top of the Instrument Panel

Use only mild soap and water to clean the top surfaces of the instrument panel. Sprays containing silicones or waxes may cause annoying reflections in the windshield and even make it difficult to see through the windshield under certain conditions.

Cleaning the Built-In Child Restraint Pad

The built-in child restraint pad is attached to the seat frame with fastener strips. You can remove the pad and hand wash it with mild soap and water.

Care of Safety Belts and Built-in Child Restraint Harness

Keep the safety belts and the built-in child restraint harness clean and dry.



CAUTION:

Do not bleach or dye safety belts or the built-in child restraint harness. If you do, they may be severely weakened. In a crash, they might not be able to provide adequate protection. Clean the safety belts and the child restraint harness only with mild soap and lukewarm water.

Glass

Glass should be cleaned often. GM Glass Cleaner (GM Part No. 1050427) or a liquid household glass cleaner will remove normal tobacco smoke and dust films.

Don't use abrasive cleaners on glass, because they may cause scratches. Avoid placing decals on the inside rear window, since they may have to be scraped off later. If abrasive cleaners are used on the inside of the rear window, an electric defogger element may be damaged. Any temporary license should not be attached across the defogger grid.

Cleaning the Outside of the Windshield, Backglass and Wiper Blades

If the windshield is not clear after using the windshield washer, or if the wiper blade chatters when running, wax or other material may be on the blade or windshield.

Clean the outside of the windshield with GM Windshield Cleaner, Bon-Ami Powder[®] (GM Part No. 1050011). The windshield is clean if beads do not form when you rinse it with water.

Clean the blade by wiping vigorously with a cloth soaked in full-strength windshield washer solvent. Then rinse the blade with water.

Wiper blades should be checked on a regular basis and replaced when worn.

Weatherstrips

Silicone grease on weatherstrips will make them last longer, seal better, and not stick or squeak. Apply silicone grease with a clean cloth at least every six months. During very cold, damp weather more frequent application may be required. (See "Recommended Fluids and Lubricants" in the Index.)

Cleaning the Outside of Your Oldsmobile

The paint finish on your vehicle provides beauty, depth of color, gloss retention and durability.

Washing Your Vehicle

The best way to preserve your vehicle's finish is to keep it clean by washing it often with lukewarm or cold water.

Don't wash your vehicle in the direct rays of the sun. Don't use strong soaps or chemical detergents. Use liquid hand, dish or car washing (mild detergent) soaps.

Don't use cleaning agents that are petroleum based, or that contain acid or abrasives. All cleaning agents should be flushed promptly and not allowed to dry on the surface, or they could stain. Dry the finish with a soft, clean chamois or a 100% cotton towel to avoid surface scratches and water spotting.

Before you enter an automatic car wash, if your vehicle is equipped with the optional power sliding door, be sure to have the ON/OFF switch in the OFF position.

High pressure car washes may cause water to enter your vehicle.

Finish Care

Occasional waxing or mild polishing of your Oldsmobile by hand may be necessary to remove residue from the paint finish. You can get GM-approved cleaning products from your retailer. (See "Appearance Care and Materials" in the Index.)

Your Oldsmobile has a "basecoat/clearcoat" paint finish. The clearcoat gives more depth and gloss to the colored basecoat. Always use waxes and polishes that are non-abrasive and made for a basecoat/clearcoat paint finish.

NOTICE:

Machine compounding or aggressive polishing on a basecoat/clearcoat paint finish may dull the finish or leave swirl marks.

Foreign materials such as calcium chloride and other salts, ice melting agents, road oil and tar, tree sap, bird droppings, chemicals from industrial chimneys, etc., can damage your vehicle's finish if they remain on painted surfaces. Wash the vehicle as soon as possible. If necessary, use non-abrasive cleaners that are marked safe for painted surfaces to remove foreign matter.

Exterior painted surfaces are subject to aging, weather and chemical fallout that can take their toll over a period of years. You can help to keep the paint finish looking new by keeping your Oldsmobile garaged or covered whenever possible.

Aluminum Wheels (If So Equipped)

Keep your wheels clean using a soft clean cloth with mild soap and water. Rinse with clean water. After rinsing thoroughly, dry with a soft clean towel. A wax may then be applied.

The surface of these wheels is similar to the painted surface of your vehicle. Don't use strong soaps, chemicals, abrasive polishes, abrasive cleaners or abrasive cleaning brushes on them because you could damage the surface.

Don't take your vehicle through an automatic car wash that has silicon carbide tire cleaning brushes. These brushes can also damage the surface of these wheels.

Tires

To clean your tires, use a stiff brush with a tire cleaner.

NOTICE:

When applying a tire dressing always take care to wipe off any overspray or splash from all painted surfaces on the body or wheels of the vehicle. Petroleum-based products may damage the paint finish.

Finish Damage

Any stone chips, fractures or deep scratches in the finish should be repaired right away.

Minor chips and scratches can be repaired with touch-up materials available from your retailer or other service outlets. Larger areas of finish damage can be corrected in your retailer's body and paint shop.

Underbody Maintenance

Chemicals used for ice and snow removal and dust control can collect on the underbody. If these are not removed, accelerated corrosion (rust) can occur on the underbody parts such as fuel lines, frame, floor pan and exhaust system even though they have corrosion protection.

At least every spring, flush these materials from the underbody with plain water. Clean any areas where mud and other debris can collect. Dirt packed in closed areas of the frame should be loosened before being flushed. Your retailer or an underbody vehicle washing system can do this for you.

Collision Repair

Your vehicle was built with composite SMC (Sheet Molded Compound) fiberglass body panels and molded RIM (Reaction Injection Molded) front fenders and bumper covers. These panels require different collision repair procedures than metal-paneled vehicles. See your Oldsmobile retailer for information on collision repair.

Chemical Paint Spotting

Some weather and atmospheric conditions can create a chemical fallout. Airborne pollutants can fall upon and attack painted surfaces on your vehicle. This damage can take two forms: blotchy, ringlet-shaped discolorations, and small irregular dark spots etched into the paint surface.

Although no defect in the paint job causes this, Oldsmobile will repair, at no charge to the owner, the surfaces of new vehicles damaged by this fallout condition within 12 months or 12,000 miles (20 000 km) of purchase, whichever occurs first.

Appearance Care Materials Chart

PART NUMBER	SIZE	DESCRIPTION	USAGE
1050004	2.75 sq. ft.	Chamois	Shines vehicle without scratching
1050172	16 oz. (0.473 L)	Tar and Road Oil Remover	Also removes old waxes and polishes
1050173	16 oz. (0.473 L)	Chrome Cleaner and Polish	Removes rust and corrosion
1050174	16 oz. (0.473 L)	White Sidewall Tire Cleaner	Removes soil and black marks
1050201	16 oz. (0.473 L)	Magic Mirror Cleaner Polish	Exterior cleaner and polish
1050214	32 oz. (0.946 L)	Vinyl and Leather Cleaner	Spot and stain removal
1050427	23 oz. (0.680 L)	Glass Cleaner	Cleans grease, grime and smoke film
1050429	6 lbs. (2.72 kg)	Multi-Purpose Powdered Cleaner	Cleans vinyl, cloth, tires and mats
1051398*	8 oz. (0.237 L)	Spot Lifter	For cloth
1051515	32 oz. (0.946 L)	Optikleen	Windshield washer solvent and antifreeze
1052870	16 oz. (0.473 L)	Wash and Wax Concentrate	Exterior wash
1052918**	8 oz. (0.237 L)	Armor All™ Protector	Protects vinyl, leather and rubber
1052929	16 oz. (0.473 L)	Wheel Cleaner	Spray on wheel cleaner
1052930	8 oz. (0.237 L)	Capture Dry Spot Remover	Attracts and absorbs soils
12345002**	16 oz. (0.473 L)	Armor All™ Cleaner	Cleans vinyl, leather and rubber
12345725	12 oz. (0.354 L)	Silicone Tire Shine	Shines tires

See your General Motors Parts Department for these products.
See "Fluids and Lubricants" in the Index.

* Not recommended for pigskin suede leather.

** Not recommended for use on instrument panel vinyl.

Vehicle Identification Number (VIN)

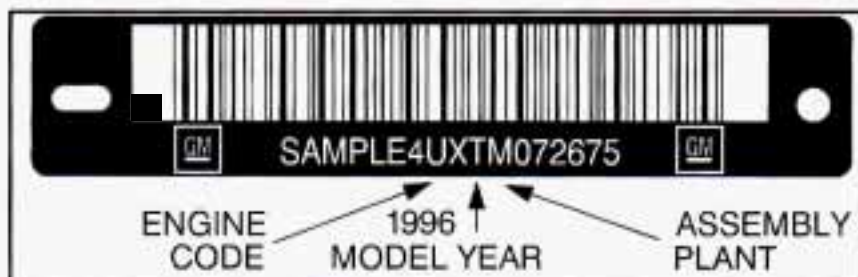

This is the legal identifier for your Oldsmobile. It appears on a plate in the front corner of the instrument panel, on the driver's side. You can see it if you look through the windshield from outside your vehicle. The VIN also appears on the Vehicle Certification and Service Parts labels and the certificates of title and registration.

Engine Identification

The eighth character in your VIN is the engine code. This code will help you identify your engine, specifications and replacement parts.

Service Parts Identification Label

You'll find this label inside the glove box door. It's very helpful if you ever need to order parts. On this label is:

- your VIN,
- the model designation,
- paint information, and
- a list of all production options and special equipment.

Be sure that this label is not removed from the vehicle.

Electrical System

Add-On Electrical Equipment

NOTICE:

Don't add anything electrical to your Oldsmobile unless you check with your retailer first. Some electrical equipment can damage your vehicle and the damage wouldn't be covered by your warranty. Some add-on electrical equipment can keep other components from working as they should.

Your vehicle has an air bag system. Before attempting to add anything electrical to your Oldsmobile, see "Servicing Your Air Bag-Equipped Oldsmobile" in the Index.

Headlamp Wiring

The headlamp wiring is protected by a circuit breaker in the lamp switch. An electrical overload will cause the lamps to go on and off, or in some cases to remain off. If this happens, have your headlamp system checked right away.

Windshield Wipers

The windshield wiper motor is protected by a circuit breaker and a fuse. If the motor overheats due to heavy snow, etc., the wiper will stop until the motor cools. If the overload is caused by some electrical problem, be sure to get it fixed.

Power Windows and Other Power Options

Circuit breakers in the circuit breaker/relay panel protect the power windows and other power accessories. When the current load is too heavy, the circuit breaker opens and closes, protecting the circuit until the problem is fixed.

Fuses and Circuit Breakers

The wiring circuits in your vehicle are protected from short circuits by a combination of fuses, circuit breakers and fusible thermal links. This greatly reduces the chance of damages caused by electrical problems.

Look at the silver-colored band inside the fuse. If the band is broken or melted, replace the fuse. Be sure you replace a bad fuse with a new one of the identical size and rating.

If you ever have a problem on the road and don't have a spare fuse, you can borrow one that has the same amperage. Just pick some feature of your vehicle that you can get along without -- like the radio or cigarette lighter -- and use its fuse, if it is the correct amperage. Replace it as soon as you can.

There are four fuse blocks in your vehicle: the instrument panel fuse block, the Anti-Lock Brake System (ABS) junction block fuse, the circuit breaker/relay panel and the injector fuse.

Instrument Panel Fuse Block

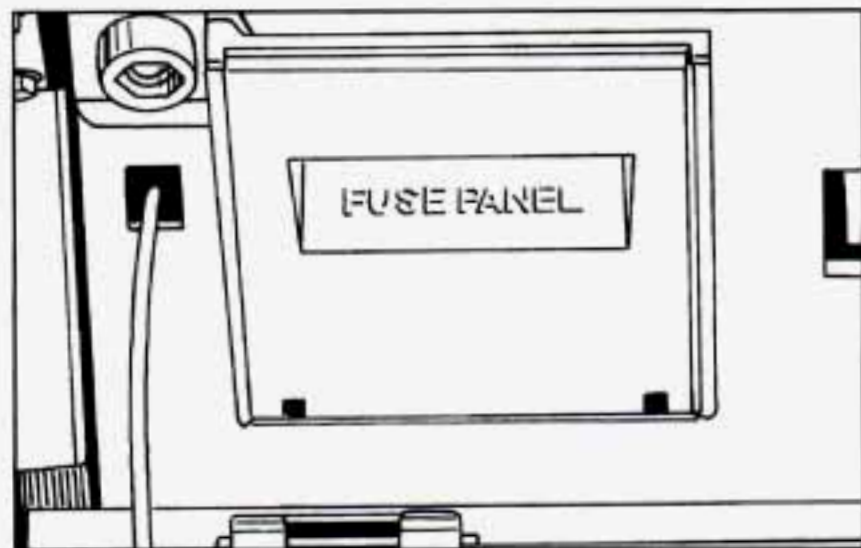

Pull the door open to gain access to the instrument panel fuse block.

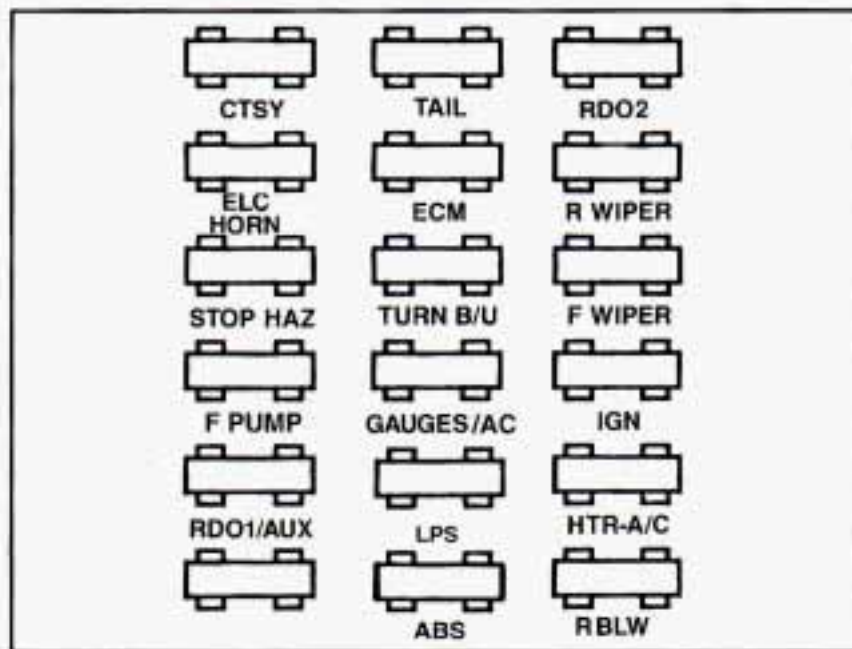

Fuse	Usage
CTSY	Automatic Door Lock Module, Dome Lamps, Courtesy Lamps, Power Door Lock Switches, Glove Box Lamp, Power Mirrors, Remote Lock Control Receiver
ELC	Electronic Level Control, Air Inflator, Underhood Lamp

Fuse	Usage
HORN	Horns, Horn Relay, Safety Belt Buzzer, Lamps On Reminder, Key in the Ignition Warning
STOP HAZ	Hazards, Rear Stoplamps, Anti-Lock Brake System (ABS), Center High-Mounted Stoplamp
F PUMP	Fuel Pump, Rear Engine Fan Relay
RD01/AUX	Radio, Cigarette Lighter, Accessory Power Outlet, Trailer Harness, Heater-A/C Control
TAIL	Headlamp and Instrument Panel Dimmer Switch (to LPS fuse), Power Sliding Door Controller
ECM	Powertrain Control Module
TURN B/U	Automatic Door Locks Module, Back-Up Lamps, Power Sliding Door Alarm Module, Fog Lamp Relay, Power Sliding Door Controller, Remote Lock Control Receiver, Brake-Transaxle Shift Interlock (BTSI), Front/Rear Turn Lamps

Fuse	Usage	Fuse	Usage
GAUGES/AC	A/C Compressor Relay, ABS, Electronic Level Control Height Sensor, Instrument Panel Cluster, Power Sliding Door Controller	RDO2	Radio, Steering Wheel Controls
LPS	Interior Lamps Dimming, Rear Climate Control Blower, Door Lock Switches, Temperature and Compass Display, Headlamp and Instrument Panel Dimmer Switch, Heater-A/C Control, Instrument Panel Cluster, Illumination for Power Sliding Door Switches	R WIPER	Temperature and Compass Display, Rear Window Wiper/Washer
ABS	ABS Enable Relay	F WIPER	Windshield and Rear Window Wiper/Washer
		IGN	Cruise Control Switch, Heater-A/C Control, Speedometer and Tachometer, Rear Window Defogger Relay, Safety Belt Reminder Chime, Lamps on Reminder, Key in the Ignition Warning
		HTR-A/C	Low Speed A/C Blower Relay
		R BLW	Rear Climate Control Blower

Circuit Breaker/Relay Panel

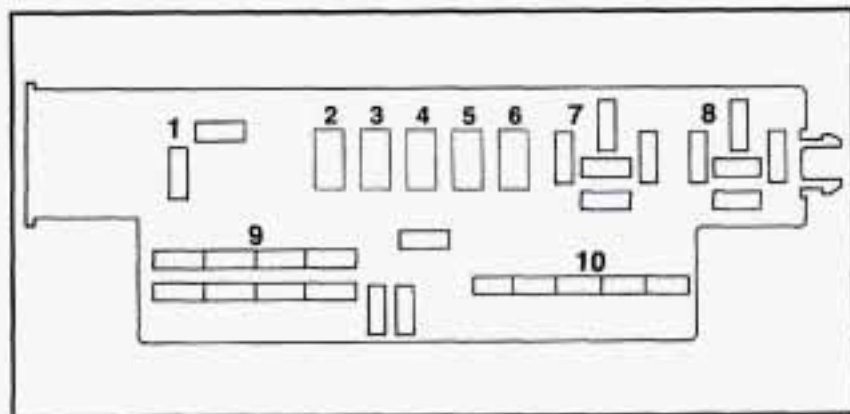

Circuit breakers and relays are located in the circuit breaker/relay panel. This is located behind the panel under the glove box, near the passenger's door.

Circuit Breakers

	Usage
1	Hazard Flashers
2 (fuse)	Automatic Transaxle, Evaporative Emission (EVAP) Canister Purge Solenoid Valve, Evaporative Emissions Canister Purge Vacuum Diagnostic Switch, Linear Exhaust Gas Recirculation (EGR) Valve, Front Engine Fan Relay, Heated Oxygen Sensors, Mass Air Flow (MAF) Sensor, Powertrain Control Module (PCM)
3	Not Used
4	Power Windows
5	Power Seat, Power Sliding Door Controller, Power Door Locks
6	Rear Defogger
7	Air Conditioning Blower, Rear Blower Motor
8	Horns
9	Safety Belt Reminder Chime, Lamps on Reminder, Key In the Ignition Warning (Chime Module)
10	Rear Defogger Timer

Anti-Lock Brake System (ABS) Junction Block Fuse

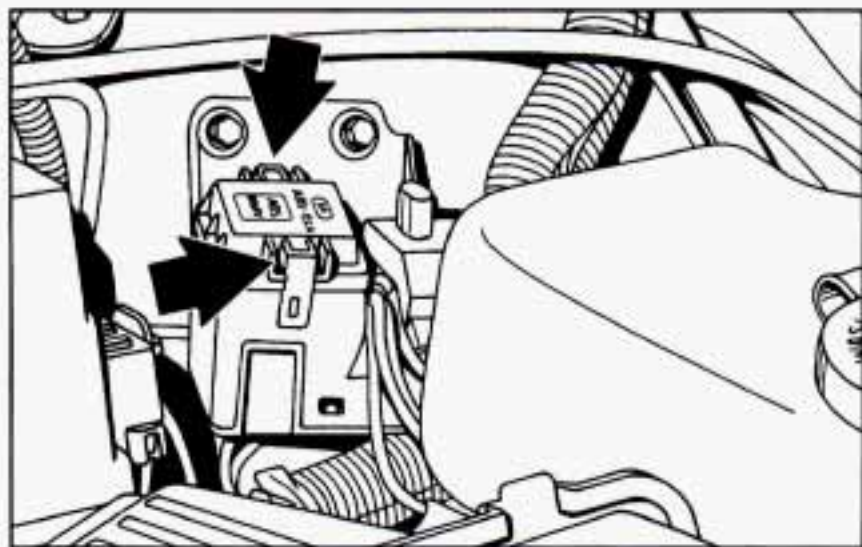

You'll find this fuse under the hood in the ABS junction block, located next to the remote positive jump starting terminal.

To open the junction block, press in on both sides of the cover.

Injector Fuse

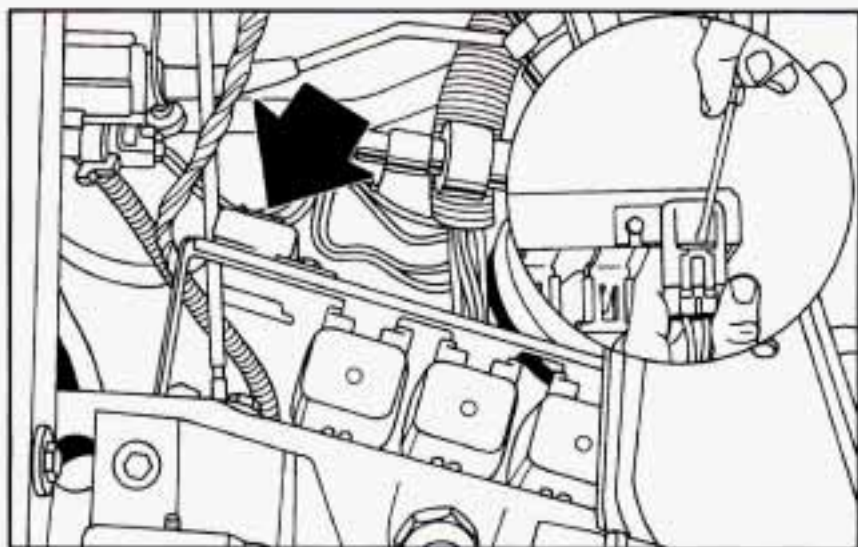

This fuse is located under the hood, on a bracket just behind the passenger's side headlamp. It is mounted on the face of the bracket in the position closest to the passenger's side of the vehicle. The fuse services the injectors, fuel pump, oil pressure sender and fuel pump switch.

To access the fuse, pry back the latch with a screwdriver, then pull down on the base of the unit. If you need to replace the fuse, be sure to use one with the same amperage.

Push the base of the unit firmly into the cover until the latch snaps into the locked position.

Replacement Bulbs

OUTSIDE LAMPS	BULB
Back-up Lamps	3057
Center High-Mounted Stoplamp	577
Front Parking/Turn Signal Lamps	3357
License Plate Lamp	194
Halogen Headlamps	
Outer	9006
Inner	9005
Fog Lamps	H-1
Front Sidemarkers Lamps	194
Stop/Tail/Turn Signal Lamps	
Upper Two Positions	194
Lower Two Positions	2057
Underhood Lamp	561

INSIDE LAMPS	BULB
Dome Lamps	
Front	561
Rear	561

Capacities and Specifications

Engine Crankcase 4.5 to 5 quarts 3.75 L

Oil change with filter change. Use your dipstick to measure.

Automatic Transaxle

When draining or replacing torque converter, more fluid may be needed.

Pan Removal and Replacement 6 quarts 5.70 L

After Complete Overhaul 8 quarts 7.60 L

Cooling System

With Air Conditioning 11.75 quarts 11.25 L

With Rear Climate Control 13.5 quarts 12.75 L

NOTE: All capacities are approximate. When adding, be sure to fill to the appropriate level, as recommended in this manual.

Refrigerant (R-134a), Air Conditioning

Front A/C only 2.25 lbs. 1.02 kg

Front and Rear A/C 3 lbs. 1.36 kg

Not all air conditioning refrigerants are the same. If the air conditioning system in your vehicle needs refrigerant, be sure the proper refrigerant is used. If you're not sure, ask your Oldsmobile retailer. For additional information, see your "Warranty and Owner Assistance Information" booklet.

Fuel Tank 20 gallons 76 L

Wheel Nut Torque 100 lb-ft 140 N·m

NOTE: All capacities are approximate. When adding, be sure to fill to the appropriate level, as recommended in this manual.

Engine Specifications

VIN Engine Code	E
Type	V6
Displacement	3.4L
Firing Order	1-2-3-4-5-6
Thermostat Temperature Specification	195°F (91°C)

Normal Maintenance Replacement Parts

Air Cleaner Element	AC Type A-974C
Engine Oil Filter	AC Type PF-47
PCV Valve	AC Type CV-892C
Spark Plugs	AC Type 41-940 Gap: 0.060 inch (1.52 mm)
Remote Lock Control Battery (1)	CR 2032

Dimensions

Wheelbase	109.8 inches 2788 mm
Tread Width	
Front	59.2 inches 1503 mm
Rear	61.4 inches 1559 mm
Length	194.7 inches 4946 mm
Width	73.9 inches 1878 mm
Height	65.7 inches 1670 mm



Section 7 Maintenance Schedule

**IMPORTANT:
KEEP ENGINE OIL
AT THE PROPER
LEVEL AND CHANGE AS
RECOMMENDED**

This section covers the maintenance required for your Oldsmobile. Your vehicle needs these services to retain its safety, dependability and emission control performance.



***Protection
Plan***

Have you purchased the GM Protection Plan? The Plan supplements your new vehicle warranties. See your Warranty and Owner Assistance booklet, or your Oldsmobile retailer for details.

Introduction

Your Vehicle and the Environment

Proper vehicle maintenance not only helps to keep your vehicle in good working condition, but also helps the environment. All recommended maintenance procedures are important. Improper vehicle maintenance can even affect the quality of the air we breathe. Improper fluid levels or the wrong tire inflation can increase the level of emissions from your vehicle. To help protect our environment, and to keep your vehicle in good condition, please maintain your vehicle properly.

How This Section is Organized

The remainder of this section is divided into five parts:

“Part A: Scheduled Maintenance Services” shows what to have done and how often. Some of these services can be complex, so unless you are technically qualified and have the necessary equipment, you should let your retailer’s service department or another qualified service center do these jobs.

CAUTION:

Performing maintenance work on a vehicle can be dangerous. In trying to do some jobs, you can be seriously injured. Do your own maintenance work only if you have the required know-how and the proper tools and equipment for the job. If you have any doubt, have a qualified technician do the work.

If you are skilled enough to do some work on your vehicle, you will probably want to get the service information GM publishes. See “Service and Owner Publications” in the Index.

“Part B: Owner Checks and Services” tells you what should be checked whenever you stop for fuel. It also explains what you can easily do to help keep your vehicle in good condition.

“Part C: Periodic Maintenance Inspections” explains important inspections that your Oldsmobile retailer’s service department or another qualified service center should perform.

“Part D: Recommended Fluids and Lubricants” lists some products GM recommends to help keep your vehicle properly maintained. These products, or their equivalents, should be used whether you do the work yourself or have it done.

“Part E: Maintenance Record” provides a place for you to record the maintenance performed on your vehicle. Whenever any maintenance is performed, be sure to write it down in this part. This will help you determine when your next maintenance should be done. In addition, it is a good idea to keep your maintenance receipts. They may be needed to qualify your vehicle for warranty repairs.

Part A: Scheduled Maintenance Services

Using Your Maintenance Schedule

We at General Motors want to help you keep your vehicle in good working condition. But we don't know exactly how you'll drive it. You may drive very short distances only a few times a week. Or you may drive long distances all the time in very hot, dusty weather. You may use your vehicle in making deliveries. Or you may drive it to work, to do errands or in many other ways.

Because of all the different ways people use their GM vehicles, maintenance needs vary. You may even need more frequent checks and replacements than you'll find in the schedules in this section. So please read this section and note how you drive. If you have any questions on how to keep your vehicle in good condition, see your Oldsmobile retailer.

This part tells you the maintenance services you should have done and when you should schedule them. If you go to your retailer for your service needs, you'll know that GM-trained and supported service people will perform the work using genuine GM parts.

The proper fluids and lubricants to use are listed in Part D. Make sure whoever services your vehicle uses these. All parts should be replaced and all necessary repairs done before you or anyone else drives the vehicle.

These schedules are for vehicles that:

- carry passengers and cargo within recommended limits. You will find these limits on your vehicle's Certification/Tire label. See "Loading Your Vehicle" in the Index.
- are driven on reasonable road surfaces within legal driving limits.
- use the recommended fuel. See "Fuel" in the Index.

Selecting the Right Schedule

First you'll need to decide which of the two schedules is right for your vehicle. Here's how to decide which schedule to follow:

Maintenance Schedule

Short Trip/City Definition

Follow the Short Trip/City Maintenance Schedule if any one of these conditions is true for your vehicle:

- Most trips are less than 5 to 10 miles (8 to 16 km). This is particularly important when outside temperatures are below freezing.
- Most trips include extensive idling (such as frequent driving in stop-and-go traffic).
- Most trips are through dusty areas.
- You frequently tow a trailer or use a carrier on top of your vehicle.
- If the vehicle is used for delivery service, police, taxi or other commercial application.

One of the reasons you should follow this schedule if you operate your vehicle under any of these conditions is that these conditions cause engine oil to break down sooner.

Short Trip/City Intervals

Every 3,000 Miles (5 000 km): Engine Oil and Filter Change (or 3 months, whichever occurs first).

Every 6,000 Miles (10 000 km): Chassis Lubrication (or 6 months, whichever occurs first).

At 6,000 Miles (10 000 km) -- Then Every 12,000 Miles (20 000 km): Tire Rotation.

Every 15,000 Miles (25 000 km): Air Cleaner Filter Inspection, if driving in dusty conditions.

Every 30,000 Miles (50 000 km): Air Cleaner Filter Replacement.

Every 50,000 Miles (83 000 km): Automatic Transaxle Service (severe conditions only).

Every 60,000 Miles (100 000 km): Engine Accessory Drive Belt Inspection. Fuel Tank, Cap and Lines Inspection (or every 60 months, whichever occurs first).

Every 100,000 Miles (166 000 km): Cooling System Service (or every 60 months, whichever occurs first). Spark Plug Wire Inspection. Spark Plug Replacement.

These intervals only summarize maintenance services. Be sure to follow the complete maintenance schedule on the following pages.

Maintenance Schedule

Long Trip/Highway Definition

Follow this maintenance schedule *only* if none of the conditions from the Short Trip/City Maintenance Schedule is true.

Driving a vehicle with a fully warmed engine under highway conditions causes engine oil to break down slower.

Long Trip/Highway Intervals

Every 7,500 Miles (12 500 km): Engine Oil and Filter Change (or every 12 months, whichever occurs first). Chassis Lubrication (or every 12 months, whichever occurs first).

At 7,500 Miles (12 500 km) -- Then Every 15,000 Miles (25 000 km): Tire Rotation.

Every 30,000 Miles (50 000 km): Air Cleaner Filter Replacement.

Every 50,000 Miles (83 000 km): Automatic Transaxle Service (severe conditions only).

Every 60,000 Miles (100 000 km): Engine Accessory Drive Belt Inspection. Fuel Tank, Cap and Lines Inspection (or every 60 months, whichever occurs first).

Every 100,000 Miles (166 000 km): Cooling System Service (or every 60 months, whichever occurs first). Spark Plug Wire Inspection. Spark Plug Replacement.

These intervals only summarize maintenance services. Be sure to follow the complete maintenance schedule on the following pages.

Short Trip/City Maintenance Schedule

The services shown in this schedule up to 100,000 miles (166 000 km) should be performed after 100,000 miles (166 000 km) at the same intervals.

Footnotes

† The U.S. Environmental Protection Agency or the California Air Resources Board has determined that the failure to perform this maintenance item will not nullify the emission warranty or limit recall liability prior to the completion of the vehicle's useful life. We, however, urge that all recommended maintenance services be performed at the indicated intervals and the maintenance be recorded.

Lubricate the parking brake cable guides and underbody contact points and linkage.

3,000 Miles (5 000 km)

- Change engine oil and filter (or every 3 months, whichever occurs first).

An Emission Control Service.

DATE	ACTUAL MILEAGE	SERVICED BY:

Short Trip/City Maintenance Schedule

6,000 Miles (10 000 km)

- Change engine oil and filter (or every 3 months, whichever occurs first).
An Emission Control Service.
- Lubricate chassis components; see footnote # (or every 6 months, whichever occurs first).
- Rotate tires. See "Tire Inspection and Rotation" in the Index for proper rotation pattern and additional information. During tire rotation, check brake calipers for freedom of movement and lubricate if required.

DATE	ACTUAL MILEAGE	SERVICED BY:

9,000 Miles (15 000 km)

- Change engine oil and filter (or every 3 months, whichever occurs first).
An Emission Control Service.

DATE	ACTUAL MILEAGE	SERVICED BY:

Short Trip/City Maintenance Schedule

12,000 Miles (20 000 km)

- Change engine oil and filter (or every 3 months, whichever occurs first).
An Emission Control Service.
- Lubricate chassis components; see footnote # (or every 6 months, whichever occurs first).

DATE	ACTUAL MILEAGE	SERVICED BY:

15,000 Miles (25 000 km)

- Change engine oil and filter (or every 3 months, whichever occurs first).
An Emission Control Service.
- Inspect air cleaner filter if you are driving in dusty conditions. Replace filter if necessary. *An Emission Control Service.* †

DATE	ACTUAL MILEAGE	SERVICED BY:

Short Trip/City Maintenance Schedule

18,000 Miles (30 000 km)

- Change engine oil and filter (or every 3 months, whichever occurs first).
An Emission Control Service.
- Lubricate chassis components; see footnote # (or every 6 months, whichever occurs first).
- Rotate tires. See "Tire Inspection and Rotation" in the Index for proper rotation pattern and additional information. During tire rotation, check brake calipers for freedom of movement and lubricate if required.

DATE	ACTUAL MILEAGE	SERVICED BY:

21,000 Miles (35 000 km)

- Change engine oil and filter (or every 3 months, whichever occurs first).
An Emission Control Service.

DATE	ACTUAL MILEAGE	SERVICED BY:

Short Trip/City Maintenance Schedule

24,000 Miles (40 000 km)

- Change engine oil and filter (or every 3 months, whichever occurs first).
An Emission Control Service.
- Lubricate chassis components; see footnote # (or every 6 months, whichever occurs first).

DATE	ACTUAL MILEAGE	SERVICED BY:

27,000 Miles (45 000 km)

- Change engine oil and filter (or every 3 months, whichever occurs first).
An Emission Control Service.

DATE	ACTUAL MILEAGE	SERVICED BY:

Short Trip/City Maintenance Schedule

30,000 Miles (50 000 km)

- Change engine oil and filter (or every 3 months, whichever occurs first).
An Emission Control Service.
- Lubricate chassis components; see footnote # (or every 6 months, whichever occurs first).
- Replace air cleaner filter.
An Emission Control Service.
- Rotate tires. See "Tire Inspection and Rotation" in the Index for proper rotation pattern and additional information. During tire rotation, check brake calipers for freedom of movement and lubricate if required.

DATE	ACTUAL MILEAGE	SERVICED BY:

33,000 Miles (55 000 km)

- Change engine oil and filter (or every 3 months, whichever occurs first).
An Emission Control Service.

DATE	ACTUAL MILEAGE	SERVICED BY:

Short Trip/City Maintenance Schedule

36,000 Miles (60 000 km)

- Change engine oil and filter (or every 3 months, whichever occurs first).
An Emission Control Service.
- Lubricate chassis components; see footnote # (or every 6 months, whichever occurs first).

DATE	ACTUAL MILEAGE	SERVICED BY:

39,000 Miles (65 000 km)

- Change engine oil and filter (or every 3 months, whichever occurs first).
An Emission Control Service.

DATE	ACTUAL MILEAGE	SERVICED BY:

Short Trip/City Maintenance Schedule

42,000 Miles (70 000 km)

- Change engine oil and filter (or every 3 months, whichever occurs first).
An Emission Control Service.
- Lubricate chassis components; see footnote # (or every 6 months, whichever occurs first).
- Rotate tires. See "Tire Inspection and Rotation" in the Index for proper rotation pattern and additional information. During tire rotation, check brake calipers for freedom of movement and lubricate if required.

DATE	ACTUAL MILEAGE	SERVICED BY:

45,000 Miles (75 000 km)

- Change engine oil and filter (or every 3 months, whichever occurs first).
An Emission Control Service.
- Inspect air cleaner filter if you are driving in dusty conditions. Replace filter if necessary. *An Emission Control Service.* †

DATE	ACTUAL MILEAGE	SERVICED BY:

Short Trip/City Maintenance Schedule

48,000 Miles (80 000 km)

- Change engine oil and filter (or every 3 months, whichever occurs first).
An Emission Control Service.
- Lubricate chassis components; see footnote # (or every 6 months, whichever occurs first).

DATE	ACTUAL MILEAGE	SERVICED BY:

50,000 Miles (83 000 km)

- Change automatic transaxle fluid and filter if the vehicle is mainly driven under one or more of these conditions:
 - In heavy city traffic where the outside temperature regularly reaches 90°F (32°C) or higher.
 - In hilly or mountainous terrain.
 - When doing frequent trailer towing.
 - Uses such as found in taxi, police or delivery service.

If you do not use your vehicle under any of these conditions, the fluid and filter do not require changing.

DATE	ACTUAL MILEAGE	SERVICED BY:

Short Trip/City Maintenance Schedule

51,000 Miles (85 000 km)

- Change engine oil and filter (or every 3 months, whichever occurs first).

An Emission Control Service.

DATE	ACTUAL MILEAGE	SERVICED BY:

54,000 Miles (90 000 km)

- Change engine oil and filter (or every 3 months, whichever occurs first).
An Emission Control Service.
- Lubricate chassis components; see footnote # (or every 6 months, whichever occurs first).
- Rotate tires. See "Tire Inspection and Rotation" in the Index for proper rotation pattern and additional information. During tire rotation, check brake calipers for freedom of movement and lubricate if required.

DATE	ACTUAL MILEAGE	SERVICED BY:

Short Trip/City Maintenance Schedule

57,000 Miles (95 000 km)

- Change engine oil and filter (or every 3 months, whichever occurs first).

An Emission Control Service.

DATE	ACTUAL MILEAGE	SERVICED BY:

60,000 Miles (100 000 km)

- Change engine oil and filter (or every 3 months, whichever occurs first).
An Emission Control Service.
- Lubricate chassis components; see footnote # (or every 6 months, whichever occurs first).
- Inspect engine accessory drive belt.
- Replace air cleaner filter.
An Emission Control Service.
- Inspect fuel tank, cap and lines for damage or leaks. Inspect fuel cap gasket for any damage. Replace parts as needed.
An Emission Control Service. †

DATE	ACTUAL MILEAGE	SERVICED BY:

Short Trip/City Maintenance Schedule

63,000 Miles (105 000 km)

- Change engine oil and filter (or every 3 months, whichever occurs first).

An Emission Control Service.

DATE	ACTUAL MILEAGE	SERVICED BY:

66,000 Miles (110 000 km)

- Change engine oil and filter (or every 3 months, whichever occurs first).
An Emission Control Service.
- Lubricate chassis components; see footnote # (or every 6 months, whichever occurs first).
- Rotate tires. See "Tire Inspection and Rotation" in the Index for proper rotation pattern and additional information. During tire rotation, check brake calipers for freedom of movement and lubricate if required.

DATE	ACTUAL MILEAGE	SERVICED BY:

Short Trip/City Maintenance Schedule

69,000 Miles (115 000 km)

- Change engine oil and filter (or every 3 months, whichever occurs first).

An Emission Control Service.

72,000 Miles (120 000 km)

- Change engine oil and filter (or every 3 months, whichever occurs first).
An Emission Control Service.
- Lubricate chassis components; see footnote # (or every 6 months, whichever occurs first).

DATE	ACTUAL MILEAGE	SERVICED BY:

DATE	ACTUAL MILEAGE	SERVICED BY:

Short Trip/City Maintenance Schedule

75,000 Miles (125 000 km)

- Change engine oil and filter (or every 3 months, whichever occurs first).
An Emission Control Service.
- Inspect air cleaner filter if you are driving in dusty conditions. Replace filter if necessary. *An Emission Control Service.* †

DATE	ACTUAL MILEAGE	SERVICED BY:

78,000 Miles (130 000 km)

- Change engine oil and filter (or every 3 months, whichever occurs first).
An Emission Control Service.
- Lubricate chassis components; see footnote # (or every 6 months, whichever occurs first).
- Rotate tires. See "Tire Inspection and Rotation" in the Index for proper rotation pattern and additional information. During tire rotation, check brake calipers for freedom of movement and lubricate if required.

DATE	ACTUAL MILEAGE	SERVICED BY:

Short Trip/City Maintenance Schedule

81,000 Miles (135 000 km)

- Change engine oil and filter (or every 3 months, whichever occurs first).

An Emission Control Service.

DATE	ACTUAL MILEAGE	SERVICED BY:

84,000 Miles (140 000 km)

- Change engine oil and filter (or every 3 months, whichever occurs first).
An Emission Control Service.
- Lubricate chassis components; see footnote # (or every 6 months, whichever occurs first).

DATE	ACTUAL MILEAGE	SERVICED BY:

Short Trip/City Maintenance Schedule

87,000 Miles (145 000 km)

- Change engine oil and filter (or every 3 months, whichever occurs first).

An Emission Control Service.

DATE	ACTUAL MILEAGE	SERVICED BY:

90,000 Miles (150 000 km)

- Change engine oil and filter (or every 3 months, whichever occurs first).
An Emission Control Service.
- Lubricate chassis components; see footnote # (or every 6 months, whichever occurs first).
- Replace air cleaner filter.
An Emission Control Service.
- Rotate tires. See "Tire Inspection and Rotation" in the Index for proper rotation pattern and additional information. During tire rotation, check brake calipers for freedom of movement and lubricate if required.

DATE	ACTUAL MILEAGE	SERVICED BY:

Short Trip/City Maintenance Schedule

93,000 Miles (155 000 km)

- Change engine oil and filter (or every 3 months, whichever occurs first).

An Emission Control Service.

96,000 Miles (160 000 km)

- Change engine oil and filter (or every 3 months, whichever occurs first).
An Emission Control Service.
- Lubricate chassis components; see footnote # (or every 6 months, whichever occurs first).

DATE	ACTUAL MILEAGE	SERVICED BY:

DATE	ACTUAL MILEAGE	SERVICED BY:

Short Trip/City Maintenance Schedule

99,000 Miles (165 000 km)

- Change engine oil and filter (or every 3 months, whichever occurs first).
An Emission Control Service.

100,000 Miles (166 000 km)

- Drain, flush and refill cooling system (or every 60 months since last service, whichever occurs first). See "Engine Coolant" in the Index for what to use. Inspect hoses. Clean radiator, condenser, pressure cap and neck. Pressure test cooling system and pressure cap.
An Emission Control Service. †
- Inspect spark plug wires.
An Emission Control Service.

DATE	ACTUAL MILEAGE	SERVICED BY:

(Continued)

Short Trip/City Maintenance Schedule

100,000 Miles (166 000 km) (Continued)

- Replace spark plugs.
An Emission Control Service.
- Change automatic transaxle fluid and filter if the vehicle is mainly driven under one or more of these conditions:
 - In heavy city traffic where the outside temperature regularly reaches 90°F (32°C) or higher.

- In hilly or mountainous terrain.
- When doing frequent trailer towing.
- Uses such as found in taxi, police or delivery service.

If you do not use your vehicle under any of these conditions, the fluid and filter do not require changing.

DATE	ACTUAL MILEAGE	SERVICED BY:

Long Trip/Highway Maintenance Schedule

The services shown in this schedule up to 100,000 miles (166 000 km) should be performed after 100,000 miles (166 000 km) at the same intervals.

Footnotes

† The U.S. Environmental Protection Agency or the California Air Resources Board has determined that the failure to perform this maintenance item will not nullify the emission warranty or limit recall liability prior to the completion of the vehicle's useful life. We, however, urge that all recommended maintenance services be performed at the indicated intervals and the maintenance be recorded.

Lubricate the parking brake cable guides and underbody contact points and linkage.

7,500 Miles (12 500 km)

- Change engine oil and filter (or every 12 months, whichever occurs first).
An Emission Control Service.
- Lubricate chassis components; see footnote # (or every 12 months, whichever occurs first).
- Rotate tires. See "Tire Inspection and Rotation" in the Index for proper rotation pattern and additional information. During tire rotation, check brake calipers for freedom of movement and lubricate if required.

DATE	ACTUAL MILEAGE	SERVICED BY:

Long Trip/Highway Maintenance Schedule

15,000 Miles (25 000 km)

- Change engine oil and filter (or every 12 months, whichever occurs first).
An Emission Control Service.
- Lubricate chassis components; see footnote # (or every 12 months, whichever occurs first).

DATE	ACTUAL MILEAGE	SERVICED BY:

22,500 Miles (37 500 km)

- Change engine oil and filter (or every 12 months, whichever occurs first).
An Emission Control Service.
- Lubricate chassis components; see footnote # (or every 12 months, whichever occurs first).
- Rotate tires. See "Tire Inspection and Rotation" in the Index for proper rotation pattern and additional information. During tire rotation, check brake calipers for freedom of movement and lubricate if required.

DATE	ACTUAL MILEAGE	SERVICED BY:

Long Trip/Highway Maintenance Schedule

30,000 Miles (50 000 km)

- Change engine oil and filter (or every 12 months, whichever occurs first).
An Emission Control Service.
- Lubricate chassis components; see footnote # (or every 12 months, whichever occurs first).
- Replace air cleaner filter.
An Emission Control Service.

DATE	ACTUAL MILEAGE	SERVICED BY:

37,500 Miles (62 500 km)

- Change engine oil and filter (or every 12 months, whichever occurs first).
An Emission Control Service.
- Lubricate chassis components; see footnote # (or every 12 months, whichever occurs first).
- Rotate tires. See "Tire Inspection and Rotation" in the Index for proper rotation pattern and additional information. During tire rotation, check brake calipers for freedom of movement and lubricate if required.

DATE	ACTUAL MILEAGE	SERVICED BY:

Long Trip/Highway Maintenance Schedule

45,000 Miles (75 000 km)

- Change engine oil and filter (or every 12 months, whichever occurs first).
An Emission Control Service.
- Lubricate chassis components; see footnote # (or every 12 months, whichever occurs first).

DATE	ACTUAL MILEAGE	SERVICED BY:

50,000 Miles (83 000 km)

- Change automatic transaxle fluid and filter if the vehicle is mainly driven under one or more of these conditions:
 - In heavy city traffic where the outside temperature regularly reaches 90°F (32°C) or higher.
 - In hilly or mountainous terrain.
 - When doing frequent trailer towing.
 - Uses such as found in taxi, police or delivery service.

If you do not use your vehicle under any of these conditions, the fluid and filter do not require changing.

DATE	ACTUAL MILEAGE	SERVICED BY:

Long Trip/Highway Maintenance Schedule

52,500 Miles (87 500 km)

- Change engine oil and filter (or every 12 months, whichever occurs first).
An Emission Control Service.
- Lubricate chassis components; see footnote # (or every 12 months, whichever occurs first).
- Rotate tires. See "Tire Inspection and Rotation" in the Index for proper rotation pattern and additional information. During tire rotation, check brake calipers for freedom of movement and lubricate if required.

DATE	ACTUAL MILEAGE	SERVICED BY:

60,000 Miles (100 000 km)

- Change engine oil and filter (or every 12 months, whichever occurs first).
An Emission Control Service.
- Lubricate chassis components; see footnote # (or every 12 months, whichever occurs first).
- Inspect engine accessory drive belt.
- Replace air cleaner filter.
An Emission Control Service.
- Inspect fuel tank, cap and lines for damage or leaks. Inspect fuel cap gasket for any damage. Replace parts as needed.
An Emission Control Service. †

DATE	ACTUAL MILEAGE	SERVICED BY:

Long Trip/Highway Maintenance Schedule

67,500 Miles (112 500 km)

- Change engine oil and filter (or every 12 months, whichever occurs first).
An Emission Control Service.
- Lubricate chassis components; see footnote # (or every 12 months, whichever occurs first).
- Rotate tires. See "Tire Inspection and Rotation" in the Index for proper rotation pattern and additional information. During tire rotation, check brake calipers for freedom of movement and lubricate if required.

DATE	ACTUAL MILEAGE	SERVICED BY:

75,000 Miles (125 000 km)

- Change engine oil and filter (or every 12 months, whichever occurs first).
An Emission Control Service.
- Lubricate chassis components; see footnote # (or every 12 months, whichever occurs first).

DATE	ACTUAL MILEAGE	SERVICED BY:

Long Trip/Highway Maintenance Schedule

82,500 Miles (137 500 km)

- Change engine oil and filter (or every 12 months, whichever occurs first).
An Emission Control Service.
- Lubricate chassis components; see footnote # (or every 12 months, whichever occurs first).
- Rotate tires. See "Tire Inspection and Rotation" in the Index for proper rotation pattern and additional information. During tire rotation, check brake calipers for freedom of movement and lubricate if required.

DATE	ACTUAL MILEAGE	SERVICED BY:

90,000 Miles (150 000 km)

- Change engine oil and filter (or every 12 months, whichever occurs first).
An Emission Control Service.
- Lubricate chassis components; see footnote # (or every 12 months, whichever occurs first).
- Replace air cleaner filter.
An Emission Control Service.

DATE	ACTUAL MILEAGE	SERVICED BY:

Long Trip/Highway Maintenance Schedule

97,500 Miles (162 500 km)

- Change engine oil and filter (or every 12 months, whichever occurs first).
An Emission Control Service.
- Lubricate chassis components; see footnote # (or every 12 months, whichever occurs first).
- Rotate tires. See “Tire Inspection and Rotation” in the Index for proper rotation pattern and additional information. During tire rotation, check brake calipers for freedom of movement and lubricate if required.

100,000 Miles (166 000 km)

- Drain, flush and refill cooling system (or every 60 months since last service, whichever occurs first). See “Engine Coolant” in the Index for what to use. Inspect hoses. Clean radiator, condenser, pressure cap and neck. Pressure test the cooling system and pressure cap.
An Emission Control Service. †
- Inspect spark plug wires.
An Emission Control Service.

DATE	ACTUAL MILEAGE	SERVICED BY:

Long Trip/Highway Maintenance Schedule

- Replace spark plugs.
An Emission Control Service.
- Change automatic transaxle fluid and filter if the vehicle is mainly driven under one or more of these conditions:
 - In heavy city traffic where the outside temperature regularly reaches 90°F (32°C) or higher.

- In hilly or mountainous terrain.
- When doing frequent trailer towing.
- Uses such as found in taxi, police or delivery service.

If you do not use your vehicle under any of these conditions, the fluid and filter do not require changing.

DATE	ACTUAL MILEAGE	SERVICED BY:

Part B: Owner Checks and Services

Listed below are owner checks and services which should be performed at the intervals specified to help ensure the safety, dependability and emission control performance of your vehicle.

Be sure any necessary repairs are completed at once. Whenever any fluids or lubricants are added to your vehicle, make sure they are the proper ones, as shown in Part D.

At Each Fuel Fill

It is important for you or a service station attendant to perform these underhood checks at each fuel fill.

Engine Oil Level Check

Check the engine oil level and add the proper oil if necessary. See “Engine Oil” in the Index for further details.

Engine Coolant Level Check

Check the engine coolant level and add the proper coolant mix if necessary. See “Engine Coolant” in the Index for further details.

Windshield Washer Fluid Level Check

Check the windshield washer fluid level in the windshield washer tank and add the proper fluid if necessary. See “Windshield Washer Fluid” in the Index for further details.

At Least Once a Month

Tire Inflation Check

Make sure tires are inflated to the correct pressures. See “Tires” in the Index for further details.

Cassette Deck Service

Clean cassette deck. Cleaning should be done every 50 hours of tape play. See “Audio Systems” in the Index for further details.

At Least Twice a Year

Restraint System Check

Make sure the safety belt reminder light and all your belts, buckles, latch plates, retractors and anchorages are working properly. If your vehicle has a built-in child restraint, also periodically make sure the harness straps, latch plates, buckle, clip, child head restraint and anchorages are working properly. Look for any other loose or damaged safety belt and built-in child restraint system parts. If you see anything that might keep a safety belt or built-in child restraint system from doing its job, have it repaired. Have any torn or frayed safety belts or harness straps replaced.

Also look for any opened or broken air bag covers, and have them repaired or replaced. (The air bag system does not need regular maintenance.)

Automatic Transaxle Check

Check the transaxle fluid level; add if needed. See “Automatic Transaxle” in the Index. A fluid loss may indicate a problem. Check the system and repair if needed.

At Least Once a Year

Key Lock Cylinders Service

Lubricate the key lock cylinders with the lubricant specified in Part D.

Body Lubrication Service

Lubricate all body door hinges, including the liftgate. Also lubricate all hinges and latches, including those for the hood, sliding door track, rear compartment, glove box door, console door, and any folding seat hardware. Part D tells you what to use. More frequent lubrication may be required when exposed to a corrosive environment.

Starter Switch Check

CAUTION:

When you are doing this check, the vehicle could move suddenly. If it does, you or others could be injured. Follow the steps below.

1. Before you start, be sure you have enough room around the vehicle.
2. Firmly apply both the parking brake (see “Parking Brake” in the Index if necessary) and the regular brake.

NOTE: Do not use the accelerator pedal, and be ready to turn off the engine immediately if it starts.
3. Try to start the engine in each gear. The starter should work only in PARK (P) or NEUTRAL (N). If the starter works in any other position, your vehicle needs service.

Brake-Transaxle Shift Interlock (BTSI) Check

CAUTION:

When you are doing this check, the vehicle could move suddenly. If it does, you or others could be injured. Follow the steps below.

1. Before you start, be sure you have enough room around the vehicle. It should be parked on a level surface.
2. Firmly apply the parking brake (see “Parking Brake” in the Index if necessary).

NOTE: Be ready to apply the regular brake immediately if the vehicle begins to move.
3. With the engine off, turn the key to the RUN position, but don't start the engine. Without applying the regular brake, try to move the shift lever out of PARK (P) with normal effort. If the shift lever moves out of PARK (P), your vehicle's BTSI needs service.

Steering Column Lock Check

While parked, and with the parking brake set, try to turn the key to LOCK in each shift lever position.

- The key should turn to LOCK only when the shift lever is in PARK (P).
- The key should come out only in LOCK.

Parking Brake and Automatic Transaxle PARK (P) Mechanism Check

CAUTION:

When you are doing this check, your vehicle could begin to move. You or others could be injured and property could be damaged. Make sure there is room in front of your vehicle in case it begins to roll. Be ready to apply the regular brake at once should the vehicle begin to move.

Park on a fairly steep hill, with the vehicle facing downhill. Keeping your foot on the regular brake, set the parking brake.

- To check the parking brake: With the engine running and transaxle in NEUTRAL (N), slowly remove foot pressure from the regular brake pedal. Do this until the vehicle is held by the parking brake only.
- To check the PARK (P) mechanism's holding ability: With the engine running, shift to PARK (P). Then release all brakes.

Underbody Flushing Service

At least every spring, use plain water to flush any corrosive materials from the underbody. Take care to clean thoroughly any areas where mud and other debris can collect.

Part C: Periodic Maintenance Inspections

Listed below are inspections and services which should be performed at least twice a year (for instance, each spring and fall). You should let your GM retailer's service department or other qualified service center do these jobs. Make sure any necessary repairs are completed at once.

Proper procedures to perform these services may be found in an Oldsmobile Service Manual. See "Service and Owner Publications" in the Index.

Steering, Suspension and Front-Wheel-Drive Axle Boot and Seal Inspection

Inspect the front and rear suspension and steering system for damaged, loose or missing parts, signs of wear or lack of lubrication. Inspect the power steering lines and hoses for proper hook-up, binding, leaks, cracks, chafing, etc. Clean and then inspect the drive axle boot seals for damage, tears or leakage. Replace seals if necessary.

Exhaust System Inspection

Inspect the complete exhaust system. Inspect the body near the exhaust system. Look for broken, damaged, missing or out-of-position parts as well as open seams,

holes, loose connections or other conditions which could cause a heat build-up in the floor pan or could let exhaust fumes into the vehicle. See "Engine Exhaust" in the Index.

Radiator and Heater Hose Inspection

Inspect the hoses and have them replaced if they are cracked, swollen or deteriorated. Inspect all pipes, fittings and clamps; replace as needed.

Throttle Linkage Inspection

Inspect the throttle linkage for interference or binding, and for damage or missing parts. Replace parts as needed. Replace any cables that have high effort or excessive wear. Do not lubricate accelerator and cruise control cables.

Brake System Inspection

Inspect the complete system. Inspect brake lines and hoses for proper hook-up, binding, leaks, cracks, chafing, etc. Inspect disc brake pads for wear and rotors for surface condition. Also inspect drum brake linings for wear and cracks. Inspect other brake parts, including drums, wheel cylinders, calipers, parking brake, etc. Check parking brake adjustment. You may need to have your brakes inspected more often if your driving habits or conditions result in frequent braking.

Part D: Recommended Fluids and Lubricants

NOTE: Fluids and lubricants identified below by name, part number or specification may be obtained from your GM retailer.

USAGE	FLUID/LUBRICANT
Engine Oil	Engine oil with the American Petroleum Institute Certified For Gasoline Engines "Starburst" symbol of the proper viscosity. To determine the preferred viscosity for your vehicle's engine, see "Engine Oil" in the Index.
Engine Coolant	50/50 mixture of clean water (preferably distilled) and GM Goodwrench [®] DEX-COOL [™] or Havoline [®] DEX-COOL [™] (orange-colored, silicate-free) antifreeze conforming to GM Specification 6277M. See "Engine Coolant" in the Index.

USAGE	FLUID/LUBRICANT
Coolant Supplement Sealer	GM Part No. 3634621 or equivalent with a complete flush and refill.
Hydraulic Brake System	Delco Supreme 11 [®] Brake Fluid (GM Part No. 1052535 or equivalent DOT-3 brake fluid).
Parking Brake Cable Guides	Chassis lubricant (GM Part No. 1052497 or equivalent) or lubricant meeting requirements of NLGI Grade 2, Category LB or GC-LB.
Power Steering System	GM Power Steering Fluid (GM Part No. 1052884 - 1 pt., 1050017 - 1 qt., or equivalent).
Automatic Transaxle	DEXRON [®] -III Automatic Transmission Fluid.
Key Lock Cylinders	Multi-Purpose Lubricant, Superlube [®] (GM Part No. 12346241 or equivalent).

USAGE	FLUID/LUBRICANT
Chassis Lubrication	Chassis lubricant (GM Part No. 1052497 or equivalent) or lubricant meeting requirements of NLGI Grade 2, Category LB or GC-LB.
Windshield Washer Solvent	GM Optikleen [®] Washer Solvent (GM Part No. 1051515) or equivalent.
Hood Latch Assembly, Pivots, Spring Anchor and Release Pawl	Lubriplate lubricant aerosol (GM Part No. 12346293 or equivalent) or lubricant meeting requirements of NLGI Grade 2, Category LB or GC-LB.

USAGE	FLUID/LUBRICANT
Hood and Door Hinges, Rear Folding Seat, Fuel Door Hinge, Rear Compartment Lid Hinges	Multi-purpose lubricant, Superlube [®] (GM Part No. 12346241 or equivalent).
Sliding Door Track	Lubriplate lubricant aerosol (GM Part No. 12346293 or equivalent) or lubricant meeting requirements of NLGI Grade 2, Category LB or GC-LB.
Weatherstrip Conditioning	Dielectric Silicone Grease (GM Part No. 12345579 or equivalent).

See "Replacement Parts" in the Index for recommended replacement filters and spark plugs.

Part E: Maintenance Record

After the scheduled services are performed, record the date, odometer reading and who performed the service in the boxes provided after the maintenance interval. Any additional information from “Owner Checks and

Services” or “Periodic Maintenance” can be added on the following record pages. Also, you should retain all maintenance receipts. Your owner information portfolio is a convenient place to store them.

Maintenance Record

DATE	ODOMETER READING	SERVICED BY	MAINTENANCE PERFORMED



Section 8 Customer Assistance Information

Here you will find out how to contact Oldsmobile if you need assistance. This section also tells you how to obtain service publications and how to report any safety defects.

This section includes information on:

- The Customer Satisfaction Procedure
- Customer Assistance for Text Telephone (TTY) Users
- Roadside Assistance
- Courtesy Transportation
- BBB Auto Line -- Alternative Dispute Resolution Program
- Reporting Safety Defects
- Service and Owner Publications

Customer Satisfaction Procedure



Your satisfaction and goodwill are important to your retailer and Oldsmobile. Normally, any concern you may have with your vehicle can be handled by your selling or servicing retailer. Your retailer has the facility, trained technicians, special tools and up-to-date information to promptly address any issue which may arise. Oldsmobile has empowered its retailers to make decisions and repair vehicles, and they are eager to resolve your concern to your complete satisfaction. If your concern has not been resolved to your satisfaction, take the following steps:

STEP ONE -- Discuss your concern with a member of retailer management. Normally, concerns can be quickly resolved at that level. If the matter has already been reviewed with the Sales, Service or Parts Manager, contact the owner of the retail facility or the General Manager.

STEP TWO -- If after contacting a member of retail facility management, it appears your concern cannot be resolved by the retail facility without further help, contact the Oldsmobile Customer Assistance Network by calling 1-800-442-6537. In Canada, contact GM of Canada Communication Centre in Oshawa by calling 1-800-263-3777 (English) or 1-800-263-7854 (French).

For help outside of the United States and Canada, call the following numbers as appropriate:

- In Mexico: (525) 625-3256
- In Puerto Rico: 1-800-496-9992 (English) or 1-800-496-9993 (Spanish)
- In the U.S. Virgin Islands: 1-800-496-9994
- In the Dominican Republic: 1-800-751-4135 (English) or 1-800-751-4136 (Spanish)
- In the Bahamas: 1-800-389-0009
- In Bermuda, Barbados, Antigua and the British Virgin Islands: 1-800-534-0122
- In all other Caribbean countries: 1-809-763-1315
- In other overseas locations, call GM North American Export Sales in Canada at: 1-905-644-4112.

For prompt assistance, please have the following information available to give the Customer Assistance Representative:

- Your name, address, home and business telephone numbers
- Vehicle Identification Number (This is available from the vehicle registration or title, or the plate at the top left of the instrument panel and visible through the windshield.)
- Retail facility name and location
- Vehicle delivery date and present mileage
- Nature of concern

We encourage you to call us so we can give your inquiry prompt attention. However, if you wish to write Oldsmobile, write to:

Customer Assistance Representative
Oldsmobile Central Office
920 Townsend Street
P.O. Box 30095
Lansing, MI 48909

Refer to your Warranty and Owner Assistance Information booklet for addresses of Canadian and GM Overseas offices.

When contacting Oldsmobile, please remember that your concern will likely be resolved in the retail facility, using the retailer's facilities, equipment and personnel. That is why we suggest you follow Step One first if you have a concern.

Customer Assistance for Text Telephone (TTY) Users

To assist customers who are deaf, hard of hearing, or speech-impaired and who use Text Telephones (TTYs), Oldsmobile has TTY equipment available at its Customer Assistance Center. Any TTY user can communicate with Oldsmobile by dialing: 1-800-833-OLDS. (TTY users in Canada can dial 1-800-263-3830.)

Oldsmobile Roadside Assistance Program Features and Benefits

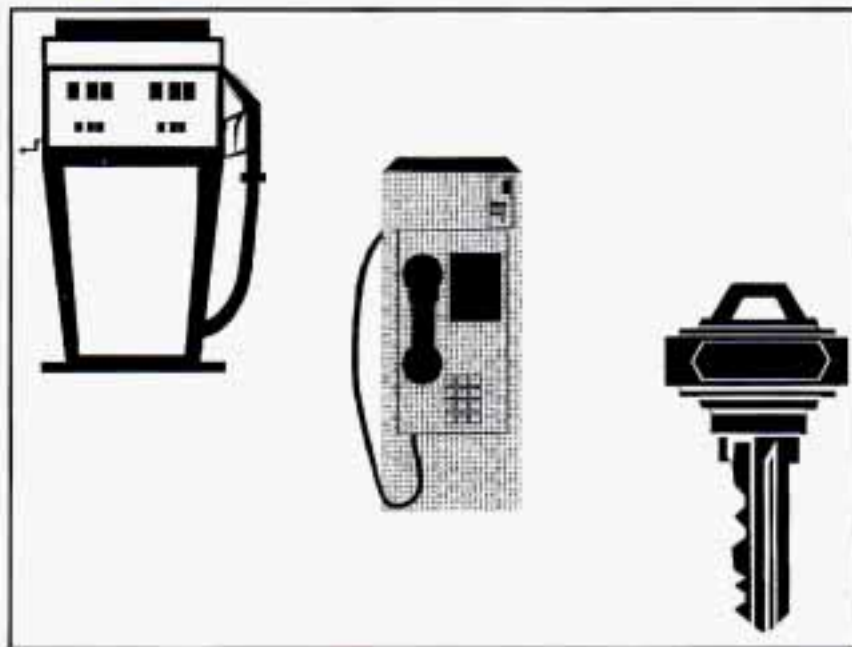

The Oldsmobile Roadside Assistance program means help is just a toll-free call away -- 24 hours a day, 365 days a year.

Courteous and capable Customer Assistance Advisors are on-call to provide you with prompt assistance.

24-Hour Oldsmobile Roadside Assistance Telephone Number

1-800-442-OLDS (6537) is the one number to call for assistance in the United States. Trained Customer Assistance Advisors, on-call to render assistance to Oldsmobile drivers, can dispatch roadside assistance and towing service, locate the nearest Oldsmobile retail facility, take your request for an Oldsmobile computerized trip routing or simply answer any questions the Oldsmobile driver may have about the coverage provided by your Oldsmobile Roadside Assistance Program. The Oldsmobile Roadside Assistance number is fully staffed and operational 24 hours a day, 365 days a year.

Who Is Covered?

Oldsmobile Roadside Assistance covers all 1996 Oldsmobile vehicles.

Coverage is for the Oldsmobile vehicle, *regardless of the driver*, and is concurrent with the Bumper to Bumper warranty period.

Oldsmobile reserves the right to limit services or reimbursement to an owner or driver when in Oldsmobile's judgement the claims become excessive in frequency or type of occurrence.

Courtesy Transportation

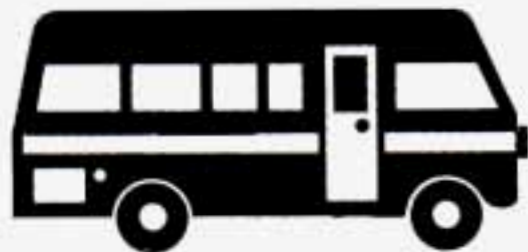

We're here to help. That's why whenever your Oldsmobile is undergoing any Bumper to Bumper Warranty service, we'll make sure you don't end up stranded at the retail facility. It's called Courtesy Transportation and it's our way to make sure you're able

to get out even when your car is in. For same-day service, we'll give you a one-way shuttle ride of up to 10 miles. If your vehicle requires overnight warranty repairs, we'll provide a loaner car or reimburse you up to \$30 a day for the cost of alternate transportation -- a cab, a bus or even a rental car if necessary. Having your car serviced is rarely convenient, but with Courtesy Transportation, at least you'll be able to get where you need to go, whether it's here, or there.

Some state insurance regulations make it impractical to rent vehicles to people under 21 years of age. If you are under 21 and have difficulty renting a vehicle, Oldsmobile will reimburse up to \$30/day for documented transportation you receive. Please consult your retailer for details.

For warranty repairs during the Complete Vehicle Coverage period in the New Vehicle Limited Warranty, interim transportation may be available under the Courtesy Transportation Program. Please consult your retailer for details. The Roadside Assistance program is available only in the United States and Canada.

GM Participation in BBB AUTO LINE -- Alternative Dispute Resolution Program*

*This program may not be available in all states, depending on state law. Canadian owners refer to your Warranty and Owner Assistance Information booklet. General Motors reserves the right to change eligibility limitations and/or to discontinue its participation in this program.

Both Oldsmobile and your Oldsmobile retailer are committed to making sure you are completely satisfied with your new vehicle. Our experience has shown that, if a situation arises where you feel your concern has not been adequately addressed, the Customer Satisfaction Procedure described earlier in this section is very successful.

There may be instances where an impartial third party can assist in arriving at a solution to a disagreement regarding vehicle repairs or interpretation of the New Vehicle Limited Warranty. To assist in resolving these disagreements, Oldsmobile voluntarily participates in BBB AUTO LINE.

BBB AUTO LINE is an out-of-court program administered by the Better Business Bureau system to settle disputes between customers and automobile manufacturers. This program is available free of charge to customers who currently own or lease a GM vehicle.

If you are not satisfied after following the Customer Satisfaction Procedure, you may contact the BBB using the toll-free telephone number, or write them at the following address:

BBB AUTO LINE
Council of Better Business Bureaus
4200 Wilson Boulevard
Suite 800
Arlington, VA 22203
Telephone: 1-800-955-5100

To file a claim, you will be asked to provide your name and address, your Vehicle Identification Number (VIN) and a statement of the nature of your complaint. Eligibility is limited by vehicle age and mileage, and other factors.

We prefer you utilize the Customer Satisfaction Procedure before you resort to AUTO LINE, but you may contact the BBB at any time. The BBB will attempt to resolve the complaint serving as an intermediary between you and Oldsmobile. If this mediation is unsuccessful, an informal hearing will be scheduled where eligible customers may present their case to an impartial third-party arbitrator.

The arbitrator will make a decision which you may accept or reject. If you accept the decision, GM will be bound by that decision. The entire dispute resolution procedure should ordinarily take about 40 days from the time you file a claim until a decision is made.

Some state laws may require you to use this program before filing a claim with a state-run arbitration program or in the courts. For further information, contact the BBB at 1-800-955-5100 or the Oldsmobile Customer Assistance Network at 1-800-442-6537.

REPORTING SAFETY DEFECTS TO THE UNITED STATES GOVERNMENT

If you believe that your vehicle has a defect which could cause a crash or could cause injury or death, you should immediately inform the National Highway Traffic Safety Administration (NHTSA), in addition to notifying General Motors.

If NHTSA receives similar complaints, it may open an investigation, and if it finds that a safety defect exists in a group of vehicles, it may order a recall and remedy campaign. However, NHTSA cannot become involved in individual problems between you, your retailer or General Motors.

To contact NHTSA, you may either call the Auto Safety Hotline toll-free at 1-800-424-9393 (or 366-0123 in the Washington, D.C. area) or write to:

NHTSA, U.S. Department of Transportation
Washington, D.C. 20590

You can also obtain other information about motor vehicle safety from the Hotline.

REPORTING SAFETY DEFECTS TO THE CANADIAN GOVERNMENT

If you live in Canada, and you believe that your vehicle has a safety defect, you should immediately notify Transport Canada, in addition to notifying General Motors of Canada Limited. You may write to:

Transport Canada
Box 8880
Ottawa, Ontario K1G 3J2

REPORTING SAFETY DEFECTS TO GENERAL MOTORS

In addition to notifying NHTSA (or Transport Canada) in a situation like this, we certainly hope you'll notify us. Please call us at 1-800-442-6537 or write:

Oldsmobile Customer Assistance Network
P.O. Box 30095
Lansing, MI 48909

In Canada, please call us at 1-800-263-3777 (English) or 1-800-263-7854 (French). Or, write:

General Motors of Canada Limited
Customer Communication Centre
1908 Colonel Sam Drive
Oshawa, Ontario L1H 8P7

Service and Owner Publications



Service manuals, service bulletins, owner's manuals and other service literature are available for purchase for all current and many past model General Motors vehicles.

Toll-free telephone numbers for ordering information:

United States 1-800-551-4123

Canada 1-800-668-5539

Service Manuals

Service manuals contain diagnostic and repair information for all chassis and body systems. They may be useful for owners who wish to get a greater understanding of their vehicle. They are also useful for owners with the appropriate skill level or training who wish to perform "do-it-yourself" service. These are authentic General Motors service manuals meant for professional, qualified technicians.

Service Bulletins

Service bulletins covering various subjects are regularly sent to all General Motors retail facilities. GM monitors product performance in the field. When service methods are found which promote better service on GM vehicles, bulletins are created to help the technician perform better service. Service bulletins may involve any number of vehicles. Some will describe inexpensive service; others will describe expensive service. Some will advise of new or unexpected conditions, and others may help avoid future costly repairs. Service bulletins are meant for qualified technicians. In some cases bulletins refer to service manuals, specialized tools, equipment and safety procedures necessary to service the vehicle. Since these bulletins are issued throughout the model year and beyond, an index is required and published quarterly to help identify specific bulletins. Subscriptions are available. You can order an index at the toll-free numbers listed previously, or ask a GM retailer to see an index or individual bulletin.

Owner Publications

Owner's manuals, warranty folders and various owner assistance booklets provide owners with general operation and maintenance information.



Section 9 Index

Accessory Power Outlet	2-66	Anti-Lock	
Adjusting Rear Seats	1-10	Brake System Warning Light	2-75, 4-6
Air Bag	1-25	Brakes	4-6
How Does it Restrain	1-28	Anti-Lock Brake System Block Fuse	657
How it Works	1-27	Appearance Care	6-42
Location	1-27	Appearance Care Materials	6-50
Readiness Light	1-26, 2-73	Ashtrays	2-58, 2-59
Servicing	1-30	Audio Controls, Steering Wheel Touch Control	3-22
What Makes it Inflate	1-28	Audio Equipment, Adding	3-23
What Will You See After it Inflates	1-29	Audio Systems	3-9
When Should it Inflate	1-28	Automatic Door Locks	2-6
Air Cleaner	6-14	Customizing	2-6
Air Cleaner, Checking or Replacing	6-15	Overriding Lock Delay	2-6
Air Conditioning	3-3	Automatic Overdrive	2-29
Air Conditioning Refrigerants	6-59	Automatic Transaxle Check	7-35
Air Inflator	2-66	Automatic Transaxle Fluid	6-15
Alignment and Balance, Tire	6-40	Checking the Level	6-16
Aluminum Wheels, Cleaning	6-48	How to Add	6-18
AMAX	3-17	How to check	6-16
Antenna, Integrated Roof	3-25	Automatic Transaxle Operation	2-27
Antifreeze	6-18	Automatic Transaxle Park Mechanism Check	7-37

B ack-Up Lamp Bulb Replacement	6-31
Battery	6-28
Jump Starting	5-2
Replacement, Remote Lock Control	2-10
Warnings	5-2
BBB Auto Line	8-6
Better Business Bureau Mediation	8-6
Booster Seat	1-46
B rake	
Adjustment	6-28
Fluid	6-25
Master Cylinder	6-25
Parking	2-31
Pedal Travel	6-28
Replacing System Parts	6-28
System Warning Light	2-74, 6-26
Trailer	4-33
Transaxle Shift Interlock	2-27, 2-35
Transaxle Shift Interlock Check	7-36
Wear	6-27
Brakes, Anti-Lock	4-6
Braking	4-5
Braking in Emergencies	4-8
Break-In, New Vehicle	2-22
BTSI	2-27, 2-35
BTSI Check	7-36
Bulb Replacement	6-29

C apacities and Specifications	6-59
Carbon Monoxide	2-36, 4-26, 4-34
Cassette Deck Service	7-34
Cassette Tape Player	3-11, 3-14
Cassette Tape Player Care	3-24
CD Player Theft-Deterrent Feature	3-19
Center Dash Storage Compartment	2-60
Center High-Mounted Stoplamp Bulb Replacement	6-32
Center Rear Passenger Position	1-35
Certification/Tire Label	4-27
Chains, Safety	4-33
Chains, Tire	6-42
Changing a Flat Tire	5-22
Checking Your Restraint Systems	1-56
Chemical Paint Spotting	6-49
Child Restraints	1-48
Built-in	1-39
Cleaning Built-in	6-45
Securing in a Rear Outside Seat Position	1-49
Securing in the Center Rear Seat Position	1-51
Top Strap	1-48
Where to Put	1-48
Cigarette Lighter	2-58
Circuit Breaker/Relay Panel	6-56
Circuit Breakers and Fuses	6-53
Cleaner, Air	6-14

Cleaning	
Aluminum Wheels	6-48
Built-in Child Restraint	6-45
Fabric	6-43
Glass	6-46
Inside of Your Oldsmobile	6-43
Instrument Panel	6-45
Leather	6-45
Outside of Your Oldsmobile	6-46
Special Problems	6-44
Stains	6-44
Tires	6-48
Vinyl	6-45
Wheels	6-48
Windshield and Wiper Blades	6-46
Climate Control System	3-1
Clock, Setting the	3-9
Coinholder	2-59
Comfort Controls	3-1
Compact Disc Care	3-24
Compact Disc Player	3-16
Compact Disc Player Errors	3-18
Compact Overhead Console	2-57
Compact Spare Tire	5-32
Compass Calibration	2-56
Compass, Electronic	2-55
Control of a Vehicle	4-5
Convenience Net	2-61
Convex Outside Mirror	2-53
Coolant	6-18
Adding	6-21
Checking	6-20
Heater, Engine	2-26
Recovery Tank	5-16
What to Use	6-19
Courtesy Transportation	8-5
Cruise Control	2-44
Cupholders	2-58, 2-61
Customer Assistance for Text Telephone Users	8-3
Customer Assistance Information	8-1
Customer Satisfaction Procedure	8-1
Customizing Your Automatic Door Locks	2-6
D amage, Finish	6-48
Defects, Reporting Safety	8-7
Defensive Driving	4-1
Defogger, Rear Window	3-9
Defogging	3-8
Defrosting	3-8
Delco LOC II [®]	3-19
Dimensions, Vehicle	6-60
Dome Lamps	2-50
Door	
Front	2-3
Locks	2-4
Power Sliding	2-13
Resetting the Power Sliding	2-17
Sliding	2-12

Driver Position	1-17	Coolant Temperature Gage	2-76
Driving		Cooling System	6-59
City	4-18	Exhaust	2-36
Defensive	4-1	Oil Level Check	7-34
Drunken	4-2	Overheating	5-12
Freeway	4-19	Running While Parked	2-36
In a Blizzard	4-25	Specifications	6-60
In Foreign Countries	6-3	Starting Your	2-24
In the Rain	4-15	Engine Oil	2-80, 6-9
Night	4-13	Adding	6-10
On Curves	4-8	Additives	6-12
On Grades While Towing a Trailer	4-36	Checking	6-10
On Hill and Mountain Roads	4-21	Pressure Indicator	2-80
On Snow and Ice	4-23	Used	6-13
Through Water	4-17	What to Use	6-11
Wet Roads	4-15	When to Change	6-13
Winter	4-23	Exhaust, Engine	2-36
With a Trailer	4-34		
Drunken Driving	4-2	F abric Cleaning	6-43
Dump and Stow Feature	1-6	Fan Lever, Climate Control System	3-2
		Filling Your Tank	6-4
E lectrical Equipment, Adding	3-23, 6-52	Filter, Air	6-14
Electrical System	6-52	Finish Care	6-47
Electronic Compass	2-55	Finish Damage	6-48
Electronic Level Control	4-28	First Gear	2-31
Engine	6-8	Flashers, Hazard Warning	5-1
Coolant	6-18	Flat Tire, Changing	5-22
Coolant Heater	2-26	Fluid Capacities	6-59
Coolant Level Check	7-34	Fluids and Lubricants	7-39

Fog Lamps	2-49
Foreign Countries, Fuel	6-3
Four-Way Manual Seat	1-1
Front Door	2-3
Front Sidemarkers Lamp Bulb Replacement	6-30
Front Towing	5-9
Front Turn Signal Lamp Bulb Replacement	6-30
Fuel	6-2
Filling Your Tank	6-4
Gage	2-83
In Foreign Countries	6-3
Fuses and Circuit Breakers	6-53

Gages

Engine Coolant Temperature	2-76
Engine Oil Pressure	2-80
Fuel	2-83
Speedometer	2-71
Tachometer	2-71
Voltmeter	2-74
Garage Door Opener	2-54
GAWR	4-27
Gear Positions, Automatic Transaxle	2-27
Glove Box	2-57
Gross Axle Weight Rating	4-27
Gross Vehicle Weight Rating	4-27
GVWR	4-27

H alogen Bulbs	6-29
Hazard Warning Flashers	5-1
Head Restraints	1-4
Headlamps	2-48
Bulb Replacement	6-29
High/Low Beam Changer	2-40
On Reminder	2-48
Wiring	6-52
Hearing Impaired, Customer Assistance	8-3
Heating	3-3
High-Beam Headlamps	2-40
Highway Hypnosis	4-21
Hill and Mountain Roads	4-21
Hitches, Trailer	4-33
Hood	
Checking Things Under	6-6
Prop	6-7
Release	6-6
Horn	2-38
Hydroplaning	4-17

I gnition Positions	2-23
Illuminated Entry	2-11, 2-50
Inflation, Tire	6-36
Inflator, Air	2-66
Injector Fuse	6-57
Inside Day/Night Rearview Mirror	2-52

Inspections		Service Parts Identification	6-51
Brake System	7-38	Tire-Loading Information	4-27
Exhaust Systems	7-38	Vehicle Identification Number	6-51
Front-Wheel-Drive Axle Boot	7-38	Lamps	2-48
Front-Wheel-Drive Axle Seal	7-38	Dome	2-50
Radiator and Heater Hose	7-38	Interior	2-49
Steering	7-38	On Reminder	2-48
Suspension	7-38	Underhood	6-9
Throttle Linkage	7-38	Leaving Your Vehicle	2-7
Instrument Panel	2-68	Leaving Your Vehicle with the Engine Running	2-34
Cleaning	6-45	License Plate Lamp Bulb Replacement	6-31
Cluster	2-70	Liftgate	2-19
Fuse Block	6-53	Liftgate Ajar Light	2-82
Light Intensity Control	2-49	Liftgate Lock	2-21
Interior Lamps	2-49	Lighter	2-58
Interior Lights Control	2-49	Lights	
Interior Lights Override Switch	2-49	Air Bag Readiness	1-26, 2-73
J ack, Tire	5-25	Anti-Lock Brake System Warning	2-75, 4-6
Jump Starting	5-2	Brake System Warning	2-74, 6-26
K ey Lock Cylinders Service	7-35	Interior	2-49
Key Reminder Warning	2-21	Interior Lights Override Switch	2-49
Keys	2-1	Liftgate Ajar	2-82
L abels		Low Coolant Warning	2-77
Certification/Tire	4-27	Low Fuel	2-84
Identification	6-51	Low Oil	2-81
		Power Sliding Door Warning	2-81
		Safety Belt Reminder	1-13, 2-73
		Service Engine Soon	2-77
		Loading Your Vehicle	4-27

Lock Delay	2-9	Scheduled Maintenance Services	7-3
Locking Storage Bin	2-59	Short Trip/City Definition	7-4
Locks	2-4	Short Trip/City Intervals	7-4
Automatic Door	2-6	Your Vehicle and the Environment	7-1
Cylinders	7-35	Maintenance, Underbody	6-49
Door	2-4	Maintenance When Trailer Towing	4-37
Key Lock Cylinder Service	7-35	Malfunction Indicator Lamp	2-77
Liftgate	2-21	Manual Front Seat	1-2
Power Door	2-5	Matching Transmitters to Your Vehicle	2-10
Sliding Door	2-13	Mirrors	2-52
Sliding Door Security	2-18	Convex Outside	2-53
Steering Column Lock Check	7-37	Inside Day/Night Rearview	2-52
Low Coolant Warning Light	2-77	Power Remote Control	2-52
Low Fuel Light	2-84	Visor Vanity	2-65
Low Oil Light	2-81	Mode Buttons, Climate Control System	3-2
Lubricants and Fluids	7-39	Mountain Roads	4-21
Lubrication Service, Body	7-35	Multifunction Lever	2-39
Luggage Carrier	2-62		
M aintenance, Normal Replacement Parts	6-60	N et, Convenience	2-61
Maintenance Record	7-41	Neutral	2-28
Maintenance Schedule	7-1	New Vehicle "Break-In"	2-22
How the Section is Organized	7-2	Night Vision	4-14
Long Trip/Highway Definition	7-5		
Long Trip/Highway Intervals	7-5	O dometer	2-71
Owner Checks and Services	7-34	Odometer, Trip	2-72
Periodic Maintenance Inspections	7-38	Off-Road Recovery	4-10
Recommended Fluids and Lubricants	7-39	Oil, Engine	6-9

Opener, Garage Door	2-54
Overhead Console	2-53
Overheating Engine	5-12
Overriding Lock Delay	2-6
Owner Checks and Services	7-34
Owner Publications, Ordering	8-10

P aint Spotting, Chemical	6-49
Park	2-27
Shifting Into	2-32
Shifting Out of	2-35
Parking	
At Night	2-21
Brake	2-31
Brake Mechanism Check	7-37
Lots	2-22
Over Things That Burn	2-35
With a Trailer	4-36
Passenger Position	1-31
Passing	4-11
Periodic Maintenance Inspections	7-38
Power	
Accessory Outlet	2-66
Door Locks	2-5
Option Fuses	6-52
Remote Control Mirror	2-52
Seat	1-3
Sliding Door Warning Light	2-81

Steering	4-8
Steering Fluid	6-22
Windows	2-37
Pregnancy, Use of Safety Belts	1-30
Problems on the Road	5-1
Publications, Service and Owner	8-9

R adiator	5-19
Radiator Pressure Cap	6-22
Radio Reception	3-23
Radios	3-9
Rain, Driving In	4-15
Reading Lamps	2-50, 2-51
Rear	
Air Vents	3-7
Climate Control	3-6
Fan	3-7
Outside Seat Position	1-31
Seat Passengers	1-31
Towing	5-11
Window Defogger	3-9
Windshield Washer	2-43
Rear Air Vents	3-7
Rear Climate Control	3-6
Rear Compartment Lamps	2-51
Rear Fan, Master Control	3-7
Rear Fan, Rear Control	3-8
Rearview Mirror, Inside Day/Night	2-52

Reclining Front Seatbacks	1-3
Recovery Tank, Coolant	5-16
Refrigerants, Air Conditioning	6-59
Remote	
Lock Control	2-8
Operation of the Power Sliding Door	2-10
Remote Operation of the Power Sliding Door	2-10
Removable Rear Bucket Seats	1-5
Replacement	
Bulbs	6-58
Parts	6-60
Wheel	6-40
Replacing Rear Bucket Seats	1-11
Replacing Safety Belts	1-56
Reporting Safety Defects	8-7
Resetting the Power Sliding Door	2-17
Restraints	
Checking	1-56
Head	1-4
Replacing Parts After a Crash	1-56
System Check	7-35
Restraints, Child	1-48
Reverse	2-28
Right Front Passenger Position	1-31
Roadside Assistance	8-4
Rocking Your Vehicle	5-34
Rotation, Tires	6-37

S afety Belt Extender	1-56
Safety Belts	1-12
Adults	1-17
Care	6-45
Center Rear Passenger Position	1-35
Children	1-37
Driver Position	1-17
Extender	1-56
How to Wear Properly	1-17
Incorrect Usage	1-20, 1-54, 1-55
Lap Belt	1-35
Lap-Shoulder	1-17, 1-31
Larger Children	1-53
Passenger Position	1-31
Questions and Answers	1-16
Rear Seat Outside Passenger Positions	1-31
Rear Seat Passengers	1-31
Reminder Light	1-13, 2-73
Replacing After a Crash	1-56
Right Front Passenger Position	1-31
Smaller Children and Babies	1-37
Use During Pregnancy	1-30
Why They Work	1-13
Safety Chains	4-33
Safety Defects, Reporting	8-7
Safety Warnings and Symbols	iii
Scheduled Maintenance Services	7-3
Seatback	
Reclining Front	1-3

Seats		
Adjusting Rear	1-10	
Booster	1-46	
Dump and Stow	1-6	
Entry to Third Row Bucket	1-7	
Four-Way Manual	1-1	
Manual Front	1-2	
Power	1-3	
Rear	1-5	
Removable Rear Bucket	1-5	
Removing CENTER OR LEFT Seats	1-9	
Removing LEFT ONLY Seats	1-9	
Removing RIGHT ONLY Seats	1-8	
Replacing Rear Bucket	1-11	
Restraint Systems	1-1	
Seat Controls	1-1	
Securing a Child Restraint	1-49	
Second Gear	2-30	
Service	6-1	
Bulletins, Ordering	8-10	
Engine Soon Light	2-77	
Manuals, Ordering	8-9	
Parts Identification Label	6-51	
Publications, Ordering	8-9	
Work, Doing Your Own	6-1	
Service and Appearance Care	6-1	
Service and Owner Publications	8-9	
Service Publications	8-9	
Servicing Your Air Bag-Equipped Oldsmobile	1-30	
Shifting		
Into Park (P)	2-32	
Out of Park	2-35	
Signaling Turns	2-40	
Skidding	4-12	
Sliding Door Security Locks	2-18	
Sound Equipment, Adding	3-23	
Spare Tire, Compact	5-32	
Specifications and Capacities	6-59	
Specifications, Engine	6-60	
Speech Impaired, Customer Assistance	8-3	
Speedometer	2-71	
SRS	1-25	
Stains, Cleaning	6-44	
Starter Switch Check	7-36	
Starting Your Engine	2-24	
Steam	5-12	
Steering	4-8	
Column Lock Check	7-37	
In Emergencies	4-9	
Power	4-8	
Tips	4-8	
Wheel, Tilt	2-39	
Steering Wheel Touch Controls	3-22	
Storage Areas	2-53	
Storage, Overhead	2-57	
Storage, Vehicle	6-28	

Stuck: In Sand, Mud, Ice or Snow	5-33
Sun Visors	2-65
Sunglasses Storage	2-57
Supplemental Restraint System	1-25
Symbols, Vehicle	v

T achometer	2-71
Taillamp Bulb Replacement	6-33
Tape Player Care	3-24
Temperature and Compass Display	2-55
Temperature Control, Climate Control System	3-2
Theft	2-21
Theft-Deterrent Feature, CD Player	3-19
Thermostat	6-22
Third Gear	2-29
Tilt Steering Wheel	2-39
Time, Setting the	3-9
Tire Chains	6-42
Tire Loading	4-27
Tire-Loading Information Label	4-27
Tires	6-35
Alignment and Balance	6-40
Buying New	6-38
Chains	6-42
Changing a Flat	5-22
Cleaning	6-48
Compact Spare	5-32
Inflation	6-36

Inflation Check	7-34
Inspection and Rotation	6-37
Loading	4-27
Pressure	6-36
Temperature	6-40
Traction	6-39
Treadwear	6-39
Uniform Quality Grading	6-39
Wear Indicators	6-38
Wheel Replacement	6-40
When It's Time for New	6-38
Top Strap	1-48
Torque Lock	2-34
Torque, Wheel Nut	5-30, 6-59
Towing a Trailer	4-29
Towing Your Vehicle	5-7
Trailer	
Brakes	4-33
Driving on Grades	4-36
Driving with	4-34
Hitches	4-33
Maintenance When Towing	4-37
Parking on Hills	4-36
Safety Chains	4-33
Tongue Weight	4-32
Total Weight on Tires	4-32
Towing	4-29
Turn Signals	4-35
Weight	4-31

Transaxle Fluid, Automatic	6-15
Transmitters, Remote Lock Control	2-8
Matching Transmitters	2-10
Transportation, Courtesy	8-5
Trip Odometer	2-72
TTY Users	8-3
Turn Signal and Lane Change Signals	2-40
Turn Signal/Multifunction Lever	2-39
Turn Signals When Towing a Trailer	4-35

U nderbody Flushing Service	7-37
Underbody Maintenance	6-49
Used Replacement Wheel	6-41

V ehicle	
Control	4-5
Damage Warnings	iv
Dimensions	6-60
Identification Number	6-51
Loading	4-27
Storage	6-28
Ventilation System	3-4
Ventilation System, Rear Fan	3-4
Ventilation Tips	3-5
Visor Vanity Mirrors	2-65
Visors, Sun	2-65
Voltmeter	2-74

W arning Devices	5-2
Warning Lights, Gages and Indicators	2-72
Washer Fluid, Windshield	2-42, 6-23
Washing Your Vehicle	6-46
Weatherstrips	6-46
Wheel	
Alignment	6-40
Nut Torque	5-30, 6-59
Replacement	6-40
Used Replacement	6-41
Wrench	5-25
Windows	2-37
Power	2-37
Side Latches	2-38
Windshield Washer	2-42
Fluid	2-42, 6-23
Fluid Level Check	7-34
Rear	2-43
Windshield Wiper	2-41
Rear	2-43
Blade Replacement	6-34
Fuses	6-52
Winter Driving	4-23
Wiring, Headlamp	6-52
Wrench, Wheel	5-25

