

1996  
1996  
1996  
1996  
1996  
1996  
1996



# Yukon/ Suburban

---

O W N E R ' S M A N U A L



# The 1996 GMC Yukon and Suburban Owner's Manual

<b>Seats and Restraint Systems</b> .....	1-1
This section tells you how to use your seats and safety belts properly. It also explains the "SIR" system.	
<b>Features and Controls</b> .....	2-1
This section explains how to start and operate your vehicle.	
<b>Comfort Controls and Audio Systems</b> .....	3-1
This section tells you how to adjust the ventilation and comfort controls and how to operate your audio system.	
<b>Your Driving and the Road</b> .....	4-1
Here you'll find helpful information and tips about the road and how to drive under different conditions.	
<b>Problems on the Road</b> .....	5-1
This section tells you what to do if you have a problem while driving, such as a flat tire or overheated engine, etc.	
<b>Service and Appearance Care</b> .....	6-1
Here the manual tells you how to keep your vehicle running properly and looking good.	
<b>Maintenance Schedule</b> .....	7-1
This section tells you when to perform vehicle maintenance and what fluids and lubricants to use.	
<b>Customer Assistance Information</b> .....	8-1
This section tells you how to contact GMC Truck for assistance and how to get service and owner publications. It also gives you information on "Reporting Safety Defects" on page 8-8.	
<b>Index</b> .....	9-1
Here's an alphabetical listing of almost every subject in this manual. You can use it to quickly find something you want to read.	



GENERAL MOTORS, GM, the GM Emblem, GMC TRUCK, the GMC TRUCK Emblem, the name YUKON and the name SUBURBAN are registered trademarks of General Motors Corporation.

This manual includes the latest information at the time it was printed. We reserve the right to make changes in the product after that time without further notice. For vehicles first sold in Canada, substitute the name "General Motors of Canada Limited" for GMC Truck Division whenever it appears in this manual.

Please keep this manual in your vehicle, so it will be there if you ever need it when you're on the road. If you sell the vehicle, please leave this manual in it so the new owner can use it.

Litho in U.S.A.  
X9609 B First Edition



We support voluntary technician certification.

## For Canadian Owners Who Prefer a French Language Manual:

**Aux propriétaires canadiens:** Vous pouvez vous procurer un exemplaire de ce guide en français chez votre concessionnaire ou au:

DGN Marketing Services Ltd.  
1500 Bonhill Rd.  
Mississauga, Ontario L5T 1C7

© Copyright General Motors Corporation 1995  
All Rights Reserved

## About Driving Your Vehicle

As with other vehicles of this type, failure to operate this vehicle correctly may result in loss of control or an accident. Be sure to read the “on-pavement” and “off-road” driving guidelines in this manual. (See “Driving Guidelines” and “Off-Road Driving with your Four-Wheel-Drive Vehicle” in the Index.)

## How to Use this Manual

Many people read their owner’s manual from beginning to end when they first receive their new vehicle. If you do this, it will help you learn about the features and controls for your vehicle. In this manual, you’ll find that pictures and words work together to explain things quickly.

## Index

A good place to look for what you need is the Index in the back of the manual. It’s an alphabetical list of all that’s in the manual, and the page number where you’ll find it.

## Safety Warnings and Symbols

You will find a number of safety cautions in this book. We use a box and the word CAUTION to tell you about things that could hurt you if you were to ignore the warning.



**These mean there is something that could hurt you or other people.**

In the caution area, we tell you what the hazard is. Then we tell you what to do to help avoid or reduce the hazard. Please read these cautions. If you don’t, you or others could be hurt.



You will also find a circle with a slash through it in this book. This safety symbol means “Don’t,” “Don’t do this,” or “Don’t let this happen.”

In the notice area, we tell you about something that can damage your vehicle. Many times, this damage would not be covered by your warranty, and it could be costly. But the notice will tell you what to do to help avoid the damage.

When you read other manuals, you might see CAUTION and NOTICE warnings in different colors or in different words.

You’ll also see warning labels on your vehicle. They use the same words, CAUTION or NOTICE.

## Vehicle Damage Warnings

Also, in this book you will find these notices:

### **NOTICE:**

**These mean there is something that could damage your vehicle.**

## Vehicle Symbols

These are some of the symbols you may find on your vehicle.

For example, these symbols are used on an original battery:

CAUTION  
POSSIBLE  
INJURY



PROTECT  
EYES BY  
SHIELDING



CAUSTIC  
BATTERY  
ACID COULD  
CAUSE  
BURNS



AVOID  
SPARKS OR  
FLAMES



SPARK OR  
FLAME  
COULD  
EXPLODE  
BATTERY



These symbols are important for you and your passengers whenever your vehicle is driven:

DOOR LOCK  
UNLOCK



FASTEN  
SEAT  
BELTS



POWER  
WINDOW



AIR BAG



These symbols have to do with your lights:

MASTER  
LIGHTING  
SWITCH



TURN  
SIGNALS

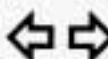

PARKING  
LAMPS

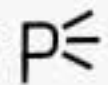

HAZARD  
WARNING  
FLASHER



DAYTIME  
RUNNING  
LAMPS



FOG LAMPS



These symbols are on some of your controls:

WINDSHIELD  
WIPER



WINDSHIELD  
WASHER



WINDSHIELD  
DEFROSTER



REAR  
WINDOW  
DEFOGGER



VENTILATING  
FAN



These symbols are used on warning and indicator lights:

ENGINE  
COOLANT  
TEMP

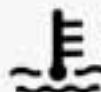

BATTERY  
CHARGING  
SYSTEM



BRAKE



COOLANT



ENGINE OIL  
PRESSURE



ANTI-LOCK  
BRAKES



Here are some other symbols you may see:

FUSE



LIGHTER



HORN



SPEAKER



FUEL



## Model Reference

This manual covers these models:

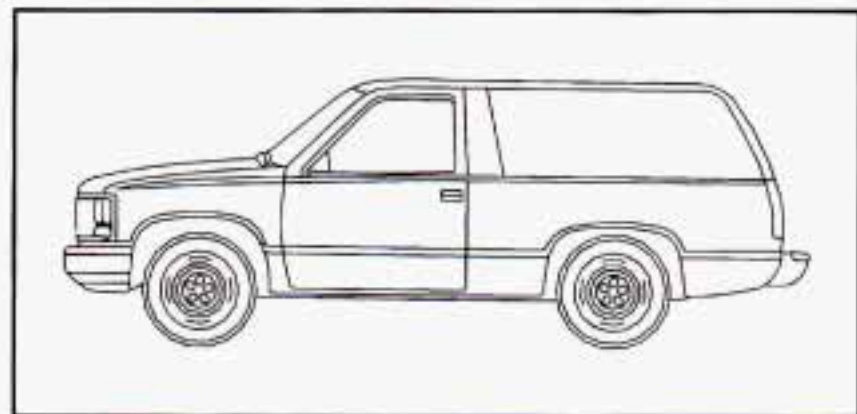

2-Door Utility

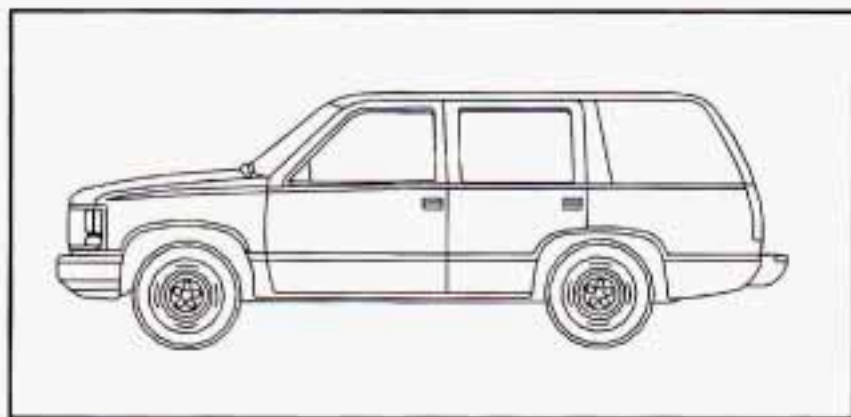

4-Door Utility

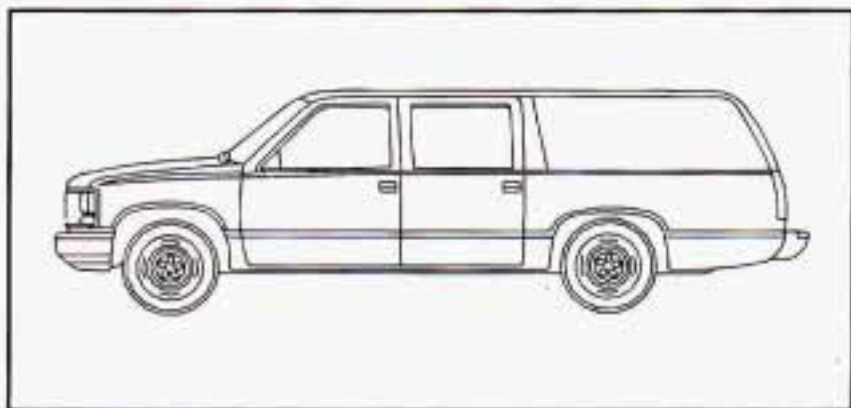

Suburban



# Section 1 Seats and Restraint Systems

---

---

Here you'll find information about the seats in your vehicle and how to use your safety belts properly. You can also learn about some things you should *not* do with air bags and safety belts.

## Seats and Seat Controls

This section tells you about the seats -- how to adjust them and fold them up and down. It also tells you about reclining front seatbacks and head restraints.

## Manual Front Seat

 **CAUTION:**

**You can lose control of the vehicle if you try to adjust a manual driver's seat while the vehicle is moving. The sudden movement could startle and confuse you, or make you push a pedal when you don't want to. Adjust the driver's seat only when the vehicle is not moving.**



If your vehicle has a manual bucket, split bench or full bench seat, you can adjust it with this lever at the front of the seat.

Slide the lever at the front of the seat toward the passenger's side to unlock it. Using your body, slide the seat to where you want it. Then, release the lever and try to move the seat with your body, to make sure the seat is locked in place.

## Power Driver's Seat (Option)

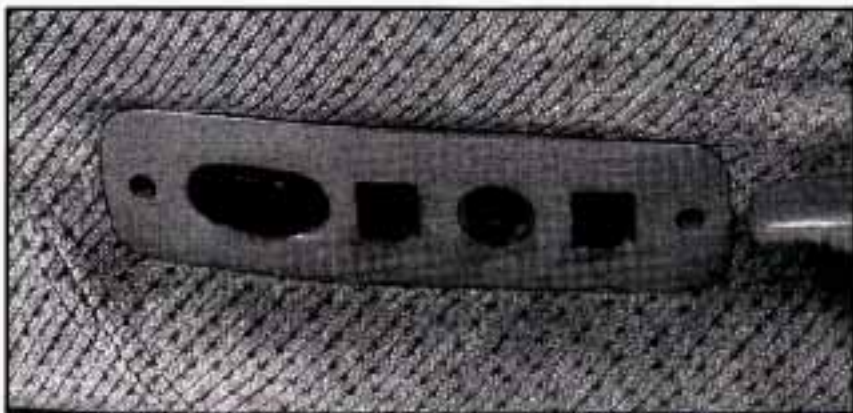

If your vehicle has a power seat on the driver's side, you can adjust it with these controls at the outside edge of the seat.

You can use the round center knob to move the seat where you want it. To raise the seat, move the knob up. To lower the seat, move the knob down. To move the seat forward, move the knob toward the front of the vehicle. To move the seat rearward, move the knob toward the rear of the vehicle.

You can also raise and lower the front and rear of the seat. To raise the front of the seat, move the front lever up. To lower the front of the seat, move the front lever down. To raise the rear of the seat, move the rear lever up. To lower the rear of the seat, move the rear lever down.

## Power Lumbar Adjustment



If you have power lumbar adjustment, you can increase or decrease lumbar support in an area of the lower seatback.

To increase support, press and hold the front of the rocker switch. Let go of the switch when the lower seatback reaches the desired level of support.

To decrease support, press and hold the rear of the rocker switch. Let go of the switch when the lower seatback reaches the desired level of support.

## Reclining Front Seatbacks



To adjust the seatback, lift the front of this lever.

Release the lever to lock the seatback where you want it. Pull up on the front of the lever and the seatback will go to an upright position.



But don't have a seatback reclined if your vehicle is moving.



## **CAUTION:**

**Sitting in a reclined position when your vehicle is in motion can be dangerous. Even if you buckle up, your safety belts can't do their job when you're reclined like this.**

**The shoulder belt can't do its job because it won't be against your body. Instead, it will be in front of you. In a crash you could go into it, receiving neck or other injuries.**

**The lap belt can't do its job either. In a crash the belt could go up over your abdomen. The belt forces would be there, not at your pelvic bones. This could cause serious internal injuries.**

**For proper protection when the vehicle is in motion, have the seatback upright. Then sit well back in the seat and wear your safety belt properly.**

## **Head Restraints**

Slide the head restraint up or down so that the top of the restraint is closest to the top of your ears. This position reduces the chance of a neck injury in a crash.

## **Seatback Latches (2-Door Utility)**

The front seatback folds forward to let you access the rear of the vehicle.



To fold a seatback forward, pull this lever forward and fold the seatback forward.

To return the seatback to the upright position, just push the seatback rearward until it latches.

After returning the seatback to its upright position, pull the seatback forward to make sure it is locked.

**⚠ CAUTION:**

**If the seatback isn't locked, it could move forward in a sudden stop or crash. That could cause injury to the person sitting there. Always press rearward on the seatback to be sure it is locked.**

## Easy Entry Seat (2-Door Utility)

The driver and passenger front bucket seat and the 60/40 split bench seat of your vehicle has an easy entry feature. This makes it easy to get in and out of the rear seat.



To operate the seat, pull forward on the top of the lever, located at the side of the seatback, and tilt the back forward toward the front of the vehicle.

When you do, the seat bottom will release. Just pull or push the seat forward until it stops.

To return the seat to its regular position, return the seatback to its upright position, then push the whole seat rearward until it latches.

After returning the seat to its regular position, try to move the seat with your body, to make sure the seat is locked into place.

 **CAUTION:**

**If any easy entry seat isn't locked, it can move. In a sudden stop or crash, the person sitting there could be injured. And, even if there is no crash or sudden stop, a driver sitting in an unlocked easy entry seat could be startled by the sudden movement and hit the wrong control or pedal, causing an accident. After you've used it, be sure to push rearward on any easy entry seat to be sure it is locked.**

## Rear Seats

 **CAUTION:**

**If a head restraint is not installed on the seatback or stored in the vehicle properly, it could be thrown about the vehicle in a crash or sudden maneuver. People in the vehicle could be injured. Remove the head restraints only when you need to fold the seat, and be sure that the head restraints are stored securely in the storage bag and placed under the rear seat. When the seat is returned to the passenger position, be sure the head restraints are installed properly.**

## Folding the Rear Seat (2-Door Utility Model)

If your vehicle has a rear seat, the seat can be folded flat for more cargo space. Before folding, make sure nothing is under or in front of the seat. When the seat is folded, it will lay almost flat on the floor.

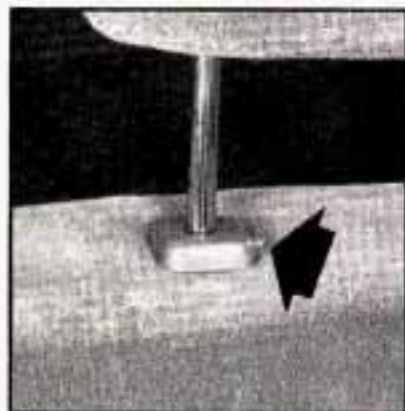

When folding the seat, first remove the head restraints. Push the release button at the top of the seat back and slide the head restraint out of the height adjust tubes.

Detach the stowage bag from the back of the rear seat. Then, put the head restraints in the stowage bag and place the bag in the rear seat foot well, under the seat.



To fold the seat, pull on the release handle at the bottom of the seat cushion marked **RELEASE**.





When you release the seat cushion, the seatback is automatically released. Pull the loop on the seatback forward and fold the seatback onto the seat cushion.

While the seat is in the folded position, hang the latch plate end of the outer passenger position safety belts on the hooks at the top of each retractor cover, out of the way.

To return the seat to the passenger position, just lift up on the seatback and push it rearward until it latches.

After returning the seat to the passenger position, pull forward on the seatback to make sure it is locked in place. Also, return the safety belts and head restraints to their original positions, so they will be available for rear seat passengers to use.

### Folding the Rear Seat (4-Door Utility Model)

If your vehicle has a 60/40 rear seat, either side may be folded down to give you more cargo space.

Before folding, place the latch plate portion of the center safety belt in the center arm rest. That way, the center safety belt will be out of the way when the seat is folded and also will be easily available for passengers to use when the seat is returned to the passenger position. Also, make sure that nothing is under or in front of the seat. When the seat is folded, it will lay flat on the floor.

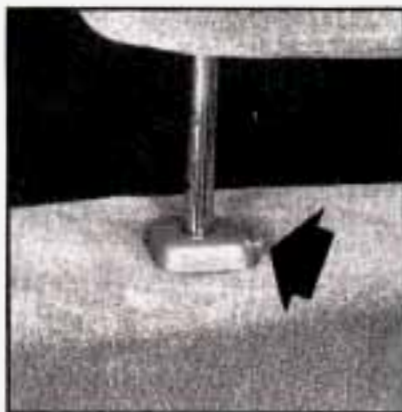

First, remove the head restraints. Push the release buttons at the bottom of each head restraint height adjust post and slide the head restraint out of the height adjust tubes.

Set the head restraints aside for now. You will stow them in their proper position after you are done folding the seat.



To fold the seat, pull up on the strap loop at the rear of the seat cushion.

Then, pull the seat cushion up and fold it forward.

After folding the seat cushion fully forward, pull the seatback forward and fold the seatback down until it is flat.



Then, stow the head restraints by sliding them into the rear of the seatback. Make sure the posts go in all the way.

To return the seat to the passenger position, first remove the head restraints by sliding them out of the seat cushion. Lift the seatback up and push rearward all the way. Then, lower the seat cushion until it latches in position.

After returning the seat to the passenger position, return the head restraints to the top of each seatback. Pull forward on the seatback and up on the seat cushion to make sure the seat is securely in place.

If the latch plate portion of the center safety belt was put in the center armrest when the seat was folded, take the latch plate portion out and place it on the seat. That way, the center seat position safety belt will be available for the center rear seat passenger to use.

## Folding Second Seat (Suburban)

If your vehicle has a 60/40 second seat, either side may be folded down to give you more cargo space.

Before folding, push the buckle portion of the safety belt down into the seat cushion pockets, out of the way.

Also, make sure that nothing is under or in front of the seat. When the seat is folded, it will lay flat on the floor.

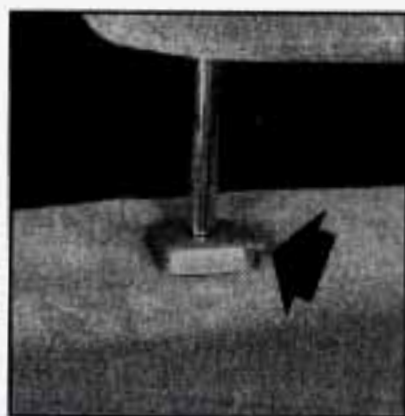

First, remove the head restraints. Push the release button at the top of the seatback and slide the head restraint out of the height adjust tubes.

Set the head restraints aside for now. You will stow them in their proper position after you are done folding the seat.



To fold the seat, pull up on the strap loop at the rear outer edge of the seat cushion. Then, pull the seat cushion up.

After folding the seat cushion fully forward, push down on the lever at the side of the seatback and fold the seatback forward until it is flat.



Then, stow the head restraints by sliding them into the rear of the seatback. Make sure the posts go in all the way.



To create a load floor, release the panels from the seatback by pushing rearward on the latch and fold them out to cover the rear seat footwell.

To return the seat to the passenger position, lift the load floor panels and latch them into the seatback.

Then, lift the seatback up and push rearward until it latches. Return head restraints to their original position and lower the seat cushion until it latches in position.

After returning the seat to the passenger position, pull forward on the seatback and up on the seat cushion to make sure the seat is locked in place. Also, pull the safety belt buckles out of the seat cushion pockets, so they will be available for rear seat passengers to use.

 **CAUTION:**

**A seat that isn't locked into place properly can move around in a collision or sudden stop. People in the vehicle could be injured. Be sure to lock the seat into place properly when installing it.**

 **CAUTION:**

**A safety belt that is twisted or not properly attached won't provide the protection needed in a crash. The person wearing the belt could be seriously injured. After installing the seat, always check to be sure that the safety belts are not twisted and are properly attached.**

### Entry to the Rear Seat (Suburban Second Seat)

The right side of the rear 60/40 split folding bench seat, available in the Suburban, has an easy entry feature. That makes it easy to get in and out of the third seat, if you have one.



There is a foot operated release lever for rear seat passengers to use when getting out of the third seat.

To operate the seat, move the lever at the side of the seat down.

Tilt the seatback toward the front of the vehicle by pulling the top of the seatback forward.

When you do, the seat bottom will release. Just pull the seat forward until it stops.

To release the easy entry second seat, lift up on the top of the release lever with your foot. Push the top of the seatback forward and tilt it toward the front of the vehicle.

To return the seat to its regular position, return the seatback to its upright position, then push the whole seat rearward until it latches.

After returning the seat to its regular position, try to move the seat with your body, to make sure the seat is locked into place.

## Removing the Rear (Suburban Third Seat)

If your vehicle has a rear seat, it can be taken out for more cargo space.

Before removing the seat, unlatch the outside passenger position safety belts from the seat frame.



To unlatch the safety belt, press the tip of a key into the release hole of the safety belt attachment while pulling up on the safety belt.



Then, hang the latch plate end of the belt on the hook at the top of the retractor cover, out of the way.

To remove the seat, fully open the rear load doors and enter the back of the vehicle.



Move the seatback release lever, at the right rear of the seat, toward the center of the vehicle.

Then, fold the seatback forward into the seat cushion.

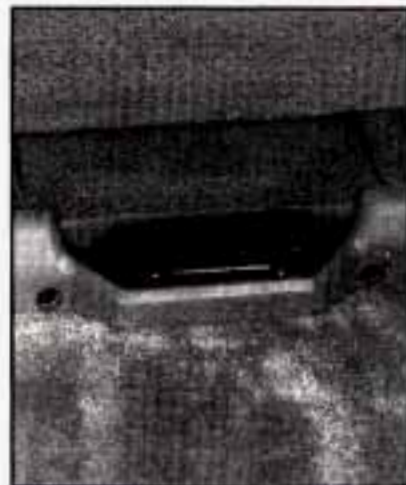

To unlatch the seat from the floor, pull up on the center release handle at the rear of the seat and lift the rear of the seat up, off of the floor.

Turn the seat sideways and take it out of the vehicle.

## Replacing the Rear Seat

To put the seat back in, hold the seat sideways and put it into the vehicle. Turn the seat to the forward position and set it down, with the latches at the bottom of the seat over the hooks in the floor. Pull up on the center release handle and let the seat drop into place. Release the handle to let the seat latch close and make sure it locks into place. Then, move the seatback release lever at the right rear of the seat toward the center of the vehicle and raise the seatback.

After returning the seatback to the upright position, push the seatback forward to make sure it is locked in place.

Then, return the outside passenger position safety belts to the seat frame buckles, so they will be available for rear seat passengers to use.

## Safety Belts: They're for Everyone

This part of the manual tells you how to use safety belts properly. It also tells you some things you should not do with safety belts.

And it explains the Supplemental Inflatable Restraint (SIR), or air bag system.



### CAUTION:

**Don't let anyone ride where he or she can't wear a safety belt properly. If you are in a crash and you're not wearing a safety belt, your injuries can be much worse. You can hit things inside the vehicle or be ejected from it. You can be seriously injured or killed. In the same crash, you might not be if you are buckled up. Always fasten your safety belt, and check that your passengers' belts are fastened properly too.**





Your vehicle has a light that comes on as a reminder to buckle up. (See “Safety Belt Reminder Light” in the Index.)

In most states and Canadian provinces, the law says to wear safety belts. Here’s why: *They work.*

You never know if you’ll be in a crash. If you do have a crash, you don’t know if it will be a bad one.

A few crashes are mild, and some crashes can be so serious that even buckled up a person wouldn’t survive. But most crashes are in between. In many of them, people who buckle up can survive and sometimes walk away. Without belts they could have been badly hurt or killed.

After more than 25 years of safety belts in vehicles, the facts are clear. In most crashes buckling up does matter ... a lot!

## Why Safety Belts Work

When you ride in or on anything, you go as fast as it goes.

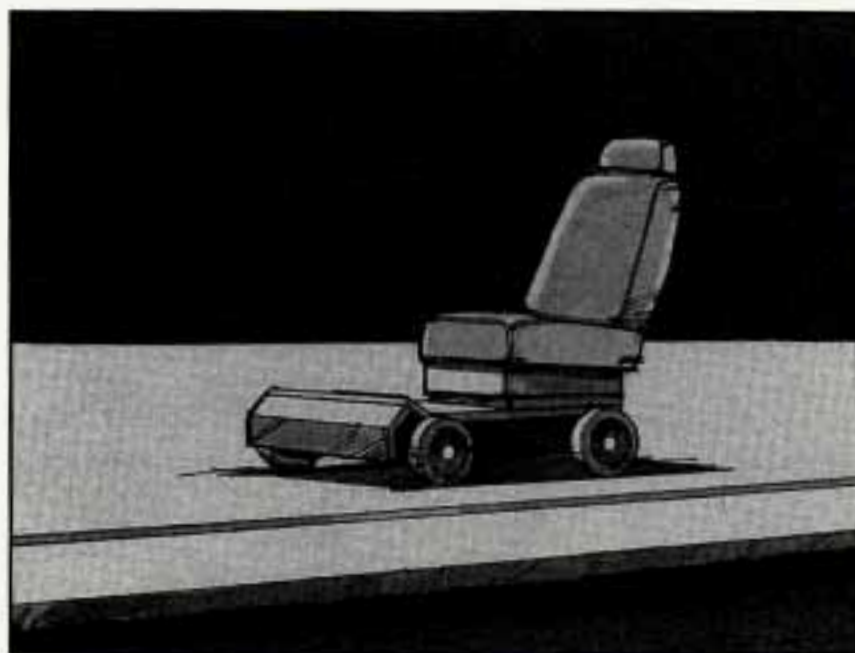

Take the simplest vehicle. Suppose it’s just a seat on wheels.

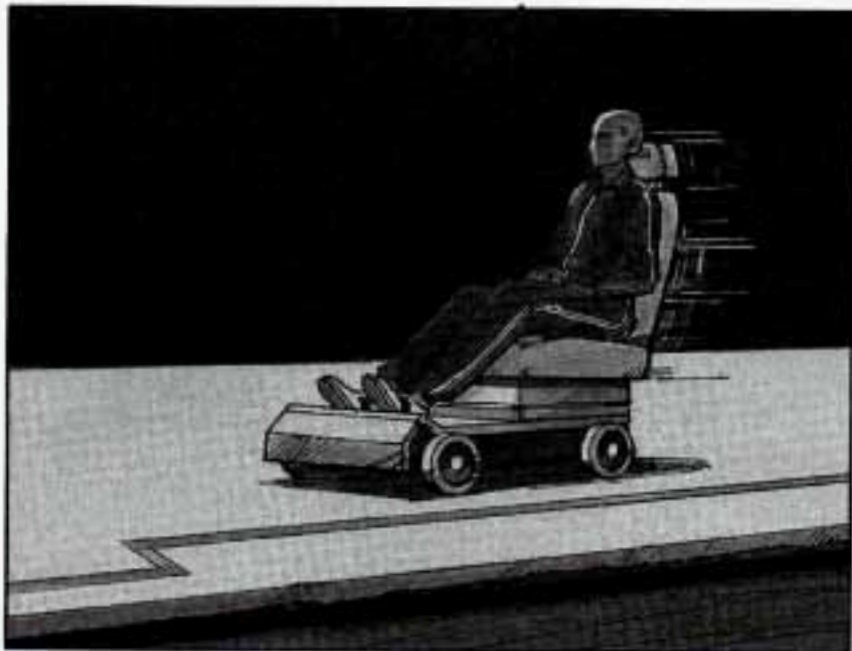

Put someone on it.

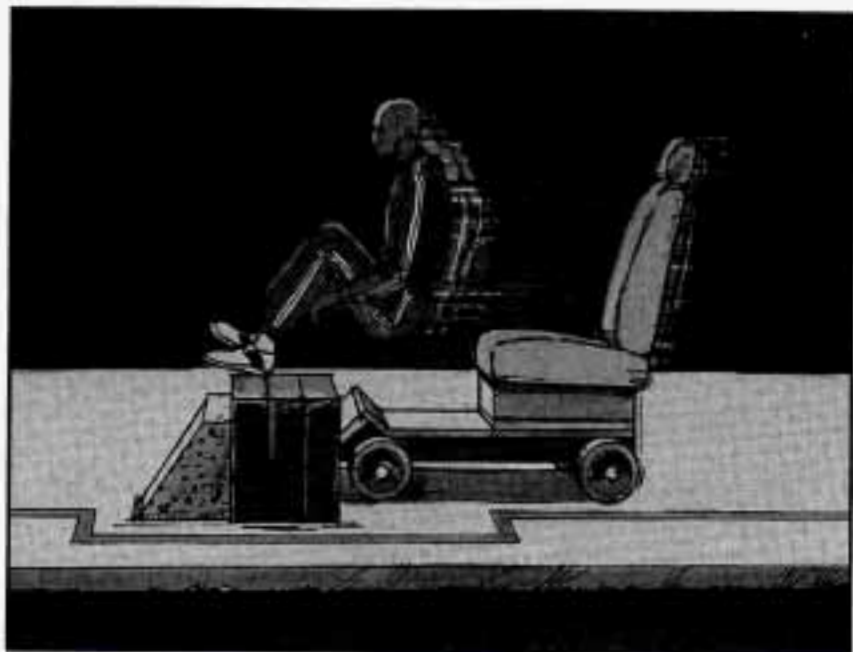

Get it up to speed. Then stop the vehicle. The rider doesn't stop.



The person keeps going until stopped by something.  
In a real vehicle, it could be the windshield ...



or the instrument panel ...

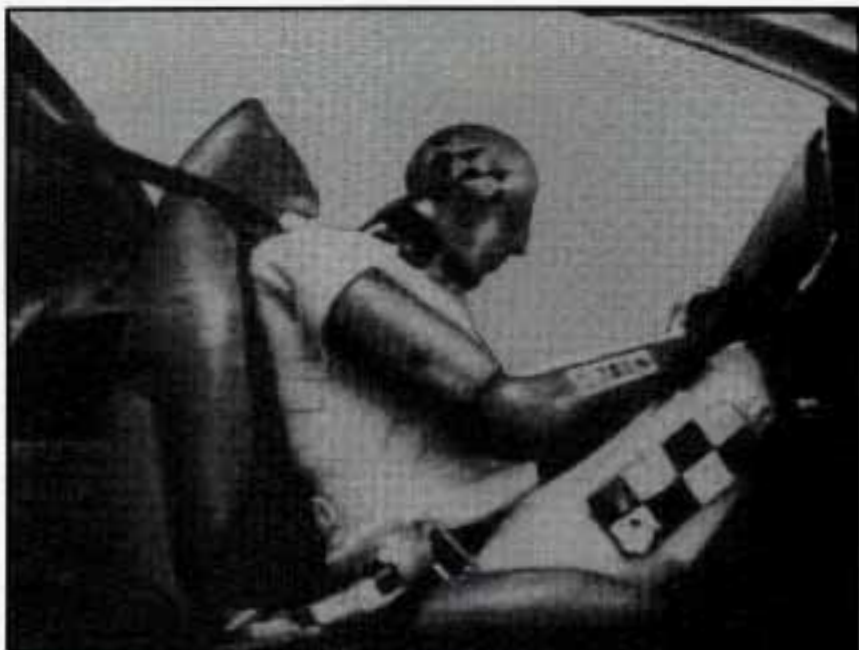

or the safety belts!

With safety belts, you slow down as the vehicle does. You get more time to stop. You stop over more distance, and your strongest bones take the forces. That's why safety belts make such good sense.

## Here Are Questions Many People Ask About Safety Belts -- and the Answers

**Q:** Won't I be trapped in the vehicle after an accident if I'm wearing a safety belt?

**A:** You *could* be -- whether you're wearing a safety belt or not. But you can unbuckle a safety belt, even if you're upside down. And your chance of being conscious during and after an accident, so you *can* unbuckle and get out, is *much* greater if you are belted.

**Q:** If my vehicle has air bags, why should I have to wear safety belts?

**A:** Air bags are in many vehicles today and will be in most of them in the future. But they are supplemental systems only; so they work *with* safety belts -- not instead of them. Every air bag system ever offered for sale has required the use of safety belts. Even if you're in a vehicle that has air bags, you still have to buckle up to get the most protection. That's true not only in frontal collisions, but especially in side and other collisions.

**Q:** If I'm a good driver, and I never drive far from home, why should I wear safety belts?

**A:** You may be an excellent driver, but if you're in an accident -- even one that isn't your fault -- you and your passengers can be hurt. Being a good driver doesn't protect you from things beyond your control, such as bad drivers.

Most accidents occur within 25 miles (40 km) of home. And the greatest number of serious injuries and deaths occur at speeds of less than 40 mph (65 km/h).

Safety belts are for everyone.

## How to Wear Safety Belts Properly

### Adults

This part is only for people of adult size.

Be aware that there are special things to know about safety belts and children. And there are different rules for smaller children and babies. If a child will be riding in your vehicle, see the part of this manual called "Children." Follow those rules for everyone's protection.

First, you'll want to know which restraint systems your vehicle has.

We'll start with the driver position.

### Driver Position

This part describes the driver's restraint system.

### Lap-Shoulder Belt

The driver has a lap-shoulder belt. Here's how to wear it properly.

1. Close and lock the door.
2. Adjust the seat (to see how, see "Seats" in the Index) so you can sit up straight.

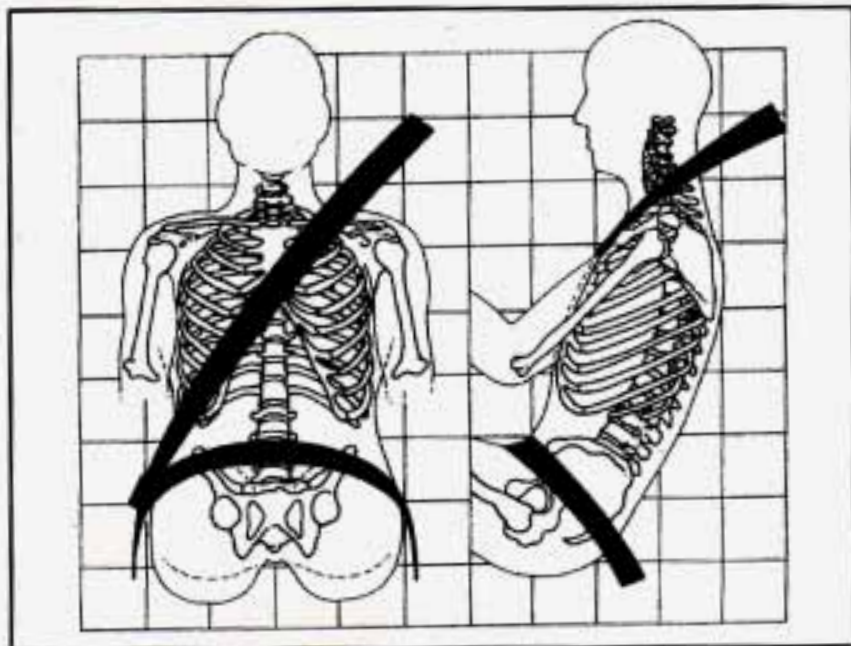

3. Pick up the latch plate and pull the belt across you. Don't let it get twisted.
4. Push the latch plate into the buckle until it clicks. Pull up on the latch plate to make sure it is secure.  
If the belt isn't long enough, see "Safety Belt Extender" at the end of this section.

Make sure the release button on the buckle is positioned so you would be able to unbuckle the safety belt quickly if you ever had to.

The lap part of the belt should be worn low and snug on the hips, just touching the thighs. In a crash, this applies force to the strong pelvic bones. And you'd be less likely to slide under the lap belt. If you slid under it, the belt would apply force at your abdomen. This could cause serious or even fatal injuries. The shoulder belt should go over the shoulder and across the chest. These parts of the body are best able to take belt restraining forces.

The safety belt locks if there's a sudden stop or a crash.

## Shoulder Belt Height Adjuster

Before you begin to drive, move the shoulder belt adjuster to the height that is right for you.



To move it down, push in at the word **PRESS** and move the height adjuster to the desired position. You can move the adjuster up just by pushing up on the shoulder belt guide. After you move the adjuster to where you want it, try to move it down without pushing in to make sure it has locked into position.

Adjust the height so that the shoulder portion of the belt is centered on your shoulder. The belt should be away from your face and neck, but not falling off your shoulder.

**Q:** What's wrong with this?

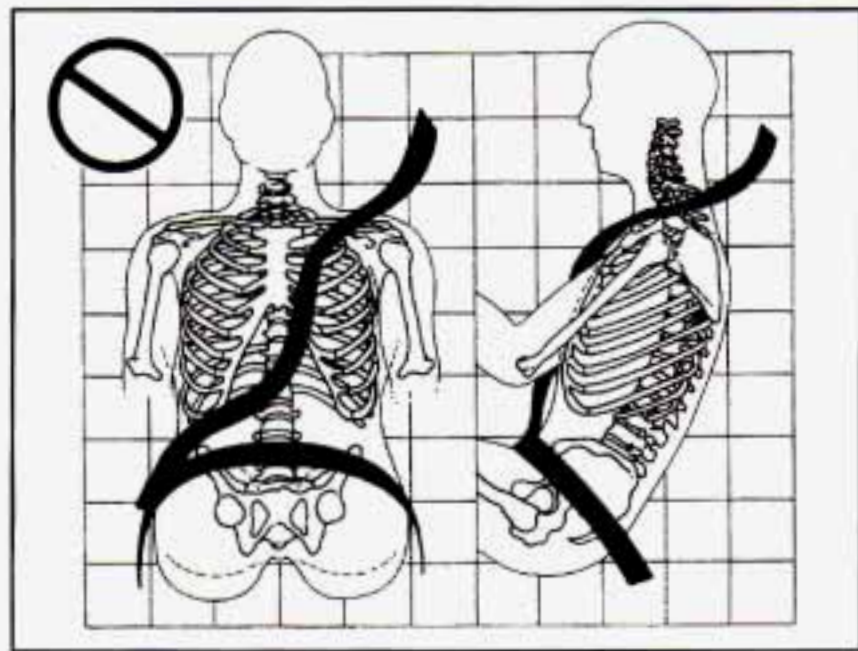

**A:** The shoulder belt is too loose. It won't give nearly as much protection this way.

**⚠ CAUTION:**

You can be seriously hurt if your shoulder belt is too loose. In a crash, you would move forward too much, which could increase injury. The shoulder belt should fit against your body.



**Q:** What's wrong with this?

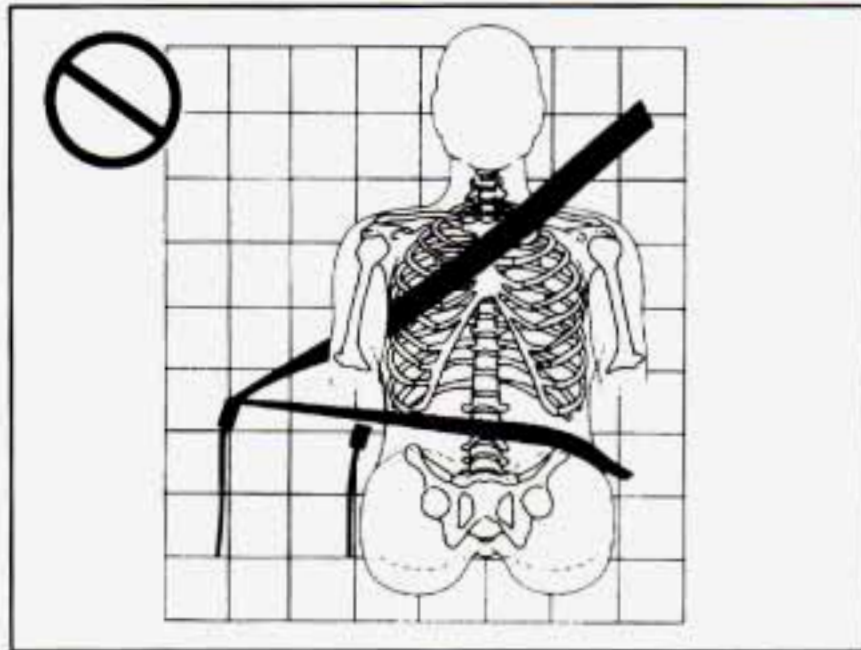

**A:** The belt is buckled in the wrong place.

**⚠ CAUTION:**

You can be seriously injured if your belt is buckled in the wrong place like this. In a crash, the belt would go up over your abdomen. The belt forces would be there, not at the pelvic bones. This could cause serious internal injuries. Always buckle your belt into the buckle nearest you.

**Q:** What's wrong with this?

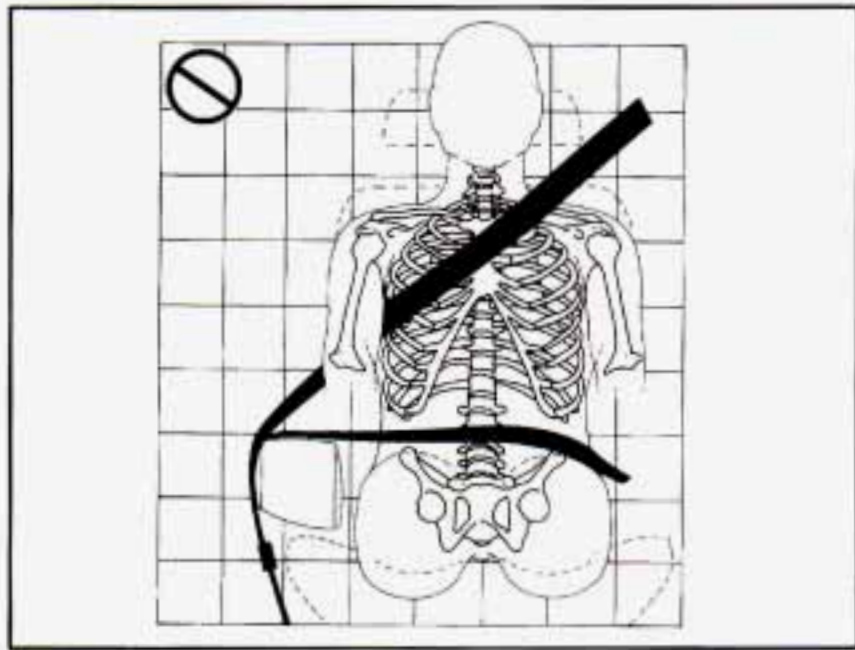

**⚠ CAUTION:**

You can be seriously injured if your belt goes over an armrest like this. The belt would be much too high. In a crash, you can slide under the belt. The belt force would then be applied at the abdomen, not at the pelvic bones, and that could cause serious or fatal injuries. Be sure the belt goes under the armrests.

**A:** The belt is over an armrest.

**Q:** What's wrong with this?

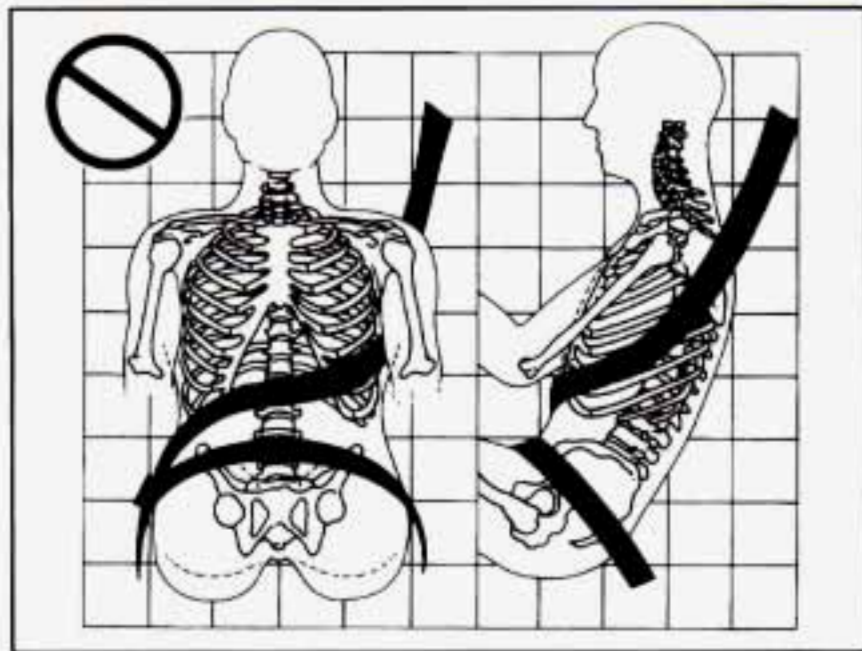

**A:** The shoulder belt is worn under the arm. It should be worn over the shoulder at all times.

**⚠ CAUTION:**

You can be seriously injured if you wear the shoulder belt under your arm. In a crash, your body would move too far forward, which would increase the chance of head and neck injury. Also, the belt would apply too much force to the ribs, which aren't as strong as shoulder bones. You could also severely injure internal organs like your liver or spleen.

**Q:** What's wrong with this?

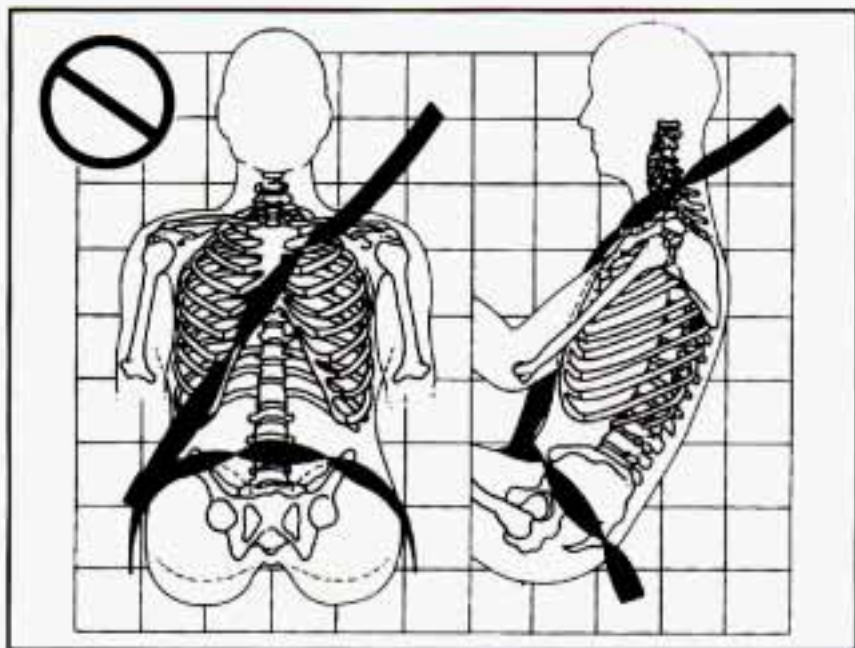

**⚠ CAUTION:**

You can be seriously injured by a twisted belt. In a crash, you wouldn't have the full width of the belt to spread impact forces. If a belt is twisted, make it straight so it can work properly, or ask your dealer to fix it.

**A:** The belt is twisted across the body.



To unlatch the belt, just push the button on the buckle. The belt should go back out of the way.

Before you close the door, be sure the belt is out of the way. If you slam the door on it, you can damage both the belt and your vehicle.

## Supplemental Inflatable Restraint (SIR) System

This part explains the Supplemental Inflatable Restraint (SIR) system or air bag system.

Your vehicle has an air bag for the driver.

Here are the most important things to know about the air bag system:

### CAUTION:

You can be severely injured or killed in a crash if you aren't wearing your safety belt -- even if you have an air bag. Wearing your safety belt during a crash helps reduce your chance of hitting things inside the vehicle or being ejected from it. The air bag is only a "supplemental restraint." That is, it works with safety belts but doesn't replace them. Air bags are designed to work only in moderate to severe crashes where the front of your vehicle hits something. They aren't designed to inflate at all in rollover, rear, side or low-speed frontal crashes. Everyone in your vehicle, including the driver, should wear a safety belt properly -- whether or not there's an air bag for that person.

 **CAUTION:**

**Air bags inflate with great force, faster than the blink of an eye. If you're too close to an inflating air bag, it could seriously injure you. Safety belts help keep you in position for an air bag inflation in a crash. Always wear your safety belt, even with an air bag, and sit as far back as you can while still maintaining control of your vehicle.**

**AIR  
BAG**

There is an air bag readiness light on the instrument panel, which shows AIR BAG.

The system checks the air bag's electrical system for malfunctions. The light tells you if there is an electrical problem. See "Air Bag Readiness Light" in the Index for more information.

## How the Air Bag System Works



### Where is the air bag?

The driver's air bag is in the middle of the steering wheel.

### CAUTION:

Don't put anything on, or attach anything to, the steering wheel. Also, don't put anything (such as pets or objects) between the driver and the steering wheel. If something is between an occupant and an air bag, it could affect the performance of the air bag -- or worse, it could cause injury.

## **When should an air bag inflate?**

The air bag is designed to inflate in moderate to severe frontal or near-frontal crashes. The air bag will inflate only if the impact speed is above the system's designed "threshold level." If your vehicle goes straight into a wall that doesn't move or deform, the threshold level is about 9 to 16 mph (14 to 26 km/h). The threshold level can vary, however, with specific vehicle design, so that it can be somewhat above or below this range. If your vehicle strikes something that will move or deform, such as a parked car, the threshold level will be higher. The air bag is not designed to inflate in rollovers, side impacts or rear impacts, because inflation would not help the occupant.

In any particular crash, no one can say whether an air bag should have inflated simply because of the damage to a vehicle or because of what the repair costs were. Inflation is determined by the angle of the impact and the vehicle's deceleration. Vehicle damage is only one indication of this.

The air bag system is designed to work properly under a wide range of conditions, including off-road usage. Observe safe driving speeds, especially on rough terrain. As always, wear your safety belt. See "Off-Road Driving" in the Index for more tips on off-road driving.

## **What makes an air bag inflate?**

In a frontal or near-frontal impact of sufficient severity, the air bag sensing system detects that the vehicle is suddenly stopping as a result of a crash. The sensing system triggers a chemical reaction of the sodium azide sealed in the inflator. The reaction produces nitrogen gas, which inflates the air bag. The inflator, air bag and related hardware are all part of the air bag module packed inside the steering wheel.

## **How does an air bag restrain?**

In moderate to severe frontal or near-frontal collisions, even belted occupants can contact the steering wheel. The air bag supplements the protection provided by safety belts. Air bags distribute the force of the impact more evenly over the occupant's upper body, stopping the occupant more gradually. But air bags would not help you in many types of collisions, including rollovers, rear impacts and side impacts, primarily because an occupant's motion is not toward the air bag. Air bags should never be regarded as anything more than a supplement to safety belts, and then only in moderate to severe frontal or near-frontal collisions.



## What will you see after an air bag inflates?

After the air bag inflates, it quickly deflates. This occurs so quickly that some people may not even realize the air bag inflated. Some components of the air bag module in the steering wheel hub will be hot for a short time. The part of the bag that comes into contact with you may be warm, but it will never be too hot to touch. There will be some smoke and dust coming from vents in the deflated air bag. Air bag inflation will not prevent the driver from seeing or from being able to steer the vehicle, nor will it stop people from leaving the vehicle.

### CAUTION:

**When an air bag inflates, there is dust in the air. This dust could cause breathing problems for people with a history of asthma or other breathing trouble. To avoid this, everyone in the vehicle should get out as soon as it is safe to do so. If you have breathing problems but can't get out of the vehicle after an air bag inflates, then get fresh air by opening a window or door.**

- The air bag is designed to inflate only once. After it inflates, you'll need some new parts for your air bag system. If you don't get them, the air bag system won't be there to help protect you in another crash. A new system will include the air bag module and possibly other parts. The service manual for your vehicle covers the need to replace other parts.
- Your vehicle is equipped with a diagnostic module, which records information about the air bag system. The module records information about the readiness of the system, when the sensors are activated and driver's safety belt usage at deployment.
- Let only qualified technicians work on your air bag system. Improper service can mean that your air bag system won't work properly. See your dealer for service.

### NOTICE:

**If you damage the cover for the driver's air bag, it may not work properly. You may have to replace the air bag module. Do not open or break the air bag cover.**

## Servicing Your Air Bag-Equipped Vehicle

The air bag affects how your vehicle should be serviced. There are parts of the air bag system in several places around your vehicle. You don't want the system to inflate while someone is working on your vehicle. Your GM dealer and the service manual have information about servicing your vehicle and the air bag system. To purchase a service manual, see "Service and Owner Publications" in the Index.

### CAUTION:

**For up to two minutes after the ignition key is turned off and the battery is disconnected, an air bag can still inflate during improper service. You can be injured if you are close to an air bag when it inflates. Avoid wires wrapped with yellow tape, or yellow connectors. They are probably part of the air bag system. Be sure to follow proper service procedures, and make sure the person performing work for you is qualified to do so.**

The air bag system does not need regular maintenance.

## Adding Equipment to Your Air Bag-Equipped Vehicle

**Q:** If I add a push bumper or a bicycle rack to the front of my vehicle, will it keep the air bag from working properly?

**A:** As long as the push bumper or bicycle rack is attached to your vehicle so that the vehicle's basic structure isn't changed, it's not likely to keep the air bags from working properly in a crash.

**Q:** What if I add a snow plow? Will it keep the air bag from working properly?

**A:** We've designed our air bag systems to work properly under a wide range of conditions, including snow plowing with vehicles equipped with the optional Snow Plow Prep Package (RPO VYU). But don't change or defeat the snow plow's "tripping mechanism." If you do, it can damage your snow plow and your vehicle, and it may cause an air bag inflation.

**Q:** Is there anything I might add to the front of the vehicle that could keep the air bag from working properly?

**A:** Yes. If you add things that change your vehicle's frame, bumper system, front end sheet metal or height, they may keep the air bag system from working properly. Also, the air bag system may not work properly if you relocate any of the air bag sensors. If you have any question about this, you should contact Customer Assistance before you modify your vehicle. (The phone numbers and addresses for Customer Assistance are in Step Two of the Customer Satisfaction Procedure in this manual. See "Customer Satisfaction Procedure" in the Index.)

## Safety Belt Use During Pregnancy

Safety belts work for everyone, including pregnant women. Like all occupants, they are more likely to be seriously injured if they don't wear safety belts.



A pregnant woman should wear a lap-shoulder belt, and the lap portion should be worn as low as possible, below the rounding, throughout the pregnancy.

The best way to protect the fetus is to protect the mother. When a safety belt is worn properly, it's more likely that the fetus won't be hurt in a crash. For pregnant women, as for anyone, the key to making safety belts effective is wearing them properly.

## Right Front Passenger Position

The right front passenger's safety belt works the same way as the driver's safety belt. See "Driver Position" earlier in this section.

When the lap belt is pulled out all the way, it will lock. If it does, let it go back all the way and start again.

## Center Passenger Position

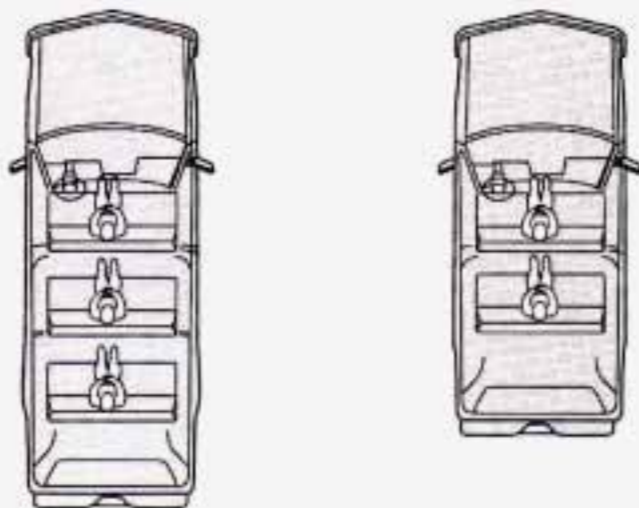

## Lap Belt

If your vehicle has front and rear bench seats, someone can sit in the center positions.



When you sit in a center seating position, you have a lap safety belt, which has no retractor. To make the belt longer, tilt the latch plate and pull it along the belt.



To make the belt shorter, pull its free end as shown until the belt is snug.

Buckle, position and release it the same way as the lap part of a lap-shoulder belt. If the belt isn't long enough, see "Safety Belt Extender" at the end of this section.

Make sure the release button on the buckle is positioned so you would be able to unbuckle the safety belt quickly if you ever had to.

## Rear Seat Passengers

It's very important for rear seat passengers to buckle up! Accident statistics show that unbelted people in the rear seat are hurt more often in crashes than those who are wearing safety belts.

Rear passengers who aren't safety belted can be thrown out of the vehicle in a crash. And they can strike others in the vehicle who are wearing safety belts.

## Rear Seat Outside Passenger Positions

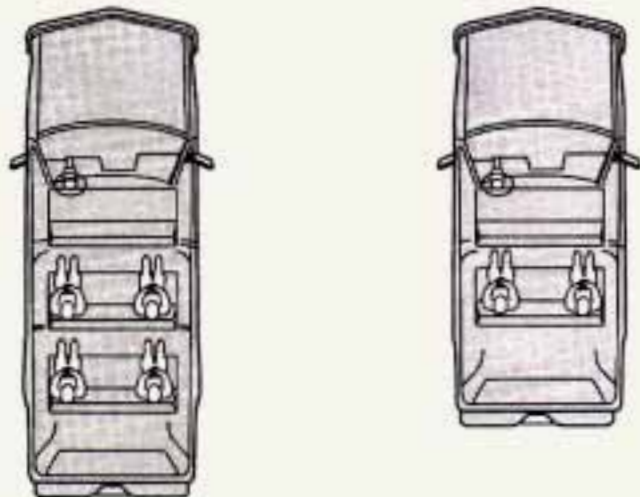

## Lap-Shoulder Belt

The positions next to the windows have lap-shoulder belts. Here's how to wear one properly.



2-Door Utility and Suburban



4-Door Utility

1. Pick up the latch plate and pull the belt across you. Don't let it get twisted.
2. Push the latch plate into the buckle until it clicks. Pull up on the latch plate to make sure it is secure. When the shoulder belt is pulled out all the way, it will lock. If it does, let it go back all the way and start again.

If the belt is not long enough, see "Safety Belt Extender" at the end of this section.

Make sure the release button on the buckle is positioned so you would be able to unbuckle the safety belt quickly if you ever had to.



2-Door Utility and Suburban



4-Door Utility

3. To make the lap part tight, pull down on the buckle end of the belt as you pull up on the shoulder part.



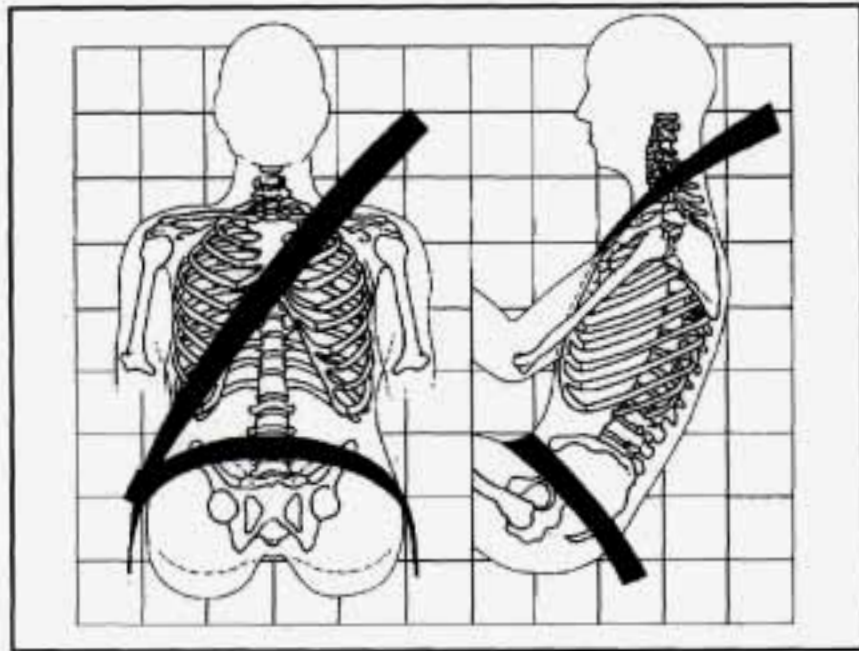

The lap part of the belt should be worn low and snug on the hips, just touching the thighs. In a crash, this applies force to the strong pelvic bones. And you'd be less likely to slide under the lap belt. If you slid under it, the belt would apply force at your abdomen. This could cause serious or even fatal injuries. The shoulder belt should go over the shoulder and across the chest. These parts of the body are best able to take belt restraining forces.

The safety belt locks if there's a sudden stop or a crash.

**⚠ CAUTION:**

**You can be seriously hurt if your shoulder belt is too loose. In a crash, you would move forward too much, which could increase injury. The shoulder belt should fit against your body.**

On four-door utility models, move the shoulder belt height adjuster to the height that is right for you.



To move the height adjuster down, push in at the word PRESS and move the height adjuster to the desired position. You can move the adjuster up just by pushing up on the shoulder belt guide. After you move the adjuster to where you want it, try to move it down without pushing in to make sure it has locked into position.

Adjust the height so that the shoulder portion of the belt is centered on your shoulder. The belt should be away from your face and neck, but not falling off your shoulder.



2-Door Utility and Suburban



#### 4-Door Utility

To unlatch the belt, just push the button on the buckle.

## Children

Everyone in a vehicle needs protection! That includes infants and all children smaller than adult size. In fact, the law in every state in the United States and in every Canadian province says children up to some age must be restrained while in a vehicle.

### Smaller Children and Babies

#### CAUTION:

**Smaller children and babies should always be restrained in a child or infant restraint. The instructions for the restraint will say whether it is the right type and size for your child. A very young child's hip bones are so small that a regular belt might not stay low on the hips, as it should. Instead, the belt will likely be over the child's abdomen. In a crash, the belt would apply force right on the child's abdomen, which could cause serious or fatal injuries. So, be sure that any child small enough for one is always properly restrained in a child or infant restraint.**



**⚠ CAUTION:**

Never hold a baby in your arms while riding in a vehicle. A baby doesn't weigh much -- until a crash. During a crash a baby will become so heavy you can't hold it. For example, in a crash

**CAUTION: (Continued)**

**CAUTION: (Continued)**

at only 25 mph (40 km/h), a 12-lb. (5.5 kg) baby will suddenly become a 240-lb. (110 kg) force on your arms. The baby would be almost impossible to hold.

Secure the baby in an infant restraint.



## Child Restraints

Be sure the child restraint is designed to be used in a vehicle. If it is, it will have a label saying that it meets Federal Motor Vehicle Safety Standards.

Then follow the instructions for the restraint. You may find these instructions on the restraint itself or in a booklet, or both. These restraints use the belt system in your vehicle, but the child also has to be secured within the restraint to help reduce the chance of personal injury. The instructions that come with the infant or child restraint will show you how to do that.

### Where to Put the Restraint

Accident statistics show that children are safer if they are restrained in the rear rather than the front seat. We at General Motors therefore recommend that you put your child restraint in the rear seat unless the child is an infant and you're the only adult in the vehicle. In that case, you might want to secure the restraint in the front seat where you can keep an eye on the baby.

Wherever you install it, be sure to secure the child restraint properly.

Keep in mind that an unsecured child restraint can move around in a collision or sudden stop and injure people in the vehicle. Be sure to properly secure any child restraint in your vehicle -- even when no child is in it.

## Top Strap

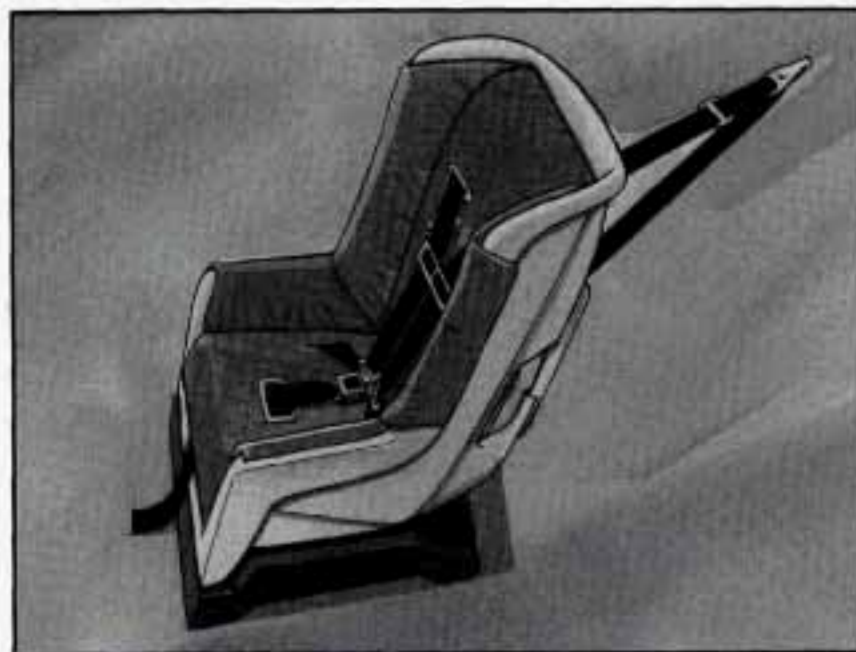

If your child restraint has a top strap, it should be anchored. If you need to have an anchor installed, you can ask your GM dealer to put it in for you. If you want to install an anchor yourself, your dealer can tell you how to do it.

## Securing a Child Restraint in a Rear Outside Seat Position

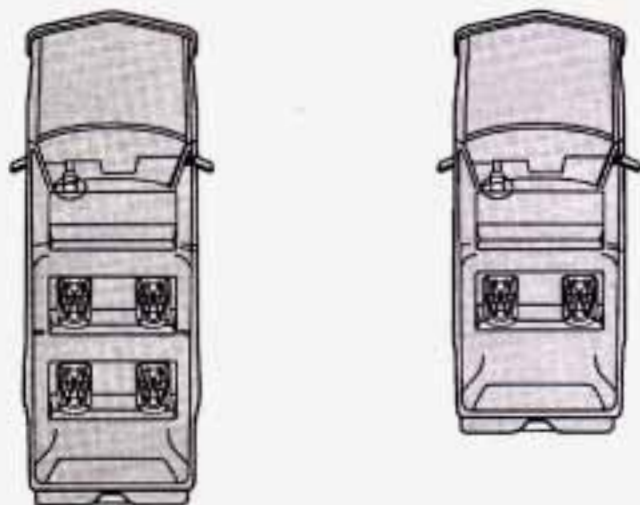

You'll be using the lap-shoulder belt. See the earlier part about the top strap if the child restraint has one.

1. Put the restraint on the seat. Follow the instructions for the child restraint.
2. Secure the child in the child restraint as the instructions say.
3. Pick up the latch plate, and run the lap and shoulder portions of the vehicle's safety belt through or around the restraint. The child restraint instructions will show you how.

If the shoulder belt goes in front of the child's face or neck, put it behind the child restraint.

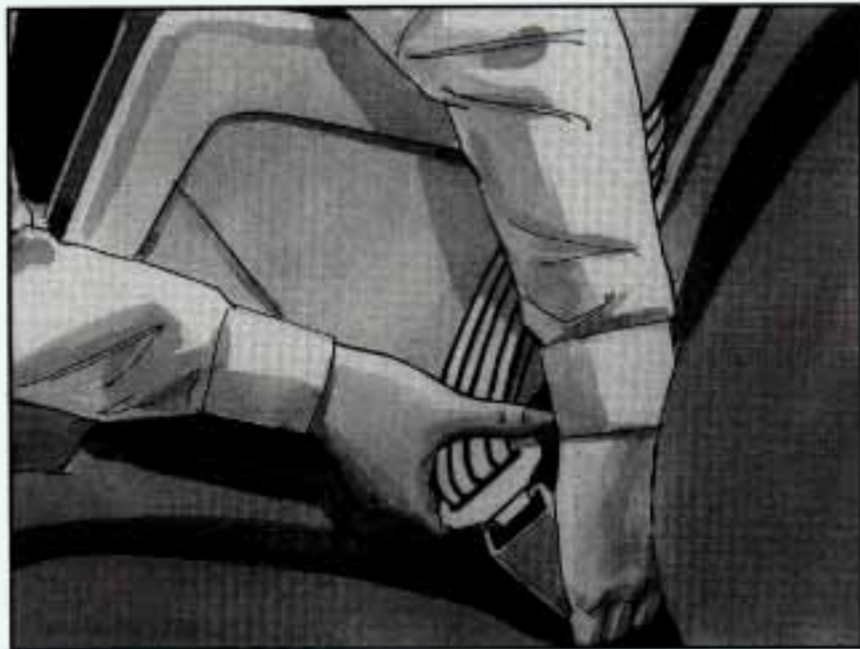

4. Buckle the belt. Make sure the release button is positioned so you would be able to unbuckle the safety belt quickly if you ever had to.



5. Pull the rest of the shoulder belt all the way out of the retractor to set the lock.



## Securing a Child Restraint in a Center Seat Position

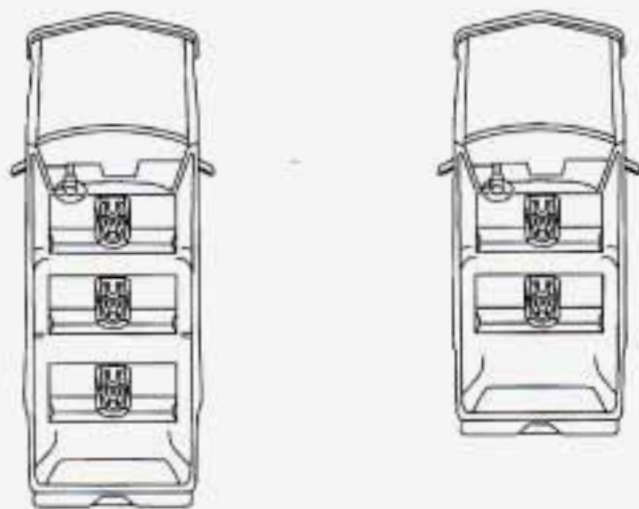

6. To tighten the belt, feed the shoulder belt back into the retractor while you push down on the child restraint.
7. Push and pull the child restraint in different directions to be sure it is secure.

To remove the child restraint, just unbuckle the vehicle's safety belt and let it go back all the way. The safety belt will move freely again and be ready to work for an adult or larger child passenger.

You'll be using the lap belt.

See the earlier part about the top strap if the child restraint has one.



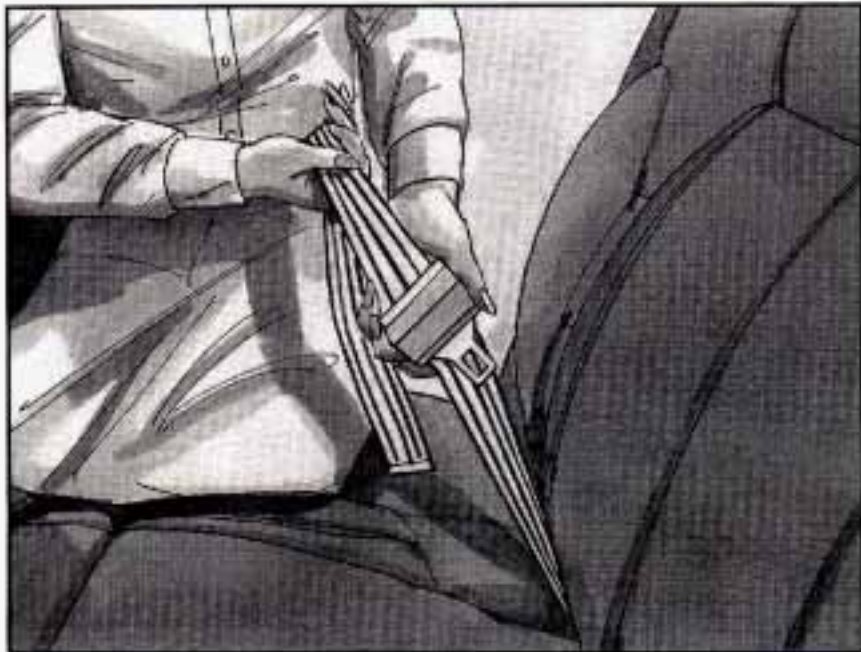

1. Make the belt as long as possible by tilting the latch plate and pulling it along the belt.
2. Put the restraint on the seat. Follow the instructions for the child restraint.
3. Secure the child in the child restraint as the instructions say.
4. Run the vehicle's safety belt through or around the restraint. The child restraint instructions will show you how.



5. Buckle the belt. Make sure the release button is positioned so you would be able to unbuckle the safety belt quickly if you ever had to.
6. To tighten the belt, pull its free end while you push down on the child restraint.
7. Push and pull the child restraint in different directions to be sure it is secure. If it isn't, secure the restraint in a different place in the vehicle and contact the child restraint maker for their advice about how to attach the child restraint properly.

To remove the child restraint, just unbuckle the vehicle's safety belt. It will be ready to work for an adult or larger child passenger.

## Securing a Child Restraint in the Right Front Seat Position

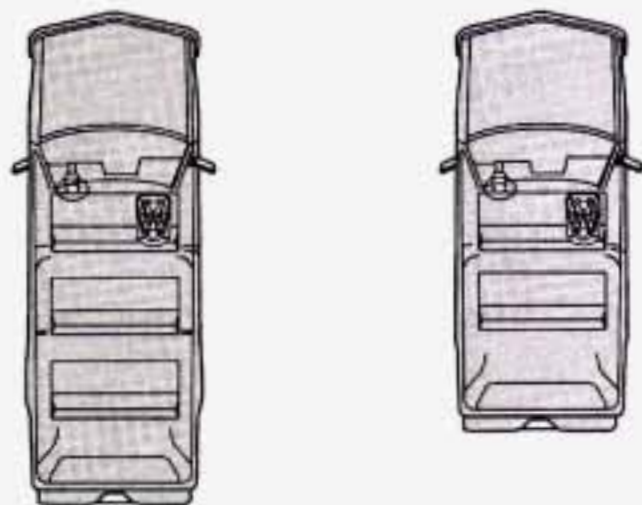

You'll be using the lap-shoulder belt. See the earlier part about the top strap if the child restraint has one.

1. Put the restraint on the seat. Follow the instructions for the child restraint.
2. Secure the child in the child restraint as the instructions say.
3. Pick up the latch plate, and run the lap and shoulder portions of the vehicle's safety belt through or around the restraint. The child restraint instructions will show you how.

If the shoulder belt goes in front of the child's face or neck, put it behind the child restraint.



4. Buckle the belt. Make sure the release button is positioned so you would be able to unbuckle the safety belt quickly if you ever had to.



5. Pull the rest of the lap belt all the way out of the retractor to set the lock.



6. To tighten the belt, feed the lap belt back into the retractor while you push down on the child restraint.
7. Push and pull the child restraint in different directions to be sure it is secure.

To remove the child restraint, just unbuckle the vehicle's safety belt and let it go back all the way. The safety belt will move freely again and be ready to work for an adult or larger child passenger.

## Larger Children



Children who have outgrown child restraints should wear the vehicle's safety belts.

If you have the choice, a child should sit next to a window so the child can wear a lap-shoulder belt and get the additional restraint a shoulder belt can provide.

Accident statistics show that children are safer if they are restrained in the rear seat. But they need to use the safety belts properly.

- Children who aren't buckled up can be thrown out in a crash.
- Children who aren't buckled up can strike other people who are.



## CAUTION:

**Never do this.**

**Here two children are wearing the same belt. The belt can't properly spread the impact forces. In a crash, the two children can be crushed together and seriously injured. A belt must be used by only one person at a time.**

**Q:** What if a child is wearing a lap-shoulder belt, but the child is so small that the shoulder belt is very close to the child's face or neck?

**A:** Move the child toward the center of the vehicle, but be sure that the shoulder belt still is on the child's shoulder, so that in a crash the child's upper body would have the restraint that belts provide. If the child is so small that the shoulder belt is still very close to the child's face or neck, you might want to place the child in a seat that has a lap belt, if your vehicle has one.



2-Door Utility and Suburban



4-Door Utility



## CAUTION:

Never do this.

**Here a child is sitting in a seat that has a lap-shoulder belt, but the shoulder part is behind the child. If the child wears the belt in this way, in a crash the child might slide under the belt. The belt's force would then be applied right on the child's abdomen. That could cause serious or fatal injuries.**

Wherever the child sits, the lap portion of the belt should be worn low and snug on the hips, just touching the child's thighs. This applies belt force to the child's pelvic bones in a crash.

## Safety Belt Extender

If the vehicle's safety belt will fasten around you, you should use it.

But if a safety belt isn't long enough to fasten, your dealer will order you an extender. It's free. When you go in to order it, take the heaviest coat you will wear, so the extender will be long enough for you. The extender will be just for you, and just for the seat in your vehicle that you choose. Don't let someone else use it, and use it only for the seat it is made to fit. To wear it, just attach it to the regular safety belt.

## Checking Your Restraint Systems

Now and then, make sure the safety belt reminder light and all your belts, buckles, latch plates, retractors and anchorages are working properly. Look for any other loose or damaged safety belt system parts. If you see anything that might keep a safety belt system from doing its job, have it repaired.

Torn or frayed safety belts may not protect you in a crash. They can rip apart under impact forces. If a belt is torn or frayed, get a new one right away.

Also look for any opened or broken air bag covers, and have them repaired or replaced. (The air bag system does not need regular maintenance.)

## Replacing Restraint System Parts After a Crash

If you've had a crash, do you need new belts?

After a very minor collision, nothing may be necessary. But if the belts were stretched, as they would be if worn during a more severe crash, then you need new belts.



If you ever see a label on a right front safety belt in a two-door Utility model that says to replace the belt, be sure to do so. Then the new belt will be there to help protect you in a collision. You would see this label on the belt near the door opening.

If belts are cut or damaged, replace them. Collision damage also may mean you will need to have safety belt or seat parts repaired or replaced. New parts and repairs may be necessary even if the belt wasn't being used at the time of the collision.

If an air bag inflates, you'll need to replace air bag system parts. See the part on the air bag system earlier in this section.



## Section 2 Features and Controls

Here you can learn about the many standard and optional features on your vehicle, and information on starting, shifting and braking. Also explained are the instrument panel and the warning systems that tell you if everything is working properly -- and what to do if you have a problem.

### Keys

#### CAUTION:

**Leaving young children in a vehicle with the ignition key is dangerous for many reasons. A child or others could be badly injured or even killed.**

**They could operate power windows or other controls or even make the vehicle move. Don't leave the keys in a vehicle with young children.**





Your vehicle has one double-sided key for the ignition and all door locks.

If you ever lose your key, your dealer will be able to assist you with obtaining a new one.

## Door Locks

### CAUTION:

Unlocked doors can be dangerous.

Passengers -- especially children -- can easily open the doors and fall out. When a door is locked, the inside handle won't open it.

Outsiders can easily enter through an unlocked door when you slow down or stop your vehicle.

**This may not be so obvious: You increase the chance of being thrown out of the vehicle in a crash if the doors aren't locked. Wear safety belts properly, lock your doors, and you will be far better off whenever you drive your vehicle.**

There are several ways to lock and unlock your vehicle. From the outside, use your key.



From the inside, to lock the door, slide the lever on your door down.

To unlock the door, slide the lever up.

## Power Door Locks (Option)



Press the side of the power door lock switch marked LOCK on either front door to lock all the doors at once. Press the ribbed side of the switch to unlock all the doors at once.

On four-door models, the switch on each rear door works only that door's lock. It won't lock (or unlock) all of the doors -- that's a safety feature.

## Rear Door Security Locks (4-Door Utility)

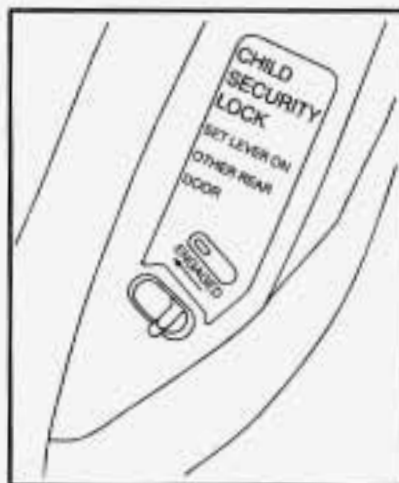

With this feature, you can lock the rear doors so they can't be opened from the inside by passengers.

Move the button up to engage the security feature. Move the button down to return the door locks to normal operation.

## Leaving Your Vehicle

If you are leaving the vehicle, take your keys, open your door and set the locks from inside. Then get out and close the door.

## Keyless Entry System (Option)

If your vehicle has this option, you can lock and unlock your doors or your tailgate from up to 30 feet (9 m) away using the key chain transmitter supplied with your vehicle.

Your Keyless Entry System operates on a radio frequency subject to Federal Communications Commission (FCC) Rules.

This device complies with Part 15 of the FCC Rules. Operation is subject to the following two conditions: (1) This device may not cause harmful interference, and (2) This device must accept any interference received, including interference that may cause undesired operation.

Should interference to this system occur, try this:

- Check to determine if battery replacement is necessary. See the instructions on battery replacement.
- Check the distance. You may be too far from your vehicle. This product has a maximum range.

- Check the location. Other vehicles or objects may be blocking the signal.
- See your GM dealer or a qualified technician for service.

Changes or modifications to this system by other than an authorized service facility could void authorization to use this equipment.

### Operation

To unlock the driver's door, press the UNLOCK button. If you press this button again within five seconds, all the doors will unlock. Press the REAR button to unlock the rear door only, or to release the tailgate glass.

Press the LOCK button to lock all the doors.

When the UNLOCK button is pushed, the interior dome lamps are turned on for 40 seconds or until the ignition switch is activated.

When the LOCK button is pushed, the interior lamps are turned on for two seconds if the doors are closed. If the LOCK button is pushed when a door is open, the interior lamps will stay on for two seconds after the door is closed.

## Matching Transmitter(s) To Your Vehicle

Each key chain transmitter is coded to prevent another transmitter from unlocking your vehicle. If a transmitter is lost or stolen, a replacement can be purchased through your dealer. Remember to bring any remaining transmitters with you when you go to your dealer. When the dealer matches the replacement transmitter to your vehicle, any remaining transmitters must also be matched. Once the new transmitter is coded, the lost transmitter will not unlock your vehicle. Each vehicle can have only two transmitters matched to it.

## Battery Replacement

Under normal use, the batteries in your key chain transmitter should last about two years.

You can tell the batteries are weak if the transmitter won't work at the normal range in any location. If you have to get close to your vehicle before the transmitter works, it's probably time to change the batteries.

Use two Duracell® type DL2016, or a similar type.

To replace the batteries:

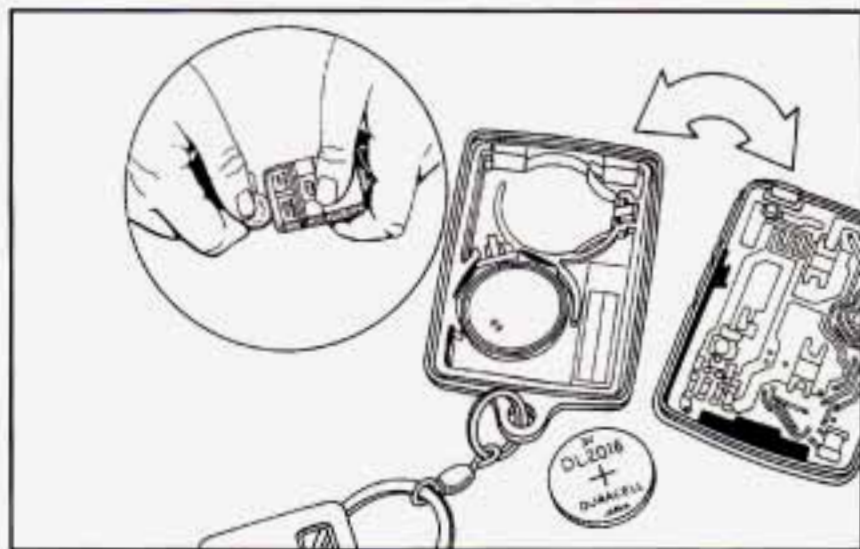

1. Insert a dime in the side seam of the transmitter housing, near the key ring hole.
2. Twist the dime to separate the two halves of the transmitter housing. Separate the housing, bottom half first.
3. Remove and replace the batteries. Put the new batteries in with the printed side down.
4. Align the housing and snap the halves together.

## Your Doors and How They Work

### Side Doors

To open the door from the outside, pull the handle up and pull the door open.

To open the door from the inside, pull the lever toward you and push the door open.

#### CAUTION:

**It can be dangerous to drive with the tailgate glass, tailgate or rear doors open because carbon monoxide (CO) gas can come into your vehicle. You can't see or smell CO. It can cause unconsciousness and even death.**

**CAUTION: (Continued)**

#### **CAUTION: (Continued)**

**If you must drive with the tailgate glass, tailgate or rear doors open or if electrical wiring or other cable connections must pass through the seal between the body and the tailgate glass, tailgate or rear doors:**

- **Make sure all windows are shut.**
- **Turn the fan on your heating or cooling system to its highest speed with the setting on VENT. That will force outside air into your vehicle. See “Comfort Controls” in the Index.**
- **If you have air outlets on or under the instrument panel, open them all the way. See “Engine Exhaust” in the Index.**

## Tailgate Glass and Tailgate

If your vehicle has a tailgate, you must raise the rear glass before lowering the tailgate.

To open the glass from the outside, use your key. With the key in the lock, turn the key clockwise to release the glass, then lift it up.

To release the glass from the inside, use the electric tailgate glass release switch on the instrument panel. For more information, see “Tailgate -- Electric Glass Release” in the Index.

Open the tailgate by lifting up on the handle while pulling the tailgate toward you.

Close the tailgate before closing the rear glass. After closing, make sure the tailgate is securely latched by pulling it toward you. After closing the rear glass, pull up on its handle to make sure it is locked.

## Panel Doors

To open the rear panel doors, you must open the passenger's side door first. If the door is locked, insert your door key in the lock and turn it counterclockwise to unlock it.

To open the passenger's side door, pull up on the handle and pull the door open.

To open the driver's side door, first open the passenger's side door. Then, pull the handle on the left door edge out and pull the door open.

The rear doors have a check assembly to keep them from fully opening during normal use. To fully open either rear door, you must release the check strap.

First, open the door partway until the white mark on the check strap is fully outside the door edge. If the end of the strap catches the pin on the door, the door is open too far.



Then, hold the strap at the white mark, pull the strap toward you and open the door all the way.

To re-engage the door check strap, just close the door and the strap will catch the pin.

To close the doors, close the driver's side door first. After securely closing the door, close the passenger's side door. Make sure both doors are latched securely.

To lock the rear doors from outside the vehicle, put your key in the lock and turn it clockwise. If you have power door locks, you can lock the side doors as well as the rear doors from inside the vehicle. For more information, see "Power Door Locks" in this section.

## Theft

Vehicle theft is big business, especially in some cities. Although your vehicle has a number of theft-deterrent features, we know that nothing we put on it can make it impossible to steal. However, there are ways you can help.

### Key in the Ignition

If you leave your vehicle with the keys inside, it's an easy target for joy riders or professional thieves -- so don't do it.

When you park your vehicle and open the driver's door, you'll hear a tone reminding you to remove your key from the ignition and take it with you. Always do this. Your steering wheel will be locked, and so will your ignition. If you have an automatic transmission, taking your key out also locks your transmission. And remember to lock the doors.



## Parking at Night

Park in a lighted spot, close all windows and lock your vehicle. Remember to keep your valuables out of sight. Put them in a storage area, or take them with you.

## Parking Lots

If you park in a lot where someone will be watching your vehicle, it's best to lock it up and take your keys. But what if you have to leave your ignition key? What if you have to leave something valuable in your vehicle?

- Put your valuables in a storage area, like your glove box.
- Lock all the doors except the driver's.

## New Vehicle “Break-In”

### **NOTICE:**

**Your modern vehicle doesn't need an elaborate “break-in.” But it will perform better in the long run if you follow these guidelines:**

- **Keep your speed at 55 mph (88 km/h) or less for the first 500 miles (804 km).**
- **Don't drive at any one speed -- fast or slow -- for the first 500 miles (804 km). Don't make full-throttle starts.**
- **Avoid making hard stops for the first 200 miles (322 km) or so. During this time your new brake linings aren't yet broken in. Hard stops with new linings can mean premature wear and earlier replacement. Follow this breaking-in guideline every time you get new brake linings.**
- **Don't tow a trailer during break-in. See “Towing a Trailer” in the Index for more information.**

## Ignition Positions

Use your key to start your vehicle. The key lets you turn the ignition switch to five different positions.

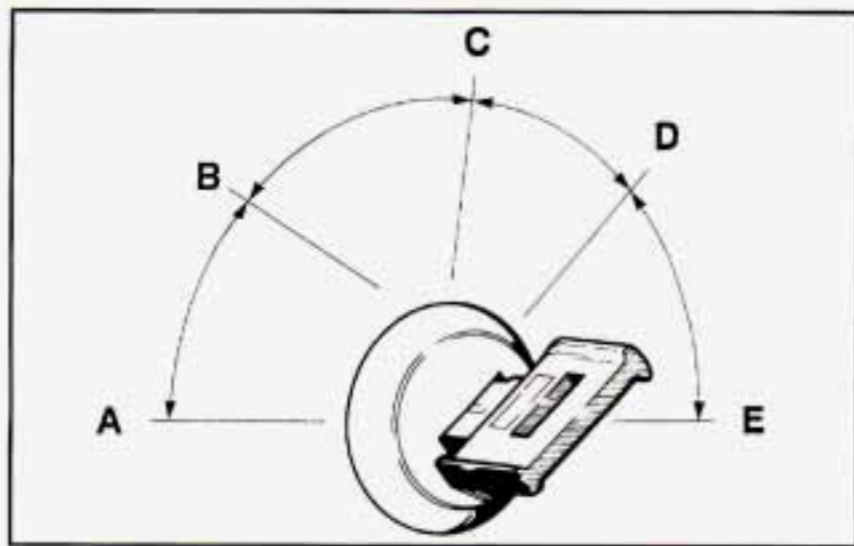

**ACCESSORY (A):** This position lets you use things like the radio and the windshield wipers when the engine is off. Push in the key and turn it toward you. Your steering wheel will remain locked, just as it was before you inserted the key.

**LOCK (B):** This position locks your ignition, steering wheel and transmission. It's a theft-deterrent feature. You will only be able to remove your key when the ignition is turned to LOCK.

**OFF (C):** This position lets you turn off the engine but still turn the steering wheel. It doesn't lock the steering wheel like LOCK. Use OFF if you must have your vehicle in motion while the engine is off (for example, if your vehicle is being pushed).

**RUN (D):** This is the position for driving.

**START (E):** This position starts your engine.

### NOTICE:

If your key seems stuck in LOCK and you can't turn it, be sure it is all the way in. If it is, then turn the steering wheel left and right while you turn the key hard. But turn the key only with your hand. Using a tool to force it could break the key or the ignition switch. If none of this works, then your vehicle needs service.

## Starting Your Gasoline Engine

If you have a diesel engine, see "Starting Your Diesel Engine" in the Diesel Engine Supplement.

Move your shift lever to PARK (P) or NEUTRAL (N). Your engine won't start in any other position -- that's a safety feature. To restart when you're already moving, use NEUTRAL (N) only.

### **NOTICE:**

**Don't try to shift to PARK (P) if your vehicle is moving. If you do, you could damage the transmission. Shift to PARK (P) only when your vehicle is stopped.**

1. Without pushing the accelerator pedal, turn your ignition key to START. When the engine starts, let go of the key. The idle speed will go down as your engine gets warm.

### **NOTICE:**

**Holding your key in START for longer than 15 seconds at a time will cause your battery to be drained much sooner. And the excessive heat can damage your starter motor.**

2. If it doesn't start right away, hold your key in START. If it doesn't start in 10 seconds, push the accelerator pedal all the way down for five more seconds, or until it starts.

3. If your engine still won't start (or starts but then stops), wait 15 seconds and start over.

When the engine starts, let go of the key and the accelerator pedal.

## **NOTICE:**

**Your engine is designed to work with the electronics in your vehicle. If you add electrical parts or accessories, you could change the way the engine operates. Before adding electrical equipment, check with your dealer. If you don't, your engine might not perform properly.**

**If you ever have to have your vehicle towed, see the part of this manual that tells how to do it without damaging your vehicle. See "Towing Your Vehicle" in the Index.**

## **Engine Coolant Heater (Option)**

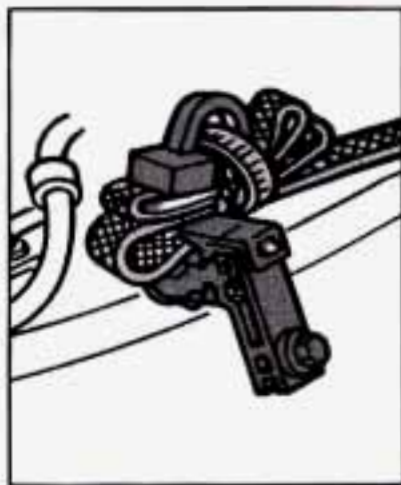

In very cold weather, 0°F (-18°C) or colder, the engine coolant heater can help.

You'll get easier starting and better fuel economy during engine warm-up. Usually, the coolant heater should be plugged in a minimum of four hours prior to starting your vehicle.

**To use the coolant heater:**

1. Turn off the engine.
2. Open the hood and unwrap the electrical cord.
3. Plug it into a normal, grounded 110-volt AC outlet.

 **CAUTION:**

**Plugging the cord into an ungrounded outlet could cause an electrical shock. Also, the wrong kind of extension cord could overheat and cause a fire. You could be seriously injured. Plug the cord into a properly grounded three-prong 110-volt AC outlet. If the cord won't reach, use a heavy-duty three-prong extension cord rated for at least 15 amps.**

4. After you've used the coolant heater, be sure to store the cord as it was before to keep it away from moving engine parts. If you don't, it could be damaged.

How long should you keep the coolant heater plugged in? The answer depends on the outside temperature, the kind of oil you have, and some other things. Instead of trying to list everything here, we ask that you contact your GM dealer in the area where you'll be parking your vehicle. The dealer can give you the best advice for that particular area.

## Automatic Transmission Operation



There are several different positions for your shift lever.

Your vehicle now features an electronic shift position indicator within the instrument cluster. This display must be powered anytime the shift lever is capable of being moved out of the PARK (P) position. This means that if your key is in the OFF position, rather than the LOCK position, there will be a small current drain on your battery which could discharge your battery over a period of time. If you have a need to leave your key in the ignition in the OFF position for an extended period for any reason, it is recommended that you disconnect the battery cable from the battery to prevent discharging your battery.

**PARK (P):** This locks your rear wheels. It's the best position to use when you start your engine because your vehicle can't move easily.



### CAUTION:

**It is dangerous to get out of your vehicle if the shift lever is not fully in PARK (P) with the parking brake firmly set. Your vehicle can roll. Don't leave your vehicle when the engine is running unless you have to. If you have left the engine running, the vehicle can move suddenly. You or others could be injured. To be sure your vehicle won't move, even when you're on fairly level ground, always set your parking brake and move the shift lever to PARK (P).**

**CAUTION: (Continued)**

**CAUTION: (Continued)**

If you have four-wheel drive, your vehicle will be free to roll -- even if your shift lever is in PARK (P) -- if your transfer case is in NEUTRAL (N). So, be sure the transfer case is in a drive gear, two-wheel high (2H) or four-wheel high (4H) or four-wheel low (4L) -- not in NEUTRAL (N). See "Shifting Into PARK (P)" in the Index. If you're pulling a trailer, see "Towing a Trailer" in the Index.

**REVERSE (R):** Use this gear to back up.

**NOTICE:**

Shifting to REVERSE (R) while your vehicle is moving forward could damage your transmission. Shift to REVERSE (R) only after your vehicle is stopped.

To rock your vehicle back and forth to get out of snow, ice or sand without damaging your transmission, see "Stuck: In Sand, Mud, Ice or Snow" in the Index.

**NEUTRAL (N):** In this position, your engine doesn't connect with the wheels. To restart when you're already moving, use NEUTRAL (N) only. Also, use NEUTRAL (N) when your vehicle is being towed.



**CAUTION:**

Shifting out of PARK (P) or NEUTRAL (N) while your engine is "racing" (running at high speed) is dangerous. Unless your foot is firmly on the brake pedal, your vehicle could move very rapidly. You could lose control and hit people or objects. Don't shift out of PARK (P) or NEUTRAL (N) while your engine is racing.

**NOTICE:**

Damage to your transmission caused by shifting out of PARK (P) or NEUTRAL (N) with the engine racing isn't covered by your warranty.

**AUTOMATIC OVERDRIVE (Ⓢ):** This position is for normal driving. If you need more power for passing, and you're:

- Going less than about 35 mph (56 km/h), push your accelerator pedal about halfway down.
- Going about 35 mph (56 km/h) or more, push the accelerator all the way down.

You'll shift down to the next gear and have more power.

**AUTOMATIC OVERDRIVE (Ⓢ)** can be used when towing a trailer. You may want to shift the transmission to **THIRD (3)** or, if necessary, a lower gear selection if the transmission shifts too often when carrying a heavy load, driving on steep hills or for off-road driving.

**THIRD (3):** This position is also used for normal driving, however, it offers more power and lower fuel economy than **AUTOMATIC OVERDRIVE (Ⓢ)**.

**SECOND (2):** This position gives you more power but lower fuel economy. You can use **SECOND (2)** on hills. It can help control your speed as you go down steep mountain roads, but then you would also want to use your brakes off and on.

If you manually select **SECOND (2)**, the transmission will drive in second gear. You may use this feature for reducing torque to the rear wheels when you are trying to start your vehicle from a stop on slippery road surfaces.

**FIRST (1):** This position gives you even more power (but lower fuel economy) than **SECOND (2)**. You can use it on very steep hills, or in deep snow or mud. If the selector lever is put in **FIRST (1)** while the vehicle is moving forward, the transmission won't shift into first gear until the vehicle is going slowly enough.

## **NOTICE:**

**If your rear wheels can't rotate, don't try to drive. This might happen if you were stuck in very deep sand or mud or were up against a solid object. You could damage your transmission. Also, if you stop when going uphill, don't hold your vehicle there with only the accelerator pedal. This could overheat and damage the transmission. Use your brakes or shift into PARK (P) to hold your vehicle in position on a hill.**



## Locking Rear Axle (Option)

If you have this feature, your rear axle can give you additional traction on snow, mud, ice, sand or gravel. It works like a standard axle most of the time, but when one of the rear wheels has no traction and the other does, the locking feature will allow the wheel with traction to move the vehicle.

## Four-Wheel Drive

If your vehicle has four-wheel drive, you can send your engine's driving power to all four wheels for extra traction. To get the most satisfaction out of four-wheel drive, you must be familiar with its operation. Read the part that follows before using four-wheel drive. You should use 2-WHEEL HIGH (2H) for most normal driving conditions.

### **NOTICE:**

**Driving in the 4-WHEEL HIGH (4H) or 4-WHEEL LOW (4L) positions for a long time on dry or wet pavement could shorten the life of your vehicle's drivetrain.**

## Front Axle Locking Feature

The front axle locks and unlocks automatically when you shift the transfer case. Some delay for the axle to lock or unlock is normal. If the outside temperature is very hot, or the vehicle has been used under hard driving conditions, there may be a slight delay for the axle to unlock.

## Manual Transfer Case



The transfer case shift lever is on the floor to the right of the driver. Use this lever to shift into and out of four-wheel drive.

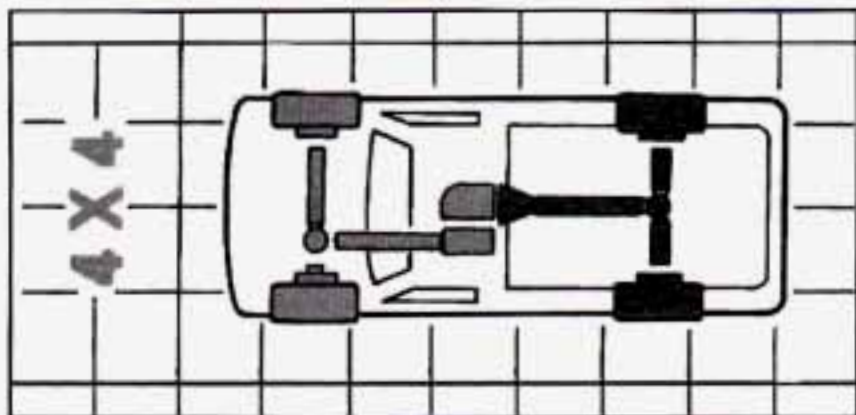

The front axle portion of the indicator diagram will light up when you shift into four-wheel drive.

Some delay between shifting and the indicator's lighting is normal. If the indicator light does not light up, or if the front axle light does not go out after you shift out of four-wheel drive, have your dealer check your system.

An indicator near the lever shows you the transfer case settings:

**2H (2-Wheel High):** This setting is for driving in most street and highway situations. Your front axle is not engaged in two-wheel drive.

**4H (4-Wheel High):** This setting engages your front axle to help drive your vehicle. Use 4H when you need extra traction, such as on wet or icy roads, or in most off-road situations.

**N (Neutral):** Shift to this setting only when your vehicle needs to be towed or when using a power take-off.

**4L (4-Wheel Low):** This setting also engages your front axle to give you extra power, but should be used only for off-road driving.

You can shift from 2-WHEEL HIGH (2H) to 4-WHEEL HIGH (4H) or from 4-WHEEL HIGH (4H) to 2-WHEEL HIGH (2H) while the vehicle is moving. Your front axle may engage faster if you take your foot off of the accelerator for a few seconds after you shift. In extremely cold weather, it may be necessary to stop or slow the vehicle to shift out of 2-WHEEL HIGH (2H).

To shift into or out of 4-WHEEL LOW (4L) or NEUTRAL (N):

1. Slow the vehicle to a roll, about 1 to 3 mph (2 to 5 km/h) and shift the transmission into NEUTRAL (N).
2. Shift the transfer case shift lever in one continuous motion.

Don't pause in NEUTRAL (N) as you shift the transfer case into 4-WHEEL LOW (4L), or the gears could clash.

Remember that driving in 4-WHEEL HIGH (4H) or 4-WHEEL LOW (4L) may reduce fuel economy. Also, driving in four-wheel drive on dry pavement could cause your tires to wear faster and make your transfer case harder to shift.

When your headlamps or parking lamps are on, rotate the thumb wheel next to the headlamp switch up to brighten, and down to dim, your transfer case indicator light.

## Electronic Transfer Case (Option)



If your four-wheel-drive vehicle has the electronic transfer case, the transfer case switches are below and to the left of the climate controls.

Use these switches to shift into and out of four-wheel drive. You can choose among three driving settings:

**2HI:** This setting is for driving in most street and highway situations. Your front axle is not engaged in two-wheel drive.

**4HI:** This setting engages your front axle to help drive your vehicle. Use 4HI when you need extra traction, such as on snowy or icy roads, or in most off-road situations.

**4LO:** This setting also engages your front axle to give you extra traction. You may never need 4LO. It sends the maximum power to all four wheels. You might choose 4LO if you were driving off-road in sand, mud or deep snow and climbing or descending steep hills.

Indicator lights in the switches show you which setting you are in. The indicator lights will come on briefly when you turn on the ignition and one will stay on. If the lights do not come on, you should take your vehicle in for service. An indicator light will flash while shifting. It will remain illuminated when the shift is completed.

### **Shifting from 2HI to 4HI**

Press and release the 4HI switch. This can be done at any speed, and the indicator light will flash while shifting. It will remain illuminated when the shift is completed.

### **Shifting from 4HI to 2HI**

Press and release the 2HI switch. This can be done at any speed, and the system will unlock automatically.

### **Shifting from 2HI or 4HI to 4LO**

To shift from 2HI or 4HI to 4LO, the vehicle must be stopped or moving less than 3 mph (4.8 km/h) with the transmission in NEUTRAL (N). The preferred method for shifting into 4LO is to have your vehicle moving 1 to 2 mph (1.6 to 3.2 km/h). Press and release the 4LO switch. You must wait for the 4LO indicator light to stop flashing and remain illuminated before shifting your transmission into gear.

If the 4LO switch is pressed when your vehicle is in gear and/or moving, the 4LO indicator light will flash for 30 seconds and not complete the shift unless your vehicle is moving slower than 3 mph (4.8 km/h) and the transmission is in NEUTRAL (N).

## Shifting from 4LO to 4HI or 2HI

To shift from 4LO to 4HI or 2HI your vehicle must be stopped or moving less than 3 mph (4.8 km/h) with the transmission in NEUTRAL (N). The preferred method for shifting out of 4LO is to have your vehicle moving 1 to 2 mph (1.6 to 3.2 km/h). Press and release the 4HI switch. You must wait for the 4HI indicator light to stop flashing and remain illuminated before shifting your transmission into gear.

If the 4HI switch is pressed when your vehicle is in gear and/or moving, the 4HI indicator light will flash for 30 seconds but not complete the shift unless the vehicle is moving slower than 3 mph (4.8 km/h) and the transmission is in NEUTRAL (N).

## Parking Brake

To set the parking brake, hold the regular brake pedal down with your right foot. Push down the parking brake pedal with your left foot.

If the ignition is on, the brake system warning light will come on.



To release the parking brake, hold the regular brake pedal down. Pull the lever, located just above the parking brake pedal, marked BRAKE RELEASE, to release the parking brake.

If the ignition is on when the parking brake is released, the brake system warning light will go off.

### NOTICE:

**Driving with the parking brake on can cause your rear brakes to overheat. You may have to replace them, and you could also damage other parts of your vehicle.**

If you are towing a trailer and are parking on any hill, see “Towing a Trailer” in the Index. That section shows what to do first to keep the trailer from moving.

## Shifting Into PARK (P)

### CAUTION:

It can be dangerous to get out of your vehicle if the shift lever is not fully in PARK (P) with the parking brake firmly set. Your vehicle can roll. If you have left the engine running, the vehicle can move suddenly. You or others could be injured. To be sure your vehicle won't move, even when you're on fairly level ground, use the steps that follow. If you have four-wheel drive and your transfer case is in NEUTRAL (N), your vehicle will be free to roll, even if your shift lever is in PARK (P). So, be sure the transfer case is in a drive gear -- not in NEUTRAL (N). If you're pulling a trailer, see "Towing a Trailer" in the Index.

## Steering Column Shift Lever

1. Hold the brake pedal down with your right foot and set the parking brake.
2. Move the shift lever into PARK (P) position like this:

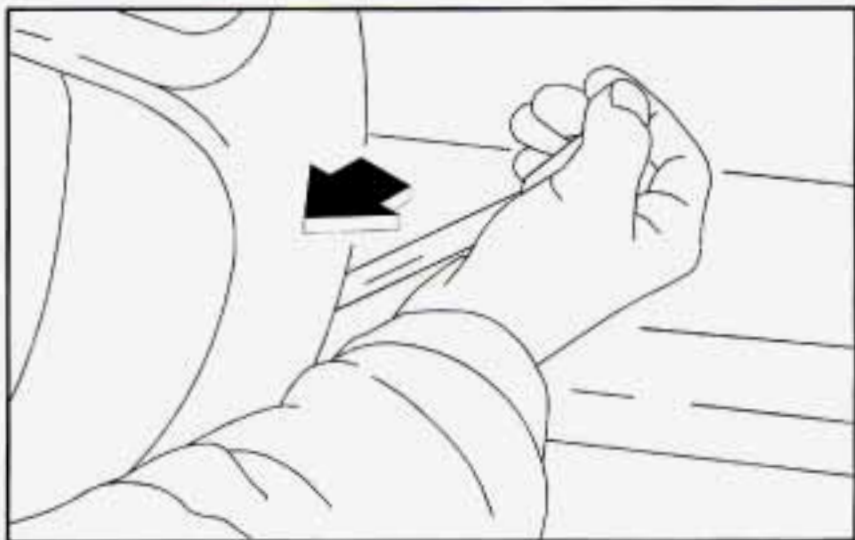

- Pull the lever toward you.

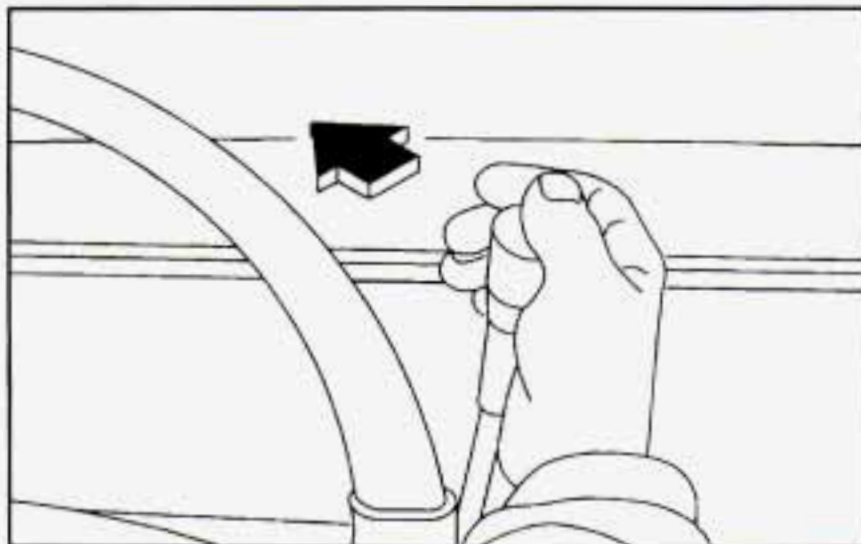

- Move the lever up as far as it will go.
3. If you have four-wheel drive, be sure the transfer case is in a drive gear -- not in NEUTRAL (N).
  4. Move the ignition key to LOCK.
  5. Remove the key and take it with you. If you can leave your vehicle with the ignition key in your hand, your vehicle is in PARK (P).

## Leaving Your Vehicle With the Engine Running

### CAUTION:

It can be dangerous to leave your vehicle with the engine running. Your vehicle could move suddenly if the shift lever is not fully in PARK (P) with the parking brake firmly set. If you have four-wheel drive with a manual transfer case shift lever and your transfer case is in NEUTRAL (N), your vehicle will be free to roll, even if your shift lever is in PARK (P). So be sure the transfer case is in a drive gear -- not in NEUTRAL (N). And, if you leave the vehicle with the engine running, it could overheat and even catch fire. You or others could be injured. Don't leave your vehicle with the engine running unless you have to.

## Torque Lock

If you are parking on a hill and you don't shift your transmission into PARK (P) properly, the weight of the vehicle may put too much force on the parking pawl in the transmission. You may find it difficult to pull the shift lever out of PARK (P). This is called "torque lock." To prevent torque lock, set the parking brake and then shift into PARK (P) properly before you leave the driver's seat. To find out how, see "Shifting Into PARK (P)" in the Index.

When you are ready to drive, move the shift lever out of PARK (P) *before* you release the parking brake.

If torque lock does occur, you may need to have another vehicle push yours a little uphill to take some of the pressure from the transmission, so you can pull the shift lever out of PARK (P).

## Parking Over Things That Burn



### CAUTION:

Things that can burn could touch hot exhaust parts under your vehicle and ignite. Don't park over papers, leaves, dry grass or other things that can burn.



## Engine Exhaust

### CAUTION:

Engine exhaust can kill. It contains the gas carbon monoxide (CO), which you can't see or smell. It can cause unconsciousness and death.

You might have exhaust coming in if:

- Your exhaust system sounds strange or different.
- Your vehicle gets rusty underneath.
- Your vehicle was damaged in a collision.
- Your vehicle was damaged when driving over high points on the road or over road debris.
- Repairs weren't done correctly.
- Your vehicle or exhaust system had been modified improperly.

If you ever suspect exhaust is coming into your vehicle:

- Drive it only with all the windows down to blow out any CO; and
- Have your vehicle fixed immediately.

## Running Your Engine While You're Parked

It's better not to park with the engine running. But if you ever have to, here are some things to know.

### CAUTION:

Idling the engine with the air system control off could allow dangerous exhaust into your vehicle (see the earlier Caution under "Engine Exhaust").

Also, idling in a closed-in place can let deadly carbon monoxide (CO) into your vehicle even if the fan switch is at the highest setting. One place this can happen is a garage. Exhaust -- with CO -- can come in easily. NEVER park in a garage with the engine running.

Another closed-in place can be a blizzard. (See "Blizzard" in the Index.)



## **CAUTION:**

**It can be dangerous to get out of your vehicle if the shift lever is not fully in PARK (P) with the parking brake firmly set. Your vehicle can roll. Don't leave your vehicle when the engine is running unless you have to. If you've left the engine running, the vehicle can move suddenly. You or others could be injured. To be sure your vehicle won't move, even when you're on fairly level ground, always set your parking brake and move the shift lever to PARK (P).**

If you have four-wheel drive and your transfer case is in NEUTRAL (N), your vehicle will be free to roll, even if your shift lever is in PARK (P). So, be sure the transfer case is in a drive gear -- not in NEUTRAL (N). Always set your parking brake. Follow the proper steps to be sure your vehicle won't move. See "Shifting Into PARK (P)" in the Index.

If you're pulling a trailer, see "Towing a Trailer" in the Index.

## Windows

### Manual Windows

To open your manual windows, turn the hand crank on each door to raise or lower your side door windows.

### Power Windows (Option)



If you have the optional power windows, the controls are on each of the side doors.

The driver's door has a switch for the passenger windows as well. Your power windows will work when the ignition has been turned to ACC or RUN.

Push the rear of the switch with the power window symbol on it to lower the window.

Push the front of the switch with the power window symbol on it to raise the window.

The driver's window switch has an express down feature that allows the window to lower without holding the switch. Press and hold the side of the window switch marked AUTO for one second to activate the express down mode. The express down mode can be canceled at any time by pressing the opposite side of the switch. To open the window part way, lightly tap the switch until the window is at the desired position.

If you have a four-door vehicle and power windows, the power window switch has a lockout feature. This feature prevents the rear windows from operating except from the driver's position, when the front driver's side switch is in the lockout position. When the switch is moved out of the lockout position, the rear power windows will operate again.

### Electric Tailgate Glass Release

Before operating your electric tailgate glass release, see the caution under "Your Doors and How They Work" in this section.



The electric hatch release button lets you release the tailgate glass. To release the glass, press the top of the button.

Then, lift the window up to open.

The shift lever must be in PARK (P) or NEUTRAL (N) for the release to work.

## Horn

If your vehicle is equipped with an air bag, press on the air bag module in the center of the steering wheel to sound the horn.

If your vehicle is not equipped with an air bag, press on the horn cap in the center of the steering wheel to sound the horn.

## Tilt Wheel (Option)



A tilt steering wheel allows you to adjust the steering wheel before you drive.

You can also raise it to the highest level to give your legs more room when you enter and exit the vehicle.

To tilt the wheel, hold the steering wheel and pull the lever. Move the steering wheel to a comfortable level, then release the lever to lock the wheel in place.

## Multifunction Lever

The lever on the left side of the steering column includes your:

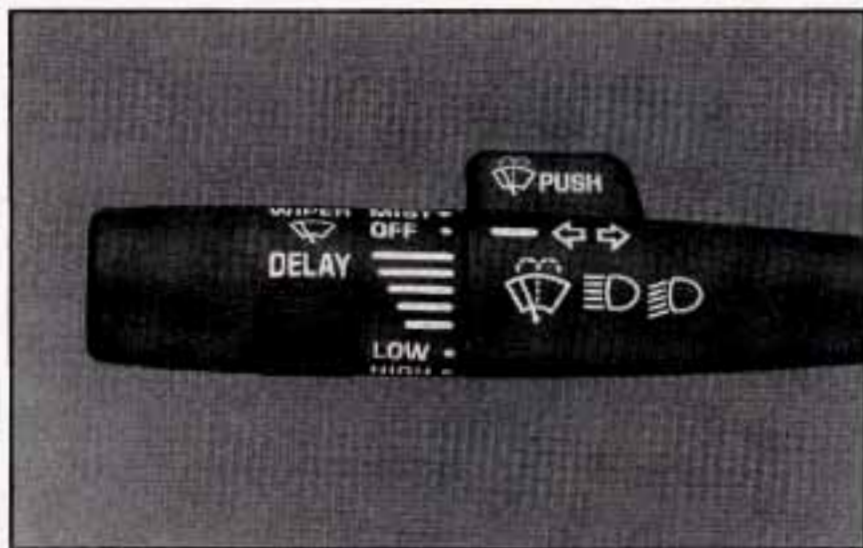

- Turn Signal and Lane Change Indicator
- Headlamp High/Low Beam Changer
- Windshield Wipers
- Windshield Washer
- Cruise Control (Option)

## Turn Signal and Lane Change Indicator

The turn signal has two upward (for right) and two downward (for left) positions. These positions allow you to signal a turn or a lane change.

To signal a turn, move the lever all the way up or down. When the turn is finished, the lever will return automatically.

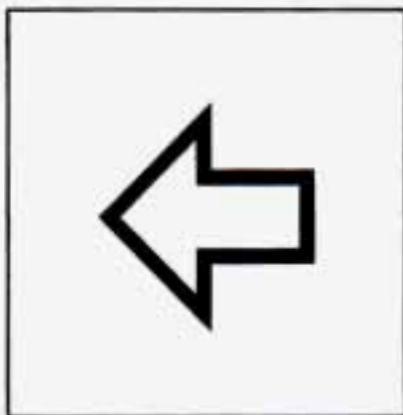

An arrow on the instrument panel will flash in the direction of the turn or lane change.

To signal a lane change, just raise or lower the lever until the arrow starts to flash. Hold it there until you complete your lane change. The lever will return by itself when you release it.

If you move the lever all the way up or down and the arrow flashes at twice the normal rate, a signal bulb may be burned out and other drivers may not see your turn signal.

If a bulb is burned out, replace it to help avoid an accident. If the arrows don't go on at all when you signal a turn, check for burned-out bulbs and a blown fuse (see "Fuses" in the Index).

## Headlamp High/Low Beam Changer

To change the headlamps from low beam to high or high to low, pull the turn signal lever all the way toward you. Then release it.

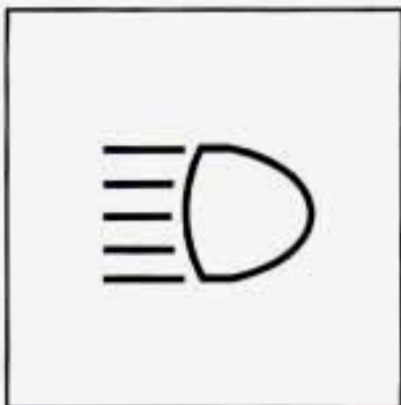

When the high beams are on, this light on the instrument panel also will be on.

## Windshield Wipers



You control the windshield wipers by turning the knob with the wiper symbol on it.

For a single wiping cycle, turn the knob to MIST. Hold it there until the wipers start, then let go. The wipers will stop after one cycle. If you want more cycles, hold the knob on MIST longer.

You can set the wiper speed for a long or short delay between wipes. This can be very useful in light rain or snow. Turn the knob to choose the delay time. The closer to LOW, the shorter the delay.

For steady wiping at low speed, turn the knob to the LOW position. For high-speed wiping, turn the knob further, to HIGH. To stop the wipers, move the knob to OFF.

Remember that damaged wiper blades may prevent you from seeing well enough to drive safely. To avoid damage, be sure to clear ice and snow from the wiper blades before using them. If they are frozen to the windshield, carefully loosen or thaw them. If your blades do become damaged, get new blades or blade inserts.

Heavy snow or ice can overload your wipers. The windshield wiper motor is protected from overload by a circuit breaker and a fuse. If the motor overheats due to heavy snow, etc., the wiper will stop until the motor cools. Although the circuit is protected from electrical overload, overload due to heavy snow, etc. may cause wiper linkage damage. Always clear ice and heavy snow from the windshield before using your windshield wipers.

## Windshield Washer



At the top of the lever, there's a paddle with the word PUSH on it. To spray washer fluid on the windshield, push the paddle.



## CAUTION:

**In freezing weather, don't use your washer until the windshield is warmed. Otherwise the washer fluid can form ice on the windshield, blocking your vision.**

Washer fluid will spray as long as you push the paddle. When you let go of the paddle, the wipers will continue to wipe for a few seconds and then either stop or return to the preset speed.

Driving without washer fluid can be dangerous. A bad mud splash can block your vision. You could hit another vehicle or go off the road. Check your washer fluid level often.

## Rear Window Wiper and Washer



The rear window wiper/washer switch is on your instrument panel, to the right of the gage cluster.

To turn the wiper on, slide the switch all the way up.

For delay wiping, slide the switch even with DELAY in the center position of the rear wiper control. The wiper will cycle every nine seconds.

To wash the window, push in on the switch. Window washer fluid will continue to spray until the switch is released. The wiper will continue with three more wipes and then return to the setting that was chosen before the lever was pushed.

The rear window washer uses the same fluid bottle as the front windshield washer. If the fluid level is low in

the washer fluid bottle, you may not be able to wash your rear window. If you can wash your windshield, but not your rear window, check the fluid level.

## Cruise Control (Option)

With cruise control, you can maintain a speed of about 25 mph (40 km/h) or more without keeping your foot on the accelerator. This can really help on long trips. Cruise control does not work at speeds below 25 mph (40 km/h).

When you apply your brakes, cruise control shuts off.

### CAUTION:

- **Cruise control can be dangerous where you can't drive safely at a steady speed. So, don't use your cruise control on winding roads or in heavy traffic.**
- **Cruise control can be dangerous on slippery roads. On such roads, fast changes in tire traction can cause needless wheel spinning, and you could lose control. Don't use cruise control on slippery roads.**



## Setting Cruise Control

### CAUTION:

If you leave your cruise control switch on when you're not using cruise, you might hit a button and go into cruise when you don't want to. You could be startled and even lose control. Keep the cruise control switch OFF until you want to use it.



1. Move the cruise control switch to ON.

2. Get up to the speed you want.

3. Push in the SET button at the end of the lever and release it.
4. Take your foot off the accelerator pedal.

### Resuming a Set Speed

Suppose you set your cruise control at a desired speed and then you apply the brake. This, of course, shuts off the cruise control. But you don't need to reset it.



Once you're going about 25 mph (40 km/h) or more, you can move the cruise control switch from ON to R/A (Resume/Accelerate) for about half a second.

You'll go right back up to your chosen speed and stay there.

Remember, if you hold the switch at R/A longer than half a second, the vehicle will keep going faster until you release the switch or apply the brake. You could be startled and even lose control. So unless you want to go faster, don't hold the switch at R/A.

## Increasing Speed While Using Cruise Control

There are two ways to go to a higher speed:

- Use the accelerator pedal to get to the higher speed. Push the SET button at the end of the lever, then release the button and the accelerator pedal. You'll now cruise at the higher speed.
- Move the cruise control switch from ON to R/A. Hold it there until you get up to the speed you want, and then release the switch. (To increase your speed in very small amounts, move the switch to R/A for less than half a second. Each time you do this, your vehicle will go about 1 mph (1.6 km/h) faster.)

## Reducing Speed While Using Cruise Control

There are two ways to reduce your speed while using cruise control:

- Push in the SET button at the end of the lever until you reach the lower speed you want, then release it.
- To slow down in very small amounts, push the button for less than half a second. Each time you do this, you'll go 1 mph (1.6 km/h) slower.

## Passing Another Vehicle While Using Cruise Control

Use the accelerator pedal to increase your speed. When you take your foot off the pedal, your vehicle will slow down to the cruise control speed you set earlier.

## Using Cruise Control on Hills

How well your cruise control will work on hills depends upon your speed, load and the steepness of the hills. When going up steep hills, you may have to step on the accelerator pedal to maintain your speed. If the steepness of the hill causes the vehicle speed to drop more than 15 mph (24 km/h) below the set speed, your cruise control will automatically disengage. When going downhill, you may have to brake or shift to a lower gear to keep your speed down. Of course, applying the brake takes you out of cruise control. Many drivers find this to be too much trouble and don't use cruise control on steep hills.

## Ending Cruise Control

There are two ways to turn off the cruise control:

- Step lightly on the brake pedal; OR



- Move the cruise control switch to OFF.

## Erasing Speed Memory

When you turn off the cruise control or the ignition, your cruise control set speed memory is erased.

## Lamps



Your parking/headlamp knob is on the driver's side of your instrument panel.

Rotate the knob clockwise to the parking lamp symbol to turn on the following:

- Parking Lamps
- Sidemarkers Lamps
- Clearance Lamps (if you have them)
- Taillamps
- License Plate Lamps
- Instrument Panel Lights

Rotate the knob clockwise again to the master lighting symbol to turn on all the lamps listed as well as the headlamps.

Rotate the knob counterclockwise to the OFF symbol to turn off your lamps.

Rotate the thumb wheel next to the knob up to adjust instrument panel lights. Rotate the thumb wheel up to the first notch to return the radio display and gearshift indicator LED display to full intensity when the headlamps or parking lamps are on. To turn on the dome lamps (with the vehicle doors closed) rotate the thumb wheel up to the second notch position.

You can switch your headlamps from high to low beam by pulling on the turn signal/high beam lever.

A circuit breaker protects your headlamps. If you have an electrical overload, your headlamps will flicker on and off. Have your headlamp wiring checked right away if this happens.

## Headlamps-On Reminder

A buzzer will sound when your headlamps are turned on and your ignition is in OFF, LOCK or ACCESSORY. If you need to use your headlamps when the ignition switch is in OFF, LOCK or ACCESSORY, the buzzer can be turned off by turning the thumb wheel next to the parking/headlamp switch all the way down.

## Daytime Running Lamps

Daytime Running Lamps (DRL) can make it easier for others to see the front of your vehicle during the day. DRL can be helpful in many different driving conditions, but they can be especially helpful in the short periods after dawn and before sunset.

The DRL system will make your headlamps come on at a reduced brightness when:

- The ignition is on,
- The headlamp switch is off, and
- The parking brake is released.

When the DRL are on, only your headlamps will be on. The taillamps, sidemarker and other lamps won't be on. Your instrument panel won't be lit up either.

When it begins to get dark, your DRL indicator light is a reminder to turn your headlamp switch on. The other lamps that come on with your headlamps will also come on.

When you turn the headlamp switch off, the regular lamps will go off, and your headlamps will change to the reduced brightness of DRL.

To idle your vehicle with the DRL off, set the parking brake. The DRL will stay off until you release the parking brake.

As with any vehicle, you should turn on the regular headlamp system when you need it.

## Underhood Reel Lamp



If you have an underhood reel lamp, it is located inside the engine compartment on the rear passenger side of the engine compartment. You can use it as a flashlight.

To use the lamp, pull up on the lever and pull the lamp out. The cord will unreel as you pull the lamp.

When you are done using the lamp, reel the cord back into the housing by turning the handle.

Then, slide the lamp into the holder. Press PUSH on the lever to hook the lamp into the holder.

## Interior Lamps

### Instrument Panel Intensity Control

Rotate the thumb wheel up to adjust the instrument panel lights. Rotate the thumb wheel up to the first notch to return the radio display and gear shift indicator LED display to full intensity when the headlamps or parking lamps are on. To turn on the dome lamps (with the vehicle doors closed) rotate the thumb wheel up to the second notch position.

### Illuminated Entry

Your vehicle may be equipped with an illuminated entry feature.

When the doors are opened, the dome lamps will come on if the dome lamp button is in the out position. When all doors are closed or the dome lamp button is pressed in, the lamps will stay on for a short period of time and will then go out.

## Dome Lamps

The dome lamps will come on when you open the doors.

You can also turn the dome lamps on by rotating the thumb wheel, located next to the parking/headlamp knob, all the way up to the second notch. In this position, the dome lamps will remain on whether the doors are opened or closed.

You can use the dome lamp button, located below the parking/headlamp knob, to set the dome lamps to come on automatically when the doors are open, or remain off. To turn the lamps off, press the button once. With the button in this position, the dome lamps will remain off when the doors are open. To return the lamps to automatic operation, press the button again and return it to the out position. With the button in this position, the dome lamps will come on when you open the door.

## Reading Lamps

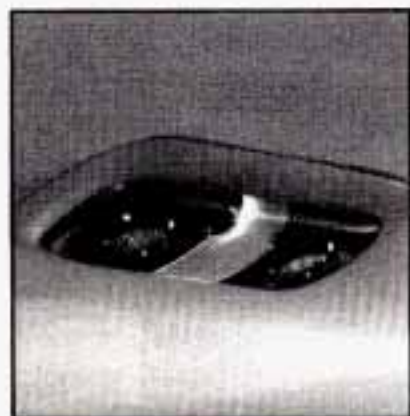

If your vehicle has reading lamps, press the button next to the lamp to turn the lamp on.

The lamps can be adjusted to point in the direction you want.

Press the button again to turn the lamp off.

If your vehicle has an overhead console with reading lamps, press the button next to the lamp to turn the lamp on.

The lamps can be adjusted to point in the direction you want.

Press the button again to turn the lamp off.

## Mirrors

### Inside Mirror

Push or pull the tab under the mirror to reduce glare from headlamps behind you after dark.

## Electrochromic Inside Rearview Mirror with Compass (Option)

Your vehicle may have an electrochromic inside rearview mirror.

An electrochromic inside rearview mirror, when on, automatically dims to the proper level to minimize glare from lights behind you after dark.

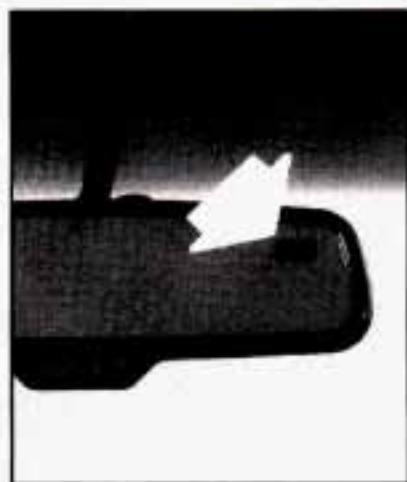

The mirror also includes an eight point compass display in the upper right corner of the mirror face. When on, the compass automatically calibrates as the vehicle is driven.

To use the electrochromic mirror only, move the switch at the bottom of the mirror to the M position. To use the electrochromic mirror as well as the compass, move the switch to the C/M position. To turn both features off, move the switch to the OFF position.

## Compass Operation

When the ignition is on and the mirror switch is in the C/M position, the compass display will show two character boxes for approximately two seconds. If, after two seconds, the display does not show a compass heading ("N" for North, for example), there may be a strong magnetic field interfering with the compass. Such interference may include magnetic antenna mounts, a magnetic note pad holder, or a similar magnetic item. If removing these items does not correct the condition, see your GM dealer for assistance.

When cleaning the mirror, use a paper towel or similar material dampened with glass cleaner. Do not spray glass cleaner directly on the mirror as that may cause liquid cleaner to enter the mirror housing.

## Compass Variance

Under certain circumstances, as during a long distance cross-country trip, it will be necessary to adjust the compass to compensate for compass variance. Compass variance is the difference between earth's magnetic North and true geographic North. If not adjusted to account for compass variance, your compass could give false readings.

To adjust for compass variance:

1. Use the CAL switch located at the bottom of the mirror housing near the on/off switch. A safety pin or a paper clip can be used to press the button. Press and hold the CAL switch for five seconds until a zone number appears in the display.
2. Find your current location and variance zone number on the following zone map.



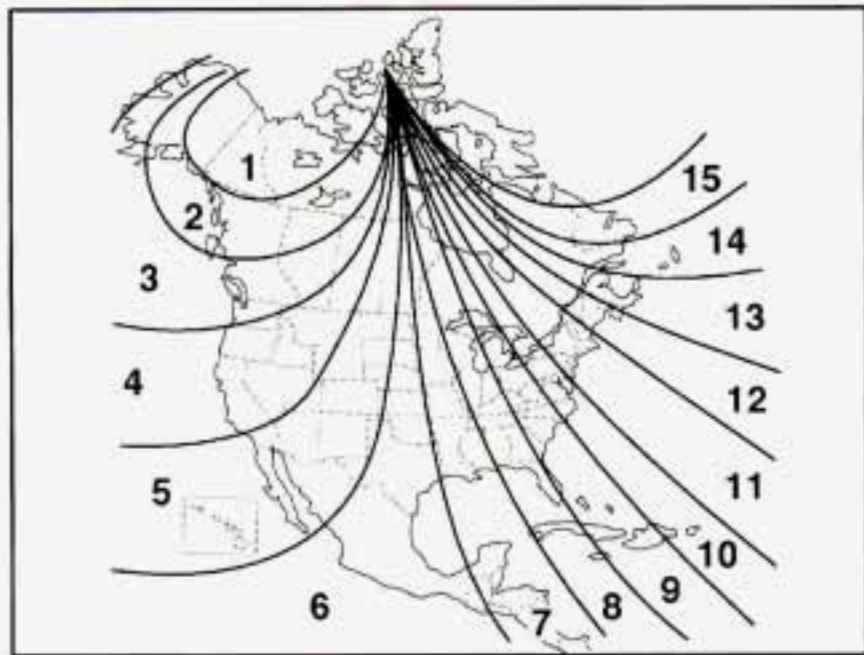

3. Press the CAL switch on the bottom of the mirror until the new zone number appears in the display. After you stop pressing the button in, the display will show a compass direction within a few seconds.

## Outside Mirrors

Adjust your outside mirrors so you can just see the side of your vehicle, and have a clear view of objects behind you. Some mirrors can be folded in to enter narrow doorways.

### Electric Outside Rearview Mirrors

If you have electric mirrors, they can be adjusted to point where you want from inside the vehicle.



Select the mirror you want to move by moving the center of the switch, located on the driver's door armrest, to R (right) or L (left).

Then, adjust the mirror angle by pressing the outer arrows on the switch until the mirror is adjusted where you want it.

## Convex Outside Mirror

Your passenger's side mirror may be convex. A convex mirror's surface is curved so you can see more from the driver's seat.

### CAUTION:

**A convex mirror can make things (like other vehicles) look farther away than they really are. If you cut too sharply into the right lane, you could hit a vehicle on your right. Check your inside mirror or glance over your shoulder before changing lanes.**

## Storage Compartments

Your vehicle has a variety of storage compartments designed to store small items.

## Glove Box

To open your glove box, move the switch button toward the passenger side and pull the door open.

Two cup depressions are provided at the top of the instrument panel to hold cups or other containers when the vehicle is not moving.

## Center Floor Console

Your vehicle may have a console compartment between the bucket seats.

To open it, lift the latch handle and swing the door open.



Your console also has a cupholder that swings out for the back seat passengers to use.



There is also a drawer that slides out at the bottom of the console.

### **Memo Pad Holder**



Your vehicle may have a memo holder attached to the front of the console. Use it to hold pads of paper or similar items.

### **Cassette/Compact Disc Holder**



Your vehicle may have a cassette/compact disc holder at the front of the console. The holder will store up to four compact disc cases, up to four cassette tape cases, or any combination of these items that adds up to four.

### **Instrument Panel Cupholder**

Your vehicle has a cupholder in the middle of the instrument panel.



To use the cupholder, pull the handle and slide the cupholder tray open.

To close the cupholder, slide it back in the instrument panel.

## Center Overhead Console

Your vehicle may have an overhead console. It has storage compartments inside it.

## Garage Door Opener Compartment

If you have a garage door opener, the front overhead compartment can be used to conveniently store the opener.

To install the garage door opener, first open the compartment door by pressing the release button forward.



Peel the protective backing from the hook and loop patch. Press it firmly to the back of your garage door opener, as close to the center of the opener as possible.

Center the garage door opener activation button over the console door button, and press the opener firmly into place.

The pegs inside the compartment door are used to make sure the button on the compartment door will contact the control button on the garage door opener.



Add one peg at a time until the PUSH button on the closed compartment door operates the garage door opener.



Now, with the compartment door closed, push the button marked PUSH to make sure the garage door opener operates properly.

With the garage door opener positioned properly and the right number of pegs in place, you should only have to push the PUSH button slightly to operate the opener.

Adjust the position of the garage door opener and add or remove pegs, as needed, until the opener operates properly.

## Sunglasses Compartment

The center overhead compartment can be used to conveniently store your sunglasses.



To open the center compartment, press the release button located at the rear of the compartment door.

Place your sunglasses in the compartment door with the lenses facing out.

## Rear Compartment

The rear compartment can be used to store a small item, like a book.

To open the rear compartment, press the release button located at the rear of the compartment door.

## Other Storage Compartments

Your vehicle includes a number of storage compartments for storage of often used items.

Some vehicles have storage areas in the instrument panel. Use these spaces for items such as gloves or small books.

Some models have a storage pocket on each of the front doors. You can use the pocket to store a variety of small items.

## Armrest Storage Compartment

Your vehicle may have a center armrest storage compartment in the front bench seat.

To open it, fold down the armrest, press the latch handle located at the front of the armrest. Then let the lid pop up and swing open.

The storage compartment has a cassette/compact disc holder. The holder will store up to five compact disc cases and up to six cassette tape cases.

The storage compartment also has a folding writing table on the top of the armrest lid.

To use the writing table, pull the latch at the rear of the table and swing the writing table forward. Use it to hold pads of paper and a pen.

## 4-Door Utility Rear Storage Compartment

If you have a Four-door Utility model, it has a storage compartment located in the rear cargo area of the vehicle, in the driver's side trim panel.

To open the compartment, press down on the release latches and swing the compartment door open.

When closing the compartment, press both latches down and move the door to the close position.

## Underhood Storage Area



There is a storage compartment in the front driver's side of the engine compartment.

## Convenience Net

If you have a convenience net, it is stored in a pouch attached to the spare tire.

## Cargo Security Shade (4-Door Utility Model)

### CAUTION:

An improperly stored cargo cover could be thrown about the vehicle during a collision or sudden maneuver. You or others could be injured. If you remove the cover, always store it outside of the vehicle. When you put it back, always be sure that it is securely reattached.



If you have a cargo security shade, you can use it to cover items in the cargo area of your vehicle.

To use the shade, pull the shade handle toward the rear of the vehicle. Latch the shade posts into the retaining sockets on the cargo area trim panels.

To return the shade to the shade holder, pull up on the shade handle to release the shade posts from the retaining sockets. Let the shade move forward and latch the shade posts into the front-most retaining sockets.



To remove the shade from the vehicle, first let the shade go all the way into the holder. Then, push the shade holder toward the passenger side of the vehicle. Lift the shade up on the driver's side, swing the shade rearward, and take it out of the vehicle.

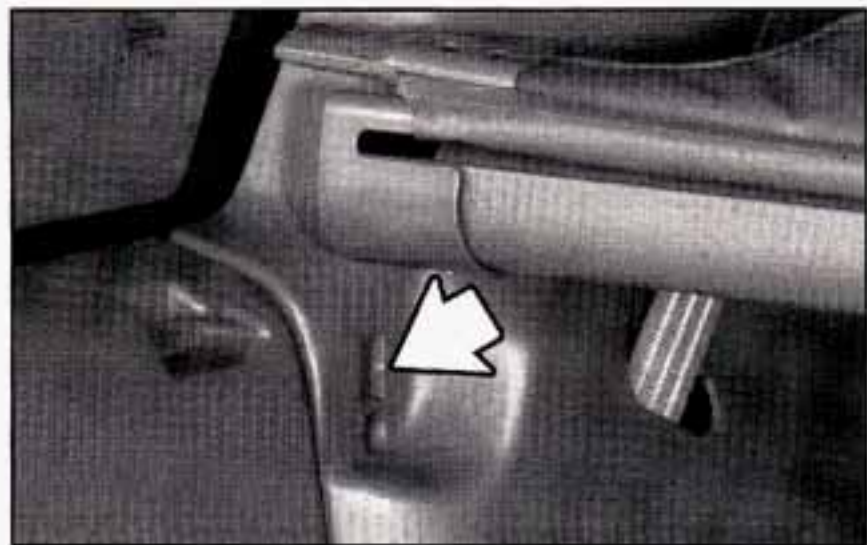

To put the shade in the vehicle, first make sure the shade slot in the holder faces rearward with the round surface facing down. Then, hold the shade at an angle and place the shade holder tab into the slot in the passenger's side trim panel. Move the other end of the shade forward and hold it next to the driver's side trim panel slot.

Push the shade holder toward the passenger side of the vehicle and place the tab in the driver's side trim panel slot. Make sure the tab goes all the way in the slot.

Lightly pull on the shade holder to make sure it is secure. Then, pull the shade to the desired position and secure the shade posts in the appropriate retaining sockets.

## Cargo Tie Downs



There are cargo tie downs in the rear cargo area that allow you to strap cargo in and keep it from moving inside the vehicle.

When not using the tie downs, flip them down out of the way.

## Luggage Carrier (Option)

If you have the optional luggage carrier, you can load things on top of your vehicle.

The luggage carrier has slats and side rails attached to the roof, and crossrails which can be moved towards the front or the rear in the side rails to help secure cargo. Tie the load to the side rails or side rail supports.

### **NOTICE:**

**Loading cargo that weighs more than 200 lbs. (90.6 kg) on the luggage carrier may damage your vehicle. When you carry large things, never let them hang over the rear or the sides of your vehicle. Load your cargo so that it rests on the slats and does not scratch or damage the vehicle. Put the cargo against the side rails and fasten it securely to the luggage carrier.**

Don't exceed the maximum vehicle capacity when loading your vehicle. For more information on vehicle capacity and loading, see "Loading Your Vehicle" in the Index.

To prevent damage or loss of cargo as you're driving, check now and then to make sure the luggage carrier and cargo are still securely fastened.

Be sure the cargo is properly loaded.

- If small heavy objects are placed on the roof, place the load in the area over the rear wheels (behind the rear side door on Suburbans). If you need to, cut a piece of 3/8 inch plywood to fit inside the crossrails and side rails to spread the load. If plywood is used, tie it to the side rail supports.
- Tie the load to the crossrails or the side rail supports. Use the crossrails only to keep the load from sliding.

- If you need to carry long items, move the crossrails as far apart as they will go. Tie the load to the crossrails and the side rails or side rail supports. Also tie the load to the bumpers. Do not tie the load so tightly that the crossrails or side rails are damaged.
- After moving the crossrails, be sure to tighten all the slider screws.

Your vehicle has a Center High-Mounted Stoplamp (CHMSL) located above the tailgate glass or above the rear load doors.

If items are loaded on the roof of the vehicle, as in a luggage carrier, care should be taken not to block or damage the CHMSL unit.

## Cigarette Lighter/Ashtrays

The front ashtray is located at the bottom of the instrument panel. Pull on the bottom of the ashtray door to open it.

### **NOTICE:**

**If you store paper or other things that burn in your ashtrays, they could be set on fire by cigarettes or other smoking materials. That could cause a fire and possibly damage your vehicle. Do not store papers and other things that burn in your ashtrays.**

To use the cigarette lighter, push it in all the way, and let go. When it's ready, it will pop back by itself.

### **NOTICE:**

**Holding a cigarette lighter in with your hand while it is heating can make it overload, damaging the lighter and the heating element. Just push the lighter all the way in and let go. When it's done, it will pop back by itself.**

To remove the front ashtray, pull on the front of the ashtray insert. Then slide the insert out of the ashtray door.

To use a rear ashtray, if you have them, pull at the top of the ashtray door to flip the door open.

To remove a rear ashtray, if you have them, press down on the inside tabs and open the door fully.

## Sun Visors

To block out glare, you can swing down the visors. You can also swing them out to help block glare at the front and side windows.

Your visor may have a strap to hold small items, such as maps.

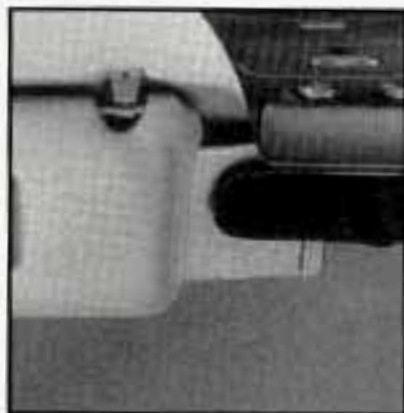

Some visors have an extender on the inside edge. When the visor is down, pull the extender out for extra glare coverage at the front or side.

Some visors have mirrors with lights. If the mirror has lights, they will come on when you lift the mirror cover.

## Power Outlets



You may have two power outlets near the cigarette lighter. To access these outlets, pull down the covers. Use these outlets to power mobile telephones or other devices designed to operate with vehicle electrical systems.

## Instrument Panel

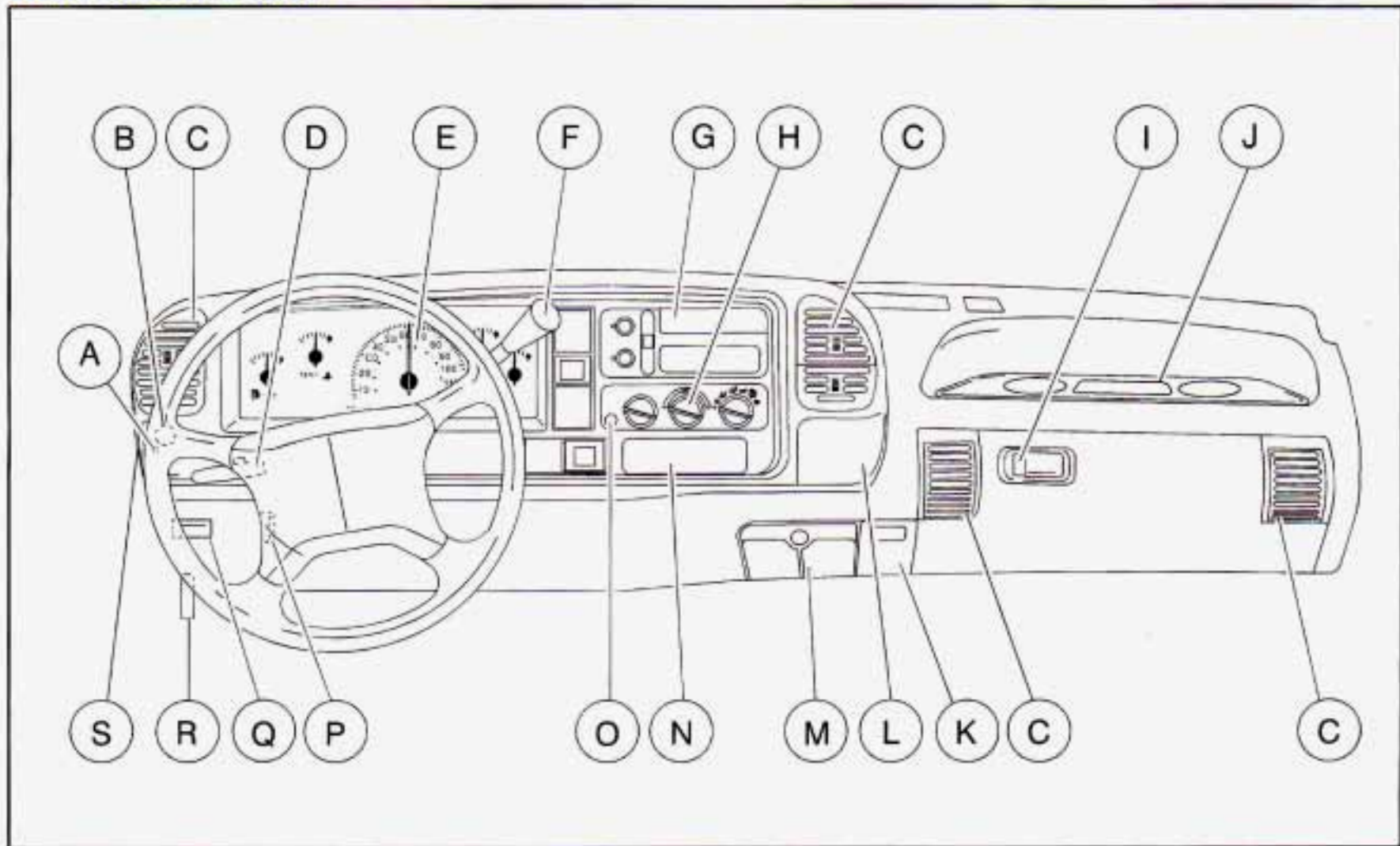

- A. Dome Lamp Switch
- B. Lamp Controls
- C. Air Vents
- D. Multifunction Lever
- E. Instrument Cluster
- F. Gearshift Lever
- G. Audio System
- H. Comfort Control System
- I. Glove Box
- J. Storage Tray
- K. Ashtray
- L. Cupholder
- M. Power Outlets
- N. Storage Area or Optional Compact Disc Player
- O. Rear Window Defogger Switch
- P. Tilt Lever
- Q. Parking Brake Release Handle
- R. Hood Release
- S. Fuse Panel

## Instrument Cluster

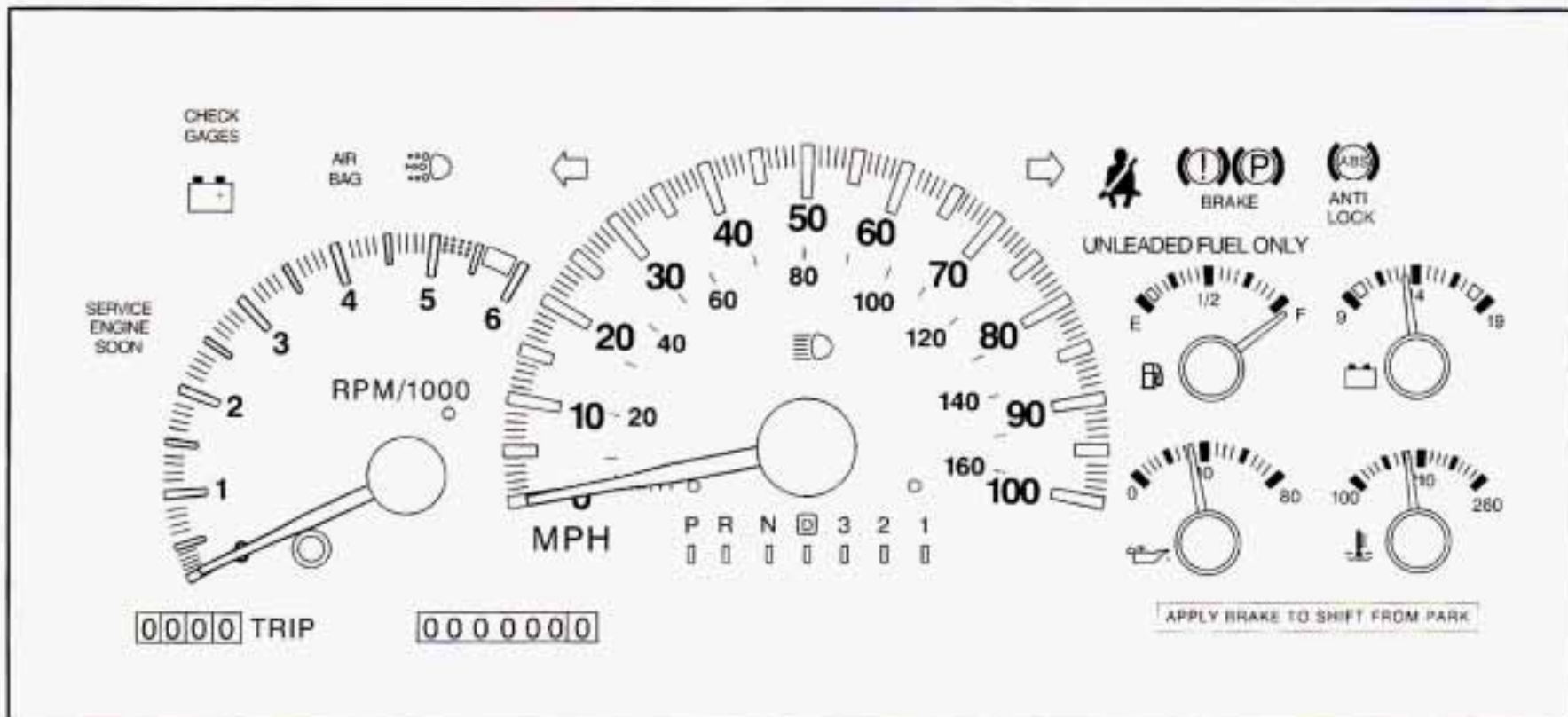

United States version shown, Canadian similar.

Your instrument cluster is designed to let you know at a glance how your vehicle is running. You'll know how fast you're going, about how much fuel you have and many other things you'll need to know to drive safely and economically.



## Speedometer and Odometer

Your speedometer lets you see your speed in both miles per hour (mph) and kilometers per hour (km/h). Your odometer shows how far your vehicle has been driven, in either miles (used in the United States) or kilometers (used in Canada).

## Tamper-Resistant Odometer

Your odometer is tamper-resistant. The odometer will show silver lines between the numbers if someone tries to turn it back.

You may wonder what happens if your vehicle needs a new odometer installed. Laws vary as to the procedure that must be followed, so check with your state or provincial vehicle registration office. But generally, if the new odometer can be set to the mileage total of the old odometer, then it must be. But if it can't, then it's set at zero, and a label must be put on the driver's door to show the old mileage reading when the new odometer was installed.

## Trip Odometer

The trip odometer can tell you how far your vehicle has been driven since you last set the trip odometer to zero.

To reset the trip odometer, fully press the reset button located near the trip odometer readout. If the reset button is not fully pressed, the trip odometer may not go all the way back to zero. If it doesn't, you may have to press the reset button again to reset the readout to zero.

## Tachometer

Your tachometer displays the engine speed in revolutions per minute (rpm).

### **NOTICE:**

**Do not operate the engine with the tachometer in the red area, your engine or other parts could be damaged.**

**Damage to your engine or vehicle caused by operating the engine in the red area isn't covered by your vehicle warranty.**

## Warning Lights, Gages and Indicators

This part describes the warning lights and gages that may be on your vehicle. The pictures will help you locate them.

Warning lights and gages can signal that something is wrong before it becomes serious enough to cause an expensive repair or replacement. Paying attention to your warning lights and gages could also save you or others from injury.

Warning lights come on when there may be or is a problem with one of your vehicle's functions. As you will see in the details on the next few pages, some warning lights come on briefly when you start the engine just to let you know they're working. If you are familiar with this section, you should not be alarmed when this happens.

Gages can indicate when there may be or is a problem with one of your vehicle's functions. Often gages and warning lights work together to let you know when there's a problem with your vehicle.

When one of the warning lights comes on and stays on when you are driving, or when one of the gages shows there may be a problem, check the section that tells you what to do about it. Please follow this manual's advice. Waiting to do repairs can be costly -- and even dangerous. So please get to know your warning lights and gages. They're a big help.

### Safety Belt Reminder Light

When the key is turned to RUN or START, a tone will come on for about eight seconds to remind people to fasten their safety belts, unless the driver's safety belt is already buckled.



The safety belt light will also come on and stay on for about 20 seconds, then it will flash for about 55 seconds. If the driver's belt is already buckled, neither the tone nor the light will come on.

## Air Bag Readiness Light

There is an air bag readiness light on the instrument panel, which shows AIR BAG. The system checks the air bag's electrical system for malfunctions. The light tells you if there is an electrical problem. The system check includes the air bag sensors, the air bag module, the wiring and the diagnostic module. For more information on the air bag system, see "Air Bag" in the Index.



You will see this light flash for a few seconds when you turn your ignition to RUN or START. Then the light should go out. This means the system is ready.

If the air bag readiness light doesn't come on when you start your vehicle, or stays on, or comes on when you are driving, your air bag system may not work properly. Have your vehicle serviced right away.

## Charging System Warning Light

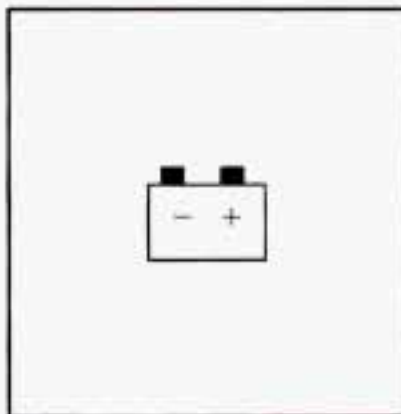

The charging system warning light should come on briefly when you turn on the ignition, before starting the engine, as a check to show you it is working.

After the engine starts, the light should go out. If it stays on or comes on while you are driving, you may have a problem with your charging system. It could indicate a problem with the alternator drive belt, or some other charging system problem. Have it checked right away. Driving while this light is on could drain your battery.

If you must drive a short distance with this light on, it helps to turn off all your accessories, such as the radio and air conditioner.

## Voltmeter

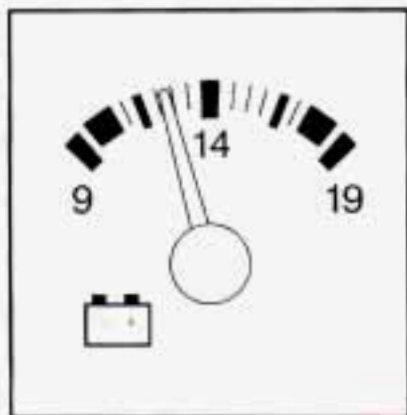

When your engine is not running, but the ignition is in the RUN position, this gage shows your battery's state of charge in DC volts.

When the engine is running, the gage shows the condition of the charging system. Readings between the low and high warning zones indicate the normal operating range.

Readings in the low warning zone may occur when a large number of electrical accessories are operating in the vehicle and the engine is left at an idle for an extended period. This condition is normal since the charging system is not able to provide full power at engine idle. As engine speeds are increased, this condition should correct itself as higher engine speeds allow the charging system to create maximum power.

You can only drive for a short time with the reading in either warning zone. If you must drive, turn off all unnecessary accessories.

Readings in either warning zone indicate a possible problem in the electrical system. Have the vehicle serviced as soon as possible.

## Brake System Warning Light

Your vehicle's hydraulic brake system is divided into two parts. If one part isn't working, the other part can still work and stop you. For good braking, though, you need both parts working well.

If the warning light comes on, there could be a brake problem. Have your brake system inspected right away.



This light should come on briefly when you turn the ignition key to RUN. If it doesn't come on then, have it fixed so it will be ready to warn you if there's a problem.

If the light comes on while you are driving, pull off the road and stop carefully. You may notice that the pedal is

harder to push. Or, the pedal may go closer to the floor. It may take longer to stop. If the light is still on, have the vehicle towed for service. (See "Towing Your Vehicle" in the Index.)

### CAUTION:

**Your brake system may not be working properly if the brake system warning light is on. Driving with the brake system warning light on can lead to an accident. If the light is still on after you've pulled off the road and stopped carefully, have the vehicle towed for service.**

When the ignition is on, the brake system warning light will also come on when you set your parking brake. The light will stay on if your parking brake doesn't release fully. If it stays on after your parking brake is fully released, it means you have a brake problem.

## Anti-Lock Brake System Warning Light



With the anti-lock brake system, this light will come on when you start your engine and may stay on for several seconds. That's normal.

If the light stays on, or comes on when you're driving, your vehicle needs service. If the regular brake system warning light isn't on, you still have brakes, but you don't have anti-lock brakes. If the regular brake system warning light is also on, you don't have anti-lock brakes and there's a problem with your regular brakes. See "Brake System Warning Light" earlier in this part.

The anti-lock brake system warning light should come on briefly when you turn the ignition key to RUN. If the light doesn't come on then, have it fixed so it will be ready to warn you if there is a problem.

## Engine Coolant Temperature Gage

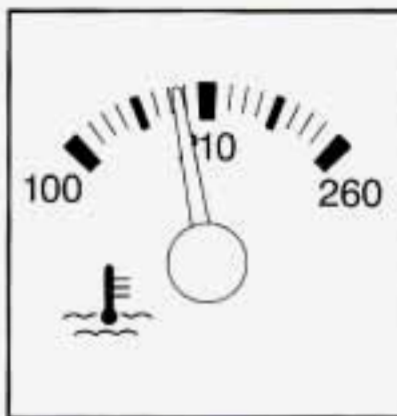

This gage shows the engine coolant temperature.

It also provides an indicator of how hard your vehicle is working. During a majority of the operation the gage will read 210°F (100°C) or less. If you are pulling a load or going up hills, it is normal for the temperature to fluctuate and approach the 260°F (160°C) mark. If the gage reaches the 260°F (160°C) mark, it indicates that the cooling system is working beyond its capacity.

In "Problems on the Road," this manual shows what to do. See "Engine Overheating" in the Index.

## Malfunction Indicator Lamp (Service Engine Soon Light) (Gasoline Engine)

SERVICE  
ENGINE  
SOON

Your vehicle is equipped with a computer which monitors operation of the fuel, ignition and emission control systems.

This system is called OBD II (On-Board Diagnostics-Second Generation) and is intended to assure that emissions are at acceptable levels for the life of the vehicle, helping to produce a cleaner environment. (In Canada, OBD II is replaced by Enhanced Diagnostics.) The SERVICE ENGINE SOON light comes on to indicate that there is a problem and service is required. Malfunctions often will be indicated by the system before any problem is apparent, which may prevent more serious damage to your vehicle. This system is also designed to assist your service technician in correctly diagnosing any malfunction.

### NOTICE:

**If you keep driving your vehicle with this light on, after a while, your emission controls may not work as well, your fuel economy may not be as good and your engine may not run as smoothly. This could lead to costly repairs that may not be covered by your warranty.**

This light should come on, as a check to show you it is working, when the ignition is on and the engine is not running. If the light doesn't come on, have it repaired. This light will also come on during a malfunction in one of two ways:

- **Light Flashing** -- A misfire condition has been detected. A misfire increases vehicle emissions and may damage the emission control system on your vehicle. Dealer or qualified service center diagnosis and service is required.
- **Light On Steady** -- An emission control system malfunction has been detected on your vehicle. Dealer or qualified service center diagnosis and service may be required.

## If the Light Is Flashing

The following may prevent more serious damage to your vehicle:

- Reduce vehicle speed.
- Avoid hard accelerations.
- Avoid steep uphill grades.
- If towing a trailer, reduce the amount of cargo being hauled as soon as it is possible.

If the light stops flashing and remains on steady, see “If the Light Is On Steady” following.

If the light continues to flash, when it is safe to do so, *stop the vehicle*. Put your vehicle in PARK (P). Turn the key off, wait at least 10 seconds and restart the engine.

If the light remains on steady, see “If the Light Is On Steady” following. If the light is still flashing follow the previous steps, and drive the vehicle to your dealer or qualified service center for service.

## If the Light Is On Steady

You may be able to correct the emission system malfunction by considering the following:

Did you just put fuel into your vehicle?

If so, reinstall the fuel cap, making sure to fully install the cap. The diagnostic system can determine if the fuel cap has been left off or improperly installed. This will allow fuel to evaporate into the atmosphere. A few driving trips should turn the light off.

Did you just drive through a deep puddle of water?

If so, your electrical system may be wet. The condition will usually be corrected when the electrical system dries out. A few driving trips should turn the light off.

Are you low on fuel?

As your engine starts to run out of fuel, your engine may not run as efficiently as designed since small amounts of air are sucked into the fuel line causing a misfire. The system can detect this. Adding fuel should correct this condition. Make sure to install the fuel cap properly. It will take a few driving trips to turn the light off.



Have you recently changed brands of fuel?

If so, be sure to fuel your vehicle with quality fuel (see “Fuel” in the Index). Poor fuel quality will cause your engine not to run as efficiently as designed. You may notice this as stalling after start-up, stalling when you put the vehicle into gear, misfiring, hesitation on acceleration or stumbling on acceleration. (These conditions may go away once the engine is warmed up.) This will be detected by the system and cause the light to turn on.

If you experience this condition, change the fuel brand you use. It will require at least one full tank of the proper fuel to turn the light off.

If none of the above steps have made the light turn off, have your dealer or qualified service center check the vehicle. Your dealer has the proper test equipment and diagnostic tools to fix any mechanical or electrical problems that may have developed.

## Oil Pressure Gage

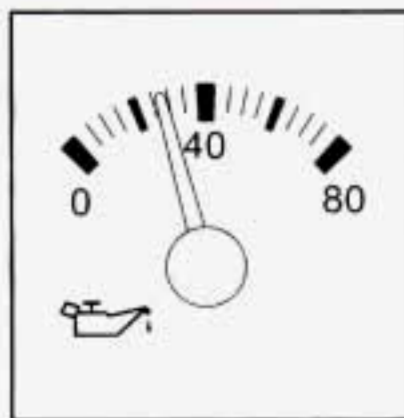

The oil pressure gage shows the engine oil pressure in psi (pounds per square inch) when the engine is running. Canadian vehicles indicate pressure in kPa (kilopascals).

Oil pressure may vary with engine speed, outside temperature and oil viscosity, but readings above the low pressure zone indicate the normal operating range.

A reading in the low pressure zone may be caused by a dangerously low oil level or other problem causing low oil pressure. Check your oil as soon as possible.

**⚠ CAUTION:**

Don't keep driving if the oil pressure is low. If you do, your engine can become so hot that it catches fire. You or others could be burned. Check your oil as soon as possible and have your vehicle serviced.

**NOTICE:**

Damage to your engine from neglected oil problems can be costly and is not covered by your warranty.

**Daytime Running Lamps (DRL)  
Indicator Light**

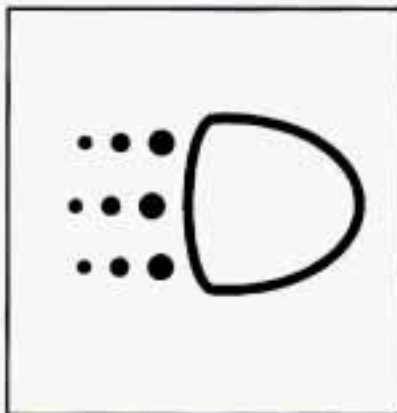

This light will go on whenever the DRL are on.

When it begins to get dark, the DRL indicator light is a reminder to turn on your headlamps.

## Check Gages Light



This light will come on briefly when you are starting the engine.

If the light comes on and stays on while you are driving, it could indicate a problem with your vehicle. It could be a problem with your oil pressure, coolant temperature, or some other problem. Check your various gages to see if they are in the warning zones. If they are, have your vehicle serviced right away.

## Headlamp High-Beam Indicator Light

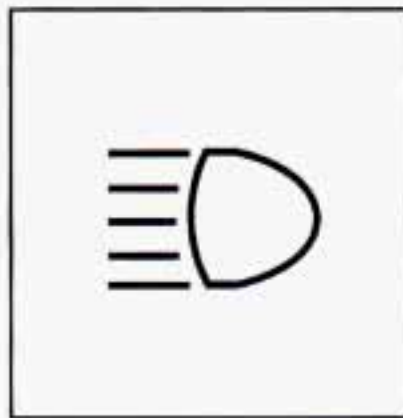

The high-beam indicator is on whenever you use your high-beam headlamps. For more details about high beams, see "Headlamp High/Low Beam Changer" earlier in this section.

## Turn Signal and Lane Change Indicator Lights

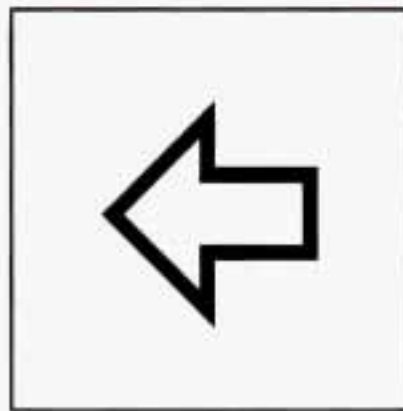

The signal indicator will come on whenever you signal a turn or lane change. See "Turn Signal and Lane Change Indicator" earlier in this section.

## Fuel Gage

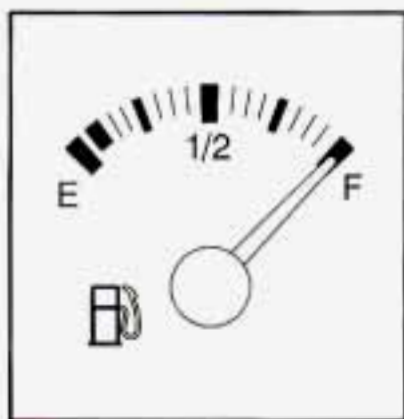

When the ignition is on, the fuel gage tells you about how much fuel you have left in your tank.

The gage will first indicate EMPTY (E) before you are out of fuel, and you should get more fuel as soon as possible.

Listed are four situations you may experience with your fuel gage:

- At the gas station, the fuel pump shuts off before the gage reads FULL (F).

- It takes a little more or less fuel to fill up than the fuel gage indicated. For example, the gage may have indicated the tank was half full, but it actually took a little more or less than half the tank's capacity to fill the tank.
- The gage moves a little when you turn a corner or speed up.
- The gage doesn't go back to EMPTY (E) when you turn off the ignition.

None of these indicate a problem with the fuel gage.

For information on how to fill your fuel tank, see "Fuel -- Filling Your Tank" in the Index.

For your fuel tank capacity, see "Fuel -- Tank Capacity" in the Index.

For the diesel engine fuel gage, see your Diesel Engine Supplement.

## Section 3 Comfort Controls and Audio Systems

---

---

In this section you'll find out how to operate the comfort control and audio systems offered with your vehicle. Be sure to read about the particular systems supplied with your vehicle.

### Comfort Controls

#### Standard Climate Control System



#### Fan Knob

The knob on the left side of the heating system control panel controls the fan speed. The knob has four speed positions. To increase airflow, move the knob toward HI. To decrease airflow, move it toward LO. To turn the fan off, move the knob to OFF.

#### Temperature Knob

The middle knob on the control panel lets you select the relative temperature of the air flowing into the passenger area of your vehicle. This knob will allow you to adjust the relative air temperature independently of the function knob setting. Move the knob clockwise toward the red area for warmer air. Move the knob counterclockwise toward the blue area for cooler air.

## Mode Knob

The right knob on the control panel allows you to choose the direction of air delivery. The control knob can be placed in any position between any two mode settings to blend the flow of air.



**VENT:** This setting directs air through the instrument panel outlets.



**VENT/HEAT:** Use this setting to divide airflow between the floor outlets and instrument panel outlets.



**HEATER:** This setting directs air through the floor outlets.



**DEFOG:** This setting directs air to the heater outlets and toward the windshield.



**DEFROST:** This setting directs air toward the windshield.

## Optional Climate Control System



### Fan Knob

The knob on the left side of the heating system control panel controls the fan speed. The knob has four speed positions. To increase airflow, move the knob toward HI. To decrease airflow, move it toward LO. To turn the fan off, move the knob to OFF. If you have the air conditioner on, moving the fan knob to OFF also turns off the A/C compressor.

## Temperature Knob

The middle knob on the control panel lets you select the relative temperature of the air flowing into the passenger area of your vehicle. This knob will allow you to adjust the relative air temperature independently of the function knob setting. Move the knob clockwise toward the red area for warmer air. Move the knob counterclockwise toward the blue area for cooler air.

## Mode Knob

The right knob on the control panel allows you to choose the direction of air delivery. The control knob can be placed in any position between any two mode settings to blend the flow of air.



**VENT:** This setting directs air through the instrument panel outlets.



**VENT/HEAT:** Use this setting to divide airflow between the floor outlets and instrument panel outlets.



**HEATER:** This setting directs air through the floor outlets.



**DEFOG:** This setting directs air to the heater outlets and toward the windshield.



**DEFROST:** This setting directs air toward the windshield.

## Rear Air Conditioning and Heating Systems (Suburban)

If your vehicle has either or both of these systems, you can increase and decrease the airflow at the rear vents. Depending on the system you have and the setting selected, you can send cooled or heated air to the rear of the vehicle.

### Rear Air Conditioning (Without Rear Heater)

If your vehicle has rear air conditioning (without rear heater), the controls are located above the front and second seats. The front and rear overhead controls let you increase and decrease the airflow at the rear vents.

To operate the rear air conditioning system, the front air conditioning system must be on. With the front air conditioning system off, the rear system controls can be used to circulate air in the rear of the vehicle.



To operate the rear system using the front control, just turn the knob to the blower position you want.



To use the rear control, first turn the front control knob to REAR CNTL. Then, the rear control can be used to increase and decrease the airflow.



## Rear Heater (Without Rear Air Conditioning)



If you have a rear heater (without rear air conditioning), the control switch is located on the instrument panel.

To increase and decrease the flow of heated air to the rear floor vents, move the switch marked REAR HEAT to the blower speed you want.

The knob has three speed positions. To increase the flow of heated air, move the switch toward HIGH. To decrease the flow of heated air, move it toward LOW. To turn the fan off, move the switch to OFF.

## Rear Air Conditioning and Rear Heater

If your vehicle has the rear air conditioning and rear heater system combination, controls are provided to regulate temperature, location and speed of the airflow.



To adjust the air temperature, turn the temperature knob on the right of the control panel.

For warmer air, turn the knob clockwise toward the red, and for cooler air, turn the knob counterclockwise.

To regulate the airflow location, adjust the center knob on the control panel. Turn the knob clockwise for floor vent airflow or counterclockwise for headliner vent airflow. Generally, the upper vents are used for air conditioning and the floor vents for heating. The control knob can be set to any blend setting.

To adjust the airflow speed, turn the fan control knob on the left side of the control panel to the desired blower setting.

To activate the rear control, move the fan knob on the front control to REAR CNTL.



The rear control works just like the front control. It will allow second seat passengers to adjust the controls as they desire.

## Air Conditioning

On hot days, open the windows long enough to let hot air inside escape. This reduces the time it takes for your vehicle to cool down. Then keep your windows closed for the air conditioner to work its best.

The recirculation button, between the fan and temperature knobs, allows the air inside your vehicle to be recirculated. This setting helps to maximize your air conditioner's performance and your vehicle's fuel economy. This setting also cools the air the fastest and can be used to keep unwanted odors and/or dust from entering the vehicle. When using the air conditioner, turn off recirculation after the vehicle reaches a comfortable interior temperature. When the right knob on the control panel is between HEATER and DEFROST, the recirculation feature will not function.

The A/C button, between the temperature and mode knobs, allows the air coming into your vehicle to be cooled. This setting is useful for normal cooling on hot days. When you use A/C with the recirculation button pushed in, turn off recirculation as soon as the vehicle reaches a comfortable interior temperature.

With the A/C on, move the temperature knob to MAX for maximum cooling. This setting also puts the system in the recirculation mode and helps to maximize your air conditioner's performance and your vehicle's fuel economy. This setting also cools the air the fastest. After the vehicle's interior reaches a comfortable temperature, move the temperature knob clockwise to place the air conditioning system in the normal mode.

## Heating

The heater works best if you keep your windows closed while using it. On cold days, use the HEATER or VENT/HEAT setting with the temperature knob in the red area.

If you use the engine coolant heater before starting your engine (in cold weather (20°F (-8°C) or lower), your heating system will produce warmer air faster, to heat the passenger compartment in cold weather.

The use of an engine coolant heater also reduces the time it takes for the engine to reach normal operating temperature, and shortens the time it takes the heater to reach full output. For more information, see "Engine Coolant Heater" in the Index.

## Ventilation System

For mild outside temperature when little heating or cooling is needed, use VENT to direct outside air through your vehicle. Air will flow through the instrument panel outlets.

Your vehicle's ventilation system supplies outside air to the inside of your vehicle when it is moving. With the side windows closed, air will flow into the front air inlet grilles, through the vehicle, and out the air exhaust valves.

Outside air will also enter the vehicle when the heater or the air conditioning fan is running, unless you have the recirculation button pushed in. For more information on the recirculation button, see "Air Conditioning" earlier in this section.



Your vehicle has air outlets in the center and on the sides of your instrument panel. You can move the outlets from side to side or up and down to direct the flow of air, or close the outlets altogether. When you close an outlet, it will increase the flow of air coming out of any outlets that are open. These outlets do not completely shut off airflow when in a closed vent position.

### Ventilation Tips

- Keep the hood and front air inlet free of ice, snow or any other obstruction (such as leaves). The heater and defroster will work far better, reducing the chance of fogging the inside of your windows.
- When you enter a vehicle in cold weather, turn the blower fan to HI for a few moments before driving. This helps clear the intake ducts of snow and moisture, and reduces the chance of fogging the inside of your windows.
- Keep the air path under the front seats clear of objects. This helps air to circulate throughout your vehicle.

### Defogging and Defrosting

On cool, humid days, use DEFOG to keep the windshield and side windows clear. Use DEFROST to remove fog or ice from the windshield in extremely humid or cold conditions. Use DEFROST with the temperature knob toward the red area and the fan control toward HI.

## Rear Window Defogger (Option)

If you see lines running across the rear window, you have the rear window defogger. The lines warm the glass.



To turn on the rear window defogger, press this button next to the fan control knob. The rear window defogger will only work if the ignition switch is turned to RUN. For best results, first clear the window of as much snow or ice as possible.

The defogger will shut itself off after several minutes. If you need additional warming time, press the button again. You can turn the defogger off at any time by pressing the button.

Do not attach a temporary vehicle license, tape or decals across the defogger grid on the rear window.

### NOTICE:

**Don't use a razor blade or something else sharp on the inside of the rear window. If you do, you could cut or damage the warming grid, and the repairs wouldn't be covered by your warranty.**

## Audio Systems

Your Delco<sup>®</sup> audio system has been designed to operate easily and give years of listening pleasure. You will get the most enjoyment out of it if you acquaint yourself with it first. Find out what your Delco system can do and how to operate all its controls, to be sure you're getting the most out of the advanced engineering that went into it.

## Setting the Clock for Systems without Automatic Tone Control

Press SET. Within five seconds, press and hold the SEEK right arrow until the correct minute appears on the display. Press and hold the SEEK left arrow until the correct hour appears on the display.

## Setting the Clock for Systems with Automatic Tone Control

Press and hold HR until the correct hour appears on the display. Press and hold MIN until the correct minute appears on the display. To display the clock with the ignition off, press RECALL and the time will be displayed for a few seconds. There is an initial two-second delay before the clock goes into the time-set mode.

## AM-FM Stereo



## Playing the Radio

**VOLUME-BAL:** Turn the knob clockwise to turn the radio on and counterclockwise to turn it off. To increase the volume, turn the knob clockwise. To decrease the volume, turn the knob counterclockwise. Display the time with the ignition off by pressing the VOLUME-BAL knob. When the radio is playing, press this button to recall the station frequency.

## Finding a Station

**AM-FM:** Press the lower knob to get AM or FM.

**TUNE:** Turn this knob to tune in radio stations.

**SEEK:** Press the right arrow to tune to the next higher station and the left arrow to tune to the next lower station and stay there.

**SCAN:** Press both SEEK buttons to listen to a few seconds of each radio station. SCAN will light up on the display. Press the right arrow to tune in the next higher station and press the left arrow to tune to the next lower station. Press VOLUME-BAL or both SEEK buttons to stop scanning.

**PUSHBUTTONS:** The four numbered pushbuttons let you return to your favorite stations. You can set up to 14 stations (seven AM and seven FM).

1. Tune in the desired station.
2. Press SET.
3. Press and hold one of the four pushbuttons, within five seconds. Whenever you press that numbered button, the station you set will return.

In addition to the four stations set as above, up to three additional stations may be preset on each band by pressing two adjoining buttons at the same time. Just:

1. Tune in the desired station.
2. Press SET.
3. Press two adjoining buttons at the same time, within five seconds. Whenever you press the same two buttons, the station you set will return.
4. Repeat these steps for each pair of buttons.

## Setting the Tone

**BASS:** Slide this lever up to increase the bass.

**TREB:** Slide this lever up to increase the treble. Slide the lever down to reduce noise with a weak or noisy station.

## Adjusting the Speakers

**BAL:** The control behind the VOLUME-BAL knob balances the sound between the right and left speakers.

**FADE:** The control behind the TUNE knob fades the sound between the front and rear speakers.

## AM-FM Stereo with Cassette Tape Player (Option)



### Playing the Radio

**VOLUME-BAL:** Turn the knob clockwise to turn the radio on and counterclockwise to turn it off. To increase the volume, turn the knob clockwise. To decrease the volume, turn the knob counterclockwise.

**RECALL:** Display the time with the ignition off by pressing the RECALL knob. When the radio is playing, press this button to recall the station frequency.

### Finding a Station

**AM-FM:** Press the lower knob to get AM or FM.

**TUNE:** Turn this knob to tune in radio stations.

**SEEK:** Press this button and the radio will tune to the next higher or lower station and stay there.

**PUSHBUTTONS:** The four numbered pushbuttons let you return to your favorite stations. You can set up to 14 stations (seven AM and seven FM).

1. Tune in the desired station.
2. Press SET.
3. Press and hold one of the four pushbuttons, within five seconds. Whenever you press that numbered button, the station you set will return.

In addition to the four stations set as above, up to three additional stations may be preset on each band by pressing two adjoining buttons at the same time. Just:

1. Tune in the desired station.
2. Press SET.
3. Press two adjoining buttons at the same time, within five seconds. Whenever you press the same two buttons, the station you set will return.
4. Repeat these steps for each pair of buttons.



**P.SCAN:** Press both SEEK buttons to scan through each of the preset stations. The system will scan through and play each preset station stored on your pushbuttons for a few seconds. Press either SEEK button or RECALL to stop scanning through the preset stations.

### Setting the Tone

**BASS:** Slide this lever up to increase the bass.

**TREB:** Slide this lever up to increase the treble. Slide the lever down to reduce noise with a weak or noisy station.

### Adjusting the Speakers

**BAL:** The control behind the VOLUME-BAL knob balances the sound between the right and left speakers.

**FADE:** The control behind the TUNE knob fades the sound between the front and rear speakers.

### Playing a Cassette Tape

Your tape player is built to work best with tapes that are 30 to 45 minutes long on each side. Tapes longer than that are so thin they may not work well in this player.

Once the tape is playing, use the knobs for VOLUME, FADE and BAL just as you do for the radio.

**FWD:** Press the SEEK right arrow to advance the cassette tape. Press the SEEK left arrow to stop forwarding the tape.

**REV:** Press the SEEK left arrow to reverse the cassette tape. Press the SEEK right arrow to stop reversing the tape.

**RECALL:** Press this button to switch tape sides.

**EJECT:** Press this button to remove the tape or stop the tape and play the radio.

**CLN:** This message may appear on the display. If it does, your cassette tape player needs to be cleaned. It will still play tapes, but you should clean it as soon as possible to prevent damage to your tapes and player. See "Care of Your Cassette Tape Player" in the Index. After you clean the player, press and hold EJECT for five seconds to reset the CLN indicator. The radio will display --- to show the indicator was reset.

## AM-FM Stereo with Cassette Tape and Automatic Tone Control (Option)



### Playing the Radio

**PWR-VOL:** Press this knob to turn the system on and off. Turn this control clockwise to increase the volume and counterclockwise to decrease the volume. The faster the PWR-VOL knob is rotated, the quicker the volume is increased or decreased.

**RECALL:** Press this button to switch between the clock and the radio station frequency displayed when the radio is on. Also, press this button to display the time when the ignition is off.

**SCV:** This is the Speed-Compensated-Volume (SCV) knob. Move the control ring behind the PWR-VOL knob clockwise to adjust the SCV. Set the volume at the desired level. As you drive, the SCV automatically increases the volume, as necessary, to overcome road and wind noise at any particular speed. The volume should always sound the same. Each clockwise position on the control ring allows for more compensation at a faster rate.

### Finding a Station

**AM-FM:** Press this button to switch between AM, FM1 and FM2. The display will show your selection.

**TUNE:** Press lightly on this knob to release it from its stored position. Rotate the knob clockwise to increase frequency and counterclockwise to decrease frequency. When finished tuning, press the knob again to return it to its stored position.

**SEEK:** Press the right arrow to tune to the next higher station and the left arrow to tune to the next lower station and stay there. The sound will mute while seeking.

**SCAN:** Press and hold SEEK for two seconds until SCAN appears on the display. SCAN allows you to listen to stations for a few seconds. The receiver will continue to scan and momentarily stop at each station until you press the button again. The sound will mute while scanning.

**AUTO TONE:** Press this button to select among the five preset equalization settings and tailor the sound to the music or voice being heard. Each time you press the button, the selection will switch to one of the preset settings of CLASSIC, NEWS, ROCK, POP or JAZZ. To return to the manual mode, press and release this button until MAN appears on the display. This will return the tone adjustment to the TREB and BASS controls. If a TREB or BASS control is rotated, the AUTO TONE setting will change to MAN.

**PUSHBUTTONS:** The six numbered pushbuttons let you return to your favorite stations. You can set up to 18 stations (six AM, six FM1 and six FM2).

1. Press AM-FM to select the band.
2. Tune in the desired station by pressing TUNE or the SEEK left or right arrows.
3. Press AUTO TONE to select the setting you prefer.
4. Press and hold one of the six pushbuttons.
5. The sound will mute. When it returns, release the button. Whenever you press that numbered button, the station you set will return and the tone you selected will be automatically selected for that button.

**P.SCAN:** The preset scan button lets you scan through your favorite stations stored on your pushbuttons. Select either the AM, FM1 or FM2 mode and then press P.SCAN. It will scan through each station stored on your pushbuttons and stop for a few seconds before continuing to scan through all of the pushbuttons. Press P.SCAN again or one of the pushbuttons to stop scanning to listen to a specific preset station. P.SCAN will light up on the display while in this mode. If one of the stations stored on a pushbutton is too weak for the location you are in, the radio display will show the channel number (P1-P6) for several seconds before advancing to the next preset station.

### Setting the Tone

**BASS:** Press lightly on this knob to release it from its stored position. Turn the knob clockwise to increase the bass and counterclockwise to decrease the bass. When the BASS control is rotated, the AUTO TONE setting will change to MAN. Push the knob back in to its stored position when done.

**TREB:** Press lightly on the TREB knob to release it from its stored position. Turn the knob clockwise to increase the treble and counterclockwise to decrease the treble. When the TREB control is rotated, the AUTO TONE setting will change to MAN. Push the knob back in to its stored position when done.

## Adjusting the Speakers

**BAL:** Press this button to remove the control from its stored position. Turn the control clockwise to adjust sound to the right speakers and counterclockwise to adjust sound to the left speakers. Press the button again to return BAL to its stored position.

**FADE:** Press this button to remove the control from its stored position. Turn the control clockwise to adjust the sound to the front and counterclockwise for rear speakers. Press the button again to return FADE to its stored position.

## Playing a Cassette Tape

Your tape player is built to work best with tapes that are 30 to 45 minutes long on each side. Tapes longer than that are so thin they may not work well in this player.

To load a cassette tape with the ignition off, press EJECT or RECALL. Then, insert the cassette tape. If the ignition is on but the radio is off, the tape will begin playing.

The player automatically senses if the cassette tape is metal or CrO<sub>2</sub> and adjusts for best playback sound. For metal tapes, the double-D symbol will appear on the display.

Once the tape is playing, use the VOL, BAL, FADE, TREB and BASS controls just as you do for the radio. The tape symbol and a direction arrow will be on the display whenever a tape is being played. Anytime a tape is inserted, the top side is selected for play first.

**PREV (1):** Press the PREV or the SEEK left arrow to search for the previous selection. A minimum three-second blank gap is required for the player to stop at the beginning of the selection. The tape direction arrow will blink during the SEEK operation.

**PROG (2):** Press this button to switch from one side of the tape to the other.

**NEXT (3):** Press NEXT or the SEEK right arrow to search for the next selection. A minimum three-second blank gap is required for the player to stop at the beginning of the selection. The tape direction arrow will blink during the SEEK operation.

**REV (4):** Press this button to rapidly reverse the tape to the beginning of the cassette reel or until you press REV again. The radio will play the last selected station while reversing the tape. The tape direction arrow will blink during REV operation.

**DD (5):** Press this button to reduce cassette tape noise. The double-D symbol will appear on the display while the player is in this mode.

Dolby Noise Reduction is manufactured under a license from Dolby Laboratories Licensing Corporation. Dolby and the double-D symbol are trademarks of Dolby Laboratories Licensing Corporation.

**FWD (6):** Press this button to rapidly forward the tape to the end of the cassette reel or until you press FWD again. The radio will play the last selected station while forwarding the tape. The tape direction arrow will blink during FWD operation.

**AM-FM:** Press this button to switch from a tape to the radio.

**TAPE AUX:** Press this button to return to the tape player. The lighted arrow will appear and show the direction of play when a tape is in the active mode.

**EJECT:** Press this button to remove the tape. The radio will now play. EJECT can be used with either the ignition or radio off. To load a cassette tape with the ignition or radio off, press EJECT before loading the cassette.

**CLN:** This message may appear on the display. If it does, your cassette tape player needs to be cleaned. It will still play tapes, but you should clean it as soon as possible to prevent damage to your tapes and player. See “Care of Your Cassette Tape Player” in the Index. After you clean the player, press and hold EJECT for five seconds to reset the CLN indicator. The radio will display --- to show the indicator was reset.

### CD Adapter Kits

Although this is not a recommended practice, it is possible to use a CD adapter kit with your cassette tape player.

The adapter kit cassette should begin playing like a regular audio cassette tape once inserted. If the cassette immediately ejects, turn the radio off, turn the ignition on and press and hold the TAPE AUX button until the tape icon flashes on the display. Insert the adapter cassette again. It will power up the radio and begin playing.

This override routine will remain active until the EJECT button is pressed.

## Playing a Compact Disc in the Single Remote Disc Player



If you have this option, you can play one compact disc (CD) at a time.

To load a CD into the player, hold the disc with the label side up and insert it carefully into the player (approximately half way). The disc will automatically be pulled into the player. If the radio is off and the ignition is on when a CD is inserted, the radio will turn on and begin playing the CD. It is possible to load and unload CD's with the ignition off. To load a disc with the ignition off, press the EJECT button on the remote player and then insert the disc. To remove the disc, press the EJECT button and remove the disc from the player.

A disc that has been ejected but is still sitting in the remote CD player will be pulled back into the player after approximately 30 seconds. This protects the disc and player from damage. The disc will not start playing. To remove the disc, press the EJECT button and remove the disc from the player.

All of the compact disc functions are controlled by the radio buttons except for EJECT. When a disc is in the player, a CD symbol will appear on the display. When a disc is playing, the letters CD will appear next to the CD symbol in the bottom left corner. The track number will also be displayed.

If the disc comes back out and ERR appears on the display, it could be that:

- The disc is upside down.
- It is dirty, scratched or wet.
- There's too much moisture in the air. (Wait about an hour and try again.)
- You are driving on a very rough road.

Please contact your dealer if any error recurs or cannot be corrected.

**TAPE AUX:** With a disc loaded in the player and the radio playing, press this button once to play the compact disc. To return to playing the radio, press AM-FM. If both a cassette tape and CD are loaded, press TAPE AUX to switch between the tape and compact disc.

**SEEK:** Press the left arrow while playing a CD to go back to the start of the current track. It will go back to the current track if more than eight seconds have played. Press the left arrow again to go to previous tracks. Press the right arrow to go to the next higher track on the disc.

**PREV (1):** Press this button to go back to the start of the current track if more than eight seconds have played. Press PREV again to go to the previous track on the disc.

**PROG (2):** This button is active only when you have the 12-disc changer.

**NEXT (3):** Press this button to advance to the next track on the disc.

**REV (4):** Press and hold this button to quickly reverse within a track (song). As the CD reverses, elapsed time will be displayed to help you find the correct passage.

**FWD (6):** Press and hold this button to quickly advance within a track (song). As the CD advances, elapsed time will be displayed to help you find the correct passage.

**RANDOM:** Press P.SCAN to enter the random play mode. RANDOM will appear on the display. While in this mode, the tracks on the discs will be played in random order. If you press SEEK, PREV or NEXT while in the random mode, the PREV or NEXT track will be scanned randomly. Press P.SCAN again to turn off RANDOM and return to normal operation.

**EJECT:** Press this button on the remote player to eject a compact disc.

**RECALL:** Press this button to see what track is currently playing. Press RECALL again within five seconds to see how long the track has been playing. When a new track starts to play, the track number will also appear. Press RECALL a third time and the time of day will be displayed.

## AM-FM Stereo with Compact Disc Player and Automatic Tone Control (Option)



### Playing the Radio

**PWR-VOL:** Press this knob to turn the system on and off. Turn this control clockwise to increase the volume and counterclockwise to decrease the volume. The faster the PWR-VOL knob is rotated, the quicker the volume is increased or decreased.

**RECALL:** Press this button to switch between the clock and the radio station frequency displayed when the radio is on. Also, press this button to display the time when the ignition is off.

**SCV:** This is the Speed-Compensated-Volume (SCV) knob. Move the control ring behind the PWR-VOL knob clockwise to adjust the SCV. Set the volume at the desired level. As you drive, the SCV automatically increases the volume, as necessary, to overcome road and wind noise at any particular speed. The volume should always sound the same. Each clockwise position on the control ring allows for more compensation at a faster rate.

### Finding a Station

**AM-FM:** Press this button to switch between AM, FM1 and FM2. The display will show your selection.

**TUNE:** Press lightly on this knob to release it from its stored position. Rotate the knob clockwise to increase frequency and counterclockwise to decrease frequency. When finished tuning, press the knob again to return it to its stored position.

**SEEK:** Press the right arrow to tune to the next higher station and the left arrow to tune to the next lower station and stay there. There will be no sound when using the SEEK feature.



**SCAN:** Press and hold SEEK for two seconds until SCAN appears on the display. SCAN allows you to listen to stations for a few seconds. The receiver will continue to scan and momentarily stop at each station until you press the button again. There will be no sound when using the SCAN feature.

**PUSHBUTTONS:** The six numbered pushbuttons let you return to your favorite stations. You can set up to 18 stations (six AM, six FM1 and six FM2).

1. Press AM-FM to select the band.
2. Tune in the desired station by pressing TUNE or the SEEK left or right arrows.
3. Press AUTO TONE to select the setting you prefer.
4. Press and hold one of the four pushbuttons.
5. The sound will mute. When it returns, release the button. Whenever you press that numbered button, the station you set will return and the tone you selected will be automatically selected for that button.

**P.SCAN:** The preset scan button lets you scan through your favorite stations stored on your pushbuttons. Select either the AM, FM1 or FM2 mode and then press P.SCAN. It will scan through each station stored on your pushbuttons and stop for a few seconds before continuing to scan through all of the pushbuttons. Press P.SCAN again or one of the pushbuttons to stop scanning to listen to a specific stored station. P.SCAN will light up on the display while in this mode. If one of the stations stored on a pushbutton is too weak for the location you are in, the radio display will show the channel number (P1-P6) for several seconds before advancing to the next preset station.

### Setting the Tone

**AUTO TONE:** Press this button to select among the five preset equalization settings and tailor the sound to the music or voice being heard. Each time you press the button, the selection will switch to one of the preset settings of CLASSIC, NEWS, ROCK, POP or JAZZ. The display will show which mode the receiver is in. To return to the manual mode, press and release this button until MAN appears on the display. This will return the tone adjustment to the TREB and BASS controls. When a TREB or BASS control is rotated, tone is automatically set to MAN.

**BASS:** Press lightly on this knob to release it from its stored position. Turn the knob clockwise to increase the bass and counterclockwise to decrease the bass. When the BASS control is rotated, the AUTO TONE setting will change to MAN. Push the knob back in to its stored position when done.

**TREB:** Press lightly on the TREB knob to release it from its stored position. Turn the knob clockwise to increase the treble and counterclockwise to decrease the treble. When the TREB control is rotated, the AUTO TONE setting will change to MAN. Push the knob back in to its stored position when done.

### Adjusting the Speakers

**BAL:** Press this button to remove the control from its stored position. Turn the control clockwise to adjust sound to the right speakers and counterclockwise to adjust sound to the left speakers. Press the button again to return BAL to its stored position.

**FADE:** Press this button to remove the control from its stored position. Turn the control clockwise to adjust the sound to the front and counterclockwise for rear speakers. Press the button again to return FADE to its stored position.

### Playing a Compact Disc

**PWR:** Press this knob to turn the system on. (Please note that you can also turn the system on when you insert a compact disc into the player with the ignition on.)

Insert a disc partway into the slot, label side up. The player will pull it in. Wait a few seconds and the disc should play. CD and a CD symbol will also appear on the display. Anytime you are playing a CD, the letters CD will be next to the CD symbol.

If the disc comes back out and ERR appears on the display, it could be that:

- You are driving on a very rough road. (The disc should play when the road gets smoother.)
- The disc is upside down.
- It is dirty, scratched or wet.
- It is very humid. (If so, wait about an hour and try again.)
- The disc player is very hot.

Press RECALL to make ERR go off the display.

**RECALL:** Press this button to see what track is playing. Press it again within five seconds to see how long the CD has been playing that track. Elapsed time is displayed in minutes and tenths of a second. The track number will also appear when a new track begins to play. Press RECALL again to return to the time display.

**PREV (1):** Press PREV or the SEEK left arrow to search for the previous selection. If you hold this button or press it more than once, the disc will advance further. Sound is muted in this mode.

**RDM (2):** Press this button to play the tracks on the disc in random (instead of 1, 2, 3, . . .) order. While in the RDM mode, RANDOM appears on the display. Press RDM again to return to normal play.

**NEXT (3):** Press NEXT or the SEEK right arrow to search for the next selection. If you hold this button or press it more than once, the disc will advance further. The next track number will appear on the display. Sound is muted in this mode.

**REV (4):** Press and hold REV to return rapidly to a favorite passage. You will hear the disc selection play at high speed while you press the REV button. This allows you to listen and find out when the disc is at the desired selection. Release REV to resume playing.

**FWD (6):** Press and hold this button to advance rapidly within a track. You will hear the disc selection play at high speed while you press the FWD button. This allows you to listen and find out when the disc is at the desired selection. Release FWD to resume playing.

**AM-FM:** While in the CD mode, press this button to stop playing the CD and play the radio. The CD symbol will still display but the word CD will be replaced with either AM, FM1 or FM2. (If the radio is turned off, the disc stays in the player and will resume playing at the point where it stopped.)

**CD AUX:** To switch between the player and the radio when a disc is playing, press the AM-FM button. To return to the player, press CD AUX. When a disc is playing, the letters CD and the CD symbol will appear on the display. (If the radio is turned off, the disc stays in the player and will resume playing at the point where it stopped.)

**EJECT:** Press this button to eject the disc from the player and play the radio. When the same or a new disc is inserted, the disc will start playing on track one. If a compact disc is left sitting in the opening for more than a few seconds, the player will pull the CD back in. The radio will continue playing. When the ignition is off, press this button to load a CD.

## Theft-Deterrent Feature

THEFTLOCK™ is designed to discourage theft of your radio. It works by using a secret code to disable all radio functions whenever battery power is removed.

The THEFTLOCK feature for the radio may be used or ignored. If ignored, the system plays normally and the radio is not protected by the feature. If THEFTLOCK is activated, your radio will not operate if stolen.

When THEFTLOCK is activated, the radio will display LOC to indicate a locked condition anytime battery power is removed. If your battery loses power for any reason, you must unlock the radio with the secret code before it will operate.

### Activating the Theft-Deterrent Feature

The instructions which follow, explain how to enter your secret code to activate the THEFTLOCK system. It is recommended that you read through all nine steps before starting the procedure.

NOTE: If you allow more than 15 seconds to elapse between any steps, the radio automatically reverts to time and you must start the procedure over at Step 4.

1. Write down any three or four-digit number from 000 to 1999 and keep it in a safe place separate from the vehicle.
2. Turn the ignition to the ACCESSORY or RUN position.
3. Turn the radio off.
4. Press the 1 and 4 buttons together. Hold them down until --- shows on the display. Next you will use the secret code number which you have written down.
5. Press MN and 000 will appear on the display.
6. Press MN again to make the last two digits agree with your code.
7. Press HR to make the first one or two digits agree with your code.
8. Press AM-FM after you have confirmed that the code matches the secret code you have written down. The display will show REP to let you know that you need to repeat Steps 5 through 7 to confirm your secret code.
9. Press AM-FM and this time the display will show SEC to let you know that your radio is secure. The indicator by the volume control will begin flashing when the ignition is turned off.

## Unlocking the Theft-Deterrent Feature After a Power Loss

Enter your secret code as follows; pause no more than 15 seconds between steps:

1. LOC appears when the ignition is on.
2. Press MN and 000 will appear on the display.
3. Press MN again to make the last two digits agree with your code.
4. Press HR to make the first one or two digits agree with your code.
5. Press AM-FM after you have confirmed that the code matches the secret code you have written down. The display will show SEC, indicating the radio is now operable and secure.

If you enter the wrong code eight times, INOP will appear on the display. You will have to wait an hour with the ignition on before you can try again. When you try again, you will only have three chances to enter the correct code before INOP appears.

If you lose or forget your code, contact your dealer.

## Disabling the Theft-Deterrent Feature

Enter your secret code as follows; pause no more than 15 seconds between steps:

1. Turn the ignition to the ACCESSORY or RUN position.
2. Turn the radio off.
3. Press the 1 and 4 buttons together. Hold them down until SEC shows on the display.
4. Press MN and 000 will appear on the display.
5. Press MN again to make the last two digits agree with your code.
6. Press HR to make the first one or two digits agree with your code.
7. Press AM-FM after you have confirmed that the code matches the secret code you have written down. The display will show ---, indicating that the radio is no longer secured.

If the code entered is incorrect, SEC will appear on the display. The radio will remain secured until the correct code is entered.

When battery power is disconnected from a secured radio, the radio won't turn on and LOC will appear on the display.

To unlock a secured radio, see “Unlocking the Theft-Deterrent Feature After a Power Loss” earlier in this section.

## Understanding Radio Reception

### FM Stereo

FM stereo will give you the best sound. But FM signals will reach only about 10 to 40 miles (16 to 65 km). Tall buildings or hills can interfere with FM signals, causing the sound to come and go.

### AM

The range for most AM stations is greater than for FM, especially at night. The longer range, however, can cause stations to interfere with each other. AM can pick up noise from things like storms and power lines. Try reducing the treble to reduce this noise if you ever get it.

## Tips About Your Audio System

Hearing damage from loud noise is almost undetectable until it is too late. Your hearing can adapt to higher volumes of sound. Sound that seems normal can be loud and harmful to your hearing. Take precautions by adjusting the volume control on your radio to a safe sound level before your hearing adapts to it.

To help avoid hearing loss or damage:

- Adjust the volume control to the lowest setting.
- Increase volume slowly until you hear comfortably and clearly.

### **NOTICE:**

**Before you add any sound equipment to your vehicle -- like a tape player, CB radio, mobile telephone or two-way radio -- be sure you can add what you want. If you can, it's very important to do it properly. Added sound equipment may interfere with the operation of your vehicle's engine, Delco radio or other systems, and even damage them. Your vehicle's systems may interfere with the operation of sound equipment that has been added improperly.**

**So, before adding sound equipment, check with your dealer and be sure to check Federal rules covering mobile radio and telephone units.**

## Care of Your Cassette Tape Player

A tape player that is not cleaned regularly can cause reduced sound quality, ruined cassettes or a damaged mechanism. Cassette tapes should be stored in their cases away from contaminants, direct sunlight and extreme heat. If they aren't, they may not operate properly or may cause failure of the tape player.

Your tape player should be cleaned regularly after every 50 hours of use. Your radio may display CLN to indicate that you have used your tape player for 50 hours without resetting the tape clean timer. If you notice a reduction in sound quality, try a known good cassette to see if the tape or the tape player is at fault. If this other cassette has no improvement in sound quality, clean the tape player.

Cleaning may be done with a scrubbing action, non-abrasive cleaning cassette with pads which scrub the tape head as the hubs of the cleaner cassette turn. It is normal for the cassette to eject while cleaning because your unit is equipped with a cut tape feature.

To temporarily override this feature (for one insertion), turn the radio off and press and hold TAPE AUX until the tape symbol flashes on the display, then insert the cassette again. Insert the cassette at least three times to ensure thorough cleaning. A scrubbing action cleaning cassette is available through your GM dealer.

You may also choose a non-scrubbing action, wet-type cleaner which uses a cassette with a fabric belt to clean the tape head. This type of cleaning cassette will not eject. It may not clean as thoroughly as the scrubbing type cleaner.

Cassettes are subject to wear and the sound quality may degrade over time. Always make sure that the cassette tape is in good condition before you have your tape player serviced.

## Care of Your Compact Discs

Handle discs carefully. Store them in their original cases or other protective cases and away from direct sunlight and dust. If the surface of a disc is soiled, dampen a clean, soft cloth in a mild, neutral detergent solution and clean it, wiping from the center to the edge.

Be sure never to touch the signal surface when handling discs. Pick up discs by grasping the outer edges or the edge of the hole and the outer edge.

## Fixed Mast Antenna

The fixed mast antenna can withstand most vehicle washes without being damaged. If the mast should ever become slightly bent, you can straighten it out by hand. If the mast is badly bent, as it might be by vandals, you should replace it.

Check every once in a while to be sure the mast is still tightened to the cowl.



## Section 4 Your Driving and the Road



Here you'll find information about driving on different kinds of roads and in varying weather conditions. We've also included many other useful tips on driving.

### Defensive Driving

The best advice anyone can give about driving is: Drive defensively.

Please start with a very important safety device in your vehicle: Buckle up. (See "Safety Belts" in the Index.)

Defensive driving really means "be ready for anything." On city streets, rural roads or freeways, it means "always expect the unexpected."

Assume that pedestrians or other drivers are going to be careless and make mistakes. Anticipate what they might do. Be ready for their mistakes.

Rear-end collisions are about the most preventable of accidents. Yet they are common. Allow enough following distance. It's the best defensive driving maneuver, in both city and rural driving. You never know when the vehicle in front of you is going to brake or turn suddenly.

## Drunken Driving

Death and injury associated with drinking and driving is a national tragedy. It's the number one contributor to the highway death toll, claiming thousands of victims every year.

Alcohol affects four things that anyone needs to drive a vehicle:

- Judgment
- Muscular Coordination
- Vision
- Attentiveness.

Police records show that almost half of all motor vehicle-related deaths involve alcohol. In most cases, these deaths are the result of someone who was drinking and driving. In recent years, some 18,000 annual motor vehicle-related deaths have been associated with the use of alcohol, with more than 300,000 people injured.

Many adults -- by some estimates, nearly half the adult population -- choose never to drink alcohol, so they never drive after drinking. For persons under 21, it's against the law in every U.S. state to drink alcohol. There are good medical, psychological and developmental reasons for these laws.

The obvious way to solve this highway safety problem is for people never to drink alcohol and then drive. But what if people do? How much is "too much" if the driver plans to drive? It's a lot less than many might think. Although it depends on each person and situation, here is some general information on the problem.

The Blood Alcohol Concentration (BAC) of someone who is drinking depends upon four things:

- The amount of alcohol consumed
- The drinker's body weight
- The amount of food that is consumed before and during drinking
- The length of time it has taken the drinker to consume the alcohol.

According to the American Medical Association, a 180-lb. (82 kg) person who drinks three 12-ounce (355 ml) bottles of beer in an hour will end up with a BAC of about 0.06 percent. The person would reach the same BAC by drinking three 4-ounce (120 ml) glasses of wine or three mixed drinks if each had 1-1/2 ounces (45 ml) of a liquor like whiskey, gin or vodka.

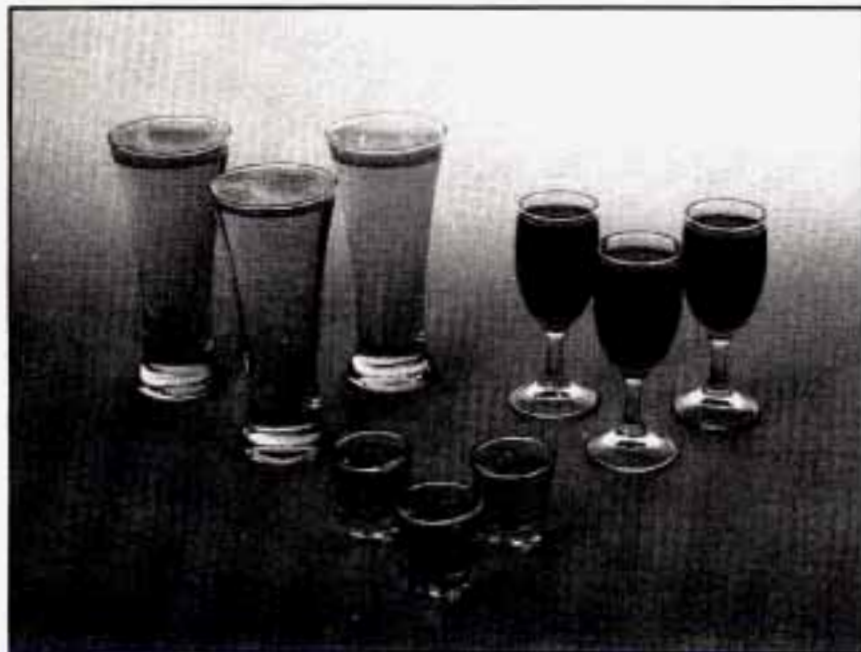

It's the amount of alcohol that counts. For example, if the same person drank three double martinis (3 ounces or 90 ml of liquor each) within an hour, the person's BAC would be close to 0.12 percent. A person who consumes food just before or during drinking will have a somewhat lower BAC level.

There is a gender difference, too. Women generally have a lower relative percentage of body water than men.

Since alcohol is carried in body water, this means that a woman generally will reach a higher BAC level than a man of her same body weight when each has the same number of drinks.

The law in many U.S. states sets the legal limit at a BAC of 0.10 percent. In a growing number of U.S. states, and throughout Canada, the limit is 0.08 percent. In some other countries, it's even lower. The BAC limit for all commercial drivers in the United States is 0.04 percent.

The BAC will be over 0.10 percent after three to six drinks (in one hour). Of course, as we've seen, it depends on how much alcohol is in the drinks, and how quickly the person drinks them.

But the ability to drive is affected well below a BAC of 0.10 percent. Research shows that the driving skills of many people are impaired at a BAC approaching 0.05 percent, and that the effects are worse at night. All drivers are impaired at BAC levels above 0.05 percent. Statistics show that the chance of being in a collision increases sharply for drivers who have a BAC of 0.05 percent or above. A driver with a BAC level of 0.06 percent has doubled his or her chance of having a collision. At a BAC level of 0.10 percent, the chance of this driver having a collision is 12 times greater; at a level of 0.15 percent, the chance is 25 times greater!

The body takes about an hour to rid itself of the alcohol in one drink. No amount of coffee or number of cold showers will speed that up. "I'll be careful" isn't the right answer. What if there's an emergency, a need to take sudden action, as when a child darts into the street? A person with even a moderate BAC might not be able to react quickly enough to avoid the collision.

There's something else about drinking and driving that many people don't know. Medical research shows that alcohol in a person's system can make crash injuries worse, especially injuries to the brain, spinal cord or heart. This means that when anyone who has been drinking -- driver or passenger -- is in a crash, that person's chance of being killed or permanently disabled is higher than if the person had not been drinking.



## **CAUTION:**

**Drinking and then driving is very dangerous. Your reflexes, perceptions, attentiveness and judgment can be affected by even a small amount of alcohol. You can have a serious -- or even fatal -- collision if you drive after drinking. Please don't drink and drive or ride with a driver who has been drinking. Ride home in a cab; or if you're with a group, designate a driver who will not drink.**

## Control of a Vehicle

You have three systems that make your vehicle go where you want it to go. They are the brakes, the steering and the accelerator. All three systems have to do their work at the places where the tires meet the road.

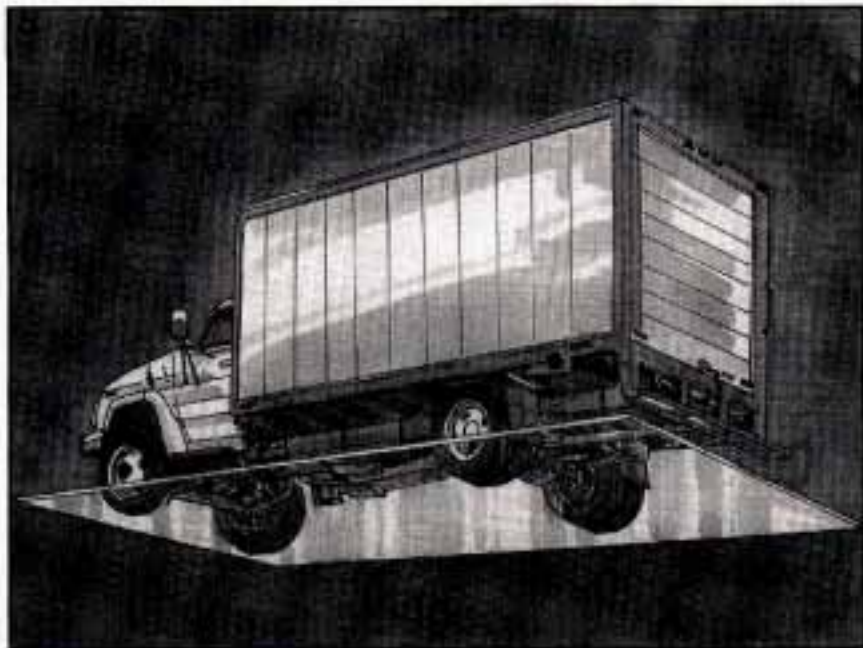

Sometimes, as when you're driving on snow or ice, it's easy to ask more of those control systems than the tires and road can provide. That means you can lose control of your vehicle.

## Braking

Braking action involves *perception time* and *reaction time*.

First, you have to decide to push on the brake pedal. That's *perception time*. Then you have to bring up your foot and do it. That's *reaction time*.

Average *reaction time* is about  $\frac{3}{4}$  of a second. But that's only an average. It might be less with one driver and as long as two or three seconds or more with another. Age, physical condition, alertness, coordination and eyesight all play a part. So do alcohol, drugs and frustration. But even in  $\frac{3}{4}$  of a second, a vehicle moving at 60 mph (100 km/h) travels 66 feet (20 m). That could be a lot of distance in an emergency, so keeping enough space between your vehicle and others is important.

And, of course, actual stopping distances vary greatly with the surface of the road (whether it's pavement or gravel); the condition of the road (wet, dry, icy); tire tread; and the condition of your brakes.

Avoid needless heavy braking. Some people drive in spurts -- heavy acceleration followed by heavy braking -- rather than keeping pace with traffic. This is a mistake. Your brakes may not have time to cool between hard stops. Your brakes will wear out much faster if you do a lot of heavy braking. If you keep pace with the traffic and allow realistic following distances, you will eliminate a lot of unnecessary braking. That means better braking and longer brake life.

If your engine ever stops while you're driving, brake normally but don't pump your brakes. If you do, the pedal may get harder to push down. If your engine stops, you will still have some power brake assist. But you will use it when you brake. Once the power assist is used up, it may take longer to stop and the brake pedal will be harder to push.

## Anti-Lock Brakes

Your vehicle has anti-lock brakes (ABS). ABS is an advanced electronic braking system that will help prevent a braking skid.

When you start your engine and begin to drive away, your anti-lock brake system will check itself. You may hear a momentary motor or clicking noise while this test is going on. This is normal.

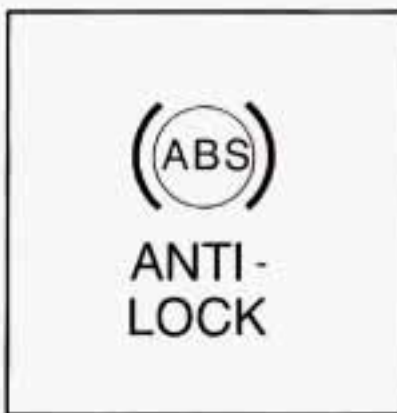

If there's a problem with the anti-lock brake system, this warning light will stay on. See "Anti-Lock Brake System Warning Light" in the Index.



Here's how anti-lock works. Let's say the road is wet. You're driving safely. Suddenly an animal jumps out in front of you.

You slam on the brakes. Here's what happens with ABS. A computer senses that wheels are slowing down. If one of the wheels is about to stop rolling, the computer will separately work the brakes at each front wheel and at the rear wheels.

The anti-lock system can change the brake pressure faster than any driver could. The computer is programmed to make the most of available tire and road conditions.



You can steer around the obstacle while braking hard.

As you brake, your computer keeps receiving updates on wheel speed and controls braking pressure accordingly.

Remember: Anti-lock doesn't change the time you need to get your foot up to the brake pedal or always decrease stopping distance. If you get too close to the vehicle in front of you, you won't have time to apply your brakes if that vehicle suddenly slows or stops. Always leave enough room up ahead to stop, even though you have anti-lock brakes.

### Using Anti-Lock

Don't pump the brakes. Just hold the brake pedal down and let anti-lock work for you. You may feel the brakes vibrate, or you may notice some noise, but this is normal. On vehicles with four-wheel drive, your anti-lock brakes work at all times -- whether you are in two-wheel drive or four-wheel drive.

### Braking in Emergencies

Use your anti-lock braking system when you need to. With anti-lock, you can steer and brake at the same time. In many emergencies, steering can help you more than even the very best braking.

## Steering

### Power Steering

If you lose power steering assist because the engine stops or the system is not functioning, you can steer but it will take much more effort.

### Steering Tips

#### Driving on Curves

It's important to take curves at a reasonable speed.

A lot of the "driver lost control" accidents mentioned on the news happen on curves. Here's why:

Experienced driver or beginner, each of us is subject to the same laws of physics when driving on curves. The traction of the tires against the road surface makes it possible for the vehicle to change its path when you turn the front wheels. If there's no traction, inertia will keep the vehicle going in the same direction. If you've ever tried to steer a vehicle on wet ice, you'll understand this.

The traction you can get in a curve depends on the condition of your tires and the road surface, the angle at which the curve is banked, and your speed. While you're in a curve, speed is the one factor you can control.



Suppose you're steering through a sharp curve. Then you suddenly accelerate. Both control systems -- steering and acceleration -- have to do their work where the tires meet the road. Adding the sudden acceleration can demand too much of those places. You can lose control.

What should you do if this ever happens? Ease up on the accelerator pedal, steer the vehicle the way you want it to go, and slow down.

Speed limit signs near curves warn that you should adjust your speed. Of course, the posted speeds are based on good weather and road conditions. Under less favorable conditions you'll want to go slower.

If you need to reduce your speed as you approach a curve, do it before you enter the curve, while your front wheels are straight ahead.

Try to adjust your speed so you can "drive" through the curve. Maintain a reasonable, steady speed. Wait to accelerate until you are out of the curve, and then accelerate gently into the straightaway.

## Steering in Emergencies

There are times when steering can be more effective than braking. For example, you come over a hill and find a truck stopped in your lane, or a car suddenly pulls out from nowhere, or a child darts out from between parked cars and stops right in front of you. You can avoid these problems by braking -- if you can stop in time. But sometimes you can't; there isn't room. That's the time for evasive action -- steering around the problem.

Your vehicle can perform very well in emergencies like these. First apply your brakes. (See "Braking in Emergencies" earlier in this section.) It is better to remove as much speed as you can from a possible collision. Then steer around the problem, to the left or right depending on the space available.



An emergency like this requires close attention and a quick decision. If you are holding the steering wheel at the recommended 9 and 3 o'clock positions, you can turn it a full 180 degrees very quickly without removing either hand. But you have to act fast, steer quickly, and just as quickly straighten the wheel once you have avoided the object.

The fact that such emergency situations are always possible is a good reason to practice defensive driving at all times and wear safety belts properly.

## Off-Road Recovery

You may find sometime that your right wheels have dropped off the edge of a road onto the shoulder while you're driving.

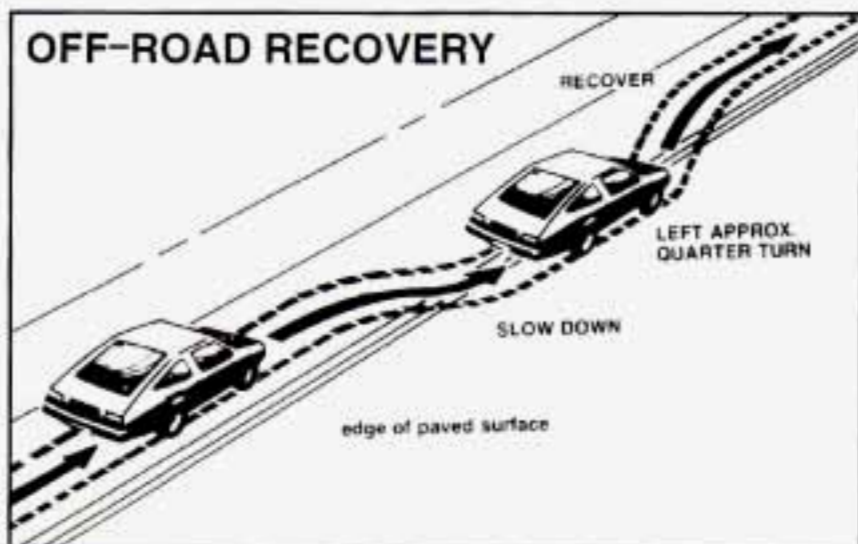

If the level of the shoulder is only slightly below the pavement, recovery should be fairly easy. Ease off the accelerator and then, if there is nothing in the way, steer so that your vehicle straddles the edge of the pavement. You can turn the steering wheel up to one-quarter turn until the right front tire contacts the pavement edge. Then turn your steering wheel to go straight down the roadway.

## Passing

The driver of a vehicle about to pass another on a two-lane highway waits for just the right moment, accelerates, moves around the vehicle ahead, then goes back into the right lane again. A simple maneuver?

Not necessarily! Passing another vehicle on a two-lane highway is a potentially dangerous move, since the passing vehicle occupies the same lane as oncoming traffic for several seconds. A miscalculation, an error in judgment, or a brief surrender to frustration or anger can suddenly put the passing driver face to face with the worst of all traffic accidents -- the head-on collision.

So here are some tips for passing:

- "Drive ahead." Look down the road, to the sides and to crossroads for situations that might affect your passing patterns. If you have any doubt whatsoever about making a successful pass, wait for a better time.
- Watch for traffic signs, pavement markings and lines. If you can see a sign up ahead that might indicate a turn or an intersection, delay your pass. A broken center line usually indicates it's all right to pass (providing the road ahead is clear). Never cross a solid line on your side of the lane or a double solid line, even if the road seems empty of approaching traffic.

- Do not get too close to the vehicle you want to pass while you're awaiting an opportunity. For one thing, following too closely reduces your area of vision, especially if you're following a larger vehicle. Also, you won't have adequate space if the vehicle ahead suddenly slows or stops. Keep back a reasonable distance.
- When it looks like a chance to pass is coming up, start to accelerate but stay in the right lane and don't get too close. Time your move so you will be increasing speed as the time comes to move into the other lane. If the way is clear to pass, you will have a "running start" that more than makes up for the distance you would lose by dropping back. And if something happens to cause you to cancel your pass, you need only slow down and drop back again and wait for another opportunity.
- If other cars are lined up to pass a slow vehicle, wait your turn. But take care that someone isn't trying to pass you as you pull out to pass the slow vehicle. Remember to glance over your shoulder and check the blind spot.

- Check your mirrors, glance over your shoulder and start your left lane change signal before moving out of the right lane to pass. When you are far enough ahead of the passed vehicle to see its front in your inside mirror, activate your right lane change signal and move back into the right lane. (Remember that if your right outside mirror is convex, the vehicle you just passed may seem to be farther away from you than it really is.)
- Try not to pass more than one vehicle at a time on two-lane roads. Reconsider before passing the next vehicle.
- Don't overtake a slowly moving vehicle too rapidly. Even though the brake lamps are not flashing, it may be slowing down or starting to turn.
- If you're being passed, make it easy for the following driver to get ahead of you. Perhaps you can ease a little to the right.

## Loss of Control

Let's review what driving experts say about what happens when the three control systems (brakes, steering and acceleration) don't have enough friction where the tires meet the road to do what the driver has asked.

In any emergency, don't give up. Keep trying to steer and constantly seek an escape route or area of less danger.

## Skidding

In a skid, a driver can lose control of the vehicle. Defensive drivers avoid most skids by taking reasonable care suited to existing conditions, and by not "overdriving" those conditions. But skids are always possible.

The three types of skids correspond to your vehicle's three control systems. In the braking skid, your wheels aren't rolling. In the steering or cornering skid, too much speed or steering in a curve causes tires to slip and lose cornering force. And in the acceleration skid, too much throttle causes the driving wheels to spin.

A cornering skid and an acceleration skid are best handled by easing your foot off the accelerator pedal.

If your vehicle starts to slide, ease your foot off the accelerator pedal and quickly steer the way you want the vehicle to go. If you start steering quickly enough, your vehicle may straighten out. Always be ready for a second skid if it occurs.

Of course, traction is reduced when water, snow, ice, gravel or other material is on the road. For safety, you'll want to slow down and adjust your driving to these conditions. It is important to slow down on slippery surfaces because stopping distance will be longer and vehicle control more limited.

While driving on a surface with reduced traction, try your best to avoid sudden steering, acceleration or braking (including engine braking by shifting to a lower gear). Any sudden changes could cause the tires to slide. You may not realize the surface is slippery until your vehicle is skidding. Learn to recognize warning clues -- such as enough water, ice or packed snow on the road to make a "mirrored surface" -- and slow down when you have any doubt.

Remember: Any anti-lock brake system (ABS) helps avoid only the braking skid.

## Driving Guidelines

This multipurpose passenger vehicle is defined as a utility vehicle in Consumer Information Regulations issued by the National Highway Traffic Safety Administration (NHTSA) of the United States Department of Transportation. Utility vehicles have higher ground clearance and a narrower track to make them capable of performing in a wide variety of off-road applications. Specific design characteristics give them a higher center of gravity than ordinary cars. An advantage of the higher ground clearance is a better view of the road allowing you to anticipate problems. They are not designed for cornering at the same speeds as conventional two-wheel-drive vehicles any more than low-slung sports cars are designed to perform satisfactorily under off-road conditions. If at all possible, avoid sharp turns or abrupt maneuvers. As with other vehicles of this type, failure to operate this vehicle correctly may result in loss of control or vehicle rollover.

## Off-Road Driving with Your Four-Wheel-Drive Vehicle

This off-road guide is for vehicles that have four-wheel drive.

Also, see “Anti-Lock Brakes” in the Index.

If your vehicle doesn't have four-wheel drive, you shouldn't drive off-road unless you're on a level, solid surface.

Off-road driving can be great fun. But it does have some definite hazards. The greatest of these is the terrain itself.

“Off-roading” means you've left the great North American road system behind. Traffic lanes aren't marked. Curves aren't banked. There are no road signs. Surfaces can be slippery, rough, uphill or downhill. In short, you've gone right back to nature.

Off-road driving involves some new skills. And that's why it's very important that you read this guide. You'll find many driving tips and suggestions. These will help make your off-road driving safer and more enjoyable.

## Before You Go Off-Road

There are some things to do before you go out. For example, be sure to have all necessary maintenance and service work done. Check to make sure all underbody shields (if so equipped) are properly attached. Be sure you read all the information about your four-wheel-drive vehicle in this manual. Is there enough fuel? Is the spare tire fully inflated? Are the fluid levels up where they should be? What are the local laws that apply to off-roading where you'll be driving? If you don't know, you should check with law enforcement people in the area. Will you be on someone's private land? If so, be sure to get the necessary permission.

## Loading Your Vehicle for Off-Road Driving

There are some important things to remember about how to load your vehicle.

- The heaviest things should be on the load floor and forward of your rear axle. Put heavier items as far forward as you can.
- Be sure the load is secured properly, so driving on the off-road terrain doesn't toss things around.

## CAUTION:

- **Cargo on the load floor piled higher than the seatbacks can be thrown forward during a sudden stop. You or your passengers could be injured. Keep cargo below the top of the seatbacks.**
- **Unsecured cargo on the load floor can be tossed about when driving over rough terrain. You or your passengers can be struck by flying objects. Secure the cargo properly.**
- **Heavy loads on the roof raise the vehicle's center of gravity, making it more likely to roll over. You can be seriously or fatally injured if the vehicle rolls over. Put heavy loads inside the cargo area, not on the roof. Keep cargo in the cargo area as far forward and low as possible.**

You'll find other important information in this manual. See "Vehicle Loading," "Luggage Carrier" and "Tires" in the Index.

## Environmental Concerns

Off-road driving can provide wholesome and satisfying recreation. However, it also raises environmental concerns. GM recognizes these concerns and urges every off-roader to follow these basic rules for protecting the environment:

- Always use established trails, roads and areas that have been specially set aside for public off-road recreational driving; obey all posted regulations.
- Avoid any driving practice that could damage the environment -- shrubs, flowers, trees, grasses -- or disturb wildlife (this includes wheel-spinning, breaking down trees or unnecessary driving through streams or over soft ground).
- Always carry a litter bag -- make sure all refuse is removed from any campsite before leaving.
- Take extreme care with open fires (where permitted), camp stoves and lanterns.
- Never park your vehicle over dry grass or other combustible materials that could catch fire from the heat of the vehicle's exhaust system.

## Traveling to Remote Areas

It makes sense to plan your trip, especially when going to a remote area. Know the terrain and plan your route. You are much less likely to get bad surprises. Get accurate maps of trails and terrain. Try to learn of any blocked or closed roads.

It's also a good idea to travel with at least one other vehicle. If something happens to one of them, the other can help quickly.

Does your vehicle have a winch? If so, be sure to read the winch instructions. In a remote area, a winch can be handy if you get stuck. But you'll want to know how to use it properly.

## Getting Familiar with Off-Road Driving

It's a good idea to practice in an area that's safe and close to home before you go into the wilderness. Off-road driving does require some new and different driving skills. Here's what we mean.

Tune your senses to different kinds of signals. Your eyes, for example, need to constantly sweep the terrain for unexpected obstacles. Your ears need to listen for unusual tire or engine sounds. With your arms, hands, feet and body, you'll need to respond to vibrations and vehicle bounce.

Controlling your vehicle is the key to successful off-road driving. One of the best ways to control your vehicle is to control your speed. Here are some things to keep in mind. At higher speeds:

- you approach things faster and you have less time to scan the terrain for obstacles.
- you have less time to react.
- you have more vehicle bounce when you drive over obstacles.
- you'll need more distance for braking, especially since you're on an unpaved surface.

### CAUTION:

**When you're driving off-road, bouncing and quick changes in direction can easily throw you out of position. This could cause you to lose control and crash. So, whether you're driving on or off the road, you and your passengers should wear safety belts.**



## Scanning the Terrain

Off-road driving can take you over many different kinds of terrain. You need to be familiar with the terrain and its many different features. Here are some things to consider.

*Surface Conditions.* Off-roading can take you over hard-packed dirt, gravel, rocks, grass, sand, mud, snow or ice. Each of these surfaces affects the steering, acceleration and braking of your vehicle in different ways. Depending upon the kind of surface you are on, you may experience slipping, sliding, wheel spinning, delayed acceleration, poor traction and longer braking distances.

*Surface Obstacles.* Unseen or hidden obstacles can be hazardous. A rock, log, hole, rut or bump can startle you if you're not prepared for them. Often these obstacles are hidden by grass, bushes, snow or even the rise and fall of the terrain itself. Here are some things to consider:

- Is the path ahead clear?
- Will the surface texture change abruptly up ahead?
- Does the travel take you uphill or downhill?  
(There's more discussion of these subjects later.)
- Will you have to stop suddenly or change direction quickly?

When you drive over obstacles or rough terrain, keep a firm grip on the steering wheel. Ruts, troughs or other surface features can jerk the wheel out of your hands if you're not prepared.

When you drive over bumps, rocks, or other obstacles, your wheels can leave the ground. If this happens, even with one or two wheels, you can't control the vehicle as well or at all.

Because you will be on an unpaved surface, it's especially important to avoid sudden acceleration, sudden turns or sudden braking.

In a way, off-road driving requires a different kind of alertness from driving on paved roads and highways. There are no road signs, posted speed limits or signal lights. You have to use your own good judgment about what is safe and what isn't.

Drinking and driving can be very dangerous on any road. And this is certainly true for off-road driving. At the very time you need special alertness and driving skills, your reflexes, perceptions and judgment can be affected by even a small amount of alcohol. You could have a serious -- or even fatal -- accident if you drink and drive or ride with a driver who has been drinking. See "Drunken Driving" in the Index.

## Driving on Off-Road Hills

Off-road driving often takes you up, down or across a hill. Driving safely on hills requires good judgment and an understanding of what your vehicle can and can't do. There are some hills that simply can't be driven, no matter how well built the vehicle.

### CAUTION:

**Many hills are simply too steep for any vehicle. If you drive up them, you will stall. If you drive down them, you can't control your speed. If you drive across them, you will roll over. You could be seriously injured or killed. If you have any doubt about the steepness, don't drive the hill.**

## Approaching a Hill

When you approach a hill, you need to decide if it's one of those hills that's just too steep to climb, descend or cross. Steepness can be hard to judge. On a very small hill, for example, there may be a smooth, constant

incline with only a small change in elevation where you can easily see all the way to the top. On a large hill, the incline may get steeper as you near the top, but you may not see this because the crest of the hill is hidden by bushes, grass or shrubs.

Here are some other things to consider as you approach a hill.

- Is there a constant incline, or does the hill get sharply steeper in places?
- Is there good traction on the hillside, or will the surface cause tire slipping?
- Is there a straight path up or down the hill so you won't have to make turning maneuvers?
- Are there obstructions on the hill that can block your path (boulders, trees, logs or ruts)?
- What's beyond the hill? Is there a cliff, an embankment, a drop-off, a fence? Get out and walk the hill if you don't know. It's the smart way to find out.
- Is the hill simply too rough? Steep hills often have ruts, gullies, troughs and exposed rocks because they are more susceptible to the effects of erosion.

## Driving Uphill

Once you decide you can safely drive up the hill, you need to take some special steps.

- Use a low gear and get a firm grip on the steering wheel.
- Get a smooth start up the hill and try to maintain your speed. Don't use more power than you need, because you don't want your wheels to start spinning or sliding.
- Try to drive straight up the hill if at all possible. If the path twists and turns, you might want to find another route.

### CAUTION:

**Turning or driving across steep hills can be dangerous. You could lose traction, slide sideways, and possibly roll over. You could be seriously injured or killed. When driving up hills, always try to go straight up.**

- Ease up on your speed as you approach the top of the hill.

- Attach a flag to the vehicle to make you more visible to approaching traffic on trails or hills.
- Sound the horn as you approach the top of the hill to let opposing traffic know you're there.
- Use your headlamps even during the day. They make you more visible to oncoming traffic.

### CAUTION:

**Driving to the top (crest) of a hill at full speed can cause an accident. There could be a drop-off, embankment, cliff, or even another vehicle. You could be seriously injured or killed. As you near the top of a hill, slow down and stay alert.**

**Q:** What should I do if my vehicle stalls, or is about to stall, and I can't make it up the hill?

**A:** If this happens, there are some things you should do, and there are some things you must not do. First, here's what you *should* do:

- Push the brake pedal to stop the vehicle and keep it from rolling backwards. Also, apply the parking brake.
- If your engine is still running, shift the transmission to REVERSE (R), release the parking brake, and slowly back down the hill in REVERSE (R).
- If your engine has stopped running, you'll need to restart it. With the brake pedal depressed and the parking brake still applied, shift the transmission to PARK (P) and restart the engine. Then, shift to REVERSE (R), release the parking brake, and slowly back down the hill as straight as possible in REVERSE (R).

- As you are backing down the hill, put your left hand on the steering wheel at the 12 o'clock position. This way, you'll be able to tell if your wheels are straight and maneuver as you back down. It's best that you back down the hill with your wheels straight rather than in the left or right direction. Turning the wheel too far to the left or right will increase the possibility of a rollover.

Here are some things you *must not* do if you stall, or are about to stall, when going up a hill.

- Never attempt to prevent a stall by shifting into NEUTRAL (N) to "rev-up" the engine and regain forward momentum. This won't work. Your vehicle will roll backwards very quickly and you could go out of control.  
  
Instead, apply the regular brake to stop the vehicle. Then apply the parking brake. Shift to REVERSE (R), release the parking brake, and slowly back straight down.
- Never attempt to turn around if you are about to stall when going up a hill. If the hill is steep enough to stall your vehicle, it's steep enough to cause you to roll over if you turn around. If you can't make it up the hill, you must back straight down the hill.

**Q:** Suppose, after stalling, I try to back down the hill and decide I just can't do it. What should I do?

**A:** Set the parking brake, put your transmission in PARK (P) and turn off the engine. Leave the vehicle and go get some help. Exit on the uphill side and stay clear of the path the vehicle would take if it rolled downhill. Do not shift the transfer case to NEUTRAL (N) when you leave the vehicle. Leave it in some gear.

 **CAUTION:**

Shifting the transfer case to NEUTRAL (N) can cause your vehicle to roll even if the transmission is in PARK (P). This is because the NEUTRAL (N) position on the transfer case overrides the transmission. If you are going to leave your vehicle, set the parking brake and shift the transmission to PARK (P). But do not shift the transfer case to the NEUTRAL (N) position. Leave the transfer case in the 2 Wheel, 4 High or 4 Low position.

## Driving Downhill

When off-roading takes you downhill, you'll want to consider a number of things:

- How steep is the downhill? Will I be able to maintain vehicle control?
- What's the surface like? Smooth? Rough? Slippery? Hard-packed dirt? Gravel?
- Are there hidden surface obstacles? Ruts? Logs? Boulders?
- What's at the bottom of the hill? Is there a hidden creek bank or even a river bottom with large rocks?

If you decide you can go down a hill safely, then try to keep your vehicle headed straight down, and use a low gear. This way, engine drag can help your brakes and they won't have to do all the work. Descend slowly, keeping your vehicle under control at all times.

 **CAUTION:**

Heavy braking when going down a hill can cause your brakes to overheat and fade. This could cause loss of control and a serious accident. Apply the brakes lightly when descending a hill and use a low gear to keep vehicle speed under control.

**Q:** Are there some things I should not do when driving down a hill?

**A:** Yes! These are important because if you ignore them you could lose control and have a serious accident.

- When driving downhill, avoid turns that take you across the incline of the hill. A hill that's not too steep to drive down may be too steep to drive across. You could roll over if you don't drive straight down.
- Never go downhill with the transmission in NEUTRAL (N). This is called "free-wheeling." Your brakes will have to do all the work and could overheat and fade.

**Q:** Am I likely to stall when going downhill?

**A:** It's much more likely to happen going uphill. But if it happens going downhill, here's what to do.

- Stop your vehicle by applying the regular brakes. Apply the parking brake.
- Shift to PARK (P) and, while still braking, restart the engine.
- Shift back to a low gear, release the parking brake, and drive straight down.
- If the engine won't start, get out and get help.

## Driving Across an Incline

Sooner or later, an off-road trail will probably go across the incline of a hill. If this happens, you have to decide whether to try to drive across the incline. Here are some things to consider:

- A hill that can be driven straight up or down may be too steep to drive across. When you go straight up or down a hill, the length of the wheel base (the distance from the front wheels to the rear wheels) reduces the likelihood the vehicle will tumble end over end. But when you drive across an incline, the much more narrow track width (the distance between the left and right wheels) may not prevent the vehicle from tilting and rolling over. Also, driving across an incline puts more weight on the downhill wheels. This could cause a downhill slide or a rollover.
- Surface conditions can be a problem when you drive across a hill. Loose gravel, muddy spots, or even wet grass can cause your tires to slip sideways, downhill. If the vehicle slips sideways, it can hit something that will trip it (a rock, a rut, etc.) and roll over.

- Hidden obstacles can make the steepness of the incline even worse. If you drive across a rock with the uphill wheels, or if the downhill wheels drop into a rut or depression, your vehicle can tilt even more.

For reasons like these, you need to decide carefully whether to try to drive across an incline. Just because the trail goes across the incline doesn't mean you have to drive it. The last vehicle to try it might have rolled over.



### CAUTION:

**Driving across an incline that's too steep will make your vehicle roll over. You could be seriously injured or killed. If you have any doubt about the steepness of the incline, don't drive across it. Find another route instead.**

**Q:** What if I'm driving across an incline that's not too steep, but I hit some loose gravel and start to slide downhill. What should I do?

**A:** If you feel your vehicle starting to slide sideways, turn downhill. This should help straighten out the vehicle and prevent the side slipping. However, a much better way to prevent this is to get out and "walk the course" so you know what the surface is like before you drive it.

### Stalling on an Incline

If your vehicle stalls when you're crossing an incline, be sure you (and your passengers) get out on the uphill side, even if the door there is harder to open. If you get out on the downhill side and the vehicle starts to roll over, you'll be right in its path.

If you have to walk down the slope, stay out of the path the vehicle will take if it does roll over.



### CAUTION:

Getting out on the downhill (low) side of a vehicle stopped across an incline is dangerous. If the vehicle rolls over, you could be crushed or killed. Always get out on the uphill (high) side of the vehicle and stay well clear of the rollover path.



## Driving in Mud, Sand, Snow or Ice

When you drive in mud, snow or sand, your wheels won't get good traction. You can't accelerate as quickly, turning is more difficult, and you'll need longer braking distances.

It's best to use a low gear when you're in mud -- the deeper the mud, the lower the gear. In really deep mud, the idea is to keep your vehicle moving so you don't get stuck.

When you drive on sand, you'll sense a change in wheel traction. But it will depend upon how loosely packed the sand is. On loosely packed sand (as on beaches or sand dunes) your tires will tend to sink into the sand. This has an effect on steering, accelerating and braking. You may want to reduce the air pressure in your tires slightly when driving on sand. This will improve traction.

Hard packed snow and ice offer the worst tire traction. On these surfaces, it's very easy to lose control. On wet ice, for example, the traction is so poor that you will have difficulty accelerating. And if you do get moving, poor steering and difficult braking can cause you to slide out of control.



### CAUTION:

**Driving on frozen lakes, ponds or rivers can be dangerous. Underwater springs, currents under the ice, or sudden thaws can weaken the ice. Your vehicle could fall through the ice and you and your passengers could drown. Drive your vehicle on safe surfaces only.**

## Driving in Water

Light rain causes no special off-road driving problems. But heavy rain can mean flash flooding, and flood waters demand extreme caution.

Find out how deep the water is before you drive through it. If it's deep enough to cover your wheel hubs, axles or exhaust pipe, don't try it -- you probably won't get through. Also, water that deep can damage your axle and other vehicle parts.

If the water isn't too deep, then drive through it slowly. At fast speeds, water splashes on your ignition system and your vehicle can stall. Stalling can also occur if you get your tailpipe under water. And, as long as your tailpipe is under water, you'll never be able to start your engine. When you go through water, remember that when your brakes get wet, it may take you longer to stop.



### CAUTION:

**Driving through rushing water can be dangerous. Deep water can sweep your vehicle downstream and you and your passengers could drown. If it's only shallow water, it can still wash away the ground from under your tires, and you could lose traction and roll the vehicle over. Don't drive through rushing water.**

See "Driving Through Water" in the Index for more information on driving through water.

## After Off-Road Driving

Remove any brush or debris that has collected on the underbody, chassis or under the hood. These accumulations can be a fire hazard.

After operation in mud or sand, have the brake linings cleaned and checked. These substances can cause glazing and uneven braking. Check the body structure, steering, suspension, wheels, tires and exhaust system for damage. Also, check the fuel lines and cooling system for any leakage.

Your vehicle will require more frequent service due to off-road use. Refer to the Maintenance Schedule for additional information.

## Driving at Night

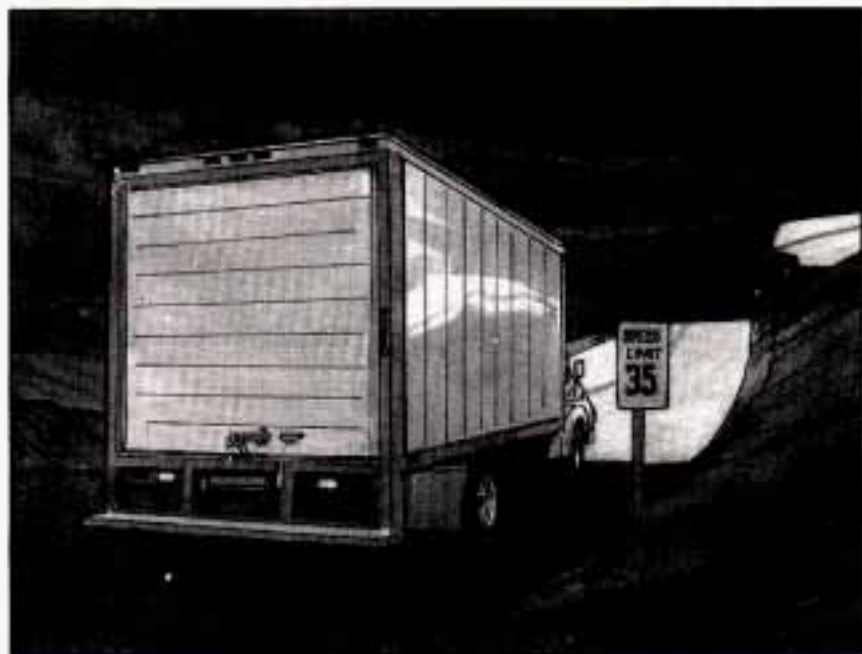

Night driving is more dangerous than day driving. One reason is that some drivers are likely to be impaired -- by alcohol or drugs, with night vision problems, or by fatigue.

Here are some tips on night driving.

- Drive defensively.
- Don't drink and drive.
- Adjust your inside rearview mirror to reduce the glare from headlamps behind you.
- Since you can't see as well, you may need to slow down and keep more space between you and other vehicles.
- Slow down, especially on higher speed roads. Your headlamps can light up only so much road ahead.
- In remote areas, watch for animals.
- If you're tired, pull off the road in a safe place and rest.

## Night Vision

No one can see as well at night as in the daytime. But as we get older these differences increase. A 50-year-old driver may require at least twice as much light to see the same thing at night as a 20-year-old.

What you do in the daytime can also affect your night vision. For example, if you spend the day in bright sunshine you are wise to wear sunglasses. Your eyes will

have less trouble adjusting to night. But if you're driving, don't wear sunglasses at night. They may cut down on glare from headlamps, but they also make a lot of things invisible.

You can be temporarily blinded by approaching headlamps. It can take a second or two, or even several seconds, for your eyes to readjust to the dark. When you are faced with severe glare (as from a driver who doesn't lower the high beams, or a vehicle with misaimed headlamps), slow down a little. Avoid staring directly into the approaching headlamps.

Keep your windshield and all the glass on your vehicle clean -- inside and out. Glare at night is made much worse by dirt on the glass. Even the inside of the glass can build up a film caused by dust. Dirty glass makes lights dazzle and flash more than clean glass would, making the pupils of your eyes contract repeatedly.

Remember that your headlamps light up far less of a roadway when you are in a turn or curve. Keep your eyes moving; that way, it's easier to pick out dimly lighted objects. Just as your headlamps should be checked regularly for proper aim, so should your eyes be examined regularly. Some drivers suffer from night blindness -- the inability to see in dim light -- and aren't even aware of it.

## Driving in Rain and on Wet Roads



Rain and wet roads can mean driving trouble. On a wet road, you can't stop, accelerate or turn as well because your tire-to-road traction isn't as good as on dry roads. And, if your tires don't have much tread left, you'll get even less traction. It's always wise to go slower and be cautious if rain starts to fall while you are driving. The surface may get wet suddenly when your reflexes are tuned for driving on dry pavement.

The heavier the rain, the harder it is to see. Even if your windshield wiper blades are in good shape, a heavy rain can make it harder to see road signs and traffic signals, pavement markings, the edge of the road and even people walking.

It's wise to keep your wiping equipment in good shape and keep your windshield washer tank filled with washer fluid. Replace your windshield wiper inserts when they show signs of streaking or missing areas on the windshield, or when strips of rubber start to separate from the inserts.



Driving too fast through large water puddles or even going through some car washes can cause problems, too. The water may affect your brakes. Try to avoid puddles. But if you can't, try to slow down before you hit them.

**⚠ CAUTION:**

**Wet brakes can cause accidents. They won't work well in a quick stop and may cause pulling to one side. You could lose control of the vehicle.**

**After driving through a large puddle of water or a vehicle wash, apply your brake pedal lightly until your brakes work normally.**

## Hydroplaning

Hydroplaning is dangerous. So much water can build up under your tires that they can actually ride on the water. This can happen if the road is wet enough and you're going fast enough. When your vehicle is hydroplaning, it has little or no contact with the road.

Hydroplaning doesn't happen often. But it can if your tires haven't much tread or if the pressure in one or more is low. It can happen if a lot of water is standing on the road. If you can see reflections from trees, telephone poles or other vehicles, and raindrops "dimple" the water's surface, there could be hydroplaning.

Hydroplaning usually happens at higher speeds. There just isn't a hard and fast rule about hydroplaning. The best advice is to slow down when it is raining.

## Driving Through Deep Standing Water

### **NOTICE:**

**If you drive too quickly through deep puddles or standing water, water can come in through your engine's air intake and badly damage your engine. Never drive through water that is slightly lower than the underbody of your vehicle. If you can't avoid deep puddles or standing water, drive through them very slowly.**

## Some Other Rainy Weather Tips

- Besides slowing down, allow some extra following distance. And be especially careful when you pass another vehicle. Allow yourself more clear room ahead, and be prepared to have your view restricted by road spray.
- Have good tires with proper tread depth. (See "Tires" in the Index.)

## City Driving



One of the biggest problems with city streets is the amount of traffic on them. You'll want to watch out for what the other drivers are doing and pay attention to traffic signals.

Here are ways to increase your safety in city driving:

- Know the best way to get to where you are going. Get a city map and plan your trip into an unknown part of the city just as you would for a cross-country trip.
- Try to use the freeways that rim and crisscross most large cities. You'll save time and energy. (See the next part, "Freeway Driving.")
- Treat a green light as a warning signal. A traffic light is there because the corner is busy enough to need it. When a light turns green, and just before you start to move, check both ways for vehicles that have not cleared the intersection or may be running the red light.



## Freeway Driving

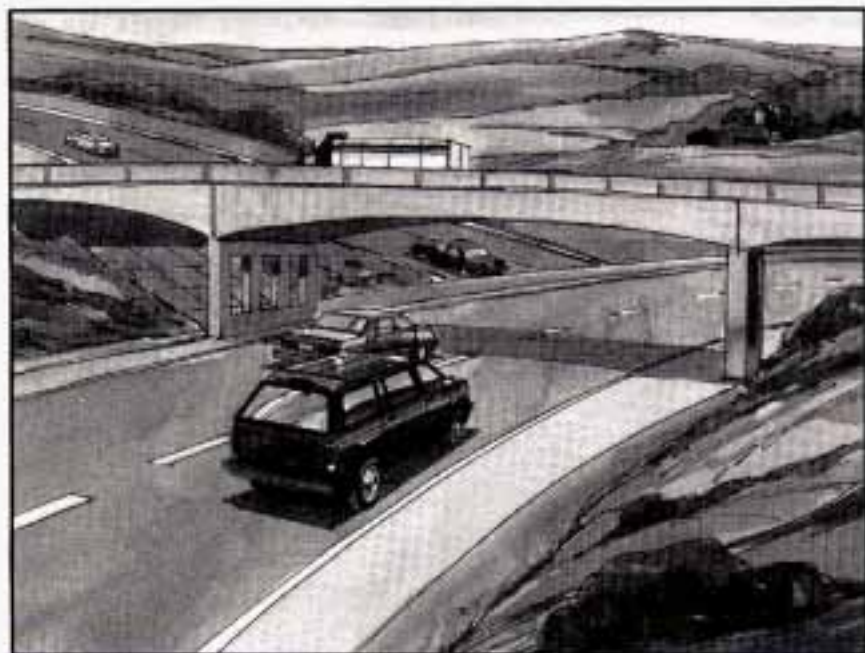

Mile for mile, freeways (also called thruways, parkways, expressways, turnpikes or superhighways) are the safest of all roads. But they have their own special rules.

The most important advice on freeway driving is: Keep up with traffic and keep to the right. Drive at the same speed most of the other drivers are driving. Too-fast or too-slow driving breaks a smooth traffic flow. Treat the left lane on a freeway as a passing lane.

At the entrance, there is usually a ramp that leads to the freeway. If you have a clear view of the freeway as you drive along the entrance ramp, you should begin to check traffic. Try to determine where you expect to blend with the flow. Try to merge into the gap at close to the prevailing speed. Switch on your turn signal, check your mirrors and glance over your shoulder as often as necessary. Try to blend smoothly with the traffic flow.

Once you are on the freeway, adjust your speed to the posted limit or to the prevailing rate if it's slower. Stay in the right lane unless you want to pass.

Before changing lanes, check your mirrors. Then use your turn signal.

Just before you leave the lane, glance quickly over your shoulder to make sure there isn't another vehicle in your "blind" spot.

Once you are moving on the freeway, make certain you allow a reasonable following distance. Expect to move slightly slower at night.

When you want to leave the freeway, move to the proper lane well in advance. If you miss your exit, do not, under any circumstances, stop and back up. Drive on to the next exit.

The exit ramp can be curved, sometimes quite sharply.

The exit speed is usually posted.

Reduce your speed according to your speedometer, not to your sense of motion. After driving for any distance at higher speeds, you may tend to think you are going slower than you actually are.

## Before Leaving on a Long Trip

Make sure you're ready. Try to be well rested. If you must start when you're not fresh -- such as after a day's work -- don't plan to make too many miles that first part of the journey. Wear comfortable clothing and shoes you can easily drive in.

Is your vehicle ready for a long trip? If you keep it serviced and maintained, it's ready to go. If it needs service, have it done before starting out. Of course, you'll find experienced and able service experts in GM dealers all across North America. They'll be ready and willing to help if you need it.

Here are some things you can check before a trip:

- *Windshield Washer Fluid:* Is the reservoir full? Are all windows clean inside and outside?
- *Wiper Blades:* Are they in good shape?
- *Fuel, Engine Oil, Other Fluids:* Have you checked all levels?
- *Lamps:* Are they all working? Are the lenses clean?
- *Tires:* They are vitally important to a safe, trouble-free trip. Is the tread good enough for long-distance driving? Are the tires all inflated to the recommended pressure?
- *Weather Forecasts:* What's the weather outlook along your route? Should you delay your trip a short time to avoid a major storm system?
- *Maps:* Do you have up-to-date maps?

## Highway Hypnosis

Is there actually such a condition as “highway hypnosis”? Or is it just plain falling asleep at the wheel? Call it highway hypnosis, lack of awareness, or whatever.

There is something about an easy stretch of road with the same scenery, along with the hum of the tires on the road, the drone of the engine, and the rush of the wind against the vehicle that can make you sleepy. Don't let it happen to you! If it does, your vehicle can leave the road in *less than a second*, and you could crash and be injured.

What can you do about highway hypnosis? First, be aware that it can happen.

Then here are some tips:

- Make sure your vehicle is well ventilated, with a comfortably cool interior.
- Keep your eyes moving. Scan the road ahead and to the sides. Check your mirrors and your instruments frequently.
- If you get sleepy, pull off the road into a rest, service or parking area and take a nap, get some exercise, or both. For safety, treat drowsiness on the highway as an emergency.

## Hill and Mountain Roads



Driving on steep hills or mountains is different from driving in flat or rolling terrain.

If you drive regularly in steep country, or if you're planning to visit there, here are some tips that can make your trips safer and more enjoyable. (See “Off-Road Driving” in the Index for information about driving off-road.)

- Keep your vehicle in good shape. Check all fluid levels and also the brakes, tires, cooling system and transmission. These parts can work hard on mountain roads.
- Know how to go down hills. The most important thing to know is this: let your engine do some of the slowing down. Shift to a lower gear when you go down a steep or long hill.

 **CAUTION:**

**If you don't shift down, your brakes could get so hot that they wouldn't work well. You would then have poor braking or even none going down a hill. You could crash. Shift down to let your engine assist your brakes on a steep downhill slope.**

 **CAUTION:**

**Coasting downhill in NEUTRAL (N) or with the ignition off is dangerous. Your brakes will have to do all the work of slowing down. They could get so hot that they wouldn't work well. You would then have poor braking or even none going down a hill. You could crash. Always have your engine running and your vehicle in gear when you go downhill.**

- Know how to go uphill. You may want to shift down to a lower gear. The lower gears help cool your engine and transmission, and you can climb the hill better.
- Stay in your own lane when driving on two-lane roads in hills or mountains. Don't swing wide or cut across the center of the road. Drive at speeds that let you stay in your own lane.
- As you go over the top of a hill, be alert. There could be something in your lane, like a stalled car or an accident.
- You may see highway signs on mountains that warn of special problems. Examples are long grades, passing or no-passing zones, a falling rocks area or winding roads. Be alert to these and take appropriate action.

## Winter Driving



Here are some tips for winter driving:

- Have your vehicle in good shape for winter.
- You may want to put winter emergency supplies in your vehicle.

Include an ice scraper, a small brush or broom, a supply of windshield washer fluid, a rag, some winter outer clothing, a small shovel, a flashlight, a red cloth and a couple of reflective warning triangles. And, if you will be driving under severe conditions, include a small bag of sand, a piece of old carpet or a couple of burlap bags to help provide traction. Be sure you properly secure these items in your vehicle.

## Driving on Snow or Ice

Most of the time, those places where your tires meet the road probably have good traction.

However, if there is snow or ice between your tires and the road, you can have a very slippery situation. You'll have a lot less traction or "grip" and will need to be very careful.



What's the worst time for this? "Wet ice." Very cold snow or ice can be slick and hard to drive on. But wet ice can be even more trouble because it may offer the least traction of all. You can get wet ice when it's about freezing (32°F; 0°C) and freezing rain begins to fall. Try to avoid driving on wet ice until salt and sand crews can get there.

Whatever the condition -- smooth ice, packed, blowing or loose snow -- drive with caution.

Accelerate gently. Try not to break the fragile traction. If you accelerate too fast, the drive wheels will spin and polish the surface under the tires even more.

Your anti-lock brakes improve your vehicle's stability when you make a hard stop on a slippery road. Even though you have an anti-lock braking system, you'll want to begin stopping sooner than you would on dry pavement. See "Anti-Lock" in the Index.

- Allow greater following distance on any slippery road.
- Watch for slippery spots. The road might be fine until you hit a spot that's covered with ice. On an otherwise clear road, ice patches may appear in shaded areas where the sun can't reach: around clumps of trees, behind buildings or under bridges. Sometimes the surface of a curve or an overpass may remain icy when the surrounding roads are clear. If you see a patch of ice ahead of you, brake before you are on it. Try not to brake while you're actually on the ice, and avoid sudden steering maneuvers.

## If You're Caught in a Blizzard



If you are stopped by heavy snow, you could be in a serious situation. You should probably stay with your vehicle unless you know for sure that you are near help and you can hike through the snow. Here are some things to do to summon help and keep yourself and your passengers safe:

- Turn on your hazard flashers.

- Tie a red cloth to your vehicle to alert police that you've been stopped by the snow.
- Put on extra clothing or wrap a blanket around you. If you have no blankets or extra clothing, make body insulators from newspapers, burlap bags, rags, floor mats -- anything you can wrap around yourself or tuck under your clothing to keep warm.



You can run the engine to keep warm, but be careful.

**⚠ CAUTION:**

**Snow can trap exhaust gases under your vehicle. This can cause deadly CO (carbon monoxide) gas to get inside. CO could overcome you and kill you. You can't see it or smell it, so you might not know it is in your vehicle. Clear away snow from around the base of your vehicle, especially any that is blocking your exhaust pipe. And check around again from time to time to be sure snow doesn't collect there.**

**Open a window just a little on the side of the vehicle that's away from the wind. This will help keep CO out.**



Run your engine only as long as you must. This saves fuel. When you run the engine, make it go a little faster than just idle. That is, push the accelerator slightly. This uses less fuel for the heat that you get and it keeps the battery (or batteries) charged. You will need a well-charged battery (or batteries) to restart the vehicle, and possibly for signaling later on with your headlamps. Let the heater run for awhile.

If you have a diesel engine, you may have to run it at a higher speed to get enough heat. Then, shut the engine off and close the window almost all the way to preserve the heat. Start the engine again and repeat this only when you feel really uncomfortable from the cold. But do it as little as possible. Preserve the fuel as long as you can. To help keep warm, you can get out of the vehicle and do some fairly vigorous exercises every half hour or so until help comes.

## Loading Your Vehicle

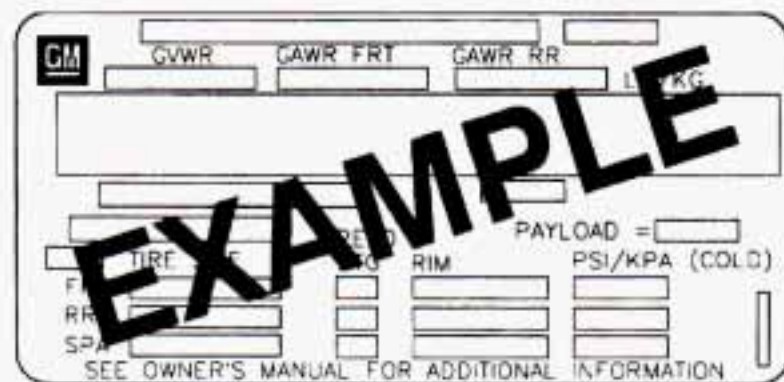

The Certification/Tire label is found on the rear edge of the driver's door.

The label shows the size of your original tires and the inflation pressures needed to obtain the gross weight capacity of your vehicle. This is called the GVWR (Gross Vehicle Weight Rating). The GVWR includes the weight of the vehicle, all occupants, fuel and cargo.

The Certification/Tire label also tells you the maximum weights for the front and rear axles, called Gross Axle Weight Rating (GAWR). To find out the actual loads on your front and rear axles, you need to go to a weigh station and weigh your vehicle. Your dealer can help you with this. Be sure to spread out your load equally on both sides of the centerline.

Never exceed the GVWR for your vehicle, or the GAWR for either the front or rear axle.

And, if you do have a heavy load, you should spread it out.

 **CAUTION:**

**Do not load your vehicle any heavier than the GVWR, or either the maximum front or rear GAWR. If you do, parts on your vehicle can break, or it can change the way your vehicle handles. These could cause you to lose control. Also, overloading can shorten the life of your vehicle.**

Using heavier suspension components to get added durability might not change your weight ratings. Ask your dealer to help you load your vehicle the right way.

**NOTICE:**

**Your warranty does not cover parts or components that fail because of overloading.**

If you put things inside your vehicle -- like suitcases, tools, packages, or anything else -- they go as fast as the vehicle goes. If you have to stop or turn quickly, or if there is a crash, they'll keep going.



## **CAUTION:**

Things you put inside your vehicle can strike and injure people in a sudden stop or turn, or in a crash.

- Put things in the cargo area of your vehicle. Try to spread the weight evenly.
- Never stack heavier things, like suitcases, inside the vehicle so that some of them are above the tops of the seats.
- Don't leave an unsecured child restraint in your vehicle.
- When you carry something inside the vehicle, secure it whenever you can.
- Don't leave a seat folded down unless you need to.

There's also important loading information for off-road driving in this manual. See "Loading Your Vehicle" in the Index.

## **Towing a Trailer**



## **CAUTION:**

If you don't use the correct equipment and drive properly, you can lose control when you pull a trailer. For example, if the trailer is too heavy, the brakes may not work well -- or even at all. You and your passengers could be seriously injured. Pull a trailer only if you have followed all the steps in this section. Ask your GM dealer for advice and information about towing a trailer with your vehicle.

## **NOTICE:**

**Pulling a trailer improperly can damage your vehicle and result in costly repairs not covered by your warranty. To pull a trailer correctly, follow the advice in this part, and see your GM dealer for important information about towing a trailer with your vehicle.**

Every vehicle is ready for some trailer towing. If yours was built with trailering options, as many are, it's ready for heavier trailers. But trailering is different than just driving your vehicle by itself. Trailering means changes in handling, durability and fuel economy. Successful, safe trailering takes correct equipment, and it has to be used properly.

That's the reason for this part. In it are many time-tested, important trailering tips and safety rules. Many of these are important for your safety and that of your passengers. So please read this section carefully before you pull a trailer.

## If You Do Decide To Pull A Trailer

If you do, here are some important points:

- There are many different laws, including speed limit restrictions, having to do with trailering. Make sure your rig will be legal, not only where you live but also where you'll be driving. A good source for this information can be state or provincial police.
- Consider using a sway control if your trailer will weigh 4,000 lbs. (1 800 kg) or less. You should always use a sway control if your trailer will weigh more than 4,000 lbs. (1 800 kg). You can ask a hitch dealer about sway controls.
- Don't tow a trailer at all during the first 500 miles (800 km) your new vehicle is driven. Your engine, axle or other parts could be damaged.
- Then, during the first 500 miles (800 km) that you tow a trailer, don't drive over 50 mph (80 km/h) and don't make starts at full throttle. This helps your engine and other parts of your vehicle wear in at the heavier loads.
- If you have an automatic transmission, you can tow in OVERDRIVE (OD). You may want to shift the transmission to DRIVE (D) or, if necessary, a lower gear selection if the transmission shifts too often (e.g., under heavy loads and/or hilly conditions).

Three important considerations have to do with weight: the weight of the trailer, the weight of the trailer tongue and the weight on your vehicle's tires.

## Weight of the Trailer

How heavy can a trailer safely be?

It depends on how you plan to use your rig. For example, speed, altitude, road grades, outside temperature and how much your vehicle is used to pull a trailer are all important. And, it can also depend on any special equipment that you have on your vehicle.

Use the following chart to determine how much your vehicle can weigh, based upon your vehicle model and options.

Maximum trailer weight is calculated assuming the driver and one passenger are in the tow vehicle and it has all the required trailering equipment. The weight of additional optional equipment, passengers and cargo in the tow vehicle must be subtracted from the maximum trailer weight.

Above the 2,000 lbs. (908 kg) trailer rating, the engine oil cooler is required on C/K-1500 models with 5.7L engine and C/K-2500 Suburban models with 5.7L engine and 3.73 axle ratio.

<b>Vehicle</b>	<b>Axle Ratio</b>	<b>Max. Trailer Wt.</b>
C-1500 (2WD) Utility	3.08	5,000 lbs. (2 270 kg)
	3.42	6,000 lbs. (2 724 kg)
	3.73	7,000 lbs. (3 178 kg)
K-1500 (4WD) Utility	3.42	5,500 lbs. (2 497 kg)
	3.73	6,500 lbs. (2 951 kg)
C-1500 (2WD) Suburban	3.42	5,500 lbs. (2 497 kg)
	3.73	6,500 lbs. (2 951 kg)
K-1500 (4WD) Suburban	3.73	5,000 lbs. (2 270 kg)
	3.73	6,000 lbs. (2 724 kg)
C-2500 (2WD) Suburban	3.73	6,000 lbs. (2 724 kg)
	4.10	7,500 lbs. (3 405 kg)
K-2500 (4WD) Suburban	4.10	7,000 lbs. (3 178 kg)

You can ask your dealer for our trailering information or advice, or you can write us at the address listed in your Warranty and Owner Assistance Information Booklet.

In Canada, write to:

General Motors of Canada Limited  
Customer Assistance Center  
1908 Colonel Sam Drive  
Oshawa, Ontario L1H 8P7

## Weight of the Trailer Tongue

The tongue load (A) of any trailer is an important weight to measure because it affects the total or gross weight of your vehicle. The Gross Vehicle Weight (GVW) includes the curb weight of the vehicle, any cargo you may carry in it, and the people who will be riding in the vehicle. And if you will tow a trailer, you must add the tongue load to the GVW because your vehicle will be carrying that weight, too. See “Loading Your Vehicle” in the Index for more information about your vehicle’s maximum load capacity.

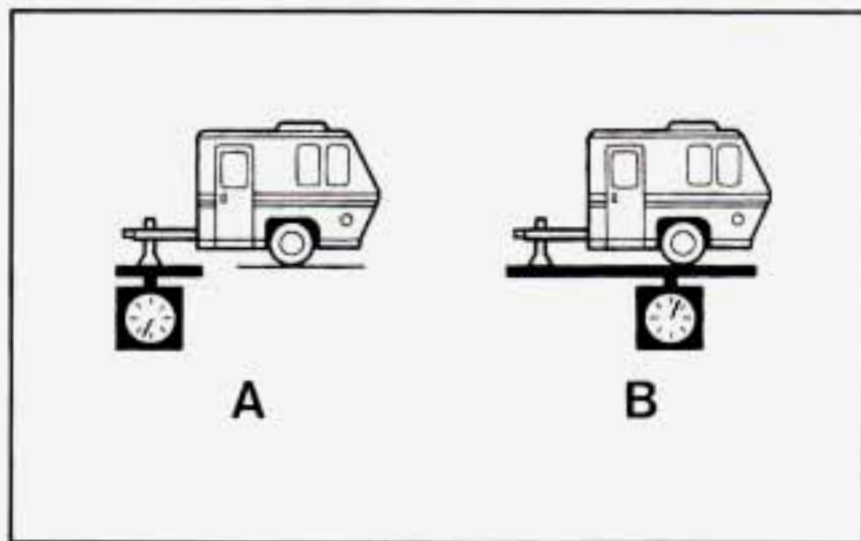

If you’re using a weight-carrying hitch, the trailer tongue (A) should weigh 10 percent of the total loaded trailer weight (B). If you’re using a weight-distributing hitch, the trailer tongue (A) should weigh 12 percent of the total loaded trailer weight (B).

After you’ve loaded your trailer, weigh the trailer and then the tongue, separately, to see if the weights are proper. If they aren’t, you may be able to get them right simply by moving some items around in the trailer.

## Total Weight on Your Vehicle’s Tires

Be sure your vehicle’s tires are inflated to the limit for cold tires. You’ll find these numbers on the Certification label at the rear edge of the driver’s door or see “Tire Loading” in the Index. Then be sure you don’t go over the GVW limit for your vehicle, including the weight of the trailer tongue.

## Hitches

It's important to have the correct hitch equipment. Crosswinds, large trucks going by and rough roads are a few reasons why you'll need the right hitch. Here are some rules to follow:

- If you use a step-bumper hitch, your bumper could be damaged in sharp turns. Make sure you have ample room when turning to avoid contact between the trailer and the bumper.
- If you'll be pulling a trailer that, when loaded, will weigh more than 4,000 lbs. (1 800 kg), be sure to use a properly mounted, weight-distributing hitch and sway control of the proper size. This equipment is very important for proper vehicle loading and good handling when you're driving.
- Will you have to make any holes in the body of your vehicle when you install a trailer hitch?

If you do, then be sure to seal the holes later when you remove the hitch. If you don't seal them, deadly carbon monoxide (CO) from your exhaust can get into your vehicle (see "Carbon Monoxide" in the Index). Dirt and water can, too.

## Safety Chains

You should always attach chains between your vehicle and your trailer. Cross the safety chains under the tongue of the trailer so that the tongue will not drop to the road if it becomes separated from the hitch. Instructions about safety chains may be provided by the hitch manufacturer or by the trailer manufacturer. Follow the manufacturer's recommendation for attaching safety chains and do not attach them to the bumper. Always leave just enough slack so you can turn with your rig. And, never allow safety chains to drag on the ground.



## Trailer Brakes

If your trailer weighs more than 1,000 lbs. (450 kg) loaded, then it needs its own brakes -- and they must be adequate. Be sure to read and follow the instructions for the trailer brakes so you'll be able to install, adjust and maintain them properly.

Your trailer brake system can tap into the vehicle's hydraulic brake system only if:

- The trailer parts can withstand 3,000 psi (20 650 kPa) of pressure.
- The trailer's brake system will use less than 0.02 cubic inch (0.3 cc) of fluid from your vehicle's master cylinder. Otherwise, both braking systems won't work well. You could even lose your brakes.

If everything checks out this far, make the brake tap at the port on the master cylinder that sends the fluid to the rear brakes. But don't use copper tubing for this. If you do, it will bend and finally break off. Use steel brake tubing.

## Driving with a Trailer

### CAUTION:

**If you have a rear-most window open and you pull a trailer with your vehicle, carbon monoxide (CO) could come into your vehicle. You can't see or smell CO. It can cause unconsciousness or death. (See "Engine Exhaust" in the Index.) To maximize your safety when towing a trailer:**

- **Have your exhaust system inspected for leaks, and make necessary repairs before starting on your trip.**
- **Keep the rear-most windows closed.**
- **If exhaust does come into your vehicle through a window in the rear or another opening, drive with your front, main heating or cooling system on and with the fan on any speed. This will bring fresh, outside air into your vehicle. Do not use MAX because it only recirculates the air inside your vehicle. (See "Comfort Controls" in the Index.)**

Towing a trailer requires a certain amount of experience. Before setting out for the open road, you'll want to get to know your rig. Acquaint yourself with the feel of handling and braking with the added weight of the trailer. And always keep in mind that the vehicle you are driving is now a good deal longer and not nearly as responsive as your vehicle is by itself.

Before you start, check the trailer hitch and platform (and attachments), safety chains, electrical connector, lamps, tires and mirror adjustment. If the trailer has electric brakes, start your vehicle and trailer moving and then apply the trailer brake controller by hand to be sure the brakes are working. This lets you check your electrical connection at the same time.

During your trip, check occasionally to be sure that the load is secure, and that the lamps and any trailer brakes are still working.

## **Following Distance**

Stay at least twice as far behind the vehicle ahead as you would when driving your vehicle without a trailer. This can help you avoid situations that require heavy braking and sudden turns.

## **Passing**

You'll need more passing distance up ahead when you're towing a trailer. And, because you're a good deal longer, you'll need to go much farther beyond the passed vehicle before you can return to your lane.

## **Backing Up**

Hold the bottom of the steering wheel with one hand. Then, to move the trailer to the left, just move that hand to the left. To move the trailer to the right, move your hand to the right. Always back up slowly and, if possible, have someone guide you.

## Making Turns

### NOTICE:

**Making very sharp turns while trailering could cause the trailer to come in contact with the vehicle. Your vehicle could be damaged. Avoid making very sharp turns while trailering.**

When you're turning with a trailer, make wider turns than normal. Do this so your trailer won't strike soft shoulders, curbs, road signs, trees or other objects. Avoid jerky or sudden maneuvers. Signal well in advance.

## Turn Signals When Towing a Trailer

The green arrows on your instrument panel will flash whenever you signal a turn or lane change. Properly hooked up, the trailer lamps will also flash, telling other drivers you're about to turn, change lanes or stop.

When towing a trailer, the green arrows on your instrument panel will flash for turns even if the bulbs on the trailer are burned out. Thus, you may think drivers behind you are seeing your signal when they are not. It's important to check occasionally to be sure the trailer bulbs are still working.

## Driving On Grades

Reduce speed and shift to a lower gear *before* you start down a long or steep downgrade. If you don't shift down, you might have to use your brakes so much that they would get hot and no longer work well.

On a long uphill grade, shift down and reduce your speed to around 45 mph (70 km/h) to reduce the possibility of engine and transmission overheating.

If you have an automatic transmission you should use THIRD (3) (or, as you need to, a lower gear) when towing a trailer. Operating your vehicle in THIRD (3) when towing a trailer will minimize heat buildup and extend the life of your transmission.

When towing at high altitude on steep uphill grades, consider the following: Engine coolant will boil at a lower temperature than at normal altitudes. If you turn your engine off immediately after towing at high altitude on steep uphill grades, your vehicle may show signs similar to engine overheating. To avoid this, let the engine run while parked (preferably on level ground) with the automatic transmission in PARK (P) for a few minutes before turning the engine off. If you do get the overheat warning, see "Engine Overheating" in the Index.

## Parking on Hills

You really should not park your vehicle, with a trailer attached, on a hill. If something goes wrong, your rig could start to move. People can be injured, and both your vehicle and the trailer can be damaged.

But if you ever have to park your rig on a hill, here's how to do it:

1. Apply your regular brakes, but don't shift into PARK (P) yet.
2. Have someone place chocks under the trailer wheels.
3. When the wheel chocks are in place, release the regular brakes until the chocks absorb the load.
4. Reapply the regular brakes. Then apply your parking brake, and then shift to PARK (P).
5. If you have a four-wheel-drive vehicle, be sure the transfer case is in a drive gear -- not in NEUTRAL (N).
6. Release the regular brakes.



### CAUTION:

**It can be dangerous to get out of your vehicle if the shift lever is not fully in PARK (P) with the parking brake firmly set. Your vehicle can roll. If you have left the engine running, the vehicle can move suddenly. You or others could be injured. To be sure your vehicle won't move, even when you're on fairly level ground, use the steps that follow.**

**If you have four-wheel drive and your transfer case is in NEUTRAL (N), your vehicle will be free to roll, even if your shift lever is in PARK (P). So, be sure the transfer case is in a drive gear -- not in NEUTRAL (N).**

## When You Are Ready to Leave After Parking on a Hill

1. Apply your regular brakes and hold the pedal down while you:
  - Start your engine;
  - Shift into a gear; and
  - Release the parking brake.
2. Let up on the brake pedal.
3. Drive slowly until the trailer is clear of the chocks.
4. Stop and have someone pick up and store the chocks.

## Maintenance When Trailer Towing

Your vehicle will need service more often when you're pulling a trailer. See the Maintenance Schedule for more on this. Things that are especially important in trailer operation are automatic transmission fluid (don't overfill), engine oil, axle lubricant, belt, cooling system and brake adjustment. Each of these is covered in this manual, and the Index will help you find them quickly. If you're trailering, it's a good idea to review these sections before you start your trip.

Check periodically to see that all hitch nuts and bolts are tight.

## Trailer Wiring Harness

A seven-wire harness is stored under the rear of your vehicle, between the frame rails. An electrical connector will need to be added at the trailer end of the harness, by a qualified electrical technician. For additional trailer wiring and towing information, please consult your dealer. Securely attach the harness to the trailer, then tape or strap it to your vehicle's frame rail. Be sure you leave it loose enough so the wiring won't bind or break when turning with the trailer, but not so loose that it drags on the ground. Store the harness in its original position. Wrap the harness together and tie it neatly so it won't be damaged. If you tow a trailer, your Center High-Mounted Stoplamp (CHMSL) may not be properly visible from behind. You should select a trailer with a CHMSL on it or, if one is not available, have one installed. See your GM dealer about how to connect your vehicle's wiring to a trailer CHMSL.

## Power Winches

If you wish to use a power winch on your vehicle, only use it when your vehicle is stationary or anchored.

### **NOTICE:**

**Using a power winch with the transmission in gear may damage the transmission. When operating a power winch, always leave the transmission in NEUTRAL (N).**

Use the regular brakes, set the parking brake, or block the wheels to keep your vehicle from rolling.

## Power Take-Off (PTO)

### **NOTICE:**

**If you have a PTO that will exceed 35 hp installed on your vehicle, it could damage the transfer case or transmission. When having a PTO installed on your vehicle, make sure that it will not exceed 35 hp.**

Before using a PTO, refer to the manufacturer's or installer's instructions.

### **NOTICE:**

**Using a PTO while operating in one place before the vehicle has reached normal operating temperature can damage the transfer case or transmission. If you will be using the PTO while operating in one place, drive and warm up the vehicle before using the PTO.**

To engage a PTO:

1. Set the parking brake.
2. Shift the transmission into NEUTRAL (N).
3. Hold the clutch pedal down and engage the PTO.

## **NOTICE:**

**Using a PTO for more than four hours without driving your vehicle can damage the transfer case or transmission. If using a PTO for more than four hours without driving your vehicle, drive your vehicle for a while to allow the transfer case and transmission to cool.**

If you are going to drive the vehicle, shift the transmission into the gear you want. Then shift the transfer case into the range you want (if you have four-wheel drive), apply the regular brakes and release the parking brake.

4. Release the clutch (and the regular brakes) as you normally would. When you release the clutch, the PTO will start.

## **Using a Transfer Case Mounted PTO**

1. Set the parking brake.
2. Shift the transfer case into NEUTRAL (N).
3. Shift the transmission into NEUTRAL (N).
4. Engage the PTO.

If you are going to drive the vehicle, shift the transfer case into the range you want. Then apply the regular brakes and release the parking brake.

5. Shift the transmission to THIRD (3) to start the PTO.
6. Release the regular brakes to drive the vehicle.

## Step-Bumper Pad

If your vehicle has a rear step bumper, it may be equipped with a rear step pad at the center of the bumper.



If you will be using the bumper to tow a trailer, you must remove the center cutout circle to install the trailer ball. You must also remove both outer cutouts to attach the trailer safety chains.



To remove the pad, lift the edge of the pad from the rear of the bumper and swing it forward. When the pad releases from the bumper holes, lift the pad off.



## Section 5 Problems On The Road

Here you'll find what to do about some problems that can occur on the road.

### Hazard Warning Flashers



Your hazard warning flashers let you warn others. They also let police know you have a problem. Your front and rear turn signal lamps will flash on and off.

But they won't flash if you're braking.



Press the button at the top of the steering column all the way down to make your front and rear turn signal lamps flash on and off.

Your hazard warning flashers work no matter what position your key is in, and even if the key isn't in.

To turn off the flashers, push the button until the first click and release.

When the hazard warning flashers are on, your turn signals won't work.

## Other Warning Devices

If you carry reflective triangles, you can set one up at the side of the road about 300 feet (100 m) behind your vehicle.

## Jump Starting

If your battery (or batteries) has run down, you may want to use another vehicle and some jumper cables to start your vehicle. But please use the following steps to do it safely.

### CAUTION:

**Batteries can hurt you. They can be dangerous because:**

- They contain acid that can burn you.
- They contain gas that can explode or ignite.
- They contain enough electricity to burn you.

**If you don't follow these steps exactly, some or all of these things can hurt you.**

### NOTICE:

**Ignoring these steps could result in costly damage to your vehicle that wouldn't be covered by your vehicle warranty.**

**Trying to start your vehicle by pushing or pulling it could damage your vehicle. With an automatic transmission, it won't start that way.**

1. Get the vehicles close enough so the jumper cables can reach, but be sure the vehicle's aren't touching each other. If they are, it could cause a ground connection you don't want. You wouldn't be able to start your vehicle, and the bad grounding could damage the electrical systems.

To avoid the possibility of the vehicles rolling, set the parking brake firmly on both vehicles involved in the jump start procedure. Put an automatic transmission in PARK (P). If you have a four-wheel-drive vehicle, be sure the transfer case is not in NEUTRAL (N).

2. Turn off the ignition on both vehicles. Turn off all lamps that aren't needed, and radios. This will avoid sparks and help save both batteries. And it could save your radio!

### **NOTICE:**

**If you leave your radio on, it could be badly damaged. The repairs wouldn't be covered by your warranty.**

3. Open the hoods and locate the batteries. Find the positive (+) and negative (-) terminals on each battery.

### **CAUTION:**

**If your vehicle has air conditioning, the auxiliary electric fan under the hood can start up even when the engine is not running and can injure you. Keep hands, clothing and tools away from any underhood electric fan.**

### **CAUTION:**

**Using a match near a battery can cause battery gas to explode. People have been hurt doing this, and some have been blinded. Use a flashlight if you need more light.**

**Be sure the batteries have enough water. You don't need to add water to the Delco Freedom<sup>®</sup> battery (or batteries) installed in every new GM vehicle. But if a battery has filler caps, be sure the right amount of fluid is there. If it is low, add water to take care of that first. If you don't, explosive gas could be present.**

**Battery fluid contains acid that can burn you. Don't get it on you. If you accidentally get it in your eyes or on your skin, flush the place with water and get medical help immediately.**

4. Check that the jumper cables don't have loose or missing insulation. If they do, you could get a shock. The vehicles could be damaged, too.

Before you connect the cables, here are some basic things you should know. Positive (+) will go to positive (+) and negative (-) will go to negative (-) or a metal engine part. Don't connect positive (+) to negative (-) or you'll get a short that would damage the battery and maybe other parts, too.

**⚠ CAUTION:**

Fans or other moving engine parts can injure you badly. Keep your hands away from moving parts once the engines are running.

5. Connect the red positive (+) cable to the positive (+) terminal of the vehicle with the dead battery. Use a remote positive (+) terminal if the vehicle has one.

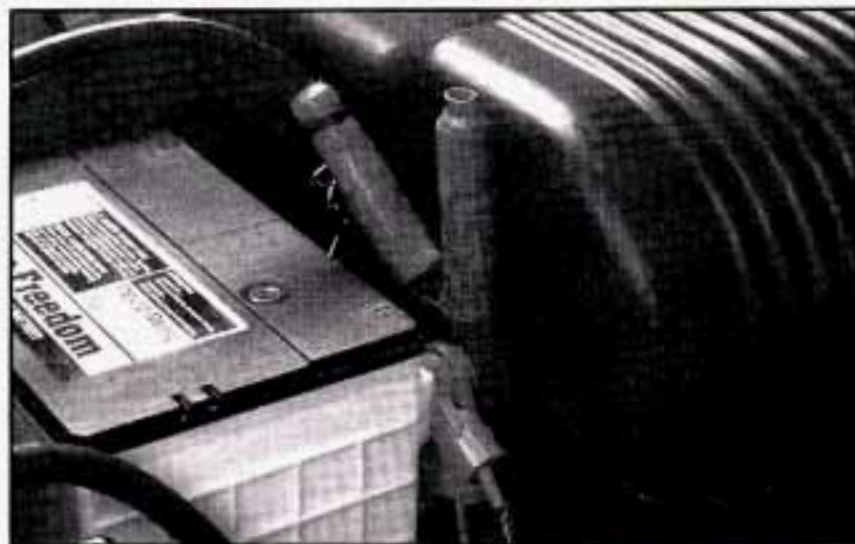



6. Don't let the other end touch metal. Connect it to the positive (+) terminal of the good battery. Use a remote positive (+) terminal if the vehicle has one.



7. Now connect the black negative (-) cable to the good battery's negative (-) cable.

Don't let the other end touch anything until the next step. The other end of the negative (-) cable doesn't go to the dead battery.

It goes to a heavy unpainted metal part of the vehicle with the dead battery.



8. Attach the cable at least 18 inches (45 cm) away from the dead battery, but not near engine parts that move. The electrical connection is just as good there, but the chance of sparks getting back to the battery is much less.
9. Now start the vehicle with the good battery and run the engine for a while.
10. Try to start the vehicle with the dead battery. If it won't start after a few tries, it probably needs service.

11. Remove the cables in reverse order to prevent electrical shorting. Take care that they don't touch each other or any other metal.

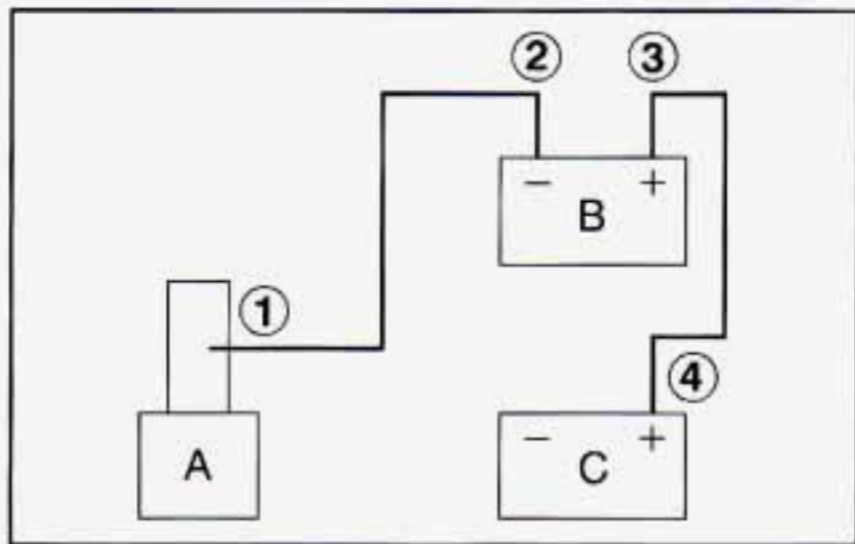

- A. Heavy Metal Engine Part  
B. Good Battery  
C. Dead Battery

## Towing Your Vehicle

Try to have your GM dealer or a professional towing service tow your vehicle. See "Roadside Assistance" in the Index. They can provide the right equipment and know how to tow it without damage.

If your vehicle has been changed since it was factory-new, by adding such things as fog lamps, aero skirting, or special tires and wheels, these things could be damaged during towing.

Before you do anything, turn on the hazard warning flashers.

When you call, tell the towing service:

- That your vehicle has rear-wheel drive, or that it has the four-wheel-drive option.
- The make, model and year of your vehicle.
- Whether you can move the shift lever for the transmission and transfer case, if you have one.
- If there was an accident, what was damaged.

When the towing service arrives, let the tow operator know that this manual contains these towing instructions. The operator may want to see them.

 **CAUTION:**

To help avoid injury to you or others:

- Never let passengers ride in a vehicle that is being towed.
- Never tow faster than safe or posted speeds.
- Never tow with damaged parts not fully secured.
- Never get under your vehicle after it has been lifted by the tow truck.
- Always use separate safety chains on each side when towing a vehicle.

 **CAUTION:**

**A vehicle can fall from a car carrier if it isn't adequately secured. This can cause a collision, serious personal injury and vehicle damage. The vehicle should be tightly secured with chains or steel cables before it is transported.**

**Don't use substitutes (ropes, leather straps, canvas webbing, etc.) that can be cut by sharp edges underneath the towed vehicle.**

When your vehicle is being towed, have the ignition key in the off position. The steering wheel should be clamped in a straight-ahead position, with a clamping device designed for towing service. Do not use the vehicle's steering column lock for this. The transmission and transfer case, if you have one, should be in NEUTRAL (N) and the parking brake released.

Don't have your vehicle towed on the drive wheels unless you must. If the vehicle must be towed on the drive wheels, be sure to follow the speed and distance restrictions later in this section or your transmission will be damaged. If these limitations must be exceeded, then the drive wheels have to be supported on a dolly.

## Towing From the Front

*Tow Limits -- 35 mph (56 km/h), 50 miles (80 km)*

*If these limits must be exceeded, then the rear wheels have to be supported on a dolly.*

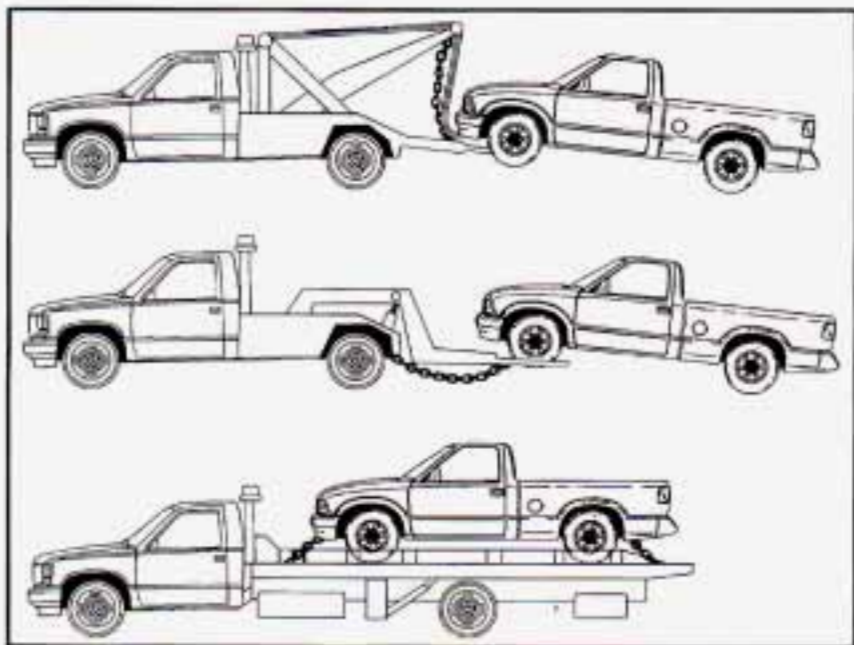

## Towing From the Rear

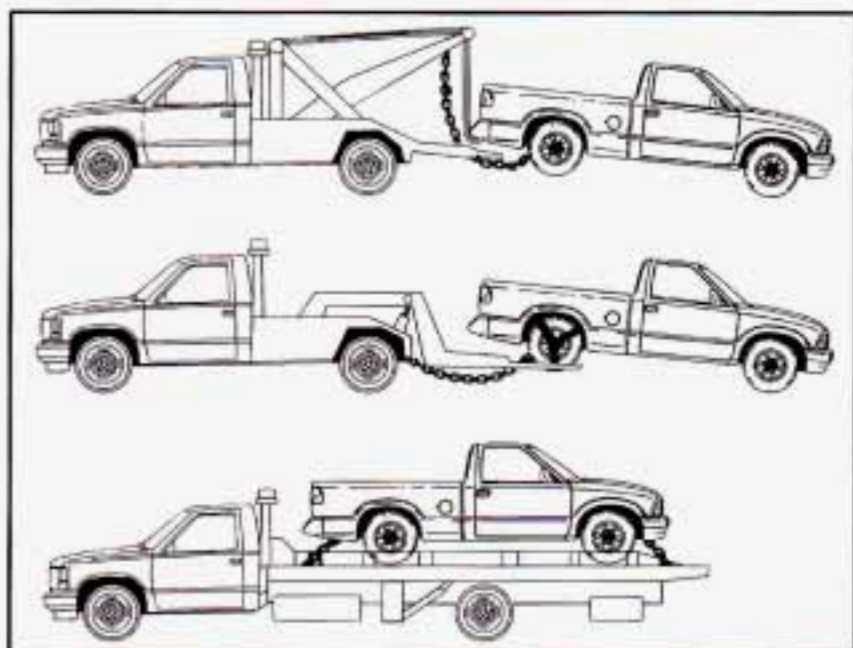



## Engine Overheating (Gasoline Engine)

You will find a coolant temperature gage on your vehicle's instrument panel. If your vehicle has a diesel engine, see "Engine Overheating" in the Diesel Engine Supplement.

### If Steam Is Coming From Your Engine



### CAUTION:

Steam from an overheated engine can burn you badly, even if you just open the hood. Stay away from the engine if you see or hear steam coming from it. Just turn it off and get everyone away from the vehicle until it cools down. Wait until there is no sign of steam or coolant before opening the hood.

If you keep driving when your engine is overheated, the liquids in it can catch fire. You or others could be badly burned. Stop your engine if it overheats, and get out of the vehicle until the engine is cool.

### NOTICE:

If your engine catches fire because you keep driving with no coolant, your vehicle can be badly damaged. The costly repairs would not be covered by your warranty.

## If No Steam Is Coming From Your Engine

If you get the overheat warning but see or hear no steam, the problem may not be too serious. Sometimes the engine can get a little too hot when you:

- Climb a long hill on a hot day.
- Stop after high-speed driving.
- Idle for long periods in traffic.
- Tow a trailer. See “Driving on Grades” in the Index.

If you get the overheat warning with no sign of steam, try this for a minute or so:

1. If you have an air conditioner, turn it off.
2. Turn on your heater to full hot at the highest fan speed and open the window as necessary.
3. If you're in a traffic jam, shift to NEUTRAL (N); otherwise, shift to the highest gear while driving -- AUTOMATIC OVERDRIVE (Ⓢ) or DRIVE (3) for automatic transmissions.

If you no longer have the overheat warning, you can drive. Just to be safe, drive slower for about 10 minutes. If the warning doesn't come back on, you can drive normally.

If the warning continues, pull over, stop, and park your vehicle right away.

If there's still no sign of steam, push the accelerator until the engine speed is about twice as fast as normal idle speed. Bring the engine speed back to normal idle speed after two or three minutes. Now see if the warning stops. But then, if you still have the warning, *turn off the engine and get everyone out of the vehicle* until it cools down.

You may decide not to lift the hood but to get service help right away.

## Cooling System -- Gasoline Engines

When you decide it's safe to lift the hood, here's what you'll see:



- A. Coolant Recovery Tank
- B. Radiator Pressure Cap
- C. Engine Fan(s)

### CAUTION:

If your vehicle has air conditioning, the auxiliary electric fan under the hood can start up even when the engine is not running and can injure you. Keep hands, clothing and tools away from any underhood electric fan.

If the coolant inside the coolant recovery tank is boiling, don't do anything else until it cools down.

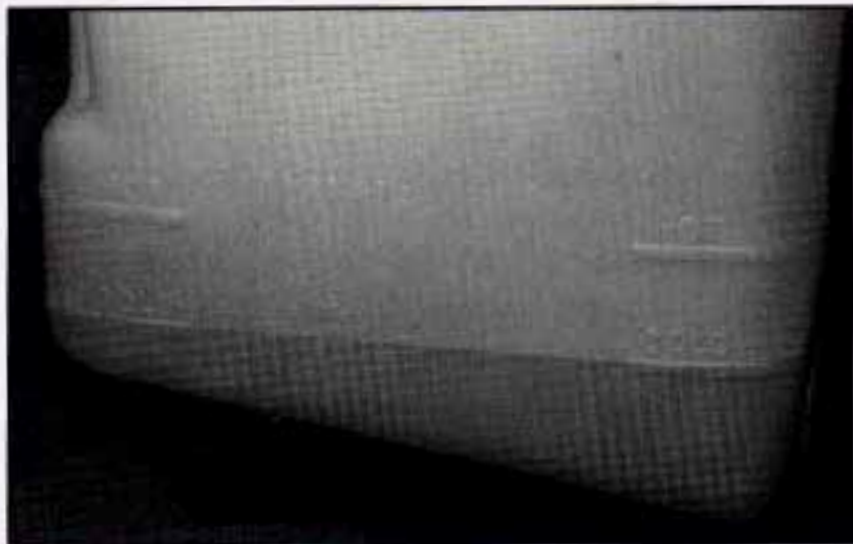

The coolant level should be at or above the COLD mark. If it isn't, you may have a leak in the radiator hoses, heater hoses, radiator, water pump or somewhere else in the cooling system.

**⚠ CAUTION:**

**Heater and radiator hoses, and other engine parts, can be very hot. Don't touch them. If you do, you can be burned.**

**Don't run the engine if there is a leak. If you run the engine, it could lose all coolant. That could cause an engine fire, and you could be burned. Get any leak fixed before you drive the vehicle.**

**NOTICE:**

**Engine damage from running your engine without coolant isn't covered by your warranty.**

If there seems to be no leak, start the engine again. See if the fan speed increases when idle speed is doubled by pushing the accelerator pedal down. If it doesn't, your vehicle needs service. Turn off the engine.

## How to Add Coolant to the Coolant Recovery Tank

If you haven't found a problem yet, but the coolant level isn't at or above the COLD mark, add a 50/50 mixture of *clean water* (preferably distilled) and DEX-COOL™ (orange-colored, silicate-free) antifreeze at the coolant recovery tank. (See "Engine Coolant" in the Index for more information.)



### CAUTION:

**Adding only plain water to your cooling system can be dangerous. Plain water, or some other liquid like alcohol, can boil before the proper coolant mix will. Your vehicle's coolant warning system is set for the proper coolant mix. With plain water or the wrong mix, your engine could get too hot but you wouldn't get the overheat warning. Your engine could catch fire and you or others could be burned. Use a 50/50 mix of clean water and DEX-COOL™ antifreeze.**

### NOTICE:

**In cold weather, water can freeze and crack the engine, radiator, heater core and other parts. Use the recommended coolant and the proper coolant mix.**



**⚠ CAUTION:**

**You can be burned if you spill coolant on hot engine parts. Coolant contains ethylene glycol and it will burn if the engine parts are hot enough. Don't spill coolant on a hot engine.**

When the coolant in the coolant recovery tank is at or above the COLD mark, start your vehicle.

If the overheat warning continues, there's one more thing you can try. You can add the proper coolant mix directly to the radiator, but be sure the cooling system is cool before you do it.

**⚠ CAUTION:**

Steam and scalding liquids from a hot cooling system can blow out and burn you badly. They are under pressure, and if you turn the radiator pressure cap -- even a little -- they can come out at high speed. Never turn the cap when the cooling system, including the radiator pressure cap, is hot. Wait for the cooling system and radiator pressure cap to cool if you ever have to turn the pressure cap.

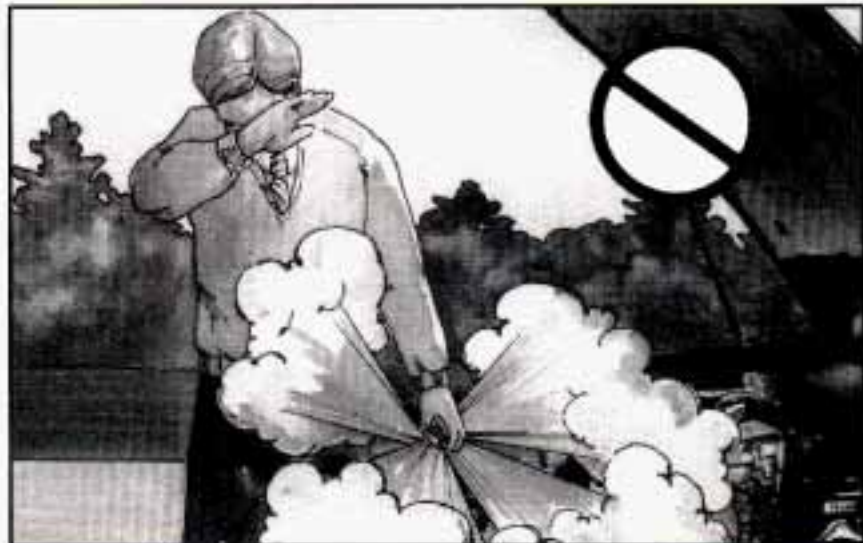







3. Fill the radiator with the proper mix, up to the base of the filler neck.



4. Then fill the coolant recovery tank to the COLD mark.
5. Put the cap back on the coolant recovery tank, but leave the radiator pressure cap off.



6. Start the engine and let it run until you can feel the upper radiator hose getting hot. Watch out for the engine fan(s).

7. By this time the coolant level inside the radiator filler neck may be lower. If the level is lower, add more of the proper mix through the filler neck until the level reaches the base of the filler neck.

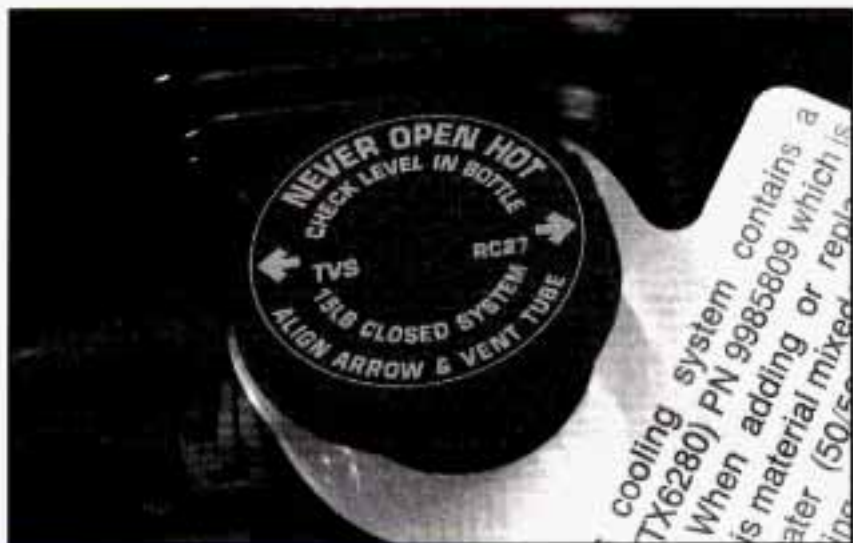

8. Then replace the pressure cap. At any time during this procedure if coolant begins to flow out of the filler neck, reinstall the pressure cap. Be sure the arrows on the pressure cap line up like this.

## Engine Fan Noise

Your vehicle has a clutched engine cooling fan. When the clutch is engaged, the fan spins faster to provide more air to cool the engine. In most every day driving conditions, the fan is spinning slower and the clutch is not fully engaged. This improves fuel economy and reduces fan noise. Under heavy vehicle loading, trailer towing and/or high outside temperatures, the fan speed increases as the clutch more fully engages. So you may hear an increase in fan noise. This is normal and should not be mistaken as the transmission slipping or making extra shifts. It is merely the cooling system functioning properly. The fan will slow down when additional cooling is not required and the clutch disengages.

You may also hear this fan noise when you start the engine. It will go away as the fan clutch partially disengages.

## If a Tire Goes Flat

It's unusual for a tire to "blow out" while you're driving, especially if you maintain your tires properly. If air goes out of a tire, it's much more likely to leak out slowly. But if you should ever have a "blowout," here are a few tips about what to expect and what to do:

If a front tire fails, the flat tire will create a drag that pulls the vehicle toward that side. Take your foot off the accelerator pedal and grip the steering wheel firmly. Steer to maintain lane position, and then gently brake to a stop well out of the traffic lane.

A rear blowout, particularly on a curve, acts much like a skid and may require the same correction you'd use in a skid. In any rear blowout, remove your foot from the accelerator pedal. Get the vehicle under control by steering the way you want the vehicle to go. It may be very bumpy and noisy, but you can still steer. Gently brake to a stop -- well off the road if possible.

If a tire goes flat, the next part shows how to use your jacking equipment to change a flat tire safely.

## Changing a Flat Tire

If a tire goes flat, avoid further tire and wheel damage by driving slowly to a level place. Turn on your hazard warning flashers.

### CAUTION:

Changing a tire can cause an injury. The vehicle can slip off the jack and roll over you or other people. You and they could be badly injured. Find a level place to change your tire. To help prevent the vehicle from moving:

1. Set the parking brake firmly.
2. Put the shift lever in **PARK (P)**.
3. If you have a four-wheel-drive vehicle, be sure the transfer case is in a drive gear -- not in **NEUTRAL (N)**.
4. Turn off the engine.

To be even more certain the vehicle won't move, you can put blocks at the front and rear of the tire farthest away from the one being changed. That would be the tire on the other side of the vehicle, at the opposite end.

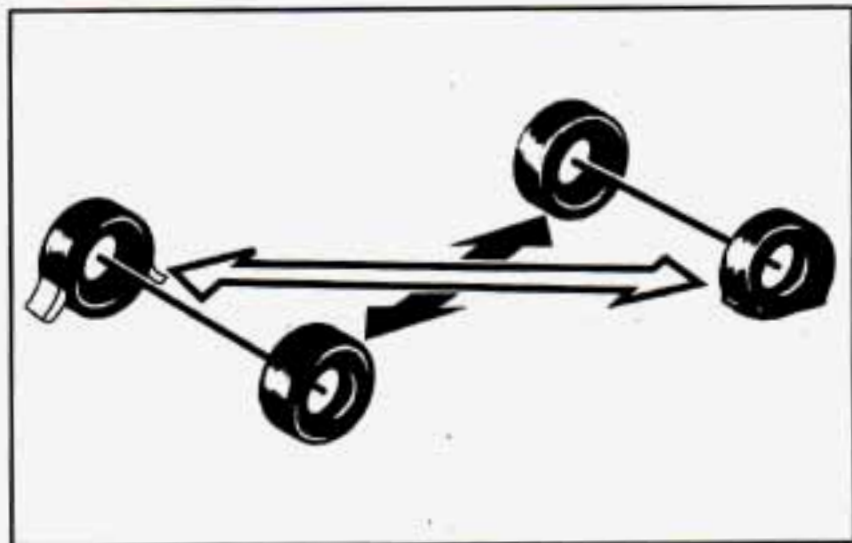

The following steps will tell you how to use the jack and change a tire.

## Removing the Spare Tire and Tools

The equipment you'll need is located in the rear cargo area. You'll also find your spare tire there.

On two-door Utility and Suburban models, the spare tire is located at the rear of the vehicle. To remove the spare tire, first open the tire cover, if you have one. Turn the wing nut counterclockwise and take it, and the adapter, off the bolt. Take the tire out of the vehicle and remove the tire cover.

On four-door utility models, the spare tire may be stored under the vehicle in an underbody carrier.

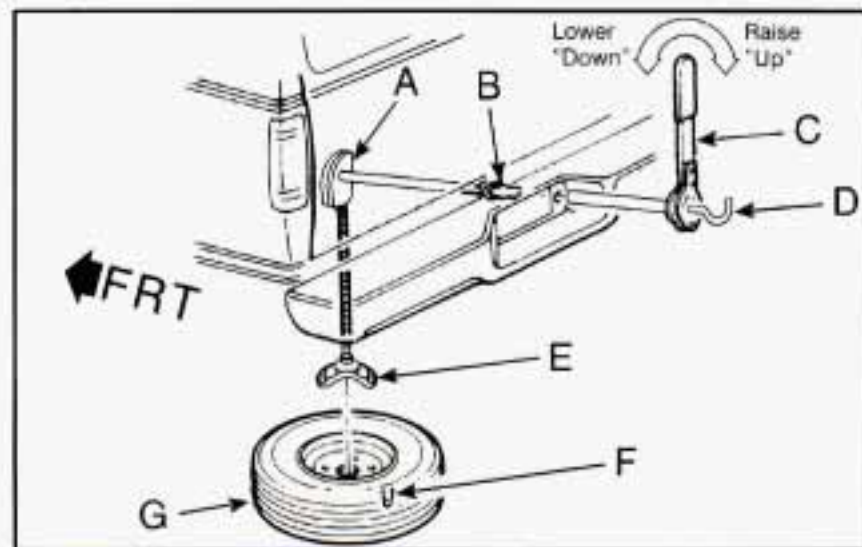

### 4-Door Utility Models

- A. Hoist Assembly
- B. Hoist Shaft
- C. Ratchet
- D. Jack Handle
- E. Retainer
- F. Valve Stem, Pointed Down
- G. Spare Tire

Follow these instructions to lower the spare tire:

1. One side of the ratchet has an UP marking. The other side has a DOWN marking. Assemble the ratchet to the hook near the end of the jack handle (as illustrated) with the DOWN marking facing you. Insert the other end through the hole in the rear bumper and into the hoist shaft.
2. Turn the ratchet to lower the spare tire to the ground. Continue to turn the ratchet until the spare tire can be pulled out from under the vehicle.
3. When the tire has been lowered, tilt the retainer at the end of the cable so it can be pulled up through the wheel opening.
4. Put the spare tire near the flat tire.



If your two-door utility model has a jack cover, turn the wing nut counterclockwise and take the cover off.

To take the jack out, turn the wing nut counterclockwise and take it and the retainer off. Take the jack and storage box out and take the tools out of the box.

Your vehicle may have a pair of emergency gloves secured to the jack. You can use them when changing the tire, or during other emergency situations. Remember to replace them with the jack, so you will have them if needed later.



To open the jack cover on four-door utility models, push the cover latches down and remove the cover.

To take the jack out, turn the wing-head bolt counterclockwise and take it and the retainer off. Take the jack and storage box out and take the tools out of the box.

Your vehicle may have a pair of emergency gloves secured to the jack. You can use them when changing the tire, or during other emergency situations. Remember to replace them with the jack, so you will have them if needed later.



If your Suburban has a jack cover, lift the tab up to release the cover, then take it off.

To take the jack out, turn the wing nut counterclockwise and take it and the retainer off. Take the jack and storage box out and take the tools out of the box.

Your vehicle may have a pair of emergency gloves secured to the jack. You can use them when changing the tire, or during other emergency situations. Remember to replace them with the jack, so you will have them if needed later.

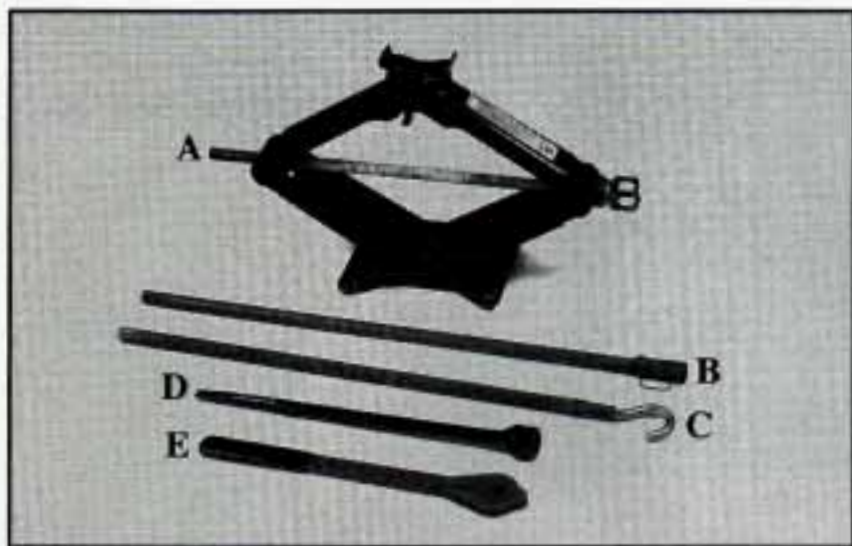

Attach the jack handle (and jack handle extension, if needed) to the jack.

The tools you'll be using include the jack (A), the jack handle extension (B), jack handle (C), wheel wrench (D) and the ratchet (E).

The jack handle extension is used if the flat tire is on the rear of the vehicle.





**UP Marking**



**DOWN Marking**

One side of the ratchet has an UP marking. The other side has a DOWN marking.

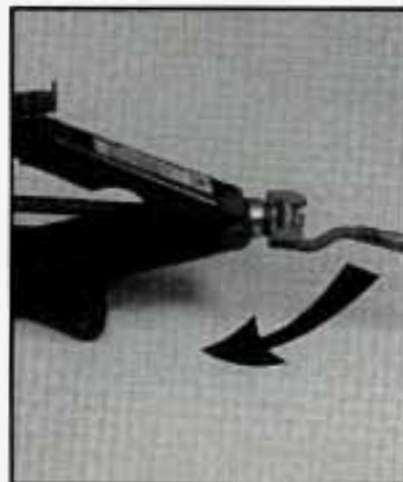

With the UP marking on the ratchet facing you, rotate the ratchet clockwise. That will lift the jack head a little.

If there is a wheel cover, pry at different points along its edge until it comes off.

Be careful; the rim edge may be sharp. Don't try to remove it with your bare hands.



If your vehicle has wheel nut caps, use the wheel wrench and ratchet to remove them. Turn the wheel wrench counterclockwise, with DOWN facing you, to remove the wheel nut caps. Then take off the hub cap.

If the wheel also has a trim ring, use the wheel wrench to pry along the edge and remove it.

If the wheel has a smooth center piece or a center piece with recessed nuts, place the wheel wrench in the slot on the wheel and gently pry off.

## Removing the Flat Tire and Installing the Spare Tire



1. Use the ratchet and wheel wrench to loosen all the wheel nuts. Turn the wheel wrench counterclockwise, with DOWN facing you, to loosen the wheel nuts. Don't remove the wheel nuts yet.

2. If the flat tire is on the rear of the vehicle, put the jack handle extension on the jack handle.
3. Position the jack under the vehicle.

**⚠ CAUTION:**

Getting under a vehicle when it is jacked up is dangerous. If the vehicle slips off the jack, you could be badly injured or killed. Never get under a vehicle when it is supported only by a jack.

**NOTICE:**

Raising your vehicle with the jack improperly positioned will damage the vehicle or may allow the vehicle to fall off the jack. Be sure to fit the jack lift head into the proper location before raising your vehicle.



**Front Position**



**Rear Position**

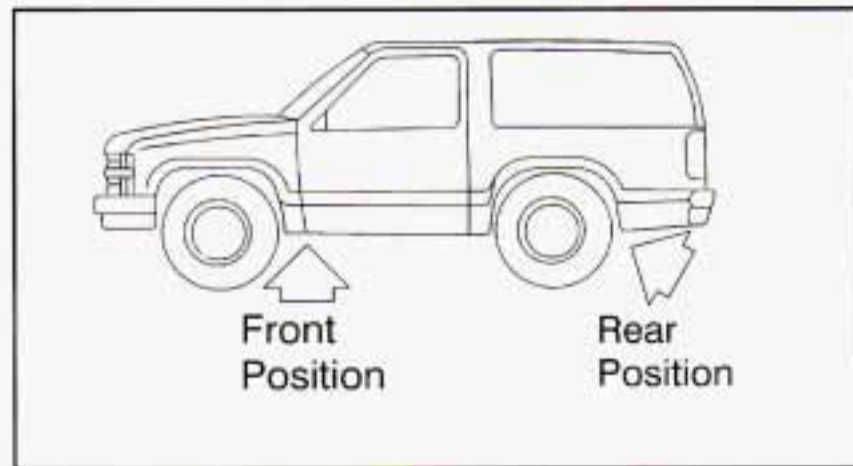

4. With UP on the ratchet facing you, raise the vehicle by rotating the ratchet and wheel wrench clockwise. Raise the vehicle far enough off the ground so there is enough room for the spare tire to fit.



5. Remove all the wheel nuts and take off the flat tire.

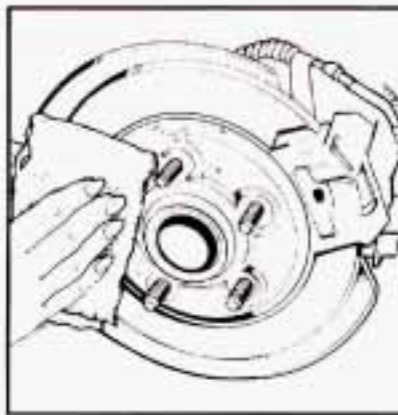

6. Remove any rust or dirt from the wheel bolts, mounting surfaces and spare wheel.

**⚠ CAUTION:**

Rust or dirt on the wheel, or on the parts to which it is fastened, can make the wheel nuts become loose after a time. The wheel could come off and cause an accident. When you change a wheel, remove any rust or dirt from the places where the wheel attaches to the vehicle. In an emergency, you can use a cloth or a paper towel to do this; but be sure to use a scraper or wire brush later, if you need to, to get all the rust or dirt off.

**⚠ CAUTION:**

Never use oil or grease on studs or nuts. If you do, the nuts might come loose. Your wheel could fall off, causing a serious accident.



7. Replace the wheel nuts with the rounded end of the nuts toward the wheel. Tighten each wheel nut by hand with the wheel wrench until the wheel is held against the hub.

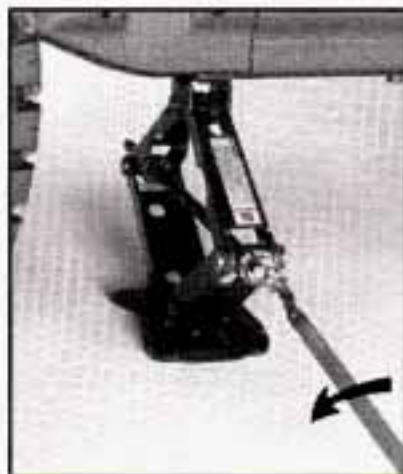

**Front Position**

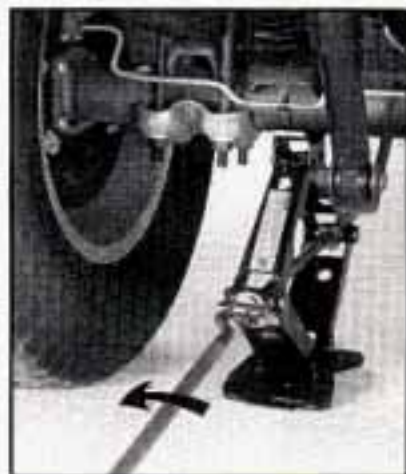

**Rear Position**

8. Lower the vehicle by rotating the ratchet and wheel wrench counterclockwise. Lower the jack completely.



9. Tighten each wheel nut clockwise.

10. Tighten the nuts firmly in a criss-cross sequence as shown. Rotate the wheel wrench clockwise.

**⚠ CAUTION:**

**Incorrect wheel nuts or improperly tightened wheel nuts can cause the wheel to become loose and even come off. This could lead to an accident. Be sure to use the correct wheel nuts. If you have to replace them, be sure to get new GM original equipment wheel nuts.**

**Stop somewhere as soon as you can and have the nuts tightened with a torque wrench to the proper torque. For proper torque, see “Wheel Nut Torque” in the Index.**

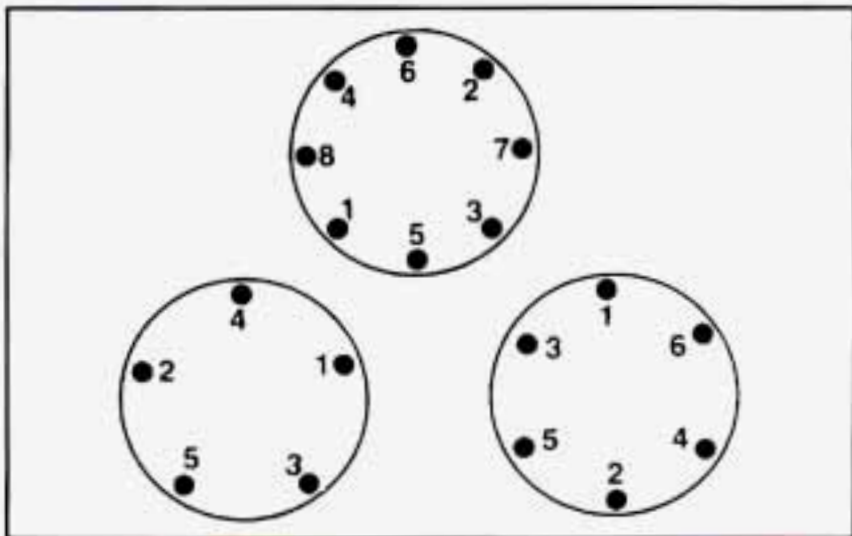

## NOTICE:

Improperly tightened wheel nuts can lead to brake pulsation and rotor damage. To avoid expensive brake repairs, evenly tighten the wheel nuts in the proper sequence and to the proper torque specification.

- Put the wheel trim back on. For vehicles with plastic wheel nut caps, tighten the caps until they are finger tight, then tighten them an additional one-half turn with the ratchet and wheel wrench.

## Storing a Flat or Spare Tire and Tools



### CAUTION:

Storing a jack, a tire or other equipment in the passenger compartment of the vehicle could cause injury. In a sudden stop or collision, loose equipment could strike someone. Store all these in the proper place.

Store the flat tire where the spare tire is stored.

Put the tools into the storage box and close it tightly. Fit the storage box on the bracket with the bolt through the box. Put the jack onto the box. Be sure the jack is stored as shown in the following illustrations. Secure the emergency gloves, if your vehicle has them, to the jack using the provided strap.

Slide the retainer over the bolt onto the jack and put the wing nut on it. Turn the nut clockwise until it is tight against the retainer.

Replace the jack storage cover, if your vehicle has one, by simply reversing the removal procedure described earlier.

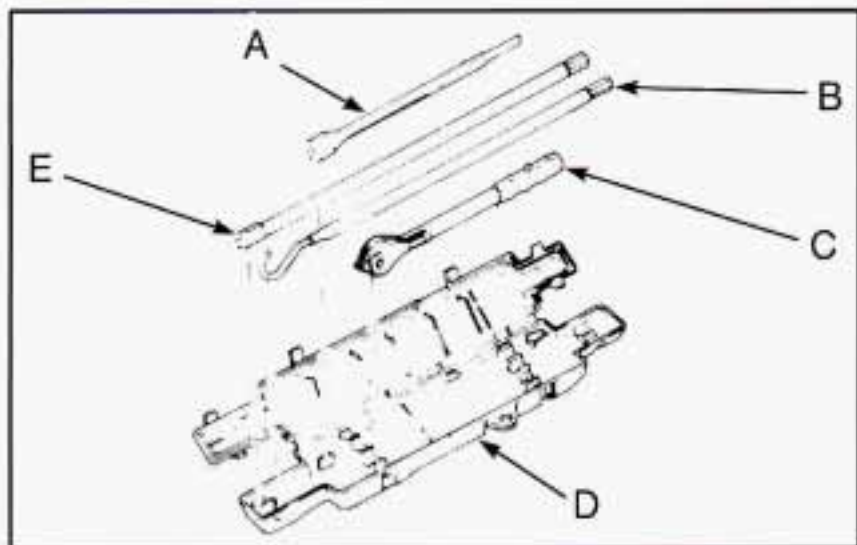

### Jacking Tool Storage

- |                 |                             |
|-----------------|-----------------------------|
| A. Wheel Wrench | D. Jacking Tool Storage Box |
| B. Jack Handle  | E. Jack Handle Extension    |
| C. Ratchet      |                             |

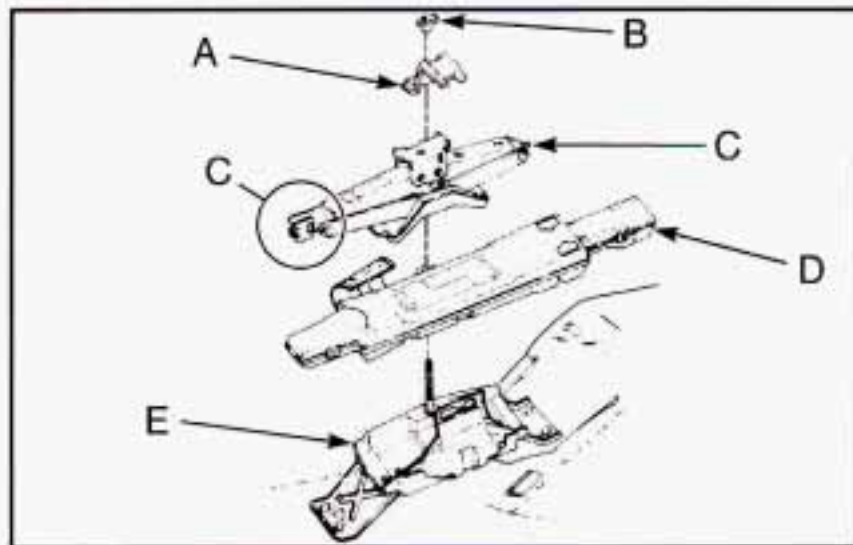

### Jack Storage -- 2-Door Utility Model

- |                                       |                     |
|---------------------------------------|---------------------|
| A. Retainer                           | D. Jack Storage Box |
| B. Nut                                | E. Bracket          |
| C. Jack -- Secure in Vehicle as Shown |                     |



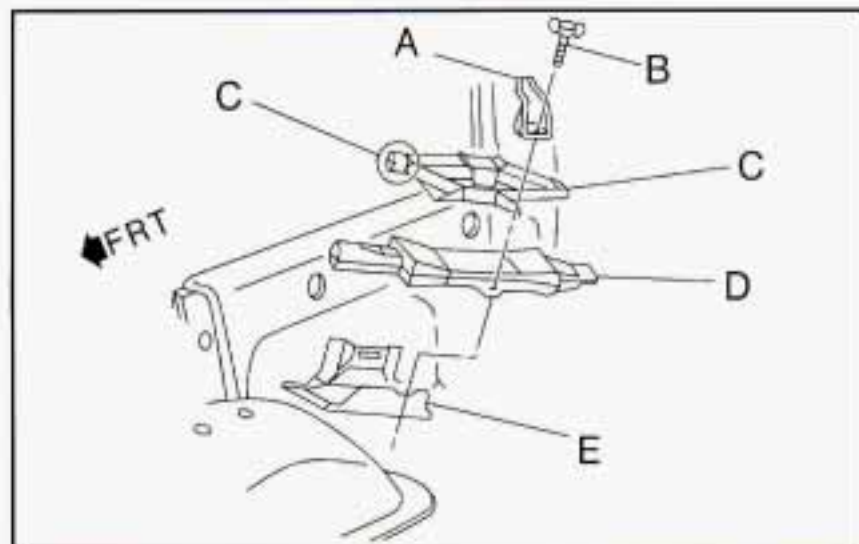

### Jack Storage -- 4-Door Utility Model

- |                                       |                     |
|---------------------------------------|---------------------|
| A. Retainer                           | D. Jack Storage Box |
| B. Nut                                | E. Bracket          |
| C. Jack -- Secure in Vehicle as Shown |                     |

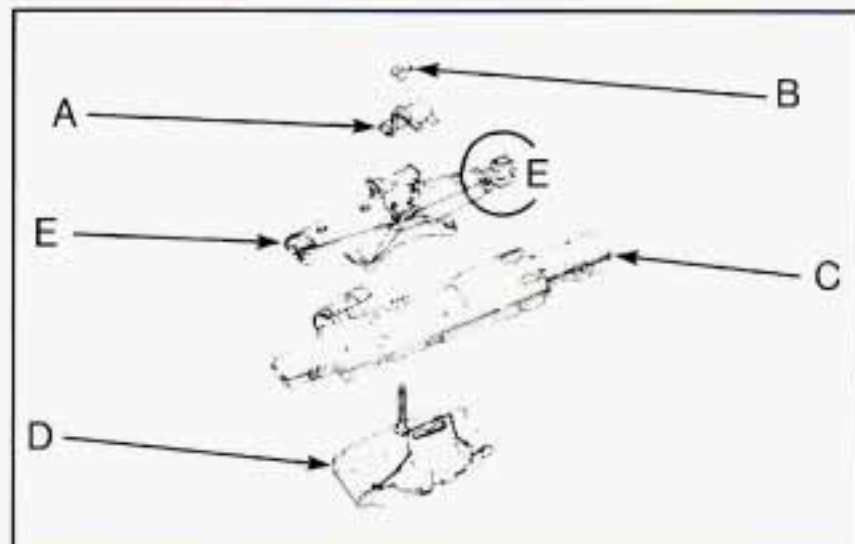

### Jack Storage -- Suburban

- |                     |                                       |
|---------------------|---------------------------------------|
| A. Retainer         | D. Bracket                            |
| B. Nut              | E. Jack -- Secure in Vehicle as Shown |
| C. Jack Storage Box |                                       |

Stow the flat tire in the cargo area of two-door Utility and Suburban models and secure it to the tire carrier. To stow the flat tire:

1. Put the cover back on the tire if your vehicle has one.
2. Put the flat tire in the cargo area of the vehicle, over the retainer bolt.
3. Slide the adapter onto the bolt in the proper location for your model and put the wing nut on.
4. Turn the wing nut clockwise until the adapter is tight and secure against the wheel.
5. Close the tire cover, if you have one.

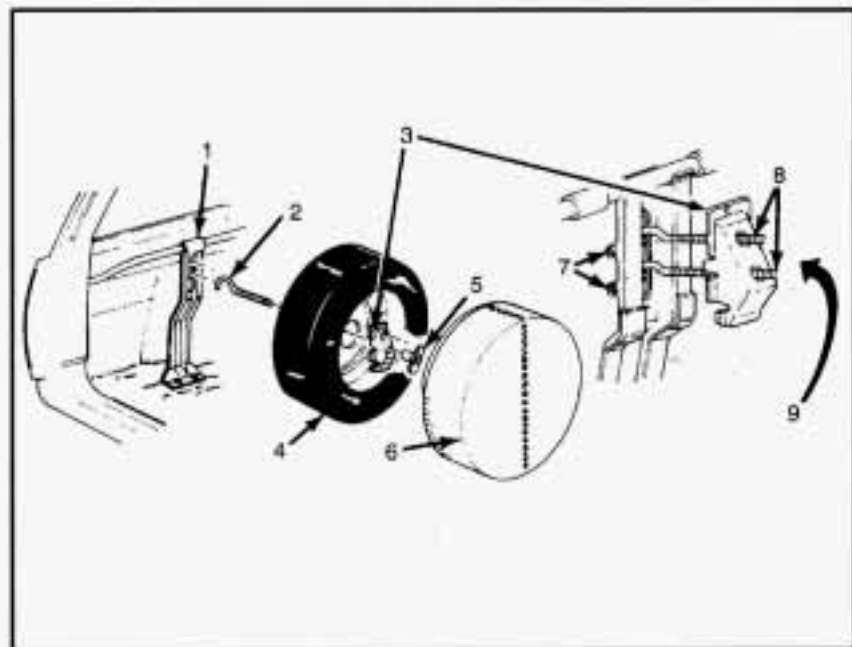

### Spare Tire -- Two-Door Utility Model

- |               |  |
|---------------|--|
| 1. Carrier    | 6. Cover   |
| 2. J-Bolt     | 7. Pins  |
| 3. Adapter    | 8. J-Bolt  |
| 4. Spare Tire | 9. Use Upper Hole and Pin for P265<br>Tire or Lower Hole and Pin for<br>LT225/245, P245 and P235 Tires |
| 5. Nut        |  |

Be sure the J-bolt is hooked properly for your model or tire size as shown.

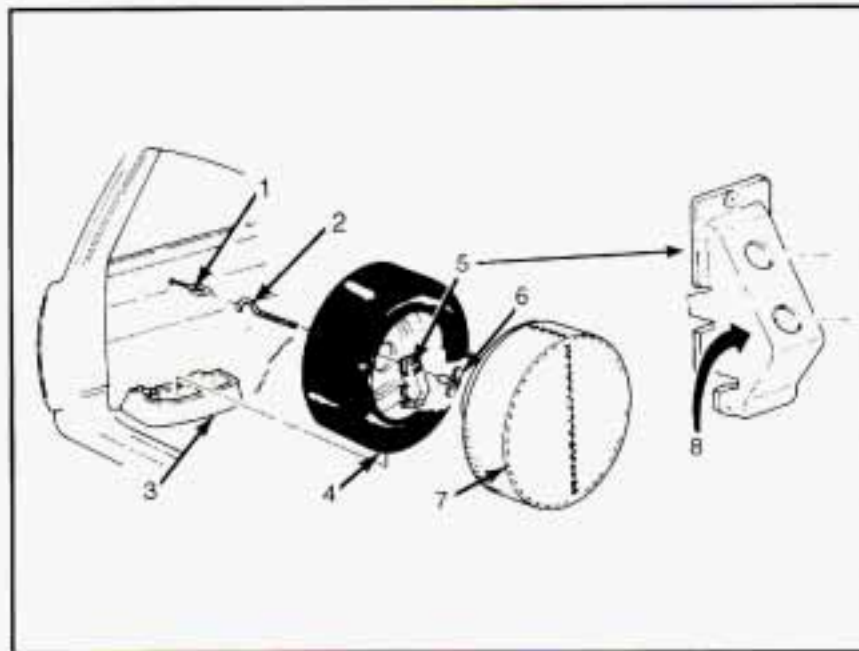

### Spare Tire -- Suburban

- |               |   |
|---------------|---|
| 1. I-Bolt     | 5. Adapter                                      |
| 2. J-Bolt     | 6. Nut  |
| 3. Carrier    | 7. Cover  |
| 4. Spare Tire | 8. Use Lower Adapter Hole<br>for 8-Lug Rim Only |

Be sure the J-bolt is hooked properly for your model or tire size as shown.

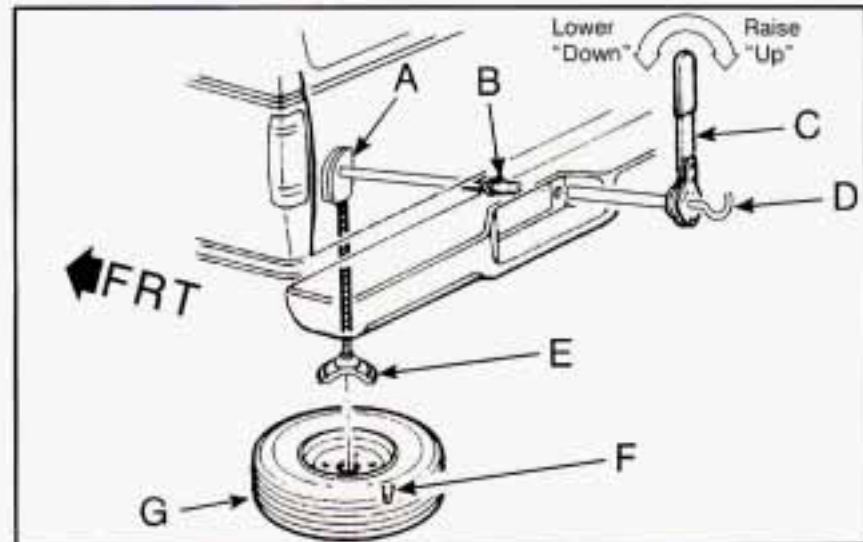

### Spare Tire -- Four-Door Utility Model

- A. Hoist Assembly
- B. Hoist Shaft
- C. Ratchet
- D. Jack Handle
- E. Retainer
- F. Valve Stem, Pointed Down
- G. Spare Tire

For four-door utility models equipped with an underbody spare tire carrier, follow these instructions to restore a spare or flat tire:

1. Lay the tire on the ground at the rear of the vehicle. Position the tire so that the valve stem is pointed down and to the rear of the vehicle.
2. Tilt the retainer downward and through the wheel opening. Make sure that the retainer is fully seated across the underside of the wheel.
3. Attach the ratchet, with the UP mark facing you, near the hook at the end of the jack handle. Insert the other end, on an angle, through the hole in the rear bumper and into the hoist shaft.
4. Raise the tire fully against the underside of the vehicle. Continue turning the ratchet until there are two “clicks” or “ratchets.” The spare tire hoist cannot be over-tightened.
5. Grasp and push against the tire to be sure it is stored securely and does not move.

## If You're Stuck: In Sand, Mud, Ice or Snow

What you don't want to do when your vehicle is stuck is to spin your wheels too fast. The method known as “rocking” can help you get out when you're stuck, but you must use caution.



### CAUTION:

**If you let your tires spin at high speed, they can explode, and you or others could be injured. And, the transmission or other parts of the vehicle can overheat. That could cause an engine compartment fire or other damage. When you're stuck, spin the wheels as little as possible. Don't spin the wheels above 35 mph (55 km/h) as shown on the speedometer.**

## NOTICE:

**Spinning your wheels can destroy parts of your vehicle as well as the tires. If you spin the wheels too fast while shifting your transmission back and forth, you can destroy your transmission.**

For information about using tire chains on your vehicle, see "Tire Chains" in the Index.

### **Rocking your vehicle to get it out:**

First, turn your steering wheel left and right. That will clear the area around your front wheels. Then shift back and forth between REVERSE (R) and a forward gear, spinning the wheels as little as possible. Release the accelerator pedal while you shift, and press lightly on the accelerator pedal when the transmission is in gear. If that doesn't get you out after a few tries, you may need to be towed out. Or, you can use your recovery hooks if your vehicle has them. If you do need to be towed out, see "Towing Your Vehicle" in the Index.

### **Using the Recovery Hooks**



Your vehicle may be equipped with recovery hooks. The recovery hooks are provided at the front of your vehicle. You may need to use them if you're stuck off-road and need to be pulled to some place where you can continue driving.



**⚠ CAUTION:**

The recovery hooks, when used, are under a lot of force. Always pull the vehicle straight out. Never pull on the hooks at a sideways angle. The hooks could break off and you or others could be injured from the chain or cable snapping back.

**NOTICE:**

Never use the recovery hooks to tow the vehicle. Your vehicle could be damaged and it would not be covered by warranty.

## Section 6 Service and Appearance Care

---

---

Here you will find information about the care of your vehicle. This section begins with service and fuel information, and then it shows how to check important fluid and lubricant levels. There is also technical information about your vehicle, and a part devoted to its appearance care.

### Service

Your GM dealer knows your vehicle best and wants you to be happy with it. We hope you'll go to your dealer for all your service needs. You'll get genuine GM parts and GM-trained and supported service people.

We hope you'll want to keep your GM vehicle all GM. Genuine GM parts have one of these marks:



## Doing Your Own Service Work

If you want to do some of your own service work, you'll want to get the proper service manual. It tells you much more about how to service your vehicle than this manual can. To order the proper service manual, see "Service and Owner Publications" in the Index.

Your vehicle has an air bag system. Before attempting to do your own service work, see "Servicing Your Air Bag-Equipped Vehicle" in the Index.

You should keep a record with all parts receipts and list the mileage and the date of any service work you perform. See "Maintenance Record" in the Index.



### CAUTION:

**You can be injured and your vehicle could be damaged if you try to do service work on a vehicle without knowing enough about it.**

- **Be sure you have sufficient knowledge, experience, and the proper replacement parts and tools before you attempt any vehicle maintenance task.**
- **Be sure to use the proper nuts, bolts and other fasteners. "English" and "metric" fasteners can be easily confused. If you use the wrong fasteners, parts can later break or fall off. You could be hurt.**



## Fuel (Gasoline Engine)

If your vehicle has a diesel engine, see “Diesel Fuel Requirements and Fuel System” in the Diesel Engine Supplement. For vehicles with gasoline engines, please read this.

Use regular unleaded gasoline rated at 87 octane or higher. At a minimum, it should meet specifications ASTM D4814 in the United States and CGSB 3.5-M93 in Canada. Improved gasoline specifications have been developed by the American Automobile Manufacturers Association (AAMA) for better vehicle performance and engine protection. Gasolines meeting the AAMA specification could provide improved driveability and emission control system protection compared to other gasolines.

Be sure the posted octane is at least 87. If the octane is less than 87, you may get a heavy knocking noise when you drive. If it's bad enough, it can damage your engine.

If you're using fuel rated at 87 octane or higher and you still hear heavy knocking, your engine needs service. But don't worry if you hear a little pinging noise when you're accelerating or driving up a hill. That's normal, and you don't have to buy a higher octane fuel to get rid of pinging. It's the heavy, constant knock that means you have a problem.

If your vehicle is certified to meet California Emission Standards (indicated on the underhood tune-up label), it is designed to operate on fuels that meet California specifications. If such fuels are not available in states adopting California emissions standards, your vehicle will operate satisfactorily on fuels meeting federal specifications, but emission control system performance may be affected. The malfunction indicator lamp on your instrument panel may turn on and/or your vehicle may fail a smog-check test. If this occurs, return to your authorized GM dealer for diagnosis to determine the cause of failure. In the event it is determined that the cause of the condition is the type of fuels used, repairs may not be covered by your warranty.

In Canada, some gasolines contain an octane-enhancing additive called MMT. If you use such fuels, your emission control system performance may deteriorate and the malfunction indicator lamp on your instrument panel may turn on. If this happens, return to your authorized GM dealer for service.

To provide cleaner air, all gasolines are now required to contain additives that will help prevent deposits from forming in your engine and fuel system, allowing your emission control system to function properly. Therefore, you should not have to add anything to the fuel. In addition, gasolines containing oxygenates, such as ethers and ethanol, and reformulated gasolines may be available in your area to help clean the air. General Motors recommends that you use these gasolines if they comply with the specifications described earlier.

## **NOTICE:**

**Your vehicle was not designed for fuel that contains methanol. Don't use it. It can corrode metal parts in your fuel system and also damage plastic and rubber parts. That damage wouldn't be covered under your warranty.**

## **Fuels in Foreign Countries -- Gasoline Engines**

If you plan on driving in another country outside the United States or Canada, the proper fuel may be hard to find. Never use leaded gasoline or any other fuel not recommended in the previous text on fuel. Costly repairs caused by use of improper fuel wouldn't be covered by your warranty.

To check on fuel availability, ask an auto club, or contact a major oil company that does business in the country where you'll be driving.

You can also write us at the following address for advice. Just tell us where you're going and give your Vehicle Identification Number (VIN).

General Motors Overseas Distribution Corporation,  
North American Export Sales (NAES)  
1908 Colonel Sam Drive  
Oshawa, Ontario L1H 8P7

## Filling Your Tank



Your vehicle ignition must be in the OFF position during refueling of the vehicle.

The fuel cap is behind a hinged door on the left side of your vehicle.

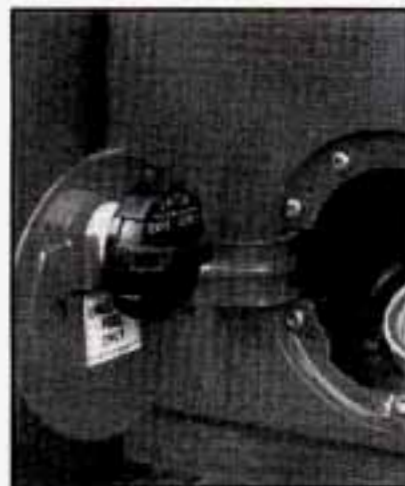

While refueling, hang the cap inside the fuel door.

To take off the cap, turn it slowly to the left (counterclockwise).

### CAUTION:

Gasoline vapor is highly flammable. It burns violently, and that can cause very bad injuries. Don't smoke if you're near gasoline or refueling your vehicle. Keep sparks, flames and smoking materials away from gasoline.

### CAUTION:

If you get gasoline on yourself and then something ignites it, you could be badly burned. Gasoline can spray out on you if you open the fuel filler cap too quickly. This spray can happen if your tank is nearly full, and is more likely in hot weather. Open the fuel filler cap slowly and wait for any "hiss" noise to stop. Then unscrew the cap all the way.

Be careful not to spill gasoline. Clean gasoline from painted surfaces as soon as possible. See “Cleaning the Outside of Your Vehicle” in the Index.

When you put the cap back on, turn it to the right until you hear at least three clicks. Make sure you fully install the cap. The diagnostic system can determine if the fuel cap has been left off or improperly installed. This would allow fuel to evaporate into the atmosphere. See “Malfunction Indicator Lamp” in the Index.

### **NOTICE:**

**If you need a new cap, be sure to get the right type. Your dealer can get one for you. If you get the wrong type, it may not fit or have proper venting, and your fuel tank and emissions system might be damaged.**

## **Checking Things Under the Hood**



### **CAUTION:**

**If your vehicle has air conditioning, the auxiliary engine fan under the hood can start up and injure you even when the engine is not running. Keep hands, clothing and tools away from any underhood electric fan.**



### **CAUTION:**

**Things that burn can get on hot engine parts and start a fire. These include liquids like gasoline or diesel fuel, oil, coolant, brake fluid, windshield washer and other fluids, and plastic or rubber. You or others could be burned. Be careful not to drop or spill things that will burn onto a hot engine.**

## Hood Release



To open the hood, first pull the handle inside the vehicle.



Then go to the front of the vehicle and pull up on the secondary hood release, located just to the passenger side of the center of the grill.

Lift the hood.

Your vehicle, if it has air conditioning, may have a auxiliary engine fan in addition to the belt driven fan.

Before closing the hood, be sure all filler caps are on properly. Pull down the hood and close it firmly.

## “VORTEC” 5700 Engine

When you lift up the hood you’ll see:

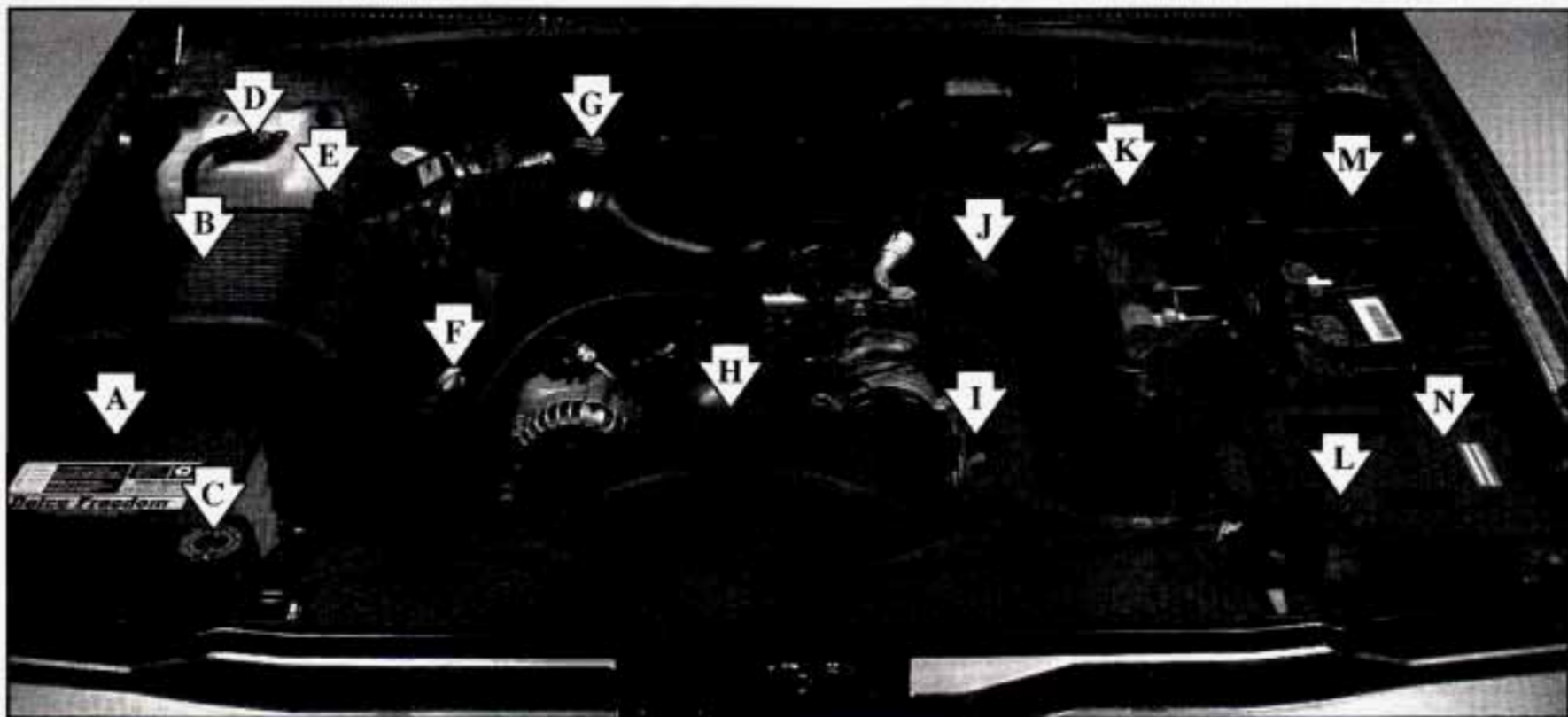

- A. Battery
- B. Air Cleaner
- C. Radiator Cap
- D. Coolant Recovery Tank
- E. Air Filter Restriction Indicator
- F. Engine Oil Dipstick
- G. Automatic Transmission Dipstick

- H. Fan
- I. Power Steering Fluid Reservoir
- J. Engine Oil Fill
- K. Brake Fluid Reservoir
- L. Windshield Washer Fluid Reservoir
- M. Fuse/Relay Center
- N. Storage Compartment

## “VORTEC” 7400 Engine

When you lift up the hood you’ll see:

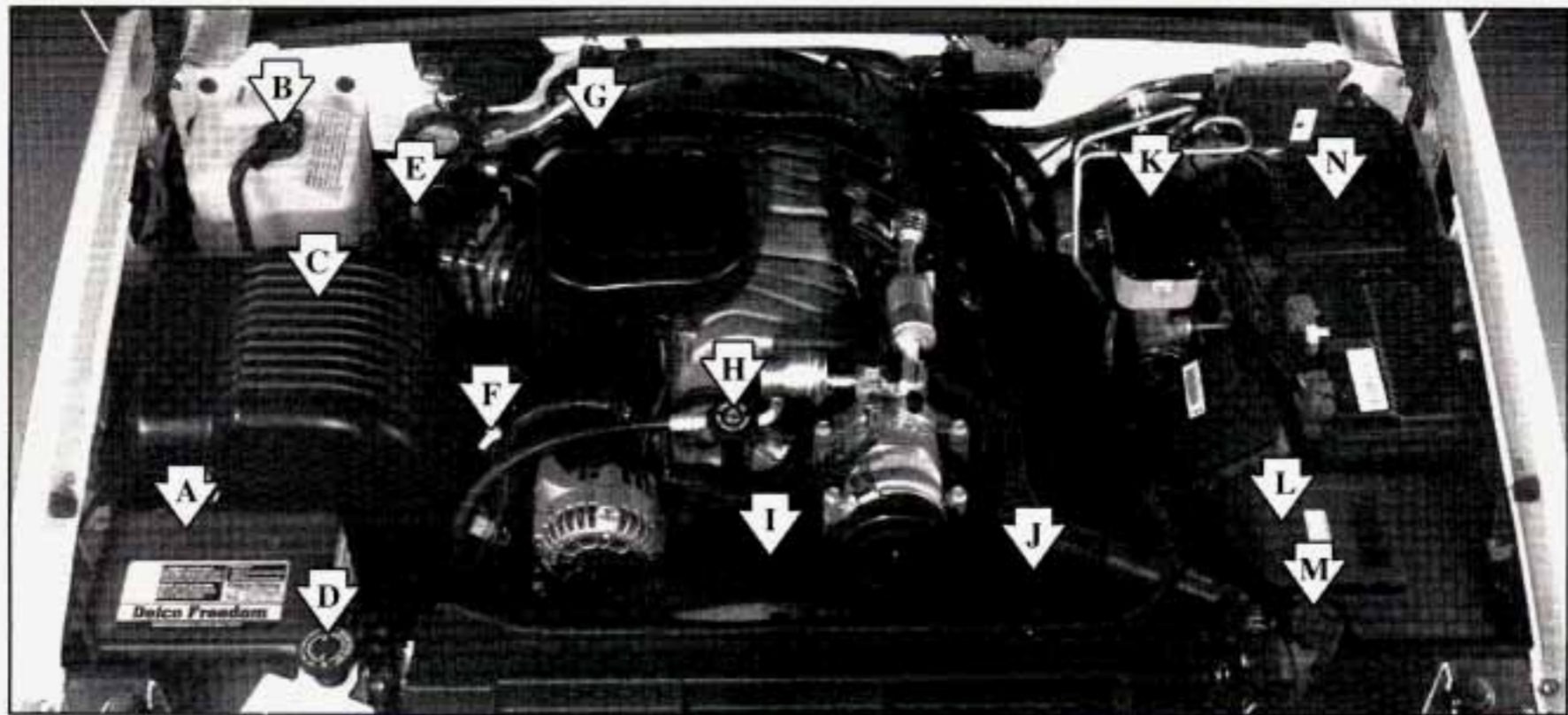



- A. Battery
- B. Coolant Recovery Tank
- C. Air Cleaner
- D. Radiator Cap
- E. Air Filter Restriction Indicator
- F. Engine Oil Dipstick
- G. Automatic Transmission Dipstick
- H. Engine Oil Fill
- I. Fan
- J. Power Steering Fluid Reservoir
- K. Brake Fluid Reservoir
- L. Storage Compartment
- M. Windshield Washer Fluid Reservoir
- N. Fuse/Relay Center

## Engine Oil (Gasoline Engine)

If your vehicle has a diesel engine, see “Engine Oil (Diesel Engine)” in the Diesel Engine Supplement.

It’s a good idea to check your engine oil every time you get fuel. In order to get an accurate reading, the oil must be warm and the vehicle must be on level ground.

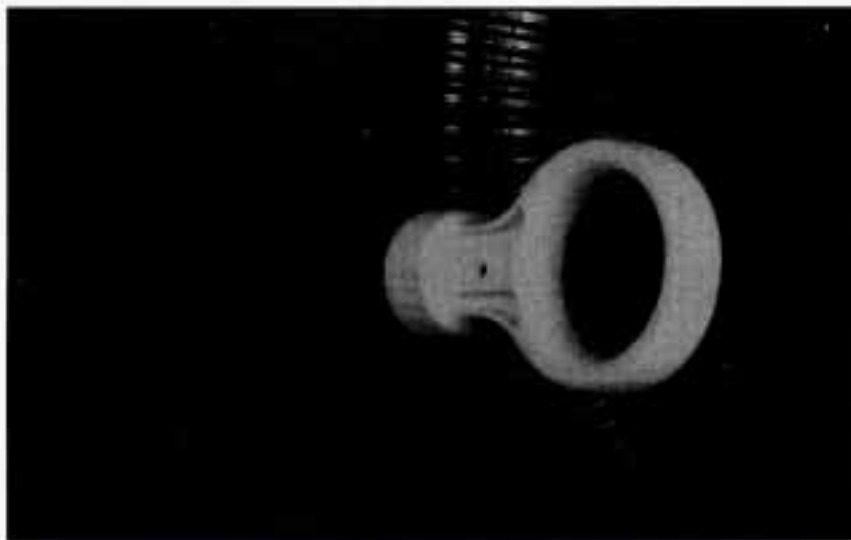

The engine oil dipstick has a yellow ring handle and is located on the passenger side of the engine.

Turn off the engine and give the oil a few minutes to drain back into the oil pan. If you don’t, the oil dipstick might not show the actual level.

## Checking Engine Oil

Pull out the dipstick and clean it with a paper towel or cloth, then push it back in all the way. Remove it again, keeping the tip down, and check the level.

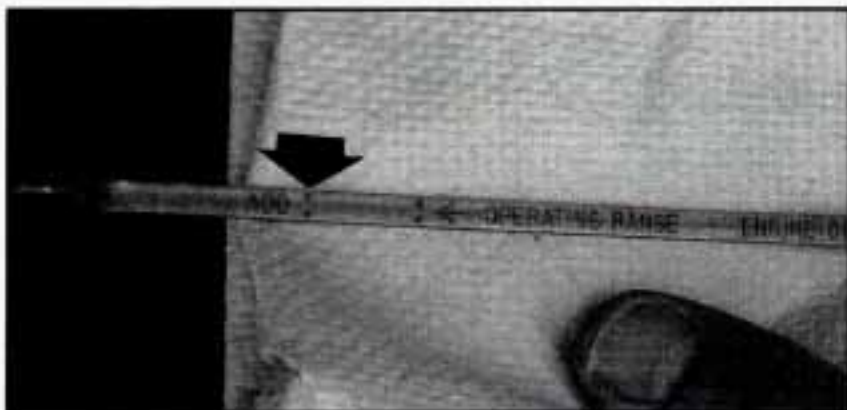

## When to Add Oil

If the oil is at or below the ADD mark, then you'll need to add some oil. But you must use the right kind. This part explains what kind of oil to use. For crankcase capacity, see "Capacities and Specifications" in the Index.

### **NOTICE:**

**Don't add too much oil. If your engine has so much oil that the oil level gets above the upper mark that shows the proper operating range, your engine could be damaged.**

The engine oil filler cap is located on the driver's side engine valve cover.

Just fill it enough to put the level somewhere in the proper operating range. Push the dipstick all the way back in when you're through.

## What Kind of Oil to Use

Oils recommended for your vehicle can be identified by looking for the "Starburst" symbol. This symbol indicates that the oil has been certified by the American Petroleum Institute (API). Do not use any oil which does not carry this Starburst symbol.



If you change your own oil, be sure you use oil that has the Starburst symbol on the front of the oil container.

If you have your oil changed for you, be sure the oil put into your engine is American Petroleum Institute certified for gasoline engines.

You should also use the proper viscosity oil for your vehicle, as shown in the following chart:

## RECOMMENDED SAE VISCOSITY GRADE ENGINE OILS

FOR BEST FUEL ECONOMY AND COLD STARTING, SELECT THE LOWEST SAE VISCOSITY GRADE OIL FOR THE EXPECTED TEMPERATURE RANGE.

HOT  
WEATHER



COLD  
WEATHER

LOOK  
FOR THIS  
SYMBOL



DO NOT USE SAE 20W-50 OR ANY OTHER GRADE OIL NOT RECOMMENDED

As shown in the chart, SAE 5W-30 is best for your vehicle. However, you can use SAE 10W-30 if it's going to be 0°F (-18°C) or above. These numbers on an oil container show its viscosity, or thickness. Do not use other viscosity oils, such as SAE 20W-50.

## NOTICE:

Use only engine oil with the American Petroleum Institute Certified For Gasoline Engines "Starburst" symbol. Failure to use the recommended oil can result in engine damage not covered by your warranty.

GM Goodwrench<sup>®</sup> oil meets all the requirements for your vehicle.

## Engine Oil Additives

Don't add anything to your oil. Your GM dealer is ready to advise if you think something should be added.

## When to Change Engine Oil

See if any one of these is true for you:

- Most trips are less than 5 to 10 miles (8 to 16 km). This is particularly important when outside temperatures are below freezing.
- Most trips include extensive idling (such as frequent driving in stop-and-go traffic).
- You operate your vehicle in dusty areas or off-road frequently.
- You frequently tow a trailer or use a carrier on top of your vehicle.
- The vehicle is used for delivery service, police, taxi or other commercial application.

Driving under these conditions causes engine oil to break down sooner. If any one of these is true for your vehicle, then you need to change your oil and filter every 3,000 miles (5 000 km) or 3 months -- whichever occurs first.

If none of them is true, change the oil and filter every 7,500 miles (12 500 km) or 12 months -- whichever occurs first. Driving a vehicle with a fully warmed engine under highway conditions causes engine oil to break down slower.

## What to Do with Used Oil

Did you know that used engine oil contains certain elements that may be unhealthy for your skin and could even cause cancer? Don't let used oil stay on your skin for very long. Clean your skin and nails with soap and water, or a good hand cleaner. Wash or properly throw away clothing or rags containing used engine oil. (See the manufacturer's warnings about the use and disposal of oil products.)

Used oil can be a real threat to the environment. If you change your own oil, be sure to drain all free-flowing oil from the filter before disposal. Don't ever dispose of oil by putting it in the trash, pouring it on the ground, into sewers, or into streams or bodies of water. Instead, recycle it by taking it to a place that collects used oil. If you have a problem properly disposing of your used oil, ask your dealer, a service station or a local recycling center for help.

## Air Cleaner



Your air cleaner is located between the battery and coolant recovery tank.



The air cleaner assembly has an indicator that lets you know when the air filter is dirty and needs to be serviced.

The indicator is located in the air intake tube between the air cleaner and the engine. See "Owner Checks and Services" in the Index on when to check the indicator.

If the area inside the clear section of the indicator is green, no air filter service is required. When the area inside the indicator is orange and **CHANGE AIR FILTER** appears, the filter should be replaced.



To remove the air filter, unhook the retainer clips and remove the cover. Lift the filter and the connected duct out of the air cleaner housing. Hold the duct and remove the filter by both pulling and twisting the filter away from the duct. Care should be taken to dislodge as little dirt as possible.

Clean the filter sealing surface of the duct and the filter housing.



Install the new filter by pushing it all the way to the stop on the duct.

Install the duct and the filter into the air cleaner housing. Make sure that the duct fits properly into the housing.

Install the cover and fasten the two retaining clips.

After the air filter is properly serviced, the indicator should be reset. Push the button on top of the indicator to reset it to the green (clean) filter zone.

Refer to the Maintenance Schedule to determine when to replace the air filter.

See "Scheduled Maintenance Services" in the Index.

 **CAUTION:**

**Operating the engine with the air cleaner off can cause you or others to be burned. The air cleaner not only cleans the air, it stops flame if the engine backfires. If it isn't there, and the engine backfires, you could be burned. Don't drive with it off, and be careful working on the engine with the air cleaner off.**

**NOTICE:**

**If the air cleaner is off, a backfire can cause a damaging engine fire. And, dirt can easily get into your engine, which will damage it. Always have the air cleaner in place when you're driving.**

## **Automatic Transmission Fluid**

### **When to Check and Change**

A good time to check your automatic transmission fluid level is when the engine oil is changed.

Change both the fluid and filter every 50,000 miles (83 000 km) if the vehicle is mainly driven under one or more of these conditions:

- In heavy city traffic where the outside temperature regularly reaches 90°F (32°C) or higher.
- In hilly or mountainous terrain.
- When doing frequent trailer towing.
- Uses such as found in taxi, police or delivery service.

If you do not use your vehicle under any of these conditions, the fluid and filter do not require changing.

See "Scheduled Maintenance Services" in the Index.



## How to Check

Because this operation can be a little difficult, you may choose to have this done at your GM dealer Service Department.

If you do it yourself, be sure to follow all the instructions here, or you could get a false reading on the dipstick.

### **NOTICE:**

**Too much or too little fluid can damage your transmission. Too much can mean that some of the fluid could come out and fall on hot engine parts or exhaust system parts, starting a fire. Be sure to get an accurate reading if you check your transmission fluid.**

Wait at least 30 minutes before checking the transmission fluid level if you have been driving:

- When outside temperatures are above 90°F (32°C).
- At high speed for quite a while.
- In heavy traffic -- especially in hot weather.
- While pulling a trailer.

To get the right reading, the fluid should be at normal operating temperature, which is 180°F to 200°F (82°C to 93°C).

### **Checking Transmission Fluid Hot**

Get the vehicle warmed up by driving about 15 miles (24 km) when outside temperatures are above 50°F (10°C). If it's colder than 50°F (10°C), drive the vehicle in DRIVE (D) until the engine temperature gage moves and then remains steady for 10 minutes. Then follow the hot check procedures.

## Checking Transmission Fluid Cold

A cold check is made after the vehicle has been sitting for eight hours or more with the engine off and is used only as a reference. Let the engine run at idle for five minutes if outside temperatures are 50°F (10°C) or more. If it's colder than 50°F (10°C), you may have to idle the engine longer. Should the fluid level be low during a cold check, you *must* perform a hot check before adding fluid. This will give you a more accurate reading of the fluid level.

## Checking the Fluid Hot or Cold

- Park your vehicle on a level place. Keep the engine running.
- With the parking brake applied, place the shift lever in PARK (P).
- With your foot on the brake pedal, move the shift lever through each gear range, pausing for about three seconds in each range. Then, position the shift lever in PARK (P).
- Let the engine run at idle for three minutes or more.

Then, without shutting off the engine, follow these steps:



1. Flip the handle up and then pull out the dipstick and wipe it with a clean rag or paper towel.
2. Push it back in all the way, wait three seconds and then pull it back out again.

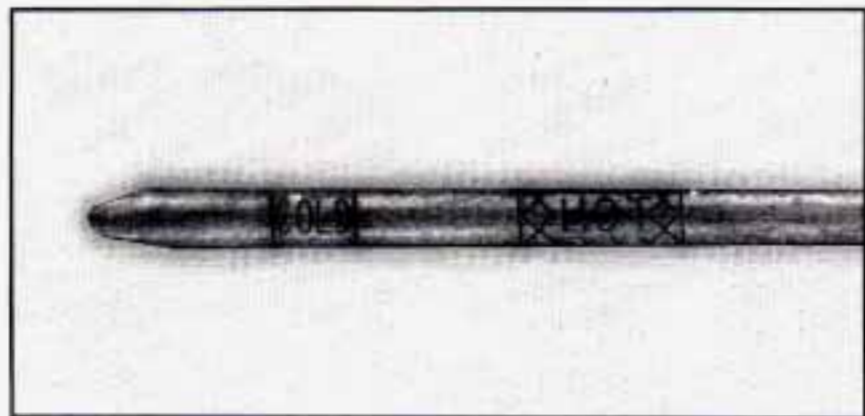

3. Check both sides of the dipstick, and read the lower level. The fluid level must be in the COLD area for a cold check or in the HOT area or cross-hatched area for a hot check.
4. If the fluid level is in the acceptable range, push the dipstick back in all the way; then flip the handle down to lock the dipstick in place.

## How to Add Fluid

Refer to the Maintenance Schedule to determine what kind of transmission fluid to use. See “Recommended Fluids and Lubricants” in the Index.

Add fluid only after checking the transmission fluid HOT. (A COLD check is used only as a reference.) If the fluid level is low, add only enough of the proper fluid to bring the level up to the HOT area for a hot check. It doesn't take much fluid, generally less than a pint (0.5 L). *Don't overfill.* We recommend you use only fluid labeled DEXRON<sup>®</sup>-III, because fluid with that label is made especially for your automatic transmission. Damage caused by fluid other than DEXRON-III is not covered by your new vehicle warranty.

- After adding fluid, recheck the fluid level as described under “How to Check.”
- When the correct fluid level is obtained, push the dipstick back in all the way; then flip the handle down to lock the dipstick in place.

## Rear Axle

### When to Check and Change Lubricant

Refer to the Maintenance Schedule to determine how often to check the lubricant and when to change it. See "Scheduled Maintenance Services" in the Index.

### How to Check Lubricant

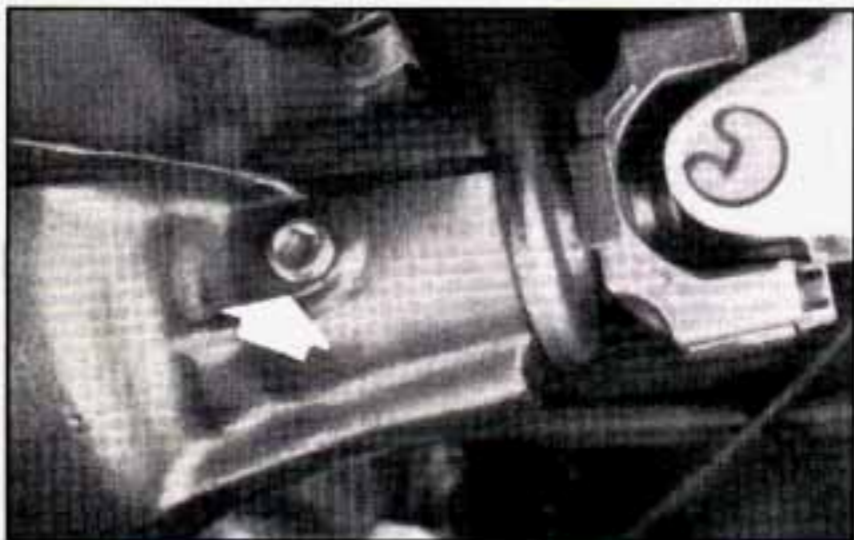

If the level is below the bottom of the filler plug hole, you'll need to add some lubricant. Add enough lubricant to raise the level to the bottom of the filler plug hole.

### What to Use

Refer to the Maintenance Schedule to determine what kind of lubricant to use. See "Recommended Fluids and Lubricants" in the Index.

## Four-Wheel Drive

Most lubricant checks in this section also apply to four-wheel-drive vehicles. However, they have two additional systems that need lubrication.

## Transfer Case

### When to Check Lubricant

Refer to the Maintenance Schedule to determine how often to check the lubricant. See "Periodic Maintenance Inspections" in the Index.

### How to Check Lubricant

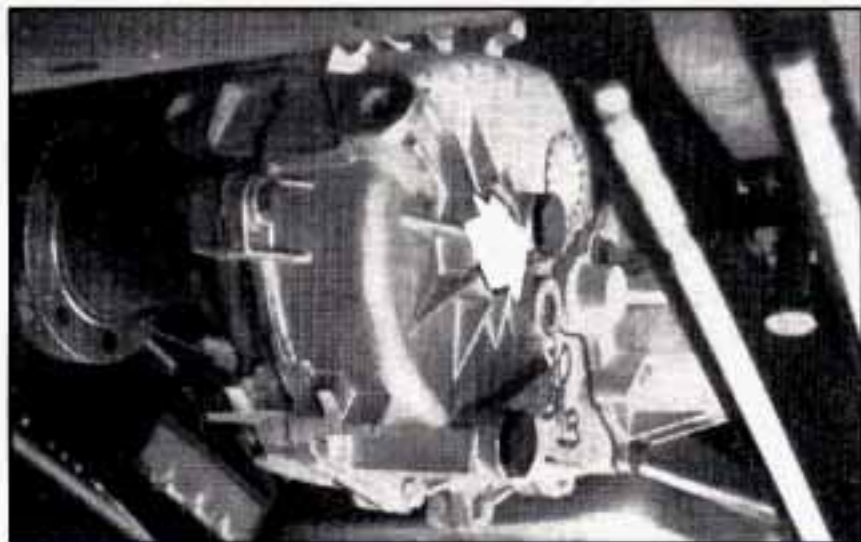

If the level is below the bottom of the filler plug hole, you'll need to add some lubricant. Add enough lubricant to raise the level to the bottom of the filler plug hole.

### What to Use

Refer to the Maintenance Schedule to determine what kind of lubricant to use. See "Recommended Fluids and Lubricants" in the Index.

## Front Axle

### When to Check and Change Lubricant

Refer to the Maintenance Schedule to determine how often to check the lubricant and when to change it. See "Scheduled Maintenance Services" in the Index.

## How to Check Lubricant

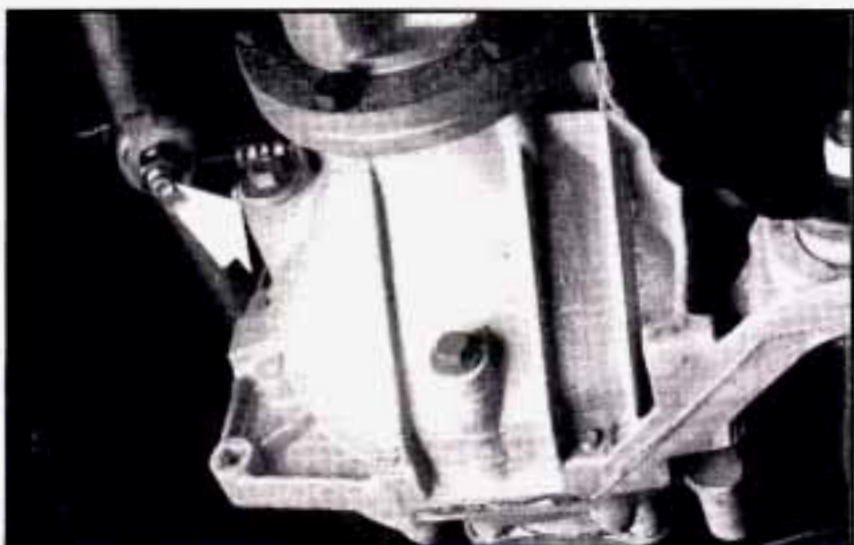

If the level is below the bottom of the filler plug hole, you'll need to add some lubricant.

If the differential is at operating temperature (warm), add enough lubricant to raise the level to the bottom of the filler plug hole.

If the differential is cold, add enough lubricant to raise the level to 1/2 inch (12 mm) below the filler plug hole.

### What to Use

Refer to the Maintenance Schedule to determine what kind of lubricant to use. See "Recommended Fluids and Lubricants" in the Index.

## Engine Coolant

The cooling system in your vehicle is filled with new DEX-COOL™ (orange-colored, silicate-free) engine coolant. This coolant is designed to remain in your vehicle for 5 years or 100,000 miles (166 000 km), whichever occurs first.

The following explains your cooling system and how to add coolant when it is low. If you have a problem with engine overheating, see “Engine Overheating” in the Index.

A 50/50 mixture of water and the proper coolant for your vehicle will:

- Give freezing protection down to -34°F (-37°C).
- Give boiling protection up to 265°F (129°C).
- Protect against rust and corrosion.
- Help keep the proper engine temperature.
- Let the warning gages work as they should.

### NOTICE:

**When adding coolant it is important that you use DEX-COOL™ (orange-colored, silicate-free) coolant meeting GM Specification 6277M.**

**If *silicated* coolant is added to the system, premature engine, heater core or radiator corrosion may result. In addition, the engine coolant will require change sooner -- at 30,000 miles (50 000 km) or 24 months, whichever occurs first.**

## What to Use

Use a mixture of one-half *clean water* (preferably distilled) and one-half DEX-COOL™ (orange-colored, silicate-free) antifreeze that meets GM Specification 6277M, which won't damage aluminum parts. Use GM Engine Coolant Supplement (sealer) (GM Part No. 3634621) with any complete coolant change. If you use this mixture, you don't need to add anything else.

### CAUTION:

**Adding only plain water to your cooling system can be dangerous. Plain water, or some other liquid like alcohol, can boil before the proper coolant mix will. Your vehicle's coolant warning system is set for the proper coolant mix. With plain water or the wrong mix, your engine could get too hot but you wouldn't get the overheat warning. Your engine could catch fire and you or others could be burned. Use a 50/50 mix of clean water and DEX-COOL™ (orange-colored, silicate-free) antifreeze.**

### NOTICE:

**If you use an improper coolant mix, your engine could overheat and be badly damaged. The repair cost wouldn't be covered by your warranty. Too much water in the mix can freeze and crack the engine, radiator, heater core and other parts.**

If you have to add coolant more than four times a year, have your dealer check your cooling system.

### NOTICE:

**If you use the proper coolant, you don't have to add extra inhibitors or additives which claim to improve the system. These can be harmful.**



## Checking Coolant



The coolant recovery tank is located on the passenger side at the rear corner of the engine compartment.

When your engine is cold, the coolant level should be at the COLD mark, or a little higher. When your engine is warm, the level should be up to the HOT mark, or a little higher.

## Adding Coolant

If you need more coolant, add the proper mix *at the coolant recovery tank*.

### CAUTION:

Turning the radiator pressure cap when the engine and radiator are hot can allow steam and scalding liquids to blow out and burn you badly. With the coolant recovery tank, you will almost never have to add coolant at the radiator. Never turn the radiator pressure cap -- even a little -- when the engine and radiator are hot.

Add coolant mix at the recovery tank, but be careful not to spill it.

### CAUTION:

You can be burned if you spill coolant on hot engine parts. Coolant contains ethylene glycol, and it will burn if the engine parts are hot enough. Don't spill coolant on a hot engine.

## Radiator Pressure Cap

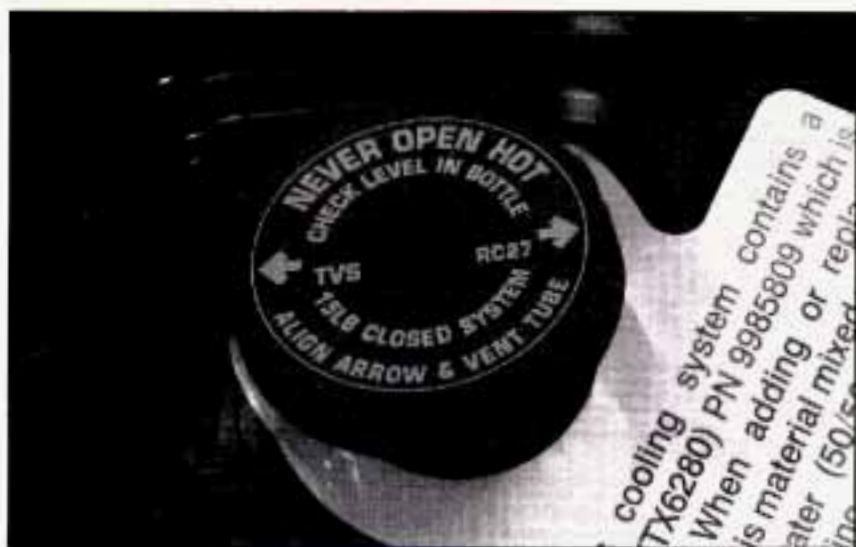

The radiator pressure cap must be tightly installed with the arrows on the cap lined up with the overflow tube on the radiator filler neck.

### NOTICE:

Your radiator cap is a 15 psi (105 kPa) pressure-type cap and must be tightly installed to prevent coolant loss and possible engine damage from overheating. Be sure the arrows on the cap line up with the overflow tube on the radiator filler neck.

## Thermostat

Engine coolant temperature is controlled by a thermostat in the engine coolant system. The thermostat stops the flow of coolant through the radiator until the coolant reaches a preset temperature.

When you replace your thermostat, an AC<sup>®</sup> thermostat is recommended.

## Power Steering Fluid



### When to Check Power Steering Fluid

It is not necessary to regularly check power steering fluid unless you suspect there is a leak in the system or you hear an unusual noise. A fluid loss in this system could indicate a problem. Have the system inspected and repaired.

### How To Check Power Steering Fluid

When the engine compartment is cool, unscrew the cap and wipe the dipstick with a clean rag. Replace the cap and completely tighten it. Then remove the cap again and look at the fluid level on the dipstick.

The level should be at the FULL COLD mark. If necessary, add only enough fluid to bring the level up to the mark.

### What to Use

Refer to the Maintenance Schedule to determine what kind of fluid to use. See "Recommended Fluids and Lubricants" in the Index. Always use the proper fluid. Failure to use the proper fluid can cause leaks and damage hoses and seals.

## Windshield Washer Fluid

### What to Use

When you need windshield washer fluid, be sure to read the manufacturer's instructions before use. If you will be operating your vehicle in an area where the temperature may fall below freezing, use a fluid that has sufficient protection against freezing.

### Adding Washer Fluid



Open the cap labeled WASHER FLUID ONLY. Add washer fluid until the tank is full.

### NOTICE:

- **When using concentrated washer fluid, follow the manufacturer's instructions for adding water.**
- **Don't mix water with ready-to-use washer fluid. Water can cause the solution to freeze and damage your washer fluid tank and other parts of the washer system. Also, water doesn't clean as well as washer fluid.**
- **Fill your washer fluid tank only three-quarters full when it's very cold. This allows for expansion, which could damage the tank if it is completely full.**
- **Don't use radiator antifreeze in your windshield washer. It can damage your washer system and paint.**

## Brakes

### Brake Fluid



Your brake master cylinder reservoir is here. It is filled with DOT-3 brake fluid.

There are only two reasons why the brake fluid level in the reservoir might go down. The first is that the brake fluid goes down to an acceptable level during normal brake lining wear. When new linings are put in, the fluid level goes back up. The other reason is that fluid is leaking out of the brake system. If it is, you should have your brake system fixed, since a leak means that sooner or later your brakes won't work well, or won't work at all.

So, it isn't a good idea to "top off" your brake fluid. Adding brake fluid won't correct a leak. If you add fluid when your linings are worn, then you'll have too much fluid when you get new brake linings. You should add (or remove) brake fluid, as necessary, only when work is done on the brake hydraulic system.

#### CAUTION:

**If you have too much brake fluid, it can spill on the engine. The fluid will burn if the engine is hot enough. You or others could be burned, and your vehicle could be damaged. Add brake fluid only when work is done on the brake hydraulic system.**

Refer to the Maintenance Schedule to determine when to check your brake fluid. See "Periodic Maintenance Inspections" in the Index.

## Checking Brake Fluid

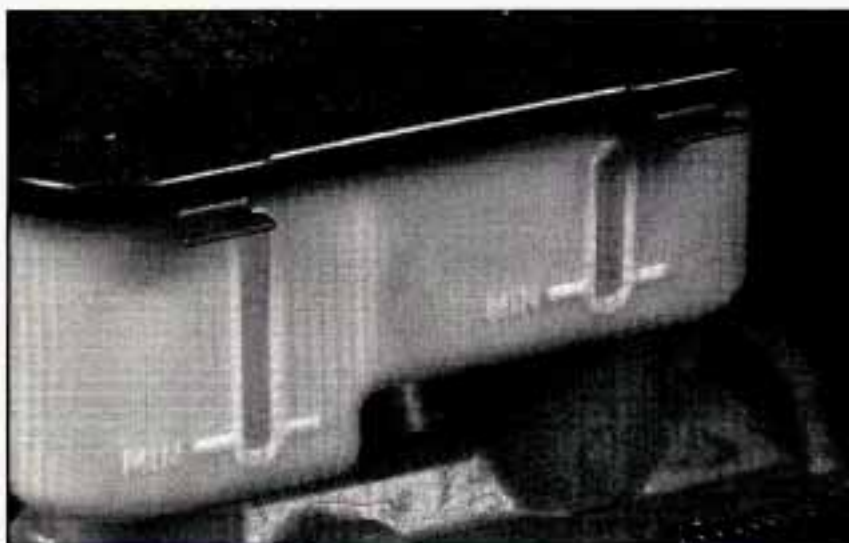

You can check the brake fluid without taking off the cap. Just look at the window on the brake fluid reservoir. The fluid level should be above MIN. If it isn't, have your brake system checked to see if there is a leak.

After work is done on the brake hydraulic system, make sure the level is above MIN and below the top of the window.

## What to Add

When you do need brake fluid, use only DOT-3 brake fluid -- such as Delco Supreme 11<sup>®</sup> (GM Part No. 1052535). Use new brake fluid from a sealed container only, and always clean the brake fluid reservoir cap before removing it.

### CAUTION:

**With the wrong kind of fluid in your brake system, your brakes may not work well, or they may not even work at all. This could cause a crash. Always use the proper brake fluid.**

## NOTICE:

- **Using the wrong fluid can badly damage brake system parts. For example, just a few drops of mineral-based oil, such as engine oil, in your brake system can damage brake system parts so badly that they'll have to be replaced. Don't let someone put in the wrong kind of fluid.**
- **If you spill brake fluid on your vehicle's painted surfaces, the paint finish can be damaged. Be careful not to spill brake fluid on your vehicle. If you do, wash it off immediately. See "Appearance Care" in the Index.**

## Brake Wear

Your vehicle has front disc brakes and rear drum brakes.

Disc brake pads have built-in wear indicators that make a high-pitched warning sound when the brake pads are worn and new pads are needed. The sound may come and go or be heard all the time your vehicle is moving (except when you are pushing on the brake pedal firmly).

### CAUTION:

**The brake wear warning sound means that sooner or later your brakes won't work well. That could lead to an accident. When you hear the brake wear warning sound, have your vehicle serviced.**

### NOTICE:

**Continuing to drive with worn-out brake pads could result in costly brake repair.**

Some driving conditions or climates may cause a brake squeal when the brakes are first applied or lightly applied. This does not mean something is wrong with your brakes.

Free movement of brake calipers and properly torqued wheel nuts are necessary to help prevent brake pulsation. When tires are rotated, inspect brake calipers for movement, brake pads for wear, and evenly torque wheel nuts in the proper sequence to GM specifications.

Your rear drum brakes don't have wear indicators, but if you ever hear a rear brake rubbing noise, have the rear brake linings inspected. Also, the rear brake drums should be removed and inspected each time the tires are removed for rotation or changing. When you have the front brakes replaced, have the rear brakes inspected, too.

Brake linings should always be replaced as complete axle sets.

## **Brake Pedal Travel**

See your dealer if the brake pedal does not return to normal height, or if there is a rapid increase in pedal travel. This could be a sign of brake trouble.

## **Brake Adjustment**

Every time you make a brake stop, your disc brakes adjust for wear.

If your brake pedal goes down farther than normal, your rear drum brakes may need adjustment. Adjust them by backing up and firmly applying the brakes a few times.

## **Replacing Brake System Parts**

The braking system on a modern vehicle is complex. Its many parts have to be of top quality and work well together if the vehicle is to have really good braking. Vehicles we design and test have top-quality GM brake parts in them, as your vehicle does when it is new. When you replace parts of your braking system -- for example, when your brake linings wear down and you have to have new ones put in -- be sure you get new genuine GM replacement parts. If you don't, your brakes may no longer work properly. For example, if someone puts in brake linings that are wrong for your vehicle, the balance between your front and rear brakes can change -- for the worse. The braking performance you've come to expect can change in many other ways if someone puts in the wrong replacement brake parts.

## **Fluid Leak Check**

After the vehicle has been parked for a while, inspect the surface under the vehicle for water, oil, fuel or other fluids. Water dripping from the air conditioning system after it has been used is normal. If you notice fuel leaks or fumes, the causes should be found and corrected at once.



## Battery

Every new vehicle has a Delco Freedom<sup>®</sup> battery. You never have to add water to one of these. When it's time for a new battery, we recommend a Delco Freedom battery. Get one that has the replacement number shown on the original battery's label.

## Vehicle Storage

If you're not going to drive your vehicle for 25 days or more, take off the black, negative (-) cable from the battery. This will help keep your battery from running down.

### CAUTION:

Batteries have acid that can burn you and gas that can explode. You can be badly hurt if you aren't careful. See "Jump Starting" in the Index for tips on working around a battery without getting hurt.

Contact your dealer to learn how to prepare your vehicle for longer storage periods.

Also, for your audio system, see "Theft-Deterrent Feature" in the Index.

## Bulb Replacement

Before you replace any bulbs, be sure that all the lamps are off and the engine isn't running.

## Halogen Bulbs

### CAUTION:

Halogen bulbs have pressurized gas inside and can burst if you drop or scratch the bulb. You or others could be injured. Be sure to read and follow the instructions on the bulb package.

## Sealed Beam Headlamps



1. Remove the four screws from the headlamp retainer.

2. Pull the headlamp out and remove the retainer.



3. Unplug and remove the headlamp.

4. Plug in the new headlamp and put it in place.
5. Install the retainer to the headlamp and tighten the screws.

## Composite Headlamps



1. Remove the two screws at the top of the radiator support.

2. Pull the headlamp lens assembly out.



3. Unplug the electrical connector.

4. Turn the bulb to the left and remove it.
5. Put the new bulb in the lens assembly and turn it to the right until it is tight.
6. Plug in the electrical connector.
7. Put the headlamp lens assembly back into the vehicle. Install and tighten the two screws.

## Front Parking/Turn Signal Lamps with Sealed Beam Headlamps



1. Remove the two screws at the inside edge of the parking/turn signal lamp assembly.

2. Remove the lamp assembly by swinging it out from the inside edge and sliding it out at the outside edge.



3. Squeeze the tab on the side of the lamp socket while turning the socket to the left.

4. Pull the socket out of the lamp assembly.
5. Push in gently on the bulb, turn it to the left and remove it from the socket.
6. Put the new bulb in the socket, gently press in on the bulb and turn it to the right until it is tight.
7. Put the socket back into the lamp assembly and turn it to the right until it locks.
8. Put the parking/turn signal lamp assembly back into the vehicle and tighten the screws.

## Front Parking/Turn Signal Lamps with Composite Headlamps



1. Remove the screws and take out the parking/turn signal lamp assembly.

2. Squeeze the tab on the side of the lamp socket while turning the socket to the left.



3. Pull the socket out of the lamp assembly.

4. Push in gently on the bulb, turn it to the left and remove it from the socket.
5. Put the new bulb in the socket, gently press in on the bulb and turn it to the right until it is tight.
6. Put the socket back into the lamp assembly and turn it to the right until it locks.
7. Put the parking/turn signal lamp assembly back into the vehicle and tighten the screws.

## Sidemarker Lamps with Sealed Beam and Composite Headlamps



1. Remove the screws and pull out the parking/turn signal lamp assembly.

2. Reach through the opening and turn the sidemarker bulb socket to the left and remove it.



3. Pull the bulb straight out of the socket.

4. Put a new bulb into the socket and push it in until it is tight.
5. Put the socket back into the sidemarker assembly and turn it to the right to tighten it.
6. Replace the parking/turn signal lamp assembly and tighten the screws.

## Center High-Mounted Stoplamp (CHMSL)

The individual bulbs in the CHMSL are not replaceable. See your dealer for assistance.

## Roof Marker Lamps

1. Remove the screws and lift off the lens.
2. Pull the bulb straight out of the socket.
3. Put a new bulb into the socket and push it in until it is tight.
4. Replace the lens and tighten the screws.

## Rear Lamps

1. Open the tailgate or rear doors.
2. Remove the two black plastic plugs in the rear lamp assembly access holes.



3. Remove the two rear lamp assembly screws inside the fender and pull out the lamp assembly. You may want to use a magnetic screwdriver when removing the screws.



4. Remove the screws from the bulb retainer and take the bulb retainer off of the lamp assembly.

5. Pull the old bulb straight out of the socket.
6. Put in a new bulb and push it in until it is tight.
7. Replace the bulb retainer.
8. Replace the rear lamp assembly and tighten the screws. You may want to use a magnetic screwdriver when installing the screws.
9. Close the tailgate or rear doors.

## Windshield Wiper Blade Replacement

For proper type and length, see “Normal Maintenance Replacement Parts” in the Index. To replace the windshield wiper blade assembly:



1. Lift the wiper arm and rotate the blade until it is facing away from the windshield.
2. Push the release lever and slide the wiper assembly toward the driver's side of the vehicle.
3. Install a new blade by reversing Steps 1 and 2.



## Tires

We don't make tires. Your new vehicle comes with high-quality tires made by a leading tire manufacturer. If you ever have questions about your tire warranty and where to obtain service, see your GM Warranty booklet for details.

### CAUTION:

Poorly maintained and improperly used tires are dangerous.

- **Overloading your tires can cause overheating as a result of too much friction. You could have an air-out and a serious accident. See "Loading Your Vehicle" in the Index.**

CAUTION: (Continued)

### CAUTION: (Continued)

- **Underinflated tires pose the same danger as overloaded tires. The resulting accident could cause serious injury. Check all tires frequently to maintain the recommended pressure. Tire pressure should be checked when your tires are cold.**
- **Overinflated tires are more likely to be cut, punctured or broken by a sudden impact -- such as when you hit a pothole. Keep tires at the recommended pressure.**
- **Worn, old tires can cause accidents. If your tread is badly worn, or if your tires have been damaged, replace them.**

## Inflation -- Tire Pressure

The Certification/Tire label, which is on the rear edge of the driver's door, or on the incomplete vehicle document in the cab, shows the correct inflation pressures for your tires when they're cold. "Cold" means your vehicle has been sitting for at least three hours or driven no more than 1 mile (1.6 km).

You can operate some vehicles at reduced inflation pressures only when you'll be carrying reduced loads. On those vehicles, the minimum cold inflation pressures for a typical reduced load are printed on the Improved Ride Tire Pressure label located on the driver's door. Weigh the vehicle to find the load on each tire and see the label for the minimum cold inflation pressures for that load.

### **NOTICE:**

**Don't let anyone tell you that underinflation or overinflation is all right. It's not. If your tires don't have enough air (underinflation), you can get the following:**

- Too much flexing
- Too much heat
- Tire overloading
- Bad wear
- Bad handling
- Bad fuel economy.

**If your tires have too much air (overinflation), you can get the following:**

- Unusual wear
- Bad handling
- Rough ride
- Needless damage from road hazards.

## When to Check

Check your tires once a month or more. Also, check the tire pressure of the spare tire.

## How to Check

Use a good quality pocket-type gage to check tire pressure. You can't tell if your tires are properly inflated simply by looking at them. Radial tires may look properly inflated even when they're underinflated.

Be sure to put the valve caps back on the valve stems. They help prevent leaks by keeping out dirt and moisture.

## Tire Inspection and Rotation

Tires should be inspected every 6,000 to 8,000 miles (10 000 to 13 000 km) for any signs of unusual wear. If unusual wear is present, rotate your tires as soon as possible and check wheel alignment. Also check for damaged tires or wheels. See "When It's Time for New Tires" and "Wheel Replacement" later in this section for more information.

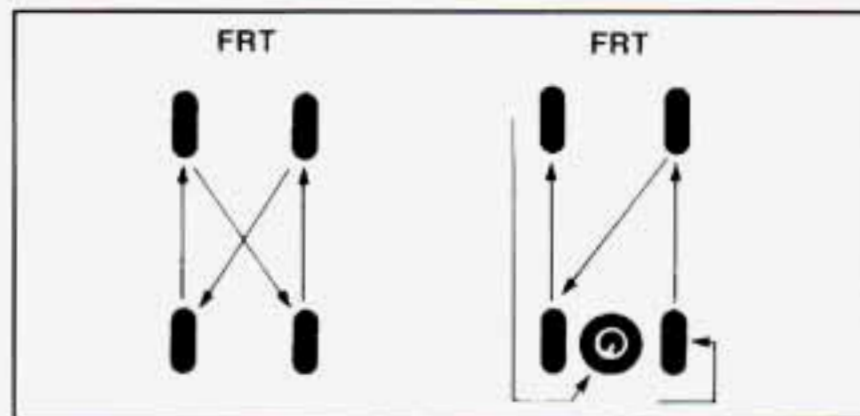

The purpose of regular rotation is to achieve more uniform wear for all tires on the vehicle. The first rotation is the most important. See "Scheduled Maintenance Services" in the Index for scheduled rotation intervals.

When rotating your tires, always use one of the correct rotation patterns shown here.

After the tires have been rotated, adjust the front and rear inflation pressures as shown on the Certification/Tire label. Make certain that all wheel nuts are properly tightened. See "Wheel Nut Torque" in the Index.

## CAUTION:

**Rust or dirt on a wheel, or on the parts to which it is fastened, can make wheel nuts become loose after a time. The wheel could come off and cause an accident. When you change a wheel, remove any rust or dirt from places where the wheel attaches to the vehicle. In an emergency, you can use a cloth or a paper towel to do this; but be sure to use a scraper or wire brush later, if you need to, to get all the rust or dirt off. (See "Changing a Flat Tire" in the Index.)**

## When It's Time for New Tires

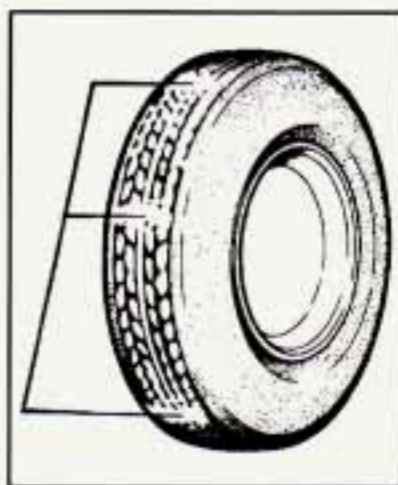

One way to tell when it's time for new tires is to check the treadwear indicators, which will appear when your tires have only 1/16 inch (1.6 mm) or less of tread remaining.

You need a new tire if any of the following statements are true:

- You can see the indicators at three or more places around the tire.
- You can see cord or fabric showing through the tire's rubber.
- The tread or sidewall is cracked, cut or snagged deep enough to show cord or fabric.
- The tire has a bump, bulge or split.

- The tire has a puncture, cut or other damage that can't be repaired well because of the size or location of the damage.

## Buying New Tires

To find out what kind and size of tires you need, look at the Certification/Tire label.

The tires installed on your vehicle when it was new had a Tire Performance Criteria Specification (TPC Spec) number on each tire's sidewall. When you get new tires, get ones with that same TPC Spec number. That way your vehicle will continue to have tires that are designed to give proper endurance, handling, speed rating, traction, ride and other things during normal service on your vehicle. If your tires have an all-season tread design, the TPC number will be followed by an "MS" (for mud and snow).

If you ever replace your tires with those not having a TPC Spec number, make sure they are the same size, load range, speed rating and construction type (bias, bias-belted or radial) as your original tires.

### CAUTION:

**Mixing tires could cause you to lose control while driving. If you mix tires of different sizes or types (radial and bias-belted tires), the vehicle may not handle properly, and you could have a crash. Using tires of different sizes may also cause damage to your vehicle. Be sure to use the same size and type tires on all wheels.**

## Uniform Tire Quality Grading

The following information relates to the system developed by the United States National Highway Traffic Safety Administration, which grades tires by treadwear, traction and temperature performance. (This applies only to vehicles sold in the United States.) The grades are molded on the sidewalls of most passenger car tires. The Uniform Tire Quality Grading system does not apply to deep tread, winter-type snow tires, space-saver or temporary use spare tires, tires with nominal rim diameters of 10 to 12 inches (25 to 30 cm), or to some limited-production tires.

While the tires available on General Motors passenger cars and light trucks may vary with respect to these grades, they must also conform to Federal safety requirements and additional General Motors Tire Performance Criteria (TPC) standards.

## Treadwear

The treadwear grade is a comparative rating based on the wear rate of the tire when tested under controlled conditions on a specified government test course. For example, a tire graded 150 would wear one and a half (1 1/2) times as well on the government course as a tire graded 100. The relative performance of tires depends upon the actual conditions of their use, however, and may depart significantly from the norm due to variations in driving habits, service practices and differences in road characteristics and climate.

## Traction -- A, B, C

The traction grades, from highest to lowest, are A, B, and C, and they represent the tire's ability to stop on wet pavement as measured under controlled conditions on specified government test surfaces of asphalt and concrete. A tire marked C may have poor traction performance.

Warning: The traction grade assigned to this tire is based on braking (straightahead) traction tests and does not include cornering (turning) traction.

## Temperature -- A, B, C

The temperature grades are A (the highest), B, and C, representing the tire's resistance to the generation of heat and its ability to dissipate heat when tested under controlled conditions on a specified indoor laboratory test wheel. Sustained high temperature can cause the material of the tire to degenerate and reduce tire life, and excessive temperature can lead to sudden tire failure. The grade C corresponds to a level of performance which all passenger car tires must meet under the Federal Motor Vehicle Safety Standard No. 109. Grades B and A represent higher levels of performance on the laboratory test wheel than the minimum required by law.

Warning: The temperature grade for this tire is established for a tire that is properly inflated and not overloaded. Excessive speed, underinflation, or excessive loading, either separately or in combination, can cause heat buildup and possible tire failure.

## Wheel Alignment and Tire Balance

The wheels on your vehicle were aligned and balanced carefully at the factory to give you the longest tire life and best overall performance.

In most cases, you will not need to have your wheels aligned again. However, if you notice unusual tire wear or your vehicle pulling one way or the other, the alignment may need to be reset. If you notice your vehicle vibrating when driving on a smooth road, your wheels may need to be rebalanced.

## Wheel Replacement

Replace any wheel that is bent, cracked, or badly rusted or corroded. If wheel nuts keep coming loose, the wheel, wheel bolts and wheel nuts should be replaced. If the wheel leaks air, replace it (except some aluminum wheels, which can sometimes be repaired). See your GM dealer if any of these conditions exist.

Your dealer will know the kind of wheel you need.

Each new wheel should have the same load-carrying capacity, diameter, width, offset and be mounted the same way as the one it replaces.

If you need to replace any of your wheels, wheel bolts or wheel nuts, replace them only with new GM original equipment parts. This way, you will be sure to have the right wheel, wheel bolts and wheel nuts for your vehicle.

 **CAUTION:**

Using the wrong replacement wheels, wheel bolts or wheel nuts on your vehicle can be dangerous. It could affect the braking and handling of your vehicle, make your tires lose air and make you lose control. You could have a collision in which you or others could be injured. Always use the correct wheel, wheel bolts and wheel nuts for replacement.

**NOTICE:**

The wrong wheel can also cause problems with bearing life, brake cooling, speedometer or odometer calibration, headlamp aim, bumper height, vehicle ground clearance and tire or tire chain clearance to the body and chassis.

See “Changing a Flat Tire” in the Index for more information.

Used Replacement Wheels

 **CAUTION:**

Putting a used wheel on your vehicle is dangerous. You can't know how it's been used or how many miles it's been driven. It could fail suddenly and cause an accident. If you have to replace a wheel, use a new GM original equipment wheel.



## Tire Chains

### **NOTICE:**

**If your vehicle has P265/75R16 size tires, don't use tire chains. They can damage your vehicle. If you have a tire size other than P265/75R16, use tire chains only where legal and only when you must. Use chains that are the proper size for your tires. Install them on the tires of the rear axle. Don't use chains on the tires of the front axle. Tighten them as tightly as possible with the ends securely fastened. Drive slowly and follow the chain manufacturer's instructions. If you can hear the chains contacting your vehicle, stop and retighten them. If the contact continues, slow down until it stops. Driving too fast or spinning the wheels with chains on will damage your vehicle.**

## Appearance Care

Remember, cleaning products can be hazardous. Some are toxic. Others can burst into flame if you strike a match or get them on a hot part of the vehicle. Some are dangerous if you breathe their fumes in a closed space. When you use anything from a container to clean your vehicle, be sure to follow the manufacturer's warnings and instructions. And always open your doors or windows when you're cleaning the inside.

*Never* use these to clean your vehicle:

- Gasoline
- Benzene
- Naphtha
- Carbon Tetrachloride
- Acetone
- Paint Thinner
- Turpentine
- Lacquer Thinner
- Nail Polish Remover

They can all be hazardous -- some more than others -- and they can all damage your vehicle, too.

Don't use any of these unless this manual says you can. In many uses, these will damage your vehicle:

- Alcohol
- Laundry Soap
- Bleach
- Reducing Agents

## **Cleaning the Inside of Your Vehicle**

Use a vacuum cleaner often to get rid of dust and loose dirt. Wipe vinyl or leather with a clean, damp cloth.

Your GM dealer has two GM cleaners, a solvent-type spot lifter and a foam-type powdered cleaner. They will clean normal spots and stains very well. Do not use them on vinyl or leather.

Here are some cleaning tips:

- Always read the instructions on the cleaner label.
- Clean up stains as soon as you can -- before they set.
- Use a clean cloth or sponge, and change to a clean area often. A soft brush may be used if stains are stubborn.
- Use solvent-type cleaners in a well-ventilated area only. If you use them, don't saturate the stained area.

- If a ring forms after spot cleaning, clean the entire area immediately or it will set.

## **Using Foam-Type Cleaner on Fabric**

1. Vacuum and brush the area to remove any loose dirt.
2. Always clean a whole trim panel or section. Mask surrounding trim along stitch or welt lines.
3. Mix Multi-Purpose Powdered Cleaner following the directions on the container label.
4. Use suds only and apply with a clean sponge.
5. Don't saturate the material.
6. Don't rub it roughly.
7. As soon as you've cleaned the section, use a sponge to remove the suds.
8. Rinse the section with a clean, wet sponge.
9. Wipe off what's left with a slightly damp paper towel or cloth.
10. Then dry it immediately with a blow dryer.
11. Wipe with a clean cloth.

## Using Solvent-Type Cleaner on Fabric

First, see if you have to use solvent-type cleaner at all. Some spots and stains will clean off better with just water and mild soap.

If you need to use a solvent:

- Gently scrape excess soil from the trim material with a clean, dull knife or scraper. Use very little cleaner, light pressure and clean cloths (preferably cheesecloth). Cleaning should start at the outside of the stain, “feathering” toward the center. Keep changing to a clean section of the cloth.
- When you clean a stain from fabric, immediately dry the area with a blow dryer to help prevent a cleaning ring.

## Fabric Protection

Your vehicle has upholstery and carpet that has been treated with Scotchgard™ Fabric Protector, a 3M product. It protects fabrics by repelling oil and water, which are the carriers of most stains. Even with this protection, you still need to clean your upholstery and carpet often to keep it looking new.

Further information on cleaning is available by calling 1-800-433-3296 (in Minnesota, 1-800-642-6167).

## Special Cleaning Problems

### Greasy or Oily Stains

Stains caused by grease, oil, butter, margarine, shoe polish, coffee with cream, chewing gum, cosmetic creams, vegetable oils, wax crayon, tar and asphalt can be removed as follows:

1. Carefully scrape off excess stain.
2. Follow the solvent-type instructions described earlier.
3. Shoe polish, wax crayon, tar and asphalt will stain if left on a vehicle's seat fabric. They should be removed as soon as possible. Be careful, because the cleaner will dissolve them and may cause them to spread.

### Non-Greasy Stains

Stains caused by catsup, coffee (black), egg, fruit, fruit juice, milk, soft drinks, wine, vomit, urine and blood can be removed as follows:

1. Carefully scrape off excess stain, then sponge the soiled area with cool water.
2. If a stain remains, follow the foam-type instructions described earlier.

3. If an odor lingers after cleaning vomit or urine, treat the area with a water/baking soda solution: 1 teaspoon (5 ml) of baking soda to 1 cup (250 ml) of lukewarm water.
4. If needed, clean lightly with solvent-type cleaner.

### **Combination Stains**

Stains caused by candy, ice cream, mayonnaise, chili sauce and unknown stains can be removed as follows:

- Carefully scrape off excess stain, then clean with cool water and allow to dry.
- If a stain remains, clean it with solvent-type cleaner.

### **Cleaning Vinyl**

Use warm water and a clean cloth.

- Rub with a clean, damp cloth to remove dirt. You may have to do it more than once.
- Things like tar, asphalt and shoe polish will stain if you don't get them off quickly. Use a clean cloth and a GM Vinyl/Leather Cleaner or equivalent product.

### **Cleaning Leather**

Use a soft cloth with lukewarm water and a mild soap or saddle soap.

- For stubborn stains, use a GM Vinyl/Leather Cleaner or equivalent product.
- *Never* use oils, varnishes, solvent-based or abrasive cleaners, furniture polish or shoe polish on leather.
- Soiled leather should be cleaned immediately. If dirt is allowed to work into the finish, it can harm the leather.

### **Cleaning the Top of the Instrument Panel**

Use only mild soap and water to clean the top surfaces of the instrument panel. Sprays containing silicones or waxes may cause annoying reflections in the windshield and even make it difficult to see through the windshield under certain conditions.

## Care of Safety Belts

Keep belts clean and dry.

### CAUTION:

**Do not bleach or dye safety belts. If you do, it may severely weaken them. In a crash, they might not be able to provide adequate protection. Clean safety belts only with mild soap and lukewarm water.**

## Glass

Glass should be cleaned often. GM Glass Cleaner (GM Part No. 1050427) or a liquid household glass cleaner will remove normal tobacco smoke and dust films.

Don't use abrasive cleaners on glass, because they may cause scratches. Avoid placing decals on the inside rear window, since they may have to be scraped off later. If abrasive cleaners are used on the inside of the rear window, an electric defogger element may be damaged. Any temporary license should not be attached across the defogger grid.

## Cleaning the Outside of the Windshield, Backglass and Wiper Blades

If the windshield is not clear after using the windshield washer, or if the wiper blade chatters when running, wax or other material may be on the blade or windshield.

Clean the outside of the windshield with GM Windshield Cleaner, Bon-Ami Powder<sup>®</sup> (GM Part No. 1050011). The windshield is clean if beads do not form when you rinse it with water.

Clean the blade by wiping vigorously with a cloth soaked in full-strength windshield washer solvent. Then rinse the blade with water.

Wiper blades should be checked on a regular basis and replaced when worn.

## Weatherstrips

Silicone grease on weatherstrips will make them last longer, seal better, and not stick or squeak. Apply silicone grease with a clean cloth at least every six months. During very cold, damp weather more frequent application may be required. (See "Recommended Fluids and Lubricants" in the Index.)

## Cleaning the Outside of Your Vehicle

The paint finish on your vehicle provides beauty, depth of color, gloss retention and durability.

### Washing Your Vehicle

The best way to preserve your vehicle's finish is to keep it clean by washing it often with lukewarm or cold water.

Don't wash your vehicle in the direct rays of the sun. Don't use strong soaps or chemical detergents. Use liquid hand, dish or car washing (mild detergent) soaps. Don't use cleaning agents that are petroleum based, or that contain acid or abrasives. All cleaning agents should be flushed promptly and not allowed to dry on the surface, or they could stain. Dry the finish with a soft, clean chamois or a 100% cotton towel to avoid surface scratches and water spotting.

High pressure vehicle washes may cause water to enter your vehicle.

## Finish Care

Occasional waxing or mild polishing of your vehicle by hand may be necessary to remove residue from the paint finish. You can get GM-approved cleaning products from your dealer. (See "Appearance Care and Materials" in the Index.)

Your vehicle has a "basecoat/clearcoat" paint finish. The clearcoat gives more depth and gloss to the colored basecoat. Always use waxes and polishes that are non-abrasive and made for a basecoat/clearcoat paint finish.

### **NOTICE:**

**Machine compounding or aggressive polishing on a basecoat/clearcoat paint finish may dull the finish or leave swirl marks.**

Foreign materials such as calcium chloride and other salts, ice melting agents, road oil and tar, tree sap, bird droppings, chemicals from industrial chimneys, etc., can damage your vehicle's finish if they remain on painted surfaces. Wash the vehicle as soon as possible. If necessary, use non-abrasive cleaners that are marked safe for painted surfaces to remove foreign matter.

Exterior painted surfaces are subject to aging, weather and chemical fallout that can take their toll over a period of years. You can help to keep the paint finish looking new by keeping your vehicle garaged or covered whenever possible.

### **Protecting Exterior Bright Metal Parts**

Bright metal parts should be cleaned regularly to keep their luster. Washing with water is all that is usually needed. However, you may use GM Chrome Polish on chrome or stainless steel trim, if necessary.

Use special care with aluminum trim. To avoid damaging protective trim, never use auto or chrome polish, steam or caustic soap to clean aluminum. A coating of wax, rubbed to high polish, is recommended for all bright metal parts.

### **Aluminum Wheels (If So Equipped)**

Keep your wheels clean using a soft clean cloth with mild soap and water. Rinse with clean water. After rinsing thoroughly, dry with a soft clean towel. A wax may then be applied.

The surface of these wheels is similar to the painted surface of your vehicle. Don't use strong soaps, chemicals, abrasive polishes, abrasive cleaners or abrasive cleaning brushes on them because you could damage the surface.

Don't take your vehicle through an automatic vehicle wash that has silicon carbide tire cleaning brushes. These brushes can also damage the surface of these wheels.

### **Tires**

To clean your tires, use a stiff brush with a tire cleaner.

#### **NOTICE:**

**When applying a tire dressing always take care to wipe off any overspray or splash from all painted surfaces on the body or wheels of the vehicle. Petroleum-based products may damage the paint finish.**

## Sheet Metal Damage

If your vehicle is damaged and requires sheet metal repair or replacement, make sure the body repair shop applies anti-corrosion material to the parts repaired or replaced to restore corrosion protection.

## Finish Damage

Any stone chips, fractures or deep scratches in the finish should be repaired right away. Bare metal will corrode quickly and may develop into a major repair expense.

Minor chips and scratches can be repaired with touch-up materials available from your dealer or other service outlets. Larger areas of finish damage can be corrected in your dealer's body and paint shop.

## Underbody Maintenance

Chemicals used for ice and snow removal and dust control can collect on the underbody. If these are not removed, accelerated corrosion (rust) can occur on the underbody parts such as fuel lines, frame, floor pan and exhaust system even though they have corrosion protection.

At least every spring, flush these materials from the underbody with plain water. Clean any areas where mud and other debris can collect. Dirt packed in closed areas of the frame should be loosened before being flushed. Your dealer or an underbody vehicle washing system can do this for you.

## Chemical Paint Spotting

Some weather and atmospheric conditions can create a chemical fallout. Airborne pollutants can fall upon and attack painted surfaces on your vehicle. This damage can take two forms: blotchy, ringlet-shaped discolorations, and small irregular dark spots etched into the paint surface.

Although no defect in the paint job causes this, GM will repair, at no charge to the owner, the surfaces of new vehicles damaged by this fallout condition within 12 months or 12,000 miles (20 000 km) of purchase, whichever occurs first.



## Appearance Care Materials Chart

PART NUMBER	SIZE	DESCRIPTION	USAGE
1050004	2.75 sq. ft.	Chamois	Shines vehicle without scratching
1050172	16 oz. (0.473 L)	Tar and Road Oil Remover	Also removes old waxes and polishes
1050173	16 oz. (0.473 L)	Chrome Cleaner and Polish	Removes rust and corrosion
1050174	16 oz. (0.473 L)	White Sidewall Tire Cleaner	Removes soil and black marks
1050201	16 oz. (0.473 L)	Magic Mirror Cleaner Polish	Exterior cleaner and polish
1050214	32 oz. (0.946 L)	Vinyl and Leather Cleaner	Spot and stain removal
1050427	23 oz. (0.680 L)	Glass Cleaner	Cleans grease, grime and smoke film
1050429	6 lbs. (2.72 kg)	Multi-Purpose Powdered Cleaner	Cleans vinyl, cloth, tires and mats
1051398*	8 oz. (0.237 L)	Spot Lifter	For cloth
1051515	32 oz. (0.946 L)	Optikleen®	Windshield washer solvent and antifreeze
1052870	16 oz. (0.473 L)	Wash and Wax Concentrate	Exterior wash
1052918**	8 oz. (0.237 L)	Armor All™ Protector	Protects vinyl, leather and rubber
1052929	16 oz. (0.473 L)	Wheel Cleaner	Spray on wheel cleaner
1052930	8 oz. (0.237 L)	Capture Dry Spot Remover	Attracts and absorbs soils
12345002**	16 oz. (0.473 L)	Armor All™ Cleaner	Cleans vinyl, leather and rubber
12345725	12 oz. (0.354 L)	Silicone Tire Shine	Shines tires
See your General Motors Parts Department for these products. See "Fluids and Lubricants" in the Index.		* Not recommended for pigskin suede leather. ** Not recommended for use on instrument panel vinyl.	

## Vehicle Identification Number (VIN)

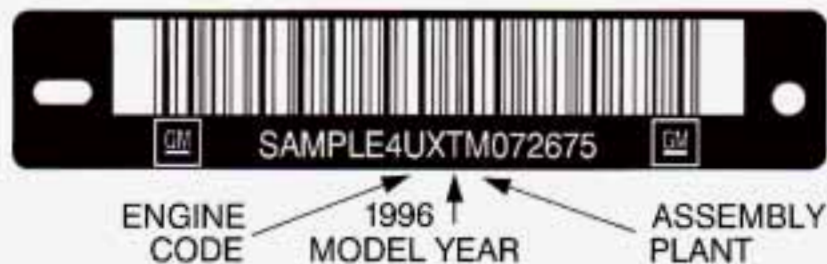

This is the legal identifier for your vehicle. It appears on a plate in the front corner of the instrument panel, on the driver's side. You can see it if you look through the windshield from outside your vehicle. The VIN also appears on the Vehicle Certification and Service Parts labels and the certificates of title and registration.

### Engine Identification

The eighth character in your VIN is the engine code. This code will help you identify your engine, specifications and replacement parts.

## Service Parts Identification Label

You'll find this label on the inside of the glove box. It's very helpful if you ever need to order parts. On this label is:

- your VIN,
- the model designation,
- paint information, and
- a list of all production options and special equipment.

Be sure that this label is not removed from the vehicle.

## Electrical System

### Add-On Electrical Equipment

#### **NOTICE:**

**Don't add anything electrical to your vehicle unless you check with your dealer first. Some electrical equipment can damage your vehicle and the damage wouldn't be covered by your warranty. Some add-on electrical equipment can keep other components from working as they should.**

Your vehicle has an air bag system. Before attempting to add anything electrical to your vehicle, see "Servicing Your Air Bag-Equipped Vehicle" in the Index.

## Headlamps

The headlamp wiring is protected by a circuit breaker in the lamp switch. An electrical overload will cause the lamps to flicker on and off, or in some cases to remain off. If this happens, have your headlamp wiring checked right away.

## Windshield Wipers

The windshield wiper motor is protected by a circuit breaker and a fuse. If the motor overheats due to heavy snow, etc., the wiper will stop until the motor cools. Although the circuit is protected from electrical overload, overload due to heavy snow, etc., may cause wiper linkage damage. Always clear ice and heavy snow from the the windshield before using the windshield wipers. If the overload is caused by some electrical problem and not snow, etc., be sure to get it fixed.

## **Power Windows and Other Power Options**

Circuit breakers in the fuse panel protect the power windows and other power accessories. When the current load is too heavy, the circuit breaker opens and closes. This protects the circuit until the current load returns to normal or the problem is fixed.

## **Fuses and Circuit Breakers**

The wiring circuits in your vehicle are protected from short circuits by a combination of fuses, circuit breakers and fusible thermal links in the wiring itself. This greatly reduces the chance of fires caused by electrical problems. See "Fuses and Circuit Breakers" in the Index for more information.

Look at the silver-colored band inside the fuse. If the band is broken or melted, replace the fuse. Be sure you replace a bad fuse with a new one of the identical size and rating.

If you ever have a problem on the road and don't have a spare fuse, you can borrow one that has the same amperage. Just pick some feature of your vehicle that you can get along without -- like the radio or cigarette lighter -- and use its fuse, if it is the correct amperage. Replace it as soon as you can.

## Instrument Panel Fuse Block



The fuse block access door is on the driver's side edge of the instrument panel. Pull off the cover to access the fuse block.

You can remove fuses with a fuse extractor. The fuse extractor is mounted to the fuse block access door.

To remove fuses if you don't have a fuse extractor, hold the end of the fuse between your thumb and index finger and pull straight out.

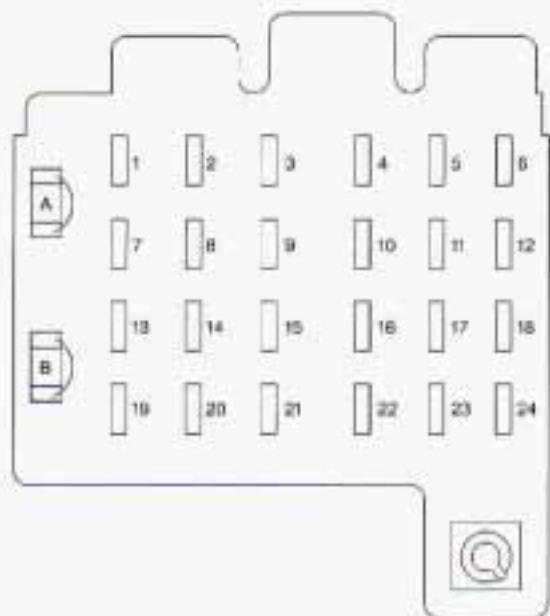

Fuse	Usage
1	Stop/TCC Switch, Buzzer, CHMSL, Hazard Lamps, Stoplamps
2	Transfer Case

Fuse	Usage
3	Courtesy Lamps, Cargo Lamp, Glove Box Lamp, Dome/Reading Lamps, Vanity Mirrors, Power Mirrors
4	Instrument Cluster, DRL Relay, Lamp Switch, Keyless Entry, Low Coolant Module, Illuminated Entry Module, DRAC (Diesel Engine)
5	Rear Comfort Controls
6	Cruise Control
7	Auxiliary Power Outlet
8	Air Bag System
9	License Lamp, Parking Lamps, Taillamps, Roof Marker Lamps, Tailgate Lamps, Front Sidemarkers, Fog Lamp Relay, Door Switch Illumination, Fender Lamps, Headlamp Switch Illumination
10	Air Bag System
11	Wiper Motor, Washer Pump
12	A/C, A/C Blower, High Blower Relay

<b>Fuse</b>	<b>Usage</b>	<b>Fuse</b>	<b>Usage</b>
13 .....	Power Amp, Rear Liftglass, Cigarette Lighter, Door Lock Relay, Power Lumbar Seat	20 .....	PRNDL, Automatic Transmission, Speedometer, Check Gages, Warning Lights
14 .....	4WD Indicator, Cluster, Front and Rear Comfort Controls, Instrument Switches, Radio Illumination, Chime Module	21 .....	Not Used
15 .....	DRL Relay, Fog Lamp Relay	22 .....	Not Used
16 .....	Front and Rear Turn Signals, Back-Up Lamps, BTSI Solenoid	23 .....	Rear Wiper, Rear Washer Pump
17 .....	Radio (Ignition)	24 .....	Front Axle, 4WD Indicator Lamp, TP2 Relay (Gasoline Engine)
18 .....	4WAL/VCM, ABS, Cruise Control	A .....	Power Door Lock, Six-Way Power Seat, Keyless Entry Module
19 .....	Radio (Battery)	B .....	Power Windows

## Underhood Fuse/Relay Center



The underhood fuse/relay center is located in the rear of the engine compartment near the brake fluid reservoir. Move the retainer clips for the cover to access the fuse block.

You can remove fuses with a fuse extractor. The fuse extractor is mounted to the interior fuse block. To remove fuses if you don't have a fuse extractor, hold the end of the fuse between your thumb and index finger and pull straight out.



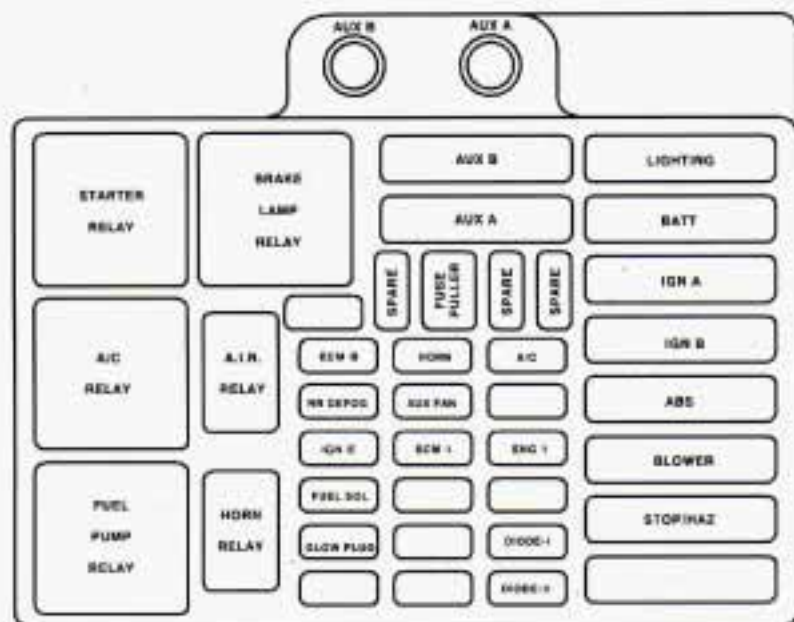

Fuse	Usage
ECM-B . . . . .	Fuel Pump, PCM/VCM
RR DEFOG . . .	Rear Window Defogger
IGN-E . . . . .	Auxiliary Fan Relay Coil, A/C Compressor Relay, Hot Fuel Module

Fuse	Usage
FUEL SOL . . . .	Fuel Solenoid (Diesel Engine)
GLOW PLUG . .	Glow plugs (Diesel Engine)
HORN . . . . .	Horn, Underhood Lamps
AUX FAN . . . .	Auxiliary Fan
ECM-1 . . . . .	Injectors, PCM/VCM
A/C . . . . .	Air Conditioning
ENG-1 . . . . .	Ignition Switch, EGR, Canister Purge, EVRV Idle Coast Solenoid, Heated O <sub>2</sub> , Fuel Heater (Diesel Engine), Water Sensor (Diesel Engine)
LIGHTING . . .	Headlamp and Panel Dimmer Switch, Fog and Courtesy Fuses
BATT . . . . .	Battery, Fuse Block Busbar
IGN-A . . . . .	Ignition Switch
IGN-B . . . . .	Ignition Switch
ABS . . . . .	Anti-Lock Brake Module
BLOWER . . . .	Hi Blower and Rear Blower Relays

## Replacement Bulbs

LAMP OR BULB	TRADE NO.	POWER RATING AT 12.8V, WATTS	QTY
<b>HEADLAMPS</b>			
<b>2 Headlamp System (Sealed Beam)</b>			
Low/High Beam	H6054	35/65	2
<b>4 Headlamp System (Composite)</b>			
Low/High Beam	6052	55/65	2
High Beam	9005	65	2

LAMP OR BULB	TRADE NO.	QTY
<b>EXTERIOR</b>		
Front Marker Lamp	194	2
Front Parking and Turn Lamp	2357NA	4
Rear Parking Lamp	3057	2
Rear Stop and Turn Lamp	3057	2
Back-up Lamp	3156	2
Roof Marker Lamp*	194	5
License Plate Lamp	194	2
Underhood Lamp	232	1
Reel Lamp	232	1

\*Suburban Only

LAMP OR BULB	TRADE NO.	QTY
<b>INTERIOR</b>		
Dome Lamps	211-2	2
Reading Lamps	211-2	4
Roof Console Lamps*	168	2
Door Courtesy Lamp	194	2/4*
Four-Wheel-Drive Indicator	194	1
Four-Wheel-Drive Shift Lever	194	1
Instrument Panel Compartment Lamp	194	1
Ashtray Lamp	194	1
Sunshade Vanity Mirror	74	4

\*Suburban Only

## Capacities and Specifications

### Engine Identification -- Gasoline Engines

Engine	“VORTEC” 5700	“VORTEC” 7400
Type	V8	V8
RPO Code	L31	L29
VIN Code	R	J
Fuel System	SFI*	SFI*

\* Sequential Fuel Injection

### Wheels and Tires

MODEL	DESCRIPTION	TORQUE
C 1500	5 bolts (14 mm)	140 lb-ft (190 N·m)
K 1500, C-K 2500	6 bolts (14 mm)	140 lb-ft (190 N·m)
C-K 2500	8 bolts (14 mm)	140 lb-ft (190 N·m)
Tire Pressure	See the Certification/Tire label on the rear edge of the driver's door or the incomplete vehicle document in the cab.	

## Normal Maintenance Replacement Parts -- Gasoline Engines

Replacement part numbers listed in this section are based on the latest information available at the time of printing, and are subject to change. If a part listed in this manual is not the same as the part used in your vehicle when it was built, or if you have any questions, please contact your GM truck dealer.

Engine	“VORTEC” 5700	“VORTEC” 7400
VIN	R	J
Oil Filter	PF1218†	PF1218
Air Cleaner Filter	A1300C	A1300C
Spark Plugs*	41-932	41-932
Spark Plug Gap	0.060 in. (1.52 mm)	0.060 in. (1.52 mm)
Fuel Filter	GF626	GF626
Wiper Blades (Front)	22154886	22154886
Wiper Blade Type (Front)	Trico	Trico
Wiper Blade Length (Front)	18 inches (45.0 cm)	18 inches (45.0 cm)
Wiper Blade (Rear)	22154396	22154396
Wiper Blade Type (Rear)	Trico	Trico
Wiper Blade Length (Rear)	14 inches (35.5 cm)	14 inches (35.5 cm)

†Four-Wheel-Drive Vehicles -- use a PF52 oil filter.

## Cooling System Capacity (Approximate)

After refill, the level must be rechecked. See “Cooling System” in the Index.

ENGINE	VIN	QTY Without Rear Heater	QTY With Rear Heater
“VORTEC” 5700	R	17.5 Quarts (16.5 L)	20 Quarts (19 L)
“VORTEC” 7400	J	25 Quarts (23.5 L)	27.5 Quarts (26 L)

## Crankcase Capacity (Approximate)

After refill, the level must be rechecked. See “Engine Oil” in the Index.

ENGINE	VIN	QUANTITY WITH FILTER†
“VORTEC” 5700	R	5 Quarts (4.8 L)
“VORTEC” 7400	J	7 Quarts (6.5 L)

†Oil filter should be changed at every oil change.

## Fuel Tank Capacity (Approximate)

TYPE	QUANTITY
Gasoline/Diesel	
Utility Model - Standard	30 Gallons (113 L)
Wagon Model - Standard	42 Gallons (159 L)

## Air Conditioning Refrigerants

Not all air conditioning refrigerants are the same. If the air conditioning system in your vehicle needs refrigerant, be sure the proper refrigerant is used. If you're not sure, ask your GM dealer.

See refrigerant charge label under the hood for charge capacity information and requirements.

## NOTES



## Section 7 Maintenance Schedule

---

---

**IMPORTANT:**  
KEEP ENGINE OIL  
AT THE PROPER  
LEVEL AND CHANGE AS  
RECOMMENDED

This section covers the maintenance required for your vehicle. Your vehicle needs these services to retain its safety, dependability and emission control performance.



***Protection  
Plan***

*Have you purchased the GM Protection Plan? The Plan supplements your new vehicle warranties. See your Warranty and Owner Assistance booklet, or your GM dealer for details.*

### Introduction

#### Your Vehicle and the Environment

Proper vehicle maintenance not only helps to keep your vehicle in good working condition, but also helps the environment. All recommended maintenance procedures are important. Improper vehicle maintenance can even affect the quality of the air we breathe. Improper fluid levels or the wrong tire inflation can increase the level of emissions from your vehicle. To help protect our environment, and to keep your vehicle in good condition, please maintain your vehicle properly.

## How This Section is Organized

The remainder of this section is divided into five parts:

**“Part A: Scheduled Maintenance Services”** shows what to have done and how often. Some of these services can be complex, so unless you are technically qualified and have the necessary equipment, you should let your dealer’s service department or another qualified service center do these jobs.



### CAUTION:

**Performing maintenance work on a vehicle can be dangerous. In trying to do some jobs, you can be seriously injured. Do your own maintenance work only if you have the required know-how and the proper tools and equipment for the job. If you have any doubt, have a qualified technician do the work.**

If you are skilled enough to do some work on your vehicle, you will probably want to get the service information GM publishes. See “Service and Owner Publications” in the Index.

**“Part B: Owner Checks and Services”** tells you what should be checked whenever you stop for fuel. It also explains what you can easily do to help keep your vehicle in good condition.

**“Part C: Periodic Maintenance Inspections”** explains important inspections that your GM dealer’s service department or another qualified service center should perform.

**“Part D: Recommended Fluids and Lubricants”** lists some products GM recommends to help keep your vehicle properly maintained. These products, or their equivalents, should be used whether you do the work yourself or have it done.

**“Part E: Maintenance Record”** provides a place for you to record the maintenance performed on your vehicle. Whenever any maintenance is performed, be sure to write it down in this part. This will help you determine when your next maintenance should be done. In addition, it is a good idea to keep your maintenance receipts. They may be needed to qualify your vehicle for warranty repairs.

## Part A: Scheduled Maintenance Services

### Using Your Maintenance Schedule

We at General Motors want to help you keep your vehicle in good working condition. But we don't know exactly how you'll drive it. You may drive very short distances only a few times a week. Or you may drive long distances all the time in very hot, dusty weather. You may use your vehicle in making deliveries. Or you may drive it to work, to do errands or in many other ways.

Because of all the different ways people use their GM vehicles, maintenance needs vary. You may even need more frequent checks and replacements than you'll find in the schedules in this section. So please read this section and note how you drive. If you have any questions on how to keep your vehicle in good condition, see your GM dealer.

This part tells you the maintenance services you should have done and when you should schedule them. If you go to your dealer for your service needs, you'll know that GM-trained and supported service people will perform the work using genuine GM parts.

The proper fluids and lubricants to use are listed in Part D. Make sure whoever services your vehicle uses these.

All parts should be replaced and all necessary repairs done before you or anyone else drives the vehicle.

These schedules are for vehicles that:

- carry passengers and cargo within recommended limits. You will find these limits on your vehicle's Certification/Tire label. See "Loading Your Vehicle" in the Index.
- are driven on reasonable road surfaces within legal driving limits.
- are driven off-road in the recommended manner. See "Off-Road Driving With Your Four-Wheel-Drive Vehicle" in the Index.
- use the recommended fuel. See "Fuel" in the Index.

### Selecting the Right Schedule

First you'll need to decide which of the two schedules is right for your vehicle. Here's how to decide which schedule to follow:

Gasoline engine vehicles and diesel engine vehicles have different maintenance requirements. If you have a diesel engine, follow a schedule designated for diesel engine vehicles only.

See the Diesel Engine Supplement for diesel engine maintenance schedules.

# Maintenance Schedule

## Short Trip/City Definition -- Gasoline Engines

Follow the Short Trip/City Maintenance Schedule if any one of these conditions is true for your vehicle:

- Most trips are less than 5 to 10 miles (8 to 16 km). This is particularly important when outside temperatures are below freezing.
- Most trips include extensive idling (such as frequent driving in stop-and-go traffic).
- You operate your vehicle in dusty areas or off-road frequently.
- You frequently tow a trailer or use a carrier on top of your vehicle.
- If the vehicle is used for delivery service, police, taxi or other commercial application.

*One of the reasons you should follow this schedule if you operate your vehicle under any of these conditions is that these conditions cause engine oil to break down sooner.*

## Short Trip/City Intervals -- Gasoline Engines

**Every 3,000 Miles (5 000 km):** Engine Oil and Filter Change (or 3 months, whichever occurs first). Chassis Lubrication (or 3 months, whichever occurs first). Drive Axle Service (or 3 months, whichever occurs first).

**At 6,000 Miles (10 000 km) -- Then Every 12,000 Miles (20 000 km):** Tire Rotation.

**Every 15,000 Miles (25 000 km):** Shields and Underhood Insulation Inspection (GVWR above 8,500 lbs. only). Thermostatically Controlled Engine Cooling Fan Check (or every 12 months, whichever occurs first). Front Wheel Bearing Repack (2WD only) (or at each brake relining, whichever occurs first).

**Every 30,000 Miles (50 000 km):** Fuel Filter Replacement.

**Every 50,000 Miles (83 000 km):** Automatic Transmission Service (severe conditions only).

**Every 60,000 Miles (100 000 km):** Engine Accessory Drive Belt Inspection. Fuel Tank, Cap and Lines Inspection. Exhaust Gas Recirculation System Inspection. Evaporative Control System Inspection.

**Every 100,000 Miles (166 000 km):** Cooling System Service (or every 60 months, whichever occurs first). Spark Plug Wire Inspection. Spark Plug Replacement. Positive Crankcase Ventilation (PCV) Valve Inspection.

*These intervals only summarize maintenance services. Be sure to follow the complete maintenance schedule on the following pages.*

# Maintenance Schedule

## Long Trip/Highway Definition -- Gasoline Engines

Follow this maintenance schedule *only* if none of the conditions from the Short Trip/City Maintenance Schedule is true.

*Driving a vehicle with a fully warmed engine under highway conditions causes engine oil to break down slower.*

## Long Trip/Highway Intervals -- Gasoline Engines

**Every 7,500 Miles (12 500 km):** Engine Oil and Filter Change (or every 12 months, whichever occurs first). Chassis Lubrication (or every 12 months, whichever occurs first). Drive Axle Service.

**At 7,500 Miles (12 500 km) -- Then Every 15,000 Miles (25 000 km):** Tire Rotation.

**Every 15,000 Miles (25 000 km):** Shields and Underhood Insulation Inspection (GVWR above 8,500 lbs. only). Thermostatically Controlled Engine Cooling Fan Check (or every 12 months, whichever occurs first).

**Every 30,000 Miles (50 000 km):** Fuel Filter Replacement. Front Wheel Bearing Repack (2WD only) (or at each brake relining, whichever occurs first).

**Every 50,000 Miles (83 000 km):** Automatic Transmission Service (severe conditions only).

**Every 60,000 Miles (100 000 km):** Engine Accessory Drive Belt Inspection. Fuel Tank, Cap and Lines Inspection. Exhaust Gas Recirculation System Inspection. Evaporative Control System Inspection.

**Every 100,000 Miles (166 000 km):** Cooling System Service (or every 60 months, whichever occurs first). Spark Plug Wire Inspection. Spark Plug Replacement. Positive Crankcase Ventilation (PCV) Valve Inspection.

*These intervals only summarize maintenance services. Be sure to follow the complete maintenance schedule on the following pages.*

## Short Trip/City Maintenance Schedule -- Gasoline Engines

The services shown in this schedule up to 100,000 miles (166 000 km) should be performed after 100,000 miles (166 000 km) at the same intervals.

### Footnotes

† The U.S. Environmental Protection Agency or the California Air Resources Board has determined that the failure to perform this maintenance item will not nullify the emission warranty or limit recall liability prior to the completion of the vehicle's useful life. We, however, urge that all recommended maintenance services be performed at the indicated intervals and the maintenance be recorded.

# Lubricate the front suspension, kingpin bushings, steering linkage, transmission shift linkage, transfer case shift linkage, parking brake cable guides, front axle propshaft splines and brake pedal springs. Ball joints and kingpin bushings should not be lubricated unless their temperature is 10°F (-12°C), or higher, or they could be damaged.

\*\* Drive axle service:

- Locking Differential -- Drain fluid and refill at first engine oil change. At subsequent oil changes, check fluid level and add fluid as needed. If driving in dusty areas or towing a trailer, drain fluid and refill every 15,000 miles (25 000 km).
- Standard Differential -- Check fluid level and add fluid as needed at every oil change. If driving in dusty areas or towing a trailer, drain fluid and refill every 15,000 miles (25 000 km).
- More frequent lubrication may be required for heavy-duty or off-road use.

## Short Trip/City Maintenance Schedule -- Gasoline Engines

### 3,000 Miles (5 000 km)

- Change engine oil and filter (or every 3 months, whichever occurs first).  
*An Emission Control Service.*
- Lubricate chassis components; see footnote # (or every 3 months, whichever occurs first).
- Check rear/front axle fluid level and add fluid as needed. Check constant velocity joints and axle seals for leaking. \*\*

DATE	ACTUAL MILEAGE	SERVICED BY:

### 6,000 Miles (10 000 km)

- Change engine oil and filter (or every 3 months, whichever occurs first).  
*An Emission Control Service.*
- Lubricate chassis components; see footnote # (or every 3 months, whichever occurs first).
- Check rear/front axle fluid level and add fluid as needed. Check constant velocity joints and axle seals for leaking. \*\*
- Rotate tires. See "Tire Inspection and Rotation" in the Index for proper rotation pattern and additional information. During tire rotation, check brake calipers for freedom of movement. Refer to the appropriate GM service manual for proper caliper service procedures.

DATE	ACTUAL MILEAGE	SERVICED BY:

## Short Trip/City Maintenance Schedule -- Gasoline Engines

### *9,000 Miles (15 000 km)*

- Change engine oil and filter (or every 3 months, whichever occurs first).  
*An Emission Control Service.*
- Lubricate chassis components; see footnote # (or every 3 months, whichever occurs first).
- Check rear/front axle fluid level and add fluid as needed. Check constant velocity joints and axle seals for leaking. \*\*

DATE	ACTUAL MILEAGE	SERVICED BY:

### *12,000 Miles (20 000 km)*

- Change engine oil and filter (or every 3 months, whichever occurs first).  
*An Emission Control Service.*
- Lubricate chassis components; see footnote # (or every 3 months, whichever occurs first).
- Check rear/front axle fluid level and add fluid as needed. Check constant velocity joints and axle seals for leaking. \*\*

DATE	ACTUAL MILEAGE	SERVICED BY:



## Short Trip/City Maintenance Schedule -- Gasoline Engines

### *15,000 Miles (25 000 km)*

- Change engine oil and filter (or every 3 months, whichever occurs first).  
*An Emission Control Service.*
- Lubricate chassis components; see footnote # (or every 3 months, whichever occurs first).
- Check rear/front axle fluid level and add fluid as needed. Check constant velocity joints and axle seals for leaking. \*\*
- For Two-Wheel-Drive vehicles only: Clean and repack the front wheel bearings (or at each brake relining, whichever occurs first).
- Vehicles With GVWR Above 8,500 lbs. Only: Inspect shields and underhood insulation for damage or looseness. Adjust or replace as required. *This is a Noise Emission Control Service. Applicable only to vehicles sold in the United States.*

- If your engine has a thermostatically controlled cooling fan, inspect all hoses and ducts for proper hook-up (or every 12 months, whichever occurs first). Be sure the valve works properly. *This is a Noise Emission Control Service. Applicable only to vehicles sold in the United States.*

DATE	ACTUAL MILEAGE	SERVICED BY:

## Short Trip/City Maintenance Schedule -- Gasoline Engines

### *18,000 Miles (30 000 km)*

- Change engine oil and filter (or every 3 months, whichever occurs first).  
*An Emission Control Service.*
- Lubricate chassis components; see footnote # (or every 3 months, whichever occurs first).
- Check rear/front axle fluid level and add fluid as needed. Check constant velocity joints and axle seals for leaking. \*\*
- Rotate tires. See "Tire Inspection and Rotation" in the Index for proper rotation pattern and additional information. During tire rotation, check brake calipers for freedom of movement. Refer to the appropriate GM service manual for proper caliper service procedures.

DATE	ACTUAL MILEAGE	SERVICED BY:

### *21,000 Miles (35 000 km)*

- Change engine oil and filter (or every 3 months, whichever occurs first).  
*An Emission Control Service.*
- Lubricate chassis components; see footnote # (or every 3 months, whichever occurs first).
- Check rear/front axle fluid level and add fluid as needed. Check constant velocity joints and axle seals for leaking. \*\*

DATE	ACTUAL MILEAGE	SERVICED BY:

## Short Trip/City Maintenance Schedule -- Gasoline Engines

### 24,000 Miles (40 000 km)

- Change engine oil and filter (or every 3 months, whichever occurs first).  
*An Emission Control Service.*
- Lubricate chassis components; see footnote # (or every 3 months, whichever occurs first).
- Check rear/front axle fluid level and add fluid as needed. Check constant velocity joints and axle seals for leaking. \*\*

DATE	ACTUAL MILEAGE	SERVICED BY:

### 27,000 Miles (45 000 km)

- Change engine oil and filter (or every 3 months, whichever occurs first).  
*An Emission Control Service.*
- Lubricate chassis components; see footnote # (or every 3 months, whichever occurs first).
- Check rear/front axle fluid level and add fluid as needed. Check constant velocity joints and axle seals for leaking. \*\*

DATE	ACTUAL MILEAGE	SERVICED BY:

## Short Trip/City Maintenance Schedule -- Gasoline Engines

### 30,000 Miles (50 000 km)

- Change engine oil and filter (or every 3 months, whichever occurs first).  
*An Emission Control Service.*
- Lubricate chassis components; see footnote # (or every 3 months, whichever occurs first).
- Check rear/front axle fluid level and add fluid as needed. Check constant velocity joints and axle seals for leaking. \*\*
- For Two-Wheel-Drive vehicles only: Clean and repack the front wheel bearings (or at each brake relining, whichever occurs first).
- Replace fuel filter. *An Emission Control Service.* †
- Vehicles With GVWR Above 8,500 lbs. Only: Inspect shields and underhood insulation for damage or looseness. Adjust or replace as required. *This is a Noise Emission Control Service. Applicable only to vehicles sold in the United States.*

- If your engine has a thermostatically controlled cooling fan, inspect all hoses and ducts for proper hook-up (or every 12 months, whichever occurs first). Be sure the valve works properly. *This is a Noise Emission Control Service. Applicable only to vehicles sold in the United States.*
- Rotate tires. See "Tire Inspection and Rotation" in the Index for proper rotation pattern and additional information. During tire rotation, check brake calipers for freedom of movement. Refer to the appropriate GM service manual for proper caliper service procedures.

DATE	ACTUAL MILEAGE	SERVICED BY:

## Short Trip/City Maintenance Schedule -- Gasoline Engines

### 33,000 Miles (55 000 km)

- Change engine oil and filter (or every 3 months, whichever occurs first).  
*An Emission Control Service.*
- Lubricate chassis components; see footnote # (or every 3 months, whichever occurs first).
- Check rear/front axle fluid level and add fluid as needed. Check constant velocity joints and axle seals for leaking. \*\*

DATE	ACTUAL MILEAGE	SERVICED BY:

### 36,000 Miles (60 000 km)

- Change engine oil and filter (or every 3 months, whichever occurs first).  
*An Emission Control Service.*
- Lubricate chassis components; see footnote # (or every 3 months, whichever occurs first).
- Check rear/front axle fluid level and add fluid as needed. Check constant velocity joints and axle seals for leaking. \*\*

DATE	ACTUAL MILEAGE	SERVICED BY:

## Short Trip/City Maintenance Schedule -- Gasoline Engines

### *39,000 Miles (65 000 km)*

- Change engine oil and filter (or every 3 months, whichever occurs first).  
*An Emission Control Service.*
- Lubricate chassis components; see footnote # (or every 3 months, whichever occurs first).
- Check rear/front axle fluid level and add fluid as needed. Check constant velocity joints and axle seals for leaking. \*\*

DATE	ACTUAL MILEAGE	SERVICED BY:

### *42,000 Miles (70 000 km)*

- Change engine oil and filter (or every 3 months, whichever occurs first).  
*An Emission Control Service.*
- Lubricate chassis components; see footnote # (or every 3 months, whichever occurs first).
- Check rear/front axle fluid level and add fluid as needed. Check constant velocity joints and axle seals for leaking. \*\*
- Rotate tires. See "Tire Inspection and Rotation" in the Index for proper rotation pattern and additional information. During tire rotation, check brake calipers for freedom of movement. Refer to the appropriate GM service manual for proper caliper service procedures.

DATE	ACTUAL MILEAGE	SERVICED BY:

## Short Trip/City Maintenance Schedule -- Gasoline Engines

### 45,000 Miles (75 000 km)

- Change engine oil and filter (or every 3 months, whichever occurs first).

*An Emission Control Service.*

- Lubricate chassis components; see footnote # (or every 3 months, whichever occurs first).

- Check rear/front axle fluid level and add fluid as needed. Check constant velocity joints and axle seals for leaking. \*\*

- For Two-Wheel-Drive vehicles only: Clean and repack the front wheel bearings (or at each brake relining, whichever occurs first).

- Vehicles With GVWR Above 8,500 lbs. Only: Inspect shields and underhood insulation for damage or looseness. Adjust or replace as required. *This is a Noise Emission Control Service. Applicable only to vehicles sold in the United States.*

- If your engine has a thermostatically controlled cooling fan, inspect all hoses and ducts for proper hook-up (or every 12 months, whichever occurs first). Be sure the valve works properly. *This is a Noise Emission Control Service. Applicable only to vehicles sold in the United States.*

DATE	ACTUAL MILEAGE	SERVICED BY:

## Short Trip/City Maintenance Schedule -- Gasoline Engines

### *48,000 Miles (80 000 km)*

- Change engine oil and filter (or every 3 months, whichever occurs first).  
*An Emission Control Service.*
- Lubricate chassis components; see footnote # (or every 3 months, whichever occurs first).
- Check rear/front axle fluid level and add fluid as needed. Check constant velocity joints and axle seals for leaking. \*\*

DATE	ACTUAL MILEAGE	SERVICED BY:

### *50,000 Miles (83 000 km)*

- Change automatic transmission fluid and filter if the vehicle is mainly driven under one or more of these conditions:
  - In heavy city traffic where the outside temperature regularly reaches 90°F (32°C) or higher.
  - In hilly or mountainous terrain.
  - When doing frequent trailer towing.
  - Uses such as found in taxi, police or delivery service.

*If you do not use your vehicle under any of these conditions, the fluid and filter do not require changing.*

DATE	ACTUAL MILEAGE	SERVICED BY:



## Short Trip/City Maintenance Schedule -- Gasoline Engines

### *51,000 Miles (85 000 km)*

- Change engine oil and filter (or every 3 months, whichever occurs first).  
*An Emission Control Service.*
- Lubricate chassis components; see footnote # (or every 3 months, whichever occurs first).
- Check rear/front axle fluid level and add fluid as needed. Check constant velocity joints and axle seals for leaking. \*\*

DATE	ACTUAL MILEAGE	SERVICED BY:

### *54,000 Miles (90 000 km)*

- Change engine oil and filter (or every 3 months, whichever occurs first).  
*An Emission Control Service.*
- Lubricate chassis components; see footnote # (or every 3 months, whichever occurs first).
- Check rear/front axle fluid level and add fluid as needed. Check constant velocity joints and axle seals for leaking. \*\*
- Rotate tires. See "Tire Inspection and Rotation" in the Index for proper rotation pattern and additional information. During tire rotation, check brake calipers for freedom of movement. Refer to the appropriate GM service manual for proper caliper service procedures.

DATE	ACTUAL MILEAGE	SERVICED BY:

## Short Trip/City Maintenance Schedule -- Gasoline Engines

### 57,000 Miles (95 000 km)

- Change engine oil and filter (or every 3 months, whichever occurs first).  
*An Emission Control Service.*
- Lubricate chassis components; see footnote # (or every 3 months, whichever occurs first).
- Check rear/front axle fluid level and add fluid as needed. Check constant velocity joints and axle seals for leaking. \*\*

### 60,000 Miles (100 000 km)

- Change engine oil and filter (or every 3 months, whichever occurs first).  
*An Emission Control Service.*
- Lubricate chassis components; see footnote # (or every 3 months, whichever occurs first).
- Check rear/front axle fluid level and add fluid as needed. Check constant velocity joints and axle seals for leaking. \*\*
- For Two-Wheel-Drive vehicles only: Clean and repack the front wheel bearings (or at each brake relining, whichever occurs first).
- Vehicles With GVWR Above 8,500 lbs. Only: Inspect shields and underhood insulation for damage or looseness. Adjust or replace as required. *This is a Noise Emission Control Service. Applicable only to vehicles sold in the United States.*

DATE	ACTUAL MILEAGE	SERVICED BY:

## Short Trip/City Maintenance Schedule -- Gasoline Engines

- If your engine has a thermostatically controlled cooling fan, inspect all hoses and ducts for proper hook-up (or every 12 months, whichever occurs first). Be sure the valve works properly. *This is a Noise Emission Control Service. Applicable only to vehicles sold in the United States.*
- Inspect engine accessory drive belt. *An Emission Control Service.*
- Replace fuel filter. *An Emission Control Service. †*
- Conduct Exhaust Gas Recirculation (EGR) system inspection as described in the service manual. *An Emission Control Service. †*
- Conduct evaporative control system inspection. Check all fuel and vapor lines and hoses for proper hook-up, routing and condition. Check that the purge valve works properly (if equipped). Replace as needed. *An Emission Control Service. †*
- Inspect fuel tank, cap and lines for damage or leaks. Inspect fuel cap gasket for any damage. Replace parts as needed. *An Emission Control Service. †*

DATE	ACTUAL MILEAGE	SERVICED BY:

## Short Trip/City Maintenance Schedule -- Gasoline Engines

### 63,000 Miles (105 000 km)

- Change engine oil and filter (or every 3 months, whichever occurs first).  
*An Emission Control Service.*
- Lubricate chassis components; see footnote # (or every 3 months, whichever occurs first).
- Check rear/front axle fluid level and add fluid as needed. Check constant velocity joints and axle seals for leaking. \*\*

DATE	ACTUAL MILEAGE	SERVICED BY:

### 66,000 Miles (110 000 km)

- Change engine oil and filter (or every 3 months, whichever occurs first).  
*An Emission Control Service.*
- Lubricate chassis components; see footnote # (or every 3 months, whichever occurs first).
- Check rear/front axle fluid level and add fluid as needed. Check constant velocity joints and axle seals for leaking. \*\*
- Rotate tires. See "Tire Inspection and Rotation" in the Index for proper rotation pattern and additional information. During tire rotation, check brake calipers for freedom of movement. Refer to the appropriate GM service manual for proper caliper service procedures.

DATE	ACTUAL MILEAGE	SERVICED BY:

## Short Trip/City Maintenance Schedule -- Gasoline Engines

### *69,000 Miles (115 000 km)*

- Change engine oil and filter (or every 3 months, whichever occurs first).  
*An Emission Control Service.*
- Lubricate chassis components; see footnote # (or every 3 months, whichever occurs first).
- Check rear/front axle fluid level and add fluid as needed. Check constant velocity joints and axle seals for leaking. \*\*

DATE	ACTUAL MILEAGE	SERVICED BY:

### *72,000 Miles (120 000 km)*

- Change engine oil and filter (or every 3 months, whichever occurs first).  
*An Emission Control Service.*
- Lubricate chassis components; see footnote # (or every 3 months, whichever occurs first).
- Check rear/front axle fluid level and add fluid as needed. Check constant velocity joints and axle seals for leaking. \*\*

DATE	ACTUAL MILEAGE	SERVICED BY:

## Short Trip/City Maintenance Schedule -- Gasoline Engines

### 75,000 Miles (125 000 km)

- Change engine oil and filter (or every 3 months, whichever occurs first).  
*An Emission Control Service.*
- Lubricate chassis components; see footnote # (or every 3 months, whichever occurs first).
- For Two-Wheel-Drive vehicles only: Clean and repack the front wheel bearings (or at each brake relining, whichever occurs first).
- Check rear/front axle fluid level and add fluid as needed. Check constant velocity joints and axle seals for leaking. \*\*
- Vehicles With GVWR Above 8,500 lbs. Only: Inspect shields and underhood insulation for damage or looseness. Adjust or replace as required. *This is a Noise Emission Control Service. Applicable only to vehicles sold in the United States.*

- If your engine has a thermostatically controlled cooling fan, inspect all hoses and ducts for proper hook-up (or every 12 months, whichever occurs first). Be sure the valve works properly. *This is a Noise Emission Control Service. Applicable only to vehicles sold in the United States.*

DATE	ACTUAL MILEAGE	SERVICED BY:

## Short Trip/City Maintenance Schedule -- Gasoline Engines

### 78,000 Miles (130 000 km)

- Change engine oil and filter (or every 3 months, whichever occurs first).  
*An Emission Control Service.*
- Lubricate chassis components; see footnote # (or every 3 months, whichever occurs first).
- Check rear/front axle fluid level and add fluid as needed. Check constant velocity joints and axle seals for leaking. \*\*
- Rotate tires. See "Tire Inspection and Rotation" in the Index for proper rotation pattern and additional information. During tire rotation, check brake calipers for freedom of movement. Refer to the appropriate GM service manual for proper caliper service procedures.

DATE	ACTUAL MILEAGE	SERVICED BY:

### 81,000 Miles (135 000 km)

- Change engine oil and filter (or every 3 months, whichever occurs first).  
*An Emission Control Service.*
- Lubricate chassis components; see footnote # (or every 3 months, whichever occurs first).
- Check rear/front axle fluid level and add fluid as needed. Check constant velocity joints and axle seals for leaking. \*\*

DATE	ACTUAL MILEAGE	SERVICED BY:

## Short Trip/City Maintenance Schedule -- Gasoline Engines

### 84,000 Miles (140 000 km)

- Change engine oil and filter (or every 3 months, whichever occurs first).  
*An Emission Control Service.*
- Lubricate chassis components; see footnote # (or every 3 months, whichever occurs first).
- Check rear/front axle fluid level and add fluid as needed. Check constant velocity joints and axle seals for leaking. \*\*

DATE	ACTUAL MILEAGE	SERVICED BY:

### 87,000 Miles (145 000 km)

- Change engine oil and filter (or every 3 months, whichever occurs first).  
*An Emission Control Service.*
- Lubricate chassis components; see footnote # (or every 3 months, whichever occurs first).
- Check rear/front axle fluid level and add fluid as needed. Check constant velocity joints and axle seals for leaking. \*\*

DATE	ACTUAL MILEAGE	SERVICED BY:



## Short Trip/City Maintenance Schedule -- Gasoline Engines

### 90,000 Miles (150 000 km)

- Change engine oil and filter (or every 3 months, whichever occurs first).  
*An Emission Control Service.*
- Lubricate chassis components; see footnote # (or every 3 months, whichever occurs first).
- Check rear/front axle fluid level and add fluid as needed. Check constant velocity joints and axle seals for leaking. \*\*
- For Two-Wheel-Drive vehicles only: Clean and repack the front wheel bearings (or at each brake relining, whichever occurs first).
- Replace fuel filter. *An Emission Control Service.* †
- Rotate tires. See "Tire Inspection and Rotation" in the Index for proper rotation pattern and additional information. During tire rotation, check brake calipers for freedom of movement. Refer to the appropriate GM service manual for proper caliper service procedures.

- Vehicles With GVWR Above 8,500 lbs. Only: Inspect shields and underhood insulation for damage or looseness. Adjust or replace as required. *This is a Noise Emission Control Service. Applicable only to vehicles sold in the United States.*
- If your engine has a thermostatically controlled cooling fan, inspect all hoses and ducts for proper hook-up (or every 12 months, whichever occurs first). Be sure the valve works properly. *This is a Noise Emission Control Service. Applicable only to vehicles sold in the United States.*

DATE	ACTUAL MILEAGE	SERVICED BY:

## Short Trip/City Maintenance Schedule -- Gasoline Engines

### *93,000 Miles (155 000 km)*

- Change engine oil and filter (or every 3 months, whichever occurs first).  
*An Emission Control Service.*
- Lubricate chassis components; see footnote # (or every 3 months, whichever occurs first).
- Check rear/front axle fluid level and add fluid as needed. Check constant velocity joints and axle seals for leaking. \*\*

DATE	ACTUAL MILEAGE	SERVICED BY:

### *96,000 Miles (160 000 km)*

- Change engine oil and filter (or every 3 months, whichever occurs first).  
*An Emission Control Service.*
- Lubricate chassis components; see footnote # (or every 3 months, whichever occurs first).
- Check rear/front axle fluid level and add fluid as needed. Check constant velocity joints and axle seals for leaking. \*\*

DATE	ACTUAL MILEAGE	SERVICED BY:

## Short Trip/City Maintenance Schedule -- Gasoline Engines

### *99,000 Miles (165 000 km)*

- Change engine oil and filter (or every 3 months, whichever occurs first).  
*An Emission Control Service.*
- Lubricate chassis components; see footnote # (or every 3 months, whichever occurs first).
- Check rear/front axle fluid level and add fluid as needed. Check constant velocity joints and axle seals for leaking. \*\*

### *100,000 Miles (166 000 km)*

- Drain, flush and refill cooling system (or every 60 months since last service, whichever occurs first). See "Engine Coolant" in the Index for what to use. Inspect hoses. Clean radiator, condenser, pressure cap and neck. Pressure test cooling system and pressure cap.  
*An Emission Control Service. †*
- Inspect spark plug wires.  
*An Emission Control Service.*
- Replace spark plugs.  
*An Emission Control Service.*

*(Continued)*

DATE	ACTUAL MILEAGE	SERVICED BY:

## Short Trip/City Maintenance Schedule -- Gasoline Engines

### *100,000 Miles (166 000 km) (Continued)*

- Change automatic transmission fluid and filter if the vehicle is mainly driven under one or more of these conditions:
  - In heavy city traffic where the outside temperature regularly reaches 90°F (32°C) or higher.
  - In hilly or mountainous terrain.
  - When doing frequent trailer towing.

- Uses such as found in taxi, police or delivery service.

*If you do not use your vehicle under any of these conditions, the fluid and filter do not require changing.*

- Inspect Positive Crankcase Ventilation (PCV) valve. *An Emission Control Service.*

DATE	ACTUAL MILEAGE	SERVICED BY:

## Long Trip/Highway Maintenance Schedule -- Gasoline Engines

The services shown in this schedule up to 100,000 miles (166 000 km) should be performed after 100,000 miles (166 000 km) at the same intervals.

### Footnotes

- † The U.S. Environmental Protection Agency or the California Air Resources Board has determined that the failure to perform this maintenance item will not nullify the emission warranty or limit recall liability prior to the completion of the vehicle's useful life. We, however, urge that all recommended maintenance services be performed at the indicated intervals and the maintenance be recorded.
- # Lubricate the front suspension, kingpin bushings, steering linkage, transmission shift linkage, transfer case shift linkage, parking brake cable guides, front axle propshaft splines and brake pedal springs. Ball joints and kingpin bushings should not be lubricated unless their temperature is 10°F (-12°C), or higher, or they could be damaged.

\*\* Drive axle service:

- Locking Differential -- Drain fluid and refill at first engine oil change. At subsequent oil changes, check fluid level and add fluid as needed. If driving in dusty areas or towing a trailer, drain fluid and refill every 15,000 miles (25 000 km).
- Standard Differential -- Check fluid level and add fluid as needed at every engine oil change. If driving in dusty areas or towing a trailer, drain fluid and refill every 15,000 miles (25 000 km).
- More frequent lubrication may be required for heavy-duty or off-road use.

## Long Trip/Highway Maintenance Schedule -- Gasoline Engines

### 7,500 Miles (12 500 km)

- Change engine oil and filter (or every 12 months, whichever occurs first).  
*An Emission Control Service.*
- Lubricate chassis components; see footnote # (or every 12 months, whichever occurs first).
- Check rear/front axle fluid level and add fluid as needed. Check constant velocity joints and axle seals for leaking. \*\*
- Rotate tires. See "Tire Inspection and Rotation" in the Index for proper rotation pattern and additional information. During tire rotation, check brake calipers for freedom of movement. Refer to the appropriate GM service manual for proper caliper service procedures.

DATE	ACTUAL MILEAGE	SERVICED BY:

### 15,000 Miles (25 000 km)

- Change engine oil and filter (or every 12 months, whichever occurs first).  
*An Emission Control Service.*
- Lubricate chassis components; see footnote # (or every 12 months, whichever occurs first).
- Check rear/front axle fluid level and add fluid as needed. Check constant velocity joints and axle seals for leaking. \*\*
- Vehicles With GVWR Above 8,500 lbs. Only: Inspect shields and underhood insulation for damage or looseness. Adjust or replace as required. *This is a Noise Emission Control Service. Applicable only to vehicles sold in the United States.*

## Long Trip/Highway Maintenance Schedule -- Gasoline Engines

- If your engine has a thermostatically controlled cooling fan, inspect all hoses and ducts for proper hook-up (or every 12 months, whichever occurs first). Be sure the valve works properly. *This is a Noise Emission Control Service. Applicable only to vehicles sold in the United States.*

DATE	ACTUAL MILEAGE	SERVICED BY:

### 22,500 Miles (37 500 km)

- Change engine oil and filter (or every 12 months, whichever occurs first).  
*An Emission Control Service.*
- Lubricate chassis components; see footnote # (or every 12 months, whichever occurs first).
- Check rear/front axle fluid level and add fluid as needed. Check constant velocity joints and axle seals for leaking. \*\*
- Rotate tires. See "Tire Inspection and Rotation" in the Index for proper rotation pattern and additional information. During tire rotation, check brake calipers for freedom of movement. Refer to the appropriate GM service manual for proper caliper service procedures.

DATE	ACTUAL MILEAGE	SERVICED BY:

## Long Trip/Highway Maintenance Schedule -- Gasoline Engines

### *30,000 Miles (50 000 km)*

- Change engine oil and filter (or every 12 months, whichever occurs first).  
*An Emission Control Service.*
- Lubricate chassis components; see footnote # (or every 12 months, whichever occurs first).
- Check rear/front axle fluid level and add fluid as needed. Check constant velocity joints and axle seals for leaking. \*\*
- For Two-Wheel-Drive vehicles only: Clean and repack the front wheel bearings (or at each brake relining, whichever occurs first).
- Replace fuel filter. *An Emission Control Service.* †
- Vehicles With GVWR Above 8,500 lbs. Only: Inspect shields and underhood insulation for damage or looseness. Adjust or replace as required. *This is a Noise Emission Control Service. Applicable only to vehicles sold in the United States.*

- If your engine has a thermostatically controlled cooling fan, inspect all hoses and ducts for proper hook-up (or every 12 months, whichever occurs first). Be sure the valve works properly. *This is a Noise Emission Control Service. Applicable only to vehicles sold in the United States.*

DATE	ACTUAL MILEAGE	SERVICED BY:



## Long Trip/Highway Maintenance Schedule -- Gasoline Engines

### 37,500 Miles (62 500 km)

- Change engine oil and filter (or every 12 months, whichever occurs first).  
*An Emission Control Service.*
- Lubricate chassis components; see footnote # (or every 12 months, whichever occurs first).
- Check rear/front axle fluid level and add fluid as needed. Check constant velocity joints and axle seals for leaking. \*\*
- Rotate tires. See "Tire Inspection and Rotation" in the Index for proper rotation pattern and additional information. During tire rotation, check brake calipers for freedom of movement. Refer to the appropriate GM service manual for proper caliper service procedures.

DATE	ACTUAL MILEAGE	SERVICED BY:

### 45,000 Miles (75 000 km)

- Change engine oil and filter (or every 12 months, whichever occurs first).  
*An Emission Control Service.*
- Lubricate chassis components; see footnote # (or every 12 months, whichever occurs first).
- Check rear/front axle fluid level and add fluid as needed. Check constant velocity joints and axle seals for leaking. \*\*
- Vehicles With GVWR Above 8,500 lbs. Only: Inspect shields and underhood insulation for damage or looseness. Adjust or replace as required. *This is a Noise Emission Control Service. Applicable only to vehicles sold in the United States.*

*(Continued)*

## Long Trip/Highway Maintenance Schedule -- Gasoline Engines

### 45,000 Miles (75 000 km) (Continued)

- If your engine has a thermostatically controlled cooling fan, inspect all hoses and ducts for proper hook-up (or every 12 months, whichever occurs first). Be sure the valve works properly. *This is a Noise Emission Control Service. Applicable only to vehicles sold in the United States.*

DATE	ACTUAL MILEAGE	SERVICED BY:

### 50,000 Miles (83 000 km)

- Change automatic transmission fluid and filter if the vehicle is mainly driven under one or more of these conditions:
- In heavy city traffic where the outside temperature regularly reaches 90°F (32°C) or higher.
  - In hilly or mountainous terrain.
  - When doing frequent trailer towing.
  - Uses such as found in taxi, police or delivery service.

*If you do not use your vehicle under any of these conditions, the fluid and filter do not require changing.*

DATE	ACTUAL MILEAGE	SERVICED BY:

## Long Trip/Highway Maintenance Schedule -- Gasoline Engines

### 52,500 Miles (87 500 km)

- Change engine oil and filter (or every 12 months, whichever occurs first).  
*An Emission Control Service.*
- Lubricate chassis components; see footnote # (or every 12 months, whichever occurs first).
- Check rear/front axle fluid level and add fluid as needed. Check constant velocity joints and axle seals for leaking. \*\*
- Rotate tires. See "Tire Inspection and Rotation" in the Index for proper rotation pattern and additional information. During tire rotation, check brake calipers for freedom of movement. Refer to the appropriate GM service manual for proper caliper service procedures.

DATE	ACTUAL MILEAGE	SERVICED BY:

### 60,000 Miles (100 000 km)

- Change engine oil and filter (or every 12 months, whichever occurs first).  
*An Emission Control Service.*
- Lubricate chassis components; see footnote # (or every 12 months, whichever occurs first).
- Check rear/front axle fluid level and add fluid as needed. Check constant velocity joints and axle seals for leaking. \*\*
- For Two-Wheel-Drive vehicles only: Clean and repack the front wheel bearings (or at each brake relining, whichever occurs first).
- Inspect engine accessory drive belt.  
*An Emission Control Service.*
- Replace fuel filter. *An Emission Control Service.* †

*(Continued)*

## Long Trip/Highway Maintenance Schedule -- Gasoline Engines

### 60,000 Miles (100 000 km) (Continued)

- Inspect fuel tank, cap and lines for damage or leaks. Inspect fuel cap gasket for any damage. Replace parts as needed.  
*An Emission Control Service. †*
- Vehicles With GVWR Above 8,500 lbs. Only: Inspect shields and underhood insulation for damage or looseness. Adjust or replace as required. *This is a Noise Emission Control Service. Applicable only to vehicles sold in the United States.*
- If your engine has a thermostatically controlled cooling fan, inspect all hoses and ducts for proper hook-up (or every 12 months, whichever occurs first). Be sure the valve works properly. *This is a Noise Emission Control Service. Applicable only to vehicles sold in the United States.*

- Conduct Exhaust Gas Recirculation (EGR) system inspection as described in the service manual. *An Emission Control Service. †*
- Conduct evaporative control system inspection. Check all fuel and vapor lines and hoses for proper hook-up, routing and condition. Check that the purge valve works properly, if equipped. Replace as needed.  
*An Emission Control Service. †*

DATE	ACTUAL MILEAGE	SERVICED BY:

## Long Trip/Highway Maintenance Schedule -- Gasoline Engines

### 67,500 Miles (112 500 km)

- Change engine oil and filter (or every 12 months, whichever occurs first).  
*An Emission Control Service.*
- Lubricate chassis components; see footnote # (or every 12 months, whichever occurs first).
- Check rear/front axle fluid level and add fluid as needed. Check constant velocity joints and axle seals for leaking. \*\*
- Rotate tires. See "Tire Inspection and Rotation" in the Index for proper rotation pattern and additional information. During tire rotation, check brake calipers for freedom of movement. Refer to the appropriate GM service manual for proper caliper service procedures.

DATE	ACTUAL MILEAGE	SERVICED BY:

### 75,000 Miles (125 000 km)

- Change engine oil and filter (or every 12 months, whichever occurs first).  
*An Emission Control Service.*
- Lubricate chassis components; see footnote # (or every 12 months, whichever occurs first).
- Check rear/front axle fluid level and add fluid as needed. Check constant velocity joints and axle seals for leaking. \*\*
- Vehicles With GVWR Above 8,500 lbs. Only: Inspect shields and underhood insulation for damage or looseness. Adjust or replace as required. *This is a Noise Emission Control Service. Applicable only to vehicles sold in the United States.*

*(Continued)*

## Long Trip/Highway Maintenance Schedule -- Gasoline Engines

### 75,000 Miles (125 000 km) (Continued)

- If your engine has a thermostatically controlled cooling fan, inspect all hoses and ducts for proper hook-up (or every 12 months, whichever occurs first). Be sure the valve works properly. *This is a Noise Emission Control Service. Applicable only to vehicles sold in the United States.*

DATE	ACTUAL MILEAGE	SERVICED BY:

### 82,500 Miles (137 500 km)

- Change engine oil and filter (or every 12 months, whichever occurs first).  
*An Emission Control Service.*
- Lubricate chassis components; see footnote # (or every 12 months, whichever occurs first).
- Check rear/front axle fluid level and add fluid as needed. Check constant velocity joints and axle seals for leaking. \*\*
- Rotate tires. See "Tire Inspection and Rotation" in the Index for proper rotation pattern and additional information. During tire rotation, check brake calipers for freedom of movement. Refer to the appropriate GM service manual for proper caliper service procedures.

DATE	ACTUAL MILEAGE	SERVICED BY:

## Long Trip/Highway Maintenance Schedule -- Gasoline Engines

### 90,000 Miles (150 000 km)

- Change engine oil and filter (or every 12 months, whichever occurs first).  
*An Emission Control Service.*
- Lubricate chassis components; see footnote # (or every 12 months, whichever occurs first).
- Check rear/front axle fluid level and add fluid as needed. Check constant velocity joints and axle seals for leaking. \*\*
- For Two-Wheel-Drive vehicles only: Clean and repack the front wheel bearings (or at each brake relining, whichever occurs first).
- Replace fuel filter. *An Emission Control Service.* †
- Vehicles With GVWR Above 8,500 lbs. Only: Inspect shields and underhood insulation for damage or looseness. Adjust or replace as required. *This is a Noise Emission Control Service. Applicable only to vehicles sold in the United States.*

- If your engine has a thermostatically controlled cooling fan, inspect all hoses and ducts for proper hook-up (or every 12 months, whichever occurs first). Be sure the valve works properly. *This is a Noise Emission Control Service. Applicable only to vehicles sold in the United States.*

DATE	ACTUAL MILEAGE	SERVICED BY:

## Long Trip/Highway Maintenance Schedule -- Gasoline Engines

### *97,500 Miles (162 500 km)*

- Change engine oil and filter (or every 12 months, whichever occurs first).  
*An Emission Control Service.*
- Lubricate chassis components; see footnote # (or every 12 months, whichever occurs first).
- Check rear/front axle fluid level and add fluid as needed. Check constant velocity joints and axle seals for leaking. \*\*
- Rotate tires. See "Tire Inspection and Rotation" in the Index for proper rotation pattern and additional information. During tire rotation, check brake calipers for freedom of movement. Refer to the appropriate GM service manual for proper caliper service procedures.

DATE	ACTUAL MILEAGE	SERVICED BY:

### *100,000 Miles (166 000 km)*

- Drain, flush and refill cooling system (or every 60 months since last service, whichever occurs first). See "Engine Coolant" in the Index for what to use. Inspect hoses. Clean radiator, condenser, pressure cap and neck. Pressure test the cooling system and pressure cap.  
*An Emission Control Service. †*
- Inspect spark plug wires.  
*An Emission Control Service.*



## Long Trip/Highway Maintenance Schedule -- Gasoline Engines

- Replace spark plugs. *An Emission Control Service.*
- Change automatic transmission fluid and filter if the vehicle is mainly driven under one or more of these conditions:
  - In heavy city traffic where the outside temperature regularly reaches 90°F (32°C) or higher.
  - In hilly or mountainous terrain.
  - When doing frequent trailer towing.

- Uses such as found in taxi, police or delivery service.

*If you do not use your vehicle under any of these conditions, the fluid and filter do not require changing.*

- Inspect Positive Crankcase Ventilation (PCV) valve. *An Emission Control Service.*

DATE	ACTUAL MILEAGE	SERVICED BY:

## Part B: Owner Checks and Services

Listed below are owner checks and services which should be performed at the intervals specified to help ensure the safety, dependability and emission control performance of your vehicle.

Be sure any necessary repairs are completed at once. Whenever any fluids or lubricants are added to your vehicle, make sure they are the proper ones, as shown in Part D.

### At Each Fuel Fill

*It is important for you or a service station attendant to perform these underhood checks at each fuel fill.*

#### Engine Oil Level Check

Check the engine oil level and add the proper oil if necessary. See “Engine Oil” in the Index for further details.

#### Engine Coolant Level Check

Check the engine coolant level and add the proper coolant mix if necessary. See “Engine Coolant” in the Index for further details.

#### Windshield Washer Fluid Level Check

Check the windshield washer fluid level in the windshield washer tank and add the proper fluid if necessary. See “Windshield Washer Fluid” in the Index for further details.

### At Least Once a Month

#### Tire Inflation Check

Make sure tires are inflated to the correct pressures. See “Tires” in the Index for further details.

#### Cassette Deck Service

Clean cassette deck. Cleaning should be done every 50 hours of tape play. See “Audio Systems” in the Index for further details.

## At Least Twice a Year

### Restraint System Check

Make sure the safety belt reminder light and all your belts, buckles, latch plates, retractors and anchorages are working properly. Look for any other loose or damaged safety belt system parts. If you see anything that might keep a safety belt system from doing its job, have it repaired. Have any torn or frayed safety belts replaced.

Also look for any opened or broken air bag covers, and have them repaired or replaced. (The air bag system does not need regular maintenance.)

### Air Cleaner Filter Restriction Indicator Check

Your vehicle has an indicator on the engine that lets you know when the air cleaner filter is dirty and needs to be changed. Check indicator at least twice a year or when your oil is changed. See "Air Cleaner" in the Index for more information.

### Automatic Transmission Check

Check the transmission fluid level; add if needed. See "Automatic Transmission" in the Index. A fluid loss may indicate a problem. Check the system and repair if needed.

## At Least Once a Year

### Key Lock Cylinders Service

Lubricate the key lock cylinders with the lubricant specified in Part D.

### Body Lubrication Service

Lubricate all fuel door, body hood and body door hinges, rear compartment hinges, tailgate handle pivot points, latches, locks and folding seat hardware. Part D tells you what to use. More frequent lubrication may be required when exposed to a corrosive environment.

### Starter Switch Check

#### CAUTION:

**When you are doing this check, the vehicle could move suddenly. If it does, you or others could be injured. Follow the steps below.**

1. Before you start, be sure you have enough room around the vehicle.
2. Firmly apply both the parking brake (see “Parking Brake” in the Index if necessary) and the regular brake.

NOTE: Do not use the accelerator pedal, and be ready to turn off the engine immediately if it starts.

3. Try to start the engine in each gear. The starter should work only in PARK (P) or NEUTRAL (N). If the starter works in any other position, your vehicle needs service.

### Brake-Transmission Shift Interlock (BTSI) Check

**CAUTION:**

**When you are doing this check, the vehicle could move suddenly. If it does, you or others could be injured. Follow the steps below.**

1. Before you start, be sure you have enough room around the vehicle. It should be parked on a level surface.
2. Firmly apply the parking brake (see “Parking Brake” in the Index if necessary).

NOTE: Be ready to apply the regular brake immediately if the vehicle begins to move.

3. With the engine off, turn the key to the RUN position, but don't start the engine. Without applying the regular brake, try to move the shift lever out of PARK (P) with normal effort. If the shift lever moves out of PARK (P), your vehicle's BTSI needs service.

## Steering Column Lock Check

While parked, and with the parking brake set, try to turn the key to LOCK in each shift lever position.

- The key should turn to LOCK only when the shift lever is in PARK (P).
- The key should come out only in LOCK.

## Parking Brake and Automatic Transmission PARK (P) Mechanism Check

### CAUTION:

When you are doing this check, your vehicle could begin to move. You or others could be injured and property could be damaged. Make sure there is room in front of your vehicle in case it begins to roll. Be ready to apply the regular brake at once should the vehicle begin to move.

Park on a fairly steep hill, with the vehicle facing downhill. Keeping your foot on the regular brake, set the parking brake.

- To check the parking brake: With the engine running and transmission in NEUTRAL (N), slowly remove foot pressure from the regular brake pedal. Do this until the vehicle is held by the parking brake only.
- To check the PARK (P) mechanism's holding ability: With the engine running, shift to PARK (P). Then release all brakes.

## **Part C: Periodic Maintenance Inspections**

Listed below are inspections and services which should be performed at least twice a year (for instance, each spring and fall). You should let your GM dealer's service department or other qualified service center do these jobs. Make sure any necessary repairs are completed at once.

Proper procedures to perform these services may be found in a GM Service Manual. See "Service and Owner Publications" in the Index.

### **Steering and Suspension Inspection**

Inspect the front and rear suspension and steering system for damaged, loose or missing parts, signs of wear or lack of lubrication. Inspect the power steering lines and hoses for proper hook-up, binding, leaks, cracks, chafing, etc.

### **Exhaust System Inspection**

Inspect the complete exhaust system. Inspect the body near the exhaust system. Look for broken, damaged, missing or out-of-position parts as well as open seams, holes, loose connections or other conditions which could cause a heat build-up in the floor pan or could let exhaust fumes into the vehicle. See "Engine Exhaust" in the Index.

### **Radiator and Heater Hose Inspection**

Inspect the hoses and have them replaced if they are cracked, swollen or deteriorated. Inspect all pipes, fittings and clamps; replace as needed.

### **Throttle Linkage Inspection**

Inspect the throttle linkage for interference or binding, and for damage or missing parts. Replace parts as needed. Replace any cables that have high effort or excessive wear. Do not lubricate accelerator and cruise control cables.

## **Drive Axle Service**

Check rear/front axle fluid level and add as needed.  
Check constant velocity joints and axle seals for leaking.

## **Transfer Case (Four-Wheel Drive) Inspection**

Every 12 months or at oil change intervals, check front axle and transfer case and add lubricant when necessary. Oil the control lever pivot point and all exposed control linkage. Check vent hose at transfer case for kinks and proper installation. More frequent lubrication may be required on off-road use.

## **Brake System Inspection**

Inspect the complete system. Inspect brake lines and hoses for proper hook-up, binding, leaks, cracks, chafing, etc. Inspect disc brake pads for wear and rotors for surface condition. Also inspect drum brake linings for wear and cracks. Inspect other brake parts, including drums, wheel cylinders, calipers, parking brake, etc. Check parking brake adjustment. You may need to have your brakes inspected more often if your driving habits or conditions result in frequent braking.

## Part D: Recommended Fluids and Lubricants

NOTE: Fluids and lubricants identified below by name, part number or specification may be obtained from your GM dealer.

USAGE	FLUID/LUBRICANT
Engine Oil (Gasoline Engine)	Engine oil with the American Petroleum Institute Certified For Gasoline Engines "Starburst" symbol of the proper viscosity. To determine the preferred viscosity for your vehicle's engine, see "Engine Oil" in the Index.
Engine Coolant	50/50 mixture of clean water (preferably distilled) and GM Goodwrench <sup>®</sup> DEX-COOL <sup>™</sup> or Havoline <sup>®</sup> DEX-COOL <sup>™</sup> (orange-colored, silicate-free) antifreeze conforming to GM Specification 6277M. See "Engine Coolant" in the Index.

USAGE	FLUID/LUBRICANT
Coolant Supplement Sealer	GM Part No. 3634621 or equivalent with a complete flush and refill.
Hydraulic Brake System	Delco Supreme 11 <sup>®</sup> Brake Fluid (GM Part No. 1052535 or equivalent DOT-3 brake fluid).
Parking Brake Cable Guides	Chassis lubricant (GM Part No. 1052497 or equivalent) or lubricant meeting requirements of NLGI Grade 2, Category LB or GC-LB.
Power Steering System	GM Power Steering Fluid (GM Part No. 1052884 - 1 pt., 1050017 - 1 qt., or equivalent).
Automatic Transmission	DEXRON <sup>®</sup> -III Automatic Transmission Fluid.



<b>USAGE</b>	<b>FLUID/LUBRICANT</b>
Key Lock Cylinders	Multi-Purpose Lubricant, Superlube <sup>®</sup> (GM Part No. 12346241 or equivalent).
Chassis Lubrication	Chassis lubricant (GM Part No. 1052497 or equivalent) or lubricant meeting requirements of NLGI Grade 2, Category LB or GC-LB.
Front Wheel Bearings	Wheel bearing lubricant meeting requirements of NLGI Grade 2, Category GC or GC-LB (GM Part No. 1051344 or equivalent).
Differential, Front and Rear Axle	Axle Lubricant (GM Part No. 1052271) or SAE 80W-90 GL-5 Gear Lubricant.
Transfer Case	DEXRON <sup>®</sup> -III Automatic Transmission Fluid.

<b>USAGE</b>	<b>FLUID/LUBRICANT</b>
Windshield Washer Solvent	GM Optikleen <sup>®</sup> Washer Solvent (GM Part No. 1051515) or equivalent.
Propeller Shaft Spline/Universal Joint and Propeller Shaft	Chassis lubricant (GM Part No. 1052497 or equivalent) or lubricant meeting requirements of NLGI Grade 2, Category LB or GC-LB.
Hood Latch Assembly, Pivots, Spring Anchor and Release Pawl	Lubriplate lubricant aerosol (GM Part No. 12346293 or equivalent) or lubricant meeting requirements of NLGI Grade 2, Category LB or GC-LB.

<b>USAGE</b>	<b>FLUID/LUBRICANT</b>
Hood and Door Hinges	Multi-purpose lubricant, Superlube <sup>®</sup> (GM Part No. 12346241 or equivalent).
Body Door Hinge Pins, Tailgate Hinge and Linkage, Folding Seat, Fuel Door Hinge	Multi-purpose lubricant, Superlube <sup>®</sup> (GM Part No. 12346241 or equivalent).
Outer Tailgate Handle Pivot Points	Multi-purpose lubricant Superlube <sup>®</sup> (GM Part No. 12346241 or equivalent).
Weatherstrip Conditioning	Dielectric Silicone Grease (GM Part No. 12345579 or equivalent).

<b>USAGE</b>	<b>FLUID/LUBRICANT</b>
Weatherstrip Squeaks	Multi-purpose lubricant, Superlube <sup>®</sup> (GM Part No. 12346241 or equivalent).
Gas Line	Gas Line De-Icer (GM Part No. 1051516).

See "Replacement Parts" in the Index for recommended replacement filters, valves and spark plugs.

## Part E: Maintenance Record

After the scheduled services are performed, record the date, odometer reading and who performed the service in the boxes provided after the maintenance interval. Any additional information from “Owner Checks and

Services” or “Periodic Maintenance” can be added on the following record pages. Also, you should retain all maintenance receipts. Your owner information portfolio is a convenient place to store them.

<b>Maintenance Record</b>			
<b>DATE</b>	<b>ODOMETER READING</b>	<b>SERVICED BY</b>	<b>MAINTENANCE PERFORMED</b>

## Maintenance Record

DATE	ODOMETER READING	SERVICED BY	MAINTENANCE PERFORMED

## Section 8 Customer Assistance Information

---

---

Here you will find out how to contact GMC Truck if you need assistance. This section also tells you how to obtain service publications and how to report any safety defects.

This section includes information on:

- The Customer Satisfaction Procedure
- Customer Assistance for Text Telephone (TTY) Users
- Roadside Assistance
- Courtesy Transportation
- BBB Auto Line -- Alternative Dispute Resolution Program
- Reporting Safety Defects
- Service and Owner Publications

### Customer Satisfaction Procedure



Your satisfaction and goodwill are important to your dealer and GMC Truck. Normally, any concern you may have with your vehicle can be handled by your selling or servicing dealer. Your dealer has the facility, trained technicians, special tools and up-to-date information to promptly address any issue which may arise. GMC Truck has empowered its dealers to make decisions and repair vehicles, and they are eager to resolve your concern to your complete satisfaction. If your concern has not been resolved to your satisfaction, take the following steps:

**STEP ONE** -- Discuss your concern with a member of dealer management. Normally, concerns can be quickly resolved at that level. If the matter has already been reviewed with the Sales, Service or Parts Manager, contact the owner of the dealership or the General Manager.

**STEP TWO** -- If after contacting a member of dealership management, it appears your concern cannot be resolved by the dealership without further help, contact the GMC Truck Consumer Relations Manager by calling 1-800-GMC-TRUCK (1-800-462-8782, Customer Assistance prompt.) In Canada, contact GM of Canada Customer Assistance Center in Oshawa by calling 1-800-263-3777 (English) or 1-800-263-7854 (French).

For help outside of the United States and Canada, call the following numbers as appropriate:

- In Mexico: (525) 625-3256
- In Puerto Rico: 1-800-496-9992 (English) or 1-800-496-9993 (Spanish)
- In the U.S. Virgin Islands: 1-800-496-9994
- In the Dominican Republic: 1-800-751-4135 (English) or 1-800-751-4136 (Spanish)
- In the Bahamas: 1-800-389-0009
- In Bermuda, Barbados, Antigua and the British Virgin Islands: 1-800-534-0122
- In all other Caribbean countries: 1-809-763-1315
- In other overseas locations, call GM North American Export Sales in Canada at 1-905-644-4112.

For prompt assistance, please have the following information available to give the Customer Assistance Representative:

- Your name, address, home and business telephone numbers
- Vehicle Identification Number (This is available from the vehicle registration or title, or the plate at the top left of the instrument panel and visible through the windshield.)
- Dealership name and location
- Vehicle delivery date and present mileage
- Nature of concern

We encourage you to call us so we can give your inquiry prompt attention. However, if you wish to write GMC Truck, write to:

GMC Truck Customer Assistance  
31 E. Judson Street 1607-04  
Pontiac, MI 48342-2230

Refer to your Warranty and Owner Assistance Information booklet for addresses of Canadian and GM Overseas offices.

When contacting GMC Truck, please remember that your concern will likely be resolved in the dealership, using the dealer's facilities, equipment and personnel. That is why we suggest you follow Step One first if you have a concern.

## **Customer Assistance for Text Telephone (TTY) Users**

To assist customers who are deaf, hard of hearing, or speech-impaired and who use Text Telephones (TTYs), GMC Truck has TTY equipment available at its Customer Assistance Center. Any TTY user can communicate with GMC Truck by dialing: 1-800-GMC-8583. (TTY users in Canada can dial 1-800-263-3830.)

## Roadside Assistance

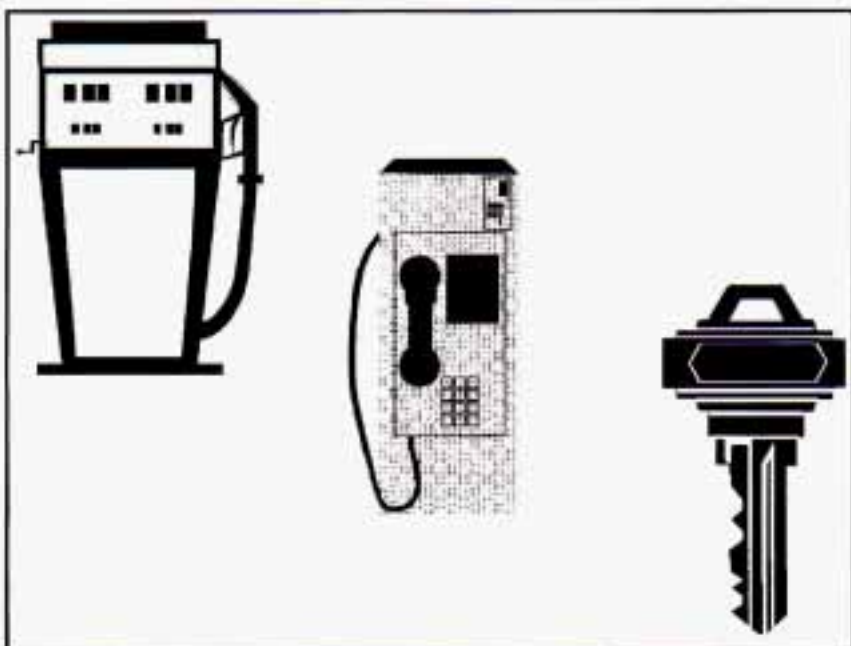

GMC Truck's Roadside Assistance provides stranded owners with over-the-phone roadside repairs, location of the nearest GMC Truck dealer or the following special services:

*Flat Tire Change:* Installation of spare tire will be covered at no charge (customer is responsible for repair or replacement of tire).

*Fuel Delivery:* Delivery of enough fuel for the customer to get to the nearest service station (up to \$4.00) will be covered.

*Jump Start:* No-start situations which require a battery jump start will be covered at no charge.

*Lock Out:* Replacement keys or locksmith service will be covered at no charge if you are unable to gain entry into your vehicle. Delivery of the replacement key will be covered at no charge within 10 miles (16 km).

*Emergency Towing Service:* Towing to the nearest GMC Truck dealer for warranty related disablements will be covered.

*Trip Routing:* Availability of customized trip routings through GMC Truck Roadside Assistance. This deluxe computerized trip routing service will provide highlighted map routing, scenic or fastest route, a listing of GMC Truck dealers along the way, and a variety of other travel related services.

*Trip Interruption:* GMC Truck Roadside Assistance will provide reimbursement for reasonable trip interruption expenses such as meals and lodging (up to \$500) directly associated with a warranty-related disablement which requires overnight accommodations.



The Roadside Assistance services listed are available to retail and retail lease customers operating 1996 GMC light duty trucks for a period of 3 years/36,000 miles (60 000 km). All services must be pre-arranged by GMC Truck Roadside Assistance.

Over-the-phone assistance, such as providing the name of the closest dealer or minor technical advice, etc., is available to all owner/operators of GMC trucks, regardless of vehicle or mileage.

Just dial GMC Truck Roadside Assistance at 1-800-GMC-TRUCK (1-800-462-8782, Roadside Assistance prompt) to reach a qualified representative who can assist you.

Your Roadside Assistance representative will ask for the following information when your call is received:

- Vehicle Identification Number (VIN)
- Name and home address
- Telephone number and location from which you are calling
- Location, license plate number and color of your GMC truck
- Mileage of vehicle and description of problem

Roadside Assistance is available 24 hours a day, 7 days a week, 365 days a year, including weekends and holidays. Should you have any questions about roadside assistance, call the GMC Truck Roadside Assistance Center or contact your dealer.

*Roadside Assistance is not part of or included in the coverage provided by the New Vehicle Limited Warranty. GMC Truck reserves the right to make any changes or discontinue the Roadside Assistance program at any time without notification.*

## Canadian Roadside Assistance

Vehicles purchased in Canada have an extensive Roadside Assistance program accessible from anywhere in Canada or the United States. Please refer to the separate brochure provided by the dealer or call 1-800-268-6800 for emergency services.

## Courtesy Transportation

GMC Truck Commitment Plus offers courtesy transportation for customers when obtaining warranty service.

This program is offered in conjunction with the 3 year/36,000 mile (60 000 km) Bumper to Bumper New Vehicle Limited Warranty.

Courtesy transportation includes:

- One way shuttle ride from the dealership (up to 10 miles (16 km)) for same-day warranty repairs.
- A loaner vehicle will be made available for overnight warranty repairs up to a five day maximum, or up to a \$30 allowance for a rental vehicle, cab, bus or other transportation in lieu of a loaner. (Bringing vehicles in late in the day, for service on the next day, *does not* constitute overnight repairs.)

- Gas allowance of up to \$10 a day for rides provided by another person (i.e., friend, neighbor, etc.) in lieu of rental for overnight warranty repair up to five day maximum.

*All Courtesy Transportation arrangements will be administered by your GMC Truck dealership service management. All requests should reflect actual costs up to and not to exceed the maximum allowable dollar limits.*

Some state insurance regulations make it impractical to rent vehicles to people under 21 years of age. If you are under 21 and have difficulty renting a vehicle, GMC Truck will reimburse up to \$30/day for documented transportation you receive.

The Commitment Plus Courtesy Transportation Program is not part of the Bumper to Bumper Limited Warranty. GMC Truck reserves the right to make any changes or discontinue the Courtesy Transportation Program at any time without notification.

For additional program details contact your GMC Truck dealer.

## **GM Participation in BBB AUTO LINE -- Alternative Dispute Resolution Program\***

\*This program may not be available in all states, depending on state law. Canadian owners refer to your Warranty and Owner Assistance Information booklet. General Motors reserves the right to change eligibility limitations and/or to discontinue its participation in this program.

Both GMC Truck and your GMC Truck dealer are committed to making sure you are completely satisfied with your new vehicle. Our experience has shown that, if a situation arises where you feel your concern has not been adequately addressed, the Customer Satisfaction Procedure described earlier in this section is very successful.

There may be instances where an impartial third party can assist in arriving at a solution to a disagreement regarding vehicle repairs or interpretation of the New Vehicle Limited Warranty. To assist in resolving these disagreements, GMC Truck voluntarily participates in BBB AUTO LINE.

BBB AUTO LINE is an out-of-court program administered by the Better Business Bureau system to settle disputes between customers and automobile manufacturers. This program is available free of charge to customers who currently own or lease a GM vehicle.

If you are not satisfied after following the Customer Satisfaction Procedure, you may contact the BBB using the toll-free telephone number, or write them at the following address:

**BBB AUTO LINE**  
Council of Better Business Bureaus  
4200 Wilson Boulevard  
Suite 800  
Arlington, VA 22203  
Telephone: 1-800-955-5100

To file a claim, you will be asked to provide your name and address, your Vehicle Identification Number (VIN) and a statement of the nature of your complaint. Eligibility is limited by vehicle age and mileage, and other factors.

We prefer you utilize the Customer Satisfaction Procedure before you resort to AUTO LINE, but you may contact the BBB at any time. The BBB will attempt to resolve the complaint serving as an intermediary between you and GMC Truck. If this mediation is unsuccessful, an informal hearing will be scheduled where eligible customers may present their case to an impartial third-party arbitrator.

The arbitrator will make a decision which you may accept or reject. If you accept the decision, GM will be bound by that decision. The entire dispute resolution procedure should ordinarily take about 40 days from the time you file a claim until a decision is made.

Some state laws may require you to use this program before filing a claim with a state-run arbitration program or in the courts. For further information, contact the BBB at 1-800-955-5100 or the GMC Truck Customer Assistance Center at 1-800-GMC-TRUCK (1-800-462-8782).

## **REPORTING SAFETY DEFECTS TO THE UNITED STATES GOVERNMENT**

If you believe that your vehicle has a defect which could cause a crash or could cause injury or death, you should immediately inform the National Highway Traffic Safety Administration (NHTSA), in addition to notifying General Motors.

If NHTSA receives similar complaints, it may open an investigation, and if it finds that a safety defect exists in a group of vehicles, it may order a recall and remedy campaign. However, NHTSA cannot become involved in individual problems between you, your dealer or General Motors.

To contact NHTSA, you may either call the Auto Safety Hotline toll-free at 1-800-424-9393 (or 366-0123 in the Washington, D.C. area) or write to:

NHTSA, U.S. Department of Transportation  
Washington, D.C. 20590

You can also obtain other information about motor vehicle safety from the Hotline.

## REPORTING SAFETY DEFECTS TO THE CANADIAN GOVERNMENT

If you live in Canada, and you believe that your vehicle has a safety defect, you should immediately notify Transport Canada, in addition to notifying General Motors of Canada Limited. You may write to:

Transport Canada  
Box 8880  
Ottawa, Ontario K1G 3J2

## REPORTING SAFETY DEFECTS TO GENERAL MOTORS

In addition to notifying NHTSA (or Transport Canada) in a situation like this, we certainly hope you'll notify us. Please call us at 1-800-GMC-TRUCK (1-800-462-8782) or write:

GMC Truck Consumer Relations  
31 E. Judson Street 1607-04  
Pontiac, MI 48342-2230

In Canada, please call us at 1-800-263-3777 (English) or 1-800-263-7854 (French). Or, write:

General Motors of Canada Limited  
Customer Assistance Center  
1908 Colonel Sam Drive  
Oshawa, Ontario L1H 8P7

## Service and Owner Publications

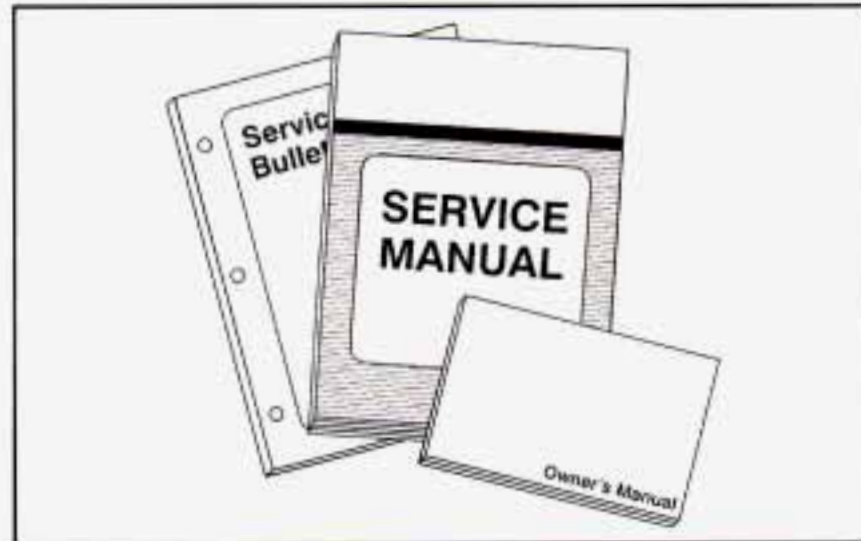

Service manuals, service bulletins, owner's manuals and other service literature are available for purchase for all current and many past model General Motors vehicles.

Toll-free telephone numbers for ordering information:

United States . . . . .	1-800-551-4123
Canada . . . . .	1-800-668-5539

## **Service Manuals**

Service manuals contain diagnostic and repair information for all chassis and body systems. They may be useful for owners who wish to get a greater understanding of their vehicle. They are also useful for owners with the appropriate skill level or training who wish to perform “do-it-yourself” service. These are authentic General Motors service manuals meant for professional, qualified technicians.

## **Service Bulletins**

Service bulletins covering various subjects are regularly sent to all General Motors dealerships. GM monitors product performance in the field. When service methods are found which promote better service on GM vehicles, bulletins are created to help the technician perform better service. Service bulletins may involve any

number of vehicles. Some will describe inexpensive service; others will describe expensive service. Some will advise of new or unexpected conditions, and others may help avoid future costly repairs. Service bulletins are meant for qualified technicians. In some cases bulletins refer to service manuals, specialized tools, equipment and safety procedures necessary to service the vehicle. Since these bulletins are issued throughout the model year and beyond, an index is required and published quarterly to help identify specific bulletins. Subscriptions are available. You can order an index at the toll-free numbers listed previously, or ask a GM dealer to see an index or individual bulletin.

## **Owner Publications**

Owner’s manuals, warranty folders and various owner assistance booklets provide owners with general operation and maintenance information.

## Section 9 Index

<b>A</b> ir Bag .....	1-29	Appearance Care Materials .....	6-59
Adding Equipment .....	1-34	Arbitration Program .....	8-7
How Does it Restrain .....	1-32	Armrest Storage Compartment .....	2-47
How it Works .....	1-31	Ashtrays .....	2-52
Location .....	1-31	Audio Equipment, Adding .....	3-26
Readiness Light .....	1-30, 2-59	Audio Systems .....	3-9
Servicing .....	1-34	Automatic Transmission	
What Makes it Inflate .....	1-32	Check .....	7-43
What Will You See After it Inflates .....	1-33	Fluid .....	6-18
When Should it Inflate .....	1-32	Operation .....	2-14
Air Cleaner .....	6-16	Overdrive .....	2-16
Air Cleaner Filter Restriction Indicator Check .....	7-43	Park Mechanism Check .....	7-45
Air Conditioning .....	3-6	Shifting .....	2-14
Air Conditioning Refrigerants .....	6-73	Auxiliary Power Outlet .....	2-53
Alignment and Balance, Tire .....	6-49	Axle, Front .....	6-23
Aluminum Wheels, Cleaning .....	6-57	Axle, Locking Rear .....	2-17
Antenna, Fixed .....	3-28	Axle, Rear .....	6-22
Antifreeze .....	6-25		
Anti-Lock		<b>B</b> attery .....	6-35
Brakes .....	4-6	Jump Starting .....	5-2
Brake System Warning Light .....	2-62, 4-6	Replacement, Keyless Entry .....	2-5
Anti-Theft, Radio .....	3-24	Warnings .....	5-2
Appearance Care .....	6-51	BBB Auto Line .....	8-7
		Better Business Bureau Mediation .....	8-7

Brake		
Adjustment	6-34	
Fluid	6-31	
Master Cylinder	6-31	
Parking	2-21	
Pedal Travel	6-34	
Replacing System Parts	6-34	
System Warning Light	2-61	
Trailer	4-49	
Transmission Shift Interlock Check	7-44	
Wear	6-33	
Brakes, Anti-Lock	4-6	
Braking	4-5	
Braking in Emergencies	4-8	
Break-In, New Vehicle	2-9	
Brightness Control	2-38	
BTSI Check	7-44	
Bulb Replacement	6-35	
<b>C</b> anadian Roadside Assistance	8-6	
Capacities and Specifications	6-70	
Carbon Monoxide	2-25, 4-40, 4-48	
Cargo Security Shade	2-48	
Cargo Tie Downs	2-50	
Cassette Deck Service	7-42	
Cassette Tape Player	3-12, 3-14	
Cassette Tape Player Care	3-27	
Cassette Tape Player Errors	3-13, 3-17	
CD Player Theft-Deterrent Feature	3-24	
Center High-Mounted Stoplamp Bulb Replacement	6-41	
Center Passenger Position	1-36	
Certification/Tire Label	4-41	
Chains, Safety	4-48	
Chains, Tire	6-51	
Changing a Flat Tire	5-19	
Charging System Warning Light	2-59	
Check Gages Light	2-67	
Checking Your Restraint Systems	1-55	
Chemical Paint Spotting	6-58	
Child Restraints	1-45	
Securing in a Rear Outside Seat Position	1-46	
Securing in the Center Seat Position	1-48	
Securing in the Right Front Seat Position	1-50	
Top Strap	1-45	
Where to Put	1-45	
Cigarette Lighter	2-52	
Circuit Breakers and Fuses	6-62	
Cleaner, Air	6-16	
Cleaning		
Aluminum Wheels	6-57	
Fabric	6-52	
Glass	6-55	
Inside of Your Vehicle	6-52	
Instrument Panel	6-54	
Leather	6-54	
Outside of Your Vehicle	6-56	
Special Problems	6-53	
Stains	6-53	
Tires	6-57	
Vinyl	6-54	
Wheels	6-57	
Windshield and Wiper Blades	6-55	
Climate Control, Optional	3-2	
Climate Control, Standard	3-1	
Climate Control System	3-1	
Clock, Setting the	3-10	
Comfort Controls	3-1	



Compact Disc Care	3-28
Compact Disc Player	3-18, 3-20
Compact Disc Player Errors	3-18, 3-22
Compass, Electronic	2-39
Compass, Rearview Mirror with	2-39
Composite Headlamps	6-37
Console Storage	2-42
Control of a Vehicle	4-5
Convenience Net	2-47
Convex Outside Mirror	2-42
Coolant	6-25
Heater, Engine	2-12
Recovery Tank	5-13
Cooling System	5-11
Courtesy Transportation	8-6
Cruise Control	2-32
Cupholders	2-42, 2-44
Customer Assistance for Text Telephone Users	8-3
Customer Assistance Information	8-1
Customer Satisfaction Procedure	8-1

<b>D</b> amage, Finish	6-58
Damage, Sheet Metal	6-58
Daytime Running Lamps	2-36
Daytime Running Lamps Indicator Light	2-66
Dead Battery	5-2
Defects, Reporting Safety	8-8
Defensive Driving	4-1
Defogger, Rear Window	3-9
Defogging	3-8
Defrosting	3-8
Dolby® B Noise Reduction	3-16, 3-17

Dome Lamps	2-38
Door	
Locks	2-2
Panel	2-7
Rear Security Locks	2-3
Side	2-6
Storage Pocket	2-46
Driver Position	1-21
Driving	
City	4-32
Defensive	4-1
Drunken	4-2
Freeway	4-33
Guidelines	4-13
In a Blizzard	4-39
In the Rain	4-29
Night	4-27
Off-Road	4-14
On Curves	4-8
On Grades While Towing a Trailer	4-51
On Hill and Mountain Roads	4-35
On Snow and Ice	4-38
Through Water	4-31
Wet Roads	4-29
Winter	4-37
With a Trailer	4-49
Drunken Driving	4-2

<b>E</b> asy Entry Seat (2-Door Utility)	1-6
Electrical Equipment, Adding	2-12, 3-26, 6-61
Electrical System	6-61
Electric Tailgate Glass Release	2-27
Electrochromic Day/Night Rearview Mirror	2-39

Electronic Compass .....	2-39
Engine .....	6-8, 6-10
Coolant .....	6-25
Coolant Heater .....	2-12
Coolant Level Check .....	7-42
Coolant Temperature Gage .....	2-62
Cooling System .....	6-72
Exhaust .....	2-25
Identification .....	6-60
Oil Level Check .....	7-42
Overheating .....	5-9
Running While Parked .....	2-25
Specifications .....	6-70
Starting Your .....	2-11
Engine Oil .....	6-12
Adding .....	6-13
Additives .....	6-14
Checking .....	6-12
Pressure Gage .....	2-65
Used .....	6-15
When to Change .....	6-15
Entry to the Rear Seat (Suburban Second Seat) .....	1-13
Ethanol .....	6-4
Exhaust, Engine .....	2-25
<b>F</b> abric Cleaning .....	6-52
Filling Your Tank .....	6-5
Filter, Air .....	6-16
Filter, Engine Oil .....	6-15
Finish Care .....	6-56
Finish Damage .....	6-58
First Gear, Automatic Transmission .....	2-16
Flashers, Hazard Warning .....	5-1

Flat Tire, Changing .....	5-19
Fluid Capacities .....	6-72
Fluid Leak Check .....	6-34
Fluids and Lubricants .....	7-48
Folding the Rear Seat (2-Door Utility) .....	1-8
Folding the Rear Seat (4-Door Utility) .....	1-9
Folding the Second Seat (Suburban) .....	1-11
Foreign Countries, Fuel .....	6-4
Four-Wheel Drive .....	2-17, 6-22
French Language Manual .....	ii
Front Axle .....	6-23
Front Axle Locking Feature .....	2-17
Front Park/Turn Signal Bulb Replacement .....	6-38, 6-39
Front Sidemarker Lamp Bulb Replacement .....	6-40
Front Towing .....	5-8
Fuel .....	6-3
Canada .....	6-3
Filling Your Tank .....	6-5
Gage .....	2-68
In Foreign Countries .....	6-4
System Chart .....	6-73
Fuses and Circuit Breakers .....	6-62

## Gages

Engine Coolant Temperature .....	2-62
Engine Oil Pressure .....	2-65
Fuel .....	2-68
Speedometer .....	2-57
Tachometer .....	2-57
Voltmeter .....	2-60
Garage Door Opener .....	2-44
GAWR .....	4-42
Gear Positions, Automatic Transmission .....	2-14

Glove Box	2-42
Gross Axle Weight Rating	4-42
Gross Vehicle Weight Rating	4-41
Guide en Français	ii
GVWR	4-41

<b>H</b> alogen Bulbs	6-35
Hazard Warning Flashers	5-1
Headlamps	2-35
Bulb Replacement	6-36, 6-37
High/Low Beam Changer	2-30
On Reminder	2-36
Wiring	6-61
Head Restraints	1-5
Hearing Impaired, Customer Assistance	8-3
Heating	3-7
High-Beam Headlamps	2-30
Highway Hypnosis	4-35
Hill and Mountain Roads	4-35
Hitches, Trailer	4-48
Hood	
Checking Things Under	6-6
Release	6-7
Horn	2-28
Hydroplaning	4-31

<b>I</b> gnition Positions	2-10
Illuminated Entry	2-38
Inflation, Tire	6-44
Inside Rearview Mirror	2-39
Inspections	7-46
Brake System	7-47

Exhaust System	7-46
Radiator and Heater Hose	7-46
Rear Axle	7-47
Steering	7-46
Suspension	7-46
Throttle Linkage	7-46
Transfer Case (Four-Wheel Drive)	7-47
Instrument Panel	2-54
Brightness Control	2-38
Cleaning	6-54
Cluster	2-56
Fuse Block	6-63
Interior Lamps	2-38

<b>J</b> ack, Tire	5-22, 5-23
Jump Starting	5-2

<b>K</b> ey Lock Cylinders Service	7-43
Keyless Entry System	2-4
Keys	2-1

<b>L</b> abels	
Certification/Tire	4-41
Service Parts Identification	6-60
Tire-Loading Information	4-41
Vehicle Identification Number	6-60
Lamps	2-35
Dome	2-38
Interior	2-38
On Reminder	2-36
Underhood Reel	2-37

Latches, Seatback	1-5
Leaving Your Vehicle	2-3
Leaving Your Vehicle with the Engine Running	2-23
Lighter	2-52
Lights	
Air Bag Readiness	1-30, 2-59
Anti-Lock Brake System Warning	2-62, 4-6
Brake System Warning	2-61
Charging Warning System	2-59
Check Gages	2-67
Daytime Running Lamps Indicator	2-66
Headlamp High-Beam Indicator	2-67
Safety Belt Reminder	1-17, 2-58
Service Engine Soon	2-63
Turn Signal and Lane Change Indicator	2-67
Loading Your Vehicle	4-41
Lockout Switch	2-27
Locks	2-2
Cylinder	7-43
Door	2-2
Key Lock Cylinder Service	7-43
Power Door	2-3
Rear Door Security	2-3
Steering Column Lock Check	7-45
Window	2-27
Lubricants and Fluids	7-48
Lubrication Service, Body	7-43
Luggage Carrier	2-50
<b>M</b> aintenance, Normal Replacement Parts	6-71
Maintenance Record	7-51
Maintenance Schedule	7-1
Long Trip/Highway Definition	7-5
Long Trip/Highway Intervals	7-5

Owner Checks and Services	7-42
Periodic Maintenance Inspections	7-46
Recommended Fluids and Lubricants	7-48
Scheduled Maintenance Services	7-3
Short Trip/City Definition	7-4
Short Trip/City Intervals	7-4
Maintenance, Underbody	6-58
Maintenance When Trailer Towing	4-53
Malfunction Indicator Lamp	2-63
Manual Front Seat	1-1
Manual Mirror	2-41
Manual Windows	2-27
Methanol	6-4
Mirrors	2-39
Convex Outside	2-42
Electrochromic Day/Night Rearview	2-39
Inside Rearview	2-39
Manual	2-41
Power Remote Control	2-41
MMT	6-3
Model Reference	vi
Mountain Roads	4-35
Multifunction Lever	2-29
<b>N</b> et, Convenience	2-47
Neutral, Automatic Transmission	2-15
New Vehicle Break-In	2-9
Night Vision	4-28
<b>O</b> dometer	2-57
Odometer, Trip	2-57
Off-Road Driving	4-14

Off-Road Recovery .....	4-10
Oil, Engine .....	6-12
Opener, Garage Door .....	2-44
Overdrive, Automatic Transmission .....	2-16
Overheating Engine .....	5-9
Owner Checks and Services .....	7-42
Owner Publications, Ordering .....	8-9

<b>P</b> aint Spotting, Chemical .....	6-58
--	------

<b>P</b> ark	
Automatic Transmission .....	2-14
Shifting Into .....	2-22

<b>P</b> arking	
At Night .....	2-9
Brake .....	2-21
Brake Mechanism Check .....	7-45
Lots .....	2-9
Over Things That Burn .....	2-24
With a Trailer .....	4-52

Passenger Position .....	1-36
--------------------------	------

Passing .....	4-11
---------------	------

Periodic Maintenance Inspections .....	7-46
--	------

<b>P</b> ower	
Auxiliary Outlet .....	2-53
Door Locks .....	2-3
Lumbar Adjustment .....	1-3
Option Fuses .....	6-62
Remote Control Mirror .....	2-41
Seat .....	1-2
Steering .....	4-8
Steering Fluid .....	6-29
Take-Off .....	4-54

Winches .....	4-54
Windows .....	2-27
Power Lumbar Adjustment .....	1-3
Pregnancy, Use of Safety Belts .....	1-35
Problems on the Road .....	5-1
Protecting Exterior Bright Metal Parts .....	6-57
PTO .....	4-54
Publications, Service and Owner .....	8-9

<b>R</b> adiator .....	5-16
------------------------	------

Radiator Pressure Cap .....	6-28
-----------------------------	------

Radio Reception .....	3-26
-----------------------	------

Radios .....	3-10, 3-12, 3-14, 3-20
--------------	------------------------

Rain, Driving In .....	4-29
------------------------	------

Reading Lamps .....	2-39
---------------------	------

<b>R</b> ear	
Axle .....	6-22

Door Security Locks .....	2-3
---------------------------	-----

Lamp Bulb Replacement .....	6-41
-----------------------------	------

Outside Seat Position .....	1-38
-----------------------------	------

Seat Passengers .....	1-38
-----------------------	------

Window Defogger .....	3-9
-----------------------	-----

Windshield Washer .....	2-32
-------------------------	------

Rear Air Conditioning and Heating Systems .....	3-3
---	-----

Rear Towing .....	5-8
-------------------	-----

Rearview Mirror .....	2-39
-----------------------	------

Electrochromic Day/Night .....	2-39
--------------------------------	------

Inside .....	2-39
--------------	------

Reclining Front Seatbacks .....	1-4
---------------------------------	-----

Recovery Hooks .....	5-37
----------------------	------

Recovery Tank, Coolant .....	5-13
------------------------------	------

Refrigerants, Air Conditioning .....	6-73
--------------------------------------	------

Removing the Rear (Third) Seat (Suburban) .....	1-14
---	------

Replacement	
Bulbs	6-68, 6-69
Parts	6-71
Wheel	6-49
Wheel, Used	6-50
Replacing Safety Belts	1-56
Replacing the Rear (Third) Seat (Suburban)	1-16
Reporting Safety Defects	8-8
Restraints	
Checking	1-55
Child	1-45
Head	1-5
Replacing Parts After a Crash	1-56
System Check	7-43
Reverse, Automatic Transmission	2-15
Right Front Passenger Position	1-36
Roadside Assistance	8-4
Roadside Assistance, Canadian	8-6
Rocking Your Vehicle	5-37
Roof Marker Lamp Bulb Replacement	6-41
Rotation, Tires	6-45
<b>S</b> afety Belt Extender	1-55
Safety Belts	1-16
Adults	1-21
Care	6-55
Center Passenger Position	1-36
Children	1-43
Driver Position	1-21
Extender	1-55
How to Wear Properly	1-21
Incorrect Usage	1-24, 1-53, 1-54
Lap Belt	1-36
Lap-Shoulder	1-21, 1-38
Larger Children	1-52
Passenger Position	1-36
Questions and Answers	1-20
Rear Seat Outside Passenger Positions	1-38
Rear Seat Passengers	1-38
Reminder Light	1-17, 2-58
Replacing After a Crash	1-56
Right Front Passenger Position	1-36
Shoulder Belt Height Adjuster	1-23, 1-42
Smaller Children and Babies	1-43
Use During Pregnancy	1-35
Why They Work	1-17
Safety Chains	4-48
Safety Defects, Reporting	8-8
Safety Warnings and Symbols	iii
Scheduled Maintenance Services	7-3
Seatback	
Latches	1-5
Reclining Front	1-4
Seats	
Easy Entry (2-Door Utility)	1-6
Entry to the Rear (Suburban Second Seat)	1-13
Folding the Rear (2-Door Utility)	1-8
Folding the Rear (4-Door Utility)	1-9
Folding the Second (Suburban)	1-11
Lumbar Adjustment	1-3
Manual Front	1-1
Power	1-2
Rear	1-7
Removing the Rear (Third) Seat (Suburban)	1-14
Replacing the Rear (Third) Seat (Suburban)	1-16
Restraint Systems	1-1
Seat Controls	1-1
Securing a Child Restraint	1-46, 1-48, 1-50

Second Gear, Automatic Transmission	2-16	Steering	4-8
Security Shade	2-48	Column Lock Check	7-45
Service	6-1	In Emergencies	4-9
Bulletins, Ordering	8-9	Power	4-8
Engine Soon Light	2-63	Tips	4-8
Manuals, Ordering	8-9	Wheel, Tilt	2-28
Parts Identification Label	6-60	Step-Bumper Pad	4-56
Publications, Ordering	8-9	Storage Compartments	2-42
Work, Doing Your Own	6-2	Storage, Overhead	2-46
Service and Appearance Care	6-1	Storage, Vehicle	6-35
Service and Owner Publications	8-9	Stuck: In Sand, Mud, Ice or Snow	5-36
Service Publications	8-9	Sunglasses Storage	2-46
Servicing Your Air Bag-Equipped Vehicle	1-34	Sun Visors	2-53
Sheet Metal Damage	6-58	Supplemental Inflatable Restraint	1-29
Shifting		Symbols, Vehicle	v
Automatic Transmission	2-14	<b>T</b> achometer	2-57
Into Park (P)	2-22	Tailgate	2-7
Shift Lever	2-14	Glass Release	2-27
Shoulder Belt Height Adjuster	1-23, 1-42	Tape Player Care	3-27
Signaling Turns	2-29	Theft	2-8
SIR	1-29	Theft-Deterrent Feature, CD Player	3-24
Skidding	4-12	THEFTLOCK™	3-24
Sound Equipment, Adding	3-26	Thermostat	6-28
Specifications and Capacities	6-70	Third Gear, Automatic Transmission	2-16
Specifications, Engine	6-70	Tilt Steering Wheel	2-28
Speech Impaired, Customer Assistance	8-3	Time, Setting the	3-10
Speedometer	2-57	Tire Chains	6-51
Stains, Cleaning	6-53	Tire Loading	4-41
Starter Switch Check	7-43	Tire-Loading Information Label	4-41
Starting Your Engine	2-11		
Steam	5-9		

Tires	6-43	Parking on Hills	4-52
Alignment and Balance	6-49	Safety Chains	4-48
Buying New	6-47	Tongue Weight	4-47
Chains	6-51	Total Weight on Tires	4-47
Changing a Flat	5-19	Towing	4-43
Cleaning	6-57	Turn Signals	4-51
Inflation	6-44	Weight	4-45
Inflation Check	7-42	Wiring Harness	4-53
Inspection and Rotation	6-45	Transfer Case	6-23
Loading	4-41	Transfer Case, Electronic	2-19
Pressure	6-44	Transfer Case, Manual	2-17
Temperature	6-49	Transmission Fluid, Automatic	6-18
Traction	6-48	Transmitters, Keyless Entry	2-4
Treadwear	6-48	Transportation, Courtesy	8-6
Uniform Quality Grading	6-48	Trip Odometer	2-57
Used Wheel Replacement	6-50	TTY Users	8-3
Wear Indicators	6-46	Turn Signal and Lane Change Signals	2-29
Wheel Replacement	6-49	Turn Signals When Towing a Trailer	4-51
When It's Time for New	6-46		
Top Strap	1-45	<b>U</b> nderbody Maintenance	6-58
Torque Lock	2-24	Underhood	
Torque, Wheel Nut	5-30, 6-70	Fuse/Relay Center	6-66
Towing		Reel Lamp	2-37
From the Front	5-8	Storage Area	2-47
From the Rear	5-8		
Trailer	4-43	<b>V</b> ehicle	
Your Vehicle	5-6	Control	4-5
Trailer		Damage Warnings	iv
Brakes	4-49	Identification Number	6-60
Driving on Grades	4-51	Loading	4-41
Driving with	4-49	Storage	6-35
Engine Cooling When Towing	4-44, 4-53	Ventilation System	3-7
Hitches	4-48		
Maintenance When Towing	4-53		



Visors, Sun .....	2-53
Voltmeter .....	2-60
<b>W</b> arning Devices .....	5-2
Warning Lights, Gages and Indicators .....	2-58
Washer Fluid, Windshield .....	6-30
Washing Your Vehicle .....	6-56
Weatherstrips .....	6-55
Wheel	
Alignment .....	6-49
Nut Torque .....	5-30, 6-70
Replacement .....	6-49
Used Replacement .....	6-50
Wrench .....	5-22, 5-23
Window Lock .....	2-27

Windows .....	2-27
Lockout Switch .....	2-27
Manual .....	2-27
Power .....	2-27
Windshield Washer .....	2-31
Fluid .....	2-31, 6-30
Fluid Level Check .....	7-42
Rear .....	2-32
Windshield Wipers .....	2-30
Blade Replacement .....	6-42, 6-71
Fuses .....	6-61
Rear .....	2-32
Winter Driving .....	4-37
Wiring, Headlamp .....	6-61
Wrecker Towing .....	5-6
Wrench, Wheel .....	5-22, 5-23



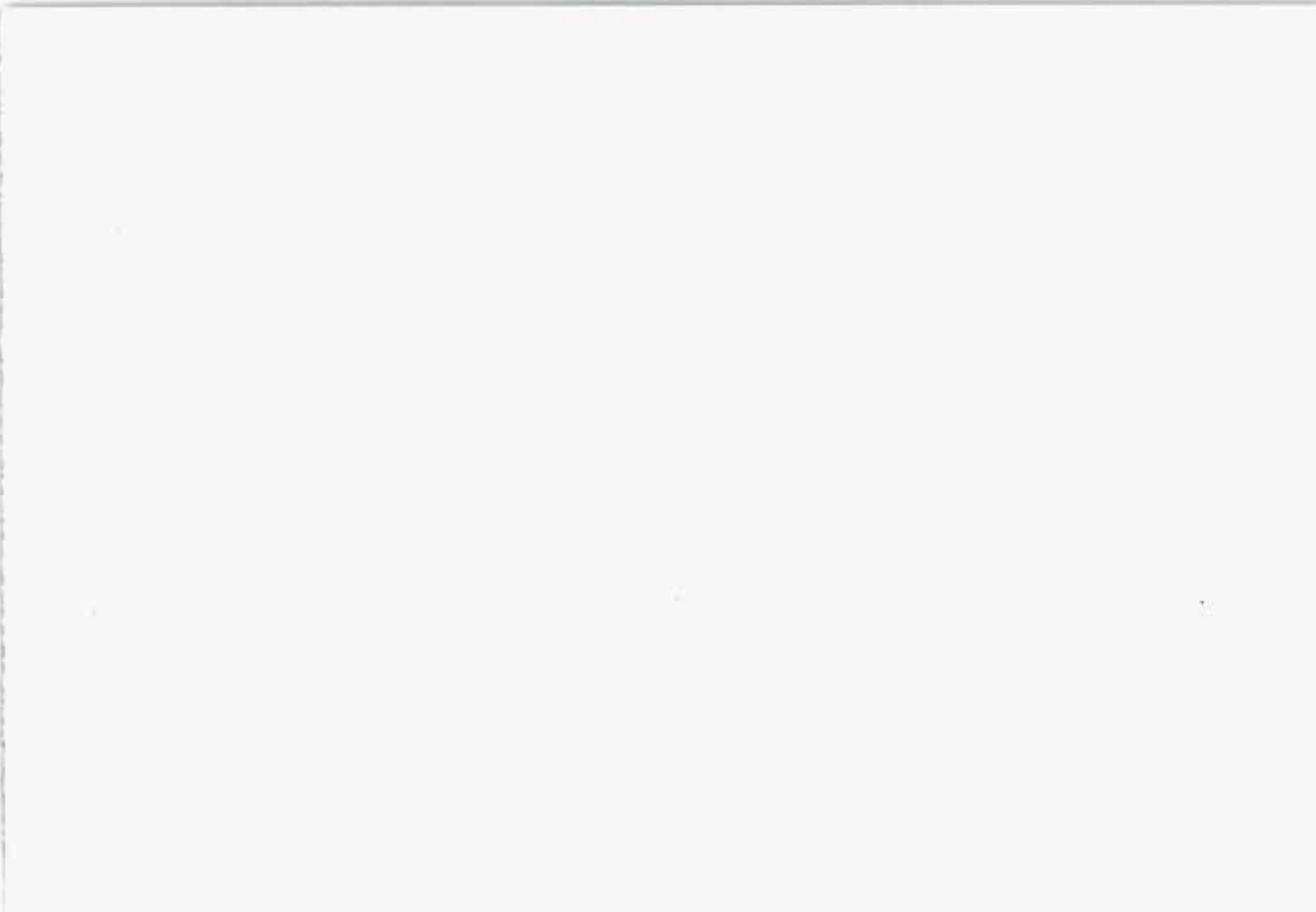

X-9609

**GMC**  
TRUCK

THE STRENGTH OF EXPERIENCE



*Keep with vehicle at all times.  
Contains important Operating, Safety,  
and Maintenance instructions.*