

Achieva



Oldsmobile

1995

Owner's Manual



The 1995 Oldsmobile Achieva Owner's Manual

How to Use this Manual	iii
This section tells you how to use your manual and includes safety and vehicle damage warnings and symbols.	
Seats and Restraint Systems	1-1
This section tells you how to use your seats and safety belts properly. It also explains the "SRS" system.	
Features and Controls	2-1
This section explains how to start and operate your Oldsmobile.	
Comfort Controls and Audio Systems	3-1
This section tells you how to adjust the ventilation and comfort controls and how to operate your audio system.	
Your Driving and the Road	4-1
Here you'll find information and tips about the road and how to drive under different conditions.	
Problems on the Road	5-1
This section tells you what to do if you have a problem while driving, such as a flat tire or overheated engine, etc.	
Service and Appearance Care	6-1
Here the manual tells you how to keep your Oldsmobile running properly and looking good.	
Maintenance Schedule	7-1
This section tells you when to perform vehicle maintenance and what fluids and lubricants to use.	
Customer Assistance Information	8-1
This section tells you how to contact Oldsmobile for assistance and how to get service publications. It also gives you information on "Reporting Safety Defects" on page 8-4.	
Index	9-1
Here's an alphabetical listing of almost every subject in this manual. You can use it to quickly find something you want to read.	



GENERAL MOTORS, GM and the GM Emblem, OLDSMOBILE and the OLDSMOBILE Rocket Emblem are registered trademarks of General Motors Corporation.

This manual includes the latest information at the time it was printed. We reserve the right to make changes in the product after that time without further notice. For vehicles first sold in Canada, substitute the name "General Motors of Canada Limited" for Oldsmobile Division whenever it appears in this manual.

Please keep this manual in your Oldsmobile, so it will be there if you ever need it when you're on the road. If you sell the vehicle, please leave this manual in it so the new owner can use it.



We support voluntary technician certification.

For Canadian Owners Who Prefer a French Language Manual:

Aux propriétaires canadiens: Vous pouvez vous procurer un exemplaire de ce guide en français chez votre concessionnaire ou au DGN Marketing Services Ltd., 1500 Bonhill Rd., Mississauga, Ontario L5T 1C7.

How to Use this Manual

Many people read their owner's manual from beginning to end when they first receive their new vehicle. This will help you learn about the features and controls for your vehicle. In this manual, you'll find that pictures and words work together to explain things quickly.

Index

A good place to look for what you need is the Index in the back of the manual. It's an alphabetical list of all that's in the manual, and the page number where you'll find it.

Safety Warnings and Symbols

You will find a number of safety cautions in this book. We use a box with gray background and the word **CAUTION** to tell you about things that could hurt you if you were to ignore the warning.



CAUTION:

These mean there is something that could hurt you or other people.

In the gray caution area, we tell you what the hazard is. Then we tell you what to do to help avoid or reduce the hazard. Please read these cautions. If you don't, you or others could be hurt.



You will also find a circle with a slash through it in this book. This safety symbol means "Don't," "Don't do this," or "Don't let this happen."

Vehicle Damage Warnings

Also in this book you will find these notices:

NOTICE:

These mean there is something that could damage your vehicle.

In the notice area, we tell you about something that can damage your vehicle. Many times, this damage would not be covered by your warranty, and it could be costly. But the notice will tell you what to do to help avoid the damage.

When you read other manuals, you might see CAUTION and NOTICE warnings in different colors or in different words.

You'll also see warning labels on your vehicle. They use yellow for cautions, blue for notices and the words CAUTION or NOTICE.

Vehicle Symbols

These are some of the symbols you may find on your vehicle.

For example, these symbols are used on an original battery:

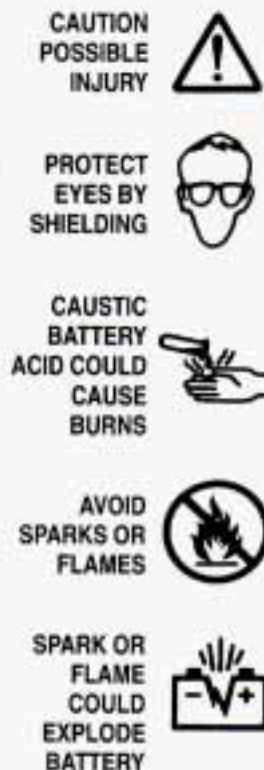

These symbols are important for you and your passengers whenever your vehicle is driven:



These symbols have to do with your lights:



These symbols are on some of your controls:



These symbols are used on warning and indicator lights:

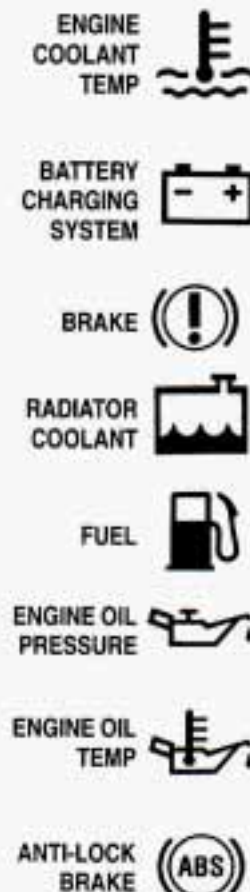

Here are some other symbols you may see:





Section 1 Seats and Restraint Systems

Here you'll find information about the seats in your Oldsmobile and how to use your safety belts properly. You can also learn about some things you should *not* do with air bags and safety belts.

Seats and Seat Controls

This section tells you about the seats -- how to adjust them -- and also about reclining seatbacks and head restraints.

Manual Front Seat



CAUTION:

You can lose control of the vehicle if you try to adjust a manual driver's seat while the vehicle is moving. The sudden movement could startle and confuse you, or make you push a pedal when you don't want to. Adjust the driver's seat only when the vehicle is not moving.



Move the control lever under the front of the seat to unlock it. Slide the seat to where you want it. Then release the lever and try to move the seat with your body, to make sure the seat is locked into place.

Manual Four-Way Adjustable Seat (Option)

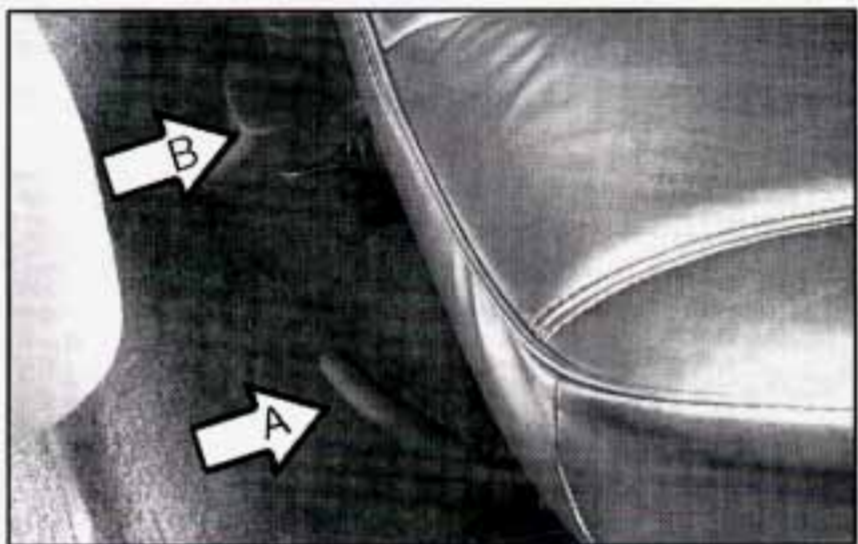

There are two levers at the front of the seat. The left lever adjusts the seat forward and back. The right lever adjusts the angle of the front of the seat.

Lift the left lever (A) up and adjust the seat forward or back. Then release the lever and try to move the seat to be certain that it is locked in place.

Lift the right lever (B), and lean forward or backward.

Power Seat Controls (Option)

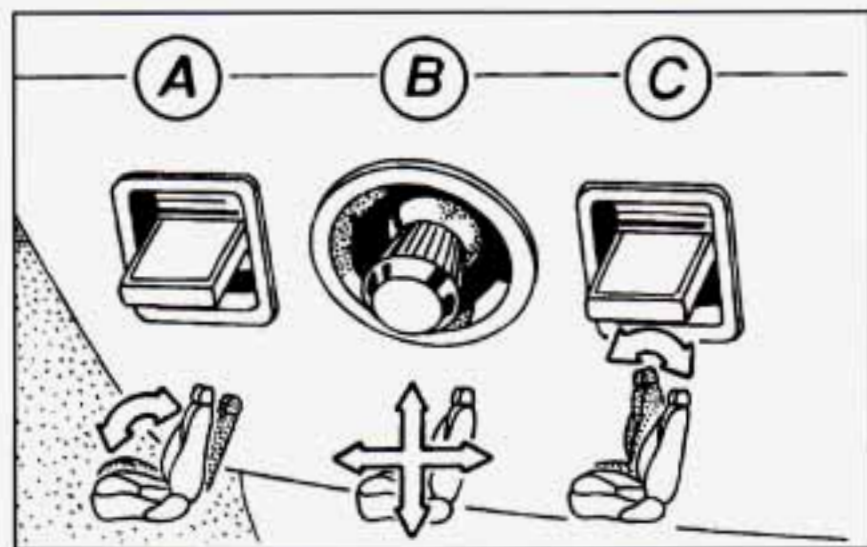

To adjust the power seat on some models:

Front Control (A): Raise the front of the seat by holding the switch up. Lower the front of the seat by holding the switch down.

Center Control (B): Move the seat forward or back by holding the control to the front or back.

Move the seat higher by holding the control up. Lower the seat by holding the control down.

Rear Control (C): Raise the rear of the seat by holding the switch up. Lower the rear of the seat by holding the switch down.

Reclining Front Seatbacks

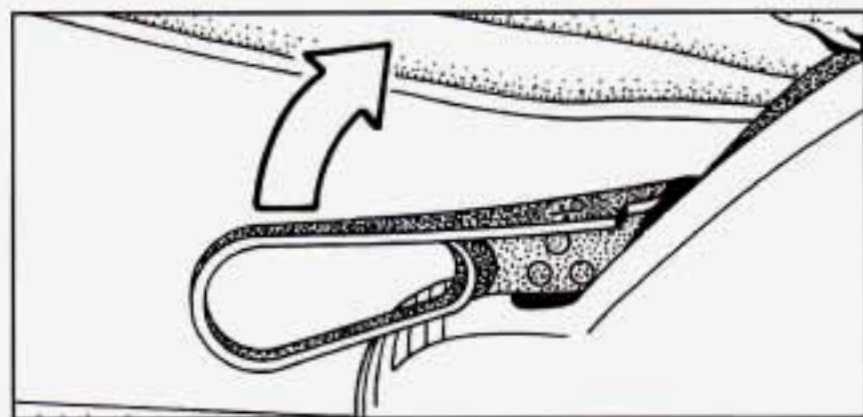

To adjust the seatback, lift the lever on the outer side of the seat and move the seatback where you want it. Release the lever to lock the seatback.

Pull up on the lever and the seat will go to an upright position.



But don't have a seatback reclined if your vehicle is moving.

⚠ CAUTION:

Sitting in a reclined position when your vehicle is in motion can be dangerous. Even if you buckle up, your safety belts can't do their job when you're reclined like this.

The shoulder belt can't do its job because it won't be against your body. Instead, it will be in front of you. In a crash you could go into it, receiving neck or other injuries.

The lap belt can't do its job either. In a crash the belt could go up over your abdomen. The belt forces would be there, not at your pelvic bones. This could cause serious internal injuries.

For proper protection when the vehicle is in motion, have the seatback upright. Then sit well back in the seat and wear your safety belt properly.

Head Restraints

Slide the head restraint up or down so that the top of the restraint is closest to the top of your ears.

This position reduces the chance of a neck injury in a crash.

Front Seatback Latches (2-Door Models)

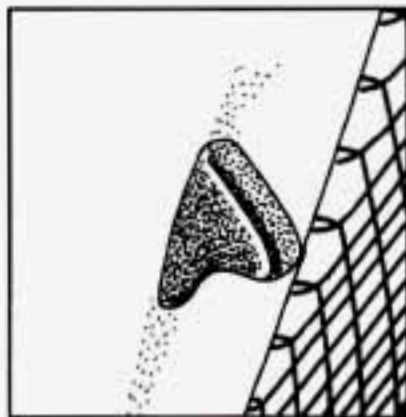

The front seatback folds forward to let people get into the back seat. Your seatback will move back and forth freely, unless you come to a sudden stop. Then it will lock into place.

There's one time the front seats may not fold without some help from you. That's if your vehicle is parked facing down a fairly steep hill.

To fold a front seatback forward, push the seatback toward the rear seat as you lift this latch. Then the seatback will fold forward. The latch must be down for the seat to work properly.

Easy-Entry Seat (2-Door Models)

The right front seat of your vehicle makes it easy to get in and out of the rear seat.

- When you tilt the right front seatback fully forward, the whole seat will slide forward.
- After someone gets into the rear seat area, move the right front seatback to its original position. Then move the seat rearward until it locks.

CAUTION:

If an easy entry right front seat isn't locked, it can move. In a sudden stop or crash, the person sitting there could be injured. After you've used it, be sure to push rearward on an easy entry seat to be sure it is locked.

To get out again, tilt the seatback fully forward.

Split Fold-Down Rear Seat (Option)

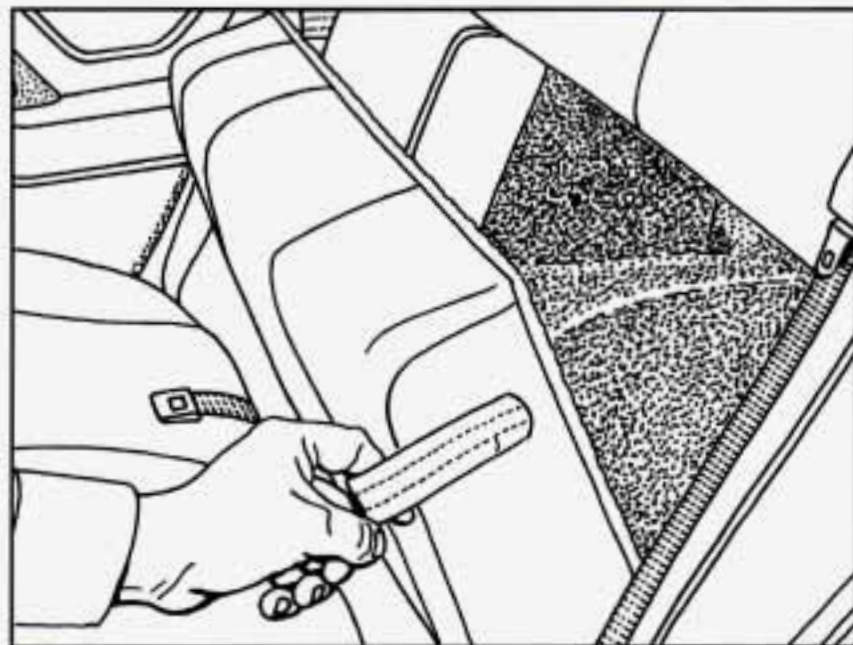

To fold down the rear seat, pull forward on the seat tab. Push the seatback up to return it to its original position. To make sure the seatback is secure, push it into a fully upright position.

Safety Belts: They're for Everyone

This part of the manual tells you how to use safety belts properly. It also tells you some things you should not do with safety belts.

And it explains the Supplemental Restraint System, or "air bag" system.

CAUTION:

Don't let anyone ride where he or she can't wear a safety belt properly. If you are in a crash and you're not wearing a safety belt, your injuries can be much worse. You can hit things inside the vehicle or be ejected from it. You can be seriously injured or killed. In the same crash, you might not be if you are buckled up. Always fasten your safety belt, and check that your passengers' belts are fastened properly too.



Your vehicle has a light that comes on as a reminder to buckle up. (See "Safety Belt Warning Light" in the Index.)

In many states and Canadian provinces, the law says to wear safety belts. Here's why: *They work.*

You never know if you'll be in a crash. If you do have a crash, you don't know if it will be a bad one.

A few crashes are mild, and some crashes can be so serious that even buckled up a person wouldn't survive. But most crashes are in between. In many of them, people who buckle up can survive and sometimes walk away. Without belts they could have been badly hurt or killed.

After more than 25 years of safety belts in vehicles, the facts are clear. In most crashes buckling up does matter ... a lot!

Why Safety Belts Work

When you ride in or on anything, you go as fast as it goes.

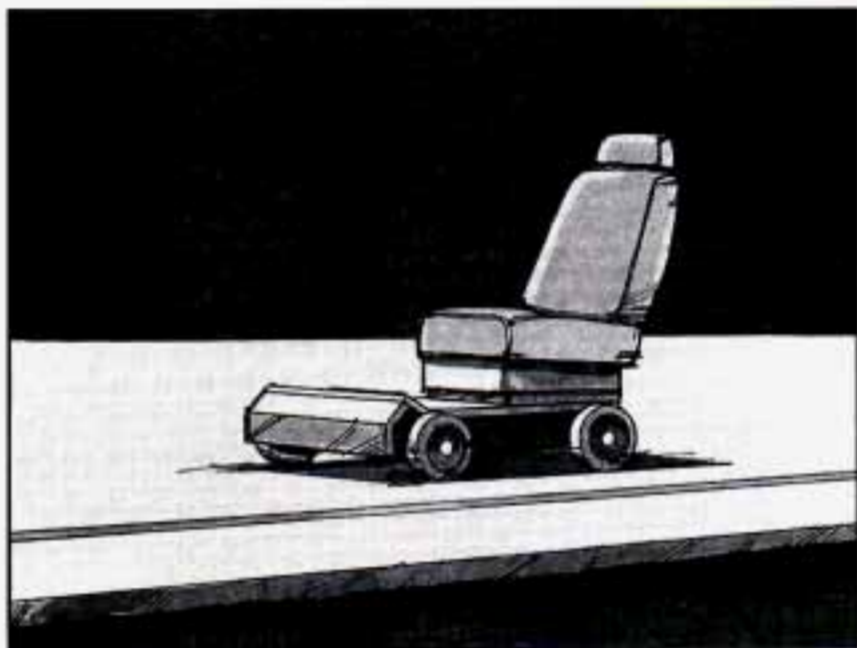

Take the simplest vehicle. Suppose it's just a seat on wheels.

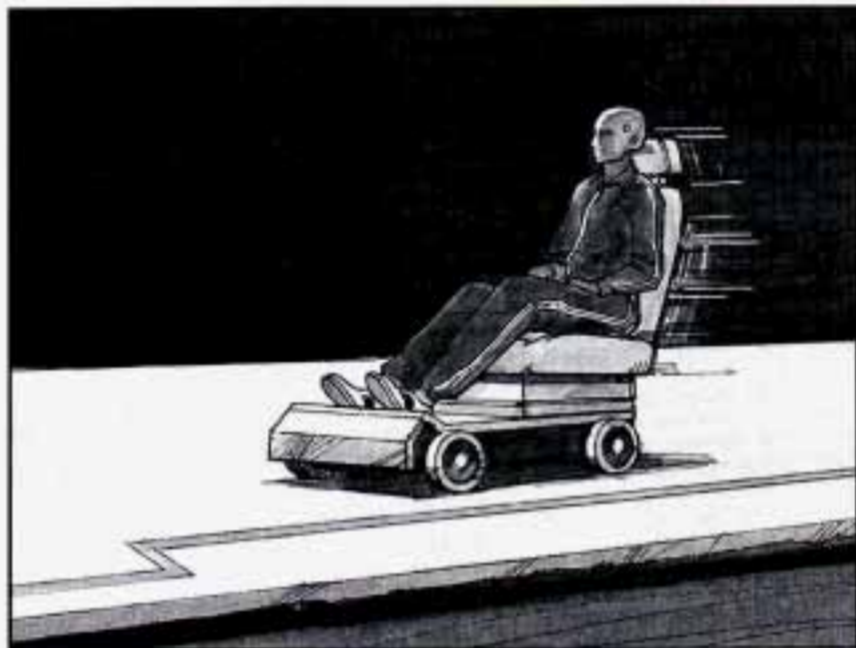

Put someone on it.

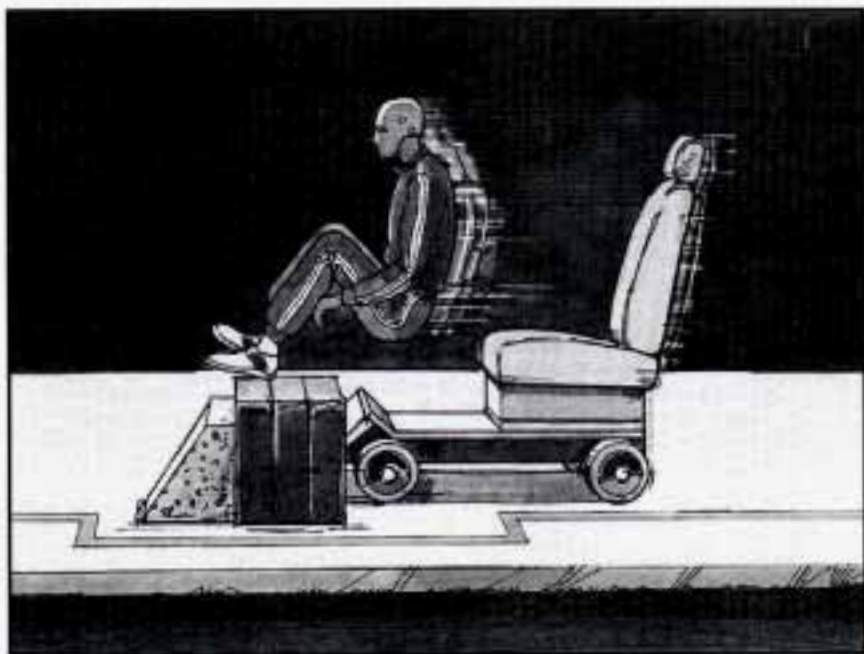

Get it up to speed. Then stop the vehicle. The rider doesn't stop.



The person keeps going until stopped by something. In a real vehicle, it could be the windshield ...

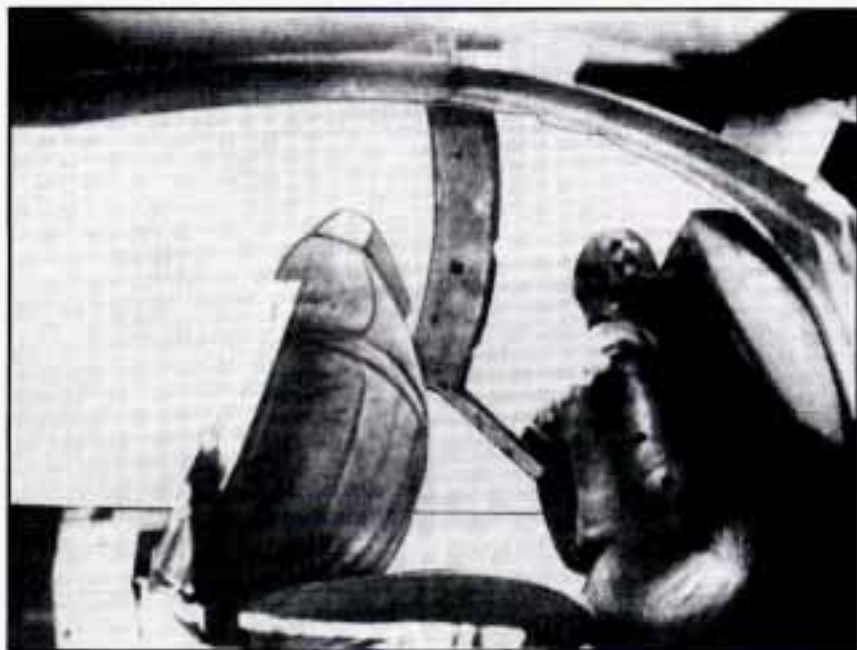

or the instrument panel ...



or the safety belts!

With safety belts, you slow down as the vehicle does. You get more time to stop. You stop over more distance, and your strongest bones take the forces. That's why safety belts make such good sense.

Here Are Questions Many People Ask About Safety Belts -- and the Answers

Q: Won't I be trapped in the vehicle after an accident if I'm wearing a safety belt?

A: You *could* be -- whether you're wearing a safety belt or not. But you can unbuckle a safety belt, even if you're upside down. And your chance of being conscious during and after an accident, so you *can* unbuckle and get out, is *much* greater if you are belted.

Q: Why don't they just put in air bags so people won't have to wear safety belts?

A: Air bags are in many vehicles today and will be in more of them in the future. But they are supplemental systems only; so they work *with* safety belts -- not instead of them. Every air bag system ever offered for sale has required the use of safety belts. Even if you're in a vehicle that has air bags, you still have to buckle up to get the most protection. That's true not only in frontal collisions, but especially in side and other collisions.

Q: If I'm a good driver, and I never drive far from home, why should I wear safety belts?

A: You may be an excellent driver, but if you're in an accident -- even one that isn't your fault -- you and your passengers can be hurt. Being a good driver doesn't protect you from things beyond your control, such as bad drivers.

Most accidents occur within 25 miles (40 km) of home. And the greatest number of serious injuries and deaths occur at speeds of less than 40 mph (65 km/h).

Safety belts are for everyone.

How to Wear Safety Belts Properly

Adults

This part is only for people of adult size.

Be aware that there are special things to know about safety belts and children. And there are different rules for smaller children and babies. If a child will be riding in your Oldsmobile, see the part of this manual called "Children." Follow those rules for everyone's protection.

First, you'll want to know which restraint systems your vehicle has.

We'll start with the driver position.

Driver Position

This part describes the driver's restraint system.

Was your Oldsmobile first sold, when new, in Canada? (If it was, a sticker on the driver's door will say "conforms to all applicable Canada motor vehicle . . ." etc.) If so, then this "Driver Position" part doesn't apply to your vehicle. To learn how to use your driver position safety belts, read the *Canadian Owner's Manual Safety Belt Supplement*. It comes with every new Oldsmobile first sold in Canada.

Automatic Lap-Shoulder Belt



This safety belt is called “automatic” because you don’t have to buckle up when you get into your vehicle.



And you don’t have to unbuckle when you get out.

Just get into your vehicle. Then close and lock the door. Adjust the seat (to see how, see “Seats” in the Index) so you can sit up straight.

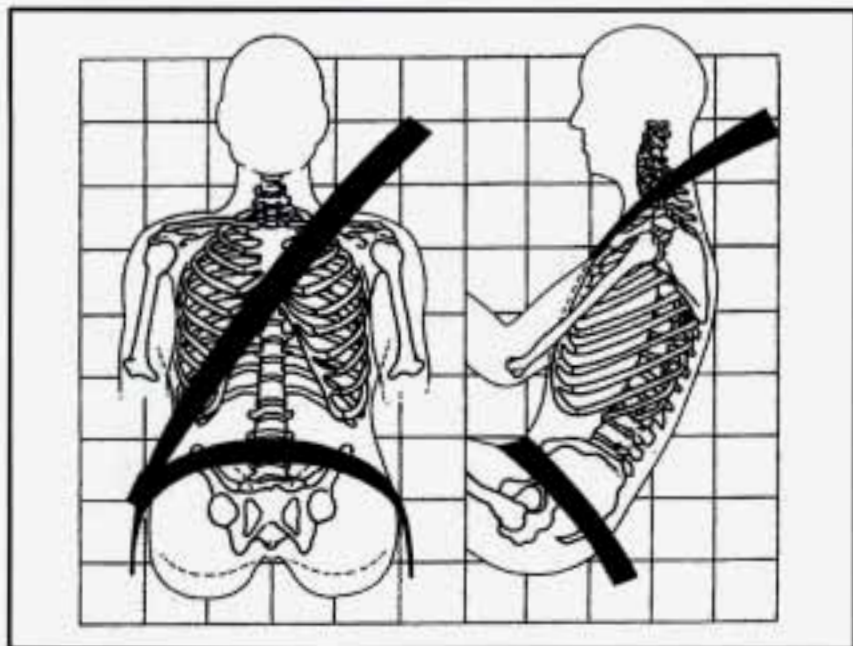

The lap belt should be worn as low on the hips as possible. In a crash, this applies force to the strong pelvic bones. And you'd be less likely to slide under the lap belt. If you slid under it, the belt would apply force at your abdomen. This could cause serious or even fatal injuries. The shoulder belt should go over the shoulder and across the chest. These parts of the body are best able to take belt restraining forces.

The safety belt locks if there's a sudden stop or a crash.

It's possible that an automatic belt could keep you from fully opening a door. That can happen if the door was slammed shut very hard. Just close the door all the way, then slowly open it. If that doesn't fix it, then your Oldsmobile needs service.

We hope you'll always keep your automatic belt buckled. However, you may need to unbuckle it in an emergency. To unbuckle the automatic belt, just push the button on the buckle.



To reattach the automatic belt:

1. Close and lock the door.
2. Adjust the seat (to see how, see "Seats" in the Index) so you can sit up straight.



3. Pick up the latch plate and pull the belt across you. Don't let it get twisted.
4. Push the latch plate into the buckle until it clicks. Pull up on the latch plate to make sure it is secure.

Q: What's wrong with this?

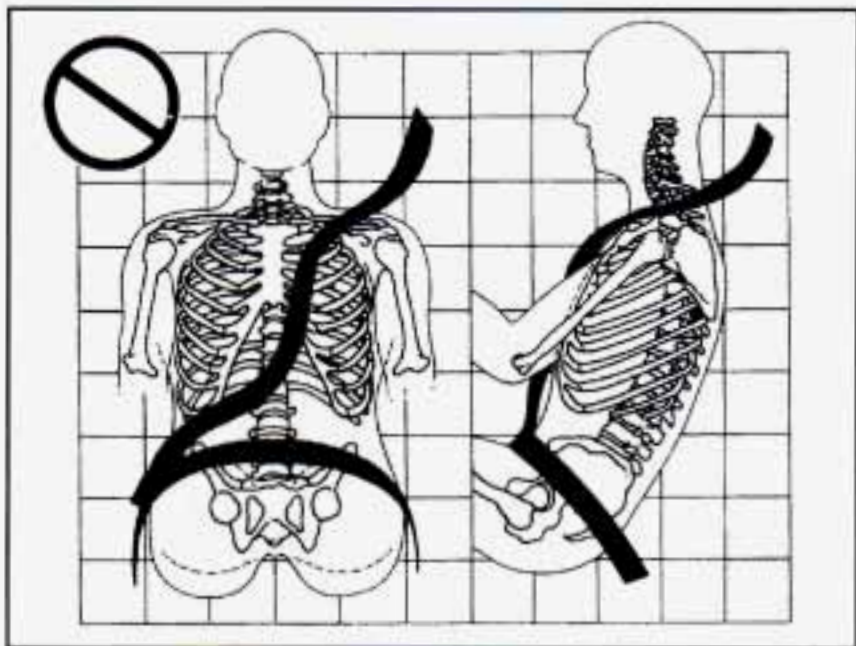

⚠ CAUTION:

You can be seriously hurt if your shoulder belt is too loose. In a crash you would move forward too much, which could significantly increase injury. The shoulder belt should fit against your body.

A: The shoulder belt is too loose. It won't give nearly as much protection this way.

Q: What's wrong with this?

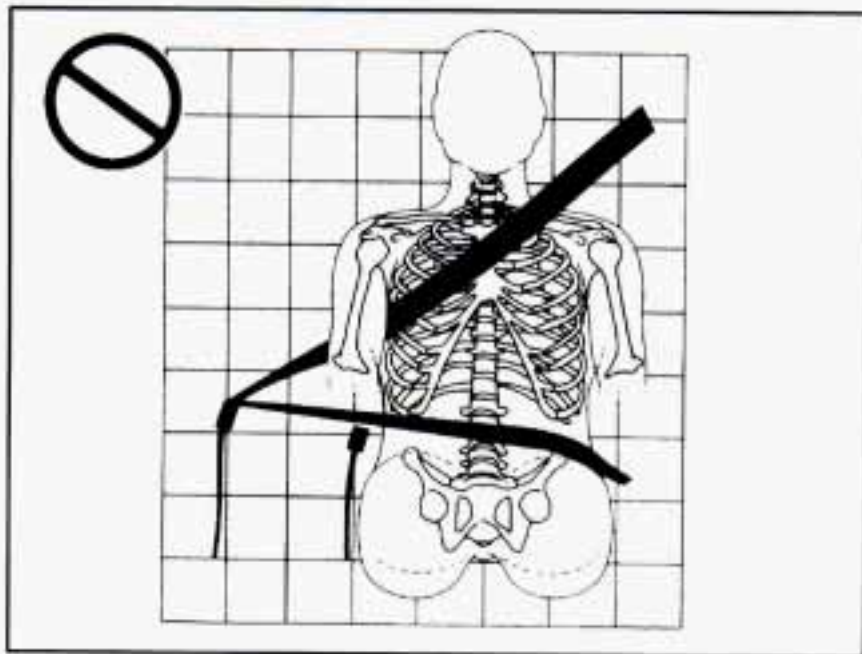

⚠ CAUTION:

You can be seriously injured if your belt is buckled in the wrong place like this. In a crash, the belt would go up over your abdomen. The belt forces would be there, not at the pelvic bones. This could cause serious internal injuries. Always buckle your belt into the buckle nearest you.

A: The belt is buckled in the wrong place.

Q: What's wrong with this?

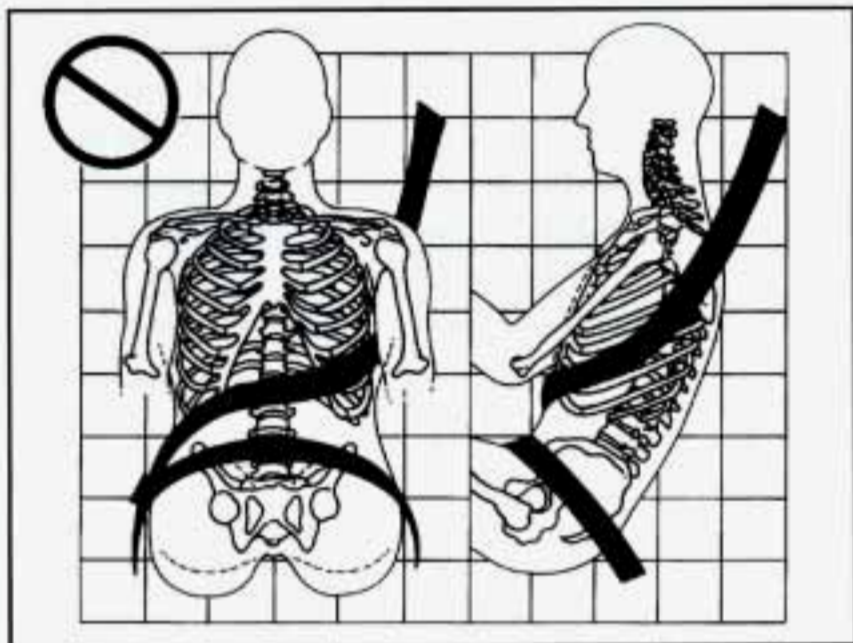

A: The shoulder belt is worn under the arm. It should be worn over the shoulder at all times.

⚠ CAUTION:

You can be seriously injured if you wear the shoulder belt under your arm. In a crash, your body would move too far forward, which would increase the chance of head and neck injury. Also, the belt would apply too much force to the ribs, which aren't as strong as shoulder bones. You could also severely injure internal organs like your liver or spleen.

Q: What's wrong with this?

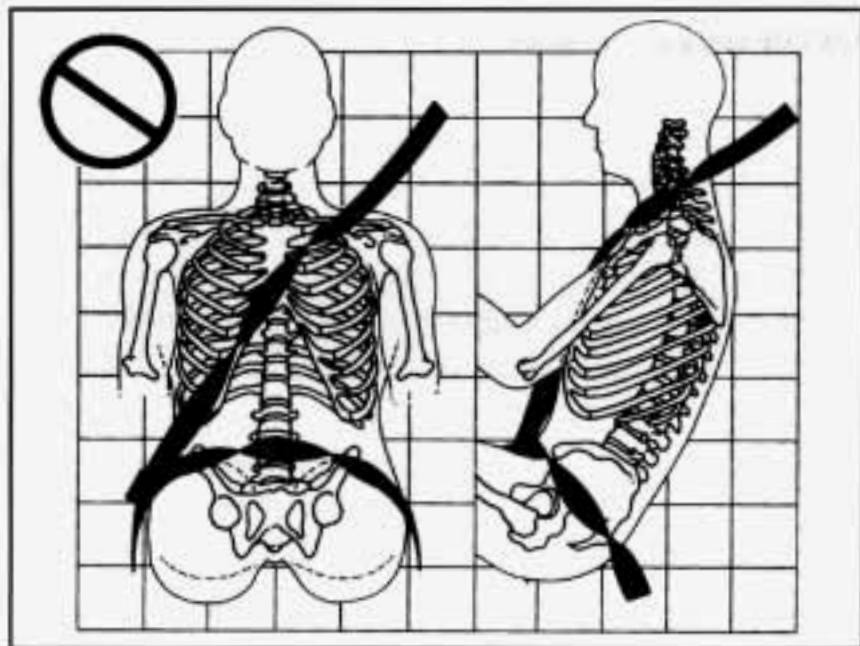

A: The belt is twisted across the body.

⚠ CAUTION:

You can be seriously injured by a twisted belt. In a crash, you wouldn't have the full width of the belt to take impact forces. If a belt is twisted, make it straight so it can work properly, or ask your retailer to fix it.

Supplemental Restraint System (SRS)

This part explains the Supplemental Restraint System (SRS), or air bag.

Your Oldsmobile has an air bag for the driver.

Here are the most important things to know about the air bag system:

CAUTION:

You can be severely injured or killed in a crash if you aren't wearing your safety belt -- even if you have an air bag. Wearing your safety belt during a crash helps reduce your chance of hitting things inside the vehicle or being ejected from it. The air bag is only a "supplemental restraint." That is, it works with safety belts but doesn't replace them. Air bags are designed to work only in moderate to severe crashes where the front of your vehicle hits something. They aren't designed to inflate at all in rollover, rear, side, or low-speed frontal crashes. Everyone in your vehicle, including the driver, should wear a safety belt properly -- whether or not there's an air bag for that person.

CAUTION:

Air bags inflate with great force, faster than the blink of an eye. If you're too close to an inflating air bag, it could seriously injure you. Safety belts help keep you in position for an air bag inflation in a crash. Always wear your safety belt, even with an air bag, and sit as far back as you can while still maintaining control of your vehicle.

AIR
BAG

There is an air bag readiness light on the instrument panel, which shows AIR BAG.

The system checks the air bag's electrical system for malfunctions. The light tells you if there is an electrical problem. See "Air Bag Readiness Light" in the Index for more information.

How the Air Bag System Works



Where is the air bag?

The driver's air bag is in the middle of the steering wheel.



CAUTION:

Don't put anything on, or attach anything to, the steering wheel. Also, don't put anything (such as pets or objects) between the driver and the steering wheel. If something is between an occupant and an air bag, it could affect the performance of the air bag -- or worse, it could cause injury.

When should an air bag inflate?

The air bag is designed to inflate in moderate to severe frontal or near-frontal crashes. The air bag will inflate only if the impact speed is above the system's designed "threshold level." If your vehicle goes straight into a wall that doesn't move or deform, the threshold level is about 9 to 16 mph (14 to 26 km/h). The threshold level can vary, however, with specific vehicle design, so that it can be somewhat above or below this range. If your vehicle strikes something that will move or deform, such as a parked car, the threshold level will be higher. The air bag is not designed to inflate in rollovers, side impacts, or rear impacts, because inflation would not help the occupant.

In any particular crash, no one can say whether an air bag should have inflated simply because of the damage to a vehicle or because of what the repair costs were. Inflation is determined by the angle of the impact and the vehicle's deceleration. Vehicle damage is only one indication of this.

What makes an air bag inflate?

In a frontal or near-frontal impact of sufficient severity, the air bag sensing system detects that the vehicle is suddenly stopping as a result of a crash. The sensing system triggers a chemical reaction of the sodium azide sealed in the inflator. The reaction produces nitrogen gas, which inflates the air bag. The inflator, air bag, and related hardware are all part of the air bag module packed inside the steering wheel.

How does an air bag restrain?

In moderate to severe frontal or near-frontal collisions, even belted occupants can contact the steering wheel. The air bag supplements the protection provided by safety belts. Air bags distribute the force of the impact more evenly over the occupant's upper body, stopping the occupant more gradually. But air bags would not help you in many types of collisions, including rollovers and rear and side impacts, primarily because an occupant's motion is not toward the air bag. Air bags should never be regarded as anything more than a supplement to safety belts, and then only in moderate to severe frontal or near-frontal collisions.

What will you see after an air bag inflates?

After the air bag inflates, it quickly deflates. This occurs so quickly that some people may not even realize the air bag inflated. Some components of the air bag module in the steering wheel hub will be hot for a short time, but the part of the bag that comes into contact with you will not be hot to the touch. There will be some smoke and dust coming from vents in the deflated air bag. Air bag inflation will not prevent the driver from seeing or from being able to steer the vehicle, nor will it stop people from leaving the vehicle.

CAUTION:

When an air bag inflates, there is dust in the air. This dust could cause breathing problems for people with a history of asthma or other breathing trouble. To avoid this, everyone in the vehicle should get out as soon as it is safe to do so. If you have breathing problems but can't get out of the vehicle after an air bag inflates, then get fresh air by opening a window or door.

- The air bag is designed to inflate only once. After it inflates, you'll need some new parts for your air bag system. If you don't get them, the air bag system won't be there to help protect you in another crash. A new system will include the air bag module and possibly other parts. The service manual for your vehicle covers the need to replace other parts.
- Your vehicle is equipped with a diagnostic module, which records information about the air bag system. The module records information about the readiness of the system, when the sensors are activated and driver's safety belt usage at deployment.
- Let only qualified technicians work on your air bag system. Improper service can mean that your air bag system won't work properly. See your retailer for service.

NOTICE:

If you damage the cover for the driver's air bag, it may not work properly. You may have to replace the air bag module. Do not open or break the air bag cover.

Servicing Your Air Bag-Equipped Oldsmobile

The air bag affects how your Oldsmobile should be serviced. There are parts of the air bag system in several places around your vehicle. You don't want the system to inflate while someone is working on your vehicle. Your Oldsmobile retailer and the 1995 Achieva Service Manual have information about servicing your vehicle and the air bag system. To purchase a service manual, see "Service Publications" in the Index. The air bag system does not need regular maintenance.



CAUTION:

For up to 2 minutes after the ignition key is turned off and the battery is disconnected, an air bag can still inflate during improper service. You can be injured if you are close to an air bag when it inflates. Avoid wires wrapped with yellow tape, or yellow connectors. They are probably part of the air bag system. Be sure to follow proper service procedures, and make sure the person performing work for you is qualified to do so.

Safety Belt Use During Pregnancy

Safety belts work for everyone, including pregnant women. Like all occupants, they are more likely to be seriously injured if they don't wear safety belts.

A pregnant woman should wear a lap-shoulder belt, and the lap portion should be worn as low as possible throughout the pregnancy.



The best way to protect the fetus is to protect the mother. When a safety belt is worn properly, it's more likely that the fetus won't be hurt in a crash. For pregnant women, as for anyone, the key to making safety belts effective is wearing them properly.

Right Front Passenger Position

Was your Oldsmobile first sold, when new, in Canada? (If it was, a sticker on the driver's door will say "conforms to all applicable Canada motor vehicle . . ." etc.) If so, then this "Right Front Passenger Position" part doesn't apply to your vehicle. To learn how to use your right front passenger position safety belts, read the *Canadian Owner's Manual Safety Belt Supplement*. It comes with every new Oldsmobile first sold in Canada.

The right front passenger's safety belt works the same way as the driver's safety belt. See "Driver Position," earlier in this section.

- Adjust the seat (to see how, see “Seats” in the Index) so you can sit up straight. Move your seat far enough forward that your feet touch the part of the car that is called the “toeboard” (A). That way you’d be less likely to slide under the lap belt in a crash.



Rear Seat Passengers

It's very important for rear seat passengers to buckle up! Accident statistics show that unbelted people in the rear seat are hurt more often in crashes than those who are wearing safety belts.

Rear passengers who aren't safety belted can be thrown out of the vehicle in a crash. And they can strike others in the vehicle who are wearing safety belts.

Rear Seat Outside Passenger Positions

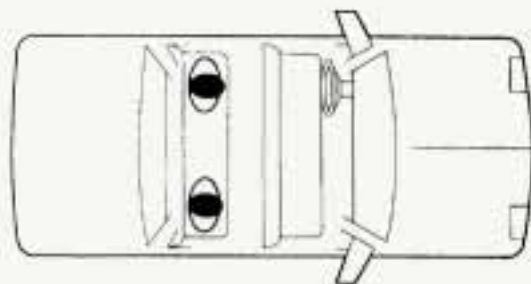

Lap-Shoulder Belt

The positions next to the windows have lap-shoulder belts. Here's how to wear one properly.



1. Pick up the latch plate and pull the belt across you. Don't let it get twisted.

2. Push the latch plate into the buckle until it clicks.



If the belt stops before it reaches the buckle, tilt the latch plate and keep pulling until you can buckle it.

Pull up on the latch plate to make sure it is secure.

If the belt is not long enough, see "Safety Belt Extender" at the end of this section. Make sure the release button on the buckle is positioned so you would be able to unbuckle the safety belt quickly if you ever had to.

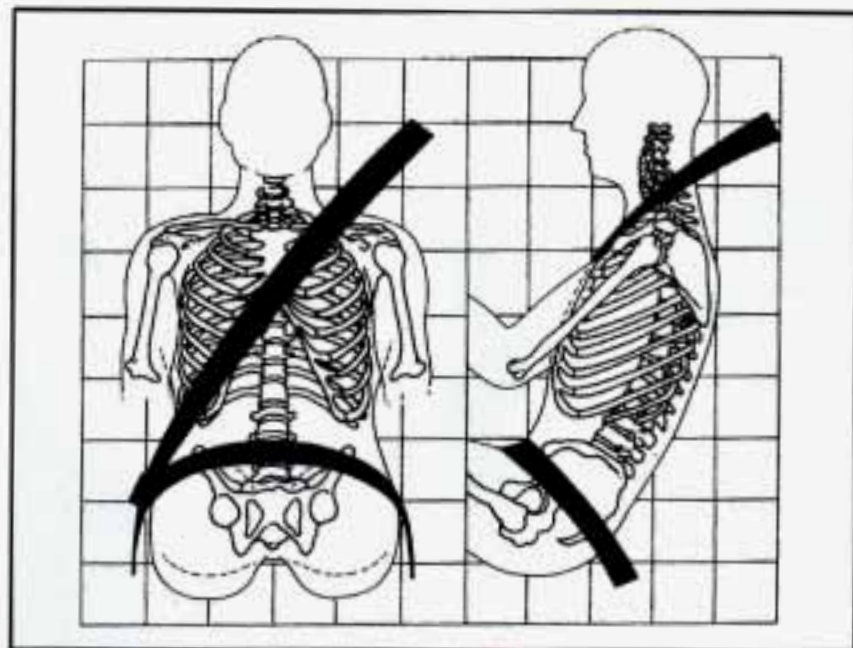

3. To make the lap part tight, pull down on the buckle end of the belt as you pull up on the shoulder part.

The lap part of the belt should be worn low and snug on the hips, just touching the thighs. In a crash, this applies force to the strong pelvic bones. And you'd be less likely to slide under the lap belt. If you slid under it, the belt would apply force at your abdomen. This could cause serious or even fatal injuries. The shoulder belt should go over the shoulder and across the chest. These parts of the body are best able to take belt restraining forces.

The safety belt locks if there's a sudden stop or a crash.

⚠ CAUTION:

You can be seriously hurt if your shoulder belt is too loose. In a crash you would move forward too much, which could increase injury. The shoulder belt should fit against your body.



To unlatch the belt, just push the button on the buckle.

Rear Safety Belt Comfort Guides for Children and Small Adults

Rear shoulder belt comfort guides will provide added comfort for children who have outgrown child restraints and for small adults. The comfort guides pull the shoulder belts away from the neck and head.

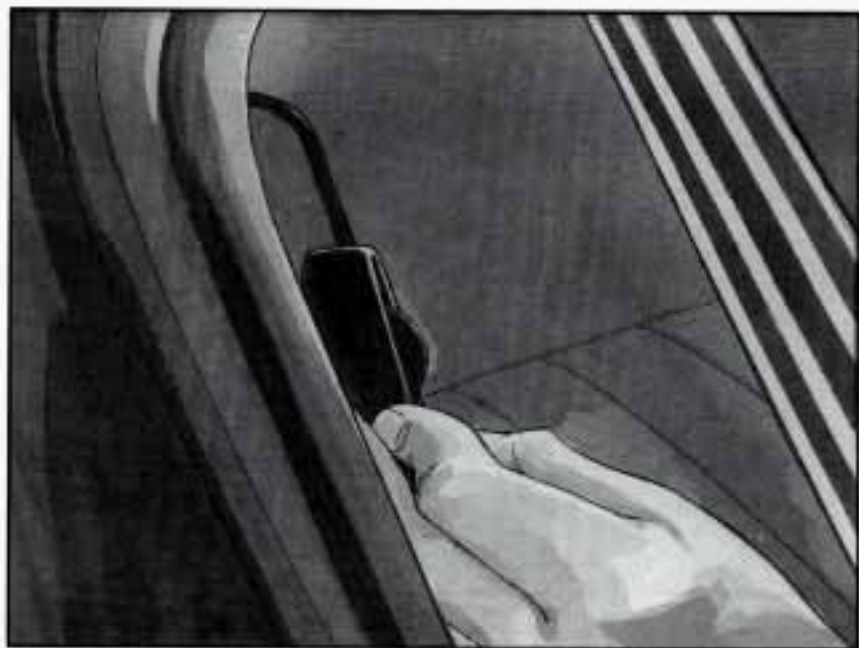

There is one guide for each outside passenger position in the rear seat. You will find them tucked in between the seatback and the interior body, about half-way down the

edge of the seatback. Here is how you should install the comfort guides on the shoulder belts:

1. Pull the elastic cord out from between the edge of the seatback and the interior body to remove the guide from its storage clip.

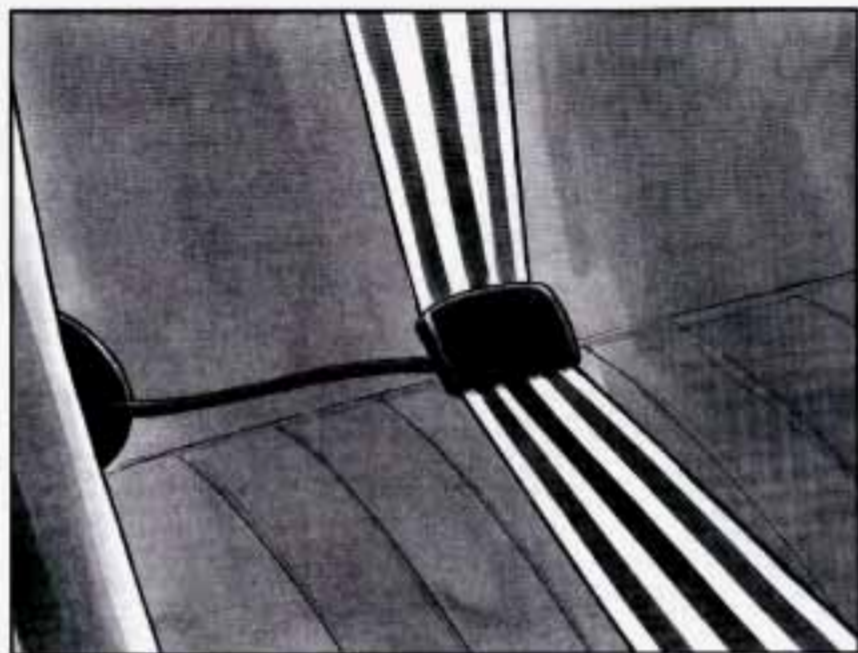

3. Be sure that the belt is not twisted and it lies flat. The elastic cord must be under the belt and the guide on top.

2. Slide the guide under and past the belt. The elastic cord must be under the belt. Then, place the guide over the belt, and insert the two edges of the belt into the slots of the guide.



4. Buckle the belt around the child, and make sure that both the lap belt and the shoulder belt are secured properly. Make sure that the shoulder belt crosses the shoulder. See "Safety Belts, Rear Seat Passengers" in the Index.

To remove and store the comfort guides, just perform these steps in reverse order. Squeeze the belt edges together so that you can take them out from the guides. Pull the guide upward to expose its storage clip, and then slide the guide onto the clip. Rotate the guide and clip inward and in between the seatback and the interior body, leaving only the loop of elastic cord exposed.

Center Passenger Position

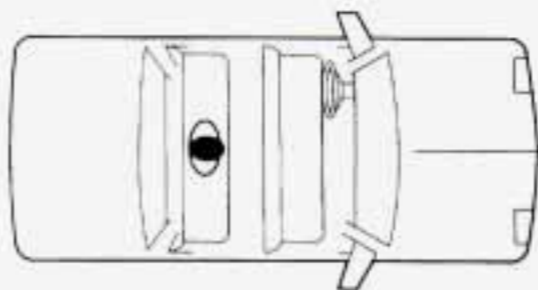

Lap Belt



When you sit in the center seating position, you have a lap safety belt, which has no retractor. To make the belt longer, tilt the latch plate and pull it along the belt.

To make the belt shorter, pull its free end as shown until the belt is snug.



Buckle, position and release it the same way as the lap part of a lap-shoulder belt. If the belt isn't long enough, see "Safety Belt Extender" at the end of this section.

Make sure the release button on the buckle is positioned so you would be able to unbuckle the safety belt quickly if you ever had to.

Children

Everyone in a vehicle needs protection! That includes infants and all children smaller than adult size. In fact, the law in every state in the United States and in every Canadian province says children up to some age must be restrained while in a vehicle.

Smaller Children and Babies

CAUTION:

Smaller children and babies should always be restrained in a child or infant restraint. The instructions for the restraint will say whether it is the right type and size for your child. A very young child's hip bones are so small that a regular belt might not stay low on the hips, as it should. Instead, the belt will likely be over the child's abdomen. In a crash the belt would apply force right on the child's abdomen, which could cause serious or fatal injuries. So, be sure that any child small enough for one is always properly restrained in a child or infant restraint.



CAUTION:

Never hold a baby in your arms while riding in a vehicle. A baby doesn't weigh much -- until a crash. During a crash a baby will become so heavy

CAUTION: (Continued)

CAUTION: (Continued)

you can't hold it. For example, in a crash at only 25 mph (40 km/h), a 12-pound (5.5 kg) baby will suddenly become a 240-pound (110 kg) force on your arms. The baby would be almost impossible to hold.

Secure the baby in an infant restraint.



Child Restraints

Be sure to follow the instructions for the restraint. You may find these instructions on the restraint itself or in a booklet, or both. These restraints use the belt system in your vehicle, but the child also has to be secured within the restraint to help reduce the chance of personal injury. The instructions that come with the infant or child restraint will show you how to do that.

Where to Put the Restraint

Accident statistics show that children are safer if they are restrained in the rear rather than the front seat. We at General Motors therefore recommend that you put your child restraint in the rear seat unless the child is an infant and you're the only adult in the vehicle. In that case, you might want to secure the restraint in the front seat where you can keep an eye on the baby.

Wherever you install it, be sure to secure the child restraint properly.

Keep in mind that an unsecured child restraint can move around in a collision or sudden stop and injure people in the vehicle. Be sure to properly secure any child restraint in your vehicle -- even when no child is in it.

Top Strap

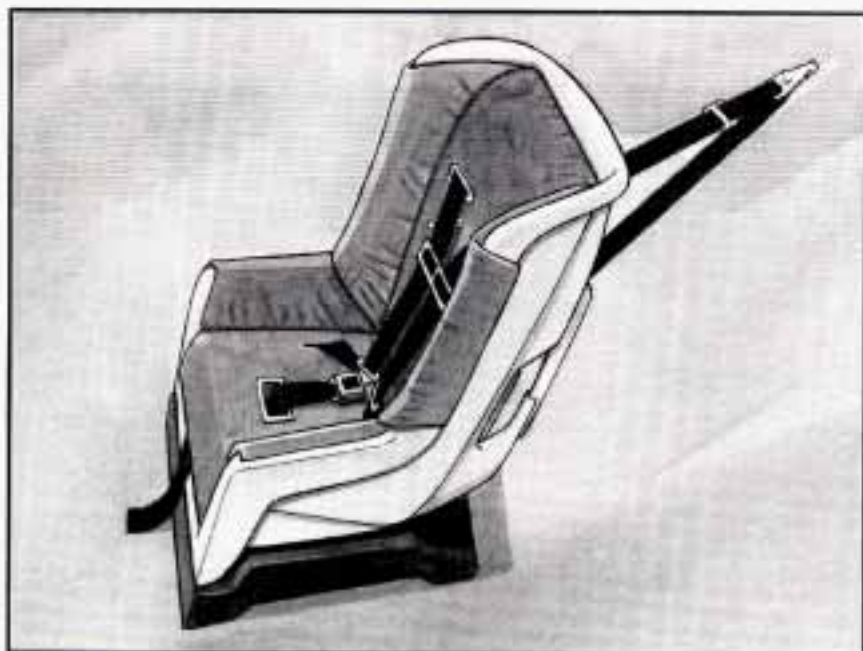

If your child restraint has a top strap, it should be anchored.

If you need to have an anchor installed, you can ask your Oldsmobile retailer to put it in for you. If you want to install an anchor yourself, your retailer can tell you how to do it.

For cars first sold in Canada, child restraints with a top strap must be anchored according to Canadian Law.

Your retailer can obtain the hardware kit and install it for you, or you may install it yourself using the instructions provided in the kit.

Use the tether hardware kit available from the retailer. The hardware and installation instructions were specifically designed for this vehicle.

Securing a Child Restraint in a Rear Outside Seat Position

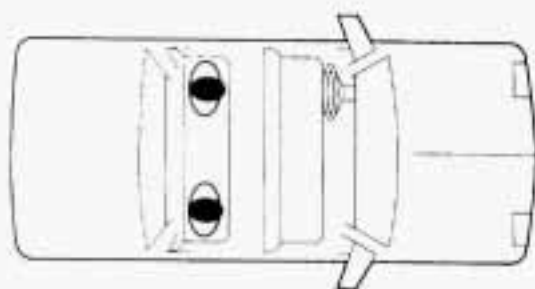

You'll be using the lap-shoulder belt. See the earlier part about the top strap if the child restraint has one.

1. Put the restraint on the seat. Follow the instructions for the child restraint.
2. Secure the child in the child restraint as the instructions say.
3. Pick up the latch plate, and run the lap and shoulder portions of the vehicle's safety belt through or around the restraint. The child restraint instructions will show you how. Tilt the latch plate to adjust the belt if needed.

If the shoulder belt goes in front of the child's face or neck, put it behind the child restraint.

4. Buckle the belt. Make sure the release button is positioned so you would be able to unbuckle the safety belt quickly if you ever had to.



5. To tighten the belt, pull up on the shoulder belt while you push down on the child restraint.



6. Push and pull the child restraint in different directions to be sure it is secure.

To remove the child restraint, just unbuckle the vehicle's safety belt and let it go back all the way. The safety belt will move freely again and be ready to work for an adult or larger child passenger.

Securing a Child Restraint in the Center Rear Seat Position

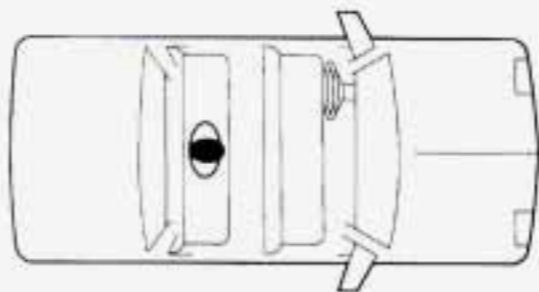

You'll be using the lap belt.

See the earlier part about the top strap if the child restraint has one.

1. Make the belt as long as possible by tilting the latch plate and pulling it along the belt.



2. Put the restraint on the seat. Follow the instructions for the child restraint.
3. Secure the child in the child restraint as the instructions say.

4. Run the vehicle's safety belt through or around the restraint. The child restraint instructions will show you how.



5. Buckle the belt. Make sure the release button is positioned so you would be able to unbuckle the safety belt quickly if you ever had to.

6. To tighten the belt, pull its free end while you push down on the child restraint.
7. Push and pull the child restraint in different directions to be sure it is secure. If the child restraint isn't secure, turn the latch plate over and buckle it again. Then see if it is secure. If it isn't, secure the restraint in a different place in the vehicle and contact the child restraint maker for their advice about how to attach the child restraint properly.

To remove the child restraint, just unbuckle the vehicle's safety belt. It will be ready to work for an adult or larger child passenger.

Securing a Child Restraint in the Right Front Seat Position

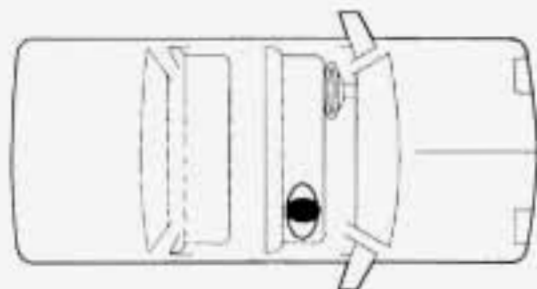

Was your Oldsmobile first sold, when new, in Canada? (If it was, a sticker on the driver's door will say "conforms to all applicable Canada motor vehicle . . ." etc.) If so, then this "Securing a Child Restraint in the Right Front Seat Position" part doesn't apply to your vehicle. To learn how to secure a child restraint in the right front seat, read the *Canadian Owner's Manual Safety Belt Supplement*. It comes with every new Oldsmobile first sold in Canada.

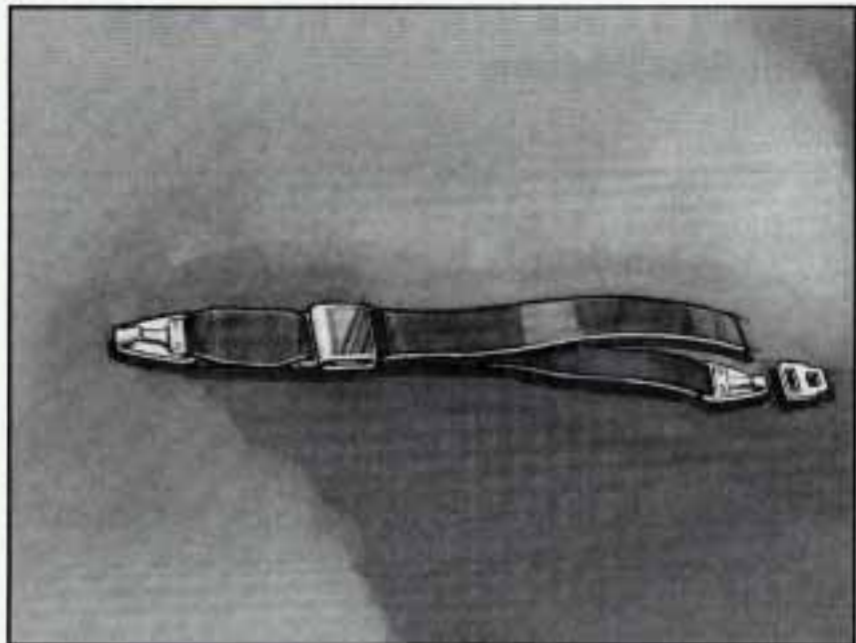

⚠ CAUTION:

Don't use the special infant/child seat attaching hardware in another vehicle. If you do, it may not work well and the child may not be protected properly in a crash. The special hardware is for your vehicle only.

Also, don't use the special belt for anything but securing a child restraint in the right front seat. If an adult or older child uses it, the belt won't provide protection and may even increase injury in a crash.

To use a child restraint here, you will need a special infant/child seat attaching belt and the hardware that goes with it. See the earlier part about the top strap if the child restraint has one.

Your retailer can order the belt and attaching hardware and install the hardware for you. It's free. The special belt is GM Part No. 12340286. Your retailer can find the part number for the correct attaching hardware in the accessory section of the GM Parts Catalog.

Once the special hardware is installed, please follow the instructions with it and these steps:

1. Unbuckle the automatic lap-shoulder belt by pushing the button on the buckle.



It will stay on the door, ready to be rebuckled for use by adults or older children.

2. Snap one hook of the infant/child seat attaching belt near the floor at the door side of the seat.

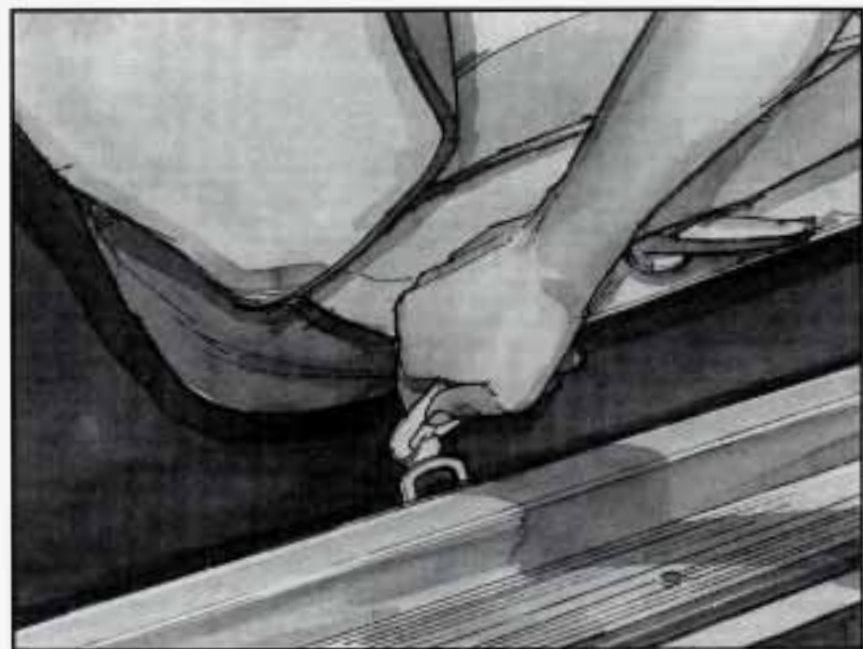

- Put the belt's special latch plate into the vehicle's safety belt buckle.



- You can make the belt longer by tilting the buckle and pulling it along the belt.

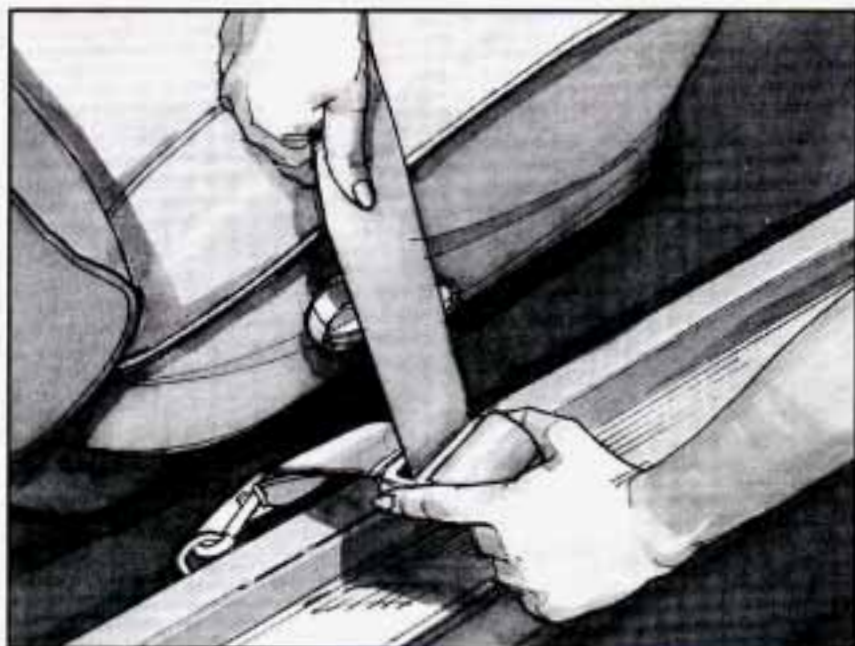

- Put the restraint on the seat. Follow the instructions for the child restraint.
- Secure the child in the child restraint as the instructions say.
- Run the belt through or around the child restraint. The child restraint instructions will show you how.

8. Put the hook on the free end through the slot in the latch plate.



9. To make it tight, pull the belt while you push down on the child restraint. If the belt won't stay tight, switch it end for end.

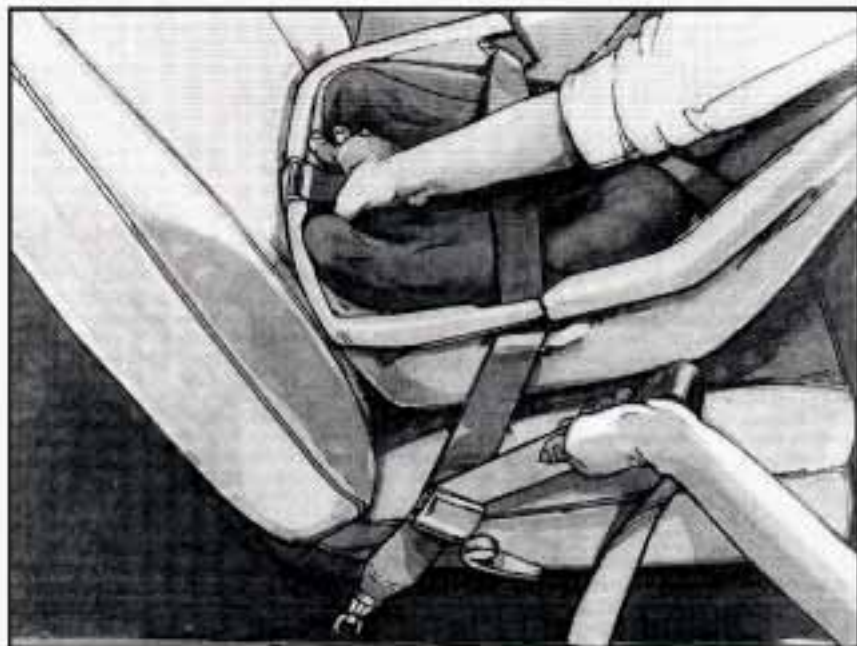

10. Push and pull the child restraint in different directions to be sure it is secure.

To remove the infant/child seat restraint:

1. Push the button on the safety belt buckle and remove the special latch plate. Leave the latch plate on the special belt.



2. Push the spring on the hook near the door and remove the special belt.
3. Put the belt away in a safe place in your vehicle, so it won't fly around in a crash and injure someone.
4. Remember to reattach the automatic belt again, once the child restraint is removed. Be sure it isn't twisted.

Larger Children



Children who have outgrown child restraints should wear the vehicle's safety belts.

If you have the choice, a child should sit next to a window so the child can wear a lap-shoulder belt and get the additional restraint a shoulder belt can provide.

Accident statistics show that children are safer if they are restrained in the rear seat. But they need to use the safety belts properly.

- Children who aren't buckled up can be thrown out in a crash.
- Children who aren't buckled up can strike other people who are.



⚠ CAUTION:

Never do this.

Here two children are wearing the same belt. The belt can't properly spread the impact forces. In a crash, the two children can be crushed together and seriously injured. A belt must be used by only one person at a time.

Q: What if a child is wearing a lap-shoulder belt, but the child is so small that the shoulder belt is very close to the child's face or neck?

A: Move the child toward the center of the vehicle, but be sure that the shoulder belt still is on the child's shoulder, so that in a crash the child's upper body would have the restraint that belts provide. If the child is sitting in a rear seat outside position, see "Rear Safety Belt Comfort Guides" in the Index. If the child is so small that the shoulder belt is still very close to the child's face or neck, you might want to place the child in the center seat position, the one that has only a lap belt.



⚠ CAUTION:

Never do this.

Here a child is sitting in a seat that has a lap-shoulder belt, but the shoulder part is behind the child. If the child wears the belt in this way, in a crash the child might slide under the belt. The belt's force would then be applied right on the child's abdomen. That could cause serious or fatal injuries.

Wherever the child sits, the lap portion of the belt should be worn low and snug on the hips, just touching the child's thighs. This applies belt force to the child's pelvic bones in a crash.

Safety Belt Extender

If the vehicle's safety belt will fasten around you, you should use it. The front seat lap-shoulder belts have plenty of extra length built in, so they will fit almost all people.

But if a safety belt isn't long enough to fasten, your retailer will order you an extender. It's free. When you go in to order it, take the heaviest coat you will wear, so the extender will be long enough for you. The extender will be just for you, and just for the seat in your vehicle that you choose. Don't let someone else use it, and use it only for the seat it is made to fit. To wear it, just attach it to the regular safety belt.

Checking Your Restraint Systems

Now and then, make sure all your belts, buckles, latch plates, retractors, anchorages and warning systems are working properly. Look for any other loose or damaged restraint system parts. If you see anything that might keep a restraint system from doing its job, have it repaired.

Torn or frayed belts may not protect you in a crash. They can rip apart under impact forces. If a belt is torn or frayed, get a new one right away.

Replacing Seat and Restraint System Parts After a Crash

If you've had a crash, do you need new belts?

After a very minor collision, nothing may be necessary. But if the belts were stretched, as they would be if worn during a more severe crash, then you need new belts.

If you ever see a label on a right front safety belt that says to replace the belt, be sure to do so. Then the new belt will be there to help protect you in an accident. You would see this label on the belt near the latch plate.



If belts are cut or damaged, replace them. Collision damage also may mean you will need to have safety belt or seat parts repaired or replaced. New parts and repairs may be necessary even if the belt wasn't being used at the time of the collision.

If your seat adjuster won't work after a crash, the special part of the safety belt that goes through the seat to the adjuster may need to be replaced.



Section 2 Features and Controls

Here you can learn about the many standard and optional features on your Oldsmobile, and information on starting, shifting and braking. Also explained are the instrument panel and the warning systems that tell you if everything is working properly -- and what to do if you have a problem.

Keys

CAUTION:

Leaving young children in a vehicle with the ignition key is dangerous for many reasons. A child or others could be badly injured or even killed.

They could operate power windows or other controls or even make the vehicle move. Don't leave the keys in a vehicle with young children.



Keys are included for the ignition, the doors, and all other locks.

When a new Oldsmobile is delivered, the retailer removes the tags from the keys, and gives them to the first owner.

Each tag has a code on it that tells your retailer or a qualified locksmith how to make extra keys. Keep the tags in a safe place. If you lose your keys, you'll be able to have new ones made easily using these tags.

NOTICE:

Your Oldsmobile has a number of new features that can help prevent theft. But you can have a lot of trouble getting into your vehicle if you ever lock your keys inside. You may even have to damage your vehicle to get in. So be sure you have extra keys.

Door Locks

CAUTION:

Unlocked doors can be dangerous.

Passengers -- especially children -- can easily open the doors and fall out. When a door is locked, the inside handle won't open it.

Outsiders can easily enter through an unlocked door when you slow down or stop your vehicle.

This may not be so obvious: You increase the chance of being thrown out of the vehicle in a crash if the doors aren't locked. Wear safety belts properly, lock your doors, and you will be far better off whenever you drive your vehicle.

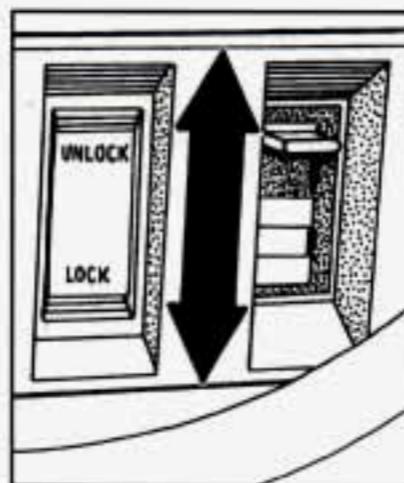

From the inside, to lock the door, slide the locking lever down.

To unlock the door, slide the locking lever up.

There are several ways to lock and unlock your vehicle.

From the outside, use your key or Remote Lock Control, if your vehicle has this option.

Power Door Locks

With power door locks, you can lock or unlock all the doors of your vehicle from the driver or front passenger door lock switch.

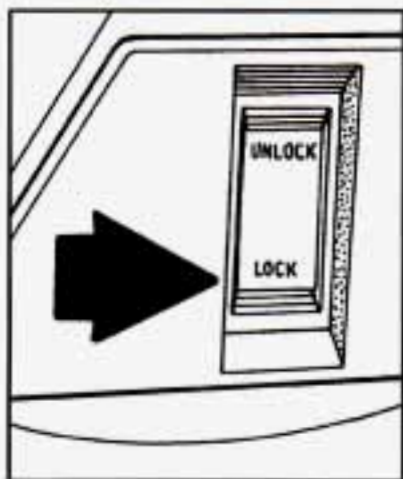

Automatic Door Locks

Just close your doors and turn on the ignition. If you have an automatic transaxle, all of the doors will lock when you move your shift lever out of PARK (P) or NEUTRAL (N). If you have a manual transaxle, all of the doors will lock when the vehicle reaches about 8 mph (13 km/h). If someone needs to get out while the vehicle is running, have that person use the manual or power lock. When the door is closed again, it will lock automatically when you move your shift lever out of PARK (P) or NEUTRAL (N). If you have a manual transaxle, the doors will lock when the vehicle reaches about 8 mph (13 km/h). All doors will automatically unlock when the key is turned to the OFF position.

If you don't want the doors to automatically unlock when the key is turned to the OFF position, you can remove the Automatic Door Unlock fuse. For fuse location, see "Fuses and Circuit Breakers" in the Index.

Leaving Your Vehicle

If you are leaving the vehicle, open your door and set the locks from inside, then get out and close the door.

Illuminated Entry/Exit System

When you lift the outside handle of either front door or open either rear door, the lamps inside your vehicle will go on. These lamps will fade out after about 40 seconds, or when the ignition is turned on after all doors have been closed. If the ignition was recently turned off, the lamps will fade out after four seconds. These lamps will also go on when you press the DOOR or UNLOCK button on the optional Remote Lock Control transmitter.

If the ignition has been off for less than two minutes, the lamps inside your vehicle will stay on for about 15 seconds after your key is removed from the ignition to provide an illuminated exit.

Rear Door Security Locks



Your Oldsmobile is equipped with rear door security locks that help prevent passengers from opening the rear doors of your vehicle from the inside.

To use one of these locks:

1. Use a key to move the lock all the way up.
2. Close the door.
3. Do the same thing to the other rear door lock.

The rear doors of your vehicle cannot be opened from inside when this feature is in use. If you want to open a rear door when the security lock is on:

1. Unlock the door from the inside.
2. Then open the door from the outside.

If you don't cancel the security lock feature, adults or older children who ride in the rear won't be able to open the rear door from the inside. You should let adults and older children know how these security locks work, and how to cancel the locks.

To Cancel the Rear Door Lock:

1. Unlock the door from the inside and open the door from the outside.
2. Use a key to move the lock all the way down.
3. Do the same for the other rear door.

The rear door locks will now work normally.

Remote Lock Control (Option)

If your Oldsmobile has this option, you can lock and unlock your doors or unlock your trunk from up to 30 feet (9 m) away using the key chain transmitter supplied with your vehicle.



Your Remote Lock Control operates on a radio frequency subject to Federal Communications Commission (FCC) Rules.

This device complies with Part 15 of the FCC Rules. Operation is subject to the following two conditions:
(1) This device may not cause harmful interference, and
(2) This device must accept any interference received, including interference that may cause undesired operation.

Should interference to this system occur, try this:

- Check to determine if battery replacement is necessary. See the instructions on battery replacement.
- Check the distance. You may be too far from your vehicle. This product has a maximum range.
- Check the location. Other vehicles or objects may be blocking the signal.
- See your Oldsmobile retailer or a qualified technician for service.

Changes or modifications to this system by other than an authorized service facility could void authorization to use this equipment.

Operation

The driver's door will unlock when UNLOCK is pressed. If pressed again within five seconds, all doors will unlock. All doors will lock when DOOR is pressed.

The trunk will unlock anytime when the vehicle symbol on the Remote Lock Control is pressed and the ignition is off. If the ignition is on, the trunk will unlock if the parking brake is set (manual transaxle) or the gear selector is in PARK (P) or NEUTRAL (N) (automatic transaxle).

Press DOOR or UNLOCK to illuminate the interior lamps. The lamps will then go off after 40 seconds when UNLOCK is pressed and four seconds when DOOR is pressed. When the ignition is turned on, the lamps will also fade out (see Illuminated Entry/Exit System earlier in this section).

Matching Transmitter(s) To Your Vehicle

Each key chain transmitter is coded to prevent another transmitter from unlocking your vehicle. If a transmitter is lost or stolen, a replacement can be purchased through your retailer. Remember to bring any remaining transmitters with you when you go to your retailer. When the retailer matches the replacement transmitter to your vehicle, the remaining transmitters must also be matched. Once the new transmitter is coded, the lost transmitter will not unlock your vehicle.

You can match a transmitter to as many different vehicles as you own, provided they are equipped with *exactly the same model system*. (General Motors offers several different models of these systems on their vehicles.) Each vehicle can have only two transmitters matched to it.

See your retailer to match transmitters to another vehicle.

Battery Replacement

Under normal use, the batteries in your key chain transmitter should last about two years.

You can tell the batteries are weak if the transmitter won't work at the normal range in any location. If you have to get close to your vehicle before the transmitter works, it's probably time to change the batteries.



To Replace Batteries in the Remote Lock Control

1. Pop the cover off by inserting a coin or similar object in the slot between the covers, and then twisting.
2. Lift the front cover off, bottom half first.
3. Remove and replace the two batteries. Use two Duracell[®] batteries, type DL-2016, or equivalent.
4. Replace the front cover. Make sure the cover is on tightly, so water won't get in.
5. Check the transmitter operation.

Trunk Lock

To unlock the trunk from the outside, insert the key and turn the trunk lock cylinder.

CAUTION:

It can be dangerous to drive with the trunk lid open because carbon monoxide (CO) gas can come into your vehicle. You can't see or smell CO. It can cause unconsciousness and even death.

If you must drive with the trunk lid open or if electrical wiring or other cable connections must pass through the seal between the body and the trunk lid:

- Make sure all windows are shut.
- Turn the fan on your heating or cooling system to its highest speed with the setting on VENT. That will force outside air into your vehicle. See "Comfort Controls" in the Index.
- If you have air outlets on or under the instrument panel, open them all the way. See "Engine Exhaust" in the Index.

Remote Trunk Release

Pull upward on the remote release handle, located on the floor near the left side of the driver's seat, to release the trunk lid. Make sure the lockout feature is not activated.

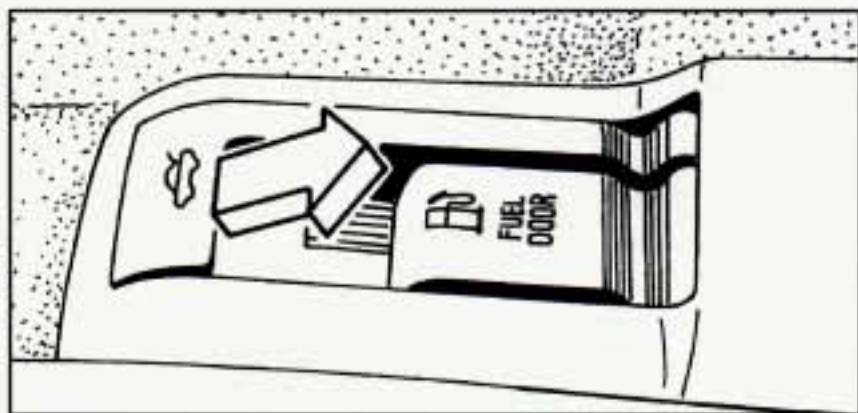

Lockout Feature:

Your remote trunk release may be equipped with a lockout feature to help prevent unauthorized entry into the trunk when leaving the vehicle unattended. The switch is located on the inside of the trunk lid, mounted to the trunk lid latch.



To turn the lockout on, slide the switch all the way to the right. To turn the lockout off, slide the switch all the way to the left.

When the lockout is on, the mechanical remote trunk release will not release the trunk lid. However, the trunk lid can still be opened with the key.

If you have the optional Remote Lock Control feature, your vehicle is not equipped with the trunk lockout switch.

Convenience Net (Option)

Your vehicle may have a convenience net. You'll see it just inside the back wall of the trunk.

Put small loads, like grocery bags, behind the net. It can help keep them from falling over during sharp turns or quick starts and stops.

The net isn't for larger, heavier loads. Store them in the trunk as far forward as you can.

You can unhook the net so that it will lie flat when you're not using it.

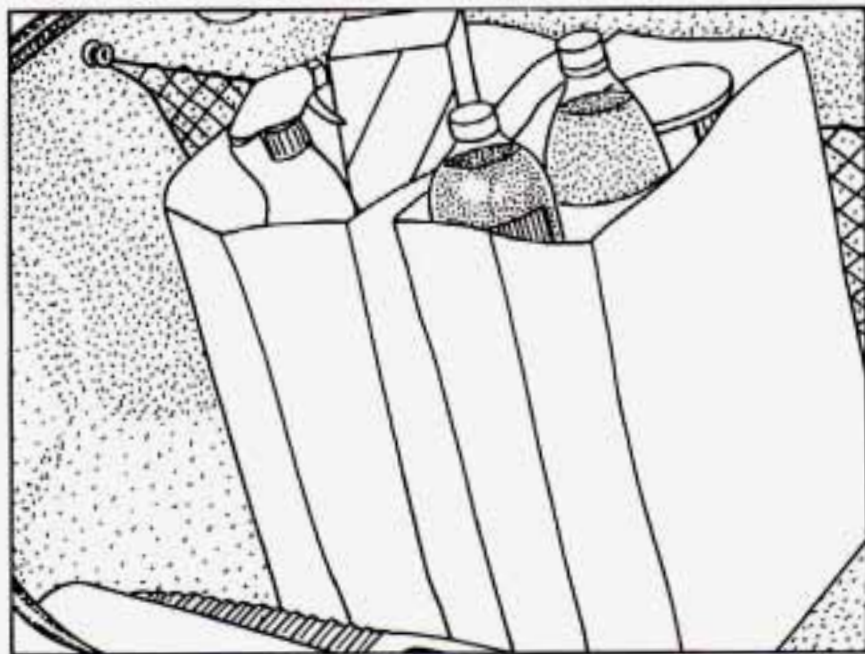

Glove Box

Use one of the vehicle's keys to lock and unlock the glove box. To open, pull the glove box handle toward you.

Theft

Vehicle theft is big business, especially in some cities. Although your Oldsmobile has a number of theft deterrent features, we know that nothing we put on it can make it impossible to steal. However, there are ways you can help.

Key in the Ignition

If you walk away from your vehicle with the keys inside, it's an easy target for joy riders or professional thieves -- so don't do it.

When you park your Oldsmobile and open the driver's door, you'll hear a chime reminding you to remove your key from the ignition and take it with you. Always do this. Your steering wheel will be locked, and so will your ignition. If you have an automatic transaxle, taking your key out also locks your transaxle. And remember to lock the doors.

Parking at Night

Park in a lighted spot, close all windows and lock your vehicle. Remember to keep your valuables out of sight. Put them in a storage area, or take them with you.

Parking Lots

If you park in a lot where someone will be watching your vehicle, it's best to lock it up and take your keys. But what if you have to leave your ignition key? What if you have to leave something valuable in your vehicle?

- Put your valuables in a storage area, like your trunk or glove box.
- Lock the glove box.
- Lock all the doors except the driver's.
- Then take the door key with you.

New Vehicle "Break-In"

NOTICE:

Your modern Oldsmobile doesn't need an elaborate "break-in." But it will perform better in the long run if you follow these guidelines:

- **Don't drive at any one speed -- fast or slow -- for the first 500 miles (804 km). Don't make full-throttle starts.**
- **Avoid making hard stops for the first 200 miles (322 km) or so. During this time your new brake linings aren't yet broken in. Hard stops with new linings can mean premature wear and earlier replacement. Follow this "breaking-in" guideline every time you get new brake linings.**
- **Don't tow a trailer during "break-in." See "Towing a Trailer" in the Index for more information.**

Ignition Switch

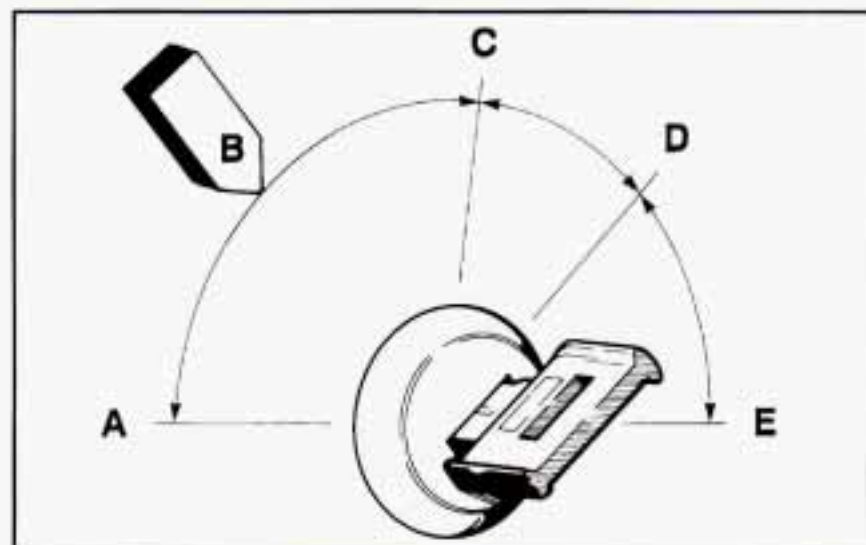

With the key in the ignition switch, you can turn the switch to five positions:

ACCESSORY (A): This is an “on” position in which you can operate some of your electrical power accessories. Press in the ignition switch as you turn the top of it toward you.

LOCK (B): This is the only position in which you can remove the key. This locks your steering wheel, ignition and transaxle (on automatic models).

OFF (C): This position unlocks the steering wheel, ignition, and transaxle (on automatic models), but does not send electrical power to any accessories. Use this position if your vehicle must be pushed or towed, but never try to push-start your vehicle. A warning chime will sound if you open the driver’s door when the ignition is off and the key is in the ignition.

RUN (D): This is an “on” position to which the switch returns after you start your engine and release the switch. The switch stays in the RUN position when the engine is running. But even when the engine is not running, you can use RUN to operate your electrical power accessories, and to display some instrument panel warning lights.

START (E): Use this for starting the engine. When the engine starts, release the key. The ignition switch will return to RUN for normal driving.

Note that even if the engine is not running, the positions ACCESSORY and RUN are “on” positions that allow you to operate your electrical accessories, such as the radio.

Key Release Button (Manual Transaxle)

The key cannot be removed from the ignition unless the key release button is used.



To remove the key, turn the key to the OFF position. While pressing the key release button in, turn the key to the LOCK position. Pull the key straight out.

CAUTION:

On manual transaxle vehicles, turning the key to **LOCK** will lock the steering column and result in a loss of ability to steer the vehicle. This could cause a collision. If you need to turn the engine off while the vehicle is moving, turn the key only to **OFF**. Don't press the key release button while the vehicle is moving.

NOTICE:

If your key seems stuck in **LOCK** and you can't turn it, be sure it is all the way in. If it is, then turn the steering wheel left and right while you turn the key hard. But turn the key only with your hand. Using a tool to force it could break the key or the ignition switch. If none of this works, then your vehicle needs service.

Starting Your Engine

Engines start differently. The 8th digit of your Vehicle Identification Number (VIN) shows the code letter or number for your engine. You will find the VIN at the top left of your instrument panel. (See "Vehicle Identification Number" in the Index.) Follow the proper steps to start the engine.

Automatic transaxle:

Move your shift lever to PARK (P) or NEUTRAL (N). Your engine won't start in any other position -- that's a safety feature. To restart when you're already moving, use NEUTRAL (N) only.

NOTICE:

Don't try to shift to PARK (P) if your Oldsmobile is moving. If you do, you could damage the transaxle. Shift to PARK (P) only when your vehicle is stopped.

Manual transaxle:

The gear selector should be in neutral. Hold the clutch pedal to the floor and start the engine. Your vehicle won't start if the clutch pedal is not all the way down -- that's a safety feature.

To start your 2.3 Liter engine:

1. Without pushing the accelerator pedal, turn your ignition key to START. When the engine starts, let go of the key. The idle speed will go down as your engine gets warm.

NOTICE:

Holding your key in START for longer than 15 seconds at a time will cause your battery to be drained much sooner. And the excessive heat can damage your starter motor.

2. If it doesn't start right away, and if the weather is very cold (below -20° F, or -29° C), push the accelerator pedal about one-quarter of the way down while you turn the key to START. Do this until the engine starts. As soon as it does, let go of the key.

3. If your engine still won't start (or starts but then stops), it could be flooded with too much gasoline. Try pushing your accelerator pedal all the way to the floor and holding it there as you hold the key in START for about three seconds. This clears the extra gasoline from the engine. If the vehicle starts briefly but then stops again, do the same thing, but this time keep the pedal about one-quarter of the way down for five or six seconds.

NOTICE:

Your engine is designed to work with the electronics in your vehicle. If you add electrical parts or accessories, you could change the way the fuel injection system operates. Before adding electrical equipment, check with your retailer. If you don't, your engine might not perform properly.

If you ever have to have your vehicle towed, see the part of this manual that tells how to do it without damaging your vehicle. See "Towing Your Vehicle" in the Index.

To start your 3.1 Liter engine:

1. Without pushing the accelerator pedal, turn your ignition key to START. When the engine starts, let go of the key. The idle speed will go down as your engine gets warm.

NOTICE:

Holding your key in START for longer than 15 seconds at a time will cause your battery to be drained much sooner. And the excessive heat can damage your starter motor.

2. If your engine won't start (or starts but then stops), it could be flooded with too much gasoline. Try pushing your accelerator pedal all the way to the floor and holding it there as you hold the key in START for about three seconds. If the vehicle starts briefly but then stops again, do the same thing, but this time keep the pedal down for five or six seconds. This clears the extra gasoline from the engine.

NOTICE:

Your engine is designed to work with the electronics in your vehicle. If you add electrical parts or accessories, you could change the way the fuel injection system operates. Before adding electrical equipment, check with your retailer. If you don't, your engine might not perform properly.

If you ever have to have your vehicle towed, see the part of this manual that tells how to do it without damaging your vehicle. See "Towing Your Vehicle" in the Index.

Driving Through Deep Standing Water

NOTICE:

If you drive too quickly through deep puddles or standing water, water can come in through your engine's air intake and badly damage your engine. If you can't avoid deep puddles or standing water, drive through them very slowly.

Engine Coolant Heater (Option)

In very cold weather, 0° F (-18° C) or colder, the engine coolant heater can help. You'll get easier starting and better fuel economy during engine warm-up. Usually, the coolant heater should be plugged in a minimum of four hours prior to starting your vehicle.

To use the coolant heater:

1. Turn off the engine.
2. Open the hood and unwrap the electrical cord.
3. Plug it into a normal, grounded 110-volt outlet.



CAUTION:

Plugging the cord into an ungrounded outlet could cause an electrical shock. Also, the wrong kind of extension cord could overheat and cause a fire. You could be seriously injured. Plug the cord into a properly grounded three-prong 110-volt outlet. If the cord won't reach, use a heavy-duty three-prong extension cord rated for at least 15 amps.

NOTICE:

After you've used the coolant heater, be sure to store the cord as it was before to keep it away from moving engine parts. If you don't, it could be damaged.

How long should you keep the coolant heater plugged in? The answer depends on the weather, the kind of oil you have, and some other things. Instead of trying to list everything here, we ask that you contact your Oldsmobile retailer in the area where you'll be parking your vehicle. The retailer can give you the best advice for that particular area.

Automatic Transaxle

Your automatic transaxle has a shift lever located on the console between the seats.



PARK (P): This locks your front wheels. It's the best position to use when you start your engine because your vehicle can't move easily.

CAUTION:

It is dangerous to get out of your vehicle if the shift lever is not fully in **PARK (P)** with the parking brake firmly set. Your vehicle can roll.

Don't leave your vehicle when the engine is running unless you have to. If you have left the engine running, the vehicle can move suddenly. You or others could be injured. To be sure your vehicle won't move, even when you're on fairly level ground, always set your parking brake and move the shift lever to **PARK (P)**.

See "Shifting Into **PARK (P)**" in the Index. If you're pulling a trailer, see "Towing a Trailer" in the Index.

Ensure the shift lever is fully in PARK (P) range before starting the engine. Your Oldsmobile has a brake-transaxle shift interlock. You have to *apply* your regular brakes *before* you can shift from PARK (P) when the ignition key is in the RUN position. If you cannot shift out of PARK (P), ease pressure on the shift lever -- push the shift lever all the way into PARK (P) -- as you maintain brake application. Then move the shift lever into the gear you wish. (Press the shift lever button before moving the shift lever.) See "Shifting Out of PARK (P)" later in this section.

REVERSE (R): Use this gear to back up.

NOTICE:

Shifting to REVERSE (R) while your vehicle is moving forward could damage your transaxle. Shift to REVERSE (R) only after your vehicle is stopped.

To rock your vehicle back and forth to get out of snow, ice or sand without damaging your transaxle, see "If You're Stuck: In Sand, Mud, Ice or Snow" in the Index.

NEUTRAL (N): In this position, your engine doesn't connect with the wheels. To restart when you're already moving, use NEUTRAL (N) only. Also, use NEUTRAL (N) when your vehicle is being towed.



CAUTION:

Shifting out of PARK (P) or NEUTRAL (N) while your engine is "racing" (running at high speed) is dangerous. Unless your foot is firmly on the brake pedal, your vehicle could move very rapidly. You could lose control and hit people or objects. Don't shift out of PARK (P) or NEUTRAL (N) while your engine is racing.

NOTICE:

Damage to your transaxle caused by shifting out of PARK (P) or NEUTRAL (N) with the engine racing isn't covered by your warranty.

AUTOMATIC OVERDRIVE (Ⓢ): If your automatic transaxle has AUTOMATIC OVERDRIVE, this position is for normal driving. If you need more power for passing, and you're:

- Going less than 35 mph (55 km/h), push your accelerator pedal about halfway down.
- Going about 35 mph (55 km/h) or more, push the accelerator all the way down. You'll shift down to the next gear and have more power.

NOTICE:

This NOTICE applies only if you have an Automatic Overdrive transaxle. If your vehicle is so equipped and if it seems to start up rather slowly, or if it seems not to shift gears as you go faster, something may be wrong with a transaxle system sensor. If you drive very far that way, your vehicle can be damaged. So, if this happens, have your vehicle serviced right away. Until then, you can use SECOND (2) when you are driving less than 35 mph (55 km/h) and OVERDRIVE (Ⓢ) for higher speeds.

DRIVE (D) or THIRD (3): If your automatic transaxle does not have OVERDRIVE, this position is for normal driving, at all speeds, in most street and highway situations.

If your automatic transaxle has OVERDRIVE (Ⓢ), THIRD (3) is like OVERDRIVE (Ⓢ), but you never go into OVERDRIVE (Ⓢ).

Here are some times you might choose THIRD (3) instead of OVERDRIVE (Ⓢ):

- When driving on hilly, winding roads.
- When towing a trailer, so there is less shifting between gears.
- When going down a steep hill.

SECOND (2): This position gives you more power but lower fuel economy. You can use SECOND (2) on hills. It can help control your speed as you go down steep mountain roads, but then you would also want to use your brakes off and on.

NOTICE:

Don't drive in SECOND (2) for more than 5 miles (8 km), or at speeds over 55 mph (88 km/h), or you can damage your transaxle.

Use DRIVE (D) (OVERDRIVE (Ⓢ)) or THIRD (3) if your vehicle has OVERDRIVE (Ⓢ)) as much as possible.

Don't shift into SECOND (2) unless you are going slower than 65 mph (105 km/h), or you can damage your engine.

If you have the four-speed transaxle with OVERDRIVE (Ⓢ), SECOND (2) will select either first or second gear depending on vehicle speed. If your vehicle is slowing, the transaxle will downshift to first gear at 20 to 25 mph (32 to 40 km/h) for engine braking. You may notice some variation in shift speed in SECOND (2) when accelerating or braking.

FIRST (1): This position gives you even more power (but lower fuel economy) than SECOND (2). You can use it on very steep hills, or in deep snow or mud. If the shift lever is put in FIRST (1), the transaxle won't shift into first gear until the vehicle is going slowly enough.

NOTICE:

If your front wheels can't rotate, don't try to drive. This might happen if you were stuck in very deep sand or mud or were up against a solid object. You can damage your transaxle.

Also, if you stop when going uphill, don't hold your vehicle there with only the accelerator pedal. This could overheat and damage the transaxle. Use your brakes or shift into PARK (P) to hold your vehicle in position on a hill.

Manual Transaxle

This is your shift pattern.

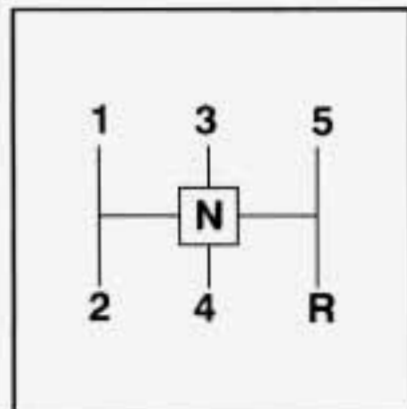

Here's how to operate your transaxle:

FIRST (1): Press the clutch pedal and shift into FIRST (1). Then, slowly let up on the clutch pedal as you press the accelerator pedal.

You can shift into FIRST (1) when you're going less than 20 mph (32 km/h). If you've come to a complete stop and it's hard to shift into FIRST (1), put the shift lever in NEUTRAL (N) and let up on the clutch. Press the clutch pedal back down. Then shift into FIRST (1).

SECOND (2): Press the clutch pedal as you let up on the accelerator pedal and shift into SECOND (2). Then slowly let up on the clutch pedal as you press the accelerator pedal.

THIRD (3), FOURTH (4) and FIFTH (5): Shift into THIRD (3), FOURTH (4) and FIFTH (5) the same way you do for SECOND (2). Slowly let up on the clutch pedal as you press the accelerator pedal.

To stop, let up on the accelerator pedal and press the brake pedal. Just before the vehicle stops, press the clutch pedal and the brake pedal, and shift into NEUTRAL (N).

NEUTRAL (N): Use this position when you start or idle your engine.

REVERSE (R): To back up, press down the clutch pedal and shift into REVERSE (R). Let up on the clutch pedal slowly while pressing the accelerator pedal.

NOTICE:

Shift to REVERSE (R) only after your vehicle is stopped. Shifting to REVERSE (R) while your vehicle is moving could damage your transaxle.

Also, use REVERSE (R), along with the parking brake, for parking your vehicle.

Up Shift Light (Manual Transaxle)



If you have a manual transaxle, you have an UP SHIFT light. This light will show you when to shift to the next higher gear for best fuel economy.

When this light comes on, you can shift to the next higher gear if weather, road and traffic conditions let you. For the best fuel economy, accelerate slowly and shift when the light comes on.

While you accelerate, it is normal for the light to go on and off if you quickly change the position of the accelerator. Ignore the UP SHIFT light when you downshift.

Shift Speeds (Manual Transaxle)

This chart shows when to shift to the next higher gear for best fuel economy.

Acceleration Shift Speeds

1st to 2nd	15 mph (24 km/h)
2nd to 3rd	25 mph (40 km/h)
3rd to 4th	40 mph (64 km/h)
4th to 5th	45 mph (72 km/h)

If your speed drops below 20 mph (32 km/h), or if the engine is not running smoothly, you should downshift to the next lower gear. You may have to downshift two or more gears to keep the engine running smoothly or for good performance.



CAUTION:

If you skip more than one gear when you downshift, you could lose control of your vehicle. And you could injure yourself or others. Don't shift from FIFTH (5) to SECOND (2) or FOURTH (4) to FIRST (1).

NOTICE:

If you skip more than one gear when you downshift, or if you race the engine when you downshift, you can damage the clutch or transaxle.

Parking Brake



To set the parking brake hold the regular brake pedal down with your right foot. Push down the parking brake pedal with your left foot. If the ignition is on, the brake system warning light will come on.



To release the parking brake hold the regular brake pedal down. Pull the BRAKE RELEASE lever.

NOTICE:

Driving with the parking brake on can cause your rear brakes to overheat. You may have to replace them, and you could also damage other parts of your vehicle.

If you are towing a trailer and are parking on a hill see "Towing a Trailer" in the Index. That section shows what to do first to keep the trailer from moving.

Shifting Into PARK (P) (Automatic Transaxle Models Only)

CAUTION:

It can be dangerous to get out of your vehicle if the shift lever is not fully in PARK (P) with the parking brake firmly set. Your vehicle can roll. If you have left the engine running, the vehicle can move suddenly. You or others could be injured. To be sure your vehicle won't move, even when you're on fairly level ground, use the steps that follow. If you're pulling a trailer, see "Towing a Trailer" in the Index.

1. Hold the brake pedal down with your right foot and set the parking brake.

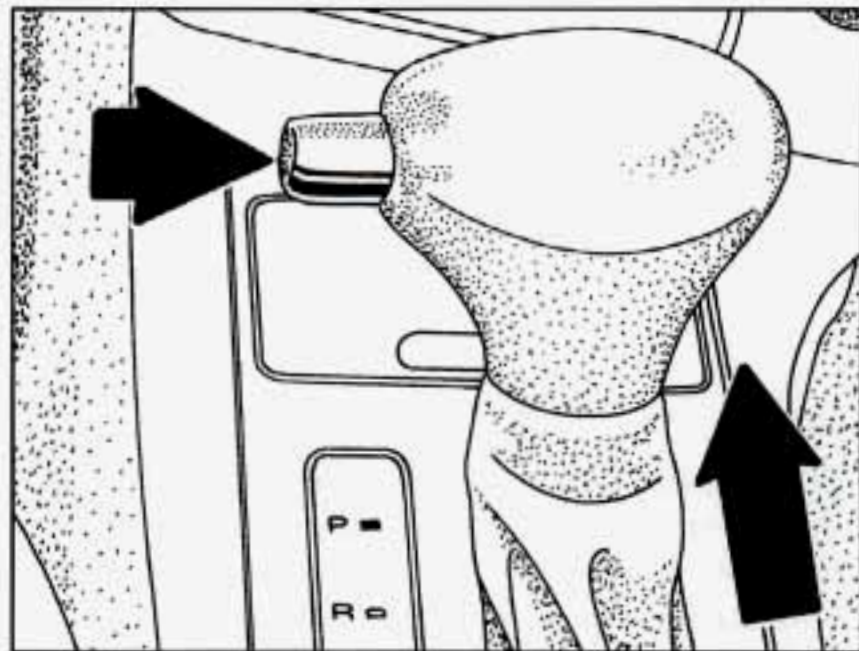

2. Move the shift lever into PARK (P) position like this:
 - Hold in the button on the lever.
 - Push the lever all the way toward the front of your vehicle.

3. Move the key to LOCK.
4. Remove the key and take it with you. If you can walk away from your vehicle with the key in your hand, your vehicle is in PARK (P).

Leaving Your Vehicle With the Engine Running (Automatic Transaxle Models Only)



CAUTION:

It can be dangerous to leave your vehicle with the engine running. Your vehicle could move suddenly if the shift lever is not fully in PARK (P) with the parking brake firmly set. And, if you leave the vehicle with the engine running, it could overheat and even catch fire. You or others could be injured. Don't leave your vehicle with the engine running unless you have to.

If you have to leave your vehicle with the engine running, be sure your vehicle is in PARK (P) and your parking brake is firmly set before you leave it.

After you've moved the shift lever into the PARK (P) position, hold the regular brake pedal down. Then, see if you can move the shift lever away from PARK (P) without first pushing the button.

If you can, it means that the shift lever wasn't fully locked into PARK (P).

Torque Lock (Automatic Transaxle)

If you are parking on a hill and you don't shift your transaxle into PARK (P) properly, the weight of the vehicle may put too much force on the parking pawl in the transaxle. You may find it difficult to pull the shift lever out of PARK (P). This is called "torque lock." To prevent torque lock, set the parking brake and then shift into PARK (P) properly before you leave the driver's seat. To find out how, see "Shifting Into PARK (P)" in the Index.

When you are ready to drive, move the shift lever out of PARK (P) *before* you release the parking brake.

If "torque lock" does occur, you may need to have another vehicle push yours a little uphill to take some of the pressure from the transaxle, so you can pull the shift lever out of PARK (P).

Shifting Out of PARK (P) (Automatic Transaxle)

Your Oldsmobile has a brake-transaxle shift interlock. You have to *apply* your regular brakes *before* you can shift from PARK (P) when the ignition is in the RUN position. See “Automatic Transaxle” in the Index.

If you cannot shift out of PARK (P), ease pressure on the shift lever -- push the shift lever all the way into PARK (P) -- as you maintain brake application. Then move the shift into the gear you wish. (Press the shift lever button before moving the shift lever.)

If you ever hold the brake pedal down but still can't shift out of PARK (P), try this:

1. Turn the key to OFF, not LOCK.
2. Apply and hold the regular brake until the end of step 4.

3. Shift to NEUTRAL (N).
4. Start the vehicle and then shift to the drive gear you want.
5. Have the vehicle fixed as soon as you can.

Parking Your Vehicle (Manual Transaxle)

Before you get out of your vehicle, put your manual transaxle in REVERSE (R) and firmly apply the parking brake.

If your vehicle is equipped to tow a trailer, see “Towing a Trailer” in the Index.

Parking Over Things That Burn



CAUTION:

Things that can burn could touch hot exhaust parts under your vehicle and ignite. Don't park over papers, leaves, dry grass or other things that can burn.

Engine Exhaust

CAUTION:

Engine exhaust can kill. It contains the gas carbon monoxide (CO), which you can't see or smell. It can cause unconsciousness and death.

You might have exhaust coming in if:

- Your exhaust system sounds strange or different.
- Your vehicle gets rusty underneath.
- Your vehicle was damaged in a collision.
- Your vehicle was damaged when driving over high points on the road or over road debris.
- Repairs weren't done correctly.
- Your vehicle or exhaust system had been modified improperly.

If you ever suspect exhaust is coming into your vehicle:

- Drive it only with all the windows down to blow out any CO; and
- Have your vehicle fixed immediately.

Running Your Engine While You're Parked (Automatic Transaxle)

It's better not to park with the engine running. But if you ever have to, here are some things to know.

CAUTION:

Idling the engine with the air system control off could allow dangerous exhaust into your vehicle (see the earlier Caution under "Engine Exhaust").

Also, idling in a closed-in place can let deadly carbon monoxide (CO) into your vehicle even if the fan switch is at the highest setting. **One place this can happen is a garage. Exhaust -- with CO -- can come in easily. NEVER park in a garage with the engine running.**

Another closed-in place can be a blizzard. (See "Blizzard" in the Index.)

CAUTION:

It can be dangerous to get out of your vehicle if the shift lever is not fully in PARK (P) with the parking brake firmly set. Your vehicle can roll. Don't leave your vehicle when the engine is running unless you have to. If you've left the engine running, the vehicle can move suddenly. You or others could be injured. To be sure your vehicle won't move, even when you're on fairly level ground, always set your parking brake and move the shift lever to PARK (P).

Follow the proper steps to be sure your vehicle won't move. See "Shifting Into PARK (P)" in the Index.

If you are parking on a hill and if you're pulling a trailer, also see "Towing a Trailer" in the Index.

Windows

On a vehicle with manual windows, use the window crank to open and close each window.

Power Windows (Option)

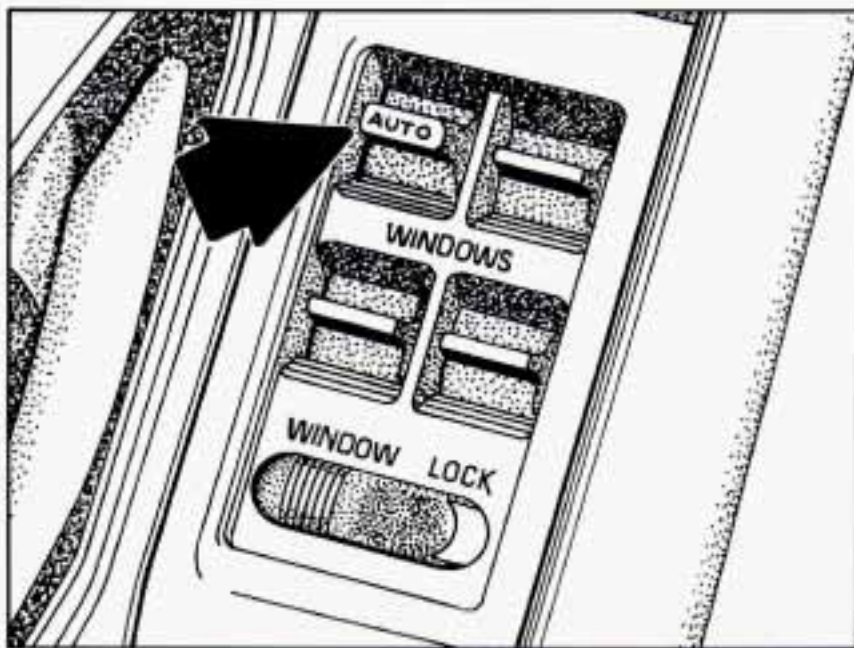

With power windows, switches on the driver's armrest control each of the windows when the ignition is on. In

addition, each passenger door has a control switch for its own window.

The driver's window switch has an Auto Down feature. The driver's window can be opened a small amount by pressing the switch rearward for less than one second. When the switch is held rearward for more than one second and then released, the window will go down all the way.

To stop the window while it is lowering, press the switch, then release.

To raise the window, press and hold the switch forward.

Power Window Lock-Out Switch (Option)

On four-door models, this switch disables all passenger power window switches. Push the right side of the switch to lock the window switches. Push the left side of the switch to unlock the window switches.

The Lock-Out Switch prevents passengers from opening and closing windows. The driver can still control all of the windows with the switch in the lock position.

Horn

You can sound the horn by pressing the horn symbol on your steering wheel.

Tilt Steering Wheel

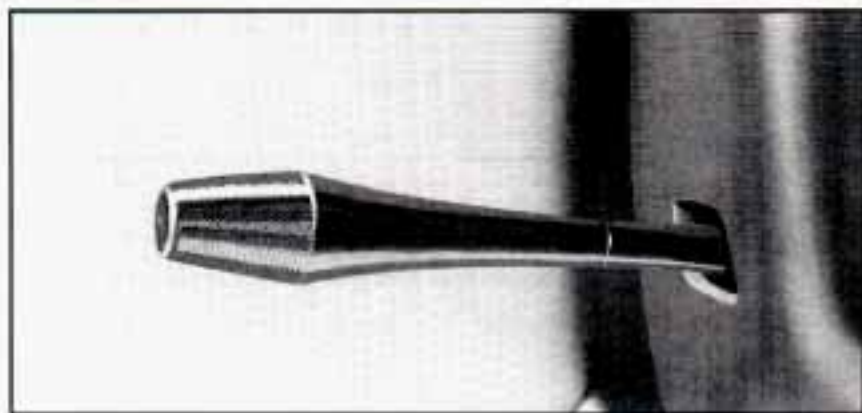

A tilt steering wheel allows you to adjust the steering wheel before you drive.

You can also raise it to the highest level to give your legs more room when you exit and enter the vehicle.

To tilt the wheel, hold the steering wheel and pull the lever.

Move the steering wheel to a comfortable level, then release the lever to lock the wheel in place.

Turn Signal/Multifunction Lever

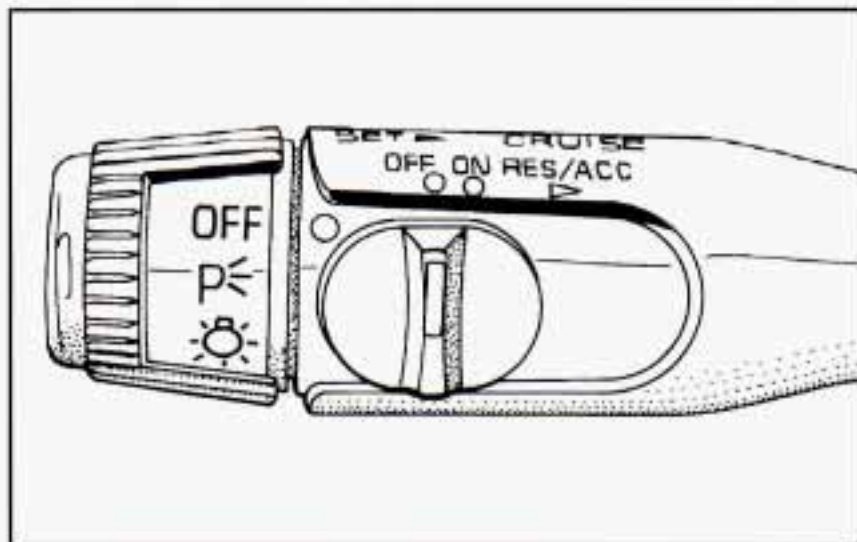

The lever on the left side of the steering column includes your:

- Turn Signal and Lane Change Indicator
- Headlamp High-Low Beam Changer
- Flash-to-Pass Feature
- Cruise Control (Option)

The High-Low Beam feature is discussed under Headlamps. See “Headlamps” in the Index.

Turn Signal and Lane Change Indicator

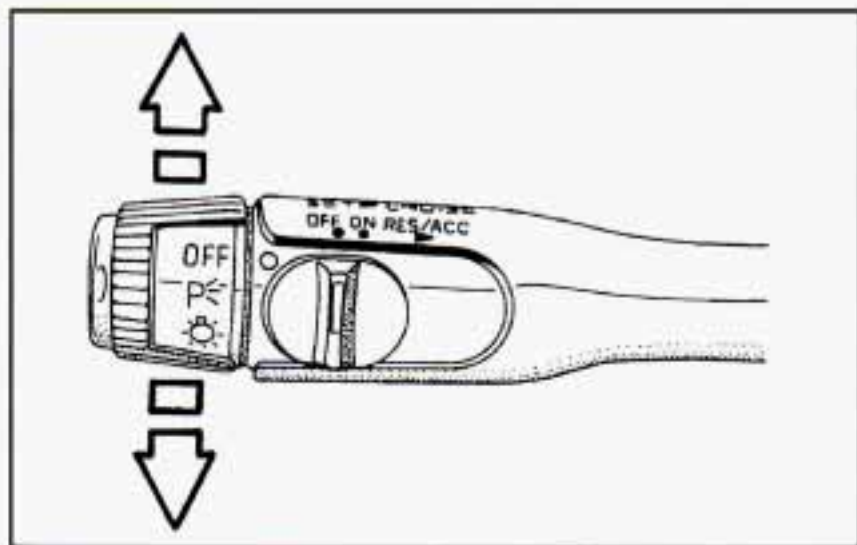

The turn signal has two upward (for right) and two downward (for left) positions. These positions allow you to signal a turn or a lane change.

To signal a turn, move the lever all the way up or down. When the turn is finished, the lever will return automatically.

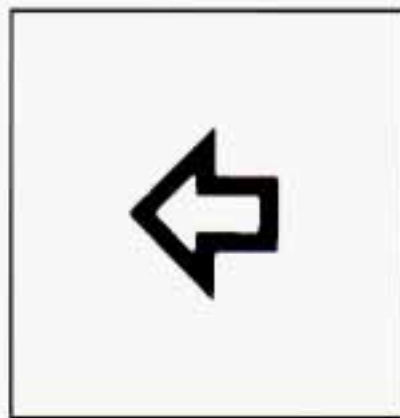

A green arrow on the instrument panel will flash in the direction of the turn or lane change.

To signal a lane change, just raise or lower the lever until the green arrow starts to flash. Hold it there until you complete your lane change. The lever will return by itself when you release it.

A warning chime signal will come on if you have left your turn signal on for more than three-quarters mile (1 km).

As you signal a turn or a lane change, if the arrows don't flash but just stay on, a signal bulb may be burned out and other drivers won't see your turn signal.

If a bulb is burned out, replace it to help avoid an accident. If the green arrows don't go on at all when you signal a turn, check the fuse (see "Fuses and Circuit Breakers" in the Index) and for burned-out bulbs.

Lamp Controls

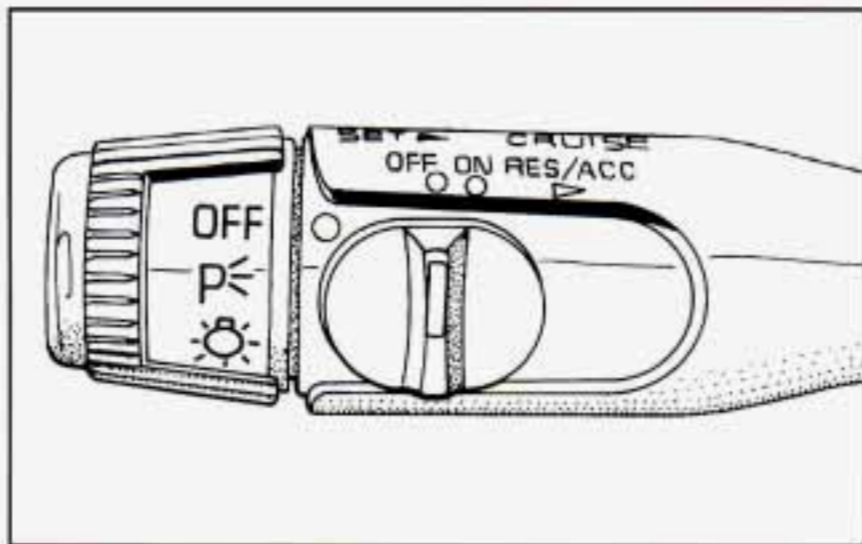

Parking Lamps

Rotate the switch up one position to turn on:

- Parking Lamps
- Side Marker Lamps

- Taillamps
- License Plate Lamps
- Instrument Panel Lamps

Headlamps

Rotate the switch up two positions to turn on:

- Headlamps
- Parking Lamps
- Side Marker Lamps
- Taillamps
- License Plate Lamps
- Instrument Panel Lamps

Rotate the switch to OFF to turn all of the lights off.

Lamps On Reminder

If you open the driver's door and turn off the ignition while leaving the lamps on, you will hear a warning chime.

Headlamp High/Low Beam Changer

To change the headlamps from low beam to high or high to low, pull the turn signal lever all the way toward you. Then release it. When the high beams are on, a blue light on the instrument panel also will be on.

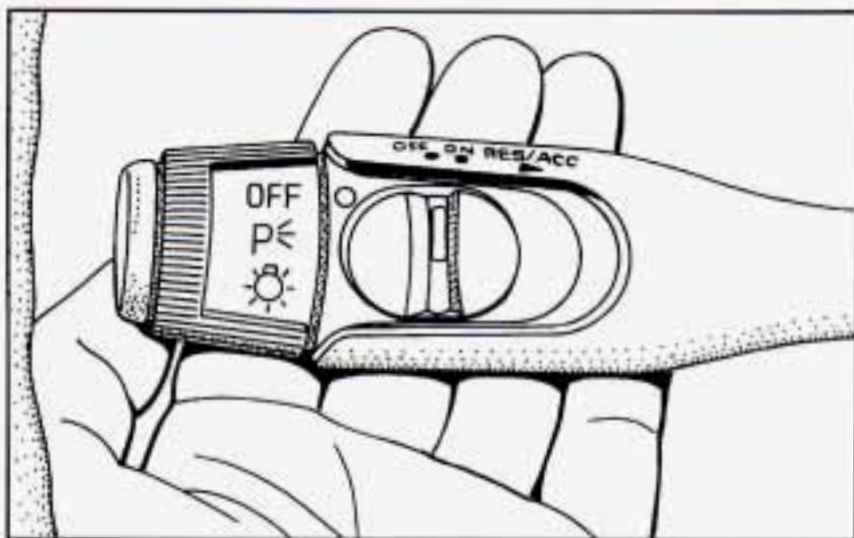

Flash-to-Pass (Except Canada)

Flash-to-pass lets you use your high beam headlamps to signal a driver in front of you that you want to pass.

To use it, pull the turn signal/multifunction lever toward you.

If your headlamps are off your high beam headlamps will turn on. They'll stay on as long as you hold the lever there. Release the lever to turn them off.

If your headlamps are on, there will be no flash-to-pass feature. Use the lever to change between high and low beams.

Controlled-Cycle Windshield Wipers

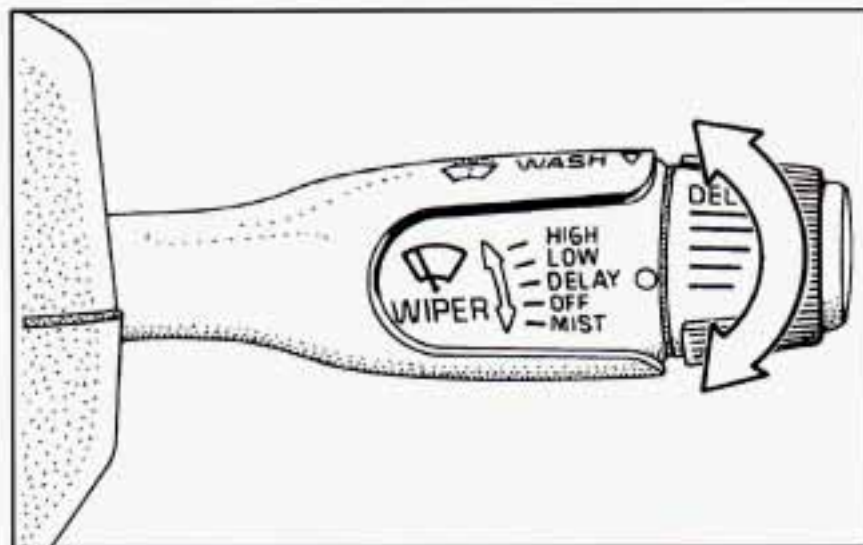

You control the windshield wipers by moving the stalk with the wiper symbol on it up or down.

For a single wiper cycle, push the stalk down to MIST, then release it. For more cycles, hold the stalk down longer.

For steady wiping at low speed, move the stalk up the LOW position. For high speed wiping, move the stalk up further, to HIGH. To stop the wipers, move the stalk to OFF.

You can set the wiper speed for a long or short delay between wipes. This can be very useful in light rain or snow.

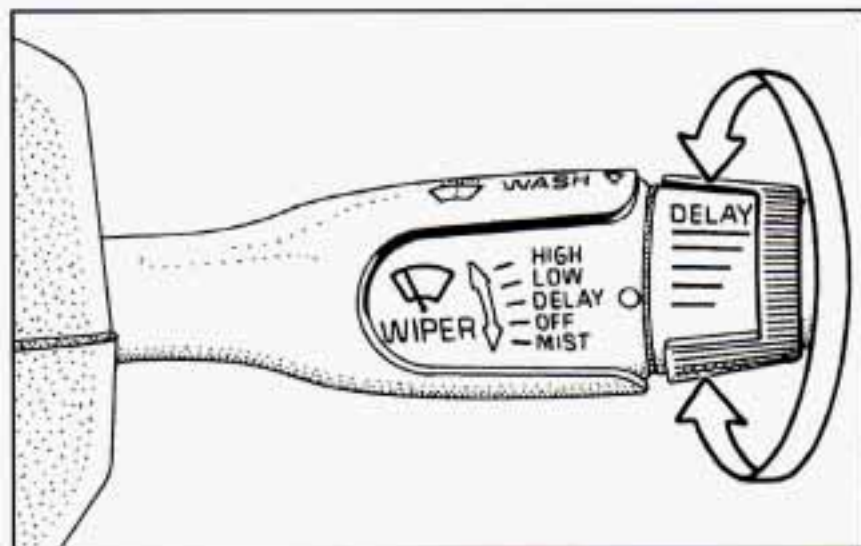

Move the stalk to DELAY, then rotate the inner band and choose the delay you want. Rotate the inner band up for shorter delay times between wiper cycles. Rotate the band down for a longer delay time between wiper cycles.

Remember that damaged wiper blades may prevent you from seeing well enough to drive safely. To avoid damage, be sure to clear ice and snow from the wiper blades before using them. If they're frozen to the windshield, carefully loosen or thaw them. If your blades do become damaged, get new blades or blade inserts.

Heavy snow or ice can overload your wiper motor. A circuit breaker will stop the motor until it cools. Clear away snow or ice to prevent an overload.

Windshield Washer

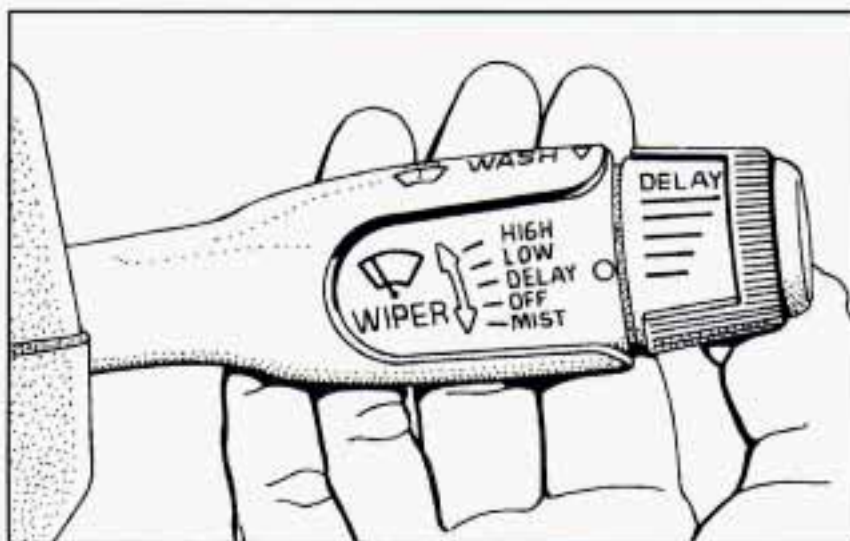

To wash your windshield, pull the stalk toward you until the washers begin.

When you release the stalk the washers will stop, but the wipers will either stop or will resume the delay speed you were using before.

Driving without washer fluid can be dangerous. A bad mud splash can block your vision. You could hit another vehicle or go off the road. Check your washer fluid level often.



CAUTION:

In freezing weather, don't use your washer until the windshield is warmed. Otherwise the washer fluid can form ice on the windshield, blocking your vision.

NOTICE:

- When using concentrated washer fluid, follow the manufacturer's instructions for adding water.
- Don't mix water with ready-to-use washer fluid. Water can cause the solution to freeze and damage your washer fluid tank and other parts of the washer system. Also, water doesn't clean as well as washer fluid.
- Fill your washer fluid tank only 3/4 full when it's very cold. This allows for expansion, which could damage the tank if it is completely full.
- Don't use radiator antifreeze in your windshield washer. It can damage your washer system and paint.

Cruise Control (Option)

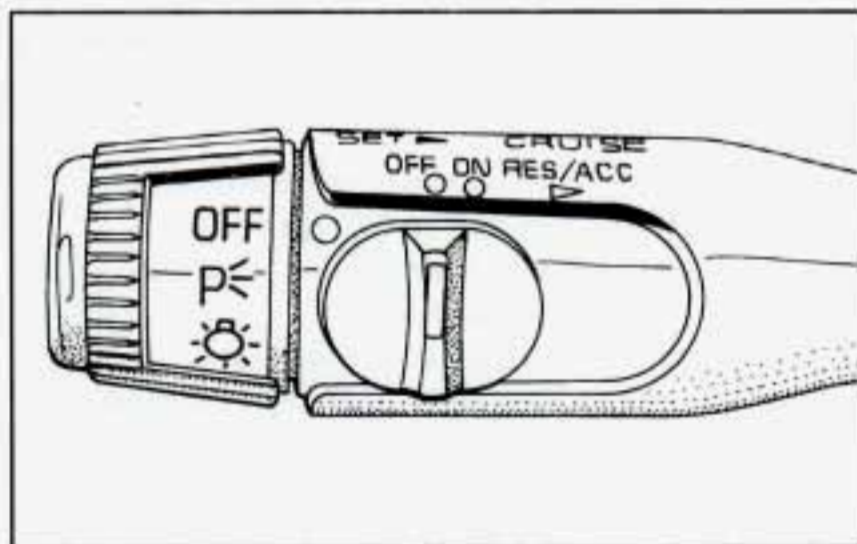

With cruise control, you can maintain a speed of about 25 mph (40 km/h) or more without keeping your foot on the accelerator. This can really help on long trips. Cruise control does not work at speeds below about 25 mph (40 km/h).

When you apply your brake or the clutch pedal, the cruise control shuts off.

 **CAUTION:**

- Cruise control can be dangerous where you can't drive safely at a steady speed. So, don't use your cruise control on winding roads or in heavy traffic.
- Cruise control can be dangerous on slippery roads. On such roads, fast changes in tire traction can cause needless wheel spinning, and you could lose control. Don't use cruise control on slippery roads.

To Set Cruise Control

1. Move the cruise control switch to ON.

 **CAUTION:**

If you leave your cruise control switch on when you're not using cruise, you might hit a button and go into cruise when you don't want to. You could be startled and even lose control. Keep the cruise control switch OFF until you want to use it.

2. Get up to the speed you want.

3. Press in the SET button at the end of the lever and release it.

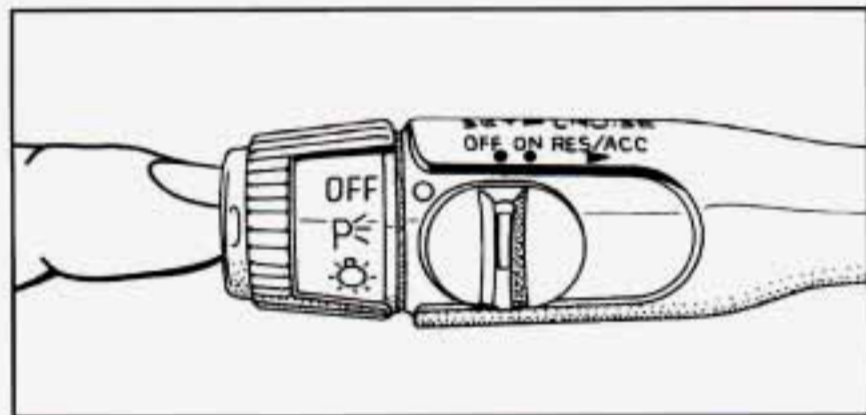

4. Take your foot off the accelerator pedal.

To Resume a Set Speed

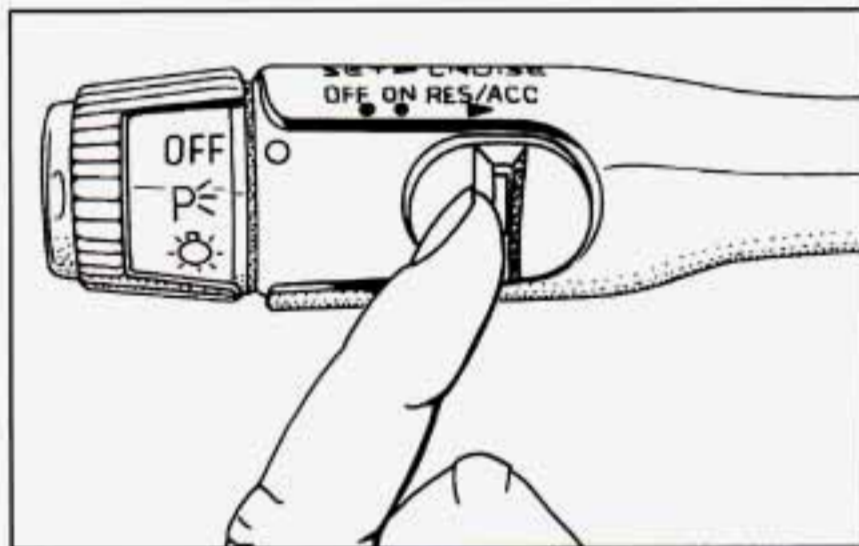

Suppose you set your cruise control at a desired speed and then you apply the brake or clutch pedal. This, of course, shuts off the cruise control. But you don't need to reset it. Once you're going about 25 mph (40 km/h) or more, you can move the cruise control switch from ON to RES/ACC (Resume/Accelerate) for about half a second.

You'll go right back up to your chosen speed and stay there.

If you hold the switch at RES/ACC longer than half a second, the vehicle will keep going faster until you release the switch or apply the brake or clutch pedal. You could be startled and even lose control. So unless you want to go faster, don't hold the switch at RES/ACC.

To Increase Speed While Using Cruise Control

There are two ways to go to a higher speed. Here's the first:

1. Use the accelerator pedal to get to the higher speed.
2. Press the button at the end of the lever, then release the button and the accelerator pedal. You'll now cruise at the higher speed.

Here's the second way to go to a higher speed:

- Move the cruise switch from ON to RES/ACC. Hold it there until you get up to the speed you want, and then release the switch.
- To increase your speed in very small amounts, move the switch to RES/ACC for less than half a second and then release it. Each time you do this, your vehicle will go about 1 mph (1.6 km/h) faster.

The accelerate feature will only work after you turn on the cruise control by pushing the SET button.

To Reduce Speed While Using Cruise Control

There are two ways to reduce your speed while using cruise control:

- Push in the button at the end of the lever until you reach the lower speed you want, then release it.
- To slow down in very small amounts, push the button for less than half a second. Each time you do this, you'll go 1 mph (1.6 km/h) slower.

Passing Another Vehicle While Using Cruise Control

Use the accelerator pedal to increase your speed. When you take your foot off the pedal, your vehicle will slow down to the cruise control speed you set earlier.

Using Cruise Control on Hills

How well your cruise control will work on hills depends upon your speed, load, and the steepness of the hills. When going up steep hills, you may have to step on the accelerator pedal to maintain your speed. When going downhill, you may have to brake or shift to a lower gear to keep your speed down. Of course, applying the brake or clutch pedal takes you out of cruise control. Many drivers find this to be too much trouble and don't use cruise control on steep hills.

To Get Out of Cruise Control

There are two ways to turn off the cruise control:

- Step lightly on the brake pedal or push the clutch pedal, if you have a manual transaxle; OR
- Move the cruise switch to OFF.

To Erase Cruise Speed Memory

When you turn off the cruise control or the ignition, your cruise control set speed memory is erased.

Instrument Panel Intensity Control

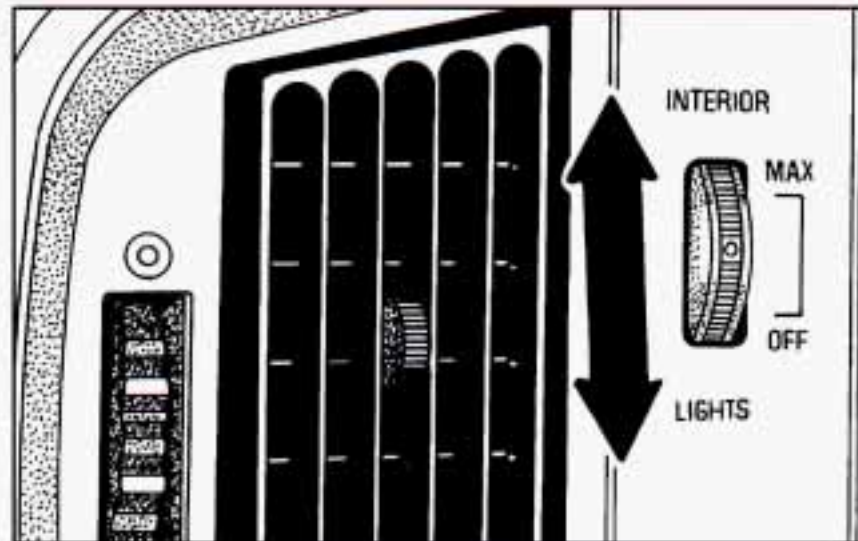

You can brighten or dim the instrument cluster lights by rotating the wheel. Rotate the wheel all the way down to turn off the instrument cluster lights and displays.

Rotate the wheel all the way up to turn on the courtesy lamps.

Fog Lamps (Option)

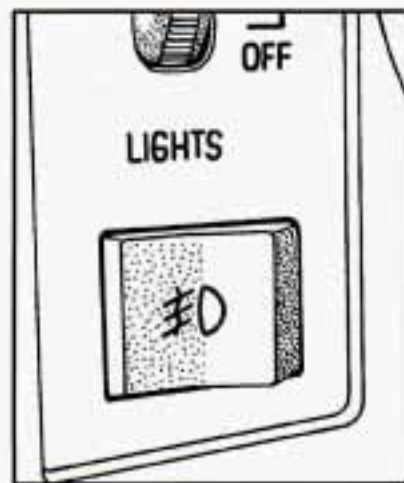

The button for your fog lamps is below the instrument panel intensity control.

Push the button to turn the fog lamps on.

When using fog lamps, the parking lamps or low beam headlamps must be on.

Fog lamps will go off whenever the high beam headlamps come on. When the high beams go off, the fog lamps will come on again.

Daytime Running Lamps (Canada Only)

Daytime Running Lamps (DRL) can make it easier for others to see the front of your vehicle during the day. DRL can be helpful in many different driving conditions, but they can be especially helpful in the short periods after dawn and before sunset. Several countries, including Canada, require DRL.

A light sensor on top of the instrument panel makes the DRL work, so be sure it isn't covered. The DRL system will make your high and low-beam headlamps come on at a reduced brightness when:

- The ignition is on,
- The headlamp switch is off, and
- The parking brake is released (manual transaxle); or
- The transaxle is not in PARK (P) or NEUTRAL (N) (automatic transaxle).

When the DRL are on, only your high and low-beam headlamps will be on. The taillamps, sidemarker and other lamps won't be on. Your instrument panel won't be lit up either.

When it's dark enough outside, your headlamps will come on at full brightness. The other lamps that come on with your headlamps will also come on.

When it's bright enough outside, the regular lamps will go off, and your high and low-beam headlamps change to the reduced brightness of the DRL.

To idle your vehicle with the DRL off, set the parking brake on a manual transaxle or put the vehicle in PARK (P) or NEUTRAL (N) on an automatic transaxle, while the ignition is in the OFF or LOCK position. Then start the vehicle. The DRL will stay off until you release the parking brake on a manual transaxle or shift out of PARK (P) or NEUTRAL (N) on an automatic transaxle.

As with any vehicle, you should turn the regular headlamp system on any time you need it.

Front Reading Lamps (Option)

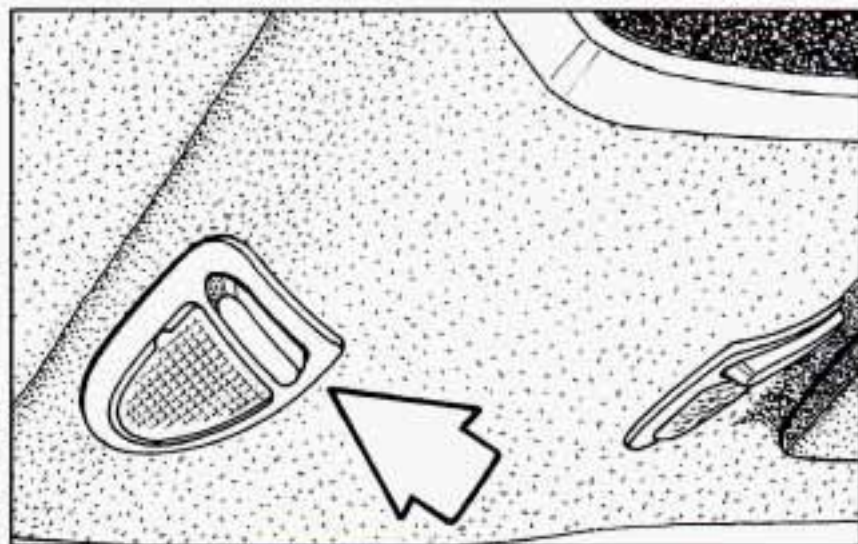

These lamps and the interior courtesy lamps will come on when you open the doors.

To turn on a reading lamp when the doors are closed, press the button. Press it again to turn the lamp off.

Front Reading/Map Lamps (Option)

If your vehicle has a sunroof, it will have a rearview mirror and lamps. The lamps go on when you open the doors. When the doors are closed, turn the lamps on and off with the switch.

Rear Reading Lamps (Option)

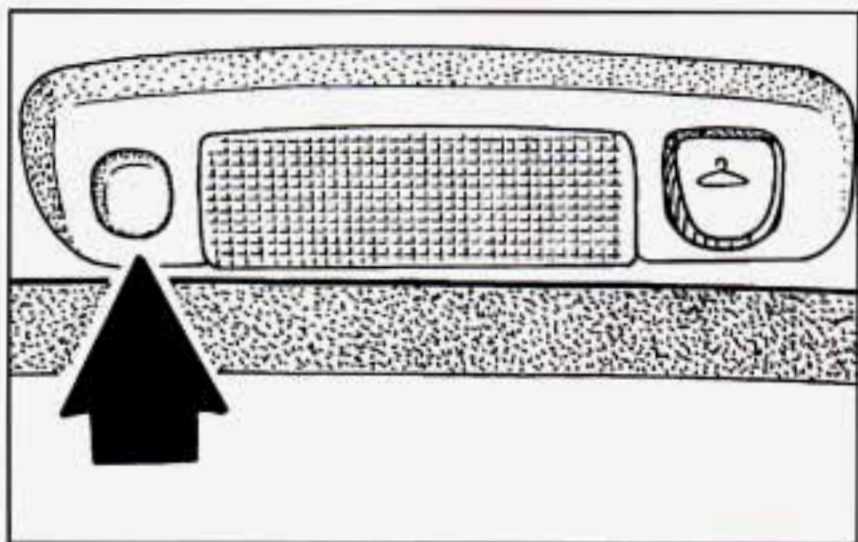

These overhead lamps and the interior courtesy lamps will come on when you open the doors.

To turn on a reading lamp when the doors are closed, press the button. Press it again to turn off the lamp.

Trunk Lamp

The trunk lamp comes on when you open your trunk.

Battery Rundown Protection

Your Oldsmobile is equipped with a Battery Rundown Protection feature designed to protect your vehicle's battery.

When any interior lamp (trunk, reading, footwell, or glove box) is left on when the ignition is turned off, the Battery Rundown Protection system will automatically shut the lamp off after 20 minutes. This will avoid draining the battery.

To reactivate the interior lamps, either:

- The ignition must be turned on
- The activated lamp switch must be turned off and then on, OR
- A front door must be opened.

The Battery Rundown Protection feature will also be activated when any door of your vehicle is left open.

Also, if your vehicle is left with the ignition turned off for over 24 days, battery power to your clock, audio system and Remote Lock Control (if you have this option) will be turned off to reduce battery drain. When the ignition is turned on again, battery power will be resupplied. However, under these conditions, it will be necessary to reset the clock and audio system settings.

Inside Manual Day/Night Rearview Mirror

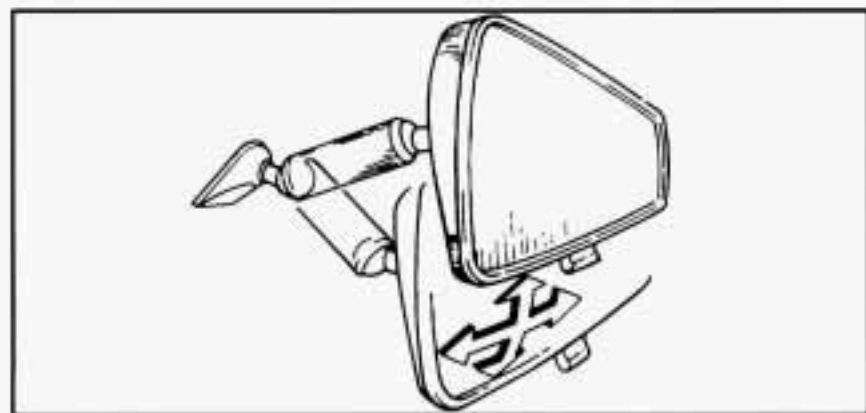

To reduce glare from lights behind you, move the lever toward you to the night position.

Convex Outside Mirror

Your passenger's side mirror is convex.

A convex mirror's surface is curved so you can see more from the driver's seat.

CAUTION:

A convex mirror can make things (like other vehicles) look farther away than they really are. If you cut too sharply into the right lane, you could hit a vehicle on your right. Check your inside mirror or glance over your shoulder before changing lanes.

Manual Remote Control Mirrors

The outside rearview mirror should be adjusted so you can just see the side of your vehicle when you are sitting in a comfortable driving position.



Adjust the driver side outside mirror with the control lever on the driver's door.

To adjust your passenger side mirror, sit in the driver's seat and have a passenger adjust the mirror for you.

Power Remote Control Mirrors (Option)



This selector knob controls both outside rearview mirrors. Select the mirror you want to adjust by rotating the knob to the left or right.

Adjust each mirror so that you can just see the side of your vehicle when you are sitting in a comfortable driving position.

Sun Visors

To block out glare, you can swing down the visors. You can also swing them to the side.

Visor Vanity Mirror

Open the visor cover to expose the vanity mirror.

Armrest Storage Compartment

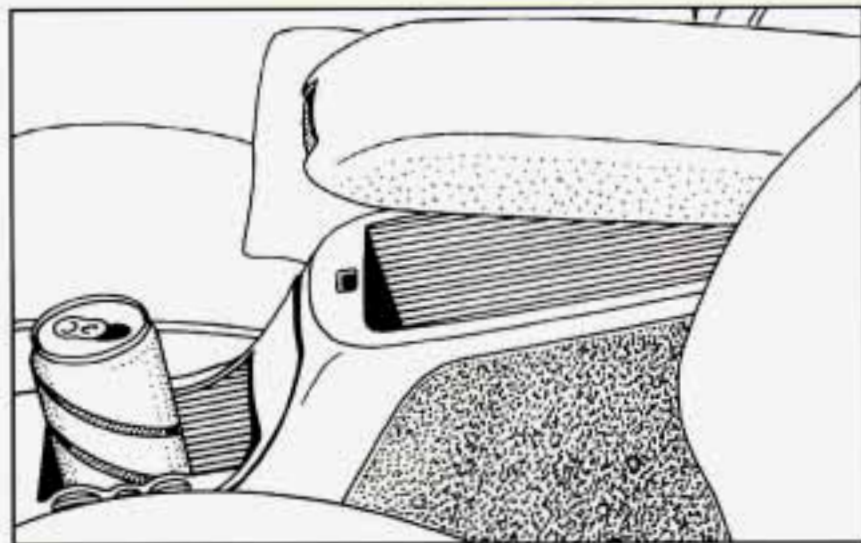

The front armrest opens into a storage area for cassette tapes, gloves, etc. To open it, push in the button and lift the front edge.

Glove Box Cup Holder

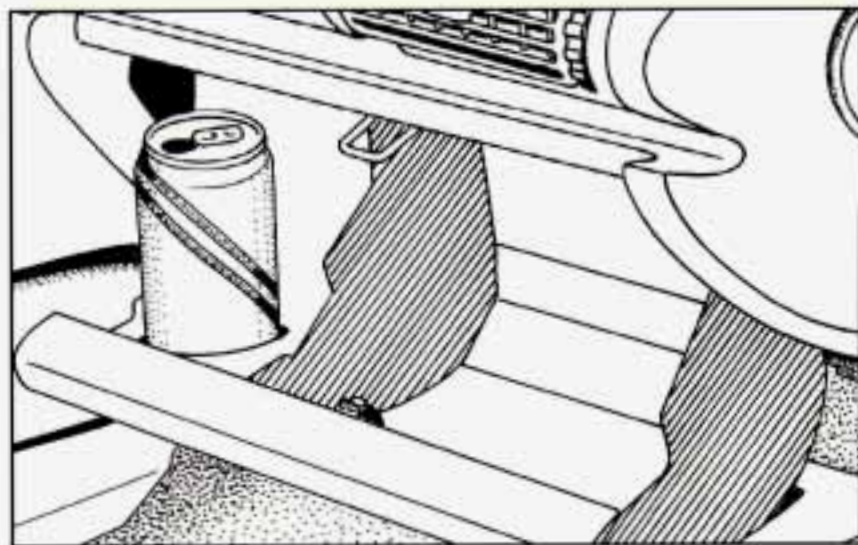

To access the cup holder, open the glove box.

Console Cup/Coin Holder

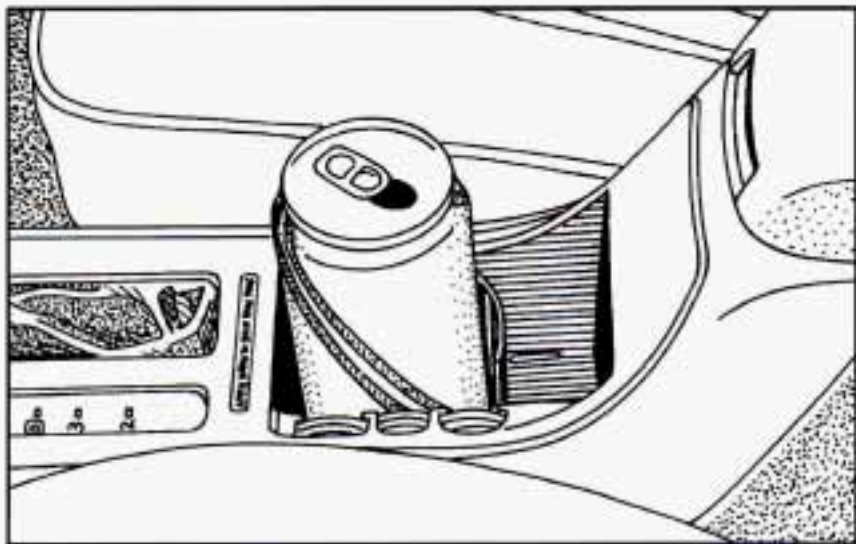

The console provides space for holding a cup or soft drink.

You may also place coins in the appropriate slots in the coin holder.

Rear Seat Cup Holder

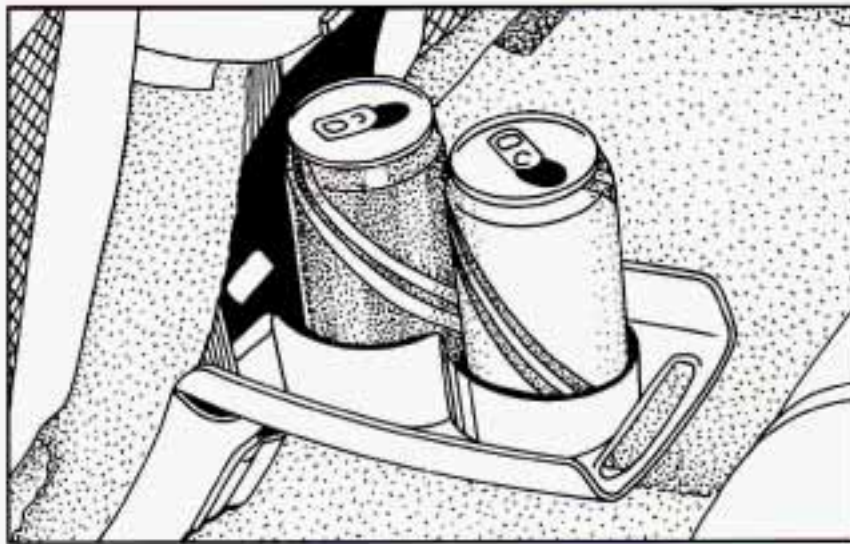

To access the rear seat cup holder, pull the door down.

Garment Hook

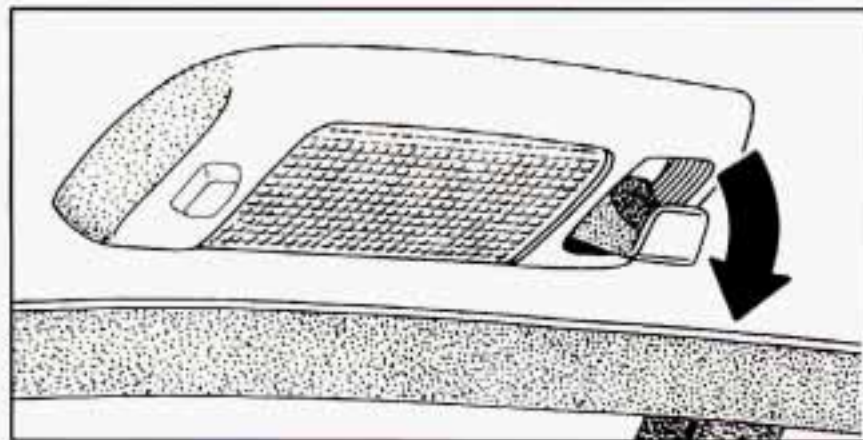

Push down on the tab marked with a hanger symbol to fold down the garment hook.

Ashtray and Lighter

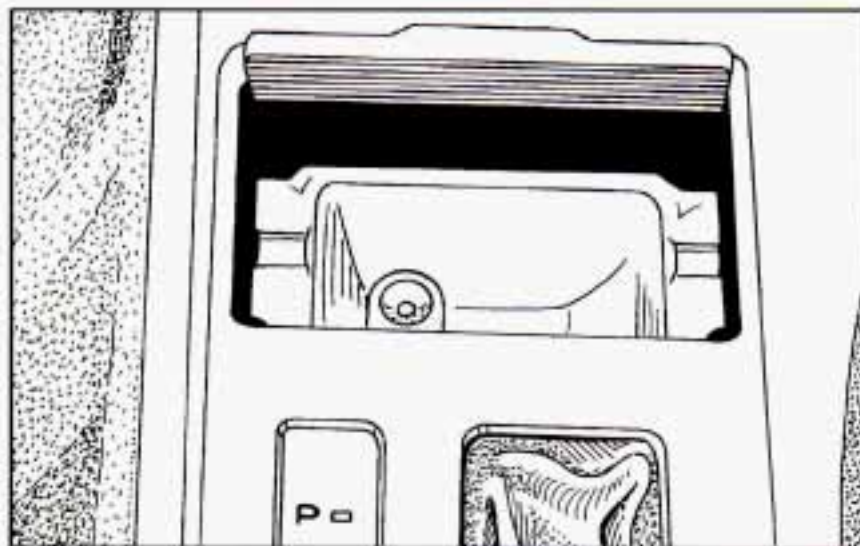

Lift the cover to reveal the ashtray.

To clean the ashtray, lift it out by pulling up on the snuffer.

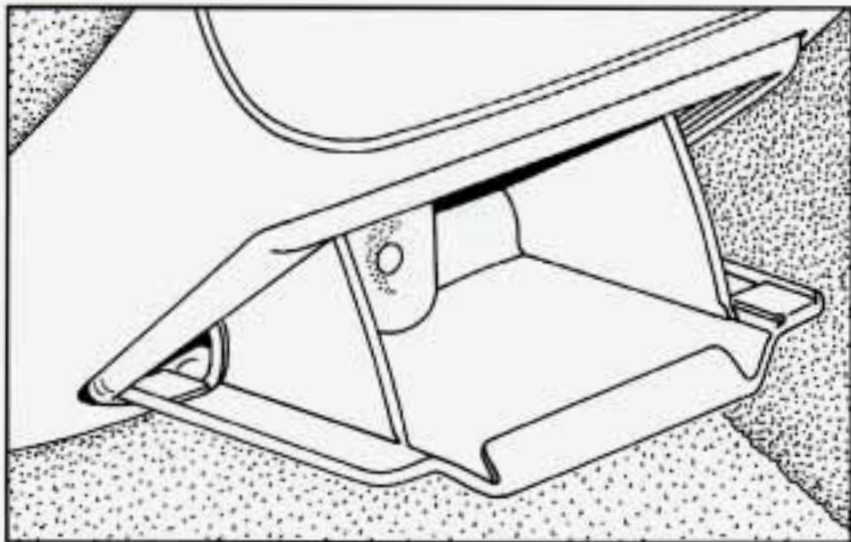

To clean the rear ashtray, pull rearward and then press down on the snuffer.

NOTICE:

Don't put papers and other things that burn into your ashtrays. If you do, cigarettes or other smoking materials could set them on fire, causing damage.



To use the lighter, just push it in all the way and let go. When it's ready, it will pop back by itself.

NOTICE:

Don't hold a cigarette lighter in with your hand while it is heating. If you do, it won't be able to back away from the heating element when it's ready. That can make it overheat, damaging the lighter and the heating element.

Sunglasses Storage

Place your sunglasses in the open area located above you in the overhead console.

Sunroof (Option)



Open the sunshade by hand when using the vent position.

Press and release the rear of the switch and the sunroof will open to the vent position.

Press the rear of the switch again to open the glass panel and the sunshade. Press the switch again to stop the panel in any position.

Press and hold the front of the switch to close the glass panel. The sunshade can only be closed by hand.

The sunroof glass panel cannot be opened or closed if your Oldsmobile has an electrical failure.

NOTICE:

Do not attempt to force the sunshade forward of the sliding glass panel. Damage will occur and the sunroof may not open or close properly.

The Instrument Panel -- Your Information System

Your instrument panel is designed to let you know at a glance how your vehicle is running. You'll know how fast you're going, how much fuel you're using, and many other things you'll need to drive safely and economically.

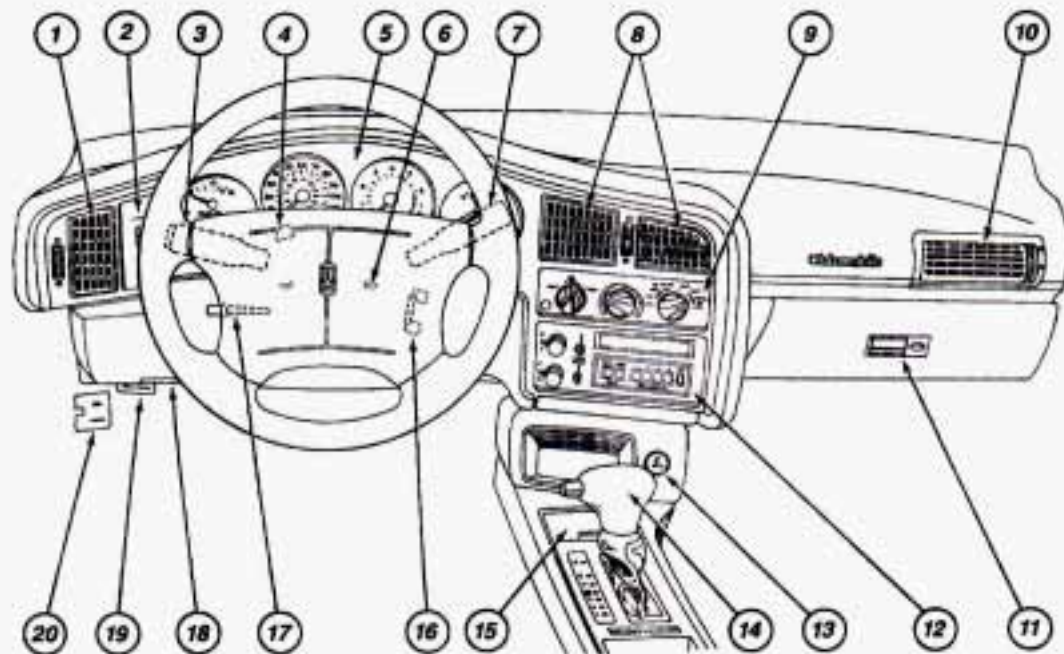

The main components of your instrument panel are:

1. Side Vent
2. Instrument Panel Intensity Control/Interior Lamps
3. Turn Signal/Multifunction Lever
4. Hazard Warning Flashers Switch
5. Instrument Cluster
6. Horn
7. Windshield Wiper/Washer Stalk
8. Center Vents
9. Climate Control System
10. Side Vent
11. Glove Box
12. Audio System
13. Lighter
14. Gear Shift Lever
15. Ashtray
16. Ignition Switch
17. Tilt Steering Wheel Lever
18. Fuse Panel (Under Instrument Panel)
19. Parking Brake Release Handle
20. Hood Release Lever

Instrument Panel Clusters

Your Oldsmobile is equipped with one of these clusters, which includes indicator warning lights and gages that

are explained on the following pages. Be sure to read them.

Standard Cluster

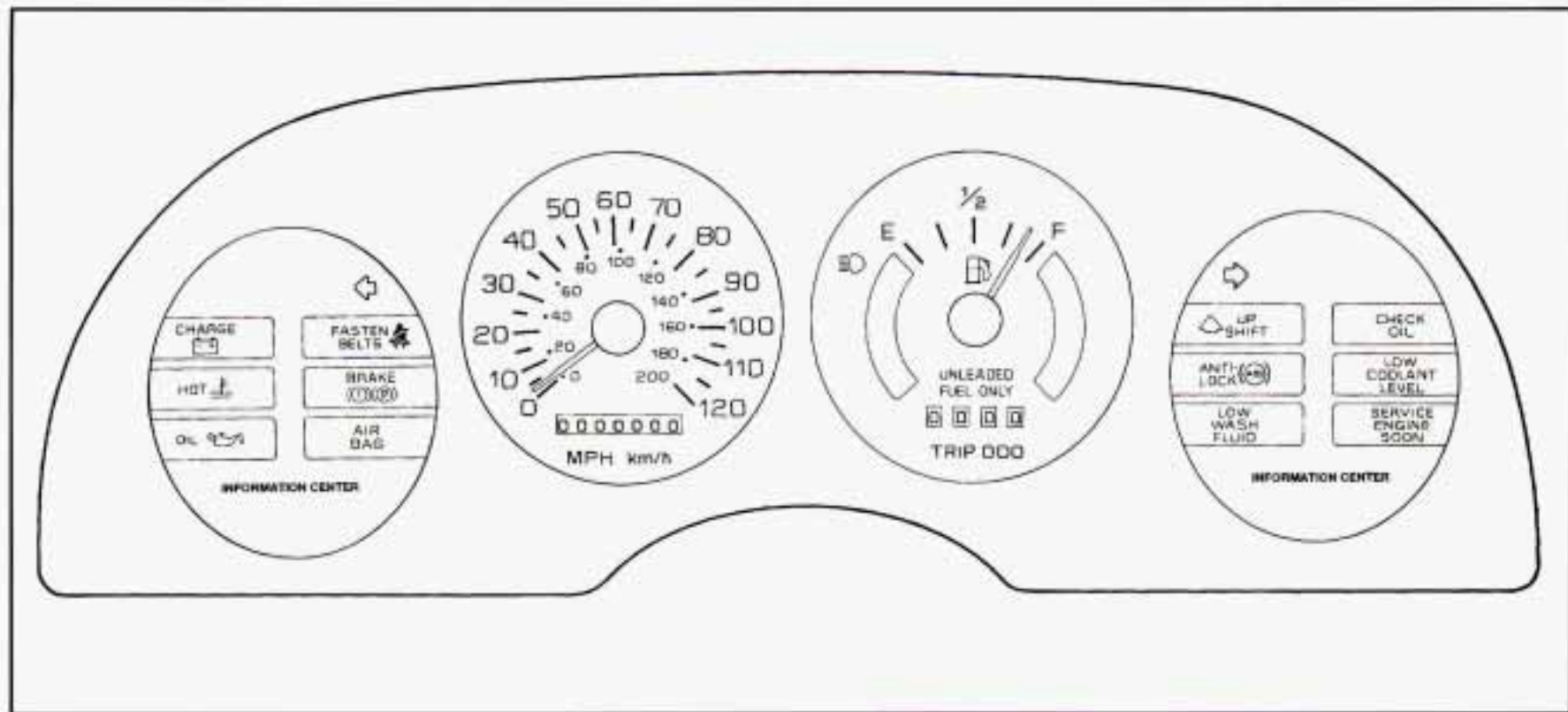

Gage Cluster

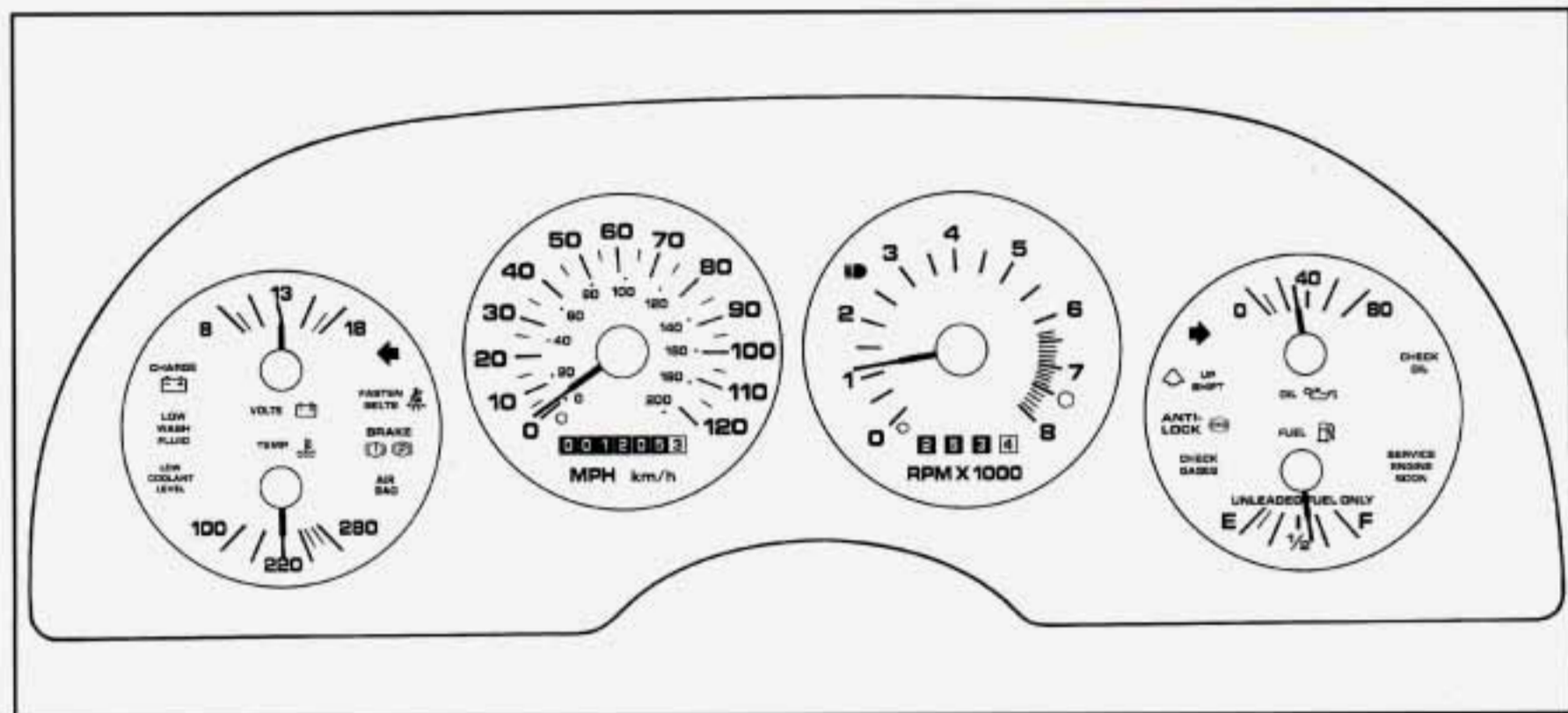

Speedometer

Your speedometer lets you see your speed in both miles per hour (mph) and kilometers per hour (km/h).

Tamper-Resistant Odometer

Your odometer shows how far your vehicle has been driven, in either miles (used in the United States) or kilometers (used in Canada).

Your Oldsmobile has a tamper-resistant odometer. If you see silver lines between the numbers, you'll know that someone has probably tried to turn it back, so the numbers may not be true.

You may wonder what happens if your vehicle needs a new odometer installed. If the new one can be set to the mileage total of the old odometer, then it must be. But if it can't, then it's set at zero and a label must be put on the driver's door to show the old mileage reading when the new odometer was installed.

Trip Odometer

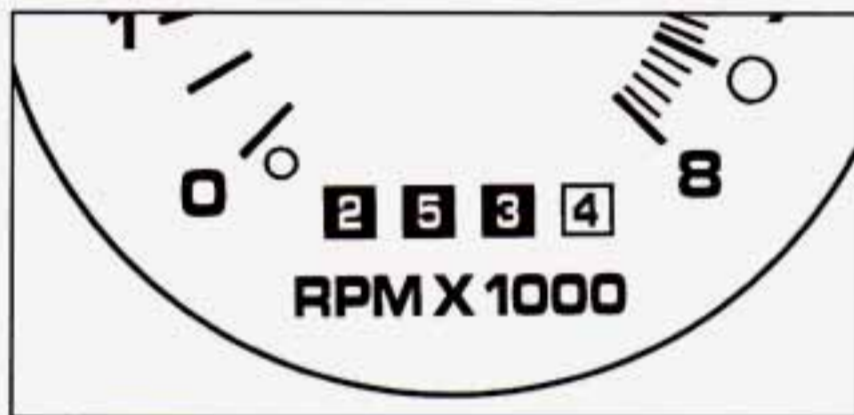

The trip odometer can tell you how far you have driven since you last reset it. To reset the trip odometer to zero, press the knob to the right of the gage.

Warning Lights, Gages and Indicators

Warning lights and gages can signal that something is wrong before it becomes serious enough to cause an expensive repair or replacement. Paying attention to your warning lights and gages could also save you or others from injury.

Warning lights come on when there may be or is a problem with one of your vehicle's functions. As you will see in the details on the next few pages, some warning lights come on briefly when you start the engine just to let you know they're working. If you are familiar with this section, you should not be alarmed when this happens.

Gages can indicate when there may be or is a problem with one of your vehicle's functions. Often gages and warning lights work together to let you know when there's a problem with your vehicle.

When one of the warning lights comes on and stays on when you are driving, or when one of the gages shows there may be a problem, check the section that tells you what to do about it. Please follow this manual's advice. Waiting to do repairs can be costly -- and even dangerous. So please get to know your warning lights and gages. They're a big help.

Safety Belt Warning Light



When the key is turned to RUN or START a chime will come on for about eight seconds to remind people to fasten their safety belts, unless the driver's safety belt is already buckled.

The safety belt light will also come on and stay on for about 20 seconds, then it will flash for about 55 seconds. If the driver's belt is already buckled, neither the chime nor the light will come on.



CAUTION:

If your safety belt light ever comes on or stays on after the front doors are closed and the driver's belt is buckled, have your vehicle fixed.

If you don't, the belt might not work as it should, and you might not have the protection you'd need in a crash.

Air Bag Readiness Light

There is an air bag readiness light on the instrument panel, which shows AIR BAG. The system checks the air bag's electrical system for malfunctions. The light tells you if there is an electrical problem. The system check includes the air bag sensors and module, the wiring and the diagnostic module. For more information on the air bag system, see "Air Bag" in the Index.



You will see this light flash for a few seconds when you turn your ignition to RUN or START. Then the light should go out. This means the system is ready.

If the air bag readiness light doesn't come on when you start your vehicle, or stays on, or comes on when you are driving, your air bag system may not work properly. Have your vehicle serviced right away.

Charging System Light

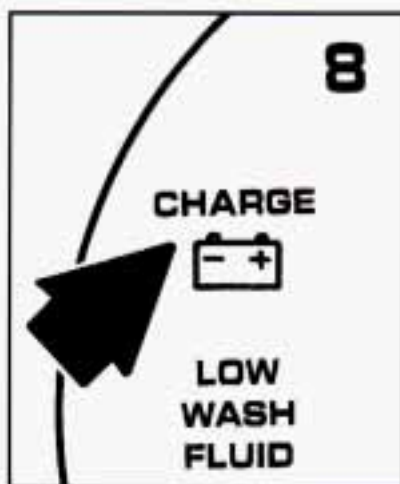

The CHARGE light will come on when you turn on the ignition, but the engine is not running, as a check to show you it is working.

Then it should go out. If it stays on, or comes on while you are driving, you may have a problem with the electrical charging system. It could indicate that you have a loose generator drive belt or another electrical problem. Have it checked right away. Driving while this light is on could drain your battery.

If you must drive a short distance with the light on, be certain to turn off all your accessories, such as the radio and air conditioner.

Voltmeter (Gage Cluster)

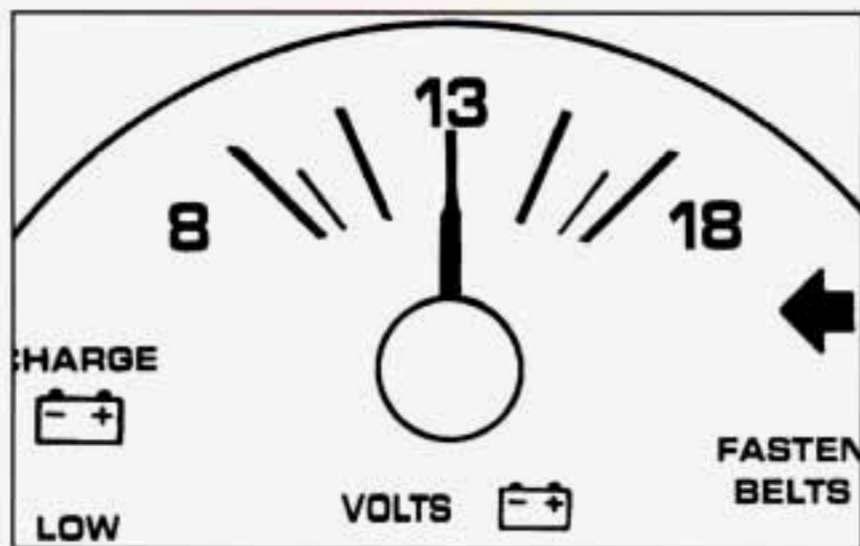

When the engine is running, this gage shows the condition of your charging system. Readings between the red warning zones indicate the normal operating range.

Readings in either red warning zone indicate a possible problem in the electrical system. Have your vehicle serviced immediately.

When your engine is not running, but the ignition is on (in the RUN position), the gage shows your battery's state of charge in DC volts.

Up Shift Light (Manual Transaxle)

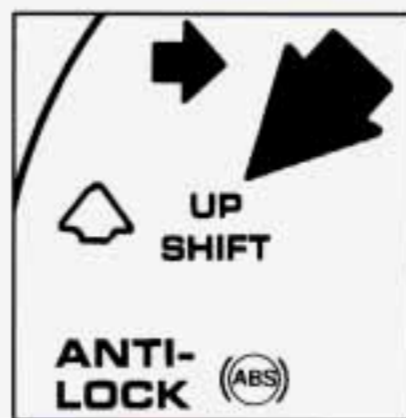

This light comes on when you need to shift to the next higher gear. See "Manual Transaxle" in the Index.

Brake System Warning Light



Your Oldsmobile's hydraulic brake system is divided into two parts. If one part isn't working, the other part can still work and stop you. For good braking, though, you need both parts working well.

If the warning light comes on, there could be a brake problem. Have your brake system inspected right away.

This light should come on briefly as you start the vehicle. If it doesn't come on then, have it fixed so it will be ready to warn you if there's a problem.

If the light comes on while you are driving, pull off the road and stop carefully. You may notice that the pedal is harder to push. Or, the pedal may go closer to the floor. It may take longer to stop. If the light is still on, or if the anti-lock brake system warning light is flashing, have the vehicle towed for service. (See "Anti-Lock Brake System Warning Light" and "Towing Your Vehicle" in the Index.)



CAUTION:

Your brake system may not be working properly if the brake system warning light is on. Driving with the brake system warning light on can lead to an accident. If the light is still on or if the anti-lock brake system warning light is flashing after you've pulled off the road and stopped carefully, have the vehicle towed for service.

The brake system warning light will also come on when you set your parking brake, and it will stay on if your parking brake doesn't release fully. If it stays on after your parking brake is fully released, it means you have a brake problem.

Anti-Lock Brake System Warning Light

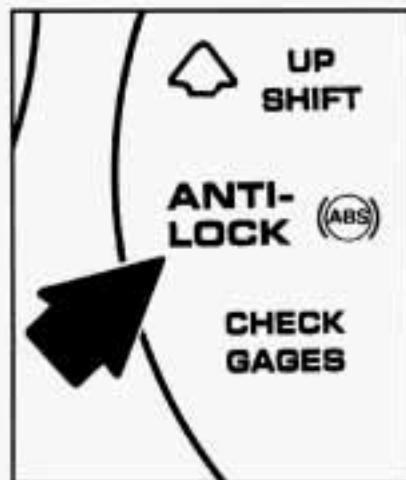

With the anti-lock brake system, this light will come on when you start your engine and it will stay on for three seconds. That's normal. If the light doesn't come on, have it fixed so it will be ready to warn you if there is a problem.

If the light flashes when you're driving, you don't have anti-lock brakes and there could be a problem with your regular brakes. Pull off the road and stop carefully. You may notice that the pedal is harder to push. Or, the pedal may go closer to the floor. It may take longer to stop. Have the vehicle towed for service. (See "Towing Your Vehicle" in the Index.)

CAUTION:

Your regular brake system may not be working properly if the anti-lock brake system warning light is flashing. Driving with the anti-lock brake system warning light flashing can lead to an accident. After you've pulled off the road and stopped carefully, have the vehicle towed for service.

If the anti-lock brake system warning light stays on longer than normal after you've started your engine, turn the ignition off. Or, if the light comes on and stays on when you're driving, stop as soon as possible and turn the ignition off. Then start the engine again to reset the system. If the light still stays on, or comes on again while you're driving, your Oldsmobile needs service. If the light is on but not flashing and the regular brake system warning light isn't on, you still have brakes, but you don't have anti-lock brakes.

Engine Coolant Temperature Warning Light (Standard Cluster)

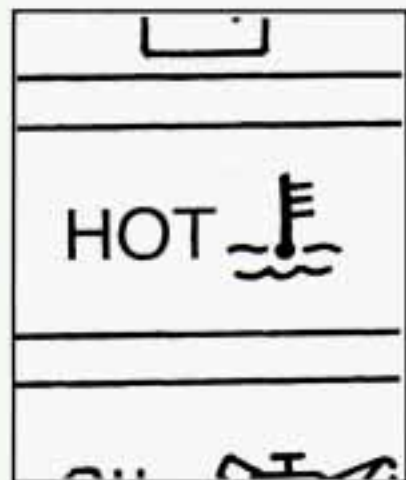

This light tells you that your engine coolant has overheated or your radiator cooling fan is not working.

If you have been operating your vehicle under normal driving conditions, you should pull off the road, stop your vehicle and turn off the engine as soon as possible.

HOT COOLANT CAN BURN YOU BADLY!

In Problems on the Road, this manual shows what to do. See "Engine Overheating" in the Index.

Engine Coolant Temperature Gage (Gage Cluster)

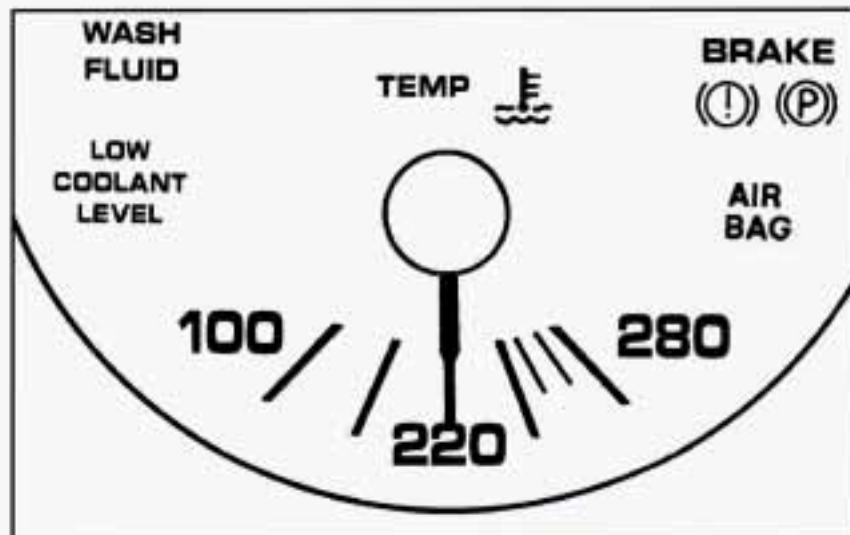

This gage shows the engine coolant temperature. If the gage pointer moves into the red area, your engine is too hot! It means that your engine coolant has overheated.

If you have been operating your vehicle under normal driving conditions, you should pull off the road, stop your vehicle and turn off the engine as soon as possible.

HOT COOLANT CAN BURN YOU BADLY!

In Problems on the Road, this manual shows what to do. See "Engine Overheating" in the Index.

Low Coolant Level Warning Light

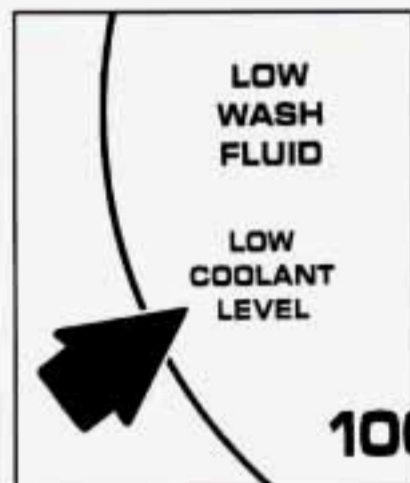

If this light comes on and stays on, the vehicle should promptly be pulled off the road and the coolant level checked.

See "Engine Coolant" in the Index. If there are visible signs of steam, see "Engine Overheating" in the Index before opening the hood. Have your vehicle serviced as soon as you can.

Malfunction Indicator Lamp (Service Engine Soon Light)

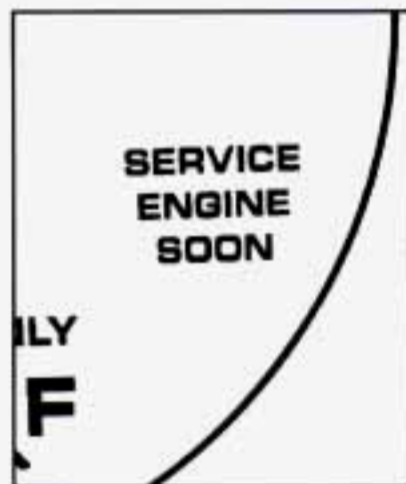

A computer monitors operation of your fuel, ignition and emission control systems.

This light should come on when the ignition is on, but the engine is not running, as a check to show you it is working. If it does not come on at all, have it fixed right away. If it stays on, or it comes on while you are driving, the computer is indicating that you have a problem. You should take your vehicle in for service soon.

NOTICE:

If you keep driving your vehicle with this light on, after a while the emission controls won't work as well, your fuel economy won't be as good and your engine may not run as smoothly. This could lead to costly repairs not covered by your warranty.

Check Gages Light (Gage Cluster)

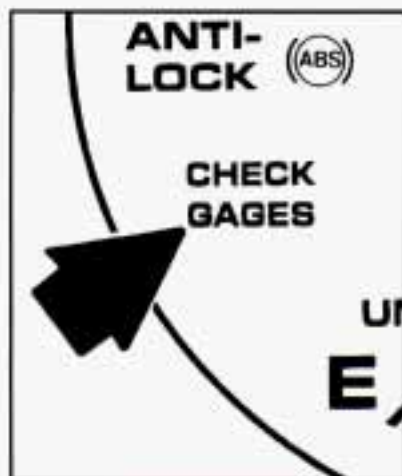

This light will come on briefly when you are starting the engine. If it stays on, or if it comes on and stays on while you are driving, check your various gages to see if they are in the warning zones.

Oil Pressure Gage (Gage Cluster)

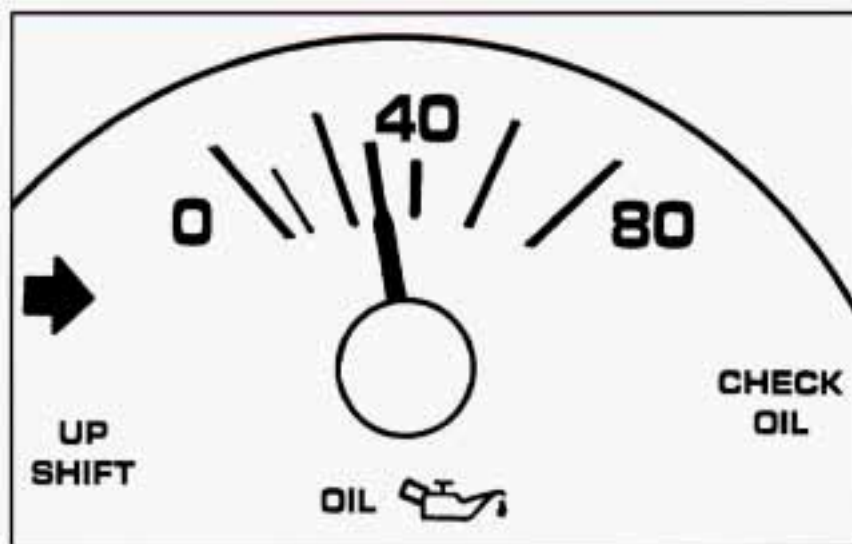

The oil pressure gage shows the engine oil pressure in psi (pounds per square inch) when the engine is running. Canadian vehicles indicate pressure in kPa. Oil pressure may vary with engine speed, outside temperature and oil viscosity, but readings above the red warning zone indicate the normal operating range.

A reading in the red zone may be caused by a dangerously low oil level or other problem causing low oil pressure. Have your vehicle serviced immediately.

⚠ CAUTION:

Don't keep driving if the oil pressure is low. If you do, your engine can become so hot that it catches fire. You or others could be burned. Check your oil as soon as possible and have your vehicle serviced.

NOTICE:

Damage to your engine from neglected oil problems can be costly and is not covered by your warranty.

Oil Warning Light (Standard Cluster)

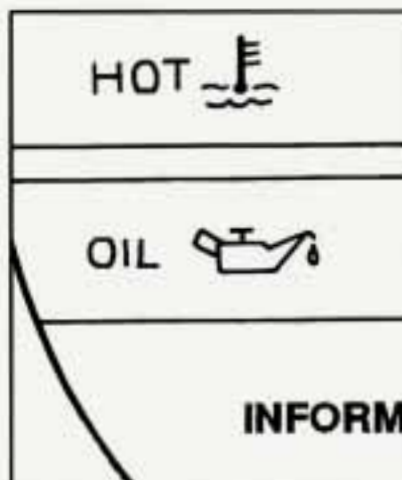

If you have a low engine oil pressure problem, this light will stay on after you start your engine, or come on when you are driving. This indicates that your engine is not receiving enough oil. The engine could be low on oil, or could have some other oil problem. Have it fixed immediately.

The oil light could also come on in two other situations:

- When the ignition is on but the engine is not running, the light will come on as a test to show you it is working, but the light will go out when you turn the ignition to START. If it doesn't come on with the ignition on, you may have a problem with the fuse or bulb. Have it fixed right away.
- If you make a hard stop, the light may come on for a moment. This is normal.

Check Oil Light

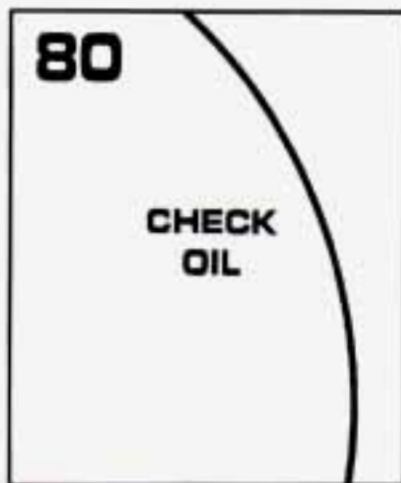

Your engine is equipped with an oil level monitoring system. When the ignition key is turned on, the CHECK OIL light will briefly flash.

NOTICE:

The oil level monitoring system only checks oil level during the brief period between key on and engine crank. It does not monitor engine oil level when the engine is running. Additionally, an oil level check is only performed if the engine has been turned off for a considerable period of time allowing the oil normally in circulation to drain back into the oil pan.

If the light stays on, stop the vehicle on a level surface and turn the engine off. Check the oil level using the engine oil dipstick. (See "Engine Oil" in the Index.) If the light does not flash, have the low oil level sensor system repaired so it will be ready to warn you if there's a problem.

Tachometer (Gage Cluster)

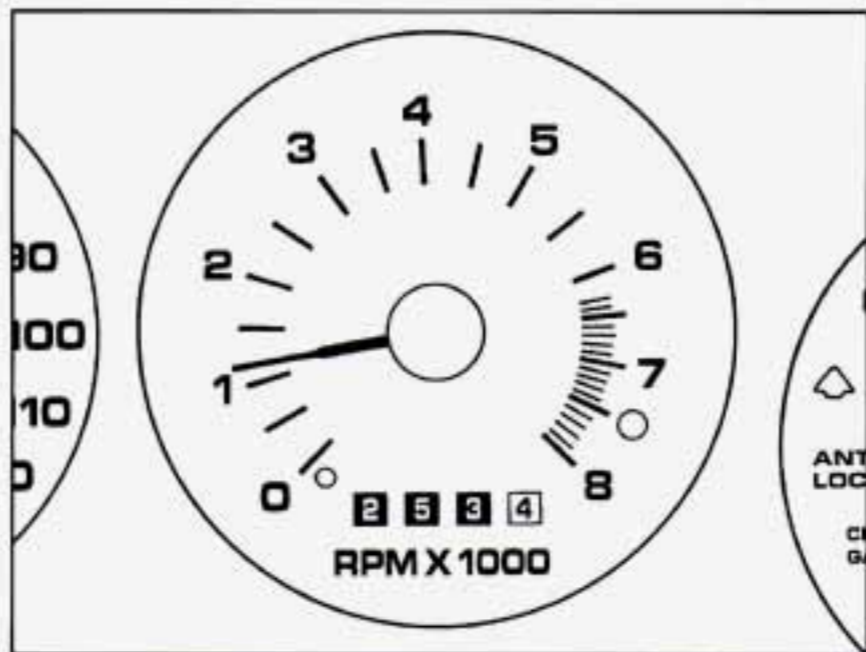

The tachometer shows your engine speed in revolutions per minute (rpm).

NOTICE:

Do not run your engine at speeds in the red area, or engine damage may occur.

Fuel Gage

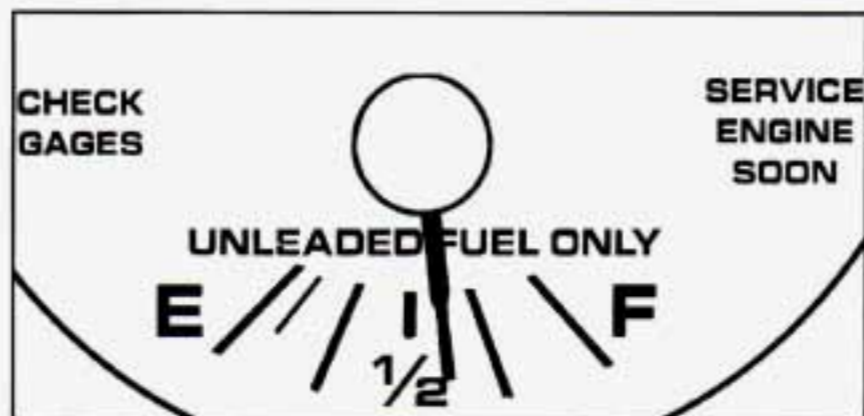

Your fuel gage tells you about how much fuel you have left, when the ignition is on. When the indicator nears E (EMPTY), you still have a little fuel left, but you should get more soon.

Here are four things that some owners ask about. None of these show a problem with your fuel gage:

- At the service station, the gas pump shuts off before the gage reads F (FULL).
- It takes a little more or less fuel to fill up than the gage indicated. For example, the gage may have indicated the tank was half full, but it actually took a little more or less than half the tank's capacity to fill the tank.
- The gage moves a little when you turn a corner or speed up.
- The gage doesn't go back to E (EMPTY) when you turn off the ignition.

Low Washer Fluid Warning Light

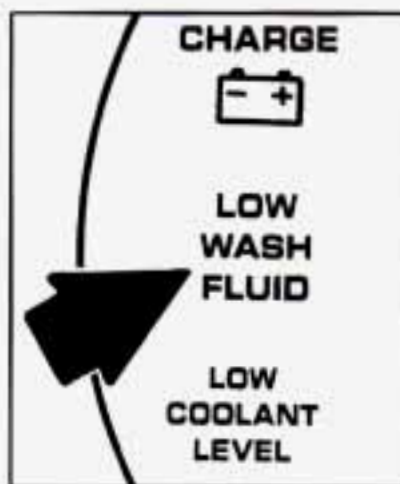

The LOW WASH FLUID light will come on when you turn on the ignition, and the fluid container is less than one-third full.

Driving without washer fluid can be dangerous. A bad mud splash can block your vision. You could hit another vehicle or go off the road. Check your washer fluid level often.



Section 3 Comfort Controls and Audio Systems

In this section you'll find out how to operate the comfort control systems and audio systems offered with your Oldsmobile. Be sure to read about the particular system supplied with your vehicle.

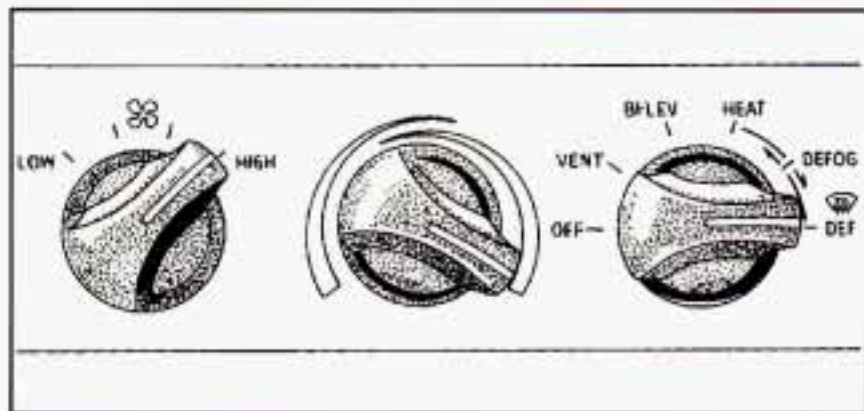

Climate Control System

With this system, you can control the ventilation and heating in your vehicle.

Your vehicle also has the flow-through ventilation system described later in this section.

FAN: The left control knob sets the fan speed. To select the force of air you want, turn the knob. The fan is always running unless the mode control is moved to OFF.

TEMPERATURE CONTROL: The center control knob regulates the temperature of the air coming through the system.

MODE CONTROL: The right control knob changes the functions of your system.

VENT: Use when outside temperatures are mild, and little heating or cooling is needed. Air flow is through the instrument panel outlets. Set the center control knob to the temperature desired.

BI-LEV: Use on cool, but sunny days. This setting brings in the outside air, but directs it in two ways. The cool air is directed to the upper portion of your body through the instrument panel outlets, but slightly warmer air is directed through the heater ducts and defroster vents. At times this temperature difference may be more apparent than others.

HEAT: This setting brings heated air through the heater ducts, and some through the windshield defroster vents.

If you have the optional engine coolant heater (engine block heater) and use it during cold weather, 0°F (-18°C) or lower, your heating system will more quickly provide heat because the engine coolant is already warmed. See “Engine Coolant Heater (Engine Block Heater)” in the Index.

DEFOG: This setting divides air flow equally between the heater ducts and the windshield defroster vents.

 **DEF:** This setting directs air through the windshield defroster vents located on top of the instrument panel.

Defogging Windows

To defog the windshield, turn all three control knobs to the far right.

Air Conditioning System (Option)

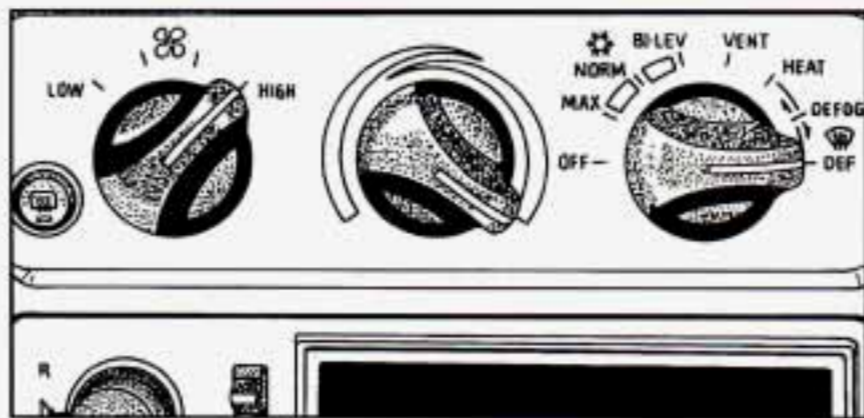

The air conditioner and heater work best if you keep your windows closed while using them. Your vehicle also has the flow-through ventilation system described later in this section.

Air Conditioning

Your system has three air conditioner settings in addition to the standard climate control system. Before

using your air conditioner on very hot days, open the windows long enough to let hot inside air escape. This reduces the amount of work your air conditioner's compressor will have to do, which should help fuel economy.

MAX: Use for maximum cooling. This setting recirculates much of the air inside your vehicle so it maximizes your air conditioner's performance and your vehicle's fuel economy.

NORM: Use for normal cooling on hot days. This setting cools outside air and directs it through the instrument panel outlets.

BI-LEV: Use on cool, but sunny days. This setting brings in the outside air, but directs it in two ways. The cool air is directed to the upper portion of your body through the instrument panel outlets, but slightly warmer air is directed through the heater ducts and defroster vents. At times this temperature difference may be more apparent than others.

The air conditioner compressor is enabled in all three air conditioning positions.

Rear Window Defogger

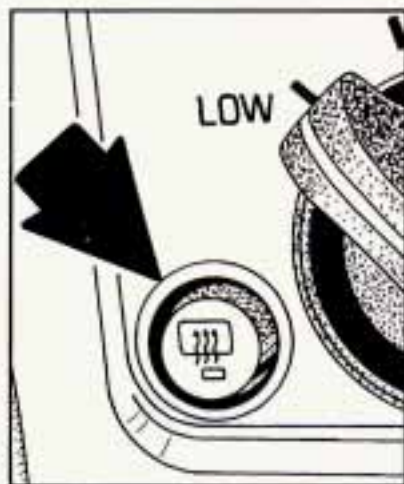

The rear window defogger uses a warming grid to remove fog from the rear window.

Press the defogger switch. The indicator light will glow. If your vehicle is traveling under 45 mph (70 km/h), the rear window defogger will turn off automatically after about 10 minutes of use. If your vehicle is traveling over 45 mph (70 km/h), the defogger will operate continuously. You can turn the defogger off by turning off the ignition or pressing the switch again.

Do not attach a temporary vehicle license across the defogger grid on the rear window.

NOTICE:

Don't use a razor blade or something else sharp on the inside of the rear window. If you do, you could cut or damage the warming grid, and the repairs wouldn't be covered by your warranty.

Flow-Through Ventilation System

Your Oldsmobile's flow-through ventilation system supplies outside air into the vehicle when it is moving. Outside air will also enter the vehicle when the fan is running.

Ventilation Tips

- Keep the hood and front air inlet free of ice, snow, or any other obstruction (such as leaves). The heater and defroster will work far better, reducing the chance of fogging the inside of your windows.
- When you enter a vehicle in cold weather, turn the fan control to **HIGH** for a few moments before driving off. This helps clear the intake ducts of snow and moisture, and reduces the chance of fogging the inside of your windows.
- Keep the air path under the front seats clear of objects. This helps air to circulate throughout your vehicle.

Audio Systems

The following pages describe the audio systems available for your Oldsmobile and how to get the best performance from them. Please read about the system in your vehicle.

Setting the Clock

No matter which audio system you have in your vehicle, setting the clock is easy.

1. With the ignition on and radio either on or off, press SET. The SET indicator will appear on the digital display for five seconds.
2. You must begin to set the clock to the correct hour and minute during those five seconds.

If your audio system does not have a compact disc player:

Press SCAN to set the hour.

Press SEEK to set the minute.

If your system has a compact disc player:

Press SCAN to set the hour.

Press the left SEEK arrow to decrease minutes or the right SEEK arrow to increase minutes.

If your vehicle is left with the ignition turned off for over 24 days, battery power to your clock, audio system and Remote Lock Control (if you have this option) will be turned off to reduce battery drain. When the ignition is turned on again, battery power will be resupplied. However, under these conditions, it will be necessary to reset the clock and audio system settings. The Delco-LOC II[®] feature on vehicles equipped with the optional CD player will also be activated and will need to be reset.

AM/FM Stereo Radio

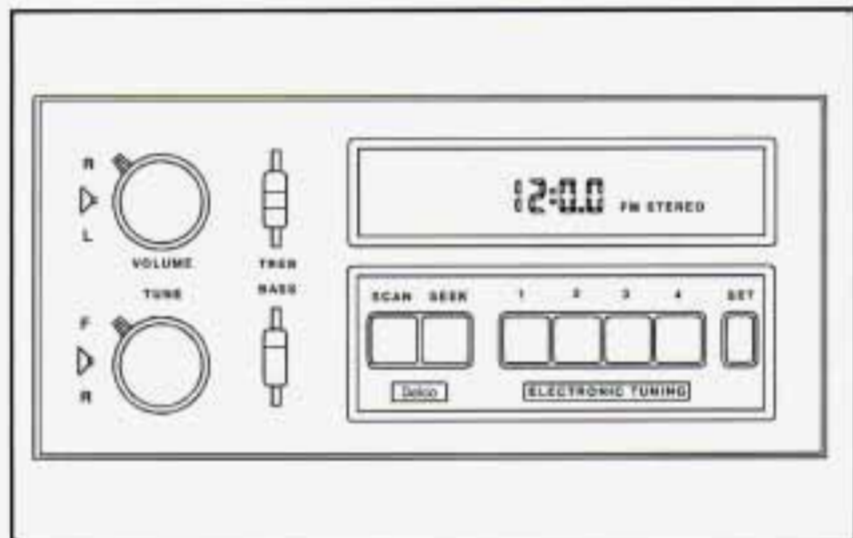

The digital display indicates information on time or radio station frequency, the AM or FM radio band, whether the station is in stereo, and other radio functions.

Playing the Radio

VOLUME: With the ignition on, turn the upper knob clockwise to turn on the radio and increase volume. Press it to change between the clock and the radio station frequency display when the radio is on.

Finding a Station

AM/FM: Press the lower knob to change between the AM and FM bands (the digital display will display AM or FM, and if the station is in stereo, STEREO will be displayed).

TUNE: Turn the lower knob clockwise or counterclockwise to tune in radio stations (the radio station frequency will be displayed on the digital display).

SCAN: Press this button to listen to stations for a few seconds. Press it again to stop scanning.

SEEK: Each time you press SEEK, you will tune in the next station on the AM or FM radio band.

Presets: The four numbered pushbuttons can be used to preset up to 14 radio stations (seven AM and seven FM).

1. Tune in the desired station.
2. Press SET. The word SET will appear on the digital display for five seconds.
3. While SET is displayed, press one of the four pushbuttons. Whenever you press this button again, the preset station will be tuned in.
4. Repeat steps 1-3 for each of four AM and four FM stations.

Up to three additional stations on each band may be preset by "pairing" pushbuttons:

1. Tune in the desired station.
2. Press SET, and within five seconds press any two adjacent pushbuttons at the same time. Whenever you press these two buttons again, the preset station will be tuned in.

Setting the Tone

TREB: Slide this lever up to increase treble or down to decrease it. If a station is weak or noisy, reduce the treble.

BASS: Slide this lever up to increase bass or down to decrease it.

Adjusting the Speakers

R/L BALANCE: The control ring behind the VOLUME knob adjusts the left/right speaker balance.

F/R FADE: The control ring behind the TUNE knob adjusts the front/rear speaker balance.

AM/FM Stereo Radio with Cassette Tape Player (Option)

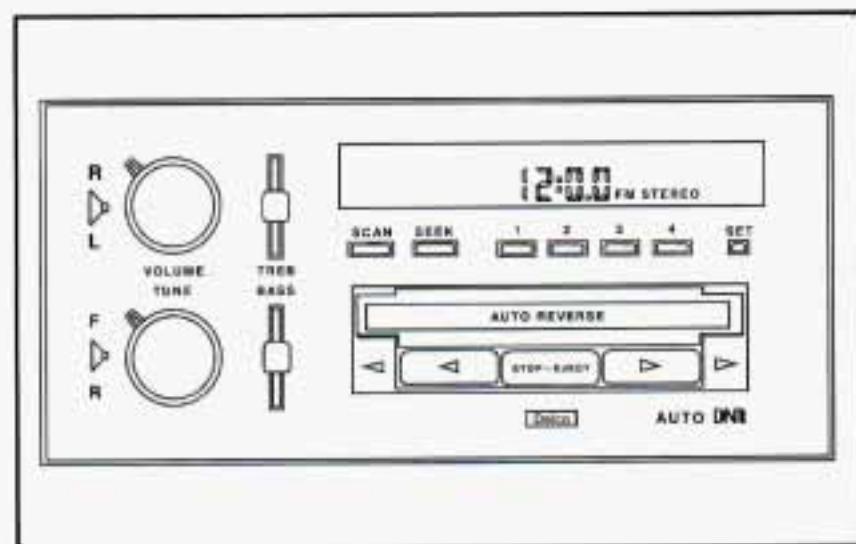

The digital display indicates information on time or radio station frequency, the AM or FM radio band, whether the station is in stereo, and other radio functions.

Playing the Radio

VOLUME: With the ignition on, turn the upper knob clockwise to turn on your audio system and increase volume. Press it to change between the clock and the radio station frequency display when the radio is on, or to change sides of a tape when a cassette is playing.

Finding a Station

AM/FM: Press the lower knob to change between the AM and FM bands (the digital display will display AM or FM, and if the station is in stereo, STEREO will be displayed).

TUNE: Turn the lower knob clockwise or counterclockwise to tune in radio stations (the radio station frequency will be displayed on the digital display).

SCAN: Press this button to listen to stations for a few seconds. Press it again to stop scanning.

SEEK: Each time you press SEEK, you will tune in the next station on the AM or FM radio band.

Presets: The four numbered pushbuttons can be used to preset up to 14 radio stations (seven AM and seven FM).

1. Tune in the desired station.
2. Press SET. The word SET will appear on the digital display for five seconds.
3. While SET is displayed, press one of the four pushbuttons. Whenever you press this button again, the preset station will be tuned in.
4. Repeat steps 1-3 for each of four AM and four FM stations.

Up to three additional stations on each band may be preset by "pairing" pushbuttons:

1. Tune in the desired station.
2. Press SET, and within five seconds press any two adjacent pushbuttons at the same time. Whenever you press these two buttons again, the preset station will be tuned in.

Setting the Tone

TREB: Slide this lever up to increase treble or down to decrease it. If a station is weak or noisy, reduce the treble.

BASS: Slide this lever up to increase bass or down to decrease it.

Adjusting the Speakers

R/L BALANCE: The control ring behind the upper knob adjusts the left/right speaker balance.

F/R FADE: The control ring behind the lower knob adjusts the front/rear speaker balance.

Playing a Cassette Tape

With the power on, insert a tape into the cassette door. Do not use tapes that are longer than 45 minutes on each side.

When the left indicator arrow is lit, selections listed on the top side of the cassette are playing. When the right indicator arrow is lit, selections listed on the bottom side of the cassette are playing. Press the upper control knob to change sides of a cassette while it is playing. The tape player automatically begins playing the other side when it reaches the end of a tape.

To advance the tape rapidly, press the button with the arrow pointing to the right. To stop fast forward, press the STOP-EJECT button.

To reverse the tape rapidly, press the button with the arrow pointing to the left. To stop reverse, press the STOP-EJECT button.

To stop playing a tape, press the STOP-EJECT button. The cassette will be ejected, and the radio will begin playing.

AM/FM Stereo with Compact Disc Player (Option)

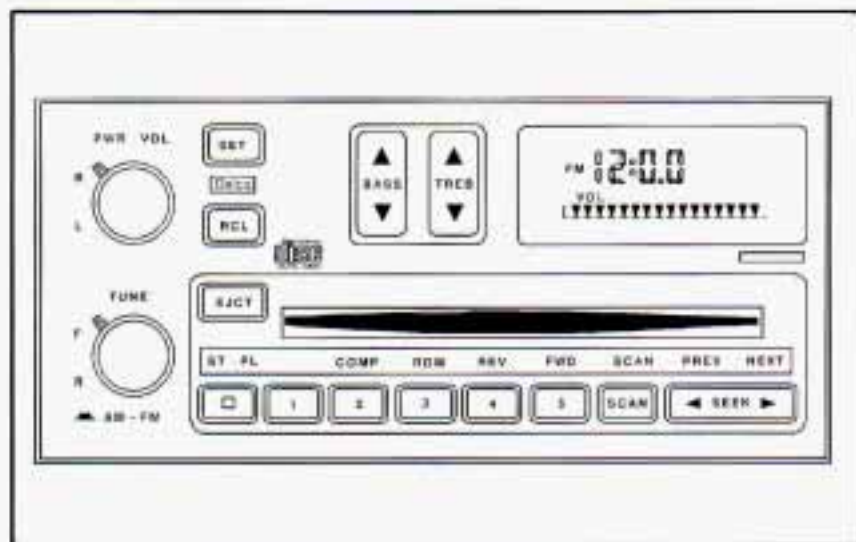

The digital display indicates information on time or radio station frequency, the AM or FM radio band, whether the station is in stereo, and other radio functions.

Playing the Radio

PWR-VOL: With the ignition on, turn the upper knob to turn your audio system on and off, and to increase or decrease the volume.

RCL: Press this button to alternate the digital display between the time, station and band.

Finding a Station

AM-FM: Press the lower knob to change between the AM and FM bands (the digital display will display AM or FM, and if the station is in stereo, FM ST will be displayed).

TUNE: Turn the lower knob clockwise or counterclockwise to tune in radio stations (the radio station frequency will be displayed on the digital display).

SEEK: Each time you press SEEK, you will tune in the next station higher or lower on the AM or FM radio band.

SCAN: Press this button to listen to stations for a few seconds. Press it again to stop scanning. The receiver will scan twice around the band if SCAN is pressed only once.

Presets: The five numbered pushbuttons can be used to preset up to ten radio stations (five AM and five FM). The buttons have other uses when you are playing a compact disc.

1. Tune in the desired station.
2. Press SET. The word SET will appear on the digital display for five seconds.
3. While SET is displayed, press one of the five pushbuttons. Whenever you press this button again, the preset station will be tuned in.
4. Repeat steps 1-3 for each of five AM and five FM stations.

Setting the Tone

BASS: Press the up or down arrows to increase or decrease the bass level. Press the center of the button for the factory preset level. The bass level will appear on the display for approximately ten seconds.

TREB: Press the up or down arrows to increase or decrease the treble level. Press the center of the button for the factory preset level. The treble level will appear on the display for approximately ten seconds. If a station is weak or noisy, reduce the treble.

Adjusting the Speakers

R-L BALANCE: The control ring behind the upper knob adjusts the left/right speaker balance.

F-R FADE: The control ring behind the lower knob adjusts the front/rear speaker balance.

Compact Disc Player

Many of the controls for the radio also have functions for the compact disc player, as explained here.

Don't use mini-discs that are called singles. They won't eject. *Use only full-size compact discs.*

1. Turn the PWR-VOL knob to turn on the power.
2. Insert a disc part-way into the slot, with the label side up. The player will pull it in. Within a few seconds, the disc should play. To insert a disc with the ignition in the OFF position, press EJCT then insert the disc.

If the disc comes back out and/or Err appears on the display:

- The disc may be upside down.
- The disc may be dirty, scratched or wet.

- There may be too much moisture in the air (wait about one hour and try again).
- The player may be too hot, too cold or the road may be too rough for the disc to play. As soon as things get back to normal, the disc should play.

While a disc is playing, the CD indicator is displayed on the digital display, as is the clock.

RCL: Press this button once to see what track is playing. Press again within five seconds to see how long your selection has been playing. The track number also will be displayed when the volume is changed or a new track starts to play.

COMP: Pressing this button makes soft and loud passages more equal in volume. Press again to resume normal play.

RDM: Press to play tracks in random, rather than sequential, order. RDM will be displayed on the digital display when this function is active.

Press the button again to play tracks sequentially.

REV: Press and hold to rapidly reverse the disc. Release to resume playing.

FWD: Press and hold to rapidly advance the disc. Release to resume playing.

SCAN: Press this button to sample each track for approximately ten seconds. SCAN will continue until another button is pressed.

PREV: Press to play a track again. If you keep pressing the PREV button, the disc will keep backing up to previous tracks.

NEXT: Press to advance to the next track. If you keep pressing the NEXT button, the disc will keep advancing to other tracks.

When Finished with the Compact Disc Player

If you use the PWR-VOL knob to turn off the power, or turn off the ignition, the disc will stay in the player and start again when you turn on the ignition or the PWR-VOL knob. The disc will begin playing at the point where it had been stopped.

ST-PL: Press to stop the disc player; the radio will play. Press again to play the disc (the player will start playing the disc where it had stopped earlier).

EJCT: Press to eject the disc; the radio will play. You can also eject the disc with the radio or ignition off.

CD Player Theft Deterrent Feature

Delco LOC II[®] is an theft deterrent feature for the compact disc player. It can be used or ignored. If ignored, the system plays normally. If it is used, your player won't be usable if it is ever stolen because it will go to "LOC" mode any time battery power is removed. It will also go to LOC mode any time power from the battery is turned off by the Battery Rundown Protection feature (see "Battery Rundown Protection" in the Index). Until an unlock code is entered, it will not turn on.

The instructions below tell you how to enter a secret code into the system. If your vehicle loses battery power for any reason, you must unlock the system with the secret code before your audio system will turn on.

Setting the Anti-Theft System

1. Write down any six-digit number and keep it in a safe place. This is your secret code.
 2. Turn the ignition to the ACC or RUN position.
 3. Turn the PWR-VOL knob to turn the radio off.
 4. Press station preset buttons 1 and 4 at the same time and hold until "---" shows on the display.
- You now have only 15 seconds between each of the following steps.
5. Press SET, and "000" will appear on the display.
 6. Press SCAN until the first digit of your code appears.
 7. Press SEEK until the second and third digits of your code appear.
 8. Press the TUNE knob ("000" will appear again on the display).
 9. Press SCAN until the fourth digit of your code appears.
 10. Press SEEK until the fifth and sixth digits of your code appear.
 11. Press the TUNE knob ("rEP" will appear for five seconds, then 000).
 12. Repeat steps 6 through 10. Then press the TUNE knob again. SEC will appear, indicating that Delco LOC II[®] is set, and your audio system is secure. If "---" appears, the steps were not successful, and you must repeat the entire procedure.

Disabling the Anti-Theft System

Enter your secret code by following these steps (you will have only 15 seconds between each step).

1. Turn the ignition to the ACC or RUN position, and turn the radio off.
2. Press station preset buttons 1 and 4 at the same time. SEC will appear in the display, indicating the audio system is secure.
3. Press SET, and "000" will appear on the display.
4. Press SCAN until the first digit of your secret code appears.
5. Press SEEK until the second and third digits of your code appear.
6. Press the TUNE knob ("000" will appear on the display).
7. Press SCAN until the fourth digit of your code appears.
8. Press SEEK until the fifth and sixth digits of your code appear.
9. Press the TUNE knob. If the display shows "---," the radio is unsecured and will play again. If the display shows SEC, the disabling sequence was unsuccessful and the numbers did not match the secret code.

If you lose or forget your code, see your retailer.

Unlocking the System After a Power Loss

When battery power is reapplied to a secured audio system after a loss of power, the audio system will not turn on and LOC will appear on the digital display. You will need to unlock the Delco LOC II® system.

1. Turn the ignition to the ACC or RUN position, and turn the radio off.
2. Press SET, and "000" will appear on the display.
3. Follow steps 4-8 for disabling your anti-theft system.
4. Press the lower knob. The time will appear on the digital display if you are successful. If SEC appears, however, the numbers did not match, and your audio system is still locked.

Understanding Radio Reception

FM Stereo

FM stereo will give you the best sound, but FM signals will reach only about 10 to 40 miles (16 to 65 km). Tall buildings or hills can interfere with FM signals, causing the sound to come and go.

AM

The range for most AM stations is greater than for FM, especially at night. The longer range, however, can cause stations to interfere with each other. AM can also pick up noise from things like storms and power lines. To lower this noise, try reducing the treble level.

Be aware that hearing damage from loud noise is almost undetectable until it is too late. Your hearing can adapt to higher volumes of sound. Sound that seems normal can be loud and harmful to your hearing. Take precautions by adjusting the volume control on your radio to a safe sound level before your hearing adapts to it. To help avoid hearing loss or damage:

- Adjust the volume control to the lowest setting.
- Increase volume slowly until you hear comfortably and clearly.

NOTICE:

Before you add any sound equipment to your vehicle -- like a tape player, CB radio, mobile telephone or two-way radio -- be sure you can add what you want. If you can, it's very important to do it properly. Added sound equipment may interfere with the operation of your vehicle's engine, Delco[®] radio or other systems, and even damage them. And, your vehicle's systems may interfere with the operation of sound equipment that has been added improperly.

So, before adding sound equipment, check with your retailer and be sure to check Federal rules covering mobile radio and telephone units.

Care of Your Cassette Tape Player

A tape player that is not cleaned regularly can cause reduced sound quality, ruined cassette, or a damaged mechanism. Cassette tapes should be stored in their cases away from contaminants, direct sunlight, and extreme heat. If they aren't, they may not operate properly or cause failure of the tape player.

Your tape player should be cleaned after every 50 hours of use. If you notice a reduction in sound quality, try a good cassette to see if the tape or the tape player is at fault. If this other cassette has no improvement in sound quality, clean the tape player.

Cleaning may be done with a scrubbing action non-abrasive cleaning cassette. This system uses a cleaning cassette with pads which scrub the tape head as the hubs of the cleaner cassette turn. It is normal for the cartridge to eject while cleaning. Insert the cassette at least three times to ensure a thorough cleaning. A scrubbing action cleaning cassette is available through your Oldsmobile retail facility.

You may use a non-scrubbing action wet-type cleaner which uses a cassette with a fabric belt to clean the tape head. This type of cleaning cassette will not eject. It may not clean as thoroughly as the scrubbing type cleaner.

Cassettes are subject to wear and the sound quality may degrade over time. Always make sure that the cassette tape is in good condition before you have your tape player serviced.

Care of Your Compact Discs

Handle discs carefully. Store them in their original cases or other protective cases and away from direct sunlight and dust. If the surface of a disc is soiled, dampen a clean, soft cloth in a mild, neutral detergent solution and clean it, wiping from the center to the edge.

Be sure never to touch the signal surface when handling discs. Pick up discs by grasping the outer edges or the edge of the hole and the outer edge.

Fixed Mast Antenna

The fixed mast antenna can withstand most car washes without being damaged. If the mast should ever become slightly bent, you can straighten it out by hand. If the mast is badly bent, as it might be by vandals, you should replace it.

Check every once in a while to be sure the mast is still tightened to the fender.

Rear Window Defogger Antenna (Option)

This particular rear window defogger also serves as a radio antenna. If you have this option, do not apply aftermarket glass tinting. The metallic film in some tinting materials will interfere with or distort the incoming radio reception.



Section 4 Your Driving and the Road



Here you'll find information about driving on different kinds of roads and in varying weather conditions. We've also included many other useful tips on driving.

Defensive Driving

The best advice anyone can give about driving is: Drive defensively.

Please start with a very important safety device in your Oldsmobile: Buckle up. (See "Safety Belts" in the Index.)

Defensive driving really means "be ready for anything." On city streets, rural roads, or freeways, it means "always expect the unexpected."

Assume that pedestrians or other drivers are going to be careless and make mistakes. Anticipate what they might do. Be ready for their mistakes.

Rear-end collisions are about the most preventable of accidents. Yet they are common. Allow enough following distance. It's the best defensive driving maneuver, in both city and rural driving. You never know when the vehicle in front of you is going to brake or turn suddenly.

Drunken Driving

Death and injury associated with drinking and driving is a national tragedy. It's the number one contributor to the highway death toll, claiming thousands of victims every year.

Alcohol affects four things that anyone needs to drive a vehicle:

- Judgment
- Muscular Coordination
- Vision
- Attentiveness

Police records show that almost half of all motor vehicle-related deaths involve alcohol. In most cases, these deaths are the result of someone who was drinking and driving. In recent years, some 18,000 annual motor vehicle-related deaths have been associated with the use of alcohol, with more than 300,000 people injured.

Many adults -- by some estimates, nearly half the adult population -- choose never to drink alcohol, so they never drive after drinking. For persons under 21, it's against the law in every U.S. state to drink alcohol. There are good medical, psychological and developmental reasons for these laws.

The obvious way to solve this highway safety problem is for people never to drink alcohol and then drive. But what if people do? How much is "too much" if the driver plans to drive? It's a lot less than many might think. Although it depends on each person and situation, here is some general information on the problem.

The Blood Alcohol Concentration (BAC) of someone who is drinking depends upon four things:

- How much alcohol consumed
- The drinker's body weight
- The amount of food that is consumed before and during drinking
- The length of time it's taken the drinker to consume the alcohol

According to the American Medical Association, a 180-pound (82 kg) person who drinks three 12-ounce (355 ml) bottles of beer in an hour will end up with a BAC of about 0.06 percent. The person would reach the same BAC by drinking three 4-ounce (120 ml) glasses of wine or three mixed drinks if each had 1-1/2 ounces (45 ml) of a liquor like whiskey, gin or vodka.

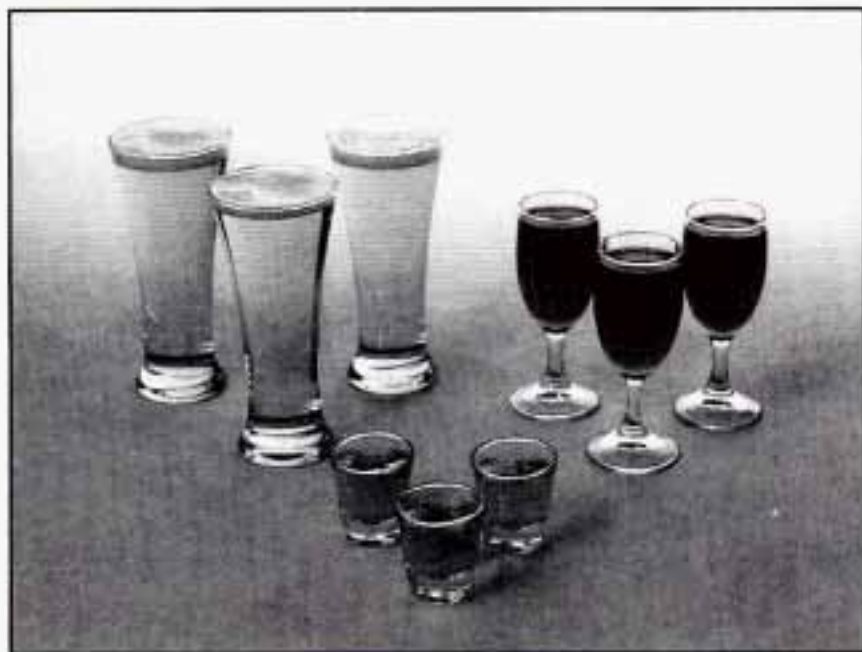

It's the amount of alcohol that counts. For example, if the same person drank three double martinis (3 ounces or 90 ml of liquor each) within an hour, the person's BAC would be close to 0.12 percent. A person who consumes food just before or during drinking will have a somewhat lower BAC level.

There is a gender difference, too. Women generally have a lower relative percentage of body water than men. Since alcohol is carried in body water, this means that a

woman generally will reach a higher BAC level than a man of her same body weight when each has the same number of drinks.

The law in many U.S. states sets the legal limit at a BAC of 0.10 percent. In a growing number of U.S. states, and throughout Canada, the limit is 0.08 percent. In some other countries it's even lower. The BAC limit for all commercial drivers in the U.S. is 0.04 percent.

The BAC will be over 0.10 percent after three to six drinks (in one hour). Of course, as we've seen, it depends on how much alcohol is in the drinks, and how quickly the person drinks them.

But the ability to drive is affected well below a BAC of 0.10 percent. Research shows that the driving skills of many people are impaired at a BAC approaching 0.05 percent, and that the effects are worse at night. All drivers are impaired at BAC levels above 0.05 percent. Statistics show that the chance of being in a collision increases sharply for drivers who have a BAC of 0.05 percent or above. A driver with a BAC level of 0.06 percent has doubled his or her chance of having a collision. At a BAC level of 0.10 percent, the chance of this driver having a collision is twelve times greater; at a level of 0.15 percent, the chance is twenty-five times greater!

The body takes about an hour to rid itself of the alcohol in one drink. No amount of coffee or number of cold showers will speed that up. "I'll be careful" isn't the right answer. What if there's an emergency, a need to take sudden action, as when a child darts into the street? A person with even a moderate BAC might not be able to react quickly enough to avoid the collision.

There's something else about drinking and driving that many people don't know. Medical research shows that alcohol in a person's system can make crash injuries worse, especially injuries to the brain, spinal cord or heart. This means that when anyone who has been drinking -- driver or passenger -- is in a crash, that person's chance of being killed or permanently disabled is higher than if the person had not been drinking.



CAUTION:

Drinking and then driving is very dangerous. Your reflexes, perceptions, attentiveness and judgment can be affected by even a small amount of alcohol. You can have a serious -- or even fatal -- collision if you drive after drinking. Please don't drink and drive or ride with a driver who has been drinking. Ride home in a cab; or if you're with a group, designate a driver who will not drink.

Control of a Vehicle

You have three systems that make your vehicle go where you want it to go. They are the brakes, the steering and the accelerator. All three systems have to do their work at the places where the tires meet the road.

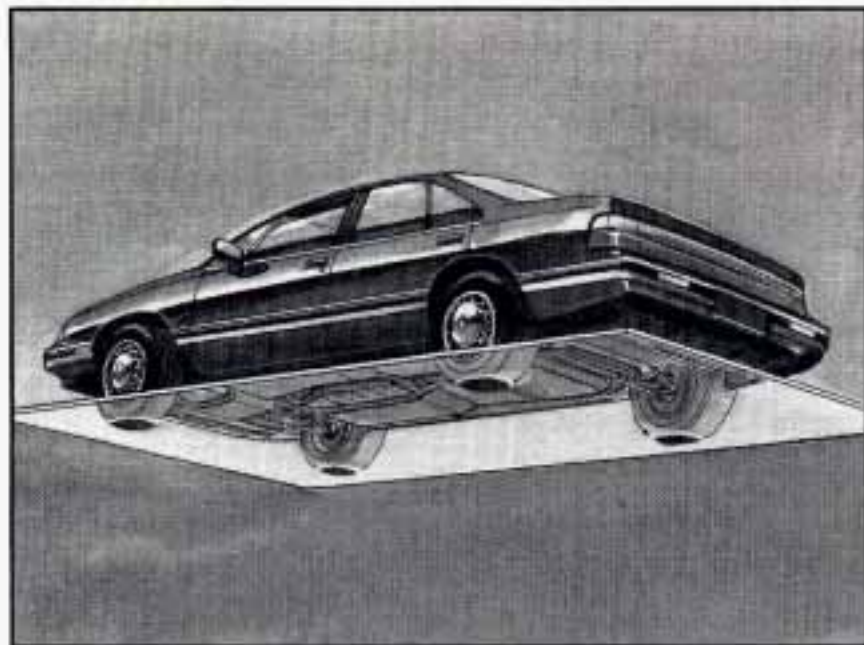

Sometimes, as when you're driving on snow or ice, it's easy to ask more of those control systems than the tires and road can provide. That means you can lose control of your vehicle.

Braking

Braking action involves *perception time* and *reaction time*.

First, you have to decide to push on the brake pedal. That's *perception time*. Then you have to bring up your foot and do it. That's *reaction time*.

Average *reaction time* is about $\frac{3}{4}$ of a second. But that's only an average. It might be less with one driver and as long as two or three seconds or more with another. Age, physical condition, alertness, coordination, and eyesight all play a part. So do alcohol, drugs and frustration. But even in $\frac{3}{4}$ of a second, a vehicle moving at 60 mph (100 km/h) travels 66 feet (20 m). That could be a lot of distance in an emergency, so keeping enough space between your vehicle and others is important.

And, of course, actual stopping distances vary greatly with the surface of the road (whether it's pavement or gravel); the condition of the road (wet, dry, icy); tire tread; and the condition of your brakes.

Avoid needless heavy braking. Some people drive in spurts -- heavy acceleration followed by heavy braking -- rather than keeping pace with traffic. This is a mistake. Your brakes may not have time to cool between hard stops. Your brakes will wear out much faster if you do a lot of heavy braking. If you keep pace with the traffic and allow realistic following distances,

you will eliminate a lot of unnecessary braking. That means better braking and longer brake life.

If your engine ever stops while you're driving, brake normally but don't pump your brakes. If you do, the pedal may get harder to push down. If your engine stops, you will still have some power brake assist. But you will use it when you brake. Once the power assist is used up, it may take longer to stop and the brake pedal will be harder to push.

Anti-Lock Brakes (ABS)

Your Oldsmobile has an advanced electronic braking system that will help prevent a braking skid.

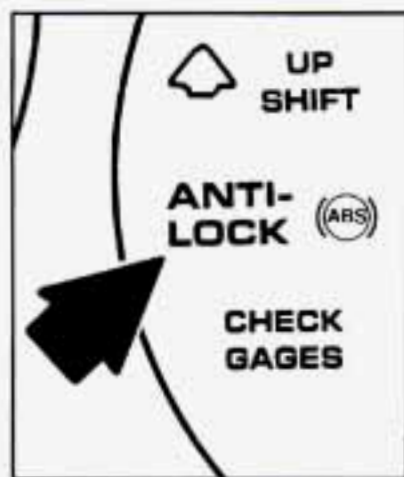

This light on the instrument panel will come on briefly when you start your vehicle.

When you start your vehicle, or when you begin to drive away, you may hear a momentary motor or clicking noise. And you may even notice that your brake pedal moves a little while this is going on. This is the ABS system testing itself. If there's a problem with the anti-lock brake system, the anti-lock brake system warning light will stay on or flash.

See "Anti-Lock Brake System Warning Light" in the Index.



Here's how anti-lock works. Let's say the road is wet. You're driving safely. Suddenly an animal jumps out in front of you.

You slam on the brakes. Here's what happens with ABS.

A computer senses that wheels are slowing down. If one of the wheels is about to stop rolling, the computer will separately work the brakes at each front wheel and at the rear wheels.

The anti-lock system can change the brake pressure faster than any driver could. The computer is programmed to make the most of available tire and road conditions.



You can steer around the obstacle while braking hard.

As you brake, your computer keeps receiving updates on wheel speed and controls braking pressure accordingly.

Remember: Anti-lock doesn't change the time you need to get your foot up to the brake pedal. If you get too close to the vehicle in front of you, you won't have time to apply your brakes if that vehicle suddenly slows or stops. Always leave enough room up ahead to stop, even though you have anti-lock brakes.

To Use Anti-Lock

Don't pump the brakes. Just hold the brake pedal down and let anti-lock work for you. You may feel the system working, or you may notice some noise, but this is normal.

Braking in Emergencies

Use your anti-lock braking system when you need to. With anti-lock, you can steer and brake at the same time. In many emergencies, steering can help you more than even the very best braking.

Steering

Power Steering

If you lose power steering assist because the engine stops or the system is not functioning, you can steer but it will take much more effort.

Steering Tips

Driving on Curves

It's important to take curves at a reasonable speed.

A lot of the "driver lost control" accidents mentioned on the news happen on curves. Here's why:

Experienced driver or beginner, each of us is subject to the same laws of physics when driving on curves. The traction of the tires against the road surface makes it possible for the vehicle to change its path when you turn the front wheels. If there's no traction, inertia will keep the vehicle going in the same direction. If you've ever tried to steer a vehicle on wet ice, you'll understand this.

The traction you can get in a curve depends on the condition of your tires and the road surface, the angle at which the curve is banked, and your speed. While you're in a curve, speed is the one factor you can control.

Suppose you're steering through a sharp curve. Then you suddenly accelerate. Both control systems -- steering and acceleration -- have to do their work where the tires meet the road. Adding the sudden acceleration can demand too much of those places. You can lose control.

What should you do if this ever happens? Ease up on the accelerator pedal, steer the vehicle the way you want it to go, and slow down.

Speed limit signs near curves warn that you should adjust your speed. Of course, the posted speeds are based on good weather and road conditions. Under less favorable conditions you'll want to go slower.

If you need to reduce your speed as you approach a curve, do it before you enter the curve, while your front wheels are straight ahead.

Try to adjust your speed so you can "drive" through the curve. Maintain a reasonable, steady speed. Wait to accelerate until you are out of the curve, and then accelerate gently into the straightaway.

Steering in Emergencies

There are times when steering can be more effective than braking. For example, you come over a hill and find a truck stopped in your lane, or a car suddenly pulls out from nowhere, or a child darts out from between parked cars and stops right in front of you. You can avoid these problems by braking -- if you can stop in time. But sometimes you can't; there isn't room. That's the time for evasive action -- steering around the problem.

Your Oldsmobile can perform very well in emergencies like these. First apply your brakes. It is better to remove as much speed as you can from a possible collision. Then steer around the problem, to the left or right depending on the space available.

An emergency like this requires close attention and a quick decision. If you are holding the steering wheel at the recommended 9 and 3 o'clock positions, you can turn it a full 180 degrees very quickly without removing either hand. But you have to act fast, steer quickly, and just as quickly straighten the wheel once you have avoided the object.



The fact that such emergency situations are always possible is a good reason to practice defensive driving at all times and wear safety belts properly.

Off-Road Recovery

You may find sometime that your right wheels have dropped off the edge of a road onto the shoulder while you're driving.

If the level of the shoulder is only slightly below the pavement, recovery should be fairly easy. Ease off the accelerator and then, if there is nothing in the way, steer so that your vehicle straddles the edge of the pavement. You can turn the steering wheel up to 1/4 turn until the right front tire contacts the pavement edge. Then turn your steering wheel to go straight down the roadway.



Passing

The driver of a vehicle about to pass another on a two-lane highway waits for just the right moment, accelerates, moves around the vehicle ahead, then goes back into the right lane again. A simple maneuver?

Not necessarily! Passing another vehicle on a two-lane highway is a potentially dangerous move, since the passing vehicle occupies the same lane as oncoming traffic for several seconds. A miscalculation, an error in judgment, or a brief surrender to frustration or anger can suddenly put the passing driver face to face with the worst of all traffic accidents -- the head-on collision.

So here are some tips for passing:

- "Drive ahead." Look down the road, to the sides, and to crossroads for situations that might affect your passing patterns. If you have any doubt whatsoever about making a successful pass, wait for a better time.
- Watch for traffic signs, pavement markings, and lines. If you can see a sign up ahead that might indicate a turn or an intersection, delay your pass. A broken center line usually indicates it's all right to pass (providing the road ahead is clear). Never cross a solid line on your side of the lane or a double solid line, even if the road seems empty of approaching traffic.

- Do not get too close to the vehicle you want to pass while you're awaiting an opportunity. For one thing, following too closely reduces your area of vision, especially if you're following a larger vehicle. Also, you won't have adequate space if the vehicle ahead suddenly slows or stops. Keep back a reasonable distance.
- When it looks like a chance to pass is coming up, start to accelerate but stay in the right lane and don't get too close. Time your move so you will be increasing speed as the time comes to move into the other lane. If the way is clear to pass, you will have a "running start" that more than makes up for the distance you would lose by dropping back. And if something happens to cause you to cancel your pass, you need only slow down and drop back again and wait for another opportunity.
- If other cars are lined up to pass a slow vehicle, wait your turn. But take care that someone isn't trying to pass you as you pull out to pass the slow vehicle. Remember to glance over your shoulder and check the blind spot.
- Check your mirrors, glance over your shoulder, and start your left lane change signal before moving out of the right lane to pass. When you are far enough ahead of the passed vehicle to see its front in your inside mirror, activate your right lane change signal and move back into the right lane. (Remember that your right outside mirror is convex. The vehicle you just passed may seem to be farther away from you than it really is.)
- Try not to pass more than one vehicle at a time on two-lane roads. Reconsider before passing the next vehicle.
- Don't overtake a slowly moving vehicle too rapidly. Even though the brake lamps are not flashing, it may be slowing down or starting to turn.
- If you're being passed, make it easy for the following driver to get ahead of you. Perhaps you can ease a little to the right.

Loss of Control

Let's review what driving experts say about what happens when the three control systems (brakes, steering and acceleration) don't have enough friction where the tires meet the road to do what the driver has asked.

In any emergency, don't give up. Keep trying to steer and constantly seek an escape route or area of less danger.

Skidding

In a skid, a driver can lose control of the vehicle. Defensive drivers avoid most skids by taking reasonable care suited to existing conditions, and by not "overdriving" those conditions. But skids are always possible.

The three types of skids correspond to your Oldsmobile's three control systems. In the braking skid your wheels aren't rolling. In the steering or cornering skid, too much speed or steering in a curve causes tires to slip and lose cornering force. And in the acceleration skid too much throttle causes the driving wheels to spin.

A cornering skid and an acceleration skid are best handled by easing your foot off the accelerator pedal.

If your vehicle starts to slide, ease your foot off the accelerator pedal and quickly steer the way you want the vehicle to go. If you start steering quickly enough, your vehicle may straighten out. Always be ready for a second skid if it occurs.

Of course, traction is reduced when water, snow, ice, gravel, or other material is on the road. For safety, you'll want to slow down and adjust your driving to these conditions. It is important to slow down on slippery surfaces because stopping distance will be longer and vehicle control more limited.

While driving on a surface with reduced traction, try your best to avoid sudden steering, acceleration, or braking (including engine braking by shifting to a lower gear). Any sudden changes could cause the tires to slide. You may not realize the surface is slippery until your vehicle is skidding. Learn to recognize warning clues -- such as enough water, ice or packed snow on the road to make a "mirrored surface" -- and slow down when you have any doubt.

Remember: Any anti-lock brake system (ABS) helps avoid only the braking skid.

Driving at Night

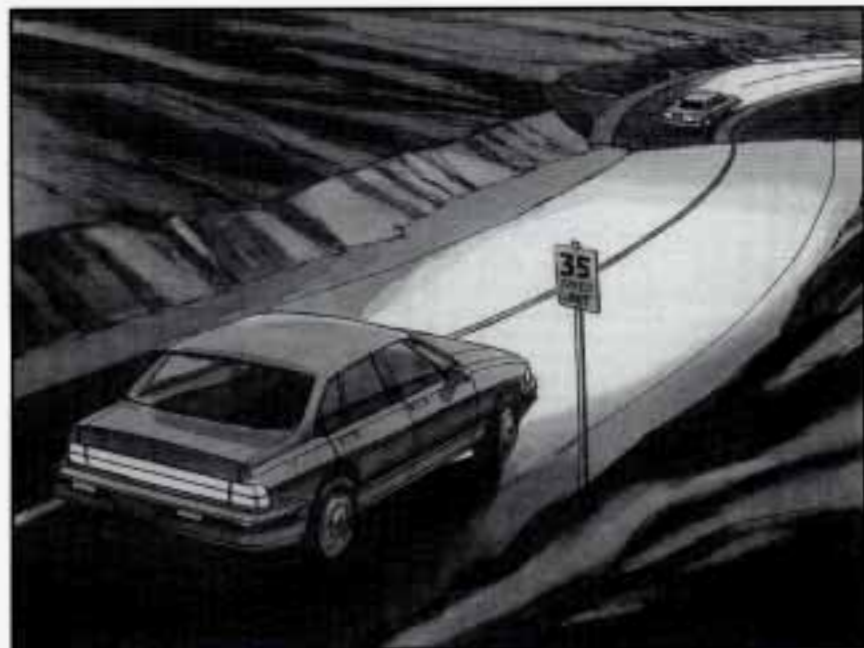

Night driving is more dangerous than day driving. One reason is that some drivers are likely to be impaired -- by alcohol or drugs, with night vision problems, or by fatigue.

Here are some tips on night driving.

- Drive defensively.
- Don't drink and drive.

- Adjust your inside rearview mirror to reduce the glare from headlamps behind you.
- Since you can't see as well, you may need to slow down and keep more space between you and other vehicles.
- Slow down, especially on higher speed roads. Your headlamps can light up only so much road ahead.
- In remote areas, watch for animals.
- If you're tired, pull off the road in a safe place and rest.

Night Vision

No one can see as well at night as in the daytime. But as we get older these differences increase. A 50-year-old driver may require at least twice as much light to see the same thing at night as a 20-year-old.

What you do in the daytime can also affect your night vision. For example, if you spend the day in bright sunshine you are wise to wear sunglasses. Your eyes will have less trouble adjusting to night. But if you're driving, don't wear sunglasses at night. They may cut down on glare from headlamps, but they also make a lot of things invisible.

You can be temporarily blinded by approaching lights. It can take a second or two, or even several seconds, for your eyes to readjust to the dark. When you are faced with severe glare (as from a driver who doesn't lower the high beams, or a vehicle with misaimed headlamps), slow down a little. Avoid staring directly into the approaching lights.

Keep your windshield and all the glass on your vehicle clean -- inside and out. Glare at night is made much worse by dirt on the glass. Even the inside of the glass can build up a film caused by dust. Dirty glass makes lights dazzle and flash more than clean glass would, making the pupils of your eyes contract repeatedly.

Remember that your headlamps light up far less of a roadway when you are in a turn or curve. Keep your eyes moving; that way, it's easier to pick out dimly lighted objects. Just as your headlamps should be checked regularly for proper aim, so should your eyes be examined regularly. Some drivers suffer from night blindness -- the inability to see in dim light -- and aren't even aware of it.

Driving in the Rain



Rain and wet roads can mean driving trouble. On a wet road you can't stop, accelerate or turn as well because your tire-to-road traction isn't as good as on dry roads. And, if your tires don't have much tread left, you'll get even less traction. It's always wise to go slower and be cautious if rain starts to fall while you are driving. The surface may get wet suddenly when your reflexes are tuned for driving on dry pavement.

The heavier the rain, the harder it is to see. Even if your windshield wiper blades are in good shape, a heavy rain can make it harder to see road signs and traffic signals, pavement markings, the edge of the road, and even people walking.

It's wise to keep your wiping equipment in good shape and keep your windshield washer tank filled. Replace your windshield wiper inserts when they show signs of streaking or missing areas on the windshield, or when strips of rubber start to separate from the inserts.



Driving too fast through large water puddles or even going through some car washes can cause problems, too. The water may affect your brakes. Try to avoid puddles. But if you can't, try to slow down before you hit them.

 **CAUTION:**

Wet brakes can cause accidents. They won't work well in a quick stop and may cause pulling to one side. You could lose control of the vehicle.

After driving through a large puddle of water or a car wash, apply your brake pedal lightly until your brakes work normally.

Hydroplaning

Hydroplaning is dangerous. So much water can build up under your tires that they can actually ride on the water. This can happen if the road is wet enough and you're going fast enough. When your vehicle is hydroplaning, it has little or no contact with the road.

Hydroplaning doesn't happen often. But it can if your tires haven't much tread or if the pressure in one or

more is low. It can happen if a lot of water is standing on the road. If you can see reflections from trees, telephone poles, or other vehicles, and raindrops "dimple" the water's surface, there could be hydroplaning.

Hydroplaning usually happens at higher speeds. There just isn't a hard and fast rule about hydroplaning. The best advice is to slow down when it is raining.

Some Other Rainy Weather Tips

- Turn on your low-beam headlamps -- not just your parking lamps -- to help make you more visible to others.
- Besides slowing down, allow some extra following distance. And be especially careful when you pass another vehicle. Allow yourself more clear room ahead, and be prepared to have your view restricted by road spray.
- Have good tires with proper tread depth. (See "Tires" in the Index.)

City Driving



One of the biggest problems with city streets is the amount of traffic on them. You'll want to watch out for what the other drivers are doing and pay attention to traffic signals.

Here are ways to increase your safety in city driving:

- Know the best way to get to where you are going. Get a city map and plan your trip into an unknown part of the city just as you would for a cross-country trip.
- Try to use the freeways that rim and crisscross most large cities. You'll save time and energy. (See the next part, "Freeway Driving.")
- Treat a green light as a warning signal. A traffic light is there because the corner is busy enough to need it. When a light turns green, and just before you start to move, check both ways for vehicles that have not cleared the intersection or may be running the red light.

Freeway Driving

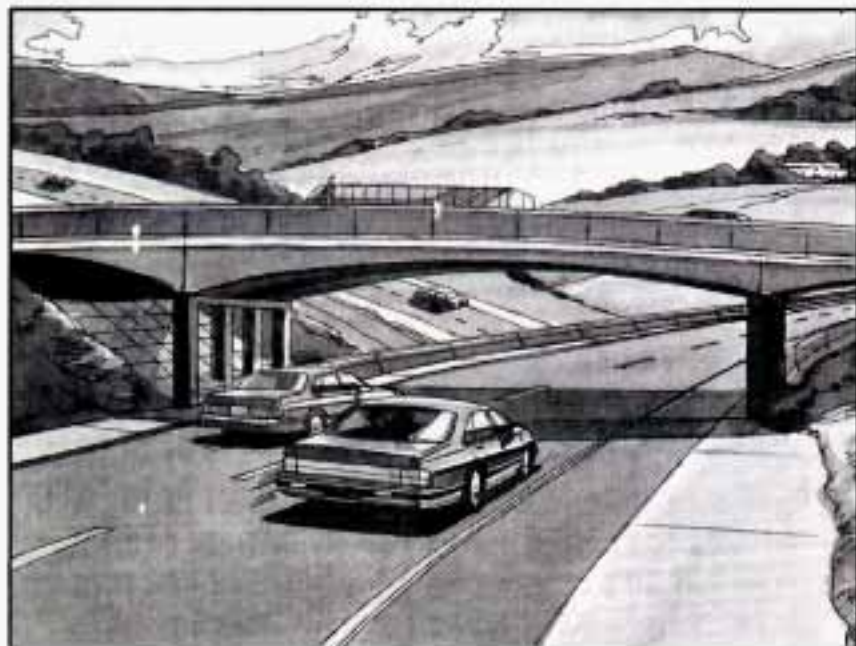

Mile for mile, freeways (also called thruways, parkways, expressways, turnpikes, or superhighways) are the safest of all roads. But they have their own special rules.

The most important advice on freeway driving is: Keep up with traffic and keep to the right. Drive at the same speed most of the other drivers are driving. Too-fast or too-slow driving breaks a smooth traffic flow. Treat the left lane on a freeway as a passing lane.

At the entrance there is usually a ramp that leads to the freeway. If you have a clear view of the freeway as you drive along the entrance ramp, you should begin to check traffic. Try to determine where you expect to blend with the flow. Try to merge into the gap at close to the prevailing speed. Switch on your turn signal, check your mirrors and glance over your shoulder as often as necessary. Try to blend smoothly with the traffic flow.

Once you are on the freeway, adjust your speed to the posted limit or to the prevailing rate if it's slower. Stay in the right lane unless you want to pass.

Before changing lanes, check your mirrors. Then use your turn signal.

Just before you leave the lane, glance quickly over your shoulder to make sure there isn't another vehicle in your "blind" spot.

Once you are moving on the freeway, make certain you allow a reasonable following distance. Expect to move slightly slower at night.

When you want to leave the freeway, move to the proper lane well in advance. If you miss your exit do not, under any circumstances, stop and back up. Drive on to the next exit.

The exit ramp can be curved, sometimes quite sharply.

The exit speed is usually posted.

Reduce your speed according to your speedometer, not to your sense of motion. After driving for any distance at higher speeds, you may tend to think you are going slower than you actually are.

Before Leaving on a Long Trip

Make sure you're ready. Try to be well rested. If you must start when you're not fresh -- such as after a day's work -- don't plan to make too many miles that first part of the journey. Wear comfortable clothing and shoes you can easily drive in.

Is your vehicle ready for a long trip? If you keep it serviced and maintained, it's ready to go. If it needs service, have it done before starting out. Of course, you'll find experienced and able service experts in Oldsmobile retail facilities all across North America. They'll be ready and willing to help if you need it.

Here are some things you can check before a trip:

- *Windshield Washer Fluid:* Is the reservoir full? Are all windows clean inside and outside?
- *Wiper Blades:* Are they in good shape?
- *Fuel, Engine Oil, Other Fluids:* Have you checked all levels?
- *Lamps:* Are they all working? Are the lenses clean?
- *Tires:* They are vitally important to a safe, trouble-free trip. Is the tread good enough for long-distance driving? Are the tires all inflated to the recommended pressure?
- *Weather Forecasts:* What's the weather outlook along your route? Should you delay your trip a short time to avoid a major storm system?
- *Maps:* Do you have up-to-date maps?

Highway Hypnosis

Is there actually such a condition as “highway hypnosis?” Or is it just plain falling asleep at the wheel? Call it highway hypnosis, lack of awareness, or whatever.

There is something about an easy stretch of road with the same scenery, along with the hum of the tires on the road, the drone of the engine, and the rush of the wind against the vehicle that can make you sleepy. Don't let it happen to you! If it does, your vehicle can leave the road in *less than a second*, and you could crash and be injured.

What can you do about highway hypnosis? First, be aware that it can happen.

Then here are some tips:

- Make sure your vehicle is well ventilated, with a comfortably cool interior.
- Keep your eyes moving. Scan the road ahead and to the sides. Check your rearview mirrors and your instruments frequently.
- If you get sleepy, pull off the road into a rest, service, or parking area and take a nap, get some exercise, or both. For safety, treat drowsiness on the highway as an emergency.

Hill and Mountain Roads



Driving on steep hills or mountains is different from driving in flat or rolling terrain.

If you drive regularly in steep country, or if you're planning to visit there, here are some tips that can make your trips safer and more enjoyable.

- Keep your vehicle in good shape. Check all fluid levels and also the brakes, tires, cooling system and transaxle. These parts can work hard on mountain roads.
- Know how to go down hills. The most important thing to know is this: let your engine do some of the slowing down. Shift to a lower gear when you go down a steep or long hill.

CAUTION:

If you don't shift down, your brakes could get so hot that they wouldn't work well. You would then have poor braking or even none going down a hill. You could crash. Shift down to let your engine assist your brakes on a steep downhill slope.

CAUTION:

Coasting downhill in NEUTRAL (N) or with the ignition off is dangerous. Your brakes will have to do all the work of slowing down. They could get so hot that they wouldn't work well. You could crash. Always have your engine running and your vehicle in gear when you go downhill.

- Know how to go uphill. Drive in the highest gear possible.
- Stay in your own lane when driving on two-lane roads in hills or mountains. Don't swing wide or cut across the center of the road. Drive at speeds that let you stay in your own lane.
- As you go over the top of a hill, be alert. There could be something in your lane, like a stalled car or an accident.
- You may see highway signs on mountains that warn of special problems. Examples are long grades, passing or no-passing zones, a falling rocks area, or winding roads. Be alert to these and take appropriate action.

Winter Driving

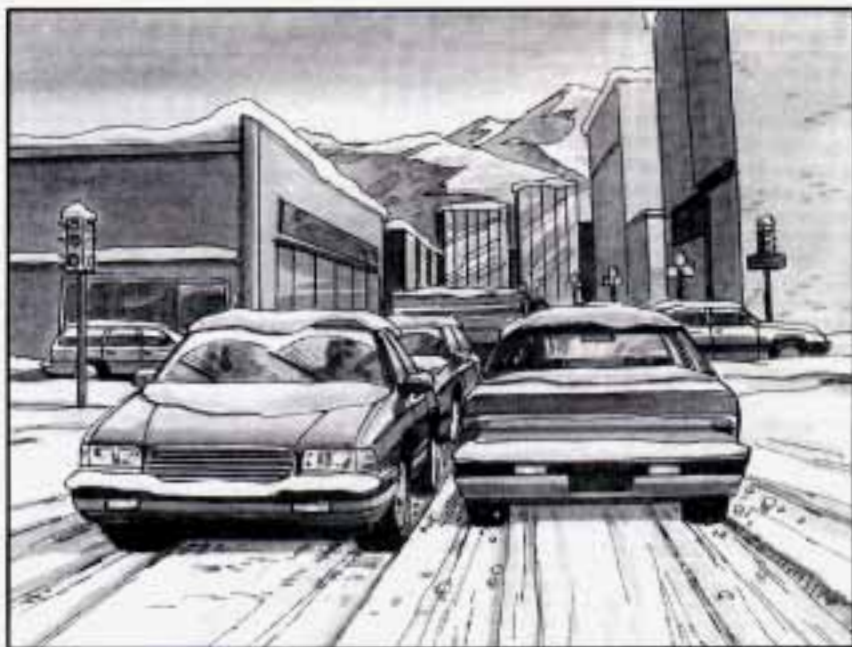

Here are some tips for winter driving:

- Have your Oldsmobile in good shape for winter. Be sure your engine coolant mix is correct.
- You may want to put winter emergency supplies in your trunk.



Include an ice scraper, a small brush or broom, a supply of windshield washer fluid, a rag, some winter outer clothing, a small shovel, a flashlight, a red cloth, and a couple of reflective warning triangles. And, if you will be driving under severe conditions, include a small bag of sand, a piece of old carpet or a couple of burlap bags to help provide traction. Be sure you properly secure these items in your vehicle.

Driving on Snow or Ice

Most of the time, those places where your tires meet the road probably have good traction.

However, if there is snow or ice between your tires and the road, you can have a very slippery situation. You'll have a lot less traction or "grip" and will need to be very careful.



What's the worst time for this? "Wet ice." Very cold snow or ice can be slick and hard to drive on. But wet ice can be even more trouble because it may offer the least traction of all. You can get "wet ice" when it's about freezing (32°F; 0°C) and freezing rain begins to fall. Try to avoid driving on wet ice until salt and sand crews can get there.

Whatever the condition -- smooth ice, packed, blowing or loose snow -- drive with caution. Accelerate gently. Try not to break the fragile traction. If you accelerate too fast, the drive wheels will spin and polish the surface under the tires even more.

Your anti-lock brakes improve your ability to make a hard stop on a slippery road. Even though you have the anti-lock braking system, you'll want to begin stopping sooner than you would on dry pavement. See "Anti-Lock" in the Index.

- Allow greater following distance on any slippery road.
- Watch for slippery spots. The road might be fine until you hit a spot that's covered with ice. On an otherwise clear road, ice patches may appear in shaded areas where the sun can't reach: around clumps of trees, behind buildings, or under bridges. Sometimes the surface of a curve or an overpass may remain icy when the surrounding roads are clear. If you see a patch of ice ahead of you, brake before you are on it. Try not to brake while you're actually on the ice, and avoid sudden steering maneuvers.

If You're Caught in a Blizzard



If you are stopped by heavy snow, you could be in a serious situation. You should probably stay with your vehicle unless you know for sure that you are near help and you can hike through the snow. Here are some things to do to summon help and keep yourself and your passengers safe: Turn on your hazard flashers. Tie a red

cloth to your vehicle to alert police that you've been stopped by the snow. Put on extra clothing or wrap a blanket around you. If you have no blankets or extra clothing, make body insulators from newspapers, burlap bags, rags, floor mats -- anything you can wrap around yourself or tuck under your clothing to keep warm.

You can run the engine to keep warm, but be careful.



 **CAUTION:**

Snow can trap exhaust gases under your vehicle. This can cause deadly CO (carbon monoxide) gas to get inside. CO could overcome you and kill you. You can't see it or smell it, so you might not know it is in your vehicle. Clear away snow from around the base of your vehicle, especially any that is blocking your exhaust pipe. And check around again from time to time to be sure snow doesn't collect there.

Open a window just a little on the side of the vehicle that's away from the wind. This will help keep CO out.

Run your engine only as long as you must. This saves fuel. When you run the engine, make it go a little faster

than just idle. That is, push the accelerator slightly. This uses less fuel for the heat that you get and it keeps the battery charged. You will need a well-charged battery to restart the vehicle, and possibly for signaling later on with your headlamps. Let the heater run for awhile.

Then, shut the engine off and close the window almost all the way to preserve the heat. Start the engine again and repeat this only when you feel really uncomfortable from the cold. But do it as little as possible. Preserve the fuel as long as you can. To help keep warm, you can get out of the vehicle and do some fairly vigorous exercises every half hour or so until help comes.

Recreational Vehicle Towing

There may be times when you want to tow your Oldsmobile behind another vehicle for use at your destination. Be sure to use the proper towing equipment designed for recreational towing. Follow the instructions for the towing equipment.

Towing Your Vehicle from the Front (Automatic Transaxle)

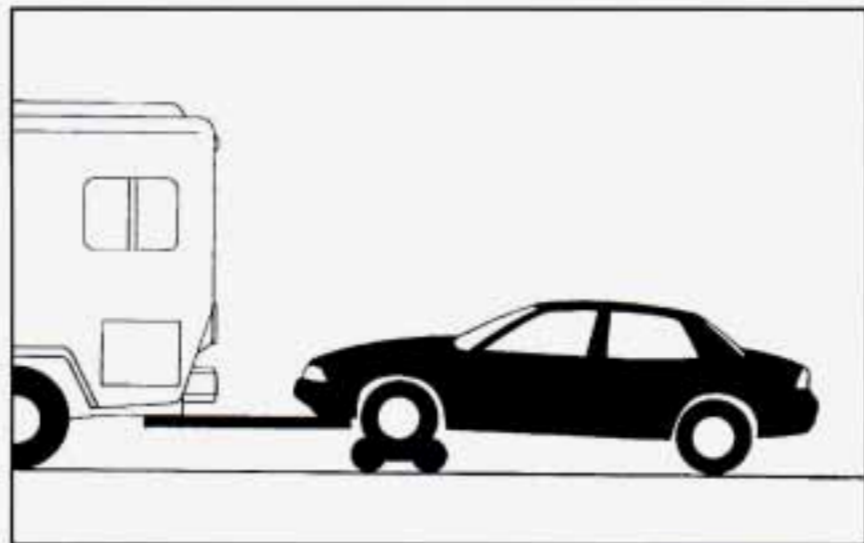

Follow these steps:

1. Put the front wheels on a dolly.

NOTICE:

Do not tow your Oldsmobile with the front wheels in contact with the ground, or the automatic transaxle could be damaged.

2. Set the parking brake.
3. Turn the ignition key to OFF to unlock the steering wheel. See "Ignition" in the Index.
4. Clamp the steering wheel in a straight-ahead position, with a clamping device designed for towing.
5. Release the parking brake.

Towing Your Vehicle from the Front (Manual Transaxle)

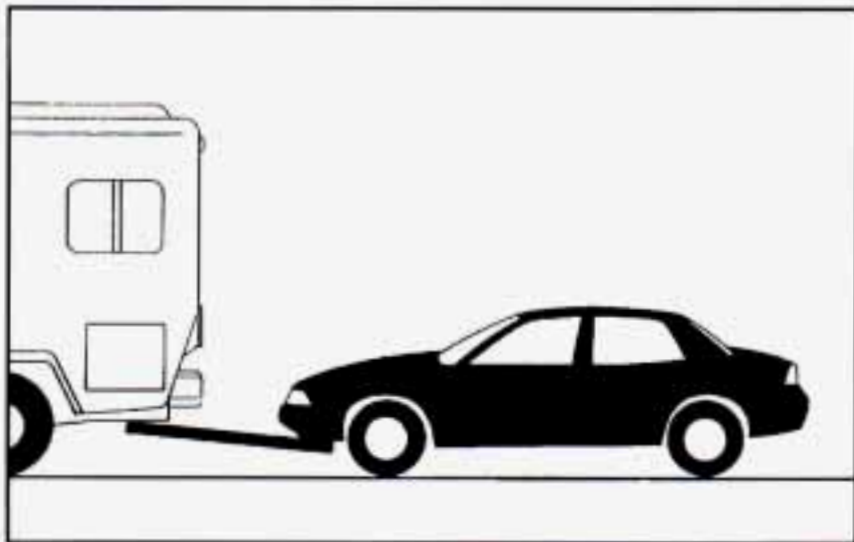

Tow your vehicle with all four wheels on the ground. Follow these steps:

1. Set the parking brake.
2. Turn the ignition key to OFF to unlock the steering wheel and prevent the automatic door locks from locking.
3. Shift your manual transaxle to NEUTRAL (N).
4. Release the parking brake.

NOTICE:

Make sure that the towing speed does not exceed 55 mph (90 km/h), or your vehicle could be badly damaged.

Towing Your Vehicle from the Rear

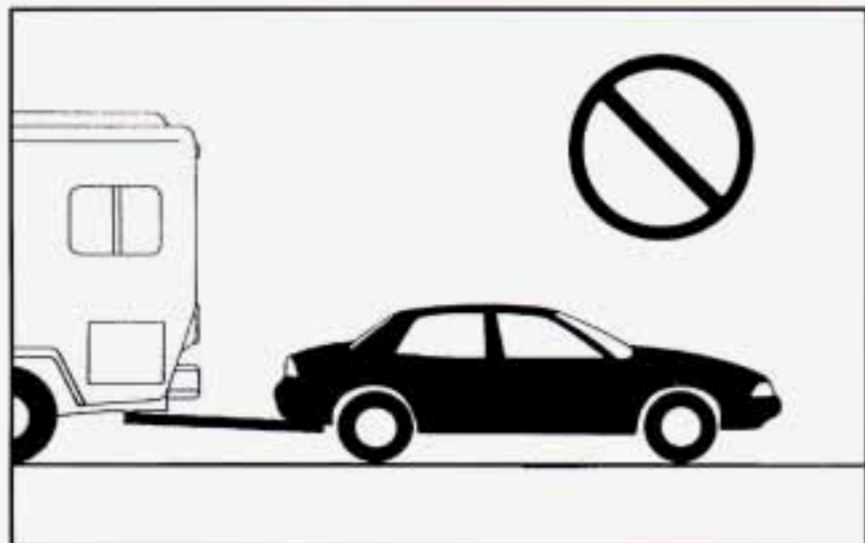

NOTICE:

Do not tow your vehicle from the rear. Your vehicle could be badly damaged and the repairs would not be covered by your warranty.

Loading Your Vehicle



TIRE-LOADING INFORMATION
OCCUPANTS VEHICLE CAP. WT.
FRT. CTR. RR. TOTAL LBS. KG

MAX. LOADING & GVWR SAME AS VEHICLE
CAPACITY WEIGHT XXX COLD TIRE
TIRE SIZE SPEED PRESSURE
 RTG PSI/KPa

FRT.
RR.
SPA.

IF TIRES ARE HOT, ADD 4PSI/28KPa
SEE OWNER'S MANUAL FOR ADDITIONAL
INFORMATION

Two labels on your vehicle show how much weight it may properly carry. The Tire-Loading Information label found on the rear edge of the driver's door tells you the proper size, speed rating and recommended inflation pressures for the tires on your vehicle. It also gives you important information about the number of people that can be in your vehicle and the total weight that you can carry. This weight is called the Vehicle Capacity Weight and includes the weight of all occupants, cargo, and all nonfactory-installed options.



MFD BY GENERAL MOTORS CORP
DATE GVWR GAWR FRT GAWR RR

THIS VEHICLE CONFORMS TO ALL APPLICABLE U.S. FEDERAL MOTOR VEHICLE SAFETY, BUMPER, AND THEFT PREVENTION STANDARDS IN EFFECT ON THE DATE OF MANUFACTURE SHOWN ABOVE.

The other label is the Certification label, found on the rear edge of the driver's door. It tells you the gross weight capacity of your vehicle, called the GVWR (Gross Vehicle Weight Rating). The GVWR includes the weight of the vehicle, all occupants, fuel and cargo. Never exceed the GVWR for your vehicle, or the Gross Axle Weight Rating (GAWR) for either the front or rear axle.

And, if you do have a heavy load, you should spread it out. Don't carry more than 132 lbs. (60 kg) in your trunk.



CAUTION:

Do not load your vehicle any heavier than the GVWR, or either the maximum front or rear GAWR. If you do, parts on your vehicle can break, or it can change the way your vehicle handles. These could cause you to lose control. Also, overloading can shorten the life of your vehicle.

NOTICE:

Your warranty does not cover parts or components that fail because of overloading.

If you put things inside your vehicle -- like suitcases, tools, packages, or anything else -- they will go as fast as the vehicle goes. If you have to stop or turn quickly, or if there is a crash, they'll keep going.

 **CAUTION:**

Things you put inside your vehicle can strike and injure people in a sudden stop or turn, or in a crash.

- **Put things in the trunk of your vehicle. In a trunk, put them as far forward as you can. Try to spread the weight evenly.**
- **Never stack heavier things, like suitcases, inside the vehicle so that some of them are above the tops of the seats.**
- **Don't leave an unsecured child restraint in your vehicle.**
- **When you carry something inside the vehicle, secure it whenever you can.**
- **Don't leave a seat folded down unless you need to.**

Towing a Trailer

 **CAUTION:**

If you don't use the correct equipment and drive properly, you can lose control when you pull a trailer. For example, if the trailer is too heavy, the brakes may not work well -- or even at all. You and your passengers could be seriously injured. Pull a trailer only if you have followed all the steps in this section. Ask your Oldsmobile retailer for advice and information about towing a trailer with your vehicle.

NOTICE:

Pulling a trailer improperly can damage your vehicle and result in costly repairs not covered by your warranty. To pull a trailer correctly, follow the advice in this part, and see your Oldsmobile retailer for important information about towing a trailer with your vehicle.

Do not tow a trailer if your vehicle is equipped with the 2.3L Quad 4 DOHC engines (Code D).

Your vehicle can tow a trailer if it is equipped with the 3.1L V6 (Code M) and proper trailer towing equipment. To identify what the vehicle trailering capacity is for your vehicle, you should read the information in “Weight of the Trailer” that appears later in this section. But trailering is different than just driving your vehicle by itself. Trailering means changes in handling, durability, and fuel economy. Successful, safe trailering takes correct equipment, and it has to be used properly.

That’s the reason for this part. In it are many time-tested, important trailering tips and safety rules. Many of these are important for your safety and that of your passengers. So please read this section carefully before you pull a trailer.

Load-pulling components such as the engine, transaxle, wheel assemblies, and tires are forced to work harder against the drag of the added weight. The engine is required to operate at relatively higher speeds and under greater loads, generating extra heat. What’s more, the trailer adds considerably to wind resistance, increasing the pulling requirements.

If You Do Decide To Pull A Trailer

If you do, here are some important points.

- There are many different laws, including speed limit restrictions, having to do with trailering. Make sure your rig will be legal, not only where you live but also where you’ll be driving. A good source for this information can be state or provincial police.
- Consider using a sway control.

You can ask a hitch dealer about sway controls.

- Don’t tow a trailer at all during the first 1000 miles (1 600 km) your new vehicle is driven. Your engine, axle or other parts could be damaged.
- Then, during the first 500 miles (800 km) that you tow a trailer, don’t drive over 50 mph (80 km/h) and don’t make starts at full throttle. This helps your engine and other parts of your vehicle wear in at the heavier loads.
- Obey speed limit restrictions when towing a trailer. Don’t drive faster than the maximum posted speed for trailers (or no more than 55 mph (90 km/h)) to save wear on your vehicle’s parts.

Three important considerations have to do with weight:

Weight of the Trailer

How heavy can a trailer safely be?

It should never weigh more than 1,000 pounds (450 kg). But even that can be too heavy.

It depends on how you plan to use your rig. For example, speed, altitude, road grades, outside temperature and how much your vehicle is used to pull a trailer are all important. And, it can also depend on any special equipment that you have on your vehicle.

You can ask your retailer for our trailering information or advice, or you can write us at:

Oldsmobile Customer Assistance Center
P.O. Box 30095
Lansing, MI 48909

In Canada, write to:

General Motors of Canada Limited
Customer Assistance Center
1908 Colonel Sam Drive, Oshawa
Ontario L1H 8P7.

Weight of the Trailer Tongue

The tongue load (A) of any trailer is an important weight to measure because it affects the total capacity weight of your vehicle. The capacity weight includes the curb weight of the vehicle, any cargo you may carry in it, and the people who will be riding in the vehicle. And if you will tow a trailer, you must subtract the tongue load from your vehicle's capacity weight because your vehicle will be carrying that weight, too. See "Loading Your Vehicle" in the Index for more information about your vehicle's maximum load capacity.

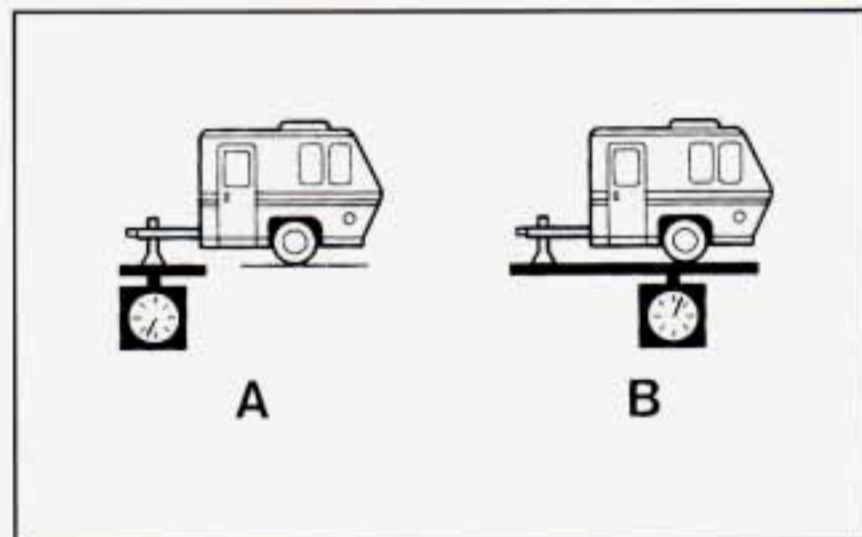

If you're using a "dead-weight" hitch, the trailer tongue (A) should weigh 10% of the total loaded trailer weight (B). If you have a "weight-distributing" hitch, the trailer tongue (A) should weigh 12% of the total loaded trailer weight (B).

After you've loaded your trailer, weigh the trailer and then the tongue, separately, to see if the weights are proper. If they aren't, you may be able to get them right simply by moving some items around in the trailer.

Total Weight on Your Vehicle's Tires

Be sure your vehicle's tires are inflated to the recommended pressure for cold tires. You'll find these numbers on the Certification label at the rear edge of the driver's door or see "Loading Your Vehicle" in the Index. Then be sure you don't go over the GVW limit for your vehicle, including the weight of the trailer tongue.

Hitches

It's important to have the correct hitch equipment. Crosswinds, large trucks going by, and rough roads are a few reasons why you'll need the right hitch. Here are some rules to follow:

- Will you have to make any holes in the body of your vehicle when you install a trailer hitch? If you do, then be sure to seal the holes later when you remove the hitch. If you don't seal them, deadly carbon monoxide (CO) from your exhaust can get into your vehicle (see "Carbon Monoxide" in the Index). Dirt and water can, too.
- The bumpers on your vehicle are not intended for hitches. Do not attach rental hitches or other bumper-type hitches to them. Use only a frame-mounted hitch that does not attach to the bumper.

Safety Chains

You should always attach chains between your vehicle and your trailer. Cross the safety chains under the tongue of the trailer so that the tongue will not drop to the road if it becomes separated from the hitch. Instructions about safety chains may be provided by the hitch manufacturer or by the trailer manufacturer. Follow the manufacturer's recommendation for attaching safety chains and do not attach them to the bumper. Always leave just enough slack so you can turn with your rig. And, never allow safety chains to drag on the ground.

Trailer Brakes

Does your trailer have its own brakes?

Be sure to read and follow the instructions for the trailer brakes so you'll be able to install, adjust and maintain them properly. And because you have anti-lock brakes, do not try to tap into your vehicle's brake system. If you do, both brake systems won't work well, or at all.

Driving with a Trailer

Towing a trailer requires a certain amount of experience. Before setting out for the open road, you'll want to get to know your rig. Acquaint yourself with the feel of handling and braking with the added weight of the

trailer. And always keep in mind that the vehicle you are driving is now a good deal longer and not nearly as responsive as your vehicle is by itself.

Before you start, check the trailer hitch and platform (and attachments), safety chains, electrical connector, lamps, tires and mirror adjustment. If the trailer has electric brakes, start your vehicle and trailer moving and then apply the trailer brake controller by hand to be sure the brakes are working. This lets you check your electrical connection at the same time.

During your trip, check occasionally to be sure that the load is secure, and that the lamps and any trailer brakes are still working.

Following Distance

Stay at least twice as far behind the vehicle ahead as you would when driving your vehicle without a trailer. This can help you avoid situations that require heavy braking and sudden turns.

Passing

You'll need more passing distance up ahead when you're towing a trailer. And, because you're a good deal longer, you'll need to go much farther beyond the passed vehicle before you can return to your lane.

Backing Up

Hold the bottom of the steering wheel with one hand. Then, to move the trailer to the left, just move that hand to the left. To move the trailer to the right, move your hand to the right. Always back up slowly and, if possible, have someone guide you.

Making Turns

NOTICE:

Making very sharp turns while trailering could cause the trailer to come in contact with the vehicle. Your vehicle could be damaged. Avoid making very sharp turns while trailering.

When you're turning with a trailer, make wider turns than normal. Do this so your trailer won't strike soft shoulders, curbs, road signs, trees, or other objects. Avoid jerky or sudden maneuvers. Signal well in advance.

Turn Signals When Towing a Trailer

When you tow a trailer, your vehicle has to have a different turn signal flasher and extra wiring. The green arrows on your instrument panel will flash whenever you signal a turn or lane change. Properly hooked up, the trailer lamps will also flash, telling other drivers you're about to turn, change lanes or stop.

When towing a trailer, the green arrows on your instrument panel will flash for turns even if the bulbs on the trailer are burned out. Thus, you may think drivers behind you are seeing your signal when they are not. It's important to check occasionally to be sure the trailer bulbs are still working.

Driving On Grades

Reduce speed and shift to a lower gear *before* you start down a long or steep downgrade. If you don't shift down, you might have to use your brakes so much that they would get hot and no longer work well.

On a long uphill grade, use the highest gear possible. If you cannot maintain posted speeds, driving at a lower speed may help avoid overheating your engine and transaxle.

If you have a manual transaxle with fifth gear, it's better not to use fifth gear. Just drive in fourth gear (or, as you need to, a lower gear).

Parking on Hills

You really should not park your vehicle, with a trailer attached, on a hill. If something goes wrong, your rig could start to move. People can be injured, and both your vehicle and the trailer can be damaged.

But if you ever have to park your rig on a hill, here's how to do it:

1. Apply your regular brakes, but don't shift into PARK (P) yet, or into gear for a manual transaxle.
2. Have someone place chocks under the trailer wheels.
3. When the wheel chocks are in place, release the regular brakes until the chocks absorb the load.
4. Reapply the regular brakes. Then apply your parking brake, and then shift to PARK (P), or REVERSE (R) for a manual transaxle.
5. Release the regular brakes.

When You Are Ready to Leave After Parking on a Hill

1. Apply your regular brakes and hold the pedal down while you:
 - Start your engine;
 - Shift into a gear; and
 - Release the parking brake.
2. Let up on the brake pedal.
3. Drive slowly until the trailer is clear of the chocks.
4. Stop and have someone pick up and store the chocks.

Maintenance When Trailer Towing

Your vehicle will need service more often when you're pulling a trailer. See the Maintenance Schedule for more on this. Things that are especially important in trailer operation are automatic transaxle fluid (don't overfill), engine oil, belt, cooling system, and brake adjustment. Each of these is covered in this manual, and the Index will help you find them quickly. If you're trailering, it's a good idea to review these sections before you start your trip.

Check periodically to see that all hitch nuts and bolts are tight.



Section 5 Problems on the Road

Here you'll find what to do about some problems that can occur on the road.

Hazard Warning Flashers



Your hazard warning flashers let you warn others. They also let police know you have a problem. Your front and rear turn signal lamps will flash on and off.

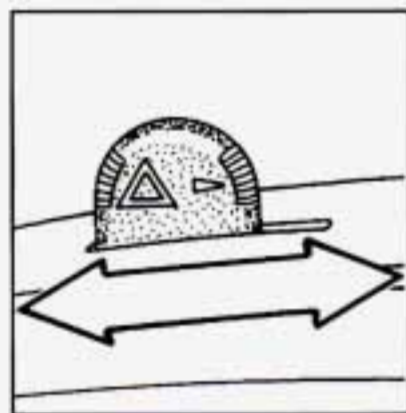

Move the switch to the right to make your front and rear turn signal lamps flash on and off.

Your hazard warning flashers work no matter what position your key is in, and even if the key isn't in. To turn off the flashers, move the switch to the left. When the hazard warning flashers are on, your turn signals won't work.

Other Warning Devices

If you carry reflective triangles, you can set one up at the side of the road about 300 feet (100 m) behind your vehicle.

Jump Starting

If your battery has run down, you may want to use another vehicle and some jumper cables to start your Oldsmobile. But please follow the steps here to do it safely.

CAUTION:

Batteries can hurt you. They can be dangerous because:

- They contain acid that can burn you.
- They contain gas that can explode or ignite.
- They contain enough electricity to burn you.

If you don't follow these steps exactly, some or all of these things can hurt you.

NOTICE:

Ignoring these steps could result in costly damage to your vehicle that wouldn't be covered by your warranty.

Trying to start your Oldsmobile by pushing or pulling it could damage your vehicle, even if you have a manual transaxle. And if you have an automatic transaxle, it won't start that way.

To Jump Start Your Oldsmobile

1. Check the other vehicle. It must have a 12-volt battery with a negative ground system.

NOTICE:

If the other system isn't a 12-volt system with a negative ground, both vehicles can be damaged.

2. Get the vehicles close enough so the jumper cables can reach, but be sure the vehicles aren't touching each other. If they are, it could cause a ground connection you don't want. You wouldn't be able to start your Oldsmobile, and the bad grounding could damage the electrical systems.

You could be injured if the vehicles roll. Set the parking brake firmly on each vehicle. Put an automatic transaxle in PARK (P) or a manual transaxle in NEUTRAL (N).

3. Turn off the ignition on both vehicles. Turn off all lamps that aren't needed, and radios. This will avoid sparks and help save both batteries. And it could save your radio!

NOTICE:

If you leave your radio on, it could be badly damaged. The repairs wouldn't be covered by your warranty.

4. Open the hoods and locate the batteries.

CAUTION:

An electric fan can start up even when the engine is not running and can injure you. Keep hands, clothing and tools away from any underhood electric fan.

Find the positive (+) and negative (-) terminals on each battery.

CAUTION:

Using a match near a battery can cause battery gas to explode. People have been hurt doing this, and some have been blinded. Use a flashlight if you need more light.

Be sure the battery has enough water. You don't need to add water to the Delco Freedom[®] battery installed in every new GM vehicle. But if a battery has filler caps, be sure the right amount of fluid is there. If it is low, add water to take care of that first. If you don't, explosive gas could be present.

Battery fluid contains acid that can burn you. Don't get it on you. If you accidentally get it in your eyes or on your skin, flush the place with water and get medical help immediately.

5. Check that the jumper cables don't have loose or missing insulation. If they do, you could get a shock. The vehicles could be damaged, too. Before you connect the cables, here are some things you should know. Positive (+) will go to positive (+) and negative (-) will go to negative (-) or a metal engine part. Don't connect (+) to (-) or you'll get a short that would damage the battery and maybe other parts, too.

⚠ CAUTION:

Fans or other moving engine parts can injure you badly. Keep your hands away from moving parts once the engines are running.

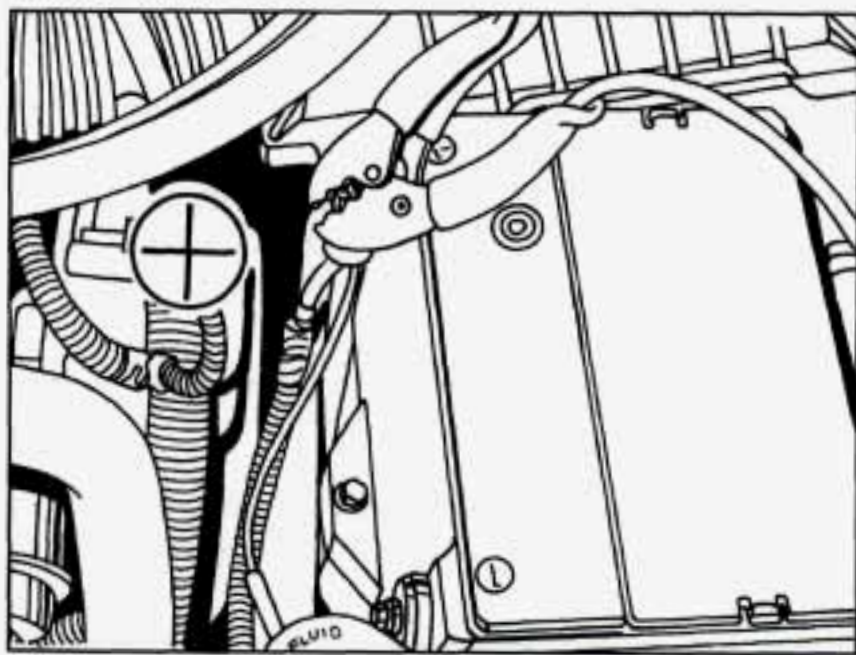

6. Connect the red positive (+) cable to the positive (+) terminal of the vehicle with the dead battery. Use a remote positive (+) terminal if the vehicle has one.

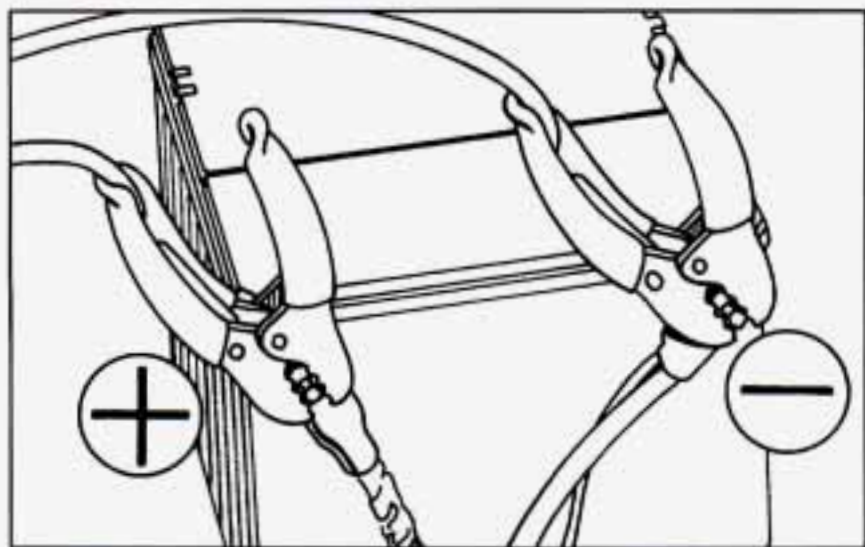

7. Don't let the other end touch metal. Connect it to the positive (+) terminal of the good battery. Use a remote positive (+) terminal if the vehicle has one.
8. Now connect the black negative (-) cable to the good battery's negative (-) terminal. Don't let the other end touch anything until the next step. The other end of the negative cable *doesn't* go to the dead battery. It goes to a heavy unpainted metal part on the engine of the vehicle with the dead battery.

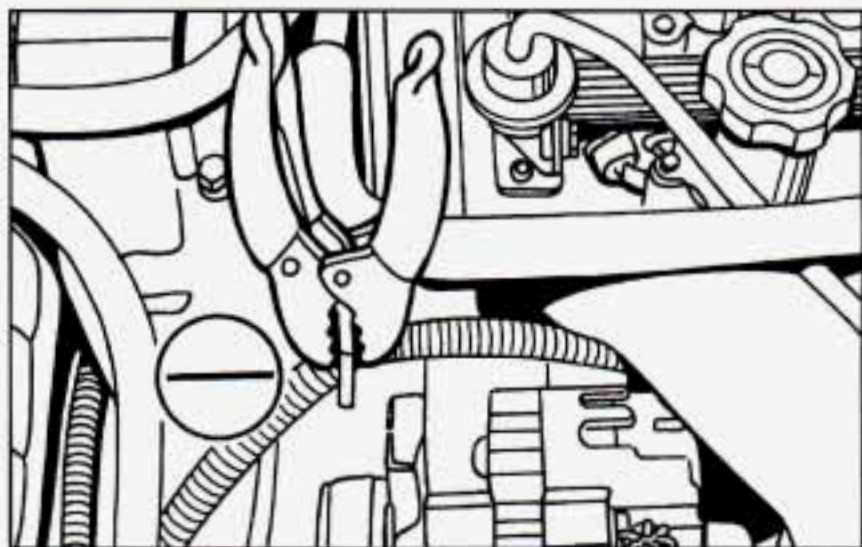

9. Attach the cable at least 18 inches (45 cm) away from the dead battery, but not near engine parts that move. The electrical connection is just as good there, but the chance of sparks getting back to the battery is much less.
10. Now start the vehicle with the good battery and run the engine for a while.

11. Try to start the vehicle with the dead battery. If it won't start after a few tries, it probably needs service.

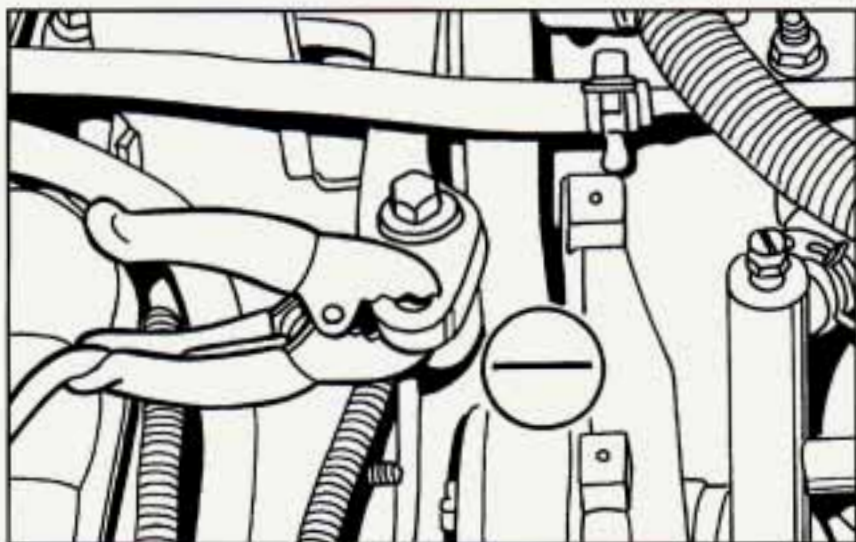

12. Remove the cables in reverse order to prevent electrical shorting. Take care that they don't touch each other or any other metal.

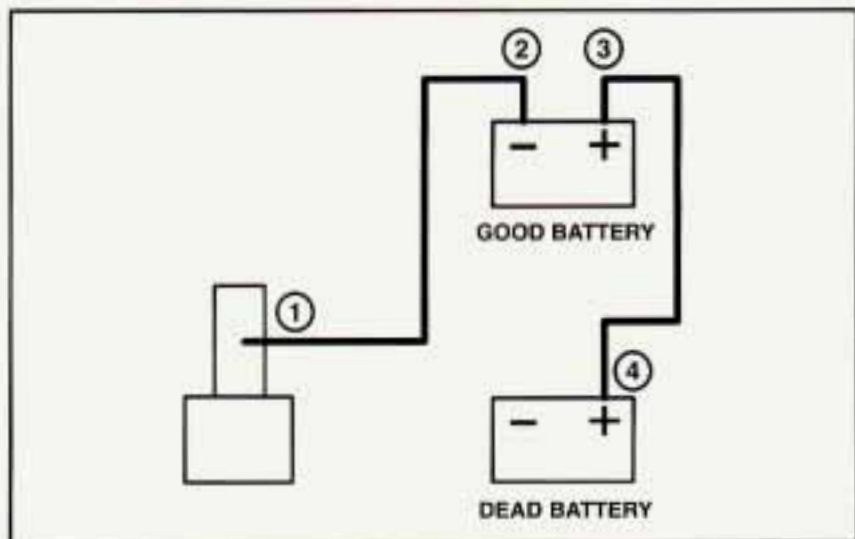

Towing Your Vehicle

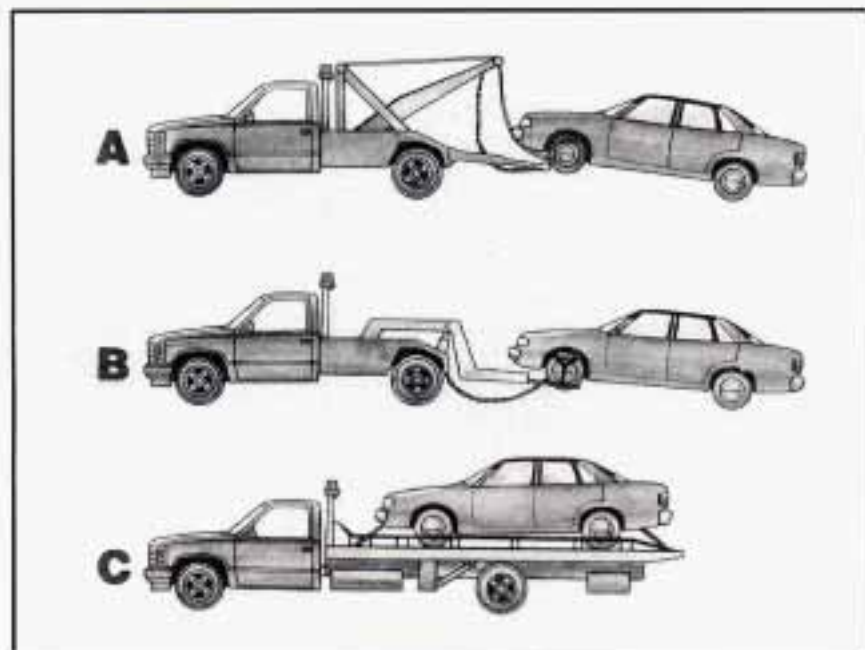

Try to have a GM retailer or a professional towing service tow your Oldsmobile. The usual towing equipment is:

- (A) Sling-type tow truck
- (B) Wheel-lift tow truck
- (C) Car carrier

If your vehicle has been changed or modified since it was factory-new by adding aftermarket items like fog lamps, aero skirting, or special tires and wheels, these instructions and illustrations may not be correct.

Before you do anything, turn on the hazard warning flashers.

When you call, tell the towing service:

- That your vehicle cannot be towed from the front or rear with sling-type equipment, as described later in this section.
- That your vehicle has front-wheel drive.
- The make, model and year of your vehicle.
- Whether you can still move the shift lever.
- If there was an accident, what was damaged.

When the towing service arrives, let the tow operator know that this manual contains detailed towing instructions and illustrations. The operator may want to see them.

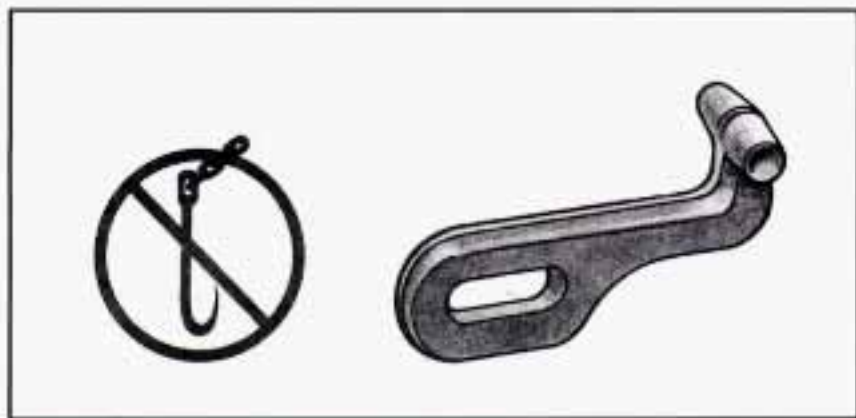

When your vehicle is being towed, have the ignition key off. The steering wheel should be clamped in a straight-ahead position, with a clamping device designed for towing service. Do not use the vehicle's steering column lock for this. The transaxle should be in NEUTRAL (N) and the parking brake released.

Don't have your vehicle towed on the front wheels, unless you must. If the vehicle must be towed on the front wheels, don't go more than 35 mph (56 km/h) or farther than 50 miles (80 km) or your transaxle will be damaged. If these limits must be exceeded, then the front wheels have to be supported on a dolly.

⚠ CAUTION:

To help avoid injury to you or others:

- Never let passengers ride in a vehicle that is being towed.
- Never tow faster than safe or posted speeds.
- Never tow with damaged parts not fully secured.
- Never get under your vehicle after it has been lifted by the tow truck.
- Always secure the vehicle on each side with separate safety chains when towing it.
- Never use J-hooks. Use T-hooks instead.

CAUTION:

A vehicle can fall from a car carrier if it isn't adequately secured. This can cause a collision, serious personal injury and vehicle damage. The vehicle should be tightly secured with chains or steel cables before it is transported.

Don't use substitutes (ropes, leather straps, canvas webbing, etc.) that can be cut by sharp edges underneath the towed vehicle. Always use T-hooks inserted in the T-hook slots. Never use J-hooks. They will damage drivetrain and suspension components.

Front Towing

Before hooking up to a tow truck, be sure to read all the information on "Towing Your Vehicle" earlier in this section.

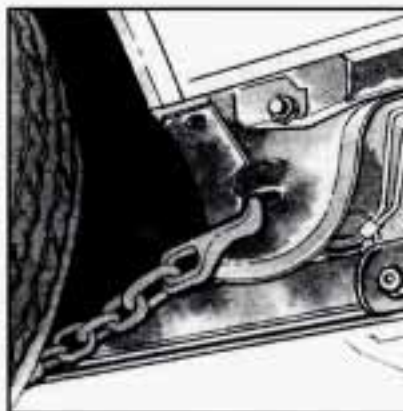

1. Attach T-hook chains into the slots in the bottom of the floor pan, just behind the front wheels, on both sides.

NOTICE:

Do not tow with sling-type equipment or fascia/fog lamp damage will occur. Use wheel-lift or car carrier equipment. Additional ramping may be required for car carrier equipment.

NOTICE:

Towing a vehicle over rough surfaces could damage a vehicle. Damage can occur from vehicle to ground or vehicle to wheel-lift equipment. To help avoid damage, install a towing dolly and raise vehicle until adequate clearance is obtained between the ground and/or wheel-lift equipment. Do not attach winch cables or J-hooks to suspension components when using car carrier equipment. Always use T-hooks inserted in the T-hook slots.

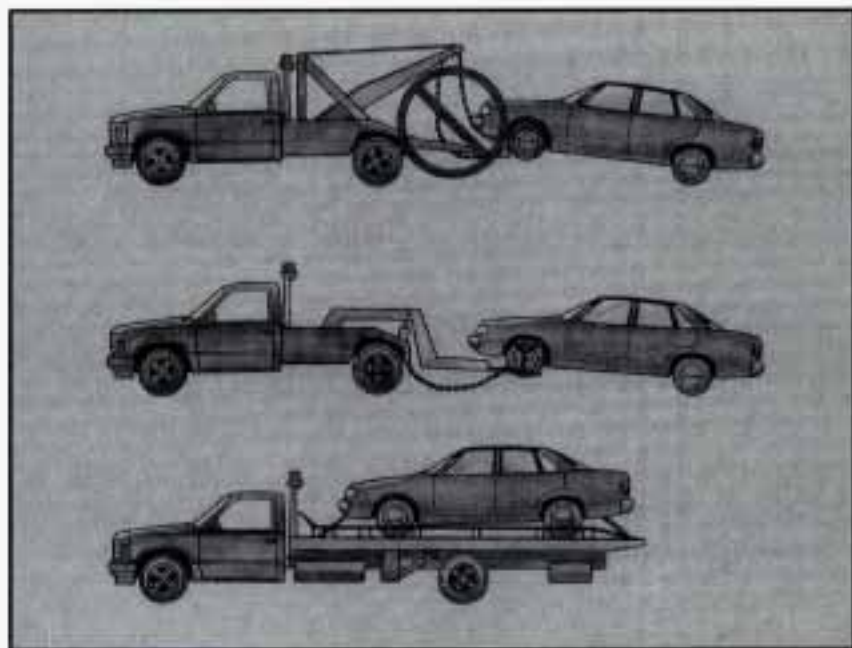

2. Attach a separate safety chain around the outboard end of each lower control arm.

Rear Towing

TOW LIMITS - 35 MPH (56 KPH), 50 MILES (80 KM)

Before hooking up to a tow truck, be sure to read all the information on "Towing Your Vehicle" earlier in this section. Also be sure to use the proper hook-up for your particular vehicle.

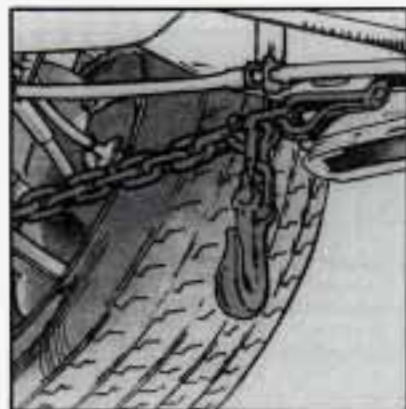

1. Attach T-hook chains on both sides, in the slotted holes in the bottom of the frame rail, just ahead of the rear wheels.

NOTICE:

Do not tow with sling-type equipment or rear bumper valance will be damaged. Use wheel-lift or car carrier equipment (additional ramping may be required for car carrier equipment). Use safety chains and wheel straps.

NOTE: The ignition must be in the OFF position to keep automatic door locks from locking during tow.

NOTICE:

Towing a vehicle over rough surfaces could damage a vehicle. Damage can occur from vehicle to ground or vehicle to wheel-lift equipment. To help avoid damage, install a towing dolly and raise vehicle until adequate clearance is obtained between the ground and/or wheel-lift equipment. Do not attach winch cables or J-hooks to suspension components when using car carrier equipment. Always use T-hooks inserted in the T-hook slots.

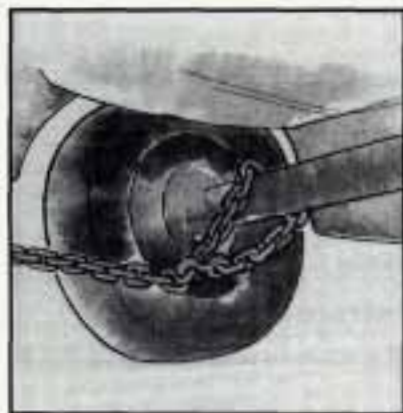

2. Attach a separate chain to each side of the axle inboard of the spring.

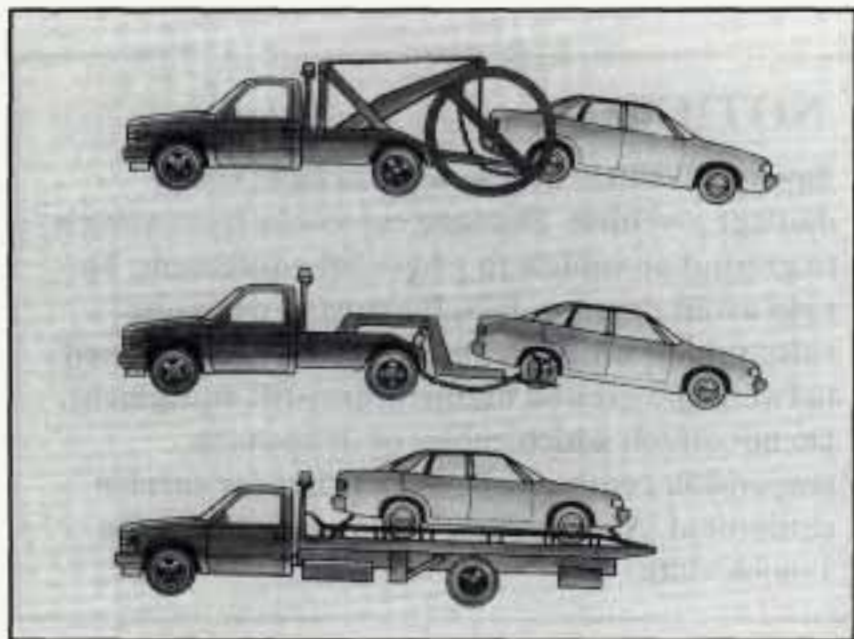

Engine Overheating

You will find a coolant temperature gage on your Oldsmobile's instrument panel. See "Coolant Temperature Gage" in the Index. You will also find a low coolant level warning light on your Oldsmobile's instrument panel.

If Steam Is Coming From Your Engine

CAUTION:

Steam from an overheated engine can burn you badly, even if you just open the hood. Stay away from the engine if you see or hear steam coming from it. Just turn it off and get everyone away from the vehicle until it cools down. Wait until there is no sign of steam or coolant before opening the hood.

If you keep driving when your engine is overheated, the liquids in it can catch fire. You or others could be badly burned. Stop your engine if it overheats, and get out of the vehicle until the engine is cool.

NOTICE:

If your engine catches fire because you keep driving with no coolant, your vehicle can be badly damaged. The costly repairs would not be covered by your warranty.

If No Steam Is Coming From Your Engine

If you get the overheat warning but see or hear no steam, the problem may not be too serious. Sometimes the engine can get a little too hot when you:

- Climb a long hill on a hot day.
- Stop after high speed driving.
- Idle for long periods in traffic.
- Tow a trailer.

If you get the overheat warning with no sign of steam, try this for a minute or so:

1. If you have an air conditioner, turn it off.

2. Turn on your heater to full hot at the highest fan speed and open the window as necessary.
3. If you're in a traffic jam, shift to NEUTRAL (N); otherwise, shift to the highest gear while driving -- AUTOMATIC OVERDRIVE (Ⓢ) or DRIVE (D) for automatic transaxles.

If you no longer have the overheat warning, you can drive. Just to be safe, drive slower for about ten minutes. If the warning doesn't come back on, you can drive normally.

If the warning continues, pull over, stop, and park your vehicle right away.

If there's still no sign of steam, you can idle the engine for two or three minutes while you're parked, to see if the warning stops. But then, if you still have the warning, *turn off the engine and get everyone out of the vehicle* until it cools down.

You may decide not to lift the hood but to get service help right away.

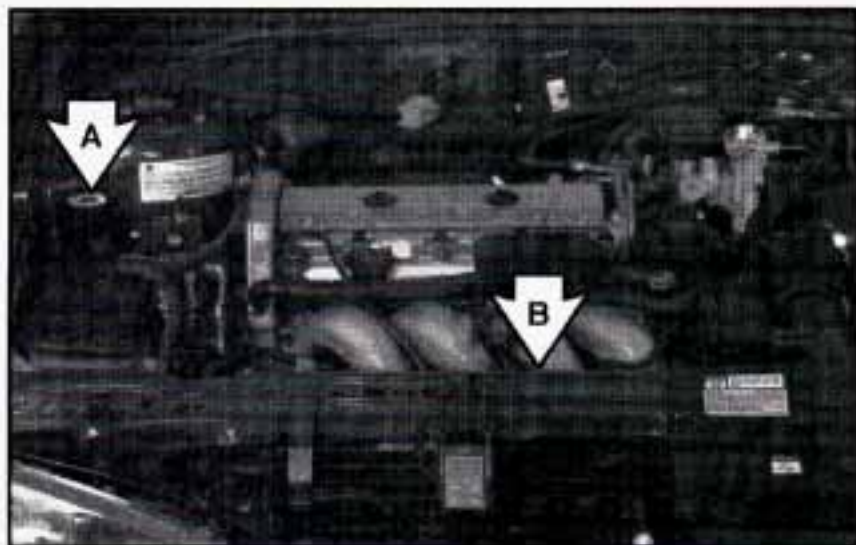

When you decide it's safe to lift the hood, here's what you'll see:

- A. Coolant surge tank with pressure cap
- B. Electric engine fan



CAUTION:

An electric fan under the hood can start up even when the engine is not running and can injure you. Keep hands, clothing and tools away from any underhood electric fan.

If the coolant inside the coolant surge tank is boiling, don't do anything else until it cools down.

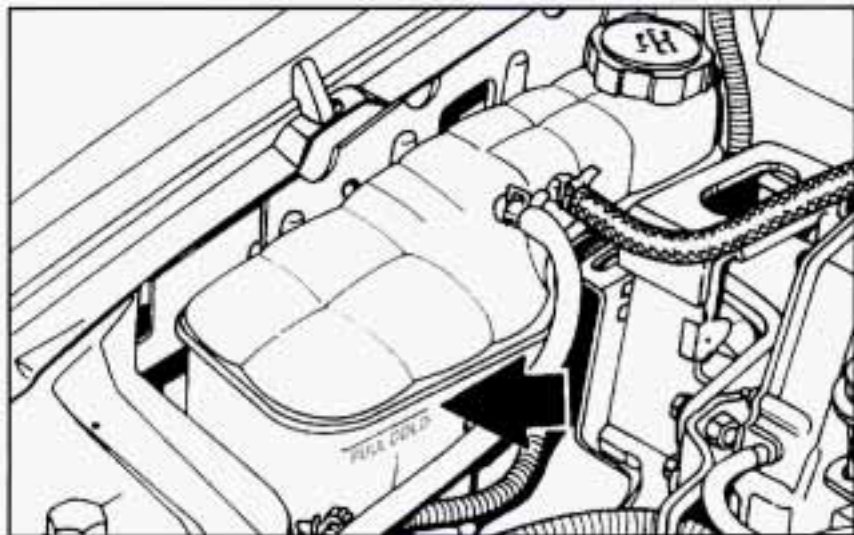

The coolant level should be at or above FULL COLD. If it isn't, you may have a leak in the radiator hoses, heater hoses, radiator, water pump or somewhere else in the cooling system.

 **CAUTION:**

Heater and radiator hoses, and other engine parts, can be very hot. Don't touch them. If you do, you can be burned.

Don't run the engine if there is a leak. If you run the engine, it could lose all coolant. That could cause an engine fire, and you could be burned. Get any leak fixed before you drive the vehicle.

NOTICE:

Engine damage from running your engine without coolant isn't covered by your warranty.

If there seems to be no leak, with the engine on check to see if the electric engine fan is running. If the engine is overheating, the fan should be running. If it isn't, your vehicle needs service.

How to Add Coolant to the Coolant Surge Tank

If you haven't found a problem yet, but the coolant level isn't at FULL COLD, add a 50/50 mixture of *clean water* (preferably distilled) and a proper antifreeze at the coolant surge tank, but be sure the cooling system, including the coolant surge tank pressure cap, is cool before you do it. (See "Engine Coolant" in the Index for more information about the proper coolant mix.)

 **CAUTION:**

Steam and scalding liquids from a hot cooling system can blow out and burn you badly. They are under pressure, and if you turn the coolant surge tank pressure cap -- even a little -- they can come out at high speed. Never turn the cap when the cooling system, including the coolant surge tank pressure cap, is hot. Wait for the cooling system and coolant surge tank pressure cap to cool if you ever have to turn the pressure cap.



⚠ CAUTION:

Adding only plain water to your cooling system can be dangerous. Plain water, or some other liquid like alcohol, can boil before the proper coolant mix will. Your vehicle's coolant warning system is set for the proper coolant mix. With plain water or the wrong mix, your engine could get too hot but you wouldn't get the overheat warning. Your engine could catch fire and you or others could be burned. Use a 50/50 mix of clean water and a proper antifreeze.

NOTICE:

In cold weather, water can freeze and crack the engine, radiator, heater core and other parts. So use the recommended coolant.

⚠ CAUTION:

You can be burned if you spill coolant on hot engine parts. Coolant contains ethylene glycol and it will burn if the engine parts are hot enough. Don't spill coolant on a hot engine.



1. You can remove the coolant surge tank pressure cap when the cooling system, including the coolant surge tank pressure cap and upper radiator hose, is no longer hot. Turn the pressure cap slowly about one-quarter turn to the left and then stop.

If you hear a hiss, wait for that to stop. A hiss means there is still some pressure left.

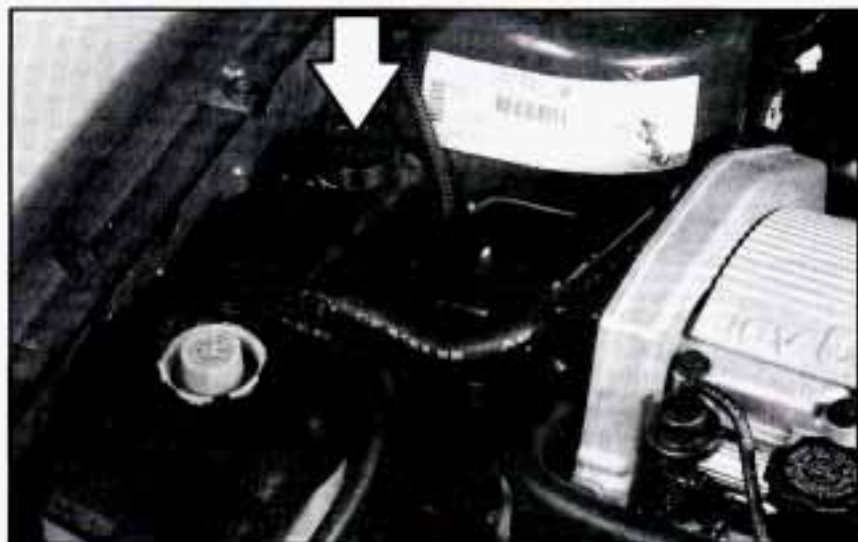

2. Then keep turning the pressure cap slowly, and remove it.



3. Then fill the coolant surge tank with the proper mix, up to **FULL COLD**, or just above the small cylinder at the base of the opening.



4. With the coolant surge tank pressure cap off, start the engine and let it run until you can feel the upper radiator hose getting hot. Watch out for the engine fan.

By this time, the coolant level inside the coolant surge tank may be lower. If the level is lower, add more of the proper mix to the coolant surge tank until the level reaches FULL COLD, or just above the small cylinder at the base of the opening.



5. Then replace the pressure cap. Be sure the pressure cap is tight.

If a Tire Goes Flat

It's unusual for a tire to "blow out" while you're driving, especially if you maintain your tires properly. If air goes out of a tire, it's much more likely to leak out slowly. But if you should ever have a "blowout," here are a few tips about what to expect and what to do:

If a front tire fails, the flat tire will create a drag that pulls the vehicle toward that side. Take your foot off the accelerator pedal and grip the steering wheel firmly. Steer to maintain lane position, then gently brake to a stop well out of the traffic lane.

A rear blowout, particularly on a curve, acts much like a skid and may require the same correction you'd use in a skid. In any rear blowout, remove your foot from the accelerator pedal. Get the vehicle under control by steering the way you want the vehicle to go. It may be very bumpy and noisy, but you can still steer. Gently brake to a stop, well off the road if possible.

If a tire goes flat, the next part shows how to use your jacking equipment to change a flat tire safely.

Changing a Flat Tire

If a tire goes flat, avoid further tire and wheel damage by driving slowly to a level place. Turn on your hazard warning flashers.



CAUTION:

Changing a tire can cause an injury. The vehicle can slip off the jack and roll over you or other people. You and they could be badly injured. Find a level place to change your tire. To help prevent the vehicle from moving:

- 1. Set the parking brake firmly.**
- 2. Put an automatic transaxle shift lever in PARK (P), or shift a manual transaxle to FIRST (1) or REVERSE (R).**
- 3. Turn off the engine.**

To be even more certain the vehicle won't move, you can put blocks at the front and rear of the tire farthest away from the one being changed. That would be the tire on the other side of the vehicle, at the opposite end.



The following steps will tell you how to use the jack and change a tire.

The equipment you'll need is in the trunk.

1. Turn the center retainer nut on the compact spare tire housing counterclockwise to remove it, then lift the tire cover. You will find the jacking instructions label on the underside of the tire cover.

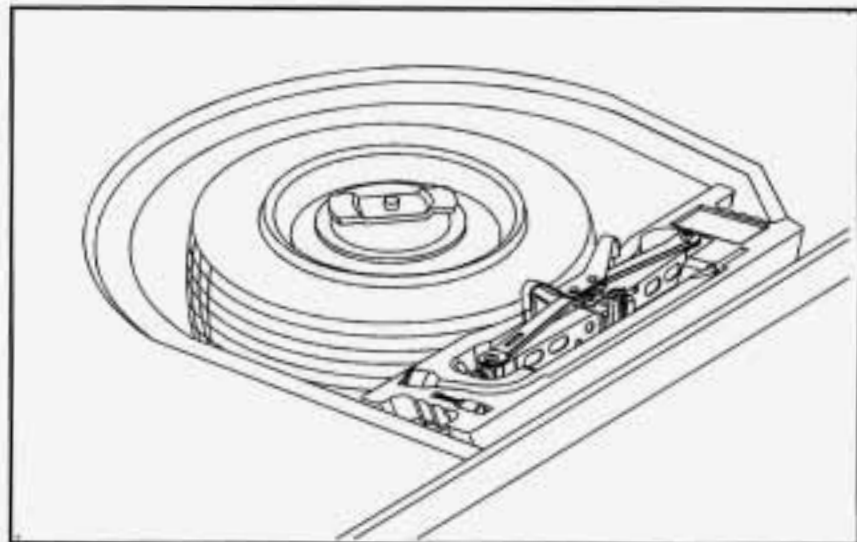

2. Remove the wing bolt securing the compact spare tire and spacer by turning it counterclockwise. Then lift off the spacer and remove the spare tire.
3. The jack and wheel wrench are stored in a foam tray by the compact spare tire.
4. Using the wheel wrench, remove the wheel nut caps (if your vehicle has them) and loosen all the wheel nuts. Don't remove them yet. On some models, a cover plate must be removed to find the wheel nuts. Carefully use the wedge end of the wheel wrench to pry it off.

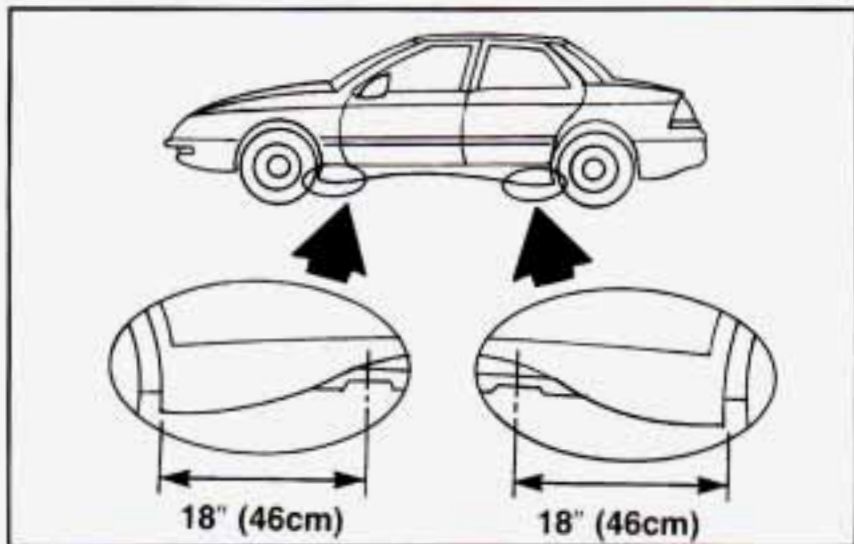

5. Near each wheel well is a notch in the frame which the jack head fits in.
6. Position the jack under the vehicle. Raise the jack head until it fits firmly into the notch in the vehicle's frame nearest the flat tire. Do not raise the vehicle yet. Put the compact spare tire near you.

⚠ CAUTION:

Getting under a vehicle when it is jacked up is dangerous. If the vehicle slips off the jack, you could be badly injured or killed. Never get under a vehicle when it is supported only by a jack.

NOTICE:

Raising your vehicle with the jack improperly positioned will damage the vehicle or may allow the vehicle to fall off the jack. Be sure to fit the jack lift head into the proper location before raising your vehicle.

NOTICE:

Do not jack or lift the vehicle using the oil pan. Pans could crack and begin to leak fluid.

7. Raise the vehicle by rotating the jack handle clockwise. Raise the vehicle far enough off the ground so there is enough room for the spare tire to fit.
8. Remove all the wheel nuts, and carefully pry the wheel cover from the wheel, if your flat tire has one. Then take off the flat tire.

⚠ CAUTION:

Rust or dirt on the wheel, or on the parts to which it is fastened, can make the wheel nuts become loose after a time. The wheel could come off and cause an accident. When you change a wheel, remove any rust or dirt from the places where the wheel attaches to the vehicle. In an emergency, you can use a cloth or a paper towel to do this; but be sure to use a scraper or wire brush later, if you need to, to get all the rust or dirt off.

9. Remove any rust or dirt from the wheel bolts, mounting surfaces and spare wheel. Place the spare on the wheel mounting surface.

⚠ CAUTION:

Never use oil or grease on studs or nuts. If you do, the nuts might come loose. Your wheel could fall off, causing a serious accident.

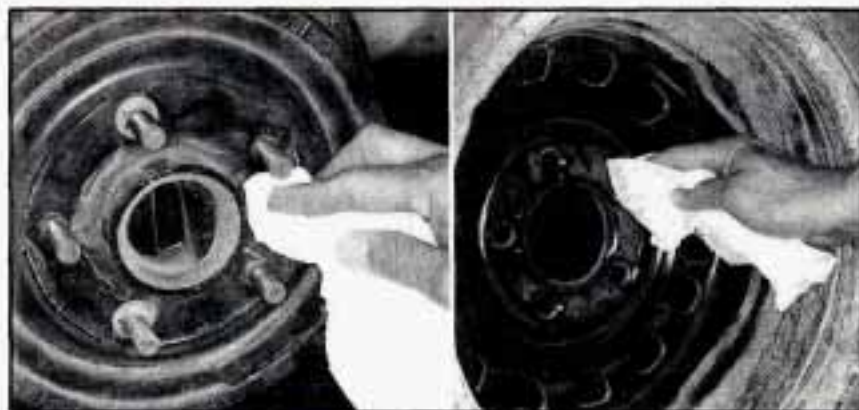



10. Replace the wheel nuts with the rounded end of the nuts toward the wheel. Tighten each nut by hand until the wheel is held against the hub.

11. Lower the vehicle by rotating the jack handle counterclockwise. Lower the jack completely.

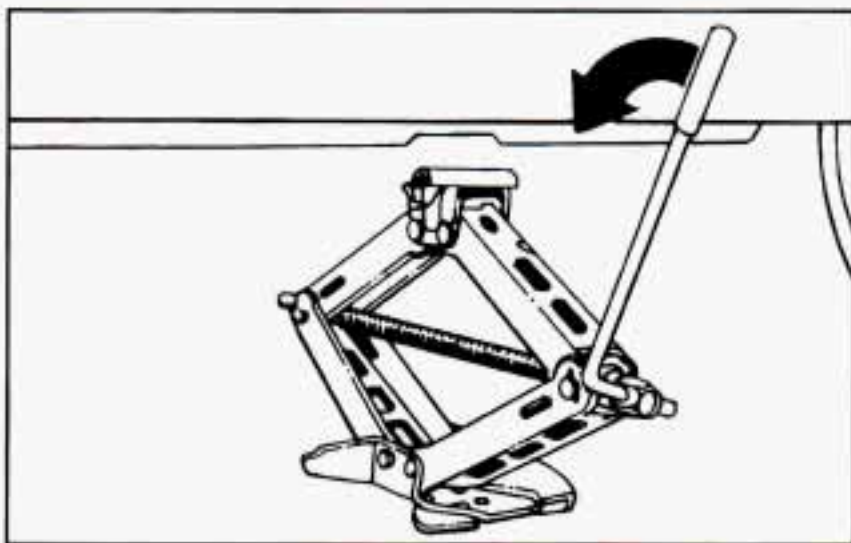

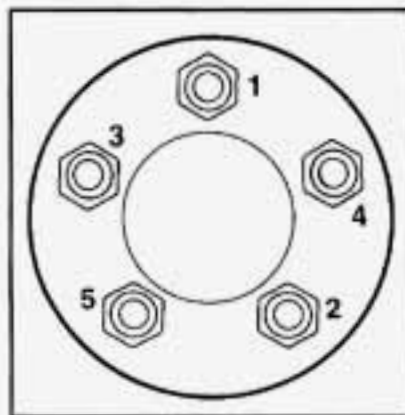

12. Tighten the wheel nuts firmly in a criss-cross sequence, as shown.

Don't try to put a wheel cover on your compact spare tire. It won't fit. Store the wheel cover and wheel nut caps in the trunk until you have the flat tire repaired or replaced.

NOTICE:

Wheel covers won't fit on your compact spare. If you try to put a wheel cover on your compact spare, you could damage the cover or the spare.

⚠ CAUTION:

Incorrect wheel nuts or improperly tightened wheel nuts can cause the wheel to become loose and even come off. This could lead to an accident. Be sure to use the correct wheel nuts. If you have to replace them, be sure to get the right kind.

Stop somewhere as soon as you can and have the nuts tightened with a torque wrench to 100 lb-ft (140 N•m).

13. Store the flat tire in the compact spare tire compartment, and secure with the wing bolt and extension. Store the jack and wheel wrench back in the foam tray provided.

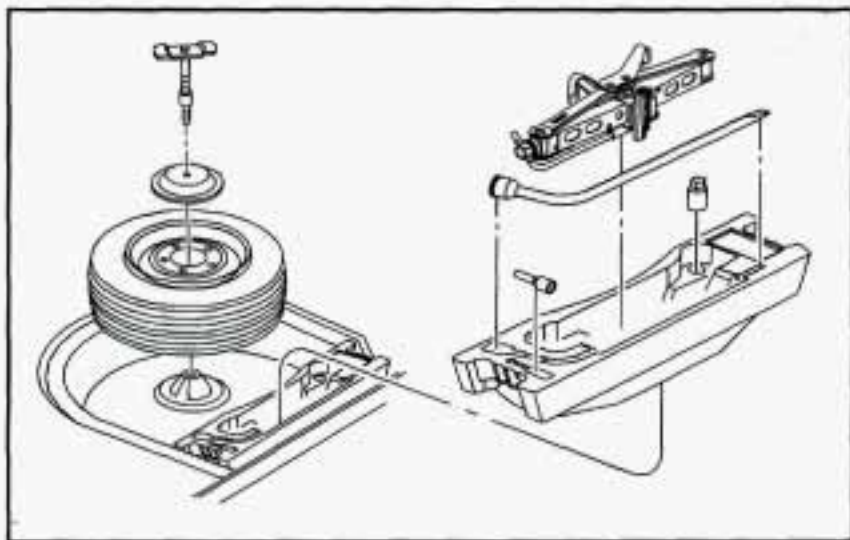

⚠ CAUTION:

Storing a jack, a tire or other equipment in the passenger compartment of the vehicle could cause injury. In a sudden stop or collision, loose equipment could strike someone. Store all these in the proper place.

Compact Spare Tire

Although the compact spare was fully inflated when your vehicle was new, it can lose air after a time. Check the inflation pressure regularly. It should be 60 psi (420 kPa). After installing the compact spare on your vehicle, you should stop as soon as possible and make sure your spare tire is correctly inflated. The compact spare is made to perform well at posted speed limits for distances up to 3,000 miles (5 000 km), so you can finish your trip and have your full-size tire repaired or replaced where you want. Of course, it's best to replace your spare with a full-size tire as soon as you can. Your spare will last longer and be in good shape in case you need it again.

NOTICE:

Don't take your compact spare through an automatic car wash with guide rails. The compact spare can get caught on the rails. That can damage the tire and wheel, and maybe other parts of your vehicle.

Don't use your compact spare on some other vehicle.

And don't mix your compact spare or wheel with other wheels or tires. They won't fit. Keep your spare and its wheel together.

NOTICE:

Tire chains won't fit your compact spare. Using them will damage your vehicle and destroy the chains too. Don't use tire chains on your compact spare.

If You're Stuck: In Sand, Mud, Ice or Snow

What you don't want to do when your vehicle is stuck is to spin your wheels too fast. The method known as "rocking" can help you get out when you're stuck, but you must use caution.

CAUTION:

If you let your tires spin at high speed, they can explode and you or others could be injured. And, the transaxle or other parts of the vehicle can overheat. That could cause an engine compartment fire or other damage. When you're stuck, spin the wheels as little as possible. Don't spin the wheels above 35 mph (55 km/h) as shown on the speedometer.

NOTICE:

Spinning your wheels can destroy parts of your vehicle as well as the tires. If you spin the wheels too fast while shifting your transaxle back and forth, you can destroy your transaxle.

For information about using tire chains on your vehicle, see "Tire Chains" in the Index.

Rocking your vehicle to get it out

First, turn your steering wheel left and right. That will clear the area around your front wheels. Then shift back and forth between REVERSE (R) and a forward gear (or with a manual transaxle, between FIRST (1) or SECOND (2) gear and REVERSE (R)), spinning the wheels as little as possible. Release the accelerator pedal while you shift, and press lightly on the accelerator pedal when the transaxle is in gear. If that doesn't get you out after a few tries, you may need to be towed out. If you do need to be towed out, see "Towing Your Vehicle" in the Index.



Section 6 Service and Appearance Care

Here you will find information about the care of your Oldsmobile. This section begins with service and fuel information, and then it shows how to check important fluid and lubricant levels. There is also technical information about your vehicle, and a part devoted to its appearance care.

Service

Your Oldsmobile retailer knows your vehicle best and wants you to be happy with it. We hope you'll go to your retailer for all your service needs. You'll get genuine GM parts and GM-trained and supported service people.

We hope you'll want to keep your GM vehicle all GM. Genuine GM parts have one of these marks:



Doing Your Own Service Work

If you want to do some of your own service work, you'll want to get the proper Oldsmobile Service Manual. It tells you much more about how to service your Oldsmobile than this manual can. To order the proper service manual, see "Service Publications" in the Index.

Your vehicle has an air bag system. Before attempting to do your own service work, see "Servicing Your Air Bag-Equipped Oldsmobile" in the Index.

You should keep a record with all parts receipts and list the mileage and the date of any service work you perform. See "Maintenance Record" in the Index.

CAUTION:

You can be injured if you try to do service work on a vehicle without knowing enough about it.

- Be sure you have sufficient knowledge, experience, and the proper replacement parts and tools before you attempt any vehicle maintenance task.
- Be sure to use the proper nuts, bolts and other fasteners. “English” and “metric” fasteners can be easily confused. If you use the wrong fasteners, parts can later break or fall off. You could be hurt.

NOTICE:

If you try to do your own service work without knowing enough about it, your vehicle could be damaged.

Fuel

Use regular unleaded gasoline rated at 87 octane or higher. It should meet specifications ASTM D4814 in the United States and CGSB 3.5-92 in Canada. These fuels should have the proper additives, so you should not have to add anything to the fuel.

In the United States and Canada, it's easy to be sure you get the right kind of gasoline (unleaded). You'll see UNLEADED right on the pump. And only unleaded nozzles will fit into your vehicle's filler neck.

Be sure the posted octane is at least 87. If the octane is less than 87, you may get a heavy knocking noise when you drive. If it's bad enough, it can damage your engine.

If you're using fuel rated at 87 octane or higher and you still hear heavy knocking, your engine needs service. But don't worry if you hear a little pinging noise when you're accelerating or driving up a hill. That's normal, and you don't have to buy a higher octane fuel to get rid of pinging. It's the heavy, constant knock that means you have a problem.

What about gasoline with blending materials that contain oxygen (oxygenates), such as MTBE or alcohol?

MTBE is “methyl tertiary-butyl ether.” Fuel that is no more than 15% *MTBE* is fine for your vehicle.

Ethanol is ethyl or grain alcohol. Properly-blended fuel that is no more than 10% *ethanol* is fine for your vehicle.

Methanol is methyl or wood alcohol.

NOTICE:

Fuel that is more than 5% methanol is bad for your vehicle. Don't use it. It can corrode metal parts in your fuel system and also damage plastic and rubber parts. That damage wouldn't be covered under your warranty. And even at 5% or less, there must be “cosolvents” and corrosion preventers in this fuel to help avoid these problems.

Gasolines for Cleaner Air

Your use of gasoline with deposit control additives will help prevent deposits from forming in your engine and fuel system. That helps keep your engine in tune and your emission control system working properly. It's good for your vehicle, and you'll be doing your part for cleaner air.

Many gasolines are now blended with oxygenates. General Motors recommends that you use gasolines with these blending materials, such as *MTBE* and *ethanol*. By doing so, you can help clean the air, especially in those parts of the country that have high carbon monoxide levels.

In addition, some gasoline suppliers are now producing reformulated gasolines. These gasolines are specially designed to reduce vehicle emissions. General Motors recommends that you use reformulated gasoline. By doing so, you can help clean the air, especially in those parts of the country that have high ozone levels.

You should ask your service station operators if their gasolines contain deposit control additives and oxygenates, and if they have been reformulated to reduce vehicle emissions.

Fuels in Foreign Countries

If you plan on driving in another country outside the U.S. or Canada, unleaded fuel may be hard to find. Do not use leaded gasoline. If you use even one tankful, your emission controls won't work well or at all. With continuous use, spark plugs can get fouled, the exhaust system can corrode, and your engine oil can deteriorate quickly. Your vehicle's oxygen sensor will be damaged. All of that means costly repairs that wouldn't be covered by your warranty.

To check on fuel availability, ask an auto club, or contact a major oil company that does business in the country where you'll be driving.

You can also write us at the following address for advice. Just tell us where you're going and give your Vehicle Identification Number (VIN).

General Motors Overseas Distribution Corporation
North American Export Sales (NAES)
1908 Colonel Sam Drive
Oshawa, Ontario
L1H 8P7

Filling Your Tank

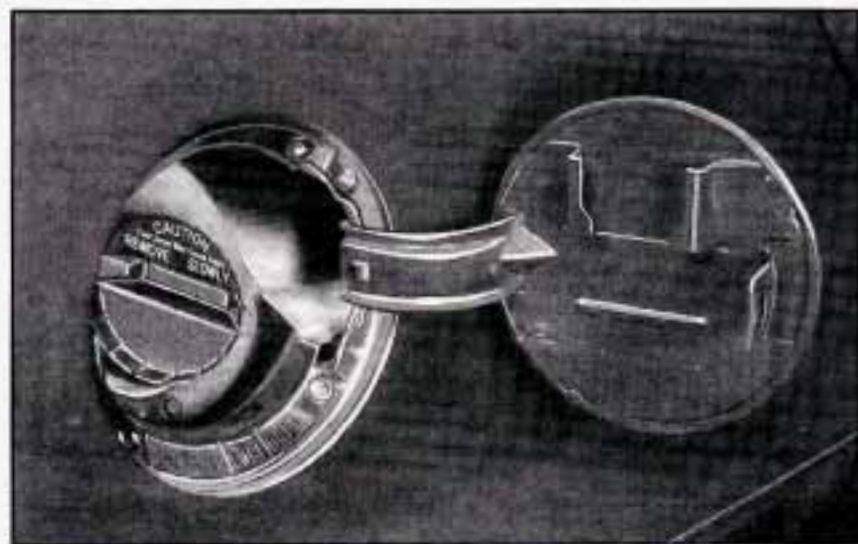

CAUTION:

Gasoline vapor is highly flammable. It burns violently, and that can cause very bad injuries. Don't smoke if you're near gasoline or refueling your vehicle. Keep sparks, flames, and smoking materials away from gasoline.

Fuel Capacity: 15.2 U.S. Gallons (57.5 L). Use unleaded fuel only.

The cap is behind a hinged door on the right side of your vehicle.

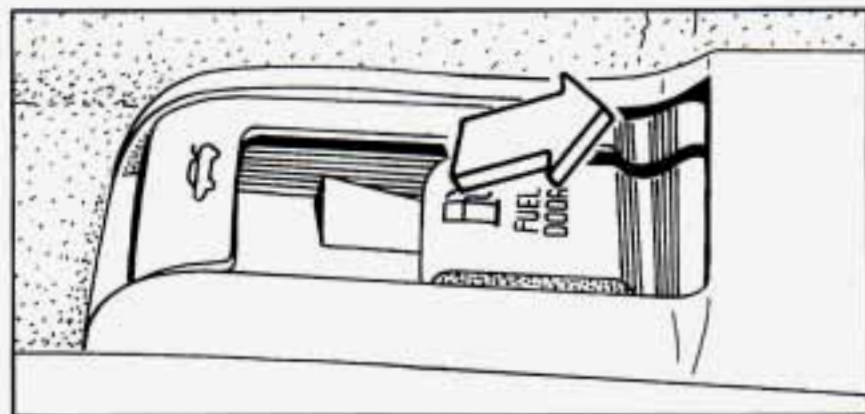

To open the fuel door, pull the fuel access handle on the floor by the driver's seat.

The remote fuel filler door release can help keep your fuel tank from being siphoned. Always be sure the fuel door is closed and latched after refueling.

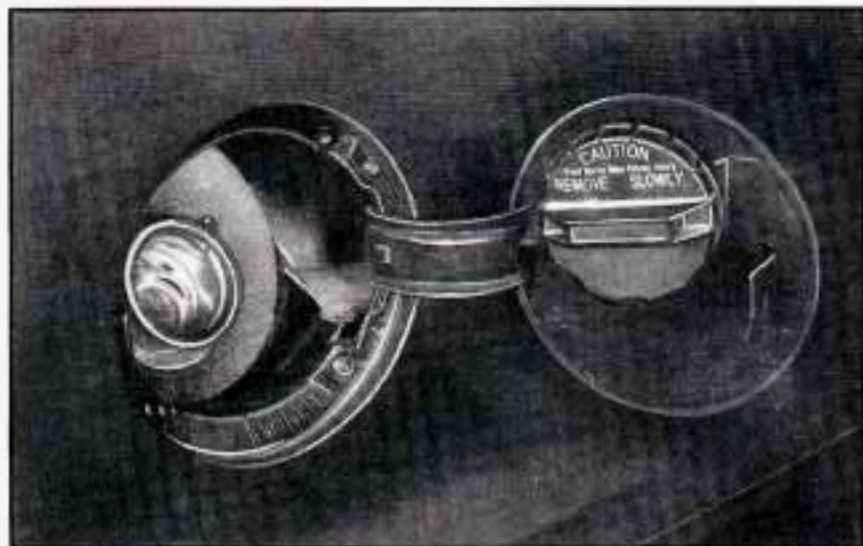

While refueling, hang the cap inside the fuel door.

To take off the cap, turn it slowly to the left (counterclockwise).

 **CAUTION:**

If you get gasoline on yourself and then something ignites it, you could be badly burned. Gasoline can spray out on you if you open the fuel filler cap too quickly. This spray can happen if your tank is nearly full, and is more likely in hot weather. Open the fuel filler cap slowly and wait for any “hiss” noise to stop. Then unscrew the cap all the way.

Be careful not to spill gasoline. Clean gasoline from painted surfaces as soon as possible. See “Cleaning the Outside of Your Oldsmobile” in the Index.

When you put the cap back on, turn it to the right until you hear at least three clicks.

NOTICE:

If you need a new cap, be sure to get the right type. Your retailer can get one for you. If you get the wrong type, it may not fit or have proper venting, and your fuel tank and emissions system might be damaged.

Checking Things Under the Hood

The following sections tell you how to check fluids, lubricants and important parts underhood.

Hood Release



To open the hood, first pull the HOOD release handle inside the vehicle.

Then go to the front of the vehicle and push the secondary hood release down to lift the hood.

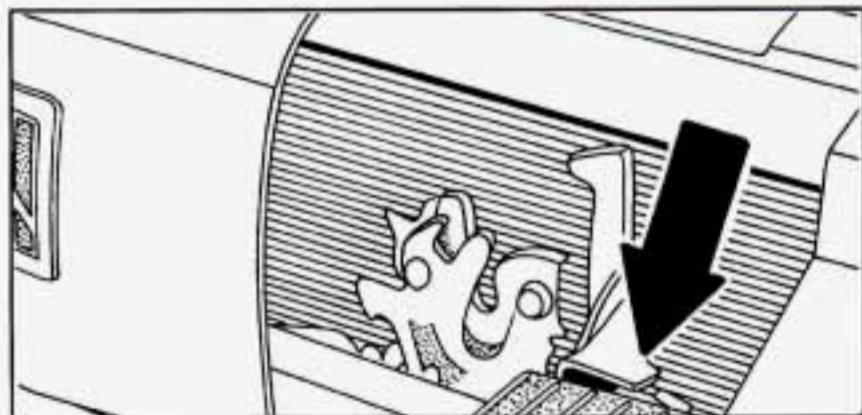

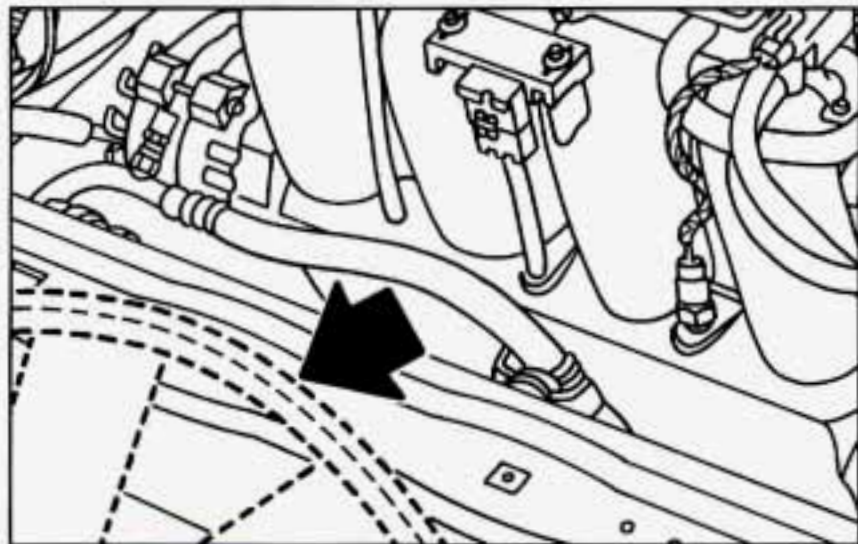

⚠ CAUTION:

Things that burn can get on hot engine parts and start a fire. These include liquids like gasoline, oil, coolant, brake fluid, windshield washer and other fluids, and plastic or rubber. You or others could be burned. Be careful not to drop or spill things that will burn onto a hot engine.

Before closing the hood, be sure all the filler caps are on properly. Then just let the hood down and close it firmly.

⚠ CAUTION:

An electric fan under the hood can start up and injure you even when the engine is not running. Keep hands, clothing and tools away from any underhood electric fan.

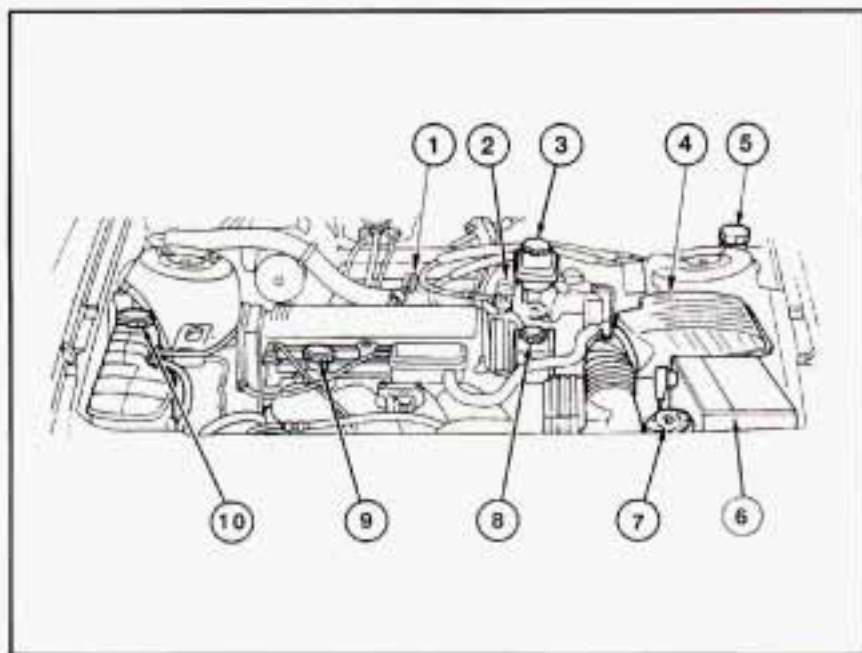

When you open the hood, you'll see:

1. Engine Oil Dipstick
2. Automatic Transaxle Fluid Dipstick (if equipped)
3. Brake Fluid Reservoir
4. Air Cleaner
5. Hydraulic Clutch Fluid Reservoir (if equipped)
6. Battery
7. Windshield Washer Fluid Reservoir
8. Power Steering Fluid Reservoir
9. Engine Oil Fill Cap
10. Engine Coolant Surge Tank

2.3L Quad 4 Engine (CODE D)

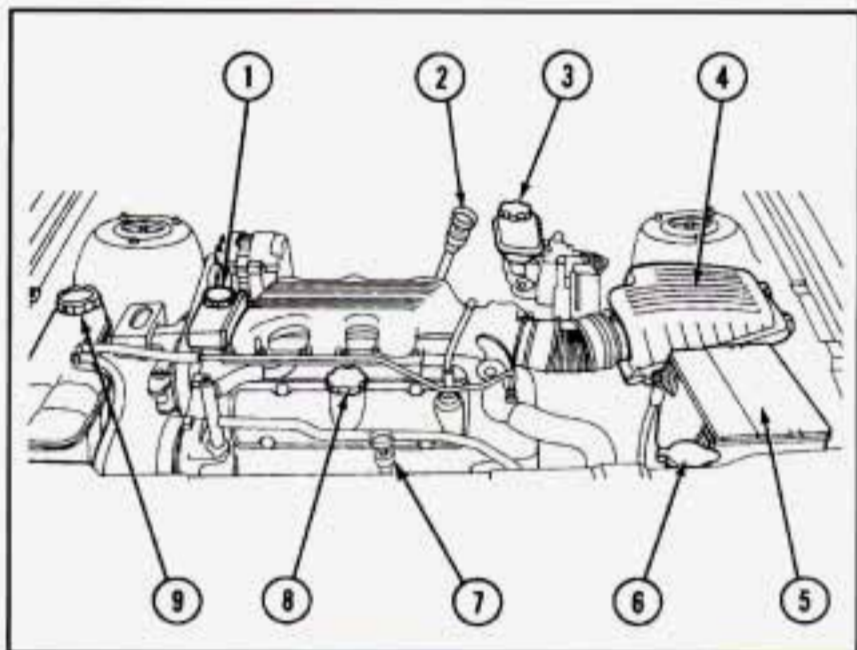

When you open the hood, you'll see:

1. Power Steering Fluid Reservoir
2. Automatic Transaxle Fluid Dipstick (if equipped)
3. Brake Fluid Reservoir
4. Air Cleaner
5. Battery
6. Windshield Washer Fluid Reservoir
7. Engine Oil Dipstick
8. Engine Oil Fill Cap
9. Engine Coolant Surge Tank

3.1L V6 Engine (CODE M)

Underhood Light

Your parking lights or headlights must be on for the underhood light to function when you open the hood.

Engine Oil

If the CHECK OIL light on the instrument panel comes on, it means you need to check your engine oil level right away. For more information, see "CHECK OIL LIGHT" in the Index. You should check your engine oil level regularly; this is an added reminder.

It's a good idea to check your engine oil every time you get fuel. In order to get an accurate reading, the oil must be warm and the vehicle must be on level ground.

Turn off the engine and give the oil a few minutes to drain back into the oil pan. If you don't, the oil dipstick might not show the actual level.

To Check Engine Oil

Pull out the dipstick and clean it with a paper towel or cloth, then push it back in all the way. Remove it again, keeping the tip down, and check the level.

Checking Engine Oil

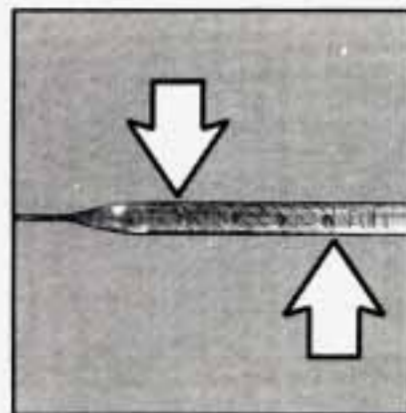

The engine oil dipstick handle is yellow. The dipstick handle for the 2.3L L-4 is located behind the engine. The dipstick for the 3.1L V-6 is located in front of the engine behind the fan.

2.3L Quad 4: Adding Engine Oil

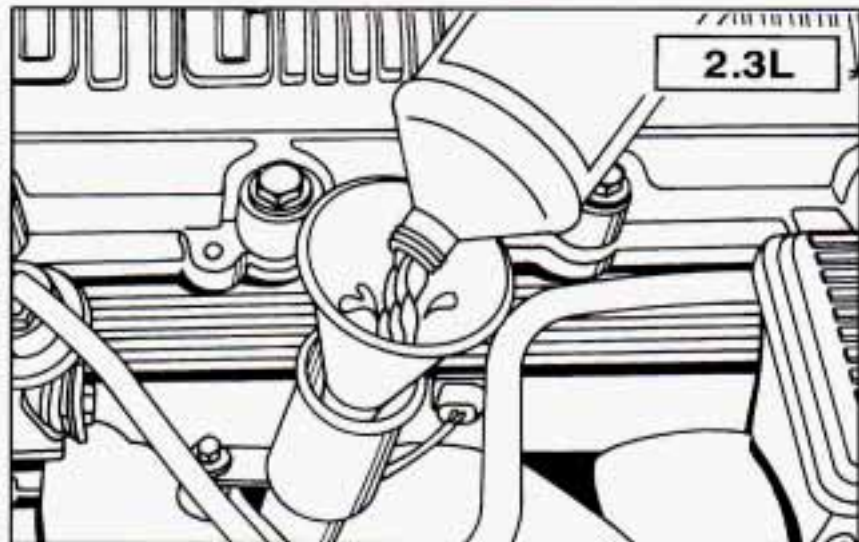

3100 V6: Adding Engine Oil

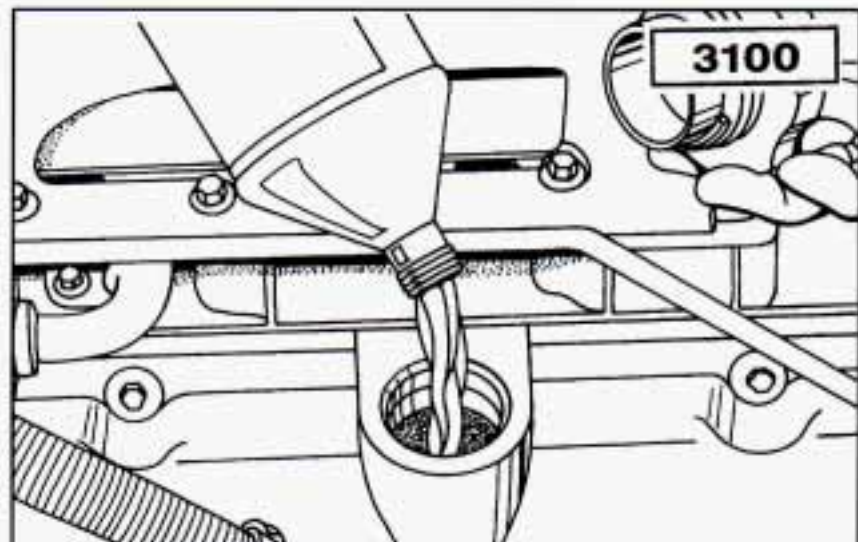

When to Add Oil

If the oil is at or below the ADD line, then you'll need to add some oil. But you must use the right kind. This part explains what kind of oil to use. For crankcase capacity, see "Capacities and Specifications" in the Index.

NOTICE:

Don't add too much oil. If your engine has so much oil that the oil level gets above the upper mark that shows the proper operating range, your engine could be damaged.

Just fill it enough to put the level somewhere in the proper operating range. Push the dipstick all the way back in when you're through.

What Kind of Oil to Use

Oils of the proper quality for your vehicle can be identified by looking for the "Starburst" symbol. The "Starburst" symbol indicates that the oil has been certified by the American Petroleum Institute (API), and is preferred for use in your gasoline engine.



If you change your own oil, be sure you use oil that has the "Starburst" symbol on the front of the oil container. If you have your oil changed for you, be sure the oil put into your engine is American Petroleum Institute certified for gasoline engines.

You should also use the proper viscosity oil for your vehicle, as shown in the following chart:

RECOMMENDED SAE VISCOSITY GRADE ENGINE OILS

FOR BEST FUEL ECONOMY AND COLD STARTING, SELECT THE LOWEST SAE VISCOSITY GRADE OIL FOR THE EXPECTED TEMPERATURE RANGE.

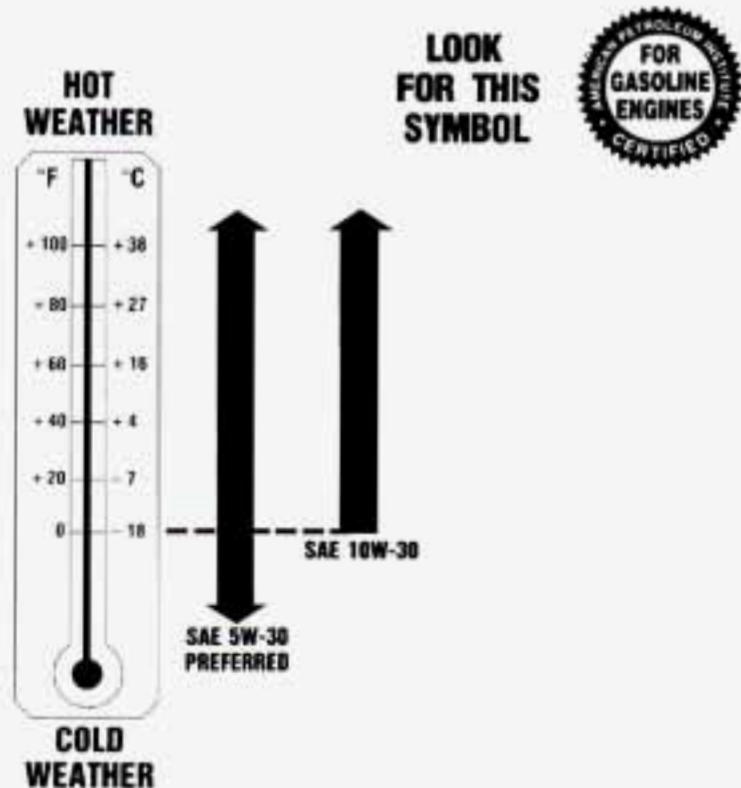

DO NOT USE SAE 20W-50 OR ANY OTHER GRADE OIL NOT RECOMMENDED

As shown in the chart, SAE 5W-30 is best for your vehicle. However, you can use SAE 10W-30 if it's going to be 0°F (-18°C) or above. These numbers on an oil container show its viscosity, or thickness. Do not use other viscosity oils, such as SAE 20W-50.

NOTICE:

Use only engine oil with the American Petroleum Institute Certified For Gasoline Engines "Starburst" symbol. Failure to use the proper oil can result in engine damage not covered by your warranty.

GM Goodwrench[®] oil (in Canada, GM Engine Oil) meets all the requirements for your vehicle.

Engine Oil Additives

Don't add anything to your oil. Your Oldsmobile retailer is ready to advise if you think something should be added.

When to Change Engine Oil

See if any one of these is true for you:

- Most trips are less than 5 to 10 miles (8 to 16 km). This is particularly important when outside temperatures are below freezing.
- Most trips include extensive idling (such as frequent driving in stop and go traffic).
- Most trips are through dusty areas.
- You frequently tow a trailer or use a carrier on top of your vehicle.

If any one of these is true for your vehicle, then you need to change your oil and filter every 3,000 miles (5 000 km) or 3 months -- whichever comes first.

If none of them is true, change the oil and filter every 7,500 miles (12 500 km) or 12 months -- whichever comes first.

Engine Coolant Heater

An engine coolant heater can be a big help if you have to park outside in very cold weather, 0°F (-18°C) or colder. If your vehicle has this option, see "Engine Coolant Heater" in the Index.

What to Do with Used Oil

Did you know that used engine oil contains certain elements that may be unhealthy for your skin and could even cause cancer? Don't let used oil stay on your skin for very long. Clean your skin and nails with soap and water, or a good hand cleaner. Wash or properly throw away clothing or rags containing used engine oil. (See the manufacturer's warnings about the use and disposal of oil products.)

Used oil can be a real threat to the environment. If you change your own oil, be sure to drain all free-flowing oil from the filter before disposal. Don't ever dispose of oil by putting it in the trash, pouring it on the ground, into sewers, or into streams or bodies of water. Instead, recycle it by taking it to a place that collects used oil. If you have a problem properly disposing of your used oil, ask your retailer, a service station or a local recycling center for help.

Air Cleaner

Refer to the Maintenance Schedule to determine when to replace the air filter.

See “Scheduled Maintenance Services” in the Index.

CAUTION:

Operating the engine with the air cleaner off can cause you or others to be burned. The air cleaner not only cleans the air, it stops flame if the engine backfires. If it isn't there, and the engine backfires, you could be burned. Don't drive with it off, and be careful working on the engine with the air cleaner off.

NOTICE:

If the air cleaner is off, a backfire can cause a damaging engine fire. And, dirt can easily get into your engine, which will damage it. Always have the air cleaner in place when you're driving.

To Check or Replace the Air Filter



1. Unscrew the four Phillips-head screws, then pull the cover back.
2. Remove the air cleaner filter.
3. Be sure to install the air cleaner filter and replace the cover tightly.

Automatic Transaxle Fluid

When to Check and Change

A good time to check your automatic transaxle fluid level is when the engine oil is changed. Refer to the Maintenance Schedule to determine when to change your fluid. See "Scheduled Maintenance Services" in the Index.

How to Check

Because this operation can be a little difficult, you may choose to have this done at your Oldsmobile retailer Service Department.

If you do it yourself, be sure to follow all the instructions here, or you could get a false reading on the dipstick.

NOTICE:

Too much or too little fluid can damage your transaxle. Too much can mean that some of the fluid could come out and fall on hot engine parts or exhaust system parts, starting a fire. Be sure to get an accurate reading if you check your transaxle fluid.

Wait at least 30 minutes before checking the transaxle fluid level if you have been driving:

- When outside temperatures are above 90°F (32°C).
- At high speed for quite a while.
- In heavy traffic -- especially in hot weather.
- While pulling a trailer.

To get the right reading, the fluid should be at normal operating temperature, which is 180°F to 200°F (82°C to 93°C).

Get the vehicle warmed up by driving about 15 miles (24 km) when outside temperatures are above 50°F (10°C). If it's colder than 50°F (10°C), you may have to drive longer.

To check the fluid level

1. Park your vehicle on a level place. Keep the engine running.
2. With the parking brake applied, place the shift lever in PARK (P).
3. With your foot on the brake pedal, move the shift lever through each gear range, pausing for about three seconds in each range. Then, position the shift lever in PARK (P).
4. Let the engine run at idle for three to five minutes.

Then, without shutting off the engine, follow these steps:

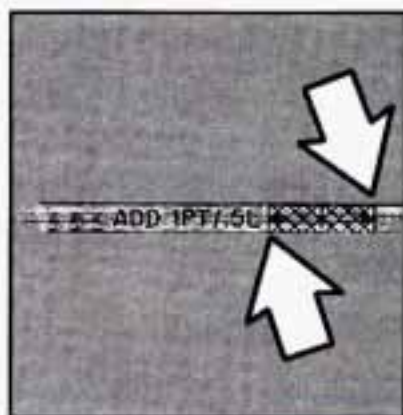

The automatic transaxle dipstick handle is red. Pull out the dipstick and wipe it with a clean rag or paper towel.

1. Push it back in all the way, wait three seconds and then pull it back out again.
2. Check both sides of the dipstick, and read the lower level. The fluid level must be in the cross-hatched area.
3. If the fluid level is in the acceptable range, push the dipstick back in all the way.

How to Add Fluid

Refer to the Maintenance Schedule to determine what kind of transaxle fluid to use. See “Recommended Fluids and Lubricants” in the Index.

If the fluid level is low, add only enough of the proper fluid to bring the level into the cross-hatched area on the dipstick.

1. Pull out the dipstick.
 2. Using a long-neck funnel, add enough fluid at the dipstick hole to bring it to the proper level. It doesn't take much fluid, generally less than a pint (0.5L). *Don't overfill.* We recommend you use only fluid labeled DEXRON[®]-III, because fluid with that label is made especially for your automatic transaxle. Damage caused by fluid other than DEXRON[®]-III is not covered by your new vehicle warranty.
- After adding fluid, recheck the fluid level as described under “How to Check.”
 - When the correct fluid level is obtained, push the dipstick back in all the way.

Manual Transaxle Fluid

When to Check

A good time to have it checked is when the engine oil is changed. However, the fluid in your manual transaxle doesn't require changing.

How to Check

Because this operation can be a little difficult, you may choose to have this done at your Oldsmobile retailer Service Department.

If you do it yourself, be sure to follow all the instructions here, or you could get a false reading on the dipstick.

NOTICE:

Too much or too little fluid can damage your transaxle. Too much can mean that some of the fluid could come out and fall on hot engine parts or exhaust system parts, starting a fire. Be sure to get an accurate reading if you check your transaxle fluid.

Check the fluid level only when your engine is off, the vehicle is parked on a level place and the transaxle is cool enough for you to rest your fingers on the transaxle case.

Then, follow these steps:

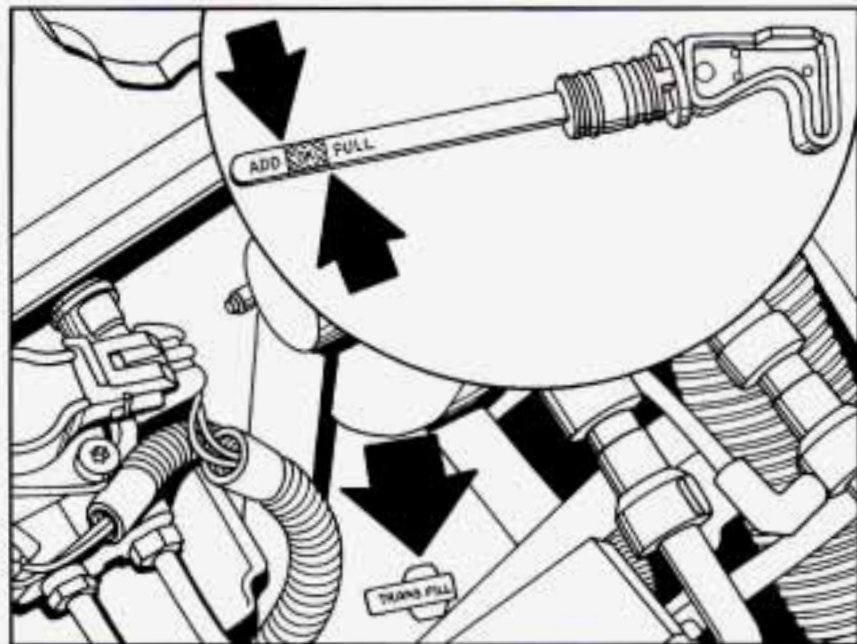

1. Flip the handle up and then pull out the dipstick and clean it with a rag or paper towel.

2. Push it back in all the way and remove it.
3. Check both sides of the dipstick and read the lower level. The fluid level must be between the ADD and FULL marks. (Note: Fluid may appear at the bottom of the dipstick even when the fluid level is several pints low.)
4. If the fluid level is where it should be, push the dipstick back in all the way and flip the handle down. If the fluid level is low, add more fluid as described in the next steps.

How to Add Fluid

Here's how to add fluid. Refer to the Maintenance Schedule to determine what kind of fluid to use. See "Recommended Fluids and Lubricants" in the Index.

1. Remove the dipstick by flipping the handle up and then pulling the dipstick out.
2. Add fluid at the dipstick hole.

Add only enough fluid to bring the fluid level up to the FULL mark on the dipstick.
3. Push the dipstick back in all the way; then flip the handle down to lock the dipstick in place.

Hydraulic Clutch

The hydraulic clutch linkage in your vehicle is self-adjusting. The clutch master cylinder reservoir is filled with hydraulic clutch fluid.

It isn't a good idea to "top off" your clutch fluid. Adding fluid won't correct a leak.

A fluid loss in this system could indicate a problem. Have the system inspected and repaired.

When to Check and What to Use

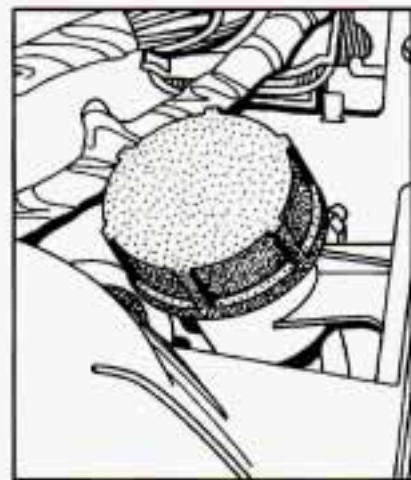

Refer to the Maintenance Schedule to determine how often you should check the fluid level in your clutch master cylinder reservoir and for the proper fluid. See "Owner Checks and Services" and "Recommended Fluids and Lubricants" in the Index.

How to Check

If you can see fluid in the reservoir, the level is acceptable.

Engine Coolant

The following explains your cooling system and how to add coolant when it is low. If you have a problem with engine overheating, see "Engine Overheating" in the Index.

The proper coolant for your Oldsmobile will:

- Give freezing protection down to -34°F (-37°C).
- Give boiling protection up to 262°F (128°C).
- Protect against rust and corrosion.
- Help keep the proper engine temperature.
- Let the warning lights work as they should.

What to Use

Use a mixture of one-half *clean water* (preferably distilled) and one-half antifreeze that meets "GM Specification 1825M," which won't damage aluminum parts. You can also use a recycled coolant conforming to GM Specification 1825M with a complete coolant flush and refill. Use GM Engine Coolant Supplement (sealer) with any complete coolant flush and refill. If you use this mixture, you don't need to add anything else.

CAUTION:

Adding only plain water to your cooling system can be dangerous. Plain water, or some other liquid like alcohol, can boil before the proper coolant mix will. Your vehicle's coolant warning system is set for the proper coolant mix. With plain water or the wrong mix, your engine could get too hot but you wouldn't get the overheat warning. Your engine could catch fire and you or others could be burned. Use a 50/50 mix of clean water and a proper antifreeze.

NOTICE:

If you use an improper coolant mix, your engine could overheat and be badly damaged. The repair cost wouldn't be covered by your warranty. Too much water in the mix can freeze and crack the engine, radiator, heater core and other parts.

Adding Coolant

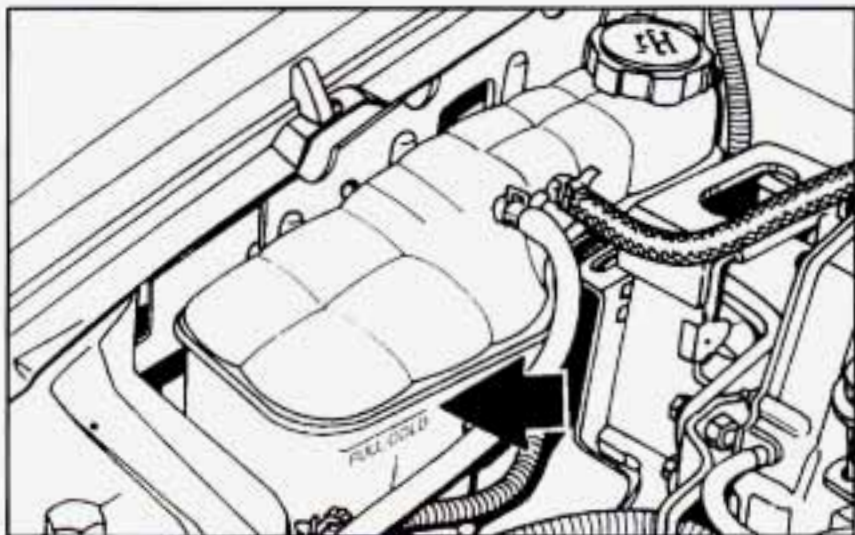

To Check Coolant

CAUTION:

Turning the surge tank pressure cap when the engine and radiator are hot can allow steam and scalding liquids to blow out and burn you badly. Never turn the surge tank pressure cap -- even a little -- when the engine and radiator are hot.

When your engine is cold, the coolant level should be at the FULL COLD mark.

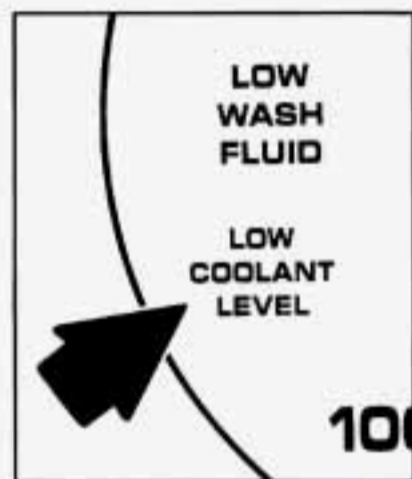

If this light comes on, it means you're low on engine coolant.

To Add Coolant

If you need more coolant, add the proper mix *at the surge tank*, but only when the engine is cool.

CAUTION:

You can be burned if you spill coolant on hot engine parts. Coolant contains ethylene glycol, and it will burn if the engine parts are hot enough. Don't spill coolant on a hot engine.

When replacing the pressure cap, make sure it is tight.

Surge Tank Pressure Cap

NOTICE:

Your pressure cap is an 18 psi (124 kPa) pressure-type cap and must be tightly installed to prevent coolant loss and possible engine damage from overheating.

When you replace your surge tank pressure cap, a GM cap is recommended.

Thermostat

Engine coolant temperature is controlled by a thermostat in the engine coolant system. The thermostat stops the flow of coolant through the radiator until the coolant reaches a preset temperature.

When you replace your thermostat, an AC[®] thermostat is recommended.

Power Steering Fluid



How To Check Power Steering Fluid

When the engine compartment is cool, unscrew the cap and wipe the dipstick with a clean rag. Replace the cap and completely tighten it. Then remove the cap again and look at the fluid level on the dipstick.

The level should be at the FULL COLD mark. Add enough fluid to bring the level up to the mark.

A fluid loss in this system could indicate a problem. Have the system inspected and repaired.

What to Add

Refer to the Maintenance Schedule to determine what kind of fluid to use. See “Recommended Fluids and Lubricants” in the Index.

NOTICE:

When adding power steering fluid or making a complete fluid change, always use the proper fluid. Failure to use the proper fluid can cause leaks and damage hoses and seals.

Windshield Washer Fluid

What to Use

When you need windshield washer fluid, be sure to read the manufacturer's instructions before use. If you will be operating your vehicle in an area where the temperature may fall below freezing, use a fluid that has sufficient protection against freezing.

To Add

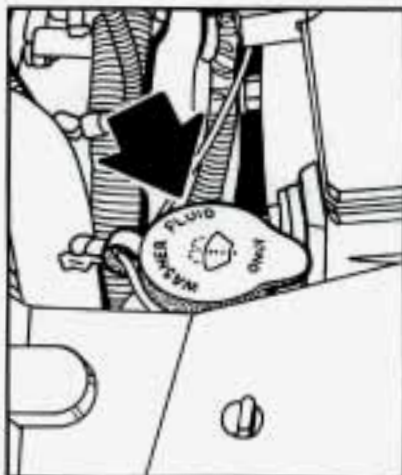

Open the cap labeled WASHER FLUID ONLY. Add washer fluid until the tank is full.

NOTICE:

- When using concentrated washer fluid, follow the manufacturer's instructions for adding water.
- Don't mix water with ready-to-use washer fluid. Water can cause the solution to freeze and damage your washer fluid tank and other parts of the washer system. Also, water doesn't clean as well as washer fluid.
- Fill your washer fluid tank only 3/4 full when it's very cold. This allows for expansion, which could damage the tank if it is completely full.
- Don't use radiator antifreeze in your windshield washer. It can damage your washer system and paint.

Brakes

Brake Master Cylinder



Your brake master cylinder is here. It is filled with DOT-3 brake fluid.

There are only two reasons why the brake fluid level in your master cylinder might go down. The first is that the brake fluid goes down to an acceptable level during normal brake lining wear. When new linings are put in, the fluid level goes back up. The other reason is that fluid is leaking out of the brake system. If it is, you should have your brake system fixed, since a leak means

that sooner or later your brakes won't work well, or won't work at all. So, it isn't a good idea to "top off" your brake fluid. Adding brake fluid won't correct a leak. If you add fluid when your linings are worn, then you'll have too much fluid when you get new brake linings. You should add (or remove) brake fluid, as necessary, only when work is done on the brake hydraulic system.



CAUTION:

If you have too much brake fluid, it can spill on the engine. The fluid will burn if the engine is hot enough. You or others could be burned, and your vehicle could be damaged. Add brake fluid only when work is done on the brake hydraulic system.

When your brake fluid falls to a low level, your brake warning light will come on. See "Brake System Warning Light" in the Index.

What to Add

When you do need brake fluid, use only DOT-3 brake fluid -- such as Delco Supreme 11[®] (GM Part No. 1052535). Use new brake fluid from a sealed container only, and always clean the brake fluid reservoir cap before removing it.

NOTICE:

- **Don't let someone put in the wrong kind of fluid. For example, just a few drops of mineral-based oil, such as engine oil, in your brake system can damage brake system parts so badly that they'll have to be replaced.**
- **Brake fluid can damage paint, so be careful not to spill brake fluid on your vehicle. If you do, wash it off immediately. See "Appearance Care" in the Index.**

Brake Wear

Your Oldsmobile has front disc brakes and rear drum brakes.

Disc brake pads have built-in wear indicators that make a high-pitched warning sound when the brake pads are worn and new pads are needed. The sound may come and go or be heard all the time your vehicle is moving (except when you are pushing on the brake pedal firmly).



CAUTION:

The brake wear warning sound means that sooner or later your brakes won't work well. That could lead to an accident. When you hear the brake wear warning sound, have your vehicle serviced.

NOTICE:

Continuing to drive with worn-out brake pads could result in costly brake repair.

Some driving conditions or climates may cause a brake squeal when the brakes are first applied or lightly applied. This does not mean something is wrong with your brakes.

Your rear drum brakes don't have wear indicators, but if you ever hear a rear brake rubbing noise, have the rear brake linings inspected. Also, the rear brake drums should be removed and inspected each time the tires are removed for rotation or changing. When you have the front brakes replaced, have the rear brakes inspected, too.

Brake linings should always be replaced as complete axle sets.

Brake Pedal Travel

See your retailer if the brake pedal does not return to normal height, or if there is a rapid increase in pedal travel. This could be a sign of brake trouble.

Brake Adjustment

Every time you make a moderate brake stop, your disc brakes adjust for wear. If you rarely make a moderate or heavier stop, then your brakes might not adjust correctly. If you drive in that way, then -- very carefully -- make a few moderate brake stops about every 1,000 miles (1600 km), so your brakes will adjust properly.

If your brake pedal goes down farther than normal, your rear drum brakes may need adjustment. Adjust them by backing up and firmly applying the brakes a few times.

Replacing Brake System Parts

The braking system on a modern vehicle is complex. Its many parts have to be of top quality and work well together if the vehicle is to have really good braking. Vehicles we design and test have top-quality GM brake parts in them, as your Oldsmobile does when it is new. When you replace parts of your braking system -- for example, when your brake linings wear down and you have to have new ones put in -- be sure you get new genuine GM replacement parts. If you don't, your brakes may no longer work properly. For example, if someone puts in brake linings that are wrong for your vehicle, the balance between your front and rear brakes can change -- for the worse. The braking performance you've come to expect can change in many other ways if someone puts in the wrong replacement brake parts.

Battery

Every new Oldsmobile has a Delco Freedom[®] battery. You never have to add water to one of these. When it's time for a new battery, we recommend a Delco Freedom[®] battery. Get one that has the replacement number shown on the original battery's label.

Vehicle Storage

If you're not going to drive your vehicle for 25 days or more, take off the black, negative (-) cable from the battery. This will help keep your battery from running down.



CAUTION:

Batteries have acid that can burn you and gas that can explode. You can be badly hurt if you aren't careful. See "Jump Starting" in the Index for tips on working around a battery without getting hurt.

Contact your retailer to learn how to prepare your vehicle for longer storage periods.

Halogen Bulbs



CAUTION:

Halogen bulbs have pressurized gas inside and can burst if you drop or scratch the bulb. You or others could be injured. Take special care when handling and disposing of halogen bulbs.

Headlamp Bulb Replacement

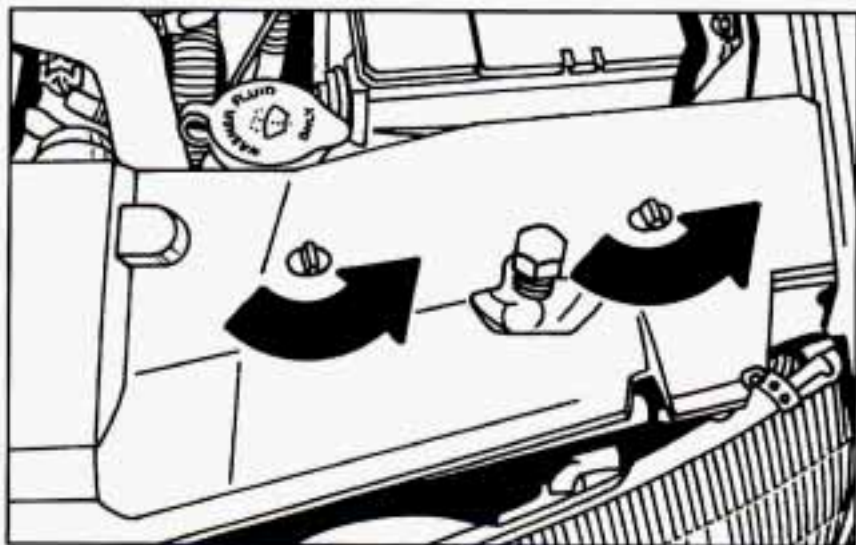

For the type of bulb, see the Index under Replacement Bulbs.

1. On the driver's side only, unscrew the butterfly fasteners. Then lift the plate.

Both Sides:

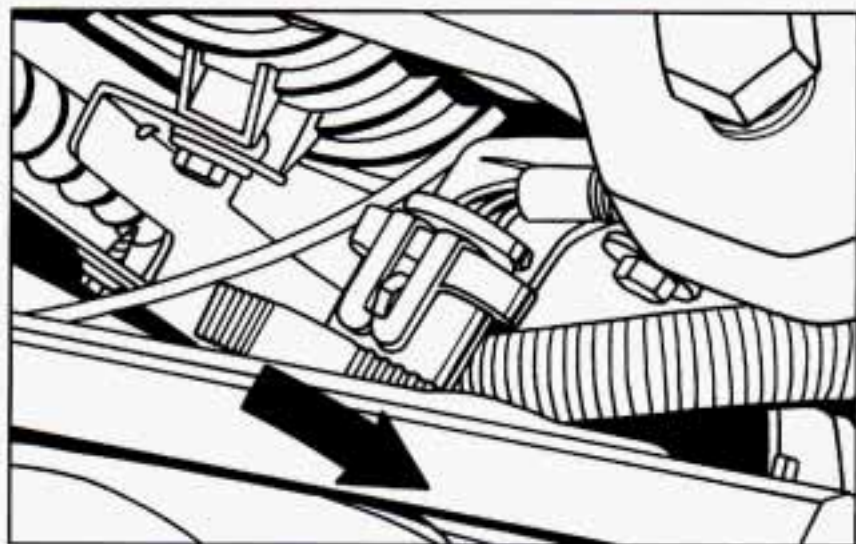

2. Twist the lock ring clockwise $1/6$ turn and pull out the bulb assembly.

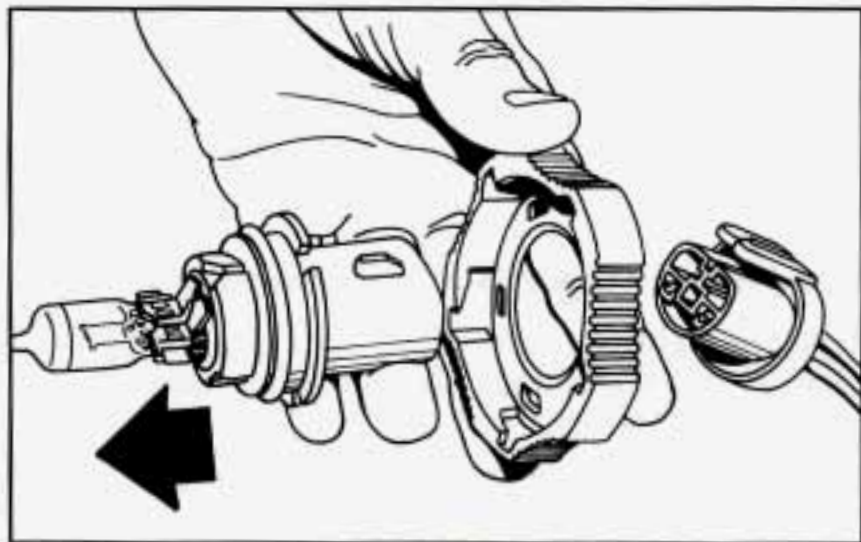

3. Unclip the bulb assembly from the wiring harness.
4. Reverse steps 1-3 to replace the bulb assembly and headlamp housing.

Taillamp Bulb Replacement

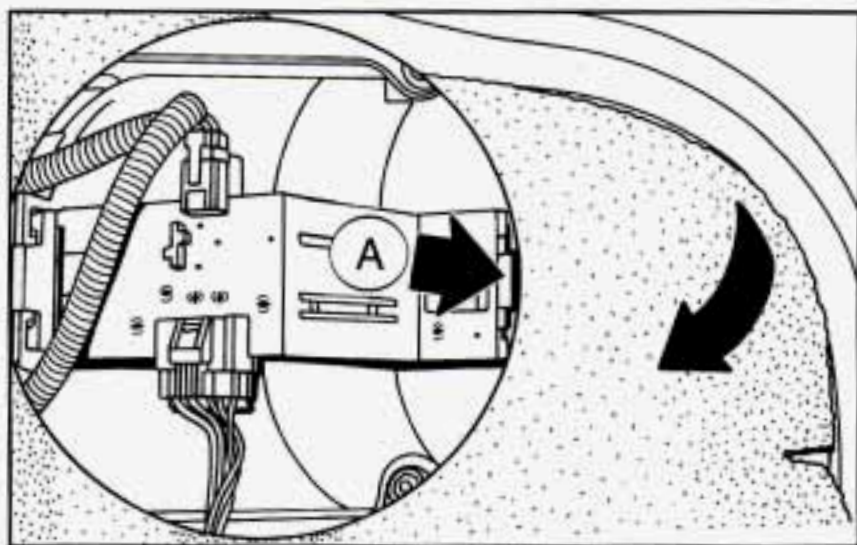

For the type of bulb, see the Index under Replacement Bulbs.

1. Pull back the trunk trim.
2. Carefully pull tab A of the plastic taillamp bracket away from the center of the trunk, then forward. When the bracket releases from its mount, pull the taillamp assembly forward.

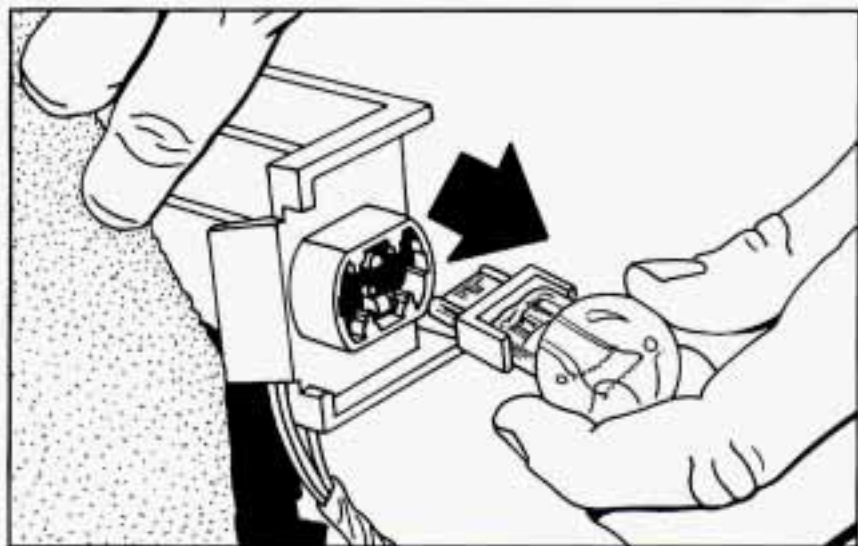

3. Wiggle the bulb out of the socket.
4. Replace the bulb.
5. Reverse the steps to reassemble the taillamp.

Fog Lamp Bulb Replacement

If you have fog lamps, don't change your fog lamp bulbs unless you have the proper aiming equipment. See your Oldsmobile retailer if you have any further questions.

Windshield Wiper Blade Replacement

Replacement blades come in different types and are removed in different ways. Here's how to remove the type with a release clip:

1. Pull the windshield wiper arm away from the windshield.
2. Lift the release clip with a screwdriver and pull the blade assembly off the wiper arm.
3. Push the new wiper blade securely on the wiper arm.

Tires

We don't make tires. Your new vehicle comes with high quality tires made by a leading tire manufacturer. These tires are warranted by the tire manufacturers and their warranties are delivered with every new Oldsmobile. If your spare tire is a different brand than your road tires, you will have a tire warranty folder from each of these manufacturers.



CAUTION:

Poorly maintained and improperly used tires are dangerous.

- **Overloading your tires can cause overheating as a result of too much friction. You could have an air-out and a serious accident. See "Loading Your Vehicle" in the Index.**
- **Underinflated tires pose the same danger as overloaded tires. The resulting accident could cause serious injury. Check all tires frequently to maintain the recommended pressure. Tire pressure should be checked when your tires are cold.**
- **Overinflated tires are more likely to be cut, punctured, or broken by a sudden impact, such as when you hit a pothole. Keep tires at the recommended pressure.**
- **Worn, old tires can cause accidents. If your tread is badly worn, or if your tires have been damaged, replace them.**

Inflation - Tire Pressure

The Tire-Loading Information label which is on the rear edge of the driver's door shows the correct inflation pressures for your tires, when they're cold. "Cold" means your vehicle has been sitting for at least three hours or driven no more than a mile.

NOTICE:

Don't let anyone tell you that underinflation or overinflation is all right. It's not. If your tires don't have enough air (underinflation) you can get:

- Too much flexing
- Too much heat
- Tire overloading
- Bad wear
- Bad handling
- Bad fuel economy.

If your tires have too much air (overinflation), you can get:

- Unusual wear
- Bad handling
- Rough ride
- Needless damage from road hazards.

When to Check

Check your tires once a month or more.

Don't forget your compact spare tire. It should be at 60 psi (420 kPa).

How to Check

Use a good quality pocket-type gage to check tire pressure. Simply looking at the tires will not tell you the pressure, especially if you have radial tires -- which may look properly inflated even if they're underinflated.

If your tires have valve caps, be sure to put them back on. They help prevent leaks by keeping out dirt and moisture.

Tire Inspection and Rotation

Tires should be inspected every 6,000 to 8,000 miles (10 000 to 13 000 km) for any signs of unusual wear. If unusual wear is present, rotate your tires as soon as possible and check wheel alignment. Also check for damaged tires or wheels. See “When it’s Time for New Tires” and “Wheel Replacement” later in this section for more information.

The purpose of regular rotation is to achieve more uniform wear for all tires on the vehicle. The first rotation is the most important. See “Scheduled Maintenance Services” in the Index for scheduled rotation intervals.

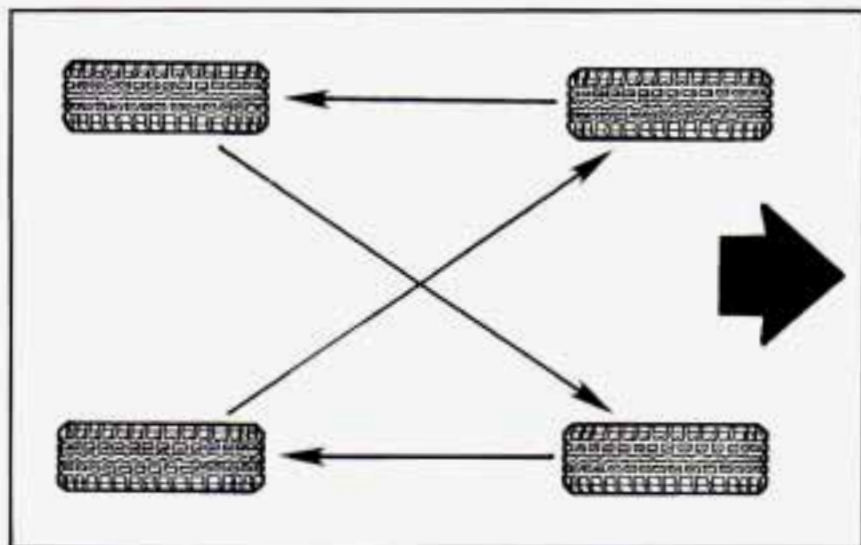

When rotating your tires, always use the correct rotation pattern shown here.

Don't include the compact spare tire in your tire rotation.

After the tires have been rotated, adjust the front and rear inflation pressures as shown on the Tire-Loading Information label. Make certain that all wheel nuts are properly tightened. See "Wheel Nut Torque" in the Index.

⚠ CAUTION:

Rust or dirt on a wheel, or on the parts to which it is fastened, can make wheel nuts become loose after a time. The wheel could come off and cause an accident. When you change a wheel, remove any rust or dirt from places where the wheel attaches to the vehicle. In an emergency, you can use a cloth or a paper towel to do this; but be sure to use a scraper or wire brush later, if you need to, to get all the rust or dirt off. (See "Changing a Flat Tire" in the Index.)

When it's Time for New Tires

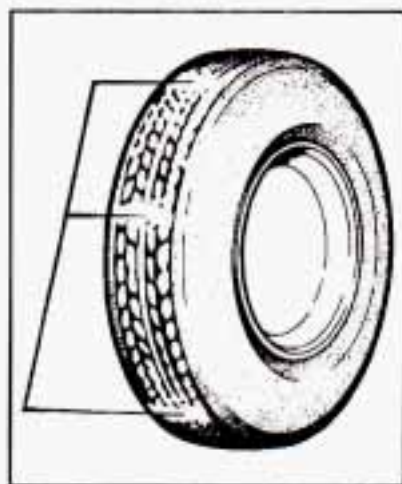

One way to tell when it's time for new tires is to check the treadwear indicators, which will appear when your tires have only 1/16 inch (1.6 mm) or less of tread remaining.

You need a new tire if:

- You can see the indicators at three or more places around the tire.
- You can see cord or fabric showing through the tire's rubber.
- The tread or sidewall is cracked, cut or snagged deep enough to show cord or fabric.

- The tire has a bump, bulge or split.
- The tire has a puncture, cut, or other damage that can't be repaired well because of the size or location of the damage.

Buying New Tires

To find out what kind and size of tires you need, look at the Tire-Loading Information label.

The tires installed on your vehicle when it was new had a Tire Performance Criteria Specification (TPC Spec) number on each tire's sidewall. When you get new tires, get ones with that same TPC Spec number. That way, your vehicle will continue to have tires that are designed to give proper endurance, handling, speed rating, traction, ride and other things during normal service on your vehicle. If your tires have an all-season tread design, the TPC number will be followed by an "MS" (for mud and snow).

If you ever replace your tires with those not having a TPC Spec number, make sure they are the same size, load range, speed rating and construction type (bias, bias-belted or radial) as your original tires.



CAUTION:

Mixing tires could cause you to lose control while driving. If you mix tires of different sizes or types (radial and bias-belted tires), the vehicle may not handle properly, and you could have a crash. Be sure to use the same size and type tires on all four wheels.

It's all right to drive with your compact spare, though. It was developed for use on your vehicle.

Uniform Tire Quality Grading

The following information relates to the system developed by the United States National Highway Traffic Safety Administration which grades tires by treadwear, traction and temperature performance. (This applies only to vehicles sold in the United States.)

Treadwear

The treadwear grade is a comparative rating based on the wear rate of the tire when tested under controlled conditions on a specified government test course. For example, a tire graded 150 would wear one and a half (1 1/2) times as well on the government course as a tire graded 100. The relative performance of tires depends upon the actual conditions of their use, however, and may depart significantly from the norm due to variations in driving habits, service practices and differences in road characteristics and climate.

Traction - A, B, C

The traction grades, from highest to lowest are: A, B, and C. They represent the tire's ability to stop on wet pavement as measured under controlled conditions on specified government test surfaces of asphalt and concrete. A tire marked C may have poor traction performance.

Warning: The traction grade assigned to this tire is based on braking (straight-ahead) traction tests and does not include cornering (turning) traction.

Temperature - A, B, C

The temperature grades are A (the highest), B, and C, representing the tire's resistance to the generation of heat and its ability to dissipate heat when tested under controlled conditions on a specified indoor laboratory test wheel. Sustained high temperature can cause the material of the tire to degenerate and reduce tire life, and excessive temperature can lead to sudden tire failure. The grade C corresponds to a level of performance which all passenger car tires must meet under the Federal Motor Vehicle Safety Standard No. 109. Grades B and A represent higher levels of performance on the laboratory test wheel than the minimum required by law.

Warning: The temperature grade for this tire is established for a tire that is properly inflated and not overloaded. Excessive speed, underinflation, or excessive loading, either separately or in combination, can cause heat buildup and possible tire failure.

These grades are molded on the sidewalls of passenger car tires.

While the tires available as standard or optional equipment on General Motors vehicles may vary with respect to these grades, all such tires meet General Motors performance standards and have been approved for use on General Motors vehicles. All passenger type (P Metric) tires must conform to Federal safety requirements in addition to these grades.

Wheel Alignment and Tire Balance

The wheels on your vehicle were aligned and balanced carefully at the factory to give you the longest tire life and best overall performance.

In most cases, you will not need to have your wheels aligned again. However, if you notice unusual tire wear or your vehicle pulling one way or the other, the alignment may need to be reset. If you notice your vehicle vibrating when driving on a smooth road, your wheels may need to be rebalanced.

Wheel Replacement

Replace any wheel that is bent, cracked, or badly rusted or corroded. If wheel nuts keep coming loose, the wheel, wheel bolts, and wheel nuts should be replaced. If the wheel leaks air, replace it (except some aluminum wheels, which can sometimes be repaired). See your Oldsmobile retailer if any of these conditions exist.

Your retailer will know the kind of wheel you need.

Each new wheel should have the same load carrying capacity, diameter, width, offset, and be mounted the same way as the one it replaces.

If you need to replace any of your wheels, wheel bolts, or wheel nuts, replace them only with new GM original equipment parts. This way, you will be sure to have the right wheel, wheel bolts, and wheel nuts for your Oldsmobile model.

 **CAUTION:**

Using the wrong replacement wheels, wheel bolts, or wheel nuts on your vehicle can be dangerous. It could affect the braking and handling of your vehicle, make your tires lose air and make you lose control. You could have a collision in which you or others could be injured. Always use the correct wheel, wheel bolts, and wheel nuts for replacement.

NOTICE:

The wrong wheel can also cause problems with bearing life, brake cooling, speedometer/odometer calibration, headlamp aim, bumper height, vehicle ground clearance, and tire or tire chain clearance to the body and chassis.

Used Replacement Wheels

 **CAUTION:**

Putting a used wheel on your vehicle is dangerous. You can't know how it's been used or how many miles it's been driven. It could fail suddenly and cause an accident. If you have to replace a wheel use a new GM original equipment wheel.

Tire Chains

NOTICE:

If your Oldsmobile has P195/65R15 or P205/55R16 size tires, don't use tire chains; they can damage your vehicle.

If you have other tires, use tire chains only where legal and only when you must. Use only SAE Class "S" type chains that are the proper size for your tires. Install them on the front tires and tighten them as tightly as possible with the ends securely fastened. Drive slowly and follow the chain manufacturer's instructions. If you can hear the chains contacting your vehicle, stop and retighten them. If the contact continues, slow down until it stops. Driving too fast or spinning the wheels with chains on will damage your vehicle.

Appearance Care

Remember, cleaning products can be hazardous. Some are toxic. Others can burst into flame if you strike a match or get them on a hot part of the vehicle. Some are dangerous if you breathe their fumes in a closed space. When you use anything from a container to clean your Oldsmobile, be sure to follow the manufacturer's warnings and instructions. And always open your doors or windows when you're cleaning the inside.

Never use these to clean your vehicle:

- Gasoline
- Benzene
- Naphtha
- Carbon Tetrachloride
- Acetone
- Paint Thinner
- Turpentine
- Lacquer Thinner
- Nail Polish Remover

They can all be hazardous -- some more than others -- and they can all damage your vehicle, too.

Don't use any of these unless this manual says you can. In many uses, these will damage your vehicle:

- Alcohol
- Laundry Soap
- Bleach
- Reducing Agents

Cleaning the Inside of Your Oldsmobile

Use a vacuum cleaner often to get rid of dust and loose dirt. Wipe vinyl or leather with a clean, damp cloth.

Your Oldsmobile retailer has two GM cleaners, a solvent-type spot lifter and a foam-type powdered cleaner. They will clean normal spots and stains very well. Do not use them on vinyl or leather.

Here are some cleaning tips:

- Always read the instructions on the cleaner label.
- Clean up stains as soon as you can -- before they set.
- Use a clean cloth or sponge, and change to a clean area often. A soft brush may be used if stains are stubborn.
- Use solvent-type cleaners in a well-ventilated area only. If you use them, don't saturate the stained area.
- If a ring forms after spot cleaning, clean the entire area immediately or it will set.

Using Foam-Type Cleaner on Fabric

- Vacuum and brush the area to remove any loose dirt.
- Always clean a whole trim panel or section. Mask surrounding trim along stitch or welt lines.
- Mix Multi-Purpose Powdered Cleaner following the directions on the container label.
- Use suds only and apply with a clean sponge.
- Don't saturate the material.
- Don't rub it roughly.
- As soon as you've cleaned the section, use a sponge to remove the suds.
- Rinse the section with a clean, wet sponge.
- Wipe off what's left with a slightly damp paper towel or cloth.
- Then dry it immediately with a blow dryer or a heat lamp.

NOTICE:

Be careful. A blow dryer may scorch the fabric.

- Wipe with a clean cloth.

Using Solvent-Type Cleaner on Fabric

First, see if you have to use solvent-type cleaner at all. Some spots and stains will clean off better with just water and mild soap.

If you need to use a solvent:

- Gently scrape excess soil from the trim material with a clean, dull knife or scraper. Use very little cleaner, light pressure and clean cloths (preferably cheesecloth). Cleaning should start at the outside of the stain, "feathering" toward the center. Keep changing to a clean section of the cloth.
- When you clean a stain from fabric, immediately dry the area with a blow dryer to help prevent a cleaning ring. (See the previous NOTICE.)

Special Cleaning Problems

Greasy or Oily Stains

Stains caused by grease, oil, butter, margarine, shoe polish, coffee with cream, chewing gum, cosmetic creams, vegetable oils, wax crayon, tar and asphalt can be removed as follows:

- Carefully scrape off excess stain.
- Follow the solvent-type instructions described earlier.
- Shoe polish, wax crayon, tar and asphalt will stain if left on a vehicle seat fabric. They should be removed as soon as possible. Be careful, because the cleaner will dissolve them and may cause them to spread.

Non-Greasy Stains

Stains caused by catsup, coffee (black), egg, fruit, fruit juice, milk, soft drinks, wine, vomit, urine and blood can be removed as follows:

- Carefully scrape off excess stain, then sponge the soiled area with cool water.
- If a stain remains, follow the foam-type instructions described earlier.
- If an odor lingers after cleaning vomit or urine, treat the area with a water/baking soda solution: 1 teaspoon (5 ml) of baking soda to 1 cup (250 ml) of lukewarm water.
- If needed, clean lightly with solvent-type cleaner.

Combination Stains

Stains caused by candy, ice cream, mayonnaise, chili sauce and unknown stains can be removed as follows:

- Carefully scrape off excess stain, then clean with cool water and allow to dry.
- If a stain remains, clean it with solvent-type cleaner.

Cleaning Vinyl

Use warm water and a clean cloth.

- Rub with a clean, damp cloth to remove dirt. You may have to do it more than once.
- Things like tar, asphalt and shoe polish will stain if you don't get them off quickly. Use a clean cloth and a GM Vinyl/Leather Cleaner or equivalent product.

Cleaning Leather

Use a soft cloth with lukewarm water and a mild soap or saddle soap.

- For stubborn stains, use a GM Vinyl/Leather Cleaner or equivalent product.
- *Never* use oils, varnishes, solvent-based or abrasive cleaners, furniture polish or shoe polish on leather.
- Soiled leather should be cleaned immediately. If dirt is allowed to work into finish, it can harm the leather.

Cleaning the Top of the Instrument Panel

Use only mild soap and water to clean the top surfaces of the instrument panel. Sprays containing silicones or waxes may cause annoying reflections in the windshield and even make it difficult to see through the windshield under certain conditions.

Care of Safety Belts

Keep belts clean and dry.

CAUTION:

Do not bleach or dye safety belts. If you do, it may severely weaken them. In a crash they might not be able to provide adequate protection. Clean safety belts only with mild soap and lukewarm water.

Glass

Glass should be cleaned often. GM Glass Cleaner (GM Part No. 1050427) or a liquid household glass cleaner will remove normal tobacco smoke and dust films.

Don't use abrasive cleaners on glass, because they may cause scratches. Avoid placing decals on the inside rear window, since they may have to be scraped off later. If abrasive cleaners are used on the inside of the rear window, an electric defogger element may be damaged. Any temporary license should not be attached across the defogger grid.

Cleaning the Outside of the Windshield and Wiper Blades

If the windshield is not clear after using the windshield washer, or if the wiper blade chatters when running, wax or other material may be on the blade or windshield.

Clean the outside of the windshield with GM Windshield Cleaner, Bon-Ami Powder[®] (GM Part No. 1050011). The windshield is clean if beads do not form when you rinse it with water.

Clean the blade by wiping vigorously with a cloth soaked in full strength windshield washer solvent. Then rinse the blade with water.

Wiper blades should be checked on a regular basis and replaced when worn.

Weatherstrips

Silicone grease on weatherstrips will make them last longer, seal better, and not stick or squeak. Apply silicone grease with a clean cloth at least every six months. During very cold, damp weather more frequent application may be required. (See "Recommended Fluids and Lubricants" in the Index.)

Cleaning the Outside of Your Oldsmobile

The paint finish on your vehicle provides beauty, depth of color, gloss retention and durability.

Washing Your Vehicle

The best way to preserve your vehicle's finish is to keep it clean by washing it often with lukewarm or cold water.

Don't wash your vehicle in the direct rays of the sun. Don't use strong soaps or chemical detergents. Use liquid hand, dish or car washing (mild detergent) soaps. Don't use cleaning agents that are petroleum based, or that contain acid or abrasives. All cleaning agents should be flushed promptly and not allowed to dry on the surface, or they could stain. Dry the finish with a soft, clean chamois or a 100% cotton towel to avoid surface scratches and water spotting.

High pressure vehicle washes may cause water to enter your vehicle.

Finish Care

Occasional waxing or mild polishing of your Oldsmobile by hand may be necessary to remove residue from the paint finish. You can get GM approved cleaning products from your retailer. (See "Appearance Care and Materials" in the Index.)

Your Oldsmobile has a "basecoat/clearcoat" paint finish. The clearcoat gives more depth and gloss to the colored basecoat. Always use waxes and polishes that are non-abrasive and made for a basecoat/clearcoat paint finish.

NOTICE:

Machine compounding or aggressive polishing on a basecoat/clearcoat paint finish may dull the finish or leave swirl marks.

Foreign materials such as calcium chloride and other salts, ice melting agents, road oil and tar, tree sap, bird droppings, chemicals from industrial chimneys, etc. can damage your vehicle's finish if they remain on painted surfaces. Wash the vehicle as soon as possible. If necessary, use non-abrasive cleaners that are marked safe for painted surfaces to remove foreign matter.

Exterior painted surfaces are subject to aging, weather and chemical fallout that can take their toll over a period of years. You can help to keep the paint finish looking new by keeping your Oldsmobile garaged or covered whenever possible.

Aluminum Wheels (If So Equipped)

Your aluminum wheels have a protective coating similar to the painted surface of your vehicle. Don't use strong soaps, chemicals, chrome polish, abrasive cleaners or abrasive cleaning brushes on them because you could damage this coating. After rinsing thoroughly, a wax may be applied.

NOTICE:

If you have aluminum wheels, don't use an automatic vehicle wash that has hard silicon carbide cleaning brushes. These brushes can take the protective coating off your aluminum wheels.

Tires

To clean your tires, use a stiff brush with a tire cleaner. When applying a tire dressing always take care to wipe off any overspray or splash from painted surfaces. Petroleum-based products may damage the paint finish.

Sheet Metal Damage

If your vehicle is damaged and requires sheet metal repair or replacement, make sure the body repair shop applies anti-corrosion material to the parts repaired or replaced to restore corrosion protection.

Finish Damage

Any stone chips, fractures or deep scratches in the finish should be repaired right away. Bare metal will corrode quickly and may develop into a major repair expense.

Minor chips and scratches can be repaired with touch-up materials available from your retailer or other service outlets. Larger areas of finish damage can be corrected in your retailer's body and paint shop.

Underbody Maintenance

Chemicals used for ice and snow removal and dust control can collect on the underbody. If these are not removed, accelerated corrosion (rust) can occur on the underbody parts such as fuel lines, frame, floor pan, and exhaust system even though they have corrosion protection.

At least every spring, flush these materials from the underbody with plain water. Clean any areas where mud and other debris can collect. Dirt packed in closed areas of the frame should be loosened before being flushed. Your retailer or an underbody vehicle washing system can do this for you.

Chemical Paint Spotting

Some weather and atmospheric conditions can create a chemical fallout. Airborne pollutants can fall upon and attack painted surfaces on your vehicle. This damage can take two forms: blotchy, ringlet-shaped discolorations, and small irregular dark spots etched into the paint surface.

Although no defect in the paint job causes this, Oldsmobile will repair, at no charge to the owner, the surfaces of new vehicles damaged by this fallout condition within 12 months or 12,000 miles (20 000 km) of purchase, whichever comes first.

Appearance Care and Maintenance Materials

You can get these from your GM Parts Department.

PART NUMBER	SIZE	DESCRIPTION	USAGE
12345343	16 oz. (0.473L)	Goodwrench® Liquid Wax	Exterior polish
1052277	12 oz. (0.354L)	Spray-A-Squeak Silicone Grease	Weatherstrips. Stops squeaks
1052863	1 oz. (0.028kg)		
1050172	16 oz. (0.473L)	Tar and Road Oil Remover	Also removes old waxes, polishes
1050173	16 oz. (0.473L)	Chrome Cleaner and Polish	Removes rust and corrosion
1050174	16 oz. (0.473L)	White Sidewall Tire Cleaner	Cleans white and black tires
1050214	32 oz. (0.946L)	Vinyl/Leather Cleaner	Spot and stain removal
1050244	16 oz. (0.473L)	Fabric Cleaner	Spot and stain removal
1050427	23 oz. (0.680L)	Glass Cleaner	Also spot cleans vinyls
1050429	6 lbs. (2.72kg)	Multi-Purpose Powdered Cleaner	Cleans vinyl and cloth, also, tires and mats
1052349	12 oz. (0.340kg)	Lubriplate (White Grease)	For hood, trunk, door hinges and latches
1051055	16 oz. (0.473L)	Preservatone	Vinyl top dressing
1051398*	6 oz. (0.237L)	Spot Lifter	For cloth
1051515	32 oz. (0.946L)	Washer Solvent	Windshield-washing system
1052870	16 oz. (0.473L)	Wash-Wax (conc.)	Exterior wash

* Not recommended for pigskin suede leather.

See your General Motors Parts Departments for these products.

See your Maintenance Schedule for other products.

Vehicle Identification Number (VIN)



This is the legal identifier for your Oldsmobile. It appears on a plate in the front corner of the instrument panel, on the driver's side. You can see it if you look through the windshield from outside your vehicle. The VIN also appears on the Vehicle Certification and Service Parts labels and the certificates of title and registration.

Engine Identification

The eighth character in your VIN is the engine code. This code will help you identify your engine, specifications, and replacement parts.

Service Parts Identification Label

You'll find this label on the bottom of your spare tire cover. It's very helpful if you ever need to order parts. On this label is:

- your VIN,
- the model designation,
- paint information, and
- a list of all production options and special equipment.

Be sure that this label is not removed from the vehicle.

Add-On Electrical Equipment

NOTICE:

Don't add anything electrical to your Oldsmobile unless you check with your retailer first. Some electrical equipment can damage your vehicle and the damage wouldn't be covered by your warranty. Some add-on electrical equipment can keep other components from working as they should.

Your vehicle has an air bag system. Before attempting to add anything electrical to your Oldsmobile, see "Servicing Your Air Bag-Equipped Oldsmobile" in the Index.

Fuses & Circuit Breakers

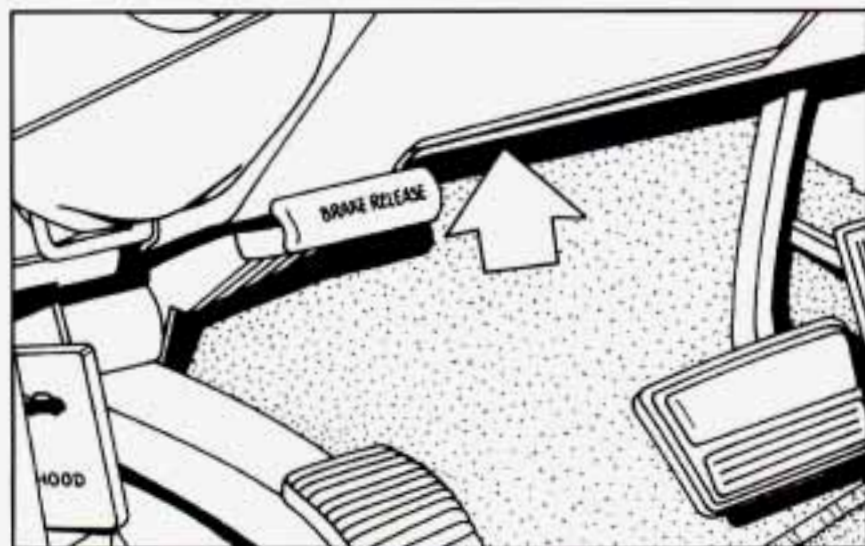

The wiring circuits in your vehicle are protected from short circuits by a combination of fuses and circuit breakers. This greatly reduces the chance of damage caused by electrical problems.

The main fuse panel is located to the left of the steering wheel under the instrument panel. To open, push forward on the tab and pull down.

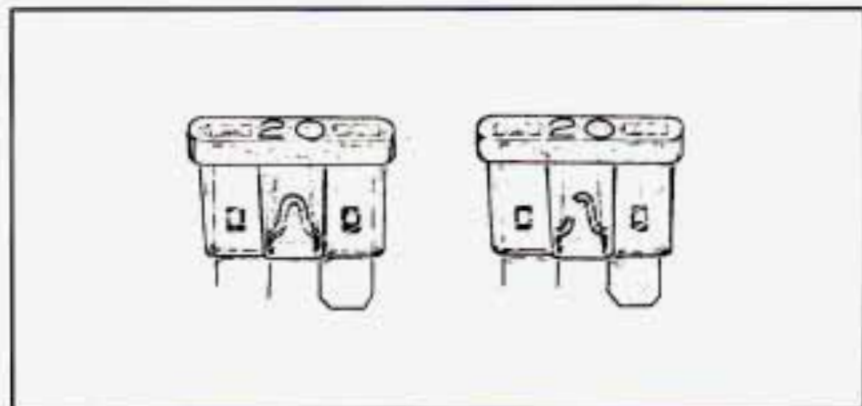

Look at the silver-colored band inside the fuse. If the band is broken or melted, replace the fuse. Be sure you replace a bad fuse with a new one of the correct size.

When finished, replace the cover and pinch the release levers again to unlock the panel. Press it back up into place.

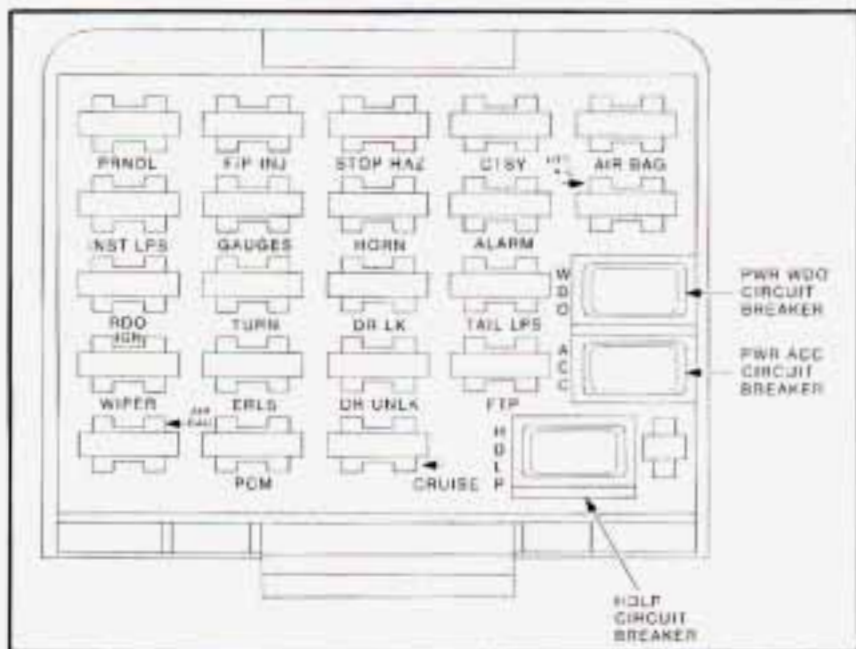

Fuse Usage

Fuse	Circuitry
PRNDL	Electronic PRNDL display (automatic transaxle)
F/P INJ	Fuel Pump, Fuel Injectors
STOP HAZ	Hazard/Stop Lamps
CTSY	Power Door Locks, Power Mirrors, Cigar Lighter
AIR BAG	Supplemental Inflatable Restraint
INST. LPS	Interior Lamps Dimming

Fuse	Circuitry
GAUGES	Rear Window Defogger, Gauges, Warning Lights
HORN	Horn, Fog Lamps
ALARM	Chime, Interior Lamps, Automatic Door Locks, Remote Lock Control
HTR-A/C	Heater, Air Conditioning, Anti-Lock Brakes (ABS), Daytime Running Lamps (DRL) (Canada)
RDO	Radio
TURN	Turn Signals
DR LK	Automatic Door Locks
TAIL LPS	Fog Lamps, Tail Lamps, Marker Lamps, License Lamp
WDO	Power Windows, Sunroof (Circuit Breaker)
WIPER	Windshield Wipers/Washers
ERLS	Engine Controls, Back-Up Lamps
DR UNLK	Automatic Door Unlock (Remove to Disable)
FTP	Flash-to-Pass (U.S.)
ACC	Rear Window Antenna, Power Seats, Rear Window Defogger, Power Sunroof (Circuit Breaker)
AIR BAG	Supplemental Inflatable Restraint
PCM	Powertrain Control Module, Ignition System
CRUISE	Cruise Control
HDLP	Headlamps (Circuit Breaker)

Headlamp Wiring

The headlamp wiring is protected by a circuit breaker in the fuse block. An electrical overload will cause the lights to go on and off or, in some cases, to remain off. If this happens, have your headlamp system checked right away.

Windshield Wipers

The windshield wiper motor is protected by a circuit breaker and a fuse. If the motor overheats due to heavy snow, etc., the wiper will stop until the motor cools. If the overload is caused by some electrical problem, have it fixed.

Power Windows and Other Power Options

Circuit breakers in the fuse panel protect the power windows and other power accessories. When the current load is too heavy, the circuit breaker opens and closes, protecting the circuit until the problem is fixed.

Capacities & Specifications

Engine Crankcase (All Models) 4.5 quarts 4.3 L

Automatic Transaxle, 3-Speed

Pan Removal and Replacement 4.0 quarts 3.8 L

After Complete Overhaul 7.0 quarts 6.6 L

When draining or replacing torque converter, more fluid may be needed.

Automatic Transaxle, 4-Speed

Pan Removal and Replacement 6.0 quarts 5.7 L

After Complete Overhaul 8.0 quarts 7.6 L

When draining or replacing torque converter, more fluid may be needed.

Manual Transaxle, 5-Speed

Complete Drain and Refill 2.0 quarts 1.9 L

Cooling System

2.3L Quad 4 10.4 quarts 9.8 L

3.1L V6 13.1 quarts 12.4 L

Refrigerant (R-134a), Air Conditioning See refrigerant charge label underhood.

Not all air conditioning refrigerants are the same. If the air conditioning system in your vehicle needs refrigerant, be sure the proper refrigerant is used. If you're not sure, ask your Oldsmobile retailer. For additional information, see your "Warranty and Owner Assistance Information" booklet.

Capacities & Specifications

Fuel Tank	15.2 gallons	57.5 L
Power Steering		
Pump Only	1.00 pint	0.50 L
Complete System	2.25 pints	1.25 L
Tire Pressures, Sizes	See Tire-Loading Information label on driver's door.	
Wheel Nut Torque	100 pound-feet	140 N·m

NOTE: All capacities are approximate. When adding, be sure to fill to the appropriate level or as recommended in this manual.

Replacement Bulbs

OUTSIDE LAMPS	BULB
Back-up Lamps	2057
Front Parking/Turn Signal Lamps	2057 NA
License Plate Lamp	194
Center High-Mounted Stoplamp	912
Halogen Headlamps	
Low Beam	9004
High Beam	9004
Fog Lamps	885
Side Marker Lamps	
Front	194 NA
Rear	161
Stop/Tail/Turn Signal Lamps	3057
Trunk Lamp	906
Underhood Lamp	906

INSIDE LAMPS	BULB
Ashtray	161
Front Reading Lamps	
Without Sunroof	168
With Sunroof	214-2
Rear Reading Lamps	168
Underdash Lamps	194
Heater & A/C Control	161
High-Beam Indicator	161
Instrument Cluster Warning Lights	161
Glove Box	161

Engine Specifications

	2.3L Quad 4	3.1L V6
VIN Engine Code	D	M
Type	L4	V6
Displacement	2.3 Liters	3.1 Liters
Compression Ratio	9.5:1	9.6:1
Firing Order	1-3-4-2	1-2-3-4-5-6
Thermostat Temperature	180°F (82°C)	195°F (91°C)

Normal Maintenance Replacement Parts

Air Cleaner Element

All engines AC Type A-1233C

Engine Oil Filter

2.3L Quad 4 AC Type PF-1225

3.1L V6 AC Type PF-47

PCV Valve

3.1L V6 AC Type CV-892C

Spark Plugs

2.3L Quad 4 AC Type 41-910 (Platinum Plug)
Gap: 0.060 inch (1.52 mm)

3.1L V6 AC Type R44LTSM6
Gap: 0.060 inch (1.52 mm)

NOTES



Section 7 Maintenance Schedule

**IMPORTANT:
KEEP ENGINE OIL
AT THE PROPER
LEVEL AND CHANGE AS
RECOMMENDED**

This section covers the maintenance required for your Oldsmobile. Your vehicle needs these services to retain its safety, dependability and emission control performance.



***Protection
Plan***

Have you purchased the GM Protection Plan? The Plan supplements your new vehicle warranties. See your Oldsmobile retailer for details.

Introduction

Your Vehicle and the Environment

Proper vehicle maintenance not only helps to keep your vehicle in good working condition, but also helps the environment. All recommended maintenance procedures are important. Improper vehicle maintenance or the removal of important components can significantly affect the quality of the air we breathe. Improper fluid levels or even the wrong tire inflation can increase the level of emissions from your vehicle. To help protect our environment, and to help keep your vehicle in good condition, please maintain your vehicle properly.

How This Section is Organized

The remainder of this section is divided into five parts:

“Part A: Scheduled Maintenance Services” shows what to have done and how often. Some of these services can be complex, so unless you are technically qualified and have the necessary equipment, you should let your retailer’s service department or another qualified service center do these jobs.



CAUTION:

Performing maintenance work on a vehicle can be dangerous. In trying to do some jobs, you can be seriously injured. Do your own maintenance work only if you have the required know-how and the proper tools and equipment for the job. If you have any doubt, have a qualified technician do the work.

If you are skilled enough to do some work on your vehicle, you will probably want to get the service information GM publishes. See “Service Publications” in the Index.

“Part B: Owner Checks and Services” tells you what should be checked whenever you stop for fuel. It also explains what you can easily do to help keep your vehicle in good condition.

“Part C: Periodic Maintenance Inspections” explains important inspections that your Oldsmobile retailer’s service department or another qualified service center should perform.

“Part D: Recommended Fluids and Lubricants” lists some products GM recommends to help keep your vehicle properly maintained. These products, or their equivalents, should be used whether you do the work yourself or have it done.

“Part E: Maintenance Record” provides a place for you to record the maintenance performed on your vehicle. Whenever any maintenance is performed, be sure to write it down in this part. This will help you determine when your next maintenance should be done. In addition, it is a good idea to keep your maintenance receipts. They may be needed to qualify your vehicle for warranty repairs.

Part A: Scheduled Maintenance Services

Using Your Maintenance Schedule

We at General Motors want to help you keep your vehicle in good working condition. But we don't know exactly how you'll drive it. You may drive very short distances only a few times a week. Or you may drive long distances all the time in very hot, dusty weather. You may use your vehicle in making deliveries. Or you may drive it to work, to do errands or in many other ways.

Because of all the different ways people use their GM vehicles, maintenance needs vary. You may even need more frequent checks and replacements than you'll find in the schedules in this section. So please read this section and note how you drive. If you have any questions on how to keep your vehicle in good condition, see your Oldsmobile retailer.

This part tells you the maintenance services you should have done and when you should schedule them. If you go to your retailer for your service needs, you'll know that GM-trained and supported service people will perform the work using genuine GM parts.

The proper fluids and lubricants to use are listed in Part D. Make sure whoever services your vehicle uses these. All parts should be replaced and all necessary repairs done before you or anyone else drives the vehicle.

These schedules are for vehicles that:

- carry passengers and cargo within recommended limits. You will find these limits on your vehicle's Tire-Loading Information label. See "Loading Your Vehicle" in the Index.
- are driven on reasonable road surfaces within legal driving limits.
- use the recommended unleaded fuel. See "Fuel" in the Index.

Selecting the Right Schedule

First you'll need to decide which of the two schedules is right for your vehicle. Here's how to decide which schedule to follow:

Maintenance Schedule

Schedule I Definition

Follow Maintenance Schedule I if any one of these is true for your vehicle:

- Most trips are less than 5 to 10 miles (8 to 16 km). This is particularly important when outside temperatures are below freezing.
- Most trips include extensive idling (such as frequent driving in stop and go traffic).
- Most trips are through dusty areas.
- You frequently tow a trailer or use a carrier on top of your vehicle. (With some models, you should never tow a trailer. See "Towing a Trailer" in the Index.)

Schedule I should also be followed if the vehicle is used for delivery service, police, taxi, or other commercial application.

Schedule I Intervals

Every 3,000 Miles (5 000 km) or 3 Months, Whichever Occurs First

Engine Oil and Filter Change

Every 6,000 Miles (10 000 km) or 6 Months, Whichever Occurs First

Chassis Lubrication

At 6,000 Miles (10 000 km) - Then Every 12,000 Miles (25 000 km)

Tire Rotation

Every 15,000 Miles (25 000 km)

Air Cleaner Filter Inspection, if driving in dusty conditions

Every 30,000 Miles (50 000 km)

Air Cleaner Filter Replacement

Spark Plug Replacement (except 2.3L Code D engine)

Spark Plug Wire Inspection (except 2.3L Code D engine)

Fuel Tank, Cap and Lines Inspection

Engine Accessory Drive Belt Inspection (or every 24 months, whichever occurs first)

Cooling System Service (or every 24 months, whichever occurs first)

Every 50,000 Miles (83 000 km)

Automatic Transaxle Service (severe conditions only)

Every 100,000 Miles (166 000 km)

Spark Plug Replacement (2.3L Code D engine only)

Maintenance Schedule

Schedule II Definition

Follow Schedule II *only* if none of the conditions from Schedule I is true.

Schedule II Intervals

Every 7,500 Miles (12 500 km)

Engine Oil and Filter Change (or every 12 months, whichever occurs first)

Chassis Lubrication (or every 12 months, whichever occurs first)

At 7,500 Miles (12 500 km) - Then Every 15,000 Miles (25 000 km)

Tire Rotation

Every 30,000 Miles (50 000 km)

Engine Accessory Drive Belt Inspection (or every 24 months, whichever occurs first)

Cooling System Service (or every 24 months, whichever occurs first)

Spark Plug Replacement (except 2.3L Code D engine)

Spark Plug Wire Inspection (except 2.3L Code D engine)

Air Cleaner Filter Replacement

Fuel Tank, Cap and Lines Inspection

Every 50,000 Miles (83 000 km)

Automatic Transaxle Service (severe conditions only)

Every 100,000 Miles (166 000 km)

Spark Plug Replacement (2.3L Code D engine only)

Maintenance Schedule I

The services shown in this schedule up to 100,000 miles (166 000 km) should be performed after 100,000 miles (166 000 km) at the same intervals.

Footnotes

† The U.S. Environmental Protection Agency or the California Air Resources Board has determined that the failure to perform this maintenance item will not nullify the emission warranty or limit recall liability prior to the completion of vehicle useful life. We, however, urge that all recommended maintenance services be performed at the indicated intervals and the maintenance be recorded.

3,000 Miles (5 000 km)

- Change engine oil and filter (or every 3 months, whichever occurs first).
An Emission Control Service.

DATE	ACTUAL MILEAGE	SERVICED BY:

Maintenance Schedule I

6,000 Miles (10 000 km)

- Change engine oil and filter (or every 3 months, whichever occurs first).
An Emission Control Service.
- Lubricate the suspension, steering linkage and transaxle shift linkage (or every 6 months, whichever occurs first).
- Rotate tires. See "Tire Inspection and Rotation" in the Index for proper rotation pattern and additional information.

DATE	ACTUAL MILEAGE	SERVICED BY:

9,000 Miles (15 000 km)

- Change engine oil and filter (or every 3 months, whichever occurs first).
An Emission Control Service.

DATE	ACTUAL MILEAGE	SERVICED BY:

Maintenance Schedule I

12,000 Miles (20 000 km)

- Change engine oil and filter (or every 3 months, whichever occurs first).
An Emission Control Service.
- Lubricate the suspension, steering linkage and transaxle shift linkage (or every 6 months, whichever occurs first).

DATE	ACTUAL MILEAGE	SERVICED BY:

15,000 Miles (25 000 km)

- Change engine oil and filter (or every 3 months, whichever occurs first).
An Emission Control Service.
- Inspect air cleaner filter if you are driving in dusty conditions. Replace filter if necessary. *An Emission Control Service.*

DATE	ACTUAL MILEAGE	SERVICED BY:

Maintenance Schedule I

18,000 Miles (30 000 km)

- Change engine oil and filter (or every 3 months, whichever occurs first).
An Emission Control Service.
- Lubricate the suspension, steering linkage and transaxle shift linkage (or every 6 months, whichever occurs first).
- Rotate tires. See "Tire Inspection and Rotation" in the Index for proper rotation pattern and additional information.

DATE	ACTUAL MILEAGE	SERVICED BY:

21,000 Miles (35 000 km)

- Change engine oil and filter (or every 3 months, whichever occurs first).
An Emission Control Service.

DATE	ACTUAL MILEAGE	SERVICED BY:

Maintenance Schedule I

24,000 Miles (40 000 km)

- Change engine oil and filter (or every 3 months, whichever occurs first).
An Emission Control Service.
- Lubricate the suspension, steering linkage and transaxle shift linkage (or every 6 months, whichever occurs first).

DATE	ACTUAL MILEAGE	SERVICED BY:

27,000 Miles (45 000 km)

- Change engine oil and filter (or every 3 months, whichever occurs first).
An Emission Control Service.

DATE	ACTUAL MILEAGE	SERVICED BY:

Maintenance Schedule I

30,000 Miles (50 000 km)

- Change engine oil and filter (or every 3 months, whichever occurs first).
An Emission Control Service.
- Lubricate the suspension, steering linkage and transaxle shift linkage (or every 6 months, whichever occurs first).
- Inspect engine accessory drive belt (or every 24 months, whichever occurs first).
An Emission Control Service
- Drain, flush and refill cooling system (or every 24 months, whichever occurs first). See "Engine Coolant" in the Index for what to use. Inspect hoses. Clean radiator, condenser, pressure cap and neck. Pressure test the cooling system and pressure cap.
An Emission Control Service.
- Replace spark plugs (except 2.3L Code D engine). *An Emission Control Service.*
- Inspect spark plug wires (except 2.3L Code D engine). *An Emission Control Service.*†
- Replace air cleaner filter. Replace filter more often under dusty conditions.
An Emission Control Service.
- Inspect fuel tank, cap and lines for damage or leaks. Inspect fuel cap gasket for any damage. Replace parts as needed.
An Emission Control Service.†
- Rotate tires. See "Tire Inspection and Rotation" in the Index for proper rotation pattern and additional information.

DATE	ACTUAL MILEAGE	SERVICED BY:

Maintenance Schedule I

33,000 Miles (55 000 km)

- Change engine oil and filter (or every 3 months, whichever occurs first).
An Emission Control Service.

DATE	ACTUAL MILEAGE	SERVICED BY:

36,000 Miles (60 000 km)

- Change engine oil and filter (or every 3 months, whichever occurs first).
An Emission Control Service.
- Lubricate the suspension, steering linkage and transaxle shift linkage (or every 6 months, whichever occurs first).

DATE	ACTUAL MILEAGE	SERVICED BY:

Maintenance Schedule I

39,000 Miles (65 000 km)

- Change engine oil and filter (or every 3 months, whichever occurs first).
An Emission Control Service.

DATE	ACTUAL MILEAGE	SERVICED BY:

42,000 Miles (70 000 km)

- Change engine oil and filter (or every 3 months, whichever occurs first).
An Emission Control Service.
- Lubricate the suspension, steering linkage and transaxle shift linkage (or every 6 months, whichever occurs first).
- Rotate tires. See "Tire Inspection and Rotation" in the Index for proper rotation pattern and additional information.

DATE	ACTUAL MILEAGE	SERVICED BY:

Maintenance Schedule I

45,000 Miles (75 000 km)

- Change engine oil and filter (or every 3 months, whichever occurs first).
An Emission Control Service.
- Inspect air cleaner filter if you are driving in dusty conditions. Replace filter if necessary. *An Emission Control Service.*

DATE	ACTUAL MILEAGE	SERVICED BY:

48,000 Miles (80 000 km)

- Change engine oil and filter (or every 3 months, whichever occurs first).
An Emission Control Service.
- Lubricate the suspension, steering linkage and transaxle shift linkage (or every 6 months, whichever occurs first).

DATE	ACTUAL MILEAGE	SERVICED BY:

Maintenance Schedule I

50,000 Miles (83 000 km)

- Change automatic transaxle fluid and filter if the vehicle is mainly driven under one or more of these conditions:
- In heavy city traffic where the outside temperature regularly reaches 90°F (32°C) or higher.
 - In hilly or mountainous terrain.
 - When doing frequent trailer towing.
 - Uses such as found in taxi, police or delivery service.

If you do not use your vehicle under any of these conditions, the fluid and filter do not require changing.

Manual transaxle fluid doesn't require change.

DATE	ACTUAL MILEAGE	SERVICED BY:

51,000 Miles (85 000 km)

- Change engine oil and filter (or every 3 months, whichever occurs first).
An Emission Control Service.

DATE	ACTUAL MILEAGE	SERVICED BY:

Maintenance Schedule I

54,000 Miles (90 000 km)

- Change engine oil and filter (or every 3 months, whichever occurs first).
An Emission Control Service.
- Lubricate the suspension, steering linkage and transaxle shift linkage (or every 6 months, whichever occurs first).
- Rotate tires. See "Tire Inspection and Rotation" in the Index for proper rotation pattern and additional information.

DATE	ACTUAL MILEAGE	SERVICED BY:

57,000 Miles (95 000 km)

- Change engine oil and filter (or every 3 months, whichever occurs first).
An Emission Control Service.

DATE	ACTUAL MILEAGE	SERVICED BY:

Maintenance Schedule I

60,000 Miles (100 000 km)

- Change engine oil and filter (or every 3 months, whichever occurs first).
An Emission Control Service.
- Lubricate the suspension, steering linkage and transaxle shift linkage (or every 6 months, whichever occurs first).
- Inspect engine accessory drive belt (or every 24 months, whichever occurs first).
An Emission Control Service.
- Drain, flush and refill cooling system (or every 24 months, whichever occurs first). See "Engine Coolant" in the Index for what to use. Inspect hoses. Clean radiator, condenser, pressure cap and neck. Pressure test the cooling system and pressure cap.
An Emission Control Service.

- Replace spark plugs (except 2.3L Code D engine). *An Emission Control Service.*
- Inspect spark plug wires (except 2.3L Code D engine). *An Emission Control Service.* †
- Replace air cleaner filter. Replace filter more often under dusty conditions.
An Emission Control Service.
- Inspect fuel tank, cap and lines for damage or leaks. Inspect fuel cap gasket for any damage. Replace parts as needed.
An Emission Control Service. †

DATE	ACTUAL MILEAGE	SERVICED BY:

Maintenance Schedule I

63,000 Miles (105 000 km)

- Change engine oil and filter (or every 3 months, whichever occurs first).
An Emission Control Service.

DATE	ACTUAL MILEAGE	SERVICED BY:

66,000 Miles (110 000 km)

- Change engine oil and filter (or every 3 months, whichever occurs first).
An Emission Control Service.
- Lubricate the suspension, steering linkage and transaxle shift linkage (or every 6 months, whichever occurs first).
- Rotate tires. See "Tire Inspection and Rotation" in the Index for proper rotation pattern and additional information.

DATE	ACTUAL MILEAGE	SERVICED BY:

Maintenance Schedule I

69,000 Miles (115 000 km)

- Change engine oil and filter (or every 3 months, whichever occurs first).
An Emission Control Service.

DATE	ACTUAL MILEAGE	SERVICED BY:

72,000 Miles (120 000 km)

- Change engine oil and filter (or every 3 months, whichever occurs first).
An Emission Control Service.
- Lubricate the suspension, steering linkage and transaxle shift linkage (or every 6 months, whichever occurs first).

DATE	ACTUAL MILEAGE	SERVICED BY:

Maintenance Schedule I

75,000 Miles (125 000 km)

- Change engine oil and filter (or every 3 months, whichever occurs first).
An Emission Control Service.
- Inspect air cleaner filter if you are driving in dusty conditions. Replace filter if necessary. *An Emission Control Service.*

DATE	ACTUAL MILEAGE	SERVICED BY:

78,000 Miles (130 000 km)

- Change engine oil and filter (or every 3 months, whichever occurs first).
An Emission Control Service.
- Lubricate the suspension, steering linkage and transaxle shift linkage (or every 6 months, whichever occurs first).
- Rotate tires. See "Tire Inspection and Rotation" in the Index for proper rotation pattern and additional information.

DATE	ACTUAL MILEAGE	SERVICED BY:

Maintenance Schedule I

81,000 Miles (135 000 km)

- Change engine oil and filter (or every 3 months, whichever occurs first).
An Emission Control Service.

DATE	ACTUAL MILEAGE	SERVICED BY:

84,000 Miles (140 000 km)

- Change engine oil and filter (or every 3 months, whichever occurs first).
An Emission Control Service.
- Lubricate the suspension, steering linkage and transaxle shift linkage (or every 6 months, whichever occurs first).

DATE	ACTUAL MILEAGE	SERVICED BY:

Maintenance Schedule I

87,000 Miles (145 000 km)

- Change engine oil and filter (or every 3 months, whichever occurs first).
An Emission Control Service.

DATE	ACTUAL MILEAGE	SERVICED BY:

90,000 Miles (150 000 km)

- Change engine oil and filter (or every 3 months, whichever occurs first).
An Emission Control Service.
- Lubricate the suspension, steering linkage and transaxle shift linkage (or every 6 months, whichever occurs first).
- Inspect engine accessory drive belt (or every 24 months, whichever occurs first).
An Emission Control Service.
- Drain, flush and refill cooling system (or every 24 months, whichever occurs first). See "Engine Coolant" in the Index for what to use. Inspect hoses. Clean radiator, condenser, pressure cap and neck. Pressure test the cooling system and pressure cap.
An Emission Control Service.
- Replace spark plugs (except 2.3L Code D engine). *An Emission Control Service.*

(Continued)

Maintenance Schedule I

90,000 Miles (150 000 km) (Continued)

- Inspect spark plug wires (except 2.3L Code D engine). *An Emission Control Service.*†
- Replace air cleaner filter. Replace filter more often under dusty conditions. *An Emission Control Service.*
- Inspect fuel tank, cap and lines for damage or leaks. Inspect fuel cap gasket for any damage. Replace parts as needed. *An Emission Control Service.*†
- Rotate tires. See "Tire Inspection and Rotation" in the Index for proper rotation pattern and additional information.

DATE	ACTUAL MILEAGE	SERVICED BY:

93,000 Miles (155 000 km)

- Change engine oil and filter (or every 3 months, whichever occurs first). *An Emission Control Service.*

DATE	ACTUAL MILEAGE	SERVICED BY:

Maintenance Schedule I

96,000 Miles (160 000 km)

- Change engine oil and filter (or every 3 months, whichever occurs first).
An Emission Control Service.
- Lubricate the suspension, steering linkage and transaxle shift linkage (or every 6 months, whichever occurs first).

DATE	ACTUAL MILEAGE	SERVICED BY:

99,000 Miles (165 000 km)

- Change engine oil and filter (or every 3 months, whichever occurs first).
An Emission Control Service.

DATE	ACTUAL MILEAGE	SERVICED BY:

Maintenance Schedule I

100,000 Miles (166 000 km)

- Replace spark plugs (2.3L Code D engine only). *An Emission Control Service.*
- Change automatic transaxle fluid and filter if the vehicle is mainly driven under one or more of these conditions:
 - In heavy city traffic where the outside temperature regularly reaches 90°F (32°C) or higher.
 - In hilly or mountainous terrain.
 - When doing frequent trailer towing.

- Uses such as found in taxi, police or delivery service.

If you do not use your vehicle under any of these conditions, the fluid and filter do not require changing.

Manual transaxle fluid doesn't require change.

DATE	ACTUAL MILEAGE	SERVICED BY:

Maintenance Schedule II

The services shown in this schedule up to 100,000 miles (166 000 km) should be performed after 100,000 miles (166 000 km) at the same intervals.

Footnotes

† The U.S. Environmental Protection Agency or the California Air Resources Board has determined that the failure to perform this maintenance item will not nullify the emission warranty or limit recall liability prior to the completion of vehicle useful life. We, however, urge that all recommended maintenance services be performed at the indicated intervals and the maintenance be recorded.

7,500 Miles (12 500 km)

- Change engine oil and filter (or every 12 months, whichever occurs first).
An Emission Control Service.
- Lubricate the suspension, steering linkage and transaxle shift linkage (or every 12 months, whichever occurs first).
- Rotate tires. See "Tire Inspection and Rotation" in the Index for proper rotation pattern and additional information.

DATE	ACTUAL MILEAGE	SERVICED BY:

Maintenance Schedule II

15,000 Miles (25 000 km)

- Change engine oil and filter (or every 12 months, whichever occurs first).
An Emission Control Service.
- Lubricate the suspension, steering linkage and transaxle shift linkage (or every 12 months, whichever occurs first).

DATE	ACTUAL MILEAGE	SERVICED BY:

22,500 Miles (37 500 km)

- Change engine oil and filter (or every 12 months, whichever occurs first).
An Emission Control Service.
- Lubricate the suspension, steering linkage and transaxle shift linkage (or every 12 months, whichever occurs first).
- Rotate tires. See "Tire Inspection and Rotation" in the Index for proper rotation pattern and additional information.

DATE	ACTUAL MILEAGE	SERVICED BY:

Maintenance Schedule II

30,000 Miles (50 000 km)

- Change engine oil and filter (or every 12 months, whichever occurs first).
An Emission Control Service.
- Lubricate the suspension, steering linkage and transaxle shift linkage (or every 12 months, whichever occurs first).
- Inspect engine accessory drive belt (or every 24 months, whichever occurs first).
An Emission Control Service.
- Drain, flush and refill cooling system (or every 24 months, whichever occurs first). See "Engine Coolant" in the Index for what to use. Inspect hoses. Clean radiator, condenser, pressure cap and neck. Pressure test the cooling system and pressure cap.
An Emission Control Service.
- Replace spark plugs (except 2.3L Code D engine). *An Emission Control Service.*

- Inspect spark plug wires (except 2.3L Code D engine). *An Emission Control Service.†*
- Replace air cleaner filter. *An Emission Control Service.*
- Inspect fuel tank, cap and lines for damage or leaks. Inspect fuel cap gasket for any damage. Replace parts as needed.
An Emission Control Service.†

DATE	ACTUAL MILEAGE	SERVICED BY:

Maintenance Schedule II

37,500 Miles (62 500 km)

- Change engine oil and filter (or every 12 months, whichever occurs first).
An Emission Control Service.
- Lubricate the suspension, steering linkage and transaxle shift linkage (or every 12 months, whichever occurs first).
- Rotate tires. See "Tire Inspection and Rotation" in the Index for proper rotation pattern and additional information.

DATE	ACTUAL MILEAGE	SERVICED BY:

45,000 Miles (75 000 km)

- Change engine oil and filter (or every 12 months, whichever occurs first).
An Emission Control Service.
- Lubricate the suspension, steering linkage and transaxle shift linkage (or every 12 months, whichever occurs first).

DATE	ACTUAL MILEAGE	SERVICED BY:

Maintenance Schedule II

50,000 Miles (83 000 km)

- Change automatic transaxle fluid and filter if the vehicle is mainly driven under one or more of these conditions:
- In heavy city traffic where the outside temperature regularly reaches 90°F (32°C) or higher.
 - In hilly or mountainous terrain.
 - When doing frequent trailer towing.
 - Uses such as found in taxi, police or delivery service.

If you do not use your vehicle under any of these conditions, the fluid and filter do not require changing.

Manual transaxle fluid doesn't require change.

DATE	ACTUAL MILEAGE	SERVICED BY:

52,500 Miles (87 500 km)

- Change engine oil and filter (or every 12 months, whichever occurs first).
An Emission Control Service.
- Lubricate the suspension, steering linkage and transaxle shift linkage (or every 12 months, whichever occurs first).
- Rotate tires. See "Tire Inspection and Rotation" in the Index for proper rotation pattern and additional information.

DATE	ACTUAL MILEAGE	SERVICED BY:

Maintenance Schedule II

60,000 Miles (100 000 km)

- Change engine oil and filter (or every 12 months, whichever occurs first).
An Emission Control Service.
- Lubricate the suspension, steering linkage and transaxle shift linkage (or every 12 months, whichever occurs first).
- Inspect engine accessory drive belt (or every 24 months, whichever occurs first).
An Emission Control Service.
- Drain, flush and refill cooling system (or every 24 months, whichever occurs first). See "Engine Coolant" in the Index for what to use. Inspect hoses. Clean radiator, condenser, pressure cap and neck. Pressure test the cooling system and pressure cap.
An Emission Control Service.
- Replace spark plugs (except 2.3L Code D engine). *An Emission Control Service.*
- Inspect spark plug wires (except 2.3L Code D engine). *An Emission Control Service. †*
- Replace air cleaner filter. *An Emission Control Service.*
- Inspect fuel tank, cap and lines for damage or leaks. Inspect fuel cap gasket for any damage. Replace parts as needed.
An Emission Control Service. †

DATE	ACTUAL MILEAGE	SERVICED BY:

Maintenance Schedule II

67,500 Miles (112 500 km)

- Change engine oil and filter (or every 12 months, whichever occurs first).
An Emission Control Service.
- Lubricate the suspension, steering linkage and transaxle shift linkage (or every 12 months, whichever occurs first).
- Rotate tires. See "Tire Inspection and Rotation" in the Index for proper rotation pattern and additional information.

DATE	ACTUAL MILEAGE	SERVICED BY:

75,000 Miles (125 000 km)

- Change engine oil and filter (or every 12 months, whichever occurs first).
An Emission Control Service.
- Lubricate the suspension, steering linkage and transaxle shift linkage (or every 12 months, whichever occurs first).

DATE	ACTUAL MILEAGE	SERVICED BY:

Maintenance Schedule II

82,500 Miles (137 500 km)

- Change engine oil and filter (or every 12 months, whichever occurs first).
An Emission Control Service.
- Lubricate the suspension, steering linkage and transaxle shift linkage (or every 12 months, whichever occurs first).
- Rotate tires. See "Tire Inspection and Rotation" in the Index for proper rotation pattern and additional information.

DATE	ACTUAL MILEAGE	SERVICED BY:

90,000 Miles (150 000 km)

- Change engine oil and filter (or every 12 months, whichever occurs first).
An Emission Control Service.
- Lubricate the suspension, steering linkage and transaxle shift linkage (or every 12 months, whichever occurs first).
- Inspect engine accessory drive belt (or every 24 months, whichever occurs first).
An Emission Control Service.
- Drain, flush and refill cooling system (or every 24 months, whichever occurs first). See "Engine Coolant" in the Index for what to use. Inspect hoses. Clean radiator, condenser, pressure cap and neck. Pressure test the cooling system and pressure cap.
An Emission Control Service.

(Continued)

Maintenance Schedule II

90,000 Miles (150 000 km) (Continued)

- Replace spark plugs (except 2.3L Code D engine). *An Emission Control Service.*
- Inspect spark plug wires (except 2.3L Code D engine). *An Emission Control Service.*†
- Replace air cleaner filter. *An Emission Control Service.*
- Inspect fuel tank, cap and lines for damage or leaks. Inspect fuel cap gasket for any damage. Replace parts as needed. *An Emission Control Service.*†

DATE	ACTUAL MILEAGE	SERVICED BY:

97,500 Miles (162 500 km)

- Change engine oil and filter (or every 12 months, whichever occurs first). *An Emission Control Service.*
- Lubricate the suspension, steering linkage and transaxle shift linkage (or every 12 months, whichever occurs first).
- Rotate tires. See "Tire Inspection and Rotation" in the Index for proper rotation pattern and additional information.

DATE	ACTUAL MILEAGE	SERVICED BY:

Maintenance Schedule II

100,000 Miles (166 000 km)

- Replace spark plugs (2.3L Code D engine only). *An Emission Control Service.*
- Change automatic transaxle fluid and filter if the vehicle is mainly driven under one or more of these conditions:
 - In heavy city traffic where the outside temperature regularly reaches 90°F (32°C) or higher.
 - In hilly or mountainous terrain.
 - When doing frequent trailer towing.

- Uses such as found in taxi, police or delivery service.

If you do not use your vehicle under any of these conditions, the fluid and filter do not require changing.

Manual transaxle fluid doesn't require change.

DATE	ACTUAL MILEAGE	SERVICED BY:

Part B: Owner Checks and Services

Listed below are owner checks and services which should be performed at the intervals specified to help ensure the safety, dependability and emission control performance of your vehicle.

Be sure any necessary repairs are completed at once. Whenever any fluids or lubricants are added to your vehicle, make sure they are the proper ones, as shown in Part D.

At Each Fuel Fill

It is important for you or a service station attendant to perform these underhood checks at each fuel fill.

Engine Oil Level

Check the engine oil level and add the proper oil if necessary. See “Engine Oil” in the Index for further details.

Engine Coolant Level

Check the engine coolant level and add the proper coolant mix if necessary. See “Coolant” in the Index for further details.

Windshield Washer Fluid Level

Check the windshield washer fluid level in the windshield washer tank and add the proper fluid if necessary. See “Windshield Washer Fluid” in the Index for further details.

At Least Once a Month

Tire Inflation

Check tire inflation. Make sure tires are inflated to the pressures specified on the Tire-Loading Information label located on the rear edge of the driver’s door. See “Tires” in the Index for further details.

Cassette Deck

Clean cassette deck. Cleaning should be done every 50 hours of tape play. See “Audio Systems” in the Index for further details.

At Least Twice a Year

Hydraulic Clutch System Inspection

Check the fluid level in the clutch reservoir. See “Hydraulic Clutch Fluid” in the Index. A fluid loss in this system could indicate a problem. Have the system inspected and repaired at once.

At Least Once a Year

Key Lock Cylinders

Lubricate the key lock cylinders with the lubricant specified in Part D.

Body Lubrication

Lubricate all body door hinges. Also lubricate all hinges and latches, including those for the hood, trunk lid, glove box door and console door. Part D tells you what to use. More frequent lubrication may be required when exposed to a corrosive environment.

Starter Switch



CAUTION:

When you are doing this check, the vehicle could move suddenly. If it does, you or others could be injured. Follow the steps below.

1. Before you start, be sure you have enough room around the vehicle.
2. Firmly apply both the parking brake (see “Parking Brake” in the Index if necessary) and the regular brake.

NOTE: Do not use the accelerator pedal, and be ready to turn off the engine immediately if it starts.

3. On automatic transaxle vehicles, try to start the engine in each gear. The starter should work only in PARK (P) or NEUTRAL (N). If the starter works in any other position, your vehicle needs service.

On manual transaxle vehicles, put the shift lever in NEUTRAL (N), push the clutch down halfway and try to start the engine. The starter should work only when the clutch is pushed down all the way to the floor. If the starter works when the clutch isn't pushed all the way down, your vehicle needs service.

Brake-Transaxle Shift Interlock -- BTSI (Automatic Transaxle)



CAUTION:

When you are doing this check, the vehicle could move suddenly. If it does, you or others could be injured. Follow the steps below.

1. Before you start, be sure you have enough room around the vehicle. It should be parked on a level surface.
2. Firmly apply the parking brake (see "Parking Brake" in the Index if necessary).

NOTE: Be ready to apply the regular brake immediately if the vehicle begins to move.

3. With the engine off, turn the key to the RUN position, but don't start the engine. Without applying the regular brake, try to move the shift lever out of PARK (P) with normal effort. If the shift lever moves out of PARK (P), your vehicle's BTSI needs service.

Steering Column Lock

While parked, and with the parking brake set, try to turn the key to LOCK in each shift lever position.

- With an automatic transaxle, the key should turn to LOCK only when the shift lever is in PARK (P).
- With a manual transaxle, the key should turn to LOCK only when the shift lever is in REVERSE (R).

On vehicles with a key release button, try to turn the key to LOCK without pressing the button. The key should turn to LOCK only with the key button depressed.

On all vehicles, the key should come out only in LOCK.

Parking Brake and Automatic Transaxle PARK (P) Mechanism Check

CAUTION:

When you are doing this check, your vehicle could begin to move. You or others could be injured and property could be damaged. Make sure there is room in front of your vehicle in case it begins to roll. Be ready to apply the regular brake at once should the vehicle begin to move.

Park on a fairly steep hill, with the vehicle facing downhill. Keeping your foot on the regular brake, set the parking brake.

- To check the parking brake: With the engine running and transaxle in NEUTRAL (N), slowly remove foot pressure from the regular brake pedal. Do this until the vehicle is held by the parking brake only.
- To check the PARK (P) mechanism's holding ability: Shift to PARK (P). Then release all brakes.

Underbody Flushing

At least every spring, use plain water to flush any corrosive materials from the underbody. Take care to clean thoroughly any areas where mud and other debris can collect.

Part C: Periodic Maintenance Inspections

Listed below are inspections and services which should be performed at least twice a year (for instance, each spring and fall). You should let your GM retailer's service department or other qualified service center do these jobs. Make sure any necessary repairs are completed at once.

Restraint Systems

Now and then, make sure all your belts, buckles, latch plates, retractors, anchorages and reminder systems are working properly. Look for any loose parts or damage. If you see anything that might keep a restraint system from doing its job, have it repaired.

Steering, Suspension and Front-Wheel-Drive Axle Boot and Seal Inspection

Inspect the front and rear suspension and steering system for damaged, loose or missing parts, signs of wear, or lack of lubrication. Inspect the power steering lines and hoses for proper hookup, binding, leaks, cracks, chafing, etc. Clean and then inspect the drive axle boot seals for damage, tears or leakage. Replace seals if necessary.

Exhaust System Inspection

Inspect the complete exhaust system. Inspect the body near the exhaust system. Look for broken, damaged, missing or out-of-position parts as well as open seams, holes, loose connections, or other conditions which could cause a heat build-up in the floor pan or could let exhaust fumes into the vehicle. See "Engine Exhaust" in the Index.

Throttle Linkage Inspection

Inspect the throttle linkage for interference or binding, and for damaged or missing parts. Replace parts as needed. Accelerator and cruise control cables should not be lubricated.

Manual Transaxle

Check the transaxle fluid level; add if needed. See "Manual Transaxle" in the Index. A fluid loss may indicate a problem. Check the system and repair if needed.

Brake System Inspection

Inspect the complete system. Inspect brake lines and hoses for proper hookup, binding, leaks, cracks, chafing, etc. Inspect disc brake pads for wear and rotors for surface condition. Also inspect drum brake linings for wear and cracks. Inspect other brake parts, including drums, wheel cylinders, calipers, parking brake, etc. The parking brake is self-adjusting and no manual adjustment is required. You may need to have your brakes inspected more often if your driving habits or conditions result in frequent braking.

Part D: Recommended Fluids and Lubricants

NOTE: Fluids and lubricants identified below by name, part number or specification may be obtained from your GM retailer.

USAGE	FLUID/LUBRICANT
Engine Oil	Engine oil with the American Petroleum Institute Certified For Gasoline Engines "Starburst" symbol of the proper viscosity. To determine the preferred viscosity for your vehicle's engine, see "Engine Oil" in the Index.
Engine Coolant	50/50 mixture of water (preferably distilled) and good quality ethylene glycol base antifreeze (GM Part No. 1052753 or equivalent) conforming to GM Specification 1825M or approved recycled coolant conforming to GM Specification 1825M.

USAGE	FLUID/LUBRICANT
Coolant Supplement	GM Part No. 3634621 or equivalent.
Hydraulic Brake System	Delco Supreme 11 [®] Brake Fluid (GM Part No. 1052535 or equivalent DOT-3 brake fluid).
Hydraulic Clutch System	Hydraulic Clutch Fluid (GM Part No. 12345347 or equivalent).
Power Steering System	GM Hydraulic Power Steering Fluid (GM Part No. 1052884 or equivalent).
Manual Transaxle	Synchromesh Transmission Fluid (GM Part No. 12345349 or equivalent).
Automatic Transaxle	DEXRON [®] -III Automatic Transmission Fluid.
Key Lock Cylinders	Lubricate with Multi-Purpose Lubricant (GM Part No. 12345120) or synthetic SAE 5W-30 engine oil.

USAGE	FLUID/LUBRICANT
Manual Transaxle Shift Linkage	Chassis lubricant (GM Part No. 1052497 or equivalent) or lubricant meeting requirements of NLGI Grade 2, Category LB or GC-LB.
Automatic Transaxle Shift Linkage	Engine oil.
Clutch Linkage Pivot Points	Engine oil.
Chassis Lubrication and Fuel Filler Door and Striker Plunger	Chassis lubricant (GM Part No. 1052497 or equivalent) or lubricant meeting requirements of NLGI Grade 2, Category LB or GC-LB.
Windshield Washer Solvent	GM Optikleen [®] Washer Solvent (GM Part No. 1051515) or equivalent.
Hood Latch Assembly	

USAGE	FLUID/LUBRICANT
a. Pivots and Spring Anchor b. Release Pawl	a. Engine oil. b. Chassis lubricant (GM Part No. 1052497 or equivalent) or lubricant meeting requirements of NLGI Grade 2, Category LB or GC-LB.
Hood and Door Hinges	Engine oil or Lubriplate Lubricant (GM Part No. 1050109).
Weatherstrip Conditioning	Dielectric Silicone Grease (GM Part No. 12345579 or equivalent).

See "Replacement Parts" in the Index for recommended replacement filters, valves and spark plugs.

Part E: Maintenance Record

After the scheduled services are performed, record the date, odometer reading and who performed the service in the boxes provided after the maintenance interval.

Any additional information from "Owner Checks and Services" or "Periodic Maintenance" can be added on the following record pages. Also, you should retain all maintenance receipts. Your owner information portfolio is a convenient place to store them.

Maintenance Record

DATE	ODOMETER READING	SERVICED BY	MAINTENANCE PERFORMED

Maintenance Record

DATE	ODOMETER READING	SERVICED BY	MAINTENANCE PERFORMED



Section 8 Customer Assistance Information

Here you will find out how to contact Oldsmobile if you need assistance. This section includes information on: The Customer Satisfaction Procedure, Customer Assistance for Hearing or Speech Impaired, BBB Auto Line -- Alternative Dispute Resolution Program, Reporting Safety Defects, Roadside Assistance and Service and Owner Publications.

Customer Satisfaction Procedure

Your satisfaction and goodwill are important to your retailer and Oldsmobile. Normally, any concern with the sales transaction or the operation of your vehicle will be resolved by your retailer's Sales or Service Departments. Sometimes, however, despite the best intentions of all concerned, misunderstandings can occur. If your concern has not been resolved to your satisfaction, the following steps should be taken:

STEP ONE -- Discuss your concern with a member of your retail facility management. Normally, concerns can be quickly resolved at that level. If the matter has already been reviewed with the Sales, Service, or Parts

Manager, contact the owner of the retail facility or the General Manager.

STEP TWO -- If after contacting a member of the retail facility management, it appears your concern cannot be resolved by the retail facility without further help, contact the Oldsmobile Customer Assistance Network by calling 1-800-442-6537. In Canada, contact GM of Canada Customer Assistance Center in Oshawa by calling 1-800-263-3777 (English) or 1-800-263-7854 (French).

In Mexico, call (525) 254-3777. In Puerto Rico, call 1-800-496-9992 (English) or 1-800-496-9993 (Spanish). In the U.S. Virgin Islands, call 1-800-496-9994. In other overseas locations, contact GM North American Export Sales in Canada by calling 1-905-644-4112.

For prompt assistance, please have the following information available to give the Customer Assistance Representative:

- Your name, address, home and business telephone numbers
- Vehicle Identification Number (This is available from the vehicle registration or title, or the plate at the left top of the instrument panel and visible through the windshield.)
- Retail facility name and location
- Vehicle delivery date and present mileage
- Nature of concern

We encourage you to call the toll-free number listed previously in order to give your inquiry prompt attention. However, if you wish to write Oldsmobile, write to:

United States

Customer Assistance Representative
Oldsmobile Central Office
920 Townsend St.
P.O. Box 30095
Lansing, MI 48909

Canada

Customer Assistance Center
General Motors of Canada Limited
1908 Colonel Sam Drive
Oshawa, Ontario L1H 8P7

Refer to your Warranty and Owner Assistance Information booklet for addresses of Canadian and GM Overseas offices.

When contacting Oldsmobile, please remember that your concern will likely be resolved in the retail facility, using the retailer's facilities, equipment and personnel. That is why we suggest you follow Step One first if you have a concern .

Customer Assistance for the Hearing or Speech Impaired (TDD)

To assist customers who have hearing difficulties, Oldsmobile has installed special TDD (Telecommunication Devices for the Deaf) equipment at its Customer Assistance Center. Any hearing or speech impaired customer who has access to a TDD or a conventional teletypewriter (TTY) can communicate with Oldsmobile by dialing: 1-800-TDD-OLDS. (TDD users in Canada can dial 1-800-263-3830.)

GM Participation in BBB AUTO LINE - Alternative Dispute Resolution Program*

*This program may not be available in all states, depending on state law. Canadian owners refer to your Warranty and Owner Assistance Information booklet. General Motors reserves the right to change eligibility limitations and/or to discontinue its participation in this program.

Both Oldsmobile and your Oldsmobile retailer are committed to making sure you are completely satisfied with your new vehicle. Our experience has shown that, if a situation arises where you feel your concern has not been adequately addressed, the Customer Satisfaction Procedure described earlier in this section is very successful.

There may be instances where an impartial third-party can assist in arriving at a solution to a disagreement regarding vehicle repairs or interpretation of the New Vehicle Limited Warranty. To assist in resolving these disagreements Oldsmobile voluntarily participates in BBB AUTO LINE.

BBB AUTO LINE is an out-of-court program administered by the Better Business Bureau system to settle disputes between customers and automobile manufacturers. This program is available free of charge to customers who currently own or lease a GM vehicle.

If you are not satisfied after following the Customer Satisfaction Procedure, you may contact the BBB using the toll-free telephone number, or write them at the following address:

BBB AUTO LINE

Council of Better Business Bureaus
4200 Wilson Boulevard
Suite 800
Arlington, VA 22203
Telephone: 1-800-955-5100

To file a claim, you will be asked to provide your name and address, your Vehicle Identification Number (VIN), and a statement of the nature of your complaint. Eligibility is limited by vehicle age and mileage, and other factors.

We prefer you utilize the Customer Satisfaction Procedure before you resort to AUTO LINE, but you may contact the BBB at any time. The BBB will attempt to resolve the complaint serving as an intermediary between you and Oldsmobile. If this mediation is unsuccessful, an informal hearing will be scheduled where eligible customers may present their case to an impartial third-party arbitrator.

The arbitrator will make a decision which you may accept or reject. If you accept the decision, GM will be bound by that decision. The entire dispute resolution procedure should ordinarily take about forty days from the time you file a claim until a decision is made.

Some state laws may require you to use this program before filing a claim with a state-run arbitration program or in the courts. For further information, contact the BBB at 1-800-955-5100 or the Oldsmobile Customer Assistance Network at 1-800-442-6537.

REPORTING SAFETY DEFECTS TO THE UNITED STATES GOVERNMENT

If you believe that your vehicle has a defect which could cause a crash or could cause injury or death, you should immediately inform the National Highway Traffic Safety Administration (NHTSA), in addition to notifying General Motors.

If NHTSA receives similar complaints, it may open an investigation, and if it finds that a safety defect exists in a group of vehicles, it may order a recall and remedy campaign. However, NHTSA cannot become involved in individual problems between you, your retailer, or General Motors.

To contact NHTSA, you may either call the Auto Safety Hotline toll-free at 1-800-424-9393 (or 366-0123 in the Washington, D.C. area) or write to:

NHTSA, U.S. Department of Transportation
Washington, D.C. 20590

You can also obtain other information about motor vehicle safety from the Hotline.

REPORTING SAFETY DEFECTS TO THE CANADIAN GOVERNMENT

If you live in Canada, and you believe that your vehicle has a safety defect, you should immediately notify Transport Canada, in addition to notifying General Motors of Canada Limited. You may write to:

Transport Canada
Box 8880
Ottawa, Ontario K1G 3J2.

REPORTING SAFETY DEFECTS TO GENERAL MOTORS

In addition to notifying NHTSA (or Transport Canada) in a situation like this, we certainly hope you'll notify us. Please call us at 1-800-442-6537, or write:

Oldsmobile Customer Assistance Network
P.O. Box 30095
Lansing, MI 48909

In Canada, please call us at 1-800-263-3777 (English) or 1-800-263-7854 (French). Or, write:

General Motors of Canada Limited
Customer Assistance Center
1908 Colonel Sam Drive
Oshawa, Ontario L1H 8P7

Oldsmobile Roadside Assistance Program Features and Benefits

The Oldsmobile Roadside Assistance program means help is just a toll-free call away -- 24 hours a day, 365 days a year.

Courteous and capable Customer Assistance Advisors are on-call to provide you with prompt assistance.

24-Hour Oldsmobile Roadside Assistance Telephone Number

1-800-442-OLDS (6537) is the one number to call for assistance in the United States. Trained Customer Assistance Advisors, on-call to render assistance to Achieva drivers, can dispatch roadside assistance and towing service, locate the nearest Oldsmobile retail facility, take your request for an Oldsmobile computerized trip routing or simply answer any questions the Achieva driver may have about the coverage provided by your Oldsmobile Roadside Assistance Program. The Oldsmobile Roadside Assistance number is fully staffed and operational 24 hours a day, 365 days a year.

Who Is Covered?

Oldsmobile Roadside Assistance (Oldsmobile Edge) covers all 1995 Oldsmobile vehicles.*

Coverage is for the Oldsmobile vehicle, *regardless of the driver*, and is concurrent with the Bumper-to-Bumper warranty period.

Oldsmobile reserves the right to limit services or reimbursement to an owner or driver when in Oldsmobile's judgement the claims become excessive in frequency or type of occurrence.

**Vehicles sold in Canada have a separate roadside assistance program, as described later in this section.*

Canadian Roadside Assistance

Vehicles purchased in Canada have an extensive roadside assistance program accessible from anywhere in Canada or the U.S.A. Please refer to the separate brochure provided by the retailer or call 1-800-268-6800 for emergency services.

Service and Owner Publications

Service manuals, service bulletins, owner's manuals and other service literature are available for purchase for all current and many past model General Motors vehicles.

Toll-free telephone numbers for ordering information:

United States	1-800-551-4123
Canada	1-800-668-5539

Service Manuals

Service manuals contain diagnosis and repair information for all chassis and body systems. They may be useful for owners who wish to get a greater understanding of their vehicle. They are also useful for owners with the appropriate skill level or training who wish to perform "do-it-yourself" service. These are authentic General Motors service manuals meant for professional, qualified technicians.

Service Bulletins

Service bulletins covering various subjects are regularly sent to all General Motors dealerships/retail facilities. GM monitors product performance in the field. When service methods are found which promote better service on GM vehicles, bulletins are created to help the technician perform better service. Service bulletins may involve any number of vehicles. Some will describe inexpensive service, others will describe expensive service. Some will advise new or unexpected conditions, and others may help avoid future costly repairs. Service bulletins are meant for qualified technicians. In some cases they refer to service manuals, specialized tools, equipment and safety procedures necessary to service the vehicle. Since these bulletins are issued throughout the model year and beyond, an index is required and published quarterly to help identify specific bulletins. Subscriptions are available. You can order an index at the toll-free numbers listed previously, or ask a GM dealer/retailer to see an index or individual bulletin.

Owner Publications

Owner's manuals, warranty folders and various owner assistance booklets provide owners with general operation and maintenance information.

NOTES

NOTES



Section 9 Index

- A**dding
- Automatic Transaxle Fluid 6-19
 - Brake Fluid 6-26
 - Electrical Equipment 2-16, 17, 3-15, 6-50
 - Engine Coolant 5-15, 6-23
 - Engine Oil 6-12
 - Hydraulic Clutch Fluid 6-21
 - Manual Transaxle Fluid 6-20
 - Power Steering Fluid 6-24
 - Sound Equipment 3-15
 - Windshield Washer Fluid 2-39, 6-25
- Air Bag
- How Does it Restrain 1-22
 - How it Works 1-21
 - Location 1-21
 - Readiness Light 1-20, 2-60
 - Servicing 1-24
 - What Makes it Inflate 1-22
 - What Will You See After it Inflates 1-23
 - When Should it Inflate 1-22
- Air Cleaner 6-16
- Air Conditioning 3-3
- Alignment and Balance, Tires 6-39
- Aluminum Wheels, Cleaning 6-47
- Antenna, Fixed Mast 3-17
- Antenna, Rear Window Defogger 3-17
- Antifreeze 6-21
- Adding 5-15, 6-23
 - Checking 6-23
- Anti-Lock 4-6
- Anti-Lock Brake System Warning Light 2-63, 4-6
- Anti-Lock Brakes 4-6
- Appearance Care 6-41
- Appearance Care and Materials 6-49
- Armrest, Storage 2-49
- Ashtray and Lighter 2-51
- Ashtray, Rear 2-52
- Audio Systems 3-5
- Auto Down Window 2-32
- Automatic Door Locks 2-4
- Automatic Overdrive Position, Automatic Transaxle 2-21
- Automatic Transaxle 2-19
- Automatic Transaxle, Automatic Overdrive Position 2-21
 - Automatic Transaxle Chart 6-54
 - Drive (D) Position 2-21
 - First Gear (1) Position 2-22
 - Neutral (N) Position 2-20
 - Park (P) Position 2-19
 - Reverse (R) Position 2-20
 - Second Gear (2) Position 2-21
 - Shifting 2-19, 27, 29
 - Starting Your Engine 2-15
 - Third Gear (3) Position 2-21

Automatic Transaxle Fluid	6-17
Adding	6-19
Checking	6-17

Battery

Charge Light	2-60
Low Maintenance	6-28
Replacement, Remote Lock Control	2-8
Replacement, Vehicle	6-28
Rundown Protection	2-46
Voltmeter	2-61
Warnings	5-2
BBB Auto Line	8-3
Blizzard	4-25
Brake	
Anti-Lock	4-6
Adjustment	6-28
Fluid, Adding	6-26
Master Cylinder	6-26
Parking	2-26
Pedal Travel	6-28
System Parts, Replacing	6-28
System Warning Light	2-62
Trailer	4-35
Transaxle Shift Interlock	2-20, 29, 7-38
Wear	6-27
Brakes, Anti-Lock	4-6
Brakes, Trailer	4-35
Braking	4-5
Braking, In Emergencies	4-8
Break-In, New Vehicle	2-12
BTSI (Brake Transaxle Shift Interlock)	2-20, 29, 7-38

Bulb Replacement

Fog Lamp	6-32
Headlamps	6-30
Replacement Bulb Chart	6-56
Taillamps	6-31

Canada, Vehicles First Sold In 1-12, 25, 39

Canadian Roadside Assistance	8-6
Capacities and Specifications	6-54
Carbon Monoxide	2-30, 4-26, 34
Cassette Tape Player Care	3-16
CD Errors	3-11
CD Player	3-10
CD Player Anti-Theft Feature	3-13
Center Passenger Position	1-31
Certification/Tire Label	4-29
Chains, Safety	4-35
Chains, Tire	6-41
Changing a Flat Tire	5-20
Charging System Light	2-60
Check Gages Warning Light	2-66
Check Oil Light	2-68
Checking Your Restraint Systems	1-47
Checking	
Automatic Transaxle Fluid	6-17
Brake Fluid	6-26
BTSI	7-38
Engine Coolant	6-21
Engine Oil	6-11
Hydraulic Clutch Fluid	6-21
Manual Transaxle Fluid	6-19

Power Steering Fluid	6-24	Clutch, Hydraulic	6-21
Restraint Systems	1-47	Comfort Controls	3-1
Starter Switch	7-37	Compact Disc Player	3-10
Steering Column Lock	7-38	Compact Disc Player Care	3-16
Things Under the Hood	6-7	Compact Spare Tire	5-27
Chemical Paint Spotting	6-48	Console Cup/ Coin Holder	2-50
Child Restraints		Control of a Vehicle	4-5
Securing in a Rear Outside Seat Position	1-35	Control, Loss of	4-12
Securing in the Center Rear Seat Position	1-37	Convenience Net	2-10
Securing in the Right Front Seat Position	1-39	Convex Outside Mirror	2-47
Top Strap	1-35	Coolant	6-21
Where to Put	1-34	Coolant Heater, Engine	2-17, 6-15
Cigarette Lighter	2-52	Coolant Level Warning Light	2-65
Circuit Breaker, Power Windows		Coolant Surge Tank	5-15, 6-21
and Other Power Options	6-53	Coolant Temperature Gage	2-64
Cleaner, Air	6-16	Coolant Temperature Warning Light	2-64
Cleaning		Coolant, How to Add to the Coolant Surge Tank	5-15
Aluminum Wheels	6-47	Cooling System	5-14
Fabric	6-42	Cruise Control	
Glass	6-45	Erasing Speed Memory	2-43
Leather	6-44	Getting Out of	2-43
Outside of the Windshield and Wiper Blades	6-45	Passing Another Vehicle While Using	2-42
Special Problems	6-43	To Increase Speed	2-42
Stains	6-43	To Reduce Speed	2-42
The Inside of Your Oldsmobile	6-42	To Resume a Set Speed	2-41
The Outside of Your Oldsmobile	6-46	To Set	2-40
Tires	6-47	Use on Hills	2-42
Top of the Instrument Panel	6-44	Cupholder, Glove Box	2-49
Vinyl	6-44	Cupholder, Rear Seat	2-50
Climate Control	3-1	Customer Assistance for the Hearing or Speech Impaired	8-2
Clock, Setting the	3-5	Customer Assistance Information	8-1
Clutch Adjustment	6-21	Customer Satisfaction Procedure	8-1

Damage, Finish	6-48
Damage, Sheet Metal	6-48
Daytime Running Lamps	2-44
Dead Battery	5-2
Defects, Reporting	8-4
Defensive Driving	4-1
Defogger, Rear Window	3-4
Defogging	3-2
Defrosting	3-2
Door	
Locks	2-3
Locks, Power	2-4
Driver Position	1-12
Driving On Grades, With a Trailer	4-37
Driving	
At Night	4-13
City	4-17
Defensive	4-1
Drunken	4-2
Freeway	4-18
In a Blizzard	4-25
In Foreign Countries	6-4
In the Rain	4-14
On Curves	4-8
On Hill and Mountain Roads	4-21
On Snow and Ice	4-23
Through Deep Standing Water	2-17
Winter	4-22
With a Trailer	4-35
Drunken Driving	4-2

Easy-Entry Seat	1-6
Electrical Equipment, Adding	2-16, 3-15, 6-50
Engine Coolant	
Adding	5-12, 6-23
Checking	6-23
Heater	2-17, 6-15
Low Coolant Level Warning Light	2-65
Temperature Gage	2-64
Temperature Warning Light	2-64
Engine	
Cooling System	6-54
Exhaust	2-30
Identification	6-50
Lubrication System Chart	6-54
Overheating	5-12
Running it While You're Parked	2-31
Specifications	6-57
Starting	2-15, 16
2.3 L	2-15, 6-9, 54, 57
3.1 L	2-16, 6-10, 54, 57
Engine Oil	6-11
Adding	6-12
Additives	6-14
Checking	6-11
Warning Light	2-67, 68
What Kind to Use	6-13
What to do with Used Oil	6-15
When to Change	6-15
Ethanol (In Fuel)	6-3
Exhaust, Engine	2-30

Expectant Mothers, Use of Safety Belts	1-25
Extender, Safety Belt	1-47

F abric Cleaning	6-42
Fifth Gear (5), Manual Transaxle	2-24
Filling Your Tank	6-4
Filter	
Air Cleaner	6-16
Engine Oil	6-57
Finish Care	6-46
Finish Damage	6-48
First Gear, Automatic Transaxle	2-22
First Gear (1), Manual Transaxle	2-23
Fixed Mast Antenna	3-17
Flash-To-Pass Feature	2-36
Flashers, Hazard Warning	5-1
Flat Tire, Changing	5-20
Flow-Trough Ventilation System	3-4
Fluid Capacities Chart	6-54
Fluids and Lubricants	7-41, 42
Fog Lamp Bulb Replacement	6-32
Fog Lamps	2-44
Foreign Countries, Fuel	6-4
Four-Way Manual Seat	1-2
Fourth Gear (4), Manual Transaxle	2-24
French Language Manual	ii
Front Reading Lamps	2-45, 46
Front Seatback Latches	1-5
Front Towing Hookups	5-9
Fuel	
Door Release, Remote	6-5
Filling Your Tank	6-4

Gage	2-69
In Foreign Countries	6-4
Fuses and Circuit Breakers	6-51

G age, Engine Coolant Temperature (Gage Clusters) ..	2-64
Gage, Fuel (Std and Gage Clusters)	2-69
Gage, Oil (Gage Clusters)	2-66
Gage, Tachometer (Gage Clusters)	2-69
Gage, Voltmeter (Gage Clusters)	2-61
Gasolines for Cleaner Air	6-3
GAWR (Gross Axle Weight Rating)	4-30
Gear Positions (Automatic Transaxle)	2-19, 20, 21, 22
Gear Positions (Manual Transaxle)	2-23, 24
Glass, Cleaning	6-45
Glove Box	2-11
GVWR (Gross Vehicle Weight Rating)	4-30

H alogen Bulbs	6-29
Hazard Warning Flashers	5-1
Head Restraints	1-5
Headlamp High-Low Beam Changer	2-36
Headlamp, Wiring	6-53
Headlamps	2-35
Headlamps, Bulb Replacement	6-30
Hearing or Speech Impaired, Customer Assistance	8-2
Heating	3-2
High Beam Lamps, How to Change	2-36
Highway Hypnosis	4-20
Hill and Mountain Roads	4-21
Hitches, Trailer	4-34
Hood Release	6-7

Hook, Garment	2-51
Horn	2-33
Hydraulic Clutch	6-21
Hydraulic Clutch Fluid	
Adding	6-21
Checking	6-21
Hydroplaning	4-16

I f You're Stuck: In Sand, Mud, Ice or Snow	5-28
Ignition Key Positions	2-13
Ignition Switch	2-13
Illuminated Entry System	2-5
Inside Day/Night Rearview Mirror	2-47
Inspections	
Brake System	7-40
Exhaust Systems	7-40
Restraint Systems	7-40
Steering, Suspension and Front-Wheel-Drive Axle	
Boot and Seal	7-40
Throttle Linkage	7-40
Instrument Panel	2-54
Instrument Panel Cluster	
Gage	2-57
Standard	2-56
Instrument Panel Intensity Control	2-43
Instrument Panel, Cleaning	6-44

J ack, Tire	5-20
Jump Starting	5-2

K ey Lock Cylinders	7-37
Key Release Button	2-14
Key Reminder Warning	2-13
Keys	2-1

L amp Controls	2-35
Lamp Trunk	2-46
Lamp, Underhood	6-11
Lamps, Daytime Running	2-44
Lamps, Fog	2-44
Lamps On Reminder	2-36
Lane Change Indicator	2-34
Larger Children, Safety Belt Use	1-44
Latches, Front Seatback	1-5
Leaving Your Vehicle	2-4
Leaving Your Vehicle With the Engine Running	2-28
Lights	
Air Bag Readiness	1-20, 2-60
Anti-Lock Brake System Warning	2-63, 4-6
Brake System Warning	2-62
Charging System	2-60
Check Gages	2-66
Check Oil	2-68
Engine Coolant Temperature Warning	2-64
Engine Oil	2-67
Engine Oil Pressure	2-67
Low Coolant Level	2-65
Low Washer Fluid Warning	2-70
Malfunction Indicator Lamp (Service Engine Soon)	2-65
Safety Belt Warning	1-7, 2-59
Up Shift (Manual Transaxle)	2-24, 2-61

Lighter	2-52
Loading Your Vehicle	4-29
Locks	
Automatic Door	2-4
Door	2-3
Power Door	2-4
Rear Door Security	2-5
Steering Column	7-38
Trunk	2-9
Window	2-32
Lockout Feature, Trunk	2-9
Long Trip, Before Leaving on a	4-19
Loss of Control	4-12
Low Coolant Level Warning Light	2-65
Low Maintenance Battery	6-28
Low Washer Fluid Warning Light	2-70
Lubricants and Fluids	7-41, 42
Lubrication, Body	7-37

M aintenance Record	7-43
Maintenance Schedule	
Owner Checks and Services	7-36
Periodic Maintenance Inspections	7-40
Recommended Fluids and Lubricants	7-41, 42
Schedule I	7-6
Schedule I Definition	7-4
Schedule II	7-26
Schedule II Definition	7-5
Scheduled Maintenance Services	7-2
Maintenance, Normal Replacement Parts	6-57
Maintenance, Underbody	6-48
Maintenance, When Trailer Towing	4-38

Malfunction Indicator Lamp (Service Engine Soon)	2-65
Manual Front Seat	1-1
Manual Adjustable Seat (Four-Way)	1-2
Manual Remote Control Mirror	2-48
Manual Transaxle	
Fifth Gear (5)	2-24
First Gear (1)	2-23
Fourth Gear (4)	2-24
Neutral (N) Position	2-24
Parking Your Vehicle	2-29
Reverse (R) Position	2-24
Second Gear (2)	2-24
Shift Light	2-24
Shift Speeds	2-25
Shifting	2-23
Starting Your Engine	2-15
Third Gear (3)	2-24
Methanol (In Fuel)	6-3
Mirrors	
Convex Outside	2-47
Inside Day/Night Rearview	2-47
Manual Remote Control	2-48
Power Remote Control	2-48
Visor Vanity	2-48
MTBE (In Fuel)	6-3

N et, Convenience	2-10
Neutral (N) Position, Automatic Transaxle	2-20
Neutral (N) Position, Manual Transaxle	2-24
New Vehicle "Break-In"	2-12
Night Vision	4-13

Odometer, Tamper Resistant	2-58	Power Remote Control Mirrors	2-48
Odometer, Trip	2-58	Power Seat	1-3
Off-Road Recovery	4-10	Power Steering	4-8
Oil		Power Steering Fluid	
Check Oil Warning Light	2-68	Adding	6-24
Engine	6-11	Checking	6-24
Pressure Gage	2-66	Power Windows	2-32
Warning Light	2-67	Pregnancy, Use of Safety Belts	1-25
Ordering		Problems on the Road	5-1
Owner Publications	8-7	Publications, Service and Owner	8-7
Service Bulletins	8-7		
Service Manuals	8-7		
Overdrive Position, Automatic Transaxle	2-21	R adio Reception, Understanding	3-14
Overheated Engine	5-12	Radios	
Owner Checks and Services	7-36	AM/FM Stereo	3-6
Owner Publications, Ordering	8-7	AM/FM Stereo Radio with Cassette Tape Player	3-8
		AM/FM Stereo Radio with Compact Disc Player	3-10
		Rain, Driving In	4-14
		Reading Lamps	
		Front	2-45, 46
		Rear	2-46
		Rear Door Security Locks	2-5
		Rear Safety Belt Comfort Guides	1-29
		Rear Seat Cup Holder	2-50
		Rear Seat Outside Position	1-26
		Rear Seat Passengers	1-26
		Rear Towing	5-11
		Rear Window Defogger	3-4
		Rear Window Defogger Antenna	3-17
		Rearview Mirror, Inside Day/ Night	2-47
		Reclining Front Seatbacks	1-3
		Recommended Fluids and Lubricants	7-41, 42
P aint Spotting, Chemical	6-48		
Park (P), Shifting Into	2-27		
Park (P), Shifting Out of	2-29		
Park (P) Position, Automatic Transaxle	2-19		
Parking			
At Night	2-12		
Lots	2-12		
On Hills While Towing a Trailer	4-37		
Over Things That Burn	2-30		
Your Vehicle, Manual Transaxle	2-29		
Parking Brake	2-26		
Parking Brake Release	2-26		
Passing	4-10		
Periodic Maintenance Inspections	7-40		
Power Door Locks	2-4		

Recreational Vehicle Towing	4-26
Front	4-27, 28
Rear	4-29
Reminder, Lamps On	2-36
Remote Fuel Door Release	6-5
Remote Lock Control	2-6
Battery Replacement	2-8
Matching Transmitters	2-7
Operation	2-7
Remote Trunk Release	2-9
Replacement Bulbs	6-56
Replacement Parts	6-57
Replacement, Wheel	6-39
Replacing Safety Belts	1-48
Replacing Seat and Restraint System Parts After a Crash	1-48
Restraints, Checking Your	1-47
Restraints, Child	1-34
Restraints, Head	1-5
Restraints, Replacing Parts After a Crash	1-48
Reverse (R) Position, Automatic Transaxle	2-20
Reverse (R) Position, Manual Transaxle	2-24
Right Front Passenger Position	1-25
Roadside Assistance	8-6
Roadside Assistance, Canadian	8-6
Rocking Your Vehicle	5-28
Rotation, Tire	6-35

S afety Belt Extender	1-47
Safety Belt Warning Light	1-7, 2-59
Safety Belts	1-7
Adults	1-12
Automatic Lap-Shoulder	1-13

Care of	6-45
Center Passenger Position	1-31
Driver Position	1-12
Extender	1-47
How to Wear Properly	1-12
Incorrect Usage	1-16, 17, 18, 19, 45, 46
Lap Belt	1-32
Lap-Shoulder	1-27
Questions People Ask	1-11
Rear Comfort Guides	1-29
Rear Seat Outside Passenger Positions	1-26
Rear Seat Passengers	1-26
Replacing After a Crash	1-48
Right Front Passenger Position	1-25
Use by Children	1-33
Use by Larger Children	1-44
Use by Smaller Children and Babies	1-33
Use During Pregnancy	1-25
Why They Work	1-8
Safety Chains	4-35
Safety Defects	
Reporting to General Motors	8-5
Reporting to the Canadian Government	8-5
Reporting to the United States Government	8-4
Safety Warnings and Symbols	iii
Scheduled Maintenance Services	7-2
Seat, Power	1-3
Seats	1-1
Easy Entry	1-6
Four-Way Manual	1-2
Manual Front	1-1
Reclining Front	1-3
Securing a Child Restraint	1-35
Split Fold-Down Rear	1-6

Seats and Restraint Systems	1-1
Seats and Seat Controls	1-1
Second Gear (2), Automatic Transaxle	2-21
Second Gear (2), Manual Transaxle	2-24
Service	6-1
Service and Appearance Care	6-1
Service and Owner Publications	8-7
Service Bulletins, Ordering	8-7
Service Engine Soon Light (Malfunction Indicator Lamp)	2-65
Service Manuals, Ordering	8-7
Service Parts Identification Label	6-50
Service Publications	8-7
Service Work, Doing Your Own	6-1
Servicing Your Air Bag-Equipped Oldsmobile	1-24
Sheet Metal Damage	6-48
Shift Light, Manual Transaxle	2-24, 2-61
Shift Speeds, Manual Transaxle	2-25
Shifting Into Park (P)	2-27
Shifting Out of Park (P)	2-29
Shifting, Automatic Transaxle	2-19
Signaling Turns	2-34
Skidding	4-12
Sound Equipment, Adding	3-15
Spare Tire, Compact	5-27
Specifications Chart	6-57
Speedometer (Std and Gage Cluster)	2-58
Split Fold-Down Seat	1-6
Stains, Cleaning	6-43
Starter Switch	7-37
Starting Your Engine	
2.3 Liter	2-15
3.1 Liter	2-16
Automatic Transaxle	2-15
Manual Transaxle	2-15

Steam, If Coming From Your Engine	5-12
Steering	4-8
Steering Column Lock	7-38
Steering Wheel, Tilt	2-33
Steering, In Emergencies	4-9
Steering, Power	4-8
Steering, Tips	4-8
Storage Armrest	2-49
Storage, Of Your Vehicle	6-29
Storage, Sunglasses	2-53
Stuck, If You Are	5-28
Sun Visors	2-48
Sunglasses Storage	2-53
Sunroof	2-53
Supplemental Restraint System (SRS)	1-20
Surge Tank Pressure Cap	6-23
Symbols, Vehicle	v

T achometer (Gage Cluster)	2-69
Taillamps, Bulb Replacement	6-31
Tamper Resistant Odometer	2-58
Tape Player Care	3-16
Theft	2-11
Theft Deterrent Feature, CD Player	3-13
Thermostat	6-24
Third Gear (3), Automatic Transaxle	2-21
Third Gear (3), Manual Transaxle	2-24
Tilt Steering Wheel	2-33
Time, Setting the	3-5
Tire Chains	6-41
Tire Inspection and Rotation	6-35
Tire Loading	4-29

Tires	6-33	Turn Signals	4-36
Alignment and Balance	6-39	Weight of a Trailer	4-33
Buying New	6-37	Transaxle Fluid, Automatic	6-17
Changing a Flat	5-20	Transaxle Fluid, Manual	6-19
Inflation	6-34	Transmitters, Matching to Your Vehicle	2-7
Inspection and Rotation	6-35	Trip Odometer	2-58
Spare, Compact	5-27	Trunk Lamp	2-46
Temperature	6-38	Trunk Lock	2-9
Traction	6-38	Trunk Release, Remote	2-9
Treadwear	6-38	Turn Signal and Lane Change Indicator	2-34
Uniform Quality Grading	6-37	Turn Signal/Multifunction Lever	2-33
Wear Indicators	6-36	Turn Signals When Towing a Trailer	4-36
Wheel Replacement	6-39		
When It's Time for New	6-36	U nderbody Maintenance	6-48
Top Strap	1-35	Underhood Lamp	6-11
Torque Lock	2-28		
Torque, Wheel Nut	5-25, 6-55	V ehicle Damage Warnings	iv
Towing a Trailer	4-31	Vehicle Identification Number (VIN)	6-50
Towing Your Vehicle	5-7	Vehicle Loading	4-29
Front	5-9	Vehicle Storage	6-29
Rear	5-11	Vehicle Symbols	v
Towing, Recreational Vehicle	4-26	Vehicle, Control of a	4-5
Trailer Tongue Weight	4-33	Vehicle, Leaving Your	2-4
Trailer Towing	4-31	Vehicles First Sold in Canada	1-12, 25, 39
Brakes	4-35	Ventilation System, Flow-Through	3-4
Driving on Grades	4-37	Ventilation Tips	3-4
Driving with a Trailer	4-35	Vision, Night	4-13
Hitches	4-34	Visor Vanity Mirrors	2-48
Maintenance	4-38	Visors, Sun	2-48
Parking on Hills	4-37	Voltmeter	2-61
Safety Chains	4-35		
Total Weight on Your Vehicle's Tires	4-34		
Towing a Trailer	4-31		

Warning Devices	5-2	Windows	2-32
Warning Flashers, Hazard	5-1	Windows, Power	2-32
Warning Lights, Gages and Indicators	2-59	Windshield Washer Fluid	2-38, 6-25
Washing Your Vehicle	6-46	Windshield Washers	2-38
Water, Driving Through Deep Standing	2-17	Windshield Wiper, Blade Replacement	6-32
Weatherstrips	6-45	Windshield Wiper, Circuit Breaker	6-53
Wheel Nut Torque	5-25, 6-55	Windshield Wipers, Controlled-Cycle	2-37
Wheel Replacement	6-39	Winter, Driving in	4-22
Wheel Replacement, Used	6-40	Wiring, Headlamp	6-53
Window Lock	2-32	Wrecker Towing	5-7
Window, Auto Down	2-32		

