

**GMC**  
TRUCK

19 **95**

**SAFARI**

*Owner's Manual*



# ***Table of Contents***

## **Introduction — How to Use this Manual**

This section tells you how to use your manual and includes safety and vehicle damage warnings and symbols.

## **Section 1 — Seats and Restraint Systems**

This section tells you how to use your seats and safety belts properly. It also explains the air bag system.

## **Section 2 — Features & Controls**

This section explains how to start and operate your vehicle.

## **Section 3 — Comfort Controls & Audio Systems**

This section tells you how to adjust the ventilation and comfort controls and how to operate your audio system.

## **Section 4 — Your Driving and the Road**

Here you'll find helpful information and tips about the road and how to drive under different conditions.

## **Section 5 — Problems on the Road**

This section tells you what to do if you have a problem while driving, such as a flat tire or engine overheating, etc.

## **Section 6— Service & Appearance Care**

Here the manual tells you how to keep your vehicle running properly and looking good.

## **Section 7 — Maintenance Schedule**

This section tells you when to perform vehicle maintenance and what fluids and lubricants to use.

## **Section 8 — Customer Assistance Information**

This section tells you how to contact GM for assistance and how to get service publications. It also gives you information on "Reporting Safety Defects" on page 8-4.

## **Index**

Here's an alphabetical listing of almost every subject in this manual. You can use it to quickly find something you want to read.

# ***Introduction***

## ***1995 GMC Safari Owner's Manual***

### **Welcome**

This manual was prepared to acquaint you with the operation and maintenance of your 1995 GMC Safari and to provide important safety information. There is also a GMC Truck Warranty and Owner Assistance Information booklet. In some vehicles, there can be information manuals from other manufacturers like body builders or special equipment companies. We urge you to review all these publications carefully. This will help you enjoy safe and trouble-free operation of your vehicle.

When it comes to service, keep in mind that your GMC Truck dealer knows your vehicle best and is interested in your complete satisfaction. Your dealer invites you to return for all of your service needs both during and after the warranty period.

Remember, if you have a concern and need help handling it to your satisfaction, see the procedure in the GMC Truck Warranty and Owner Assistance Information booklet.

Thanks for choosing a GMC Truck product. We value you as a member of the GMC Truck family. We want to assure you of our continuing interest in your pleasure and satisfaction with your vehicle.

GMC Truck Division  
General Motors Corporation  
Pontiac, Michigan

©Copyright 1994 General Motors Corporation, GMC Truck Division  
All Rights Reserved

First Edition

Printed in U.S.A.

## ***Important Notes to Owners and Drivers***

### ***About This Manual***

Please keep this manual in your vehicle so it will be there if you ever need it when you're on the road. If you sell the vehicle, please leave this manual in it so the new owner can use it.

This manual includes the latest information at the time it was printed. We reserve the right to make changes in the product after that time without further notice. For vehicles first sold in Canada, substitute the name "General Motors of Canada Limited" for GMC Truck Division whenever it appears in this manual.



### ***For Canadian Owners Who Prefer a French Language Manual:***

*Aux propriétaires canadiens:* Vous pouvez vous procurer un exemplaire de ce guide en français chez votre concessionnaire ou au DGN Marketing Services Ltd., 1500 Bonhill Rd., Mississauga, Ontario L5T 1C7.

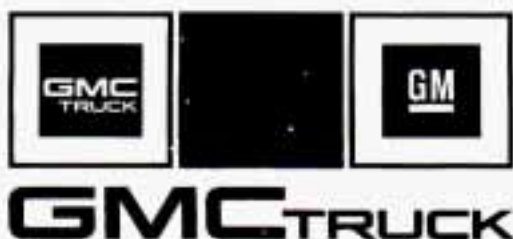

General Motors, GM and the GM Emblem, GMC and the GMC Emblem, SAFARI and the SAFARI Emblem are registered trademarks of General Motors Corporation.

## ***How to Use This Manual***

Many people read their owner's manual from beginning to end when they first receive their new vehicle. This will help you learn about the features and controls for your vehicle. In this manual, you'll find that pictures and words work together to explain things quickly.

**INDEX:** A good place to look for what you need is the Index in back of the manual. It's an alphabetical list of all that's in the manual, and the page number where you'll find it.

## ***Safety Warnings and Symbols***

You will find a number of safety cautions in this book. We use a box with gray background and the word CAUTION to tell you about things that could hurt you if you were to ignore the warning.



### **CAUTION:**

**These mean there is something that could hurt you or other people.**

In the gray caution area, we tell you what the hazard is. Then we tell you what to do to help avoid or reduce the hazard. Please read these cautions. If you don't, you or others could be hurt.

You will also find a circle with a slash through it in this book. This safety symbol means "Don't," "Don't do this," or "Don't let this happen."



## ***Vehicle Damage Warnings***

Also, in this book you will find these notices:

### **NOTICE:**

**These mean there is something that could damage your vehicle.**

In the notice area, we tell you about something that can damage your vehicle. Many times, this damage would not be covered by your warranty, and it could be costly. But the notice will tell you what to do to help avoid the damage.

When you read other manuals, you might see CAUTION and NOTICE warnings in different colors or in different words.

You'll also see warning labels on your vehicle. They use yellow for cautions, blue for notices and the words CAUTION or NOTICE.

## ***Vehicle Symbols***

These are some of the symbols you will find on your vehicle. For example, these symbols are used on an original battery:



*Caution  
Possible Injury*



*Protect Eyes  
by Shielding*



*Caustic Battery Acid  
Could Cause Burns*



*Spark or Flame Could  
Explode Battery*



*Avoid Sparks  
or Flames*

These symbols are important for you and your passengers whenever your vehicle is driven:



*Fasten Safety Belts*



*Door Lock/Unlock*

These symbols have to do with your lights:

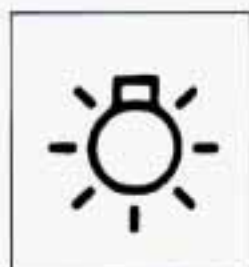

*Master Lighting Switch*

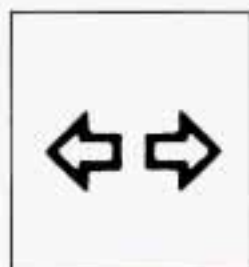

*Turn Signal Direction*



*Hazard Warning Flasher*



*Headlight High Beam*

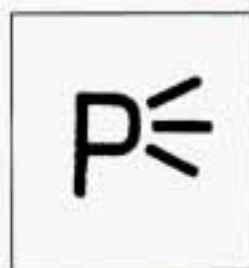

*Parking Lights*



*Daytime Running Lights*



These symbols are on some of your controls:



*Hood Release*



*Windshield Wiper*



*Windshield Washer*



*Windshield Defroster*



*Ventilating Fan*



*Rear Window Wiper & Washer*

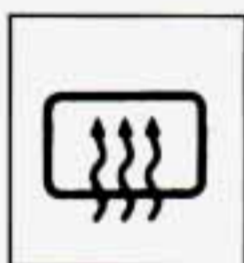

*Rear Window Defogger*



*Hatch Release*

These symbols are used on warning and indicator lights:



*Engine Coolant Temperature*



*Battery Charging System*



*Fuel*



*Engine Oil Pressure*



*Brake (Digital Cluster)*

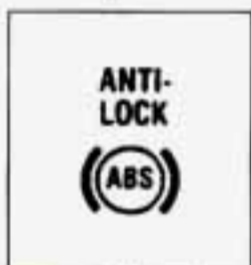

*4 - Wheel Anti - Lock (Digital Cluster)*

Here are some other symbols you may see:



*Fuse*



*Lighter*



*Horn*



*Speaker*

## ***Seats and Restraint Systems***

### ***Section***

# ***1***

Here you'll find information about the seats in your vehicle and how to use your safety belts properly. You can also learn about some things you should *not* do with air bags and safety belts.

### ***Seats and Seat Controls***

This section tells you about the seats—how to adjust them, take them out and put them back in. It also tells you about bucket and bench seats, power seats, and head restraints.

#### ***Front Seats***



#### **CAUTION:**

**You can lose control of the vehicle if you try to adjust a manual driver's seat while the vehicle is moving. The sudden movement could startle and confuse you, or make you push a pedal when you don't want to. Adjust the driver's seat only when the vehicle is not moving.**

### ***Manual Front Seat***



The bucket seats can be adjusted forward or rearward by the lever at the front of the seat.

Move the seat adjustment lever at the front of the seat towards the driver's door to unlock it. Slide the seat to where you want it. Then release the lever and try to move the seat with your body, to make sure the seat is locked into place.

### ***Power Driver's Seat***



You can adjust the seat before entering the vehicle.

The front control makes the front of the seat go up and down.

The rear control makes the rear of the seat go up and down.

The center control makes the whole seat go up and down or forward and rearward.

## ***Reclining Bucket Seats***

If you have this feature, you will have a lever on the inside of the seat to adjust the seatback.



You can adjust the seatback by lifting the lever. Release the lever to lock the seat back where you want it. Pull up on the lever and the seat will go to an upright position.

Don't adjust the driver's seatback while your vehicle is moving.

Don't have a seatback reclined if your vehicle is moving.

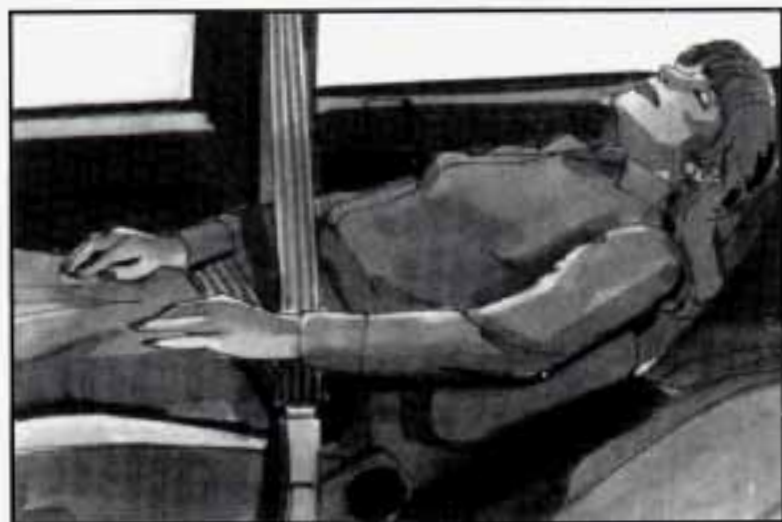

But don't have a seatback reclined if your vehicle is moving.



## **CAUTION:**

Sitting in a reclined position when your vehicle is in motion can be dangerous. Even if you buckle up, your safety belts can't do their job when you're reclined like this.

The shoulder belt can't do its job because it won't be against your body. Instead, it will be in front of you. In a crash you could go into it, receiving neck or other injuries.

The lap belt can't do its job either. In a crash the belt could go up over your abdomen. The belt forces would be there, not at your pelvic bones. This could cause serious internal injuries.

For proper protection when the vehicle is in motion, have the seatback upright. Then sit well back in the seat and wear your safety belt properly.

## ***Rear Seats***

### ***Bucket Seats***

If you have rear bucket seats in your vehicle, they will recline and adjust the same way as the front manual bucket seats. See "Front Seats" earlier in this section or in the Index.

### ***Bench Seats***

If you have bench seats in your vehicle, each seat can carry up to three passengers. They can also be removed to increase storage space.

The center and rear bench seats can be adjusted forward or rearward by the lever at the front of the seat.



Move the seat adjustment lever at the front of the seat towards the passenger's side to unlock it. Slide the seat to where you want it. Then release the lever and try to move the seat with your body, to make sure the seat is locked into place.

The non-touring center bench seat has a pivoting right armrest. The left armrest can also be used as a storage compartment.

The storage compartment and beverage cooler can also be used as rear seat armrests. See "Storage Compartment/Beverage Cooler" in the Index.

The optional touring bench seats come with moveable armrests, individual reclining seatbacks, adjustable headrests and a fold down center console.



To adjust your seatback, pull up on the lever on the lower outside of the seat.

The center bench seatbacks will recline further back than the rear bench seatbacks.

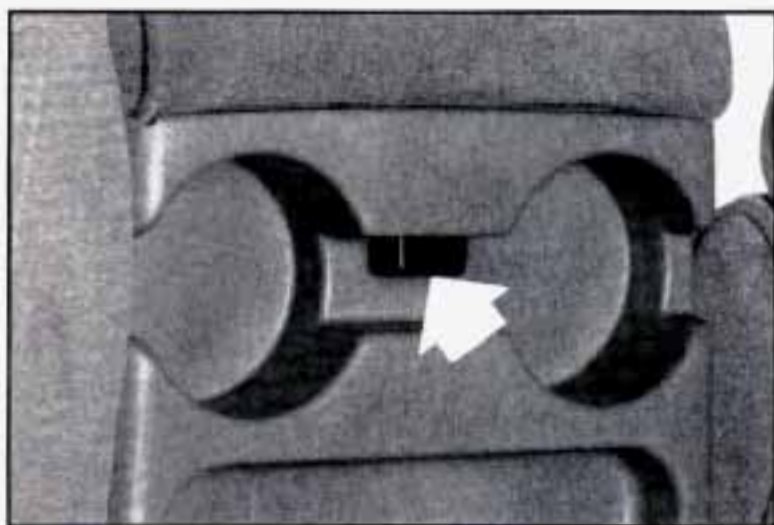

To raise or lower the center console, press the button between the beverage holders.

Only sit in the center seating position when the console is in an upright position. For details about headrests, see “Head Restraints” in this section.

### ***Seatback Latches (Non-Touring Bench Seats)***



To fold your non-touring seatback forward, pull up on the latch release lever while pulling the seatback toward you. The lever is on the right rear of your seat.

After the latch has been released, push the seatback down until it locks in place. To raise the seatback, unlock the seat by pushing forward on the lever. Make sure the seatback is locked when it is put back in the upright position.



## ***Removable Seats (Touring and Non-Touring Bench Seats)***

### **To Remove The Seat**



1. Disconnect the quick release latch plates for the lap-shoulder belt from the buckles in the roof.

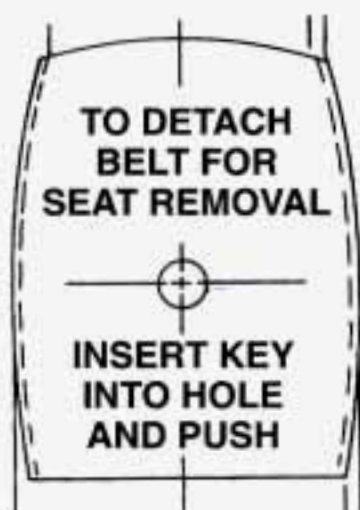

2. If you are removing the center seat, remove the right lap-shoulder belt. To do this, press the tip of a key into the release hole of the safety belt attachment while pulling up on the safety belt.

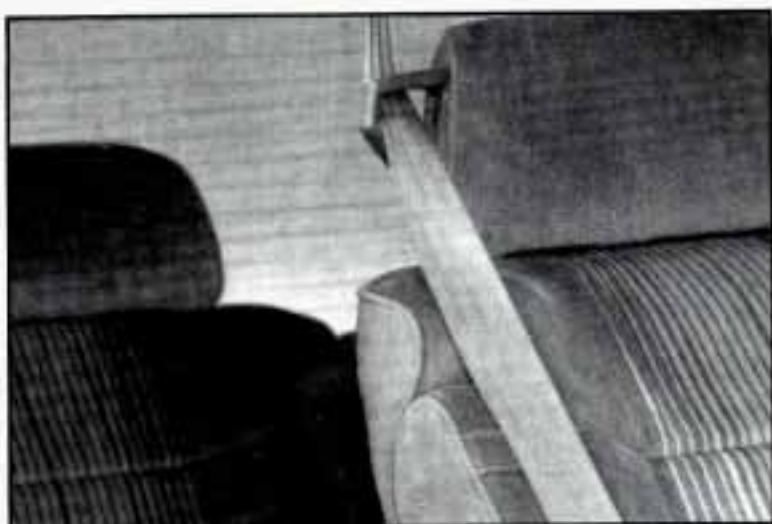

3. If you have a safety belt guide on your seat, pull the safety belt all the way out through the guide.



4. Pull up on the seatback latch on the right rear of the front seat. Push the seatback down until it locks in place (non-touring bench seats only).

5. Lift up on the seat release latch. The latches are near the floor on the rear legs of the seat. To relieve pressure on the latch, pull back on the seat.

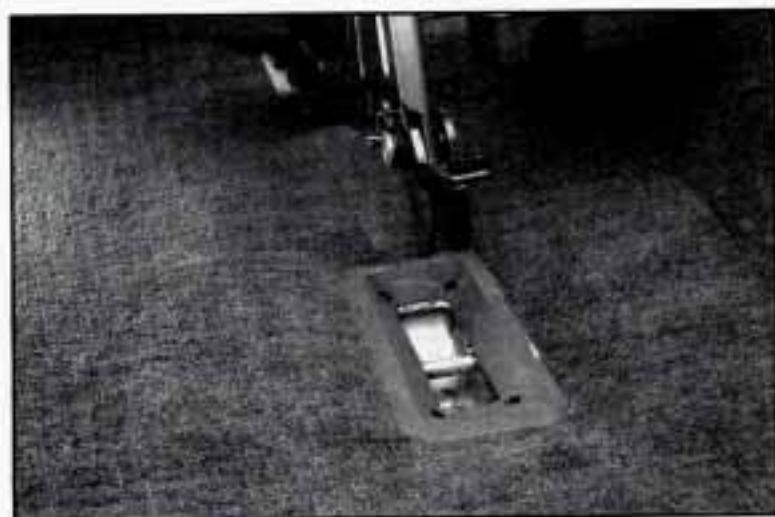

6. Lift up on the rear of the seat to remove the seat assembly from the rear latch pins. Then, pull back and lift the seat out of the vehicle.

## To Install The Seat



1. Lower the seat into position. Make sure the front retainers are hooked onto the anchor pins. Pull the seat down to latch the rear retainers. Make sure the seat is locked in by pulling up and down on the seat.



### **CAUTION:**

A seat that isn't locked into place properly can move around in a collision or sudden stop. People in the vehicle could be injured. Be sure to lock the seat into place properly when installing it.



2. Raise the seatback by pushing forward on the latch at the right rear of the seat. Pull up on the seatback until it is locked securely in the up position.

3. Attach the quick release latch plate to the buckles in the roof. If you are installing the center seat, connect the right lap–shoulder belt to the attachment on the seat cushion. If you have a safety belt guide on your seat, pull the belt through the guide before reattaching the lap–shoulder belt to the side of the seat. The release hole should be facing outward.



### **CAUTION:**

**A safety belt that is twisted or not properly attached won't provide the protection needed in a crash. The person wearing the belt could be seriously injured. After installing the seat, always check to be sure that the safety belts are not twisted and are properly attached.**

### **NOTICE:**

**Be sure to put the correct seats back in the proper positions so the safety belts will work properly.**

If you installed the safety belt with the release hole facing inward (toward the seat), slide the plastic cover up so you can see the buckle. Disconnect the seat belt. Slide the cover back down and reinstall the belt correctly.

## ***Head Restraints***

Head restraints are fixed on some models and adjustable on others. Slide an adjustable head restraint up or down so that the top of the restraint is closest to the top of your ears. This position reduces the chance of a neck injury in a crash.

## ***Safety Belts: They're for Everyone***

This part of the manual tells you how to use safety belts properly. It also tells you some things you should not do with safety belts.

And it explains the Supplemental Inflatable Restraint, or “air bag” system.

 **CAUTION:**

**Don't let anyone ride where he or she can't wear a safety belt properly. If you are in a crash and you're not wearing a safety belt, your injuries can be much worse. You can hit things inside the vehicle or be ejected from it. You can be seriously injured or killed. In the same crash, you might not be if you are buckled up. Always fasten your safety belt, and check that your passengers' belts are fastened properly too.**



Your vehicle has a light that comes on as a reminder to buckle up. (See "Safety Belt Reminder Light" in the Index.)

In many states and Canadian provinces, the law says to wear safety belts. Here's why: *They work.*

You never know if you'll be in a crash. If you do have a crash, you don't know if it will be a bad one.

A few crashes are mild, and some crashes can be so serious that even buckled up a person wouldn't survive. But most crashes are in between. In many of them, people who buckle up can survive and sometimes walk away. Without belts they could have been badly hurt or killed.

After more than 25 years of safety belts in vehicles, the facts are clear. In most crashes buckling up does matter ... a lot!

## **Why Safety Belts Work**

When you ride in or on anything, you go as fast as it goes.

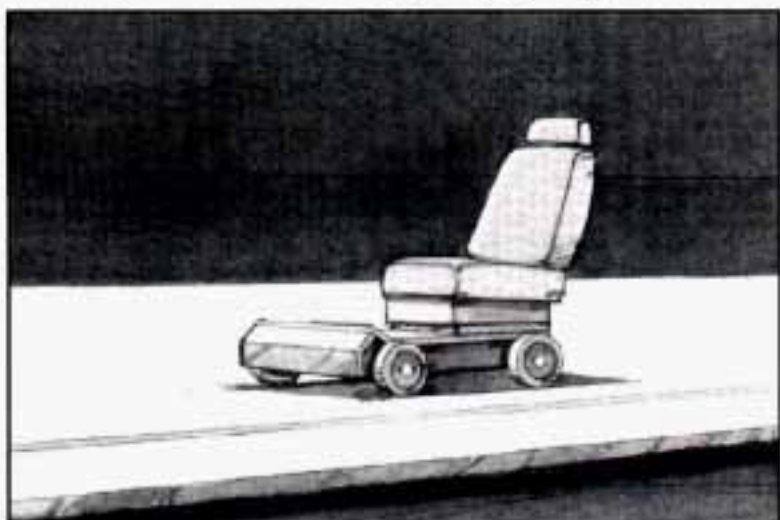

Take the simplest vehicle. Suppose it's just a seat on wheels.



Put someone on it.

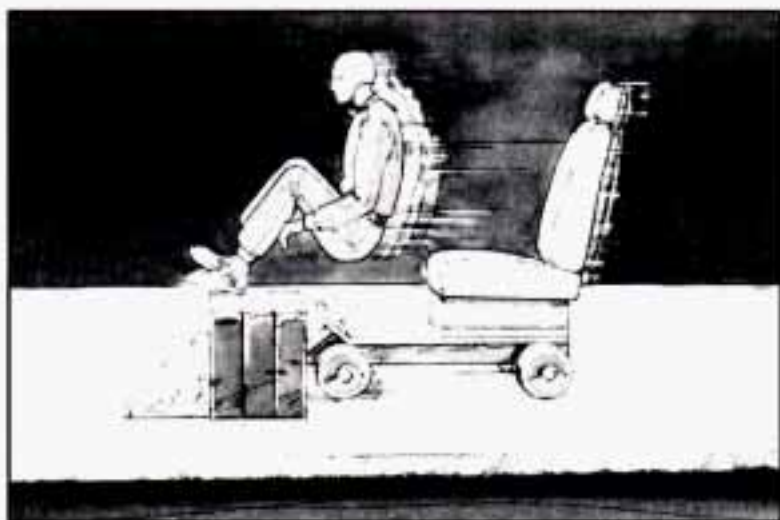

Get it up to speed.  
Then stop the vehicle.  
The rider doesn't stop.



The person keeps going until stopped by something.  
In a real vehicle, it could be the windshield ...

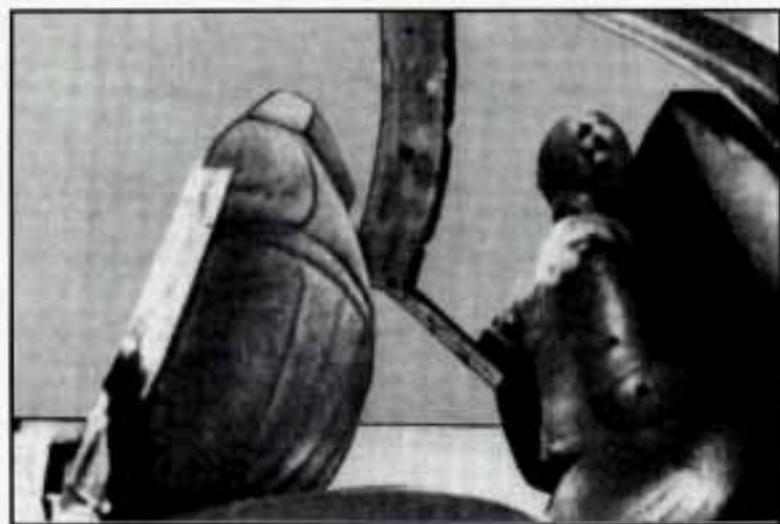

or the instrument  
panel ...



or the safety belts!

With safety belts, you slow down as the vehicle does. You get more time to stop. You stop over more distance, and your strongest bones take the forces. That's why safety belts make such good sense.

## ***Here Are Questions Many People Ask About Safety Belts — and the Answers***

**Q:** *Won't I be trapped in the vehicle after an accident if I'm wearing a safety belt?*

**A:** You *could* be — whether you're wearing a safety belt or not. But you can unbuckle a safety belt, even if you're upside down. And your chance of being conscious during and after an accident, so you *can* unbuckle and get out, is *much* greater if you are belted.

**Q:** *Why don't they just put in air bags so people won't have to wear safety belts?*

**A:** Air bags are in many vehicles today and will be in more of them in the future. But they are supplemental systems only; so they work *with* safety belts — not instead of them. Every air bag system ever offered for sale has required the use of safety belts. Even if you're in a vehicle that has air bags, you still have to buckle up to get the most protection. That's true not only in frontal collisions, but especially in side and other collisions.

**Q:** *If I'm a good driver, and I never drive far from home, why should I wear safety belts?*

**A:** You may be an excellent driver, but if you're in an accident — even one that isn't your fault — you and your passengers can be hurt. Being a good driver doesn't protect you from things beyond your control, such as bad drivers.

Most accidents occur within 25 miles (40 km) of home. And the greatest number of serious injuries and deaths occur at speeds of less than 40 mph (65 km/h).

Safety belts are for everyone.



# ***How to Wear Safety Belts Properly***

## ***Adults***

This part is only for people of adult size.

Be aware that there are special things to know about safety belts and children. And there are different rules for smaller children and babies. If a child will be riding in your vehicle, see the part of this manual called "Children." Follow those rules for everyone's protection.

First, you'll want to know which restraint systems your vehicle has.

We'll start with the driver position.

## ***Driver Position***

This part describes the driver's restraint system.

### ***Lap–Shoulder Belt***

The driver has a lap–shoulder belt. Here's how to wear it properly.

1. Close and lock the door.
2. Adjust the seat (to see how, see "Seats" in the Index) so you can sit up straight.



3. Pick up the latch plate and pull the belt across you. Don't let it get twisted.
4. Push the latch plate into the buckle until it clicks.

Pull up on the latch plate to make sure it is secure.

If the belt isn't long enough, see "Safety Belt Extender" at the end of this section.

Make sure the release button on the buckle is positioned so you would be able to unbuckle the safety belt quickly if you ever had to.



5. To make the lap part tight, pull down on the buckle end of the belt as you pull up on the shoulder belt.

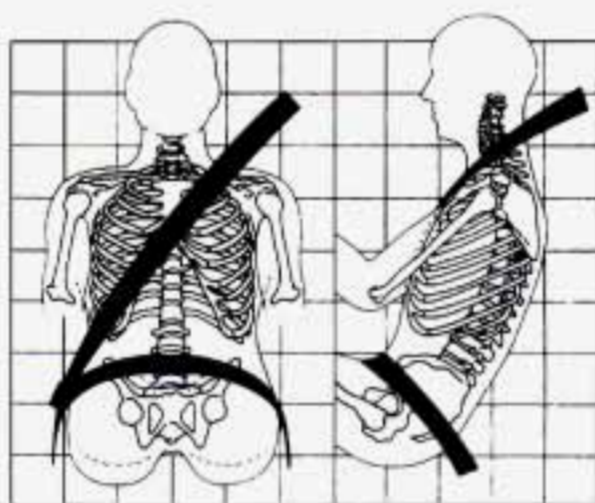

The lap part of the belt should be worn low and snug on the hips, just touching the thighs. In a crash, this applies force to the strong pelvic bones. And you'd be less likely to slide under the lap belt. If you slid under it, the belt would apply force at your abdomen. This could cause serious or even fatal injuries. The shoulder belt should go over the shoulder and across the chest. These parts of the body are best able to take belt restraining forces.

The safety belt locks if there's a sudden stop or a crash.

## Shoulder Belt Height Adjuster

Before you begin to drive, move the shoulder belt adjuster to the height that is right for you.



To move it down, push in at the top of the arrows and move the height adjuster to the desired position. You can move the adjuster up just by pushing up on the shoulder belt guide. After you move the adjuster to where you want it, try to move it down without pushing in to make sure it has locked into position.

Adjust the height so that the shoulder portion of the belt is centered on your shoulder. The belt should be away from your face and neck, but not falling off your shoulder.

**Q:** What's wrong with this?

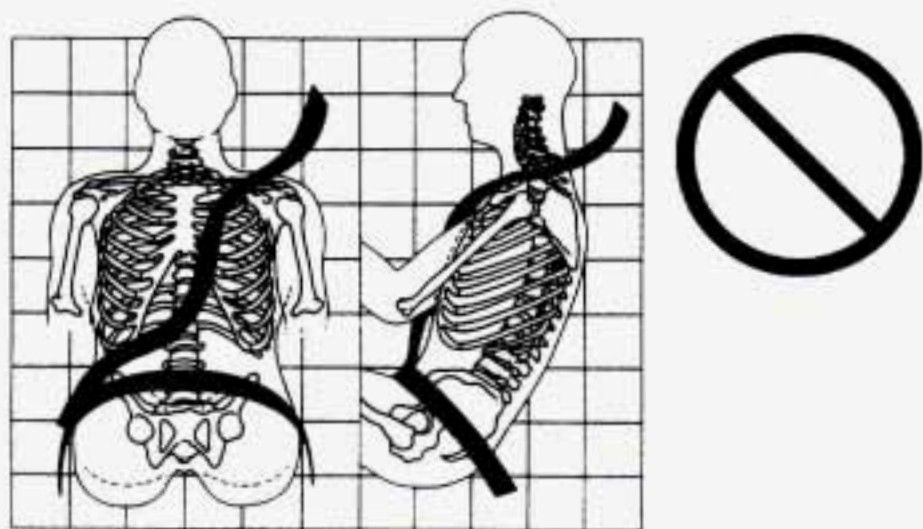

**A:** The shoulder belt is too loose. It won't give nearly as much protection this way.



## **CAUTION:**

**You can be seriously hurt if your shoulder belt is too loose. In a crash you would move forward too much, which could increase injury. The shoulder belt should fit against your body.**

**Q:** What's wrong with this?

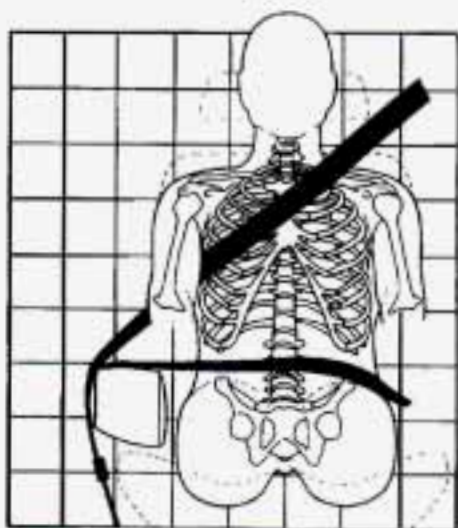

**A:** The belt is over an armrest.



## **CAUTION:**

**You can be seriously injured if your belt goes over an armrest like this. The belt would be much too high. In a crash, you can slide under the belt. The belt force would then be applied at the abdomen, not at the pelvic bones, and that could cause serious or fatal injuries. Be sure the belt goes under the armrests.**

**Q:** What's wrong with this?

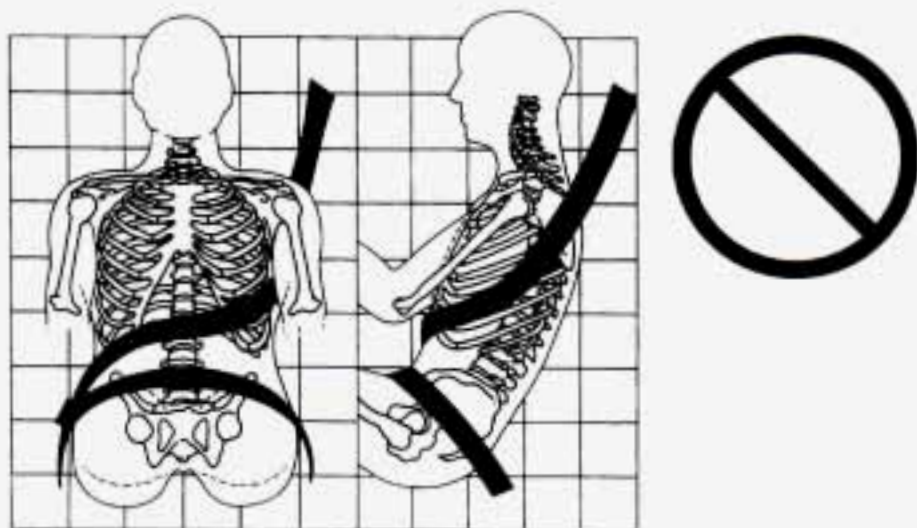

**A:** The shoulder belt is worn under the arm. It should be worn over the shoulder at all times.



**CAUTION:**

**You can be seriously injured if you wear the shoulder belt under your arm. In a crash, your body would move too far forward, which would increase the chance of head and neck injury. Also, the belt would apply too much force to the ribs, which aren't as strong as shoulder bones. You could also severely injure internal organs like your liver or spleen.**

**Q:** What's wrong with this?

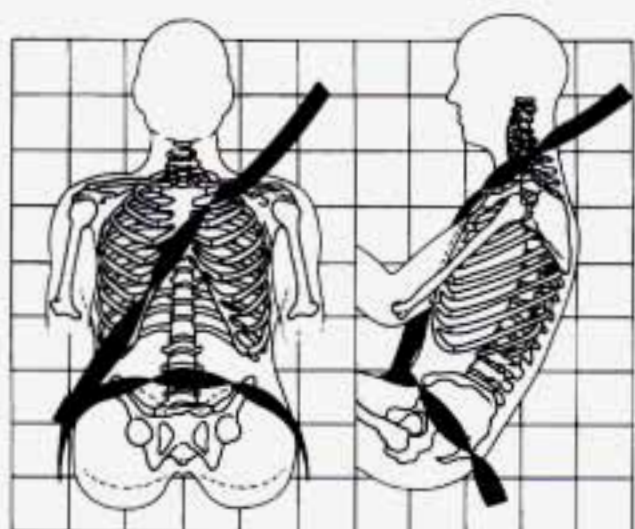

**A:** The belt is twisted across the body.



**CAUTION:**

You can be seriously injured by a twisted belt. In a crash, you wouldn't have the full width of the belt to spread impact forces. If a belt is twisted, make it straight so it can work properly, or ask your dealer to fix it.

To unlatch the belt, just push the button on the buckle. The belt should go back out of the way.



Before you close the door, be sure the belt is out of the way. If you slam the door on it, you can damage both the belt and your vehicle.

## ***Driver's Facial Air Bag System***

This part explains the driver's facial air bag system.

Your vehicle has a facial air bag for the driver.

The driver's facial air bag will help reduce facial injuries when used with the safety belt.

Here are the most important things to know about the facial air bag system:

### **CAUTION:**

**You can be severely injured or killed in a crash if you aren't wearing your safety belt — even if you have an air bag. Wearing your safety belt during a crash helps reduce your chance of hitting things inside the vehicle or being ejected from it. The air bag is only a “supplemental restraint.” That is, it works with safety belts but doesn't replace them. Air bags are designed to work only in moderate to severe crashes where the front of your vehicle hits something. They aren't designed to inflate at all in rollover, rear, side, or low-speed frontal crashes. Everyone in your vehicle, including the driver, should wear a safety belt properly — whether or not there's an air bag for that person.**

### **CAUTION:**

**Air bags inflate with great force, faster than the blink of an eye. If you're too close to an inflating air bag, it could seriously injure you. Safety belts help keep you in position for an air bag inflation in a crash. Always wear your safety belt, even with an air bag, and sit as far back as you can while still maintaining control of your vehicle.**

# AIR BAG

There is an air bag readiness light on the instrument panel, which shows AIR BAG . The system checks the air bag's electrical system for malfunctions. The light tells you if there is an electrical problem. See "Air Bag Readiness Light" in the Index for more information.

## *How the Air Bag System Works*



### **Where is the air bag?**

The driver's facial air bag is in the middle of the steering wheel.





## **CAUTION:**

**Don't put anything on, or attach anything to, the steering wheel. Also, don't put anything (such as pets or objects) between the driver and the steering wheel. If something is between an occupant and an air bag, it could affect the performance of the air bag — or worse, it could cause injury.**

### **When should an air bag inflate?**

The air bag is designed to inflate in moderate to severe frontal or near-frontal crashes. The air bag will inflate only if the impact speed is above the system's designed "threshold level." If your vehicle goes straight into a wall that doesn't move or deform, the threshold level is about 11 to 16 mph (18 to 26 km/h). The threshold level can vary, however, with specific vehicle design, so that it can be somewhat above or below this range. If your vehicle strikes something that will move or deform, such as a parked car, the threshold level will be higher. The air bag is not designed to inflate in rollovers, side impacts, or rear impacts, because inflation would not help the occupant.

In any particular crash, no one can say whether an air bag should have inflated simply because of the damage to a vehicle or because of what the repair costs were. Inflation is determined by the angle of the impact and the vehicle's deceleration. Vehicle damage is only one indication of this.

### **What makes an air bag inflate?**

In a frontal impact of sufficient severity, the air bag sensing system detects that the vehicle is suddenly stopping as a result of a crash. The sensing system triggers a chemical reaction of the sodium azide sealed in the inflator. The reaction produces nitrogen gas, which inflates the air bag. The inflator, air bag, and related hardware are all part of the air bag module packed inside the steering wheel.

### **How does an air bag restrain?**

In moderate to severe frontal or near-frontal collisions, even belted occupants can contact the steering wheel. The air bag supplements the protection provided by safety belts. Air bags distribute the force of the impact more evenly over the occupant's upper body, stopping the occupant more gradually. But air bags would not help you in many types of collisions, including rollovers and rear and side impacts, primarily because an occupant's motion is not toward the air bag. Air bags should never be regarded as anything more than a supplement to safety belts, and then only in moderate to severe frontal or near-frontal collisions.

## What will you see after an air bag inflates?

After the air bag inflates, it quickly deflates. This occurs so quickly that some people may not even realize the air bag inflated. Some components of the air bag module in the steering wheel hub will be hot for a short time, but the part of the bag that comes into contact with you will not be hot to the touch. There will be some smoke coming from vents in the deflated air bag. Air bag inflation will not prevent the driver from seeing or from being able to steer the vehicle, nor will it stop people from leaving the vehicle.



### **CAUTION:**

**When an air bag inflates, there is dust in the air. This dust could cause breathing problems for people with a history of asthma or other breathing trouble. To avoid this, everyone in the vehicle should get out as soon as it is safe to do so. If you have breathing problems but can't get out of the vehicle after an air bag inflates, then get fresh air by opening a window or door.**

- The air bag is designed to inflate only once. After it inflates, you'll need some new parts for your air bag system. If you don't get them, the air bag system won't be there to help protect you in another crash. A new system will include the air bag module and possibly other parts. The service manual for your vehicle covers the need to replace other parts.
- Your vehicle is equipped with a diagnostic module, which records information about the air bag system. The module records information about the readiness of the system, when the sensors are activated and driver's safety belt usage at deployment.
- Let only qualified technicians work on your air bag system. Improper service can mean that your air bag system won't work properly. See your dealer for service.

### **NOTICE:**

**If you damage the cover of the driver's facial air bag, it may not work properly. You may have to replace the air bag module. Do not open or break the air bag cover.**

## ***Servicing Your Facial Air Bag–Equipped Vehicle***

The facial air bag affects how your vehicle should be serviced. There are parts of the air bag system in several places around your vehicle. You don't want the system to inflate while someone is working on your vehicle. Your GM dealer and the 1995 GM Service Manual have information about servicing your vehicle and the air bag system. To purchase a service manual, see "Service Publications" in the Index. The air bag system does not need regular maintenance.



### **CAUTION:**

**For up to 2 minutes after the ignition key is turned off and the battery disconnected, an air bag can still inflate during improper service. You can be injured if you are close to an air bag when it inflates. Avoid wires wrapped with yellow tape, or yellow connectors. They are part of the air bag system. Be sure to follow proper service procedures, and make sure the person performing work for you is qualified to do so.**

## ***Adding Equipment to Your Facial Air Bag–Equipped Vehicle***

**Q:** *If I add a push bumper or a bicycle rack to the front of my vehicle, will it keep the air bag from working properly?*

**A:** As long as the push bumper or bicycle rack is attached to your vehicle so that the vehicle's basic structure isn't changed, it's not likely to keep the air bags from working properly in a crash.

**Q:** *Is there anything I might add to the front of the vehicle that could keep the air bag from working properly?*

**A:** Yes. If you add things that change your vehicle's frame, bumper system, front end sheet metal or height, they may keep the air bag system from working properly. Also, the air bag system may not work properly if you relocate any of the air bag sensors. If you have any question about this, you should contact Customer Assistance before you modify your vehicle. (The phone numbers and addresses for Customer Assistance are in Step Two of the Customer Satisfaction Procedure in this manual. See "Customer Satisfaction Procedure" in the Index.)

## ***Safety Belt Use During Pregnancy***

Safety belts work for everyone, including pregnant women. Like all occupants, they are more likely to be seriously injured if they don't wear safety belts.

A pregnant woman should wear a lap-shoulder belt, and the lap portion should be worn as low as possible throughout the pregnancy.



The best way to protect the fetus is to protect the mother. When a safety belt is worn properly, it's more likely that the fetus won't be hurt in a crash. For pregnant women, as for anyone, the key to making safety belts effective is wearing them properly.

### ***Right Front Passenger Position***

The right front passenger's safety belt works the same way as the driver's safety belt. See "Driver Position," earlier in this section.

When the shoulder belt is pulled out all the way, it will lock. If it does, let it go back all the way and start again.

### ***Rear Seat Passengers***

It's very important for rear seat passengers to buckle up! Accident statistics show that unbelted people in the rear seat are hurt more often in crashes than those who are wearing safety belts.

Rear passengers who aren't safety belted can be thrown out of the vehicle in a crash. And they can strike others in the vehicle who are wearing safety belts.

## ***Rear Seat Outside Passenger Positions***

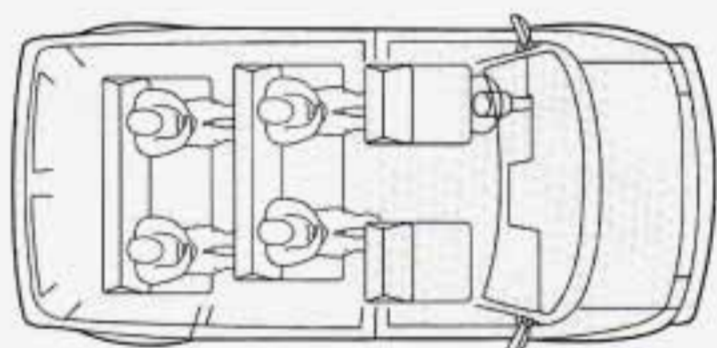

### ***Lap-Shoulder Belt***

These positions have lap-shoulder belts. Here's how to wear one properly.



1. Pick up the latch plate and pull it across you. Don't let it get twisted.
2. Push the latch plate into the buckle until it clicks. If the belt stops before it reaches the buckle, tilt the latch plate and keep pulling until you can buckle it. Pull up on the latch plate to make sure it is secure.

If the belt is not long enough, see "Safety Belt Extender" at the end of this section.

Make sure the release button on the buckle is positioned so you would be able to unbuckle the safety belt quickly if you ever had to.



3. To make the lap part tight, pull down on the buckle end of the belt as you pull up on the shoulder part.

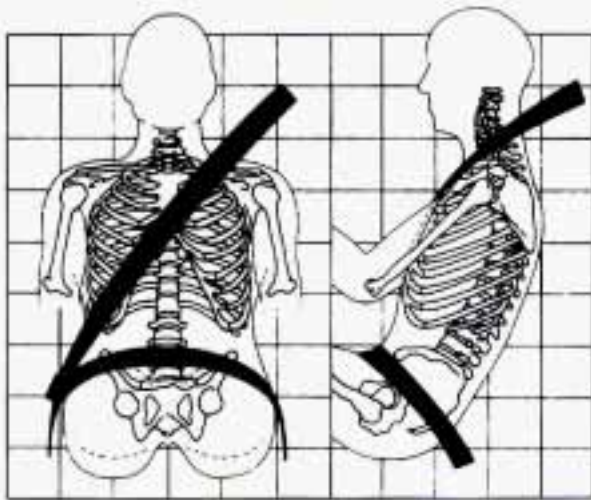

The lap part of the belt should be worn low and snug on the hips, just touching the thighs. In a crash, this applies force to the strong pelvic bones. And you'd be less likely to slide under the lap belt. If you slid under it, the belt would apply force at your abdomen. This could cause serious or even fatal injuries. The shoulder belt should go over the shoulder and across the chest. These parts of the body are best able to take belt restraining forces.

The safety belt locks if there's a sudden stop or a crash.



## **CAUTION:**

You can be seriously hurt if your shoulder belt is too loose. In a crash you would move forward too much, which could increase injury. The shoulder belt should fit against your body.



To unlatch the belt, just push the button on the buckle.

### ***Center Passenger Position (Bench Seat)***

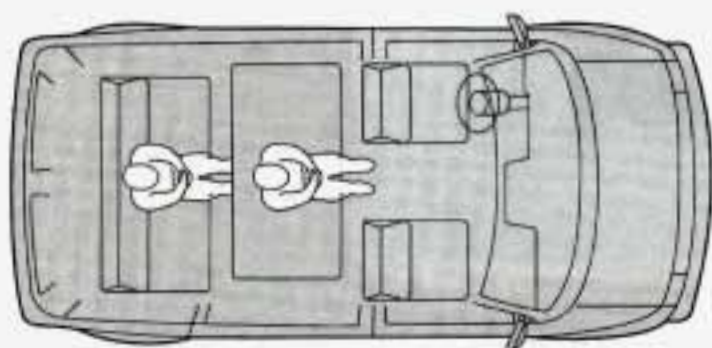

## **Lap Belt**

If your vehicle has rear bench seats, someone can sit in the center positions.



When you sit in a center seating position, you have a lap safety belt, which has no retractor. To make the belt longer, tilt the latch plate and pull it along the belt.

To make the belt shorter, pull its free end as shown until the belt is snug.



Buckle, position and release it the same way as the lap part of a lap-shoulder belt. If the belt isn't long enough, see "Safety Belt Extender" at the end of this section.

Make sure the release button on the buckle is positioned so you would be able to unbuckle the safety belt quickly if you ever had to.



## **Children**

Everyone in a vehicle needs protection! That includes infants and all children smaller than adult size. In fact, the law in every state in the United States and in every Canadian province says children up to some age must be restrained while in a vehicle.

### **Smaller Children and Babies**



#### **CAUTION:**

Smaller children and babies should always be restrained in a child or infant restraint. The instructions for the restraint will say whether it is the right type and size for your child. A very young child's hip bones are so small that a regular belt might not stay low on the hips, as it should. Instead, the belt will likely be over the child's abdomen. In a crash the belt would apply force right on the child's abdomen, which could cause serious or fatal injuries. So, be sure that any child small enough for one is always properly restrained in a child or infant restraint.





 **CAUTION:**

Never hold a baby in your arms while riding in a vehicle. A baby doesn't weigh much — until a crash. During a crash a baby will become so heavy you can't hold it. For example, in a crash at only 25 mph (40 km/h), a 12-pound (5.5 kg) baby will suddenly become a 240-pound (110 kg) force on your arms. The baby would be almost impossible to hold.

Secure the baby in an infant restraint.

## ***Child Restraints***

Be sure to follow the instructions for the restraint. You may find these instructions on the restraint itself or in a booklet, or both. These restraints use the belt system in your vehicle, but the child also has to be secured within the restraint to help reduce the chance of personal injury. The instructions that come with the infant or child restraint will show you how to do that.

### ***Where to Put the Restraint***

Accident statistics show that children are safer if they are restrained in the rear rather than the front seat. We at General Motors therefore recommend that you put your child restraint in the rear seat unless the child is an infant and you're the only adult in the vehicle. In that case, you might want to secure the restraint in the front seat where you can keep an eye on the baby.

Wherever you install it, be sure to secure the child restraint properly.

Keep in mind that an unsecured child restraint can move around in a collision or sudden stop and injure people in the vehicle. Be sure to properly secure any child restraint in your vehicle — even when no child is in it.

### ***Top Strap***



If your child restraint has a top strap, it should be anchored.

If you need to have an anchor installed, you can ask your GM dealer to put it in for you. If you want to install an anchor yourself, your dealer can tell you how to do it.

### ***Securing a Child Restraint in a Rear Outside Seat Position***

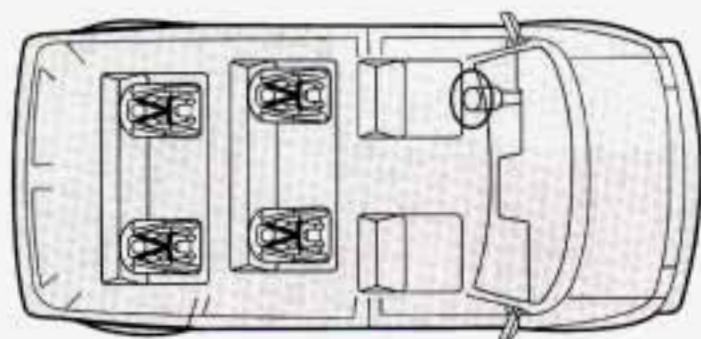

You'll be using the lap-shoulder belt. See the earlier part about the top strap if the child restraint has one.

1. Put the restraint on the seat. Follow the instructions for the child restraint.
2. Secure the child in the child restraint as the instructions say.



3. Pick up the latch plate, and run the lap and shoulder portions of the vehicle's safety belt through or around the restraint. The child restraint instructions will show you how. Tilt the latch plate to adjust the belt if needed. If the shoulder belt goes in front of the child's face or neck, put it behind the child restraint.



4. Buckle the belt. Make sure the release button is positioned so you would be able to unbuckle the safety belt quickly if you ever had to.



5. To tighten the belt, pull up on the shoulder belt while you push down on the child restraint.
6. Push and pull the child restraint in different directions to be sure it is secure.

To remove the child restraint, just unbuckle the vehicle's safety belt and let it go back all the way. The safety belt will move freely again and be ready to work for an adult or larger child passenger.

### ***Securing a Child Restraint in a Center Seat Position (Bench Seat)***

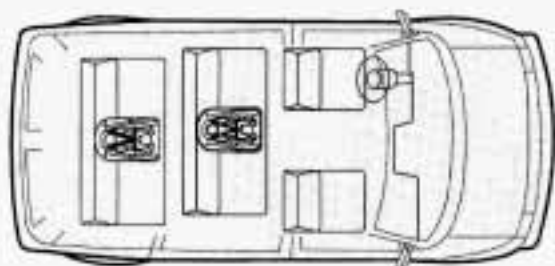

You'll be using the lap belt.

See the earlier part about the top strap if the child restraint has one.

1. Make the belt as long as possible by tilting the latch plate and pulling it along the belt.



2. Put the restraint on the seat. Follow the instructions for the child restraint.
3. Secure the child in the child restraint as the instructions say.
4. Run the vehicle's safety belt through or around the restraint. The child restraint instructions will show you how.



5. Buckle the belt. Make sure the release button is positioned so you would be able to unbuckle the safety belt quickly if you ever had to.

6. To tighten the belt, pull its free end while you push down on the child restraint.
7. Push and pull the child restraint in different directions to be sure it is secure. If the child restraint isn't secure, turn the latch plate over and buckle it again. Then see if it is secure. If it isn't, secure the restraint in a different place in the vehicle and contact the child restraint maker for their advice about how to attach the child restraint properly.

To remove the child restraint, just unbuckle the vehicle's safety belt. It will be ready to work for an adult or larger child passenger.

### ***Securing a Child Restraint in the Right Front Seat Position***

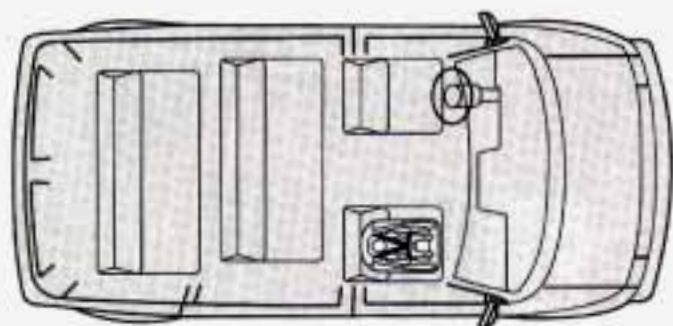

You'll be using the lap-shoulder belt. See the earlier part about the top strap if the child restraint has one.

1. Put the restraint on the seat. Follow the instructions for the child restraint.
2. Secure the child in the child restraint as the instructions say.
3. Pick up the latch plate, and run the lap and shoulder portions of the vehicle's safety belt through or around the restraint. The child restraint instructions will show you how.

If the shoulder belt goes in front of the child's face or neck, put it behind the child restraint.



4. Buckle the belt.

Make sure the release button is positioned so you would be able to unbuckle the safety belt quickly if you ever had to.

5. Pull the rest of the shoulder belt all the way out of the retractor to set the lock.







6. To tighten the belt, feed the shoulder belt back into the retractor while you push down on the child restraint.
7. Push and pull the child restraint in different directions to be sure it is secure.

To remove the child restraint, just unbuckle the vehicle's safety belt and let it go back all the way.

The safety belt will move freely again and be ready to work for an adult or larger child passenger.

### ***Larger Children***



Children who have outgrown child restraints should wear the vehicle's safety belts.

If you have the choice, a child should sit next to a window so the child can wear a lap-shoulder belt and get the additional restraint a shoulder belt can provide.

Accident statistics show that children are safer if they are restrained in the rear seat. But they need to use the safety belts properly.

- Children who aren't buckled up can be thrown out in a crash.
- Children who aren't buckled up can strike other people who are.



### **CAUTION:**

**Never do this.**

**Here two children are wearing the same belt. The belt can't properly spread the impact forces. In a crash, the two children can be crushed together and seriously injured. A belt must be used by only one person at a time.**

**Q:** What if a child is wearing a lap-shoulder belt, but the child is so small that the shoulder belt is very close to the child's face or neck?

**A:** Move the child toward the center of the vehicle, but be sure that the shoulder belt still is on the child's shoulder, so that in a crash the child's upper body would have the restraint that belts provide. If the child is so small that the shoulder belt is still very close to the child's face or neck, you might want to place the child in a seat that has a lap belt, if your vehicle has one.



## **CAUTION:**

Never do this.

**Here a child is sitting in a seat that has a lap-shoulder belt, but the shoulder part is behind the child. If the child wears the belt in this way, in a crash the child might slide under the belt. The belt's force would then be applied right on the child's abdomen. That could cause serious or fatal injuries.**

Wherever the child sits, the lap portion of the belt should be worn low and snug on the hips, just touching the child's thighs. This applies belt force to the child's pelvic bones in a crash.

## ***Safety Belt Extender***

If the vehicle's safety belt will fasten around you, you should use it.

But if a safety belt isn't long enough to fasten, your dealer will order you an extender. It's free. When you go in to order it, take the heaviest coat you will wear, so the extender will be long enough for you. The extender will be just for you, and just for the seat in your vehicle that you choose. Don't let someone else use it, and use it only for the seat it is made to fit. To wear it, just attach it to the regular safety belt.

## ***Checking Your Restraint Systems***

Now and then, make sure all your belts, buckles, latch plates, retractors, anchorages and reminder systems are working properly. Look for any other loose or damaged restraint system parts. If you see anything that might keep a restraint system from doing its job, have it repaired.

Torn or frayed belts may not protect you in a crash. They can rip apart under impact forces. If a belt is torn or frayed, get a new one right away.

## ***Replacing Seat and Restraint System Parts After a Crash***

If you've had a crash, do you need new belts?

After a very minor collision, nothing may be necessary. But if the belts were stretched, as they would be if worn during a more severe crash, then you need new belts.

If belts are cut or damaged, replace them. Collision damage also may mean you will need to have safety belt or seat parts repaired or replaced. New parts and repairs may be necessary even if the belt wasn't being used at the time of the collision.

Before replacing any safety belt, see your dealer for the correct part number. You'll need the model year and model number for your vehicle. The model year is on your title and registration. And you can find the model number on the Certification/Tire label of your vehicle. See "Certification/Tire Label" in the Index.



The model number on the replacement belt must be listed on the safety belt you want to replace. Pull the shoulder belt all the way out to see this label.

## ***Features & Controls***

## ***Section***

# **2**

Here you can learn about the many standard and optional features on your vehicle, and information on starting, shifting and braking. Also explained are the instrument panel and the warning systems that tell you if everything is working properly — and what to do if you have a problem.

### ***Keys***





## **CAUTION:**

**Leaving young children in a vehicle with the ignition key is dangerous for many reasons. A child or others could be badly injured or even killed.**

**They could operate power windows or other controls or even make the vehicle move. Don't leave the keys in a vehicle with young children.**



The square-shaped key is for the ignition only.



The oval-shaped key is for the doors and all other locks.

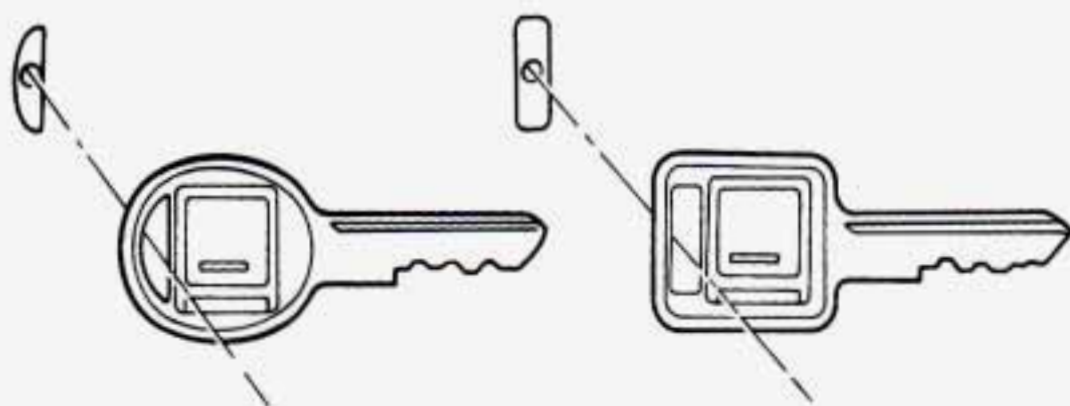

When a new vehicle is delivered, the dealer removes the plugs from the keys, and gives them to the first owner.

Each plug has a code on it that tells the dealer or a qualified locksmith how to make extra keys. Keep the plugs in a safe place. If you lose your keys, you'll be able to have new ones made easily using these plugs.

### **NOTICE:**

**Your vehicle has a number of new features that can help prevent theft. But you can have a lot of trouble getting into your vehicle if you ever lock your keys inside. You may even have to damage your vehicle to get in. So be sure you have extra keys.**

# ***Your Doors and How They Work***

## ***Side Doors***

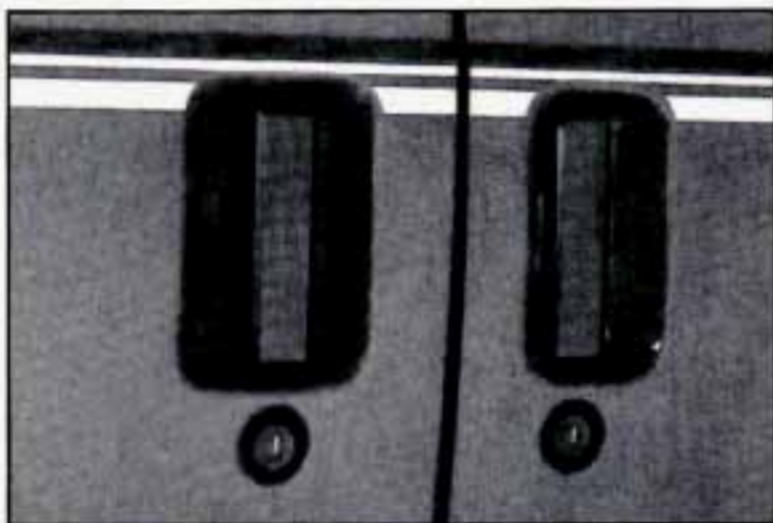

To open the front side door from the outside, grasp the handle and pull the door open.



To open the front side door from the inside, pull the lever toward you and push the door open.



## ***Sliding Side Door***

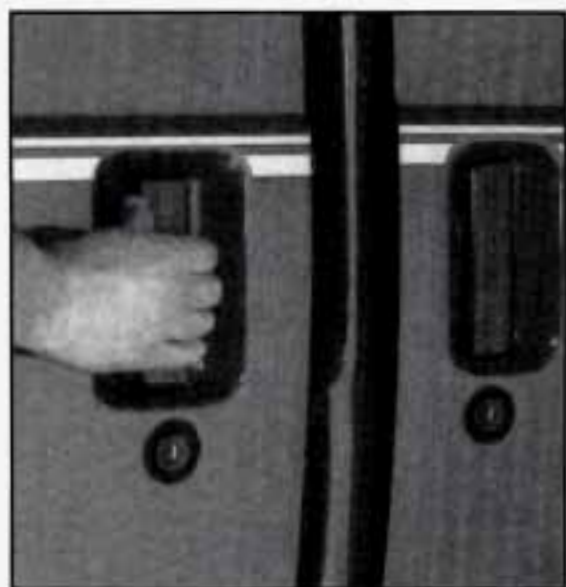

To open the sliding side door, pull the handle toward the back and slide the door to the rear until it latches in the open position.



To close the sliding side door, pull the handle toward the front to release the rear latch, and slide the door forward.

## ***Rear Doors***

If you have the Dutch doors, you must open the hatch first.



To open the rear doors from the outside, open the right rear door first. Grasp the handle and pull the door open.



To open the left rear door, pull on the latch release handle in the inside of the door.

To close the rear doors, close the left door first. Check to make sure both doors are completely closed.

The rear doors have a check assembly to keep the doors from opening beyond 90°.



To fully open the doors, push in on the clip and lift the check assembly up off the mounting bracket. Do this on each door. Replace the assemblies the same way.

See the caution under “Swing-Out Windows” in this section.

## ***Door Locks***



### **CAUTION:**

**Unlocked doors can be dangerous.**

**Passengers — especially children — can easily open the doors and fall out. When a door is locked, the inside handle won't open it.**

**Outsiders can easily enter through an unlocked door when you slow down or stop your vehicle.**

**This may not be so obvious: You increase the chance of being thrown out of the vehicle in a crash if the doors aren't locked. Wear safety belts properly, lock your doors, and you will be far better off whenever you drive your vehicle.**

There are several ways to lock and unlock your vehicle:

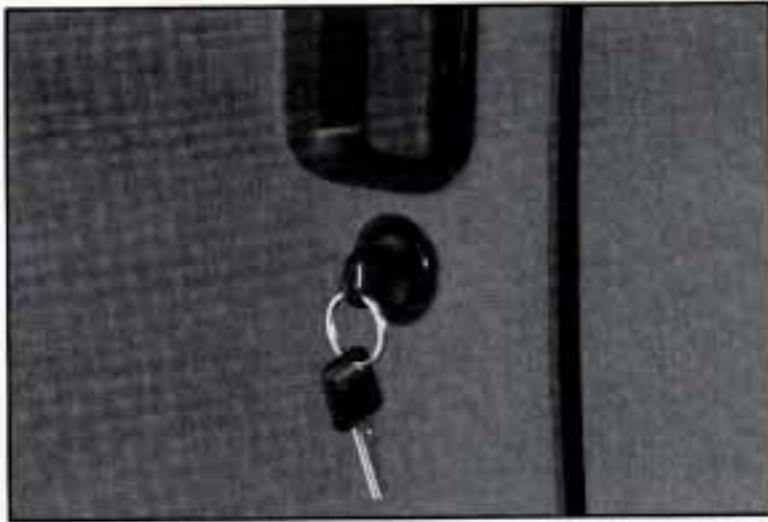

From the outside: Use your door key.



From the inside: To lock front doors and sliding side door, slide the lock levers down.

To unlock the front doors and the sliding side door from the inside: Slide the lock levers up.

Rear doors cannot be manually locked from the inside.

To unlock the rear hatch and Dutch doors from the inside: Push the top of the HATCH REL switch.

## ***Rear Hatch and Dutch Doors Release***

If you have this option, your vehicle must be in either PARK (P) or NEUTRAL (N) to release the hatch and unlock the Dutch doors. If your battery is dead, the hatch and doors will not open, even from the outside with a key.



To release the hatch and unlock the doors from the inside of the vehicle, press the HATCH REL switch on the instrument panel. It is located on the driver's side of the steering column. The hatch will release with or without the key in the ignition.

Then, pull up on the hatch handle and open the doors.

To release the hatch using the optional Keyless Entry hand held transmitter, see "Keyless Entry System" in the Index.



To release the hatch and unlock the doors from the outside of the vehicle, put the key in the lock and turn clockwise. Then, pull up on the hatch and open the right rear door first. Grasp the handle and pull the door open.

The hatch and doors will automatically lock when the hatch is shut.

If the hatch is partially closed, the rear doors will lock and you will need to use the key or HATCH REL switch to unlock them.

Also, see the Caution under "Swing Out Windows", located in this section.

## ***Power Door Locks***



If your vehicle has power door locks, push the power door lock switch to lock or unlock all the doors at once.

The power door lock switch will not lock or unlock the rear hatch and Dutch doors. You must use the HATCH REL switch. See “Rear Hatch and Dutch Doors Release” in this section.

Every vehicle with power door locks has a pulse lock system. A pulse lock system works like this:

If the sliding door is open and you push the power door lock switch, the sliding door will not lock immediately. After you close the door, the system comes on and, in about five seconds, locks the sliding door.

All models have overriding door locks. When a door is locked, the door handle will not work the latch. This will help stop a door from being accidentally opened. However, power door locks do not affect the operation of the hatch.

## ***Leaving Your Vehicle***

If you are leaving the vehicle, take your keys, open your door and set the locks from inside. Then get out and close the door.

## ***Keyless Entry System***

If your vehicle has this option, you can lock and unlock your doors or hatch from up to 30 feet (9 m) away using the key chain transmitter supplied with your vehicle.

Your Keyless Entry System operates on a radio frequency subject to Federal Communications Commission (FCC) Rules.

This device complies with Part 15 of the FCC Rules. Operation is subject to the following two conditions: (1) This device may not cause harmful interference, and (2) This device must accept any interference received, including interference that may cause undesired operation.

Should interference to this system occur, try this:

- Check to determine if battery replacement is necessary. See the instructions on battery replacement.
- Check the distance. You may be too far from your vehicle. This product has a maximum range.
- Check the location. Other vehicles or objects may be blocking the signal.
- See your GM dealer or a qualified technician for service.

Changes or modifications to this system by other than an authorized service facility could void authorization to use this equipment.

## ***Operation***

When you press UNLOCK, the driver's door will unlock automatically. If you press UNLOCK again within five seconds, all doors will unlock. All doors will lock when DOOR is pressed. Pressing REAR will unlock the hatch.

## ***Matching Transmitter(s) To Your Vehicle***

Each key chain transmitter is coded to prevent another transmitter from unlocking your vehicle. If a transmitter is lost or stolen, a replacement can be purchased through your dealer. Remember to bring any remaining transmitters with you when you go to your dealer. When the dealer matches the replacement transmitter to your vehicle, the remaining transmitters must also be matched. Once the new transmitter is coded, the lost transmitter will not unlock your vehicle.

You can match a transmitter to as many different vehicles as you own, provided they are equipped with *exactly the same model system*. (General Motors offers several different models of these systems on their vehicles.) Each vehicle can have only two transmitters matched to it.

See your dealer to match transmitters to another vehicle.

## ***Battery Replacement***

Under normal use, the batteries in your key chain transmitter should last about two years.

You can tell the batteries are weak if the transmitter won't work at the normal range in any location. If you have to get close to your vehicle before the transmitter works, it's probably time to change the batteries.

Your transmitter housing snaps apart for ease in battery replacement. To open the housing:



1. Insert a dime between two halves of the transmitter housing near the key ring hole.
2. Remove the bottom by twisting the dime.
3. Remove and replace the batteries with two Duracell<sup>®</sup>-type batteries (DL2016 or equivalent), positive side down.
4. Align and snap together the back and top transmitter housings.

## ***Theft***

Vehicle theft is big business, especially in some cities. Although your vehicle has a number of theft deterrent features, we know that nothing we put on it can make it impossible to steal. However, there are ways you can help.

### ***Key in the Ignition***

If you walk away from your vehicle with the keys inside, it's an easy target for joy riders or professional thieves — so don't do it.

When you park your Vehicle and open the driver's door, you'll hear a chime reminding you to remove your key from the ignition and take it with you. Always do this. Your steering wheel will be locked, and so will your ignition and transmission. And remember to lock the doors.



## ***Parking at Night***

Park in a lighted spot, close all windows and lock your vehicle. Remember to keep your valuables out of sight. Put them in a storage area, or take them with you.

## ***Parking Lots***

If you park in a lot where someone will be watching your vehicle, it's best to lock it up and take your keys. But what if you have to leave your ignition key? What if you have to leave something valuable in your vehicle?

- Put your valuables in a storage area out of sight.
- Lock all the doors except the driver's.
- Then take the door key with you.

## ***New Vehicle "Break-In"***

### **NOTICE:**

Your modern vehicle doesn't need an elaborate "break-in." But it will perform better in the long run if you follow these guidelines:

- Keep your speed at 55 mph (88 km/h) or less for the first 500 miles (804 km).
- Don't drive at any one speed — fast or slow — for the first 500 miles (804 km). Don't make full-throttle starts.
- Avoid making hard stops for the first 200 miles (322 km) or so. During this time your new brake linings aren't yet broken in. Hard stops with new linings can mean premature wear and earlier replacement. Follow this "breaking-in" guideline every time you get new brake linings.

## Ignition Switch

Use your ignition key to start your vehicle. The ignition key lets you turn the ignition switch to five different positions.

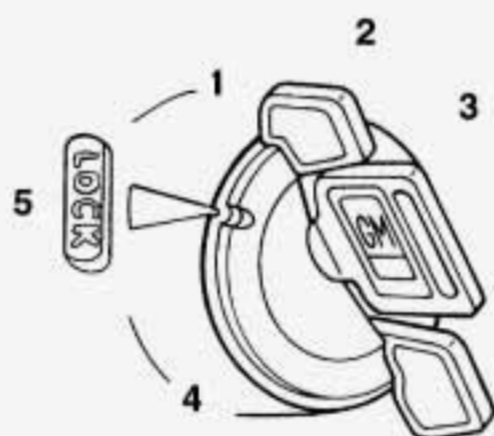

1. OFF
2. RUN
3. START
4. ACC
5. LOCK

**ACC (Accessory)** — ACC lets you use things like the radio and the windshield wipers when the engine is off. To get into ACC, push in the key and turn it toward you. Your steering wheel will remain locked, just as it was before you inserted the key.

### **NOTICE:**

**Don't operate accessories in the ACC position for long periods of time. Prolonged operation of accessories in the ACC position could drain your battery and prevent you from starting your vehicle.**

**LOCK** — This position locks your ignition, steering wheel and transmission. It's a theft deterrent feature. You will only be able to remove your key when the ignition is turned to LOCK.

**OFF** — This position lets you turn off the engine but still turn the steering wheel. Use OFF if you must have your vehicle in motion while the engine is off (for example, if your vehicle is being pushed).

**RUN** — This is the position for driving.

**START** — This starts your engine.

## **NOTICE:**

If your key seems stuck in **LOCK** and you can't turn it, be sure it is all the way in. If it is, then turn the steering wheel left and right while you turn the key hard. But turn the key only with your hand. Using a tool to force it could break the key or the ignition switch. If none of this works, then your vehicle needs service.

## ***Starting Your Engine***

Engines start differently. The 8th digit of your Vehicle Identification Number (VIN) shows the code letter or number for your engine. You will find the VIN at the top left of your instrument panel. (See "Vehicle Identification Number" in the Index.) Follow the proper steps to start the engine.

Move your shift lever to **PARK (P)** or **NEUTRAL (N)**. Your engine won't start in any other position — that's a safety feature. To restart when you're already moving, use **NEUTRAL (N)** only.

## **NOTICE:**

**Don't try to shift to **PARK (P)** if your vehicle is moving. If you do, you could damage the transmission. Shift to **PARK (P)** only when your vehicle is stopped.**

1. Without pushing the accelerator pedal, turn your ignition key to **START**. When the engine starts, let go of the key. The idle speed will go down as your engine gets warm.

## **NOTICE:**

**Holding your key in **START** for longer than 15 seconds at a time will cause your battery to be drained much sooner. And the excessive heat can damage your starter motor.**

2. If it doesn't start right away, hold your key in **START**. If it doesn't start in three seconds, push the accelerator pedal about one-quarter of the way down for 12 more seconds, or until it starts.

3. If your engine still won't start (or starts but then stops), it could be flooded with too much gasoline. Try this:
4. Wait 15 seconds to let the starter motor cool down. Then push your accelerator pedal all the way to the floor. Hold it there. Then, hold the key in START for no more than ten seconds. This clears the extra gasoline from the engine.

If the engine still doesn't start, wait another 15 seconds and do Step 4 again.

When the engine starts, let go of the key and the accelerator pedal.

## **NOTICE:**

Your engine is designed to work with the electronics in your vehicle. If you add electrical parts or accessories, you could change the way the fuel injection system operates. Before adding electrical equipment, check with your dealer. If you don't, your engine might not perform properly.

If you ever have to have your vehicle towed, see the part of this manual that tells how to do it without damaging your vehicle. See "Towing Your Vehicle" in the Index.

## ***Fuel Regulator***

You have a fuel regulator that shuts the fuel off when the engine reaches 5,600 rpm.

## ***Driving Through Deep Standing Water***

### **NOTICE:**

If you drive too quickly through deep puddles or standing water, water can come in through your engine's air intake and badly damage your engine. If you can't avoid deep puddles or standing water, drive through them very slowly.

## Engine Coolant Heater (Option)

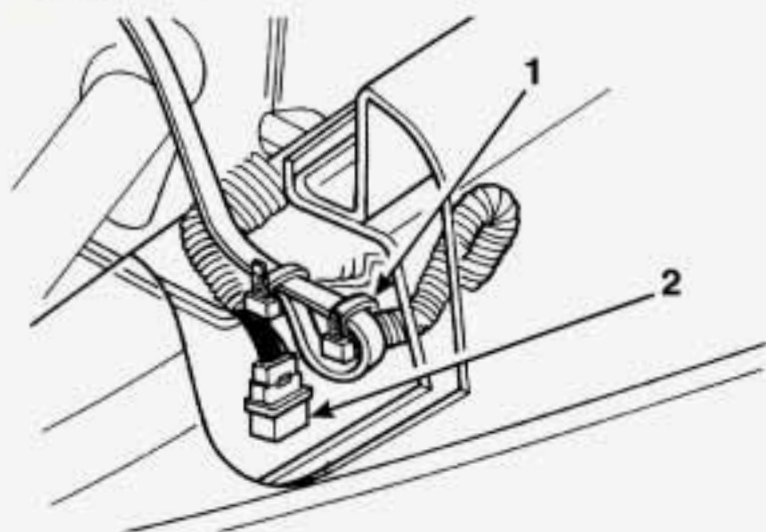

1. Engine Coolant Heater Strap
2. Engine Coolant Heater Cap

In very cold weather, 0°F (-18°C) or colder, the engine coolant heater can help. You'll get easier starting and better fuel economy during engine warm-up. Usually, the coolant heater should be plugged in a minimum of four hours prior to starting your vehicle.

### To use the coolant heater:

1. Turn off the engine.
2. Open the hood and unwrap the electrical cord.
3. Plug it into a normal, grounded 110-volt outlet.



### **CAUTION:**

**Plugging the cord into an ungrounded outlet could cause an electrical shock. Also, the wrong kind of extension cord could overheat and cause a fire. You could be seriously injured. Plug the cord into a properly grounded three-prong 110-volt outlet. If the cord won't reach, use a heavy-duty three-prong extension cord rated for at least 15 amps.**

### **NOTICE:**

**After you've used the coolant heater, be sure to store the cord as it was before to keep it away from moving engine parts. If you don't, it could be damaged.**

How long should you keep the coolant heater plugged in? The answer depends on the weather, the kind of oil you have, and some other things. Instead of trying to list everything here, we ask that you contact your GM dealer in the area where you'll be parking your vehicle. The dealer can give you the best advice for that particular area.

## ***Automatic Transmission***

There are several different positions for your shift lever.

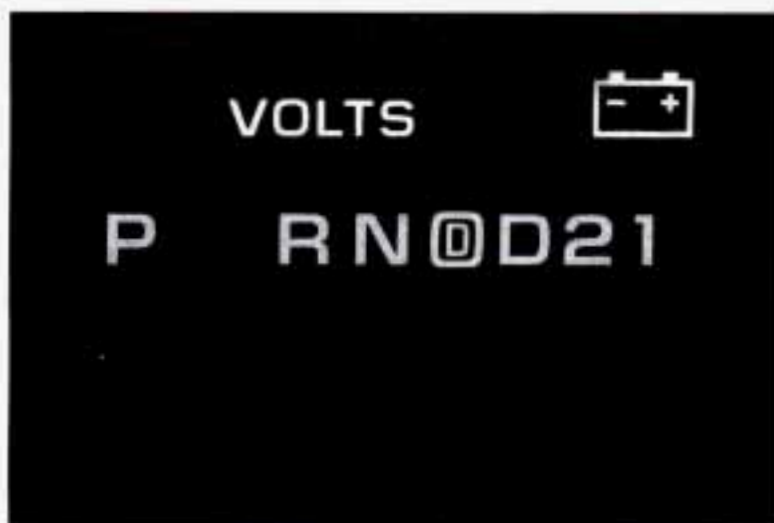

- **PARK (P)** —This locks your rear wheels. It's the best position to use when you start your engine because your vehicle can't move easily.

### **CAUTION:**

**It is dangerous to get out of your vehicle if the shift lever is not fully in PARK (P) with the parking brake firmly set. Your vehicle can roll.**

**Don't leave your vehicle when the engine is running unless you have to. If you have left the engine running, the vehicle can move suddenly. You or others could be injured. To be sure your vehicle won't move, even when you're on fairly level ground, always set your parking brake and move the shift lever to PARK (P).**

**See "Shifting Into PARK (P)" in the Index. If you're pulling a trailer, see "Towing a Trailer" in the Index.**

Ensure the shift lever is fully in PARK (P) range before starting the engine. Your vehicle has a brake–transmission shift interlock. You have to fully apply your regular brakes before you can shift from PARK (P) when the ignition key is in the RUN position. If you cannot shift out of PARK (P), ease pressure on the shift lever — push the shift lever all the way into PARK (P) as you maintain brake application. Then move the shift lever into the gear you wish. See “Shifting Out of PARK (P)” in this section.

- **REVERSE (R)** — Use this gear to back up.

## **NOTICE:**

**Shifting to REVERSE (R) while your vehicle is moving forward could damage your transmission. Shift to REVERSE (R) only after your vehicle is stopped.**

To rock your vehicle back and forth to get out of snow, ice or sand without damaging your transmission, see “If You’re Stuck: In Sand, Mud, Ice or Snow” in the Index.

- **NEUTRAL (N)** — In this position, your engine doesn’t connect with the wheels. To restart when you’re already moving, use NEUTRAL (N) only. Also, use NEUTRAL (N) when your vehicle is being towed.



## **CAUTION:**

**Shifting out of PARK (P) or NEUTRAL (N) while your engine is “racing” (running at high speed) is dangerous. Unless your foot is firmly on the brake pedal, your vehicle could move very rapidly. You could lose control and hit people or objects. Don’t shift out of PARK (P) or NEUTRAL (N) while your engine is racing.**

## **NOTICE:**

**Damage to your transmission caused by shifting out of PARK (P) or NEUTRAL (N) with the engine racing isn’t covered by your warranty.**

- **OVERDRIVE (Ⓢ)**

This position is for normal driving. If you need more power for passing, and you're:

- Going less than about 35 mph (56 km/h), push your accelerator pedal about halfway down.
- Going about 35 mph (56 km/h) or more, push the accelerator pedal all the way down. You'll shift down to the next gear and have more power.

OVERDRIVE (Ⓢ) should not be used when towing a trailer, carrying a heavy load, or driving on steep hills. Select THIRD GEAR (D) when operating the vehicle under any of these conditions.

- **THIRD GEAR (D)** — This is like OVERDRIVE (Ⓢ), but you never go into OVERDRIVE (Ⓢ). You should use THIRD GEAR (D) when towing a trailer, carrying a heavy load or driving on steep hills.
- **SECOND GEAR (2)** — This position gives you more power but lower fuel economy. You can use SECOND GEAR (2) on hills. It can help control your speed as you go down steep mountain roads, but then you would also want to use your brakes off and on.

If you manually select SECOND GEAR (2), the transmission will drive in second gear. You may use this feature for reducing torque to the rear wheels when you are trying to start your vehicle from a stop on slippery road surfaces.

- **FIRST GEAR (1)** — This position gives you even more power (but lower fuel economy) than SECOND GEAR (2). You can use it on very steep hills, or in deep snow or mud. If the selector lever is put in FIRST GEAR (1), the transmission won't shift into FIRST GEAR (1) until the vehicle is going slowly enough.

## **NOTICE:**

**If your rear wheels can't rotate, don't try to drive. This might happen if you were stuck in very deep sand or mud or were up against a solid object. You could damage your transmission or transfer case or both.**

**Also, if you stop when going uphill, don't hold your vehicle there with only the accelerator pedal. This could overheat and damage the transmission. Use your brakes or shift into PARK (P) to hold your vehicle in position on a hill.**



## ***Parking Brake***

### ***To Set the Parking Brake***



Hold the regular brake pedal down with your right foot. Push down the parking brake pedal with your left foot. If the ignition is on, the brake system warning light will come on.

### ***To Release the Parking Brake***



Hold the regular brake pedal down. Pull the brake release lever.

### **NOTICE:**

Driving with the parking brake on can cause your rear brakes to overheat. You may have to replace them, and you could also damage other parts of your vehicle.

**If you are on a hill:** See "Parking on Hills" in the Index.

**If you are towing a trailer and are parking on any hill:** See "Towing a Trailer" in the Index. that section shows what to do first to keep the trailer from moving.

## Locking Rear Axle

If you have this feature, your rear axle can give you additional traction on snow, mud, ice, sand or gravel. It works like a standard axle most of the time, but when one of the rear wheels has no traction and the other does, the locking feature will allow the wheel with traction to move the vehicle.

## Shifting Into PARK (P)



### CAUTION:

It can be dangerous to get out of your vehicle if the shift lever is not fully in PARK (P) with the parking brake firmly set. Your vehicle can roll.

If you have left the engine running, the vehicle can move suddenly. You or others could be injured. To be sure your vehicle won't move, even when you're on fairly level ground, use the steps that follow. If you're pulling a trailer, see "Towing a Trailer" in the Index.

1. Hold the brake pedal down with your right foot and set the parking brake.



2. Move the shift lever into PARK (P) position like this:
  - Pull the lever toward you.
  - Move the lever up as far as it will go.

3. Move the ignition key to LOCK
4. Remove the key and take it with you. If you can walk away from your vehicle with the ignition key in your hand, your vehicle is in PARK (P).

## ***Leaving Your Vehicle With the Engine Running***



### **CAUTION:**

**It can be dangerous to leave your vehicle with the engine running. Your vehicle could move suddenly if the shift lever is not fully in PARK (P) with the parking brake firmly set. And, if you leave the vehicle with the engine running, it could overheat and even catch fire. You or others could be injured. Don't leave your vehicle with the engine running unless you have to.**

If you have to leave your vehicle with the engine running, be sure your vehicle is in PARK (P) and your parking brake is firmly set before you leave it. After you've moved the shift lever into the PARK (P) position, hold the regular brake pedal down. Then, see if you can move the shift lever away from PARK (P) without first pulling it toward you. If you can, it means that the shift lever wasn't fully locked into PARK (P).

### ***Torque Lock***

If you are parking on a hill and you don't shift your transmission into PARK (P) properly, the weight of the vehicle may put too much force on the parking pawl in the transmission. You may find it difficult to pull the shift lever out of PARK (P). This is called "torque lock." To prevent torque lock, set the parking brake and then shift into PARK (P) properly before you leave the driver's seat. To find out how, see "Shifting Into PARK (P)" in the Index.

When you are ready to drive, move the shift lever out of PARK (P) *before* you release the parking brake.

If "torque lock" does occur, you may need to have another vehicle push yours a little uphill to take some of the pressure from the transmission, so you can pull the shift lever out of PARK (P).

## ***Shifting Out of PARK (P)***

Your vehicle has a brake–transmission shift interlock. You have to fully apply your regular brake before you can shift from PARK (P) when the ignition is in the RUN position. See “Automatic Transmission” in the Index.

If you cannot shift out of PARK (P), ease pressure on the shift lever — push the shift lever all the way into PARK (P) as you maintain brake application. Then move the shift lever into the gear you want.

If you ever hold the brake pedal down but still can't shift out of PARK (P), try this:

1. Turn the key to OFF.
2. Apply and hold the brake until the end of Step 4.
3. Shift to NEUTRAL (N).
4. Start the vehicle and then shift to the drive gear you want.
5. Have the vehicle fixed as soon as you can.

## ***Parking Over Things That Burn***



### **CAUTION:**

Things that can burn could touch hot exhaust parts under your vehicle and ignite. Don't park over papers, leaves, dry grass or other things that can burn.

## ***Engine Exhaust***



### **CAUTION:**

**Engine exhaust can kill. It contains the gas carbon monoxide (CO), which you can't see or smell. It can cause unconsciousness and death.**

**You might have exhaust coming in if:**

- **Your exhaust system sounds strange or different.**
- **Your vehicle gets rusty underneath.**
- **Your vehicle was damaged in a collision.**
- **Your vehicle was damaged when driving over high points on the road or over road debris.**
- **Repairs weren't done correctly.**
- **Your vehicle or exhaust system had been modified improperly.**

**If you ever suspect exhaust is coming into your vehicle:**

- **Drive it only with all the windows down to blow out any CO;  
and**
- **Have your vehicle fixed immediately.**

## ***Running Your Engine While You're Parked***

It's better not to park with the engine running. But if you ever have to, here are some things to know.



### **CAUTION:**

**Idling the engine with the air system control off could allow dangerous exhaust into your vehicle (see the earlier Caution under "Engine Exhaust").**

**Also, idling in a closed-in place can let deadly carbon monoxide (CO) into your vehicle even if the fan switch is at the highest setting. One place this can happen is a garage. Exhaust — with CO — can come in easily. NEVER park in a garage with the engine running.**

**Another closed-in place can be a blizzard.**



### **CAUTION:**

**It can be dangerous to get out of your vehicle if the shift lever is not fully in PARK (P) with the parking brake firmly set. Your vehicle can roll. Don't leave your vehicle when the engine is running unless you have to. If you've left the engine running, the vehicle can move suddenly. You or others could be injured. To be sure your vehicle won't move, even when you're on fairly level ground, always set your parking brake and move the shift lever to PARK (P).**

Follow the proper steps to be sure your vehicle won't move. See "Shifting Into PARK (P)" in the Index.

## ***All-Wheel Drive (Option)***

If your vehicle has all-wheel drive, your engine's driving power is sent to all four wheels for extra traction.



This is like four-wheel drive, but there is no separate lever or switch to engage or disengage the front axle. It is fully automatic, and adjusts itself as needed for road conditions.

## ***Windows***

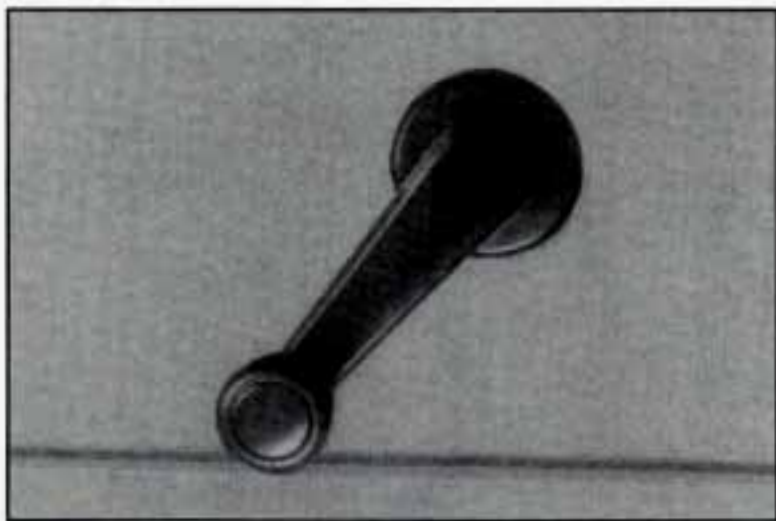

To open your manual windows, turn the hand crank on each door to raise or lower your side door windows.



If you have optional power windows, the controls are on each of the front side doors. The driver's door has a switch for the front passenger window as well. Your power windows will not move unless the ignition has been turned to RUN.

## Swing-Out Windows

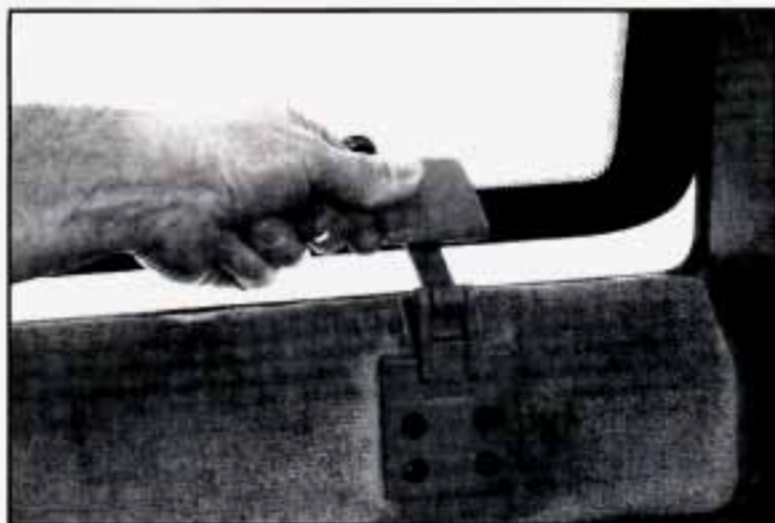

To open your swing-out windows, pull up on the latch and push the window out.

To close the window, pull the latch toward you and push it down.

### **CAUTION:**

It can be dangerous to drive with the rear swing-out windows, rear hatch or rear doors open because carbon monoxide (CO) gas can come into your vehicle. You can't see or smell CO. It can cause unconsciousness and even death.

If you must drive with the rear swing-out windows, rear hatch or rear doors open or if electrical wiring or other cable connections must pass through the seal between the body and the rear swing-out windows, rear hatch or rear doors:

- Make sure all windows are shut.
- Turn the fan on your heating or cooling system to its highest speed with the setting on anything but MAX A/C . That will force outside air into your vehicle. See "Comfort Controls" in the Index.
- If you have air outlets on or under the instrument panel, open them all the way.

See "Engine Exhaust" in the Index.



## ***Horn***



To sound the horn, press the pads on the steering wheel with the horn symbols.

## ***Tilt Wheel (Option)***



A tilt steering wheel allows you to adjust the steering wheel before you drive.

You can also raise it to the highest level to give your legs more room when you exit and enter the vehicle.

To tilt the wheel, hold the steering wheel and pull the lever. Move the steering wheel to a comfortable level, then release the lever to lock the wheel in place.

## Multifunction Lever



The lever on the driver's side of the steering column includes your:

- Turn Signal and Lane Change Indicator
- Headlamp High–Low Beam
- Windshield Wipers
- Windshield Washer
- Cruise Control (Option)

### Turn Signal and Lane Change Indicator



The turn signal has two upward (for Right) and two downward (for Left) positions. These positions allow you to signal a turn or a lane change.

To signal a turn, move the lever all the way up or down. When the turn is finished, the lever will return automatically.

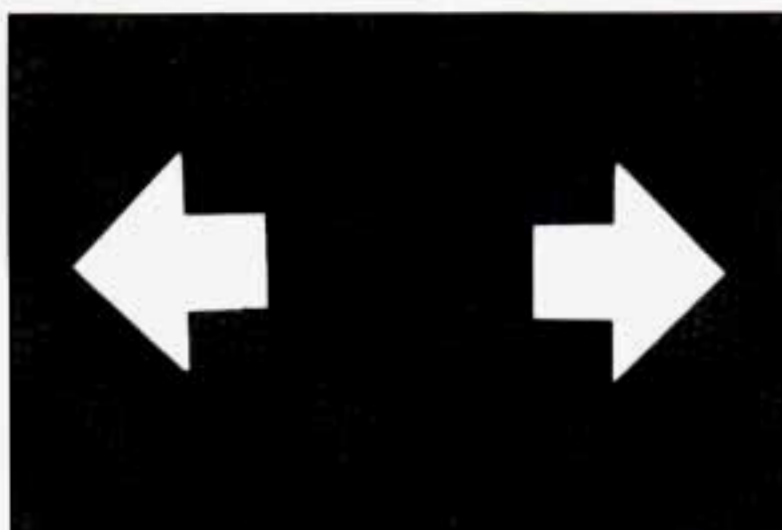

A green arrow on the instrument panel will flash in the direction of the turn or lane change.

To signal a lane change, just raise or lower the lever until the green arrow starts to flash. Hold it there until you complete your lane change. The lever will return by itself when you release it.

As you signal a turn or a lane change, if the arrows don't flash but just stay on, a signal bulb may be burned out and other drivers won't see your turn signal.

If a bulb is burned out, replace it to help avoid an accident. If the green arrows don't go on at all when you signal a turn, check the fuse (see "Fuses" in the Index) and for burned-out bulbs.

If you have a trailer towing option with added wiring for the trailer lights, a different turn signal flasher is used. With this flasher installed, the signal indicator will flash even if a turn signal bulb is burned out. Check the front and rear turn signal lights regularly to make sure they are working.

## ***Headlamp High-Low Beam***



To change the headlamps from low beam to high or high to low, pull the turn signal lever all the way toward you. Then release it.

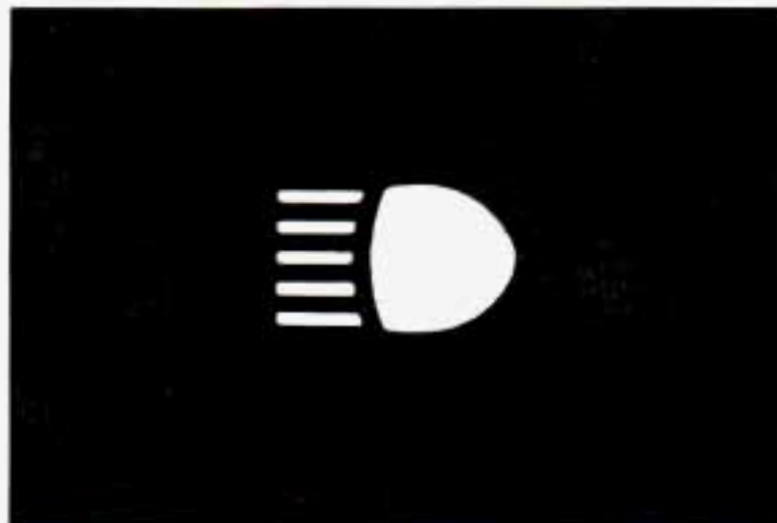

When the high beams are on, this blue indicator light on the instrument panel also will be on.

## ***Windshield Wipers***



You control the windshield wipers by turning the band with the wiper symbol on it.

For a single wiping cycle, turn the band to MIST. Hold it there until the wipers start, then let go. The wipers will stop after one wipe. If you want more wipes, hold the band on MIST longer.

You can set the wiper speed for a long or short delay between wipes. This can be very useful in light rain or snow. Turn the band to choose the delay time. The closer to LO, the shorter the delay.

For steady wiping at low speed, turn the band away from you to the LO position. For high speed wiping, turn the band further, to HI. To stop the wipers, move the band to the off symbol.

Remember that worn or damaged wiper blades may prevent you from seeing well enough to drive safely. To avoid damage, be sure to clear ice and snow from the wiper blades before using them. If they're frozen to the windshield, carefully loosen or thaw them. If your blades do become worn or damaged, get new blades or blade inserts.

Heavy snow or ice can overload your wipers. The windshield wiper motor is protected from overload by a circuit breaker and a fuse. If the motor overheats due to heavy snow, etc., the wiper will stop until the motor cools. Although the circuit is protected from electrical overload, overload due to heavy snow, etc. may cause wiper linkage damage. Always clear ice and heavy snow from the windshield before using your windshield wipers.

## ***Windshield Washer***

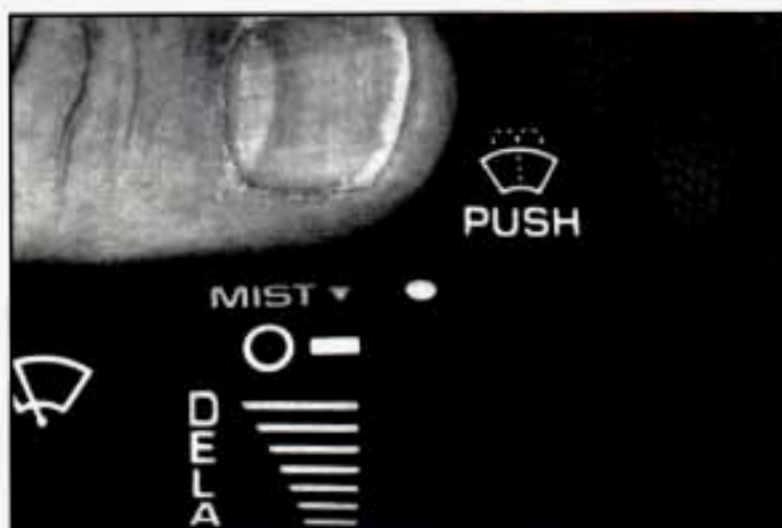

At the top of the multifunction lever there's a paddle marked with the windshield washer symbol and PUSH. To spray washer fluid on the windshield, push the paddle.

The wipers will clear the window and then either stop or return to your preset speed.

Driving without washer fluid can be dangerous. A bad mud splash can block your vision. You could hit another vehicle or go off the road. Check your washer fluid level often.



### **CAUTION:**

**In freezing weather, don't use your washer until the windshield is warmed. Otherwise the washer fluid can form ice on the windshield, blocking your vision.**

## **NOTICE:**

- When using concentrated washer fluid, follow the manufacturer's instructions for adding water.
- Don't mix water with ready-to-use washer fluid. Water can cause the solution to freeze and damage your washer fluid tank and other parts of the washer system. Also, water doesn't clean as well as washer fluid.
- Fill your washer fluid tank only 3/4 full when it's very cold. This allows for expansion, which could damage the tank if it is completely full.
- Don't use radiator antifreeze in your windshield washer. It can damage your washer system and paint.

## ***Rear Window Wiper/Washer — Dutch Door***



You control your rear window wiper/washer from a switch on your instrument panel, on the driver's side of your steering column.

- Press the top of the switch to the first position to turn on the wiper.
- Press the top of the switch in all the way and hold to release the desired amount of washer fluid. The wipers will continue to work after you release the switch.
- Press the bottom of the switch (OFF) to turn the wiper off.

The rear window washer system uses the same fluid tank as the windshield washer system.

The rear window washer system will run out of fluid before the windshield washer system, indicating you need to check your fluid level and fill the fluid tank.

## *Cruise Control (Option)*

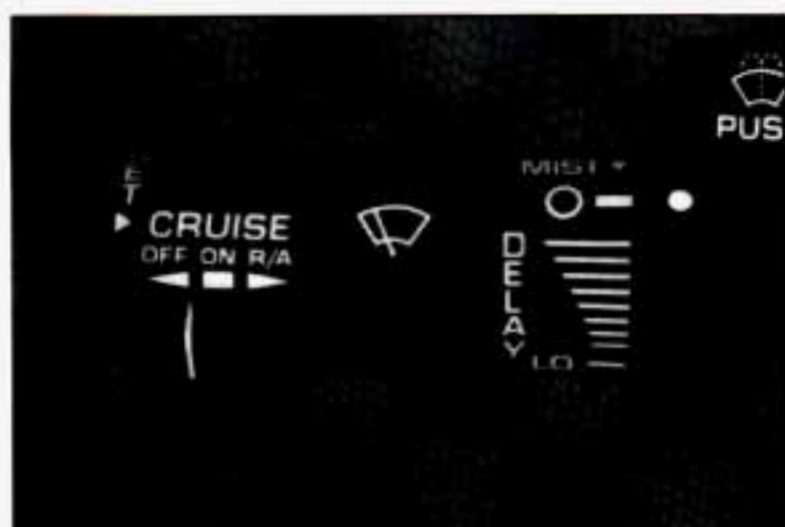

With Cruise Control, you can maintain a speed of about 25 mph (40 km/h) or more without keeping your foot on the accelerator. This can really help on long trips. Cruise Control does not work at speeds below about 25 mph (40 km/h).

When you apply your brakes, the Cruise Control shuts off.



### **CAUTION:**

- Cruise control can be dangerous where you can't drive safely at a steady speed. So, don't use your cruise control on winding roads or in heavy traffic.
- Cruise control can be dangerous on slippery roads. On such roads, fast changes in tire traction can cause needless wheel spinning, and you could lose control. Don't use cruise control on slippery roads.

## To Set Cruise Control



1. Move the Cruise Control switch to ON.

### CAUTION:

If you leave your cruise control switch on when you're not using cruise, you might hit a button and go into cruise when you don't want to. You could be startled and even lose control. Keep the cruise control switch OFF until you want to use it.

2. Get up to the speed you want.
3. Push in the set button at the end of the lever and release it.
4. Take your foot off the accelerator pedal.

## To Resume a Set Speed





Suppose you set your Cruise Control at a desired speed and then you apply the brake. This, of course, shuts off the Cruise Control. But you don't need to reset it. Once you're going about 25 mph (40 km/h) or more, you can move the Cruise Control switch from ON to R/A (Resume/Accelerate) for about half a second.

You'll go right back up to your chosen speed and stay there.

Remember, if you hold the switch at R/A (Resume/Accelerate) longer than half a second, the vehicle will keep going faster until you release the switch or apply the brake. You could be startled and even lose control. So unless you want to go faster, don't hold the switch at R/A (Resume/Accelerate).

### ***To Increase Speed While Using Cruise Control***

While your cruise control switch is in the ON position, here are two ways to go to a higher speed.



- Use the accelerator pedal to get to the higher speed. Push the button at the end of the lever, then release the button and the accelerator pedal. You'll now cruise at the higher speed.



- Move the Cruise switch from ON to R/A (Resume/Accelerate). Hold it there until you get up to the speed you want, and then release the switch.

To increase your speed in very small amounts, move the switch to R/A (Resume/Accelerate). Each time you do this, your vehicle will go about 1 mph (1.6 km/h) faster.

### ***To Reduce Speed While Using Cruise Control***



Push in the button at the end of the lever until you reach the lower speed you want, then release it.

To slow down in very small amounts, push the button for less than half a second. Each time you do this, you'll go 1 mph (1.6 km/h) slower.

### ***Passing Another Vehicle While Using Cruise Control***

Use the accelerator pedal to increase your speed. When you take your foot off the pedal, your vehicle will slow down to the Cruise Control speed you set earlier.

### ***Using Cruise Control on Hills***

How well your Cruise Control will work on hills depends upon your speed, load, and the steepness of the hills. When going up steep hills, you may want to step on the accelerator pedal to maintain your speed. When going downhill, you may have to brake or shift to a lower gear to keep your speed down. Of course, applying the brake takes you out of Cruise Control. Many drivers find this to be too much trouble and don't use Cruise Control on steep hills.

## ***To Get Out of Cruise Control***

There are two ways to turn off the Cruise Control:



- Step lightly on the brake pedal.



- Move the Cruise switch to OFF.

## ***To Erase Speed Memory***

When you turn off the Cruise Control or the ignition, your Cruise Control set speed memory is erased.

## Lights



Your light switches are on the driver's side of your instrument panel.

Push the top switch with the parking lights symbol on it to turn on:

- Parking Lamps
- Taillamps
- License Plate Lamps
- Instrument Panel Lights

Push the bottom switch with the master lighting symbol on it to turn on all the lights listed above as well as the headlamps.

Push the side of the switch marked OFF to turn off your lights.

Turn the dial above the light switches counterclockwise to dim your instrument panel lights.

Turn the dial clockwise to brighten your instrument panel lights. If you turn the dial clockwise all the way until it clicks, your interior lights will come on.

You can switch your headlamps from high to low beam by pulling on the turn signal/high beam lever.

A circuit breaker protects your headlamps. If you have an electrical overload, your headlamps will flicker on and off. Have your headlamp wiring checked right away if this happens.

## ***Daytime Running Lamps (DRL) Indicator Light***

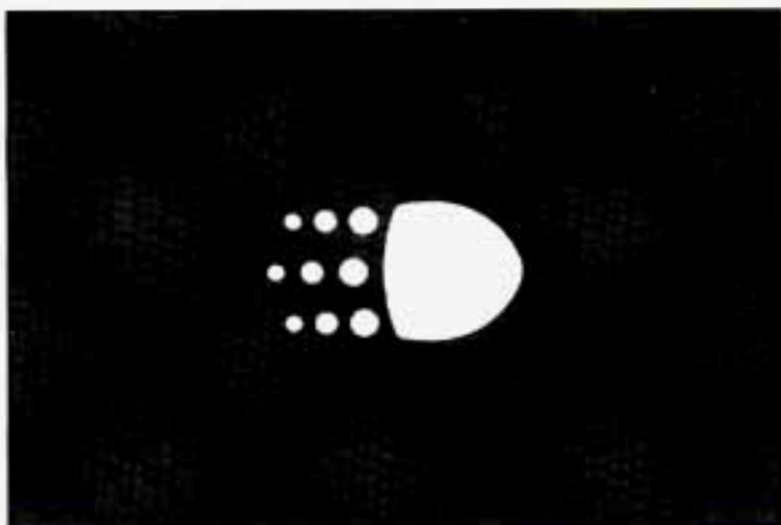

If your vehicle was first sold, when new, in Canada, you will have this light on the instrument panel.

It goes on whenever the Daytime Running Lamps are on.

When it begins to get dark, the DRL indicator light is a reminder to turn on your headlamps.

## ***Daytime Running Lamps***

Daytime Running Lamps (DRL) make it easier to see the front of your vehicle during the day. DRL can be helpful when it's raining and in the short periods after dawn and before sunset. Several countries, including Canada, require DRL.

The DRL system will make your high-beam headlamps come on at a reduced brightness when:

- The ignition is on,
- The headlamp switch is off, and
- The parking brake is released.

When the DRL are on, only your high-beam headlamps will be on. The taillamps, sidemarker and other lamps won't be on. Your instrument panel won't be lit up either.

When it begins to get dark, your DRL indicator light is a reminder to turn your headlamp switch on. The other lamps that come on with your headlamps will also come on.

When you turn the headlamp switch off, the regular lamps will go off, and your high-beam headlamps will change to the reduced brightness of DRL.

To idle your vehicle with the DRL off, set the parking brake. The DRL will stay off until you release the parking brake.

## ***Headlamps—On Reminder***

A reminder tone will sound when your headlamps or parking lamps are turned on and your ignition is in OFF, LOCK or ACC. To turn the tone off, press the OFF switch.

## ***Dome Lamps***

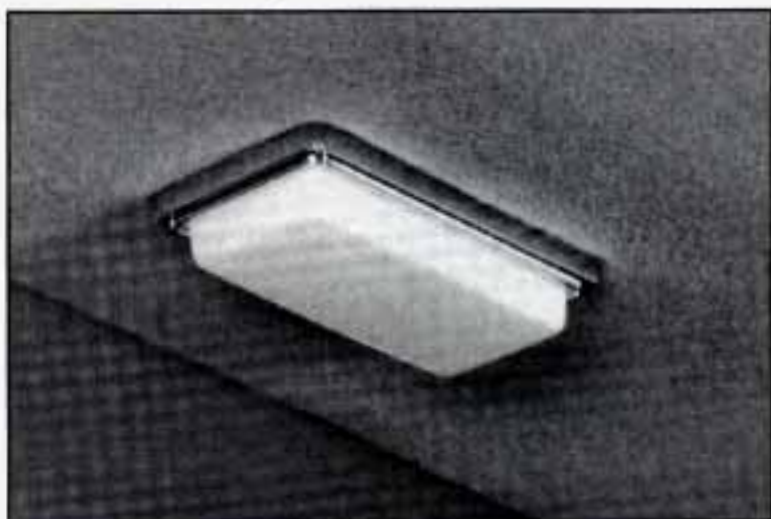

The dome lamps may come on when you open any of the doors. You can also turn on the dome lamps by turning the dimmer dial clockwise until it clicks.

## ***Reading Lamps***



You may have the optional reading lamps next to the dome lamps. Turn the lamps on and off by pressing the switch next to the lamp.

You can adjust the lamps to any desired position by rotating the lamp and they will work when the ignition is on or off. Be sure to turn the lamps off before you leave the vehicle.

## ***Interior Lamps Override Switch***

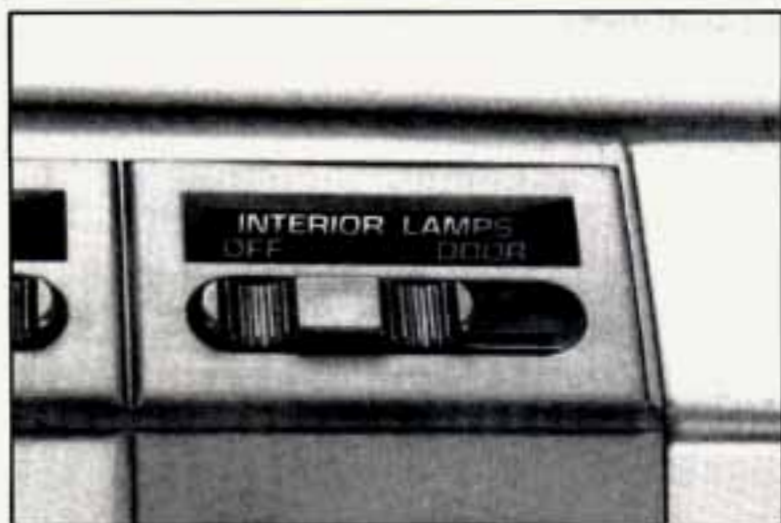

If you have the optional interior lights override switch and it is in the DOOR position, your interior lights will work as usual.

If the switch is OFF, the interior lights will not come on when any of the vehicle doors are open. The switch is located on the instrument panel above the radio.

If you have the optional reading lamps, they will still operate if the switch is in the OFF position.

If you have the optional Keyless Illumination feature, the interior lamps will come on briefly when doors are locked and unlocked or the door handles are lifted.

## ***Mirrors***

### ***Inside Mirror***

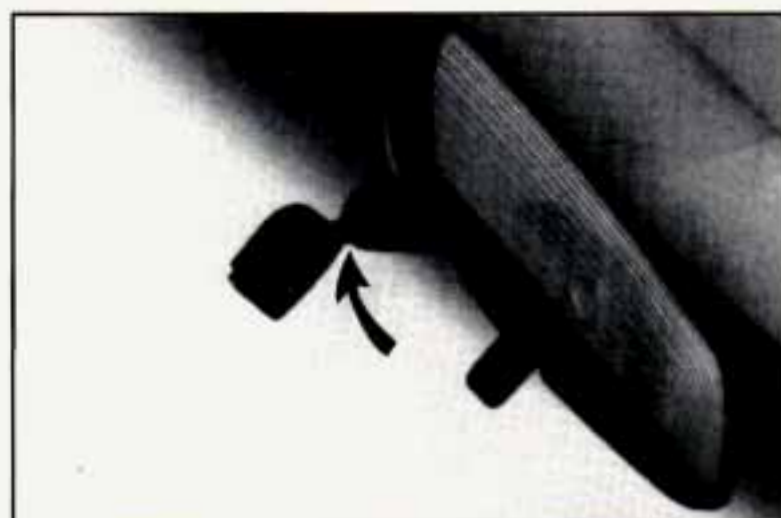

Your inside rearview mirror has two pivots so you can adjust it up and down or side to side.

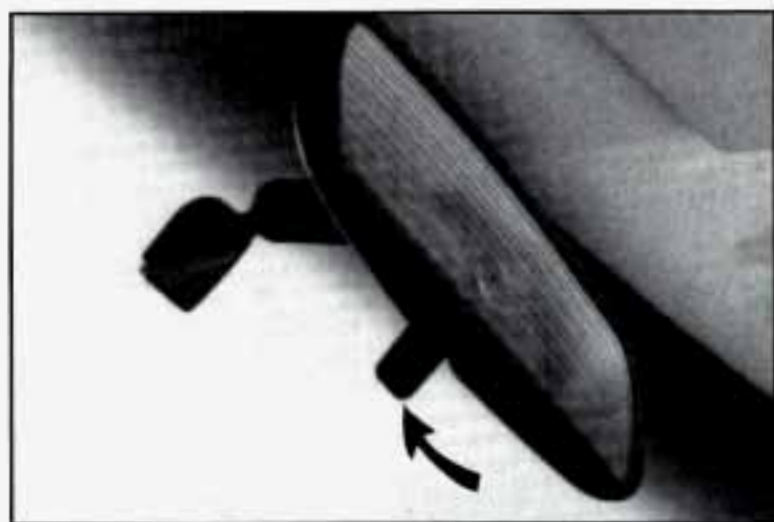

You can also adjust the mirror for day or night driving. Press the tab forward (away from you) for day driving. Pull the tab back (towards you) for night driving.

## ***Outside Mirrors***



Adjust your outside mirrors so you can just see the side of your vehicle.



Some mirrors are manually adjustable. The optional electric mirrors come with a remote control adjustment switch. Find the switch on the instrument panel above the radio.



To move a mirror, slide the switch to L for the driver's side mirror or to R for the passenger's side mirror. Then, press the four-way pad to move the mirror in the desired direction. To make sure you do not accidentally move a mirror, slide the switch to the middle (OFF) position.

If you have the manually adjustable mirror, it can also be folded in or out. Push the mirror towards the vehicle to move it in. After pushing the mirror out, adjustment will be maintained.

## ***Convex Outside Mirror***

Your passenger's side mirror is convex.

A convex mirror's surface is curved so you can see more from the driver's seat.



### **CAUTION:**

**A convex mirror can make things (like other vehicles) look farther away than they really are. If you cut too sharply into the right lane, you could hit a vehicle on your right. Check your inside mirror or glance over your shoulder before changing lanes.**

## ***Sun Visors/Vanity Mirrors***

To block out glare, you can swing down the visors. You can also swing them from side to side.

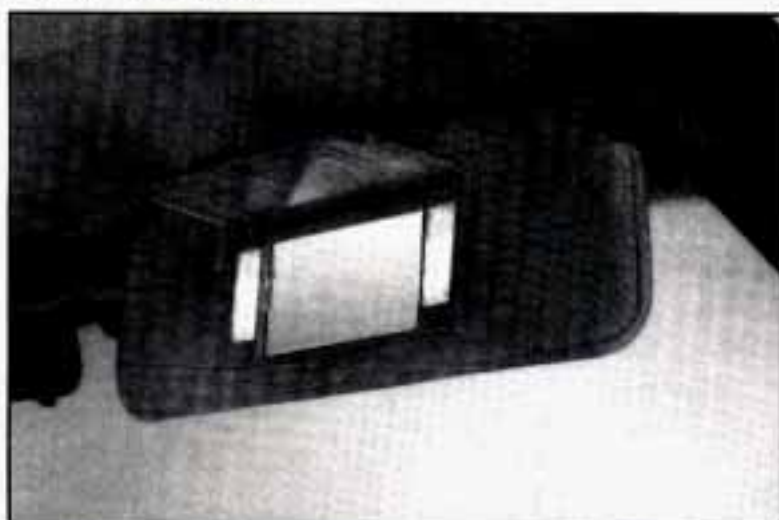

Some visors have mirrors built in, with or without lights. Just lift the mirror cover on each visor to turn the lights on if you have them.

Lighted mirrors also have a density switch to make the mirror lights brighter or dimmer.

## ***Cigarette Lighter/Ashtrays***

The cigarette lighter is on the left of the engine cover console. To use the lighter, press it in all the way and let go. When it's ready, it will pop back by itself.

Don't hold a cigarette lighter in with your hand while it is heating. If you do, it won't be able to back away from the heating element when it's ready. That can make it overheat, damaging the lighter and the heating element.



To remove the front ashtray, pull on the front of it while pressing on the inner tab.



To remove the smaller ashtrays on each sidewall, press down on the tabs inside and pull out.

Don't put papers and other things that burn into your ashtrays. If you do, cigarettes or other smoking materials could set them on fire, causing damage.

## ***Assist Handles***

Assist handles may be located on the inside passenger vehicle pillars.



Grasp them as necessary to help enter and exit your vehicle.

If you have the optional rear hatch and Dutch doors, you will also have an assist handle on the inside hatch.

## ***Storage Compartments***



Your front storage compartment is at the center of the engine cover. To open the compartment, press the two tabs together and pull.



If you have an optional sliding tray storage compartment, it is under the front passenger seat. To open the compartment, move the latch in the top handle and pull the tray forward.



If you have a beverage cooler, lift up on the armrest to open. The cooler has a drain system that drains off as much fluid as necessary. There is also an ashtray and a cupholder for your convenience.



If you have a rear storage compartment, pull up on the handle to open or remove the cover. To replace the cover, fit the notches on the cover into the storage compartment slots and push down.

### ***Center Overhead Console***

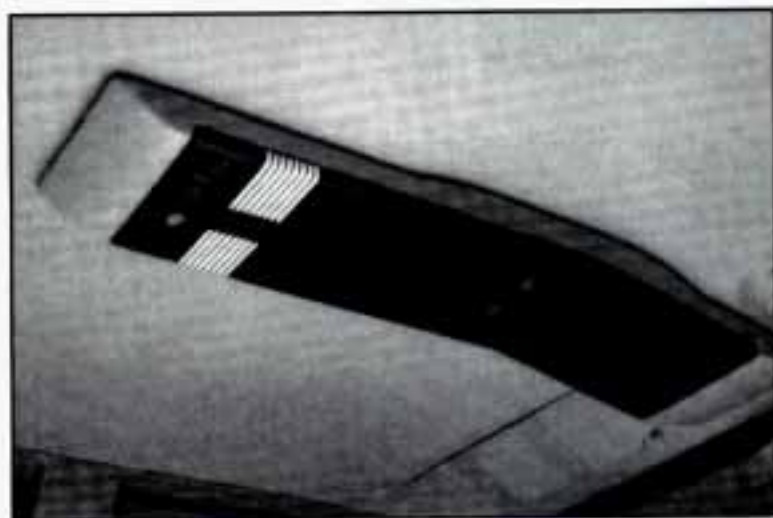

The optional roof console has two storage compartments. To open the compartments, push up and slide the door forward. To close the compartments, slide the door back. Use the straps to secure items.

## ***Instrument Cluster***

Your instrument cluster is designed to let you know at a glance how your vehicle is running. You'll know how fast you're going, about how much fuel remains, and many other things you'll need to know to drive safely and economically.

The optional digital cluster on your vehicle's instrument panel is displayed electronically and will tell you everything the standard cluster does.

The digital cluster will give readings in either English or Metric. To switch from English to Metric, just press the E/M button.

## ***Instrument Panel***

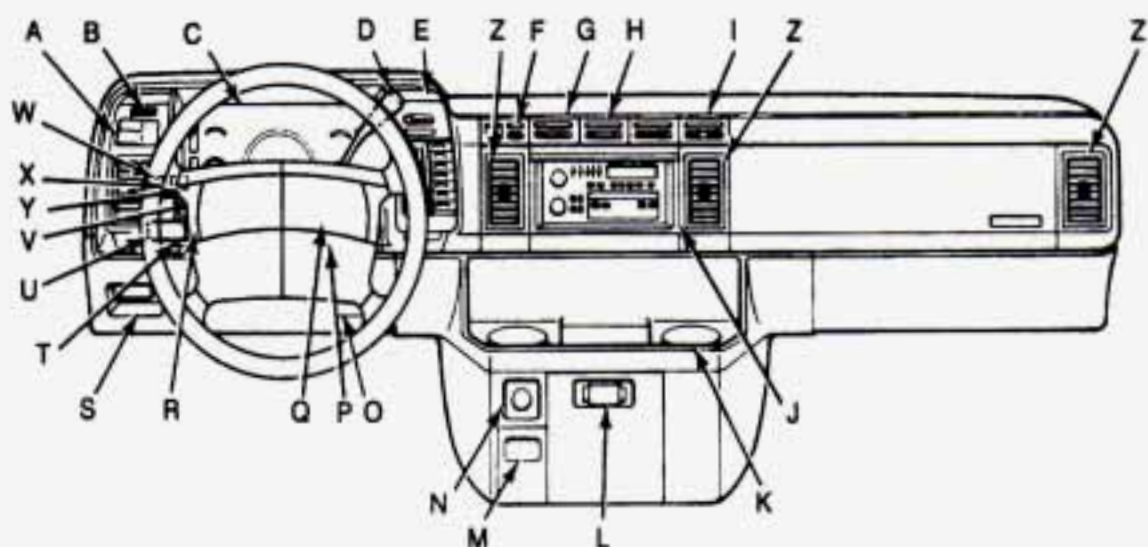

A. Light Switches

B. Dimmer Switch

C. Instrument Cluster

D. Gearshift Lever

E. Air Conditioner/Heater

F. Remote Outside Mirror Switch

G. Rear Heater Switch

H. Rear A/C Switch

I. Interior Lamp Override Switch

J. Audio System

K. Convenience Tray

L. Glove Box

M. Ashtray

N. Cigarette Lighter

O. Hood Release Handle

P. Hazard Warning Flasher

Q. Ignition Switch

R. Horn

S. Brake Release Handle

T. Multifunction Lever

U. Cruise Control

V. Tilt Wheel Lever

W. Rear Wiper/Washer Switch

X. Hatch Release Switch

Y. Rear Window Defogger Switch

Z. Vent

## ***Speedometer and Odometer***

**Standard Cluster**



**Digital Cluster**



Your speedometer lets you see your speed in both miles per hour (mph) and kilometers per hour (km/h). Your odometer shows how far your vehicle has been driven, in either miles (used in the U.S.) or kilometers (used in Canada).

## ***Tamper Resistant Odometer***

**Standard Cluster**



**Digital Cluster**

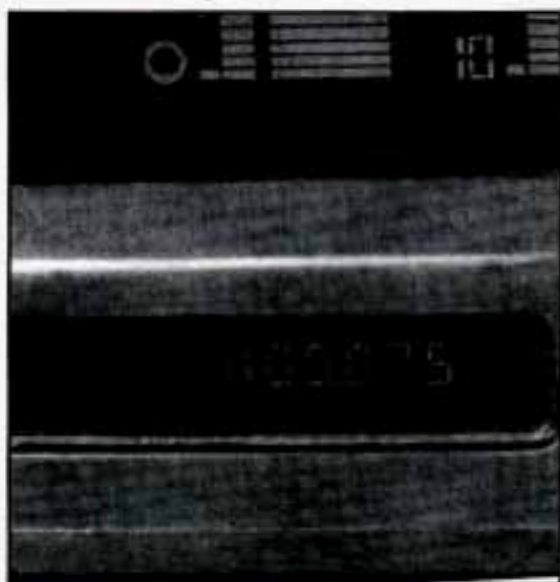

Your odometer is tamper resistant. The odometer will show silver lines between the numbers if someone tries to turn it back.

The digital odometer will read 999,999 if someone tries to turn it back.

You may wonder what happens if your vehicle needs a new odometer installed. If the new one can be set to the mileage total of the old odometer, then it must be. But if it can't, then it's set at zero, and a label must be put on the driver's door to show the old mileage reading when the new odometer was installed.

## ***Trip Odometer***

**Standard Cluster**



**Digital Cluster**

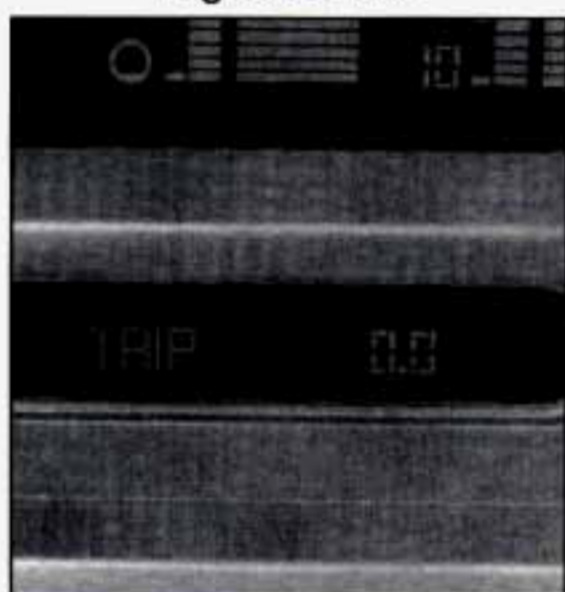

The trip odometer can tell you how far your vehicle has been driven since you last set the trip odometer to zero.

To reset the trip odometer on the standard cluster, press the button near the readout.

The trip odometer on the digital will appear in place of your regular odometer when you press the TRIP button.

To reset the trip odometer on the digital cluster, press the RESET button. To change back to the regular odometer, press the TRIP button again.

## ***Warning Lights and Indicators***

Warning lights and gages can signal that something is wrong before it becomes serious enough to cause an expensive repair or replacement. Paying attention to your warning lights and gages could also save you or others from injury.

Warning lights come on when there may be or is a problem with one of your vehicle's functions. As you will see in the details on the next few pages, some warning lights come on briefly when you start the engine just to let you know they're working. If you are familiar with this section, you should not be alarmed when this happens.

Gages can indicate when there may be or is a problem with one of your vehicle's functions. Often gages and warning lights work together to let you know when there's a problem with your vehicle.

When one of the warning lights comes on and stays on when you are driving, or when one of the gages shows there may be a problem, check the section that tells you what to do about it. Please follow this manual's advice. Waiting to do repairs can be costly — and even dangerous. So please get to know your warning lights and gages. They're a big help.

### ***Safety Belt Reminder Light***



When the key is turned to RUN or START, a light will come on for about eight seconds to remind people to fasten their safety belts. Unless the driver's safety belt is already buckled, a tone will also sound.

### ***Air Bag Readiness Light***

There is an air bag readiness light on the instrument panel, which shows AIR BAG . The system checks the air bag's electrical system for malfunctions. The light tells you if there is an electrical problem. The system check includes the air bag sensors and the wiring and the diagnostic module. For more information on the air bag system, see "Air Bag" in the Index.



# AIR BAG

You will see this light flash for a few seconds when you turn your ignition to RUN or START. Then the light should go out. This means the system is ready.

If the air bag readiness light doesn't come on when you start your vehicle, or stays on, or comes on when you are driving, your air bag system may not work properly. Have your vehicle serviced right away.

## ***Brake System Warning Light***

**Standard Cluster**



**Digital Cluster**



Your vehicle's hydraulic brake system is divided into two parts. If one part isn't working, the other part can still work and stop you. For good braking, though, you need both parts working well.

If the warning light comes on, there could be a brake problem. Have your brake system inspected right away.

This light should come on briefly as you start the vehicle. If it doesn't come on then, have it fixed so it will be ready to warn you if there's a problem.

If the light comes on while you are driving, pull off the road and stop carefully. You may notice that the pedal is harder to push. Or, the pedal may go closer to the floor. It may take longer to stop. If the light is still on, have the vehicle towed for service. (See "Towing Your Vehicle" in the Index.)



### **CAUTION:**

**Your brake system may not be working properly if the brake system warning light is on. Driving with the brake system warning light on can lead to an accident. If the light is still on after you've pulled off the road and stopped carefully, have the vehicle towed for service.**

The brake system warning light will also come on when you set your parking brake, and it will stay on if your parking brake doesn't release fully. If it stays on after your parking brake is fully released, it means you have a brake problem.

### ***Anti-Lock Brake System Warning Light***

**Standard Cluster**

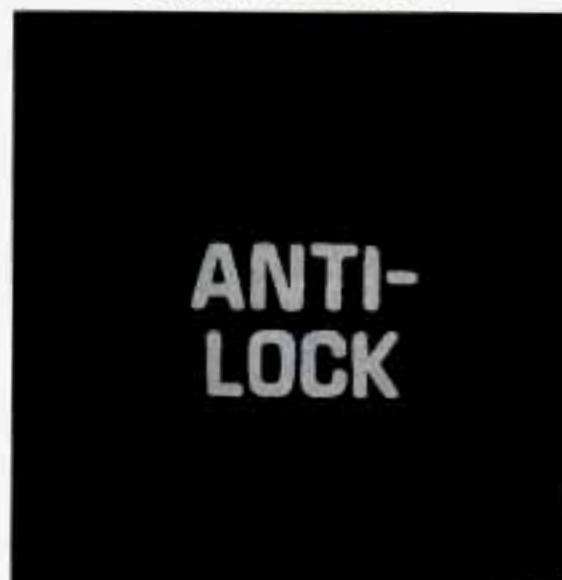

**Digital Cluster**

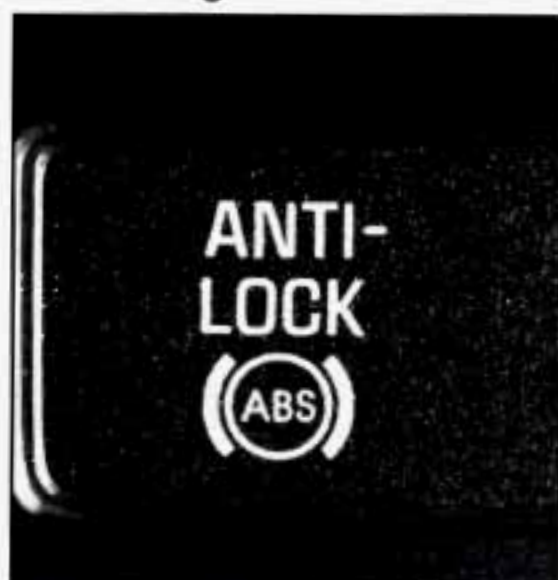

With the anti-lock brake system, this light will come on when you start your engine and may stay on for several seconds. That's normal. If the light doesn't come on, have it fixed so it will be ready to warn you if there is a problem.

If the light stays on, or comes on when you're driving, your vehicle needs service. If the regular brake system warning light isn't on, you still have brakes, but you don't have anti-lock brakes. If the regular brake system warning light is also on, you don't have anti-lock brakes and there's a problem with your regular brakes. See "Brake System Warning Light" earlier in this part.

### ***Malfunction Indicator Lamp (SERVICE ENGINE SOON)***



**SERVICE  
ENGINE  
SOON**

The amber Malfunction Indicator (SERVICE ENGINE SOON) Lamp is located on the passenger side of your standard cluster. If you have the digital cluster, it is on the driver's side.

A computer monitors operation of your fuel, ignition and emission control systems. This light should come on when the ignition is on, but the engine is not running, as a check to show you it is working. If it does not come on at all, have it fixed right away. If it stays on, or it comes on while you are driving, the computer is indicating that you have a problem. You should take your vehicle in for service soon.

#### **NOTICE:**

**If you keep driving your vehicle with this light on, after a while the emission controls won't work as well, your fuel economy won't be as good and your engine may not run as smoothly. This could lead to costly repairs not covered by your warranty.**

### ***Indicator Lights***

Indicator lights go on when you use your turn signals, change from low beam headlamps to high beams, or when you use your hazard flashers. The next few pages will also tell you about the indicator lights on your vehicle and help you locate them.

## ***Charging System Light***

**Standard Cluster**

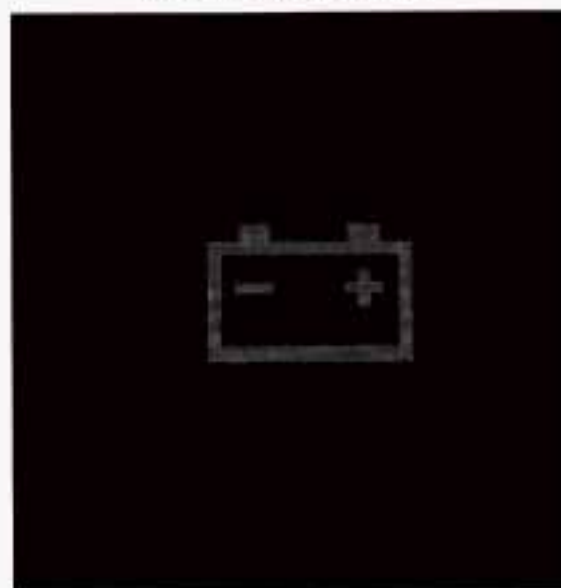

**Digital Cluster**

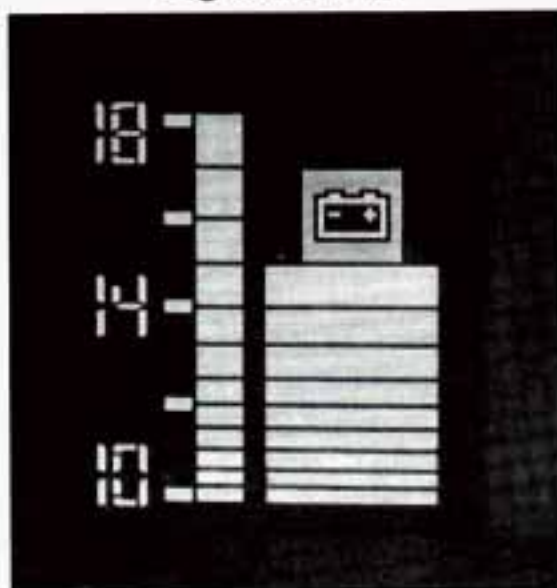

The red charging system light is on the bottom driver's-side corner of your standard cluster. It is part of the digital cluster voltmeter.

The charging system light will come on briefly when you turn the ignition on, but the engine is not running, as a check to show you the light is working. Then it should go out once the engine is running. If it stays on, or comes on while you are driving, you may have a problem with the electrical charging system. It could indicate that you have a loose accessory drive belt, or another electrical problem. Have it checked right away. Driving while this light is on could drain your battery.

If you must drive a short distance with the light on, be certain to turn off all your accessories, such as the radio and heater/air conditioner.

## ***Daytime Running Lamps (DRL) Indicator Light***

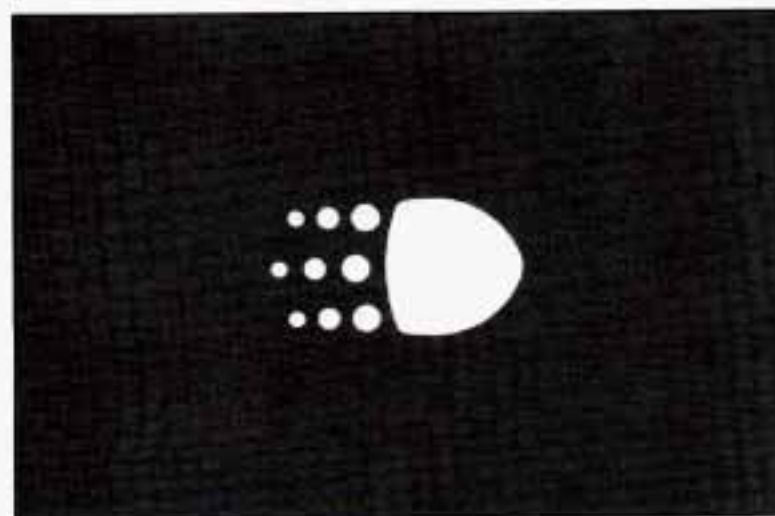

If your vehicle was first sold, when new, in Canada, you will have this green light on the instrument panel. It will light whenever the Daytime Running Lamps are on. It is also a reminder to turn on your headlamps when driving at night.

For more details about DRL, see “Headlamps and Vehicle Lighting” in this section.

The DRL indicator light is on whenever the ignition and the headlight switch and parking brake are off. For more details about DRL, see “Lights” in this part.

### ***Headlamp High Beam Indicator Light***

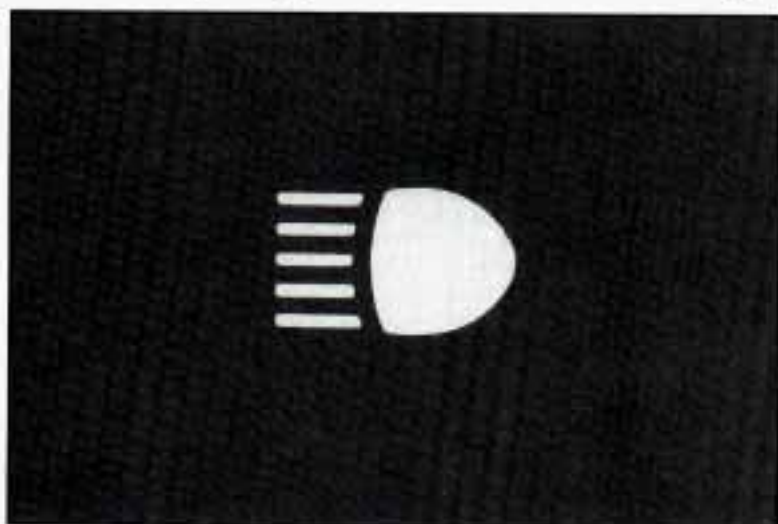

This blue light is on the driver’s side of the standard cluster. If you have the digital cluster, it is on the top of the cluster.

The high beam indicator light is on whenever you use your high beam headlamps.

For more details, see “Headlamp High–Low Beam Changer” in this part.

### ***Turn Signal and Lane Change Indicator***

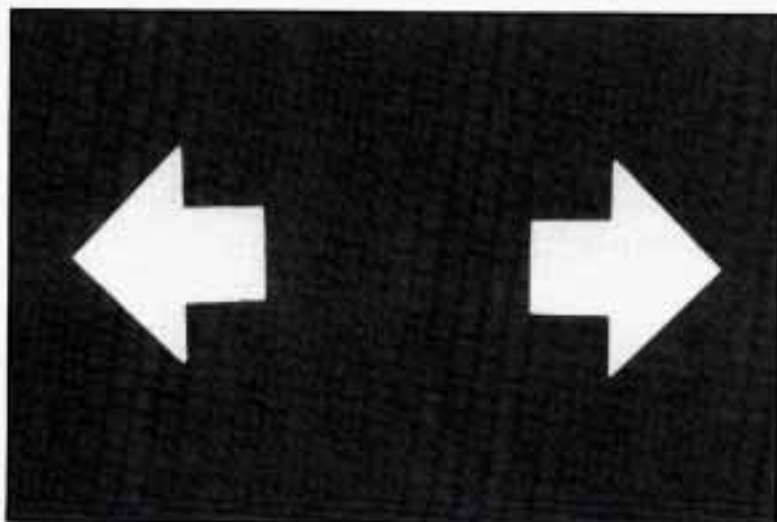

The turn signal indicator is a light with two green arrows. It comes on whenever you signal a turn or lane change.

Turn signal arrows are at the top of the standard and digital clusters. For more details, see “Turn and Lane Change Signal” in this part.

## Gages

### Engine Coolant Temperature Gage

Standard Cluster



Digital Cluster



If you have the standard cluster, you have a gage that shows the engine coolant temperature. If the gage pointer moves to the “H” (red) side, your engine is too hot!

It means that your engine coolant has overheated. If you have been operating your vehicle under normal driving conditions, you should pull off the road, stop your vehicle and turn off the engine as soon as possible.

If you have a digital cluster, a box around the temperature symbol will also flash when your engine is too hot.

**Hot Coolant Can Burn you Badly!** In *Problems On The Road*, this manual explains what to do. See “Engine Overheating” in the Index.

## Oil Pressure Gage

Standard Cluster



Digital Cluster



The oil pressure gage shows the engine oil pressure in psi (pounds per square inch) when the engine is running. Canadian vehicles indicate pressure in kPa (kilopascals). Oil pressure may vary with engine speed, outside temperature and oil viscosity, but readings above the low pressure zone indicate the normal operating range.

A reading in the low pressure zone may be caused by a dangerously low oil level or other problems causing low oil pressure.

On the digital cluster, a box around the oil pressure symbol will begin to flash when the oil pressure is low.



### **CAUTION:**

**Don't keep driving if the oil pressure is low. If you do, your engine can become so hot that it catches fire. You or others could be burned. Check your oil as soon as possible and have your vehicle serviced.**

### **NOTICE:**

**Damage to your engine from neglected oil problems can be costly and is not covered by your warranty.**

## Fuel Gage

Standard Cluster



Digital Cluster

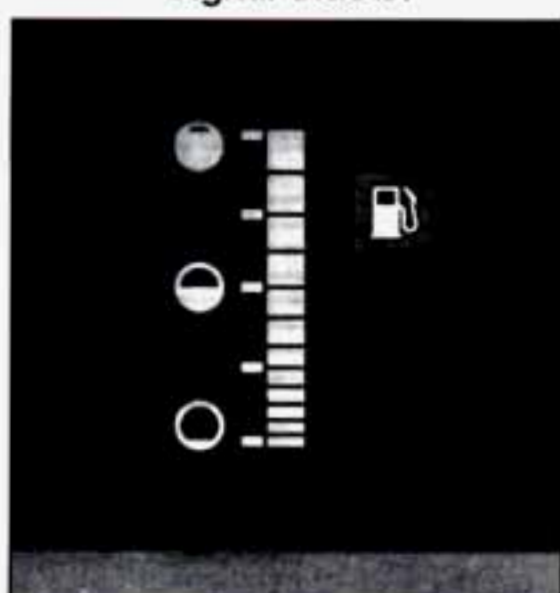

The fuel gage tells you how much fuel you have remaining when the ignition is on. When the gage first indicates empty you still have a little fuel left, but you should get more fuel as soon as possible.

A box around the fuel gage symbol on the digital cluster will begin to flash when your tank is 1/8 full or less.

Here are things some owners ask about. None of these indicate a problem with your fuel gage:

- At the gas station, the gas pump shuts off before the gage reads full.
- The fuel tank will take either a little more or a little less fuel to fill up than the gage shows.
- The gage moves a little when you turn a corner or speed up.
- The gage doesn't go back to empty when you turn off the ignition.

For your fuel tank capacity, see the Index under "Fluid Capacities."



## Voltmeter

Standard Cluster

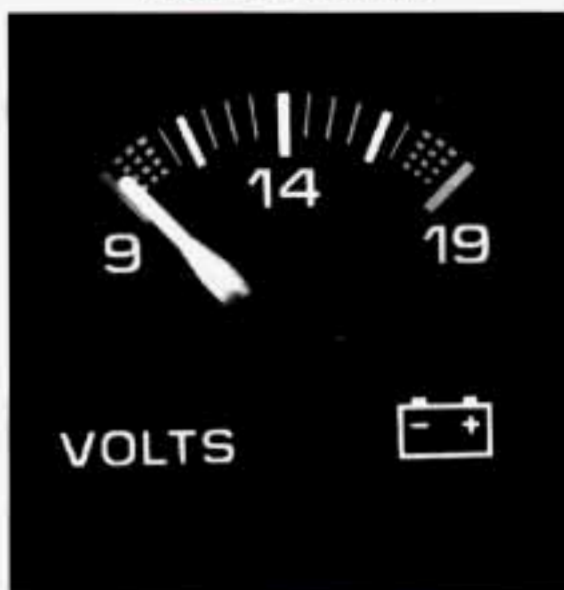

Digital Cluster

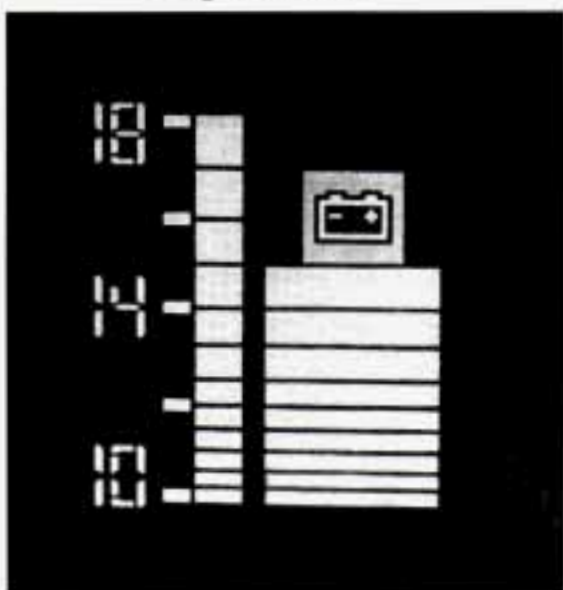

When your engine is not running, but the ignition is on (in the RUN position), the gage shows your battery's state of charge in DC volts. When the ignition is running, the gage shows the condition of the charging system. Readings between the low and high warning zones indicate the normal operating range.

Readings in the low warning zone may occur when a large number of electrical accessories are operating in the vehicle and the engine is left at an idle for an extended period. This condition is normal since the charging system is not able to provide full power at engine idle. As engine speeds are increased, this condition should correct itself as higher engine speeds allow the charging system to create maximum power.

On the digital cluster, a box around the voltmeter symbol will begin to flash when the charging system needs service.

You can only drive for a short time with the readings in either warning zone. If you must drive, turn off all unnecessary accessories.

Readings in either warning zone indicate a possible problem in the electrical system. Have the vehicle serviced as soon as possible.

## ***Luggage Carrier (Option)***



If you have the luggage carrier, you can load things on top of your vehicle. The luggage carrier has slats attached to the roof, side rails, and tiedowns.

### **NOTICE:**

**Loading cargo that weighs more than 200 pounds (91 kg) on the luggage carrier may damage your vehicle. When you carry large things, never let them hang over the rear or the sides of your vehicle. Load your cargo so that it rests on the slats and does not scratch or damage the vehicle. Put the cargo against the side rails and fasten it securely to the luggage carrier. Put the main weight as far forward as you can.**

Don't exceed the maximum vehicle capacity when loading your vehicle. For more information on vehicle capacity and loading, see "Loading Your Vehicle" in the Index.

To prevent damage or loss of cargo as you're driving, check now and then to make sure the luggage carrier and cargo are still securely fastened.

## ***Trailer Wiring Harness***

If you have the optional trailering package, your vehicle will have an 8-wire harness, consisting of a 7-wire harness and one CHMSL battery feed wire.

The harness is stored on the passenger side of the van near the rear wheel well. This harness has a 30 amp battery feed wire and no connector, and should be wired by a qualified service person. Attach the harness to the trailer, then tape or strap it to your vehicle's frame rail. Be sure you leave it loose enough so the wiring doesn't bend or break, but not so loose that it drags on the ground.

The harness must be routed out of your vehicle between the rear door and the floor, with enough of the harness left on both sides so that the trailer or the body won't pull it.

Store the harness in its original place. Wrap the harness together and tie it neatly so it won't be damaged.

## **Notes**

## ***Comfort Controls & Audio Systems***

### ***Section***

# **3**

In this section you'll find out how to operate the comfort control systems and audio systems offered with your vehicle. Be sure to read about the particular system supplied with your vehicle.

### ***Comfort Controls***

#### ***Heater Controls***



If your vehicle does not have air conditioning, your heater controls will look like this.

**Fan Lever** — The top lever has four positions. To increase the air flow, move the lever toward **HIGH**. To decrease the air flow, move it toward **OFF**.

**Temperature Lever** — This lever is below the fan lever and selects the temperature of the air flowing into your vehicle. Move the lever up for warmer air. Move the lever down for cooler air.

**Function Lever** — This lever is below the fan lever and can be moved to five different functions.

**DEFROST** — The setting with the defrost symbol operates the defroster. Most of the air comes out near the windshield, with some going to the floor vents and front side windows. Use this when you get fog or ice on the windshield.

**HTR (Heater)** — Most of the air comes out near the floor. The rest comes out from the defroster vents under the windshield and at the front side windows. This is best for cold weather.

**VENT** — The air comes out at the vents on your instrument panel.

**BLEND (Position 1)** — With this setting, the heated outside air comes out both the heater vents and defroster vents. The lever can be positioned anywhere between to adjust the proportion of air coming through each vent. Adjust the temperature lever for warmer or cooler air.

**BLEND (Position 2)** — With this setting, the heated outside air comes out both the instrument panel vents and heater vents. The lever can be positioned anywhere between to adjust the proportion of air coming through each vent. Adjust the temperature lever for warmer or cooler air.

## ***Heater/Air Conditioning Controls***



If your vehicle has air conditioning, your heating/air conditioning controls will look like this.

Before using your vehicle's air conditioning, open the windows to clear the vehicle of hot air. Close the windows when using the system.

**Fan Lever** — The top lever has five positions. To increase the air flow, move the lever toward HIGH. To decrease the air flow, move the lever toward OFF.

**Temperature Lever** — This lever is below the fan lever and selects the temperature of the air flowing into your vehicle. Move the lever up for warmer air. Move the lever down for cooler air.

**Function Lever** — This lever is below the fan lever and can be moved to seven different functions.

**DEFROST** — The setting with the defrost symbol operates the defroster. Most of the air comes out near the windshield, with some going to the floor vents and side window defrost vents. Use this when you get fog or ice on the windshield. The A/C compressor may operate in this setting to dehumidify the air.

**BLEND** — With this setting, the heated outside air comes out both the heater vents and defroster vents, with some air coming through the side window vents. Adjust the temperature lever for warmer or cooler air. This setting is useful for cold weather with a large number of passengers or very humid conditions to help keep the windshield clear. The A/C compressor may operate in this setting to dehumidify the air.

**HTR (Heater)** — Most of the air comes out near the floor. The rest comes out from the defroster vents under the windshield and at the front side windows. This is best for cold weather.

**VENT** — The air comes out at the vents on your instrument panel. The air conditioner will not run. Adjust the temperature lever for warmer or cooler air.

**BI-LEV A/C** — With this, outside air comes out through the heater floor vent and the instrument panel vents. If you move your temperature control lever between cold and hot, cooler air will come out of the upper vents while warmer air comes out of the floor vent. This setting is useful in cool weather with bright sunlight.

**NORM A/C** — This setting cools the outside air. If you first used MAX A/C, use NORM A/C as soon as the vehicle has cooled down, so outside air will be going through your vehicle.

**MAX A/C** — This cools the air the fastest. Move the other lever all the way to Cold. MAX A/C lets in only a little air from the outside. You can use MAX A/C at first when it's really hot outside and you need to cool off quickly.

When the air conditioning, defrost or BLEND is on, you may notice a slight increase or decrease in engine speed, due to compressor operation.

## ***Engine Coolant Heater (Option)***

If you use the optional engine coolant heater before starting your engine, your heating system will produce warmer air faster to heat the passenger compartment in cold weather. See "Engine Coolant Heater" in the Index.

## ***Rear Heater (Option)***



You may have the optional rear heater. The three speed fan switch is above the radio. Slide the lever toward HI for warmer air in the rear area. Move the switch to OFF to turn the system off.

## ***Rear Air Conditioning (Option)***



You may have rear air conditioning. The rear air conditioning switch is located above the radio at the top of the instrument panel. Slide the lever toward HI for cooler air in the rear area. Slide the lever to OFF to turn the system off.

If your vehicle has rear air conditioning, setting it on LO may enhance front A/C performance by allowing trapped refrigerant in rear lines to circulate.

The system will only send cooled air if the front system is on. It can still be used to circulate air, even if the front system is off.

Before using the rear air conditioning, open the windows to clear the vehicle of hot air. Close the windows when using the system.



## ***Rear Window Defogger (Option)***

If your vehicle has this option, the rear window will have lines running across the glass. These lines heat your window.

For best results, clear the window of as much snow or ice as possible before using the rear window defogger.



To turn on the rear window defogger, find the switch marked REAR DEFOG on your instrument panel to the left of the steering column. Press the top of this switch until the light in the switch comes on, then release it.

The rear window defogger will only work when the ignition switch is in the RUN position.

You can turn the defogger off at any time by pressing the bottom of the switch. The defogger will shut itself off after several minutes so that the glass does not get too hot. If the window still isn't clear, turn the defogger on again.

### **NOTICE:**

**Scraping the inside of your rear window could cut and damage the defogger. Your warranty would not cover this damage. And don't put decals there, you might have to scrape them off.**

## ***Ventilation System***



Your vehicle's ventilation system supplies outside air to the inside of your vehicle when it is moving. With the side windows closed, air will flow into the front air inlet grilles at the base of the windshield, through the vehicle and out the rear air exhaust valves. Outside air will also enter the vehicle when the heater or the air conditioning fan is running.

### ***Ventilation Tips***

- Keep the hood and front air inlet free of ice, snow, or any other obstruction (such as leaves). The heater and defroster will work far better, reducing the chance of fogging the inside of your windows.
- When you enter a vehicle in cold weather, turn the blower fan to **HIGH** for a few moments before driving off. This helps clear the intake ducts of snow and moisture, and reduces the change of fogging the inside of your windows.
- Keep the air path under the front seats clear of objects. This helps air to circulate throughout your vehicle.

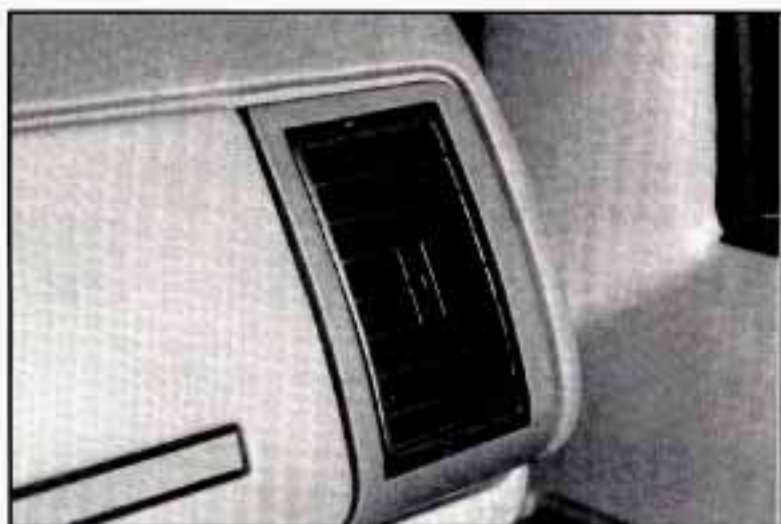

You will find air vents in the center and on the sides of your instrument panel.

You can move the vents to direct the flow of air, or close the vents altogether. When you close a vent, it will increase the flow of air coming out of any vents that are open.

If your vehicle doesn't have air conditioning, there is an air vent in the passenger-side kick panel below the instrument panel. The vent has a handle to open and close it.

## ***Audio Systems***

Your Delco<sup>®</sup> audio system has been designed to operate easily and give years of listening pleasure. But you will get the most enjoyment out of it if you acquaint yourself with it first. Find out what your Delco<sup>®</sup> system can do and how to operate all its controls, to be sure you're getting the most out of the advanced engineering that went into it.

### ***Setting the Clock (ETR<sup>®</sup> AM Radio)***

To set the clock:

1. Press the SET button.
2. Within 5 seconds, press and hold MINS until the correct minute appears on the display.
3. Press and hold HRS until the correct hour appears on the display

To display the clock with the ignition off, push the upper knob. The time will be displayed for a few seconds.

## **Setting the Clock (Audio Systems with AM/FM Stereo)**

To set the clock:

1. Press the SET button. The radio may be on or off.
2. Within 5 seconds, press and hold either SEEK until the correct minute appears on the display.
3. Press and hold SCAN until the correct hour appears on the display.

## **How to Operate Your ETR<sup>®</sup> AM Radio**

This part tells you how your ETR<sup>®</sup> AM radio works.

Upper Knob (VOL-RECALL) — The upper knob has these four functions:

- Turn it to switch the system on and off.
- Turn it to control the volume.
- Press it to display the time when the ignition is off.
- Press it to change between the clock and the radio station frequency displayed when the radio is on.

BAL (Balance) — The control ring behind the upper knob adjusts the left/right speaker balance.

Lower Knob (TUNE) — The lower knob has one function:

- Turn it to tune in radio stations.

Pushbuttons — The four pushbuttons let you return to favorite stations. To set the pushbuttons for up to fourteen favorite stations (7 AM and 7 FM):

1. Tune in the desired station.
2. Press the SET button. "SET" appears in the display.
3. Within 5 seconds, press one of the four pushbuttons to store the station. Whenever you press that button, the preset station will return.

Repeat these steps for each pushbutton.

In addition to the four stations set as above, up to three additional stations may be preset on each band by pressing two adjoining buttons at the same time. Then do the following:

1. Tune in the desired station.
2. Press the SET button. "SET" appears in the display momentarily.

3. Within 5 seconds, press any two adjoining pushbuttons at the same time. (The station will return when the same two buttons are pressed again.)

**TREBLE** — Slide the TREBLE lever up to increase the treble response. If a station is weak or noisy, slide the TREBLE lever down to reduce the noise.

**BASS** — Slide the BASS lever up to increase the bass response. Adjust the BASS lever to give a pleasing sound to your ear.

## ***How to Operate Your ETR<sup>®</sup> AM–FM Stereo Audio System***

This part tells you how your ETR<sup>®</sup> AM–FM stereo audio system works.

**Upper Knob (VOL–RECALL)** — The upper knob has these four functions:

- Turn it to switch the system on and off.
- Turn it to control the volume.
- Press it to display the time when the ignition is off.
- Press it to change between the clock and the radio station frequency displayed when the radio is on.

**BAL (Balance)** — The control ring behind the upper knob adjusts the left/right speaker balance.

**Lower Knob (TUNE–AM–FM)** — The lower knob has two functions:

- Turn it to tune in radio stations.
- Press it to change between the AM and FM bands.

**FADE** — The control ring behind the lower knob adjusts the front/rear speaker balance.

**SEEK** — Press the SEEK button to cause the receiver to SEEK the next higher station and stop.

**SCAN** — Press the SCAN button to hear each station for a few seconds. Push it again when you reach the station you want to listen to and the radio will stop scanning. “SCAN” appears in the display.

**Pushbuttons** — The four pushbuttons let you return to favorite stations. To set the pushbuttons for up to fourteen favorite stations (7 AM and 7 FM):

1. Tune in the desired station.
2. Press the SET button. “SET” appears in the display.
3. Within 5 seconds, press one of the four pushbuttons to store the station. Whenever you press that button, the preset station will return.

Repeat these steps for each pushbutton.

In addition to the four stations set as above, up to three additional stations may be preset on each band by pressing two adjoining buttons at the same time. Then do the following:

1. Tune in the desired station.
2. Press the SET button. "SET" appears in the display momentarily.
3. Within 5 seconds, press any two adjoining pushbuttons at the same time. (The station will return when the same two buttons are pressed again.)

**TREBLE** — Slide the TREBLE lever up to increase the treble response. If a station is weak or noisy, slide the TREBLE lever down to reduce the noise.

**BASS** — Slide the BASS lever up to increase the bass response. Adjust the BASS lever to give a pleasing sound to your ear.

## ***How to Operate Your ETR<sup>®</sup> AM–FM Stereo Audio Cassette System***

This part tells you how your ETR<sup>®</sup> AM–FM stereo audio cassette system works.

**Upper Knob (VOL–PROG–RCL)** — The upper knob has these five functions:

- Turn it to switch the system on and off.
- Turn it to control the volume.
- Press it to display the time when the ignition is off.
- Press it to change between the clock and the radio station frequency displayed when the radio is on.
- Press it to change sides of a tape when a cassette is playing.

**BAL (Balance)** — The control ring behind the upper knob adjusts the left/right speaker balance.

**Lower Knob (TUNE–AM–FM)** — The lower knob has two functions:

- Turn it to tune in radio stations.
- Press it to change between the AM and FM bands.

**FADE** — The control ring behind the lower knob adjusts the front/rear speaker balance.

**SEEK** — Press the SEEK button to cause the receiver to SEEK the next higher station and stop.

**SCAN** — Press the SCAN button to hear each station for a few seconds. Push it again when you reach the station you want to listen to and the radio will stop scanning. "SCAN" appears in the display.

**Pushbuttons** — The four pushbuttons let you return to favorite stations. To set the pushbuttons for up to fourteen favorite stations (7 AM and 7 FM):

1. Tune in the desired station.
2. Press the SET button. "SET" appears in the display momentarily.
3. Within 5 seconds, press one of the four pushbuttons to store the station. Whenever you press that button, the preset station will return.

In addition to the four stations set as above, up to three additional stations may be preset on each band by pressing two adjoining pushbuttons at the same time. Then do the following:

1. Tune in the desired station.
2. Push the SET button. "SET" appears in the display momentarily.
3. Within 5 seconds, press any two adjoining pushbuttons at the same time. (The station will return when the same two buttons are pressed again.)

Repeat these steps for each pair of buttons.

**TREBLE** — Slide the TREBLE lever up to increase the treble response. If the station is weak or noisy, slide the TREBLE lever down to reduce the noise.

**BASS** — Slide the BASS lever up to increase the bass response. Adjust the BASS lever to give a pleasing sound to your ear.

## ***To Play A Cassette***

Your tape player is built to work best with tapes that are 30 to 45 minutes long on each side. Tapes longer than that are so thin they may not work well in this player.

Once the tape is playing, use the upper and lower knobs for volume, balance and fade just as you do for the radio. A lighted arrow shows which direction the tape is being played.

**FORWARD** — To rapidly advance the tape, press ◀ or ▶ in the direction that the amber arrow points and the tape will rapidly go forward until you press the STOP-EJECT button lightly.

**REVERSE** — To rapidly reverse the tape, press ◀ or ▶ in the opposite direction that the amber arrow points and the tape will rapidly reverse until you press the STOP-EJECT button lightly.

**PROGRAM** — To go from one side of the tape to the other, press the VOL-PROG-RCL knob.

**STOP-EJECT** — To remove the tape or stop the tape and switch to radio, press the STOP-EJECT button.

If a tape is inserted with side "1" (or "A") up, then the right arrow means that that side is being played. Likewise, a left arrow would indicate that side "2" (or "B") had been selected. The player will automatically switch to the other side of the tape when the first side ends.

If "Cln" (Clean) appears on the display when you insert your cassette tape, your cassette player needs to be cleaned. It will still play cassette tapes but it should be cleaned to prevent damage to your cassette tapes and the cassette tape player. See "Care of Your Cassette Tape Player" later in this section. After you have cleaned the cassette tape player, press and hold STOP-EJECT for 5 seconds to reset the "Cln" indicator. The radio will display "---" to show the clean feature has been reset.

## ***How to Operate Your ETR<sup>®</sup> AM-FM Stereo Audio Cassette System with Equalizer***

This part tells you how your ETR<sup>®</sup> AM-FM stereo audio cassette system with equalizer works:

Upper Knob (VOL-PROG-RCL) — The upper knob has these five functions:

- Turn it to switch the system on and off.
- Turn it to control the volume.
- Press it to display the time when the ignition is off.
- Press it to change between the clock and the radio station frequency displayed when the radio is on.
- Press it to change sides of a tape when a cassette is playing.

BAL (Balance) — The control ring behind the upper knob adjusts the left/right speaker balance.

Lower Knob (TUNE-AM-FM) — The lower knob has two functions:

- Turn it to tune in radio stations.
- Press it to change between the AM and FM bands.

FADE — The control ring behind the lower knob adjusts the front/rear speaker balance.

SEEK — Press the SEEK button to cause the receiver to SEEK the next higher station and stop.

SCAN — Press the SCAN button to hear each station for a few seconds. Push it again when you reach the station you want to listen to and the radio will stop scanning. "SCAN" appears in the display.



**Pushbuttons** — The four pushbuttons let you return to favorite stations. To set the pushbuttons for up to fourteen favorite stations (7 AM and 7 FM):

1. Tune in the desired station.
2. Push the SET button. "SET" appears in the display for about 5 seconds.
3. Within the 5 seconds, push one of the four pushbuttons. Whenever you press that button, the preset station will return.

In addition to the four stations set as above, up to three additional stations may be preset on each band by pressing two adjoining pushbuttons at the same time. Then do the following:

1. Tune in the desired station.
2. Press the SET button.
3. Within 5 seconds, press any two adjoining pushbuttons at the same time. (The station will return when the same two buttons are pressed again.)

**To Adjust the Tone** — Use the levers in the upper middle left corner to set the bass, midrange, and treble until you get the sound you want. The 60 and 250 levers adjust the bass, 1K is midrange, and 3.5K and 10K control the treble.

We suggest you start with the center lever (1K) in the midpoint position, then move the others up until you get the amount of bass and treble you like.

**Am–St Button** — Push the Am–St button when you tune to an AM station that broadcasts in stereo. Your STEREO light will come on when you're receiving AM stereo. If you push Am–St and there is no more noise, it means the station is weak. You'll hear the station better if you don't use Am–St. Just push the Am–St button again to delete stereo.

## ***To Play A Cassette***

Your tape player is built to work best with tapes that are 30 to 45 minutes long on each side. Tapes longer than that are so thin they may not work well in this player.

Once the tape is playing, use the upper and lower knobs for volume, balance and fade just as you do for the radio. A lighted arrow shows which direction the tape is being played.

**Cr02** — The Cr02 button lets you set the system for the type of cassette being used. If you are using chrome or metal tapes, push the Cr02 button in.

**FWD** — To rapidly advance the tape, press ◀ or ▶ in the direction that the amber arrow points and the tape will rapidly go forward until you press the STOP–EJECT button lightly.

**REV** — To rapidly reverse the tape, press ◀ or ▶ in the opposite direction that the amber arrow points and the tape will rapidly reverse until you press the STOP-EJECT button lightly.

**APS** — Press the APS button to the recessed position.

Press ◀ or ▶ in the direction that the amber arrow points to go to the beginning of the next selection.

Press ◀ or ▶ in the opposite direction that the amber arrow points and the tape will reverse to the beginning of the current selection.

**PROGRAM** — To go from one side of the tape to the other, press the VOL-PROG-RCL knob.

**STOP-EJECT** — To remove the tape or stop the tape and switch to radio, press the STOP-EJECT button.

If “Cln” (Clean) appears on the display when you insert your cassette tape, your cassette player needs to be cleaned. It will still play cassette tapes but it should be cleaned to prevent damage to your cassette tapes and the cassette tape player. See “Care of Your Cassette Tape Player” later in this section. After you have cleaned the cassette tape player, press and hold EJECT for 5 seconds to reset the the “Cln” indicator. The radio will display “---” to show the clean feature has been reset.

## ***How to Operate Your ETR<sup>®</sup> AM-FM Stereo Audio Compact Disc (CD) System***

This part tells you how your ETR<sup>®</sup> AM-FM stereo system works:

**Upper Knob VOL)** — The upper knob has one function:

- Turn it to control the volume. Volume will be displayed briefly unless Left/Right speaker control, Rear/Front speaker control, BASS or TREB are adjusted.

**Left/Right Speaker Control** — The control ring behind the upper knob allows you to balance the sound between the left and right speakers. Balance will be displayed briefly when using this control.

**Lower Knob (TUNE-BAND)** — The lower knob has two functions:

- Turn it to tune in radio stations.
- Press it to change between the AM and FM bands.

**Rear/Front Speaker Control** — The control ring behind the lower knob fades the sound between your rear and front speakers. Fade levels will be briefly displayed.

**SEEK** — Press the SEEK ▶ button to cause the receiver to seek the next higher station.

Press the ◀ SEEK button to cause the receiver to seek the next lower station.

SCAN — Press the SCAN button to hear each station for a few seconds. Push it again when you reach the station you want to listen to and the radio will stop scanning. “SC” appears in the display.

Pushbuttons — The five pushbuttons let you return to favorite stations. They are also used when you play a disc. (See “To Play A Compact Disc”.) To set the pushbuttons for up to ten favorite stations (5 AM and 5 FM):

1. Tune in the desired station.
2. Push the SET button. “SET” is displayed briefly.
3. Within 5 seconds, push one of the five pushbuttons to store the station. Whenever you press that button, the preset station will return. Repeat the steps for each of the 5 AM and 5 FM stations.

MUTE — Press the MUTE button and all sound from the radio or CD player stops. By pressing the button again sound will begin again.

RCL — Press the RCL button to change between the clock and the radio station frequency displayed when the radio is on. RCL may be pressed when the ignition is off to see the time.

BASS — Press the BASS ▲ to increase the bass tones and ▼ BASS to decrease bass tones. Press the center of the control for a preset BASS position. The bass level will be displayed briefly when using this control.

TREBLE — Press the TREB ▲ to increase the treble tones and ▼ TREB to decrease the treble tones. Press the center of the control for a preset TREB position. The treble level will be displayed briefly when using this control.

## ***To Play A Compact Disc (CD)***

### **NOTICE:**

**DO NOT use mini-discs that are called singles. They won't eject.  
USE FULL-SIZE COMPACT DISCS.**

Press the PWR button to turn the player on. Inserting a disc partway with the power off and ignition on will also turn the player on. Insert a disc into the slot, label side up. The player will pull it in. Wait a few seconds and the disc should play.

If the disc player is very hot, or if you're driving on a very rough road, a disc may come out or just not play. If you see the word HOT on the display, the disc player is too hot to play the disc. Press RCL to make the word HOT go off the display.

When things get back to normal, the disc should play again. If the disc comes back out, check whether:

- The disc is upside down.
- It is dirty, scratched, or wet.
- Too much moisture is in the air. (If there is, wait about one hour and try again.)

**RCL** — Press RCL to see what track is playing. Press it again within 5 seconds to see how long it has been playing. The track number also appears when you change the volume or when a new track starts to play.

**COMP** — Press the COMP button to make soft and loud passages more nearly equal in volume. “COMP” will appear in the display while using this control.

**RDM** — The RDM button means random and when it is pressed, it causes the CD mechanism to play the tracks in a random order rather than in the sequential 1, 2, 3 order. “RDM” will appear in the display while using this control. To return to normal sequence, press RDM again.

**REV** — Press and hold the REV button to quickly return to a favorite passage. Release it to display the passage. The counter reading will be displayed while using this control.

**FWD** — Press and hold the FWD button to advance quickly within a track. Release it to resume playing. Watch the display to stop at a specific passage.

**SCAN** — Press SCAN to sample each track for approximately 10 seconds. Scanning will continue until the RDM, SCAN or any other motion button is pressed again.

**PREV** — Hold the PREV (◀ SEEK) button, or press it more than once, and the disc will return to previous tracks.

**NEXT** — Press NEXT (SEEK ▶) to hear the next track now instead of waiting until the present track is finished. If you hold this button or press it more than once, the disc will advance further.

**ST-PL** — Press ST-PL (Stop-Play) to make the disc stop and the radio play. Press ST-PL again to restart the disc at the point where it stopped.

Press PWR or turn the ignition key off to stop the disc player. The disc stays in the player and will resume playing at the point where it stopped.

Press EJCT to eject the disc and make the radio play. The disc will start at track 1 when you reinsert it.

## ***Delco LOC II Theft Deterrent Feature***

Delco LOC II<sup>®</sup> is an anti-theft feature for the compact disc player. It can be used or ignored. If ignored, the system plays normally. If it is used, your player won't be usable if it is ever stolen, because it will go to LOC mode any time the battery power is removed. After a loss of battery power, the player cannot be turned on unless an unlock code is entered.

The instructions below tell you how to enter a secret code into the system. If your vehicle loses battery power for any reason, you must unlock the system with the secret code before the radio will turn on.

### ***To Lock The System:***

1. Write down any 6 digit number and keep it in a safe place.
2. Turn the ignition to the ACC (Accessory) or RUN position.
3. Press the PWR knob to turn the radio off.
4. Press the 1 and 4 buttons together. Hold them down until “— — —” shows on the display.

You are now ready to enter your secret code. Don't wait more than 15 seconds between steps.

5. Press SET and “000” will appear on the display.
6. Press the SEEK ► or ◀ button to make the first number appear.
7. Press SCAN to make the next two numbers agree with your code.
8. Press BAND and “000” will appear again. Now you are ready to enter the last three digits of your code.
9. Repeat steps 6 and 7 for the last three digits of your code.
10. Press BAND and “REP” will appear for 5 seconds and then “000” will appear.
11. Repeat steps 6 through 10. This time “SEC” will appear — indicating that the radio is secure.

### ***To Unlock The System After A Power Loss***

When battery power is reapplied to a secured radio, the radio won't turn on and “LOC” will appear on the display.

Enter your secret code as follows. Pause no more than 15 seconds between steps.

1. Turn the ignition on. (Radio off.)
2. Press the SET button. The display will show “000”.

3. Enter the six digits of the code following steps 6–9 above. The display will show the numbers as entered.
4. Press the BAND knob and the time appears — indicating that the disabling sequence was successful. If the display indicates “SEC”, the numbers did not match and the unit is still secured.

### ***Disabling The Theft System***

1. Press presets 1 and 4 for 5 seconds with ignition on and radio off. The display will show “SEC”, indicating the unit is in the secure mode.
2. Press the SET button. The display will show “000”.
3. Enter the first three digits of the code following steps 6 and 7 of the preceding paragraphs (To Lock the System). The display will show the numbers as entered.
4. Press the BAND knob. The radio will display “000”.
5. Enter the second three digits of the code. The display will show the numbers as entered.
6. Press the BAND knob. If the display shows “— — —”, the disabling sequence was successful. The numbers matched the user-selected code or the factory back-up code, and the unit is in the UNSECURED mode. If the display shows “SEC”, the disabling sequence was unsuccessful and the numbers did not match either of the codes and the unit will remain in the SECURED mode.

### ***Understanding Radio Reception***

FM stereo will give you the best sound. But FM signals will reach only about 10 to 40 miles (16 to 65 km). And, tall buildings or hills can interfere with FM signals, causing the sound to come and go.

The range for most AM stations is greater than for FM, especially at night. The longer range, however, can cause stations to interfere with each other. AM can pick up noise from things like storms and power lines. Try reducing the treble to reduce this noise if you ever get it.

AM Stereo means the Delco<sup>®</sup> system can receive C-QUAM<sup>®</sup> stereo broadcasts. Many AM stations around the country use C-QUAM<sup>®</sup> to produce stereo, though some do not. (C-QUAM<sup>®</sup> is a registered trademark of Motorola, Inc.) If your Delco<sup>®</sup> system can get C-QUAM<sup>®</sup>, your “STEREO” light will come on when you’re receiving it.

Be aware that hearing damage from loud noise is almost undetectable until it is too late. Your hearing can adapt to higher volumes of sound. Sound that seems normal can be loud and harmful to your hearing. Take precautions by adjusting the volume control on your radio to a safe sound level before your hearing adapts to it.

To help avoid hearing loss or damage:

1. Adjust the volume control to the lowest setting.
2. Increase volume slowly until you hear comfortably and clearly.

## **NOTICE:**

**Before you add any sound equipment to your vehicle — like a tape player, CB radio, mobile telephone or two-way radio — be sure you can add what you want. If you can, it's very important to do it properly. Added sound equipment may interfere with the operation of your vehicle's engine, Delco<sup>®</sup> radio or other systems, and even damage them. And, your vehicle's systems may interfere with the operation of sound equipment that has been added improperly.**

**So, before adding sound equipment, check with your dealer and be sure to check Federal rules covering mobile radio and telephone units.**

## ***Care of Your Cassette Player and Tape***

A tape player that is not cleaned regularly is subject to reduced sound quality, ruining the cassette, or damaging the mechanism. Tape cassettes that are not properly stored in their plastic cases away from contaminants, direct sunlight, and extreme heat, may not operate properly and could cause premature failure of the tape player.

Your tape player should be cleaned with every 50 hours of use to provide optimum performance. Your radio may display "Cln" (Clean) to indicate that you have used your tape player for 50 hours without re-setting the tape clean timer. If you notice a reduction in sound quality, regardless of when the tape player was last cleaned, try playing a different cassette to see if the tape or tape player is at fault. If the second cassette results in no improvement in sound quality, try cleaning the tape player.

Proper tape player cleaning should be done with a scrubbing action, non-abrasive cleaning cassette. This is a wet-type cleaning system that uses a cleaning cassette with pads which scrub the tape head as the hubs of the cleaner cassette turn. To properly clean your tape player, follow instructions with the cleaning cassette. If you use this type of cleaner, the radio may display an error and eject the cartridge. This is normal and is the result of an added feature in the tape player that detects broken tapes. If an error occurs, you will need to insert the cleaning cassette at least 3 times to thoroughly clean the tape player.

You may prefer to use a non-scrubbing action, wet-type cleaner. This type of cleaner uses a fabric belt to clean the tape head. This type of cleaner cassette will not cause an error, but it may not clean the tape player as thoroughly as the scrubbing type cleaner.

A scrubbing action cleaner cassette is available through your retailer (SPO 12344600).

Cassettes are subject to wear and the sound quality may degrade over time. Always verify that the cassette tape is in good condition and the tape player is clean before obtaining service on your tape player.

## **NOTICE:**

**Cassette tape adapter kits for portable CD players will not work in your cassette player. These adapters will cause the radio to display an error and the adapter cassette will be ejected.**

### ***Care of Compact Discs***

Handle discs carefully. Store them in their original cases or other protective cases and away from direct sunlight and dust. If the surface of a disc is soiled, dampen a clean, soft cloth in a mild, neutral detergent solution and clean it, wiping from the center to the edge.

Be sure never to touch the signal surface when handling discs. Pick up discs by grasping the outer edges or the edge of the hole and the outer edge.

### ***Antenna Care***

The fixed mast antenna can withstand most car washes without being damaged. If the mast should ever become slightly bent, you can straighten it out by hand. If the mast is badly bent, as it might be by vandals, you should replace it.

Check every once in a while to be sure the mast is still tightened to the fender.



## ***Your Driving and the Road***

### ***Section***

# **4**

Here you'll find information about driving on different kinds of roads and in varying weather conditions. We've also included many other useful tips on driving.



### ***Defensive Driving***

The best advice anyone can give about driving is: Drive defensively.

Please start with a very important safety device in your vehicle: Buckle up. (See "Safety Belts" in the Index.)

Defensive driving really means "be ready for anything." On city streets, rural roads, or freeways, it means "always expect the unexpected."

Assume that pedestrians or other drivers are going to be careless and make mistakes. Anticipate what they might do. Be ready for their mistakes.

Rear-end collisions are about the most preventable of accidents. Yet they are common. Allow enough following distance. It's the best defensive driving maneuver, in both city and rural driving. You never know when the vehicle in front of you is going to brake or turn suddenly.

## ***Drunken Driving***

Death and injury associated with drinking and driving is a national tragedy. It's the number one contributor to the highway death toll, claiming thousands of victims every year.

Alcohol affects four things that anyone needs to drive a vehicle:

- Judgment
- Muscular Coordination
- Vision
- Attentiveness

Police records show that almost half of all motor vehicle-related deaths involve alcohol. In most cases, these deaths are the result of someone who was drinking and driving. In recent years, some 18,000 annual motor vehicle-related deaths have been associated with the use of alcohol, with more than 300,000 people injured.

Many adults — by some estimates, nearly half the adult population — choose never to drink alcohol, so they never drive after drinking. For persons under 21, it's against the law in every U.S. state to drink alcohol. There are good medical, psychological and developmental reasons for these laws.

The obvious way to solve this highway safety problem is for people never to drink alcohol and then drive. But what if people do? How much is "too much" if the driver plans to drive? It's a lot less than many might think. Although it depends on each person and situation, here is some general information on the problem.

The Blood Alcohol Concentration (BAC) of someone who is drinking depends upon four things:

- How much alcohol consumed
- The drinker's body weight
- The amount of food that is consumed before and during drinking
- The length of time it's taken the drinker to consume the alcohol

According to the American Medical Association, a 180-pound (82 kg) person who drinks three 12-ounce (355 ml) bottles of beer in an hour will end up with a BAC of about 0.06 percent. The person would reach the same BAC by drinking three 4-ounce (120 ml) glasses of wine or three mixed drinks if each had 1-1/2 ounces (45 ml) of a liquor like whiskey, gin or vodka.



It's the amount of alcohol that counts. For example, if the same person drank three double martinis (3 ounces or 90 ml of liquor each) within an hour, the person's BAC would be close to 0.12 percent. A person who consumes food just before or during drinking will have a somewhat lower BAC level.

There is a gender difference, too. Women generally have a lower relative percentage of body water than men. Since alcohol is carried in body water, this means that a woman generally will reach a higher BAC level than a man of her same body weight when each has the same number of drinks.

The law in many U.S. states sets the legal limit at a BAC of 0.10 percent. In a growing number of U.S. states, and throughout Canada, the limit is 0.08 percent. In some other countries it's even lower. The BAC limit for all commercial drivers in the U.S. is 0.04 percent.

The BAC will be over 0.10 percent after three to six drinks (in one hour). Of course, as we've seen, it depends on how much alcohol is in the drinks, and how quickly the person drinks them.

But the ability to drive is affected well below a BAC of 0.10 percent. Research shows that the driving skills of many people are impaired at a BAC approaching 0.05 percent, and that the effects are worse at night. All drivers are impaired at BAC levels above 0.05 percent. Statistics show that the chance of being in a collision increases sharply for drivers who have a BAC of 0.05 percent or above. A driver with a BAC level of 0.06 percent has doubled his or her chance of having a collision. At a BAC level of 0.10 percent, the chance of this driver having a collision is twelve times greater; at a level of 0.15 percent, the chance is twenty-five times greater!

The body takes about an hour to rid itself of the alcohol in one drink. No amount of coffee or number of cold showers will speed that up. "I'll be careful" isn't the right answer. What if there's an emergency, a need to take sudden action, as when a child darts into the street? A person with even a moderate BAC might not be able to react quickly enough to avoid the collision.

There's something else about drinking and driving that many people don't know. Medical research shows that alcohol in a person's system can make crash injuries worse, especially injuries to the brain, spinal cord or heart. This means that when anyone who has been drinking — driver or passenger — is in a crash, that person's chance of being killed or permanently disabled is higher than if the person had not been drinking.



## **CAUTION:**

**Drinking and then driving is very dangerous. Your reflexes, perceptions, attentiveness and judgment can be affected by even a small amount of alcohol. You can have a serious — or even fatal — collision if you drive after drinking. Please don't drink and drive or ride with a driver who has been drinking. Ride home in a cab; or if you're with a group, designate a driver who will not drink.**

## ***Control of a Vehicle***

You have three systems that make your vehicle go where you want it to go. They are the brakes, the steering and the accelerator. All three systems have to do their work at the places where the tires meet the road.



Sometimes, as when you're driving on snow or ice, it's easy to ask more of those control systems than the tires and road can provide. That means you can lose control of your vehicle.

## **Braking**

Braking action involves *perception time* and *reaction time*.

First, you have to decide to push on the brake pedal. That's *perception time*. Then you have to bring up your foot and do it. That's *reaction time*.

Average *reaction time* is about 3/4 of a second. But that's only an average. It might be less with one driver and as long as two or three seconds or more with another. Age, physical condition, alertness, coordination, and eyesight all play a part. So do alcohol, drugs and frustration. But even in 3/4 of a second, a vehicle moving at 60 mph (100 km/h) travels 66 feet (20 m). That could be a lot of distance in an emergency, so keeping enough space between your vehicle and others is important.

And, of course, actual stopping distances vary greatly with the surface of the road (whether it's pavement or gravel); the condition of the road (wet, dry, icy); tire tread; and the condition of your brakes.

Avoid needless heavy braking. Some people drive in spurts — heavy acceleration followed by heavy braking — rather than keeping pace with traffic. This is a mistake. Your brakes may not have time to cool between hard stops. Your brakes will wear out much faster if you do a lot of heavy braking. If you keep pace with the traffic and allow realistic following distances, you will eliminate a lot of unnecessary braking. That means better braking and longer brake life.

If your engine ever stops while you're driving, brake normally but don't pump your brakes. If you do, the pedal may get harder to push down. If your engine stops, you will still have some power brake assist. But you will use it when you brake. Once the power assist is used up, it may take longer to stop and the brake pedal will be harder to push.

## ***Anti-Lock Brakes (ABS)***

Your vehicle has an advanced electronic braking system that can help you keep it under control. When you start your vehicle and begin to drive away, you may hear a momentary motor or clicking noise. This is the ABS system testing itself.



Here's how anti-lock works. Let's say the road is wet. You're driving safely. Suddenly an animal jumps out in front of you.

You slam on the brakes. Here's what happens with ABS.

A computer senses that wheels are slowing down. If one of the wheels is about to stop rolling, the computer will separately work the brakes at each front wheel and at the rear wheels. The anti-lock system can change the brake pressure faster than any driver could. The computer is programmed to make the most of available tire and road conditions. You can steer around the obstacle while braking hard.



As you brake, your computer keeps receiving updates on wheel speed and controls braking pressure accordingly.

Remember: Anti-lock doesn't change the time you need to get your foot up to the brake pedal. If you get too close to the vehicle in front of you, you won't have time to apply your brakes if that vehicle suddenly slows or stops. Always leave enough room up ahead to stop, even though you have anti-lock brakes.

### ***To Use Anti-Lock***

Don't pump the brakes. Just hold the brake pedal down and let anti-lock work for you. You may feel the brakes vibrate, or you may notice some noise, but this is normal.

### ***Braking in Emergencies***

Use your anti-lock braking system when you need to. With anti-lock, you can steer and brake at the same time. In many emergencies, steering can help you more than even the very best braking.

## ***Steering***

### ***Power Steering***

If you lose power steering assist because the engine stops or the system is not functioning, you can steer but it will take much more effort.

### ***Steering Tips***

#### ***Driving on Curves***

It's important to take curves at a reasonable speed.

A lot of the "driver lost control" accidents mentioned on the news happen on curves. Here's why:

Experienced driver or beginner, each of us is subject to the same laws of physics when driving on curves. The traction of the tires against the road surface makes it possible for the vehicle to change its path when you turn the front wheels. If there's no traction, inertia will keep the vehicle going in the same direction. If you've ever tried to steer a vehicle on wet ice, you'll understand this.

The traction you can get in a curve depends on the condition of your tires and the road surface, the angle at which the curve is banked, and your speed. While you're in a curve, speed is the one factor you can control.

Suppose you're steering through a sharp curve. Then you suddenly accelerate. Both control systems — steering and acceleration — have to do their work where the tires meet the road. Adding the sudden acceleration can demand too much of those places. You can lose control.

What should you do if this ever happens? Ease up on the accelerator pedal, steer the vehicle the way you want it to go, and slow down.

Speed limit signs near curves warn that you should adjust your speed. Of course, the posted speeds are based on good weather and road conditions. Under less favorable conditions you'll want to go slower.

If you need to reduce your speed as you approach a curve, do it before you enter the curve, while your front wheels are straight ahead.

Try to adjust your speed so you can "drive" through the curve. Maintain a reasonable, steady speed. Wait to accelerate until you are out of the curve, and then accelerate gently into the straightaway.

## ***Steering in Emergencies***

There are times when steering can be more effective than braking. For example, you come over a hill and find a truck stopped in your lane, or a car suddenly pulls out from nowhere, or a child darts out from between parked cars and stops right in front of you. You can avoid these problems by braking — if you can stop in time. But sometimes you can't; there isn't room. That's the time for evasive action — steering around the problem.

Your vehicle can perform very well in emergencies like these. First apply your brakes. It is better to remove as much speed as you can from a possible collision. Then steer around the problem, to the left or right depending on the space available.

An emergency like this requires close attention and a quick decision. If you are holding the steering wheel at the recommended 9 and 3 o'clock positions, you can turn it a full 180 degrees very quickly without removing either hand. But you have to act fast, steer quickly, and just as quickly straighten the wheel once you have avoided the object.



The fact that such emergency situations are always possible is a good reason to practice defensive driving at all times and wear safety belts properly.



## ***Off-Road Recovery***

You may find sometime that your right wheels have dropped off the edge of a road onto the shoulder while you're driving.

If the level of the shoulder is only slightly below the pavement, recovery should be fairly easy. Ease off the accelerator and then, if there is nothing in the way, steer so that your vehicle straddles the edge of the pavement. You can turn the steering wheel up to 1/4 turn until the right front tire contacts the pavement edge. Then turn your steering wheel to go straight down the roadway.

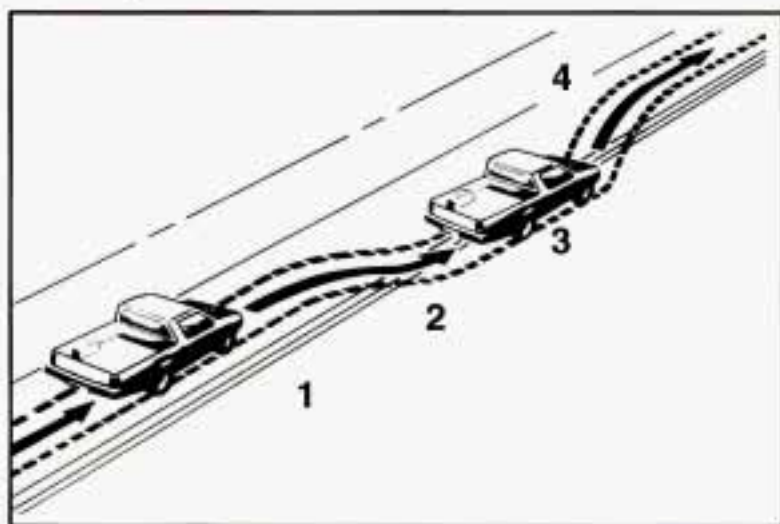

1. Edge of Road Surface
2. Slow Down
3. Left Approx. Quarter Turn
4. Recover

## ***Passing***

The driver of a vehicle about to pass another on a two-lane highway waits for just the right moment, accelerates, moves around the vehicle ahead, then goes back into the right lane again. A simple maneuver?

Not necessarily! Passing another vehicle on a two-lane highway is a potentially dangerous move, since the passing vehicle occupies the same lane as oncoming traffic for several seconds. A miscalculation, an error in judgment, or a brief surrender to frustration or anger can suddenly put the passing driver face to face with the worst of all traffic accidents — the head-on collision.

So here are some tips for passing:

- "Drive ahead." Look down the road, to the sides, and to crossroads for situations that might affect your passing patterns. If you have any doubt whatsoever about making a successful pass, wait for a better time.

- Watch for traffic signs, pavement markings, and lines. If you can see a sign up ahead that might indicate a turn or an intersection, delay your pass. A broken center line usually indicates it's all right to pass (providing the road ahead is clear). Never cross a solid line on your side of the lane or a double solid line, even if the road seems empty of approaching traffic.
- Do not get too close to the vehicle you want to pass while you're awaiting an opportunity. For one thing, following too closely reduces your area of vision, especially if you're following a larger vehicle. Also, you won't have adequate space if the vehicle ahead suddenly slows or stops. Keep back a reasonable distance.
- When it looks like a chance to pass is coming up, start to accelerate but stay in the right lane and don't get too close. Time your move so you will be increasing speed as the time comes to move into the other lane. If the way is clear to pass, you will have a "running start" that more than makes up for the distance you would lose by dropping back. And if something happens to cause you to cancel your pass, you need only slow down and drop back again and wait for another opportunity.
- If other cars are lined up to pass a slow vehicle, wait your turn. But take care that someone isn't trying to pass you as you pull out to pass the slow vehicle. Remember to glance over your shoulder and check the blind spot.
- Check your mirrors, glance over your shoulder, and start your left lane change signal before moving out of the right lane to pass. When you are far enough ahead of the passed vehicle to see its front in your inside mirror, activate your right lane change signal and move back into the right lane. (Remember that your right outside mirror is convex. The vehicle you just passed may seem to be farther away from you than it really is.)
- Try not to pass more than one vehicle at a time on two-lane roads. Reconsider before passing the next vehicle.
- Don't overtake a slowly moving vehicle too rapidly. Even though the brake lights are not flashing, it may be slowing down or starting to turn.
- If you're being passed, make it easy for the following driver to get ahead of you. Perhaps you can ease a little to the right.

## ***Loss of Control***

Let's review what driving experts say about what happens when the three control systems (brakes, steering and acceleration) don't have enough friction where the tires meet the road to do what the driver has asked.

In any emergency, don't give up. Keep trying to steer and constantly seek an escape route or area of less danger.

### ***Skidding***

In a skid, a driver can lose control of the vehicle. Defensive drivers avoid most skids by taking reasonable care suited to existing conditions, and by not "overdriving" those conditions. But skids are always possible.

The three types of skids correspond to your vehicle's three control systems. In the braking skid your wheels aren't rolling. In the steering or cornering skid, too much speed or steering in a curve causes tires to slip and lose cornering force. And in the acceleration skid too much throttle causes the driving wheels to spin.

A cornering skid and an acceleration skid are best handled by easing your foot off the accelerator pedal.

If your vehicle starts to slide, ease your foot off the accelerator pedal and quickly steer the way you want the vehicle to go. If you start steering quickly enough, your vehicle may straighten out. Always be ready for a second skid if it occurs.

Of course, traction is reduced when water, snow, ice, gravel, or other material is on the road. For safety, you'll want to slow down and adjust your driving to these conditions. It is important to slow down on slippery surfaces because stopping distance will be longer and vehicle control more limited.

While driving on a surface with reduced traction, try your best to avoid sudden steering, acceleration, or braking (including engine braking by shifting to a lower gear). Any sudden changes could cause the tires to slide. You may not realize the surface is slippery until your vehicle is skidding. Learn to recognize warning clues — such as enough water, ice or packed snow on the road to make a "mirrored surface" — and slow down when you have any doubt.

Remember: Any anti-lock brake system (ABS) helps avoid only the braking skid.

## ***Driving at Night***



Night driving is more dangerous than day driving. One reason is that some drivers are likely to be impaired — by alcohol or drugs, with night vision problems, or by fatigue.

Here are some tips on night driving.

- Drive defensively.
- Don't drink and drive.
- Adjust your inside rearview mirror to reduce the glare from headlights behind you.
- Since you can't see as well, you may need to slow down and keep more space between you and other vehicles.
- Slow down, especially on higher speed roads. Your headlights can light up only so much road ahead.
- In remote areas, watch for animals.
- If you're tired, pull off the road in a safe place and rest.

### ***Night Vision***

No one can see as well at night as in the daytime. But as we get older these differences increase. A 50-year-old driver may require at least twice as much light to see the same thing at night as a 20-year-old.

What you do in the daytime can also affect your night vision. For example, if you spend the day in bright sunshine you are wise to wear sunglasses. Your eyes will have less trouble adjusting to night. But if you're driving, don't wear sunglasses at night. They may cut down on glare from headlights, but they also make a lot of things invisible.

You can be temporarily blinded by approaching lights. It can take a second or two, or even several seconds, for your eyes to readjust to the dark. When you are faced with severe glare (as from a driver who doesn't lower the high beams, or a vehicle with misaimed headlights), slow down a little. Avoid staring directly into the approaching lights.

Keep your windshield and all the glass on your vehicle clean — inside and out. Glare at night is made much worse by dirt on the glass. Even the inside of the glass can build up a film caused by dust. Dirty glass makes lights dazzle and flash more than clean glass would, making the pupils of your eyes contract repeatedly.

Remember that your headlights light up far less of a roadway when you are in a turn or curve. Keep your eyes moving; that way, it's easier to pick out dimly lighted objects. Just as your headlights should be checked regularly for proper aim, so should your eyes be examined regularly. Some drivers suffer from night blindness — the inability to see in dim light — and aren't even aware of it.

## ***Driving in the Rain***



Rain and wet roads can mean driving trouble. On a wet road you can't stop, accelerate or turn as well because your tire-to-road traction isn't as good as on dry roads. And, if your tires don't have much tread left, you'll get even less traction. It's always wise to go slower and be cautious if rain starts to fall while you are driving. The surface may get wet suddenly when your reflexes are tuned for driving on dry pavement.

The heavier the rain, the harder it is to see. Even if your windshield wiper blades are in good shape, a heavy rain can make it harder to see road signs and traffic signals, pavement markings, the edge of the road, and even people walking.

It's wise to keep your wiping equipment in good shape and keep your windshield washer tank filled. Replace your windshield wiper inserts when they show signs of streaking or missing areas on the windshield, or when strips of rubber start to separate from the inserts.



Driving too fast through large water puddles or even going through some car washes can cause problems, too. The water may affect your brakes. Try to avoid puddles. But if you can't, try to slow down before you hit them.



### **CAUTION:**

**Wet brakes can cause accidents. They won't work well in a quick stop and may cause pulling to one side. You could lose control of the vehicle.**

**After driving through a large puddle of water or a car wash, apply your brake pedal lightly until your brakes work normally.**

### ***Hydroplaning***

Hydroplaning is dangerous. So much water can build up under your tires that they can actually ride on the water. This can happen if the road is wet enough and you're going fast enough. When your vehicle is hydroplaning, it has little or no contact with the road.

Hydroplaning doesn't happen often. But it can if your tires haven't much tread or if the pressure in one or more is low. It can happen if a lot of water is standing on the road. If you can see reflections from trees, telephone poles, or other vehicles, and raindrops "dimple" the water's surface, there could be hydroplaning.

Hydroplaning usually happens at higher speeds. There just isn't a hard and fast rule about hydroplaning. The best advice is to slow down when it is raining.

## ***Some Other Rainy Weather Tips***

- Turn on your low-beam headlights — not just your parking lights — to help make you more visible to others.
- Besides slowing down, allow some extra following distance. And be especially careful when you pass another vehicle. Allow yourself more clear room ahead, and be prepared to have your view restricted by road spray.
- Have good tires with proper tread depth. (See “Tires” in the Index.)

## ***City Driving***



One of the biggest problems with city streets is the amount of traffic on them. You'll want to watch out for what the other drivers are doing and pay attention to traffic signals.

Here are ways to increase your safety in city driving:

- Know the best way to get to where you are going. Get a city map and plan your trip into an unknown part of the city just as you would for a cross-country trip.
- Try to use the freeways that rim and crisscross most large cities. You'll save time and energy. (See the next part, “Freeway Driving.”)
- Treat a green light as a warning signal. A traffic light is there because the corner is busy enough to need it. When a light turns green, and just before you start to move, check both ways for vehicles that have not cleared the intersection or may be running the red light.

## ***Freeway Driving***

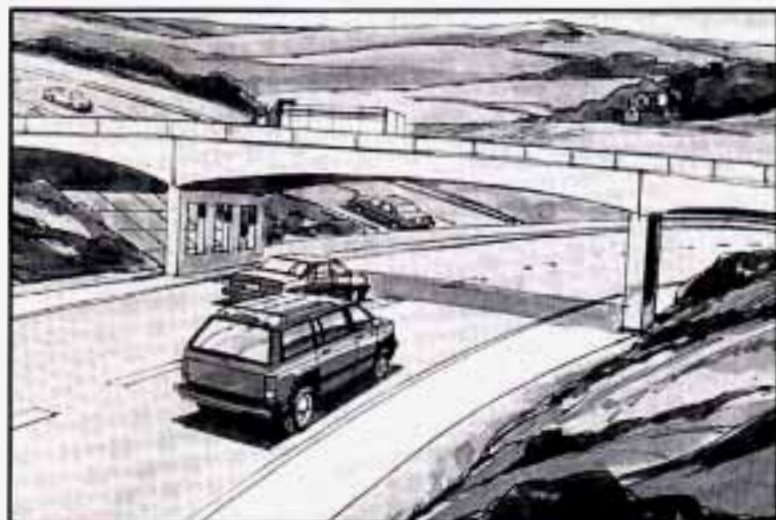

Mile for mile, freeways (also called thruways, parkways, expressways, turnpikes, or superhighways) are the safest of all roads. But they have their own special rules.

The most important advice on freeway driving is: Keep up with traffic and keep to the right. Drive at the same speed most of the other drivers are driving. Too-fast or too-slow driving breaks a smooth traffic flow. Treat the left lane on a freeway as a passing lane.

At the entrance there is usually a ramp that leads to the freeway. If you have a clear view of the freeway as you drive along the entrance ramp, you should begin to check traffic. Try to determine where you expect to blend with the flow. Try to merge into the gap at close to the prevailing speed. Switch on your turn signal, check your mirrors and glance over your shoulder as often as necessary. Try to blend smoothly with the traffic flow.

Once you are on the freeway, adjust your speed to the posted limit or to the prevailing rate if it's slower. Stay in the right lane unless you want to pass.

Before changing lanes, check your mirrors. Then use your turn signal.

Just before you leave the lane, glance quickly over your shoulder to make sure there isn't another vehicle in your "blind" spot.

Once you are moving on the freeway, make certain you allow a reasonable following distance. Expect to move slightly slower at night.

When you want to leave the freeway, move to the proper lane well in advance. If you miss your exit do not, under any circumstances, stop and back up. Drive on to the next exit.

The exit ramp can be curved, sometimes quite sharply.

The exit speed is usually posted.

Reduce your speed according to your speedometer, not to your sense of motion. After driving for any distance at higher speeds, you may tend to think you are going slower than you actually are.



## ***Before Leaving on a Long Trip***

Make sure you're ready. Try to be well rested. If you must start when you're not fresh — such as after a day's work — don't plan to make too many miles that first part of the journey. Wear comfortable clothing and shoes you can easily drive in.

Is your vehicle ready for a long trip? If you keep it serviced and maintained, it's ready to go. If it needs service, have it done before starting out. Of course, you'll find experienced and able service experts in GM dealerships all across North America. They'll be ready and willing to help if you need it.

Here are some things you can check before a trip:

- *Windshield Washer Fluid:* Is the reservoir full? Are all windows clean inside and outside?
- *Wiper Blades:* Are they in good shape?
- *Fuel, Engine Oil, Other Fluids:* Have you checked all levels?
- *Lights:* Are they all working? Are the lenses clean?
- *Tires:* They are vitally important to a safe, trouble-free trip. Is the tread good enough for long-distance driving? Are the tires all inflated to the recommended pressure?
- *Weather Forecasts:* What's the weather outlook along your route? Should you delay your trip a short time to avoid a major storm system?
- *Maps:* Do you have up-to-date maps?

## ***Highway Hypnosis***

Is there actually such a condition as “highway hypnosis”? Or is it just plain falling asleep at the wheel? Call it highway hypnosis, lack of awareness, or whatever.

There is something about an easy stretch of road with the same scenery, along with the hum of the tires on the road, the drone of the engine, and the rush of the wind against the vehicle that can make you sleepy. Don't let it happen to you! If it does, your vehicle can leave the road in *less than a second*, and you could crash and be injured.

What can you do about highway hypnosis? First, be aware that it can happen.

Then here are some tips:

- Make sure your vehicle is well ventilated, with a comfortably cool interior.
- Keep your eyes moving. Scan the road ahead and to the sides. Check your mirrors and your instruments frequently.
- If you get sleepy, pull off the road into a rest, service, or parking area and take a nap, get some exercise, or both. For safety, treat drowsiness on the highway as an emergency.

## ***Hill and Mountain Roads***



Driving on steep hills or mountains is different from driving in flat or rolling terrain.

If you drive regularly in steep country, or if you're planning to visit there, here are some tips that can make your trips safer and more enjoyable.

- Keep your vehicle in good shape. Check all fluid levels and also the brakes, tires, cooling system and transmission. These parts can work hard on mountain roads.
- Know how to go down hills. The most important thing to know is this: let your engine do some of the slowing down. Shift to a lower gear when you go down a steep or long hill.



### **CAUTION:**

**If you don't shift down, your brakes could get so hot that they wouldn't work well. You would then have poor braking or even none going down a hill. You could crash. Shift down to let your engine assist your brakes on a steep downhill slope.**



## **CAUTION:**

**Coasting downhill in NEUTRAL (N) or with the ignition off is dangerous. Your brakes will have to do all the work of slowing down. They could get so hot that they wouldn't work well. You could crash. Always have your engine running and your vehicle in gear when you go downhill.**

- Know how to go uphill. You may want to shift down to a lower gear. The lower gears help cool your engine and transmission, and you can climb the hill better.
- Stay in your own lane when driving on two-lane roads in hills or mountains. Don't swing wide or cut across the center of the road. Drive at speeds that let you stay in your own lane.
- As you go over the top of a hill, be alert. There could be something in your lane, like a stalled car or an accident.
- You may see highway signs on mountains that warn of special problems. Examples are long grades, passing or no-passing zones, a falling rocks area, or winding roads. Be alert to these and take appropriate action.

## ***Winter Driving***



Here are some tips for winter driving:

- Have your vehicle in good shape for winter. Be sure your engine coolant mix is correct.
- You may want to put winter emergency supplies in your vehicle.

Include an ice scraper, a small brush or broom, a supply of windshield washer fluid, a rag, some winter outer clothing, a small shovel, a flashlight, a red cloth, and a couple of reflective warning triangles. And, if you will be driving under severe conditions, include a small bag of sand, a piece of old carpet or a couple of burlap bags to help provide traction. Be sure you properly secure these items in your vehicle.

## ***Driving on Snow or Ice***

Most of the time, those places where your tires meet the road probably have good traction.

However, if there is snow or ice between your tires and the road, you can have a very slippery situation. You'll have a lot less traction or "grip" and will need to be very careful.



What's the worst time for this? "Wet ice." Very cold snow or ice can be slick and hard to drive on. But wet ice can be even more trouble because it may offer the least traction of all. You can get "wet ice" when it's about freezing (32°F; 0°C) and freezing rain begins to fall. Try to avoid driving on wet ice until salt and sand crews can get there.

Whatever the condition — smooth ice, packed, blowing or loose snow — drive with caution.

Accelerate gently. Try not to break the fragile traction. If you accelerate too fast, the drive wheels will spin and polish the surface under the tires even more.

Your anti-lock brakes improve your ability to make a hard stop on a slippery road. Even though you have an anti-lock braking system, you'll want to begin stopping sooner than you would on dry pavement. See "Anti-Lock" in the Index.

- Allow greater following distance on any slippery road.
- Watch for slippery spots. The road might be fine until you hit a spot that's covered with ice. On an otherwise clear road, ice patches may appear in shaded areas where the sun can't reach: around clumps of trees, behind buildings, or under bridges. Sometimes the surface of a curve or an overpass may remain icy when the surrounding roads are clear. If you see a patch of ice ahead of you, brake before you are on it. Try not to brake while you're actually on the ice, and avoid sudden steering maneuvers.

### ***If You're Caught in a Blizzard***



If you are stopped by heavy snow, you could be in a serious situation. You should probably stay with your vehicle unless you know for sure that you are near help and you can hike through the snow. Here are some things to do to summon help and keep yourself and your passengers safe: Turn on your hazard flashers. Tie a red cloth to your vehicle to alert police that you've been stopped by the snow. Put on extra clothing or wrap a blanket around you. If you have no blankets or extra clothing, make body insulators from newspapers, burlap bags, rags, floor mats — anything you can wrap around yourself or tuck under your clothing to keep warm.

You can run the engine to keep warm, but be careful.

 **CAUTION:**

**Snow can trap exhaust gases under your vehicle. This can cause deadly CO (carbon monoxide) gas to get inside. CO could overcome you and kill you. You can't see it or smell it, so you might not know it is in your vehicle. Clear away snow from around the base of your vehicle, especially any that is blocking your exhaust pipe. And check around again from time to time to be sure snow doesn't collect there.**

**Open a window just a little on the side of the vehicle that's away from the wind. This will help keep CO out.**



Run your engine only as long as you must. This saves fuel. When you run the engine, make it go a little faster than just idle. That is, push the accelerator slightly. This uses less fuel for the heat that you get and it keeps the battery charged. You will need a well-charged battery to restart the vehicle, and possibly for signaling later on with your headlights. Let the heater run for awhile.

Then, shut the engine off and close the window almost all the way to preserve the heat. Start the engine again and repeat this only when you feel really uncomfortable from the cold. But do it as little as possible. Preserve the fuel as long as you can. To help keep warm, you can get out of the vehicle and do some fairly vigorous exercises every half hour or so until help comes.

## Loading Your Vehicle

The diagram shows a rectangular label with a GM logo in the top left corner. The label contains several fields for information: GVWR, GAWR FRT, GAWR RR, and LKGC. Below these are fields for TIRE, RIM, and PSI/KPA (COLD). There are also fields for F, RR, and SPA. A large 'EXAMPLE' watermark is overlaid diagonally across the center of the label. At the bottom, it says 'SEE OWNER'S MANUAL FOR ADDITIONAL INFORMATION'.

The Certification/Tire label is found on the rear edge of the driver's door. The label shows the size of your original tires and the inflation pressures needed to obtain the gross weight capacity of your vehicle.

This is called the GVWR (Gross Vehicle Weight Rating). The GVWR includes the weight of the vehicle, all occupants, fuel, cargo, and tongue weight, if pulling a trailer.

The Certification/Tire label also tells you the maximum weights for the front and rear axles, called Gross Axle Weight Rating (GAWR). To find out the actual loads on your front and rear axles, you need to go to a weigh station and weigh your vehicle. Your dealer can help you with this. Be sure to spread out your load equally on both sides of the centerline.

Never exceed the GVWR for your vehicle, or the Gross Axle Weight Rating (GAWR) for either the front or rear axle.

And, if you do have a heavy load, you should spread it out.



### **CAUTION:**

**Do not load your vehicle any heavier than the GVWR, or either the maximum front or rear GAWR. If you do, parts on your vehicle can break, or it can change the way your vehicle handles. These could cause you to lose control. Also, overloading can shorten the life of your vehicle.**

Using heavier suspension components to get added durability might not change your weight ratings. Ask your dealer to help you load your vehicle the right way.

## **NOTICE:**

**Your warranty does not cover parts or components that fail because of overloading.**

If you put things inside your vehicle — like suitcases, tools, packages, or anything else — they will go as fast as the vehicle goes. If you have to stop or turn quickly, or if there is a crash, they'll keep going.



## **CAUTION:**

**Things you put inside your vehicle can strike and injure people in a sudden stop or turn, or in a crash.**

- **Put things in the cargo area of your vehicle. Try to spread the weight evenly.**
- **Never stack heavier things, like suitcases, inside the vehicle so that some of them are above the tops of the seats.**
- **Don't leave an unsecured child restraint in your vehicle.**
- **When you carry something inside the vehicle, secure it whenever you can.**
- **Don't have a seat folded down unless you need to.**

## ***Payload***

The Payload Capacity is shown on the Certification/Tire label. This is the maximum load capacity that your vehicle can carry. Be sure to include the weight of the people inside as part of your load. If you added any accessories or equipment after your vehicle left the factory, remember to subtract the weight of these things from the payload. Your dealer can help you with this.



## ***Trailer Package***

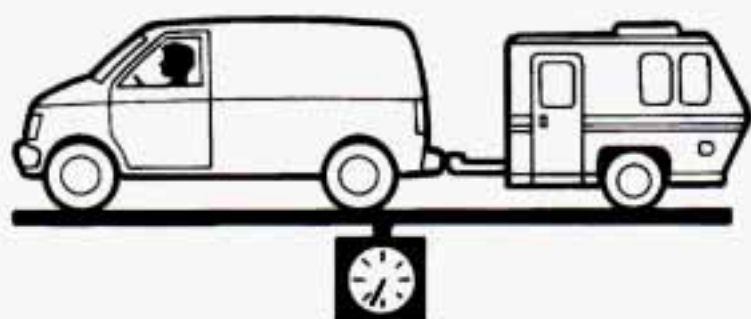

If your vehicle comes with the Trailer Package, there is also a load rating which includes the weight of the vehicle **and** the trailer it tows. This rating is called the Gross Combination Weight Rating (GCWR).

When you weigh your trailer, be sure to include the weight of everything you put in it. And, remember to figure the weight of the people inside as part of your load.

Your dealer can help you determine your GCWR.

## ***Add-On Equipment***

When you carry removable items, you may need to put a limit on how many people you carry inside your vehicle. Be sure to weigh your vehicle before you buy and install the new equipment.

### **NOTICE:**

**Your warranty doesn't cover parts or components that fail because of overloading.**

## Towing a Trailer



### **CAUTION:**

**If you don't use the correct equipment and drive properly, you can lose control when you pull a trailer. For example, if the trailer is too heavy, the brakes may not work well — or even at all. You and your passengers could be seriously injured. Pull a trailer only if you have followed all the steps in this section. Ask your GM dealer for advice and information about towing a trailer with your vehicle.**

### **NOTICE:**

**Pulling a trailer improperly can damage your vehicle and result in costly repairs not covered by your warranty. To pull a trailer correctly, follow the advice in this part, and see your GM dealer for important information about towing a trailer with your vehicle.**

Most vehicles are ready for some trailer towing. If yours was built with trailering options, as many are, it's ready for heavier trailers. But trailering is different than just driving your vehicle by itself. Trailering means changes in handling, durability, and fuel economy. Successful, safe trailering takes correct equipment, and it has to be used properly.

That's the reason for this part. In it are many time-tested, important trailering tips and safety rules. Many of these are important for your safety and that of your passengers. So please read this section carefully before you pull a trailer.

#### *If You Do Decide To Pull A Trailer*

If you do, here are some important points.

- There are many different laws, including speed limit restrictions, having to do with trailering. Make sure your rig will be legal, not only where you live but also where you'll be driving. A good source for this information can be state or provincial police.
- Consider using a sway control if your trailer will weigh 2,000 pounds (900 kg) or less. You should always use a sway control if your trailer will weigh more than 2,000 pounds (900 kg). You can ask a hitch dealer about sway controls.

- Don't tow a trailer at all during the first 500 miles (800 km) your new vehicle is driven. Your engine, axle or other parts could be damaged.
- Then, during the first 500 miles (800 km) that you tow a trailer, don't drive over 50 mph (80 km/h) and don't make starts at full throttle. This helps your engine and other parts of your vehicle wear in at the heavier loads.
- You should use DRIVE (D) (or, as you need to, a lower gear) when towing a trailer. Operating your vehicle in DRIVE (D) when towing a trailer will minimize heat build-up and extend the life of your transmission.

Three important considerations have to do with weight:

### ***Weight of the Trailer***

How heavy can a trailer safely be?

It depends on how you plan to use your rig. For example, speed, altitude, road grades, outside temperature and how much your vehicle is used to pull a trailer are all important. And, it can also depend on any special equipment that you have on your vehicle.

You can ask your dealer for our trailering information or advice, or you can write us at the address listed in your Warranty and Owner Assistance Information Booklet.

In Canada, write to:

General Motors of Canada Limited  
Customer Assistance Center  
1908 Colonel Sam Drive  
Oshawa, Ontario L1H 8P7

### ***Weight of the Trailer Tongue***

The tongue load (A) of any trailer is an important weight to measure because it affects the total or gross weight of your vehicle. The gross vehicle weight (GVW) includes the curb weight of the vehicle, any cargo you may carry in it, and the people who will be riding in the vehicle. And if you will tow a trailer, you must add the tongue load to the GVW because your vehicle will be carrying that weight, too. See "Loading Your Vehicle" in the Index for more information about your vehicle's maximum load capacity.

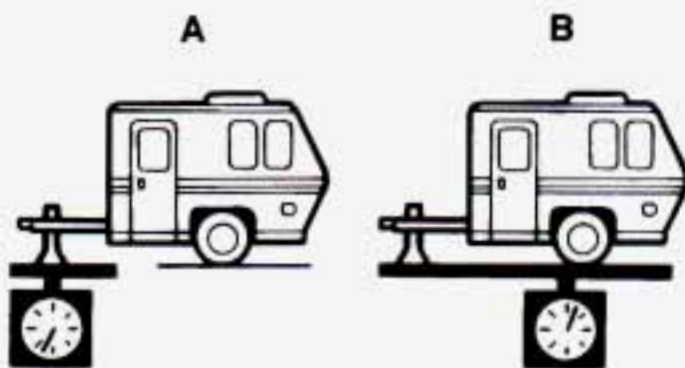

If you're using a "dead-weight" hitch, the trailer tongue (A) should weigh 10% of the total loaded trailer weight (B). If you have a "weight-distributing" hitch, the trailer tongue (A) should weigh 12% of the total loaded trailer weight (B).

After you've loaded your trailer, weigh the trailer and then the tongue, separately, to see if the weights are proper. If they aren't, you may be able to get them right simply by moving some items around in the trailer.

### ***Total Weight on Your Vehicle's Tires***

Be sure your vehicle's tires are inflated to the limit for cold tires. You'll find these numbers on the Certification label at the rear edge of the driver's door or see "Tire Loading" in the Index. Then be sure you don't go over the GVW limit for your vehicle, including the weight of the trailer tongue.

### ***Hitches***

It's important to have the correct hitch equipment. Crosswinds, large trucks going by, and rough roads are a few reasons why you'll need the right hitch. Here are some rules to follow:

- If you'll be pulling a trailer that, when loaded, will weigh more than 2,000 pounds (900 kg), be sure to use a properly mounted, weight-distributing hitch and sway control of the proper size. This equipment is very important for proper vehicle loading and good handling when you're driving.
- Will you have to make any holes in the body of your vehicle when you install a trailer hitch? If you do, then be sure to seal the holes later when you remove the hitch. If you don't seal them, deadly carbon monoxide (CO) from your exhaust can get into your vehicle (see "Carbon Monoxide" in the Index). Dirt and water can, too.

## ***Safety Chains***

You should always attach chains between your vehicle and your trailer. Cross the safety chains under the tongue of the trailer so that the tongue will not drop to the road if it becomes separated from the hitch. Instructions about safety chains may be provided by the hitch manufacturer or by the trailer manufacturer. Follow the manufacturer's recommendation for attaching safety chains and do not attach them to the bumper. Always leave just enough slack so you can turn with your rig. And, never allow safety chains to drag on the ground.

## ***Trailer Brakes***

If your trailer weighs more than 1,000 pounds (450 kg) loaded, then it needs its own brakes — and they must be adequate. Be sure to read and follow the instructions for the trailer brakes so you'll be able to install, adjust and maintain them properly.

Your trailer brake system can tap into your vehicle's hydraulic brake system, except:

- Don't tap into your vehicle's brake system if the trailer's brake system will use more than 0.02 cubic inch (0.3cc) of fluid from your vehicle's master cylinder. If it does, both braking systems won't work well. You could even lose your brakes.
- Will the trailer parts take 3,000 psi (20 650 kPa) of pressure? If not, the trailer brake system must not be used with your vehicle.
- If everything checks out this far, then make the brake fluid tap at the port on the master cylinder that sends fluid to the rear brakes. But don't use copper tubing for this. If you do, it will bend and finally break off. Use steel brake tubing.

## ***Driving with a Trailer***



### **CAUTION:**

If you have a rear-most window open and you pull a trailer with your vehicle, carbon monoxide (CO) could come into your vehicle. You can't see or smell CO. It can cause unconsciousness or death. (See "Engine Exhaust" in the Index.) To maximize your safety when towing a trailer:

- **Have your exhaust system inspected for leaks, and make necessary repairs before starting on your trip.**
- **Keep the rear-most windows closed.**
- **If exhaust does come into your vehicle through a window in the rear or another opening, drive with your front, main heating or cooling system on and with the fan on any speed. This will bring fresh, outside air into your vehicle. Do not use MAX A/C because it only recirculates the air inside your vehicle. (See "Comfort Controls" in the Index.)**

Towing a trailer requires a certain amount of experience. Before setting out for the open road, you'll want to get to know your rig. Acquaint yourself with the feel of handling and braking with the added weight of the trailer. And always keep in mind that the vehicle you are driving is now a good deal longer and not nearly as responsive as your vehicle is by itself.

Before you start, check the trailer hitch and platform (and attachments), safety chains, electrical connector, lights, tires and mirror adjustment. If the trailer has electric brakes, start your vehicle and trailer moving and then apply the trailer brake controller by hand to be sure the brakes are working. This lets you check your electrical connection at the same time.

During your trip, check occasionally to be sure that the load is secure, and that the lights and any trailer brakes are still working.

### ***Following Distance***

Stay at least twice as far behind the vehicle ahead as you would when driving your vehicle without a trailer. This can help you avoid situations that require heavy braking and sudden turns.

## ***Passing***

You'll need more passing distance up ahead when you're towing a trailer. And, because you're a good deal longer, you'll need to go much farther beyond the passed vehicle before you can return to your lane.

## ***Backing Up***

Hold the bottom of the steering wheel with one hand. Then, to move the trailer to the left, just move that hand to the left. To move the trailer to the right, move your hand to the right. Always back up slowly and, if possible, have someone guide you.

## ***Making Turns***

### **NOTICE:**

**Making very sharp turns while trailering could cause the trailer to come in contact with the vehicle. Your vehicle could be damaged. Avoid making very sharp turns while trailering.**

When you're turning with a trailer, make wider turns than normal. Do this so your trailer won't strike soft shoulders, curbs, road signs, trees, or other objects. Avoid jerky or sudden maneuvers. Signal well in advance.

## ***Turn Signals When Towing a Trailer***

When you tow a trailer, your vehicle has to have extra wiring and a heavy-duty turn signal flasher (included in the optional trailering package). The green arrows on your instrument panel will flash whenever you signal a turn or lane change. Properly hooked up, the trailer lamps will also flash, telling other drivers you're about to turn, change lanes or stop.

When towing a trailer, the green arrows on your instrument panel will flash for turns even if the bulbs on the trailer are burned out. Thus, you may think drivers behind you are seeing your signal when they are not. It's important to check occasionally to be sure the trailer bulbs are still working.

## ***Driving On Grades***

Reduce speed and shift to a lower gear *before* you start down a long or steep downgrade. If you don't shift down, you might have to use your brakes so much that they would get hot and no longer work well.

On a long uphill grade, shift down and reduce your speed to around 45 mph (70 km/h) to reduce the possibility of engine and transmission overheating.

When towing at high altitude on steep uphill grades, consider the following: Engine coolant will boil at a lower temperature than at normal altitudes. If you turn your engine off immediately after towing at high altitude on steep uphill grades, your vehicle may show signs similar to engine overheating. To avoid this, let the engine run while parked (preferably on level ground) with the automatic transmission in PARK (P) for a few minutes before turning the engine off. If you do get the overheat warning, see "Engine Overheating" in the Index.

## ***Parking on Hills***

You really should not park your vehicle, with a trailer attached, on a hill. If something goes wrong, your rig could start to move. People can be injured, and both your vehicle and the trailer can be damaged.

But if you ever have to park your rig on a hill, here's how to do it:

1. Apply your regular brakes, but don't shift into PARK (P) yet. Turn your wheels into the curb when facing downhill and away from the curb when facing uphill.
2. Have someone place chocks under the trailer wheels.
3. When the wheel chocks are in place, release the regular brakes until the chocks absorb the load.
4. Reapply the regular brakes. Then apply your parking brake, and shift to PARK (P).
5. Release the regular brakes.

## ***When You Are Ready to Leave After Parking on a Hill***

1. Apply your regular brakes and hold the pedal down while you:
  - Start your engine;
  - Shift into a gear; and
  - Release the parking brake.
2. Let up on the brake pedal.
3. Drive slowly until the trailer is clear of the chocks.
4. Stop and have someone pick up and store the chocks.



## ***Maintenance When Trailer Towing***

Your vehicle will need service more often when you're pulling a trailer. See the Maintenance Schedule for more on this. Things that are especially important in trailer operation are automatic transmission fluid (don't overfill), engine oil, axle lubricant, belt, cooling system, and brake adjustment. Each of these is covered in this manual, and the Index will help you find them quickly. If you're trailering, it's a good idea to review these sections before you start your trip.

Check periodically to see that all hitch nuts and bolts are tight.

## ***Trailer Lighting Systems Wiring***

See "Trailer Wiring Harness" in the Index.

## **Notes**

## ***Problems on the Road***

## ***Section***

# **5**

Here you'll find what to do about some problems that can occur on the road.

### ***Hazard Warning Flashers***



Your hazard warning flashers let you warn others. They also let police know you have a problem. Your front and rear turn signal lamps will flash on and off.

But they won't flash if you're braking.



Press the button in to make your front and rear turn signal lights flash on and off. Your hazard warning flashers work no matter what position your key is in, and even if the key isn't in.



To turn off the flashers, pull out on the collar.

When the hazard warning flashers are on, your turn signals won't work.

## ***Other Warning Devices***

If you carry reflective triangles, you can set one up at the side of the road about 300 feet (100 m) behind your vehicle.

## ***Jump Starting***

If your battery has run down, you may want to use another vehicle and some jumper cables to start your vehicle. But please follow the steps below to do it safely.



### **CAUTION:**

**Batteries can hurt you. They can be dangerous because:**

- They contain acid that can burn you.
- They contain gas that can explode or ignite.
- They contain enough electricity to burn you.

**If you don't follow these steps exactly, some or all of these things can hurt you.**

### **NOTICE:**

**Ignoring these steps could result in costly damage to your vehicle that wouldn't be covered by your warranty.**

**Trying to start your vehicle by pushing or pulling it won't work, and it could damage your vehicle.**

### ***To Jump Start Your Vehicle:***

1. Check the other vehicle. It must have a 12-volt battery with a negative ground system.

### **NOTICE:**

**If the other system isn't a 12-volt system with a negative ground, both vehicles can be damaged.**

2. Get the vehicles close enough so the jumper cables can reach, but be sure the vehicles aren't touching each other. If they are, it could cause a ground connection you don't want. You wouldn't be able to start your vehicle, and the bad grounding could damage the electrical systems.

You could be injured if the vehicles roll. Set the parking brake firmly on each vehicle. Put an automatic transmission in PARK (P) or a manual transmission in NEUTRAL (N). If you have a four-wheel-drive vehicle with a manual transfer case shift lever, be sure the transfer case is not in NEUTRAL (N).

3. Turn off the ignition on both vehicles. Turn off all lights that aren't needed, and radios. This will avoid sparks and help save both batteries. And it could save your radio!

## **NOTICE:**

**If you leave your radio on, it could be badly damaged. The repairs wouldn't be covered by your warranty.**

4. Open the hoods and locate the batteries. Find the positive (+) and negative (-) terminals on each battery.



## **CAUTION:**

**Using a match near a battery can cause battery gas to explode. People have been hurt doing this, and some have been blinded. Use a flashlight if you need more light.**

**Be sure the battery has enough water. You don't need to add water to the Delco Freedom<sup>®</sup> battery installed in every new GM vehicle. But if a battery has filler caps, be sure the right amount of fluid is there. If it is low, add water to take care of that first. If you don't, explosive gas could be present.**

**Battery fluid contains acid that can burn you. Don't get it on you. If you accidentally get it in your eyes or on your skin, flush the place with water and get medical help immediately.**

5. Check that the jumper cables don't have loose or missing insulation. If they do, you could get a shock. The vehicles could be damaged too.

Before you connect the cables, here are some basic things you should know. Positive (+) will go to positive (+) and negative (-) will go to negative (-) or a metal engine part. Don't connect (+) to (-) or you'll get a short that would damage the battery and maybe other parts too.



## **CAUTION:**

**Fans or other moving engine parts can injure you badly. Keep your hands away from moving parts once the engines are running.**

6. Connect the red positive (+) cable to the positive (+) terminal of the vehicle with the dead battery. Use a remote positive (+) terminal if the vehicle has one.

**Dead Battery (+)**



**Good Battery (+)**



7. Don't let the other end touch metal. Connect it to the positive (+) terminal of the good battery. Use a remote positive (+) terminal if the vehicle has one.
8. Now connect the black negative (-) cable to the good battery's negative (-) terminal.

Don't let the other end touch anything until the next step. The other end of the negative cable doesn't go to the dead battery. It goes to a heavy unpainted metal part of the vehicle with the dead battery.

**Good Battery (-)**



**Heavy Metal Engine Part**



9. Attach the cable at least 18 inches (45 cm) away from the dead battery, but not near engine parts that move. The electrical connection is just as good there, but the chance of sparks getting back to the battery is much less.
10. Now start the vehicle with the good battery and run the engine for a while.
11. Try to start the vehicle with the dead battery. If it won't start after a few tries, it probably needs service.
12. Remove the cables in reverse order to prevent electrical shorting. Take care that they don't touch each other or any other metal.

**Remove Cables In This Order:**

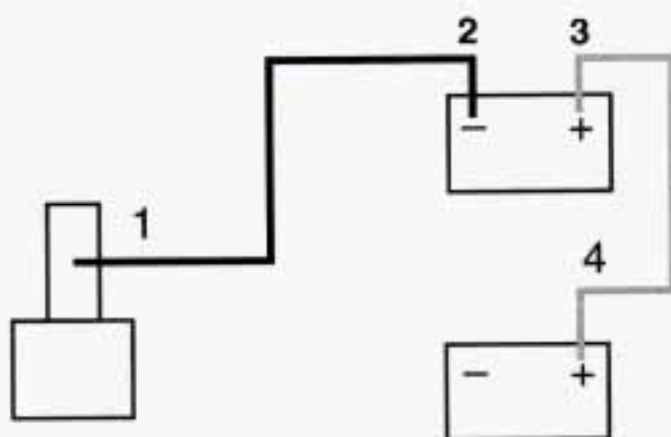

1. Heavy Metal Engine Part
2. Good Battery (-)
3. Good Battery (+)
4. Dead Battery (+)



## ***Towing Your Vehicle***

Try to have a GM dealer or a professional towing service tow your vehicle. They can provide the right equipment and know how to tow it without damage.

If your vehicle has been changed or modified since it was factory–new by adding aftermarket items like fog lamps, aero skirting, or special tires and wheels, these things can be damaged during towing.

Before you do anything, turn on the hazard warning flashers.

When you call, tell the towing service:

- Whether your vehicle has rear–wheel drive or the all–wheel–drive option. If your vehicle has fog lamps, it cannot be towed from the front with sling–type equipment.
- The make, model, and year of your vehicle.
- Whether you can still move the shift lever.
- If there was an accident, what was damaged.



### **CAUTION:**

**To help avoid injury to you or others:**

- **Never let passengers ride in a vehicle that is being towed.**
- **Never tow faster than safe or posted speeds.**
- **Never tow with damaged parts not fully secured.**
- **Never get under your vehicle after it has been lifted by the tow truck.**
- **Always use separate safety chains on each side when towing a vehicle.**
- **Use T–hooks on front of vehicle, J–hooks on rear.**

When your vehicle is being towed, have the ignition key off. The steering wheel should be clamped in a straight–ahead position, with a clamping device designed for towing service. Do not use the vehicle's steering column lock for this. The transmission should be in NEUTRAL (N) and the parking brake released.

If your vehicle has the all-wheel drive option, it can only be towed with all four wheels off the ground. A dolly must be used under the un-raised wheels when towing or the vehicle must be transported on a flat bed carrier.

Don't have your vehicle towed with the wheels in contact with the ground if it has all-wheel drive. If a vehicle with all-wheel drive must be towed with sling-type or wheel lift equipment, then either the front or rear wheels must be supported on a dolly.

If your vehicle has rear-wheel drive, don't have it towed on the rear wheels, unless you must. If a vehicle with rear-wheel drive must be towed on the rear wheels, don't go more than 35 mph (56 km/h) or farther than 50 miles (80 km) or your transmission will be damaged. If these limits must be exceeded, then the rear wheels have to be supported on a dolly.



### **CAUTION:**

**A vehicle can fall from a car carrier if it isn't adequately secured. This can cause a collision, serious personal injury and vehicle damage. The vehicle should be tightly secured with chains or steel cables before it is transported.**

**Don't use substitutes (ropes, leather straps, canvas webbing, etc.) that can be cut by sharp edges underneath the towed vehicle.**

## ***Towing From the Front (Except All-Wheel Drive)***

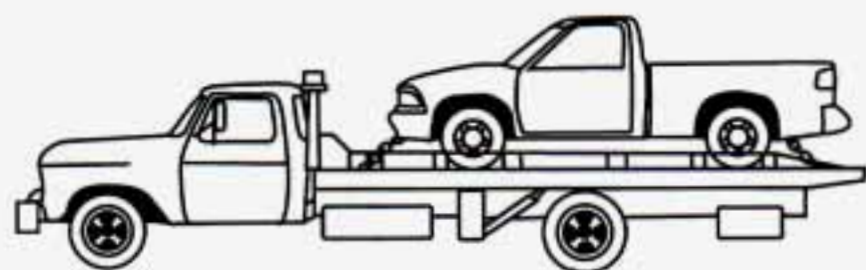

### **NOTICE:**

Do not tow with sling-type equipment or the front bumper system will be damaged.

Use wheel lift or car-carrier equipment.

Additional ramping may be required for car-carrier equipment.

Use safety chains and wheel straps.

If your vehicle has the all-wheel-drive option, a dolly *MUST* be used under the rear wheels when towing from the front.

## ***Towing From the Rear (Except All-Wheel Drive)***

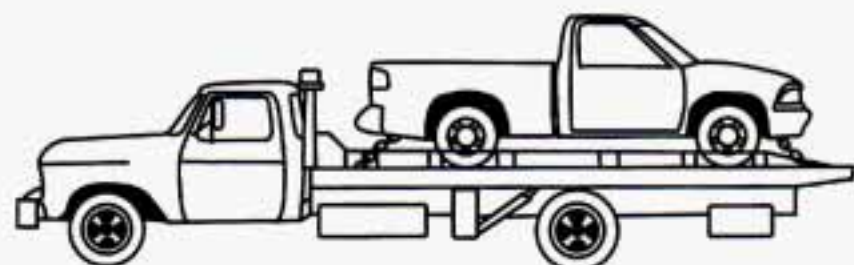

### **NOTICE:**

Do not tow with sling-type equipment or the rear bumper system will be damaged.

Use wheel lift or car-carrier equipment.

Additional ramping may be required for car-carrier equipment.

Use safety chains and wheel straps.

If your vehicle has the all-wheel-drive option, a dolly *MUST* be used under the front wheels when towing from the rear.

## ***Towing From the Front (All-Wheel-Drive)***

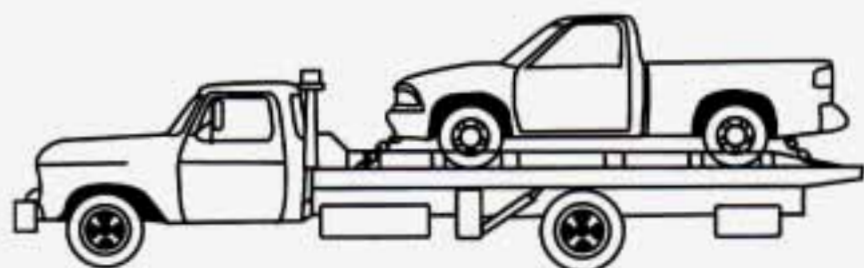

### **NOTICE:**

**Do not tow with sling-type equipment or the front bumper system will be damaged.**

**Use wheel lift or car-carrier equipment.**

**Additional ramping may be required for car-carrier equipment.**

**Use safety chains and wheel straps.**

**If your vehicle has the all-wheel-drive option, a dolly **MUST** be used under the rear wheels when towing from the front.**

## ***Towing From the Rear (All-Wheel-Drive)***

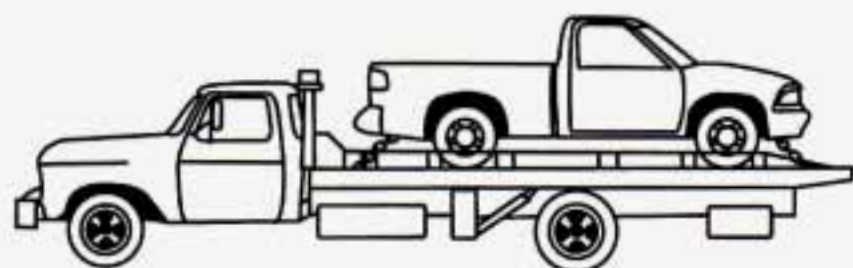

### **NOTICE:**

**Do not tow with sling-type equipment or the rear bumper system will be damaged.**

**Use wheel lift or car-carrier equipment.**

**Additional ramping may be required for car-carrier equipment.**

**Use safety chains and wheel straps.**

**If your vehicle has the all-wheel-drive option, a dolly **MUST** be used under the front wheels when towing from the rear.**

## ***Engine Overheating***

### ***If Steam Is Coming From Your Engine***



#### **CAUTION:**

Steam from an overheated engine can burn you badly, even if you just open the hood. Stay away from the engine if you see or hear steam coming from it. Just turn it off and get everyone away from the vehicle until it cools down. Wait until there is no sign of steam or coolant before opening the hood.

If you keep driving when your engine is overheated, the liquids in it can catch fire. You or others could be badly burned. Stop your engine if it overheats, and get out of the vehicle until the engine is cool.

#### **NOTICE:**

If your engine catches fire because you keep driving with no coolant, your vehicle can be badly damaged. The costly repairs would not be covered by your warranty.

## ***If No Steam Is Coming From Your Engine***

If you get the overheat warning but see or hear no steam, the problem may not be too serious. Sometimes the engine can get a little too hot when you:

- Climb a long hill on a hot day.
- Stop after high speed driving.
- Idle for long periods in traffic.
- Tow a trailer.

If you get the overheat warning with no sign of steam, try this for a minute or so:

1. If you have an air conditioner, turn it off.
2. Turn on your heater to full hot at the highest fan speed and open the window as necessary.
3. If you're in a traffic jam, shift to NEUTRAL (N); otherwise, shift to the highest gear while driving — AUTOMATIC OVERDRIVE (Ⓢ) or DRIVE (D).

If you no longer have the overheat warning, you can drive. Just to be safe, drive slower for about ten minutes. If the warning doesn't come back on, you can drive normally.

If the warning continues, pull over, stop, and park your vehicle right away.

If there's still no sign of steam, push the accelerator until the engine speed is about twice as fast as normal idle speed. Bring the engine speed back to normal idle speed after two or three minutes. Now see if the warning stops. But then, if you still have the warning, *turn off the engine and get everyone out of the vehicle* until it cools down.

You may decide not to lift the hood but to get service help right away.





When you decide it's safe to lift the hood, here's what you'll see:

- A. Coolant recovery tank
- B. Radiator pressure cap
- C. Engine fan

If the coolant inside the coolant recovery tank is boiling, don't do anything else until it cools down.



The coolant level should be at ADD. If it isn't, you may have a leak in the radiator hoses, heater hoses, radiator, water pump or somewhere else in the cooling system.



### **CAUTION:**

**Heater and radiator hoses, and other engine parts, can be very hot. Don't touch them. If you do, you can be burned.**

**Don't run the engine if there is a leak. If you run the engine, it could lose all coolant. That could cause an engine fire, and you could be burned. Get any leak fixed before you drive the vehicle.**

### **NOTICE:**

**Engine damage from running your engine without coolant isn't covered by your warranty.**

If there seems to be no leak, start the engine again. See if the fan speed increases when idle speed is doubled by pushing the accelerator pedal down. If it doesn't, your vehicle needs service. Turn off the engine.

## ***How to Add Coolant to the Coolant Recovery Tank***

If you haven't found a problem yet, but the coolant level isn't at ADD , add a 50/50 mixture of *clean water* (preferably distilled) and a proper antifreeze at the coolant recovery tank. (See "Engine Coolant" in the Index for more information about the proper coolant mix.)



### **CAUTION:**

**Adding only plain water to your cooling system can be dangerous. Plain water, or some other liquid like alcohol, can boil before the proper coolant mix will. Your vehicle's coolant warning system is set for the proper coolant mix. With plain water or the wrong mix, your engine could get too hot but you wouldn't get the overheat warning. Your engine could catch fire and you or others could be burned. Use a 50/50 mix of clean water and a proper antifreeze.**

### **NOTICE:**

**In cold weather, water can freeze and crack the engine, radiator, heater core and other parts. Use the recommended coolant.**



### **CAUTION:**

**You can be burned if you spill coolant on hot engine parts. Coolant contains ethylene glycol and it will burn if the engine parts are hot enough. Don't spill coolant on a hot engine.**

When the coolant in the coolant recovery tank is at ADD , start your vehicle.

If the overheat warning continues, there's one more thing you can try. You can add the proper coolant mix directly to the radiator, but be sure the cooling system is cool before you do it.

 **CAUTION:**

Steam and scalding liquids from a hot cooling system can blow out and burn you badly. They are under pressure, and if you turn the radiator pressure cap — even a little — they can come out at high speed. Never turn the cap when the cooling system, including the radiator pressure cap, is hot. Wait for the cooling system and radiator pressure cap to cool if you ever have to turn the pressure cap.



***How to Add Coolant to the Radiator***



1. You can remove the radiator pressure cap when the cooling system, including the radiator pressure cap and upper radiator hose, is no longer hot. Turn the pressure cap slowly to the left until it first stops. (Don't press down while turning the pressure cap.)

If you hear a hiss, wait for that to stop. A hiss means there is still some pressure left.



2. Then keep turning the pressure cap, but now push down as you turn it. Remove the pressure cap.



3. Fill the radiator with the proper mix, up to the base of the filler neck.



4. Then fill the coolant recovery tank to ADD.



5. Put the cap back on the coolant recovery tank, but leave the radiator pressure cap off.



6. Start the engine and let it run until you can feel the upper radiator hose getting hot. Watch out for the engine fan.

7. By this time the coolant level inside the radiator filler neck may be lower. If the level is lower, add more of the proper mix through the filler neck until the level reaches the base of the filler neck.



8. Then replace the pressure cap. At any time during this procedure if coolant begins to flow out of the filler neck, reinstall the pressure cap. Be sure the arrows on the pressure cap line up like this.

## ***Engine Fan Noise***

This vehicle has a clutched engine cooling fan. When the clutch is engaged, the fan spins faster to provide more air to cool the engine. In most every day driving conditions the clutch is not fully engaged. This improves fuel economy and reduces fan noise. Under heavy vehicle loading, trailer towing and/or high outside temperatures, the fan speed increases when the clutch engages. So you may hear an increase in fan noise. This is normal and should not be mistaken as the transmission slipping or making extra shifts. It is merely the cooling system functioning properly. The fan will slow down when additional cooling is not required and the clutch disengages.

You may also hear this fan noise when you start the engine. It will go away as the fan clutch disengages.

## ***If a Tire Goes Flat***

It's unusual for a tire to "blow out" while you're driving, especially if you maintain your tires properly. If air goes out of a tire, it's much more likely to leak out slowly. But if you should ever have a "blowout," here are a few tips about what to expect and what to do:

If a front tire fails, the flat tire will create a drag that pulls the vehicle toward that side. Take your foot off the accelerator pedal and grip the steering wheel firmly. Steer to maintain lane position, then gently brake to a stop well out of the traffic lane.

A rear blowout, particularly on a curve, acts much like a skid and may require the same correction you'd use in a skid. In any rear blowout, remove your foot from the accelerator pedal. Get the vehicle under control by steering the way you want the vehicle to go. It may be very bumpy and noisy, but you can still steer. Gently brake to a stop, well off the road if possible.

If a tire goes flat, the next part shows how to use your jacking equipment to change a flat tire safely.

## ***Changing a Flat Tire***

If a tire goes flat, avoid further tire and wheel damage by driving slowly to a level place. Turn on your hazard warning flashers.

### **⚠ CAUTION:**

**Changing a tire can cause an injury. The vehicle can slip off the jack and roll over you or other people. You and they could be badly injured. Find a level place to change your tire. To help prevent the vehicle from moving:**

- 1. Set the parking brake firmly.**
- 2. Put the shift lever in PARK (P).**
- 3. Turn off the engine.**
- 4. Put the wheel blocks at the front and rear of the tire farthest away from the one being changed. That would be the tire on the other side of the vehicle, at the opposite end.**

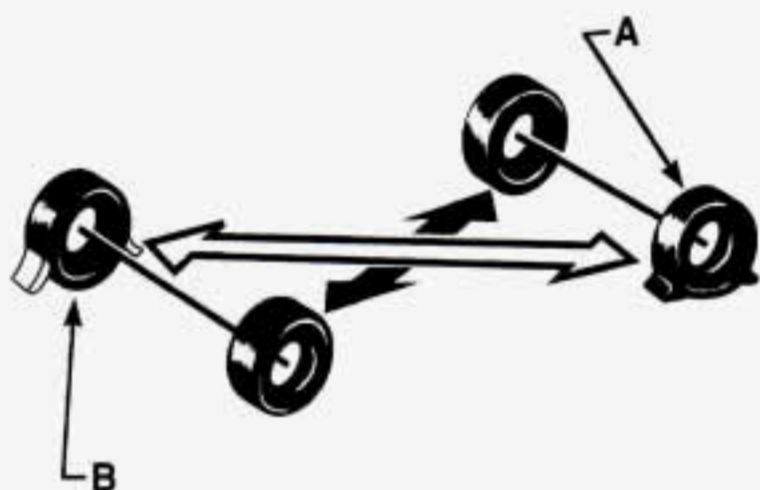

A. Flat Tire

B. Blocked Tire

The following steps will tell you how to use the jack and change a tire.

### Jack Storage

The jacking equipment you'll need is stored by your vehicle's rear doors, along the passenger side wall.



Remove your jack cover by turning the plastic wing nut counterclockwise.



Lift up on the latch and pull the jack cover off.



Remove the wheel blocks and jack by turning the wing nut counterclockwise. Remove the wing nut and washer then pull the wheel blocks and jack off the bolt.





Remove the ratchet and extension by turning the wing nut counterclockwise. Remove the wing nut and retainer and take out the ratchet and extension.

### Jacking Equipment Storage

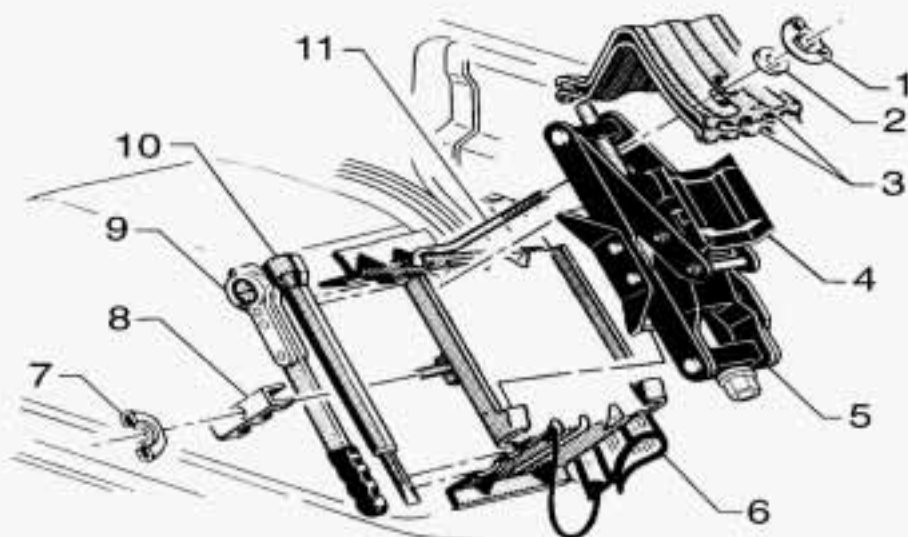

- |                             |               |
|-----------------------------|---------------|
| 1. Nut                      | 7. Nut        |
| 2. Washer                   | 8. Retainer   |
| 3. Wheel Blocks             | 9. Ratchet    |
| 4. Jack Lift Head           | 10. Extension |
| 5. Jack                     | 11. Bolt      |
| 6. Jacking Instructions Tag |               |

## Spare Tire



Your spare tire is stored underneath the rear of your vehicle. You will use the ratchet and extension to lower the spare tire.

### **NOTICE:**

Never remove or restow a tire from/to a stowage position under the vehicle while the vehicle is supported by a jack. Always tighten the tire fully against the underside of the vehicle when restowing.



The ratchet has an UP side.



And a DOWN side.

### To Remove the Spare Tire



Attach the ratchet, with the DOWN side facing you, to the extension. The extension has a socket end and a flat chisel end.

Put the flat end of the extension on an angle through the hole in the rear door frame, above the bumper. Be sure the flat end connects into the hoist shaft.



Turn the ratchet counterclockwise to lower the spare tire to the ground. Keep turning the ratchet until the spare tire can be pulled out from under the vehicle.



When the tire has been lowered, tilt the retainer at the end of the cable and pull it through the wheel opening. Pull the tire out from under the vehicle.

## **NOTICE:**

To help avoid vehicle damage, do not drive vehicle before cable is restored.

### **Changing the Tire**



Start with the jack, ratchet, extension and wheel blocks.

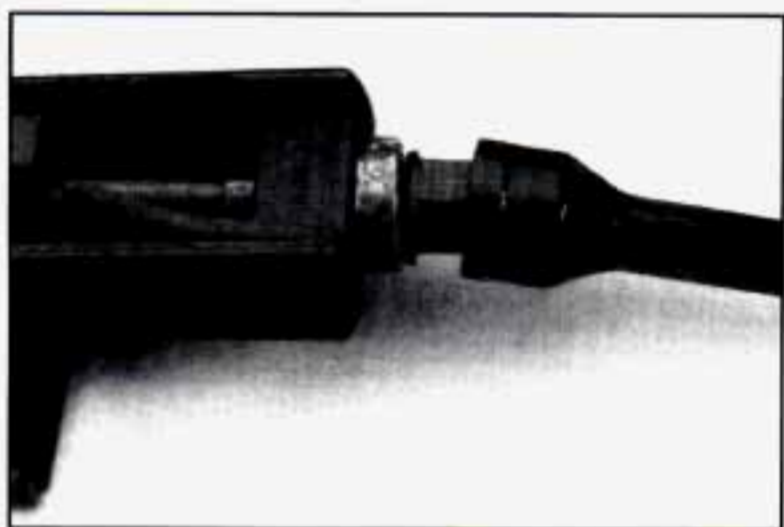

The jack has a bolt on the end.

Attach the socket end of the extension to the jack bolt like this.

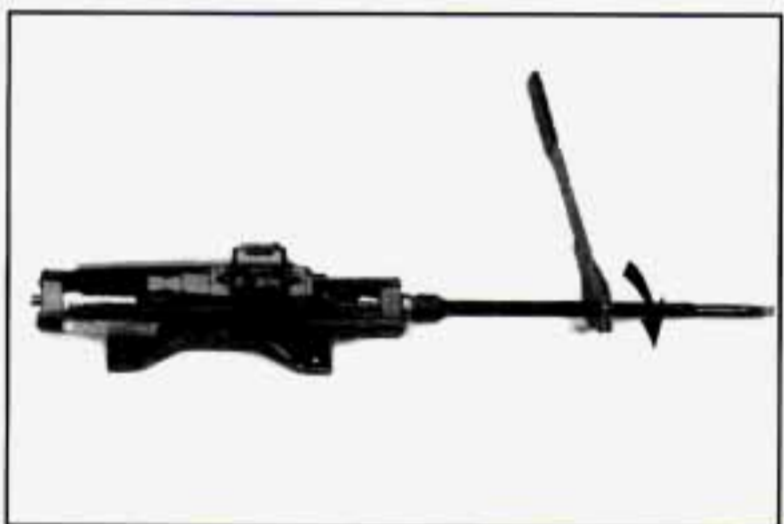

Attach the ratchet to the extension with the UP side facing you.

Rotate the ratchet to the right. That will raise the jack lift head a little. Before raising the vehicle, do the following steps.



Before you start, block the front and rear of the tire farthest away from the one being changed. Then put your spare tire near the flat tire.

## Hub Caps and Wheel Nut Caps

You will have to take off hub caps or wheel nut caps to reach your wheel nuts.

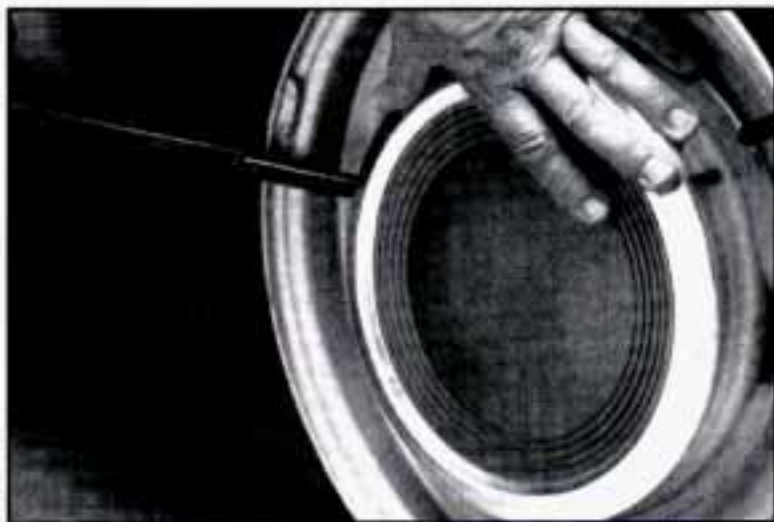

If you have a standard hub cap, remove it by using the flat end of the extension.

Pry along the edge of the cap until it comes off. Be careful, the rim edges may be sharp. Don't try to remove it with your bare hands.



If the wheel has a plastic center cap, you do not have to remove the center cap to loosen the wheel nuts.



Place the ratchet and socket end of the extension on the wheel nut with the center cap on.

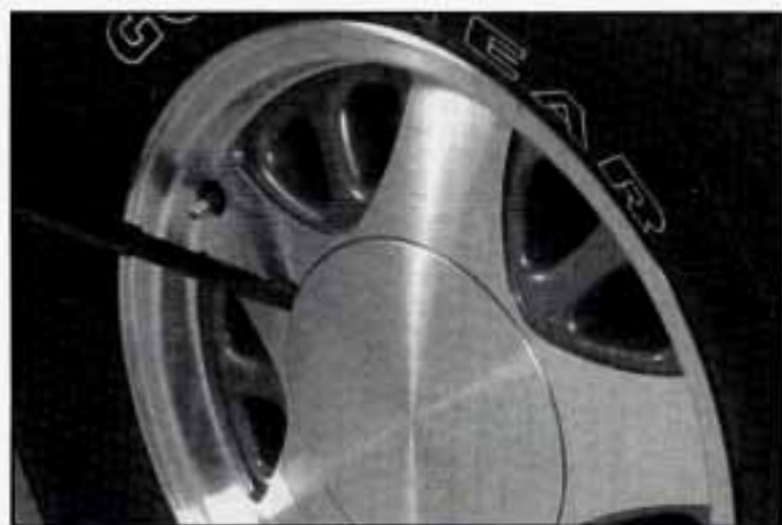

To remove the hub cap from the aluminum wheel, fit the flat end of the extension into the notch.



Remove the center cap.

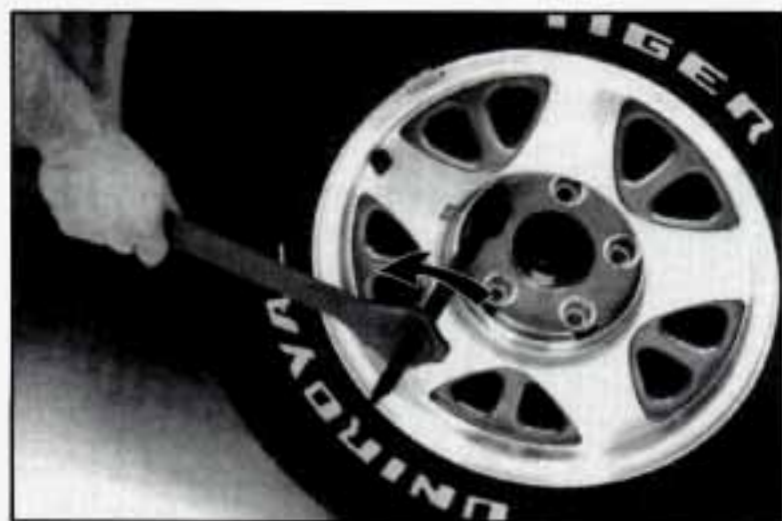

With DOWN facing you, use the ratchet and socket to loosen all the wheel nuts. Don't remove them yet.

Do not jack up the vehicle with people in or near the vehicle.  
Position jack under the vehicle.

A. Front

B. Rear

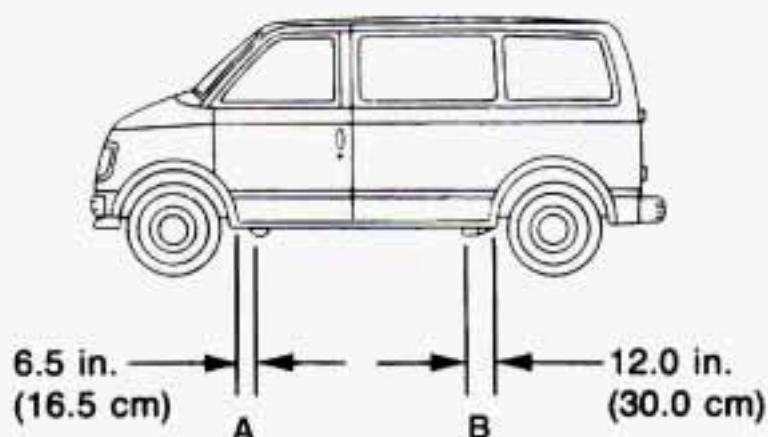

### CAUTION:

Getting under a vehicle when it is jacked up is dangerous. If the vehicle slips off the jack, you could be badly injured or killed. Never get under a vehicle when it is supported only by a jack.

### NOTICE:

Raising your vehicle with the jack improperly positioned will damage the vehicle or may allow the vehicle to fall off the jack. Be sure to fit the jack lift head into the proper location before raising your vehicle.

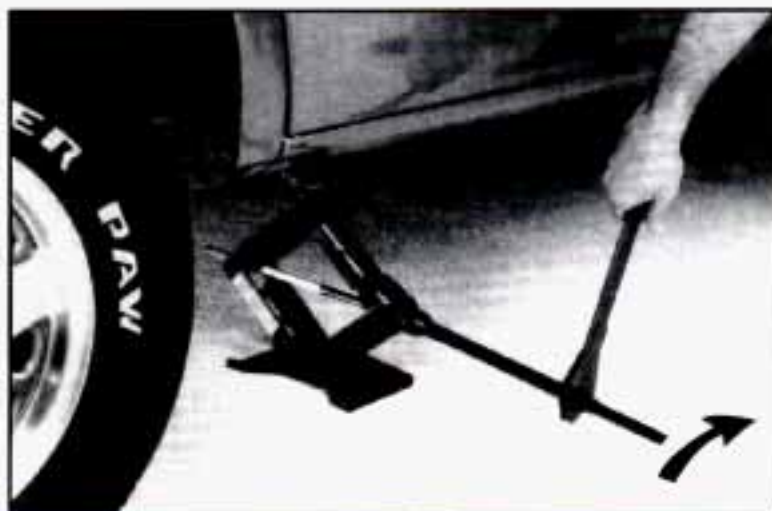

Raise the vehicle by rotating the ratchet clockwise. Make sure the UP marking faces you. Raise the vehicle far enough off the ground so there is enough room for the spare tire to fit.





Remove all the wheel nuts.



Take off the flat tire.



### **CAUTION:**

Rust or dirt on the wheel, or on the parts to which it is fastened, can make the wheel nuts become loose after a time. The wheel could come off and cause an accident. When you change a wheel, remove any rust or dirt from the places where the wheel attaches to the vehicle. In an emergency, you can use a cloth or a paper towel to do this; but be sure to use a scraper or wire brush later, if you need to, to get all the rust or dirt off.

Remove any rust or dirt from the wheel bolts, mounting surfaces and spare wheel. Place the spare on the wheel mounting surface.



## **CAUTION:**

**Never use oil or grease on studs or nuts. If you do, the nuts might come loose. Your wheel could fall off, causing a serious accident.**



Put on the spare tire. Put the nuts on by hand. Make sure the cone-shaped end is toward the wheel. Tighten each nut by hand until the wheel is held against the hub. If a nut can't be turned by hand, use the extension and see your dealer as soon as possible.



Lower the vehicle by turning the ratchet counterclockwise. Lower the jack completely.

## Tightening Wheel Nut



## Tightening Sequence

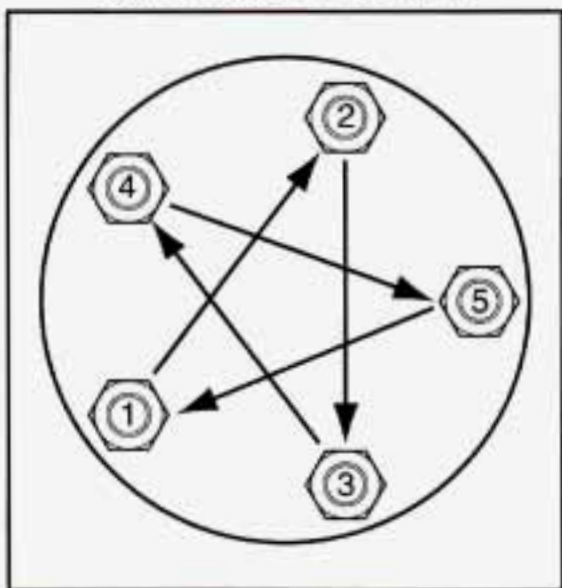

Tighten the wheel nuts firmly in a criss-cross sequence as shown. Turn the ratchet clockwise with the UP marking facing you.

Remove the wheel blocks.



### **CAUTION:**

**Incorrect wheel nuts or improperly tightened wheel nuts can cause the wheel to become loose and even come off. This could lead to an accident. Be sure to use the correct wheel nuts. If you have to replace them, be sure to get the right kind.**

**Stop somewhere as soon as you can and have the nuts tightened with a torque wrench to 100 ft. lb. (140 N·m).**

### **NOTICE:**

**Wheel covers won't fit on your compact spare. If you try to put a wheel cover on your compact spare, you could damage the cover or the spare.**

## Storing The Jack and Spare Tire

1. Put the tire on the ground at the rear of the vehicle, with the valve stem pointed down.
2. Pull the retaining bar through the center of the wheel, making sure it is properly attached. Attach the ratchet, with the UP side facing you, to the extension.
3. Put the flat end of the extension on an angle through the hole in the rear door frame, above the bumper. Turn the ratchet clockwise until the tire is against the underside of the vehicle.

You will hear two “clicks” when the tire is up all the way. Try to move the tire with your hands to make sure it is securely in place.

Return the jacking equipment to the proper location. Secure the items and replace the jack cover.



### **CAUTION:**

**Storing a jack, a tire or other equipment in the passenger compartment of the vehicle could cause injury. In a sudden stop or collision, loose equipment could strike someone. Store all these in the proper place.**

## *Compact Spare Tire*

Although the compact spare was fully inflated when your vehicle was new, it can lose air after a time. Check the inflation pressure regularly. It should be 60 psi (420 kPa). After installing the compact spare on your vehicle, you should stop as soon as possible and make sure your spare tire is correctly inflated. The compact spare is made to perform well at posted speed limits for distances up to 3,000 miles (5 000 km), so you can finish your trip and have your full-size tire repaired or replaced where you want. Of course, it's best to replace your spare with a full-size tire as soon as you can. Your spare will last longer and be in good shape in case you need it again.

### **NOTICE:**

**Don't take your compact spare through an automatic car wash with guide rails. The compact spare can get caught on the rails. That can damage the tire and wheel, and maybe other parts of your vehicle.**

Don't use your compact spare on some other vehicle.

And don't mix your compact spare or wheel with other wheels or tires. They won't fit. Keep your spare and its wheel together.

## **NOTICE:**

**Tire chains won't fit your compact spare. Using them will damage your vehicle and destroy the chains too. Don't use tire chains on your compact spare.**

## ***If You're Stuck: In Sand, Mud, Ice or Snow***

What you don't want to do when your vehicle is stuck is to spin your wheels too fast. The method known as "rocking" can help you get out when you're stuck, but you must use caution.



## **CAUTION:**

**If you let your tires spin at high speed, they can explode and you or others could be injured. And, the transmission or other parts of the vehicle can overheat. That could cause an engine compartment fire or other damage. When you're stuck, spin the wheels as little as possible. Don't spin the wheels above 35 mph (55 km/h) as shown on the speedometer.**

## **NOTICE:**

**Spinning your wheels can destroy parts of your vehicle as well as the tires. If you spin the wheels too fast while shifting your transmission back and forth, you can destroy your transmission.**

For information about using tire chains on your vehicle, see "Tire Chains" in the Index.

### **Rocking your vehicle to get it out:**

First, turn your steering wheel left and right. That will clear the area around your front wheels. Then shift back and forth between REVERSE (R) and a forward gear, spinning the wheels as little as possible. Release the accelerator pedal while you shift, and press lightly on the accelerator pedal when the transmission is in gear. If that doesn't get you out after a few tries, you may need to be towed out. If you do need to be towed out, see "Towing Your Vehicle" in the Index.

## **Notes**

## ***Service & Appearance Care***

## ***Section***

# **6**

Here you will find information about the care of your vehicle. This section begins with service and fuel information, and then it shows how to check important fluid and lubricant levels. There is also technical information about your vehicle, and a part devoted to its appearance care.

### ***Service***

Your GM dealer knows your vehicle best and wants you to be happy with it. We hope you'll go to your dealer for all your service needs. You'll get genuine GM parts and GM-trained and supported service people.

We hope you'll want to keep your GM vehicle all GM. Genuine GM parts have one of these marks:



### ***Doing Your Own Service Work***

If you want to do some of your own service work, you'll want to get the proper GM Service Manual. It tells you much more about how to service your vehicle than this manual can. To order the proper service manual, see "Service Publications" in the Index.

Your vehicle has a facial air bag system. Before attempting to do your own service work, see “Servicing Your Facial Air Bag–Equipped Vehicle” in the Index.

You should keep a record with all parts receipts and list the mileage and the date of any service work you perform. See “Maintenance Record” in the Index.



### **CAUTION:**

**You can be injured if you try to do service work on a vehicle without knowing enough about it.**

- **Be sure you have sufficient knowledge, experience, and the proper replacement parts and tools before you attempt any vehicle maintenance task.**
- **Be sure to use the proper nuts, bolts and other fasteners. “English” and “metric” fasteners can be easily confused. If you use the wrong fasteners, parts can later break or fall off. You could be hurt.**

### **NOTICE:**

**If you try to do your own service work without knowing enough about it, your vehicle could be damaged.**

## ***Fuel***

The 8th digit of your vehicle identification number (VIN) shows the code letter for your engine. You will find the VIN at the top left of your instrument panel. (See “Vehicle Identification Number” in the Index.) Following is fuel information for the 4.3L (Code W) engine.

Use regular unleaded gasoline rated at 87 octane or higher. Use premium unleaded gasoline rated at 91 octane or higher for high power performance, when towing a trailer or with a high payload requirement. But when operating with a light load as a normal condition, you may use middle grade or regular unleaded gasolines.

The gasoline you use should meet specifications ASTM D4814 in the United States and CGSB 3.5–92 in Canada. These fuels should have the proper additives, so you should not have to add anything to the fuel.



In the United States and Canada, it's easy to be sure you get the right kind of gasoline (unleaded). You'll see UNLEADED right on the pump. And only unleaded nozzles will fit into your vehicle's filler neck.

Be sure the posted octane is at least 91 for premium, 89 for middle grade and 87 for regular. If the octane is less than 87, you may get a heavy knocking noise when you drive. If it's bad enough, it can damage your engine.

If you're using fuel rated at 91 octane or higher and you still hear heavy knocking, your engine needs service. But don't worry if you hear a little pinging noise when you're accelerating or driving up a hill. That's normal, and you don't have to buy a higher octane fuel to get rid of it. It's the heavy, constant knock that means you have a problem.

What about gasoline with blending materials that contain oxygen (oxygenates), such as MTBE or alcohol?

**MTBE** is "methyl tertiary-butyl ether." Fuel that is no more than 15% MTBE is fine for your vehicle.

*Ethanol* is ethyl or grain alcohol. Properly-blended fuel that is no more than 10% *ethanol* is fine for your vehicle.

*Methanol* is methyl or wood alcohol.

## **NOTICE:**

**Fuel that is more than 5% methanol is bad for your vehicle. Don't use it. It can corrode metal parts in your fuel system and also damage plastic and rubber parts. That damage wouldn't be covered under your warranty. And even at 5% or less, there must be "cosolvents" and corrosion preventers in this fuel to help avoid these problems.**

## ***Gasolines for Cleaner Air***

Your use of gasoline with deposit control additives will help prevent deposits from forming in your engine and fuel system. That helps keep your engine in tune and your emission control system working properly. It's good for your vehicle, and you'll be doing your part for cleaner air.

Many gasolines are now blended with oxygenates. General Motors recommends that you use gasolines with these blending materials, such as MTBE and ethanol. By doing so, you can help clean the air, especially in those parts of the country that have high carbon monoxide levels.

In addition, some gasoline suppliers are now producing reformulated gasolines. These gasolines are specially designed to reduce vehicle emissions. General Motors recommends that you use reformulated gasoline.

By doing so, you can help clean the air, especially in those parts of the country that have high ozone levels.

You should ask your service station operators if their gasolines contain deposit control additives and oxygenates, and if they have been reformulated to reduce vehicle emissions.

## ***Fuels in Foreign Countries***

If you plan on driving in another country outside the U.S. or Canada, unleaded fuel may be hard to find. Do not use leaded gasoline. If you use even one tankful, your emission controls won't work well or at all. With continuous use, spark plugs can get fouled, the exhaust system can corrode, and your engine oil can deteriorate quickly. Your vehicle's oxygen sensor will be damaged. All of that means costly repairs that wouldn't be covered by your warranty.

To check on fuel availability, ask an auto club, or contact a major oil company that does business in the country where you'll be driving.

You can also write us at the following address for advice. Just tell us where you're going and give your Vehicle Identification Number (VIN).

General Motors Overseas Distribution Corporation,  
North American Export Sales (NAES)  
1908 Colonel Sam Drive  
Oshawa, Ontario  
L1H 8P7

## ***Filling Your Tank***



The cap is behind a hinged door on the driver's side of your vehicle.

**⚠ CAUTION:**

**Gasoline vapor is highly flammable. It burns violently, and that can cause very bad injuries. Don't smoke if you're near gasoline or refueling your vehicle. Keep sparks, flames, and smoking materials away from gasoline.**



While refueling, hang the cap inside the fuel door.

To take off the cap, turn it slowly to the left (counterclockwise).

**⚠ CAUTION:**

**If you get gasoline on yourself and then something ignites it, you could be badly burned. Gasoline can spray out on you if you open the fuel filler cap too quickly. This spray can happen if your tank is nearly full, and is more likely in hot weather. Open the fuel filler cap slowly and wait for any "hiss" noise to stop. Then unscrew the cap all the way.**

Be careful not to spill gasoline. Clean gasoline from painted surfaces as soon as possible. See "Cleaning the Outside of Your Vehicle" in the Index.

When you put the cap back on, turn it to the right until you hear a clicking noise.

## **NOTICE:**

If you need a new cap, be sure to get the right type. Your dealer can get one for you. If you get the wrong type, it may not fit or have proper venting, and your fuel tank and emissions system might be damaged.

## ***Checking Things Under the Hood***

### **Hood Release**

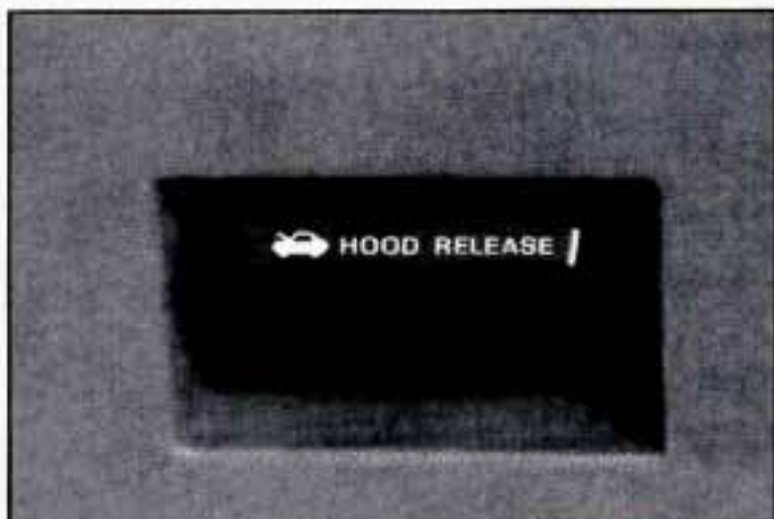

To open the hood, first pull the handle inside the vehicle on the lower driver's side of the instrument panel.



Then go to the front of the vehicle and release the secondary hood release.



Lift the hood, release the hood prop from its retainer and put the hood prop into the slot in the hood.



Before closing the hood, be sure all the filler caps are on properly. Then lift the hood to relieve pressure on the hood prop.



Remove the hood prop from the slot in the hood and return the prop to its retainer.

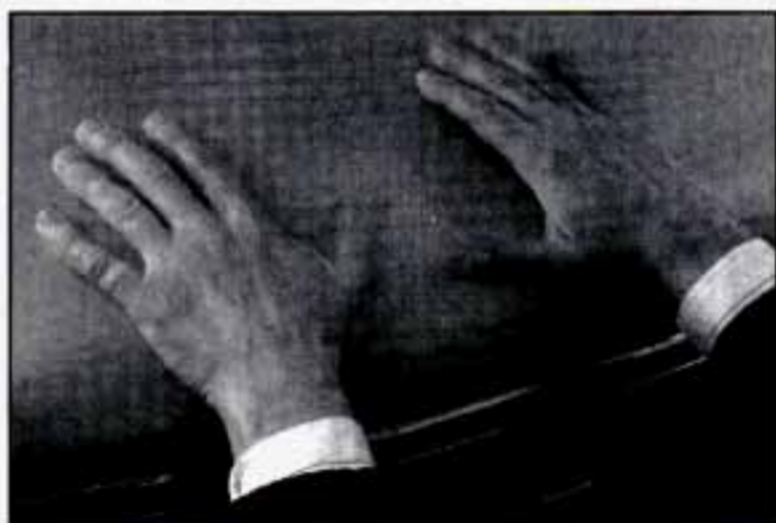

Then just pull the hood down and close it firmly.



### **CAUTION:**

Things that burn can get on hot engine parts and start a fire. These include liquids like gasoline, oil, coolant, brake fluid, windshield washer and other fluids, and plastic or rubber. You or others could be burned. Be careful not to drop or spill things that will burn onto a hot engine.

## ***Engine Oil***

It's a good idea to check your engine oil every time you get fuel. In order to get an accurate reading, the oil must be warm and the vehicle must be on level ground.



Turn off the engine and give the oil a few minutes to drain back into the oil pan. If you don't, the oil dipstick might not show the actual level.

## ***To Check Engine Oil***

Pull out the dipstick and clean it with a paper towel or cloth, then push it back in all the way. Remove it again, keeping the tip down.

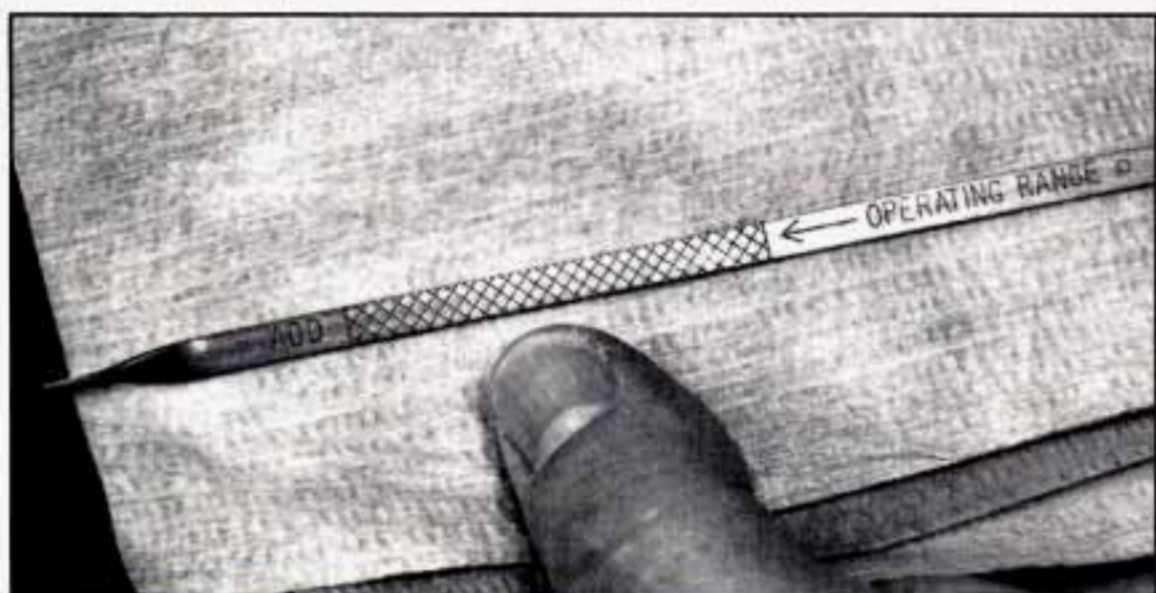

## ***When to Add Oil***

If the oil is at or below the ADD line, then you'll need to add some oil. But you must use the right kind. This part explains what kind of oil to use. For crankcase capacity, see "Capacities and Specifications" in the Index.

### **NOTICE:**

**Don't add too much oil. If your engine has so much oil that the oil level gets above the cross-hatched area that shows the proper operating range, your engine could be damaged.**

Just fill it enough to put the level somewhere in the proper operating range. Push the dipstick all the way back in when you're through.

## ***What Kind of Oil to Use***

Oils of the proper quality for your vehicle can be identified by looking for the “Starburst” symbol. The “Starburst” symbol indicates that the oil has been certified by the American Petroleum Institute (API), and is preferred for use in your gasoline engine.



If you change your own oil, be sure you use oil that has the “Starburst” symbol on the front of the oil container. If you have your oil changed for you, be sure the oil put into your engine is American Petroleum Institute certified for gasoline engines.



You should also use the proper viscosity oil for your vehicle, as shown in the following chart:

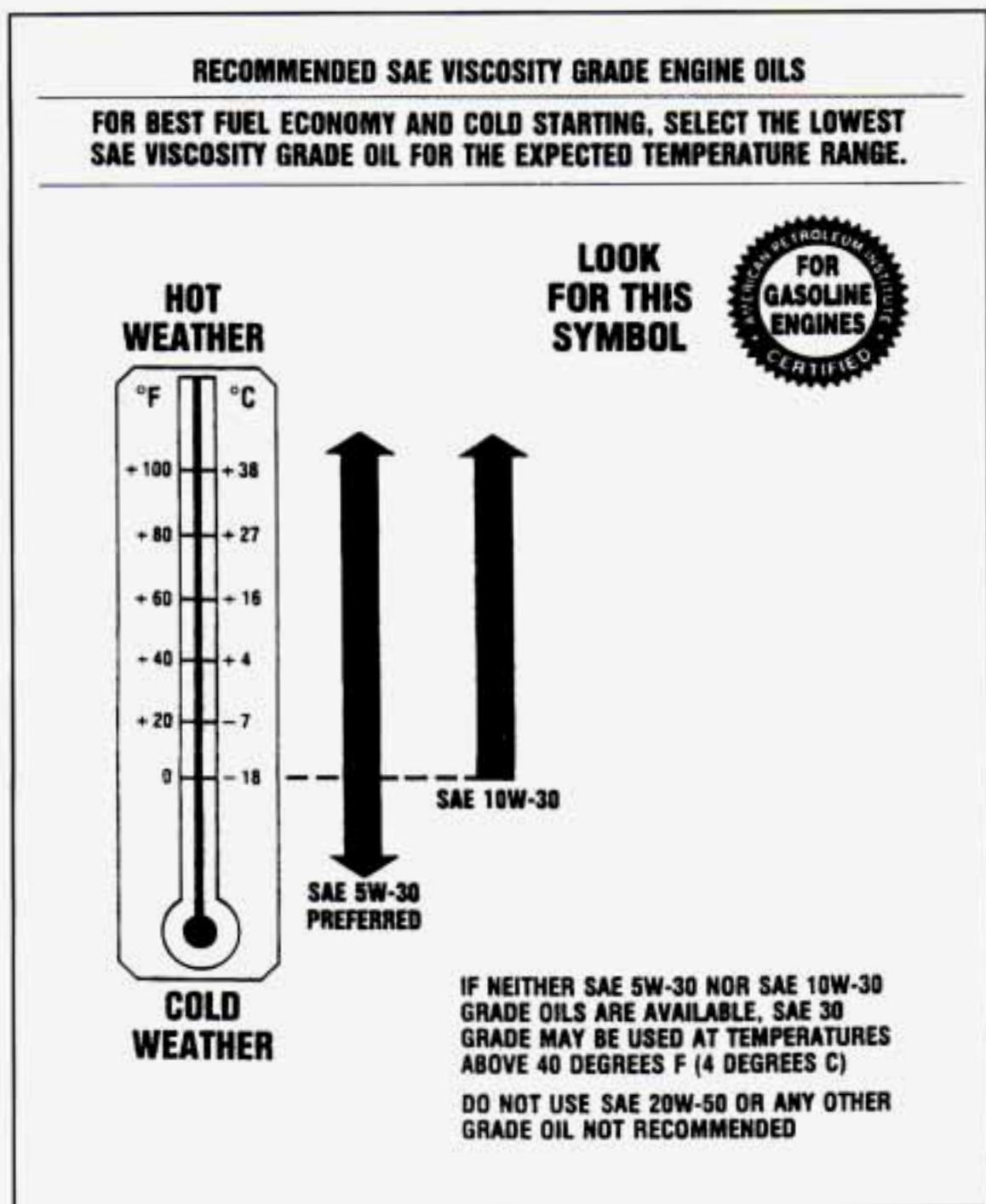

As shown in the chart, SAE 5W-30 is best for your vehicle. However, you can use SAE 10W-30 if it's going to be 0°F (-18°C) or above. These numbers on an oil container show its viscosity, or thickness. Do not use other viscosity oils, such as SAE 20W-50.

## **NOTICE:**

**Use only engine oil with the American Petroleum Institute Certified For Gasoline Engines “Starburst” symbol. Failure to use the proper oil can result in engine damage not covered by your warranty.**

GM Goodwrench<sup>®</sup> oil (in Canada, GM Engine Oil) meets all the requirements for your vehicle.

### ***Engine Oil Additives***

Don't add anything to your oil. Your GM dealer is ready to advise if you think something should be added.

### ***When to Change Engine Oil***

See if any one of these is true for you:

- Most trips are less than 5 to 10 miles (8 to 16 km). This is particularly important when outside temperatures are below freezing.
- Most trips include extensive idling (such as frequent driving in stop and go traffic).
- Most trips are through dusty areas.
- You frequently tow a trailer or use a carrier on top of your vehicle.

If any one of these is true for your vehicle, then you need to change your oil and filter every 3,000 miles (5 000 km) or 3 months — whichever comes first.

If none of them is true, change the oil and filter every 7,500 miles (12 500 km) or 12 months — whichever comes first.

### ***Engine Coolant Heater***

An engine coolant heater can be a big help if you have to park outside in very cold weather, 0°F (-18°C) or colder. If your vehicle has this option, see “Engine Coolant Heater” in the Index.

### ***What to Do with Used Oil***

Did you know that used engine oil contains certain elements that may be unhealthy for your skin and could even cause cancer? Don't let used oil stay on your skin for very long. Clean your skin and nails with soap and water, or a good hand cleaner. Wash or properly throw away clothing or rags containing used engine oil. (See the manufacturer's warnings about the use and disposal of oil products.)

Used oil can be a real threat to the environment. If you change your own oil, be sure to drain all free-flowing oil from the filter before disposal. Don't ever dispose of oil by putting it in the trash, pouring it on the ground, into sewers, or into streams or bodies of water. Instead, recycle it by taking it to a place that collects used oil. If you have a problem properly disposing of your used oil, ask your dealer, a service station or a local recycling center for help.

## ***Engine Cover***

### ***To Remove the Engine Cover:***

1. Move both front seats as far back as they will go.



2. Remove the instrument panel extension by removing the two screws and two nuts.



3. The screws are on each side at the top of the extension. The nuts are on the bottom of the extension.



4. Grasp the bottom of the extension. Lift up and then pull out.



5. Disconnect the electrical connector for the cigarette lighter. Set the extension aside.



6. Grasp the top of the heater duct and pull down gently to remove.



7. Remove the bolt from the engine cover bracket.



8. Loosen the nut and move the bracket out of the way.



9. Lift up on each of the two latches at the bottom of the cover.



10. Remove the two screws at the engine cover using a long handled screwdriver. The screws are not supposed to come out of the cover, only from the front of the dash.

When removing the cover, be careful not to damage the instrument panel or the trim.



11. Grasp the bottom of the cover and slide it backwards. Then, lift it up and out of the vehicle.

### ***To Install the Engine Cover:***

1. Lift the engine cover into the vehicle and slide it all the way forward. Make sure the rubber seal is over the latches.
2. Install the two screws at the engine cover. Do not tighten the screws all the way.
3. Press down on each of the two latches at the bottom of the cover. Make sure they are secure.
4. Tighten the two screws at the engine cover.
5. Turn the bracket into position and install the bolt. Tighten the nut at the other end of the bracket.

6. Put the heater duct over the engine cover studs. Push up on the duct gently until it snaps into place.
7. Reconnect the electrical connector for the cigarette lighter.
8. Grasp the bottom of the instrument panel extension and install the top into the groove first. Then, push the bottom of the extension into place.
9. Install the two nuts and two screws on the extension.

## ***Air Cleaner***



If you have the 4.3L engine (VIN Code W) with the rectangular air cleaner, you can change the air cleaner filter without removing the engine cover. Just lift the hood, unsnap both clips and remove the top. After changing the filter, snap both clips to secure the air cleaner. Be sure air cleaner lid is correctly positioned to seal out dust and contaminants that are harmful to your engine.

Make sure fresh air hose is still attached after filter change.

Refer to the Maintenance Schedule to determine when to replace the air filter.

See “Scheduled Maintenance Services” in the Index.



### **CAUTION:**

**Operating the engine with the air cleaner off can cause you or others to be burned. The air cleaner not only cleans the air, it stops flame if the engine backfires. If it isn't there, and the engine backfires, you could be burned. Don't drive with it off, and be careful working on the engine with the air cleaner off.**

## **NOTICE:**

If the air cleaner is off, a backfire can cause a damaging engine fire. And, dirt can easily get into your engine, which will damage it. Always have the air cleaner in place when you're driving.

## ***Automatic Transmission Fluid***

### ***When to Check and Change***

A good time to check your automatic transmission fluid level is when the engine oil is changed. Refer to the Maintenance Schedule to determine when to change your fluid. See "Scheduled Maintenance Services" in the Index.

### ***How to Check***

Because this operation can be a little difficult, you may choose to have this done at your GM dealer Service Department.

If you do it yourself, be sure to follow all the instructions here, or you could get a false reading on the dipstick.

## **NOTICE:**

**Too much or too little fluid can damage your transmission. Too much can mean that some of the fluid could come out and fall on hot engine parts or exhaust system parts, starting a fire. Be sure to get an accurate reading if you check your transmission fluid.**

Wait at least 30 minutes before checking the transmission fluid level if you have been driving:

- When outside temperatures are above 90°F (32°C).
- At high speed for quite a while.
- In heavy traffic — especially in hot weather.
- While pulling a trailer.

To get the right reading, the fluid should be at normal operating temperature, which is 180°F to 200°F (82°C to 93°C).



**To check transmission fluid hot:** Get the vehicle warmed up by driving about 15 miles (24 km) when outside temperatures are above 50°F (10°C). If it's colder than 50°F (10°C), drive the vehicle in **THIRD GEAR (D)** until the engine temperature gage moves and then remains steady for ten minutes. Then follow the hot check procedures.

**To check transmission fluid cold:** A cold check is made after the vehicle has been sitting for eight hours or more with the engine off and is used only as a reference. Let the engine run at idle for five minutes if outside temperatures are 50°F (10°C) or more. If it's colder than 50°F (10°C), you may have to idle the engine longer. Should the fluid level be low during a cold check, you **must** perform a hot check before adding fluid. This will give you a more accurate reading of the fluid level.

### ***To check the fluid hot or cold***

- Park your vehicle on a level place. Keep the engine running.
- With the parking brake applied, place the shift lever in **PARK (P)**.
- With your foot on the brake pedal, move the shift lever through each gear range, pausing for about three seconds in each range. Then, position the shift lever in **PARK (P)**.
- Let the engine run at idle for three minutes or more.

Then, without shutting off the engine, follow these steps:



1. Flip the handle up and then pull out the dipstick and wipe it with a clean rag or paper towel.
2. Push it back in all the way, wait three seconds and then pull it back out again.

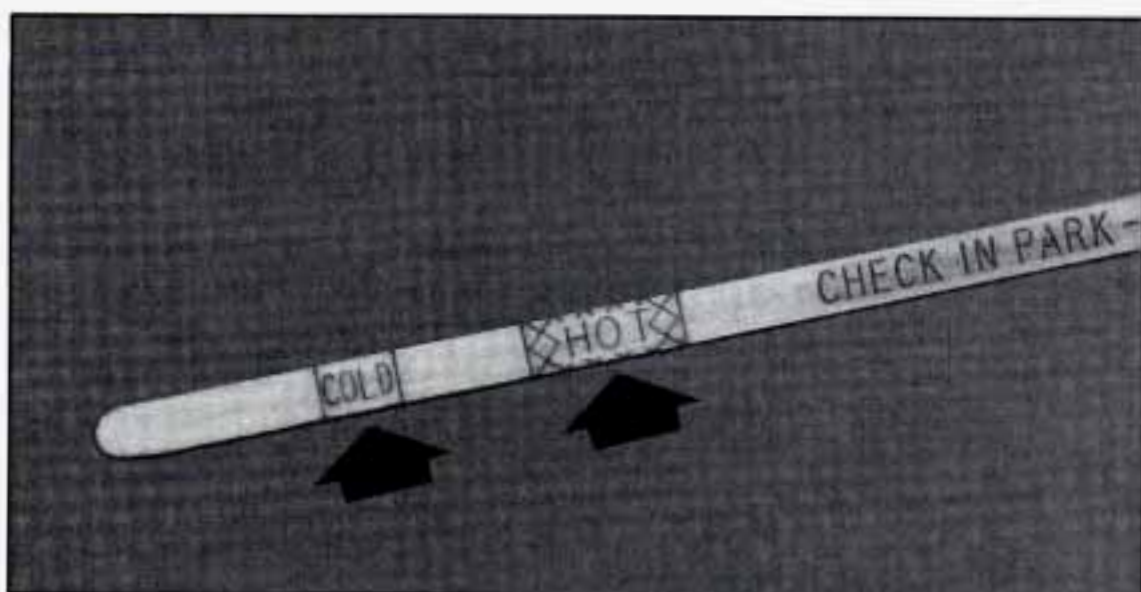

3. Check both sides of the dipstick, and read the lower level. The fluid level must be in the COLD area for a cold check or in the HOT area or cross-hatched area for a hot check.
4. If the fluid level is in the acceptable range, push the dipstick back in all the way; then flip the handle down to lock the dipstick in place.

### ***How to Add Fluid***

Refer to the Maintenance Schedule to determine what kind of transmission fluid to use. See "Recommended Fluids and Lubricants" in the Index.

Add fluid only after checking the transmission fluid HOT. (A COLD check is used only as a reference.) If the fluid level is low, add only enough of the proper fluid to bring the level up to the HOT area for a hot check. It doesn't take much fluid, generally less than a pint. *Don't overfill.* We recommend you use only fluid labeled DEXRON<sup>®</sup>-III, because fluid with that label is made especially for your automatic transmission. Damage caused by fluid other than DEXRON<sup>®</sup>-III is not covered by your new vehicle warranty.

- After adding fluid, recheck the fluid level as described under "How to Check."
- When the correct fluid level is obtained, push the dipstick back in all the way; then flip the handle down to lock the dipstick in place.

## **All-Wheel Drive**

If you have an all-wheel-drive vehicle, be sure to perform the lubricant checks described in this section. However, they have two additional systems that need lubrication.

### **Transfer Case**

#### **When to Check Lubricant**

Refer to the Maintenance Schedule to determine how often to check the lubricant. See "Periodic Maintenance Inspections" in the Index.

#### **How to Check Lubricant**

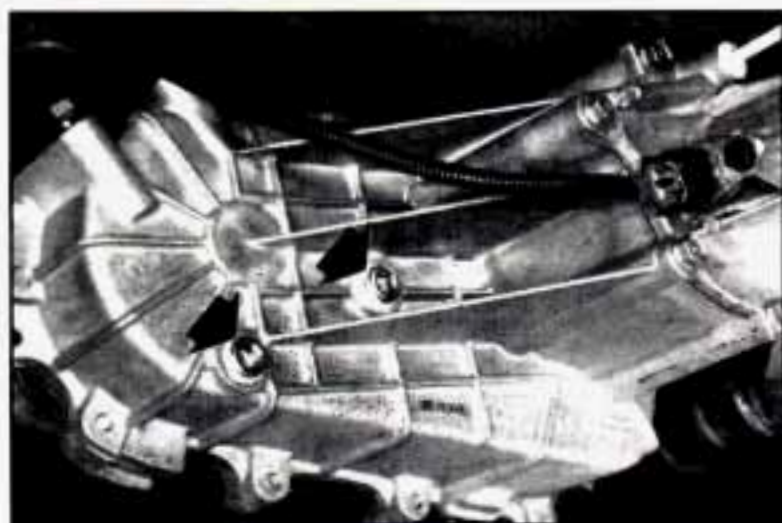

If the level is below the bottom of the filler plug hole, you'll need to add some lubricant. Add enough lubricant to raise the level to the bottom of the filler plug hole.

#### **What to Use**

Refer to the Maintenance Schedule to determine what kind of lubricant to use. See "Recommended Fluids and Lubricants" in the Index.

### **Front Axle**

#### **When to Check and Change Lubricant**

Refer to the Maintenance Schedule to determine how often to check the lubricant and when to change it. See "Scheduled Maintenance Services" in the Index.

### ***How to Check Lubricant***



If the level is below the bottom of the filler plug hole, you'll need to add some lubricant. Add enough lubricant to raise the level to the bottom of the filler plug hole.

### ***What to Use***

Refer to the Maintenance Schedule to determine what kind of lubricant to use. See "Recommended Fluids and Lubricants" in the Index.

### ***Rear Axle***

#### ***When to Check and Change Lubricant***

Refer to the Maintenance Schedule to determine how often to check the lubricant and when to change it. See "Scheduled Maintenance Services" in the Index.

### ***How to Check Lubricant***



If the level is below the bottom of the filler plug hole, you'll need to add some lubricant. Add enough lubricant to raise the level to the bottom of the filler plug hole.

## ***What to Use***

Refer to the Maintenance Schedule to determine what kind of lubricant to use. See “Recommended Fluids and Lubricants” in the Index.

## ***Engine Coolant***

The following explains your cooling system and how to add coolant when it is low. If you have a problem with engine overheating, see “Engine Overheating” in the Index.

The proper coolant for your vehicle will:

- Give freezing protection down to  $-34^{\circ}\text{F}$  ( $-37^{\circ}\text{C}$ ).
- Give boiling protection up to  $262^{\circ}\text{F}$  ( $128^{\circ}\text{C}$ ).
- Protect against rust and corrosion.
- Help keep the proper engine temperature.
- Let the warning lights and gages work as they should.

### **What to Use**

Use a mixture of one-half *clean water* (preferably distilled) and one-half antifreeze that meets “GM Specification 6038-M,” which won’t damage aluminum parts. You can also use a recycled coolant conforming to “GM Specification Use GM Coolant Supplement (Sealer) with a complete coolant flush and refill. If you use this mixture, you don’t need to add anything else.



### **CAUTION:**

**Adding only plain water to your cooling system can be dangerous. Plain water, or some other liquid like alcohol, can boil before the proper coolant mix will. Your vehicle’s coolant warning system is set for the proper coolant mix. With plain water or the wrong mix, your engine could get too hot but you wouldn’t get the overheat warning. Your engine could catch fire and you or others could be burned. Use a 50/50 mix of clean water and a proper antifreeze.**

## **NOTICE:**

**If you use an improper coolant mix, your engine could overheat and be badly damaged. The repair cost wouldn't be covered by your warranty. Too much water in the mix can freeze and crack the engine, radiator, heater core and other parts.**

Some conditions, such as air trapped in the cooling system, can affect the coolant level in the radiator. Check the coolant level when the engine is cold and follow the steps under "Adding Coolant" for the proper way to add coolant.

If you have to add coolant more than four times a year, have your dealer check your cooling system.

## **NOTICE:**

**If you use the proper coolant, you don't have to add extra inhibitors or additives which claim to improve the system. These can be harmful.**

### ***Adding Coolant***



### **To Check Coolant**

When your engine is cold, the coolant level should be at ADD, or a little higher. When your engine is warm, the level should be up to FULL HOT, or a little higher.

### **To Add Coolant**

If you need more coolant, add the proper mix *at the coolant recovery tank*.



#### **CAUTION:**

Turning the radiator pressure cap when the engine and radiator are hot can allow steam and scalding liquids to blow out and burn you badly. With the coolant recovery tank, you will almost never have to add coolant at the radiator. Never turn the radiator pressure cap — even a little — when the engine and radiator are hot.

Add coolant mix at the recovery tank, but be careful not to spill it.



#### **CAUTION:**

You can be burned if you spill coolant on hot engine parts. Coolant contains ethylene glycol, and it will burn if the engine parts are hot enough. Don't spill coolant on a hot engine.

## Radiator Pressure Cap

### NOTICE:

Your radiator cap is a 15 psi (105 kPa) pressure-type cap and must be tightly installed to prevent coolant loss and possible engine damage from overheating. Be sure the arrows on the cap line up with the overflow tube on the radiator filler neck.



When you replace your radiator pressure cap, a GM cap is recommended. See “Service Replacement Parts and Filler Recommendations” in the Index.

## Thermostat

Engine coolant temperature is controlled by a thermostat in the engine coolant system. The thermostat stops the flow of coolant through the radiator until the coolant reaches a preset temperature.

When you replace your thermostat, an AC<sup>®</sup> thermostat is recommended.



## ***Power Steering Fluid***



### ***How To Check Power Steering Fluid***

When the engine compartment is cool, unscrew the cap and wipe the dipstick with a clean rag. Replace the cap and completely tighten it. Then remove the cap again and look at the fluid level on the dipstick.

The level should be at the FULL COLD mark. Add enough fluid to bring the level up to the mark.

A fluid loss in this system could indicate a problem. Have the system inspected and repaired.

### ***What to Add***

Refer to the Maintenance Schedule to determine what kind of fluid to use. See "Recommended Fluids and Lubricants" in the Index.

#### **NOTICE:**

**When adding power steering fluid or making a complete fluid change, always use the proper fluid. Failure to use the proper fluid can cause leaks and damage hoses and seals.**

## ***Windshield Washer Fluid***

### ***To Add***



Open the cap labeled **WASHER FLUID ONLY**. Add washer fluid until the tank is full.

### **NOTICE:**

- When using concentrated washer fluid, follow the manufacturer's instructions for adding water.
- Don't mix water with ready-to-use washer fluid. Water can cause the solution to freeze and damage your washer fluid tank and other parts of the washer system. Also, water doesn't clean as well as washer fluid.
- Fill your washer fluid tank only 3/4 full when it's very cold. This allows for expansion, which could damage the tank if it is completely full.
- Don't use radiator antifreeze in your windshield washer. It can damage your washer system and paint.

## **Brakes**

### **Brake Master Cylinder**

Your brake master cylinder is here. It is filled with DOT-3 brake fluid.



There are only two reasons why the brake fluid level in your master cylinder might go down. The first is that the brake fluid goes down to an acceptable level during normal brake lining wear. When new linings are put in, the fluid level goes back up. The other reason is that fluid is leaking out of the brake system. If it is, you should have your brake system fixed, since a leak means that sooner or later your brakes won't work well, or won't work at all. So, it isn't a good idea to "top off" your brake fluid. Adding brake fluid won't correct a leak. If you add fluid when your linings are worn, then you'll have too much fluid when you get new brake linings. You should add (or remove) brake fluid, as necessary, only when work is done on the brake hydraulic system.



#### **CAUTION:**

**If you have too much brake fluid, it can spill on the engine. The fluid will burn if the engine is hot enough. You or others could be burned, and your vehicle could be damaged. Add brake fluid only when work is done on the brake hydraulic system.**

Refer to the Maintenance Schedule to determine when to check your brake fluid. See "Periodic Maintenance Inspections" in the Index.

## **To Check Brake Fluid**



You can check the brake fluid without taking off the cap. Just look at the windows on the brake fluid reservoir. The fluid levels should be above MIN. If they aren't, have your brake system checked to see if there is a leak.

After work is done on the brake hydraulic system, make sure the levels are above MIN and below the top of each window.

## **What to Add**

When you do need brake fluid, use only DOT-3 brake fluid — such as Delco Supreme 11<sup>®</sup> (GM Part No.1052535). Use new brake fluid from a sealed container only, and always clean the brake fluid reservoir cap before removing it.

### **NOTICE:**

- **Don't let someone put in the wrong kind of fluid. For example, just a few drops of mineral-based oil, such as engine oil, in your brake system can damage brake system parts so badly that they'll have to be replaced.**
- **Brake fluid can damage paint, so be careful not to spill brake fluid on your vehicle. If you do, wash it off immediately. See "Appearance Care" in the Index.**

## ***Brake Wear***

Your Vehicle has front disc brakes and rear drum brakes.

Disc brake pads have built-in wear indicators that make a high-pitched warning sound when the brake pads are worn and new pads are needed. The sound may come and go or be heard all the time your vehicle is moving (except when you are pushing on the brake pedal firmly).



### **CAUTION:**

**The brake wear warning sound means that sooner or later your brakes won't work well. That could lead to an accident. When you hear the brake wear warning sound, have your vehicle serviced.**

### **NOTICE:**

**Continuing to drive with worn-out brake pads could result in costly brake repair.**

Some driving conditions or climates may cause a brake squeal when the brakes are first applied or lightly applied. This does not mean something is wrong with your brakes.

Your rear drum brakes don't have wear indicators, but if you ever hear a rear brake rubbing noise, have the rear brake linings inspected. Also, the rear brake drums should be removed and inspected each time the tires are removed for rotation or changing. When you have the front brakes replaced, have the rear brakes inspected, too.

Brake linings should always be replaced as complete axle sets.

## ***Brake Pedal Travel***

See your dealer if the brake pedal does not return to normal height, or if there is a rapid increase in pedal travel. This could be a sign of brake trouble.

## ***Brake Adjustment***

Every time you make a brake stop, your disc brakes adjust for wear.

If your brake pedal goes down farther than normal, your rear drum brakes may need adjustment. Adjust them by backing up and firmly applying the brakes a few times.

## ***Replacing Brake System Parts***

The braking system on a modern vehicle is complex. Its many parts have to be of top quality and work well together if the vehicle is to have really good braking. Vehicles we design and test have top-quality GM brake parts in them, as your vehicle does when it is new. When you replace parts of your braking system — for example, when your brake linings wear down and you have to have new ones put in — be sure you get new genuine GM replacement parts. If you don't, your brakes may no longer work properly. For example, if someone puts in brake linings that are wrong for your vehicle, the balance between your front and rear brakes can change — for the worse. The braking performance you've come to expect can change in many other ways if someone puts in the wrong replacement brake parts.

## ***Hydro-Boost Brake System***

The power steering pump also powers the Hydro-Boost. Refer to "Power Steering Fluid" in this section when checking the fluid level or adding fluid.

## ***Battery***

Every new vehicle has a Delco Freedom<sup>®</sup> battery. You never have to add water to one of these. When it's time for a new battery, we recommend a Delco Freedom<sup>®</sup> battery. Get one that has the replacement number shown on the original battery's label.

## ***Vehicle Storage***

If you're not going to drive your vehicle for 25 days or more, take off the black, negative (-) cable from the battery. This will help keep your battery from running down.



### **CAUTION:**

**Batteries have acid that can burn you and gas that can explode. You can be badly hurt if you aren't careful. See "Jump Starting" in the Index for tips on working around a battery without getting hurt.**

Contact your dealer to learn how to prepare your vehicle for longer storage periods.

For more information on vehicle storage, contact your dealer's service department, or write to:

Adistra Corporation  
171 Hamilton Street  
Plymouth, MI 48170

In Canada, write to:  
General Motors of Canada, Limited  
Customer Services Department  
Oshawa, Ontario L1J 5Z6

## ***Fluid Leak Check***

After the vehicle has been parked for awhile, inspect the surface beneath the vehicle for water, oil, fuel or other fluids. Water dripping from the air conditioning system is normal. If you notice fuel leaks or fumes, the causes should be found and corrected at once.

## ***Bulb Replacement***

Before replacing any bulbs, make sure all lights are off and the vehicle is not running.

### ***Sealed Beam Headlamps***

1. Open the hood.



2. Remove the four screws from the headlamp bezel. Pull the bezel out so you can see the parking/turn signal sockets.

3. Press the tab and turn the socket counterclockwise to remove the socket from the bezel. If the socket does not have a tab, turn the socket counterclockwise. Set the bezel aside.
4. Remove the four retainer screws and the retainer.



5. Pull the connector out and unplug the lamp.
6. Install the new bulb into the connector.
7. Reverse Steps 1–5 to reinstall the headlamp.

## ***Halogen Bulbs***



### **CAUTION:**

Halogen bulbs have pressurized gas inside and can burst if you drop or scratch the bulb. You or others could be injured. Take special care when handling and disposing of halogen bulbs.

### **NOTICE:**

Avoid touching the bulb or letting it come in contact with anything damp. Oil from your skin or moisture on the bulb can cause the bulb to explode when it is turned on. If either comes in contact with the bulb, clean it with alcohol or a suitable degreaser and wipe the bulb dry.



## ***Composite Headlamps***

1. Open the hood.



2. Remove the two screws from the side marker/turn signal lamp.



3. Completely remove the sidemarker/turn signal lamp by pulling out the assembly and disconnecting the side marker/turn signal lamp sockets from the lamp.



4. Remove the screw located behind the corner reflector in order to remove the entire corner reflector.



5. Remove the remaining three screws; the first one from the corner reflector pocket and the two remaining from the composite assembly.



6. Remove the composite assembly.
7. Turn the halogen bulb counterclockwise to remove from the assembly.

8. Install the new bulb into the composite assembly by turning it clockwise until it is completely tightened.
9. Replace the composite assembly by installing and tightening all of the screws previously removed.

## ***Front Park/Turn Signal Lamps (Composite and Sealed Beam)***

1. Remove the two screws at the inside edge of the parking/turn signal lamp assembly.



2. Remove the lamp assembly.

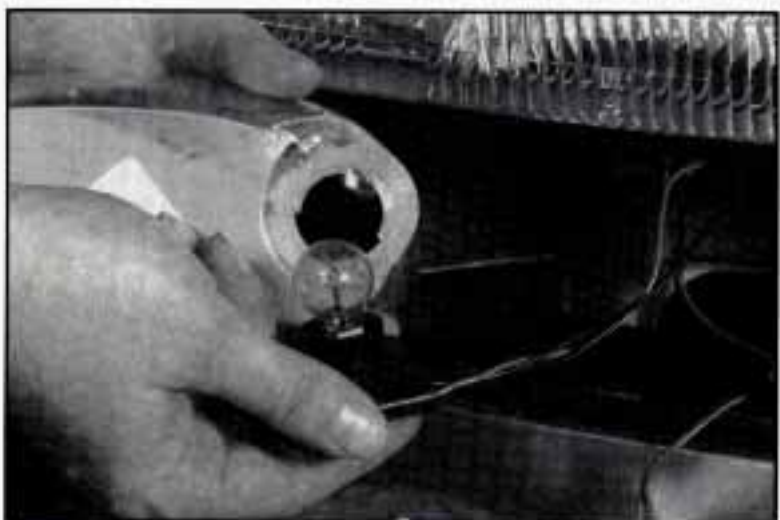

3. Squeeze the tab on the side of the lamp socket while turning the socket counterclockwise.

4. Pull the socket out of the lamp assembly.
5. Pull the bulb from the socket.
6. Gently push the new bulb into the socket.
7. Put the socket back into the lamp assembly and turn it clockwise until it locks.
8. Put the parking/turn signal lamp assembly back into the vehicle and tighten the screws.

## Rear Lamps

1. Open the rear door.

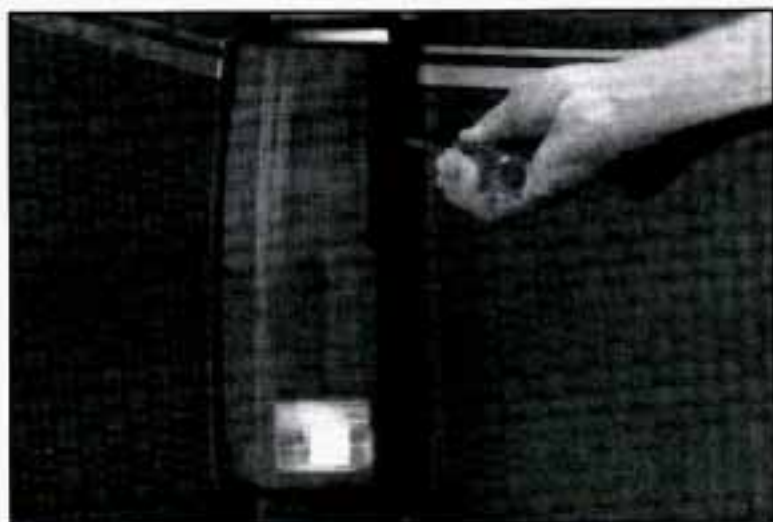

2. Remove the two screws from behind the door.



3. Pull out the rear lamp assembly so you can see the socket.



4. Press the tab and turn the socket counterclockwise to remove the socket from the bezel. If the socket does not have a tab, turn the socket counterclockwise to remove the socket from the bezel.



5. Pull out the bulb and replace it with the new bulb.
6. Reverse Steps 1–4 to reinstall the rear lamp.

### ***Center High Mounted Stop Lamp (CHMSL)***



Your CHMSL bulbs are not replaced separately. You must replace the entire unit. See your GM dealer for a replacement CHMSL assembly.

### ***Other Maintenance Items***

#### ***Windshield Wiper Blade Replacement***

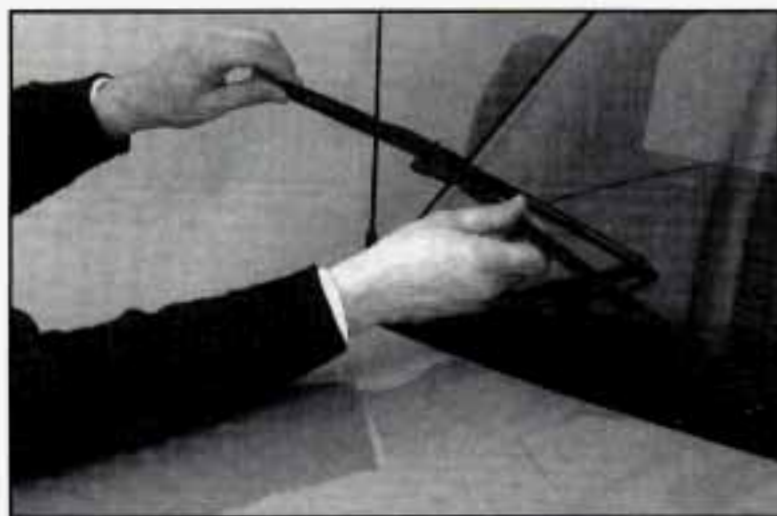

To replace your windshield wiper blade inserts, lift the wiper arm away from the windshield. Pinch the two tabs on the wiper arm and slide the insert out of the blade. Slide the new one in place. Make sure the tabs are locked into position.

## ***Air Conditioning***

Every now and then have your dealership check your air conditioning system to be sure it has not lost any cooling ability. If you think the system is not working properly, have your dealership check it out as soon as possible.

The air conditioning will not work when the temperature is below 40°F (4°C).

## ***Lock Cylinders***

To be sure your locks operate properly, they must be lubricated.

Refer to the Maintenance Schedule to determine how often to lubricate them and what type of lubricant to use.

You should not use penetrating oils because they could wash out the factory installed lubricant and cause the lock to bind. De-icers which contain alcohol could also wash away the lubricant, so be sure to lubricate the lock after using a de-icer of this type.

## ***Exhaust System***

To help prevent damage to your exhaust system, do not continue to drive your vehicle if you notice:

- Engine misfiring
- Loss of performance
- Exhaust system components hanging lower than normal.
- Loud exhaust system noises.
- Other unusual operating conditions

Have your engine and exhaust system serviced regularly.

## ***Three-Way Catalytic Converter***

Your vehicle's three-way catalytic converter is designed to reduce the pollutants in your vehicle's exhaust. Use only unleaded fuel in your vehicle. If you use leaded fuel, you could damage your three-way catalytic converter and other engine components.

## ***Engine Control Module System***

This system has an oxygen (O<sub>2</sub>) sensor that helps keep your engine's air-fuel mixture at a proper level. Use only unleaded fuel in your vehicle. If you use leaded fuel, you could damage your oxygen (O<sub>2</sub>) sensor and affect your vehicle's emissions.

## ***Malfunction Indicator Lamp (SERVICE ENGINE SOON LIGHT)***

This light on your instrument panel lets you know when your emission system needs service. The light will come on briefly when you start your engine to let you know that the system is working. If it does not come on when you start your engine, or if it comes on and stays on while you're driving, your system may need service. Your vehicle should still be driveable, but you should have your system serviced right away.

## ***Tires***

We don't make tires. Your new vehicle comes with high quality tires made by a leading tire manufacturer. These tires are warranted by the tire manufacturers and their warranties are delivered with every new vehicle. If your spare tire is a different brand than your road tires, you will have a tire warranty folder from each of these manufacturers.



### **CAUTION:**

**Poorly maintained and improperly used tires are dangerous.**

- **Overloading your tires can cause overheating as a result of too much friction. You could have an air-out and a serious accident. See "Loading Your Vehicle" in the Index.**
- **Underinflated tires pose the same danger as overloaded tires. The resulting accident could cause serious injury. Check all tires frequently to maintain the recommended pressure. Tire pressure should be checked when your tires are cold.**
- **Overinflated tires are more likely to be cut, punctured, or broken by a sudden impact, such as when you hit a pothole. Keep tires at the recommended pressure.**
- **Worn, old tires can cause accidents. If your tread is badly worn, or if your tires have been damaged, replace them.**

## ***Inflation – Tire Pressure***

The Certification/Tire label which is on the rear edge of the driver's door, shows the correct inflation pressures for your tires, when they're cold. "Cold" means your vehicle has been sitting for at least three hours or driven no more than a mile.

### **NOTICE:**

**Don't let anyone tell you that underinflation or overinflation is all right. It's not. If your tires don't have enough air (underinflation) you can get:**

- Too much flexing
- Too much heat
- Tire overloading
- Bad wear
- Bad handling
- Bad fuel economy.

**If your tires have too much air (overinflation), you can get:**

- Unusual wear
- Bad handling
- Rough ride
- Needless damage from road hazards.

### ***When to Check***

Check your tires once a month or more.

Don't forget your compact spare tire. It should be at 60 psi (420 kPa).

### ***How to Check***

Use a good quality pocket-type gage to check tire pressure. Simply looking at the tires will not tell you the pressure, especially if you have radial tires — which may look properly inflated even if they're underinflated.

If your tires have valve caps, be sure to put them back on. They help prevent leaks by keeping out dirt and moisture.



## ***Tire Inspection and Rotation***

Tires should be inspected every 6,000 to 8,000 miles (10 000 to 13 000 km) for any signs of unusual wear. If unusual wear is present, rotate your tires as soon as possible and check wheel alignment. Also check for damaged tires or wheels. See “When it’s Time for New Tires” and “Wheel Replacement” later in this section for more information.

The purpose of regular rotation is to achieve more uniform wear for all tires on the vehicle. The first rotation is the most important. See “Scheduled Maintenance Services” in the Index for scheduled rotation intervals.

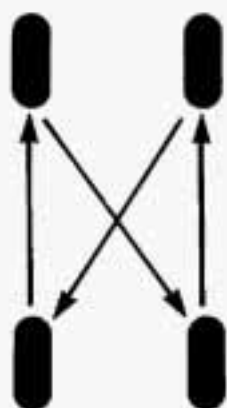

When rotating your tires, always use the correct rotation pattern shown here.

Don't include the compact spare tire in your tire rotation.

After the tires have been rotated, adjust the front and rear inflation pressures as shown on the Certification/Tire label. Make certain that all wheel nuts are properly tightened. See “Wheel Nut Torque” in the Index.



### **CAUTION:**

**Rust or dirt on a wheel, or on the parts to which it is fastened, can make wheel nuts become loose after a time. The wheel could come off and cause an accident. When you change a wheel, remove any rust or dirt from places where the wheel attaches to the vehicle. In an emergency, you can use a cloth or a paper towel to do this; but be sure to use a scraper or wire brush later, if you need to, to get all the rust or dirt off. (See “Changing a Flat Tire” in the Index.)**

## ***When it's Time for New Tires***



### **Tread Wear Indicators**

One way to tell when it's time for new tires is to check the treadwear indicators, which will appear when your tires have only 1/16 inch (1.6 mm) or less of tread remaining.

You need a new tire if:

- You can see the indicators at three or more places around the tire.
- You can see cord or fabric showing through the tire's rubber.
- The tread or sidewall is cracked, cut or snagged deep enough to show cord or fabric.
- The tire has a bump, bulge or split.
- The tire has a puncture, cut, or other damage that can't be repaired well because of the size or location of the damage.

## ***Buying New Tires***

To find out what kind and size of tires you need, look at the Certification/Tire label.

The tires installed on your vehicle when it was new had a Tire Performance Criteria Specification (TPC Spec) number on each tire's sidewall. When you get new tires, get ones with that same TPC Spec number. That way, your vehicle will continue to have tires that are designed to give proper endurance, handling, speed rating, traction, ride and other things during normal service on your vehicle. If your tires have an all-season tread design, the TPC number will be followed by an "MS" (for mud and snow).

If you ever replace your tires with those not having a TPC Spec number, make sure they are the same size, load range, speed rating and construction type (bias, bias-belted or radial) as your original tires.



## **CAUTION:**

**Mixing tires could cause you to lose control while driving. If you mix tires of different sizes or types (radial and bias-belted tires), the vehicle may not handle properly, and you could have a crash. Be sure to use the same size and type tires on all four wheels.**

**It's all right to drive with your compact spare, though. It was developed for use on your vehicle.**

### ***Uniform Tire Quality Grading***

The following information relates to the system developed by the United States National Highway Traffic Safety Administration which grades tires by treadwear, traction and temperature performance. (This applies only to vehicles sold in the United States.)

#### ***Treadwear***

The treadwear grade is a comparative rating based on the wear rate of the tire when tested under controlled conditions on a specified government test course. For example, a tire graded 150 would wear one and a half (1 1/2) times as well on the government course as a tire graded 100. The relative performance of tires depends upon the actual conditions of their use, however, and may depart significantly from the norm due to variations in driving habits, service practices and differences in road characteristics and climate.

#### ***Traction – A, B, C***

The traction grades, from highest to lowest are: A, B, and C. They represent the tire's ability to stop on wet pavement as measured under controlled conditions on specified government test surfaces of asphalt and concrete. A tire marked C may have poor traction performance.

Warning: The traction grade assigned to this tire is based on braking (straight-ahead) traction tests and does not include cornering (turning) traction.

#### ***Temperature – A, B, C***

The temperature grades are A (the highest), B, and C, representing the tire's resistance to the generation of heat and its ability to dissipate heat when tested under controlled conditions on a specified indoor laboratory test wheel. Sustained high temperature can cause the material of the tire to degenerate and reduce tire life, and excessive temperature can lead to

sudden tire failure. The grade C corresponds to a level of performance which all passenger car tires must meet under the Federal Motor Vehicle Safety Standard No. 109. Grades B and A represent higher levels of performance on the laboratory test wheel than the minimum required by law.

**Warning:** The temperature grade for this tire is established for a tire that is properly inflated and not overloaded. Excessive speed, underinflation, or excessive loading, either separately or in combination, can cause heat buildup and possible tire failure.

These grades are molded on the sidewalls of passenger car tires.

While the tires available as standard or optional equipment on General Motors vehicles may vary with respect to these grades, all such tires meet General Motors performance standards and have been approved for use on General Motors vehicles. All passenger type (P Metric) tires must conform to Federal safety requirements in addition to these grades.

### ***Wheel Alignment and Tire Balance***

The wheels on your vehicle were aligned and balanced carefully at the factory to give you the longest tire life and best overall performance.

In most cases, you will not need to have your wheels aligned again. However, if you notice unusual tire wear or your vehicle pulling one way or the other, the alignment may need to be reset. If you notice your vehicle vibrating when driving on a smooth road, your wheels may need to be rebalanced.

### ***Wheel Replacement***

Replace any wheel that is bent, cracked, or badly rusted or corroded. If wheel nuts keep coming loose, the wheel, wheel bolts, and wheel nuts should be replaced. If the wheel leaks air, replace it (except some aluminum wheels, which can sometimes be repaired). See your GM dealer if any of these conditions exist.

Your dealer will know the kind of wheel you need.

Each new wheel should have the same load carrying capacity, diameter, width, offset, and be mounted the same way as the one it replaces.

If you need to replace any of your wheels, wheel bolts, or wheel nuts, replace them only with new GM original equipment parts. This way, you will be sure to have the right wheel, wheel bolts, and wheel nuts for your GM model.



### **CAUTION:**

**Using the wrong replacement wheels, wheel bolts, or wheel nuts on your vehicle can be dangerous. It could affect the braking and handling of your vehicle, make your tires lose air and make you lose control. You could have a collision in which you or others could be injured. Always use the correct wheel, wheel bolts, and wheel nuts for replacement.**

### **NOTICE:**

**The wrong wheel can also cause problems with bearing life, brake cooling, speedometer/odometer calibration, headlamp aim, bumper height, vehicle ground clearance, and tire or tire chain clearance to the body and chassis.**

#### *Used Replacement Wheels*



### **CAUTION:**

**Putting a used wheel on your vehicle is dangerous. You can't know how it's been used or how many miles it's been driven. It could fail suddenly and cause an accident. If you have to replace a wheel use a new GM original equipment wheel.**

## ***Tire Chains***

### **NOTICE:**

**If your vehicle has P235/65R15 size tires, don't use tire chains; they can damage your vehicle.**

**If you have other size tires, use tire chains only where legal and only when you must. Use only SAE Class "S" type chains that are the proper size for your tires. Install them on the rear axle tires and tighten them as tightly as possible with the ends securely fastened. Drive slowly and follow the chain manufacturer's instructions. If you can hear the chains contacting your vehicle, stop and retighten them. If the contact continues, slow down until it stops. Driving too fast or spinning the wheels with chains on will damage your vehicle.**

## ***Appearance Care***

Remember, cleaning products can be hazardous. Some are toxic. Others can burst into flame if you strike a match or get them on a hot part of the vehicle. Some are dangerous if you breathe their fumes in a closed space. When you use anything from a container to clean your vehicle, be sure to follow the manufacturer's warnings and instructions. And always open your doors or windows when you're cleaning the inside.

*Never* use these to clean your vehicle:

- Gasoline
- Benzene
- Naphtha
- Carbon Tetrachloride
- Acetone
- Paint Thinner
- Turpentine
- Lacquer Thinner
- Nail Polish Remover

They can all be hazardous — some more than others — and they can all damage your vehicle, too.

Don't use any of these unless this manual says you can. In many uses, these will damage your vehicle:

- Alcohol
- Laundry Soap
- Bleach
- Reducing Agents

## ***Cleaning the Inside of Your Vehicle***

Use a vacuum cleaner often to get rid of dust and loose dirt. Wipe vinyl or leather with a clean, damp cloth.

Your GM dealer has two GM cleaners, a solvent-type spot lifter and a foam-type powdered cleaner. They will clean normal spots and stains very well. Do not use them on vinyl or leather.

Here are some cleaning tips:

- Always read the instructions on the cleaner label.
- Clean up stains as soon as you can — before they set.
- Use a clean cloth or sponge, and change to a clean area often. A soft brush may be used if stains are stubborn.
- Use solvent-type cleaners in a well-ventilated area only. If you use them, don't saturate the stained area.
- If a ring forms after spot cleaning, clean the entire area immediately or it will set.

## ***Using Foam-Type Cleaner on Fabric***

- Vacuum and brush the area to remove any loose dirt.
- Always clean a whole trim panel or section. Mask surrounding trim along stitch or welt lines.
- Mix Multi-Purpose Powdered Cleaner following the directions on the container label.
- Use suds only and apply with a clean sponge.
- Don't saturate the material.
- Don't rub it roughly.
- As soon as you've cleaned the section, use a sponge to remove the suds.

- Rinse the section with a clean, wet sponge.
- Wipe off what's left with a slightly damp paper towel or cloth.
- Then dry it immediately with a blow dryer or a heat lamp.

## **NOTICE:**

**Be careful. A blow dryer may scorch the fabric.**

- Wipe with a clean cloth.

### ***Using Solvent-Type Cleaner on Fabric***

First, see if you have to use solvent-type cleaner at all. Some spots and stains will clean off better with just water and mild soap.

If you need to use a solvent:

- Gently scrape excess soil from the trim material with a clean, dull knife or scraper. Use very little cleaner, light pressure and clean cloths (preferably cheesecloth). Cleaning should start at the outside of the stain, "feathering" toward the center. Keep changing to a clean section of the cloth.
- When you clean a stain from fabric, immediately dry the area with a blow dryer to help prevent a cleaning ring. (See the previous NOTICE.)

### ***Fabric Protection***

Your vehicle has upholstery that has been treated with Scotchgard™ Fabric Protector, a 3M product. Scotchgard™ protects fabrics by repelling oil and water, which are the carriers of most stains. Even with this protection, you still need to clean your upholstery often to keep it looking new.

Further information on cleaning is available by calling 1-800-433-3296 (in Minnesota, 1-800-642-6167).

### ***Special Cleaning Problems***

#### ***Greasy or Oily Stains***

Such as grease, oil, butter, margarine, shoe polish, coffee with cream, chewing gum, cosmetic creams, vegetable oils, wax crayon, tar and asphalt.

- Carefully scrape off excess stain.
- Follow the solvent-type instructions described earlier.
- Shoe polish, wax crayon, tar and asphalt will stain if left on a vehicle seat fabric. They should be removed as soon as possible. Be careful, because the cleaner will dissolve them and may cause them to spread.



### ***Non-Greasy Stains***

Such as catsup, coffee (black), egg, fruit, fruit juice, milk, soft drinks, wine, vomit, urine and blood.

- Carefully scrape off excess stain, then sponge the soiled area with cool water.
- If a stain remains, follow the foam-type instructions described earlier.
- If an odor lingers after cleaning vomit or urine, treat the area with a water/baking soda solution: 1 teaspoon (5 ml) of baking soda to 1 cup (250 ml) of lukewarm water.
- If needed, clean lightly with solvent-type cleaner.

### ***Combination Stains***

Such as candy, ice cream, mayonnaise, chili sauce and unknown stains.

- Carefully scrape off excess stain, then clean with cool water and allow to dry.
- If a stain remains, clean it with solvent-type cleaner.

### ***Cleaning Vinyl***

Use warm water and a clean cloth.

- Rub with a clean, damp cloth to remove dirt. You may have to do it more than once.
- Things like tar, asphalt and shoe polish will stain if you don't get them off quickly. Use a clean cloth and a solvent-type vinyl cleaner.

### ***Cleaning the Top of the Instrument Panel***

Use only mild soap and water to clean the top surfaces of the instrument panel. Sprays containing silicones or waxes may cause annoying reflections in the windshield and even make it difficult to see through the windshield under certain conditions.

## ***Care of Safety Belts***

Keep belts clean and dry.



### **CAUTION:**

**Do not bleach or dye safety belts. If you do, it may severely weaken them. In a crash they might not be able to provide adequate protection. Clean safety belts only with mild soap and lukewarm water.**

## ***Glass***

Glass should be cleaned often. GM Glass Cleaner (GM Part No. 1050427) or a liquid household glass cleaner will remove normal tobacco smoke and dust films.

Don't use abrasive cleaners on glass, because they may cause scratches. Avoid placing decals on the inside rear window, since they may have to be scraped off later. If abrasive cleaners are used on the inside of the rear window, an electric defogger element may be damaged. Any temporary license should not be attached across the defogger grid.

## ***Cleaning the Outside of the Windshield, Backglass and Wiper Blades***

If the windshield is not clear after using the windshield washer, or if the wiper blade chatters when running, wax or other material may be on the blade or windshield.

Clean the outside of the windshield with GM Windshield Cleaner, Bon-Ami Powder<sup>®</sup> (GM Part No. 1050011). The windshield is clean if beads do not form when you rinse it with water.

Clean the blade by wiping vigorously with a cloth soaked in full strength windshield washer solvent. Then rinse the blade with water.

Wiper blades should be checked on a regular basis and replaced when worn.

## ***Weatherstrips***

Silicone grease on weatherstrips will make them last longer, seal better, and not stick or squeak. Apply silicone grease with a clean cloth at least every six months. During very cold, damp weather more frequent application may be required. (See "Recommended Fluids & Lubricants" in the Index.)

## ***Cleaning the Outside of Your Vehicle***

The paint finish on your vehicle provides beauty, depth of color, gloss retention and durability.

### ***Washing Your Vehicle***

The best way to preserve your vehicle's finish is to keep it clean by washing it often with lukewarm or cold water.

Don't wash your vehicle in the direct rays of the sun. Don't use strong soaps or chemical detergents. Use liquid hand, dish or car washing (mild detergent) soaps. Don't use cleaning agents that are petroleum based, or that contain acid or abrasives. All cleaning agents should be flushed promptly and not allowed to dry on the surface, or they could stain. Dry the finish with a soft, clean chamois or a 100% cotton towel to avoid surface scratches and water spotting.

High pressure vehicle washes may cause water to enter your vehicle.

### ***Finish Care***

Occasional waxing or mild polishing of your vehicle by hand may be necessary to remove residue from the paint finish. You can get GM approved cleaning products from your dealer. (See "Appearance Care and Materials" in the Index.)

Your vehicle has a "basecoat/clearcoat" paint finish. The clearcoat gives more depth and gloss to the colored basecoat. Always use waxes and polishes that are non-abrasive and made for a basecoat/clearcoat paint finish.

#### **NOTICE:**

**Machine compounding or aggressive polishing on a basecoat/clearcoat paint finish may dull the finish or leave swirl marks.**

Foreign materials such as calcium chloride and other salts, ice melting agents, road oil and tar, tree sap, bird droppings, chemicals from industrial chimneys, etc. can damage your vehicle's finish if they remain on painted surfaces. Wash the vehicle as soon as possible. If necessary, use non-abrasive cleaners that are marked safe for painted surfaces to remove foreign matter.

Exterior painted surfaces are subject to aging, weather and chemical fallout that can take their toll over a period of years. You can help to keep the paint finish looking new by keeping your vehicle garaged or covered whenever possible.

## ***Protecting Exterior Bright Metal Parts***

Bright metal parts should be cleaned regularly to keep their luster. Washing with water is all that is usually needed. However, you may use GM Chrome Polish on chrome or stainless steel trim, if necessary.

Use special care with aluminum trim. To avoid damaging protective trim, never use auto or chrome polish, steam or caustic soap to clean aluminum. A coating of wax, rubbed to high polish, is recommended for all bright metal parts.

## ***Aluminum Wheels (If So Equipped)***

Your aluminum wheels have a protective coating similar to the painted surface of your vehicle. Don't use strong soaps, chemicals, chrome polish, abrasive cleaners or abrasive cleaning brushes on them because you could damage this coating. After rinsing thoroughly, a wax may be applied.

### **NOTICE:**

**If you have aluminum wheels, don't use an automatic vehicle wash that has hard silicon carbide cleaning brushes. These brushes can take the protective coating off your aluminum wheels.**

## ***Tires***

To clean your tires, use a stiff brush with a tire cleaner.

When applying a tire dressing always take care to wipe off any overspray or splash from painted surfaces. Petroleum-based products may damage the paint finish.

## ***Sheet Metal Damage***

If your vehicle is damaged and requires sheet metal repair or replacement, make sure the body repair shop applies anti-corrosion material to the parts repaired or replaced to restore corrosion protection.

## ***Foreign Material***

Calcium chloride and other salts, ice melting agents, road oil and tar, tree sap, bird droppings, chemicals from industrial chimneys, and other foreign matter can damage your vehicle's finish if they remain on painted surfaces. Use cleaners that are marked safe for painted surfaces to remove foreign matter.

## ***Finish Damage***

Any stone chips, fractures or deep scratches in the finish should be repaired right away. Bare metal will corrode quickly and may develop into a major repair expense.

Minor chips and scratches can be repaired with touch-up materials available from your dealer or other service outlets. Larger areas of finish damage can be corrected in your dealer's body and paint shop.

## ***Underbody Maintenance***

Chemicals used for ice and snow removal and dust control can collect on the underbody. If these are not removed, accelerated corrosion (rust) can occur on the underbody parts such as fuel lines, frame, floor pan, and exhaust system even though they have corrosion protection.

At least every spring, flush these materials from the underbody with plain water. Clean any areas where mud and other debris can collect. Dirt packed in closed areas of the frame should be loosened before being flushed. Your dealer or an underbody vehicle washing system can do this for you.

## ***Fiberglass Springs***

### **NOTICE:**

**Don't use corrosive or acidic cleaning agents, engine degreasers, aluminum cleaning agents or other harsh solvents to clean fiberglass springs; they'll damage the springs.**

## ***Chemical Paint Spotting***

Some weather and atmospheric conditions can create a chemical fallout. Airborne pollutants can fall upon and attack painted surfaces on your vehicle. This damage can take two forms: blotchy, ringlet-shaped discolorations, and small irregular dark spots etched into the paint surface.

Although no defect in the paint job causes this, GM will repair, at no charge to the owner, the surfaces of new vehicles damaged by this fallout condition within 12 months or 12,000 miles (20 000 km) of purchase, whichever comes first.

## ***Appearance Care Materials Chart***

<b>PART NUMBER</b>	<b>SIZE</b>	<b>PRODUCT</b>	<b>USAGE</b>
1050172	16 oz. (0.473L)	Tar and Road Oil Remover	Removes old waxes, polishes, tar and road oil
1050173	16 oz. (0.473L)	Chrome Cleaner and Polish	Removes rust and corrosion on chrome and stainless steel
1050174	16 oz. (0.473L)	White Sidewall Tire Cleaner	Cleans white and black tires
1050214	32 oz. (0.946L)	Vinyl Leather Cleaner	Spot and stain removal on leather or vinyl
1050244	16 oz. (0.473L)	Fabric Cleaner	Spot and stain removal on cloth and fabric
1050427	23 oz. (0.680L)	Glass Cleaner	Glass cleaning and spot cleaning on vinyls
1050429	6 lbs. (2.72 kg)	Multi-Purpose Powder Cleaner	Cleans vinyl and cloth on door trim, seats, and carpet—also tires and mats
1050729	8 oz. (0.237L)	Vinyl Top Cleaner	Cleaning of vinyl tops
1051055	16 oz. (0.473L)	Preservatone	Vinyl top dressing
1051398	8 oz. (0.237L)	Spot Lifter	Spot and stain removal on cloth and fabric
1052870	16 oz. (0.473L)	Wash-Wax (conc.)	Exterior wash
1050201	16 oz. (0.473L)	Magic Mirror Cleaner-Polish	Exterior cleaner and polish

## ***Vehicle Identification Number (VIN)***



This is the legal identifier for your vehicle. It appears on a plate in the front corner of the instrument panel, on the driver's side. You can see it if you look through the windshield from outside your vehicle. The VIN also appears on the Vehicle Certification and Service Parts labels and the certificates of title and registration.

### ***Engine Identification***

The eighth character in your VIN is the engine code. This code will help you identify your engine, specifications, and replacement parts.

# VEHICLE IDENTIFICATION NUMBER (VIN)

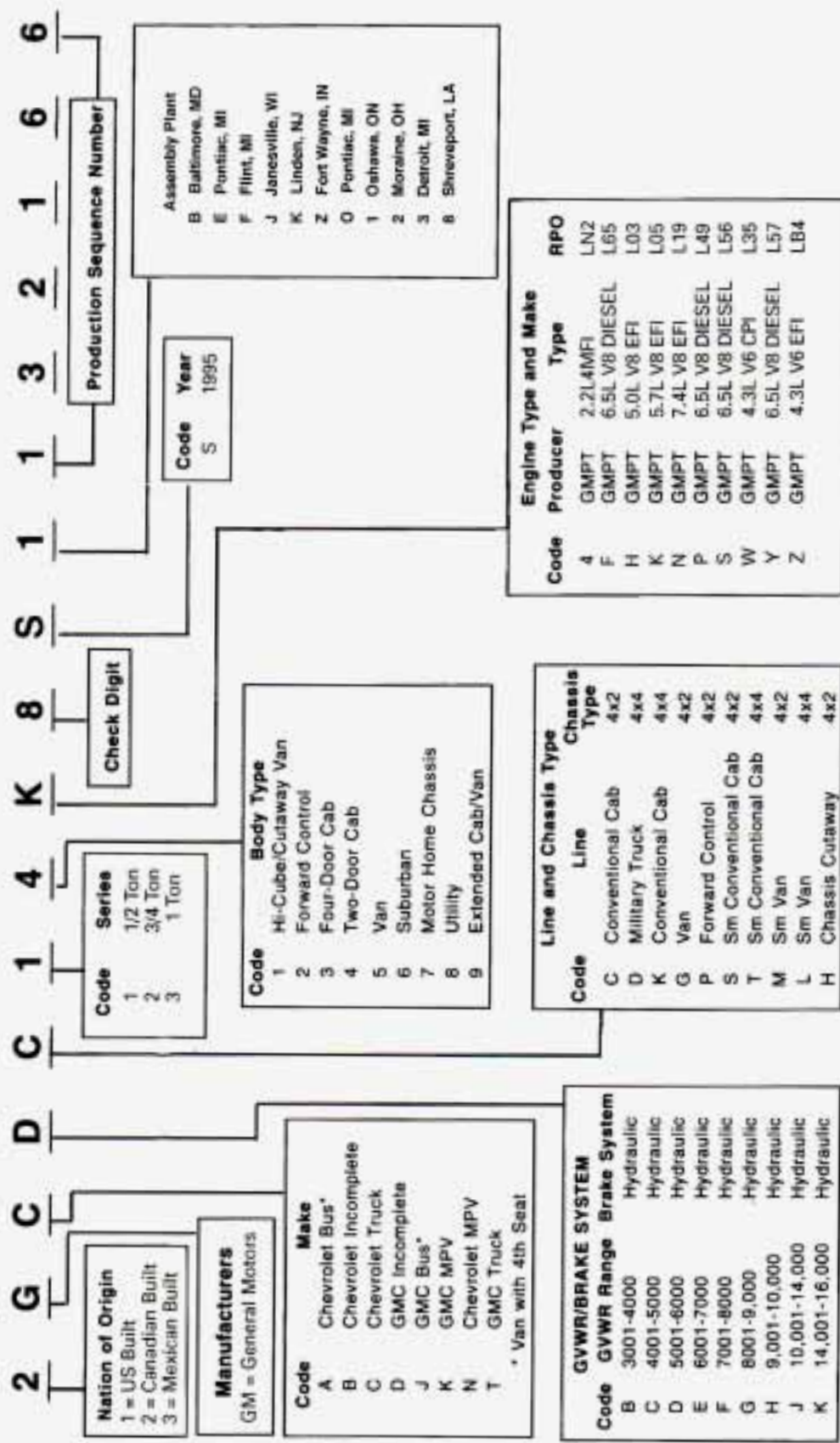



## Service Parts Identification Label

You'll find this label on the inside of the glove box door.

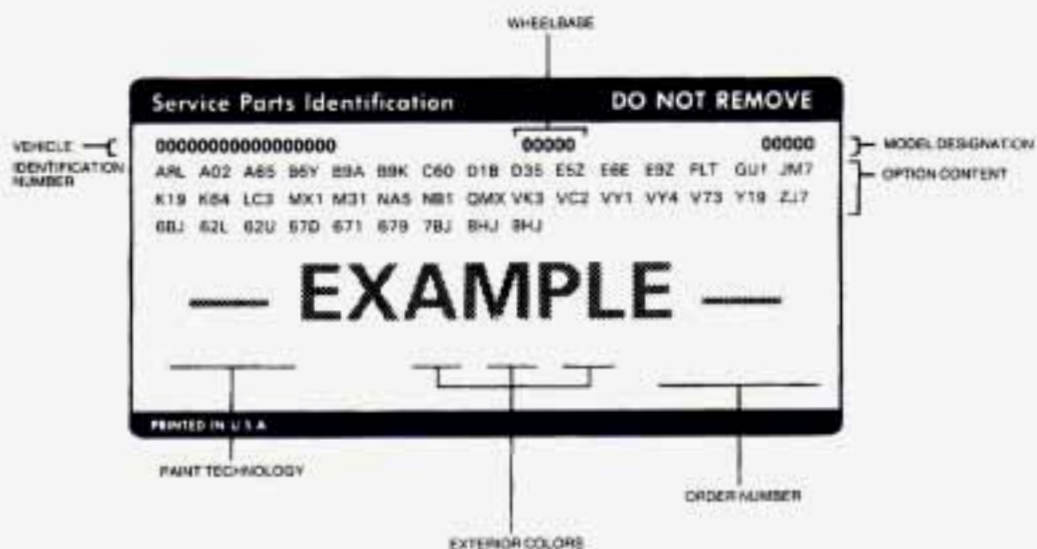

It's very helpful if you ever need to order parts. On this label is:

- your VIN,
- the model designation,
- paint information, and
- a list of all production options and special equipment.

Be sure that this label is not removed from the vehicle.

## Add-On Electrical Equipment

### NOTICE:

Don't add anything electrical to your vehicle unless you check with your dealer first. Some electrical equipment can damage your vehicle and the damage wouldn't be covered by your warranty. Some add-on electrical equipment can keep other components from working as they should.

Your vehicle has a facial air bag system. Before attempting to add anything electrical to your vehicle, see "Servicing Your Facial Air Bag-Equipped Vehicle" in the Index.

## ***Fuses and Circuit Breakers***

The wiring circuits in your vehicle are protected from short circuits by a combination of fuses, circuit breakers, and fusible thermal links in the wiring itself. This greatly reduces the chance of fires caused by electrical problems. See “Fuses and Circuit Breakers” in the Index for more information.

### ***Headlamps***

The headlamp wiring is protected by a circuit breaker in the light switch. An electrical overload will cause the lights to go on and off, or in some cases to remain off. If this happens, have your headlamp wiring checked right away.

### ***Windshield Wipers***

The windshield wiper motor is protected by a circuit breaker and a fuse. If the motor overheats due to heavy snow, etc., the wiper will stop until the motor cools. If the overload is caused by some electrical problem and not snow, etc., be sure to get it fixed.

### ***Power Windows and Other Power Options***

Circuit breakers in the fuse panel protect the power windows and other power accessories. When the current load is too heavy, the circuit breaker opens and closes, protecting the circuit until the problem is fixed or goes away.

### ***Trailer Wiring Harness***

The optional eight-wire trailer wiring harness is protected by an in-line fuse in the battery feed wire. This fuse is near the junction block. See “Trailer Wiring Harness” in the Index.

## ***Fuse Block***



The fuse block is in the instrument panel on the driver's side. Remove the cover with a screwdriver.

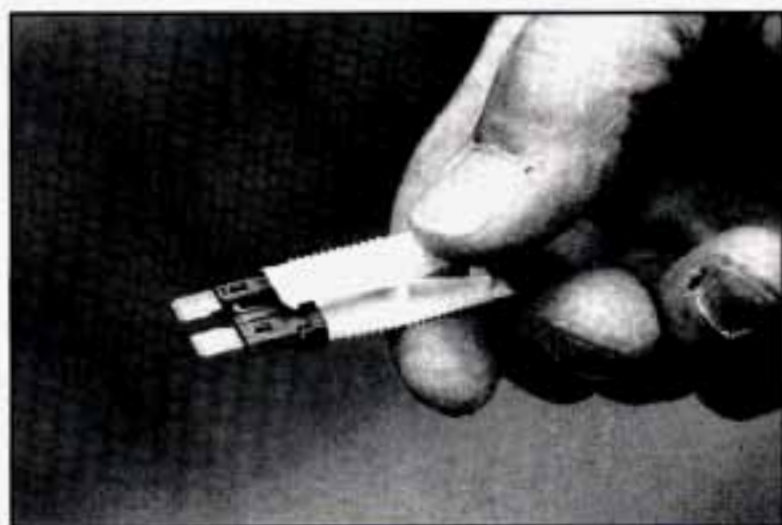

You can remove fuses with a fuse extractor.

To remove fuses if you don't have a fuse extractor, hold the end of the fuse between your thumb and index finger and pull straight out.

Be sure to use the correct fuse. If you ever have a problem on the road and don't have a spare fuse, you can "borrow" one of the correct value. Just pick some feature of your vehicle that you can get along without—like the radio or cigarette lighter—and use its fuse, if it is of the value you need. Replace it as soon as you can. See "Fuses and Circuit Breakers" in this section.

## ***Capacities and Specification Charts***

### ***Replacement Parts***

Replacement part numbers listed in this section are based on the latest information available at the time of printing, and are subject to change. If a part listed in this manual is not the same as the part used in your vehicle when it was built, or if you have any questions, please contact your GM truck dealer.

## ***Engine Identification***

Engine Description	<b>4.3L</b>
Type	V6
VIN Code	W
Fuel System	CPI**
Produced By	U.S.
Emissions	L.D.

\*\*Central Port Fuel Injection

## ***Wheel Nut Torque***

<b>DESCRIPTION</b>	<b>TORQUE</b>
Base or Optional Wheel	100 ft. lbs. (140 N•m)

## ***Cooling System Capacity***

<b>ENGINE</b>	<b>VIN CODE</b>	<b>QUANTITY* Without Rear Heater</b>	<b>QUANTITY* With Rear Heater</b>
4.3L	W	13.5 Quarts (12.8 Liters)	16.5 Quarts (15.5 Liters)

\*All quantities are approximate. After refill, the level **MUST** be checked.

## ***Crankcase Capacity***

<b>ENGINE</b>	<b>VIN CODE</b>	<b>QUANTITY* With Filter</b>
4.3L	W	4.5 Quarts (4.3 Liters)

\*All quantities are approximate. After refill, the level **MUST** be checked.  
Do not overfill.

## ***Fuel Tank Capacity***

<b>TYPE</b>	<b>QUANTITY*</b>
Standard Tank	27 Gallons (102 Liters)

\*All quantities are approximate.

## **Lamp and Bulb Data**

<b>EXTERIOR LAMPS</b>	<b>QUANTITY</b>	<b>TRADE NO.</b>
Halogen Headlamps – Sealed Beam	2	H6054
Halogen Headlamps – Composite	2	9006 (Low Beam)
Halogen Headlamps – Composite	2	9005 (High Beam)
Park, Signal Lamp	2	3157NA
Rear, Stop Lamps	2	2057
Marker Lamps	4	194
Backup Lamp	2	1156
License Lamp	1	194
CHMSL Assembly	1 Unit	See GM Dealer
<b>INTERIOR LAMPS</b>		
Dome Lamp (w/o Roof Console)	2	211-2
Dome Lamp (with Roof Console)	3	211-2
Glove Box Lamp	1	194
Heater & AC Control	2	37
Visor Vanity Mirror Lamps	4	194
Stepwell Lamp	3	211-2
Reading Lamp (with Roof Console)	4	906
Reading Lamp (w/o Roof Console)	2	906
Ashtray Lamp	1	161
Heater or A/C Control	2	194

## Instrument Cluster Lamps

**NOTE: A PC part number indicates that the bulb and base are one assembly and must be replaced as such.**

General Indicator Lamp†	1	PC74
Instrument Cluster Illum.†	1	PC94
Headlamp Beam Indicator Lamp†	1	PC74
Headlamp Beam Indicator Lamp\$	1	PC161
Malfunction Indicator Lamp (Service Engine Soon)†	1	PC74
Malfunction Indicator Lamp (Service Engine Soon)\$	1	PC194
Directional Indicator†	2	PC74
Directional Indicator\$	2	PC194
Brake Warning Indicator Lamp†	1	PC74
Brake Warning Indicator Lamp\$	1	PC194
Transmission Indicator Dial\$	1	PC194
Safety Belt Warning†	2	PC74
Safety Belt Warning\$	2	PC194
Daytime Running Lamps Indicator†	2	PC74
Daytime Running Lamps Indicator\$	2	PC161
Anti-lock Warning Indicator†	2	PC74
Anti-lock Warning Indicator\$	2	PC194
Air Bag†	2	PC74
Air Bag\$	2	PC194

†With Standard Cluster

\$With Digital Cluster

## Fuses and Circuit Breakers

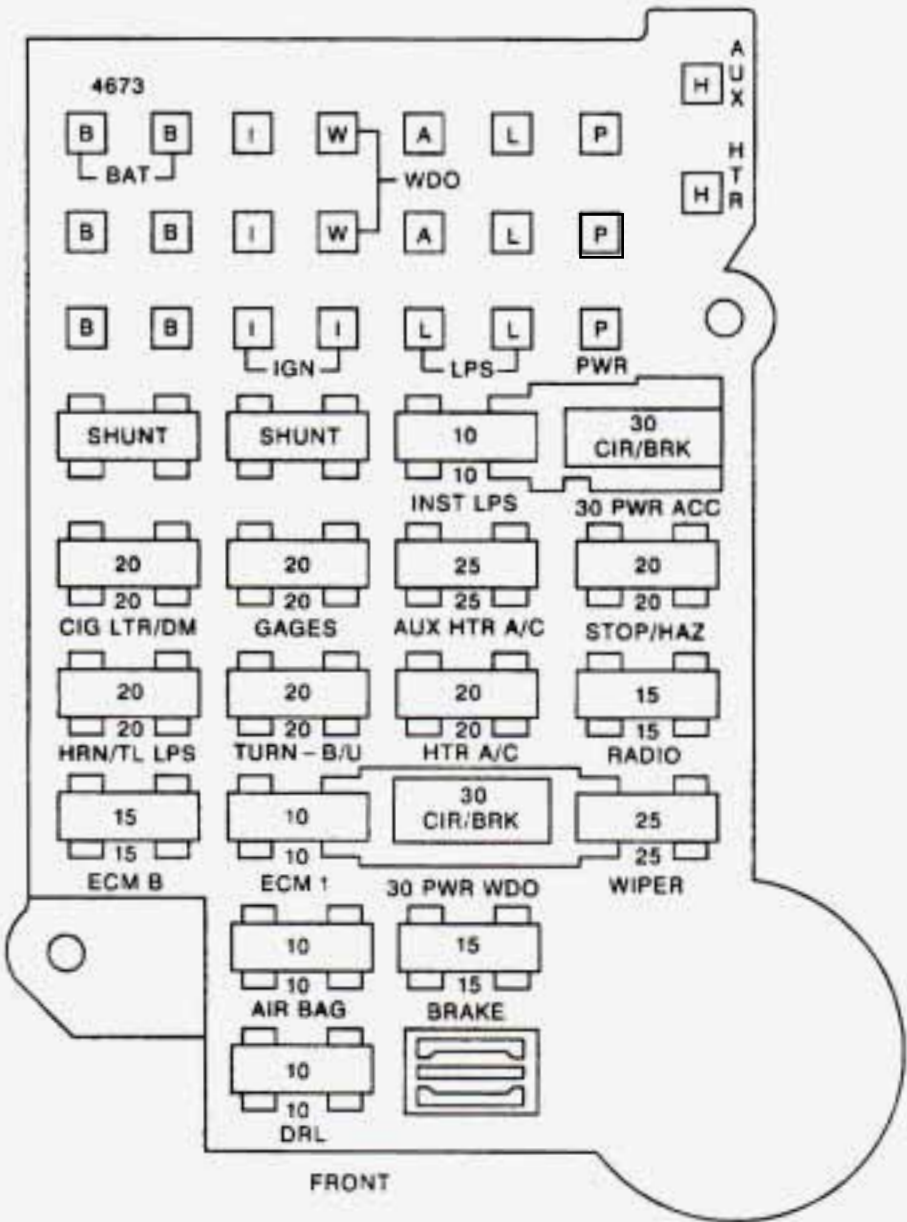

### Fuse Legend

- 5 Amp — Tan
- 7.5 Amp — Brown
- 10 Amp — Red
- 15 Amp — Blue
- 20 Amp — Yellow
- 25 Amp — Clear
- 30 Amp — Green

<b>NAME</b>	<b>CIRCUITS PROTECTED</b>	<b>FUSE</b>	<b>CIRCUIT BREAKER</b>
INST LPS	Instrument Panel Lamps, Radio Dial Lamps, Heater Lamps	10 Amp	
PWR ACCY	Power Door Locks, Power Seat		30 Amp
CIG LTR/DM	Digital Clock, Cigarette Lighter, Dome Lights, Radio Memory, Glove Box Lamp	20 Amp	
GAGES	Instrument Cluster Gages, Brake Switch, Audio Alarm, Headlight Switch Illumination, Ash Tray Illumination	20 Amp	
AUX HTR-A/C	Auxiliary Heater-Rear A/C (if equipped)	25 Amp	
STOP-HAZ	Stop Lamps, Hazard Flash, Digital Instrument Cluster	20 Amp	
HORN/TL LMPS	Headlamp Switch, Rear and Parking Lamps, Horn Relay	20 Amp	
TURN-B/U	Direction Signal Flash, Back Up Lamps	20 Amp	



<b>NAME</b>	<b>CIRCUITS PROTECTED</b>	<b>FUSE</b>	<b>CIRCUIT BREAKER</b>
HTR A/C	Front Heater & Air Conditioning	20 Amp	
RADIO	Radio	15 Amp	
ECM B	Engine Control Module	15 Amp	
ECM I	Engine Control Module	10 Amp	
PWR WDO	Power Windows		30 Amp
AIR BAG	Air Bag	10 Amp	
WIPER	Windshield Wiper	25 Amp	
BRAKE	Anti-Lock Brake System, Speedometer, Cruise Control	15 Amp	
DRL**	Canadian Daytime Running Lamps	10 Amp	
PWR MIRRORS*	Power Mirror	3 Amp	
TRAILER*	Trailer Wiring Harness	30 Amp	

\*In-line fuse

\*\*Canada only

\*\*\*In-line fuse (certain models)

## ***Service Replacement Part and Filter Recommendations***

<b>ENGINE (VIN)</b>	<b>4.3L (W)</b>
<b>OIL FILTER</b>	PF52
<b>AIR CLEANER FILTER</b>	A1163C
<b>PCV VALVE</b>	CV774C
<b>SPARK PLUGS*</b>	.CR43TSM
<b>FUEL FILTER</b>	GF481
<b>RADIATOR CAP</b>	RC27

\*Use copper-cored resistor type spark plugs.

## ***Air Conditioning Refrigerants***

Not all air conditioning refrigerants are the same. If the air conditioning system in your vehicle needs refrigerant, be sure the proper refrigerant is used. If you're not sure, ask your GM dealer. For additional information, see your "Warranty and Owner Assistance Information" booklet.

Refrigerant should be added only by a qualified A/C technician.

## ***Air Conditioning Refrigerant Capacity***

<b>TYPE</b>	<b>SYSTEM</b>	<b>QUANTITY*</b>
R-134a	C-60**	2.00 lbs. (.91 kg)
R-134a	C-69***	3.00 lbs. (1.36 kg)

\*All Quantities Are Approximate

\*\*Front A/C Only

\*\*\*Front & Rear A/C

### **NOTICE:**

**R-134a refrigerant is not compatible with R-12 refrigerant in an air conditioning system. R-12 in an R-134a system will cause compressor failure, refrigerant oil sludge, or poor air conditioning system performance.**

## ***Scheduled Maintenance Services***

### ***Section***

#### **IMPORTANT:**

**KEEP ENGINE OIL  
AT THE PROPER  
LEVEL AND CHANGE  
AS RECOMMENDED**

# **7**

This section covers the maintenance required for your vehicle. Your vehicle needs these services to retain its safety, dependability and emission control performance.



*Have you purchased the GM Protection Plan? The Plan supplements your new vehicle warranties. See your GM dealer for details.*

### ***Introduction***

#### ***Your Vehicle and the Environment***

Proper vehicle maintenance not only helps to keep your vehicle in good working condition, but also helps the environment. All recommended maintenance procedures are important. Improper vehicle maintenance or the removal of important components can significantly affect the quality of the air we breathe. Improper fluid levels or even the wrong tire inflation can increase the level of emissions from your vehicle. To help protect our environment, and to help keep your vehicle in good condition, please maintain your vehicle properly.

## ***How This Section is Organized***

The remainder of this section is divided into five parts:

**“Part A: Scheduled Maintenance Services”** shows what to have done and how often. Some of these services can be complex, so unless you are technically qualified and have the necessary equipment, you should let your dealer’s service department or another qualified service center do these jobs.



### **CAUTION:**

**Performing maintenance work on a vehicle can be dangerous. In trying to do some jobs, you can be seriously injured. Do your own maintenance work only if you have the required know-how and the proper tools and equipment for the job. If you have any doubt, have a qualified technician do the work.**

If you are skilled enough to do some work on your vehicle, you will probably want to get the service information GM publishes. You will find a list of publications and how to get them in this manual. See “Service Publications” in the Index.

**“Part B: Owner Checks and Services”** tells you what should be checked whenever you stop for fuel. It also explains what you can easily do to help keep your vehicle in good condition.

**“Part C: Periodic Maintenance Inspections”** explains important inspections that your GM dealer’s service department or another qualified service center should perform.

**“Part D: Recommended Fluids and Lubricants”** lists some products GM recommends to help keep your vehicle properly maintained. These products, or their equivalents, should be used whether you do the work yourself or have it done.

**“Part E: Maintenance Record”** provides a place for you to record the maintenance performed on your vehicle. Whenever any maintenance is performed, be sure to write it down in this part. This will help you determine when your next maintenance should be done. In addition, it is a good idea to keep your maintenance receipts. They may be needed to qualify your vehicle for warranty repairs.

## ***Part A: Scheduled Maintenance Services***

### ***Using Your Maintenance Schedule***

We at General Motors want to help you keep your vehicle in good working condition. But we don't know exactly how you'll drive it. You may drive very short distances only a few times a week. Or you may drive long distances all the time in very hot, dusty weather. You may use your vehicle in making deliveries. Or you may drive it to work, to do errands or in many other ways.

Because of all the different ways people use their GM vehicles, maintenance needs vary. You may even need more frequent checks and replacements than you'll find in the schedules in this section. So please read this section and note how you drive. If you have any questions on how to keep your vehicle in good condition, see your GM dealer.

This part tells you the maintenance services you should have done and when you should schedule them. If you go to your dealer for your service needs, you'll know that GM-trained and supported service people will perform the work using genuine GM parts.

The proper fluids and lubricants to use are listed in Part D. Make sure whoever services your vehicle uses these. All parts should be replaced and all necessary repairs done before you or anyone else drives the vehicle.

These schedules are for vehicles that:

- carry passengers and cargo within recommended limits. You will find these limits on your vehicle's Certification/Tire label. See "Loading Your Vehicle" in the Index.
- are driven on reasonable road surfaces within legal driving limits.
- use the recommended unleaded fuel. See "Fuel" in the Index.

### ***Selecting the Right Schedule***

First you'll need to decide which of the two schedules is right for your vehicle. Here's how to decide which schedule to follow:

## **Schedule I Definition**

Follow Maintenance Schedule I if any one of these is true for your vehicle:

- Most trips are less than 5 to 10 miles (8 to 16 km). This is particularly important when outside temperatures are below freezing.
- Most trips include extensive idling (such as frequent driving in stop and go traffic).
- Most trips are through dusty areas.
- You frequently tow a trailer or use a carrier on top of your vehicle.

Schedule I should also be followed if the vehicle is used for delivery service, police, taxi, or other commercial application.

## **Schedule I Intervals**

### **Every 3,000 Miles (5 000 km) or 3 Months**

Engine Oil and Filter Change

Chassis Lubrication

Drive Axle Service

### **At 6,000 Miles (10 000 km) – Then Every 12,000 Miles (25 000 km)**

Tire Rotation

### **Every 15,000 Miles (25 000 km)**

Air Cleaner Filter Inspection, if driving in dusty conditions

Front Wheel Bearing Repack (2WD Only)

### **Every 30,000 Miles (50 000 km)**

Air Cleaner Filter Replacement

Spark Plug Replacement

Fuel Filter Replacement

Cooling System Service (or every 24 months)

### **Every 50,000 Miles (83 000 km)**

Automatic Transmission Service (severe conditions)

### ***Every 60,000 Miles (100 000 km)***

Engine Accessory Drive Belt Inspection

Spark Plug Wire Inspection

Engine Timing Check

Fuel Tank, Cap and Lines Inspection

### ***Schedule II Definition***

Follow Schedule II *only* if none of the conditions from Schedule I is true.

### ***Schedule II Intervals***

#### ***Every 7,500 Miles (12 500 km)***

Engine Oil and Filter Change (or every 12 months)

Chassis Lubrication (or every 12 months)

Drive Axle Service

#### ***At 7,500 Miles (12 500 km) – Then Every 15,000 Miles (25 000 km)***

Tire Rotation

#### ***Every 30,000 Miles (50 000 km)***

Cooling System Service (or every 24 months)

Spark Plug Replacement

Fuel Filter Replacement

Air Cleaner Filter Replacement

Front Wheel Bearing Repack (2-Wheel Drive Only)

#### ***Every 50,000 Miles (83 000 km)***

Automatic Transmission Service (severe conditions)

#### ***Every 60,000 Miles (100 000 km)***

Spark Plug Wire Inspection

Engine Accessory Drive Belt Inspection

Fuel Tank, Cap and Lines Inspection

Engine Timing Check

## Maintenance Schedule I

The services shown in this schedule up to 100,000 miles (166 000 km) should be performed after 100,000 miles (166 000 km) at the same intervals.

### Footnotes

† The California Air Resources Board has determined that the failure to perform this maintenance item will not nullify the emission warranty or limit recall liability prior to the completion of vehicle useful life. We, however, urge that all recommended maintenance services be performed at the indicated intervals and the maintenance be recorded.

\*\* Drive axle service:

- Locking Differential — Drain fluid and refill at first engine oil change. At subsequent oil changes, check fluid level and add fluid as needed. If driving in dusty areas or towing a trailer, drain fluid and refill every 15,000 miles (25 000 km).
- Standard Differential — Check fluid level and add fluid as needed at every oil change. If driving in dusty areas or towing a trailer, drain fluid and refill every 15,000 miles (25 000 km).
- More frequent lubrication may be required for heavy-duty use.

### 3,000 Miles (5 000 km)

- Change engine oil and filter (or every 3 months, whichever occurs first). *An Emission Control Service.*
- Lubricate the front suspension, ball joints and king pin bushings, steering linkage and transfer case shift linkage, parking brake cable guides, and brake pedal springs at every oil change (or every 6 months, whichever occurs first).
- Check rear/front axle fluid level and add fluid as needed. Check constant velocity joints and axle seals for leaking. \*\*

DATE	ACTUAL MILEAGE	SERVICED BY:



## Maintenance Schedule I

### 6,000 Miles (10 000 km)

- Change engine oil and filter (or every 3 months, whichever occurs first). *An Emission Control Service.*
- Lubricate the front suspension, ball joints and king pin bushings, steering linkage and transfer case shift linkage, parking brake cable guides, and brake pedal springs at every oil change (or every 6 months, whichever occurs first).
- Check rear/front axle fluid level and add fluid as needed. Check constant velocity joints and axle seals for leaking. \*\*
- Rotate tires. See "Tire Inspection and Rotation" in the Index for proper rotation pattern and additional information.

DATE	ACTUAL MILEAGE	SERVICED BY:

### 9,000 Miles (15 000 km)

- Change engine oil and filter (or every 3 months, whichever occurs first). *An Emission Control Service.*
- Lubricate the front suspension, ball joints and king pin bushings, steering linkage and transfer case shift linkage, parking brake cable guides, and brake pedal springs at every oil change (or every 6 months, whichever occurs first).
- Check rear/front axle fluid level and add fluid as needed. Check constant velocity joints and axle seals for leaking. \*\*

DATE	ACTUAL MILEAGE	SERVICED BY:

## Maintenance Schedule I

### 12,000 Miles (20 000 km)

- Change engine oil and filter (or every 3 months, whichever occurs first). *An Emission Control Service.*
- Lubricate the front suspension, ball joints and king pin bushings, steering linkage and transfer case shift linkage, parking brake cable guides, and brake pedal springs at every oil change (or every 6 months, whichever occurs first).
- Check rear/front axle fluid level and add fluid as needed. Check constant velocity joints and axle seals for leaking. \*\*

DATE	ACTUAL MILEAGE	SERVICED BY:

### 15,000 Miles (25 000 km)

- Change engine oil and filter (or every 3 months, whichever occurs first). *An Emission Control Service.*
- Lubricate the front suspension, ball joints and king pin bushings, steering linkage and transfer case shift linkage, parking brake cable guides, and brake pedal springs at every oil change (or every 6 months, whichever occurs first).
- Inspect air cleaner filter if you are driving in dusty conditions. Replace filter if necessary. *An Emission Control Service.*
- Check rear/front axle fluid level and add fluid as needed. Check constant velocity joints and axle seals for leaking. \*\*
- Clean and repack the front wheel bearings (or at each brake relining, whichever occurs first).

DATE	ACTUAL MILEAGE	SERVICED BY:

## Maintenance Schedule I

### 18,000 Miles (30 000 km)

- Change engine oil and filter (or every 3 months, whichever occurs first). *An Emission Control Service.*
- Lubricate the front suspension, ball joints and king pin bushings, steering linkage and transfer case shift linkage, parking brake cable guides, and brake pedal springs at every oil change (or every 6 months, whichever occurs first).
- Check rear/front axle fluid level and add fluid as needed. Check constant velocity joints and axle seals for leaking. \*\*
- Rotate tires. See "Tire Inspection and Rotation" in the Index for proper rotation pattern and additional information.

DATE	ACTUAL MILEAGE	SERVICED BY:

### 21,000 Miles (35 000 km)

- Change engine oil and filter (or every 3 months, whichever occurs first). *An Emission Control Service.*
- Lubricate the front suspension, ball joints and king pin bushings, steering linkage and transfer case shift linkage, parking brake cable guides, and brake pedal springs at every oil change (or every 6 months, whichever occurs first).
- Check rear/front axle fluid level and add fluid as needed. Check constant velocity joints and axle seals for leaking. \*\*

DATE	ACTUAL MILEAGE	SERVICED BY:

## Maintenance Schedule I

### 24,000 Miles (40 000 km)

- Change engine oil and filter (or every 3 months, whichever occurs first). *An Emission Control Service.*
- Lubricate the front suspension, ball joints and king pin bushings, steering linkage and transfer case shift linkage, parking brake cable guides, and brake pedal springs at every oil change (or every 6 months, whichever occurs first).
- Check rear/front axle fluid level and add fluid as needed. Check constant velocity joints and axle seals for leaking. \*\*

DATE	ACTUAL MILEAGE	SERVICED BY:

### 27,000 Miles (45 000 km)

- Change engine oil and filter (or every 3 months, whichever occurs first). *An Emission Control Service.*
- Lubricate the front suspension, ball joints and king pin bushings, steering linkage and transfer case shift linkage, parking brake cable guides, and brake pedal springs at every oil change (or every 6 months, whichever occurs first).
- Check rear/front axle fluid level and add fluid as needed. Check constant velocity joints and axle seals for leaking. \*\*

DATE	ACTUAL MILEAGE	SERVICED BY:

## Maintenance Schedule I

### 30,000 Miles (50 000 km)

- Change engine oil and filter (or every 3 months, whichever occurs first). *An Emission Control Service.*
- Lubricate the front suspension, ball joints and king pin bushings, steering linkage and transfer case shift linkage, parking brake cable guides, and brake pedal springs at every oil change (or every 6 months, whichever occurs first).
- Check rear/front axle fluid level and add fluid as needed. Check constant velocity joints and axle seals for leaking.\*\*
- Inspect engine accessory drive belts (or every 24 months, whichever occurs first). *An Emission Control Service*
- Drain, flush and refill cooling system (or every 24 months, whichever occurs first). See "Engine Coolant" in the Index for what to use. Inspect hoses. Clean radiator, condenser, pressure cap and neck. Pressure test the cooling system and pressure cap. *An Emission Control Service.*
- Clean and repack the front wheel bearings (or at each brake relining, whichever occurs first).
- Replace spark plugs. *An Emission Control Service.*
- Replace air cleaner filter. Replace filter more often under dusty conditions. *An Emission Control Service.*
- Rotate tires. See "Tire Inspection and Rotation" in the Index for proper rotation pattern and additional information.

DATE	ACTUAL MILEAGE	SERVICED BY:

## Maintenance Schedule I

### 33,000 Miles (55 000 km)

- Change engine oil and filter (or every 3 months, whichever occurs first). *An Emission Control Service.*
- Lubricate the front suspension, ball joints and king pin bushings, steering linkage and transfer case shift linkage, parking brake cable guides, and brake pedal springs at every oil change (or every 6 months, whichever occurs first).
- Check rear/front axle fluid level and add fluid as needed. Check constant velocity joints and axle seals for leaking.\*\*

DATE	ACTUAL MILEAGE	SERVICED BY:

### 36,000 Miles (60 000 km)

- Change engine oil and filter (or every 3 months, whichever occurs first). *An Emission Control Service.*
- Lubricate the front suspension, ball joints and king pin bushings, steering linkage and transfer case shift linkage, parking brake cable guides, and brake pedal springs at every oil change (or every 6 months, whichever occurs first).
- Check rear/front axle fluid level and add fluid as needed. Check constant velocity joints and axle seals for leaking.\*\*

DATE	ACTUAL MILEAGE	SERVICED BY:

## Maintenance Schedule I

### 39,000 Miles (65 000 km)

- Change engine oil and filter (or every 3 months, whichever occurs first). *An Emission Control Service.*
- Lubricate the front suspension, ball joints and king pin bushings, steering linkage and transfer case shift linkage, parking brake cable guides, and brake pedal springs at every oil change (or every 6 months, whichever occurs first).
- Check rear/front axle fluid level and add fluid as needed. Check constant velocity joints and axle seals for leaking.\*\*

DATE	ACTUAL MILEAGE	SERVICED BY:

### 42,000 Miles (70 000 km)

- Change engine oil and filter (or every 3 months, whichever occurs first). *An Emission Control Service.*
- Lubricate the front suspension, ball joints and king pin bushings, steering linkage and transfer case shift linkage, parking brake cable guides, and brake pedal springs at every oil change (or every 6 months, whichever occurs first).
- Check rear/front axle fluid level and add fluid as needed. Check constant velocity joints and axle seals for leaking.\*\*
- Rotate tires. See "Tire Inspection and Rotation" in the Index for proper rotation pattern and additional information.

DATE	ACTUAL MILEAGE	SERVICED BY:

## Maintenance Schedule I

### 45,000 Miles (75 000 km)

- Change engine oil and filter (or every 3 months, whichever occurs first). *An Emission Control Service.*
- Lubricate the front suspension, ball joints and king pin bushings, steering linkage and transfer case shift linkage, parking brake cable guides, and brake pedal springs at every oil change (or every 6 months, whichever occurs first).
- Check rear/front axle fluid level and add fluid as needed. Check constant velocity joints and axle seals for leaking.\*\*
- Inspect air cleaner filter if you are driving in dusty conditions. Replace filter if necessary. *An Emission Control Service.*

DATE	ACTUAL MILEAGE	SERVICED BY:

### 48,000 Miles (80 000 km)

- Change engine oil and filter (or every 3 months, whichever occurs first). *An Emission Control Service.*
- Lubricate the front suspension, ball joints and king pin bushings, steering linkage and transfer case shift linkage, parking brake cable guides, and brake pedal springs at every oil change (or every 6 months, whichever occurs first).
- Check rear/front axle fluid level and add fluid as needed. Check constant velocity joints and axle seals for leaking.\*\*

DATE	ACTUAL MILEAGE	SERVICED BY:



## Maintenance Schedule I

### 50,000 Miles (83 000 km)

- Change automatic transmission fluid and filter if the vehicle is mainly driven under one or more of these conditions:
  - In heavy city traffic where the outside temperature regularly reaches 90°F (32°C) or higher.
  - In hilly or mountainous terrain.
  - When doing frequent trailer towing.
  - Uses such as found in taxi, police or delivery service.

*If you do not use your vehicle under any of these conditions, the fluid and filter do not require changing.*

DATE	ACTUAL MILEAGE	SERVICED BY:

### 51,000 Miles (85 000 km)

- Change engine oil and filter (or every 3 months, whichever occurs first). *An Emission Control Service.*
- Lubricate the front suspension, ball joints and king pin bushings, steering linkage and transfer case shift linkage, parking brake cable guides, and brake pedal springs at every oil change (or every 6 months, whichever occurs first).
- Check rear/front axle fluid level and add fluid as needed. Check constant velocity joints and axle seals for leaking.\*\*

DATE	ACTUAL MILEAGE	SERVICED BY:

## Maintenance Schedule I

### 54,000 Miles (90 000 km)

- Change engine oil and filter (or every 3 months, whichever occurs first). *An Emission Control Service.*
- Lubricate the front suspension, ball joints and king pin bushings, steering linkage and transfer case shift linkage, parking brake cable guides, and brake pedal springs at every oil change (or every 6 months, whichever occurs first).
- Check rear/front axle fluid level and add fluid as needed. Check constant velocity joints and axle seals for leaking.\*\*
- Rotate tires. See "Tire Inspection and Rotation" in the Index for proper rotation pattern and additional information.

DATE	ACTUAL MILEAGE	SERVICED BY:

### 57,000 Miles (95 000 km)

- Change engine oil and filter (or every 3 months, whichever occurs first). *An Emission Control Service.*
- Lubricate the front suspension, ball joints and king pin bushings, steering linkage and transfer case shift linkage, parking brake cable guides, and brake pedal springs at every oil change (or every 6 months, whichever occurs first).
- Check rear/front axle fluid level and add fluid as needed. Check constant velocity joints and axle seals for leaking.\*\*

DATE	ACTUAL MILEAGE	SERVICED BY:

## Maintenance Schedule I

### 60,000 Miles (100 000 km)

- Change engine oil and filter (or every 3 months, whichever occurs first). *An Emission Control Service.*
- Lubricate the front suspension, ball joints and king pin bushings, steering linkage and transfer case shift linkage, parking brake cable guides, and brake pedal springs at every oil change (or every 6 months, whichever occurs first).
- Check rear/front axle fluid level and add fluid as needed. Check constant velocity joints and axle seals for leaking.\*\*
- Inspect engine accessory drive belt (or every 24 months, whichever occurs first). *An Emission Control Service.*
- Drain, flush and refill cooling system (or every 24 months, whichever occurs first). See "Engine Coolant" in the Index for what to use. Inspect hoses. Clean radiator, condenser, pressure cap and neck. Pressure test the cooling system and pressure cap. *An Emission Control Service.*
- Replace spark plugs. *An Emission Control Service.*
- Inspect spark plug wires. *An Emission Control Service.* †
- Replace air cleaner filter. Replace filter more often under dusty conditions. *An Emission Control Service.*
- Inspect fuel tank, cap and lines for damage or leaks . Inspect fuel cap gasket for any damage. Replace parts as needed. *An Emission Control Service.* †

DATE	ACTUAL MILEAGE	SERVICED BY:

## Maintenance Schedule I

### 63,000 Miles (105 000 km)

- Change engine oil and filter (or every 3 months, whichever occurs first). *An Emission Control Service.*
- Lubricate the front suspension, ball joints and king pin bushings, steering linkage and transfer case shift linkage, parking brake cable guides, and brake pedal springs at every oil change (or every 6 months, whichever occurs first).
- Check rear/front axle fluid level and add fluid as needed. Check constant velocity joints and axle seals for leaking.\*\*

DATE	ACTUAL MILEAGE	SERVICED BY:

### 66,000 Miles (110 000 km)

- Change engine oil and filter (or every 3 months, whichever occurs first). *An Emission Control Service.*
- Lubricate the front suspension, ball joints and king pin bushings, steering linkage and transfer case shift linkage, parking brake cable guides, and brake pedal springs at every oil change (or every 6 months, whichever occurs first).
- Check rear/front axle fluid level and add fluid as needed. Check constant velocity joints and axle seals for leaking.\*\*
- Rotate tires. See "Tire Inspection and Rotation" in the Index for proper rotation pattern and additional information.

DATE	ACTUAL MILEAGE	SERVICED BY:

## Maintenance Schedule I

### 69,000 Miles (115 000 km)

- Change engine oil and filter (or every 3 months, whichever occurs first). *An Emission Control Service.*
- Lubricate the front suspension, ball joints and king pin bushings, steering linkage and transfer case shift linkage, parking brake cable guides, and brake pedal springs at every oil change (or every 6 months, whichever occurs first).
- Check rear/front axle fluid level and add fluid as needed. Check constant velocity joints and axle seals for leaking.\*\*

DATE	ACTUAL MILEAGE	SERVICED BY:

### 72,000 Miles (120 000 km)

- Change engine oil and filter (or every 3 months, whichever occurs first). *An Emission Control Service.*
- Lubricate the front suspension, ball joints and king pin bushings, steering linkage and transfer case shift linkage, parking brake cable guides, and brake pedal springs at every oil change (or every 6 months, whichever occurs first).
- Check rear/front axle fluid level and add fluid as needed. Check constant velocity joints and axle seals for leaking.\*\*

DATE	ACTUAL MILEAGE	SERVICED BY:

## Maintenance Schedule I

### 75,000 Miles (125 000 km)

- Change engine oil and filter (or every 3 months, whichever occurs first). *An Emission Control Service.*
- Lubricate the front suspension, ball joints and king pin bushings, steering linkage and transfer case shift linkage, parking brake cable guides, and brake pedal springs at every oil change (or every 6 months, whichever occurs first).
- Inspect air cleaner filter if you are driving in dusty conditions. Replace filter if necessary. *An Emission Control Service.*
- Check rear/front axle fluid level and add fluid as needed. Check constant velocity joints and axle seals for leaking.\*\*

DATE	ACTUAL MILEAGE	SERVICED BY:

### 78,000 Miles (130 000 km)

- Change engine oil and filter (or every 3 months, whichever occurs first). *An Emission Control Service.*
- Lubricate the front suspension, ball joints and king pin bushings, steering linkage and transfer case shift linkage, parking brake cable guides, and brake pedal springs at every oil change (or every 6 months, whichever occurs first).
- Check rear/front axle fluid level and add fluid as needed. Check constant velocity joints and axle seals for leaking.\*\*
- Rotate tires. See "Tire Inspection and Rotation" in the Index for proper rotation pattern and additional information.

DATE	ACTUAL MILEAGE	SERVICED BY:

## Maintenance Schedule I

### **81,000 Miles (135 000 km)**

- Change engine oil and filter (or every 3 months, whichever occurs first). *An Emission Control Service.*
- Lubricate the front suspension, ball joints and king pin bushings, steering linkage and transfer case shift linkage, parking brake cable guides, and brake pedal springs at every oil change (or every 6 months, whichever occurs first).
- Check rear/front axle fluid level and add fluid as needed. Check constant velocity joints and axle seals for leaking.\*\*

DATE	ACTUAL MILEAGE	SERVICED BY:

### **84,000 Miles (140 000 km)**

- Change engine oil and filter (or every 3 months, whichever occurs first). *An Emission Control Service.*
- Lubricate the front suspension, ball joints and king pin bushings, steering linkage and transfer case shift linkage, parking brake cable guides, and brake pedal springs at every oil change (or every 6 months, whichever occurs first).
- Check rear/front axle fluid level and add fluid as needed. Check constant velocity joints and axle seals for leaking.\*\*

DATE	ACTUAL MILEAGE	SERVICED BY:

## Maintenance Schedule I

### 87,000 Miles (145 000 km)

- Change engine oil and filter (or every 3 months, whichever occurs first). *An Emission Control Service.*
- Lubricate the front suspension, ball joints and king pin bushings, steering linkage and transfer case shift linkage, parking brake cable guides, and brake pedal springs at every oil change (or every 6 months, whichever occurs first).
- Check rear/front axle fluid level and add fluid as needed. Check constant velocity joints and axle seals for leaking.\*\*

DATE	ACTUAL MILEAGE	SERVICED BY:

### 90,000 Miles (150 000 km)

- Change engine oil and filter (or every 3 months, whichever occurs first). *An Emission Control Service.*
- Lubricate the front suspension, ball joints and king pin bushings, steering linkage and transfer case shift linkage, parking brake cable guides, and brake pedal springs at every oil change (or every 6 months, whichever occurs first).
- Check rear/front axle fluid level and add fluid as needed. Check constant velocity joints and axle seals for leaking.\*\*
- Inspect engine accessory drive belt (or every 24 months, whichever occurs first). *An Emission Control Service.*
- Drain, flush and refill cooling system (or every 24 months, whichever occurs first). See "Engine Coolant" in the Index for what to use. Inspect hoses. Clean radiator, condenser, pressure cap and neck. Pressure test the cooling system and pressure cap. *An Emission Control Service.*

(Continued)



## Maintenance Schedule I

(Continued)

- Replace spark plugs. *An Emission Control Service.*
- Replace air cleaner filter. Replace filter more often under dusty conditions. *An Emission Control Service.*
- Rotate tires. See "Tire Inspection and Rotation" in the Index for proper rotation pattern and additional information.

DATE	ACTUAL MILEAGE	SERVICED BY:

### **93,000 Miles (155 000 km)**

- Change engine oil and filter (or every 3 months, whichever occurs first). *An Emission Control Service.*
- Lubricate the front suspension, ball joints and king pin bushings, steering linkage and transfer case shift linkage, parking brake cable guides, and brake pedal springs at every oil change (or every 6 months, whichever occurs first).
- Check rear/front axle fluid level and add fluid as needed. Check constant velocity joints and axle seals for leaking.\*\*

DATE	ACTUAL MILEAGE	SERVICED BY:

## Maintenance Schedule I

### 96,000 Miles (160 000 km)

- Change engine oil and filter (or every 3 months, whichever occurs first). *An Emission Control Service.*
- Lubricate the front suspension, ball joints and king pin bushings, steering linkage and transfer case shift linkage, parking brake cable guides, and brake pedal springs at every oil change (or every 6 months, whichever occurs first).
- Check rear/front axle fluid level and add fluid as needed. Check constant velocity joints and axle seals for leaking.\*\*

DATE	ACTUAL MILEAGE	SERVICED BY:

### 99,000 Miles (165 000 km)

- Change engine oil and filter (or every 3 months, whichever occurs first). *An Emission Control Service.*
- Lubricate the front suspension, ball joints and king pin bushings, steering linkage and transfer case shift linkage, parking brake cable guides, and brake pedal springs at every oil change (or every 6 months, whichever occurs first).
- Check rear/front axle fluid level and add fluid as needed. Check constant velocity joints and axle seals for leaking.\*\*

DATE	ACTUAL MILEAGE	SERVICED BY:

## Maintenance Schedule I

### **100,000 Miles (166 000 km)**

- Change automatic transmission fluid and filter if the vehicle is mainly driven under one or more of these conditions:
- In heavy city traffic where the outside temperature regularly reaches 90°F (32°C) or higher.
  - In hilly or mountainous terrain.
  - When doing frequent trailer towing.
  - Uses such as found in taxi, police or delivery service.

*If you do not use your vehicle under any of these conditions, the fluid and filter do not require changing.*

DATE	ACTUAL MILEAGE	SERVICED BY:

## Maintenance Schedule II

The services shown in this schedule up to 100,000 miles (166 000 km) should be performed after 100,000 miles (166 000 km) at the same intervals.

### Footnotes

† The California Air Resources Board has determined that the failure to perform this maintenance item will not nullify the emission warranty or limit recall liability prior to the completion of vehicle useful life. We, however, urge that all recommended maintenance services be performed at the indicated intervals and the maintenance be recorded.

\*\* Drive axle service:

- Locking Differential — Drain fluid and refill at first engine oil change. At subsequent oil changes, check fluid level and add fluid as needed. If driving in dusty areas or towing a trailer, drain fluid and refill every 15,000 miles (25 000 km).
- Standard Differential — Check fluid level and add fluid as needed at every engine oil change. If driving in dusty areas or towing a trailer, drain fluid and refill every 15,000 miles (25 000 km).
- More frequent lubrication may be required for heavy-duty use.

### 7,500 Miles (12 500 km)

- Change engine oil and filter (or every 12 months, whichever occurs first). *An Emission Control Service.*
- Lubricate the front suspension, ball joints and king pin bushings, steering linkage and transfer case shift linkage, parking brake cable guides, and brake pedal springs at every oil change (or every 12 months, whichever occurs first).
- Check rear/front axle fluid level and add fluid as needed. Check constant velocity joints and axle seals for leaking.\*\*
- Rotate tires. See "Tire Inspection and Rotation" in the Index for proper rotation pattern and additional information.

DATE	ACTUAL MILEAGE	SERVICED BY:

## Maintenance Schedule II

### 15,000 Miles (25 000 km)

- Change engine oil and filter (or every 12 months, whichever occurs first). *An Emission Control Service.*
- Lubricate the front suspension, ball joints and king pin bushings, steering linkage and transfer case shift linkage, parking brake cable guides, and brake pedal springs at every oil change (or every 12 months, whichever occurs first).
- Check rear/front axle fluid level and add fluid as needed. Check constant velocity joints and axle seals for leaking.\*\*

DATE	ACTUAL MILEAGE	SERVICED BY:

### 22,500 Miles (37 500 km)

- Change engine oil and filter (or every 12 months, whichever occurs first). *An Emission Control Service.*
- Lubricate the front suspension, ball joints and king pin bushings, steering linkage and transfer case shift linkage, parking brake cable guides, and brake pedal springs at every oil change (or every 12 months, whichever occurs first).
- Check rear/front axle fluid level and add fluid as needed. Check constant velocity joints and axle seals for leaking.\*\*
- Rotate tires. See "Tire Inspection and Rotation" in the Index for proper rotation pattern and additional information.

DATE	ACTUAL MILEAGE	SERVICED BY:

## Maintenance Schedule II

### 30,000 Miles (50 000 km)

- Change engine oil and filter (or every 12 months, whichever occurs first). *An Emission Control Service.*
- Lubricate the front suspension, ball joints and king pin bushings, steering linkage and transfer case shift linkage, parking brake cable guides, and brake pedal springs at every oil change (or every 12 months, whichever occurs first).
- Check rear/front axle fluid level and add fluid as needed. Check constant velocity joints and axle seals for leaking.\*\*
- Inspect engine accessory drive belt (or every 24 months, whichever occurs first). *An Emission Control Service.*
- Drain, flush and refill cooling system (or every 24 months, whichever occurs first). See "Engine Coolant" in the Index for what to use. Inspect hoses. Clean radiator, condenser, pressure cap and neck. Pressure test the cooling system and pressure cap. *An Emission Control Service.*
- Replace spark plugs. *An Emission Control Service.*
- Inspect spark plug wires. *An Emission Control Service.* †
- Replace air cleaner filter. *An Emission Control Service.*

DATE	ACTUAL MILEAGE	SERVICED BY:

### 37,500 Miles (62 500 km)

- Change engine oil and filter (or every 12 months, whichever occurs first). *An Emission Control Service.*
- Lubricate the front suspension, ball joints and king pin bushings, steering linkage and transfer case shift linkage, parking brake cable guides, and brake pedal springs at every oil change (or every 12 months, whichever occurs first).

(Continued)

## Maintenance Schedule II

(Continued)

- Check rear/front axle fluid level and add fluid as needed. Check constant velocity joints and axle seals for leaking.\*\*
- Rotate tires. See "Tire Inspection and Rotation" in the Index for proper rotation pattern and additional information.

DATE	ACTUAL MILEAGE	SERVICED BY:

### **45,000 Miles (75 000 km)**

- Change engine oil and filter (or every 12 months, whichever occurs first). *An Emission Control Service.*
- Lubricate the front suspension, ball joints and king pin bushings, steering linkage and transfer case shift linkage, parking brake cable guides, and brake pedal springs at every oil change (or every 12 months, whichever occurs first).
- Check rear/front axle fluid level and add fluid as needed. Check constant velocity joints and axle seals for leaking.\*\*

DATE	ACTUAL MILEAGE	SERVICED BY:

## Maintenance Schedule II

### 50,000 Miles (83 000 km)

- Change automatic transmission fluid and filter if the vehicle is mainly driven under one or more of these conditions:
- In heavy city traffic where the outside temperature regularly reaches 90°F (32°C) or higher.
  - In hilly or mountainous terrain.
  - When doing frequent trailer towing.
  - Uses such as found in taxi, police or delivery service.

*If you do not use your vehicle under any of these conditions, the fluid and filter do not require changing.*

DATE	ACTUAL MILEAGE	SERVICED BY:

### 52,500 Miles (87 500 km)

- Change engine oil and filter (or every 12 months, whichever occurs first). *An Emission Control Service.*
- Lubricate the front suspension, ball joints and king pin bushings, steering linkage and transfer case shift linkage, parking brake cable guides, and brake pedal springs at every oil change (or every 12 months, whichever occurs first).
- Check rear/front axle fluid level and add fluid as needed. Check constant velocity joints and axle seals for leaking.\*\*
- Rotate tires. See "Tire Inspection and Rotation" in the Index for proper rotation pattern and additional information.

DATE	ACTUAL MILEAGE	SERVICED BY:



## Maintenance Schedule II

### 60,000 Miles (100 000 km)

- Change engine oil and filter (or every 12 months, whichever occurs first). *An Emission Control Service.*
- Lubricate the front suspension, ball joints and king pin bushings, steering linkage and transfer case shift linkage, parking brake cable guides, and brake pedal springs at every oil change (or every 12 months, whichever occurs first).
- Check rear/front axle fluid level and add fluid as needed. Check constant velocity joints and axle seals for leaking.\*\*
- Inspect engine accessory drive belt (or every 24 months, whichever occurs first). *An Emission Control Service.*
- Drain, flush and refill cooling system (or every 24 months, whichever occurs first). See "Engine Coolant" in the Index for what to use. Inspect hoses. Clean radiator, condenser, pressure cap and neck. Pressure test the cooling system and pressure cap. *An Emission Control Service.*
- Replace spark plugs. *An Emission Control Service.*
- Inspect spark plug wires. *An Emission Control Service.* †
- Replace air cleaner filter. *An Emission Control Service.*
- Inspect fuel tank, cap and lines for damage or leaks. Inspect fuel cap gasket for any damage. Replace parts as needed. *An Emission Control Service.* †

DATE	ACTUAL MILEAGE	SERVICED BY:

## Maintenance Schedule II

### 67,500 Miles (112 500 km)

- Change engine oil and filter (or every 12 months, whichever occurs first). *An Emission Control Service.*
- Lubricate the front suspension, ball joints and king pin bushings, steering linkage and transfer case shift linkage, parking brake cable guides, and brake pedal springs at every oil change (or every 12 months, whichever occurs first).
- Check rear/front axle fluid level and add fluid as needed. Check constant velocity joints and axle seals for leaking.\*\*
- Rotate tires. See "Tire Inspection and Rotation" in the Index for proper rotation pattern and additional information.

DATE	ACTUAL MILEAGE	SERVICED BY:

### 75,000 Miles (125 000 km)

- Change engine oil and filter (or every 12 months, whichever occurs first). *An Emission Control Service.*
- Lubricate the front suspension, ball joints and king pin bushings, steering linkage and transfer case shift linkage, parking brake cable guides, and brake pedal springs at every oil change (or every 12 months, whichever occurs first).
- Check rear/front axle fluid level and add fluid as needed. Check constant velocity joints and axle seals for leaking.\*\*

DATE	ACTUAL MILEAGE	SERVICED BY:

## Maintenance Schedule II

### 82,500 Miles (137 500 km)

- Change engine oil and filter (or every 12 months, whichever occurs first). *An Emission Control Service.*
- Lubricate the front suspension, ball joints and king pin bushings, steering linkage and transfer case shift linkage, parking brake cable guides, and brake pedal springs at every oil change (or every 12 months, whichever occurs first).
- Check rear/front axle fluid level and add fluid as needed. Check constant velocity joints and axle seals for leaking.\*\*
- Rotate tires. See "Tire Inspection and Rotation" in the Index for proper rotation pattern and additional information.

DATE	ACTUAL MILEAGE	SERVICED BY:

### 90,000 Miles (150 000 km)

- Change engine oil and filter (or every 12 months, whichever occurs first). *An Emission Control Service.*
- Lubricate the front suspension, ball joints and king pin bushings, steering linkage and transfer case shift linkage, parking brake cable guides, and brake pedal springs at every oil change (or every 12 months, whichever occurs first).
- Check rear/front axle fluid level and add fluid as needed. Check constant velocity joints and axle seals for leaking.\*\*
- Inspect engine accessory drive belt (or every 24 months, whichever occurs first). *An Emission Control Service.*
- Drain, flush and refill cooling system (or every 24 months, whichever occurs first). See "Engine Coolant" in the Index for what to use. Inspect hoses. Clean radiator, condenser, pressure cap and neck. Pressure test the cooling system and pressure cap. *An Emission Control Service.*

(Continued)

## Maintenance Schedule II

(Continued)

- Replace spark plugs. *An Emission Control Service.*
- Inspect spark plug wires. *An Emission Control Service.* †
- Replace air cleaner filter. *An Emission Control Service.*
- Inspect fuel tank, cap and lines. Inspect fuel cap gasket for any damage. Replace parts as needed. *An Emission Control Service.* †

DATE	ACTUAL MILEAGE	SERVICED BY:

### 97,500 Miles (162 500 km)

- Change engine oil and filter (or every 12 months, whichever occurs first). *An Emission Control Service.*
- Lubricate the front suspension, ball joints and king pin bushings, steering linkage and transfer case shift linkage, parking brake cable guides, and brake pedal springs at every oil change (or every 12 months, whichever occurs first).
- Check rear/front axle fluid level and add fluid as needed. Check constant velocity joints and axle seals for leaking.\*\*
- Rotate tires. See "Tire Inspection and Rotation" in the Index for proper rotation pattern and additional information.

DATE	ACTUAL MILEAGE	SERVICED BY:

## Maintenance Schedule II

### 100,000 Miles (166 000 km)

- Change automatic transmission fluid and filter if the vehicle is mainly driven under one or more of these conditions:
- In heavy city traffic where the outside temperature regularly reaches 90°F (32°C) or higher.
  - In hilly or mountainous terrain.
  - When doing frequent trailer towing.
  - Uses such as found in taxi, police or delivery service.

*If you do not use your vehicle under any of these conditions, the fluid and filter do not require changing.*

DATE	ACTUAL MILEAGE	SERVICED BY:

### Part B: Owner Checks and Services

Listed below are owner checks and services which should be performed at the intervals specified to help ensure the safety, dependability and emission control performance of your vehicle.

Be sure any necessary repairs are completed at once. Whenever any fluids or lubricants are added to your vehicle, make sure they are the proper ones, as shown in Part D.

#### At Each Fuel Fill

*It is important for you or a service station attendant to perform these underhood checks at each fuel fill.*

#### Engine Oil Level

Check the engine oil level and add the proper oil if necessary. See "Engine Oil" in the Index for further details.

### ***Engine Coolant Level***

Check the engine coolant level and add the proper coolant mix if necessary. See "Coolant" in the Index for further details.

### ***Windshield Washer Fluid Level***

Check the windshield washer fluid level in the windshield washer tank and add the proper fluid if necessary. See "Windshield Washer Fluid" in the Index for further details.

## ***At Least Once a Month***

### ***Tire Inflation***

Check tire inflation. Make sure tires are inflated to the pressures specified on the Certification/Tire label located on the rear edge of the driver's door. See "Tires" in the Index for further details.

### ***Cassette Deck***

Clean cassette deck. Cleaning should be done every 50 hours of tape play. See "Audio Systems" in the Index for further details.

## ***At Least Once a Year***

### ***Key Lock Cylinders***

Lubricate the key lock cylinders with the lubricant specified in Part D.

### ***Body Lubrication***

Lubricate all body door hinges, the body hood, fuel door and rear compartment hinges, latches and locks including interior glove box and console doors, and any moving seat hardware. Lubricate the hood safety lever pivot and prop rod pivot. Part D tells you what to use. More frequent lubrication may be required when exposed to a corrosive environment.

## ***Starter Switch***



### **CAUTION:**

**When you are doing this check, the vehicle could move suddenly. If it does, you or others could be injured. Follow the steps below.**

1. Before you start, be sure you have enough room around the vehicle.
2. Firmly apply both the parking brake (see “Parking Brake” in the Index if necessary) and the regular brake.

**NOTE:** Do not use the accelerator pedal, and be ready to turn off the engine immediately if it starts.

3. Try to start the engine in each gear. The starter should work only in PARK (P) or NEUTRAL (N). If the starter works in any other position, your vehicle needs service.

## ***Brake–Transmission Shift Interlock — BTSI***



### **CAUTION:**

**When you are doing this check, the vehicle could move suddenly. If it does, you or others could be injured. Follow the steps below.**

1. Before you start, be sure you have enough room around the vehicle. It should be parked on a level surface.
2. Firmly apply the parking brake (see “Parking Brake” in the Index if necessary).

**NOTE:** Be ready to apply the regular brake immediately if the vehicle begins to move.

3. With the engine off, turn the key to the RUN position, but don't start the engine. Without applying the regular brake, try to move the shift lever out of PARK (P) with normal effort. If the shift lever moves out of PARK (P), your vehicle's BTSI needs service.

## ***Steering Column Lock***

While parked, and with the parking brake set, try to turn the key to LOCK in each shift lever position.

- The key should turn to LOCK only when the shift lever is in PARK (P).
- The key should come out only in LOCK.

## ***Parking Brake and Automatic Transmission PARK (P)***

### ***Mechanism Check***



### **CAUTION:**

**When you are doing this check, your vehicle could begin to move. You or others could be injured and property could be damaged. Make sure there is room in front of your vehicle in case it begins to roll. Be ready to apply the regular brake at once should the vehicle begin to move.**

Park on a fairly steep hill, with the vehicle facing downhill. Keeping your foot on the regular brake, set the parking brake.

- To check the parking brake: With the engine running and transmission in NEUTRAL (N), slowly remove foot pressure from the regular brake pedal. Do this until the vehicle is held by the parking brake only.
- To check the PARK (P) mechanism's holding ability: Shift to PARK (P). Then release all brakes.

## ***Lap and Shoulder Belts Condition and Operation***

Inspect belt system, including: webbing, buckles, latch plates, retractors, guide loops and anchors. Have a belt assembly replaced if the webbing has been cut or otherwise damaged.



## ***Part C: Periodic Maintenance Inspections***

Listed below are inspections and services which should be performed at least twice a year (for instance, each spring and fall). You should let your GM dealer's service department or other qualified service center do these jobs. Make sure any necessary repairs are completed at once.

### ***Steering and Suspension Inspection***

Inspect the front and rear suspension and steering system for damaged, loose or missing parts, signs of wear, or lack of lubrication. Inspect power steering lines and hoses for proper hookup, binding, leaks, cracks, chafing, etc. Lubricate the steering linkage.

### ***Exhaust System Inspection***

Inspect the complete exhaust system. Inspect the body near the exhaust system. Look for broken, damaged, missing or out-of-position parts as well as open seams, holes, loose connections, or other conditions which could cause a heat build-up in the floor pan or could let exhaust fumes into the vehicle. See "Engine Exhaust" in the Index.

### ***Accelerator Control System***

Lubricate all pivot points with engine oil, except the TBI throttle shaft. Do not lubricate the cam pulley. Remove all external deposits from pulley. Do not oil any accelerator or cruise control cables. Replace any cables that have high effort or excessive wear.

### ***Drive Axle Service***

Check rear/front axle fluid level and add as needed. Check constant velocity joints and axle seals for leaking.

### ***Transfer Case (All-Wheel Drive) Inspection***

Every 12 months or at oil change intervals, check front axle and transfer case and add lubricant when necessary. Oil the control lever pivot point and all exposed control linkage. Check vent hose at transfer case for kinks and proper installation.

## ***Part D: Recommended Fluids and Lubricants***

NOTE: Fluids and lubricants identified below by name, part number or specification may be obtained from your GM dealer.

### *USAGE*

### *FLUID/LUBRICANT*

Engine Oil

Engine oil with the American Petroleum Institute Certified For Gasoline Engines "Starburst" symbol of the proper viscosity. To determine the preferred viscosity for your vehicle's engine, see "Engine Oil" in the Index.

Engine Coolant

Mixture of water and a good quality ethylene glycol base antifreeze or an approved recycled coolant conforming to GM Specification 6038-M (GM Part No. 1052103).

Coolant Supplement

GM Part No. 3634621 or equivalent.

Hydraulic Brake System

Delco Supreme 11<sup>®</sup> Brake Fluid (GM Part No. 1052535 or equivalent DOT-3 brake fluid).

Parking Brake Guides

Chassis lubricant (GM Part No. 1052497 or equivalent) or lubricant meeting requirements of NLGI Grade 2, Category LB or GC-LB.

Power Steering System

GM Hydraulic Power Steering Fluid (GM Part No. 1052884 or equivalent).

Automatic Transmission

DEXRON<sup>®</sup>-III Automatic Transmission Fluid.

Key Lock Cylinders

Lubricate with Multi-Purpose Lubricant (GM Part No. 12345120) or synthetic SAE 5W-30 engine oil.

Automatic Transmission Shift Linkage

Engine oil.

Chassis Lubrication

Chassis lubricant (GM Part No. 1052497 or equivalent) or lubricant meeting requirements of NLGI Grade 2, Category LB or GC-LB.

## *USAGE*

Front Wheel Bearings

Differential, Standard, Front and Rear Axle

Differential, Locking

Transfer Case

Column Shift

Windshield Washer Solvent

Hood Latch Assembly

a. Pivots and Spring Anchor

b. Release Pawl

Hood and Door Hinges

Weatherstrip Conditioning

Gas Line

## *FLUID/LUBRICANT*

Wheel bearing lubricant meeting requirements of NLGI Grade 2, Category GC or GC-LB (GM Part No. 1051344 or equivalent).

Axle Lubricant (GM Part No. 1052271) or SAE 80W-90 GL-5 Gear Lubricant.

Axle Lubricant (GM Part No. 1052271) or SAE 80W-90 GL-5 Gear Lubricant.

DEXRON<sup>®</sup>-III Automatic Transmission Fluid.

Chassis lubricant meeting requirements of NLGI Grade 2, Category LB or GC-LB (GM Part No. 1052497).

GM Optikleen<sup>®</sup> Washer Solvent (GM Part No. 1051515) or equivalent.

a. Engine oil.

b. Chassis lubricant (GM Part No. 1052497 or equivalent) or lubricant meeting requirements of NLGI Grade 2, Category LB or GC-LB.

Engine oil or Lubriplate Lubricant (GM Part No. 1050109).

Dielectric Silicone Grease (GM Part No. 12345579 or equivalent).

Gas Line De-Icer (GM Part No. 1051516).

See "Specifications Chart" in the Index for recommended replacement filters, valves and spark plugs.

## ***Part E: Maintenance Record***

After the scheduled services are performed, record the date, odometer reading and who performed the service in the boxes provided after the maintenance interval. Any additional information from "Owner Checks and Services" or "Periodic Maintenance" can be added on the following record pages. Also, you should retain all maintenance receipts. Your owner information portfolio is a convenient place to store them.

### Maintenance Record

Date	Odometer Reading	Serviced By	Maintenance Performed

T0001



## ***Customer Assistance Information***

### ***Section***

# **8**

Here you will find out how to contact GMC Truck if you need assistance. This section also tells you how to obtain service publications and how to report any safety defects.

This section includes information on: The Customer Satisfaction Procedure, Customer Assistance for Hearing or Speech Impaired, BBB Auto Line – Alternative Dispute Resolution Program, Reporting Safety Defects, Roadside Assistance, and Service Publications.

### ***Customer Satisfaction Procedure***

Your satisfaction and goodwill are important to your dealer and GMC Truck. Normally, any concern with the sales transaction or the operation of your vehicle will be resolved by your dealer's Sales or Service Departments. Sometimes, however, despite the best intentions of all concerned, misunderstandings can occur. If your concern has not been resolved to your satisfaction, the following steps should be taken:

***STEP ONE*** — Discuss your concern with a member of dealership management. Normally, concerns can be quickly resolved at that level. If the matter has already been reviewed with the Sales, Service, or Parts Manager, contact the owner of the dealership or the General Manager.

**STEP TWO** — If after contacting a member of dealership management, it appears your concern cannot be resolved by the dealership without further help, contact the GMC Truck Consumer Relations Manager by calling 1-800-GMC-TRUCK (1-800-462-8782, Customer Assistance prompt.) In Canada, contact GM of Canada Customer Assistance Center in Oshawa by calling 1-800-263-3777 (English) or 1-800-263-7854 (French).

In Mexico, call (525) 254-3777. In Puerto Rico, call 1-800-496-9992 (English) or 1-800-496-9993 (Spanish). In the U.S. Virgin Islands, call 1-800-496-9994. In other overseas locations, contact GM North American Export Sales in Canada by calling 1-905-644-4112.

For prompt assistance, please have the following information available to give the Customer Assistance Representative:

- Your name, address, home and business telephone numbers
- Vehicle Identification Number (This is available from the vehicle registration or title, or the plate at the left top of the instrument panel and visible through the windshield.)
- Dealership name and location
- Vehicle delivery date and present mileage
- Nature of concern

We encourage you to call the toll free number listed previously in order to give your inquiry prompt attention. However, if you wish to write GMC Truck, write to:

GMC Truck Customer Assistance  
31 E. Judson Street 1607-04  
Pontiac, MI 48342-2230

Refer to your Warranty and Owner Assistance Information booklet for addresses of Canadian and GM Overseas offices.

When contacting GMC Truck, please remember that your concern will likely be resolved in the dealership, using the dealership's facilities, equipment and personnel. That is why we suggest you follow Step One first if you have a concern.



## ***Customer Assistance for the Hearing or Speech Impaired (TDD)***

To assist customers who have hearing difficulties, GMC Truck has installed special TDD (Telecommunication Devices for the Deaf) equipment at its Customer Assistance Center. Any hearing or speech impaired customer who has access to a TDD or a conventional teletypewriter (TTY) can communicate with GMC Truck by dialing: In the United States, 1-800-GMC-TKTD (1-800-462-8583). (TDD users in Canada can dial 1-800-263-3830.)

## ***GM Participation in BBB AUTO LINE – Alternative Dispute Resolution Program\****

\*This program may not be available in all states, depending on state law. Canadian owners refer to your Warranty and Owner Assistance Information booklet. General Motors reserves the right to change eligibility limitations and/or to discontinue its participation in this program.

Both GMC Truck and your GMC Truck dealer are committed to making sure you are completely satisfied with your new vehicle. Our experience has shown that, if a situation arises where you feel your concern has not been adequately addressed, the Customer Satisfaction Procedure described earlier in this section is very successful.

There may be instances where an impartial third-party can assist in arriving at a solution to a disagreement regarding vehicle repairs or interpretation of the New Vehicle Limited Warranty. To assist in resolving these disagreements, GMC Truck voluntarily participates in BBB AUTO LINE.

BBB AUTO LINE is an out-of-court program administered by the Better Business Bureau system to settle disputes between customers and automobile manufacturers. This program is available free of charge to customers who currently own or lease a GM vehicle.

If you are not satisfied after following the Customer Satisfaction Procedure, you may contact the BBB using the toll-free telephone number, or write them at the following address:

BBB AUTO LINE  
Council of Better Business Bureaus  
4200 Wilson Boulevard  
Suite 800  
Arlington, VA 22203  
Telephone: 1-800-955-5100

To file a claim, you will be asked to provide your name and address, your Vehicle Identification Number (VIN), and a statement of the nature of your complaint. Eligibility is limited by vehicle age and mileage, and other factors.

We prefer you utilize the Customer Satisfaction Procedure before you resort to AUTO LINE, but you may contact the BBB at any time. The BBB will attempt to resolve the complaint serving as an intermediary between you and GMC Truck. If this mediation is unsuccessful, an informal hearing will be scheduled where eligible customers may present their case to an impartial third-party arbitrator.

The arbitrator will make a decision which you may accept or reject. If you accept the decision, GM will be bound by that decision. The entire dispute resolution procedure should ordinarily take about forty days from the time you file a claim until a decision is made.

Some state laws may require you to use this program before filing a claim with a state-run arbitration program or in the courts. For further information, contact the BBB at 1-800-955-5100 or the GMC Truck Customer Assistance Center at 1-800-GMC-TRUCK (1-800-462-8782).

## ***REPORTING SAFETY DEFECTS TO THE UNITED STATES GOVERNMENT***

If you believe that your vehicle has a defect which could cause a crash or could cause injury or death, you should immediately inform the National Highway Traffic Safety Administration (NHTSA), in addition to notifying General Motors.

If NHTSA receives similar complaints, it may open an investigation, and if it finds that a safety defect exists in a group of vehicles, it may order a recall and remedy campaign. However, NHTSA cannot become involved in individual problems between you, your dealer, or General Motors.

To contact NHTSA, you may either call the Auto Safety Hotline toll-free at 1-800-424-9393 (or 366-0123 in the Washington, D.C. area) or write to:

NHTSA, U.S. Department of Transportation  
Washington, D.C. 20590

You can also obtain other information about motor vehicle safety from the Hotline.

## ***REPORTING SAFETY DEFECTS TO THE CANADIAN GOVERNMENT***

If you live in Canada, and you believe that your vehicle has a safety defect, you should immediately notify Transport Canada, in addition to notifying General Motors of Canada Limited. You may write to:

Transport Canada  
Box 8880  
Ottawa, Ontario K1G 3J2.

## ***REPORTING SAFETY DEFECTS TO GENERAL MOTORS***

In addition to notifying NHTSA (or Transport Canada) in a situation like this, we certainly hope you'll notify us. Please call us at 1-800-GMC-TRUCK (1-800-462-8782), or write:

GMC Truck Consumer Relations  
31 E. Judson Street 1607-04  
Pontiac, MI 48342-2230

In Canada, please call us at 1-800-263-3777 (English) or 1-800-263-7854 (French). Or, write:

General Motors of Canada Limited  
Customer Assistance Center  
1908 Colonel Sam Drive  
Oshawa, Ontario L1H 8P7

## ***Roadside Assistance***

GMC Truck's Roadside Assistance provides stranded owners with over-the-phone roadside repairs or towing service for disabled vehicles. This service combines the efforts of technically trained telephone representatives with a network of GMC Truck's dealer services.

Just dial GMC Truck Roadside Assistance at 1-800-GMC TRUCK (1-800-462-8782, Roadside Assistance prompt) to reach a qualified representative who can assist you in repair or arrange a tow. Other recommended services can also be arranged for situations such as retrieving locked-in keys, changing a tire, or delivering gasoline, at a charge to the owner. We also provide dealer information at no charge such as location of the nearest GMC Truck dealer and their hours of operation.

Roadside Assistance is available 24 hours a day, seven days a week, 365 days a year, including weekends and holidays. Should you have any questions about roadside assistance, call the GMC Truck Roadside Assistance Center or contact your dealer.

## ***Canadian Roadside Assistance***

Vehicles purchased in Canada have an extensive Roadside Assistance program accessible from anywhere in Canada or the U.S.A. Please refer to the separate brochure provided by the dealer or call 1-800-268-6800 for emergency services.

## ***Courtesy Transportation***

The GMC Truck Commitment Plus Program offers courtesy transportation for customers when obtaining warranty service. The Courtesy Transportation Program is available to retail purchasers of Commitment Plus eligible 1995 GMC light duty trucks. This program is offered in conjunction with the 36 month/36,000 mile BUMPER TO BUMPER New Vehicle Limited Warranty.

**In Canada**, please consult your GM dealer for information on courtesy transportation.

### **COURTESY TRANSPORTATION INCLUDES:**

- One way SHUTTLE RIDE from the dealership (up to 10 miles) for same-day warranty repairs.
- A loaner vehicle will be made available for overnight warranty repairs up to a 5 day maximum, or up to a \$30 allowance for a rental vehicle, cab, bus or other transportation in lieu of a loaner. (Bringing vehicles in late in the day, for service on the next day, **does not** constitute overnight repairs.)
- GAS allowance of up to \$10 a day for rides provided by another person (i.e., friend, neighbor, etc.) in lieu of rental for overnight warranty repair up to 5 day maximum.

**Note: All Courtesy Transportation arrangements will be administered by your GMC Truck dealership service management. All requests should reflect actual costs up to and not to exceed the maximum allowable dollar limits.**

- The Commitment Plus Courtesy Transportation Program is not part of the BUMPER TO BUMPER Limited Warranty. GMC Truck reserves the right to make any changes or discontinue the Courtesy Transportation Program at any time without notification.
- For additional program details contact your GMC Truck dealer.

**Note: Because of insurance liability considerations, age restrictions exist in some states when loaning dealer owned vehicles or obtaining vehicles from rental establishments. See your dealer for details.**

## ***Service and Owner Publications***

Service manuals, service bulletins, owner manuals and other service literature are available for purchase for all current and many past model General Motors' vehicles.

Toll-free telephone numbers for ordering information:

U.S. 1-800-551-4123

Canada 1-800-668-5539

### ***Service Manuals***

Service manuals contain diagnosis and repair information for all chassis and body systems. They may be useful for owners who wish to get a greater understanding of their vehicle. They are also useful for owners with the appropriate skill level or training who wish to perform "do-it-yourself" service. These are authentic General Motors' service manuals meant for professional, qualified technicians. In some cases they refer to specialized tools, equipment and safety procedures necessary to service the vehicle.

### ***Service Bulletins***

Service bulletins covering various subjects are regularly sent to all General Motors' dealerships. GM monitors product performance in the field. When service methods are found which promote better service on GM vehicles, bulletins are created to help the technician perform better service. Service bulletins may involve any number of vehicles. Some will describe inexpensive service, others will describe expensive service. Some will advise new or unexpected conditions, and others may help avoid future costly repairs. An important reminder . . . service bulletins are meant for qualified technicians. Since these bulletins are issued throughout the model year and beyond, an index is required and published quarterly to help identify specific bulletins. Subscriptions are available. You can order an index at the toll-free numbers listed, or ask a GM dealer/retailer to see an index or individual bulletin.

### ***Owner Publications***

Owner's manuals, warranty folders and various owner assistance booklets provide owners with general operation and maintenance information.

## **Notes**



# 1995 SERVICE PUBLICATIONS ORDERING INFORMATION

You can get manuals that tell how to operate and service your vehicle. To order them, fill out the order form on the next page and send it to the address below.

GMC Truck Service Publications  
Post Office Box 436006  
Pontiac, MI 48343

If you have questions or would like to order using your credit card,  
**call us TOLL FREE at 1-800-627-5699.**

From outside the Continental United States, please call 1-313-455-8016

## SERVICE MANUALS

Service Manuals have the diagnosis, repair and overhaul information on engines, transmissions, axle, suspension, brakes, electrical, steering, body, etc.

NOTE: Please specify special body or engine types on order form. Write information in the Form Number column. For example: Turbo, Convertible.

## OWNER'S INFORMATION

Owner publications are written directly for owners and intended to provide basic operational information about the vehicle. The Owner's Manual includes the Maintenance Schedule for all models. Owner's manuals are available individually or as a complete portfolio.

## GM SERVICE BULLETINS

GM Service Bulletins (GMSB) provides technical service information to knowledgeable service General Motors cars and trucks.

These bulletins may be purchased in a subscription package. Pricing and ordering information is available by calling 1-800-762-4356.



# SERVICE PUBLICATIONS ORDER FORM

NOTE: Please complete form below (Print or Type) and MAIL TO:

GMC Truck Service Publications, P.O. Box 436006, Pontiac, MI 48342

**ORDER TOLL FREE**  
**1-800-627-5699**

From outside the Continental United States,  
please call 1-313-455-8016

- Refunds or exchanges will not be accepted after 30 days.
- Routine orders will be shipped within 10 days of receipt.
- For an additional charge of \$9.00, Rush Orders will be shipped within 24 hours of receipt.
- Please allow adequate time for postal service.  
We also offer UPS-Overnight Express-Call for Rates.
- Prices subject to change without notice.

**SHIP TO**

**FROM:**

Adistra Corporation  
Attn: GMC Service Publications  
171 Hamilton St.  
Plymouth, MI 48170

**TO:**

(COMPANY NAME)

(NAME)

(STREET ADDRESS)

(APT. NO.)

(CITY)

(STATE)

(ZIP CODE)

This is your shipping label Please Print Clearly

**ORDER**

Publication  
Form Number

Description

Qty.

Price Each

Total Price

**PAYMENT**

MasterCard

VISA

American Express

Check or Money Order Enclosed.

Please be sure to sign your check!

**Make Checks Payable to Adistra Corporation (No Stamps)**

Card

Number:

Expiration

Date mo/yr:

<input type="checkbox"/>	<input type="checkbox"/>	<input type="checkbox"/>	<input type="checkbox"/>	<input type="checkbox"/>	<input type="checkbox"/>	<input type="checkbox"/>	<input type="checkbox"/>	<input type="checkbox"/>	<input type="checkbox"/>
--------------------------	--------------------------	--------------------------	--------------------------	--------------------------	--------------------------	--------------------------	--------------------------	--------------------------	--------------------------

**TOTAL MATERIAL**

Michigan Purchasers  
add 4% sales tax

Rush Order Charge

Overnight Delivery

**GRAND TOTAL**

CUSTOMER SIGNATURE \_\_\_\_\_



# Index

## A

- Adding Equipment to Your Air Bag–Equipped Vehicle (See “Supplemental Inflatable Restraint System (SIR)”)
- Air Bag (See “Supplemental Inflatable Restraint System (SIR)”)
  - Readiness Light (See “Lights”)
- Air Cleaner (See “Engine–Air Cleaner”)
- Air Conditioning (See “Heater/Air Conditioning Controls”)
- All–Wheel Drive (Option) . . . . . 2–27, 6–21
  - How to Check . . . . . 6–21
  - When to Check . . . . . 6–21
- Antenna Care . . . . . 3–20
- Anti–Lock Brakes (See “Brakes”)
- Appearance Care . . . . . 6–48
  - Materials Chart . . . . . 6–56
- Arbitration Program (See “Better Business Bureau Mediation”)
- Assist Handles . . . . . 2–47
- Audio Systems . . . . . 3–7
  - Care of Your Cassette Player and Tape . . . . . 3–19
  - Care of Compact Discs . . . . . 3–20
  - Delco LOC II<sup>®</sup> Anti–Theft Feature . . . . . 3–17
  - ETR<sup>®</sup> AM Radio . . . . . 3–8
  - ETR<sup>®</sup> AM–FM Stereo Audio Cassette System . . . . . 3–10
  - ETR<sup>®</sup> AM–FM Stereo Audio Cassette System with Equalizer . . . . . 3–12
  - ETR<sup>®</sup> AM–FM Stereo Audio Compact Disc (CD) System . . . . . 3–14
  - ETR<sup>®</sup> AM–FM Stereo Audio System . . . . . 3–9
  - Understanding Radio Reception . . . . . 3–18
- Automatic Transmission ( See “Transmission”)
- Axle
  - Front . . . . . 6–21
  - Locking Rear . . . . . 2–22
  - Rear . . . . . 6–22

## B

- Battery . . . . . 6–32
- Belts (See “Safety Belts”)
- Better Business Bureau Mediation . . . . . 8–3
- Beverage Cooler . . . . . 2–48
- Blizzard (See “Driving–If You’re Caught in a Blizzard”)
- Brakes
  - Adjustment . . . . . 6–31
  - Anti–Lock (ABS) . . . . . 4–6
  - Anti–Lock Warning Light (See “Lights”)
  - Master Cylinder . . . . . 6–29
  - Parking . . . . . 2–21
  - Pedal Travel . . . . . 6–31
  - Replacing Parts . . . . . 6–32
  - System Warning Light (See “Lights”)
  - To Check Brake Fluid . . . . . 6–30
  - Trailer (See “Trailer–Brakes”)
  - Wear . . . . . 6–31

Braking	4-5
In Emergencies	4-7
Break-In, New Vehicle	2-13
Bulb Replacement	
Center High Mounted Stop Lamp (CHMSL)	6-39
Composite Headlamps	6-35
Front Park Turn Signal Lamps	6-37
Halogen Bulb	6-34
Rear Lamps	6-38
Replacement Chart	6-63
Sealed Beam Headlamps	6-33

## C

Capacities and Specifications	6-61
Carbon Monoxide	2-25 4-30
Care of Your Cassette Tape Player (See "Audio Systems")	
Cassette Tape Player System (See "Audio Systems")	
Catalytic Converter	6-40
Center High Mounted Stop Lamp (CHMSL) (See "Bulb Replacement")	
Certification/Tire Label	4-23
Changing a Flat Tire	5-21
Chemical Paint Spotting	6-55
Child Restraints (See "Safety Belts")	
Cigarette Lighter/Ashtrays	2-46
Circuit Breakers (See "Fuses and Circuit Breakers")	
Cleaning	
Fabric Protection	6-50
Finish Care	6-53
Glass	6-52
Inside of Vehicle	6-49
Instrument Panel, Top	6-51
Outside of Vehicle	6-53
Outside of the Windshield, Backglass and Wiper Blades	6-52
Special Problems	6-50
Vinyl	6-51
Weatherstrips	6-52
Wheels and Tires	6-54
Clock, Setting the	
AM Radio	3-7
Audio Systems with AM/FM Stereo	3-8
Comfort Controls	3-1
Compact Disc (CD) System (See "Audio Systems")	
Console	
Center Overhead	2-48
Control of a Vehicle	4-4
Coolant (See "Engine")	
Cooling System Capacity	6-62
Crankcase Capacity	6-62
Cruise Control (Option)	2-35
On Hills	2-38
Passing Another Vehicle	2-38
To Get Out Of	2-39
To Erase Speed Memory	2-39
To Increase Speed	2-37

Cruise Control (continued)	
To Reduce Speed	2-38
To Resume	2-36
To Set	2-36
Cupholder	2-48
Customer Assistance for the Hearing or Speech Impaired	8-3
Customer Assistance Information	8-1
Customer Satisfaction Procedure	8-1

## D

Daytime Running Lamps	2-41
Daytime Running Lamps (DRL) Indicator Light (See "Lights")	
Differential (See "Axle")	
Doors	2-4
Locks	2-7
Power Door Locks	2-10
Rear Doors	2-6
Rear Hatch and Dutch Doors Release	2-9
Side Doors	2-4
Sliding Side Door	2-5
Drive Axle (See "Axle")	
Driving	
At Night	4-12
City	4-15
Defensive	4-1
Freeway	4-16
Hill and Mountain Roads	4-18
Highway Hypnosis	4-17
If You're Caught in a Blizzard	4-21
In the Rain	4-13
Loss of Control	4-11
Night Vision	4-12
On Snow or Ice	4-20
Passing	4-9
Through Deep Standing Water	2-16
Winter	4-19
Drunken Driving	4-2

## E

Electrical System	
Add-On Equipment	6-59
Engine	
Adding Coolant	5-16, 6-24
Air Cleaner	6-17
Control Module System	6-40
Coolant	6-23
Coolant Heater	2-17, 3-4, 6-12
Coolant Temperature Gage (See "Gages")	
Cover	6-13
Exhaust	2-25
Fan Noise	5-20
Identification	6-57, 6-62

Engine (continued)	
Oil (See "Oil")	
Overheating	5-13
Running While Parked	2-26
Starting	2-15
Exhaust System	6-40

## F

Filter Replacement Chart (See "Service-Replacement Parts and Filter Recommendations")	
Fluid Capacities (See "Capacities and Specification")	
Fluid Leak Check	6-33
Fluids (See "Scheduled Maintenance Services")	
Fuel	
Filling Your Tank	6-4
Foreign Countries	6-4
Gage (See "Gages")	
Gasolines for Cleaner Air	6-3
Tank Capacity	6-62
Fuses and Circuit Breakers	6-60, 6-65
Fuse Block	6-61

## G

Gages	
Engine Coolant Temperature Gage	2-58
Fuel Gage	2-60
Odometer	2-50
Oil Pressure Gage	2-59
Speedometer	2-50
Tamper Resistant Odometer	2-50
Trip Odometer	2-51
Voltmeter	2-61

## H

Halogen Bulbs (See "Bulb Replacement")	
Hazard Warning Flashers	5-1
Head Restraints (See "Seats")	
Headlamps	
High Beam Indicator Light (See "Lights")	
High-Low Beam Changer	2-31
Reminder	2-42
Replacement (See "Bulb Replacement")	
Heater Controls	3-1
Rear Heater (Option)	3-4
Heater/Air Conditioning Controls	3-2, 6-40
Rear Air conditioning (Option)	3-4
Refrigerant Capacity	6-68
Highway Hypnosis (See "Driving-Highway Hypnosis")	
Hitches (See "Towing-Hitches")	

Hood	
Checking Under, Hood Release .....	6-6
Horn .....	2-29
Hydroplaning (See "Driving in the Rain")	

## I

If You're Stuck in Sand, Mud, Ice, or Snow .....	5-35
Ignition Switch .....	2-14
Inflation-Tire Pressure ( See "Tires" )	
Instrument Cluster .....	2-49
Instrument Panel .....	2-49

## J

Jacking Equipment Storage .....	5-23
Jump Starting .....	5-3

## K

Key Lock Cylinders .....	6-40, 7-36
Keyless Entry System .....	2-10
Keys .....	2-1

## L

Labels	
Certification/Tire (See "Certification/Tire Label")	
Lamps	
Dome .....	2-42
Front Parking/Turn Signal .....	6-37
Headlights (See "Headlamps")	
Interior Lamps Override Switch .....	2-43
Lamp and Bulb Data .....	6-63
Reading .....	2-42
Rear Lamps .....	6-38
Replacement (See "Bulb Replacement")	
Lights .....	2-40
Air Bag Readiness Light .....	2-52
Anti-Lock Brake System Warning Light .....	2-54
Brake System Warning Light .....	2-53
Charging System Light .....	2-56
Daytime Running Lamps (DRL) Indicator Light .....	2-41, 2-56
Headlamp High Beam Indicator Light .....	2-57
Headlights (See "Headlamps")	
Malfunction Indicator .....	2-55, 6-41
Safety Belt Reminder Light .....	2-52
Service Engine Soon (See "Malfunction Indicator")	
Turn Signal and Lane Change Indicator Light .....	2-30, 2-57
Loading Your Vehicle .....	4-23
Add-On Equipment .....	4-25
Payload .....	4-24
Trailer Package .....	4-25

Lock Cylinders (See "Key Lock Cylinders")	
Loss of Control (See "Driving-Loss of Control")	
Lubrication (See "Recommended Fluids and Lubricants")	
Luggage Carrier (Option)	2-62

## M

Malfunction Indicator Lamp (See "Lights")	
Maintenance (See "Scheduled Maintenance Services")	
Master Cylinder (See "Brakes")	
Mirrors	
Convex Outside	2-45
Inside	2-43
Outside	2-44
Vanity	2-45
Multifunction Lever	2-30

## O

Odometer (See "Gages")	
Off-Road Driving (See "Driving")	
Off-Road Recovery	4-9
Oil	6-8
Additives	6-12
Pressure Gage (See "Gages")	
To Check	6-9
What Kind to Use	6-10
When to Add	6-9
When to Change	6-12
What to Do with Used	6-12
Owner Checks and Services	7-35

## P

Parking	
Brake ( See "Brakes-Parking")	
On Hills ( See "Towing-Parking on Hills")	
Over Things That Burn	2-24
Passing (See "Driving-Passing")	
Payload (See "Loading Your Vehicle")	
Periodic Maintenance Inspections (See "Scheduled Maintenance Services")	
Power	
Door Locks ( See "Doors")	
Steering	4-7
Steering Fluid	6-27

## R

Radiator Pressure Cap	6-26
Radio (See "Audio Systems")	
Rear Axle (See "Axle")	
Rear Safety Belt Comfort Guides (See "Safety Belts")	
Rear Window Defogger	3-5
Recommended Fluids and Lubricants (See "Scheduled Maintenance Services")	



Replacement Parts .....	6-61
Reporting Safety Defects To The United States Government (See "Safety Defects")	
Roadside Assistance .....	8-5
Rocking Your Vehicle .....	5-35

## S

Safety Belts .....	1-10
Adults .....	1-15
Center Passenger Position (Bench Seat) .....	1-29
Checking Restraint System .....	1-42
Child Restraints .....	1-32
Center Seat Position (Bench Seat) .....	1-35
Larger Children .....	1-39
Rear Outside Seat Position .....	1-33
Right Front Seat Position .....	1-37
Top Strap .....	1-33
Where to Put the Restraint .....	1-32
Children .....	1-31
Cleaning .....	6-52
Driver Position .....	1-15
Extender .....	1-41
Lap Belt .....	1-30
Lap-Shoulder Belt .....	1-15, 1-27
Proper Wear .....	1-15
Questions & Answers .....	1-14
Rear Seat Passengers .....	1-26
Reminder Light (See "Lights")	
Replacing Seat and Restraint Parts After a Crash .....	1-42
Right Front Passenger Position .....	1-26
Shoulder Belt Height Adjuster .....	1-17
Use During Pregnancy .....	1-26
Why Safety Belts Work .....	1-12
Safety Chains (See "Towing a Trailer")	
Safety Defects	
Reporting Safety Defects to Canada .....	8-5
Reporting Safety Defects to General Motors .....	8-5
Reporting Safety Defects to the United States .....	8-4
Safety Warnings and Symbols .....	iv
Scheduled Maintenance Services	
Maintenance Record .....	7-42
Maintenance Schedule I .....	7-6
Maintenance Schedule II .....	7-26
Periodic Maintenance Inspections .....	7-39
Recommended Fluids and Lubricants .....	7-40
Selecting the Right Schedule .....	7-3
Using Your Maintenance Schedule .....	7-3
When Trailer Towing .....	4-33
Seats .....	1-1
Bench Seats .....	1-4
Bucket Seats .....	1-4
Controls .....	1-1
Front Seat .....	1-1
Head Restraints .....	1-10
Manual Front Seat .....	1-2

Seats (continued)	
Power Driver's Seat	1-2
Rear Seats	1-4
Reclining Bucket Seats	1-3
Removable Seats (Touring and Non-Touring Bench Seats)	1-7
Seatback Latches (Non-Touring Bench Seats)	1-6
Service	
Doing Your Own Service Work	6-1
Parts Identification Label	6-59
Publications	8-7
Replacement Parts and Filter Recommendations	6-68
Service Engine Soon Light (See "Lights")	
Shift Indicator Light (See "Lights")	
Shifting Into Park (P)	2-22
Shifting Out of Park (P)	2-24
Specifications Chart (See "Service - Replacement Parts and Filter Recommendations")	
Spare Tire	5-24, 5-34
Speedometer and Odometer (See "Gages")	
Starting Your Engine (See "Engine-Starting")	
Steering	4-7
In Emergencies	4-8
Tips	4-7
Storage Compartments	2-47
Sun Visors	2-45
Supplemental Inflatable Restraint System (SIR)	
Adding Equipment to Your Facial Air Bag-Equipped Vehicle	1-25
Driver's Facial Air Bag System	1-21
How the Air Bag System Works	1-22
Servicing Your Facial Air Bag-Equipped Vehicle	1-25

## T

Tachometer (See "Gages")	
Theft	2-12
Thermostat	6-26
Tilt Wheel (Option)	2-29
Tires	6-41
Balancing (See "Wheel Alignment and Tire Balance")	
Chains	6-48
Flat (See "Changing a Flat Tire")	
Inspection and Rotation	6-43
Loading (See "Loading Your Vehicle")	
New	6-44
Pressure	6-42
Spare (See "Spare Tire")	
Underbody Carrier	5-23
Uniform Tire Quality Grading	6-45
Top Strap (See "Safety Belts-Child Restraints")	
Torque Lock (See "Transmission-Torque Lock")	

Towing	
A Trailer	4-26
Driving on Grades	4-32
Driving with a Trailer	4-30
Parking on Hills	4-32
Passing	4-31
Safety Chains	4-29
Hitches	4-28
Towing Your Vehicle	5-7
Trailer	
Brakes	4-29
Towing ( See "Towing")	
Wiring Harness	2-63, 6-60
Trailering Package ( See "Loading Your Vehicle")	
Transfer Case	6-21
Transmission	
Automatic	2-18
How To Check	6-18
How To Add	6-20
When to Check and Change Fluid	6-18
Shift Light ( See "Lights")	
Torque Lock (Automatic Transmission)	2-23
Trip Odometer ( See "Gages")	
Turn Signal and Lane Change Indicator ( See "Lights")	

## V

Vehicle	
Damage Warnings	iv
Identification Number	6-57, 6-58
Loading ( See "Loading Your Vehicle")	
Storage	6-32
Symbols	v, vi, vii, viii
Ventilation System	3-6
Tips	3-6
Voltmeter ( See "Gages")	

## W

Warning	
Devices, Other	5-2
Hazard Flashers ( See "Hazard Warning Flashers")	
Lights and Indicators	2-51
Wheels	
Alignment and Tire Balance	6-46
Aluminum	6-54
Hub Caps and Wheel Nut Caps	5-28
Nut Torque	6-62
Replacement	6-46
Used Replacement	6-47

Windows .....	2-27
Swing-Out .....	2-28
Windshield	
Rear Window Wiper/Washer-Dutch Door .....	2-34
Washer .....	2-33
Washer Fluid .....	6-28
Wipers .....	2-32
Wiper Blade Chatter .....	6-52
Wiper Blade Cleaning ( See "Cleaning")	
Wiper Blade Replacement .....	6-39



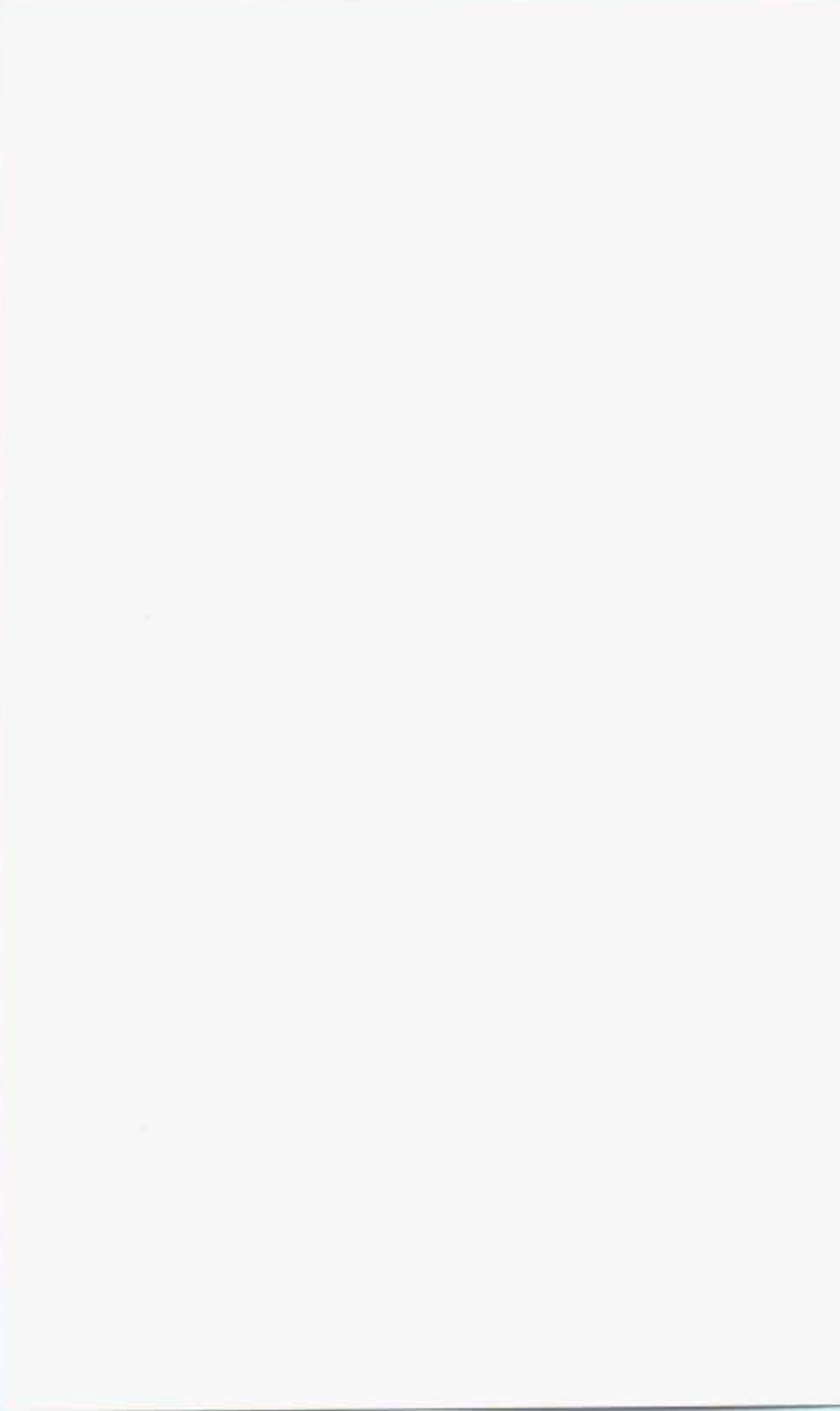

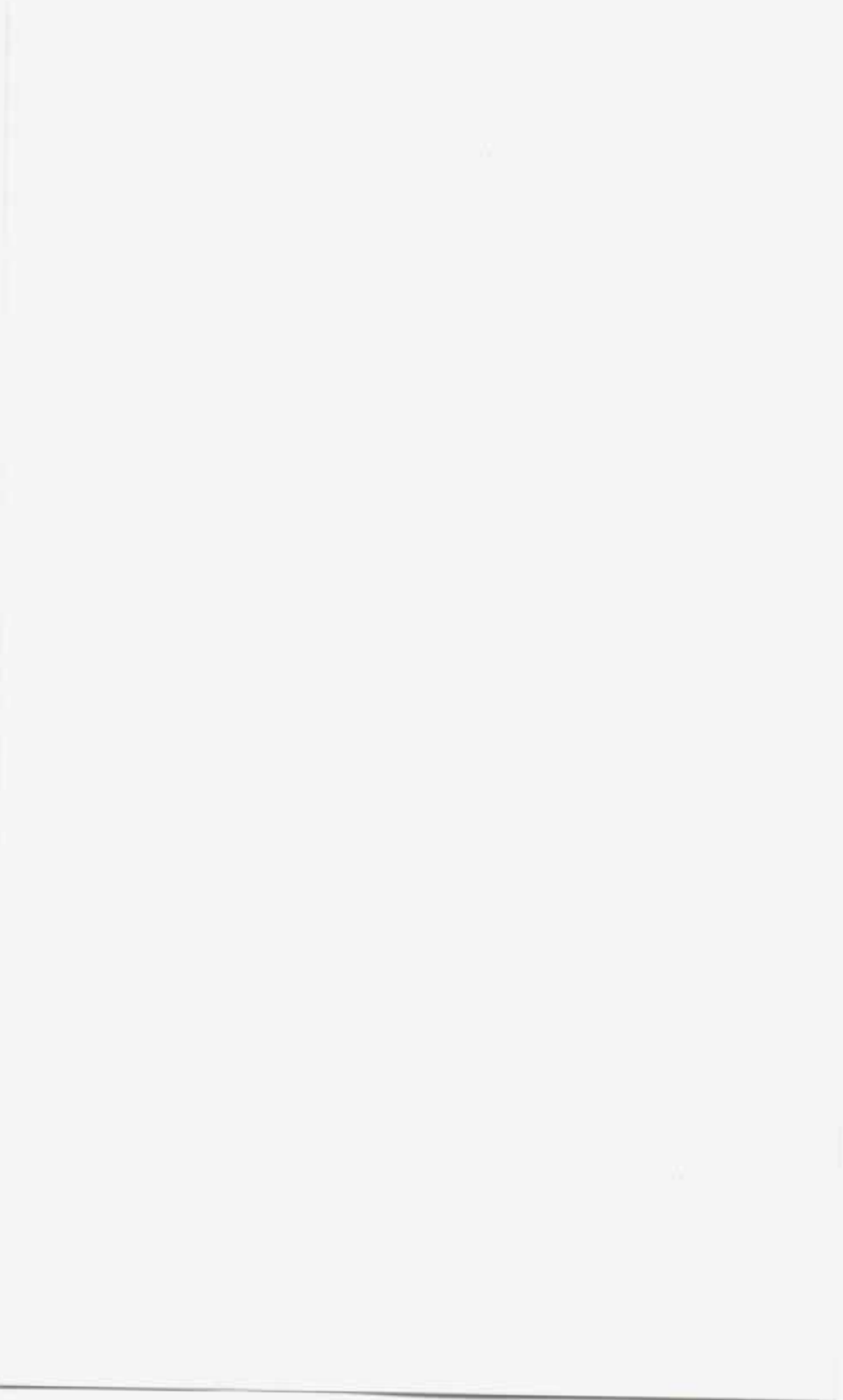

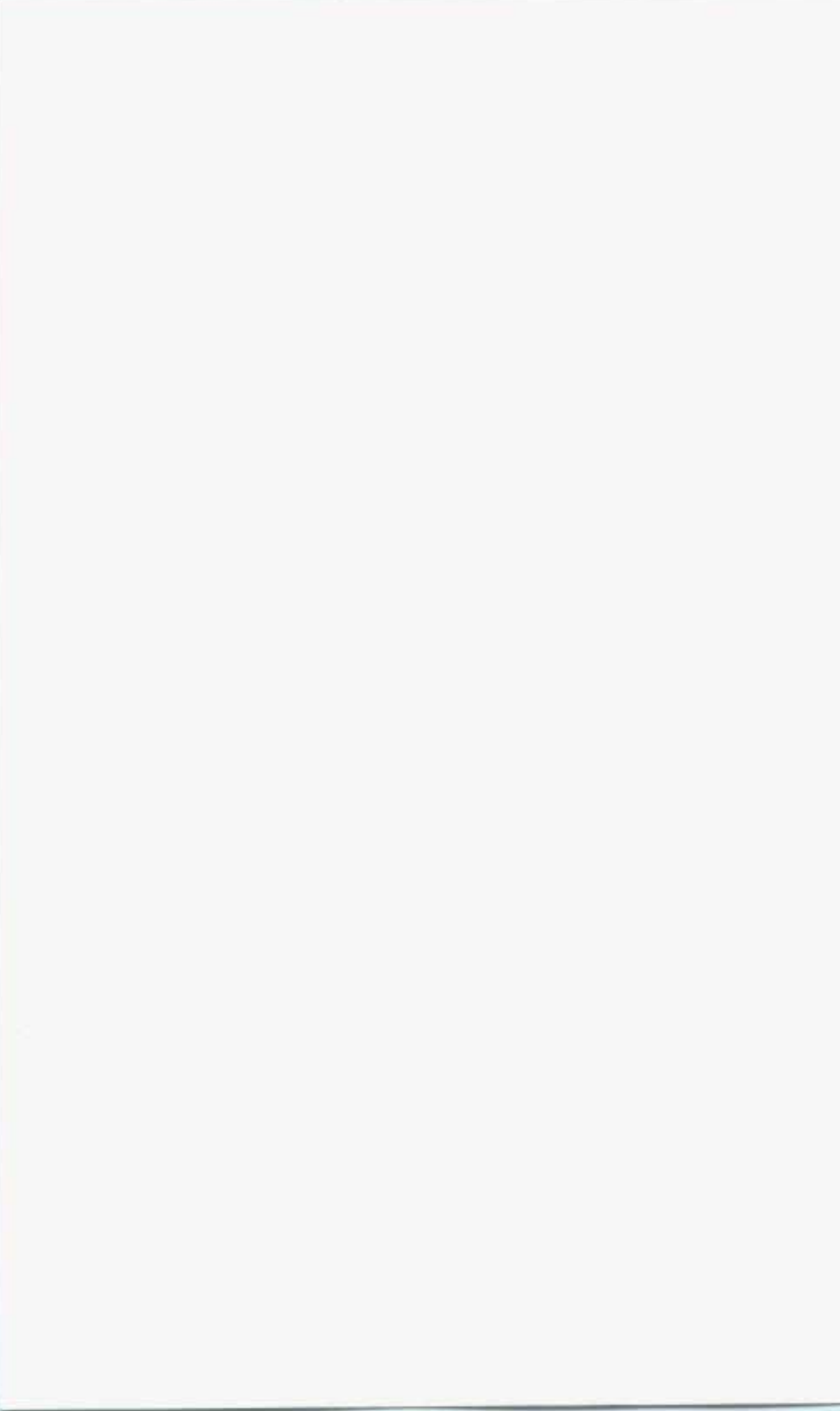





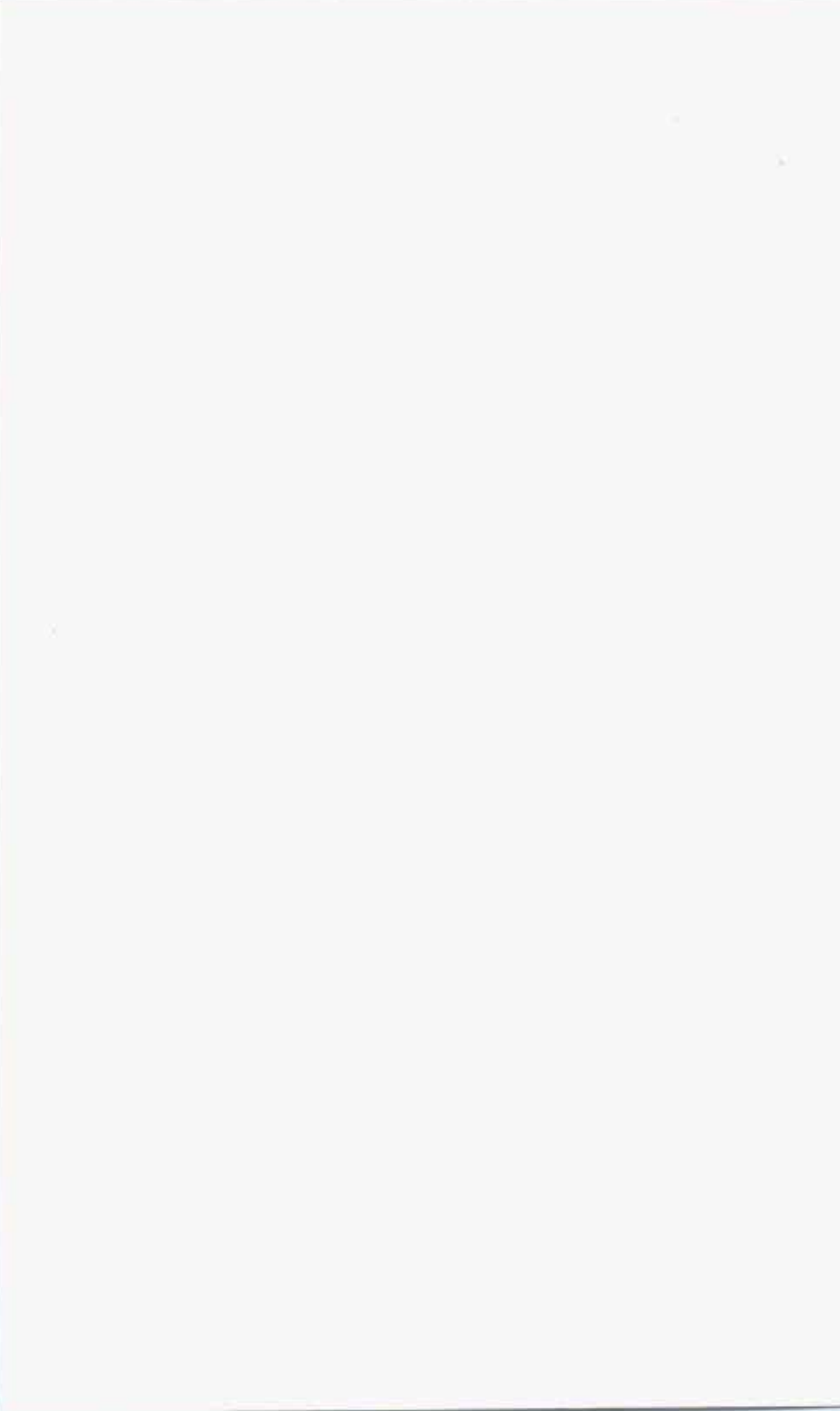





*X-9510*



Keep with vehicle at all times.  
Contains important Operating, Safety,  
and Maintenance instructions.



**GMC**  
TRUCK

**THE STRENGTH OF EXPERIENCE**