



1995 OWNER'S MANUAL

C/K PICKUP

CHEVROLET®

Table of Contents

Introduction — How to Use this Manual

This section tells you how to use your manual and includes safety and vehicle damage warnings and symbols.

Section 1 — Seats and Restraint Systems

This section tells you how to use your seats and safety belts properly. It also explains the air bag system.

Section 2 — Features & Controls

This section explains how to start and operate your vehicle.

Section 3 — Comfort Controls & Audio Systems

This section tells you how to adjust the ventilation and comfort controls and how to operate your audio system.

Section 4 — Your Driving and the Road

Here you'll find helpful information and tips about the road and how to drive under different conditions.

Section 5 — Problems on the Road

This section tells you what to do if you have a problem while driving, such as a flat tire or engine overheating, etc.

Section 6 — Service & Appearance Care

Here the manual tells you how to keep your vehicle running properly and looking good.

Section 7 — Maintenance Schedule

This section tells you when to perform vehicle maintenance and what fluids and lubricants to use.

Section 8 — Customer Assistance Information

This section tells you how to contact GM for assistance and how to get service publications. It also gives you information on "Reporting Safety Defects" on page 8-4.

Index

Here's an alphabetical listing of almost every subject in this manual. You can use it to quickly find something you want to read.

Introduction

1995 Chevrolet C/K Pickup Owner's Manual

Welcome

This manual was prepared to acquaint you with the operation and maintenance of your 1995 Chevrolet C/K Pickup or chassis and to provide important safety information. There is also a Chevrolet Truck Warranty and Owner Assistance Information booklet. In some vehicles, there can be information manuals from other manufacturers like body builders or special equipment companies. We urge you to review all these publications carefully. This will help you enjoy safe and trouble-free operation of your vehicle.

When it comes to service, keep in mind that your Chevrolet dealer knows your vehicle best and is interested in your complete satisfaction. Your dealer invites you to return for all of your service needs both during and after the warranty period.

Remember, if you have a concern and need help handling it to your satisfaction, see the procedure in the Chevrolet Truck Warranty and Owner Assistance Information booklet.

Thanks for choosing a Chevrolet product. We value you as a member of the Chevrolet family. We want to assure you of our continuing interest in your pleasure and satisfaction with your vehicle.

Chevrolet Motor Division
General Motors Corporation
30007 Van Dyke Ave.
Warren, Michigan

©Copyright 1994 General Motors Corporation, Chevrolet Motor Division.
All Rights Reserved

First Edition

Printed in U.S.A.

Important Notes to Owners and Drivers

About This Manual

Please keep this manual in your vehicle so it will be there if you ever need it when you're on the road. If you sell the vehicle, please leave this manual in it so the new owner can use it.

This manual includes the latest information at the time it was printed. We reserve the right to make changes in the product after that time without further notice. For vehicles first sold in Canada, substitute the name "General Motors of Canada Limited" for Chevrolet Motor Division whenever it appears in this manual.



For Canadian Owners Who Prefer a French Language Manual:

Aux propriétaires canadiens: Vous pouvez vous procurer un exemplaire de ce guide en français chez votre concessionnaire ou au DGN Marketing Services Ltd., 1500 Bonhill Rd., Mississauga, Ontario L5T 1C7.



General Motors, GM and the GM Emblem, Chevrolet and the Chevrolet emblem are registered trademarks of General Motors Corporation.

Model Reference

This manual covers these models:

REGULAR CAB PICKUP

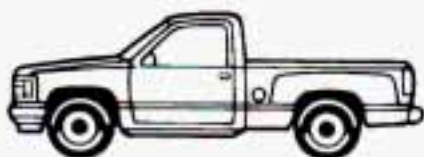

EXTENDED CAB PICKUP

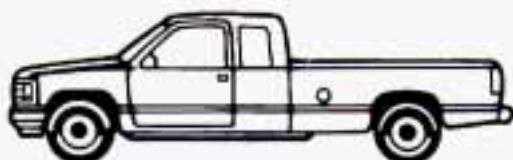

CREW CAB

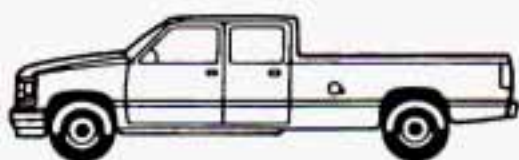

CHASSIS CAB



3500 HD CHASSIS CAB

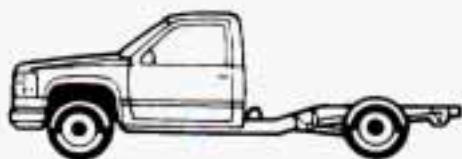

How to Use This Manual

Many people read their owner's manual from beginning to end when they first receive their new vehicle. This will help you learn about the features and controls for your vehicle. In this manual, you'll find that pictures and words work together to explain things quickly.

INDEX: A good place to look for what you need is the Index in back of the manual. It's an alphabetical list of all that's in the manual, and the page number where you'll find it.

Safety Warnings and Symbols

You will find a number of safety cautions in this book. We use a box with gray background and the word CAUTION to tell you about things that could hurt you if you were to ignore the warning.



CAUTION:

These mean there is something that could hurt you or other people.

In the gray caution area, we tell you what the hazard is. Then we tell you what to do to help avoid or reduce the hazard. Please read these cautions. If you don't, you or others could be hurt.

You will also find a circle with a slash through it in this book. This safety symbol means "Don't," "Don't do this," or "Don't let this happen."



Vehicle Damage Warnings

Also, in this book you will find these notices:

NOTICE:

These mean there is something that could damage your vehicle.

In the notice area, we tell you about something that can damage your vehicle. Many times, this damage would not be covered by your warranty, and it could be costly. But the notice will tell you what to do to help avoid the damage.

When you read other manuals, you might see CAUTION and NOTICE warnings in different colors or in different words.

You'll also see warning labels on your vehicle. They use yellow for cautions, blue for notices and the words CAUTION or NOTICE.

Vehicle Symbols

These are some of the symbols you will find on your vehicle. For example, these symbols are used on an original battery:



*Caution
Possible Injury*



*Protect Eyes
by Shielding*



*Caustic Battery Acid
Could Cause Burns*



*Spark or Flame Could
Explode Battery*



*Avoid Sparks
or Flames*

These symbols are important for you and your passengers whenever your vehicle is driven:



Fasten Safety Belts



Door Lock/Unlock

These symbols have to do with your lights:



Master Lighting Switch

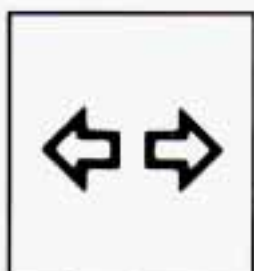

Turn Signal Direction



Hazard Warning Flasher

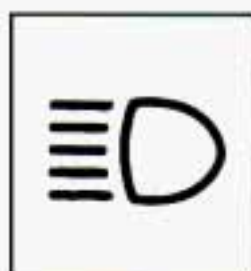

Headlight High Beam



Fog Lights

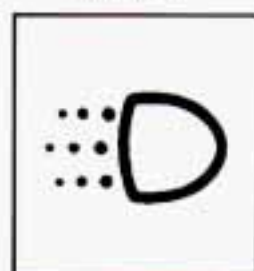

Daytime Running Lights

These symbols are on some of your controls:



*Windshield
Wiper*



*Windshield
Washer*



*Windshield
Defroster*

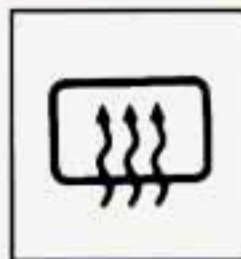

*Rear Window
Defogger*



Ventilating Fan

These symbols are used on warning and indicator lights:



*Engine Coolant
Temperature*



*Battery Charging
System*



Fuel



*Engine Oil
Pressure*



Brake

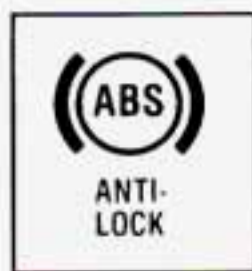

*4 Wheel
Anti-Lock*



*Parking Brake
Release*



Shift Light

Here are some other symbols you may see:



Fuse

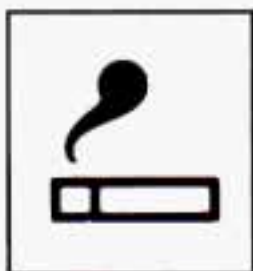

Lighter



Horn

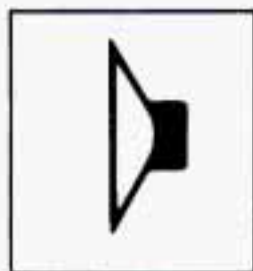

Speaker



Hood Release

Notes

Seats and Restraint Systems

Section

1

Here you'll find information about the seats in your vehicle and how to use your safety belts properly. You can also learn about some things you should *not* do with air bags and safety belts.

Seats and Seat Controls

This section tells you about the seats – how to adjust them, and fold them up and down. It also tells you about reclining front seatbacks and head restraints.

Manual Front Seat



CAUTION:

You can lose control of the vehicle if you try to adjust a manual driver's seat while the vehicle is moving. The sudden movement could startle and confuse you, or make you push a pedal when you don't want to. Adjust the driver's seat only when the vehicle is not moving.



If your vehicle has a manual bucket, split bench, or full bench seat, you can adjust it with this lever at the front of the seat.

Slide the lever at the front of the seat toward the passenger side to unlock it. Using your body, slide the seat to where you want it. Then, release the lever and try to move the seat with your body, to make sure the seat is locked in place.

Power Driver's Seat (Option)

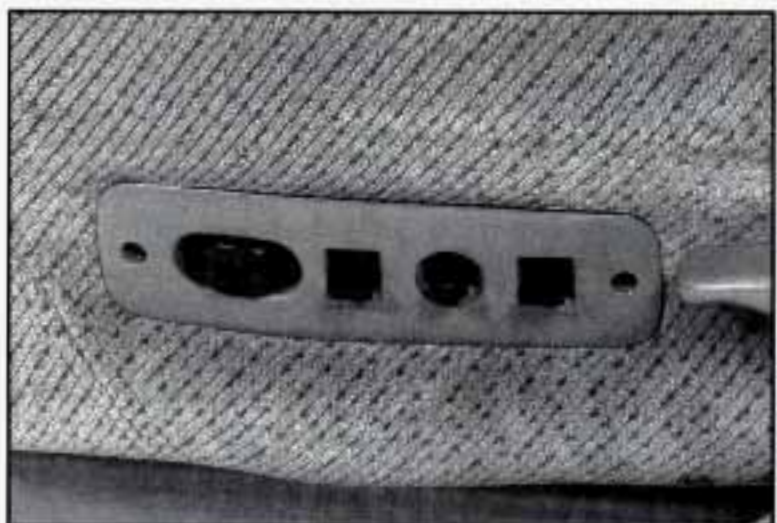

If your vehicle has a power seat on the driver's side, you can adjust it with this switch at the outside edge of the seat.

You can use the round center switch knob to move the seat where you want it. To raise the seat, move the knob up. To lower the seat, move the knob down. To move the seat forward, move the knob toward the front of the vehicle. To move the seat rearward, move the knob toward the rear of the vehicle.

You can also raise and lower the front and rear of the seat. To raise the front of the seat, move the front switch lever up. To lower the front of the seat, move the front switch lever down. To raise the rear of the seat, move the rear switch lever up. To lower the rear of the seat, move the rear switch lever down.

Power Lumbar Adjustment

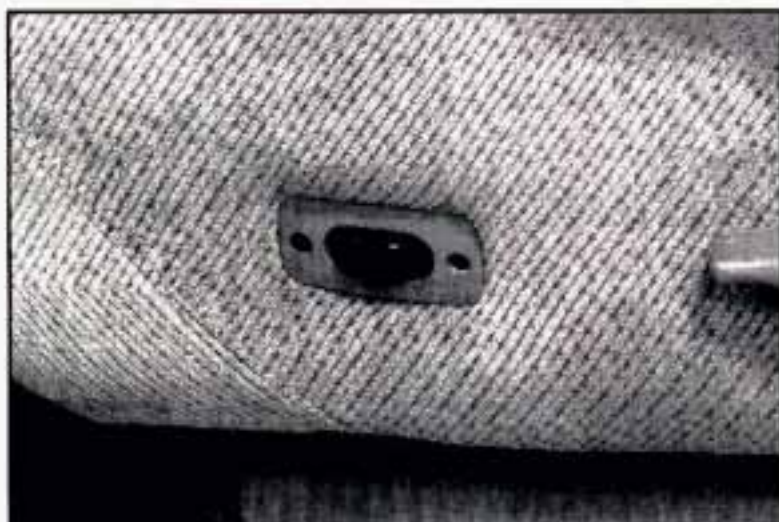

If you have power lumbar adjustment, you can increase or decrease lumbar support in an area of the lower seatback.

To increase support, press and hold the front of the rocker switch. Let go of the switch when the lower seatback reaches the desired level of support.

To decrease support, press and hold the rear of the rocker switch. Let go of the switch when the lower seatback reaches the desired level of support.

Reclining Front Seatbacks



To adjust the seatback, lift the front of this lever.

Release the lever to lock the seatback where you want it. Pull up on the front of the lever and the seatback will go to an upright position.



But don't have a seatback reclined if your vehicle is moving.



CAUTION:

Sitting in a reclined position when your vehicle is in motion can be dangerous. Even if you buckle up, your safety belts can't do their job when you're reclined like this.

The shoulder belt can't do its job because it won't be against your body. Instead, it will be in front of you. In a crash you could go into it, receiving neck or other injuries.

The lap belt can't do its job either. In a crash the belt could go up over your abdomen. The belt forces would be there, not at your pelvic bones. This could cause serious internal injuries.

For proper protection when the vehicle is in motion, have the seatback upright. Then sit well back in the seat and wear your safety belt properly.

Seatback Latches (Base Level Bench Seat)

The front seatback folds forward to let you access the rear of the cab. Your seatback will move back and forth freely, unless you come to a sudden stop. Then it will lock in place.

If you have a Crew Cab, your front seatback is designed not to fold forward. Access to the rear of the cab is available by using the rear doors.

Seatback Latches (All Except Base Level Bench Seat)

The front seatback folds forward to let you access the rear of the cab.

If you have a Crew Cab, your front seatback is designed not to fold forward. Access to the rear of the cab is available by using the rear doors.



To fold a seatback forward, pull this lever forward and fold the seatback forward.

To return the seatback to the upright position, just push the seatback rearward until it latches.

After returning the seatback to its upright position, pull the seatback forward to make sure it is locked.



CAUTION:

If the seatback isn't locked, it could move forward in a sudden stop or crash. That could cause injury to the person sitting there. Always press rearward on the seatback to be sure it is locked.

Easy Entry Seat (Extended Cab Only)

The driver and passenger front bucket seat and the 60/40 split bench seat of your vehicle has an easy entry feature. This makes it easy to get in and out of the rear seat.



To operate the seat, pull forward on the top of the lever, located at the side of the seatback, and tilt the back forward toward the front of the vehicle.



When you do, the seat bottom will release. Just pull or push the seat forward until it stops.

To return the seat to its regular position, return the seatback to its upright position, then push the whole seat rearward until it latches.

After returning the seat to its regular position, try to move the seat with your body, to make sure the seat is locked into place.



CAUTION:

If any easy entry seat isn't locked, it can move. In a sudden stop or crash, the person sitting there could be injured. And, even if there is no crash or sudden stop, a driver sitting in an unlocked easy entry seat could be startled by the sudden movement and hit the wrong control or pedal, causing an accident. After you've used it, be sure to push rearward on any easy entry seat to be sure it is locked.

Head Restraints

Slide the head restraint up or down so that the top of the restraint is closest to the top of your ears. This position reduces the chance of a neck injury in a crash.

Rear Folding Seat (Extended Cab)

The extended cab may have a rear folding seat which can be folded open for more seating space.



To use the seat, pull the entire seat forward until it is flat. Then, pull forward on the **RELEASE** lever at the side of the seat cushion, located behind the passenger side front seat. Push the seatback rearward until it latches.

After pushing the seatback upright into position, pull the seatback forward to make sure it is locked.



To store the seat, pull forward on the **RELEASE** lever at the side of the seat cushion, behind the passenger side front seat. Fold the seatback forward until it latches with the seat cushion. Lift the entire seat and push it rearward into place.

Make sure the seat is secure.

Rear Seat (Crew Cab)

You can adjust the seat by sliding the lever at the front of the seat toward the seat support to unlock it. Then, slide the seat to where you want it. Release the lever and try to move the seat with your body, to make sure the seat is locked into place.

Seatback Latch (Rear Bench Seat Without Center Armrest)

The rear seatback can be folded forward to let you reach the area behind it. Your seatback will move back and forth freely, unless you come to a sudden stop. Then, it will lock into place.

Seatback Latch (Rear Bench Seat With Center Armrest)

The rear seatback folds forward to let you access the area behind it.



To fold a seatback forward, pull this lever forward and fold the seatback forward.

To return the seatback to the upright position, just push the seatback rearward until it latches.

After returning the seatback to its upright position, pull the seatback forward to make sure it is locked.



CAUTION:

If the seatback isn't locked, it could move forward in a sudden stop or crash. That could cause injury to the person sitting there. Always press rearward on the seatback to be sure it is locked.

Safety Belts: They're for Everyone

This part of the manual tells you how to use safety belts properly. It also tells you some things you should not do with safety belts.

And it explains the Supplemental Inflatable Restraint, or “air bag” system.

CAUTION:

Don't let anyone ride where he or she can't wear a safety belt properly. If you are in a crash and you're not wearing a safety belt, your injuries can be much worse. You can hit things inside the vehicle or be ejected from it. You can be seriously injured or killed. In the same crash, you might not be if you are buckled up. Always fasten your safety belt, and check that your passengers' belts are fastened properly too.



Your vehicle has a light that comes on as a reminder to buckle up. (See “Safety Belt Reminder Light” in the Index.)

In many states and Canadian provinces, the law says to wear safety belts. Here's why: *They work.*

You never know if you'll be in a crash. If you do have a crash, you don't know if it will be a bad one.

A few crashes are mild, and some crashes can be so serious that even buckled up a person wouldn't survive. But most crashes are in between. In many of them, people who buckle up can survive and sometimes walk away. Without belts they could have been badly hurt or killed.

After more than 25 years of safety belts in vehicles, the facts are clear. In most crashes buckling up does matter ... a lot!

Why Safety Belts Work

When you ride in or on anything, you go as fast as it goes.

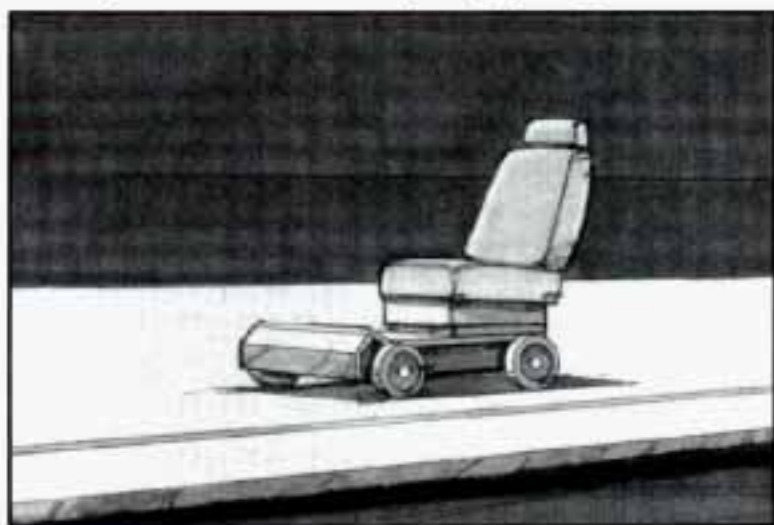

Take the simplest vehicle. Suppose it's just a seat on wheels.

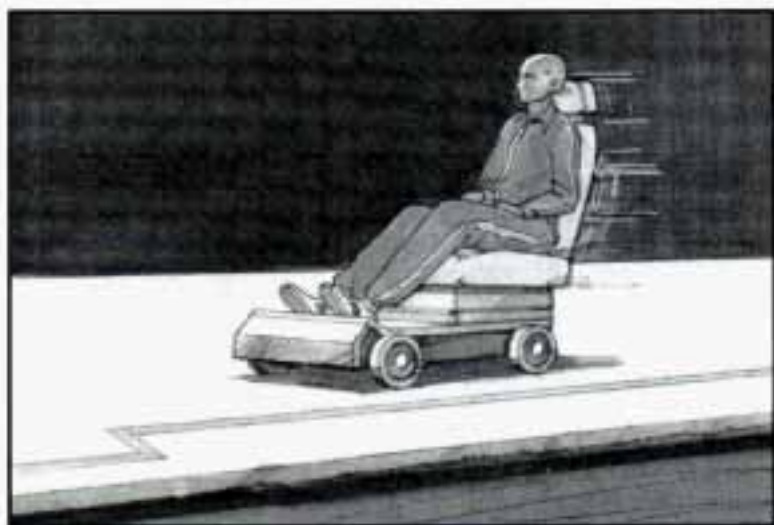

Put someone on it.

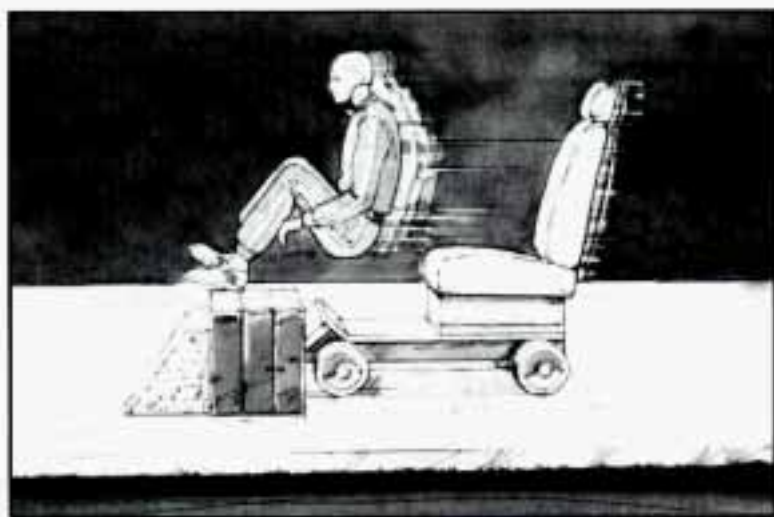

Get it up to speed.
Then stop the vehicle.
The rider doesn't stop.



The person keeps going until stopped by something.

In a real vehicle, it could be the windshield ...

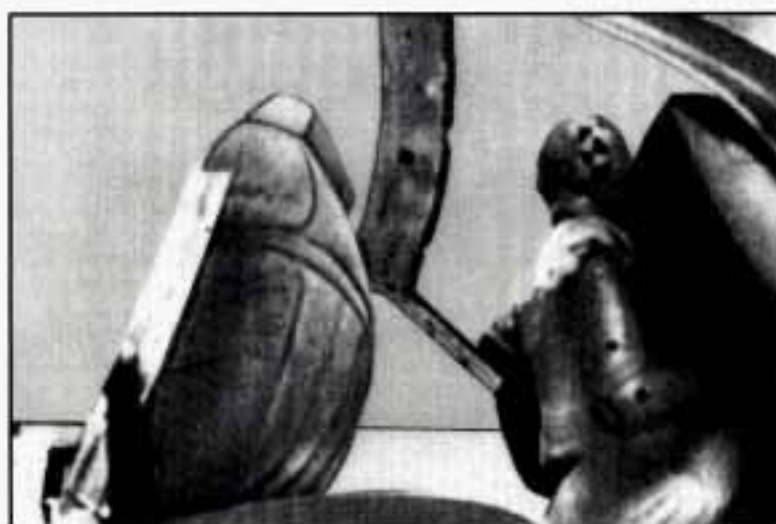

or the instrument panel ...



or the safety belts!

With safety belts, you slow down as the vehicle does. You get more time to stop. You stop over more distance, and your strongest bones take the forces. That's why safety belts make such good sense.

Here Are Questions Many People Ask About Safety Belts — and the Answers

Q: *Won't I be trapped in the vehicle after an accident if I'm wearing a safety belt?*

A: You *could* be — whether you're wearing a safety belt or not. But you can unbuckle a safety belt, even if you're upside down. And your chance of being conscious during and after an accident, so you *can* unbuckle and get out, is *much* greater if you are belted.

Q: *Why don't they just put in air bags so people won't have to wear safety belts?*

A: Air bags are in many vehicles today and will be in more of them in the future. But they are supplemental systems only; so they work *with* safety belts — not instead of them. Every air bag system ever offered for sale has required the use of safety belts. Even if you're in a vehicle that has air bags, you still have to buckle up to get the most protection. That's true not only in frontal collisions, but especially in side and other collisions.

Q: *If I'm a good driver, and I never drive far from home, why should I wear safety belts?*

A: You may be an excellent driver, but if you're in an accident — even one that isn't your fault — you and your passengers can be hurt. Being a good driver doesn't protect you from things beyond your control, such as bad drivers.

Most accidents occur within 25 miles (40 km) of home. And the greatest number of serious injuries and deaths occur at speeds of less than 40 mph (65 km/h).

Safety belts are for everyone.

How to Wear Safety Belts Properly

Adults

This part is only for people of adult size.

Be aware that there are special things to know about safety belts and children. And there are different rules for smaller children and babies. If a child will be riding in your vehicle, see the part of this manual called "Children." Follow those rules for everyone's protection.

First, you'll want to know which restraint systems your vehicle has.

We'll start with the driver position.

Driver Position

This part describes the driver's restraint system.

Lap–Shoulder Belt

The driver has a lap–shoulder belt. Here's how to wear it properly.

1. Close and lock the door.
2. Adjust the seat (to see how, see "Seats" in the Index) so you can sit up straight.



3. Pick up the latch plate and pull the belt across you. (On some models, you may hear a clicking sound as the belt is pulled out. This is the feature that reduces shoulder belt tension operating properly.) Don't let the belt get twisted.
4. Push the latch plate into the buckle until it clicks. Pull up on the latch plate to make sure it is secure.

If the belt isn't long enough, see "Safety Belt Extender" at the end of this section.

Make sure the release button on the buckle is positioned so you would be able to unbuckle the safety belt quickly if you ever had to.

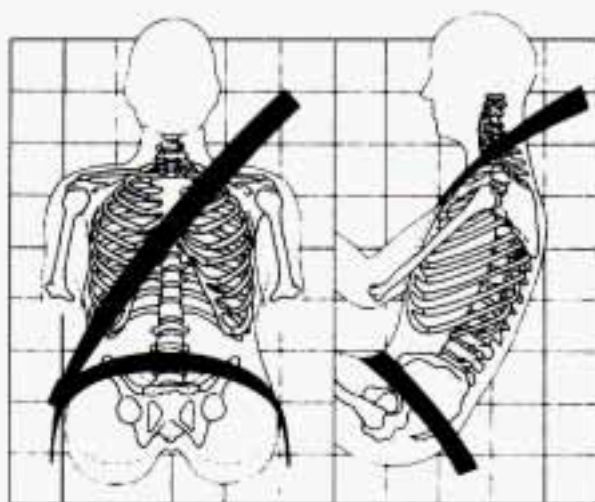

The lap part of the belt should be worn low and snug on the hips, just touching the thighs. In a crash, this applies force to the strong pelvic bones. And you'd be less likely to slide under the lap belt. If you slid under it, the belt would apply force at your abdomen. This could cause serious or even fatal injuries. The shoulder belt should go over the shoulder and across the chest. These parts of the body are best able to take belt restraining forces.

The safety belt locks if there's a sudden stop or a crash.

Q: What's wrong with this?

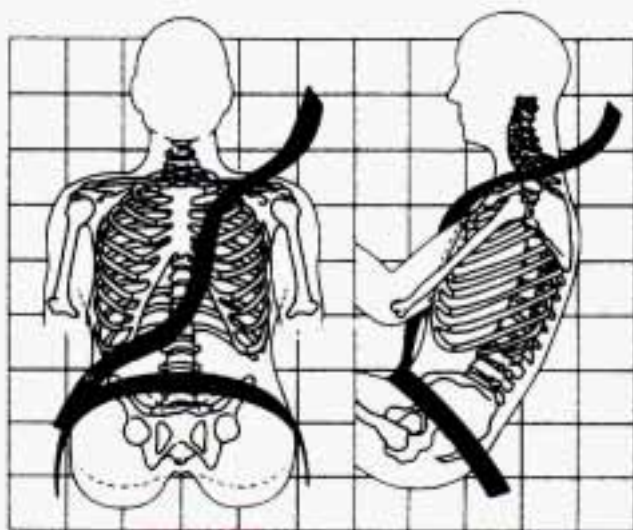

A: The shoulder belt is too loose. It won't give nearly as much protection this way.



CAUTION:

You can be seriously hurt if your shoulder belt is too loose. In a crash you would move forward too much, which could increase injury. The shoulder belt should fit against your body.

Q: What's wrong with this?

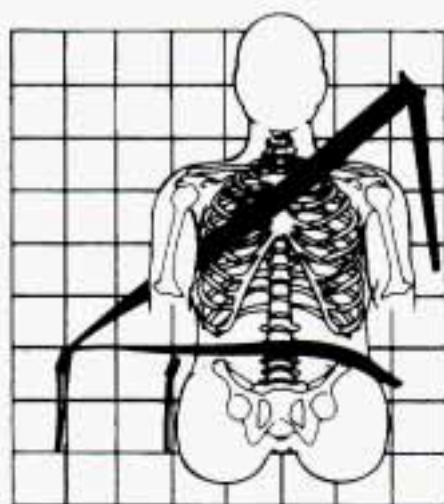

A: The belt is buckled in the wrong place.



CAUTION:

You can be seriously injured if your belt is buckled in the wrong place like this. In a crash, the belt would go up over your abdomen. The belt forces would be there, not at the pelvic bones. This could cause serious internal injuries. Always buckle your belt into the buckle nearest you.

Q: What's wrong with this?

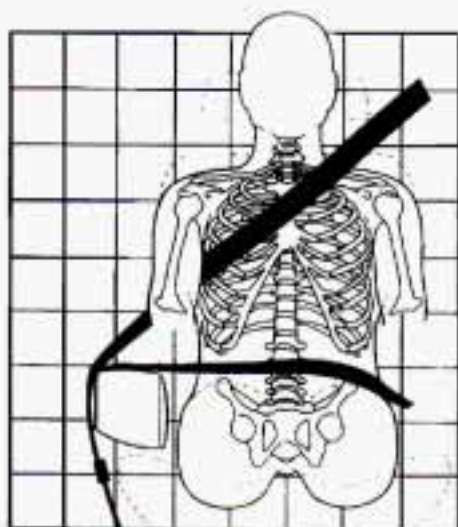

A: The belt is over an armrest.



CAUTION:

You can be seriously injured if your belt goes over an armrest like this. The belt would be much too high. In a crash, you can slide under the belt. The belt force would then be applied at the abdomen, not at the pelvic bones, and that could cause serious or fatal injuries. Be sure the belt goes under the armrests.

Q: What's wrong with this?

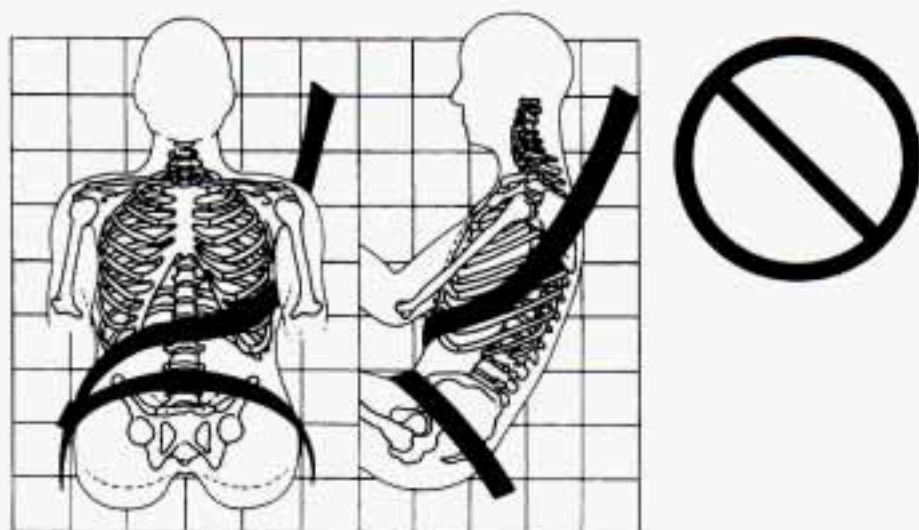

A: The shoulder belt is worn under the arm. It should be worn over the shoulder at all times.



CAUTION:

You can be seriously injured if you wear the shoulder belt under your arm. In a crash, your body would move too far forward, which would increase the chance of head and neck injury. Also, the belt would apply too much force to the ribs, which aren't as strong as shoulder bones. You could also severely injure internal organs like your liver or spleen.

Q: What's wrong with this?

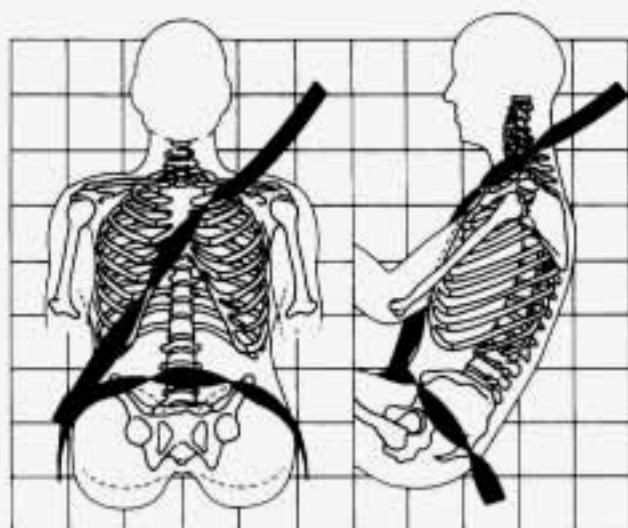

A: The belt is twisted across the body.



CAUTION:

You can be seriously injured by a twisted belt. In a crash, you wouldn't have the full width of the belt to spread impact forces. If a belt is twisted, make it straight so it can work properly, or ask your dealer to fix it.



To unlatch the belt, just push the button on the buckle. The belt should go back out of the way.

Before you close the door, be sure the belt is out of the way. If you slam the door on it, you can damage both the belt and your vehicle.

Supplemental Inflatable Restraint System (SIR)

This part explains the Supplemental Inflatable Restraint (SIR) system, or air bag.



Your vehicle may have an air bag for the driver. If it does, it will say Supplemental Inflatable Restraint on the middle part of the steering wheel. Here are the most important things to know about the air bag system:

CAUTION:

You can be severely injured or killed in a crash if you aren't wearing your safety belt — even if you have an air bag. Wearing your safety belt during a crash helps reduce your chance of hitting things inside the vehicle or being ejected from it. The air bag is only a “supplemental restraint.” That is, it works with safety belts but doesn't replace them. Air bags are designed to work only in moderate to severe crashes where the front of your vehicle hits something. They aren't designed to inflate at all in rollover, rear, side, or low-speed frontal crashes. Everyone in your vehicle, including the driver, should wear a safety belt properly — whether or not there's an air bag for that person.



CAUTION:

Air bags inflate with great force, faster than the blink of an eye. If you're too close to an inflating air bag, it could seriously injure you. Safety belts help keep you in position for an air bag inflation in a crash. Always wear your safety belt, even with an air bag, and sit as far back as you can while still maintaining control of your vehicle.

AIR BAG

There is an air bag readiness light on the instrument panel, which shows AIR BAG. The system checks the air bag's electrical system for malfunctions. The light tells you if there is an electrical problem. See "Air Bag Readiness Light" in the Index for more information.

How the Air Bag System Works



Where is the air bag?

The driver's air bag is in the middle of the steering wheel.



CAUTION:

Don't put anything on, or attach anything to, the steering wheel. Also, don't put anything (such as pets or objects) between the driver and the steering wheel. If something is between an occupant and an air bag, it could affect the performance of the air bag — or worse, it could cause injury.

When should an air bag inflate?

The air bag is designed to inflate in moderate to severe frontal or near-frontal crashes. The air bag will inflate only if the impact speed is above the system's designed "threshold level." If your vehicle goes straight into a wall that doesn't move or deform, the threshold level is about 12 to 16 mph (19 to 26 km/h). The threshold level can vary, however, with specific vehicle design, so that it can be somewhat above or below this range. If your vehicle strikes something that will move or deform, such as a parked car, the threshold level will be higher. The air bag is not designed to inflate in rollovers, side impacts, or rear impacts, because inflation would not help the occupant.

In any particular crash, no one can say whether an air bag should have inflated simply because of the damage to a vehicle or because of what the repair costs were. Inflation is determined by the angle of the impact and the vehicle's deceleration. Vehicle damage is only one indication of this.

The air bag system is designed to work properly under a wide range of conditions, including off-road usage. Observe safe driving speeds, especially on rough terrain. As always, wear your safety belt. See "Off-Road Driving" in the Index for more tips on off-road driving.

What makes an air bag inflate?

In a frontal or near-frontal impact of sufficient severity, the air bag sensing system detects that the vehicle is suddenly stopping as a result of a crash. The sensing system triggers a chemical reaction of the sodium azide sealed in the inflator. The reaction produces nitrogen gas, which inflates the air bag. The inflator, air bag, and related hardware are all part of the air bag module packed inside the steering wheel.

How does an air bag restrain?

In moderate to severe frontal or near-frontal collisions, even belted occupants can contact the steering wheel. The air bag supplements the protection provided by safety belts. Air bags distribute the force of the

impact more evenly over the occupant's upper body, stopping the occupant more gradually. But air bags would not help you in many types of collisions, including rollovers and rear and side impacts, primarily because an occupant's motion is not toward the air bag. Air bags should never be regarded as anything more than a supplement to safety belts, and then only in moderate to severe frontal or near-frontal collisions.

What will you see after an air bag inflates?

After the air bag inflates, it quickly deflates. This occurs so quickly that some people may not even realize the air bag inflated. Some components of the air bag module in the steering wheel hub will be hot for a short time, but the part of the bag that comes into contact with you will not be hot to the touch. There will be some smoke and dust coming from vents in the deflated air bag. Air bag inflation will not prevent the driver from seeing or from being able to steer the vehicle, nor will it stop people from leaving the vehicle.



CAUTION:

When an air bag inflates, there is dust in the air. This dust could cause breathing problems for people with a history of asthma or other breathing trouble. To avoid this, everyone in the vehicle should get out as soon as it is safe to do so. If you have breathing problems but can't get out of the vehicle after an air bag inflates, then get fresh air by opening a window or door.

- The air bag is designed to inflate only once. After it inflates, you'll need some new parts for your air bag system. If you don't get them, the air bag system won't be there to help protect you in another crash. A new system will include the air bag module and possibly other parts. The service manual for your vehicle covers the need to replace other parts.
- Your vehicle is equipped with a diagnostic module, which records information about the air bag system. The module records information about the readiness of the system, when the sensors are activated and driver's safety belt usage at deployment.
- Let only qualified technicians work on your air bag system. Improper service can mean that your air bag system won't work properly. See your dealer for service.

NOTICE:

If you damage the cover for the driver's air bag, it may not work properly. You may have to replace the air bag module. Do not open or break the air bag cover.

Servicing Your Air Bag–Equipped Vehicle

The air bag affects how your vehicle should be serviced. There are parts of the air bag system in several places around your vehicle. You don't want the system to inflate while someone is working on your vehicle. Your GM dealer and the 1995 GM Service Manual have information about servicing your vehicle and the air bag system. To purchase a service manual, see "Service Publications" in the Index. The air bag system does not need regular maintenance.



CAUTION:

For up to 2 minutes after the ignition key is turned off and the battery is disconnected, an air bag can still inflate during improper service. You can be injured if you are close to an air bag when it inflates. Avoid wires wrapped with yellow tape, or yellow connectors. They are probably part of the air bag system. Be sure to follow proper service procedures, and make sure the person performing work for you is qualified to do so.

Adding Equipment to Your Air Bag–Equipped Vehicle

Q: *If I add a push bumper or a bicycle rack to the front of my vehicle, will it keep the air bag from working properly?*

A: As long as the push bumper or bicycle rack is attached to your vehicle so that the vehicle's basic structure isn't changed, it's not likely to keep the air bags from working properly in a crash.

Q: *What if I add a snow plow? Will it keep the air bag from working properly?*

A: We've designed our air bag systems to work properly under a wide range of conditions, including snow plowing with vehicles equipped with the optional Snow Plow Prep Package (RPO VYU). But don't change or defeat the snow plow's "tripping mechanism." If you do, it can damage your snow plow and your vehicle, and it may cause an air bag inflation.

Q: *Is there anything I might add to the front of the vehicle that could keep the air bag from working properly?*

A: Yes. If you add things that change your vehicle's frame, bumper system, front end sheet metal or height, they may keep the air bag system from working properly. Also, the air bag system may not work properly if you relocate any of the air bag sensors. If you have any question about this, you should contact Customer Assistance before you modify your vehicle. (The phone numbers and addresses for Customer Assistance are in Step Two of the Customer Satisfaction Procedure in this manual. See "Customer Satisfaction Procedure" in the Index.)

Safety Belt Use During Pregnancy

Safety belts work for everyone, including pregnant women. Like all occupants, they are more likely to be seriously injured if they don't wear safety belts.

A pregnant woman should wear a lap-shoulder belt, and the lap portion should be worn as low as possible throughout the pregnancy.



The best way to protect the fetus is to protect the mother. When a safety belt is worn properly, it's more likely that the fetus won't be hurt in a crash. For pregnant women, as for anyone, the key to making safety belts effective is wearing them properly.

Right Front Passenger Position

The right front passenger's safety belt works the same way as the driver's safety belt. See "Driver Position," earlier in this section.

When the lap portion of the belt is pulled out all the way, it will lock. If it does, let it go back all the way and start again.

Center Passenger Position

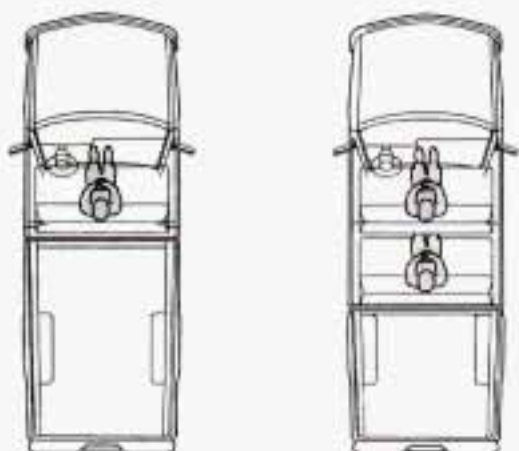

Lap Belt

If your vehicle has front and rear bench seats, someone can sit in the center positions.



When you sit in a center seating position, you have a lap safety belt, which has no retractor. To make the belt longer, tilt the latch plate and pull it along the belt.

To make the belt shorter, pull its free end as shown until the belt is snug.

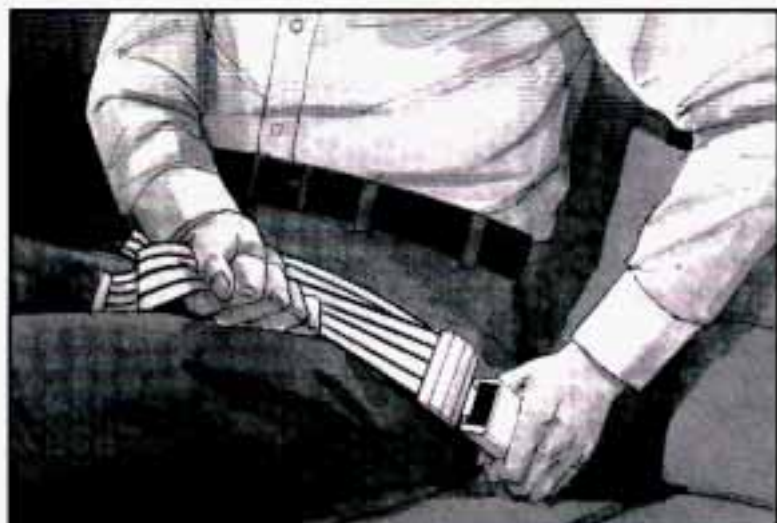

Buckle, position and release it the same way as the lap part of a lap-shoulder belt. If the belt isn't long enough, see "Safety Belt Extender" at the end of this section.

Make sure the release button on the buckle is positioned so you would be able to unbuckle the safety belt quickly if you ever had to.

Rear Seat Passengers

It's very important for rear seat passengers to buckle up! Accident statistics show that unbelted people in the rear seat are hurt more often in crashes than those who are wearing safety belts.

Rear passengers who aren't safety belted can be thrown out of the vehicle in a crash. And they can strike others in the vehicle who are wearing safety belts.

Rear Seat Outside Passenger Positions (Extended Cab)

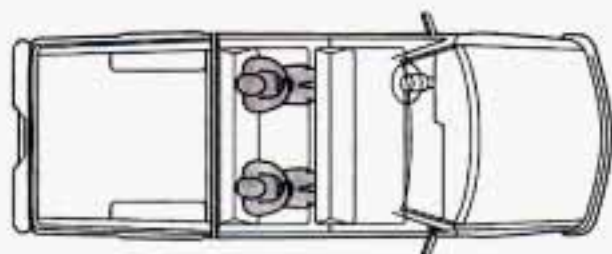

If you have a Crew Cab, see "Rear Seat Outside Passenger Positions (Crew Cab)" later in this section.

Lap–Shoulder Belt (Extended Cab)

The positions next to the windows have lap–shoulder belts. Here’s how to wear one properly.

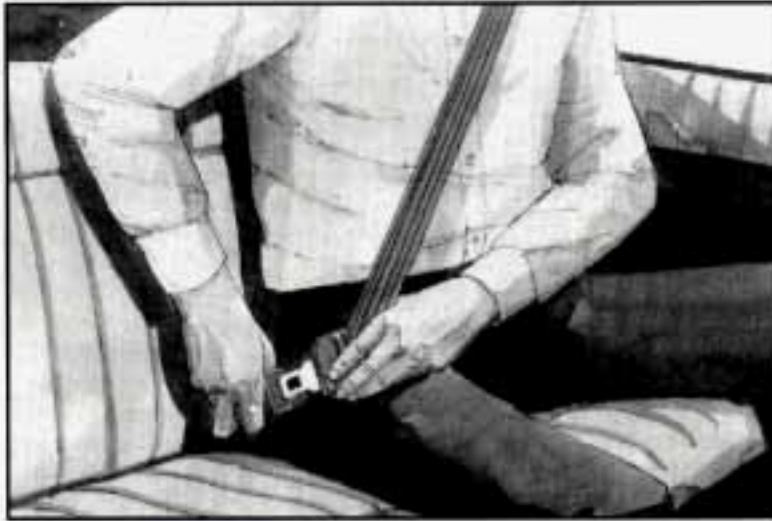

1. Pick up the latch plate and pull the belt across you. (On some models, you may hear a clicking sound as the belt is pulled out. This is the feature that reduces shoulder belt tension operating properly.) Don't let the belt get twisted.
2. Push the latch plate into the buckle until it clicks. If the belt stops before it reaches the buckle, tilt the latch plate and keep pulling until you can buckle it.

Pull up on the latch plate to make sure it is secure.

If the belt is not long enough, see "Safety Belt Extender" at the end of this section.

Make sure the release button on the buckle is positioned so you would be able to unbuckle the safety belt quickly if you ever had to.



3. To make the lap part tight, pull down on the buckle end of the belt as you pull up on the shoulder part.

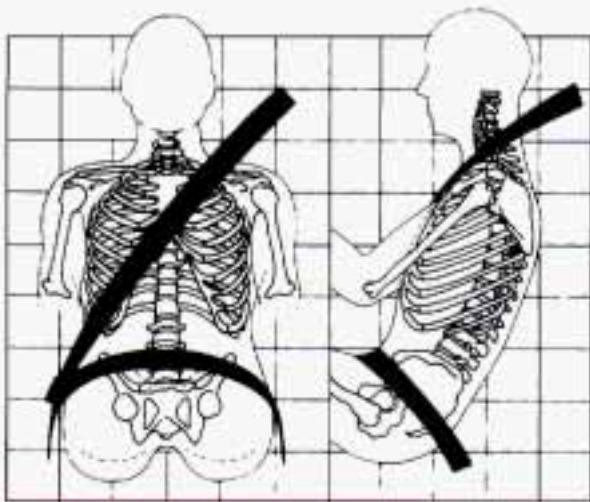

The lap part of the belt should be worn low and snug on the hips, just touching the thighs. In a crash, this applies force to the strong pelvic bones. And you'd be less likely to slide under the lap belt. If you slid under it, the belt would apply force at your abdomen. This could cause serious or even fatal injuries. The shoulder belt should go over the shoulder and across the chest. These parts of the body are best able to take belt restraining forces.

The safety belt locks if there's a sudden stop or a crash.



CAUTION:

You can be seriously hurt if your shoulder belt is too loose. In a crash you would move forward too much, which could increase injury. The shoulder belt should fit against your body.



To unlatch the belt, just push the button on the buckle.

Rear Seat Outside Passenger Positions (Crew Cab)

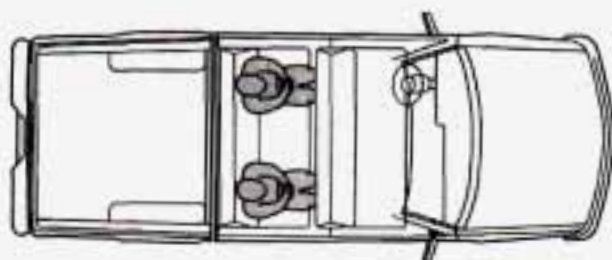

If you have an Extended Cab, see “Rear Seat Outside Passenger Positions (Extended Cab)” earlier in this section.

Lap–Shoulder Belt (Crew Cab)

The positions next to the windows have lap–shoulder belts. Here’s how to wear one properly.



1. Pick up the latch plate and pull the belt across you. (On some models, you may hear a clicking sound as the belt is pulled out. This is the feature that reduces shoulder belt tension operating properly.) Don’t let the belt get twisted.
2. Push the latch plate into the buckle until it clicks. Pull up on the latch plate to make sure it is secure. When the lap belt is pulled out all the way, it will lock. If it does, let it go back all the way and start again.

If the belt is not long enough, see “Safety Belt Extender” at the end of this section.

Make sure the release button on the buckle is positioned so you would be able to unbuckle the safety belt quickly if you ever had to.

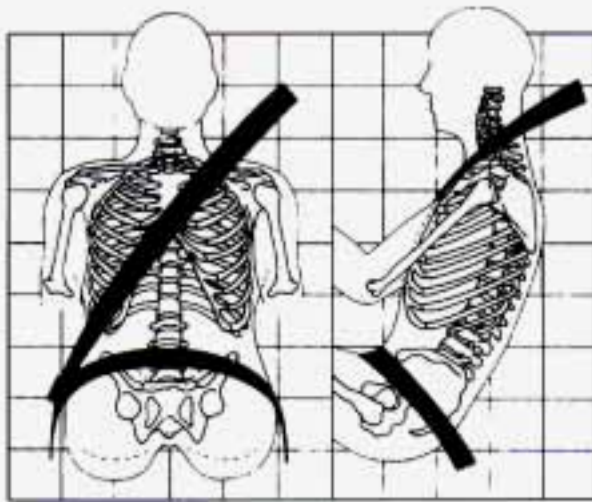

The lap part of the belt should be worn low and snug on the hips, just touching the thighs. In a crash, this applies force to the strong pelvic bones. And you'd be less likely to slide under the lap belt. If you slid under it, the belt would apply force at your abdomen. This could cause serious or even fatal injuries. The shoulder belt should go over the shoulder and across the chest. These parts of the body are best able to take belt restraining forces.

The safety belt locks only if there's a sudden stop or a crash.



CAUTION:

You can be seriously hurt if your shoulder belt is too loose. In a crash you would move forward too much, which could increase injury. The shoulder belt should fit against your body.



To unlatch the belt, just push the button on the buckle.

Children

Everyone in a vehicle needs protection! That includes infants and all children smaller than adult size. In fact, the law in every state in the United States and in every Canadian province says children up to some age must be restrained while in a vehicle.

Smaller Children and Babies

CAUTION:

Smaller children and babies should always be restrained in a child or infant restraint. The instructions for the restraint will say whether it is the right type and size for your child. A very young child's hip bones are so small that a regular belt might not stay low on the hips, as it should. Instead, the belt will likely be over the child's abdomen. In a crash the belt would apply force right on the child's abdomen, which could cause serious or fatal injuries. So, be sure that any child small enough for one is always properly restrained in a child or infant restraint.



CAUTION:

Never hold a baby in your arms while riding in a vehicle. A baby doesn't weigh much — until a crash. During a crash a baby will become so heavy you can't hold it. For example, in a crash at only 25 mph (40 km/h), a 12-pound (5.5 kg) baby will suddenly become a 240-pound (110 kg) force on your arms. The baby would be almost impossible to hold.

Secure the baby in an infant restraint.

Child Restraints

Be sure to follow the instructions for the restraint. You may find these instructions on the restraint itself or in a booklet, or both. These restraints use the belt system in your vehicle, but the child also has to be secured within the restraint to help reduce the chance of personal injury. The instructions that come with the infant or child restraint will show you how to do that.

Where to Put the Restraint (Except Extended Cab and Crew Cab)

The child restraint must be secured properly in the center or right front passenger seat.

Where to Put the Restraint (Extended Cab and Crew Cab)

Accident statistics show that children are safer if they are restrained in the rear rather than the front seat. We at General Motors therefore recommend that you put your child restraint in the rear seat unless the child is an infant and you're the only adult in the vehicle. In that case, you might want to secure the restraint in the front seat where you can keep an eye on the baby.

Wherever you install it, be sure to secure the child restraint properly.

Keep in mind that an unsecured child restraint can move around in a collision or sudden stop and injure people in the vehicle. Be sure to properly secure any child restraint in your vehicle — even when no child is in it.

Top Strap

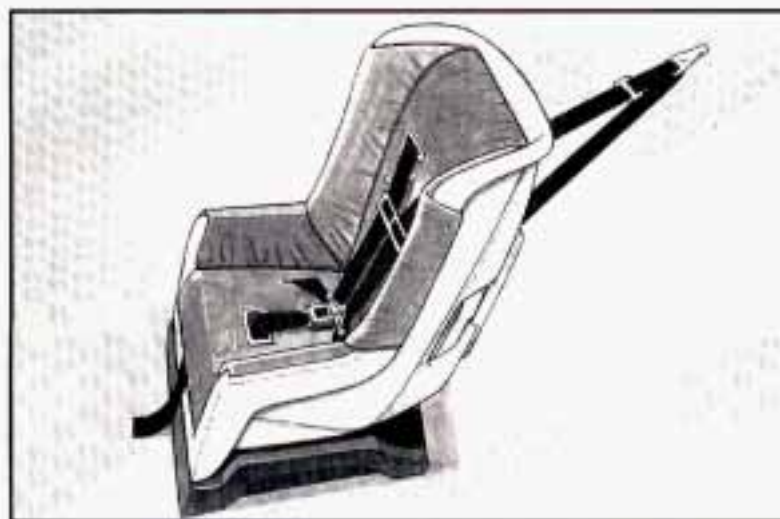

If your child restraint has a top strap, it should be anchored.

If you need to have an anchor installed, you can ask your GM dealer to put it in for you. If you want to install an anchor yourself, your dealer can tell you how to do it.

Securing a Child Restraint in a Rear Outside Seat Position (Extended Cab)

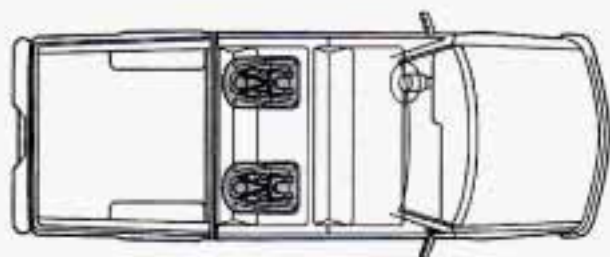

If you have a Crew Cab, see “Securing a Child Restraint in a Rear Outside Seat Position (Crew Cab)” later in this section.

You’ll be using the lap–shoulder belt. See the earlier part about the top strap if the child restraint has one.

1. Put the restraint on the seat. Follow the instructions for the child restraint.
2. Secure the child in the child restraint as the instructions say.

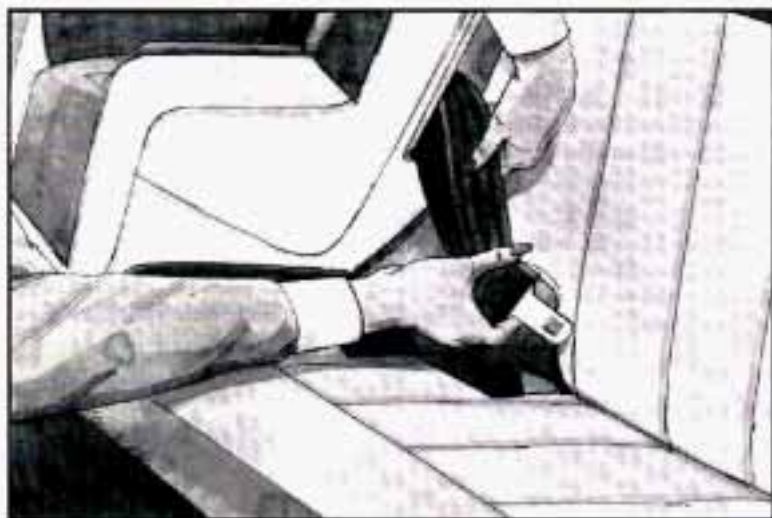

3. Pick up the latch plate, and run the lap and shoulder portions of the vehicle’s safety belt through or around the restraint. The child restraint instructions will show you how. Tilt the latch plate to adjust the belt if needed. If the shoulder belt goes in front of the child’s face or neck, put it behind the child restraint.



4. Buckle the belt. Make sure the release button is positioned so you would be able to unbuckle the safety belt quickly if you ever had to.



5. To tighten the belt, pull up on the shoulder belt while you push down on the child restraint.

Make sure the buckle end of the belt is pulled out all the way.

6. Push and pull the child restraint in different directions to be sure it is secure.

To remove the child restraint, just unbuckle the vehicle's safety belt and let it go back all the way. The safety belt will move freely again and be ready to work for an adult or larger child passenger.

Securing a Child Restraint in a Rear Outside Seat Position (Crew Cab)

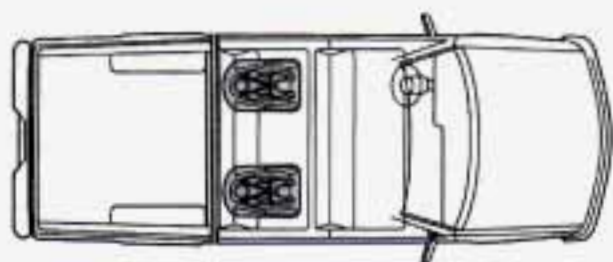

If you have an Extended Cab, see “Securing a Child Restraint in a Rear Outside Seat Position (Extended Cab)” earlier in this section.

You’ll be using the lap–shoulder belt. See the earlier part about the top strap if the child restraint has one.

1. Put the restraint on the seat. Follow the instructions for the child restraint.
2. Secure the child in the child restraint as the instructions say.
3. Pick up the latch plate, and run the lap and shoulder portions of the vehicle’s safety belt through or around the restraint. The child restraint instructions will show you how. If the shoulder belt goes in front of the child’s face or neck, put it behind the child restraint.



4. Buckle the belt. Make sure the release button is positioned so you would be able to unbuckle the safety belt quickly if you ever had to.



5. Pull the rest of the lap belt all the way out of the retractor to set the lock.



6. To tighten the belt, feed the lap belt back into the retractor while you push down on the child restraint.

7. Push and pull the child restraint in different directions to be sure it is secure.

To remove the child restraint, just unbuckle the vehicle's safety belt and let it go back all the way. The safety belt will move freely again and be ready to work for an adult or larger child passenger.

Securing a Child Restraint in a Center Seat Position

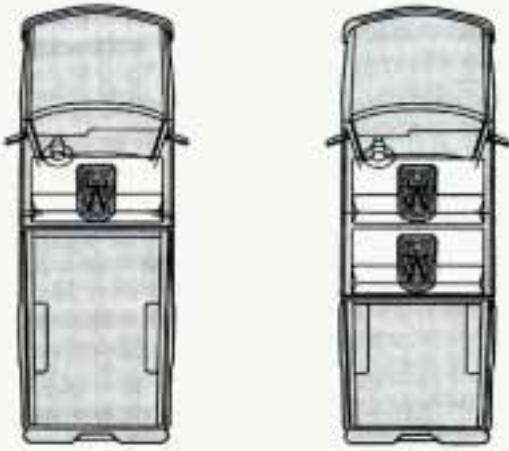

You'll be using the lap belt.

See the earlier part about the top strap if the child restraint has one.



1. Make the belt as long as possible by tilting the latch plate and pulling it along the belt.

2. Put the restraint on the seat. Follow the instructions for the child restraint.
3. Secure the child in the child restraint as the instructions say.

4. Run the vehicle's safety belt through or around the restraint. The child restraint instructions will show you how.



5. Buckle the belt. Make sure the release button is positioned so you would be able to unbuckle the safety belt quickly if you ever had to.

6. To tighten the belt, pull its free end while you push down on the child restraint.
7. Push and pull the child restraint in different directions to be sure it is secure. If the child restraint isn't secure, turn the latch plate over and buckle it again. Then see if it is secure. If it isn't, secure the restraint in a different place in the vehicle and contact the child restraint maker for their advice about how to attach the child restraint properly.

To remove the child restraint, just unbuckle the vehicle's safety belt. It will be ready to work for an adult or larger child passenger.

Securing a Child Restraint in the Right Front Seat Position

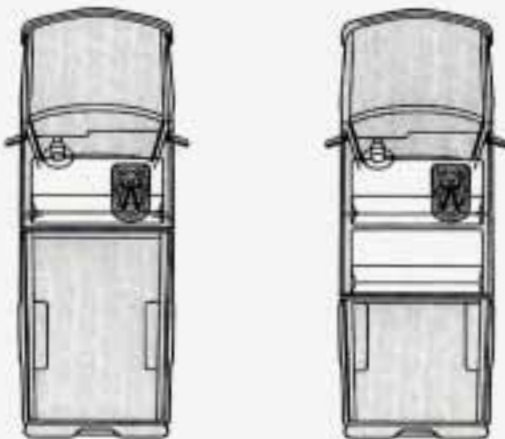

You'll be using the lap-shoulder belt. See the earlier part about the top strap if the child restraint has one.

1. Put the restraint on the seat. Follow the instructions for the child restraint.
2. Secure the child in the child restraint as the instructions say.
3. Pick up the latch plate, and run the lap and shoulder portions of the vehicle's safety belt through or around the restraint. The child restraint instructions will show you how.

If the shoulder belt goes in front of the child's face or neck, put it behind the child restraint.



4. Buckle the belt.

Make sure the release button is positioned so you would be able to unbuckle the safety belt quickly if you ever had to.



5. Pull the rest of the lap belt all the way out of the retractor to set the lock.



6. To tighten the belt, feed the lap belt back into the retractor while you push down on the child restraint.

7. Push and pull the child restraint in different directions to be sure it is secure.

To remove the child restraint, just unbuckle the vehicle's safety belt and let it go back all the way.

The safety belt will move freely again and be ready to work for an adult or larger child passenger.

Larger Children



Children who have outgrown child restraints should wear the vehicle's safety belts.

If you have the choice, a child should sit next to a window so the child can wear a lap-shoulder belt and get the additional restraint a shoulder belt can provide.

Accident statistics show that children are safer if they are restrained in the rear seat. But they need to use the safety belts properly.

- Children who aren't buckled up can be thrown out in a crash.
- Children who aren't buckled up can strike other people who are.



 **CAUTION:**

Never do this.

Here two children are wearing the same belt. The belt can't properly spread the impact forces. In a crash, the two children can be crushed together and seriously injured. A belt must be used by only one person at a time.

Q: What if a child is wearing a lap-shoulder belt, but the child is so small that the shoulder belt is very close to the child's face or neck?

A: Move the child toward the center of the vehicle, but be sure that the shoulder belt still is on the child's shoulder, so that in a crash the child's upper body would have the restraint that belts provide. If the child is so small that the shoulder belt is still very close to the child's face or neck, you might want to place the child in a seat that has a lap belt, if your vehicle has one.



 **CAUTION:**

Never do this.

Here a child is sitting in a seat that has a lap-shoulder belt, but the shoulder part is behind the child. If the child wears the belt in this way, in a crash the child might slide under the belt. The belt's force would then be applied right on the child's abdomen. That could cause serious or fatal injuries.

Wherever the child sits, the lap portion of the belt should be worn low and snug on the hips, just touching the child's thighs. This applies belt force to the child's pelvic bones in a crash.

Safety Belt Extender

If the vehicle's safety belt will fasten around you, you should use it.

But if a safety belt isn't long enough to fasten, your dealer will order you an extender. It's free. When you go in to order it, take the heaviest coat you will wear, so the extender will be long enough for you. The extender will be just for you, and just for the seat in your vehicle that you choose. Don't let someone else use it, and use it only for the seat it is made to fit. To wear it, just attach it to the regular safety belt.

Checking Your Restraint Systems

Now and then, make sure all your belts, buckles, latch plates, retractors, anchorages and reminder systems are working properly. Look for any other loose or damaged restraint system parts. If you see anything that might keep a restraint system from doing its job, have it repaired.

Torn or frayed belts may not protect you in a crash. They can rip apart under impact forces. If a belt is torn or frayed, get a new one right away.

Replacing Seat and Restraint System Parts After a Crash

If you've had a crash, do you need new belts?

After a very minor collision, nothing may be necessary. But if the belts were stretched, as they would be if worn during a more severe crash, then you need new belts.

If you ever see a label on the right front passenger's safety belt in an Extended Cab model that says to replace the belt, be sure to do so. Then the new belt will be there to help protect you in an accident. You would see this label on the belt near the door opening.



If belts are cut or damaged, replace them. Collision damage also may mean you will need to have safety belt or seat parts repaired or replaced. New parts and repairs may be necessary even if the belt wasn't being used at the time of the collision.

Before replacing any safety belt, see your dealer for the correct part number. You'll need the model year and model number for your vehicle. The model year is on your title and registration. And you can find the model number on the Certification/Tire label of your vehicle. See "Certification/Tire Label" in the Index.



The model number on the replacement belt may be listed on the safety belt you want to replace. Pull the lap belt all the way out to see this label. If there is no model number listed on the safety belt, see your dealer to make sure you get the correct part number for the replacement belt.

Notes

Features and Controls

Section

2

Here you can learn about the many standard and optional features on your vehicle, and information on starting, shifting and braking. Also explained are the instrument panel and the warning systems that tell you if everything is working properly — and what to do if you have a problem.

Keys



CAUTION:

Leaving young children in a vehicle with the ignition key is dangerous for many reasons. A child or others could be badly injured or even killed.

They could operate power windows or other controls or even make the vehicle move. Don't leave the keys in a vehicle with young children.



Your vehicle has one double-sided key for the ignition and all door locks.

If you ever lose your keys, your dealer will be able to assist you with obtaining new ones.

NOTICE:

Your vehicle has a number of new features that can help prevent theft. But you can have a lot of trouble getting into your vehicle if you ever lock your key inside. You may even have to damage your vehicle to get in. So be sure you have an extra key.

Your Doors and How They Work

Side Doors

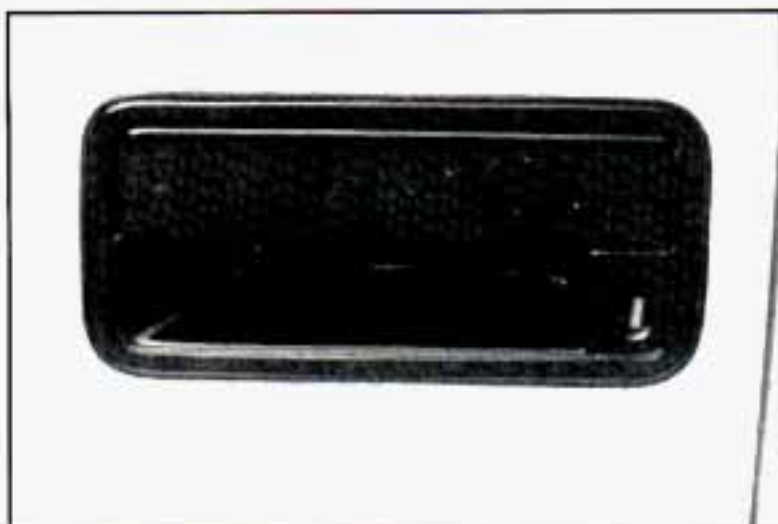

To open the door from the outside, pull the handle up and pull the door open.



To open the door from the inside, pull the lever toward you and push the door open.

Tailgate



You can open the tailgate by lifting up on its handle while pulling the tailgate toward you.

To shut the tailgate, firmly push it away from you into the latch.

When you put the tailgate back up, pull it back toward you, to be sure that it latches securely.

Tailgate Removal

The tailgate on your vehicle can be removed to allow for different loading situations. Although the tailgate can be removed without assistance, you may want someone to assist you with the removal to avoid possible finish damage.

To remove the tailgate:



- Raise the tailgate slightly and release both retaining cable clips. To release the cable clips, lift the cable so it points straight out and push the cable clips forward.



- With the tailgate at a slight upward angle, pull back on the tailgate at the right edge and then move the tailgate to the right, to release the left edge.

Reverse the above procedure to re-install. Make sure the tailgate is secure.

Door Locks



CAUTION:

Unlocked doors can be dangerous.

Passengers — especially children — can easily open the doors and fall out. When a door is locked, the inside handle won't open it.

Outsiders can easily enter through an unlocked door when you slow down or stop your vehicle.

This may not be so obvious: You increase the chance of being thrown out of the vehicle in a crash if the doors aren't locked. Wear safety belts properly, lock your doors, and you will be far better off whenever you drive your vehicle.

There are several ways to lock and unlock your vehicle:



From the outside: Use your key.



From the inside: To lock the door, slide the lever on your door down.

To unlock the door, slide the lever up.

Power Door Locks (Option)

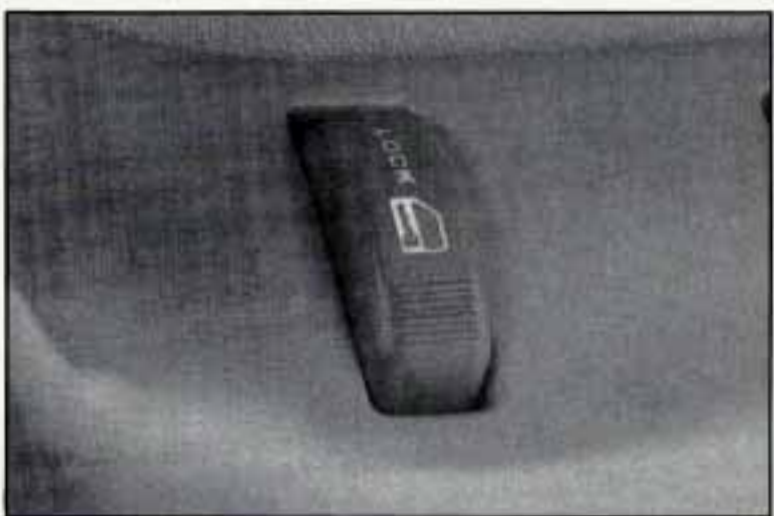

Press the side of the power door lock switch, marked LOCK, on either front door to lock all the doors at once. Press the ribbed side of the switch to unlock all the doors at once.

On Crew Cab models, the switch on each rear door works only that door's lock. It won't lock (or unlock) all of the doors — that's a safety feature.

Leaving Your Vehicle

If you are leaving the vehicle, take your keys, open your door and set the locks from inside. Then get out and close the door.

Keyless Entry System

If your vehicle has this option, you can lock and unlock your doors from up to 30 feet (9 m) away using the key chain transmitter supplied with your vehicle.

Your Keyless Entry System operates on a radio frequency subject to Federal Communications Commission (FCC) Rules.

This device complies with Part 15 of the FCC Rules. Operation is subject to the following two conditions: (1) This device may not cause harmful interference, and (2) This device must accept any interference received, including interference that may cause undesired operation.

Should interference to this system occur, try this:

- Check to determine if battery replacement is necessary. See the instructions on battery replacement.
- Check the distance. You may be too far from your vehicle. This product has a maximum range.
- Check the location. Other vehicles or objects may be blocking the signal.
- See your GM dealer or a qualified technician for service.

Changes or modifications to this system by other than an authorized service facility could void authorization to use this equipment.

Operation

To unlock the driver's door, press the UNLOCK button. If you press this button again within five seconds, all the doors will unlock.

Press the LOCK button to lock all the doors.

Matching Transmitter(s) To Your Vehicle

Each key chain transmitter is coded to prevent another transmitter from unlocking your vehicle. If a transmitter is lost or stolen, a replacement can be purchased through your dealer. Remember to bring any remaining transmitters with you when you go to your dealer. When the dealer matches the replacement transmitter to your vehicle, the remaining transmitters must also be matched. Once the new transmitter is coded, the lost transmitter will not unlock your vehicle.

You can match a transmitter to as many different vehicles as you own, provided they are equipped with *exactly the same model system*. (General Motors offers several different models of these systems on their vehicles.) Each vehicle can have only two transmitters matched to it.

See your dealer to match transmitters to another vehicle.

Battery Replacement

Under normal use, the batteries in your key chain transmitter should last about two years.

You can tell the batteries are weak if the transmitter won't work at the normal range in any location. If you have to get close to your vehicle before the transmitter works, it's probably time to change the batteries.

Use two Duracell® type DL2016, or a similar type.

To replace the batteries:



1. Insert a dime in the side seam of the transmitter housing, near the key ring hole.
2. Twist the dime to separate the two halves of the transmitter housing. Separate the housing, bottom half first.
3. Remove and replace the batteries. Put the new batteries in with the printed side down.
4. Align the housing and snap the halves together.

Theft

Vehicle theft is big business, especially in some cities. Although your vehicle has a number of theft deterrent features, we know that nothing we put on it can make it impossible to steal. However, there are ways you can help.

Key in the Ignition

If you walk away from your vehicle with the keys inside, it's an easy target for joy riders or professional thieves — so don't do it.

When you park your vehicle and open the driver's door, you'll hear a tone reminding you to remove your key from the ignition and take it with you. Always do this. Your steering wheel will be locked, and so will your ignition. If you have an automatic transmission, taking your key out also locks your transmission. And remember to lock the doors.

Parking at Night

Park in a lighted spot, close all windows and lock your vehicle. Remember to keep your valuables out of sight. Put them in a storage area, or take them with you.

Parking Lots

If you park in a lot where someone will be watching your vehicle, it's best to lock it up and take your keys. But what if you have to leave your ignition key? What if you have to leave something valuable in your vehicle?

- Put your valuables in a storage area, like your glove box.
- Lock all the doors except the driver's.

New Vehicle “Break-In”

NOTICE:

Your modern vehicle doesn't need an elaborate “break-in.” But it will perform better in the long run if you follow these guidelines:

- Keep your speed at 55 mph (88 km/h) or less for the first 500 miles (804 km).
- Don't drive at any one speed — fast or slow — for the first 500 miles (804 km). Don't make full-throttle starts.
- Avoid making hard stops for the first 200 miles (322 km) or so. During this time your new brake linings aren't yet broken in. Hard stops with new linings can mean premature wear and earlier replacement. Follow this “breaking-in” guideline every time you get new brake linings.
- Don't tow a trailer during “break-in.” See “Towing a Trailer” in the Index for more information.

New Vehicle "Break-In" – 3500 HD Model

If you have a 3500 HD model, your parking brake requires a special break-in procedure. See "Parking Brake" in the Index.

Ignition Switch

Use your key to start your vehicle. The key lets you turn the ignition switch to five different positions:

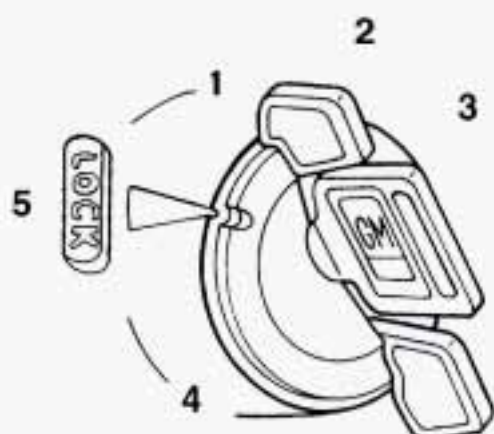

1. OFF
2. RUN
3. START
4. ACC
5. LOCK

ACC (Accessory): ACC lets you use things like the radio, power windows and the windshield wipers when the engine is off. To get into ACC, push in the key and turn it toward you. Your steering wheel will remain locked, just as it was before you inserted the key.

LOCK: This position locks your ignition, steering wheel and transmission. It's a theft deterrent feature. You will only be able to remove your key when the ignition is turned to LOCK.

OFF: This position lets you turn off the engine but still turn the steering wheel. It doesn't lock the steering wheel like LOCK. Use OFF if you must have your vehicle in motion while the engine is off (for example, if your vehicle is being pushed).

RUN: This is the position for driving.

START: This starts your engine.



CAUTION:

On manual transmission vehicles, turning the key to **LOCK** will lock the steering column and result in a loss of ability to steer the vehicle. This could cause a collision. If you need to turn the engine off while the vehicle is moving, turn the key only to **OFF**. Don't press the key release button while the vehicle is moving.

NOTICE:

If your key seems stuck in **LOCK** and you can't turn it, be sure it is all the way in. If it is, then turn the steering wheel left and right while you turn the key hard. But turn the key only with your hand. Using a tool to force it could break the key or the ignition switch. If none of this works, then your vehicle needs service.

Key Release Button



The ignition key cannot be removed from the ignition of manual transmission vehicles unless the key release button is used.

To Remove the Key

On manual transmission vehicles, turn the key to the **LOCK** position while pressing the key release button in (see the caution earlier in this section about the key release lever). Keeping your finger on the button, pull the key straight out.

On automatic transmission vehicles, turn the key to **LOCK** and pull it straight out.

Starting Your Gasoline Engine

If you have a diesel engine, see “Starting Your Diesel Engine” in the Index.

Engines start differently. The 8th digit of your Vehicle Identification Number (VIN) shows the code letter or number for your engine. You will find the VIN at the top left of your instrument panel. (See “Vehicle Identification Number” in the Index.) Follow the proper steps to start the engine.

Automatic transmission:

Move your shift lever to PARK (P) or NEUTRAL (N). Your engine won't start in any other position — that's a safety feature. To restart when you're already moving, use NEUTRAL (N) only.

NOTICE:

Don't try to shift to PARK (P) if your vehicle is moving. If you do, you could damage the transmission. Shift to PARK (P) only when your vehicle is stopped.

Manual transmission:

The gear selector should be in neutral. Hold the clutch pedal to the floor and start the engine. Your vehicle won't start if the clutch pedal is not all the way down — that's a safety feature.

To start your 4.3 Liter V6 (Code Z) or 5.0 Liter V8 (Code H) engine:

1. Without pushing the accelerator pedal, turn your ignition key to START. When the engine starts, let go of the key. The idle speed will go down as your engine gets warm.

NOTICE:

Holding your key in START for longer than 15 seconds at a time will cause your battery to be drained much sooner. And the excessive heat can damage your starter motor.

2. If it doesn't start right away, hold your key in START. If it doesn't start in three seconds, push the accelerator pedal about one-quarter of the way down for 12 more seconds, or until it starts.
3. If your engine still won't start (or starts but then stops), it could be flooded with too much gasoline. Try this:
4. Wait 15 seconds to let the starter motor cool down. Then push your accelerator pedal all the way to the floor. Hold it there. Then, hold the

key in START for no more than ten seconds. This clears the extra gasoline from the engine.

If the engine still doesn't start, wait another 15 seconds and do Step 4 again.

When the engine starts, let go of the key and the accelerator pedal.

NOTICE:

Your engine is designed to work with the electronics in your vehicle. If you add electrical parts or accessories, you could change the way the fuel injection system operates. Before adding electrical equipment, check with your dealer. If you don't, your engine might not perform properly.

If you ever have to have your vehicle towed, see the part of this manual that tells how to do it without damaging your vehicle. See "Towing Your Vehicle" in the Index.

To start your 5.7 Liter (Code K) or 7.4 Liter (Code N) V8 engine:

1. Without pushing the accelerator pedal, turn your ignition key to START. When the engine starts, let go of the key. The idle speed will go down as your engine gets warm.

NOTICE:

Holding your key in START for longer than 15 seconds at a time will cause your battery to be drained much sooner. And the excessive heat can damage your starter motor.

2. If it doesn't start right away, hold your key in START. If it doesn't start in three seconds, push the accelerator pedal about one-quarter of the way down for 12 more seconds, or until it starts.
3. If your engine still won't start (or starts but then stops), it could be flooded with too much gasoline. Try this:
4. Wait 15 seconds to let the starter motor cool down. Then push your accelerator pedal all the way to the floor. Hold it there. Then hold the key in START for no more than ten seconds. This clears the extra gasoline from the engine. If the engine still doesn't start, wait another 15 seconds and do Step 4 again.

When the engine starts, let go of the key and the accelerator pedal.

Hot Engine Restart (Vehicles With 5.7L L05 Engine and Over 8500 lbs. GVWR):

If your engine is already hot and then stalls, turn your ignition key to OFF. Then turn your key to RUN and wait 20 seconds before you restart your engine. When the engine starts, let go of the key and the accelerator pedal.

NOTICE:

Your engine is designed to work with the electronics in your vehicle. If you add electrical parts or accessories, you could change the way the fuel injection system operates. Before adding electrical equipment, check with your dealer. If you don't, your engine might not perform properly.

If you ever have to have your vehicle towed, see the part of this manual that tells how to do it without damaging your vehicle. See "Towing Your Vehicle" in the Index.

Driving Through Deep Standing Water

NOTICE:

If you drive too quickly through deep puddles or standing water, water can come in through your engine's air intake and badly damage your engine. Never drive through water that is slightly lower than the underbody of your vehicle. If you can't avoid deep puddles or standing water, drive through them very slowly.

Driving In Snow (Diesel Engines)

When driving in a heavy snowstorm or in swirling snow with a diesel engine, snow can get into the air intake system. If you keep driving in these conditions the air cleaner may get plugged, causing black smoke and loss of power. In an emergency, if the air cleaner gets plugged with snow, you can remove the air cleaner. Then, drive to a place of safety as soon as possible and put the air cleaner back on.

Starting Your Diesel Engine

Your diesel engine starts differently than a gasoline engine.

1. *Automatic transmission:* Move your shift lever to PARK (P) or NEUTRAL (N). Your engine won't start in any other position — that's a safety feature. To restart when you're already moving, use NEUTRAL (N) only.

NOTICE:

Don't try to shift to PARK (P) if your vehicle is moving. If you do, you could damage the transmission. Shift to PARK (P) only when your vehicle is stopped.

2. *Manual transmission:* Move your shift lever to neutral and hold the clutch pedal to the floor while starting the engine. Your vehicle won't start if the clutch pedal is not all the way down — that's a safety feature.

Turn your ignition key to RUN.

Observe the GLOW PLUGS light. (This light may not come on if the engine is hot.)

NOTICE:

If the GLOW PLUGS light stays on, it means that your vehicle could have one of several problems, so you should have it serviced right away.

3. As soon as the GLOW PLUGS light goes off, IMMEDIATELY turn the ignition key to START. When the engine starts, let go of the key. (The longer you wait to start after the light goes off, the harder it will be to start the engine.)

NOTICE:

Holding your key in START for longer than 15 seconds at a time will cause your battery to be drained much sooner. And the excessive heat can damage your starter motor.

4. If the engine does not start after 15 seconds of cranking, turn the ignition key to OFF. Wait one minute for the starter to cool, then try the same steps again.

If you're trying to start your engine after you've run out of fuel, follow the steps in "Running Out of Fuel" (see "Diesel Fuel Requirements and Fuel System" in the Index).

When your engine is cold, let it run for a few minutes before you move your vehicle. This lets oil pressure build up. Your engine will sound louder when it's cold.

NOTICE:

If you're not in an idling vehicle and the engine overheats, you wouldn't be there to see the coolant temperature gage. This could damage your vehicle. Don't let your engine run when you're not in your vehicle.

Cold Weather Starting (Diesel Engine)

The following tips will help you get good starting in cold weather.

Use SAE 10W-30 oil when the outside temperature drops below freezing. When the outside temperature drops below 0°F (-18°C), use your engine coolant heater.

If you park your vehicle in a garage, you shouldn't need to use the coolant heater until the garage temperature goes below 0°F (-18°C), no matter how cold it is outside.

To use the engine coolant heater, first turn off the engine. Then open the hood, unwrap the electrical cord and plug it in. It uses normal house voltage (110 volts), but:



CAUTION:

Plugging the cord into an ungrounded outlet could cause an electrical shock. Also, the wrong kind of extension cord could overheat and cause a fire. You could be seriously injured. Plug the cord into a properly grounded three-prong 110-volt outlet. If the cord won't reach, use a heavy-duty three-prong extension cord rated for at least 15 amps.

NOTICE:

After you've used the coolant heater, be sure to store the cord in the manner it was, to help keep it away from moving engine parts. If you don't, it could be torn and damaged.

How long should you keep the coolant heater plugged in? The answer depends on the weather, the kind of oil you have, and some other things. Follow this chart.

Viscosity/ Oil Grade	32°F to 0°F (0°C to -18°C)	0°F to -10°F (-18°C to -23°C)	Below -10°F Below -23°C
SAE 10W-30	Not Required	Two Hours*	Eight Hours* or Overnight
SAE 15W-40	Not Required	Two Hours*	Eight Hours* or Overnight

*The times listed are minimum times. It will not harm either the coolant heater or the vehicle to leave the coolant heater plugged in longer than the times stated.

See "Diesel Fuel Requirements and Fuel System" in the Index for information on what fuel to use in cold weather.

If Your Diesel Engine Won't Start

If you've run out of fuel, look at "Running Out of Fuel" (see "Diesel Fuel Requirements and Fuel System" in the Index).

If you're not out of fuel, and your engine won't start, do this:

Turn your ignition key to RUN. Make sure that the GLOW PLUGS light is out. Then IMMEDIATELY turn the ignition key to START.

If the light doesn't go off, wait a few seconds, then try starting your engine again. And, see your dealer as soon as you can for a starting system check.

If the light comes on and then goes off and you know your batteries are charged, but your engine still won't start, your vehicle needs service.

If the light does not come on when the engine is cold, your vehicle needs service.

If your batteries don't have enough charge to start your engine, see "Battery" in the Index.

Be sure you have the right oil for your engine, and that you've changed the oil at the proper times. If you use the wrong oil, your engine may be harder to start.

If the engine starts, runs a short time, then stops, your vehicle needs service.



CAUTION:

Do not use gasoline or starting “aids,” such as ether, in the air intake. They could damage your engine. There could also be a fire, which could cause serious personal injury.

Engine Coolant Heater (Option)

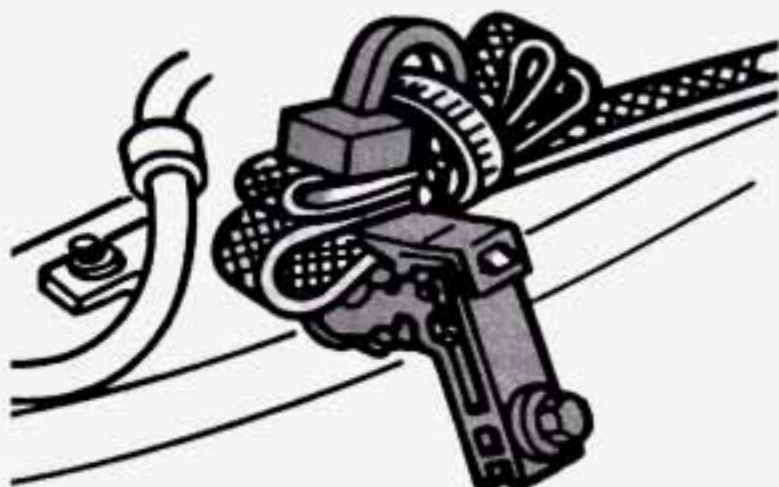

In very cold weather, 0°F (-18°C) or colder, the engine coolant heater can help. You'll get easier starting and better fuel economy during engine warm-up. Usually, the coolant heater should be plugged in a minimum of four hours prior to starting your vehicle.

To use the coolant heater:

1. Turn off the engine.
2. Open the hood and unwrap the electrical cord.
3. Plug it into a normal, grounded 110-volt outlet.



CAUTION:

Plugging the cord into an ungrounded outlet could cause an electrical shock. Also, the wrong kind of extension cord could overheat and cause a fire. You could be seriously injured. Plug the cord into a properly grounded three-prong 110-volt outlet. If the cord won't reach, use a heavy-duty three-prong extension cord rated for at least 15 amps.

NOTICE:

After you've used the coolant heater, be sure to store the cord as it was before to keep it away from moving engine parts. If you don't, it could be damaged.

How long should you keep the coolant heater plugged in? The answer depends on the weather, the kind of oil you have, and some other things. Instead of trying to list everything here, we ask that you contact your GM dealer in the area where you'll be parking your vehicle. The dealer can give you the best advice for that particular area.

Automatic Transmission



There are several different positions for your shift lever.

If your vehicle is equipped with an automatic transmission, it now features an electronic shift position indicator within the instrument cluster. This display must be powered anytime the shift lever is capable of being moved out of the PARK (P) position. This means that if your key is in the OFF position, but not locked, there will be a small current drain on your battery which could discharge your battery over a period of time. If you have a need to leave your key in the ignition in the OFF position for an extended period for any reason, it is recommended that you disconnect the battery cable from the battery to prevent discharging your battery.

- **PARK (P)** —This locks your rear wheels. It's the best position to use when you start your engine because your vehicle can't move easily.



CAUTION:

It is dangerous to get out of your vehicle if the shift lever is not fully in **PARK (P)** with the parking brake firmly set. Your vehicle can roll.

Don't leave your vehicle when the engine is running unless you have to. If you have left the engine running, the vehicle can move suddenly. You or others could be injured. To be sure your vehicle won't move, even when you're on fairly level ground, always set your parking brake and move the shift lever to **PARK (P)**.

If you have four-wheel drive, your vehicle will be free to roll — even if your shift lever is in **PARK (P)** — if your transfer case is in **NEUTRAL (N)**. So, be sure the transfer case is in a drive gear, two-wheel high (**2H**) or four-wheel high (**4H**) or four-wheel low (**4L**) — not in **NEUTRAL (N)**. See “Shifting Into **PARK (P)**” in the Index. If you're pulling a trailer, see “Towing a Trailer” in the Index.

- **REVERSE (R)** — Use this gear to back up.

NOTICE:

Shifting to **REVERSE (R)** while your vehicle is moving forward could damage your transmission. Shift to **REVERSE (R)** only after your vehicle is stopped.

To rock your vehicle back and forth to get out of snow, ice or sand without damaging your transmission, see “If You're Stuck: In Sand, Mud, Ice or Snow” in the Index.

- **NEUTRAL (N)** — In this position, your engine doesn't connect with the wheels. To restart when you're already moving, use **NEUTRAL (N)** only. Also, use **NEUTRAL (N)** when your vehicle is being towed.



CAUTION:

Shifting out of PARK (P) or NEUTRAL (N) while your engine is “racing” (running at high speed) is dangerous. Unless your foot is firmly on the brake pedal, your vehicle could move very rapidly. You could lose control and hit people or objects. Don’t shift out of PARK (P) or NEUTRAL (N) while your engine is racing.

NOTICE:

Damage to your transmission caused by shifting out of PARK (P) or NEUTRAL (N) with the engine racing isn’t covered by your warranty.

- **AUTOMATIC OVERDRIVE (Ⓢ)** — This position is for normal driving. If you need more power for passing, and you’re:
 - Going less than about 35 mph (56 km/h), push your accelerator pedal about halfway down.
 - Going about 35 mph (56 km/h) or more, push the accelerator all the way down.You’ll shift down to the next gear and have more power.
Ⓢ should not be used when towing a trailer, carrying a heavy load, driving on steep hills, or for off-road driving. Select THIRD GEAR (3) when operating the vehicle under any of these conditions.
- **THIRD GEAR (3)** — This is like Ⓢ, but you never go into Overdrive. You should use THIRD GEAR (3) when towing a trailer, carrying a heavy load, driving on steep hills, or for off-road driving.
- **SECOND GEAR (2)** — This position gives you more power but lower fuel economy. You can use SECOND GEAR (2) on hills. It can help control your speed as you go down steep mountain roads, but then you would also want to use your brakes off and on.

If you manually select SECOND GEAR (2), the transmission will drive in second gear. You may use this feature for reducing torque to the rear wheels when you are trying to start your vehicle from a stop on slippery road surfaces.

- **FIRST GEAR (1)** — This position gives you even more power (but lower fuel economy) than **SECOND GEAR (2)**. You can use it on very steep hills, or in deep snow or mud. If the selector lever is put in **FIRST GEAR (1)** while the vehicle is moving forward, the transmission won't shift into **FIRST GEAR (1)** until the vehicle is going slowly enough.

NOTICE:

If your rear wheels can't rotate, don't try to drive. This might happen if you were stuck in very deep sand or mud or were up against a solid object. You could damage your transmission.

Also, if you stop when going uphill, don't hold your vehicle there with only the accelerator pedal. This could overheat and damage the transmission. Use your brakes or shift into **PARK (P)** to hold your vehicle in position on a hill.

Five—Speed Manual Transmission (With Low Gear)



If you have a five speed manual transmission with low gear (RPO MW3), this is your shift pattern. Here's how to operate your transmission:

LOW GEAR (1) is intended only for heavy loads and is not recommended for normal driving.

- **LOW GEAR (1)** — Press the clutch pedal and shift into **LOW GEAR (1)**. Then, slowly let up on the clutch pedal as you press the accelerator pedal. Shift into **LOW GEAR (1)** only when the vehicle speed is below 5 mph (8 km/h). If you try to shift into **LOW GEAR (1)** at excessive vehicle speeds, the shift lever will not move into the **LOW GEAR (1)** position until vehicle speed is reduced.
- **FIRST GEAR (2)** — Press the clutch pedal and shift into **FIRST GEAR (2)**. Then, slowly let up on the clutch pedal as you press the accelerator pedal.

You can shift into **FIRST GEAR (2)** when you're going less than 20 mph (32 km/h). If you've come to a complete stop and it's hard to shift into **FIRST GEAR (2)**, put the shift lever in **NEUTRAL (N)** and let up on the clutch. Press the clutch pedal back down. Then shift into **FIRST GEAR (2)**. If you try to shift into **FIRST GEAR (2)** at excessive vehicle speeds, the shift lever will not move into the **FIRST GEAR (2)** position until vehicle speed is reduced.

- **SECOND GEAR (3)** — Press the clutch pedal as you let up on the accelerator pedal and shift into **SECOND GEAR (3)**. Then, slowly let up on the clutch pedal as you press the accelerator pedal.
- **THIRD GEAR (4), FOURTH GEAR (5)** — Shift into the higher forward gears the same way you do for **SECOND GEAR (3)**. Slowly let up on the clutch pedal as you press the accelerator pedal.
- **To Stop** — Let up on the accelerator pedal and press the brake pedal. Just before the vehicle stops, press the clutch pedal and the brake pedal, and shift to **NEUTRAL (N)**.
- **NEUTRAL (N)** — Use this position when you start or idle your engine.
- **REVERSE (R)** — To back up, first press down the clutch pedal. Wait about 5 seconds for the internal parts to stop spinning and then, shift into **REVERSE (R)**. Let up on the clutch pedal slowly while pressing the accelerator pedal.

NOTICE:

**Shift to REVERSE (R) only after your vehicle is stopped.
Shifting to REVERSE (R) while your vehicle is moving could
damage your transmission.**

Also, use **REVERSE (R)**, along with the parking brake, when turning off your engine and parking your vehicle.

Five Speed Manual Transmission (Without Low Gear)



If you have a five speed manual transmission without low gear (RPO MG5), this is your shift pattern. Here's how to operate your transmission:

- **FIRST GEAR (1)** — Press the clutch pedal and shift into **FIRST GEAR (1)**. Then, slowly let up on the clutch pedal as you press the accelerator pedal.

You can shift into **FIRST GEAR (1)** when you're going less than 20 mph (32 km/h). If you've come to a complete stop and it's hard to shift into **FIRST GEAR (1)**, put the shift lever in **NEUTRAL (N)** and let up on the clutch. Press the clutch pedal back down. Then shift into **FIRST GEAR (1)**.
- **SECOND GEAR (2)** — Press the clutch pedal as you let up on the accelerator pedal and shift into **SECOND GEAR (2)**. Then, slowly let up on the clutch pedal as you press the accelerator pedal.
- **THIRD GEAR (3), FOURTH GEAR (4) and FIFTH GEAR (5)** — Shift into **THIRD GEAR (3)**, **FOURTH GEAR (4)** and **FIFTH GEAR (5)** the same way you do for **SECOND GEAR (2)**. Slowly let up on the clutch pedal as you press the accelerator pedal.
- **To Stop** — Let up on the accelerator pedal and press the brake pedal. Just before the vehicle stops, press the clutch pedal and the brake pedal, and shift to **NEUTRAL (N)**.
- **NEUTRAL (N)** — Use this position when you start or idle your engine.
- **REVERSE (R)** — To back up, first press down the clutch pedal. Wait about 5 seconds for the internal parts to stop spinning and then, shift into **REVERSE (R)**. Let up on the clutch pedal slowly while pressing the accelerator pedal.

NOTICE:

Shift to REVERSE (R) only after your vehicle is stopped. Shifting to REVERSE (R) while your vehicle is moving could damage your transmission.

Also, use REVERSE (R), along with the parking brake, when turning off your engine and parking your vehicle.

SHIFT Light



If you have a manual transmission, you may have a SHIFT light. This light will show you when to shift to the next higher gear for best fuel economy.

When this light comes on, you can shift to the next higher gear if weather, road and traffic conditions let you. For the best fuel economy, accelerate slowly and shift when the light comes on.

While you accelerate, it is normal for the light to go on and off if you quickly change the position of the accelerator. Ignore the SHIFT light when you downshift.

Four-Wheel Drive Vehicles Only: If your vehicle has four-wheel drive and is equipped with a manual transmission, disregard the SHIFT light when the transfer case is in 4-LOW.

Manual Transmission Shift Speeds

If you have a five speed manual transmission with low gear (RPO MW3) and one of the following engines, this chart shows when to shift to the next higher gear for best fuel economy.

Recommended Shift Speeds*

Five Speed Manual Transmission with Low Gear

Engine (VIN CODE)	Acceleration Shift Speed MPH (KM/H)		
	2 to 3	3 to 4	4 to 5
4.3L V6 (Z)	15 (24)	40 (64)	50 (80)
6.5L V8 (P)	15 (24)	40 (64)	45 (72)

Engine (VIN CODE)	Cruise Shift Speed MPH (KM/H)		
	2 to 3	3 to 4	4 to 5
4.3L V6 (Z)	15 (24)	25–40 (40–64)	45–50 (72–80)
6.5L V8 (P)	15 (24)	25–40 (40–64)	45 (72)

*LOW GEAR (1) is intended only for heavy loads and is not recommended for normal driving.

If your speed drops below 20 mph (32 km/h), or if the engine is not running smoothly, you should downshift to the next lower gear. You may have to downshift two or more gears to keep the engine running smoothly or for good performance.



CAUTION:

If you skip more than one gear when you downshift, you could lose control of your vehicle. And you could injure yourself or others. Don't shift down more than one gear when you downshift.

NOTICE:

If you skip more than one gear when you downshift, or if you race the engine when you downshift, you can damage the engine, clutch or transmission.

Locking Rear Axle

If you have this feature, your rear axle can give you additional traction on snow, mud, ice, sand or gravel. It works like a standard axle most of the time, but when one of the rear wheels has no traction and the other does, the locking feature will allow the wheel with traction to move the vehicle.

Parking Brake

To set the parking brake:

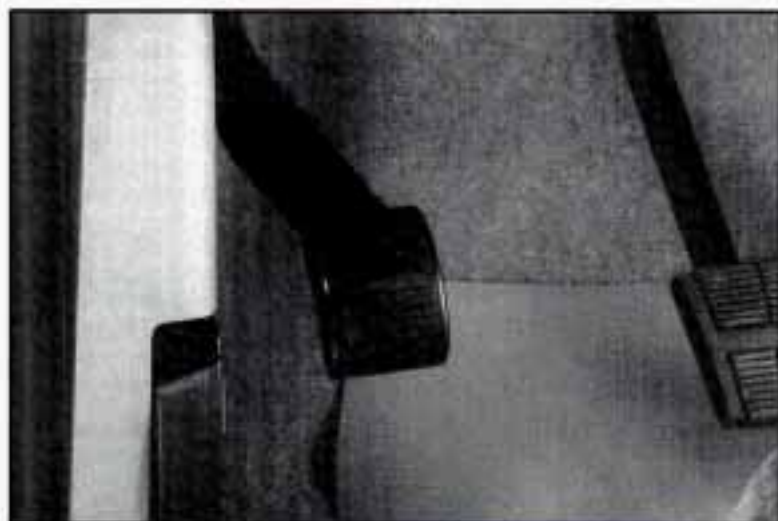

Hold the regular brake pedal down with your right foot. Push down the parking brake pedal with your left foot.

If the ignition is on, the brake system warning light will come on.

To release the parking brake:



Hold the regular brake pedal down. Pull the lever, located just above the parking brake pedal, marked **BRAKE RELEASE**, to release the parking brake.

If the ignition is on when the parking brake is released, the brake system warning light will go off.

NOTICE:

Driving with the parking brake on can cause your rear brakes to overheat. You may have to replace them, and you could also damage other parts of your vehicle. Always check to be sure your parking brake is fully released before you drive.

If you are towing a trailer and are parking on any hill: See “Towing a Trailer” in the Index. That section shows what to do first to keep the trailer from moving.

Propshaft Brake Burnish Procedure

If you have a 3500 HD model, it is recommended that the propshaft mounted parking brake be burnished as part of the new vehicle break in. The parking brake will work best after it has been burnished following these instructions.

Make 10 (ten) stops, using the parking brake foot pedal, from 20 mph (32 km/h) about 2 1/2 miles (4 km) apart. In between stops, drive the vehicle at 20 mph (32 km/h).

Torque Lock

When parking, the weight of the vehicle may put too much force on the parking pawl in the transmission. It may be difficult to pull the selector lever out of PARK (P). This is called “torque lock.” To find out how to avoid torque lock, see “Torque Lock” later in this section.

Shifting Into PARK (P) (Automatic Transmission Models Only)

CAUTION:

It can be dangerous to get out of your vehicle if the shift lever is not fully in PARK (P) with the parking brake firmly set. Your vehicle can roll.

If you have left the engine running, the vehicle can move suddenly. You or others could be injured. To be sure your vehicle won't move, even when you're on fairly level ground, use the steps that follow. If you have four-wheel drive and your transfer case is in NEUTRAL (N), your vehicle will be free to roll, even if your shift lever is in PARK (P). So, be sure the transfer case is in a drive gear — not in NEUTRAL (N). If you're pulling a trailer, see "Towing a Trailer" in the Index.

Steering Column Shift Lever



1. Hold the brake pedal down with your right foot and set the parking brake.
2. Move the shift lever into PARK (P) position like this:
 - Pull the lever toward you.
 - Move the lever up as far as it will go.
3. If you have four-wheel drive, be sure the transfer case is in a drive gear — not in NEUTRAL (N)
4. Move the ignition key to LOCK.
5. Remove the key and take it with you. If you can walk away from your vehicle with the ignition key in your hand, your vehicle is in PARK (P).

Leaving Your Vehicle With the Engine Running (Automatic Transmission Models Only)



CAUTION:

It can be dangerous to leave your vehicle with the engine running. Your vehicle could move suddenly if the shift lever is not fully in PARK (P) with the parking brake firmly set. If you have four-wheel drive with a manual transfer case shift lever and your transfer case is in NEUTRAL (N), your vehicle will be free to roll, even if your shift lever is in PARK (P). So be sure the transfer case is in a drive gear – not in NEUTRAL (N). And, if you leave the vehicle with the engine running, it could overheat and even catch fire. You or others could be injured. Don't leave your vehicle with the engine running unless you have to.

If you have to leave your vehicle with the engine running, be sure your vehicle is in PARK (P) and your parking brake is firmly set before you leave it. After you've moved the shift lever into the PARK (P) position, hold the regular brake pedal down. Then, see if you can move the shift lever away from PARK (P) without first pulling it toward you.

If you can, it means that the shift lever wasn't fully locked into PARK (P).

Torque Lock (Automatic Transmission)

If you are parking on a hill and you don't shift your transmission into PARK (P) properly, the weight of the vehicle may put too much force on the parking pawl in the transmission. You may find it difficult to pull the shift lever out of PARK (P). This is called "torque lock." To prevent torque lock, set the parking brake and then shift into PARK (P) properly before you leave the driver's seat. To find out how, see "Shifting Into PARK (P)" in the Index.

When you are ready to drive, move the shift lever out of PARK (P) *before* you release the parking brake.

If "torque lock" does occur, you may need to have another vehicle push yours a little uphill to take some of the pressure from the transmission, so you can pull the shift lever out of PARK (P).

Parking Your Vehicle (Manual Transmission Models Only)

Before you get out of your vehicle, put your manual transmission in REVERSE (R), turn off the engine, and firmly apply the parking brake.

If you have four-wheel drive, be sure your transfer case is in a drive gear. Your vehicle could roll if it isn't.

If you are parking on a hill, or if you're pulling a trailer, see "Parking on Hills" or "Towing a Trailer" in the Index.

Parking Over Things That Burn



CAUTION:

Things that can burn could touch hot exhaust parts under your vehicle and ignite. Don't park over papers, leaves, dry grass or other things that can burn.

Engine Exhaust



CAUTION:

Engine exhaust can kill. It contains the gas carbon monoxide (CO), which you can't see or smell. It can cause unconsciousness and death.

You might have exhaust coming in if:

- Your exhaust system sounds strange or different.
- Your vehicle gets rusty underneath.
- Your vehicle was damaged in a collision.
- Your vehicle was damaged when driving over high points on the road or over road debris.
- Repairs weren't done correctly.
- Your vehicle or exhaust system had been modified improperly.

If you ever suspect exhaust is coming into your vehicle:

- Drive it only with all the windows down to blow out any CO; and
- Have your vehicle fixed immediately.

Running Your Engine While You're Parked (Automatic Transmission)

It's better not to park with the engine running. But if you ever have to, here are some things to know.

 **CAUTION:**

Idling the engine with the air system control off could allow dangerous exhaust into your vehicle (see the earlier Caution under “Engine Exhaust”).

Also, idling in a closed-in place can let deadly carbon monoxide (CO) into your vehicle even if the fan switch is at the highest setting. One place this can happen is a garage. Exhaust — with CO — can come in easily. NEVER park in a garage with the engine running.

Another closed-in place can be a blizzard. (See “Blizzard” in the Index.)

 **CAUTION:**

It can be dangerous to get out of your vehicle if the shift lever is not fully in PARK (P) with the parking brake firmly set. Your vehicle can roll. Don't leave your vehicle when the engine is running unless you have to. If you've left the engine running, the vehicle can move suddenly. You or others could be injured. To be sure your vehicle won't move, even when you're on fairly level ground, always set your parking brake and move the shift lever to PARK (P).

If you have four-wheel drive and your transfer case is in NEUTRAL (N), your vehicle will be free to roll, even if your shift lever is in PARK (P). So, be sure the transfer case is in a drive gear — not in NEUTRAL (N). Always set your parking brake. Follow the proper steps to be sure your vehicle won't move. See “Shifting Into PARK (P)” in the Index.

If you're pulling a trailer, see “Towing a Trailer” in the Index.

Four-Wheel Drive

If your vehicle has four-wheel drive, you can send your engine's driving power to all four wheels for extra traction. To get the most satisfaction out of four-wheel drive, you must be familiar with its operation. Read the part that follows before using four-wheel drive. You should use 2-WHEEL HIGH (2H) for most normal driving conditions.

NOTICE:

Driving in the 4-WHEEL HIGH (4H) or 4-WHEEL LOW (4L) positions for a long time on dry or wet pavement could shorten the life of your vehicle's drivetrain.

NOTICE:

Changing your vehicle's body height can damage your vehicle's suspension, drivetrain, or other vehicle components. It may also affect the way your vehicle handles, and the function of your vehicle's safety features. Do not change your vehicle's height from the original design specifications.

Transfer Case



The transfer case shift lever is on the floor to the right of the driver. Use this lever to shift into and out of four-wheel drive.

An indicator near the lever shows you the transfer case settings.

- 4-WHEEL LOW (4L)
- NEUTRAL (N)
- 2-WHEEL HIGH (2H)
- 4-WHEEL HIGH (4H)

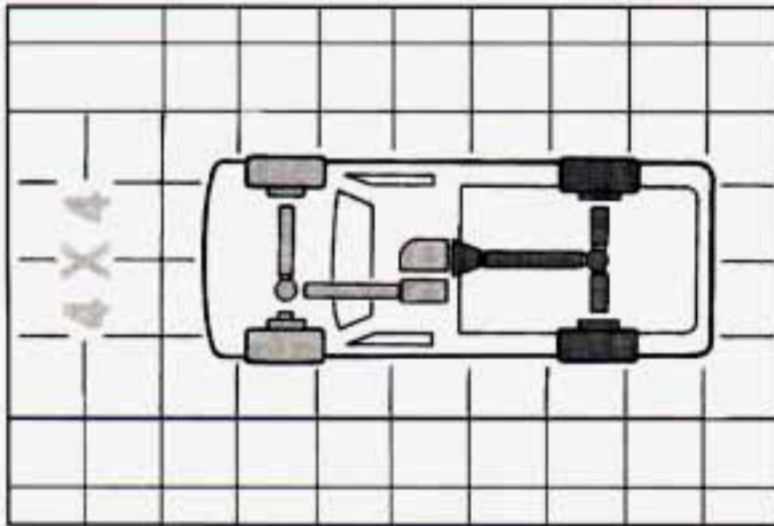

The front axle portion of the indicator diagram will light up when you shift into four-wheel drive.

Some delay between shifting and the indicator's lighting is normal. If the indicator light does not light up, or if the front axle light does not go out after you shift out of four-wheel drive, have your dealer check your system.

When your headlamps or parking lamps are on, rotate the thumb wheel next to the headlamp switch up to brighten, or down to dim, your transfer case indicator light.

- **2-WHEEL HIGH (2H)**

This setting is for driving in most street and highway situations. Your front axle is not engaged in two-wheel drive.

- **4-WHEEL HIGH (4H)**

This setting engages your front axle to help drive your vehicle. Use 4H when you need extra traction, such as on wet or icy roads, or in most off-road situations.

- **NEUTRAL (N)**

Shift to this setting only when your vehicle needs to be towed or when using a power take-off.

- **4-WHEEL LOW (4L)**

This setting also engages your front axle to give you extra power, but should be used only for off-road driving.

You can shift from 2-WHEEL HIGH (2H) to 4-WHEEL HIGH (4H) or from 4-WHEEL HIGH (4H) to 2-WHEEL HIGH (2H) while the vehicle is moving. Your front axle will engage faster if you take your foot off of the accelerator for a few seconds after you shift. In extremely cold weather it may be necessary to stop or slow the vehicle to shift out of 2-WHEEL HIGH (2H).

To shift into or out of 4-WHEEL LOW (4L) or NEUTRAL (N):

- Slow the vehicle to a roll, about 1–3 mph (2–5 km/h) and shift an automatic transmission into neutral, or with a manual transmission press the clutch pedal.
- Shift the transfer case shift lever in one continuous motion.

Don't pause in NEUTRAL (N) as you shift the transfer case into 4-WHEEL LOW (4L), or your gears could clash.

Remember that driving in 4-WHEEL HIGH (4H) or 4-WHEEL LOW (4L) may reduce fuel economy. Also, driving in four-wheel drive on dry pavement could cause your tires to wear faster and make your transfer case harder to shift.

Front Axle Locking Feature

The front axle locks and unlocks automatically when you shift the transfer case. Some delay for the axle to lock or unlock is normal. If the outside temperature is very hot, or the vehicle has been used under hard driving conditions, there may be a slight delay for the axle to unlock.

Windows

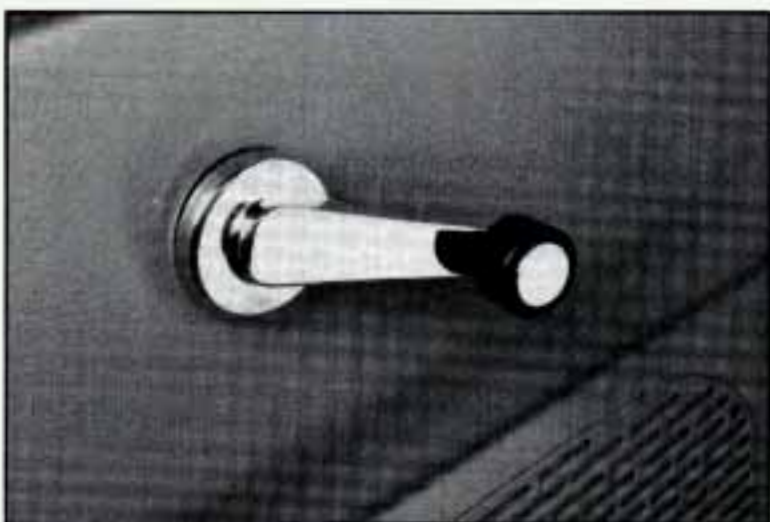

To open your manual windows, turn the hand crank on each door to raise or lower your side door windows.

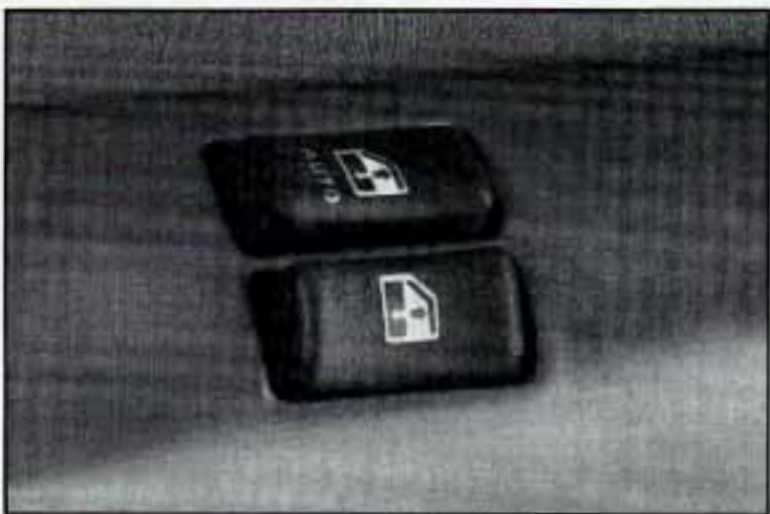

If you have the optional power windows, the controls are on each of the side doors.

The driver's door has a switch for the passenger windows as well. Your power windows will work when the ignition has been turned to ACC or RUN.

Push the rear of the switch with the power window symbol on it to lower the window.

Push the front of the switch with the power window symbol on it to raise the window.

If you have a Crew Cab and power windows, the power window switch has a lock-out feature. This feature prevents the rear windows from operating when the front drivers-side switch is in the lock-out position. When the switch is moved out of the lock-out position, the rear power windows will operate again.

Sliding Rear Window (Option)



To open the sliding rear window, unlock the latch lever by moving the lever toward the driver's side. Release the lever from the latch plate and slide the window toward the driver's side of the vehicle.

To close the window, slide the window toward the passenger's side of the vehicle. The latch lever will automatically snap locked on the latch plate. Try to open the window without releasing the latch lever to be sure the window is in the locked position.

Swing-Out Windows (Option – Extended Cab)



To open a rear swing-out window, just flip the latch open and swing the glass out.

The latch will catch when the window is fully open and hold window in the open position.

Horn



On air bag equipped vehicles, press one of the horn buttons at each side of the steering wheel to sound the horn.



On vehicles not equipped with an air bag, press the pad in the center of the steering wheel to sound the horn.

Tilt Wheel (Option)



A tilt steering wheel allows you to adjust the steering wheel **BEFORE** you drive.

You can also raise it to the highest level to give your legs more room when you enter and exit the vehicle.

To tilt the wheel, hold the steering wheel and pull the lever. Move the steering wheel to a comfortable level, then release the lever to lock the wheel in place.

Multifunction Lever

The lever on the left side of the steering column includes your:

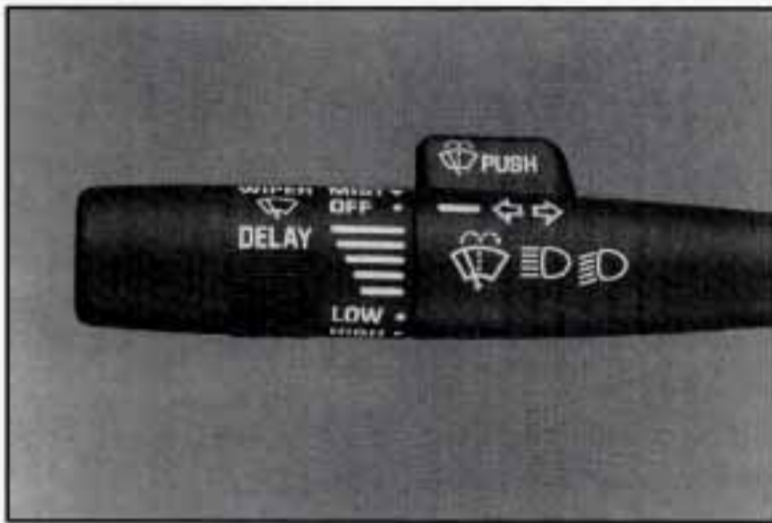

- Turn Signal and Lane Change Indicator
- Headlamp High–Low Beam & Passing Signal
- Windshield Wipers
- Windshield Washer
- Cruise Control (Option)

Turn Signal and Lane Change Indicator

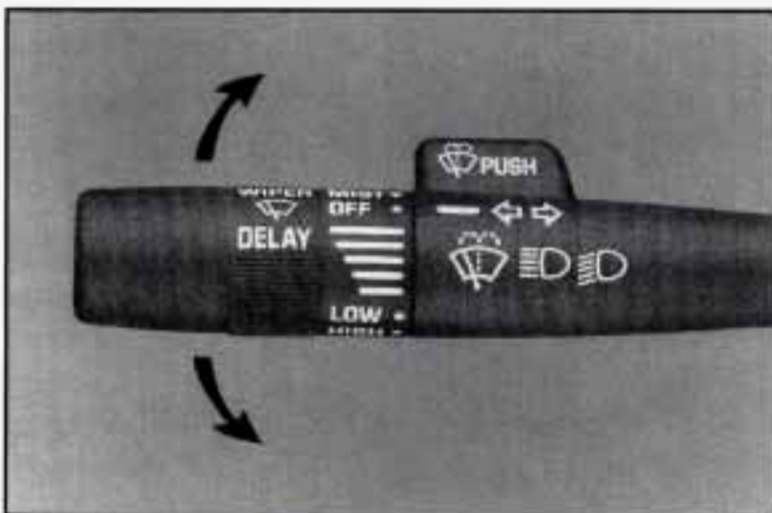

The turn signal has two upward (for right signal) and two downward (for left signal) positions. These positions allow you to signal a turn or a lane change.

To signal a turn, move the lever all the way up or down. When the turn is finished, the lever will return automatically.

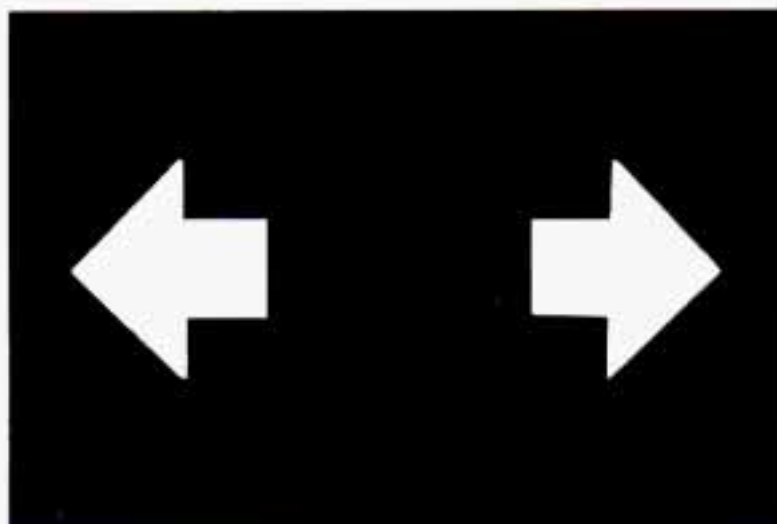

A green arrow on the instrument panel will flash in the direction of the turn or lane change.

To signal a lane change, just raise or lower the lever until the green arrow starts to flash. Hold it there until you complete your lane change. The lever will return by itself when you release it.

As you signal a turn or a lane change, if the arrows flash at twice the normal rate, a signal bulb may be burned out and other drivers may not see your turn signal.

If a bulb is burned out, replace it to help avoid an accident. If the green arrows don't go on at all when you signal a turn, check for burned-out bulbs and a blown fuse (see "Fuses" in the Index).

Headlamp High-Low Beam

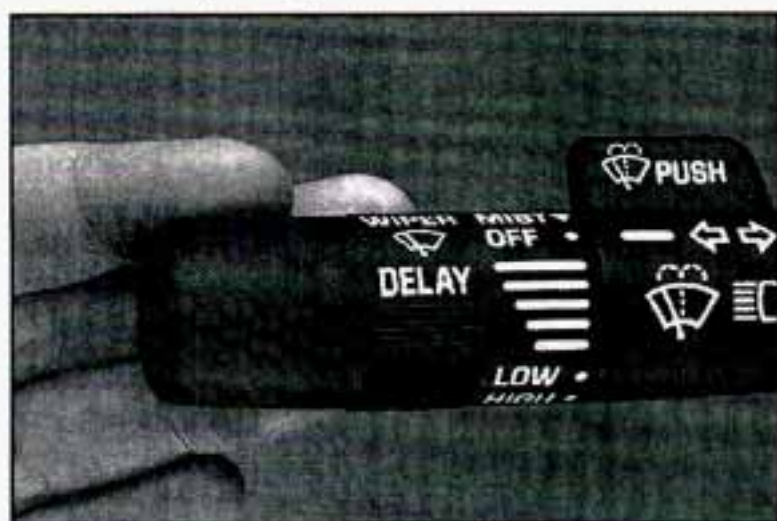

To change the headlamps from low beam to high or high to low, pull the multifunction lever all the way toward you. Then release it.

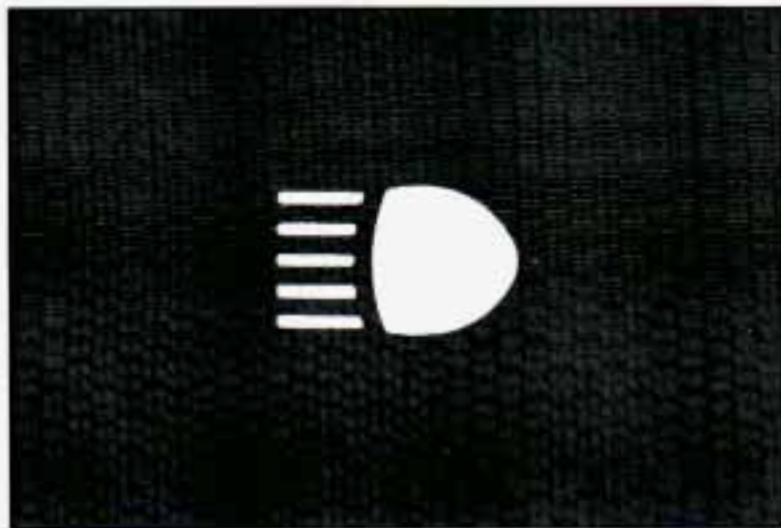

When the high beams are on, this blue light on the instrument panel also will be on.

Windshield Wipers



You control the windshield wipers by turning the band with the wiper symbol on it.

For a single wiping cycle, turn the band to MIST. Hold it there until the wipers start, then let go. The wipers will stop after one cycle. If you want more cycles, hold the band on MIST longer.

You can set the wiper speed for a long or short delay between wipes. This can be very useful in light rain or snow. Turn the band to choose the delay time. The closer to LOW, the shorter the delay.

For steady wiping at low speed, turn the band to the LOW position. For high speed wiping, turn the band further, to HIGH. To stop the wipers, move the band to the off symbol.

Remember that damaged wiper blades may prevent you from seeing well enough to drive safely. To avoid damage, be sure to clear ice and snow from the wiper blades before using them. If they are frozen to the windshield, carefully loosen or thaw them. If your blades do become damaged, get new blades or blade inserts.

Heavy snow or ice can overload your wipers. The windshield wiper motor is protected from overload by a circuit breaker and a fuse. If the motor overheats due to heavy snow, etc., the wiper will stop until the motor cools. Although the circuit is protected from electrical overload, overload due to heavy snow, etc. may cause wiper linkage damage. Always clear ice and heavy snow from the windshield before using your windshield wipers.

Windshield Washer



At the top of the lever there's a paddle with the word **PUSH** on it. To spray washer fluid on the windshield, push the paddle.

Washer fluid will spray as long as you push the paddle. When you let go of the paddle, the wipers will continue to wipe for a few seconds and then either stop or return to the preset speed.

Driving without washer fluid can be dangerous. A bad mud splash can block your vision. You could hit another vehicle or go off the road. Check your washer fluid level often.



CAUTION:

In freezing weather, don't use your washer until the windshield is warmed. Otherwise the washer fluid can form ice on the windshield, blocking your vision.

NOTICE:

- When using concentrated washer fluid, follow the manufacturer's instructions for adding water.
- Don't mix water with ready-to-use washer fluid. Water can cause the solution to freeze and damage your washer fluid tank and other parts of the washer system. Also, water doesn't clean as well as washer fluid.
- Fill your washer fluid tank only 3/4 full when it's very cold. This allows for expansion, which could damage the tank if it is completely full.
- Don't use radiator antifreeze in your windshield washer. It can damage your washer system and paint.

Cruise Control (Option)

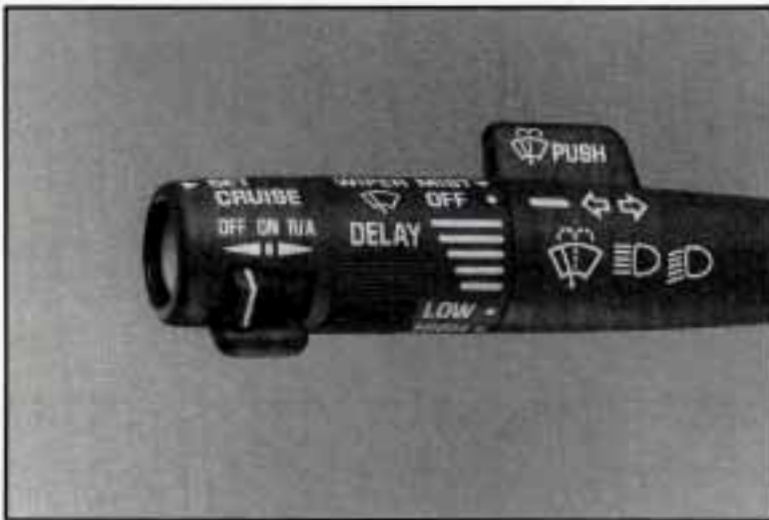

If you have Cruise Control, the end of your multifunction lever will look like this.

With Cruise Control, you can maintain a speed of about 25 mph (40 km/h) or more without keeping your foot on the accelerator. This can really help on long trips. Cruise Control does not work at speeds below about 25 mph (40 km/h).

When you apply your brakes, the Cruise Control shuts off.

⚠ CAUTION:

- Cruise control can be dangerous where you can't drive safely at a steady speed. So, don't use your cruise control on winding roads or in heavy traffic.
- Cruise control can be dangerous on slippery roads. On such roads, fast changes in tire traction can cause needless wheel spinning, and you could lose control. Don't use cruise control on slippery roads.

To Set Cruise Control



- Move the Cruise Control switch to ON.

⚠ CAUTION:

If you leave your cruise control switch on when you're not using cruise, you might hit a button and go into cruise when you don't want to. You could be startled and even lose control. Keep the cruise control switch OFF until you want to use it.

- Get up to the speed you want.
- Push in the set button at the end of the lever and release it.
- Take your foot off the accelerator pedal.

To Resume a Set Speed

Suppose you set your Cruise Control at a desired speed and then you apply the brake. This, of course, shuts off the Cruise Control. But you don't need to reset it.



Once you're going about 25 mph (40 km/h) or more, you can move the Cruise Control switch from ON to R/A (Resume/Accelerate) for about half a second.

You'll go right back up to your chosen speed and stay there.

Remember, if you hold the switch at R/A longer than half a second, the vehicle will keep going faster until you release the switch or apply the brake. You could be startled and even lose control. So unless you want to go faster, don't hold the switch at R/A.

To Increase Speed While Using Cruise Control

There are two ways to go to a higher speed.

- Use the accelerator pedal to get to the higher speed. Push the button at the end of the lever, then release the button and the accelerator pedal. You'll now cruise at the higher speed.





- Move the Cruise switch from ON to R/A. Hold it there until you get up to the speed you want, and then release the switch.

To increase your speed in very small amounts, move the switch to “R/A” for less than half a second. Each time you do this, your vehicle will go about 1 mph (1.6 km/h) faster.

To Reduce Speed While Using Cruise Control

There are two ways to reduce your speed while using cruise control:



- Push in the button at the end of the lever until you reach the lower speed you want, then release it.

- To slow down in very small amounts, push the button for less than half a second. Each time you do this, you'll go 1 mph (1.6 km/h) slower.

Passing Another Vehicle While Using Cruise Control

Use the accelerator pedal to increase your speed. When you take your foot off the pedal, your vehicle will slow down to the Cruise Control speed you set earlier.

Using Cruise Control on Hills

How well your Cruise Control will work on hills depends upon your speed, load, and the steepness of the hills. When going up steep hills, you may have to step on the accelerator pedal to maintain your speed. If the steepness of the hill causes the vehicle speed to drop more than 15 mph (9.4 km/h) below the set speed, your Cruise Control will automatically disengage. When going downhill, you may have to brake or shift to a lower gear to keep your speed down. Of course, applying the brake takes you out of Cruise Control. Many drivers find this to be too much trouble and don't use Cruise Control on steep hills.

To Get Out of Cruise Control

There are two ways to turn off the Cruise Control:

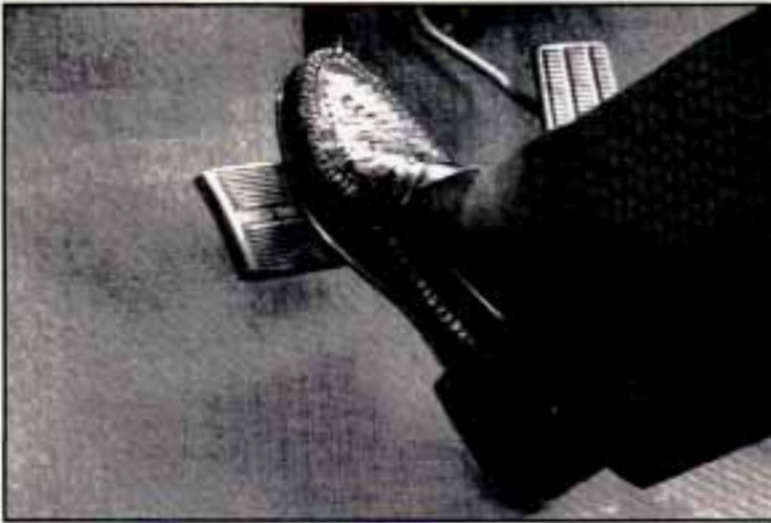

- Step lightly on the brake pedal;
OR



- Move the Cruise switch to OFF.

To Erase Speed Memory

When you turn off the Cruise Control or the ignition, your Cruise Control set speed memory is erased.

Headlamps and Vehicle Lighting



Your park/headlamp switch is on the driver's side of your instrument panel.

Rotate the switch knob clockwise to the park lamp symbol to turn on:

- Parking Lamps
- Sidemarkers Lamps
- Clearance Lamps (if you have them)
- Taillamps
- License Plate Lamps
- Instrument Panel Lamps
- Transfer Case Shift Indicator Light (four-wheel drive vehicles)

Rotate the switch knob clockwise again to the master lighting symbol to turn on all the lamps and lights listed above as well as the headlamps.

Rotate the switch counterclockwise to the off symbol to turn off your lamps and lights.

Rotate the thumb wheel next to the switch knob up to adjust instrument panel lamps. Rotate the thumb wheel up to the first notch to return the radio display and gearshift indicator LED display to full intensity when the headlamps or parklamps are on.

You can switch your headlamps from high to low beam by pulling on the turn signal/high beam lever.

A circuit breaker protects your headlamps. If you have an electrical overload, your headlamps will flicker on and off. Have your headlamp wiring checked right away if this happens.

Headlamps—On Reminder

A buzzer will sound when your headlamps are turned on and your ignition is in OFF, LOCK or ACC. If you need to use your headlamps when the ignition switch is in OFF, LOCK or ACC, the buzzer can be turned off by turning the thumb wheel next to the park/headlamp switch all the way down.

Fog Lamps (Option)

If you have fog lamps, use them for better vision in foggy or misty conditions. Your parking lights and/or low beam headlamps must be on for your fog lamps to work.



The fog lamp switch is on the lower edge of your instrument panel.

Press the top, ribbed part of the switch to turn the fog lamps on, and press the bottom of the switch to turn them off. A light will glow in the switch when the fog lamps are on.

Remember, fog lamps alone will not give off as much light as your headlamps.

Never use your fog lamps in the dark without turning on your headlamps.

Fog lamps will go off whenever your high beam headlamps come on. When the high beams go off, the fog lamps will come on again.

Daytime Running Lamps (DRL) Indicator Light

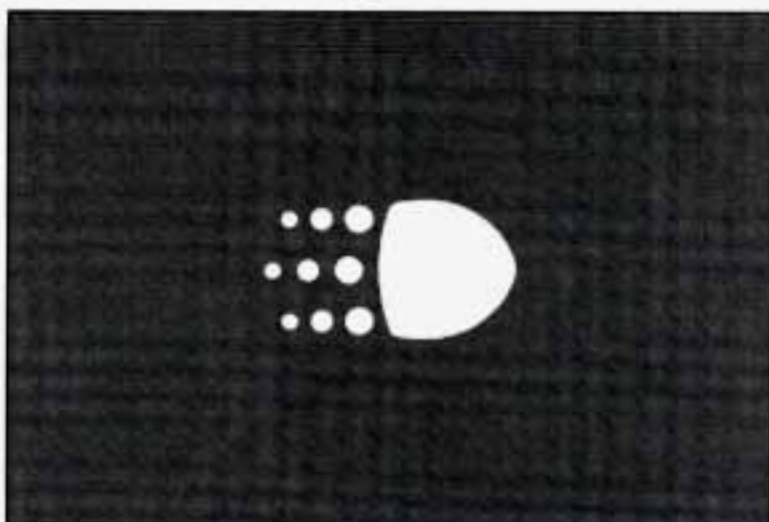

If your vehicle was first sold, when new, in Canada, you will have this light on the instrument panel.

It goes on whenever the Daytime Running Lamps are on.

When it begins to get dark, the DRL indicator light is a reminder to turn on your headlamps.

Daytime Running Lamps

Daytime Running Lamps (DRL) make it easier to see the front of your vehicle during the day. DRL can be helpful when it's raining and in the short periods after dawn and before sunset. Several countries, including Canada, require DRL.

The DRL system will make your high-beam headlamps come on at a reduced brightness when:

- The ignition is on,
- The headlamp switch is off, and
- The parking brake is released.

When the DRL are on, only your high-beam headlamps will be on. The taillamps, sidemarker and other lamps won't be on. Your instrument panel won't be lit up either.

When it begins to get dark, your DRL indicator light is a reminder to turn your headlamp switch on. The other lamps that come on with your headlamps will also come on.

When you turn the headlamp switch off, the regular lamps will go off, and your high-beam headlamps will change to the reduced brightness of DRL.

To idle your vehicle with the DRL off, set the parking brake. The DRL will stay off until you release the parking brake.

Dome Lamps

The dome lamps will come on when you open the doors.

You can also turn the dome lamps on by pushing the dome lamp switch button, located below the park/headlamp switch knob.

To turn the dome lamps on, press the switch button. To return the lamps to automatic operation, press the switch button again and return it to the "out" position.

Reading Lamps



If your vehicle has reading lamps, press the button next to the lamp to turn the lamp on.

The lamps can be adjusted to point in the direction you want.

Press the button again to turn the lamp off.



If your vehicle has an overhead console with reading lamps, press the button next to the lamp to turn the lamp on.

The lamps can be adjusted to point in the direction you want.

Press the button again to turn the lamp off.

Cargo Lamp (Option)

If you have a cargo lamp, you can use it to light the cargo area of your vehicle.



Press the top, ribbed part of the switch to turn the cargo lamp on, and press the bottom of the switch to turn it off.

The dome lamp switch must be on, or one of the doors open, for the cargo lamp to work.

Underhood Reel Lamp (Option)



If you have an underhood reel lamp, it is located inside the engine compartment on the passenger side fender. You can use it as a flashlight.

To use the lamp, pull up on the lever and pull the lamp out. The cord will unreel as you pull the lamp.

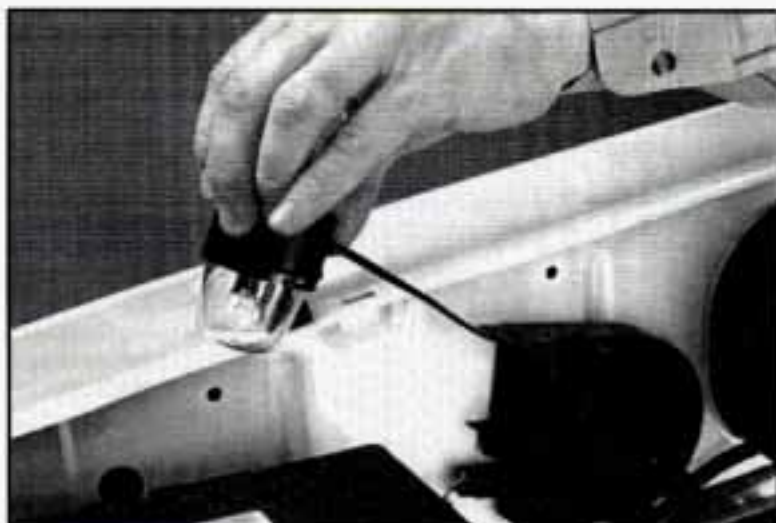

When you are done using the lamp, reel the cord back into the housing by turning the handle.

Then, slide the lamp into the holder. Press **PUSH** on the lever to hook the lamp into the holder.

Mirrors

Inside Mirror



Push or pull the tab under the mirror to reduce glare from headlamps behind you after dark.

Electrochromic Inside Rearview Mirror with Compass (Option)

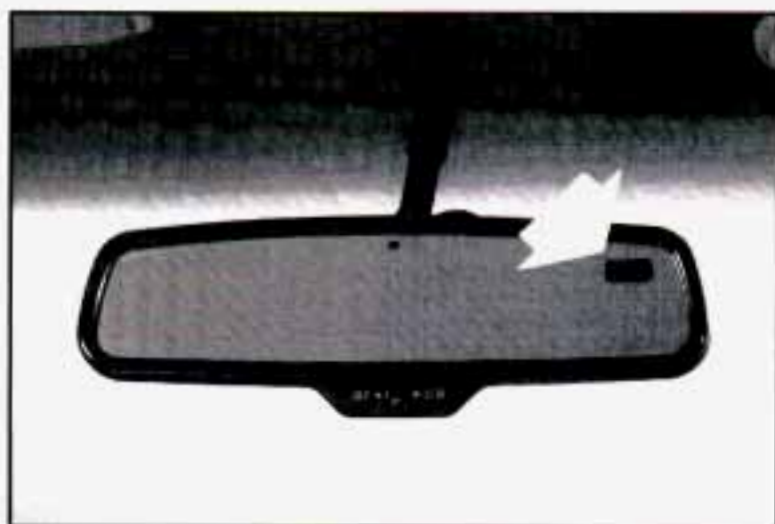

Your vehicle may have an optional electrochromic inside rearview mirror. An electrochromic inside rearview mirror, when on, automatically dims to the proper level to minimize glare from lights behind you after dark.

The mirror also includes an eight point compass display in the upper right corner of the mirror face. When on, the compass automatically calibrates as the vehicle is driven.

To use the electrochromic mirror only, move the switch at the bottom of the mirror to the M position. To use the electrochromic mirror as well as the compass, move the switch to the C/M position. To turn both features off, move the switch to the OFF position.

Compass Operation

When the ignition is on and the mirror switch is in the C/M position, the compass display will show two character boxes for approximately two seconds. If, after two seconds, the display does not show a compass heading ("N" for North, for example), there may be strong magnetic field interfering with the compass. Such interference may include magnetic antenna mounts, a magnetic note pad holder, or a similar magnetic item. If removing these items does not correct the condition, see your GM dealer for assistance.

When cleaning the mirror, use a paper towel or similar material dampened with glass cleaner. Do not spray glass cleaner directly on the mirror as that may cause liquid cleaner to enter the mirror housing.

Compass Variance

Under certain circumstances, as during a long distance cross-country trip, it will be necessary to adjust the compass to compensate for compass variance. Compass variance is the difference between earth's magnetic North and true geographic North. If not adjusted to account for compass variance, your compass could give false readings.

To adjust for compass variance:

1. Press and hold the CAL switch, located at the bottom of the mirror housing, for five seconds until a zone number appears in the display.
2. Find your current location and variance zone number on the following zone map.

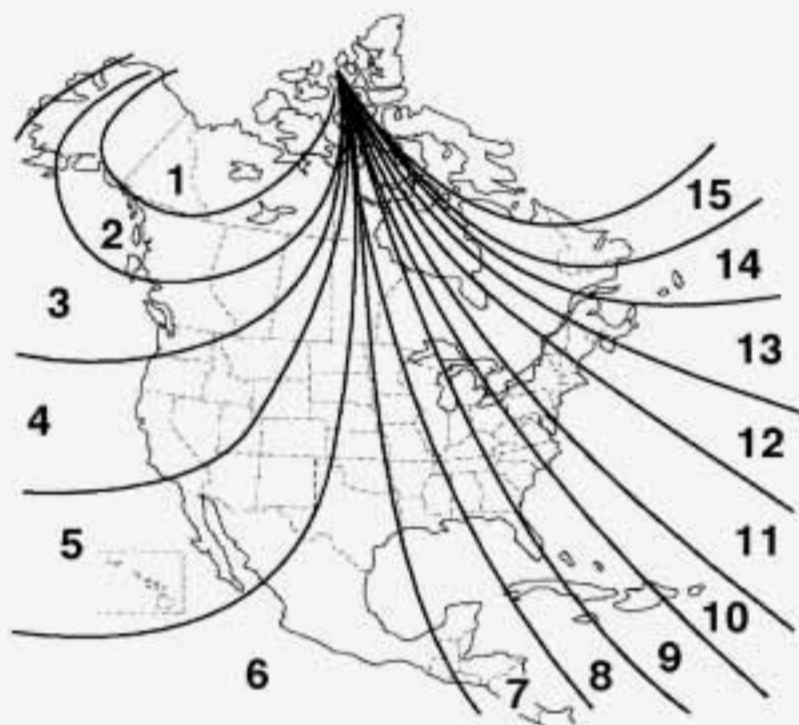

3. Press and hold the CAL switch until the new zone number appears in the display. After you release the switch, the display will show a compass direction within a few seconds.

Outside Mirrors



Adjust your outside mirrors so you can just see the side of your vehicle, and have a clear view of objects behind you. Some mirrors can be folded in to enter narrow doorways.

Electric Outside Rearview Mirrors

If you have electric mirrors, they can be adjusted to point where you want from inside the vehicle.

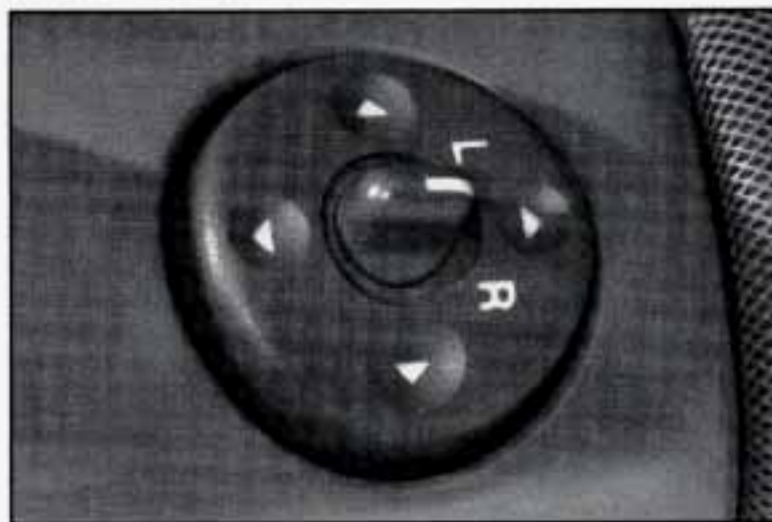

Select the mirror you want to move by moving the center of the switch, located on the driver's door armrest, to R (right) or L (left).

Then, adjust the mirror angle by pressing the outer arrows on the switch until the mirror is adjusted where you want it.

Convex Outside Mirror

Your passenger's side mirror may be convex.

A convex mirror's surface is curved so you can see more from the driver's seat.

 **CAUTION:**

A convex mirror can make things (like other vehicles) look farther away than they really are. If you cut too sharply into the right lane, you could hit a vehicle on your right. Check your inside mirror or glance over your shoulder before changing lanes.

Sun Visors

To block out glare, you can swing down the visors. You can also swing them out to help block glare at the front and side windows.

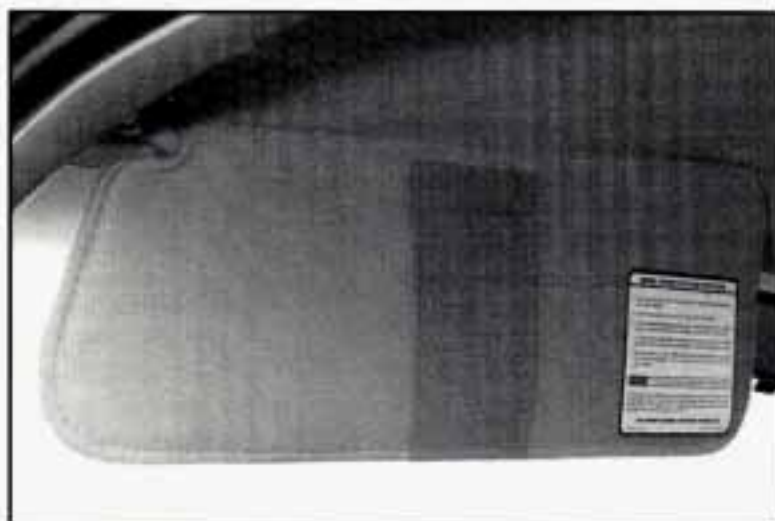

Your visor may have a strap to hold small items, such as maps.

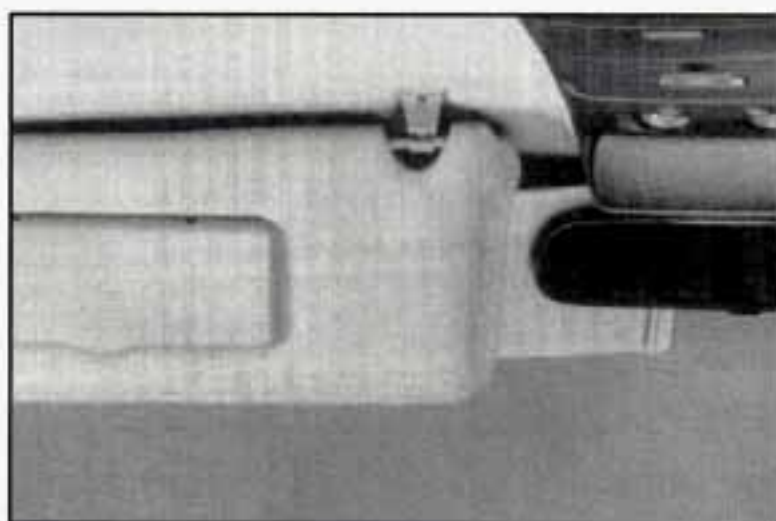

Some visors have an extender on the inside edge. When the visor is down, pull the extender out for extra glare coverage at the front or side.



Some visors have mirrors with lights. If the mirror has lights, they will come on when you lift the mirror cover.

Cigarette Lighter/Ashtrays



The front ashtray is located at the bottom of the instrument panel. Pull on the bottom of the ashtray door to open it.

NOTICE:

If you store paper or other things that burn in your ashtrays, they could be set on fire by cigarettes or other smoking materials. That could cause a fire and possibly damage your vehicle. Do not store papers and other things that burn in your ashtrays

To use the cigarette lighter, push it in all the way, and let go. When it's ready, it will pop back by itself.

NOTICE:

Holding a cigarette lighter in with your hand while it is heating can make it overload, damaging the lighter and the heating element. Just push the lighter all the way in and let go. When it's done, it will pop back by itself.

To remove the front ashtray, pull on the front of the ashtray insert. Then slide the insert out of the ashtray door.

You may also have two optional auxiliary power outlets next to the cigarette lighter. Use these outlets to power mobile telephones or other devices designed to operate with vehicle electrical systems.



To use a rear ashtray, if you have them, pull at the top of the ashtray door to flip the door open.

To remove a rear ashtray, if you have them, press down on the inside tabs and open the door fully.

NOTICE:

If you store paper or other things that burn in your ashtrays, they could be set on fire by cigarettes or other smoking materials. That could cause a fire and possibly damage your vehicle. Do not store papers and other things that burn in your ashtrays

Storage Compartments

Your vehicle has a variety of storage compartments designed to store small items.

Glove Box



To open your glove box, move the switch button toward the passenger side and pull the door open.

Two cup depressions are provided at the top of the instrument panel to hold cups or other containers when the vehicle is not moving.

Center Floor Console

Your vehicle may have a console compartment between the bucket seats.



To open it, lift the latch handle and swing the door open.



Your console also has a cup holder that swings out for the back seat passengers to use.

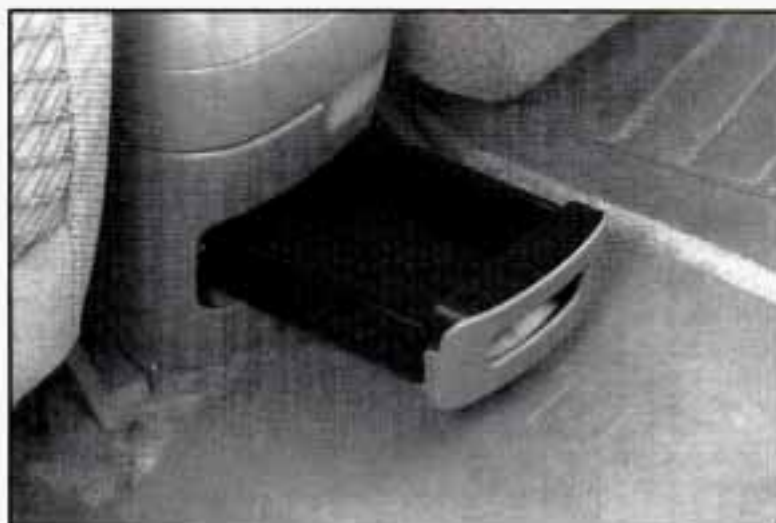

There is also a drawer that slides out at the bottom of the console.

Memo Pad Holder



Your vehicle may have a memo holder attached to the front of the console. Use it to hold pads of paper or similar items.

Cassette/Compact Disc Holder



Your vehicle may have a cassette/compact disc holder at the front of the console. The holder will store up to four compact disc cases, up to four cassette tape cases, or any combination of these items that adds up to four.

Instrument Panel Cup Holder



Your vehicle has a cup holder in the middle of the instrument panel.



To use the cup holder, pull the handle and slide the cup holder tray open.

To close the cup holder, slide it back in the instrument panel.

Center Overhead Console



Your vehicle may have an overhead console. It has storage compartments inside it.

Garage Door Opener Compartment

If you have a garage door opener, the front overhead compartment can be used to conveniently store the opener.



To install the garage door opener, first open the compartment door by pressing the release button forward.

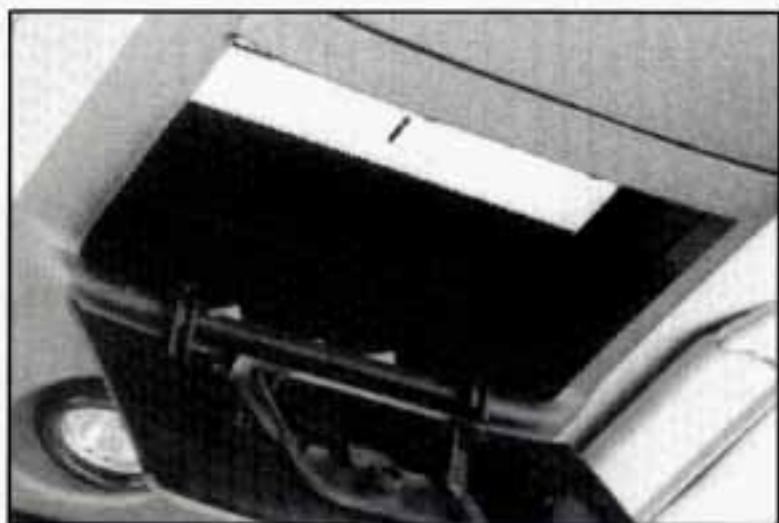

Peel the protective backing from the hook and loop patch. Press it firmly to the back of your garage door opener, as close to the center of the opener as possible.



Center the garage door opener activation button over the console door button, and press the opener firmly into place.

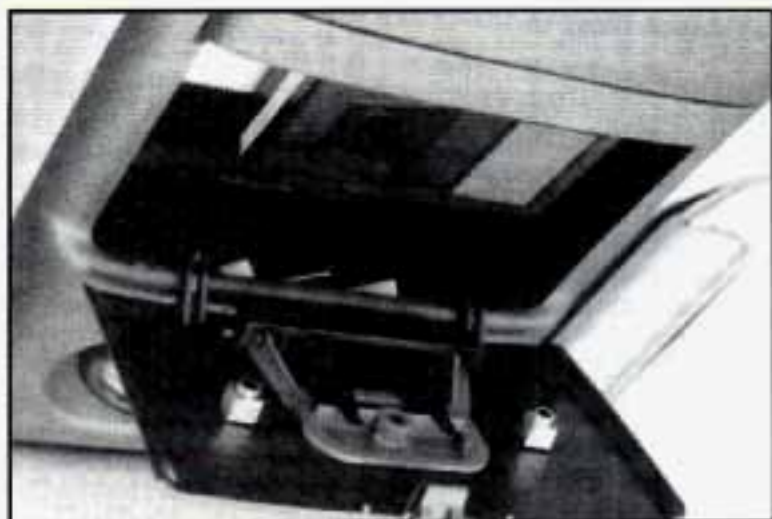

The pegs inside the compartment door are used to make sure the button on the compartment door will contact the control button on the garage door opener.



Add one peg at a time until the PUSH button on the compartment door operates the garage door opener, with the compartment door closed, when you push the button marked PUSH.



Now, with the compartment door closed, push the button marked PUSH again to make sure the garage door opener operates properly.

With the garage door opener positioned properly and the right number of pegs in place, you should only have to push the PUSH button slightly to operate the opener.

Adjust the position of the garage door opener and add or remove pegs, as needed, until the opener operates properly.

Sunglasses Compartment

The center overhead compartment can be used to conveniently store your sunglasses.



To open the center compartment, press the release button located at the rear of the compartment door.



Place your sunglasses in the compartment door with the lenses facing out.

Rear Compartment

The rear compartment can be used to store a small item, like a book.



To open the rear compartment, press the release button located at the rear of the compartment door.

Other Storage Compartments

Your vehicle includes a number of storage compartments for storage of often used items



Some vehicles have storage areas in the instrument panel.

Use these spaces for items such as gloves or small books.

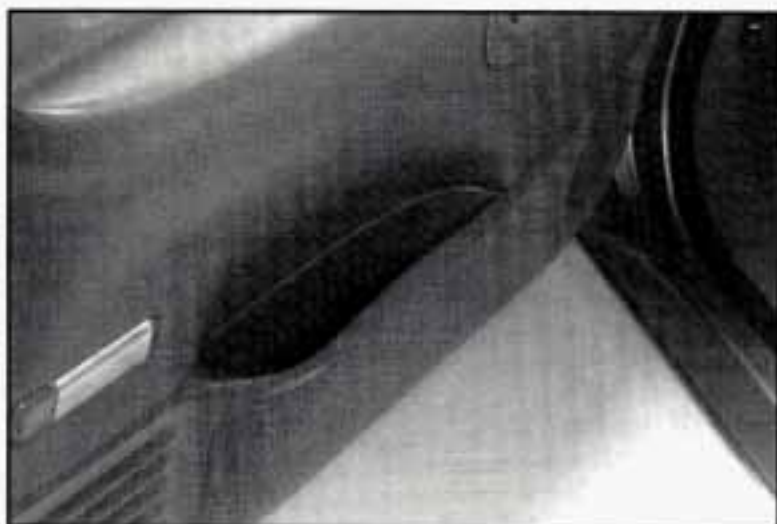

Some models have a storage pocket on each of the front doors.

You can use the pocket to store a variety of small items.



Some vehicles have a storage area behind the seat.

Instrument Panel

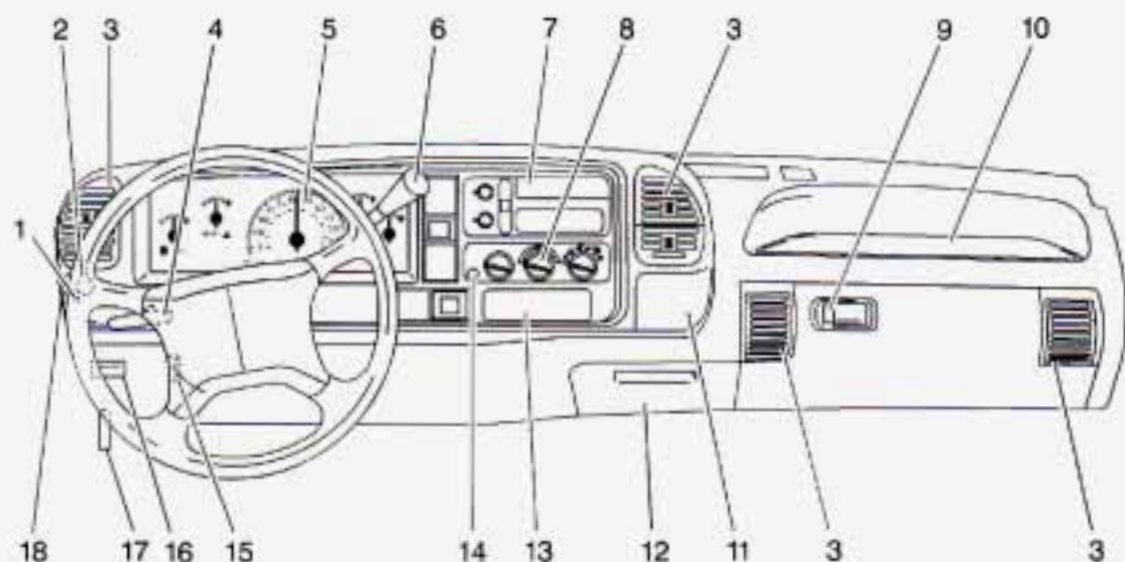

- | | |
|----------------------------|--|
| 1. Dome Lamp Switch | 10. Storage Tray |
| 2. Lamp and Light Controls | 11. IP Cupholder |
| 3. Air Vents | 12. Ashtray, Optional Aux. Outlets |
| 4. Multifunction Lever | 13. Storage Area or Optional
Cassette Tape Player |
| 5. Instrument Cluster | 14. Rear Window Defogger Switch |
| 6. Gearshift Lever | 15. Tilt Lever |
| 7. Audio System | 16. Parking Brake Release Handle |
| 8. Comfort Control System | 17. Hood Release |
| 9. Glove Box | 18. Fuse Block |

Instrument Cluster

Your instrument cluster is designed to let you know at a glance how your vehicle is running. You'll know how fast you're going, about how much fuel you have and many other things you'll need to know to drive safely and economically.

Speedometer and Odometer

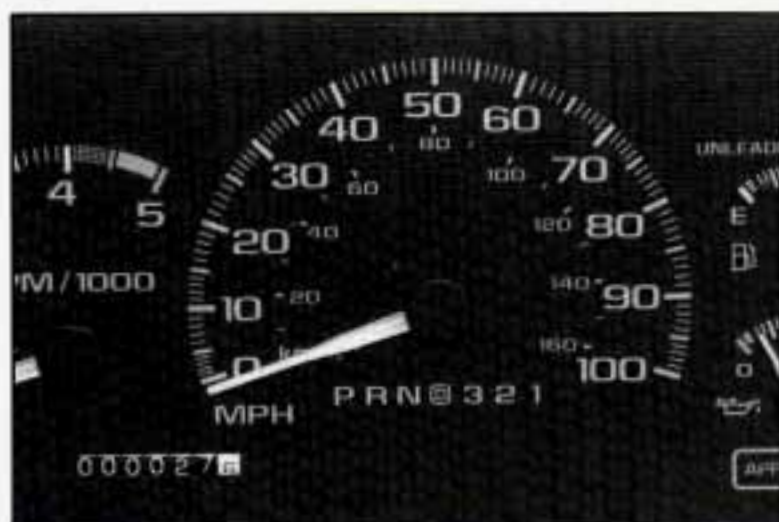

Your speedometer lets you see your speed in both miles per hour (mph) and kilometers per hour (km/h). Your odometer shows how far your vehicle has been driven, in either miles (used in the U.S.) or kilometers (used in Canada).

Tamper-Resistant Odometer

Your odometer is tamper-resistant. The odometer will show silver lines between the numbers if someone tries to turn it back.

You may wonder what happens if your vehicle needs a new odometer installed. Laws vary as to the procedure that must be followed, so check with your state or provincial vehicle registration office. But generally, if the new odometer can be set to the mileage total of the old odometer, then it must be. But if it can't, then it's set at zero, and a label must be put on the driver's door to show the old mileage reading when the new odometer was installed.

Trip Odometer



The trip odometer can tell you how far your vehicle has been driven since you last set the trip odometer to zero.

To reset the trip odometer, fully press the reset button located near the trip odometer readout. If the reset button is not fully pressed, the trip odometer may not go all the way back to zero. If it doesn't, you may have to press the reset button again to reset the readout to zero.

Tachometer



Your tachometer displays the engine speed in revolutions per minute (rpm).

NOTICE:

Do not operate the engine with the tachometer in the red area, your engine or other parts could be damaged.

Damage to your engine or vehicle caused by operating the engine in the red area isn't covered by your vehicle warranty.

Warning Lights and Indicators

This part describes the warning lights and gages that may be on your vehicle. The pictures will help you locate them.

Warning lights and gages can signal that something is wrong before it becomes serious enough to cause an expensive repair or replacement. Paying attention to your warning lights and gages could also save you or others from injury.

Warning lights come on when there may be or is a problem with one of your vehicle's functions. As you will see in the details on the next few pages, some warning lights come on briefly when you start the engine just to let you know they're working. If you are familiar with this section, you should not be alarmed when this happens.

Gages can indicate when there may be or is a problem with one of your vehicle's functions. Often gages and warning lights work together to let you know when there's a problem with your vehicle.

When one of the warning lights comes on and stays on when you are driving, or when one of the gages shows there may be a problem, check the section that tells you what to do about it. Please follow this manual's advice. Waiting to do repairs can be costly — and even dangerous. So please get to know your warning lights and gages. They're a big help.

Safety Belt Reminder Light



When the key is turned to RUN or START, a tone will come on for about eight seconds to remind people to fasten their safety belts, unless the driver's safety belt is already buckled. The safety belt light will also come on and stay on for about 20 seconds, then it will flash for about 55 seconds. If the driver's belt is already buckled, neither the tone nor the light will come on.

Air Bag Readiness Light

There is an air bag readiness light on the instrument panel, which shows AIR BAG. The system checks the air bag's electrical system for malfunctions. The light tells you if there is an electrical problem. The system check includes the air bag sensors and module, the wiring and the diagnostic module. For more information on the air bag system, see "Air Bag" in the Index.



You will see this light flash for a few seconds when you turn your ignition to RUN or START. Then the light should go out. This means the system is ready.

If the air bag readiness light doesn't come on when you start your vehicle, or stays on, or comes on when you are driving, your air bag system may not work properly. Have your vehicle serviced right away.

Brake System Warning Light



Your vehicle's hydraulic brake system is divided into two parts. If one part isn't working, the other part can still work and stop you. For good braking, though, you need both parts working well.

If the warning light comes on, there could be a brake problem. Have your brake system inspected right away.

This light should come on briefly as you start the vehicle. If it doesn't come on then, have it fixed so it will be ready to warn you if there's a problem.

If the light comes on while you are driving, pull off the road and stop carefully. You may notice that the pedal is harder to push. Or, the pedal may go closer to the floor. It may take longer to stop. If the light is still on, have the vehicle towed for service. (See "Towing Your Vehicle" in the Index.)



CAUTION:

Your brake system may not be working properly if the brake system warning light is on. Driving with the brake system warning light on can lead to an accident. If the light is still on after you've pulled off the road and stopped carefully, have the vehicle towed for service.

The brake system warning light will also come on when you set your parking brake, and it will stay on if your parking brake doesn't release fully. If it stays on after your parking brake is fully released, it means you have a brake problem.

Anti-Lock Brake System Warning Light

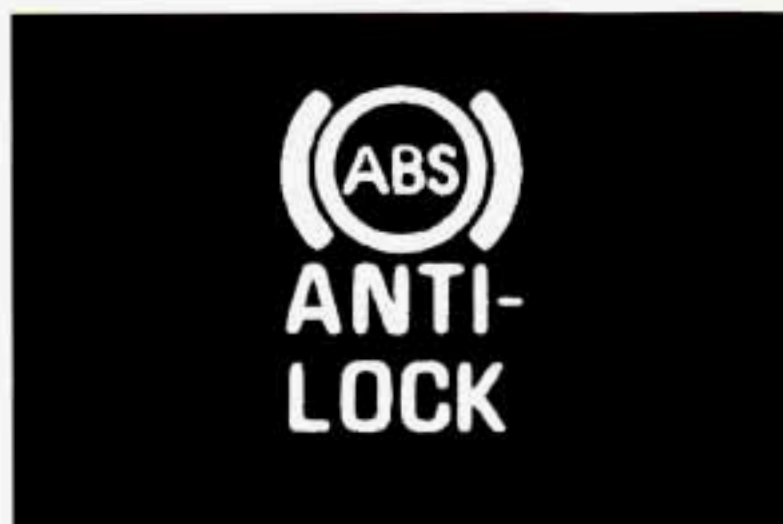

With the anti-lock brake system, this light will come on when you start your engine and may stay on for several seconds. That's normal. If the light doesn't come on, have it fixed so it will be ready to warn you if there is a problem.

If the light stays on, or comes on when you're driving, your vehicle needs service. If the regular brake system warning light isn't on, you still have brakes, but you don't have anti-lock brakes. If the regular brake system warning light is also on, you don't have anti-lock brakes and there's a problem with your regular brakes. See "Brake System Warning Light" earlier in this part.

Water in Fuel Light

A black rectangular box with the words "WATER IN FUEL" written in white, bold, sans-serif capital letters, centered within the box.

**WATER
IN
FUEL**

This red light will come on to warn you if there is water in the diesel fuel system. For more information on how this light works, see "Diesel Fuel Requirements and Fuel System" in the Index.

Service Throttle Soon Light

A black rectangular box with the words "SERVICE THROTTLE SOON" written in white, bold, sans-serif capital letters, centered within the box.

**SERVICE
THROTTLE
SOON**

On diesel engines, a computer monitors the operation of the electronic accelerator. As a check to show you it's working, this orange light comes on for a few seconds after the ignition is turned on. Normally, it will not come back on unless the ignition has been off for 30 seconds or more. If the light does not come on at all, and the ignition has been off for 30 seconds or more, have the light fixed right away. If the light stays on after the engine starts, or comes on while you are driving, the computer is indicating that your vehicle has a problem. You should take your vehicle in for service soon.

Glow Plugs Light

A black square containing the text "GLOW PLUGS" in white, bold, sans-serif capital letters, centered.

**GLOW
PLUGS**

If you have a diesel engine, it has a special starting system. An orange instrument panel Glow Plugs light shows that the system is functioning properly and tells you when the engine is ready to be started. For more details, see “Starting Your Diesel Engine” in the Index.

Low Coolant Warning Light

A black square containing a white icon of a coolant reservoir with a downward arrow and the text "LOW COOLANT" in white, bold, sans-serif capital letters, centered.

**LOW
COOLANT**

If you have a diesel engine, you have a low coolant light. As a check to show you it's working, this orange light comes on for a few seconds after the ignition is turned on. If this light comes on anytime the engine is running, your system is low on coolant and the engine may overheat. See “Engine Coolant” in the Index and have your vehicle serviced as soon as you can.

Charging System Warning Light

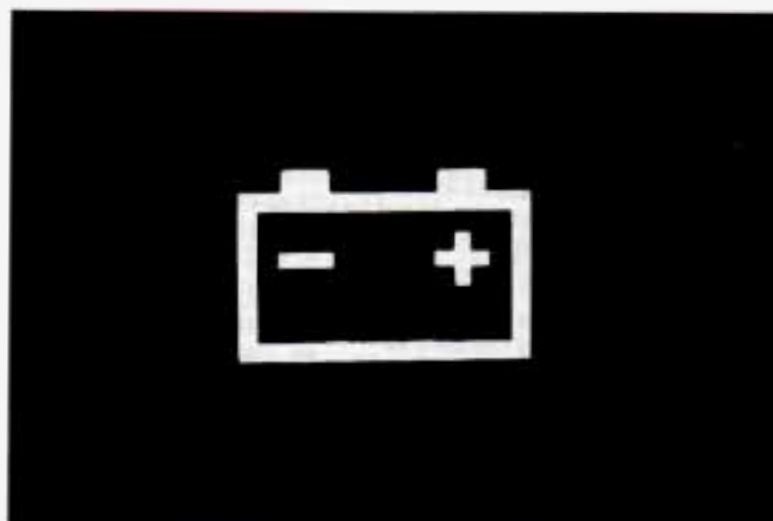

The red Charging System Warning light should come on briefly when you turn on the ignition, before starting the engine, as a check to show you it is working. After the engine starts, the light should go out. If it stays on or comes on while you are driving, you may have a problem with your charging system. It could indicate a problem with the alternator drive belt, or some other charging system problem. Have it checked right away. Driving while this light is on could drain your battery.

If you must drive a short distance with this light on, it helps to turn off all your accessories, such as the radio and air conditioner.

Malfunction Indicator (Service Engine Soon) Lamp



A computer monitors the operation of your fuel, ignition and emission control systems. This orange light should come on when the ignition is on but the engine is not running, as a check to show you it's working. If it does not come on at all, have it fixed right away. If it stays on, or comes on while you are driving, the computer is indicating that you have a problem. You should take your vehicle in for service soon.

NOTICE:

If you keep driving your vehicle with this light on, after a while the emission controls won't work as well, your fuel economy won't be as good, and your engine may not run as smoothly. This could lead to costly repairs not covered by your warranty.

Check Gages Light



This orange light will come on briefly when you are starting the engine. If the light comes on and stays on while you are driving, it could indicate a problem with your vehicle. It could be a problem with your oil pressure, coolant temperature, or some other problem. Check your various gages to see if they are in the warning zones. If they are, have your vehicle serviced right away.

Daytime Running Lamps (DRL) Indicator Light

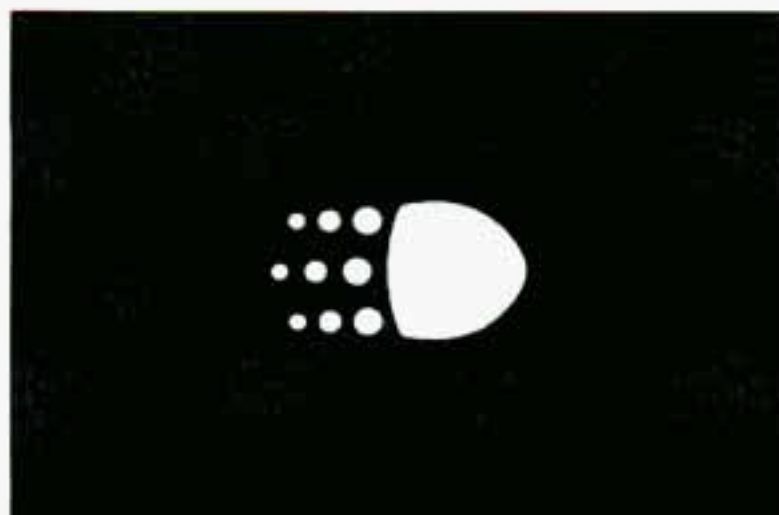

If your vehicle was first sold, when new, in Canada, you will have this green light on the instrument panel. It will light whenever the Daytime Running Lamps are on. For more details about DRL, see “Headlamps and Vehicle Lighting” in this section.

Shift Indicator Light



This orange light, with the word SHIFT and the upshift arrow, is used on some models with manual transmissions. Depending on your particular model, your vehicle may not have this light. The SHIFT indicator light will help you get the best fuel economy. See “Shift Light” or “Manual Transmission Shift Speeds” in this section for more information.

Headlamp High Beam Indicator Light

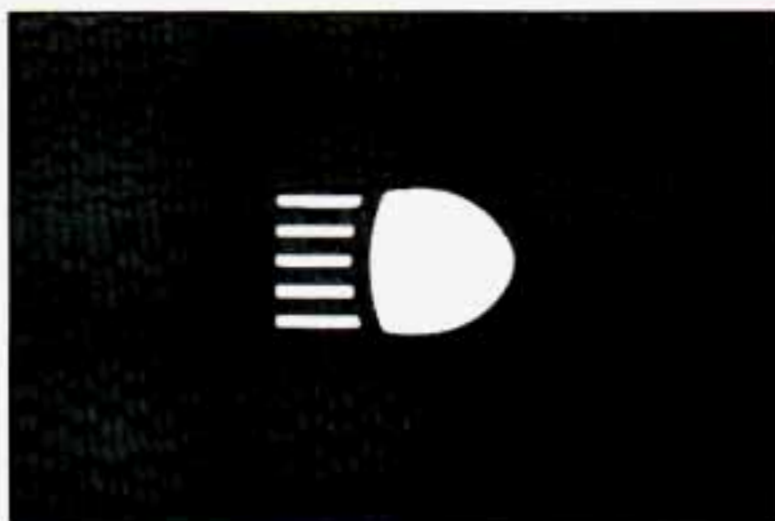

The blue high beam indicator is on whenever you use your high beam headlamps. For more details about high beams, see “Headlamp High-Low Beam” earlier in this section.

Turn Signal and Lane Change Indicator Lights

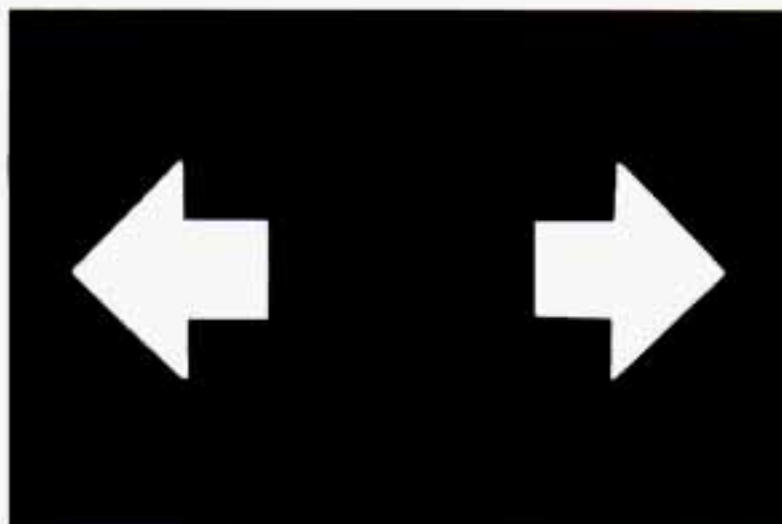

The green signal indicator will come on whenever you signal a turn or lane change. See “Turn Signal and Lane Change Indicator” earlier in this section.

Gages

Fuel Gage

Gasoline Engine



Diesel Engine



The fuel gage, when the ignition is on, tells you about how much fuel you have left in your tank. The gage will first indicate empty before you are out of fuel, and you should get more fuel as soon as possible.

Listed are four situations you may experience with your fuel gage:

- At the gas station, the fuel pump shuts off before the gage reads full.
- It takes a little more or less fuel to fill up than the fuel gage indicated. For example, the gage may have indicated the tank was half full, but it actually took a little more or less than half the tank's capacity to fill the tank.
- The gage moves a little when you turn a corner or speed up.
- The gage doesn't go back to empty when you turn off the ignition.

None of these indicate a problem with the fuel gage.

For information on how to fill your fuel tank, see "Fuel – Filling Your Tank" in the Index.

For your fuel tank capacity, see "Fuel —Tank Capacity" in the Index.

Engine Coolant Temperature Gage



This gage shows the engine coolant temperature. If the gage pointer moves into the red area, your engine is too hot! It means that your engine coolant has overheated. If you have been operating your vehicle under normal operating conditions, you should pull off the road, stop your vehicle, and turn off the engine as soon as possible.

Hot Coolant Can Burn You Badly!

In "Problems on the Road," this manual shows what to do. See "Engine Overheating" in the Index.

Oil Pressure Gage



The oil pressure gage shows the engine oil pressure in psi (pounds per square inch) when the engine is running. Canadian vehicles indicate pressure in kPa (kilopascals). Oil pressure may vary with engine speed, outside temperature and oil viscosity, but readings above the low pressure zone indicate the normal operating range.

A reading in the low pressure zone may be caused by a dangerously low oil level or other problem causing low oil pressure. Check your oil as soon as possible.



CAUTION:

Don't keep driving if the oil pressure is low. If you do, your engine can become so hot that it catches fire. You or others could be burned. Check your oil as soon as possible and have your vehicle serviced.

NOTICE:

Damage to your engine from neglected oil problems can be costly and is not covered by your warranty.

Voltmeter



When your engine is not running, but the ignition is in the RUN position, this gage shows your battery's state of charge in DC volts.

When the engine is running, the gage shows the condition of the charging system. Readings between the low and high warning zones indicate the normal operating range.

Readings in the low warning zone may occur when a large number of electrical accessories are operating in the vehicle and the engine is left at an idle for an extended period. This condition is normal since the charging system is not able to provide full power at engine idle. As engine speeds are increased, this condition should correct itself as higher engine speeds allow the charging system to create maximum power.

You can only drive for a short time with the reading in either warning zone. If you must drive, turn off all unnecessary accessories.

Readings in either warning zone indicate a possible problem in the electrical system. Have the vehicle serviced as soon as possible.

Center High Mount Stop Lamp (CHMSL)

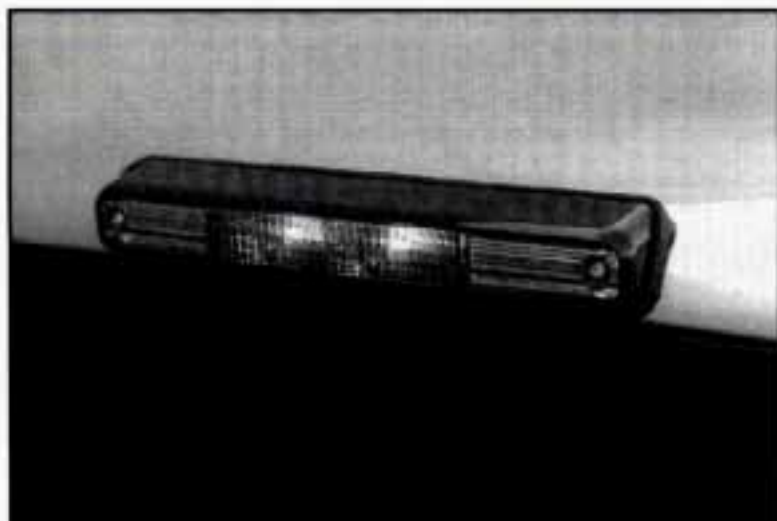

Your vehicle may have a Center High Mount Stoplamp (CHMSL) located above the rear window.

If equipment such as a cap or camper is installed, your Center High Mount Stoplamp (CHMSL) will no longer be visible from behind. You should select a cap or camper with a CHMSL on it or, if one is not available, have one installed. See your GM dealer about how to connect your vehicle's wiring to a cap or camper CHMSL.

Camper Wiring Harness (Option)

An optional 5-wire harness is stored in the front stake pocket on the driver's side of the bed. The harness has no connector, and should be wired by a qualified electrical technician.

It must be routed out of your vehicle and securely attached so that it won't be pulled or rubbed while you're using it.

Store the harness in its original position. Wrap the harness together and tie it neatly so it won't be damaged.

If a camper is installed, your Center High Mount Stoplamp (CHMSL) will no longer be visible from behind. You should select a camper with a CHMSL on it or, if one is not available, have one installed. See your GM dealer about how to connect your vehicle's wiring to a camper CHMSL.

Trailer Wiring Harness (Option)

An optional 7-wire harness is stored under your vehicle along the rear frame crossmember. The harness connects to the underhood electrical center and no connector, and should be wired by a qualified electrical technician.

Securely attach the harness to the trailer, then tape or strap it to your vehicle's frame rail. Be sure you leave it loose enough so the wiring won't bind or break when turning with the trailer, but not so loose that it drags on the ground.

Store the harness in its original position. Wrap the harness together and tie it neatly so it won't be damaged.

If you do tow a trailer, your Center High Mount Stoplamp (CHMSL) may not be properly visible from behind. You should select a trailer with a CHMSL on it or, if one is not available, have one installed. See your GM dealer about how to connect your vehicle's wiring to a trailer CHMSL.

Step-Bumper Pad

If your vehicle has a rear step bumper, it may be equipped with a rear step pad at the center of the bumper. Use this pad to improve footing when you are stepping on the bumper step.



If you will be using the bumper to tow a trailer, you must remove the center cutout circle to install the trailer ball. You must also remove both outer cutouts to attach the trailer safety chains.

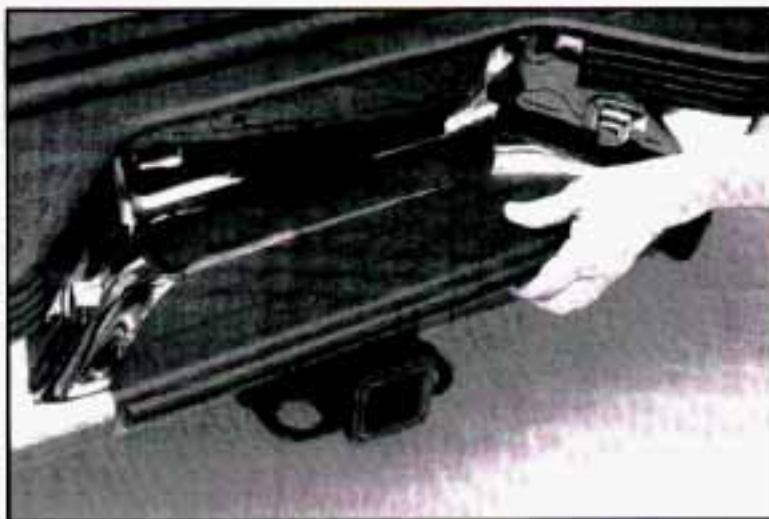

To remove the pad, lift the edge of the pad from the rear of the bumper and swing it forward. When the pad releases from the bumper holes, lift the pad off.

Comfort Controls and Audio Systems

Section

3

In this section you'll find out how to operate the comfort control systems and audio systems offered with your vehicle. Be sure to read about the particular system supplied with your vehicle.

Comfort Controls

Heater Controls

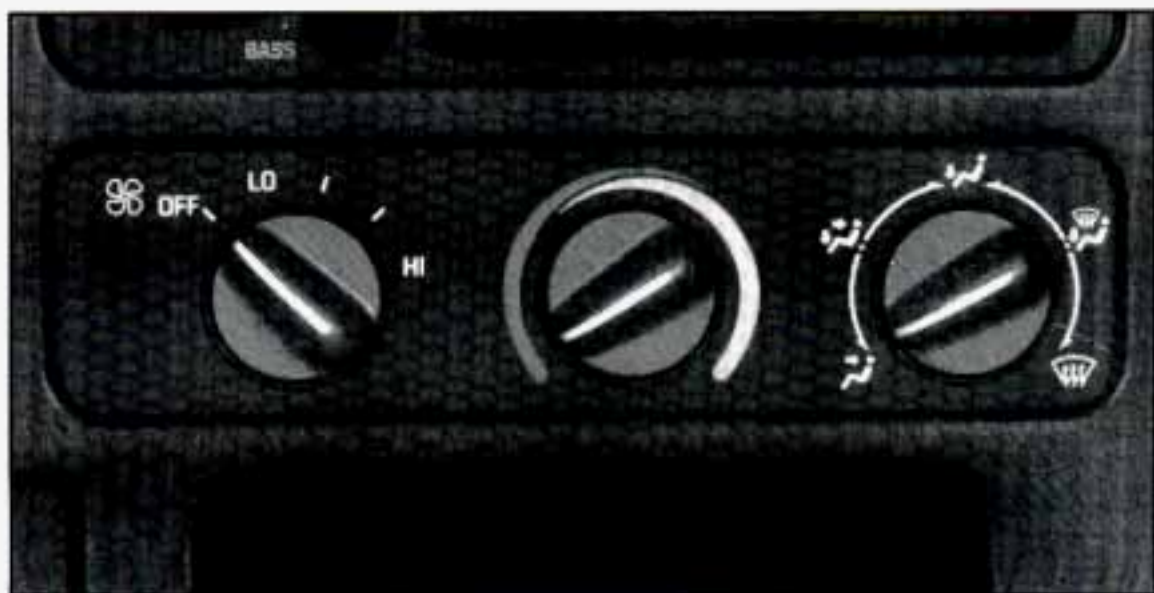

If your vehicle does not have air conditioning, your heater controls will look like this.

The knob on the left side of the heating system control panel controls the fan speed. The knob has four speed positions. To increase the air flow, move the knob toward HI. To decrease the air flow, move it toward LO. To turn the fan off, move the knob to OFF.

The middle knob on the control panel lets you select the relative temperature of the air flowing into the passenger area of your vehicle. This knob will allow you to adjust the relative air temperature independently of the function knob setting. Move the knob right toward the red area for warmer air. Move the knob left toward the blue area for cooler air.

The right knob on the control panel changes the heater setting.

VENT — This setting, with the arrow pointing at the figure's head, directs air through the instrument panel vents.

VENT/HEAT — Use this setting, with the arrows pointing at the figure's feet and head, to divide airflow between the heater floor vents and instrument panel vents.

HEAT — This setting, with the arrow pointing at the figure's feet, directs air through the heater floor vents. This setting is useful for cold weather.

HEAT/DEFROST — Use this setting, with the arrow pointing at the figure's feet and the defroster symbol near the figure's head, to divide airflow between the heater floor vents and windshield.

DEFROST — This setting with the defrost symbol directs air through the windshield defroster vents. This setting is useful when you have fog or ice on the windshield.

The control knob can be placed in any position between two heater settings to blend the flow of air. The closer the knob is to a setting symbol, the more the air flow will represent that symbol's air flow arrows.

Heater/Air Conditioning Controls



If your vehicle has air conditioning, your heater/air conditioning controls will look like this.

Before using your vehicle's air conditioning, open the windows to clear the vehicle of hot air.

Using the recirculation function can also help. See "Recirculation Button" in this section for more information.

The knob on the left side of the heating system control panel controls the fan speed. The knob has four speed positions. To increase the air flow, move the knob toward HI. To decrease the air flow, move it toward LO. To turn the fan off, move the knob to OFF. If you have the air conditioner on, moving the fan knob to OFF also turns off the A/C compressor.

The middle knob on the control panel lets you select the relative temperature of the air flowing into the passenger area of your vehicle. This knob will allow you to adjust the relative air temperature independently of the function knob setting. Move the knob right toward the red area for warmer air. Move the knob left toward the blue area for cooler air. With A/C on, move the knob to MAX for maximum cooling.

This setting puts the system in the recirculation mode and helps to maximize your air conditioner's performance and your vehicle's fuel economy. This setting also cools the air the fastest. After the vehicle's interior reaches a comfortable temperature, move the knob clockwise to place the air conditioning system in the normal mode.

The right knob on the control panel changes the heater/air conditioning setting.

VENT — This setting, with the arrow pointing at the figure's head, directs air through the instrument panel vents.

VENT/HEAT — Use this setting, with the arrows pointing at the figure's feet and head, to divide airflow between the heater floor vents and instrument panel vents.

HEAT — This setting, with the arrow pointing at the figure's feet, directs air through the heater floor vents. This setting is useful for cold weather.

HEAT/DEFROST — Use this setting, with the arrow pointing at the figure's feet and the defroster symbol near the figure's head, to divide airflow between the heater floor vents and windshield.

DEFROST — This setting with the defrost symbol directs air through the windshield defroster vents. This setting is useful when you have fog or ice on the windshield.

The control knob can be placed in any position between two heater/air conditioning settings to blend the flow of air. The closer the knob is to a setting symbol, the more the air flow will represent that symbol's air flow arrows.

RECIRCULATION BUTTON — This button, between the left and middle knobs, allows the air inside your vehicle to be recirculated. This setting helps to maximize your air conditioner's performance and your vehicle's

fuel economy. This setting also cools the air the fastest and can be used to keep “unwanted odors” and/or dust from entering the vehicle. When using the air conditioner, turn off recirculation after the vehicle reaches a comfortable interior temperature.

When the right knob on the control panel is between HEAT and DEFROST, the recirculation feature will not function.

A/C — This button, between the middle and right knobs, allows the air coming into your vehicle to be cooled and directed through the instrument panel vents. This setting is useful for normal cooling on hot days. When you first use A/C with the recirculation button pushed in, turn off recirculation as soon as the vehicle reaches a comfortable interior temperature.

Engine Coolant Heater

If your vehicle has a diesel engine, it is equipped with an engine coolant heater. An engine coolant heater is optional on gas engine vehicles. If you use the engine coolant heater before starting your engine (in cold weather (20° F, (-8° C), or lower) your heating system will produce warmer air faster, to heat the passenger compartment in cold weather.

The use of an engine coolant heater also reduces the time it takes for the engine to reach normal operating temperature, and shortens the time it takes the heater to reach full output. For more information, See “Engine Coolant Heater” in the Index.

Diesel Engine Heater Output

If you idle your diesel engine for a long time when it’s cold outside, your heater may blow out cool air. This is normal. When you increase the engine speed, your heater should blow out warmer air. If it doesn’t, your coolant level may be too low. See “Engine Coolant” in the Index to see how to check your coolant level.

Rear Window Defogger (Option)

You can tell if your vehicle has this option by looking at the rear window. If you see lines running across the glass, you have it. These are the wire-like elements which heat your window.

NOTICE:

Scraping the inside of your rear window could cut and damage the defogger. Your warranty would not cover this damage. And, don’t put decals there, you might have to scrape them off.

For best results, clear the window of as much snow or ice as possible first.



To turn on the rear window defogger, press the rear defog button next to the fan control knob.

The rear window defogger will only work if the ignition switch is turned to RUN.

You can turn the defogger off at any time by pressing the button again. The defogger will shut itself off after several minutes, so that the glass does not get too hot. If the defogger shuts off, and the window still isn't clear, turn on the defogger again.

Ventilation System

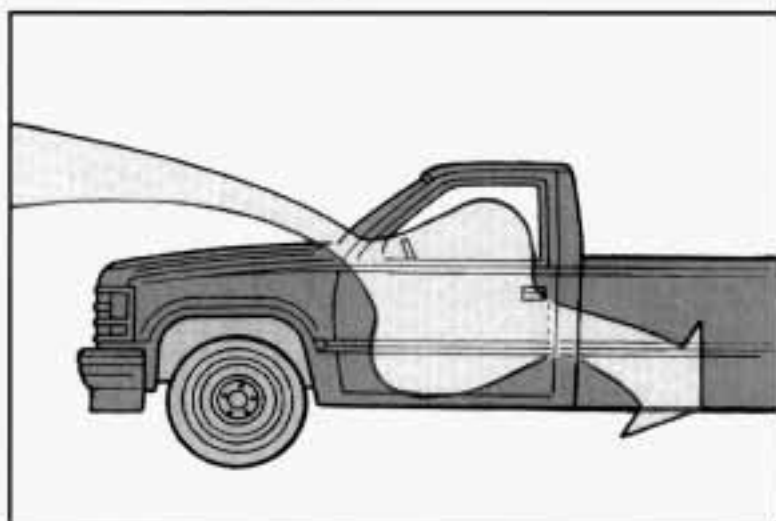

Your vehicle's ventilation system supplies outside air to the inside of your vehicle when it is moving. With the side windows closed, air will flow into the front air inlet grilles, through the vehicle, and out the rear air exhaust valve.

Outside air will also enter the vehicle when the heater or the air conditioning fan is running, unless you have the recirculation button pushed in. For more information see "Recirculation Button" in this section.

Ventilation Tips

- Keep the hood and front air inlet free of ice, snow, or any other obstruction (such as leaves). The heater and defroster will work far better, reducing the chance of fogging the inside of your windows.

- When you enter a vehicle in cold weather, turn the blower fan to HI for a few moments before driving off. This helps clear the intake ducts of snow and moisture, and reduces the chance of fogging the inside of your windows.
- Keep the air path under the front seats clear of objects. This helps air to circulate throughout your vehicle.



Your vehicle has air vents in the center and on the sides of your instrument panel.

You can move the vents from side to side or up and down to direct the flow of air, or close the vents altogether. When you close a vent, it will increase the flow of air coming out of any vents that are open.

Audio Systems

Your Delco[®] audio system has been designed to operate easily and give years of listening pleasure. But you will get the most enjoyment out of it if you acquaint yourself with it first. Find out what your Delco[®] system can do and how to operate all its controls, to be sure you're getting the most out of the advanced engineering that went into it.

Setting the Clock (Audio Systems without AUTO TONE System)

To set the clock:

1. Press the SET button.
2. Within 5 seconds, press and hold SEEK ► until the correct minute appears on the display.
3. Press and hold ◀ SEEK until the correct hour appears on the display

To display the clock with the ignition off, press the upper knob. The time will be displayed for a few seconds.

Setting the Clock (Audio Systems with AUTO TONE System)

The buttons used to set the clock are located below the AUTO TONE button in the bottom right corner of your audio system.

To set the clock:

1. Press and hold HR until the correct hour appears on the display.
2. Press and hold MIN until the correct minute appears on the display.

To display the clock with the ignition off, press the recall button. The time will be displayed for a few seconds.

There is an initial two-second delay before the clock goes into the time-set mode.

How to Operate Your ETR[®] AM-FM Stereo Audio System



This part tells you how your ETR[®] AM-FM stereo audio system works.

Upper Knob (VOL-RECALL) — The upper knob has these four functions:

- Turn it to switch the system on and off.
- Turn it to control the volume.
- Press it to display the time when the ignition is off.
- Press it to change between the clock and the radio station frequency displayed when the radio is on.

BAL (Balance) — The control ring behind the upper knob adjusts the left/right speaker balance.

Lower Knob (TUNE-AM-FM) — The lower knob has two functions:

- Turn it to tune in radio stations.
- Press it to change between the AM and FM bands.

FADE — The control ring behind the lower knob adjusts the front/rear speaker balance.

SEEK — Press the **SEEK ►** button to cause the receiver to seek the next higher station.

Press the **◀ SEEK** button to cause the receiver to seek the next lower station.

SCAN — Press the **SCAN** button to momentarily hear each available station. **SCAN** is a two button function and requires that you also press the **SEEK ►** or **◀ SEEK**. “**SCAN**” appears in the display while you are in the **SCAN** mode.

Press and hold **SEEK ►**, then press **◀ SEEK** to cause the receiver to scan to the next higher station.

Press and hold **◀ SEEK**, then press **SEEK ►** to cause the receiver to scan to the next lower station.

The receiver will continue to scan until you press the **VOL-RECALL** knob or both **SEEK** buttons again.

Pushbuttons — The four pushbuttons let you return to favorite stations. To set the pushbuttons for up to fourteen favorite stations (7 AM and 7 FM):

1. Tune in the desired station.
2. Press the **SET** button. “**SET**” appears in the display.
3. Within 5 seconds, press one of the four pushbuttons to store the station. Whenever you press that button, the preset station will return.

Repeat these steps for each pushbutton.

NOTE:

In addition to the four stations set as above, up to three additional stations may be preset on each band by pressing two adjoining buttons at the same time. Then do the following:

1. Tune in the desired station.
2. Press the **SET** button. “**SET**” appears in the display momentarily.
3. Within 5 seconds, press any two adjoining pushbuttons at the same time. (The station will return when the same two buttons are pressed again.)

TREBLE — Slide the **TREBLE** lever up to increase the treble response. If a station is weak or noisy, slide the **TREBLE** lever down to reduce the noise.

BASS — Slide the **BASS** lever up to increase the bass response. Adjust the **BASS** lever to give a pleasing sound to your ear.

How to Operate Your ETR[®] AM–FM Stereo Audio Cassette System



This part tells you how your ETR[®] AM–FM stereo audio cassette system works.

Upper Knob (VOL–RECALL) — The upper knob has these five functions:

- Turn it to switch the system on and off.
- Turn it to control the volume.
- Press it to display the time when the ignition is off.
- Press it to change between the clock and the radio station frequency displayed when the radio is on.
- Press it to change sides of a tape when a cassette is playing.

BAL (Balance) — The control ring behind the upper knob adjusts the left/right speaker balance.

Lower Knob (TUNE–AM–FM) — The lower knob has two functions:

- Turn it to tune in radio stations.
- Press it to change between the AM and FM bands.

FADE — The control ring behind the lower knob adjusts the front/rear speaker balance.

SEEK — Press the **SEEK ►** button to cause the receiver to seek the next higher station.

Press the **◀ SEEK** button to cause the receiver to seek the next lower station.

P. SCAN (Preset Scan) — Press both **SEEK** buttons to scan each preset pushbutton station. The receiver will continue to scan and momentarily stop

at each station until you press either SEEK button or the VOL-RECALL knob. "PSCAN" appears in the display while you are in the P. SCAN mode.

Pushbuttons — The four pushbuttons let you return to favorite stations. To set the pushbuttons for up to twenty-one favorite stations (7 AM, 7 FM1 and 7 FM2):

1. Tune in the desired station.
2. Press the SET button. "SET" appears in the display.
3. Within 5 seconds, press one of the four pushbuttons to store the station. Whenever you press that button, the preset station will return.

Repeat these steps for each pushbutton.

NOTE:

In addition to the four stations set as above, up to three additional stations may be preset on each band by pressing two adjoining buttons at the same time. Then do the following:

1. Tune in the desired station.
2. Press the SET button. "SET" appears in the display momentarily.
3. Within 5 seconds, press any two adjoining pushbuttons at the same time. (The station will return when the same two buttons are pressed again.)

TREBLE — Slide the TREBLE lever up to increase the treble response. If a station is weak or noisy, slide the TREBLE lever down to reduce the noise.

BASS — Slide the BASS lever up to increase the bass response. Adjust the BASS lever to give a pleasing sound to your ear.

To Play A Cassette

Your tape player is built to work best with tapes that are 30 to 45 minutes long on each side. Tapes longer than that are so thin they may not work well in this player.

Once the tape is playing, use the controls for volume, balance, fade, treble and bass just as you do for the radio. A lighted arrow will also appear and show the direction of play when a tape is in the player.

FORWARD — To rapidly advance the tape, press ◀ SEEK or SEEK ▶ in the direction that the amber arrow points and the tape will rapidly go forward until you press the same SEEK button lightly.

REVERSE — To rapidly reverse the tape, press ◀ SEEK or SEEK ▶ in the opposite direction that the amber arrow points and the tape will rapidly reverse until you press the same SEEK button lightly.

PROGRAM — To go from one side of the tape to the other, press the VOL-RCL knob.

EJECT — To remove the tape or stop the tape and switch to radio, press the EJECT button.

If a tape is inserted with side “1” (or “A”) up, then the right arrow means that that side is being played. Likewise, a left arrow would indicate that side “2” (or “B”) had been selected. The player will automatically switch to the other side of the tape when the first side ends.

How to Operate Your ETR® AM-FM Stereo Audio Cassette ATC System



This part tells you how your ETR® AM-FM stereo audio cassette ATC system works.

Upper Knob (PWR-VOL) — The upper knob has these two functions:

- Push it to switch the system on and off.
- Turn it to control the volume.

SCV (Speed Compensated Volume) — Move the control ring behind the upper knob clockwise to adjust the Speed Compensated Volume feature. As you drive, this feature increases the volume to overcome noise at any particular speed. Each clockwise position on the control ring allows more compensation and at a faster rate.

AM/FM — Press this button to switch between AM, FM1 and FM2. The display will show what mode the receiver is in.

RCL (Recall) — Press this button to change between the clock and the radio station frequency displayed when the radio is on. Also, press this button to display the time when the ignition is off.

TUNE — Press lightly on the TUNE button to release it from its stored position. Rotate the knob clockwise to increase frequency and

counterclockwise to decrease radio frequency. When done, press the knob again to return it to its stored position.

Pushbuttons — The six pushbuttons let you return to favorite stations. To set the pushbuttons for up to 18 favorite stations (6 AM, 6 FM1 and 6 FM2):

1. Tune in the desired station.
2. Press **AUTO TONE** to select the best setting for the type of station chosen.
3. Press and hold one of the pushbuttons until sound returns (approximately two seconds). Whenever you press that button, the preset station will return.

Repeat these steps for each pushbutton.

In addition to the four stations set as above, up to three additional stations may be preset on each band by pressing two adjoining buttons at the same time. Then do the following:

1. Tune in the desired station.
2. Press the **SET** button. "SET" appears in the display momentarily.
3. Within 5 seconds, press any two adjoining pushbuttons at the same time. (The station will return when the same two buttons are pressed again.)

SEEK — Press **SEEK** ► to cause the receiver to seek the next higher station.

Press ◀ **SEEK** to cause the receiver to seek the next lower station.

SCAN — Press and hold the center of the **SEEK** button to momentarily hear each available station. Release the button when **SCAN** appears in the display. The receiver will continue to scan and momentarily stop at each station until you press the center of the **SEEK** button again.

P. SCAN (Preset Scan) — Press this button to scan each preset pushbutton station. The receiver will continue to scan and momentarily stop at each station until you press either **P. SCAN** again or one of the six pushbuttons. The **AUTO SCAN** setting for that preset button will also return. The pushbutton number (P1–P6) will appear momentarily just before frequency is displayed.

AUTO TONE — Press this button to select between five preset equalization settings and tailor the sound to the music or voice being heard. Each time you press the button, the selection will switch to one of the preset settings of **CLASSIC**, **NEWS**, **ROCK**, **POP**, or **JAZZ**. The display will show which mode the receiver is in. To return to the manual mode, press and release **AUTO TONE** until **MAN** (manual) appears in the display. This will return the tone adjustment to the **TREB** and **BASS** controls. Also, any time a **TREB** or **BASS** control is rotated, tone is automatically set back to **MAN** (manual).

FADE — Press lightly on the FADE knob to release it from its stored position and pull it out to the fully extended position. Rotate the knob clockwise to adjust sound to the front speakers and counterclockwise to adjust sound to the rear speakers. Push the knob back in to the stored position when done.

BAL — Press lightly on the BAL knob to release it from its stored position and pull it out to the fully extended position. Rotate the knob clockwise to adjust sound to the right speakers and counterclockwise to adjust sound to the left speakers. Push the knob back in to the stored position when done.

BASS — Press lightly on the BASS knob to release it from its stored position and pull it out to the fully extended position. Rotate the knob clockwise to increase the bass response and counterclockwise to decrease bass response. Any time the BASS control is rotated, tone is automatically set back to MAN (manual). Push the knob back in to the stored position when done.

TREBLE — Press lightly on the TREB knob to release it from its stored position and pull it out to the fully extended position. Rotate the knob clockwise to increase the treble response and counterclockwise to decrease treble response. Any time the TREB control is rotated, tone is automatically set back to MAN (manual). Push the knob back in to the stored position when done.

To Play a Cassette

Your tape player is built to work best with tapes that are 30 to 45 minutes long on each side. Tapes longer than that are so thin they may not work well in this player.

To load a cassette tape with the ignition off, first press EJECT or RCL. Then, insert the cassette tape.

Once the tape is playing, use the control knobs for volume, balance, fade, treble and bass just as you do for the radio. A lighted tape symbol shows when a cassette tape is in the player. A lighted arrow will also appear and show the direction of play when a tape is active.

The player automatically senses if the cassette tape is metal or CR0₂ and adjusts for best playback sound. For metal tapes,  (Dolby[®] Noise Reduction) will appear in the display.



Any time a cassette tape is inserted, the top side is selected for play first.

PREV (1) — Press PREV or ◀ SEEK (in the direction that the lighted tape direction arrow points) to search for the previous selection. A minimum three-second blank gap is needed for the player to stop at the beginning of the selection. The tape direction arrow will blink during the SEEK operation.

PROG (2) — Press PROG to go from one side of the tape to the other.

NEXT (3) — Press **NEXT** or **SEEK**  (in the direction that the lighted tape direction arrow points) to search for the next selection. A minimum three-second blank gap is needed for the player to stop at the beginning of the selection. **NEXT** will appear in the display.

REV (4)— To rapidly reverse the tape, press **REV** and the tape will rapidly reverse to the beginning of the cassette reel or until you press **REV** again. The radio plays the last selected station during **REV**.



 (5)— Press  to reduce cassette tape noise. The  symbol will appear in the display while the player is in this mode.

FWD (6)— To rapidly advance the tape, press **FWD** and the tape will rapidly advance to the end of the cassette reel or until you press **FWD** again. The radio plays the last selected station during **FWD**.

TAPE AUX— To switch between the player and the radio when a tape is playing, press the **AM/FM** button. To return to the tape player, press **TAPE AUX**. The lighted arrow will appear and show the direction of play when a tape is active.

EJECT — To remove the tape press the **EJECT** button. **EJECT** can be used with either the ignition or radio off. Also, you must press **EJECT** before loading a cassette with the radio off to allow loading.

If a tape is inserted with side “1” (or “A”) up, then the right arrow means that that side is being played. Likewise, a left arrow would indicate that side “2” (or “B”) had been selected.

 **Dolby**[®] Noise Reduction is manufactured under a license from Dolby Laboratories Licensing Corporation. **Dolby**[®] and the  symbol are trademarks of Dolby Laboratories Licensing Corporation.

THEFTLOCK Theft Deterrent Feature

THEFTLOCK[®] is an anti-theft feature for the cassette player. It can be used or ignored. If ignored, the system plays normally. If it is used, your player won't be usable if it is ever stolen, because it will go to **LOC** mode any time the battery power is removed. After a loss of battery power, the player cannot be turned on unless an unlock code is entered. When activated, an indicator will flash while the ignition is off.

The following instructions tell you how to enter a secret code to activate the **THEFTLOCK** system. If your vehicle loses battery power for any reason, you must unlock the system with the secret code before the radio will turn on.

To Lock The System:

1. Write down any number from 000 to 999 and keep it in a safe place.
2. Turn the ignition to ACC or RUN.
3. Turn the radio off.
4. Press the 1 and 4 buttons together. Hold them down until “— — —” shows on the display.

You are now ready to enter your secret code. Don't wait more than 15 seconds between any of the following steps. If you do, the radio automatically returns to time display and you must start the procedure over at step 4.

5. Press MIN and “000” will appear on the display.
6. Press the MIN button again to make the last two digits agree with your code.
7. Press HR to make the first one or two digits agree with your code.
8. Press AM/FM after you have confirmed that the code matches the one you wrote down. rEP appears in the display, indicating that you need to repeat steps 5 through 7.
9. Press AM/FM and this time the display will show “SEC”. “SEC” means the system is secured.

With the ignition off, the THEFTLOCK indicator will flash.

To Unlock THEFTLOCK After a Power Loss

When battery power is reapplied to a secured radio, the radio won't turn on and “LOC” will appear on the display.

Enter your secret code as follows. Pause no more than 15 seconds between steps.

1. Turn the ignition on.
2. Turn the radio off.
3. Press MIN and “000” will appear on the display.
4. Press the MIN button again to make the last two digits agree with your code.
5. Press HR to make the first one or two digits agree with your code.
6. Press AM/FM after you have confirmed that the code matches the one you wrote down. SEC appears in the display indicating that the radio is now operable.

To Disable THEFTLOCK

1. Turn the ignition on.
2. Turn the radio off.
3. With the time showing in the display, press the 1 and 4 buttons together. Hold them down until "SEC" shows on the display.

You are now ready to enter your secret code. Don't wait more than 15 seconds between any of the following steps.

4. Press MIN and "000" will appear on the display.
5. Press the MIN button again to make the last two digits agree with your code.
6. Press HR to make the first one or two digits agree with your code.
7. Press AM/FM after you have confirmed that the code matches the one you wrote down. "—" will appear in the display, indicating that the system is unsecured (disabled).

If the code is incorrect, "SEC" will appear in the display and the system will still be secured. The radio will still operate if it is secured or unsecured. If "SEC" appears and you still want to disable the system, follow the disable procedure again and enter the correct code.

How to Operate Your ETR® AM-FM Stereo Audio Compact Disc ATC System



This part tells you how your ETR® AM-FM stereo audio compact disc ATC system works.

Upper Knob (PWR–VOL) — The upper knob has these two functions:

- Push it to switch the system on and off.
- Turn it to control the volume.

SCV (Speed Compensated Volume) — Move the control ring behind the upper knob clockwise to adjust the Speed Compensated Volume feature. As you drive, this feature increases the volume to overcome noise at any particular speed. Each clockwise position on the control ring allows more compensation and at a faster rate.

AM/FM — Press this button to switch between AM, FM1 and FM2. The display will show what mode the receiver is in.

RCL (Recall) — Press this button to change between the clock and the radio station frequency displayed when the radio is on. Also, press this button to display the time when the ignition is off.

TUNE — Press lightly on the TUNE button to release it from its stored position. Rotate the knob clockwise to increase frequency and counterclockwise to decrease radio frequency. When done, press the knob again to return it to its stored position.

Pushbuttons — The six pushbuttons let you return to favorite stations. To set the pushbuttons for up to 18 favorite stations (6 AM, 6 FM1 and 6 FM2):

1. Tune in the desired station.
2. Press AUTO TONE to select the best setting for the type of station chosen.
3. Press and hold one of the pushbuttons until sound returns (approximately two seconds). Whenever you press that button, the preset station will return.

Repeat these steps for each pushbutton.

In addition to the four stations set as above, up to three additional stations may be preset on each band by pressing two adjoining buttons at the same time. Then do the following:

1. Tune in the desired station.
2. Press the SET button. "SET" appears in the display momentarily.
3. Within 5 seconds, press any two adjoining pushbuttons at the same time. (The station will return when the same two buttons are pressed again.)

SEEK — Press SEEK ► to cause the receiver to seek the next higher station.

Press ◀ SEEK to cause the receiver to seek the next lower station.

SCAN — Press and hold the center of the **SEEK** button to momentarily hear each available station. Release the button when **SCAN** appears in the display. The receiver will continue to scan and momentarily stop at each station until you press the center of the **SEEK** button again.

P. SCAN (Preset Scan) — Press this button to scan each preset pushbutton station. The receiver will continue to scan and momentarily stop at each station until you press either **P. SCAN** again or one of the six pushbuttons. The **AUTO SCAN** setting for that preset button will also return. The pushbutton number (**P1–P6**) will appear momentarily just before frequency is displayed.

AUTO TONE — Press this button to select between five preset equalization settings and tailor the sound to the music or voice being heard. Each time you press the button, the selection will switch to one of the preset settings of **CLASSIC**, **NEWS**, **ROCK**, **POP**, or **JAZZ**. The display will show which mode the receiver is in. To return to the manual mode, press and release **AUTO TONE** until **MAN** (manual) appears in the display. This will return the tone adjustment to the **TREB** and **BASS** controls. Also, any time a **TREB** or **BASS** control is rotated, tone is automatically set back to **MAN** (manual).

FADE — Press lightly on the **FADE** knob to release it from its stored position and pull it out to the fully extended position. Rotate the knob clockwise to adjust sound to the front speakers and counterclockwise to adjust sound to the rear speakers. Push the knob back in to the stored position when done.

BAL — Press lightly on the **BAL** knob to release it from its stored position and pull it out to the fully extended position. Rotate the knob clockwise to adjust sound to the right speakers and counterclockwise to adjust sound to the left speakers. Push the knob back in to the stored position when done.

BASS — Press lightly on the **BASS** knob to release it from its stored position and pull it out to the fully extended position. Rotate the knob clockwise to increase the bass response and counterclockwise to decrease bass response. Any time the **BASS** control is rotated, tone is automatically set back to **MAN** (manual). Push the knob back in to the stored position when done.

TREBLE — Press lightly on the **TREB** knob to release it from its stored position and pull it out to the fully extended position. Rotate the knob clockwise to increase the treble response and counterclockwise to decrease treble response. Any time the **TREB** control is rotated, tone is automatically set back to **MAN** (manual). Push the knob back in to the stored position when done.

To Play A Compact Disc

NOTICE:

DO NOT use mini-discs that are called singles. They won't eject. USE FULL-SIZE COMPACT DISCS.

Press the PWR knob to turn the player on. Inserting a disc partway with the power off and ignition on will also turn the player on. Insert a disc into the slot, label side up. The player will pull it in. Wait a few seconds and the disc should play. When a disc is in the player, a CD symbol will appear in the display. When a disc is playing, the letters CD will appear next to the CD symbol.

If the disc player is very hot, or if you're driving on a very rough road, a disc may come out or just not play. If you see the word Err on the display, the disc player is too hot to play the disc. Press RECALL to make the word Err go off the display.

When things get back to normal, the disc should play again. If the disc comes back out, check whether:

- The disc is upside down.
- It is dirty, scratched, or wet.
- Too much moisture is in the air. (If there is, wait about one hour and try again.)

RECALL — Press RECALL to see what track is playing. Press it again within 5 seconds to see how long the CD has been playing that track. Elapsed time is displayed in minutes and tenths of a second. The track number will also appear when a new track begins to play. Press RECALL again to return to the time display.

COMP — Press the COMP button to make soft and loud passages more nearly equal in volume. "COMP" will appear in the display while using this control.

PREV (1) — Press PREV or ◀ SEEK to search for the previous selection. If you hold this button or press it more than once, the disc will advance further. PREV will appear in the display.

RDM (2) — Press RDM to play the tracks on the disc in random (instead of 1, 2, 3 ...) order. While in the RDM mode, RANDOM appears in the display. Press RDM again to return to normal play.

NEXT (3) — Press NEXT or SEEK ▶ to search for the next selection. If you hold this button or press it more than once, the disc will advance further. NEXT will appear in the display.

REV (4)— Press and hold REV to return rapidly to a favorite passage. You will hear the disc selection play at high speed while you press the REV button. This allows you to listen and find out when the disc is at the desired selection passage. Release REV to resume playing.

□□ (5)— Press □□ to reduce tape noise *if a remote cassette player is used*. The □□ symbol will appear in the display while the player is in this mode.

FWD (6)— Press and hold FWD to advance rapidly within a track. You will hear the disc selection play at high speed while you press the FWD button. This allows you to listen and find out when the disc is at the desired selection passage. Release FWD to resume playing.

CD AUX — To switch between the player and the radio when a disc is playing, press the AM/FM button. To return to the tape player, press CD AUX. When a disc is playing, the letters CD and the CD symbol will appear in the display.

EJECT — Press EJECT to eject the disc from the player and play the radio. When the same or a new disc is inserted, the disc will start playing on track 1.

□□ Dolby® Noise Reduction is manufactured under a license from Dolby Laboratories Licensing Corporation. Dolby® and the □□ symbol are trademarks of Dolby Laboratories Licensing Corporation.

THEFTLOCK Theft Deterrent Feature

THEFTLOCK® is an anti-theft feature for the compact disc player. It can be used or ignored. If ignored, the system plays normally. If it is used, your player won't be usable if it is ever stolen, because it will go to LOC mode any time the battery power is removed. After a loss of battery power, the player cannot be turned on unless an unlock code is entered.

The following instructions tell you how to enter a secret code into the system. If your vehicle loses battery power for any reason, you must unlock the system with the secret code before the radio will turn on.

To Lock The System:

1. Write down any number from 000 to 999 and keep it in a safe place.
2. Turn the ignition to ACC or RUN.
3. Turn the radio off.
4. Press the 1 and 4 buttons together. Hold them down until “— — —” shows on the display.

You are now ready to enter your secret code. Don't wait more than 15 seconds between any of the following steps. If you do, the radio automatically returns to time display and you must start the procedure over at step 4.

5. Press MIN and "000" will appear on the display.
6. Press the MIN button again to make the last two digits agree with your code.
7. Press HR to make the first one or two digits agree with your code.
8. Press AM/FM after you have confirmed that the code matches the one you wrote down. rEP appears in the display, indicating that you need to repeat steps 5 through 7.
9. Press AM/FM and this time the display will show SEC.

With the ignition off, the THEFTLOCK indicator will flash.

To Unlock THEFTLOCK After a Power Loss

When battery power is reapplied to a secured radio, the radio won't turn on and "LOC" will appear on the display.

Enter your secret code as follows. Pause no more than 15 seconds between steps.

1. Turn the ignition on.
2. Turn the radio off.
3. Press MIN and "000" will appear on the display.
4. Press the MIN button again to make the last two digits agree with your code.
5. Press HR to make the first one or two digits agree with your code.
6. Press AM/FM after you have confirmed that the code matches the one you wrote down. SEC appears in the display indicating that the radio is now operable.

To Disable THEFTLOCK

1. Turn the ignition on.
2. Turn the radio off.
3. With the time showing in the display, press the 1 and 4 buttons together. Hold them down until "SEC" shows on the display.

You are now ready to enter your secret code. Don't wait more than 15 seconds between any of the following steps.

4. Press MIN and "000" will appear on the display.
5. Press the MIN button again to make the last two digits agree with your code.
6. Press HR to make the first one or two digits agree with your code.

7. Press AM/FM after you have confirmed that the code matches the one you wrote down. “—” will appear in the display, indicating that the system is unsecured (disabled).

If the code is incorrect, “SEC” will appear in the display and the system will still be secured. The radio will still operate if it is secured or unsecured. If “SEC” appears and you still want to disable the system, follow the disable procedure again and enter the correct code.

Remote Cassette Player – ETR[®] AM–FM Stereo Audio Compact Disc ATC System



If you have an ETR[®] AM–FM Stereo Audio Compact Disc ATC System that includes a remote cassette player, the cassette player is located in the center of the instrument panel.

Your tape player is built to work best with tapes that are 30 to 45 minutes long on each side. Tapes longer than that are so thin they may not work well in this player.

To load a cassette tape with the ignition off, first press EJECT. Then, insert the cassette tape.

Once the tape is playing, use the control knobs for volume, balance, fade, treble and bass just as you do for the radio. A lighted tape symbol shows when a cassette tape is in the player. A lighted arrow will also appear and show the direction of play when a tape is active.

The player automatically senses if the cassette tape is metal or CR0₂ and adjusts for best playback sound. For metal tapes,  (Dolby[®] Noise Reduction) will appear in the display.

Any time a cassette tape is inserted, the top side is selected for play first.

PREV (1) — Press PREV or ◀ SEEK (in the opposite direction that the lighted tape direction arrow points) to search for the previous selection. A minimum three-second blank gap is needed for the player to stop at the beginning of the selection. The tape direction arrow will blink during the SEEK operation and the audio is in the mute mode.

PROG (on cassette player) — Press PROG to go from one side of the tape to the other.

NEXT (3) — Press NEXT or SEEK ► (in the direction that the lighted tape direction arrow points) to search for the next selection. A minimum three-second blank gap is needed for the player to stop at the beginning of the selection. NEXT will appear in the display and the audio is in the mute mode.

REV (4) — To rapidly reverse the tape, press REV and the tape will rapidly reverse to the beginning of the cassette reel or until you press REV again. The radio plays the last selected station during REV.

□□ (5) — □□ is active at all times with a tape inserted in the remote cassette. □□ will appear in the display.

FWD (6) — To rapidly advance the tape, press FWD and the tape will rapidly advance to the end of the cassette reel or until you press FWD again. The radio plays the last selected station during FWD.

TAPE — To switch between the player and the radio when a tape is playing, press the AM/FM button. To return to the tape player, press CD AUX. The lighted arrow will appear next to the tape symbol and show the direction of play when a tape is active.

EJECT (on cassette player) — To remove the tape press the EJECT button. EJECT can be used with either the ignition or radio off. Also, you must press EJECT before loading a cassette with the radio off to allow loading.

If a tape is inserted with side “1” (or “A”) up, then the right arrow means that that side is being played. Likewise, a left arrow would indicate that side “2” (or “B”) had been selected.

□□ Dolby[®] Noise Reduction is manufactured under a license from Dolby Laboratories Licensing Corporation. Dolby[®] and the □□ symbol are trademarks of Dolby Laboratories Licensing Corporation.

Understanding Radio Reception

FM stereo will give you the best sound. But FM signals will reach only about 10 to 40 miles (16 to 65 km). And, tall buildings or hills can interfere with FM signals, causing the sound to come and go.

The range for most AM stations is greater than for FM, especially at night. The longer range, however, can cause stations to interfere with each other. AM can pick up noise from things like storms and power lines. Try reducing the treble to reduce this noise if you ever get it.

AM Stereo means the Delco[®] system can receive C-QUAM[®] stereo broadcasts. Many AM stations around the country use C-QUAM[®] to produce stereo, though some do not. (C-QUAM[®] is a registered trademark of Motorola, Inc.) If your Delco[®] system can get C-QUAM[®], your “STEREO” light will come on when you’re receiving it.

Be aware that hearing damage from loud noise is almost undetectable until it is too late. Your hearing can adapt to higher volumes of sound. Sound that seems normal can be loud and harmful to your hearing. Take precautions by adjusting the volume control on your radio to a safe sound level before your hearing adapts to it.

To help avoid hearing loss or damage:

1. Adjust the volume control to the lowest setting.
2. Increase volume slowly until you hear comfortably and clearly.

NOTICE:

Before you add any sound equipment to your vehicle — like a tape player, CB radio, mobile telephone or two-way radio — be sure you can add what you want. If you can, it's very important to do it properly. Added sound equipment may interfere with the operation of your vehicle's engine, Delco[®] radio or other systems, and even damage them. And, your vehicle's systems may interfere with the operation of sound equipment that has been added improperly.

So, before adding sound equipment, check with your dealer and be sure to check Federal rules covering mobile radio and telephone units.

Care of Your Cassette Player and Tapes

A tape player that is not cleaned regularly is subject to reduced sound quality, ruining the cassette, or damaging the mechanism. Tape cassettes that are not properly stored in their plastic cases away from contaminants, direct sunlight, and extreme heat may not operate properly and could cause premature failure of the tape player.

Your tape player should be cleaned with every 50 hours of use to provide optimum performance. Your radio may display "Cln" (Clean) to indicate that you have used your tape player for 50 hours without re-setting the tape clean timer. If you notice a reduction in sound quality, regardless of when the tape player was last cleaned, try playing a different cassette to see if the tape or tape player is at fault. If the second cassette results in no improvement in sound quality, try cleaning the tape player.

Proper tape player cleaning should be done with a scrubbing action, non-abrasive cleaning cassette. This is a wet-type cleaning system that uses a cleaning cassette with pads which scrub the tape head as the hubs of the cleaner cassette turn. To properly clean your tape player, follow instructions with the cleaning cassette. If you use this type of cleaner, the radio may

display an error and eject the cartridge. This is normal and is the result of an added feature in the tape player that detects broken tapes. If an error occurs, you will need to insert the cleaning cassette at least 3 times to thoroughly clean the tape player.

You may prefer to use a non-scrubbing action, wet-type cleaner. This type of cleaner uses a fabric belt to clean the tape head. This type of cleaner cassette will not cause an error, but it may not clean the tape player as thoroughly as the scrubbing type cleaner.

A scrubbing action cleaner cassette is available through your retailer (SPO #12344600).

Cassettes are subject to wear and the sound quality may degrade over time. Always verify that the cassette tape is in good condition and the tape player is clean before obtaining service on your tape player.

NOTICE:

Cassette tape adapter kits for portable CD players will not work in your cassette player. These adapters will cause the radio to display an error and the adapter cassette will be ejected.

Care of Compact Discs

Handle discs carefully. Store them in their original cases or other protective cases and away from direct sunlight and dust. If the surface of a disc is soiled, dampen a clean, soft cloth in a mild, neutral detergent solution and clean it, wiping from the center to the edge.

Be sure never to touch the signal surface when handling discs. Pick up discs by grasping the outer edges or the edge of the hole and the outer edge.

Fixed Mast Antenna

The fixed mast antenna can withstand most car washes without being damaged. If the mast should ever become slightly bent, you can straighten it out by hand. If the mast is badly bent, as it might be by vandals, you should replace it.

Check every once in a while to be sure the mast is still tightened to the fender.

Notes

Notes

Notes

Your Driving and the Road

Section

4

Here you'll find information about driving on different kinds of roads and in varying weather conditions. We've also included many other useful tips on driving.



Defensive Driving

The best advice anyone can give about driving is: Drive defensively.

Please start with a very important safety device in your vehicle: Buckle up. (See "Safety Belts" in the Index.)

Defensive driving really means "be ready for anything." On city streets, rural roads, or freeways, it means "always expect the unexpected."

Assume that pedestrians or other drivers are going to be careless and make mistakes. Anticipate what they might do. Be ready for their mistakes.

Rear-end collisions are about the most preventable of accidents. Yet they are common. Allow enough following distance. It's the best defensive driving maneuver, in both city and rural driving. You never know when the vehicle in front of you is going to brake or turn suddenly.

Drunken Driving

Death and injury associated with drinking and driving is a national tragedy. It's the number one contributor to the highway death toll, claiming thousands of victims every year.

Alcohol affects four things that anyone needs to drive a vehicle:

- Judgment
- Muscular Coordination
- Vision
- Attentiveness

Police records show that almost half of all motor vehicle-related deaths involve alcohol. In most cases, these deaths are the result of someone who was drinking and driving. In recent years, some 18,000 annual motor vehicle-related deaths have been associated with the use of alcohol, with more than 300,000 people injured.

Many adults — by some estimates, nearly half the adult population — choose never to drink alcohol, so they never drive after drinking. For persons under 21, it's against the law in every U.S. state to drink alcohol. There are good medical, psychological and developmental reasons for these laws.

The obvious way to solve this highway safety problem is for people never to drink alcohol and then drive. But what if people do? How much is "too much" if the driver plans to drive? It's a lot less than many might think. Although it depends on each person and situation, here is some general information on the problem.

The Blood Alcohol Concentration (BAC) of someone who is drinking depends upon four things:

- How much alcohol consumed
- The drinker's body weight
- The amount of food that is consumed before and during drinking
- The length of time it has taken the drinker to consume the alcohol

According to the American Medical Association, a 180-pound (82 kg) person who drinks three 12-ounce (355 ml) bottles of beer in an hour will end up with a BAC of about 0.06 percent. The person would reach the same BAC by drinking three 4-ounce (120 ml) glasses of wine or three mixed drinks if each had 1-1/2 ounces (45 ml) of a liquor like whiskey, gin or vodka.



It's the amount of alcohol that counts. For example, if the same person drank three double martinis (3 ounces or 90 ml of liquor each) within an hour, the person's BAC would be close to 0.12 percent. A person who consumes food just before or during drinking will have a somewhat lower BAC level.

There is a gender difference, too. Women generally have a lower relative percentage of body water than men. Since alcohol is carried in body water, this means that a woman generally will reach a higher BAC level than a man of her same body weight when each has the same number of drinks.

The law in many U.S. states sets the legal limit at a BAC of 0.10 percent. In a growing number of U.S. states, and throughout Canada, the limit is 0.08 percent. In some other countries it's even lower. The BAC limit for all commercial drivers in the U.S. is 0.04 percent.

The BAC will be over 0.10 percent after three to six drinks (in one hour). Of course, as we've seen, it depends on how much alcohol is in the drinks, and how quickly the person drinks them.

But the ability to drive is affected well below a BAC of 0.10 percent. Research shows that the driving skills of many people are impaired at a BAC approaching 0.05 percent, and that the effects are worse at night. All drivers are impaired at BAC levels above 0.05 percent. Statistics show that the chance of being in a collision increases sharply for drivers who have a BAC of 0.05 percent or above. A driver with a BAC level of 0.06 percent has doubled his or her chance of having a collision. At a BAC level of 0.10 percent, the chance of this driver having a collision is twelve times greater; at a level of 0.15 percent, the chance is twenty-five times greater!

The body takes about an hour to rid itself of the alcohol in one drink. No amount of coffee or number of cold showers will speed that up. "I'll be careful" isn't the right answer. What if there's an emergency, a need to take sudden action, as when a child darts into the street? A person with even a moderate BAC might not be able to react quickly enough to avoid the collision.

There's something else about drinking and driving that many people don't know. Medical research shows that alcohol in a person's system can make crash injuries worse, especially injuries to the brain, spinal cord or heart. This means that when anyone who has been drinking — driver or passenger — is in a crash, that person's chance of being killed or permanently disabled is higher than if the person had not been drinking.



CAUTION:

Drinking and then driving is very dangerous. Your reflexes, perceptions, attentiveness and judgment can be affected by even a small amount of alcohol. You can have a serious — or even fatal — collision if you drive after drinking. Please don't drink and drive or ride with a driver who has been drinking. Ride home in a cab; or if you're with a group, designate a driver who will not drink.

Control of a Vehicle

You have three systems that make your vehicle go where you want it to go. They are the brakes, the steering and the accelerator. All three systems have to do their work at the places where the tires meet the road.



Sometimes, as when you're driving on snow or ice, it's easy to ask more of those control systems than the tires and road can provide. That means you can lose control of your vehicle.

Braking

Braking action involves *perception time* and *reaction time*.

First, you have to decide to push on the brake pedal. That's *perception time*. Then you have to bring up your foot and do it. That's *reaction time*.

Average *reaction time* is about 3/4 of a second. But that's only an average. It might be less with one driver and as long as two or three seconds or more with another. Age, physical condition, alertness, coordination, and eyesight all play a part. So do alcohol, drugs and frustration. But even in 3/4 of a second, a vehicle moving at 60 mph (100 km/h) travels 66 feet (20 m). That could be a lot of distance in an emergency, so keeping enough space between your vehicle and others is important.

And, of course, actual stopping distances vary greatly with the surface of the road (whether it's pavement or gravel); the condition of the road (wet, dry, icy); tire tread; and the condition of your brakes.

Avoid needless heavy braking. Some people drive in spurts — heavy acceleration followed by heavy braking — rather than keeping pace with traffic. This is a mistake. Your brakes may not have time to cool between hard stops. Your brakes will wear out much faster if you do a lot of heavy braking. If you keep pace with the traffic and allow realistic following distances, you will eliminate a lot of unnecessary braking. That means better braking and longer brake life.

If your engine ever stops while you're driving, brake normally but don't pump your brakes. If you do, the pedal may get harder to push down. If your engine stops, you will still have some power brake assist. But you will use it when you brake. Once the power assist is used up, it may take longer to stop and the brake pedal will be harder to push.

Anti-Lock Brakes (ABS)

Your vehicle has an advanced electronic braking system that can help you keep it under control. When you start your vehicle and begin to drive away, you may hear a momentary motor or clicking noise. This is the ABS system testing itself.



Here's how anti-lock works. Let's say the road is wet. You're driving safely. Suddenly an animal jumps out in front of you.

You slam on the brakes. Here's what happens with ABS.

A computer senses that wheels are slowing down. If one of the wheels is about to stop rolling, the computer will separately work the brakes at each front wheel and at the rear wheels. The anti-lock system can change the brake pressure faster than any driver could. The computer is programmed to make the most of available tire and road conditions.



You can steer around the obstacle while braking hard.

As you brake, your computer keeps receiving updates on wheel speed and controls braking pressure accordingly.

Remember: Anti-lock doesn't change the time you need to get your foot up to the brake pedal. If you get too close to the vehicle in front of you, you won't have time to apply your brakes if that vehicle suddenly slows or stops. Always leave enough room up ahead to stop, even though you have anti-lock brakes.

To Use Anti-Lock

Don't pump the brakes. Just hold the brake pedal down and let anti-lock work for you. You may feel the brakes vibrate, or you may notice some noise, but this is normal. On vehicles with four-wheel drive, your anti-lock brakes work at all times — whether you are in two-wheel drive or four-wheel drive.

Braking in Emergencies

Use your anti-lock braking system when you need to. With anti-lock, you can steer and brake at the same time. In many emergencies, steering can help you more than even the very best braking.

Steering

Power Steering

If you lose power steering assist because the engine stops or the system is not functioning, you can steer but it will take much more effort.

Steering Tips

Driving on Curves

It's important to take curves at a reasonable speed.

A lot of the "driver lost control" accidents mentioned on the news happen on curves. Here's why:

Experienced driver or beginner, each of us is subject to the same laws of physics when driving on curves. The traction of the tires against the road surface makes it possible for the vehicle to change its path when you turn the front wheels. If there's no traction, inertia will keep the vehicle going in the same direction. If you've ever tried to steer a vehicle on wet ice, you'll understand this.

The traction you can get in a curve depends on the condition of your tires and the road surface, the angle at which the curve is banked, and your speed. While you're in a curve, speed is the one factor you can control.

Suppose you're steering through a sharp curve. Then you suddenly accelerate. Both control systems — steering and acceleration — have to do their work where the tires meet the road. Adding the sudden acceleration can demand too much of those places. You can lose control.

What should you do if this ever happens? Ease up on the accelerator pedal, steer the vehicle the way you want it to go, and slow down.

Speed limit signs near curves warn that you should adjust your speed. Of course, the posted speeds are based on good weather and road conditions. Under less favorable conditions you'll want to go slower.

If you need to reduce your speed as you approach a curve, do it before you enter the curve, while your front wheels are straight ahead.

Try to adjust your speed so you can "drive" through the curve. Maintain a reasonable, steady speed. Wait to accelerate until you are out of the curve, and then accelerate gently into the straightaway.

Steering in Emergencies

There are times when steering can be more effective than braking. For example, you come over a hill and find a truck stopped in your lane, or a car suddenly pulls out from nowhere, or a child darts out from between parked cars and stops right in front of you. You can avoid these problems by braking — if you can stop in time. But sometimes you can't; there isn't room. That's the time for evasive action — steering around the problem.

Your vehicle can perform very well in emergencies like these. First apply your brakes. (See "Braking in Emergencies" earlier in this section.) It is better to remove as much speed as you can from a possible collision. Then steer around the problem, to the left or right depending on the space available.

An emergency like this requires close attention and a quick decision. If you are holding the steering wheel at the recommended 9 and 3 o'clock positions, you can turn it a full 180 degrees very quickly without removing either hand. But you have to act fast, steer quickly, and just as quickly straighten the wheel once you have avoided the object.



The fact that such emergency situations are always possible is a good reason to practice defensive driving at all times and wear safety belts properly.

Off-Road Recovery

You may find sometime that your right wheels have dropped off the edge of a road onto the shoulder while you're driving.

If the level of the shoulder is only slightly below the pavement, recovery should be fairly easy. Ease off the accelerator and then, if there is nothing in the way, steer so that your vehicle straddles the edge of the pavement. You can turn the steering wheel up to 1/4 turn until the right front tire contacts the pavement edge. Then turn your steering wheel to go straight down the roadway.

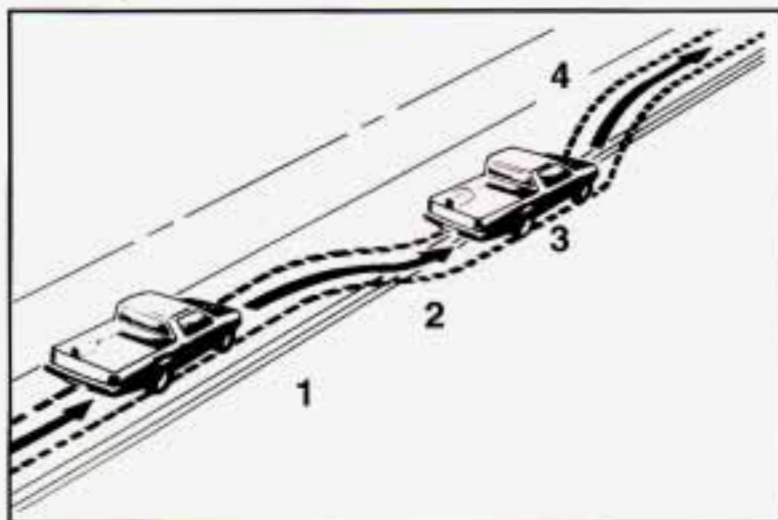

1. Edge of Road Surface
2. Slow Down
3. Left Approx. Quarter Turn
4. Recover

Passing

The driver of a vehicle about to pass another on a two-lane highway waits for just the right moment, accelerates, moves around the vehicle ahead, then goes back into the right lane again. A simple maneuver?

Not necessarily! Passing another vehicle on a two-lane highway is a potentially dangerous move, since the passing vehicle occupies the same lane as oncoming traffic for several seconds. A miscalculation, an error in judgment, or a brief surrender to frustration or anger can suddenly put the passing driver face to face with the worst of all traffic accidents — the head-on collision.

So here are some tips for passing:

- “Drive ahead.” Look down the road, to the sides, and to crossroads for situations that might affect your passing patterns. If you have any doubt whatsoever about making a successful pass, wait for a better time.
- Watch for traffic signs, pavement markings, and lines. If you can see a sign up ahead that might indicate a turn or an intersection, delay your pass. A broken center line usually indicates it’s all right to pass (providing the road ahead is clear). Never cross a solid line on your side of the lane or a double solid line, even if the road seems empty of approaching traffic.
- Do not get too close to the vehicle you want to pass while you’re awaiting an opportunity. For one thing, following too closely reduces your area of vision, especially if you’re following a larger vehicle. Also, you won’t have adequate space if the vehicle ahead suddenly slows or stops. Keep back a reasonable distance.
- When it looks like a chance to pass is coming up, start to accelerate but stay in the right lane and don’t get too close. Time your move so you will be increasing speed as the time comes to move into the other lane. If the way is clear to pass, you will have a “running start” that more than makes up for the distance you would lose by dropping back. And if something happens to cause you to cancel your pass, you need only slow down and drop back again and wait for another opportunity.
- If other cars are lined up to pass a slow vehicle, wait your turn. But take care that someone isn’t trying to pass you as you pull out to pass the slow vehicle. Remember to glance over your shoulder and check the blind spot.
- Check your mirrors, glance over your shoulder, and start your left lane change signal before moving out of the right lane to pass. When you are far enough ahead of the passed vehicle to see its front in your inside mirror, activate your right lane change signal and move back into the right lane. (Remember that if your right outside mirror is convex, the vehicle you just passed may seem to be farther away from you than it really is.)

- Try not to pass more than one vehicle at a time on two-lane roads. Reconsider before passing the next vehicle.
- Don't overtake a slowly moving vehicle too rapidly. Even though the brake lights are not flashing, it may be slowing down or starting to turn.
- If you're being passed, make it easy for the following driver to get ahead of you. Perhaps you can ease a little to the right.

Loss of Control

Let's review what driving experts say about what happens when the three control systems (brakes, steering and acceleration) don't have enough friction where the tires meet the road to do what the driver has asked.

In any emergency, don't give up. Keep trying to steer and constantly seek an escape route or area of less danger.

Skidding

In a skid, a driver can lose control of the vehicle. Defensive drivers avoid most skids by taking reasonable care suited to existing conditions, and by not "overdriving" those conditions. But skids are always possible.

The three types of skids correspond to your vehicle's three control systems. In the braking skid your wheels aren't rolling. In the steering or cornering skid, too much speed or steering in a curve causes tires to slip and lose cornering force. And in the acceleration skid too much throttle causes the driving wheels to spin.

A cornering skid and an acceleration skid are best handled by easing your foot off the accelerator pedal.

If your vehicle starts to slide, ease your foot off the accelerator pedal and quickly steer the way you want the vehicle to go. If you start steering quickly enough, your vehicle may straighten out. Always be ready for a second skid if it occurs.

Of course, traction is reduced when water, snow, ice, gravel, or other material is on the road. For safety, you'll want to slow down and adjust your driving to these conditions. It is important to slow down on slippery surfaces because stopping distance will be longer and vehicle control more limited.

While driving on a surface with reduced traction, try your best to avoid sudden steering, acceleration, or braking (including engine braking by shifting to a lower gear). Any sudden changes could cause the tires to slide. You may not realize the surface is slippery until your vehicle is skidding. Learn to recognize warning clues — such as enough water, ice or packed snow on the road to make a "mirrored surface" — and slow down when you have any doubt.

Remember: Any anti-lock brake system (ABS) helps avoid only the braking skid.

Driving Guidelines

Off-Road Driving with Your Four-Wheel Drive Vehicle

This off-road guide is for vehicles that have four-wheel drive.

Also, see “Anti-Lock Brakes” in the Index.

If your vehicle doesn't have four-wheel drive, you shouldn't drive off-road unless you're on a level, solid surface.

Off-road driving can be great fun. But it does have some definite hazards. The greatest of these is the terrain itself.

“Off-roading” means you've left the great North American road system behind. Traffic lanes aren't marked. Curves aren't banked. There are no road signs. Surfaces can be slippery, rough, uphill or downhill. In short, you've gone right back to nature.

Off-road driving involves some new skills. And that's why it's very important that you read this guide. You'll find many driving tips and suggestions. These will help make your off-road driving safer and more enjoyable.

Before You Go Off-Roading

There are some things to do before you go out. For example, be sure to have all necessary maintenance and service work done. Check to make sure all underbody shields (if so equipped) are properly attached. Be sure you read all the information about your four-wheel drive vehicle in this manual. Is there enough fuel? Is the spare tire fully inflated? Are the fluid levels up where they should be? What are the local laws that apply to off-roading where you'll be driving? If you don't know, you should check with law enforcement people in the area. Will you be on someone's private land? If so, be sure to get the necessary permission.

Loading Your Vehicle for Off-Road Driving

There are some important things to remember about how to load your vehicle.

- The heaviest things should be on the load floor and forward of your rear axle. Put heavier items as far forward as you can.
- Be sure the load is secured properly, so driving on the off-road terrain doesn't toss things around.

 **CAUTION:**

- **Cargo on the load floor piled higher than the seatbacks can be thrown forward during a sudden stop. You or your passengers could be injured. Keep cargo below the top of the seatbacks.**
- **Unsecured cargo on the load floor can be tossed about when driving over rough terrain. You or your passengers can be struck by flying objects. Secure the cargo properly.**
- **Heavy loads on the roof raise the vehicle's center of gravity, making it more likely to roll over. You can be seriously or fatally injured if the vehicle rolls over. Put heavy loads inside the cargo area, not on the roof. Keep cargo in the cargo area as far forward and low as possible.**

You'll find other important information in this manual. See "Vehicle Loading," "Luggage Carrier" and "Tires" in the Index.

Traveling to Remote Areas

It makes sense to plan your trip, especially when going to a remote area. Know the terrain and plan your route. You are much less likely to get bad surprises. Get accurate maps of trails and terrain. Try to learn of any blocked or closed roads.

It's also a good idea to travel with at least one other vehicle. If something happens to one of them, the other can help quickly.

Does your vehicle have a winch? If so, be sure to read the winch instructions. In a remote area, a winch can be handy if you get stuck. But you'll want to know how to use it properly.

Getting Familiar with Off-Road Driving

It's a good idea to practice in an area that's safe and close to home before you go into the wilderness. Off-road driving does require some new and different driving skills. Here's what we mean.

Tune your senses to different kinds of signals. Your eyes, for example, need to constantly sweep the terrain for unexpected obstacles. Your ears need to listen for unusual tire or engine sounds. With your arms, hands, feet, and body you'll need to respond to vibrations and vehicle bounce.

Controlling your vehicle is the key to successful off-road driving. One of the best ways to control your vehicle is to control your speed. Here are some things to keep in mind. At higher speeds:

- you approach things faster and you have less time to scan the terrain for obstacles.
- you have less time to react.
- you have more vehicle bounce when you drive over obstacles.
- you'll need more distance for braking, especially since you're on an unpaved surface.



CAUTION:

When you're driving off road, bouncing and quick changes in direction can easily throw you out of position. This could cause you to lose control and crash. So, whether you're driving on or off the road, you and your passengers should wear safety belts.

Scanning the Terrain

Off-road driving can take you over many different kinds of terrain. You need to be familiar with the terrain and its many different features. Here are some things to consider.

Surface Conditions. Off-roading can take you over hard-packed dirt, gravel, rocks, grass, sand, mud, snow or ice. Each of these surfaces affects the steering, acceleration, and braking of your vehicle in different ways. Depending upon the kind of surface you are on, you may experience slipping, sliding, wheel spinning, delayed acceleration, poor traction, and longer braking distances.

Surface Obstacles . Unseen or hidden obstacles can be hazardous. A rock, log, hole, rut, or bump can startle you if you're not prepared for them. Often these obstacles are hidden by grass, bushes, snow or even the rise and fall of the terrain itself. Here are some things to consider:

- Is the path ahead clear?
- Will the surface texture change abruptly up ahead?
- Does the travel take you uphill or downhill? (There's more discussion of these subjects later.)
- Will you have to stop suddenly or change direction quickly?

When you drive over obstacles or rough terrain, keep a firm grip on the steering wheel. Ruts, troughs, or other surface features can jerk the wheel out of your hands if you're not prepared.

When you drive over bumps, rocks, or other obstacles, your wheels can leave the ground. If this happens, even with one or two wheels, you can't control the vehicle as well or at all.

Because you will be on an unpaved surface, it's especially important to avoid sudden acceleration, sudden turns, or sudden braking.

In a way, off-road driving requires a different kind of alertness from driving on paved roads and highways. There are no road signs, posted speed limits or signal lights. You have to use your own good judgment about what is safe and what isn't.

Drinking and driving can be very dangerous on any road. And this is certainly true for off-road driving. At the very time you need special alertness and driving skills, your reflexes, perceptions and judgment can be affected by even a small amount of alcohol. You could have a serious — or even fatal — accident if you drink and drive or ride with a driver who has been drinking. (See "Drunken Driving" in the Index.)

Driving On Off-Road Hills

Off-road driving often takes you up, down, or across a hill. Driving safely on hills requires good judgment and an understanding of what your vehicle can and can't do. There are some hills that simply can't be driven, no matter how well built the vehicle.



CAUTION:

Many hills are simply too steep for any vehicle. If you drive up them, you will stall. If you drive down them, you can't control your speed. If you drive across them, you will roll over. You could be seriously injured or killed. If you have any doubt about the steepness, don't drive the hill.

Approaching a Hill

When you approach a hill, you need to decide if it's one of those hills that's just too steep to climb, descend, or cross. Steepness can be hard to judge. On a very small hill, for example, there may be a smooth, constant incline with only a small change in elevation where you can easily see all the way to the top. On a large hill, the incline may get steeper as you near the top, but you may not see this because the crest of the hill is hidden by bushes, grass, or shrubs.

Here are some other things to consider as you approach a hill.

- Is there a constant incline, or does the hill get sharply steeper in places?
- Is there good traction on the hillside, or will the surface cause tire slipping?
- Is there a straight path up or down the hill so you won't have to make turning maneuvers?
- Are there obstructions on the hill that can block your path (boulders, trees, logs or ruts)?
- What's beyond the hill? Is there a cliff, an embankment, a drop-off, a fence? Get out and walk the hill if you don't know. It's the smart way to find out.
- Is the hill simply too rough? Steep hills often have ruts, gullies, troughs and exposed rocks because they are more susceptible to the effects of erosion.

Driving Uphill

Once you decide you can safely drive up the hill, you need to take some special steps.

- Use a low gear and get a firm grip on the steering wheel.
- Get a smooth start up the hill and try to maintain your speed. Don't use more power than you need, because you don't want your wheels to start spinning or sliding.
- Try to drive straight up the hill if at all possible. If the path twists and turns, you might want to find another route.



CAUTION:

Turning or driving across steep hills can be dangerous. You could lose traction, slide sideways, and possibly roll over. You could be seriously injured or killed. When driving up hills, always try to go straight up.

- Ease up on your speed as you approach the top of the hill.
- Attach a flag to the vehicle to make you more visible to approaching traffic on trails or hills.
- Sound the horn as you approach the top of the hill to let opposing traffic know you're there.
- Use your headlights even during the day. They make you more visible to oncoming traffic.



CAUTION:

Driving to the top (crest) of a hill at full speed can cause an accident. There could be a drop-off, embankment, cliff, or even another vehicle. You could be seriously injured or killed. As you near the top of a hill, slow down and stay alert.

Q: What should I do if my vehicle stalls, or is about to stall, and I can't make it up the hill?

A: If this happens, there are some things you should do, and there are some things you must not do. First, here's what you *should* do:

- Push the brake pedal to stop the vehicle and keep it from rolling backwards. Also, apply the parking brake.
- If your engine is still running, shift the transmission into reverse, release the parking brake, and slowly back down the hill in reverse.
- If your engine has stopped running, you'll need to restart it. With the brake pedal depressed and the parking brake still applied, shift the transmission to PARK (P) (or, shift to NEUTRAL (N) if your vehicle has a manual transmission) and restart the engine. Then, shift to reverse, release the parking brake, and slowly back down the hill as straight as possible in reverse.
- As you are backing down the hill, put your left hand on the steering wheel at the 12 o'clock position. This way, you'll be able to tell if your wheels are straight and maneuver as you back down. It's best that you back down the hill with your wheels straight rather than in the left or right direction. Turning the wheel too far to the left or right will increase the possibility of a rollover.

Here are some things you *must not* do if you stall, or are about to stall, when going up a hill.

- Never attempt to prevent a stall by shifting into NEUTRAL (N) (or depressing the clutch, if you have a manual transmission) to "rev-up" the engine and regain forward momentum. This won't work. Your vehicle will roll backwards very quickly and you could go out of control.

Instead, apply the regular brake to stop the vehicle. Then apply the parking brake. Shift into reverse, release the parking brake, and slowly back straight down.

- Never attempt to turn around if you are about to stall when going up a hill. If the hill is steep enough to stall your vehicle, it's steep enough to cause you to roll over if you turn around. If you can't make it up the hill, you must back straight down the hill.

Q: Suppose, after stalling, I try to back down the hill and decide I just can't do it. What should I do?

A: Set the parking brake, put your transmission in PARK (P) (or the manual transmission in first gear), and turn off the engine. Leave the vehicle and go get some help. Exit on the uphill side and stay clear of the path the vehicle would take if it rolled downhill. Do not shift the transfer case to NEUTRAL (N) when you leave the vehicle. Leave it in some gear.



CAUTION:

Shifting the transfer case to NEUTRAL (N) can cause your vehicle to roll even if the transmission is in PARK (P) (or, if you have the manual transmission, even if you're in gear). This is because the NEUTRAL (N) position on the transfer case overrides the transmission. If you are going to leave your vehicle, set the parking brake and shift the transmission to PARK (P) (or, put your manual transmission in first gear). But do not shift the transfer case to the NEUTRAL (N) position. Leave the transfer case in the 2 Wheel, 4 High or 4 Low position.

Driving Downhill

When off-roading takes you downhill, you'll want to consider a number of things:

- How steep is the downhill? Will I be able to maintain vehicle control?
- What's the surface like? Smooth? Rough? Slippery? Hard-packed dirt? Gravel?
- Are there hidden surface obstacles? Ruts? Logs? Boulders?
- What's at the bottom of the hill? Is there a hidden creek bank or even a river bottom with large rocks?

If you decide you can go down a hill safely, then try to keep your vehicle headed straight down, and use a low gear. This way, engine drag can help your brakes and they won't have to do all the work. Descend slowly, keeping your vehicle under control at all times.



CAUTION:

Heavy braking when going down a hill can cause your brakes to overheat and fade. This could cause loss of control and a serious accident. Apply the brakes lightly when descending a hill and use a low gear to keep vehicle speed under control.

Q: Are there some things I should not do when driving down a hill?

A: Yes! These are important because if you ignore them you could lose control and have a serious accident.

- When driving downhill, avoid turns that take you across the incline of the hill. A hill that's not too steep to drive down may be too steep to drive across. You could roll over if you don't drive straight down.
- Never go downhill with the transmission in NEUTRAL (N) , or with the clutch pedal depressed in a manual shift . This is called "free-wheeling." Your brakes will have to do all the work and could overheat and fade.

Q: Am I likely to stall when going downhill?

A: It's much more likely to happen going uphill. But if it happens going downhill, here's what to do.

- Stop your vehicle by applying the regular brakes. Apply the parking brake.
- Shift to PARK (P) (or to Neutral with the manual transmission) and, while still braking, restart the engine.
- Shift back to a low gear, release the parking brake, and drive straight down.
- If the engine won't start, get out and get help.

Driving Across an Incline

Sooner or later, an off-road trail will probably go across the incline of a hill. If this happens, you have to decide whether to try to drive across the incline. Here are some things to consider:

- A hill that can be driven straight up or down may be too steep to drive across. When you go straight up or down a hill, the length of the wheel base (the distance from the front wheels to the rear wheels) reduces the likelihood the vehicle will tumble end over end. But when you drive across an incline, the much more narrow track width (the distance between the left and right wheels) may not prevent the vehicle from tilting and rolling over. Also, driving across an incline puts more weight on the downhill wheels. This could cause a downhill slide or a rollover.
- Surface conditions can be a problem when you drive across a hill. Loose gravel, muddy spots, or even wet grass can cause your tires to slip sideways, downhill. If the vehicle slips sideways, it can hit something that will trip it (a rock, a rut, etc.) and roll over.
- Hidden obstacles can make the steepness of the incline even worse. If you drive across a rock with the uphill wheels, or if the downhill wheels drop into a rut or depression, your vehicle can tilt even more.

For reasons like these, you need to decide carefully whether to try to drive across an incline. Just because the trail goes across the incline doesn't mean you have to drive it. The last vehicle to try it might have rolled over.



CAUTION:

Driving across an incline that's too steep will make your vehicle roll over. You could be seriously injured or killed. If you have any doubt about the steepness of the incline, don't drive across it. Find another route instead.

Q: What if I'm driving across an incline that's not too steep, but I hit some loose gravel and start to slide downhill. What should I do?

A: If you feel your vehicle starting to slide sideways, turn downhill. This should help straighten out the vehicle and prevent the side slipping. However, a much better way to prevent this is to get out and "walk the course" so you know what the surface is like before you drive it.

Hard packed snow and ice offer the worst tire traction. On these surfaces, it's very easy to lose control. On wet ice, for example, the traction is so poor that you will have difficulty accelerating. And if you do get moving, poor steering and difficult braking can cause you to slide out of control.



CAUTION:

Driving on frozen lakes, ponds or rivers can be dangerous. Underwater springs, currents under the ice, or sudden thaws can weaken the ice. Your vehicle could fall through the ice and you and your passengers could drown. Drive your vehicle on safe surfaces only.

Driving In Water

Light rain causes no special off-road driving problems. But heavy rain can mean flash flooding, and flood waters demand extreme caution.

Find out how deep the water is before you drive through it. If it's deep enough to cover your wheel hubs, axles, or exhaust pipe, don't try it — you probably won't get through. Also, water that deep can damage your axle and other vehicle parts.

If the water isn't too deep, then drive through it slowly. At fast speeds, water splashes on your ignition system and your vehicle can stall. Stalling can also occur if you get your tailpipe under water. And, as long as your tailpipe is under water, you'll never be able to start your engine. When you go through water, remember that when your brakes get wet, it may take you longer to stop.



CAUTION:

Driving through rushing water can be dangerous. Deep water can sweep your vehicle downstream and you and your passengers could drown. If it's only inches deep, it can still wash away the ground from under your tires, and you could lose traction and roll the vehicle over. Don't drive through rushing water.

If you have a diesel engine, see "Driving Through Water (Diesel Engines)" in the Index for more information on driving through water.

Stalling on an Incline

If your vehicle stalls when you're crossing an incline, be sure you (and your passengers) get out on the uphill side, even if the door there is harder to open. If you get out on the downhill side and the vehicle starts to roll over, you'll be right in its path.

If you have to walk down the slope, stay out of the path the vehicle will take if it does roll over.



⚠ CAUTION:

Getting out on the downhill (low) side of a vehicle stopped across an incline is dangerous. If the vehicle rolls over, you could be crushed or killed. Always get out on the uphill (high) side of the vehicle and stay well clear of the rollover path.

Driving In Mud, Sand, Snow, Or Ice

When you drive in mud, snow or sand, your wheels won't get good traction. You can't accelerate as quickly, turning is more difficult, and you'll need longer braking distances.

It's best to use a low gear when you're in mud — the deeper the mud, the lower the gear. In really deep mud, the idea is to keep your vehicle moving so you don't get stuck.

When you drive on sand, you'll sense a change in wheel traction. But it will depend upon how loosely packed the sand is. On loosely packed sand (as on beaches or sand dunes) your tires will tend to sink into the sand. This has an effect on steering, accelerating, and braking. You may want to reduce the air pressure in your tires slightly when driving on sand. This will improve traction.

After Off-Road Driving

Remove any brush or debris that has collected on the underbody, chassis or under the hood. These accumulations can be a fire hazard.

After operation in mud or sand, have the brake linings cleaned and checked. These substances can cause glazing and uneven braking. Check the body structure, steering, suspension, wheels, tires, and exhaust system for damage. Also, check the fuel lines and cooling system for any leakage.

Your vehicle will require more frequent service due to off-road use. Refer to the Maintenance Schedule for additional information.

Driving at Night



Night driving is more dangerous than day driving. One reason is that some drivers are likely to be impaired — by alcohol or drugs, with night vision problems, or by fatigue.

Here are some tips on night driving.

- Drive defensively.
- Don't drink and drive.
- Adjust your inside rearview mirror to reduce the glare from headlamps behind you.
- Since you can't see as well, you may need to slow down and keep more space between you and other vehicles.
- Slow down, especially on higher speed roads. Your headlamps can light up only so much road ahead.
- In remote areas, watch for animals.
- If you're tired, pull off the road in a safe place and rest.

Night Vision

No one can see as well at night as in the daytime. But as we get older these differences increase. A 50-year-old driver may require at least twice as much light to see the same thing at night as a 20-year-old.

What you do in the daytime can also affect your night vision. For example, if you spend the day in bright sunshine you are wise to wear sunglasses. Your eyes will have less trouble adjusting to night. But if you're driving, don't wear sunglasses at night. They may cut down on glare from headlamps, but they also make a lot of things invisible.

You can be temporarily blinded by approaching lights. It can take a second or two, or even several seconds, for your eyes to readjust to the dark. When you are faced with severe glare (as from a driver who doesn't lower the high beams, or a vehicle with misaimed headlamps), slow down a little. Avoid staring directly into the approaching lights.

Keep your windshield and all the glass on your vehicle clean — inside and out. Glare at night is made much worse by dirt on the glass. Even the inside of the glass can build up a film caused by dust. Dirty glass makes lights dazzle and flash more than clean glass would, making the pupils of your eyes contract repeatedly.

Remember that your headlamps light up far less of a roadway when you are in a turn or curve. Keep your eyes moving; that way, it's easier to pick out dimly lighted objects. Just as your headlamps should be checked regularly for proper aim, so should your eyes be examined regularly. Some drivers suffer from night blindness — the inability to see in dim light — and aren't even aware of it.

Driving in the Rain



Rain and wet roads can mean driving trouble. On a wet road you can't stop, accelerate or turn as well because your tire-to-road traction isn't as good as on dry roads. And, if your tires don't have much tread left, you'll get even

less traction. It's always wise to go slower and be cautious if rain starts to fall while you are driving. The surface may get wet suddenly when your reflexes are tuned for driving on dry pavement.

The heavier the rain, the harder it is to see. Even if your windshield wiper blades are in good shape, a heavy rain can make it harder to see road signs and traffic signals, pavement markings, the edge of the road, and even people walking.

It's wise to keep your wiping equipment in good shape and keep your windshield washer tank filled. Replace your windshield wiper inserts when they show signs of streaking or missing areas on the windshield, or when strips of rubber start to separate from the inserts.



Driving too fast through large water puddles or even going through some car washes can cause problems, too. The water may affect your brakes. Try to avoid puddles. But if you can't, try to slow down before you hit them.



CAUTION:

Wet brakes can cause accidents. They won't work well in a quick stop and may cause pulling to one side. You could lose control of the vehicle.

After driving through a large puddle of water or a car wash, apply your brake pedal lightly until your brakes work normally.

Hydroplaning

Hydroplaning is dangerous. So much water can build up under your tires that they can actually ride on the water. This can happen if the road is wet enough and you're going fast enough. When your vehicle is hydroplaning, it has little or no contact with the road.

Hydroplaning doesn't happen often. But it can if your tires haven't much tread or if the pressure in one or more is low. It can happen if a lot of water is standing on the road. If you can see reflections from trees, telephone poles, or other vehicles, and raindrops "dimple" the water's surface, there could be hydroplaning.

Hydroplaning usually happens at higher speeds. There just isn't a hard and fast rule about hydroplaning. The best advice is to slow down when it is raining.

Some Other Rainy Weather Tips

- Turn on your low-beam headlights — not just your parking lights — to help make you more visible to others.
- Besides slowing down, allow some extra following distance. And be especially careful when you pass another vehicle. Allow yourself more clear room ahead, and be prepared to have your view restricted by road spray.
- Have good tires with proper tread depth. (See "Tires" in the Index.)

City Driving

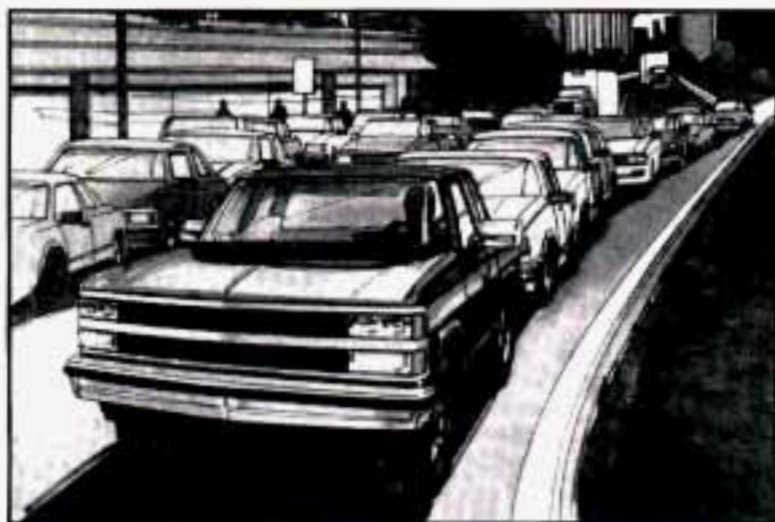

One of the biggest problems with city streets is the amount of traffic on them. You'll want to watch out for what the other drivers are doing and pay attention to traffic signals.

Here are ways to increase your safety in city driving:

- Know the best way to get to where you are going. Get a city map and plan your trip into an unknown part of the city just as you would for a cross-country trip.

- Try to use the freeways that rim and crisscross most large cities. You'll save time and energy. (See the next part, "Freeway Driving.")
- Treat a green light as a warning signal. A traffic light is there because the corner is busy enough to need it. When a light turns green, and just before you start to move, check both ways for vehicles that have not cleared the intersection or may be running the red light.

Freeway Driving

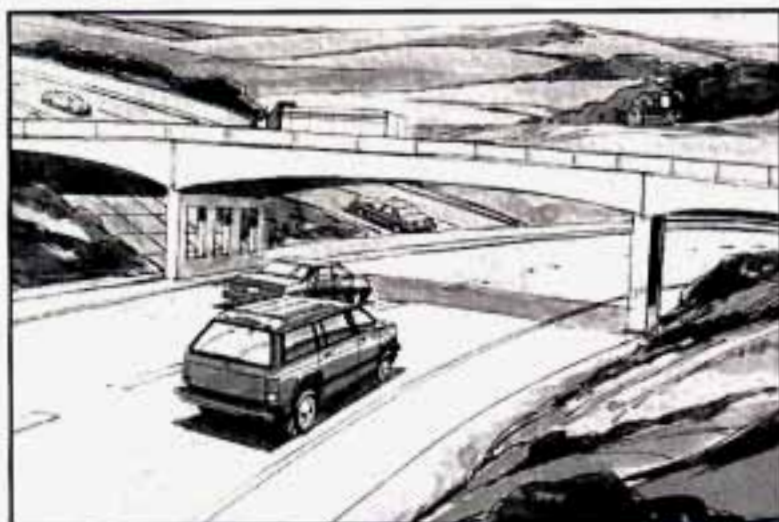

Mile for mile, freeways (also called thruways, parkways, expressways, turnpikes, or superhighways) are the safest of all roads. But they have their own special rules.

The most important advice on freeway driving is: Keep up with traffic and keep to the right. Drive at the same speed most of the other drivers are driving. Too-fast or too-slow driving breaks a smooth traffic flow. Treat the left lane on a freeway as a passing lane.

At the entrance there is usually a ramp that leads to the freeway. If you have a clear view of the freeway as you drive along the entrance ramp, you should begin to check traffic. Try to determine where you expect to blend with the flow. Try to merge into the gap at close to the prevailing speed. Switch on your turn signal, check your mirrors and glance over your shoulder as often as necessary. Try to blend smoothly with the traffic flow.

Once you are on the freeway, adjust your speed to the posted limit or to the prevailing rate if it's slower. Stay in the right lane unless you want to pass.

Before changing lanes, check your mirrors. Then use your turn signal.

Just before you leave the lane, glance quickly over your shoulder to make sure there isn't another vehicle in your "blind" spot.

Once you are moving on the freeway, make certain you allow a reasonable following distance. Expect to move slightly slower at night.

When you want to leave the freeway, move to the proper lane well in advance. If you miss your exit do not, under any circumstances, stop and back up. Drive on to the next exit.

The exit ramp can be curved, sometimes quite sharply.

The exit speed is usually posted.

Reduce your speed according to your speedometer, not to your sense of motion. After driving for any distance at higher speeds, you may tend to think you are going slower than you actually are.

Before Leaving on a Long Trip

Make sure you're ready. Try to be well rested. If you must start when you're not fresh — such as after a day's work — don't plan to make too many miles that first part of the journey. Wear comfortable clothing and shoes you can easily drive in.

Is your vehicle ready for a long trip? If you keep it serviced and maintained, it's ready to go. If it needs service, have it done before starting out. Of course, you'll find experienced and able service experts in GM dealers all across North America. They'll be ready and willing to help if you need it.

Here are some things you can check before a trip:

- *Windshield Washer Fluid:* Is the reservoir full? Are all windows clean inside and outside?
- *Wiper Blades:* Are they in good shape?
- *Fuel, Engine Oil, Other Fluids:* Have you checked all levels?
- *Lamps:* Are they all working? Are the lenses clean?
- *Tires:* They are vitally important to a safe, trouble-free trip. Is the tread good enough for long-distance driving? Are the tires all inflated to the recommended pressure?
- *Weather Forecasts:* What's the weather outlook along your route? Should you delay your trip a short time to avoid a major storm system?
- *Maps:* Do you have up-to-date maps?

Highway Hypnosis

Is there actually such a condition as "highway hypnosis"? Or is it just plain falling asleep at the wheel? Call it highway hypnosis, lack of awareness, or whatever.

There is something about an easy stretch of road with the same scenery, along with the hum of the tires on the road, the drone of the engine, and the rush of the wind against the vehicle that can make you sleepy. Don't let it happen to you! If it does, your vehicle can leave the road in *less than a second*, and you could crash and be injured.

What can you do about highway hypnosis? First, be aware that it can happen.

Then here are some tips:

- Make sure your vehicle is well ventilated, with a comfortably cool interior.
- Keep your eyes moving. Scan the road ahead and to the sides. Check your mirrors and your instruments frequently.
- If you get sleepy, pull off the road into a rest, service, or parking area and take a nap, get some exercise, or both. For safety, treat drowsiness on the highway as an emergency.

Hill and Mountain Roads



Driving on steep hills or mountains is different from driving in flat or rolling terrain.

If you drive regularly in steep country, or if you're planning to visit there, here are some tips that can make your trips safer and more enjoyable. (See "Off-Road Driving" in the Index for information about driving off-road.)

- Keep your vehicle in good shape. Check all fluid levels and also the brakes, tires, cooling system and transmission. These parts can work hard on mountain roads.
- Know how to go down hills. The most important thing to know is this: let your engine do some of the slowing down. Shift to a lower gear when you go down a steep or long hill.



CAUTION:

If you don't shift down, your brakes could get so hot that they wouldn't work well. You would then have poor braking or even none going down a hill. You could crash. Shift down to let your engine assist your brakes on a steep downhill slope.



CAUTION:

Coasting downhill in NEUTRAL (N) or with the ignition off is dangerous. Your brakes will have to do all the work of slowing down. They could get so hot that they wouldn't work well. You could crash. Always have your engine running and your vehicle in gear when you go downhill.

- Know how to go uphill. You may want to shift down to a lower gear. The lower gears help cool your engine and transmission, and you can climb the hill better.
- Stay in your own lane when driving on two-lane roads in hills or mountains. Don't swing wide or cut across the center of the road. Drive at speeds that let you stay in your own lane.
- As you go over the top of a hill, be alert. There could be something in your lane, like a stalled car or an accident.
- You may see highway signs on mountains that warn of special problems. Examples are long grades, passing or no-passing zones, a falling rocks area, or winding roads. Be alert to these and take appropriate action.

Winter Driving



Here are some tips for winter driving:

- Have your vehicle in good shape for winter. Be sure your engine coolant mix is correct.
- You may want to put winter emergency supplies in your vehicle.

Include an ice scraper, a small brush or broom, a supply of windshield washer fluid, a rag, some winter outer clothing, a small shovel, a flashlight, a red cloth, and a couple of reflective warning triangles. And, if you will be driving under severe conditions, include a small bag of sand, a piece of old carpet or a couple of burlap bags to help provide traction. Be sure you properly secure these items in your vehicle.

Driving on Snow or Ice

Most of the time, those places where your tires meet the road probably have good traction.

However, if there is snow or ice between your tires and the road, you can have a very slippery situation. You'll have a lot less traction or "grip" and will need to be very careful.



What's the worst time for this? "Wet ice." Very cold snow or ice can be slick and hard to drive on. But wet ice can be even more trouble because it may offer the least traction of all. You can get "wet ice" when it's about freezing (32°F; 0°C) and freezing rain begins to fall. Try to avoid driving on wet ice until salt and sand crews can get there.

Whatever the condition — smooth ice, packed, blowing or loose snow — drive with caution.

Accelerate gently. Try not to break the fragile traction. If you accelerate too fast, the drive wheels will spin and polish the surface under the tires even more.

Your anti-lock brakes improve your ability to make a hard stop on a slippery road. Even though you have an anti-lock braking system, you'll want to begin stopping sooner than you would on dry pavement. See "Anti-Lock" in the Index.

- Allow greater following distance on any slippery road.
- Watch for slippery spots. The road might be fine until you hit a spot that's covered with ice. On an otherwise clear road, ice patches may appear in shaded areas where the sun can't reach: around clumps of trees, behind buildings, or under bridges. Sometimes the surface of a curve or an overpass may remain icy when the surrounding roads are clear. If you see a patch of ice ahead of you, brake before you are on it. Try not to brake while you're actually on the ice, and avoid sudden steering maneuvers.

If You're Caught in a Blizzard



If you are stopped by heavy snow, you could be in a serious situation. You should probably stay with your vehicle unless you know for sure that you are near help and you can hike through the snow. Here are some things to do to summon help and keep yourself and your passengers safe: Turn on your hazard flashers. Tie a red cloth to your vehicle to alert police that you've been stopped by the snow. Put on extra clothing or wrap a blanket around you. If you have no blankets or extra clothing, make body insulators from newspapers, burlap bags, rags, floor mats — anything you can wrap around yourself or tuck under your clothing to keep warm.

You can run the engine to keep warm, but be careful.



CAUTION:

Snow can trap exhaust gases under your vehicle. This can cause deadly CO (carbon monoxide) gas to get inside. CO could overcome you and kill you. You can't see it or smell it, so you might not know it is in your vehicle. Clear away snow from around the base of your vehicle, especially any that is blocking your exhaust pipe. And check around again from time to time to be sure snow doesn't collect there.

Open a window just a little on the side of the vehicle that's away from the wind. This will help keep CO out.



Run your engine only as long as you must. This saves fuel. When you run the engine, make it go a little faster than just idle. That is, push the accelerator slightly. This uses less fuel for the heat that you get and it keeps the battery (or batteries) charged. You will need a well-charged battery (or batteries) to restart the vehicle, and possibly for signaling later on with your headlights. Let the heater run for awhile.

If you have a diesel engine, you may have to run it at a higher speed to get enough heat. Then, shut the engine off and close the window almost all the way to preserve the heat. Start the engine again and repeat this only when you feel really uncomfortable from the cold. But do it as little as possible. Preserve the fuel as long as you can. To help keep warm, you can get out of the vehicle and do some fairly vigorous exercises every half hour or so until help comes.

Power Winches

If you wish to use a power winch on your vehicle, only use it when your vehicle is stationary or anchored.

NOTICE:

Using a power winch with the transmission in gear may damage the transmission. When operating a power winch, always leave the transmission in NEUTRAL (N).

Use the regular brakes, set the parking brake, or block the wheels to keep your vehicle from rolling.

Power Take-Off (PTO)

NOTICE:

If you have a PTO that will exceed 35 horsepower installed on your vehicle, it could damage the transfer case or transmission. When having a PTO installed on your vehicle, make sure that it will not exceed 35 horsepower.

Before using a power take-off, refer to the manufacturer's or installer's instructions.

NOTICE:

Using a PTO while operating in one place before the vehicle has reached normal operating temperature can damage the transfer case or transmission. If you will be using the PTO while operating in one place, drive and warm up the vehicle before using the PTO.

To engage a power take-off:

1. Set the parking brake.
2. Shift the transmission into NEUTRAL (N).
3. Hold the clutch pedal down and engage the power take-off.

NOTICE:

Using a PTO for more than four hours without driving your vehicle can damage the transfer case or transmission. If using a PTO for more than four hours without driving your vehicle, drive your vehicle for a while to allow the transfer case and transmission to cool.

If you are going to drive the vehicle, shift the transmission into the gear you want. Then shift the transfer case into the range you want (if you have four-wheel drive), apply the regular brakes and release the parking brake.

4. Release the clutch (and the regular brakes) as you normally would. When you release the clutch, the power take-off will start.

Using a Transfer Case Mounted Power Take–Off (Manual Transmission)

1. Set the parking brake.
2. Shift the transfer case into NEUTRAL (N).
3. Hold the clutch pedal down. If the vehicle will remain in the same place, shift the transmission into the highest gear.
4. Engage the power take–off.

If you are going to drive the vehicle, shift the transmission into the gear you want. Then shift the transfer case into the range you want, apply the regular brakes and release the parking brake.

5. Release the clutch (and the regular brakes) as you normally would. When you release the clutch, the power take–off will start.

Using a Transfer Case Mounted Power Take–Off (Automatic Transmission)

1. Set the parking brake.
2. Shift the transfer case into NEUTRAL (N).
3. Shift the transmission into NEUTRAL (N).
4. Engage the power take–off.

If you are going to drive the vehicle, shift the transfer case into the range you want. Then apply the regular brakes and release the parking brake.

5. Shift the transmission to DRIVE (3) to start the power take–off.
6. Release the regular brakes to drive the vehicle.

Loading Your Vehicle

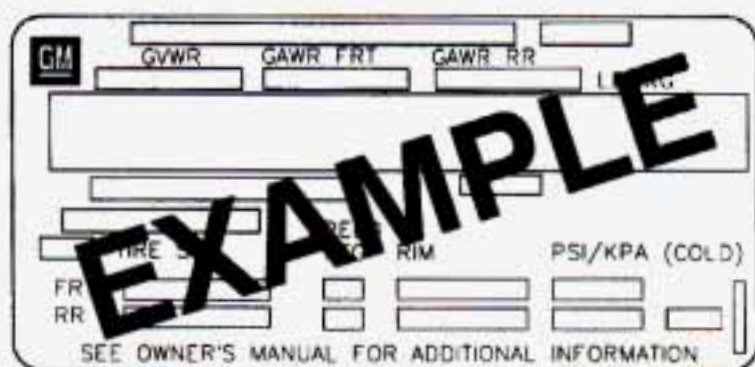

The Certification/Tire label is found on the rear edge of the driver's door or in the Incomplete Vehicle Document in the cab.

The label shows the size of your original tires and the inflation pressures needed to obtain the gross weight capacity of your vehicle. This is called the GVWR (Gross Vehicle Weight Rating). The GVWR includes the weight of the vehicle, all occupants, fuel and cargo.

The Certification/Tire label also tells you the maximum weights for the front and rear axles, called Gross Axle Weight Rating (GAWR). To find out the actual loads on your front and rear axles, you need to go to a weigh station and weigh your vehicle. Your dealer can help you with this. Be sure to spread out your load equally on both sides of the centerline.

Never exceed the GVWR for your vehicle, or the GAWR for either the front or rear axle.

And, if you do have a heavy load, you should spread it out.

CAUTION:

In the case of a sudden stop or collision, things carried in the bed of your truck could shift forward and come into the passenger area, injuring you and others. If you put things in the bed of your truck, you should make sure they are properly secured.



CAUTION:

Do not load your vehicle any heavier than the GVWR, or either the maximum front or rear GAWR. If you do, parts on your vehicle can break, or it can change the way your vehicle handles. These could cause you to lose control. Also, overloading can shorten the life of your vehicle.

Using heavier suspension components to get added durability might not change your weight ratings. Ask your dealer to help you load your vehicle the right way.

If your vehicle is equipped for front-end equipment (a snow plow, for example), the front suspension may have been adjusted (raised) to level the vehicle when the equipment was installed. If the front suspension was adjusted, you must re-adjust the front suspension after the equipment is removed to avoid possible front suspension damage. Adjust the front suspension to original design specifications for your particular model.

NOTICE:

Your warranty does not cover parts or components that fail because of overloading.

If you put things inside your vehicle—like suitcases, tools, packages, or anything else—they go as fast as the vehicle goes. If you have to stop or turn quickly, or if there is a crash, they'll keep going.



CAUTION:

Things you put inside your vehicle can strike and injure people in a sudden stop or turn, or in a crash.

- **Put things in the cargo area of your vehicle. Try to spread the weight evenly.**
- **Never stack heavier things, like suitcases, inside the vehicle so that some of them are above the tops of the seats.**
- **Don't leave an unsecured child restraint in your vehicle.**
- **When you carry something inside the vehicle, secure it whenever you can.**
- **Don't leave a seat folded down unless you need to.**

There's also important loading information for off-road driving in this manual. See "Loading Your Vehicle" in the Index.

Trailer Package

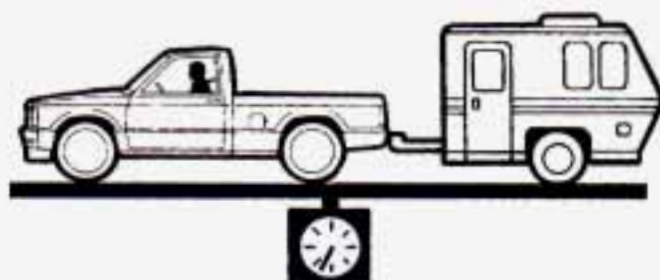



If your vehicle comes with the Trailering Package, there is also a load rating which includes the weight of the vehicle **and** the trailer it tows. This rating is called the Gross Combination Weight Rating (GCWR).

When you weigh your trailer, be sure to include the weight of everything you put in it. And, remember to figure the weight of the people inside as part of your load.

Your dealer can help you determine your GCWR.

Truck-Camper Loading Information

Open your glove box door and look for this label:

	TRUCK CAMPER LOADING INFORMATION
* This information is furnished to indicate the manufactures recommendation regarding the use of a slide-in camper with the truck as manufactured.	
1GCCS14Z8N8166054	
CARGO WEIGHT RATING 1200LB/542KB	
DIMENSIONS: "A" = 60IN/152CM "B" = 60IN/152CM	
SEE OWNER'S MANUAL FOR MORE TRUCK CAMPER LOADING INFORMATION.	
Printed in U.S.A.	 Pt. No. 15696350

This label will tell you how much of a load your vehicle can carry, and how to spread out your load the right way. Also, it will help you match the right slide-in camper to your vehicle.

When you carry a slide-in camper, the total cargo load of your vehicle is the weight of the camper, PLUS

- everything else added to the camper after it left the factory;
- everything in the camper; and
- all the people inside.

The Cargo Weight Rating (CWR) is the maximum weight of the load your vehicle can carry. It doesn't include the weight of the people inside. But, you can figure about 150 pounds for each seat.

The total cargo load must not be more than your vehicle's CWR.

TRUCK LOADING INFORMATION

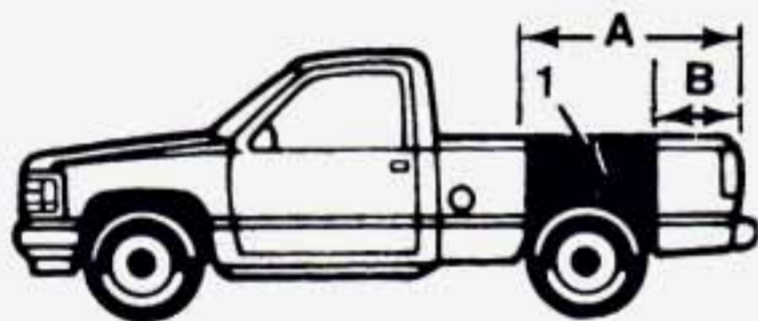

1. Recommended location for cargo center of gravity for cargo weight rating (Pickup Truck).

- Refer to the Truck Camper Loading Information label in glove box for "A" and "B" dimensions. Use the rear edge of the load floor for measurement purposes.

EXAMPLE OF PROPER TRUCK AND CAMPER MATCH

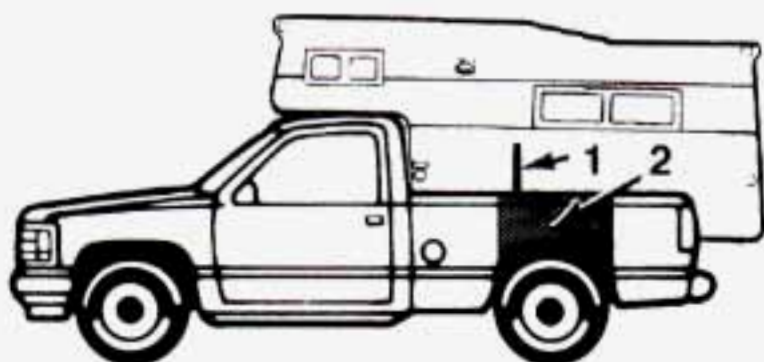

1. Camper center of gravity
2. Recommended center of gravity location zone.

The camper's center of gravity should fall within the center of gravity zone for your vehicle's cargo load.

You must weigh any accessories or other equipment that you add to your vehicle. Then, subtract this extra weight from the CWR. This extra weight may shorten the center of gravity zone of your vehicle. Your dealer can help you with this.

If your slide-in camper and its load weigh less than the CWR, the center of gravity zone for your vehicle may be larger.

Your dealer can help you make a good vehicle-camper match. He'll also help you determine your CWR.

After you've loaded your vehicle and camper, drive to a weigh station and weigh on the front and rear wheels separately. This will tell you the loads on your axles. The loads on the front and rear axles shouldn't be more than either of the GAWRs. The total of the axle loads should not be more than the GVWR.

Open your driver's door and look at the Certification/Tire label to find out your GAWR and GVWR.

If you've gone over your weight ratings, move or take out some things until all the weights fall below the ratings. Of course, you should always tie down any loose items when you load your vehicle or camper.

When you install and load your slide-in camper, check the manufacturer's instructions.

If you want more information on curb weights, cargo weights, cargo weight rating and the correct center of gravity zone for your vehicle, your dealer can help you. Just ask for a copy of "Consumer Information, Truck-Camper Loading."

Trailer Recommendations

You must subtract your hitch loads from the CWR for your vehicle. Weigh your vehicle with the trailer hitch attached, so that you won't go over the GVWR or the GAWR.

You'll get the best performance if you spread out the weight of your load the right way, and if you choose the correct hitch and trailer brakes.

For more information, see "Trailer Towing" in the Index.

Pickup Conversion to Chassis Cab

General Motors is aware that some vehicle owners may consider having the pickup box removed and a commercial or recreational body installed. Before you do so, first contact the GM Zone Office for your area for information on such conversions specific to this vehicle. (See the "Warranty and Owner Assistance" booklet for Zone Office.) Owners should be aware that, as manufactured, there are differences between a chassis cab and a pickup with the box removed which may affect vehicle safety. The components necessary to adapt a pickup to permit its safe use with a specialized body should be installed by a body builder in accordance with the information available from the Zone Office.

Towing a Trailer



CAUTION:

If you don't use the correct equipment and drive properly, you can lose control when you pull a trailer. For example, if the trailer is too heavy, the brakes may not work well — or even at all. You and your passengers could be seriously injured. Pull a trailer only if you have followed all the steps in this section. Ask your GM dealer for advice and information about towing a trailer with your vehicle.

NOTICE:

Pulling a trailer improperly can damage your vehicle and result in costly repairs not covered by your warranty. To pull a trailer correctly, follow the advice in this part, and see your GM dealer for important information about towing a trailer with your vehicle.

Most vehicles are ready for some trailer towing. If yours was built with trailering options, as many are, it's ready for heavier trailers. But trailering is different than just driving your vehicle by itself. Trailering means changes in handling, durability, and fuel economy. Successful, safe trailering takes correct equipment, and it has to be used properly.

That's the reason for this part. In it are many time-tested, important trailering tips and safety rules. Many of these are important for your safety and that of your passengers. So please read this section carefully before you pull a trailer.

If You Do Decide To Pull A Trailer

If you do, here are some important points.

- There are many different laws, including speed limit restrictions, having to do with trailering. Make sure your rig will be legal, not only where you live but also where you'll be driving. A good source for this information can be state or provincial police.
- Consider using a sway control if your trailer will weigh 4,000 pounds (1 800 kg) or less. You should always use a sway control if your trailer will weigh more than 4,000 pounds (1 800 kg). You can ask a hitch dealer about sway controls.
- Don't tow a trailer at all during the first 500 miles (800 km) your new vehicle is driven. Your engine, axle or other parts could be damaged.
- Then, during the first 500 miles (800 km) that you tow a trailer, don't drive over 50 mph (80 km/h) and don't make starts at full throttle. This helps your engine and other parts of your vehicle wear in at the heavier loads.
- If you have an automatic transmission, you should use DRIVE (3) (or, as you need to, a lower gear) when towing a trailer. Operating your vehicle in DRIVE (3) when towing a trailer will minimize heat build-up and extend the life of your transmission. If you have a manual transmission and you are towing a trailer, it's better not to use FIFTH (5) gear. Just drive in FOURTH (4) gear (or, as you need to, a lower gear).

Three important considerations have to do with weight:

Weight of the Trailer

How heavy can a trailer safely be?

It depends on how you plan to use your rig. For example, speed, altitude, road grades, outside temperature and how much your vehicle is used to pull a trailer are all important. And, it can also depend on any special equipment that you have on your vehicle.

You can ask your dealer for our trailering information or advice, or you can write us at the address listed in your Warranty and Owner Assistance Information Booklet.

In Canada, write to:

General Motors of Canada Limited
Customer Assistance Center
1908 Colonel Sam Drive
Oshawa, Ontario L1H 8P7

Weight of the Trailer Tongue

The tongue load (A) of any trailer is an important weight to measure because it affects the total or gross weight of your vehicle. The gross vehicle weight (GVW) includes the curb weight of the vehicle, any cargo you may carry in it, and the people who will be riding in the vehicle. And if you will tow a trailer, you must add the tongue load to the GVW because your vehicle will be carrying that weight, too. See "Loading Your Vehicle" in the Index for more information about your vehicle's maximum load capacity.

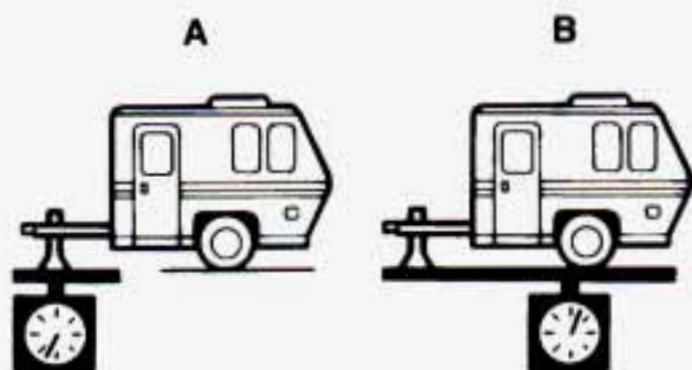

If you're using a "dead-weight" hitch, the trailer tongue (A) should weigh 10% of the total loaded trailer weight (B). If you have a "weight-distributing" hitch, the trailer tongue (A) should weigh 12% of the total loaded trailer weight (B).

After you've loaded your trailer, weigh the trailer and then the tongue, separately, to see if the weights are proper. If they aren't, you may be able to get them right simply by moving some items around in the trailer.

Total Weight on Your Vehicle's Tires

Be sure your vehicle's tires are inflated to the limit for cold tires. You'll find these numbers on the Certification label at the rear edge of the driver's door or see "Tire Loading" in the Index. Then be sure you don't go over the GVW limit for your vehicle, including the weight of the trailer tongue.

Hitches

It's important to have the correct hitch equipment. Crosswinds, large trucks going by, and rough roads are a few reasons why you'll need the right hitch. Here are some rules to follow:

- If you use a step bumper hitch, and your trailer tongue has a V-shaped foot, your bumper could be damaged in sharp turns. Check the distance from the front edge of the foot to the middle of the hitch ball socket. If the distance is less than 12 inches, take the foot off the trailer tongue.
- If you'll be pulling a trailer that, when loaded, will weigh more than 4,000 pounds (1 814 kg) be sure to use a properly mounted, weight-distributing hitch and sway control of the proper size. This equipment is very important for proper vehicle loading and good handling when you're driving.

Safety Chains

You should always attach chains between your vehicle and your trailer. Cross the safety chains under the tongue of the trailer so that the tongue will not drop to the road if it becomes separated from the hitch. Instructions about safety chains may be provided by the hitch manufacturer or by the trailer manufacturer. Follow the manufacturer's recommendation for attaching safety chains and do not attach them to the bumper. Always leave just enough slack so you can turn with your rig. And, never allow safety chains to drag on the ground.

Trailer Brakes

If your trailer weighs more than 1,000 pounds (450 kg) loaded, then it needs its own brakes — and they must be adequate. Be sure to read and follow the instructions for the trailer brakes so you'll be able to install, adjust and maintain them properly.

Your trailer brake system can tap into your vehicle's hydraulic brake system, but consider the following:

- Will the trailer brake system use more than 0.02 cubic inch (0.3 cc) of fluid from your vehicle's master cylinder? If it will, don't tap into your vehicle's brake system. Both braking systems won't work well, and you could even lose your brakes altogether.

- Will the trailer brake parts take 3,000 psi (20 650 kPa) of pressure? If not, the trailer brake system must not be used with your vehicle.

If everything checks out this far, make the brake tap at the port on the master cylinder that sends the fluid to the rear brakes. But don't use copper tubing for this. If you do, it will bend and finally break off. Use steel brake tubing.

Driving with a Trailer

Towing a trailer requires a certain amount of experience. Before setting out for the open road, you'll want to get to know your rig. Acquaint yourself with the feel of handling and braking with the added weight of the trailer. And always keep in mind that the vehicle you are driving is now a good deal longer and not nearly as responsive as your vehicle is by itself.

Before you start, check the trailer hitch and platform (and attachments), safety chains, electrical connector, lamps, tires and mirror adjustment. If the trailer has electric brakes, start your vehicle and trailer moving and then apply the trailer brake controller by hand to be sure the brakes are working. This lets you check your electrical connection at the same time.

During your trip, check occasionally to be sure that the load is secure, and that the lamps and any trailer brakes are still working.

Following Distance

Stay at least twice as far behind the vehicle ahead as you would when driving your vehicle without a trailer. This can help you avoid situations that require heavy braking and sudden turns.

Passing

You'll need more passing distance up ahead when you're towing a trailer. And, because you're a good deal longer, you'll need to go much farther beyond the passed vehicle before you can return to your lane.

Backing Up

Hold the bottom of the steering wheel with one hand. Then, to move the trailer to the left, just move that hand to the left. To move the trailer to the right, move your hand to the right. Always back up slowly and, if possible, have someone guide you.

Making Turns

NOTICE:

Making very sharp turns while trailering could cause the trailer to come in contact with the vehicle. Your vehicle could be damaged. Avoid making very sharp turns while trailering.

When you're turning with a trailer, make wider turns than normal. Do this so your trailer won't strike soft shoulders, curbs, road signs, trees, or other objects. Avoid jerky or sudden maneuvers. Signal well in advance.

Turn Signals When Towing a Trailer

When you tow a trailer, your vehicle has to have extra wiring (included in the optional trailering package). The green arrows on your instrument panel will flash whenever you signal a turn or lane change. Properly hooked up, the trailer lamps will also flash, telling other drivers you're about to turn, change lanes or stop.

When towing a trailer, the green arrows on your instrument panel will flash for turns even if the bulbs on the trailer are burned out. Thus, you may think drivers behind you are seeing your signal when they are not. It's important to check occasionally to be sure the trailer bulbs are still working.

Driving On Grades

Reduce speed and shift to a lower gear *before* you start down a long or steep downgrade. If you don't shift down, you might have to use your brakes so much that they would get hot and no longer work well.

On a long uphill grade, shift down and reduce your speed to around 45 mph (70 km/h) to reduce the possibility of engine and transmission overheating.

If you have an automatic transmission you should use DRIVE (3) (or, as you need to, a lower gear) when towing a trailer. Operating your vehicle in DRIVE (3) when towing a trailer will minimize heat build-up and extend the life of your transmission.

If you have a manual transmission and you are towing a trailer, it's better not to use FIFTH (5) gear. Just drive in FOURTH (4) gear (or, as you need to, a lower gear).

When towing at high altitude on steep uphill grades, consider the following: Engine coolant will boil at a lower temperature than at normal altitudes. If you turn your engine off immediately after towing at high altitude on steep uphill grades, your vehicle may show signs similar to engine overheating. To avoid this, let the engine run while parked (preferably on level ground) with the automatic transmission in PARK (P) (or the manual transmission out of gear and the parking brake applied) for a few minutes before turning the engine off. If you do get the overheat warning, see “Engine Overheating” in the Index.

Parking on Hills

You really should not park your vehicle, with a trailer attached, on a hill. If something goes wrong, your rig could start to move. People can be injured, and both your vehicle and the trailer can be damaged.

But if you ever have to park your rig on a hill, here's how to do it:

1. Apply your regular brakes, but don't shift into PARK (P) yet, or in gear for a manual transmission.
2. Have someone place chocks under the trailer wheels.
3. When the wheel chocks are in place, release the regular brakes until the chocks absorb the load.
4. Re-apply the regular brakes. Then apply your parking brake, and then shift to PARK (P), or REVERSE (R) for a manual transmission.
5. If you have a four-wheel-drive vehicle, be sure the transfer case is in a drive gear—not in NEUTRAL (N).
6. Release the regular brakes.



CAUTION:

It can be dangerous to get out of your vehicle if the shift lever is not fully in PARK (P) with the parking brake firmly set. Your vehicle can roll.

If you have left the engine running, the vehicle can move suddenly. You or others could be injured. To be sure your vehicle won't move, even when you're on fairly level ground, use the steps that follow.

If you have four-wheel drive and your transfer case is in NEUTRAL (N), your vehicle will be free to roll, even if your shift lever is in PARK (P). So, be sure the transfer case is in a drive gear — not in NEUTRAL (N).

When You Are Ready to Leave After Parking on a Hill

1. Apply your regular brakes and hold the pedal down while you:
 - Start your engine;
 - Shift into a gear; and
 - Release the parking brake.
2. Let up on the brake pedal.
3. Drive slowly until the trailer is clear of the chocks.
4. Stop and have someone pick up and store the chocks.

Maintenance When Trailer Towing

Your vehicle will need service more often when you're pulling a trailer. See the Maintenance Schedule for more on this. Things that are especially important in trailer operation are automatic transmission fluid (don't overfill), engine oil, axle lubricant, belt, cooling system, and brake adjustment. Each of these is covered in this manual, and the Index will help you find them quickly. If you're trailering, it's a good idea to review these sections before you start your trip.

Check periodically to see that all hitch nuts and bolts are tight.

Trailer Lighting Systems Wiring

See "Trailer Wiring Harness" in the Index.

Notes

Problems on the Road

Section

5

Here you'll find what to do about some problems that can occur on the road.

Hazard Warning Flashers



Your hazard warning flashers let you warn others. They also let police know you have a problem. Your front and rear turn signal lamps will flash on and off.

But they won't flash if you're braking.



Push the button at the top of the steering column all the way down to make your front and rear turn signals flash on and off.

Your hazard warning flashers work no matter what position your key is in, and even if the key isn't in.

To turn off the flashers, push the button until the first click and release.

When the hazard warning flashers are on, your turn signals won't work.

Other Warning Devices

If you carry reflective triangles, you can use them to warn others. Set one up at the side of the road about 300 feet (100 m) behind your vehicle.

Jump Starting

If your battery (or batteries) has run down, you may want to use another vehicle and some jumper cables to start your vehicle. But please follow the steps below to do it safely.



CAUTION:

Batteries can hurt you. They can be dangerous because:

- They contain acid that can burn you.
- They contain gas that can explode or ignite.
- They contain enough electricity to burn you.

If you don't follow these steps exactly, some or all of these things can hurt you.



CAUTION:

If your vehicle has air conditioning, the auxiliary electric fan under the hood can start up even when the engine is not running and can injure you. Keep hands, clothing and tools away from any underhood electric fan.

NOTICE:

Ignoring these steps could result in costly damage to your vehicle that wouldn't be covered by your vehicle warranty.

Trying to start your vehicle by pushing or pulling it could damage your vehicle, even if you have a manual transmission. And if you have an automatic transmission, it won't start that way.

To Jump Start Your Vehicle

1. Check the other vehicle. It must have a 12-volt battery with a negative ground system.

NOTICE:

If the other system isn't a 12-volt system with a negative ground, both vehicles can be damaged.

If you have a diesel engine vehicle with two batteries (or more), you should know before you begin that, especially in cold weather, you may not be able to get enough power from a single battery in another vehicle to start your diesel engine.

If your vehicle has more than one battery, use the battery that's on the passenger side of the vehicle – this will reduce electrical resistance.

2. Get the vehicles close enough so the jumper cables can reach, but be sure the vehicles aren't touching each other. If they are, it could cause a ground connection you don't want. You wouldn't be able to start your vehicle, and the bad grounding could damage the electrical systems.

You could be injured if the vehicles roll. Set the parking brake firmly on each vehicle. Put an automatic transmission in PARK (P) or a manual transmission in NEUTRAL (N). If you have a four-wheel-drive vehicle, be sure the transfer case is not in NEUTRAL (N).

3. Turn off the ignition on both vehicles. Turn off all lights that aren't needed, and radios. This will avoid sparks and help save both batteries. And it could save your radio!

NOTICE:

If you leave your radio on, it could be badly damaged. The repairs wouldn't be covered by your warranty.

4. Open the hoods and locate the batteries. Find the positive (+) and negative (-) terminals on each battery.



CAUTION:

Using a match near a battery can cause battery gas to explode. People have been hurt doing this, and some have been blinded. Use a flashlight if you need more light.

Be sure the batteries have enough water. You don't need to add water to the Delco Freedom[®] battery (or batteries) installed in every new GM vehicle. But if a battery has filler caps, be sure the right amount of fluid is there. If it is low, add water to take care of that first. If you don't, explosive gas could be present.

Battery fluid contains acid that can burn you. Don't get it on you. If you accidentally get it in your eyes or on your skin, flush the place with water and get medical help immediately.

5. Check that the jumper cables don't have loose or missing insulation. If they do, you could get a shock. The vehicles could be damaged, too.

Before you connect the cables, here are some basic things you should know. Positive (+) will go to positive (+) and negative (-) will go to negative (-) or a metal engine part. Don't connect (+) to (-) or you'll get a short that would damage the battery and maybe other parts, too.



CAUTION:

Fans or other moving engine parts can injure you badly. Keep your hands away from moving parts once the engines are running.

6. Connect the red positive (+) cable to the positive (+) terminal of the vehicle with the dead battery. Use a remote positive (+) terminal if the vehicle has one.

Dead Battery (+)



Good Battery (+)



7. Don't let the other end touch metal. Connect it to the positive (+) terminal of the good battery. Use a remote positive (+) terminal if the vehicle has one.
8. Now connect the black negative (-) cable to the good battery's negative (-) cable.

Don't let the other end touch anything until the next step. The other end of the negative cable **DOESN'T** go to the dead battery. It goes to a heavy unpainted metal part of the vehicle with the dead battery.

Good Battery (-)



Heavy Metal Engine Part



9. Attach the cable at least 18 inches (45 cm) away from the dead battery, but not near engine parts that move. The electrical connection is just as good there, but the chance of sparks getting back to the battery is much less.
10. Now start the vehicle with the good battery and run the engine for awhile.
11. Try to start the vehicle with the dead battery.

If it won't start after a few tries, it probably needs service.

Remove Cables in this Order:

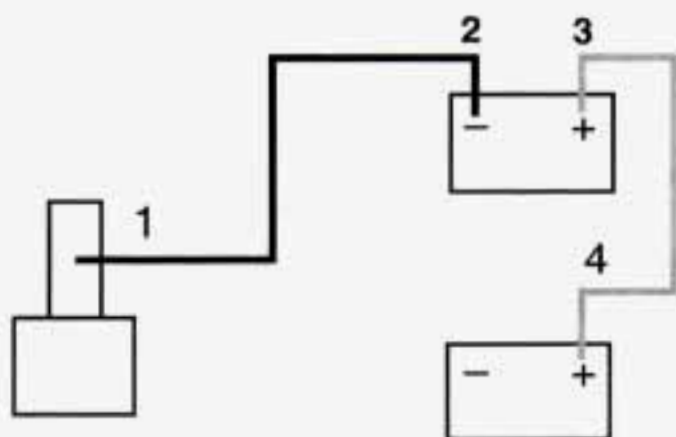

1. Heavy Metal Engine Part
2. Good Battery (-)
3. Good Battery (+)
4. Dead Battery (+)

12. Remove the cables in reverse order to prevent electrical shorting. Take care that they don't touch each other or any other metal.

Towing Your Vehicle

Try to have your GM dealer or a professional towing service tow your vehicle. They can provide the right equipment and know how to tow it without damage.

If your vehicle has been changed since it was factory–new, by adding such things like fog lamps, aero skirting, or special tires and wheels, these things could be damaged during towing.

Before you do anything, turn on the hazard warning flashers.

When you call, tell the towing service:

- That your vehicle has rear–wheel drive, or that it has the four–wheel drive option.
- The make, model, and year of your vehicle.
- Whether you can move the shift lever for the transmission and transfer case, if you have one.
- If there was an accident, what was damaged.



CAUTION:

To help avoid injury to you or others:

- **Never let passengers ride in a vehicle that is being towed.**
- **Never tow faster than safe or posted speeds.**
- **Never tow with damaged parts not fully secured.**
- **Never get under your vehicle after it has been lifted by the tow truck.**
- **Always use separate safety chains on each side when towing a vehicle.**
- **For pickups (except cab chassis models), use T–hooks on front of vehicle, J–hooks on rear.**
- **For cab chassis models, use J–hooks on front and rear of vehicle.**

When your vehicle is being towed, have the ignition key off. The steering wheel should be clamped in a straight–ahead position, with a clamping device designed for towing service. Do not use the vehicle's steering column lock for this. The transmission and transfer case, if you have one, should be in NEUTRAL (N) and the parking brake released.



CAUTION:

A vehicle can fall from a car carrier if it isn't adequately secured. This can cause a collision, serious personal injury and vehicle damage. The vehicle should be tightly secured with chains or steel cables before it is transported.

Don't use substitutes (ropes, leather straps, canvas webbing, etc.) that can be cut by sharp edges underneath the towed vehicle.

Towing From the Front

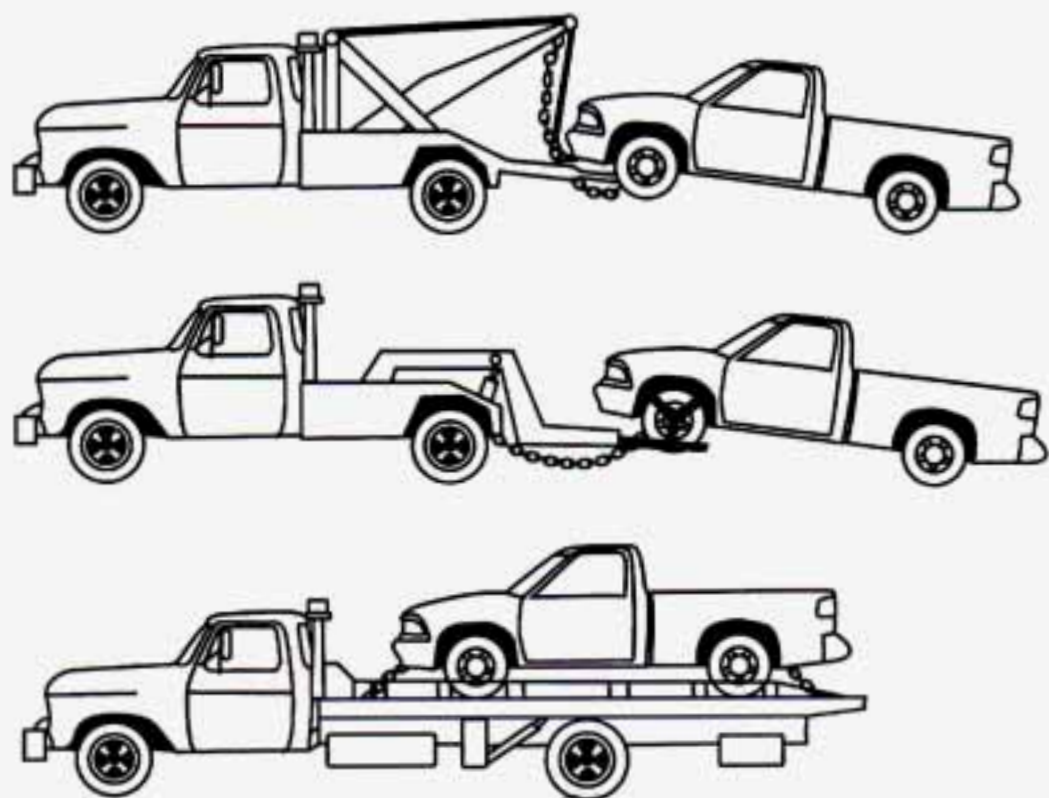

If you have a two-wheel drive vehicle, don't have your vehicle towed on the rear wheels, unless you must. If the vehicle must be towed on the rear wheels, don't go more than 35 mph (56 km/h) or farther than 50 miles (80 km) or your transmission will be damaged. If these limits must be exceeded, then the rear wheels have to be supported on a dolly.

If your vehicle has the four-wheel drive option and the transfer case is engaged, a dolly must be used under the rear wheels when towing from the front.

Towing From the Rear

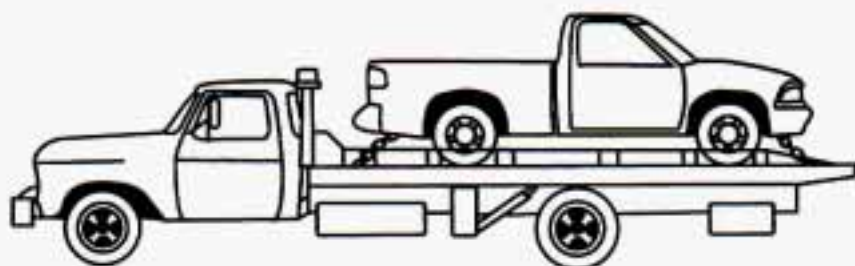

NOTICE:

Towing pickup models from the rear while loaded with heavy cargo may cause the frame side rails to flex sufficiently to allow the pickup box to contact the cab and could cause damage to the cab and/or box.

Engine Overheating

You will find a coolant temperature gage on your vehicle instrument panel. If you have a diesel engine, you will also find a low coolant light on your instrument panel.

If Steam Is Coming From Your Engine



CAUTION:

Steam from an overheated engine can burn you badly, even if you just open the hood. Stay away from the engine if you see or hear steam coming from it. Just turn it off and get everyone away from the vehicle until it cools down. Wait until there is no sign of steam or coolant before opening the hood.

If you keep driving when your engine is overheated, the liquids in it can catch fire. You or others could be badly burned. Stop your engine if it overheats, and get out of the vehicle until the engine is cool.

NOTICE:

If your engine catches fire because you keep driving with no coolant, your vehicle can be badly damaged. The costly repairs would not be covered by your warranty.

If No Steam Is Coming From Your Engine

If you get the overheat warning but see or hear no steam, the problem may not be too serious. Sometimes the engine can get a little too hot when you:

- Climb a long hill on a hot day.
- Stop after high speed driving.
- Idle for long periods in traffic.
- Tow a trailer. See “Driving on Grades” in the Index.

If you get the overheat warning with no sign of steam, try this for a minute or so:

1. If you have an air conditioner, turn it off.
2. Turn on your heater to full hot at the highest fan speed and open the window as necessary.
3. If you're in a traffic jam, shift to NEUTRAL (N); otherwise, shift to the highest gear while driving — AUTOMATIC OVERDRIVE (Ⓢ) or DRIVE (3) for automatic transmissions.

If you no longer have the overheat warning, you can drive. Just to be safe, drive slower for about ten minutes. If the warning doesn't come back on, you can drive normally.

If the warning continues, pull over, stop, and park your vehicle right away.

If there's still no sign of steam, push the accelerator until the engine speed is about twice as fast as normal idle speed. Bring the engine speed back to normal idle speed after two or three minutes. Now see if the warning stops. But then, if you still have the warning, *turn off the engine and get everyone out of the vehicle* until it cools down.

You may decide not to lift the hood but to get service help right away.

Cooling System – Gasoline Engines



When you decide it's safe to lift the hood, here's what you'll see:

- A. Coolant recovery tank
- B. Engine fan(s)
- C. Radiator pressure cap



CAUTION:

If your vehicle has air conditioning, the auxiliary electric fan under the hood can start up even when the engine is not running and can injure you. Keep hands, clothing and tools away from any underhood electric fan.

If the coolant inside the coolant recovery tank is boiling, don't do anything else until it cools down.

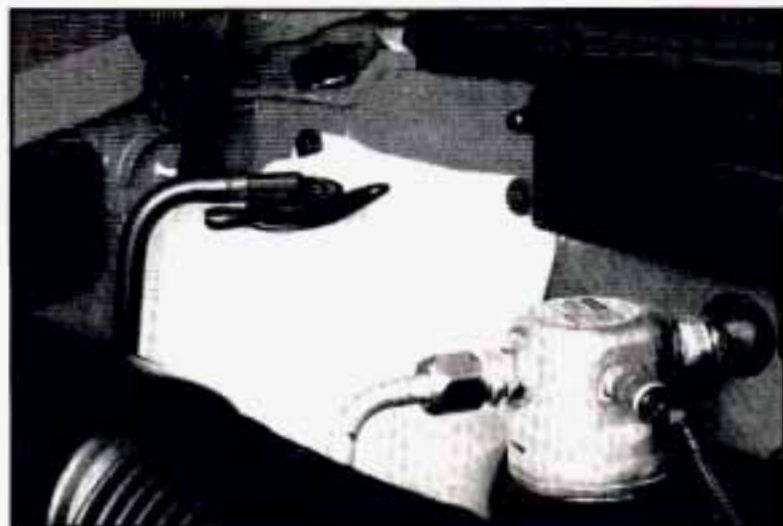

The coolant level should be at or above the COLD mark. If it isn't, you may have a leak in the radiator hoses, heater hoses, radiator, water pump or somewhere else in the cooling system.

 **CAUTION:**

Heater and radiator hoses, and other engine parts, can be very hot. Don't touch them. If you do, you can be burned.

Don't run the engine if there is a leak. If you run the engine, it could lose all coolant. That could cause an engine fire, and you could be burned. Get any leak fixed before you drive the vehicle.

NOTICE:

Engine damage from running your engine without coolant isn't covered by your warranty.

If there seems to be no leak, start the engine again. See if the fan speed increases when idle speed is doubled by pushing the accelerator pedal down. If it doesn't, your vehicle needs service. Turn off the engine.

How to Add Coolant to the Coolant Recovery Tank

If you haven't found a problem yet, but the coolant level isn't at or above the COLD mark, add a 50/50 mixture of *clean water* (preferably distilled) and a proper antifreeze at the coolant recovery tank. (See "Engine Coolant" in the Index for more information about the proper coolant mix.)

⚠ CAUTION:

Adding only plain water to your cooling system can be dangerous. Plain water, or some other liquid like alcohol, can boil before the proper coolant mix will. Your vehicle's coolant warning system is set for the proper coolant mix. With plain water or the wrong mix, your engine could get too hot but you wouldn't get the overheat warning. Your engine could catch fire and you or others could be burned. Use a 50/50 mix of clean water and a proper antifreeze.

NOTICE:

In cold weather, water can freeze and crack the engine, radiator, heater core and other parts. Use the recommended coolant.



⚠ CAUTION:

You can be burned if you spill coolant on hot engine parts. Coolant contains ethylene glycol and it will burn if the engine parts are hot enough. Don't spill coolant on a hot engine.

When the coolant in the coolant recovery tank is at or above the COLD mark, start your vehicle.

If the overheat warning continues, there's one more thing you can try. You can add the proper coolant mix directly to the radiator, but be sure the cooling system is cool before you do it.



CAUTION:

Steam and scalding liquids from a hot cooling system can blow out and burn you badly. They are under pressure, and if you turn the radiator pressure cap — even a little — they can come out at high speed. Never turn the cap when the cooling system, including the radiator pressure cap, is hot. Wait for the cooling system and radiator pressure cap to cool if you ever have to turn the pressure cap.



How to Add Coolant to the Radiator



1. You can remove the radiator pressure cap when the cooling system, including the radiator pressure cap and upper radiator hose, is no longer hot. Turn the pressure cap slowly to the left until it first stops. (Don't press down while turning the pressure cap.)

If you hear a hiss, wait for that to stop. A hiss means there is still some pressure left.



2. Then keep turning the pressure cap, but now push down as you turn it. Remove the pressure cap.



3. Fill the radiator with the proper mix, up to the base of the filler neck.

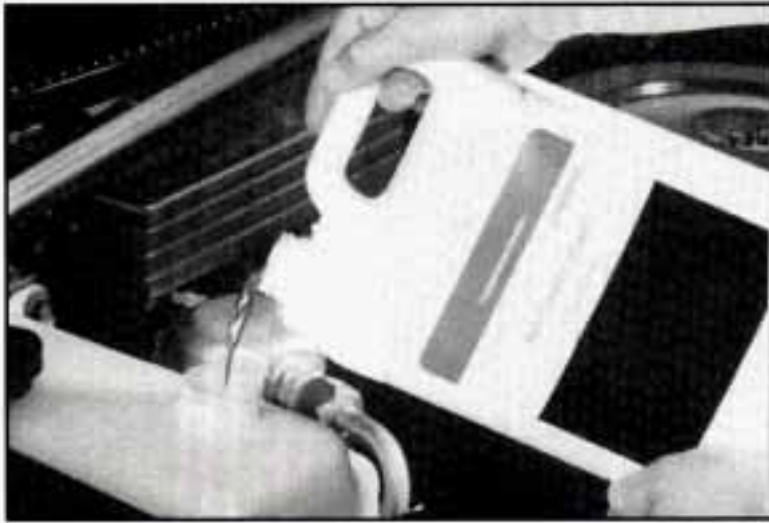

4. Then fill the coolant recovery tank to the COLD mark.



5. Put the cap back on the coolant recovery tank, but leave the radiator pressure cap off.



6. Start the engine and let it run until you can feel the upper radiator hose getting hot. Watch out for the engine fan(s).

7. By this time the coolant level inside the radiator filler neck may be lower. If the level is lower, add more of the proper mix through the filler neck until the level reaches the base of the filler neck.



8. Then replace the pressure cap. At any time during this procedure if coolant begins to flow out of the filler neck, reinstall the pressure cap. Be sure the arrows on the pressure cap line up like this.

Cooling System – Diesel Engines



When you decide it's safe to lift the hood, here's what you'll see:

- A. Coolant surge tank pressure cap
- B. Engine fan(s)
- C. Radiator



CAUTION:

If your vehicle has air conditioning, the auxiliary electric fan under the hood can start up even when the engine is not running and can injure you. Keep hands, clothing and tools away from any underhood electric fan.

If the coolant inside the coolant surge tank is boiling, don't do anything else until it cools down.



The coolant level should be at or above the COLD mark. If it isn't, you may have a leak in the radiator hoses, heater hoses, radiator, water pump or somewhere else in the cooling system.



CAUTION:

Heater and radiator hoses, and other engine parts, can be very hot. Don't touch them. If you do, you can be burned.

Don't run the engine if there is a leak. If you run the engine, it could lose all coolant. That could cause an engine fire, and you could be burned. Get any leak fixed before you drive the vehicle.

NOTICE:

Engine damage from running your engine without coolant isn't covered by your warranty.

If there seems to be no leak, start the engine again. See if the fan speed increases when idle speed is doubled by pushing the accelerator pedal down. If it doesn't, your vehicle needs service. Turn off the engine.

How to Add Coolant to the Coolant Surge Tank

NOTICE:

The diesel engine has a specific coolant fill procedure. Failure to follow this procedure could cause your engine to overheat and be severely damaged.

If you haven't found a problem yet, but the coolant level isn't at the COLD mark, add a 50/50 mixture of *clean water* (preferably distilled) and a proper antifreeze at the coolant surge tank, but be sure the cooling system, including the coolant surge tank pressure cap, is cool before you do it. (See "Engine Coolant" in the Index for more information about the proper coolant mix.)

 **CAUTION:**

Steam and scalding liquids from a hot cooling system can blow out and burn you badly. They are under pressure, and if you turn the coolant surge tank pressure cap — even a little — they can come out at high speed. Never turn the cap when the cooling system, including the coolant surge tank pressure cap, is hot. Wait for the cooling system and coolant surge tank pressure cap to cool if you ever have to turn the pressure cap.



 **CAUTION:**

Adding only plain water to your cooling system can be dangerous. Plain water, or some other liquid like alcohol, can boil before the proper coolant mix will. Your vehicle's coolant warning system is set for the proper coolant mix. With plain water or the wrong mix, your engine could get too hot but you wouldn't get the overheat warning. Your engine could catch fire and you or others could be burned. Use a 50/50 mix of clean water and a proper antifreeze.

NOTICE:

In cold weather, water can freeze and crack the engine, radiator, heater core and other parts. So use the recommended coolant.



CAUTION:

You can be burned if you spill coolant on hot engine parts. Coolant contains ethylene glycol and it will burn if the engine parts are hot enough. Don't spill coolant on a hot engine.



1. You can remove the coolant surge tank pressure cap when the cooling system, including the coolant surge tank pressure cap and upper radiator hose, is no longer hot. Turn the pressure cap slowly to the left until it first stops. (Don't press down while turning the pressure cap.)

If you hear a hiss, wait for that to stop. A hiss means there is still some pressure left.



2. Then keep turning the cap, but now push down as you turn it. Remove the pressure cap.



3. After the engine cools, open the air bleed valve on the thermostat housing.



CAUTION:

You can be burned if you spill coolant on hot engine parts. Coolant contains ethylene glycol, and it will burn if the engine parts are hot enough. Don't spill coolant on a hot engine.

4. Fill with the proper mix. Add coolant until you see a steady stream of coolant coming from the bleed valve.
5. Close the bleed valve.
6. Rinse or wipe the spilled coolant from the engine and compartment.



7. Then fill the coolant surge tank with the proper mix, up to the COLD mark.



8. With the coolant surge tank pressure cap off, start the engine and let it run until you can feel the upper radiator hose getting hot. Watch out for the engine fan(s).

By this time, the coolant level inside the coolant surge tank may be lower. If the level is lower, add more of the proper mix to the coolant surge tank until the level reaches the COLD mark.



9. Then replace the pressure cap. Be sure the arrows on the pressure cap line up like this.

Engine Fan Noise

Your vehicle has a clutched engine cooling fan. When the clutch is engaged, the fan spins faster to provide more air to cool the engine. In most every day driving conditions the fan is spinning slower and the clutch is not fully engaged. This improves fuel economy and reduces fan noise. Under heavy vehicle loading, trailer towing and/or high outside temperatures, the fan speed increases as the clutch more fully engages. So you may hear an increase in fan noise. This is normal and should not be mistaken as the transmission slipping or making extra shifts. It is merely the cooling system functioning properly. The fan will slow down when additional cooling is not required and the clutch partially disengages.

You may also hear this fan noise when you start the engine. It will go away as the fan clutch partially disengages.

If a Tire Goes Flat

It's unusual for a tire to "blow out" while you're driving, especially if you maintain your tires properly. If air goes out of a tire, it's much more likely to leak out slowly. But if you should ever have a "blowout," here are a few tips about what to expect and what to do:

If a front tire fails, the flat tire will create a drag that pulls the vehicle toward that side. Take your foot off the accelerator pedal and grip the steering wheel firmly. Steer to maintain lane position, then gently brake to a stop well out of the traffic lane.

A rear blowout, particularly on a curve, acts much like a skid and may require the same correction you'd use in a skid. In any rear blowout, remove your foot from the accelerator pedal. Get the vehicle under control by steering the way you want the vehicle to go. It may be very bumpy and noisy, but you can still steer. Gently brake to a stop, well off the road if possible.

If a tire goes flat, the next part shows how to use your jacking equipment to change a flat tire safely.

Changing a Flat Tire

If a tire goes flat, avoid further tire and wheel damage by driving slowly to a level place. Turn on your hazard warning flashers.

CAUTION:

Changing a tire can cause an injury. The vehicle can slip off the jack and roll over you or other people. You and they could be badly injured. Find a level place to change your tire. To help prevent the vehicle from moving:

1. Set the parking brake firmly.
2. Put an automatic transmission shift lever in PARK (P) or shift a manual transmission to FIRST (1) or REVERSE (R).
3. If you have a four-wheel-drive vehicle, be sure the transfer case is in a drive gear – not in NEUTRAL (N).
4. Turn off the engine.

To be even more certain the vehicle won't move, you can put blocks at the front and rear of the tire farthest away from the one being changed. That would be the tire on the other side of the vehicle, at the opposite end.

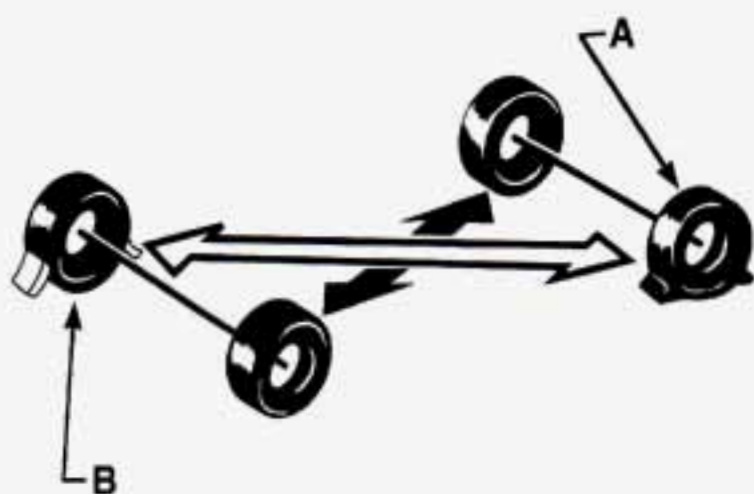

- A. Flat Tire
- B. Blocked Tire

The following steps will tell you how to use the jack and change a tire.

The equipment you'll need is behind the passenger's seat. Turn the wing nut counterclockwise and remove the jack cover, if there is one. Your spare tire is stowed under the truck or mounted to the inside of the truck bed on the driver's side.

Jack and Jacking Tool Storage – Two and Four Door Models

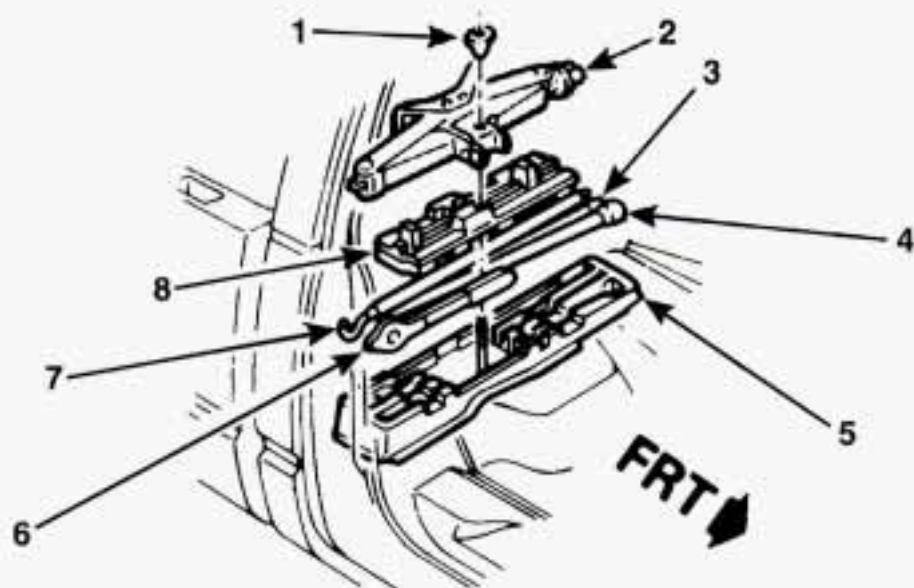

- | | |
|--------------------------|------------------------------|
| 1. Nut | 5. Jack and Tool Storage Box |
| 2. Jack | 6. Ratchet |
| 3. Jack Handle Extension | 7. Jack Handle |
| 4. Wheel Wrench | 8. Tool Retainer |

Jack and Jacking Tool Storage – Extended Cab Models

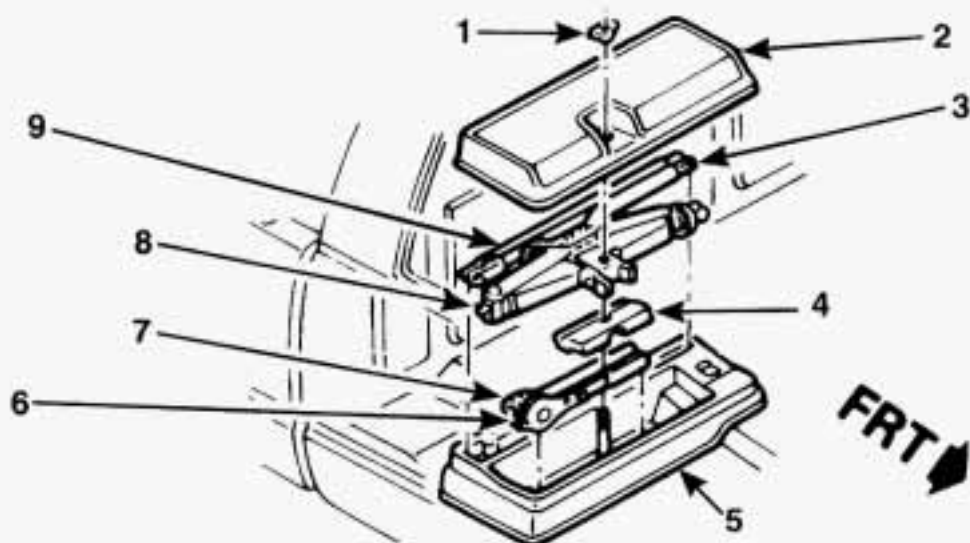

- | | |
|--------------------------|------------------------------|
| 1. Nut | 5. Jack and Tool Storage Box |
| 2. Jack and Tool Cover | 6. Ratchet |
| 3. Jack Handle Extension | 7. Wheel Wrench |
| 4. Tool Retainer | 8. Jack |
| | 9. Jack Handle |

Jack and Jacking Tool Storage – Chassis Cab Models

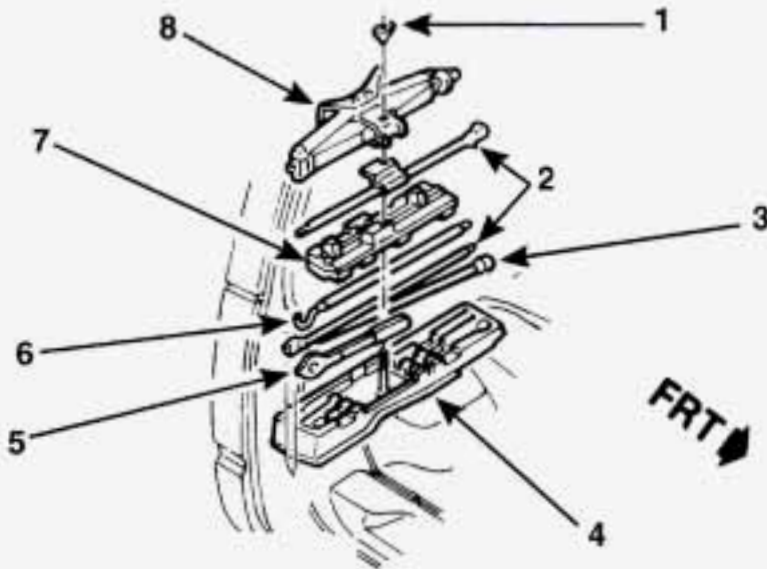

- | | |
|------------------------------|------------------|
| 1. Nut | 5. Ratchet |
| 2. Jack Handle Extension | 6. Jack Handle |
| 3. Wheel Wrench | 7. Tool Retainer |
| 4. Jack and Tool Storage Box | 8. Jack |

To Remove the Spare Tire

The spare tire, if you have one, is full size like the other tires on your vehicle.

Spare Tire Stowage – Bed-Mounted Carrier

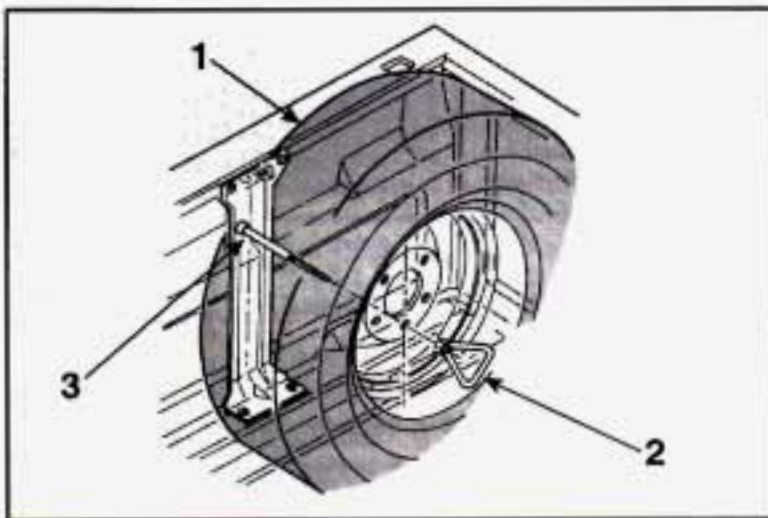

1. Spare Tire
2. Spare Wheel Mounting Nut
3. Spare Wheel Mounting Bolt

Your vehicle may have an optional bed-mounted spare tire. If it does, your spare tire will be mounted in the truck bed, on the driver's side.

Spare Tire Stowage – Under-Body Carrier

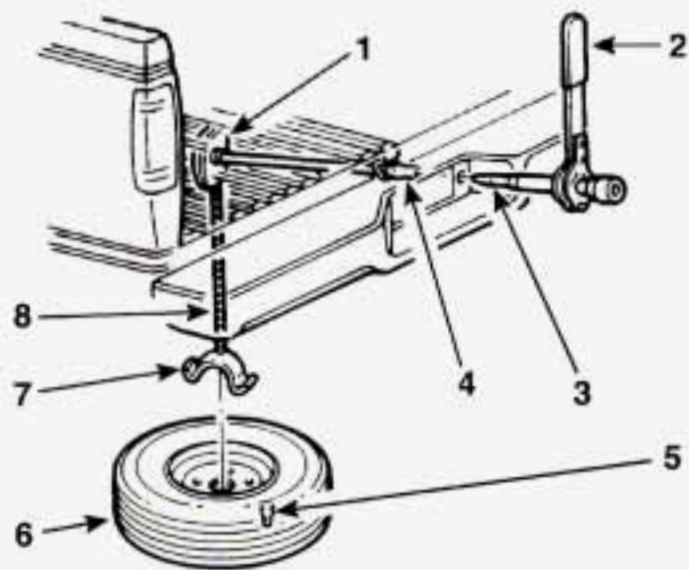

1. Hoist Assembly

2. Ratchet

3. Wheel Wrench

4. Hoist Shaft

5. Valve Stem, Pointed Down

6. Spare Tire

7. Retainer

8. Hoist Cable

If it is not stowed in the truck bed, the spare tire may be stowed under the vehicle in an under-body carrier.

Remember, never remove or restow a tire from an under-body carrier while the vehicle is supported only by a jack.

If you have a chassis cab, refer to the information from the body supplier/installer for the location of your spare tire.

UP Marking



DOWN Marking



One side of the ratchet has an UP marking. The other side has a DOWN marking.



Attach the ratchet to the wheel wrench with the DOWN marking facing you.

Put the other end of the wheel wrench through the rear bumper access hole, located at the passenger side edge of the license plate. Be sure the wheel wrench connects into the hoist shaft.



Turn the ratchet counterclockwise to lower the spare tire.

Keep turning the ratchet until the spare tire can be pulled out from under the vehicle.



When the tire has been lowered, tilt the retainer at the end of the cable and pull it through the wheel opening.

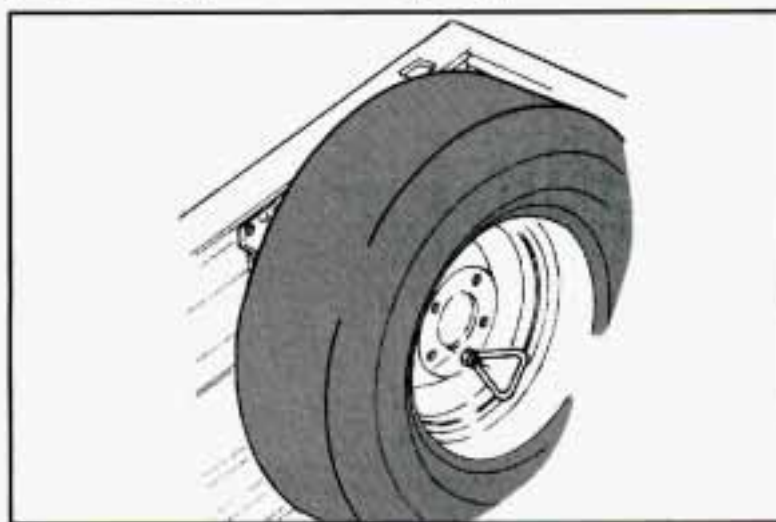

To remove a bed mounted spare tire, turn the retainer nut counterclockwise and take off the retainer bolt. Then slide the tire off the retainer bolt and remove the tire from the bed.

Changing the Tire



Start with the jack, the jack handle and the ratchet.

If the flat tire is on the rear of the vehicle, you'll need the jack handle extensions also.

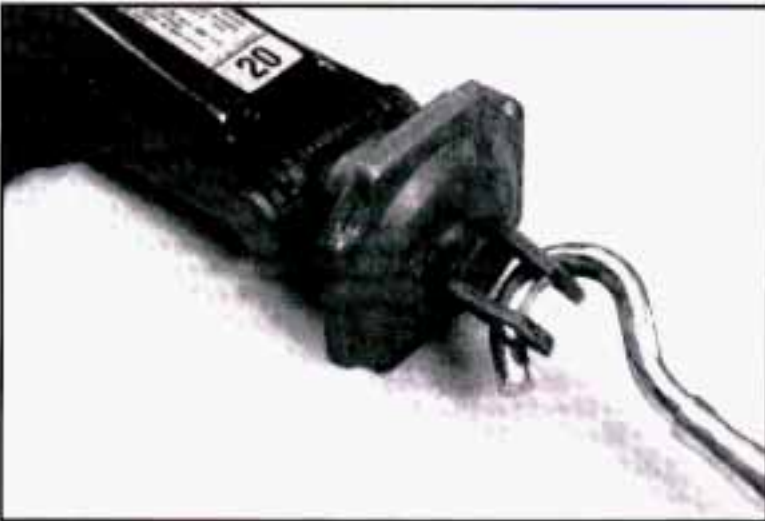

Attach the jack handle (and jack handle extension, if needed) to the jack.

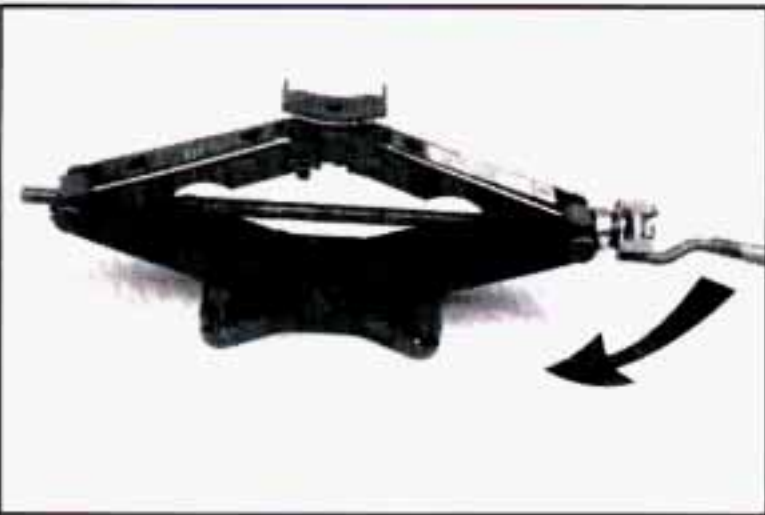

With the UP marking on the ratchet facing you, rotate the ratchet clockwise. That will lift the jack head a little.

Before you start, put the spare tire near the flat tire. Remove the wheel trim and loosen the wheel nuts. The next part will show you how to do these things properly.

Removing Wheel Trim



If there is a wheel cover, pry at different points along its edge until it comes off.

Be careful; the rim edge may be sharp. Don't try to remove it with your bare hands.

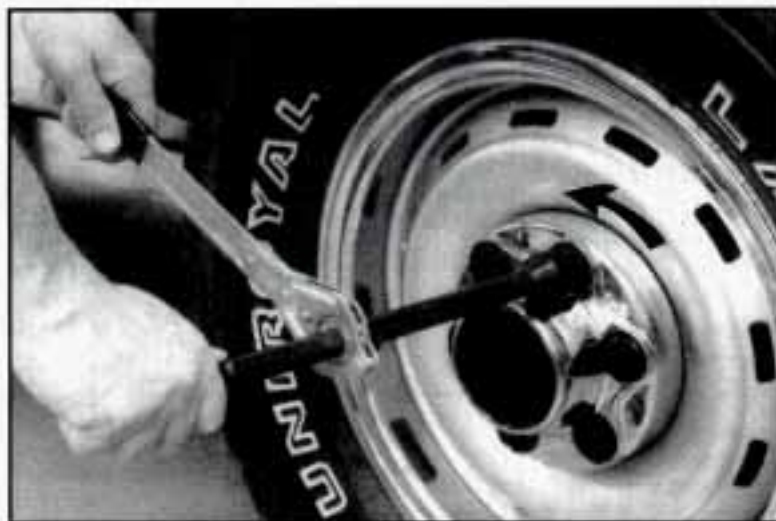

If your vehicle has wheel nut caps, use the wheel wrench and ratchet to remove them. Turn the wheel wrench counterclockwise, with DOWN facing you, to remove the wheel nut caps. Then take off the hub cap.

If the wheel also has a trim ring, use the wheel wrench to pry along the edge and remove it.



If the wheel has a smooth center piece or a center piece with recessed nuts, place the wheel wrench in the slot on the wheel and gently pry out.



Now, use the ratchet and wheel wrench to loosen all the wheel nuts. Turn the wheel wrench counterclockwise, with DOWN facing you, to loosen the wheel nuts.

Don't remove the wheel nuts yet.

If the flat tire is on the rear of the vehicle, put the jack handle extension on the jack handle.

Position the jack under the vehicle.



CAUTION:

Getting under a vehicle when it is jacked up is dangerous. If the vehicle slips off the jack, you could be badly injured or killed. Never get under a vehicle when it is supported only by a jack.

NOTICE:

Raising your vehicle with the jack improperly positioned will damage the vehicle or may allow the vehicle to fall off the jack. Be sure to fit the jack lift head into the proper location before raising your vehicle.

Front Position



Rear Position



With UP on the ratchet facing you, raise the vehicle by rotating the ratchet and wheel wrench clockwise. Raise the vehicle far enough off the ground so there is enough room for the spare tire to fit.

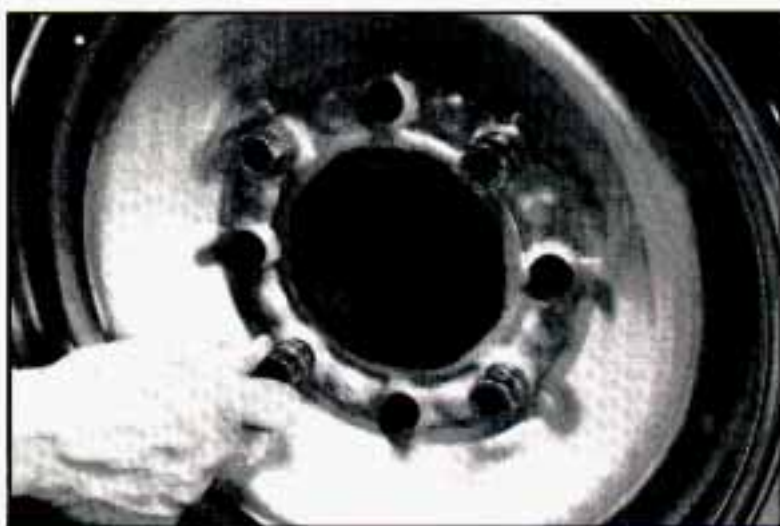

Remove all the wheel nuts and take off the flat tire.



CAUTION:

Rust or dirt on the wheel, or on the parts to which it is fastened, can make the wheel nuts become loose after a time. The wheel could come off and cause an accident. When you change a wheel, remove any rust or dirt from the places where the wheel attaches to the vehicle. In an emergency, you can use a cloth or a paper towel to do this; but be sure to use a scraper or wire brush later, if you need to, to get all the rust or dirt off.

Remove any rust or dirt from the wheel bolts, mounting surfaces and spare wheel. Place the spare on the wheel mounting surface.



CAUTION:

Never use oil or grease on studs or nuts. If you do, the nuts might come loose. Your wheel could fall off, causing a serious accident.



Replace the wheel nuts with the rounded end of the nuts toward the wheel.

Tighten each wheel nut by hand until the wheel is held against the hub.

Front Position



Rear Position

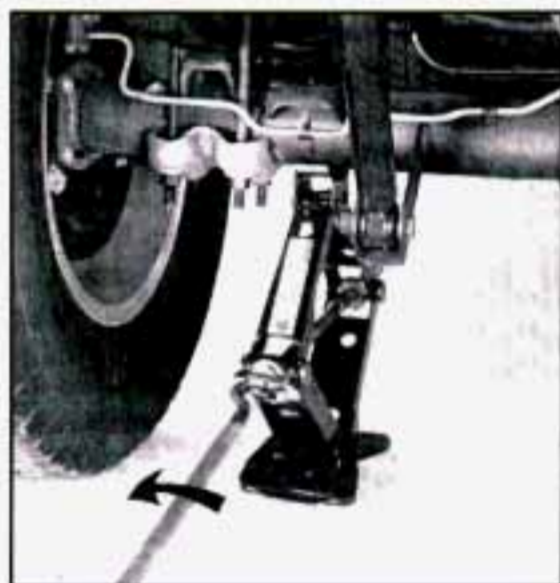

Lower the vehicle by rotating the ratchet and wheel wrench counterclockwise. Lower the jack completely.

Tighten Clockwise



Tightening Sequence

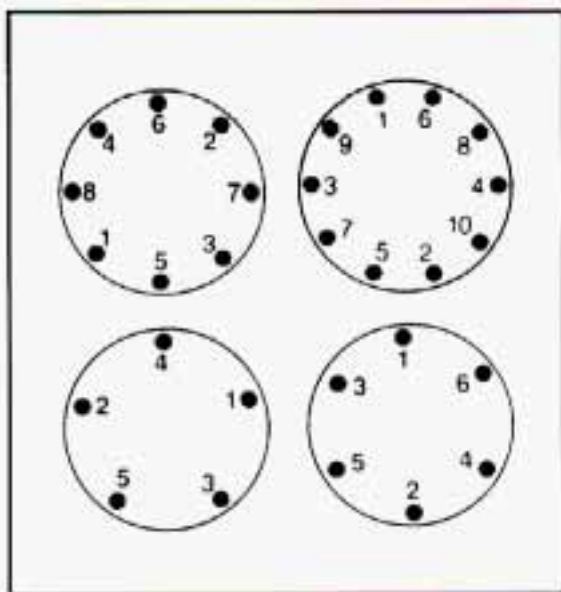

Tighten the nuts firmly in a criss-cross sequence as shown. Rotate the wheel wrench clockwise.



CAUTION:

Incorrect wheel nuts or improperly tightened wheel nuts can cause the wheel to become loose and even come off. This could lead to an accident. Be sure to use the correct wheel nuts. If you have to replace them, be sure to get the right kind.

Stop somewhere as soon as you can and have the nuts tightened with a torque wrench to the proper torque.

For proper torque, see “Wheel Nut Torque” in the Index.

Put the wheel trim back on.

For vehicles with plastic wheel nut caps, tighten the caps until they are finger tight, then tighten them an additional one-half turn with the ratchet and wheel wrench.

Remove any wheel blocks.

Remember, the jack, jacking equipment and tire must be properly stored in their original storage position before you begin driving again. The next part, “Storing the Tire and Jack,” will show you how.



CAUTION:

Storing a jack, a tire or other equipment in the passenger compartment of the vehicle could cause injury. In a sudden stop or collision, loose equipment could strike someone. Store all these in the proper place.

Stowing the Tire — Bed-Mounted Carrier

For a bed-mounted spare tire carrier, stow the flat tire in the bed of the vehicle secured in the tire carrier. To stow the flat tire:

1. Put the flat tire in the bed of the vehicle with the valve stem pointed inward.
2. Slide the wheel mounting bolt through the bottom wheel nut hole.
3. Turn the wheel mounting nut clockwise until it is tight and the tire is secure.

Stowing the Tire — Under-Body Carrier

For a under-body spare tire carrier, stow the flat tire under the rear of the vehicle in spare tire carrier. To stow the flat tire:

1. Put the tire on the ground at the rear of the vehicle with the valve stem pointed down.
2. Pull the wheel retainer through the wheel opening.
3. Attach the ratchet to the wheel wrench with the UP marking facing you.
4. Put the other end of the wheel wrench through the rear bumper access hole, located at the passenger side edge of the license plate. Be sure the wheel wrench connects into the hoist shaft.
5. Turn the ratchet clockwise to raise the tire. Keep turning the ratchet until the tire is all the way up. You will hear two “clicks” when the tire is secure. Pull on the tire to make sure it is tightly secured.

Stowing the Jack and Jacking Tools

Return the jack, ratchet, wheel wrench and jack extensions to their location behind the passenger’s seat. Stow the jack and jacking tools as shown in the illustrations earlier in this part. Secure the items and replace the jack cover, if there is one.

If You're Stuck: In Sand, Mud, Ice or Snow

What you don't want to do when your vehicle is stuck is to spin your wheels too fast. The method known as "rocking" can help you get out when you're stuck, but you must use caution.



CAUTION:

If you let your tires spin at high speed, they can explode and you or others could be injured. And, the transmission or other parts of the vehicle can overheat. That could cause an engine compartment fire or other damage. When you're stuck, spin the wheels as little as possible. Don't spin the wheels above 35 mph (55 km/h) as shown on the speedometer.

NOTICE:

Spinning your wheels can destroy parts of your vehicle as well as the tires. If you spin the wheels too fast while shifting your transmission back and forth, you can destroy your transmission.

For information about using tire chains on your vehicle, see "Tire Chains" in the Index.

Rocking your vehicle to get it out:

First, turn your steering wheel left and right. That will clear the area around your front wheels. Then shift back and forth between REVERSE (R) and a forward gear (or with a manual transmission, between FIRST (1) or SECOND (2) gear and REVERSE), spinning the wheels as little as possible. Release the accelerator pedal while you shift, and press lightly on the accelerator pedal when the transmission is in gear. If that doesn't get you out after a few tries, you may need to be towed out. Or, you can use your recovery hooks, if your vehicle has them. If you do need to be towed out, see "Towing Your Vehicle" in the Index.

Using the Recovery Hooks



Your vehicle may be equipped with recovery hooks. The recovery hooks are provided at the front of your vehicle. You may need to use them if you're stuck off-road and need to be pulled to some place where you can continue driving.



CAUTION:

The recovery hooks, when used, are under a lot of force. Always pull the vehicle straight out. Never pull on the hooks at a sideways angle. The hooks could break off and you or others could be injured from the chain or cable snapping back.

NOTICE:

Never use the recovery hooks to tow the vehicle. Your vehicle could be damaged and it would not be covered by warranty.

Notes

Service & Appearance Care

Section

6

Here you will find information about the care of your vehicle. This section begins with service and fuel information, and then it shows how to check important fluid and lubricant levels. There is also technical information about your vehicle, and a part devoted to its appearance care.

Service

Your GM dealer knows your vehicle best and wants you to be happy with it. We hope you'll go to your dealer for all your service needs. You'll get genuine GM parts and GM-trained and supported service people.

We hope you'll want to keep your GM vehicle all GM. Genuine GM parts have one of these marks:



Doing Your Own Service Work

If you want to do some of your own service work, you'll want to get the proper GM Service Manual. It tells you much more about how to service your vehicle than this manual can. To order the proper service manual, see "Service Publications" in the Index.

You should keep a record with all parts receipts and list the mileage and the date of any service work you perform. See “Maintenance Record” in the Index.



CAUTION:

You can be injured if you try to do service work on a vehicle without knowing enough about it.

- **Be sure you have sufficient knowledge, experience, and the proper replacement parts and tools before you attempt any vehicle maintenance task.**
- **Be sure to use the proper nuts, bolts and other fasteners. “English” and “metric” fasteners can be easily confused. If you use the wrong fasteners, parts can later break or fall off. You could be hurt.**

NOTICE:

If you try to do your own service work without knowing enough about it, your vehicle could be damaged.

Fuel (Gasoline Engine)

If your vehicle has a diesel engine, see “Diesel Fuel Requirements and Fuel System” in this Section. For vehicles with gasoline engines, please read this.

Use regular unleaded gasoline rated at 87 octane or higher. It should meet specifications ASTM D4814 in the United States and CGSB 3.5-92 in Canada. These fuels should have the proper additives, so you should not have to add anything to the fuel.

In the United States and Canada, it's easy to be sure you get the right kind of gasoline (unleaded). You'll see UNLEADED right on the pump. And only unleaded nozzles will fit into your vehicle's filler neck.

Be sure the posted octane is at least 87. If the octane is less than 87, you may get a heavy knocking noise when you drive. If it's bad enough, it can damage your engine.

If you're using fuel rated at 87 octane or higher and you still hear heavy knocking, your engine needs service. But don't worry if you hear a little pinging noise when you're accelerating or driving up a hill. That's normal and you don't have to buy a higher octane fuel to get rid of pinging. It's the heavy, constant knock that means you have a problem.

What about gasoline with blending materials that contain oxygen (oxygenates), such as MTBE or alcohol?

MTBE is “methyl tertiary-butyl ether.” Fuel that is no more than 15% MTBE is fine for your vehicle.

Ethanol is ethyl or grain alcohol. Properly-blended fuel that is no more than 10% *ethanol* is fine for your vehicle.

Methanol is methyl or wood alcohol.

NOTICE:

Fuel that is more than 5% methanol is bad for your vehicle. Don't use it. It can corrode metal parts in your fuel system and also damage plastic and rubber parts. That damage wouldn't be covered under your warranty. And even at 5% or less, there must be “cosolvents” and corrosion preventers in this fuel to help avoid these problems.

Gasolines for Cleaner Air

Your use of gasoline with deposit control additives will help prevent deposits from forming in your engine and fuel system. That helps keep your engine in tune and your emission control system working properly. It's good for your vehicle, and you'll be doing your part for cleaner air.

Many gasolines are now blended with oxygenates. General Motors recommends that you use gasolines with these blending materials, such as MTBE and ethanol. By doing so, you can help clean the air, especially in those parts of the country that have high carbon monoxide levels.

In addition, some gasoline suppliers are now producing reformulated gasolines. These gasolines are specially designed to reduce vehicle emissions. General Motors recommends that you use reformulated gasoline. By doing so, you can help clean the air, especially in those parts of the country that have high ozone levels.

You should ask your service station operators if their gasolines contain deposit control additives and oxygenates, and if they have been reformulated to reduce vehicle emissions.

Diesel Fuel Requirements and Fuel System

Some states and provinces have restrictions on the purchase of diesel fuel for light-duty vehicles and require you to buy permits or pay special taxes. Some of these restrictions apply only to residents, and others apply to both residents and visitors. These restrictions can change. To learn the current restrictions in any state or province, contact your auto club, the police or other officials.

Fuel Requirements

NOTICE:

Diesel fuel or fuel additives not recommended in this manual could damage your fuel system and engine. Your warranty wouldn't cover this damage. And:

- Diesel fuel that has been mixed with engine oil could damage your engine and emission controls. Always check with your service station operator to make sure his diesel fuel has not been mixed with engine oil.
- If you ever run out of diesel fuel, it can be difficult to restart your engine. "Running Out of Fuel," later in this section, tells you how to get it started again. To avoid all this, try never to let your tank get empty.

What Fuel to Use

For best results, use Number 2-D diesel fuel year-round (above and below freezing conditions) as oil companies blend Number 2-D fuel to address climate differences. Number 1-D diesel fuel may be used in very cold temperatures (when it stays below 0°F or -18°C); however, it will produce a power and fuel economy loss. The use of Number 1-D diesel fuel in warm or hot climates may result in stalling, poor starting when the engine is hot and may damage the fuel injection system.

Diesel fuel may foam when you fill your tank. This can cause the automatic pump nozzle to shut off, even though your tank isn't full. If this happens, just wait for the foaming to stop and then continue to fill your tank.



CAUTION:

Heat coming from the engine may cause the fuel to expand and force the fuel out of your tank. If something ignites the fuel, a fire could start and people could be burned. To help avoid this, fill your fuel tank only until the automatic nozzle shuts off. Don't try to "top it off."

Canadian Fuels

Diesel-powered trucks are now equipped with emission control systems that require the use of diesel fuel with low-sulfur (.05% by weight) content. Both low- and higher-sulfur fuels will be available in Canada. Only low-sulfur diesel fuels are available in the United States. It is important that diesel-powered trucks are refueled with low-sulfur fuel. Use of fuels with higher-sulfur content will affect the function of the emission components and may cause reduced performance, excessive smoke and unpleasant odor.

Cold Weather Operation

Follow the instructions listed previously under the heading “What Fuel to Use.”

If you're driving in very cold temperatures and can't get a “winterized” Number 2-D that has been adapted to cold weather or a Number 1-D, you can use one gallon of kerosene for every two gallons of diesel fuel. Once you add the kerosene, run your engine for several minutes so the fuels will mix. Add kerosene only when the temperature falls below 0°F (-18°C), because the fuel economy of kerosene isn't as good as that of diesel fuel.

NOTICE:

Never use home heating oil or gasoline in your diesel engine. They can cause engine damage.

In cold weather, your fuel filter may become clogged (waxed). To unclog it, warm the filter to between 32°F and 50°F (0°C to 10°C). You won't need to replace it.

Water in Fuel

Sometimes, water can be pumped into your fuel tank along with your diesel fuel. This can happen if a service station doesn't regularly inspect and clean its fuel tanks, or if it gets contaminated fuel from its suppliers.

If this happens, a WATER IN FUEL light will come on. If it does, the excess water must be drained. Your dealer can show you how to do this.

WATER IN FUEL

This light also should come on briefly when you start your engine, as a check. If it doesn't, have it fixed so it will be there to let you know if you ever do get water in your fuel.

If the light comes on at any other time, use this chart.

NOTICE:

If you drive when this warning light is on, you can damage your fuel injection system and your engine. If the light comes on right after you refuel, it means water was pumped into your fuel tank. Turn off your engine immediately. Then, have the water drained at once.

"WATER IN FUEL" LIGHT CHART

Problem

- Light comes on intermittently.
- Light stays on:
 1. At temperatures above freezing.
 2. At temperatures below freezing.
 3. Immediately after refueling — large amount of water possibly pumped into fuel tank.

Recommended Action

- Drain water from fuel filter.
- Drain fuel filter immediately. If no water can be drained and light stays on, see your dealer for assistance.
- Drain fuel filter immediately. If no water can be drained—water may be frozen. Open the air bleed valve to check for fuel pressure. If no fuel pressure is present, replace the fuel filter.
- Fuel tank purging required. See your dealer for assistance.

Hesitation or “flat” performance at high speed or during hard acceleration may be an indication of premature fuel filter plugging due to dirty or contaminated fuel. The filter element may need to be changed if this happens. See your dealer for assistance.

To drain water:

1. Stop and park the vehicle in a safe place. Turn off the engine and apply the parking brake.
2. Remove the fuel tank cap.
3. Place a fuel-resistant container under the filter drain hose.



4. With the engine off, open the water drain valve 2 to 3 turns. When standing in front of the vehicle, the valve is located on the right side of the thermostat housing.

5. Start the engine and allow it to idle until clear fuel is observed.
6. Stop the engine and close the water drain valve.
7. Remove the fuel-resistant container and properly dispose of the contaminated fuel. To find out how to properly dispose of contaminated diesel fuel see “What to Do with Used Oil” in the “Engine Oil (Diesel Engines)” part, later in this section.
8. Install the fuel tank cap.

If the WATER IN FUEL light comes on again after driving a short distance or the engine runs rough or stalls—a large amount of water has probably been pumped into the fuel tank. The fuel tank should be purged.



CAUTION:

Diesel fuel containing water is still flammable. You could be burned. If you ever try to drain water from your fuel, keep sparks, flames and smoking materials away from the mixture.

NOTICE:

If there is water in your diesel fuel and the weather is warm or humid, fungus and bacteria can grow in the fuel. They can damage your fuel system. You'll need a diesel fuel biocide to sterilize your fuel system. Your dealer can advise you if you ever need this.

If your fuel tank needs to be purged to remove water, see your dealer or a qualified technician. Improper purging can damage your fuel system.

Running Out of Fuel (Diesel Engines)

If the engine stalls and you think that you've run out of fuel, do this:



First, open the fuel filter air bleed valve. Briefly crank the engine and have someone watch the bleed valve. If there is air, then you are probably out of fuel.

To restart your engine:

1. If you're parked on a level surface, add at least two gallons of fuel. However, if you're parked on a slope, you may need to add up to five gallons of fuel.
2. With the air bleed valve open, turn your ignition key to START for 10 to 15 seconds to crank (but not start) your engine. Wait one minute between intervals of cranking to allow the starter motor to cool. Overheating the starter motor could damage it. Keep doing this until you can just see some clear fuel at the air bleed valve. (If, during this step, the engine starts, turn the ignition off and close the valve before restart.)



CAUTION:

Diesel fuel is flammable. It could start a fire if it gets on hot engine parts. You could be burned. Don't let too much fuel flow from the air bleed valve, and wipe up any spilled fuel with a cloth.

3. Close the air bleed valve.
4. Turn the ignition key to START for 10 to 15 seconds at a time until your engine starts.

Fuel Filter Replacement (Diesel Engines)

If you want to change the fuel filter yourself, here's how to do it:



CAUTION:

Diesel fuel is flammable. It could start a fire if something ignites it, and you could be burned. Don't let it get on hot engine parts, and keep matches or other ignition sources away.

First, drain any water from the filter following the procedure for draining water listed previously.

Your vehicle's engine should be off until the end of the following procedure.

1. Apply the parking brake.
2. Take off the fuel tank cap. This releases vacuum in the tank.
3. Unscrew and remove the ring nut from the top of the filter head.





4. Lift the element out of the filter head.
5. If there is any dirt on the element sealing surface of the filter head, clean it off.



6. Line up the widest slot in the top of the new element with the widest key on then top of the filter head. Push the element in until the mating surfaces touch.

7. Replace and tighten the ring nut to the top of the filter head
8. With the air bleed valve open, turn your ignition key to START for 10 to 15 seconds. Wait one minute for your starter to cool. Do this until you can see clear fuel coming from the air bleed valve.
9. Close the air bleed valve and replace the fuel cap.
10. Start your engine and let it idle for five minutes. Check your fuel filter and air bleed valve for leaks.

Fuels in Foreign Countries (Gasoline Engines)

If you plan on driving in another country outside the U.S. or Canada, unleaded fuel may be hard to find. Do not use leaded gasoline. If you use even one tankful, your emission controls won't work well or at all. With continuous use, spark plugs can get fouled, the exhaust system can corrode, and your engine oil can deteriorate quickly. Your vehicle's oxygen sensor will be damaged. All of that means costly repairs that wouldn't be covered by your warranty.

To check on fuel availability, ask an auto club, or contact a major oil company that does business in the country where you'll be driving.

You can also write us at the following address for advice. Just tell us where you're going and give your Vehicle Identification Number (VIN).

General Motors Overseas Distribution Corporation,
North American Export Sales (NAES)
1908 Colonel Sam Drive
Oshawa, Ontario
L1H 8P7

Filling Your Tank

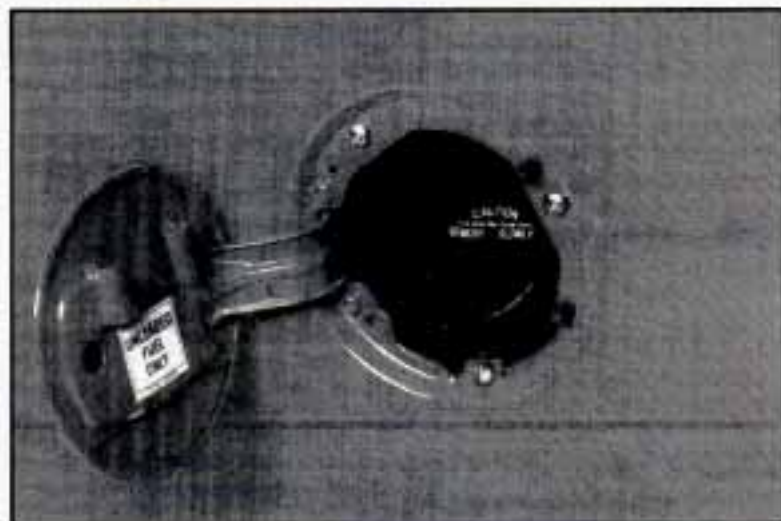

The fuel cap is behind a hinged door on the left side of your vehicle.



CAUTION:

Gasoline vapor is highly flammable. It burns violently, and that can cause very bad injuries. Don't smoke if you're near gasoline or refueling your vehicle. Keep sparks, flames, and smoking materials away from gasoline.



While refueling, hang the cap inside the fuel door.

To take off the cap, turn it slowly to the left (counterclockwise).

CAUTION:

If you get gasoline on yourself and then something ignites it, you could be badly burned. Gasoline can spray out on you if you open the fuel filler cap too quickly. This spray can happen if your tank is nearly full, and is more likely in hot weather. Open the fuel filler cap slowly and wait for any “hiss” noise to stop. Then unscrew the cap all the way.

Be careful not to spill gasoline. Clean gasoline from painted surfaces as soon as possible. See “Cleaning the Outside of Your Vehicle” in the Index.

When you put the cap back on, turn it to the right until you hear a clicking noise.

NOTICE:

If you need a new cap, be sure to get the right type. Your dealer can get one for you. If you get the wrong type, it may not fit or have proper venting, and your fuel tank and emissions system might be damaged.

Checking Things Under the Hood

Hood Release



To open the hood, first pull the handle inside the vehicle.

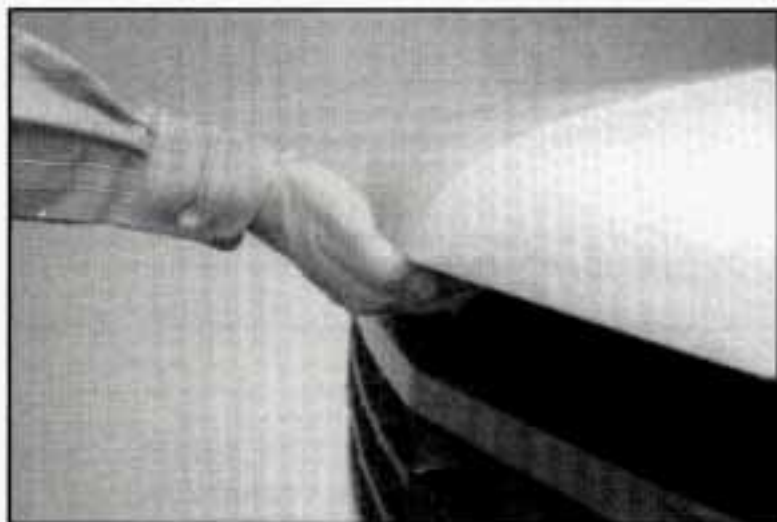

Then go to the front of the vehicle and pull up on the secondary hood release, located just to the passenger side of the center of the grill.

Lift the hood.



Your vehicle, if it has air conditioning, may have a auxiliary engine fan in addition to the belt driven fan.



CAUTION:

If your vehicle has air conditioning, the auxiliary engine fan under the hood can start up and injure you even when the engine is not running. Keep hands, clothing and tools away from any underhood electric fan.



CAUTION:

Things that burn can get on hot engine parts and start a fire. These include liquids like gasoline or diesel fuel, oil, coolant, brake fluid, windshield washer and other fluids, and plastic or rubber. You or others could be burned. Be careful not to drop or spill things that will burn onto a hot engine.

Before closing the hood, be sure all filler caps are on properly. Pull down the hood and close it firmly.

Cleaning Your Diesel Engine

NOTICE:

If you spray or pour water or any other liquid on your engine when it is warm or hot, or when it is running, you could cause serious damage to it. If you ever clean the engine, clean it only when it is cold.

Noise Control System

The following information relates to compliance with Federal noise emission standards for vehicles with a Gross Vehicle Weight Rating (GVWR) of more than 10,000 pounds (4 536 kilograms). The Maintenance Schedule booklet provides information on maintaining the noise control system to minimize degradation of the noise emission control system during the life of your vehicle. The noise control system warranty is given in your Warranty booklet.

These standards apply only to vehicles sold in the United States.

Tampering With Noise Control System Prohibited

Federal law prohibits the following acts or the causing thereof:

1. The removal or rendering inoperative by any person, other than for purposes of maintenance, repair or replacement, of any device or element of design incorporated into any new vehicle for the purpose of noise control, prior to its sale or delivery to the ultimate purchaser or while it is in use; or
2. The use of the vehicle after such device or element of design has been removed or rendered inoperative by any person.

Among those acts presumed to constitute tampering are the acts listed below.

Insulation:

- Removal of noise shields or underhood insulation.

Engine:

- Removal or rendering engine speed governor (if so equipped) inoperative so as to allow engine speed to exceed manufacturer specifications.

Fan and Drive:

- Removal of fan clutch (if so equipped) or rendering clutch inoperative.
- Removal of fan shroud (if so equipped).

Air Intake:

- Removal of air cleaner silencer.
- Reversing air cleaner cover.

Exhaust:

- Removal of muffler and/or resonator.
- Removal of exhaust pipes and exhaust pipe clamps.

Engine Oil (Gasoline Engines)

It's a good idea to check your engine oil every time you get fuel. In order to get an accurate reading, the oil must be warm and the vehicle must be on level ground.



Turn off the engine and give the oil a few minutes to drain back into the oil pan. If you don't, the oil dipstick might not show the actual level.

To Check Engine Oil

Pull out the dipstick and clean it with a paper towel or cloth, then push it back in all the way. Remove it again, keeping the tip down.

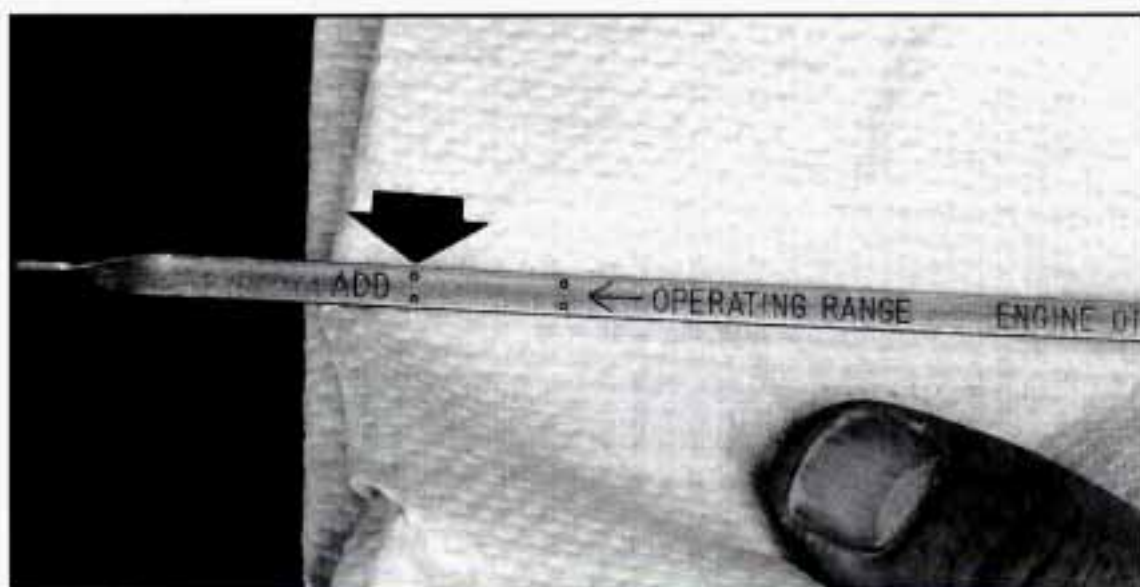

When to Add Oil

If the oil is at or below the ADD mark, then you'll need to add some oil. But you must use the right kind. This part explains what kind of oil to use. For crankcase capacity, see "Capacities and Specifications" in the Index.

NOTICE:

Don't add too much oil. If your engine has so much oil that the oil level gets above the upper mark that shows the proper operating range, your engine could be damaged.

The engine oil filler cap is located on the driver's side engine valve cover. Just fill it enough to put the level somewhere in the proper operating range. Push the dipstick all the way back in when you're through.

What Kind of Oil to Use

Oils of the proper quality for your vehicle can be identified by looking for the "Starburst" symbol. The "Starburst" symbol indicates that the oil has been certified by the American Petroleum Institute (API), and is preferred for use in your gasoline engine.



If you change your own oil, be sure you use oil that has the "Starburst" symbol on the front of the oil container. If you have your oil changed for you, be sure the oil put into your engine is American Petroleum Institute certified for gasoline engines.

You should also use the proper viscosity oil for your vehicle, as shown in the following chart:

LIGHT DUTY EMISSIONS — GASOLINE ENGINES

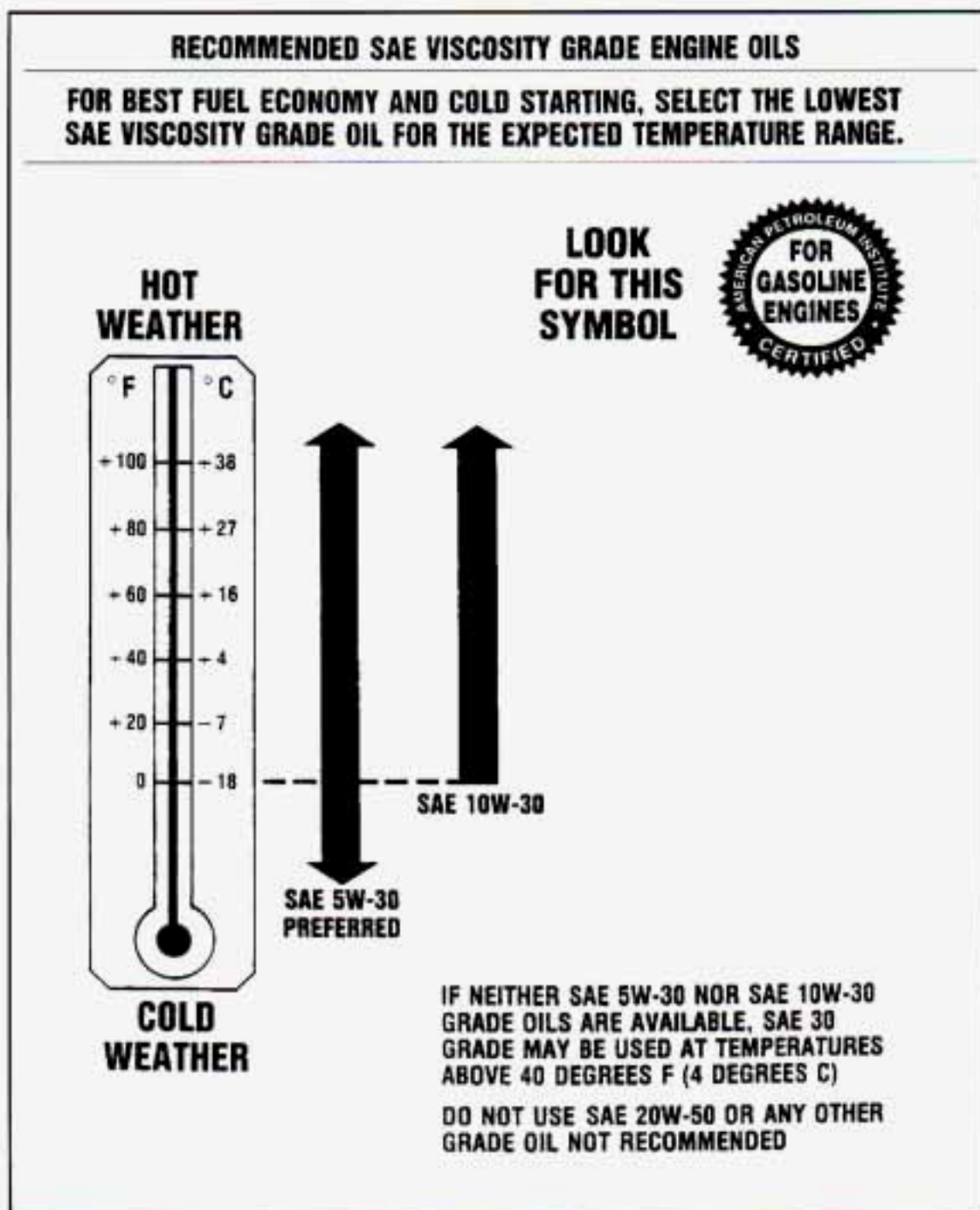

As shown in the chart, SAE 5W-30 is best for your vehicle. However, you can use SAE 10W-30 if it's going to be 0°F (-18°C) or above. These numbers on an oil container show its viscosity, or thickness. Do not use other viscosity oils, such as SAE 20W-50.

HEAVY DUTY EMISSIONS — GASOLINE ENGINES

RECOMMENDED SAE VISCOSITY GRADE ENGINE OILS

FOR BEST FUEL ECONOMY AND COLD STARTING, SELECT THE LOWEST SAE VISCOSITY GRADE OIL FOR THE EXPECTED TEMPERATURE RANGE.

HOT WEATHER

COLD WEATHER

LOOK FOR THIS SYMBOL

SAE 5W-30

SAE 10W-30 PREFERRED
above 0°F (-18°C)

IF NEITHER SAE 5W-30 NOR SAE 10W-30 GRADE OILS ARE AVAILABLE, SAE 30 GRADE MAY BE USED AT TEMPERATURES ABOVE 40 DEGREES F (4 DEGREES C)

DO NOT USE SAE 20W-50 OR ANY OTHER GRADE OIL NOT RECOMMENDED

As shown in the chart, SAE 10W-30 is best for your vehicle. However, you can use SAE 5W-30 if it's going to be colder than 60°F (16°C) before your next oil change. When it's very cold, you should use SAE 5W-30. These numbers on an oil container show its viscosity, or thickness. Do not use other viscosity oils, such as SAE 20W-50.

NOTICE:

Use only engine oil with the American Petroleum Institute Certified For Gasoline Engines “Starburst” symbol. Failure to use the proper oil can result in engine damage not covered by your warranty.

GM Goodwrench[®] oil (in Canada, GM Engine Oil) meets all the requirements for your vehicle.

Engine Oil Additives

Don't add anything to your oil. Your GM dealer is ready to advise if you think something should be added.

When to Change Engine Oil

See if any one of these is true for you:

- Most trips are less than 5 to 10 miles (8 to 16 km). This is particularly important when outside temperatures are below freezing.
- Most trips include extensive idling (such as frequent driving in stop and go traffic).
- Most trips are through dusty areas.
- You operate your vehicle in dusty areas or off-road frequently.
- You frequently tow a trailer.

If any one of these is true for your vehicle, then you need to change your oil and filter every 3,000 miles (5 000 km) or 3 months — whichever comes first.

Light Duty Emissions:

If none of them is true, change the oil and filter every 7,500 miles (12 500 km) or 12 months — whichever comes first.

Heavy Duty Emissions:

If none of them is true, change the oil and filter every 6,000 miles (10 000 km) or 12 months — whichever comes first.

Engine Coolant Heater

An engine coolant heater can be a big help if you have to park outside in very cold weather, 0°F (-18°C) or colder. If your vehicle has this option, see “Engine Coolant Heater” in the Index.

What to Do with Used Oil

Did you know that used engine oil contains certain elements that may be unhealthy for your skin and could even cause cancer? Don't let used oil stay on your skin for very long. Clean your skin and nails with soap and water, or a good hand cleaner. Wash or properly throw away clothing or rags containing used engine oil. (See the manufacturer's warnings about the use and disposal of oil products.)

Used oil can be a real threat to the environment. If you change your own oil, be sure to drain all free-flowing oil from the filter before disposal. Don't ever dispose of oil by putting it in the trash, pouring it on the ground, into sewers, or into streams or bodies of water. Instead, recycle it by taking it to a place that collects used oil. If you have a problem properly disposing of your used oil, ask your dealer, a service station or a local recycling center for help.

Engine Oil (Diesel Engines)

It's a good idea to check your engine oil level every time you get fuel. In order to get an accurate reading, the oil must be warm and the vehicle must be on level ground.



Turn off the engine and give the oil a few minutes to drain back into the oil pan. If you don't, the oil dipstick might not show the actual level.

To Check Engine Oil

Pull out the dipstick and clean it with a paper towel or a cloth, then push it back in all the way. Remove it again, keeping the tip down.



When to Add Oil

If the oil is at or below the ADD line, then you'll need to add some oil. But you must use the right kind. This part explains what kind of oil to use. For crankcase capacity, see "Capacities and Specifications" in the Index.

NOTICE:

Don't add too much oil. If your engine has so much oil that the oil level gets above the proper operating range, your engine could be damaged.

The engine oil filler cap is located on a filler tube at the front of the engine. Just fill it enough to put the level somewhere in the proper operating range. Push the dipstick all the way back in when you're through.



What Kind of Oil to Use

Look for these two things:

- CF-4/SH

CF-4/SH is the best oil for your vehicle. However, if you can not find CF-4/SH oil, you may use CF-4/SG or CE/SH or CE/SG oil.

These may be listed as shown or in reverse order, for example SH/CF-4. Other letters may also be listed, such as SH/CD, CE, CF-4. These letters show American Petroleum Institute (API) levels of quality.

NOTICE:

If you use oils that don't have these designations, you can cause engine damage which is not covered by your warranty.

DIESEL ENGINES

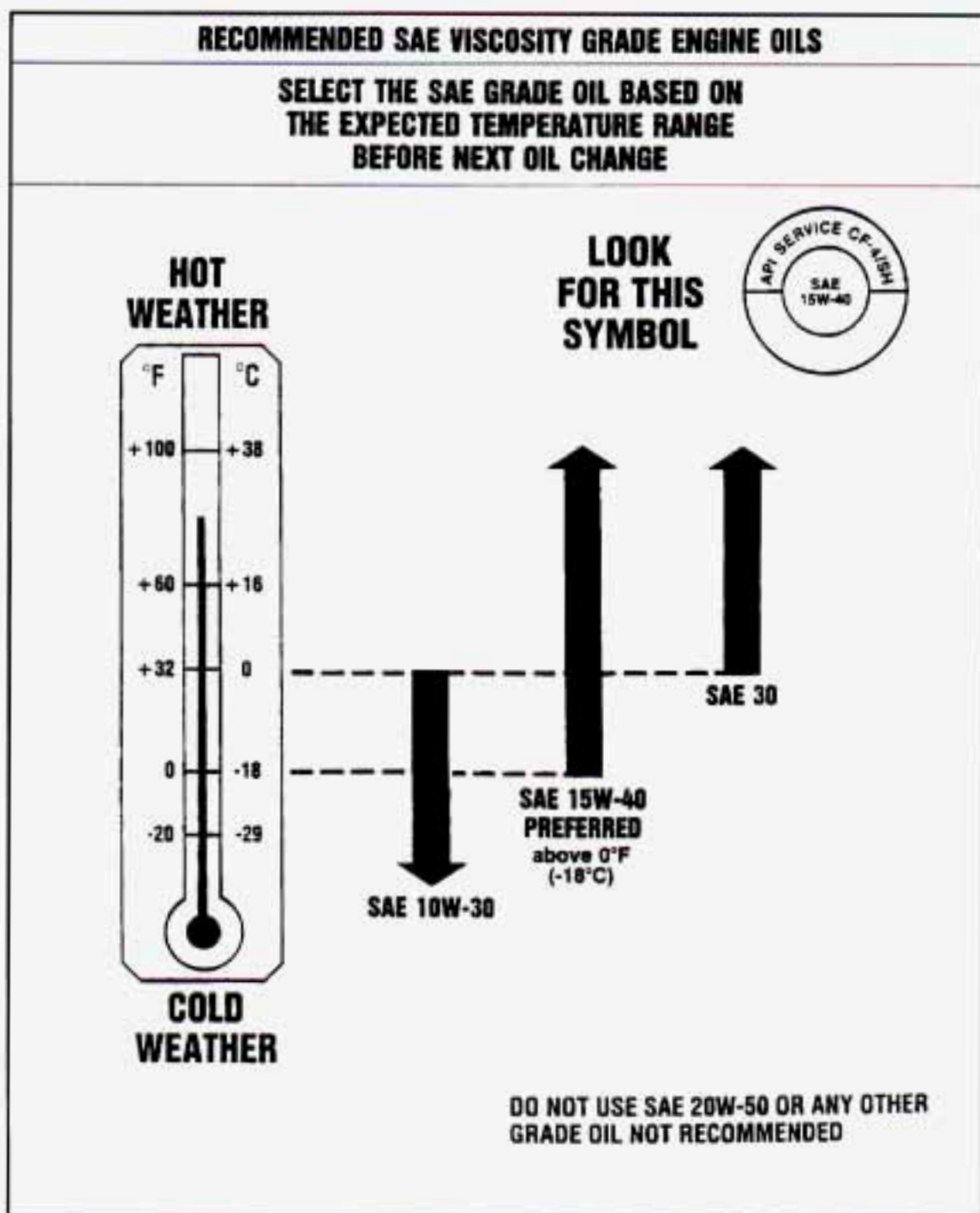

- SAE 15W-40

As shown in the viscosity chart, SAE 15W-40 is best for your vehicle. However, you can use SAE 10W-30 if it's going to be colder than 32°F (0°C) before your next oil change. When it's very cold, below 0°F (-18°C), you should use SAE 10W-30 to improve cold starting. Also, SAE 30 may be used at temperatures above freezing, 32°F (0°C).

These numbers on the oil container show its viscosity, or thickness. Do not use other viscosity oils such as SAE 10W-40 or SAE 20W-50.

This doughnut-shaped logo (symbol) is used on most oil containers to help you select the correct oil.

You should look for this on the oil container, and use *only* those oils that display the logo.

GM Goodwrench[®] oil (in Canada, GM Engine Oil) meets all the requirements for your vehicle.

Engine Oil Additives

Don't add anything to your oil. Your GM dealer is ready to advise if you think something should be added.

When to Change Engine Oil

See if any one of these is true for you:

- Most trips are less than 5 to 10 miles (8 to 16 km). This is particularly important when outside temperatures are below freezing.
- Most trips include extensive idling (such as frequent driving in stop and go traffic).
- You operate your vehicle in dusty areas or off-road frequently.
- You frequently tow a trailer or use a carrier on top of your vehicle.

If any of these is true for your vehicle, then you need to change your oil and filter every 2,500 miles (4 000 km) or 3 months — whichever comes first.

If none of them is true, change the oil and filter every 5,000 miles (8 000 km) or 12 months — whichever comes first.

What to Do with Used Oil

Did you know that used engine oil contains certain elements that may be unhealthy for your skin and could even cause cancer? Don't let used oil stay on your skin for very long. Clean your skin and nails with soap and water, or a good hand cleaner. Wash or properly throw away clothing or rags containing used engine oil. (See the manufacturer's warnings about the use and disposal of oil products.)

Used oil can be a real threat to the environment. If you change your own oil, be sure to drain all free-flowing oil from the filter before disposal. Don't ever dispose of oil by putting it in the trash, pouring it on the ground, into sewers, or into streams or bodies of water. Instead, recycle it by taking it to a place that collects used oil. If you have a problem properly disposing of your used oil, ask your dealer, a service station or a local recycling center for help.

Air Cleaner



To avoid the possibility of un-filtered air being drawn into the engine, make sure the air cleaner cover is on straight and the wing nuts are properly tightened. If there is an arrow on the air cleaner cover, it should point to the front of the engine.

Refer to the Maintenance Schedule to determine when to replace the air filter.

See "Scheduled Maintenance Services" in the Index.



CAUTION:

Operating the engine with the air cleaner off can cause you or others to be burned. The air cleaner not only cleans the air, it stops flame if the engine backfires. If it isn't there, and the engine backfires, you could be burned. Don't drive with it off, and be careful working on the engine with the air cleaner off.

NOTICE:

If the air cleaner is off, a backfire can cause a damaging engine fire. And, dirt can easily get into your engine, which will damage it. Always have the air cleaner in place when you're driving.

To remove the air cleaner filter on a gasoline engine or a 6.5 liter naturally aspirated diesel engine, turn the wing nuts to the left. Remove the cover and change the filter.

To remove the air cleaner filter on a 6.5 liter turbocharged diesel engine, first remove the rubber elbow. Remember to observe the caution about turbocharger blades on the rubber elbow.



Then, unhook the cover retaining clips and push the rear of the cover toward the engine.

Automatic Transmission Fluid

When to Check and Change

A good time to check your automatic transmission fluid level is when the engine oil is changed. Refer to the Maintenance Schedule to determine when to change your fluid. See "Scheduled Maintenance Services" in the Index.

How to Check

Because this operation can be a little difficult, you may choose to have this done at your GM dealer Service Department.

If you do it yourself, be sure to follow all the instructions here, or you could get a false reading on the dipstick.

NOTICE:

Too much or too little fluid can damage your transmission. Too much can mean that some of the fluid could come out and fall on hot engine parts or exhaust system parts, starting a fire. Be sure to get an accurate reading if you check your transmission fluid.

Wait at least 30 minutes before checking the transmission fluid level if you have been driving:

- When outside temperatures are above 90°F (32°C).
- At high speed for quite a while.
- In heavy traffic — especially in hot weather.
- While pulling a trailer.

To get the right reading, the fluid should be at normal operating temperature, which is 180°F to 200°F (82°C to 93°C).

To check transmission fluid hot: Get the vehicle warmed up by driving about 15 miles (24 km) when outside temperatures are above 50°F (10°C). If it's colder than 50°F (10°C), drive the vehicle in DRIVE (3) until the engine temperature gage moves and then remains steady for ten minutes. Then follow the hot check procedures.

To check transmission fluid cold: A cold check is made after the vehicle has been sitting for eight hours or more with the engine off and is used only as a reference. Let the engine run at idle for five minutes if outside temperatures are 50°F (10°C) or more. If it's colder than 50°F (10°C), you may have to idle the engine longer. Should the fluid level be low during a cold check, you **must** perform a hot check before adding fluid. This will give you a more accurate reading of the fluid level.

To check the fluid hot or cold

- Park your vehicle on a level place. Keep the engine running.
- With the parking brake applied, place the shift lever in PARK (P).
- With your foot on the brake pedal, move the shift lever through each gear range, pausing for about three seconds in each range. Then, position the shift lever in PARK (P).
- Let the engine run at idle for three minutes or more.

Then, without shutting off the engine, follow these steps:



1. Flip the handle up and then pull out the dipstick and wipe it with a clean rag or paper towel.
2. Push it back in all the way, wait three seconds and then pull it back out again.

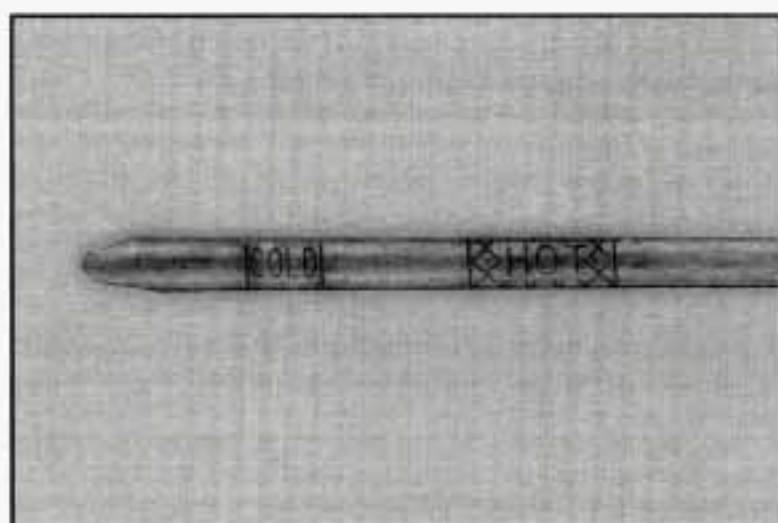

3. Check both sides of the dipstick, and read the lower level. The fluid level must be in the COLD area for a cold check or in the HOT area or cross-hatched area for a hot check.
4. If the fluid level is in the acceptable range, push the dipstick back in all the way; then flip the handle down to lock the dipstick in place.

How to Add Fluid

Refer to the Maintenance Schedule to determine what kind of transmission fluid to use. See “Recommended Fluids and Lubricants” in the Index.

Add fluid only after checking the transmission fluid HOT. (A COLD check is used only as a reference.) If the fluid level is low, add only enough of the proper fluid to bring the level up to the HOT area for a hot check. It doesn't take much fluid, generally less than a pint. *Don't overfill.* We recommend you use only fluid labeled DEXRON[®]-III, because fluid with that label is made especially for your automatic transmission. Damage caused by fluid other than DEXRON[®]-III is not covered by your new vehicle warranty.

- After adding fluid, recheck the fluid level as described under “How to Check.”
- When the correct fluid level is obtained, push the dipstick back in all the way; then flip the handle down to lock the dipstick in place.

Manual Transmission Fluid

When to Check

A good time to have it checked is when the engine oil is changed. However, the fluid in your manual transmission doesn't require changing.

How to Check

Because this operation can be a little difficult, you may choose to have this done at your GM dealer Service Department.

If you do it yourself, be sure to follow all the instructions here, or you could get a false reading.

NOTICE:

Too much or too little fluid can damage your transmission. Too much can mean that some of the fluid could come out and fall on hot engine parts or exhaust system parts, starting a fire. Be sure to get an accurate reading if you check your transmission fluid.

Check the fluid level only when your engine is off, the vehicle is parked on a level place and the transmission is cool enough for you to rest your fingers on the transmission case.

Then, follow these steps:



1. Remove the filler plug.
2. Check that the lubricant level is up to the bottom of the filler plug hole.
3. If the fluid level is good, install the plug and be sure it is fully seated. If the fluid level is low, add more fluid as described in the next steps.

How to Add Fluid

Here's how to add fluid. Refer to the Maintenance Schedule to determine what kind of fluid to use. See "Recommended Fluids and Lubricants" in the Index.

1. Remove the filler plug.
2. Add fluid at the filler plug hole. Add only enough fluid to bring the fluid level up to the bottom of the filler plug hole.
3. Install the filler plug. Be sure the plug is fully seated.

Hydraulic Clutch

The hydraulic clutch linkage in your vehicle is self-adjusting. A slight amount of play (1/4 inch to 1/2 inch) in the pedal is normal.

When to Check and What to Use



Refer to the Maintenance Schedule to determine how often you should check the fluid level in your clutch master cylinder reservoir and for the proper fluid.

See “Owner Checks and Services” and “Recommended Fluids and Lubricants” in the Index.

How to Check

The proper fluid should be added if the level does not reach the bottom of the diaphragm when it's in place in the reservoir. See the instructions on the reservoir cap.

Rear Axle

When to Check and Change Lubricant

Refer to the Maintenance Schedule to determine how often to check the lubricant and when to change it. See “Scheduled Maintenance Services” in the Index.

How to Check Lubricant

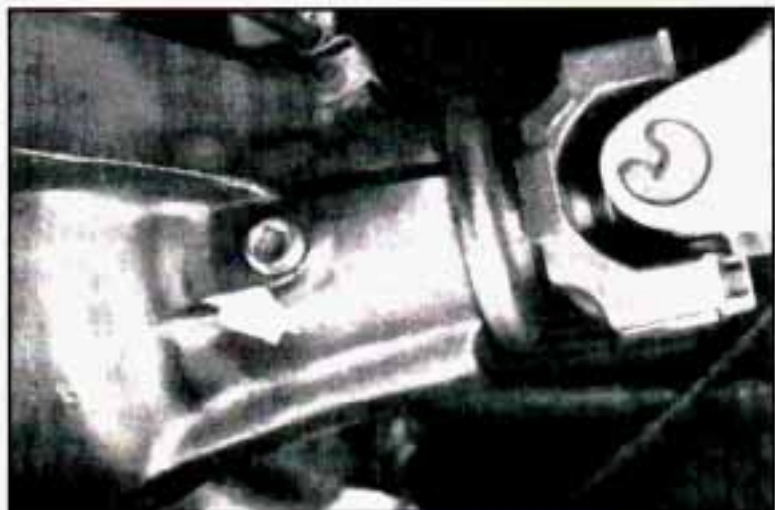

If the level is below the bottom of the filler plug hole, you'll need to add some lubricant. Add enough lubricant to raise the level to the bottom of the filler plug hole.

What to Use

Refer to the Maintenance Schedule to determine what kind of lubricant to use. See “Recommended Fluids and Lubricants” in the Index.

C3 (3500 H.D.) Trucks Equipped with Dana Rear Axle

Additional rear axle scheduled maintenance is required on 3500 H.D. models equipped with Dana rear axles when they are driven under the following conditions:

- Extreme loading (at or near GVWR) or trailer towing, and:
- Operation above 45 mph for extended periods of time

Vehicles used in any of these conditions require the rear axle lubricant (SAE 80W-90 – GL-5) be changed every 3 months or 3,000 miles, whichever comes first.

To reduce required maintenance, SAE 75W-140 synthetic gear lubricant may be used. With the use of synthetic SAE 75W-140 lubricant, the fluid change intervals may be increased to 30,000 miles. Before using SAE 75W-140, it is important to drain and flush the axle with clean mineral based (non-synthetic) axle lubricant. Fluid capacity is 4.12 qts. (3.9L).

Four-Wheel Drive

Most lubricant checks in this section also apply to four-wheel-drive vehicles. However, they have two additional systems that need lubrication.

Transfer Case

When to Check Lubricant

Refer to the Maintenance Schedule to determine how often to check the lubricant. See “Periodic Maintenance Inspections” in the Index.

How to Check Lubricant



If the level is below the bottom of the filler plug hole, you'll need to add some lubricant. Add enough lubricant to raise the level to the bottom of the filler plug hole.

What to Use

Refer to the Maintenance Schedule to determine what kind of lubricant to use. See "Recommended Fluids and Lubricants" in the Index.

Front Axle

When to Check and Change Lubricant

Refer to the Maintenance Schedule to determine how often to check the lubricant and when to change it. See "Scheduled Maintenance Services" in the Index.

How to Check Lubricant



If the level is below the bottom of the filler plug hole, you'll need to add some lubricant.

If the differential is at operating temperature (warm), add enough lubricant to raise the level to the bottom of the filler plug hole.

If the differential is cold, add enough lubricant to raise the level to 1/2 inch (12 mm) below the filler plug hole.

What to Use

Refer to the Maintenance Schedule to determine what kind of lubricant to use. See “Recommended Fluids and Lubricants” in the Index.

Engine Coolant

The following explains your cooling system and how to add coolant when it is low. If you have a problem with engine overheating, see “Engine Overheating” in the Index.

The proper coolant for your vehicle will:

- Give freezing protection down to -34°F (-37°C).
- Give boiling protection up to 262°F (128°C).
- Protect against rust and corrosion.
- Help keep the proper engine temperature.
- Let the warning gages work as they should.

What to Use

Use a mixture of one-half *clean water* (preferably distilled) and one-half antifreeze that meets “GM Specification 6038–M,” which won’t damage aluminum parts. You can also use a recycled coolant conforming to “GM Specification 6038–M.” Use GM Coolant Supplement (Sealer) with a complete coolant flush and refill. If you use this mixture, you don’t need to add anything else.



CAUTION:

Adding only plain water to your cooling system can be dangerous. Plain water, or some other liquid like alcohol, can boil before the proper coolant mix will. Your vehicle’s coolant warning system is set for the proper coolant mix. With plain water or the wrong mix, your engine could get too hot but you wouldn’t get the overheat warning. Your engine could catch fire and you or others could be burned. Use a 50/50 mix of clean water and a proper antifreeze.

NOTICE:

If you use an improper coolant mix, your engine could overheat and be badly damaged. The repair cost wouldn't be covered by your warranty. Too much water in the mix can freeze and crack the engine, radiator, heater core and other parts.

Some conditions, such as air trapped in the cooling system, can affect the coolant level in the radiator. Check the coolant level when the engine is cold and follow the steps under "Adding Coolant" for the proper way to add coolant.

If you have to add coolant more than four times a year, have your dealer check your cooling system.

NOTICE:

If you use the proper coolant, you don't have to add extra inhibitors or additives which claim to improve the system. These can be harmful.

Adding Coolant — Gasoline Engine



The coolant recovery tank is located on the passenger side at the rear corner of the engine compartment.

To Check Coolant

When your engine is cold, the coolant level should be at the COLD mark, or a little higher. When your engine is warm, the level should be up to the HOT mark, or a little higher.

To Add Coolant

If you need more coolant, add the proper mix *at the coolant recovery tank*.

⚠ CAUTION:

Turning the radiator pressure cap when the engine and radiator are hot can allow steam and scalding liquids to blow out and burn you badly. With the coolant recovery tank, you will almost never have to add coolant at the radiator. Never turn the radiator pressure cap — even a little — when the engine and radiator are hot.

Add coolant mix at the recovery tank, but be careful not to spill it.

⚠ CAUTION:

You can be burned if you spill coolant on hot engine parts. Coolant contains ethylene glycol, and it will burn if the engine parts are hot enough. Don't spill coolant on a hot engine.

Adding Coolant — Diesel Engine



The coolant surge tank is located on the passenger side at the rear corner of the engine compartment.

To Check Coolant

CAUTION:

Turning the surge tank pressure cap when the engine and radiator are hot can allow steam and scalding liquids to blow out and burn you badly. Never turn the surge tank pressure cap — even a little — when the engine and radiator are hot.

When your engine is cold, the coolant level should be at the COLD mark, or a little higher.



If this light comes on, it means you're low on engine coolant.

To Add Coolant

If you need more coolant, add the proper mix *at the surge tank*, but only when the engine is cool. If the surge tank is empty, see "Engine Overheating" in the Index for the proper fill procedure.

CAUTION:

You can be burned if you spill coolant on hot engine parts. Coolant contains ethylene glycol, and it will burn if the engine parts are hot enough. Don't spill coolant on a hot engine.

When replacing the pressure cap, make sure it is tight.

Radiator Pressure Cap — Gasoline Engine

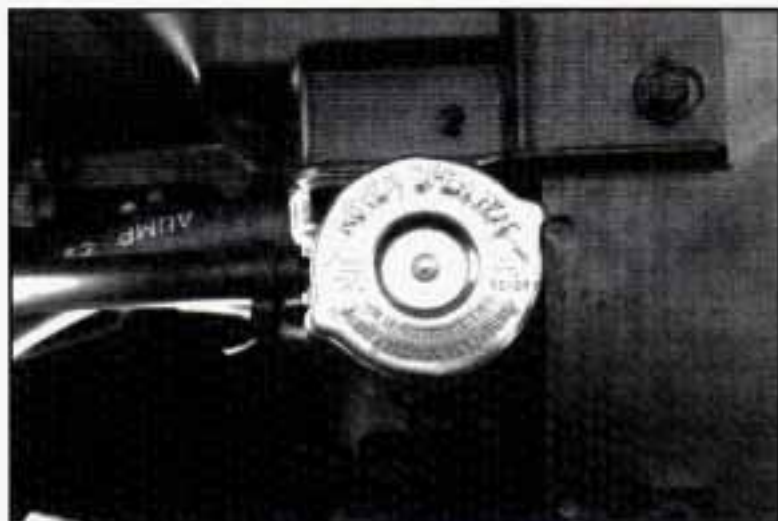

The radiator pressure cap must be tightly installed with the arrows on the cap lined up with the overflow tube on the radiator filler neck.

NOTICE:

Your radiator cap is a 15 psi (105 kPa) pressure-type cap and must be tightly installed to prevent coolant loss and possible engine damage from overheating. Be sure the arrows on the cap line up with the overflow tube on the radiator filler neck.

Surge Tank Pressure Cap — Diesel Engine



The surge tank pressure cap must be tightly installed with the arrows on the cap lined up with the top tube of the coolant surge tank.

NOTICE:

Your surge tank pressure cap is a unique 15 psi (105 kPa) pressure-type cap for use with surge tank cooling systems only. It must be tightly installed to prevent coolant loss and possible engine damage from overheating. Be sure the arrows on the cap line up with the top tube of the coolant surge tank.

Thermostat

Engine coolant temperature is controlled by a thermostat in the engine coolant system. The thermostat stops the flow of coolant through the radiator until the coolant reaches a preset temperature.

When you replace your thermostat, an AC[®] thermostat is recommended.

Power Steering Fluid



How To Check Power Steering Fluid

When the engine compartment is cool, unscrew the cap and wipe the dipstick with a clean rag. Replace the cap and completely tighten it. Then remove the cap again and look at the fluid level on the dipstick.

The level should be at the FULL COLD mark. Add enough fluid to bring the level up to the mark.

A fluid loss in this system could indicate a problem. Have the system inspected and repaired.

What to Add

Refer to the Maintenance Schedule to determine what kind of fluid to use. See "Recommended Fluids and Lubricants" in the Index.

NOTICE:

When adding power steering fluid or making a complete fluid change, always use the proper fluid. Failure to use the proper fluid can cause leaks and damage hoses and seals.

Hydro-Boost Brake System (Hydraulic Pump)

The power steering pump is also used as the Hydro-boost pump. Refer to "Power Steering System" in this section when checking fluid level or adding fluid.

Windshield Washer Fluid

To Add



Open the cap labeled **WASHER FLUID ONLY**. Add washer fluid until the tank is full.

NOTICE:

- When using concentrated washer fluid, follow the manufacturer's instructions for adding water.
- Don't mix water with ready-to-use washer fluid. Water can cause the solution to freeze and damage your washer fluid tank and other parts of the washer system. Also, water doesn't clean as well as washer fluid.
- Fill your washer fluid tank only 3/4 full when it's very cold. This allows for expansion, which could damage the tank if it is completely full.
- Don't use radiator antifreeze in your windshield washer. It can damage your washer system and paint.

Brakes

Brake Master Cylinder

Your brake master cylinder is here. It is filled with DOT-3 brake fluid.



There are only two reasons why the brake fluid level in your master cylinder might go down. The first is that the brake fluid goes down to an acceptable level during normal brake lining wear. When new linings are put in, the fluid level goes back up. The other reason is that fluid is leaking out of the brake system. If it is, you should have your brake system fixed, since a leak means that sooner or later your brakes won't work well, or won't work at all. So, it isn't a good idea to "top off" your brake fluid. Adding brake fluid won't correct a leak. If you add fluid when your linings are worn, then you'll have too much fluid when you get new brake linings. You should add

(or remove) brake fluid, as necessary, only when work is done on the brake hydraulic system.



CAUTION:

If you have too much brake fluid, it can spill on the engine. The fluid will burn if the engine is hot enough. You or others could be burned, and your vehicle could be damaged. Add brake fluid only when work is done on the brake hydraulic system.

Refer to the Maintenance Schedule to determine when to check your brake fluid. See “Periodic Maintenance Inspections” in the Index.

To Check Brake Fluid

You can check the brake fluid without taking off the cap. Just look at the windows on the brake fluid reservoir. The fluid levels should be above MIN. If they aren't, have your brake system checked to see if there is a leak.

After work is done on the brake hydraulic system, make sure the levels are above MIN and below the top of each window.

What to Add

When you do need brake fluid, use only DOT-3 brake fluid — such as Delco Supreme II[®] (GM Part No. 1052535). Use new brake fluid from a sealed container only, and always clean the brake fluid reservoir cap before removing it.

NOTICE:

- **Don't let someone put in the wrong kind of fluid. For example, just a few drops of mineral-based oil, such as engine oil, in your brake system can damage brake system parts so badly that they'll have to be replaced.**
- **Brake fluid can damage paint, so be careful not to spill brake fluid on your vehicle. If you do, wash it off immediately. See “Appearance Care” in the Index.**

Brake Wear

Your vehicle has front disc brakes and rear drum brakes. If you have a C3500 HD model, it has four-wheel disc brakes.

Disc brake pads have built-in wear indicators that make a high-pitched warning sound when the brake pads are worn and new pads are needed. The sound may come and go or be heard all the time your vehicle is moving (except when you are pushing on the brake pedal firmly).



CAUTION:

The brake wear warning sound means that sooner or later your brakes won't work well. That could lead to an accident. When you hear the brake wear warning sound, have your vehicle serviced.

NOTICE:

Continuing to drive with worn-out brake pads could result in costly brake repair.

Some driving conditions or climates may cause a brake squeal when the brakes are first applied or lightly applied. This does not mean something is wrong with your brakes.

If you have rear drum brakes, they don't have wear indicators, but if you ever hear a rear brake rubbing noise, have the rear brake linings inspected. Also, the rear brake drums should be removed and inspected each time the tires are removed for rotation or changing. When you have the front brakes replaced, have the rear brakes inspected, too.

Brake linings should always be replaced as complete axle sets.

Brake Pedal Travel

See your dealer if the brake pedal does not return to normal height, or if there is a rapid increase in pedal travel. This could be a sign of brake trouble.

Brake Adjustment

Every time you make a brake stop, your disc brakes adjust for wear.

If your brake pedal goes down farther than normal, your rear drum brakes may need adjustment. Adjust them by backing up and firmly applying the brakes a few times.

Replacing Brake System Parts

The braking system on a modern vehicle is complex. Its many parts have to be of top quality and work well together if the vehicle is to have really good braking. Vehicles we design and test have top-quality GM brake parts in them, as your vehicle does when it is new. When you replace parts of your braking system — for example, when your brake linings wear down and you have to have new ones put in — be sure you get new genuine GM replacement parts. If you don't, your brakes may no longer work properly. For example, if someone puts in brake linings that are wrong for your vehicle, the balance between your front and rear brakes can change — for the worse. The braking performance you've come to expect can change in many other ways if someone puts in the wrong replacement brake parts.

Front Shock Absorbers

The front shock absorbers of your vehicle do many things. They help the vehicle ride smoothly and also control the travel of the suspension system. When the shock absorbers are serviced, any replacement shock absorbers must be the same as the original equipment shock absorbers in both extended length and strength.

NOTICE:

If you use shock absorbers that are not the same as the original shock absorbers, the shock absorbers or suspension system could be damaged.

Windshield Wiper Blade Inserts



To replace the windshield wiper blade insert, lift the wiper arm and rotate the blade until it is facing away from the windshield.

Unlatch the end of the insert from the holding clips. Remove the insert and slide a new one in place. Make sure the blade is secured in the clips.

Air Conditioning

Every now and then have your dealership check your air conditioning system to be sure it has not lost any cooling ability. If you think the system is not working properly, have your dealership check it out as soon as possible.

The air conditioning will not work when the temperature is below 40°F (4°C).

Fluid Leak Check

After the vehicle has been parked for a while, inspect the surface under the vehicle for water, oil, fuel or other fluids. Water dripping from the air conditioning system after it has been used is normal. If you notice fuel leaks or fumes, the causes should be found and corrected at once.

Lock Cylinders

To be sure your locks operate properly, they must be lubricated. Your vehicle's maintenance schedule will tell you how often to lubricate them. See "Recommended Fluids and Lubricants" in the Index for the proper lubricant to use.

You should not use penetrating oils because they could wash out the factory installed lubricant and cause the lock to bind. De-icers which contain alcohol could also wash away the lubricant, so be sure to lubricate the lock after using a de-icer of this type.

Battery

Every new vehicle has a Delco Freedom[®] battery. You never have to add water to one of these. When it's time for a new battery, we recommend a Delco Freedom[®] battery. Get one that has the replacement number shown on the original battery's label.

Vehicle Storage

If you're not going to drive your vehicle for 25 days or more, take off the black, negative (-) cable from the battery. This will help keep your battery from running down.



CAUTION:

Batteries have acid that can burn you and gas that can explode. You can be badly hurt if you aren't careful. See "Jump Starting" in the Index for tips on working around a battery without getting hurt.

Contact your dealer to learn how to prepare your vehicle for longer storage periods.

Bulb Replacement

Before you replace any bulbs, be sure that all the lamps are off and the engine isn't running.

Sealed Beam Headlamps



1. Remove the four screws from the headlamp retainer.
2. Pull the headlamp out and remove the retainer.



3. Unplug and remove the headlamp.
4. Plug in the new headlamp and put it in place.
5. Install the retainer to the headlamp and tighten the screws.

Halogen Bulbs



CAUTION:

Halogen bulbs have pressurized gas inside and can burst if you drop or scratch the bulb. You or others could be injured. Take special care when handling and disposing of halogen bulbs.

NOTICE:

Avoid touching the bulb or letting it come in contact with anything damp. Oil from your skin or moisture on the bulb can cause the bulb to explode when it is turned on. If either comes in contact with the bulb, clean it with alcohol or a suitable degreaser and wipe the bulb dry.

Composite Headlamps



1. Remove the two screws at the top of the radiator support.
2. Pull the headlamp lens assembly out.



3. Unplug the electrical connector.
4. Turn the bulb to the left and remove it.

5. Put the new bulb in the lens assembly and turn it to the right until it is tight.
6. Plug in the electrical connector.
7. Put the headlamp lens assembly back into the vehicle. Install and tighten the two screws.

Front Parking/Turn Signal Lamps with Sealed Beam Headlamps



1. Remove the two screws at the inside edge of the parking/turn signal lamp assembly.

2. Remove the lamp assembly by swinging it out from the inside edge and sliding it out at the outside edge.



3. Squeeze the tab on the side of the lamp socket while turning the socket to the left.
4. Pull the socket out of the lamp assembly.

5. Push in gently on the bulb, turn it to the left and remove it from the socket.
6. Put the new bulb in the socket, gently press in on the bulb and turn it to the right until it is tight.
7. Put the socket back into the lamp assembly and turn it to the right until it locks.
8. Put the parking/turn signal lamp assembly back into the vehicle and tighten the screws.

Front Parking/Turn Signal Lamps with Composite Headlamps



1. Remove the screws and take out the parking/turn signal lamp assembly.
2. Squeeze the tab on the side of the lamp socket while turning the socket to the left.



3. Pull the socket out of the lamp assembly.
4. Push in gently on the bulb, turn it to the left and remove it from the socket.

5. Put the new bulb in the socket, gently press in on the bulb and turn it to the right until it is tight.
6. Put the socket back into the lamp assembly and turn it socket to the right until it locks.
7. Put the parking/turn signal lamp assembly back into the vehicle and tighten the screws.

Side Marker Lamps with Sealed Beam and Composite Headlamps

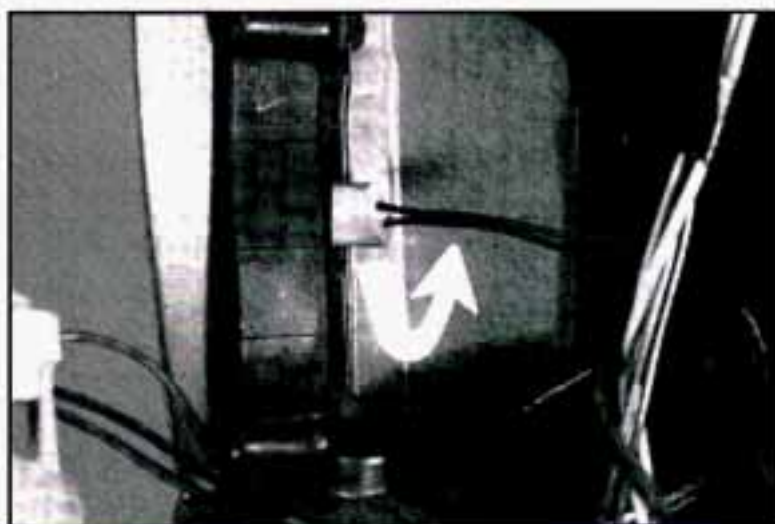

1. Remove the screws and pull out the parking/turn signal lamp assembly.
2. Reach through the opening and turn the side marker bulb socket to the left and remove it.

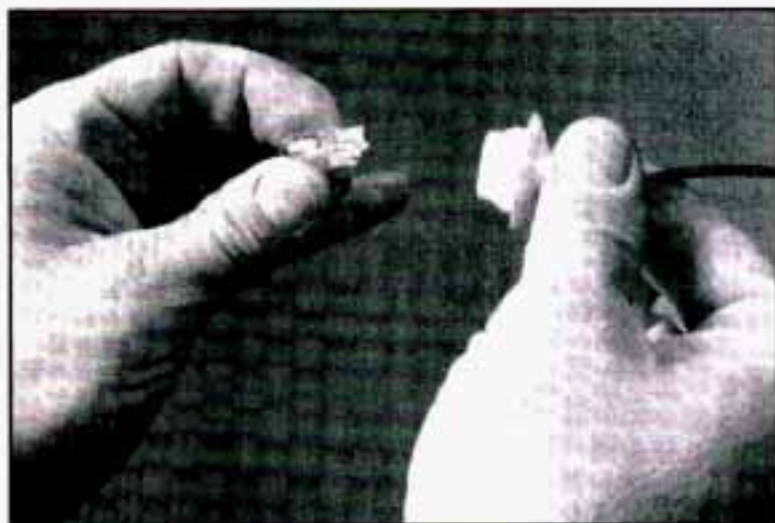

3. Pull the bulb straight out of the socket.
4. Put a new bulb into the socket and push it in until it is tight.

5. Put the socket back into the side marker assembly and turn it to the right to tighten it.
6. Replace the parking/turn signal lamp assembly and tighten the screws.

Fender Marker Lamps – Dual Rear Wheel Pickup Models



1. Remove the screws and take the fender marker assembly out of the fender.



2. Turn the bulb socket to the left and remove it from the lens assembly.
3. Pull the bulb straight out of the socket.

4. Put a new bulb into the socket and push it in until it is tight.
5. Put the socket back into the lens assembly and turn it to the right to tighten it.
6. Replace the lens and tighten the screws.

Tailgate Marker Lamps

1. Use a screwdriver to gently pry the lens/bulb assembly from the lens holder.
2. Unplug the lens/bulb assembly at the connector wire.
3. Plug in a new lens/bulb assembly and push the connector wire into the hole in the tailgate.
4. Snap the lens/bulb assembly into the lens holder.

Roof Marker Lamps

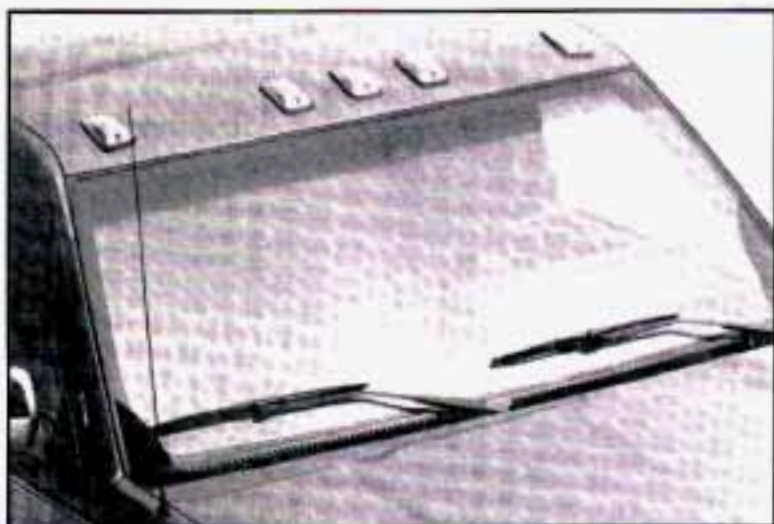

1. Remove the screws and lift off the lens.
2. Pull the bulb straight out of the socket.

3. Put a new bulb into the socket and push it in until it is tight.
4. Replace the lens and tighten the screws.

Cargo Lamp/Center High Mount Stoplamp (CHMSL)



1. Remove the screws and lift off the lens.
2. Pull the old bulb straight out of the socket.



3. Put a new bulb into the socket and push it in until it is tight.
4. Replace the lens and tighten the screws.

Rear Lamps – Pickup Models

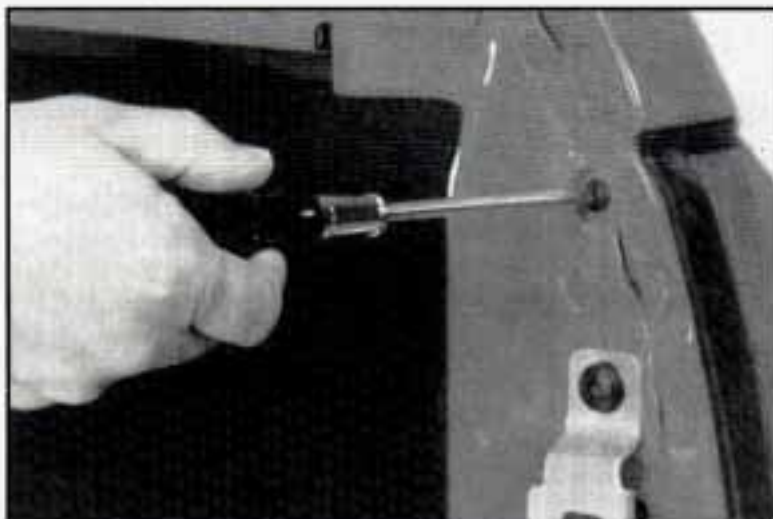

1. Open the tailgate.
2. Remove the two rear lamp assembly screws near the tailgate latch and pull out the lamp assembly.

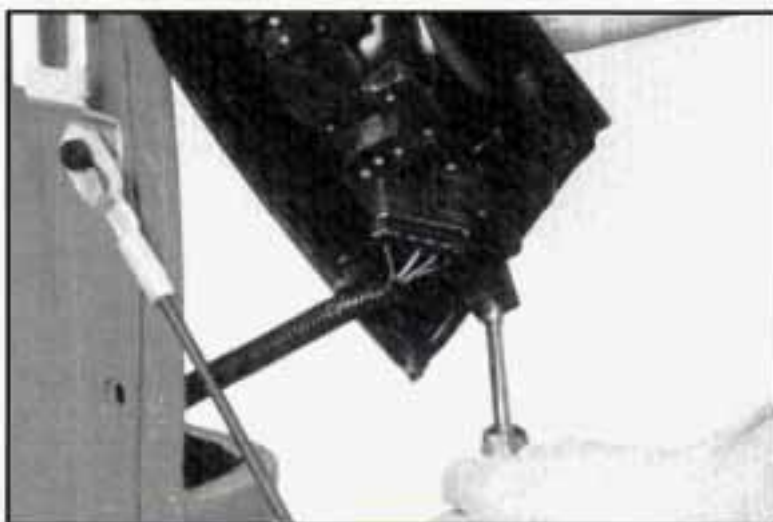

3. Remove the screws from the bulb retainer and take it off the lamp assembly.



4. Pull the old bulb straight out of the socket.
5. Put in a new bulb and push it in until it is tight.
6. Replace the bulb retainer.

7. Replace the rear lamp assembly and tighten the screws.
8. Close the tailgate.

Rear Lamps – Chassis Cab Models



1. Using your hands, peel the rubber seal away from the lens.
2. Lift the lens off the lamp assembly.
3. Slide the socket out of the lamp assembly.



4. Push in gently on the bulb, turn it to the left and remove it from the socket.
5. Put in a new bulb and, pushing in gently, turn it to the right until it is tight.

6. Put the socket back in the lamp assembly and replace the lens and lens seal.

Exhaust System

To help prevent damage to your exhaust system, do not continue to drive your vehicle if you notice:

- Engine misfiring
- Loss of performance
- Exhaust system components hanging lower than normal
- Loud exhaust system noises
- Other unusual operating conditions

Have your engine and exhaust system serviced regularly.

Three-Way Catalytic Converter (Gasoline Engines)

Your vehicle's three-way catalytic converter is designed to reduce the pollutants in your vehicle's exhaust. Use only unleaded fuel in your vehicle. If you use leaded fuel, you could damage your three-way catalytic converter and other engine components.

Oxidation Catalytic Converter (Diesel Engines)

Your vehicle's oxidation catalytic converter is designed to reduce the particulates in your vehicle's exhaust. If your vehicle's oxidation catalytic converter ever needs to be replaced, it must be replaced with an oxidation converter intended for use with diesel engines only.

Engine Control Module System

Gasoline Engines

This system has an oxygen sensor (OS) that helps keep your engine's air-fuel mixture at a proper level. Use only unleaded fuel in your vehicle. If you use leaded fuel, you could damage your oxygen sensor (OS) and three-way catalytic converter.

Diesel Vehicles Below 8,500 (3 850 Kg) GVWR

This system monitors engine speed and throttle position. It adjusts exhaust gas recirculation to limit emissions.

Malfunction Indicator (SERVICE ENGINE SOON) Light

The Malfunction Indicator (SERVICE ENGINE SOON) Light on your instrument panel lets you know when your emission system needs service. The light will come on briefly when you start your engine to let you know that the system is working. If it does not come on when you start your engine, or if it comes on and stays on while you're driving, your system may need service. Your vehicle should still be driveable, but you should have your system serviced right away.

Secondary Air Injection Reaction (AIR) System (Gasoline Engines)

You may have this system. It has a control valve that will direct air to where it is needed. If the AIR system needs service, your Malfunction Indicator (SERVICE ENGINE SOON) Lamp on your instrument panel will come on.

Tires

We don't make tires. Your new vehicle comes with high-quality tires made by a leading tire manufacturer. These tires are warranted by the tire manufacturers, and their warranties are delivered with every new vehicle. If your spare tire is a different brand than your road tires, you will have a tire warranty folder from each of these manufacturers.



CAUTION:

Poorly maintained and improperly used tires are dangerous.

- **Overloading your tires can cause overheating as a result of too much friction. You could have an air-out and a serious accident. See "Loading Your Vehicle" in the Index.**
- **Underinflated tires pose the same danger as overloaded tires. The resulting accident could cause serious injury. Check all tires frequently to maintain the recommended pressure. Tire pressure should be checked when your tires are cold.**
- **Overinflated tires are more likely to be cut, punctured, or broken by a sudden impact, such as when you hit a pothole. Keep tires at the recommended pressure.**
- **Worn, old tires can cause accidents. If your tread is badly worn, or if your tires have been damaged, replace them.**

Inflation – Tire Pressure

The Certification/Tire label which is on the rear edge of the driver's door, or on the incomplete vehicle document in the cab, shows the correct inflation pressures for your tires, when they're cold. "Cold" means your vehicle has been sitting for at least three hours or driven no more than a mile.

You can operate some vehicles at reduced inflation pressures only when you'll be carrying reduced loads. On those vehicles, the minimum cold inflation pressures for a typical reduced load are printed on the "Improved Ride Tire Pressure" label located on the driver's door. Weigh the vehicle to find the load on each tire and see the label for the minimum cold inflation pressures for that load.

NOTICE:

Don't let anyone tell you that underinflation or overinflation is all right. It's not. If your tires don't have enough air (underinflation) you can get:

- Too much flexing
- Too much heat
- Tire overloading
- Bad wear
- Bad handling
- Bad fuel economy.

If your tires have too much air (overinflation), you can get:

- Unusual wear
- Bad handling
- Rough ride
- Needless damage from road hazards.

When to Check

Check your tires once a month or more. Also, check the tire pressure of the spare tire.

How to Check

Use a good quality pocket-type gage to check tire pressure. Simply looking at the tires will not tell you the pressure, especially if you have radial tires — which may look properly inflated even if they're underinflated.

If your tires have valve caps, be sure to put them back on. They help prevent leaks by keeping out dirt and moisture.

Tire Inspection and Rotation

Tires should be inspected every 6,000 to 8,000 miles (10 000 to 13 000 km) for any signs of unusual wear. If unusual wear is present, rotate your tires as soon as possible and check wheel alignment. Also check for damaged tires or wheels. See "When it's Time for New Tires" and "Wheel Replacement" later in this section for more information. If your vehicle has dual rear wheels, also see "Dual Tire Operation" later in this section.

The purpose of regular rotation is to achieve more uniform wear for all tires on the vehicle. The first rotation is the most important. See “Scheduled Maintenance Services” in the Index for scheduled rotation intervals.

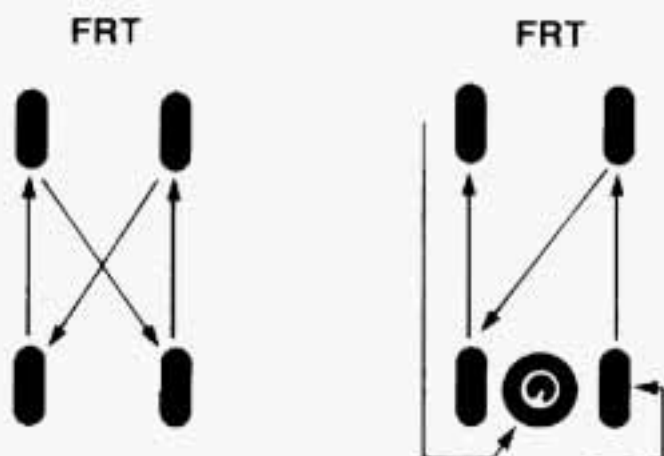

If your vehicle has single rear wheels, always use one of the correct rotation patterns shown here when rotating your tires.

If your vehicle has front tires with different load ranges or tread designs (such as all season vs. on/off road) than the rear tires, don't rotate your tires front to rear.

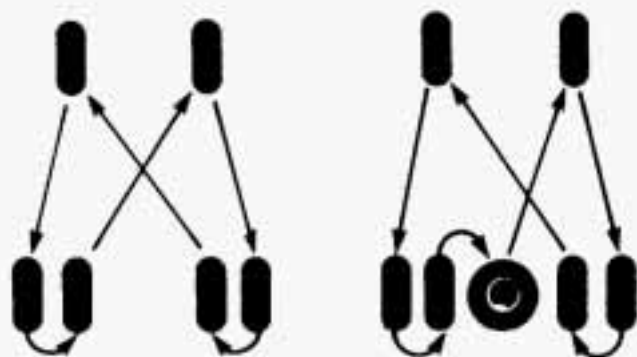

If your vehicle has dual rear wheels and the load range and tread design for your front tires is the same as your rear tires, always use one of the correct rotation patterns shown here when rotating your tires.



If your vehicle has dual rear wheels and the load range or tread design for your front tires is different from your rear tires, always use the correct rotation pattern shown here when rotating your tires. The dual tires are rotated as a pair, and the inside rear tires become the outside rear tires.

When you install dual wheels, be sure the vent holes in the inner and outer wheels on each side are lined up.

After the tires have been rotated, adjust the front and rear inflation pressures as shown on the Certification/Tire label. Make certain that all wheel nuts are properly tightened. See “Wheel Nut Torque” in the Index.



CAUTION:

Rust or dirt on a wheel, or on the parts to which it is fastened, can make wheel nuts become loose after a time. The wheel could come off and cause an accident. When you change a wheel, remove any rust or dirt from places where the wheel attaches to the vehicle. In an emergency, you can use a cloth or a paper towel to do this; but be sure to use a scraper or wire brush later, if you need to, to get all the rust or dirt off. (See “Changing a Flat Tire” in the Index.)

When it's Time for New Tires

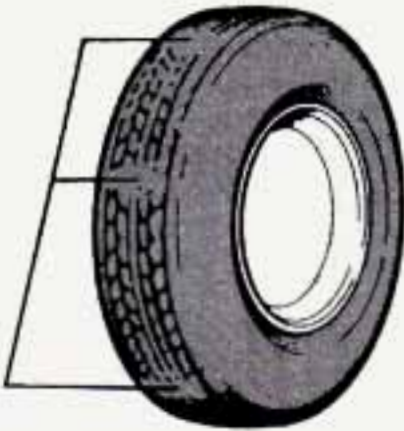

Tread Wear Indicators

One way to tell when it's time for new tires is to check the treadwear indicators, which will appear when your tires have only 1/16 inch (1.6 mm) or less of tread remaining.

You need a new tire if:

- You can see the indicators at three or more places around the tire.
- You can see cord or fabric showing through the tire's rubber.
- The tread or sidewall is cracked, cut or snagged deep enough to show cord or fabric.
- The tire has a bump, bulge or split.
- The tire has a puncture, cut, or other damage that can't be repaired well because of the size or location of the damage.

Dual Tire Operation

When the vehicle is new, or whenever a wheel, wheel bolt or wheel nut is replaced, check the wheel nut torque after 100, 1,000 and 6,000 miles (160, 1 600 and 10 000 km) of driving. For proper torque see "Wheel Nut Torque" in the Index.

The outer tire on a dual wheel setup generally wears faster than the inner tire. Your tires will wear more evenly and last longer if you rotate the tires periodically. If you're going to be doing a lot of driving on high-crown roads, you can reduce tire wear by adding 5 psi (35 kPa) to the tire pressure in the outer tires. Be sure to return to the recommended pressures when no longer driving under those conditions.



CAUTION:

If you operate your vehicle with a tire that is badly underinflated, the tire can overheat. An overheated tire can lose air suddenly or catch fire. You or others could be injured. Be sure all tires (including the spare, if any) are properly inflated.

Buying New Tires

To find out what kind and size of tires you need, look at the Certification/Tire label.

The tires installed on your vehicle when it was new a Tire Performance Criteria Specification (TPC Spec) number on each tire's sidewall. When you get new tires, get ones with that same TPC Spec number. That way, your vehicle will continue to have tires that are designed to give proper endurance, handling, speed rating, traction, ride and other things during normal service on your vehicle. If your tires have an all-season tread design, the TPC number will be followed by an "MS" (for mud and snow).

If you ever replace your tires with those not having a TPC Spec number, make sure they are the same size, load range, speed rating and construction type (bias, bias-belted or radial) as your original tires.



CAUTION:

Mixing tires could cause you to lose control while driving. If you mix tires of different sizes or types (radial and bias-belted tires), the vehicle may not handle properly, and you could have a crash. Be sure to use the same size and type tires on all four wheels.

Uniform Tire Quality Grading

The following information relates to the system developed by the United States National Highway Traffic Safety Administration which grades tires by treadwear, traction and temperature performance. (This applies only to vehicles sold in the United States.)

Treadwear

The treadwear grade is a comparative rating based on the wear rate of the tire when tested under controlled conditions on a specified government test course. For example, a tire graded 150 would wear one and a half (1 1/2) times as well on the government course as a tire graded 100. The relative performance of tires depends upon the actual conditions of their use, however, and may depart significantly from the norm due to variations in driving habits, service practices and differences in road characteristics and climate.

Traction – A, B, C

The traction grades, from highest to lowest are: A, B, and C. They represent the tire's ability to stop on wet pavement as measured under controlled conditions on specified government test surfaces of asphalt and concrete. A tire marked C may have poor traction performance.

Warning: The traction grade assigned to this tire is based on braking (straight-ahead) traction tests and does not include cornering (turning) traction.

Temperature – A, B, C

The temperature grades are A (the highest), B, and C, representing the tire's resistance to the generation of heat and its ability to dissipate heat when tested under controlled conditions on a specified indoor laboratory test wheel. Sustained high temperature can cause the material of the tire to degenerate and reduce tire life, and excessive temperature can lead to sudden tire failure. The grade C corresponds to a level of performance which all passenger car tires must meet under the Federal Motor Vehicle Safety Standard No. 109. Grades B and A represent higher levels of performance on the laboratory test wheel than the minimum required by law.

Warning: The temperature grade for this tire is established for a tire that is properly inflated and not overloaded. Excessive speed, underinflation, or excessive loading, either separately or in combination, can cause heat buildup and possible tire failure.

These grades are molded on the sidewalls of passenger car tires.

While the tires available as standard or optional equipment on General Motors vehicles may vary with respect to these grades, all such tires meet General Motors performance standards and have been approved for use on General Motors vehicles. All passenger type (P Metric) tires must conform to Federal safety requirements in addition to these grades.

Wheel Alignment and Tire Balance

The wheels on your vehicle were aligned and balanced carefully at the factory to give you the longest tire life and best overall performance.

In most cases, you will not need to have your wheels aligned again. However, if you notice unusual tire wear or your vehicle pulling one way or the other, the alignment may need to be reset. If you notice your vehicle vibrating when driving on a smooth road, your wheels may need to be rebalanced.

Wheel Replacement

Replace any wheel that is bent, cracked, or badly rusted or corroded. If wheel nuts keep coming loose, the wheel, wheel bolts, and wheel nuts should be replaced. If the wheel leaks air, replace it (except some aluminum wheels, which can sometimes be repaired). See your GM dealer if any of these conditions exist.

Your dealer will know the kind of wheel you need.

Each new wheel should have the same load carrying capacity, diameter, width, offset, and be mounted the same way as the one it replaces.

If you need to replace any of your wheels, wheel bolts, or wheel nuts, replace them only with new GM original equipment parts. This way, you will be sure to have the right wheel, wheel bolts, and wheel nuts for your vehicle.



CAUTION:

Using the wrong replacement wheels, wheel bolts, or wheel nuts on your vehicle can be dangerous. It could affect the braking and handling of your vehicle, make your tires lose air and make you lose control. You could have a collision in which you or others could be injured. Always use the correct wheel, wheel bolts, and wheel nuts for replacement.

NOTICE:

The wrong wheel can also cause problems with bearing life, brake cooling, speedometer/odometer calibration, headlamp aim, bumper height, vehicle ground clearance, and tire or tire chain clearance to the body and chassis.

Whenever a wheel, wheel bolt or wheel nut is replaced on a dual wheel setup, check the wheel nut torque after 100, 1,000 and 6,000 miles (160, 1 600 and 10 000 km) of driving. For proper torque, see “Wheel Nut Torque” in the Index.

Used Replacement Wheels



CAUTION:

Putting a used wheel on your vehicle is dangerous. You can't know how it's been used or how many miles it's been driven. It could fail suddenly and cause an accident. If you have to replace a wheel use a new GM original equipment wheel.

Tire Chains

NOTICE:

If your vehicle has dual wheels or LT265/75R16 size tires, don't use tire chains; they can damage your vehicle.

If you don't have dual wheels or if you have a tire size other than LT265/75R16, use tire chains only where legal and only when you must. Use chains that are the proper size for your tires. Install them on the tires of the rear axle.

Don't use chains on the tires of the front axle.

Tighten them as tightly as possible with the ends securely fastened. Drive slowly and follow the chain manufacturer's instructions. If you can hear the chains contacting your vehicle, stop and retighten them. If the contact continues, slow down until it stops. Driving too fast or spinning the wheels with chains on will damage your vehicle.

Appearance Care



Remember, cleaning products can be hazardous. Some are toxic. Others can burst into flame if you strike a match or get them on a hot part of the vehicle. Some are dangerous if you breathe their fumes in a closed space. When you use anything from a container to clean your vehicle, be sure to follow the manufacturer's warnings and instructions. And always open your doors or windows when you're cleaning the inside.

Never use these to clean your vehicle:

- Gasoline
- Benzene
- Naphtha
- Carbon Tetrachloride
- Acetone
- Paint Thinner
- Turpentine
- Lacquer Thinner
- Nail Polish Remover

They can all be hazardous — some more than others — and they can all damage your vehicle, too.

Don't use any of these unless this manual says you can. In many uses, these will damage your vehicle:

- Alcohol
- Laundry Soap
- Bleach
- Reducing Agents

Cleaning the Inside of Your Vehicle

Use a vacuum cleaner often to get rid of dust and loose dirt. Wipe vinyl or leather with a clean, damp cloth.

Your GM dealer has two GM cleaners, a solvent-type spot lifter and a foam-type powdered cleaner. They will clean normal spots and stains very well. Do not use them on vinyl or leather.

Here are some cleaning tips:

- Always read the instructions on the cleaner label.
- Clean up stains as soon as you can — before they set.
- Use a clean cloth or sponge, and change to a clean area often. A soft brush may be used if stains are stubborn.
- Use solvent-type cleaners in a well-ventilated area only. If you use them, don't saturate the stained area.
- If a ring forms after spot cleaning, clean the entire area immediately or it will set.

Using Foam-Type Cleaner on Fabric

- Vacuum and brush the area to remove any loose dirt.
- Always clean a whole trim panel or section. Mask surrounding trim along stitch or welt lines.
- Mix Multi-Purpose Powdered Cleaner following the directions on the container label.
- Use suds only and apply with a clean sponge.
- Don't saturate the material.
- Don't rub it roughly.
- As soon as you've cleaned the section, use a sponge to remove the suds.
- Rinse the section with a clean, wet sponge.
- Wipe off what's left with a slightly damp paper towel or cloth.
- Then dry it immediately with a blow dryer or a heat lamp.

NOTICE:

Be careful. A blow dryer may scorch the fabric.

- Wipe with a clean cloth.

Using Solvent–Type Cleaner on Fabric

First, see if you have to use solvent–type cleaner at all. Some spots and stains will clean off better with just water and mild soap.

If you need to use a solvent:

- Gently scrape excess soil from the trim material with a clean, dull knife or scraper. Use very little cleaner, light pressure and clean cloths (preferably cheesecloth). Cleaning should start at the outside of the stain, “feathering” toward the center. Keep changing to a clean section of the cloth.
- When you clean a stain from fabric, immediately dry the area with a blow dryer to help prevent a cleaning ring. (See the previous NOTICE.)

Fabric Protection

Your vehicle has upholstery and carpet that has been treated with Scotchgard™ Fabric Protector, a 3M product. Scotchgard™ protects fabrics by repelling oil and water, which are the carriers of most stains. Even with this protection, you still need to clean your upholstery and carpet often to keep it looking new.

Further information on cleaning is available by calling 1–800–433–3296 (in Minnesota, 1–800–642–6167).

Special Cleaning Problems

Greasy or Oily Stains

Stains caused by grease, oil, butter, margarine, shoe polish, coffee with cream, chewing gum, cosmetic creams, vegetable oils, wax crayon, tar and asphalt can be removed as follows:

- Carefully scrape off excess stain.
- Follow the solvent–type instructions described earlier.
- Shoe polish, wax crayon, tar and asphalt will stain if left on a vehicle seat fabric. They should be removed as soon as possible. Be careful, because the cleaner will dissolve them and may cause them to spread.

Non–Greasy Stains

Stains caused by catsup, coffee (black), egg, fruit, fruit juice, milk, soft drinks, wine, vomit, urine and blood can be removed as follows:

- Carefully scrape off excess stain, then sponge the soiled area with cool water.
- If a stain remains, follow the foam–type instructions described earlier.

- If an odor lingers after cleaning vomit or urine, treat the area with a water/baking soda solution: 1 teaspoon (5 ml) of baking soda to 1 cup (250 ml) of lukewarm water.
- If needed, clean lightly with solvent-type cleaner.

Combination Stains

Stains caused by candy, ice cream, mayonnaise, chili sauce and unknown stains can be removed as follows:

- Carefully scrape off excess stain, then clean with cool water and allow to dry.
- If a stain remains, clean it with solvent-type cleaner.

Cleaning Vinyl

Use warm water and a clean cloth.

- Rub with a clean, damp cloth to remove dirt. You may have to do it more than once.
- Things like tar, asphalt and shoe polish will stain if you don't get them off quickly. Use a clean cloth and a solvent-type vinyl cleaner.

Cleaning Leather

Use a soft cloth with lukewarm water and a mild soap or saddle soap.

- For stubborn stains, use a mild solution of 10% isopropyl alcohol (rubbing alcohol) and 90% water.
- *Never* use oils, varnishes, solvent-based or abrasive cleaners, furniture polish or shoe polish on leather.
- Soiled leather should be cleaned immediately. If dirt is allowed to work into finish, it can harm the leather.

Cleaning the Top of the Instrument Panel

Use only mild soap and water to clean the top surfaces of the instrument panel. Sprays containing silicones or waxes may cause annoying reflections in the windshield and even make it difficult to see through the windshield under certain conditions.

Care of Safety Belts

Keep belts clean and dry.



CAUTION:

Do not bleach or dye safety belts. If you do, it may severely weaken them. In a crash they might not be able to provide adequate protection. Clean safety belts only with mild soap and lukewarm water.

Glass

Glass should be cleaned often. GM Glass Cleaner (GM Part No. 1050427) or a liquid household glass cleaner will remove normal tobacco smoke and dust films.

Don't use abrasive cleaners on glass, because they may cause scratches. Avoid placing decals on the inside rear window, since they may have to be scraped off later. If abrasive cleaners are used on the inside of the rear window, an electric defogger element may be damaged. Any temporary license should not be attached across the defogger grid.

Cleaning the Outside of the Windshield and Wiper Blades

If the windshield is not clear after using the windshield washer, or if the wiper blade chatters when running, wax or other material may be on the blade or windshield.

Clean the outside of the windshield with GM Windshield Cleaner, Bon-Ami Powder[®] (GM Part No. 1050011). The windshield is clean if beads do not form when you rinse it with water.

Clean the blade by wiping vigorously with a cloth soaked in full strength windshield washer solvent. Then rinse the blade with water.

Wiper blades should be checked on a regular basis and replaced when worn.

Weatherstrips

Silicone grease on weatherstrips will make them last longer, seal better, and not stick or squeak. Apply silicone grease with a clean cloth at least every six months. During very cold, damp weather more frequent application may be required. (See "Recommended Fluids and Lubricants" in the Index.)

Cleaning the Outside of Your Vehicle

The paint finish on your vehicle provides beauty, depth of color, gloss retention and durability.

Washing Your Vehicle

The best way to preserve your vehicle's finish is to keep it clean by washing it often with lukewarm or cold water.

Don't wash your vehicle in the direct rays of the sun. Don't use strong soaps or chemical detergents. Use liquid hand, dish or car washing (mild detergent) soaps. Don't use cleaning agents that are petroleum based, or that contain acid or abrasives. All cleaning agents should be flushed promptly and not allowed to dry on the surface, or they could stain. Dry the finish with a soft, clean chamois or a 100% cotton towel to avoid surface scratches and water spotting.

High pressure vehicle washes may cause water to enter your vehicle.

Finish Care

Occasional waxing or mild polishing of your vehicle by hand may be necessary to remove residue from the paint finish. You can get GM approved cleaning products from your dealer. (See "Appearance Care and Materials" in the Index.)

Your GM manufactured vehicle may have a "basecoat/clearcoat" paint finish. The clearcoat gives more depth and gloss to the colored basecoat. Always use waxes and polishes that are non-abrasive and made for a basecoat/clearcoat paint finish.

NOTICE:

Machine compounding or aggressive polishing on a basecoat/clearcoat paint finish may dull the finish or leave swirl marks.

Foreign materials such as calcium chloride and other salts, ice melting agents, road oil and tar, tree sap, bird droppings, chemicals from industrial chimneys, etc. can damage your vehicle's finish if they remain on painted surfaces. Wash the vehicle as soon as possible. If necessary, use non-abrasive cleaners that are marked safe for painted surfaces to remove foreign matter.

Exterior painted surfaces are subject to aging, weather and chemical fallout that can take their toll over a period of years. You can help to keep the paint finish looking new by keeping your vehicle garaged or covered whenever possible.

Protecting Exterior Bright Metal Parts

Bright metal parts should be cleaned regularly to keep their luster. Washing with water is all that is usually needed. However, you may use GM Chrome Polish on chrome or stainless steel trim, if necessary.

Use special care with aluminum trim. To avoid damaging protective trim, never use auto or chrome polish, steam or caustic soap to clean aluminum. A coating of wax, rubbed to high polish, is recommended for all bright metal parts.

Aluminum Wheels (If So Equipped)

Your aluminum wheels have a protective coating similar to the painted surface of your vehicle. Don't use strong soaps, chemicals, chrome polish, abrasive cleaners or abrasive cleaning brushes on them because you could damage this coating. After rinsing thoroughly, a wax may be applied.

NOTICE:

If you have aluminum wheels, don't use an automatic vehicle wash that has hard silicon carbide cleaning brushes. These brushes can take the protective coating off your aluminum wheels.

Tires

To clean your tires, use a stiff brush with a tire cleaner.

When applying a tire dressing always take care to wipe off any overspray or splash from painted surfaces. Petroleum-based products may damage the paint finish.

Sheet Metal Damage

If your vehicle is damaged and requires sheet metal repair or replacement, make sure the body repair shop applies anti-corrosion material to the parts repaired or replaced to restore corrosion protection.

Foreign Material

Calcium chloride and other salts, ice melting agents, road oil and tar, tree sap, bird droppings, chemicals from industrial chimneys, and other foreign matter can damage your vehicle's finish if they remain on painted surfaces. Use cleaners that are marked safe for painted surfaces to remove foreign matter.

Finish Damage

Any stone chips, fractures or deep scratches in the finish should be repaired right away. Bare metal will corrode quickly and may develop into a major repair expense.

Minor chips and scratches can be repaired with touch-up materials available from your dealer or other service outlets. Larger areas of finish damage can be corrected in your dealer's body and paint shop.

Underbody Maintenance

Chemicals used for ice and snow removal and dust control can collect on the underbody. If these are not removed, accelerated corrosion (rust) can occur on the underbody parts such as fuel lines, frame, floor pan, and exhaust system even though they have corrosion protection.

At least every spring, flush these materials from the underbody with plain water. Clean any areas where mud and other debris can collect. Dirt packed in closed areas of the frame should be loosened before being flushed. Your dealer or an underbody vehicle washing system can do this for you.

Chemical Paint Spotting

Some weather and atmospheric conditions can create a chemical fallout. Airborne pollutants can fall upon and attack painted surfaces on your vehicle. This damage can take two forms: blotchy, ringlet-shaped discolorations, and small irregular dark spots etched into the paint surface.

Although no defect in the paint job causes this, GM will repair, at no charge to the owner, the surfaces of new vehicles damaged by this fallout condition within 12 months or 12,000 miles (20 000 km) of purchase, whichever comes first.

This applies only to materials manufactured and sold by General Motors. Bodies, body conversions or equipment not made or sold by General Motors are not covered.

Appearance Care Materials Chart

PART NO.	SIZE	PRODUCT	USAGE
1050172	16 oz. (0.473L)	Tar and Road Oil Remover	Removes old waxes, polishes, tar and road oil
1050173	16 oz. (0.473L)	Chrome Cleaner and Polish	Removes rust and corrosion on chrome and stainless steel
1050174	16 oz. (0.473L)	White Sidewall Tire Cleaner	Cleans white and black tires
1050214	32 oz. (0.946L)	Vinyl Leather Cleaner	Spot and stain removal on leather or vinyl
1050244	16 oz. (0.473L)	Fabric Cleaner	Spot and stain removal on cloth and fabric
1050427	23 oz. (0.680L)	Glass Cleaner	Glass cleaning and spot cleaning on vinyls
1050429	6 lbs. (2.72 kg)	Multi-Purpose Powder Cleaner	Cleans vinyl and cloth on door trim, seats, and carpet—also tires and mats.
1050729	8 oz. (0.237L)	Vinyl Top Cleaner	Cleaning of vinyl tops
1051055	16 oz. (0.473L)	Preservatone	Vinyl top dressing
1051398	8 oz. (0.237L)	Spot Lifter	Spot and stain removal on cloth and fabric
1052870	16 oz. (0.473L)	Wash-Wax (conc.)	Exterior wash
1050201	16 oz. (0.473L)	Magic Mirror Cleaner-Polish	Exterior cleaner and polish

Vehicle Identification Number (VIN)

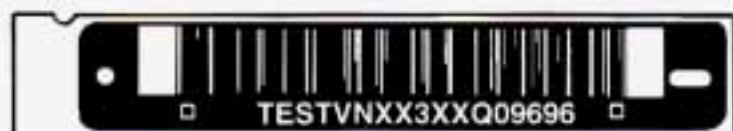

This is the legal identifier for your vehicle. It appears on a plate in the front corner of the instrument panel, on the driver's side. You can see it if you look through the windshield from outside your vehicle. The VIN also appears on the Vehicle Certification and Service Parts labels and the certificates of title and registration.

Engine Identification

The eighth character in your VIN is the engine code. This code will help you identify your engine, specifications, and replacement parts.

VEHICLE IDENTIFICATION NUMBER (VIN)

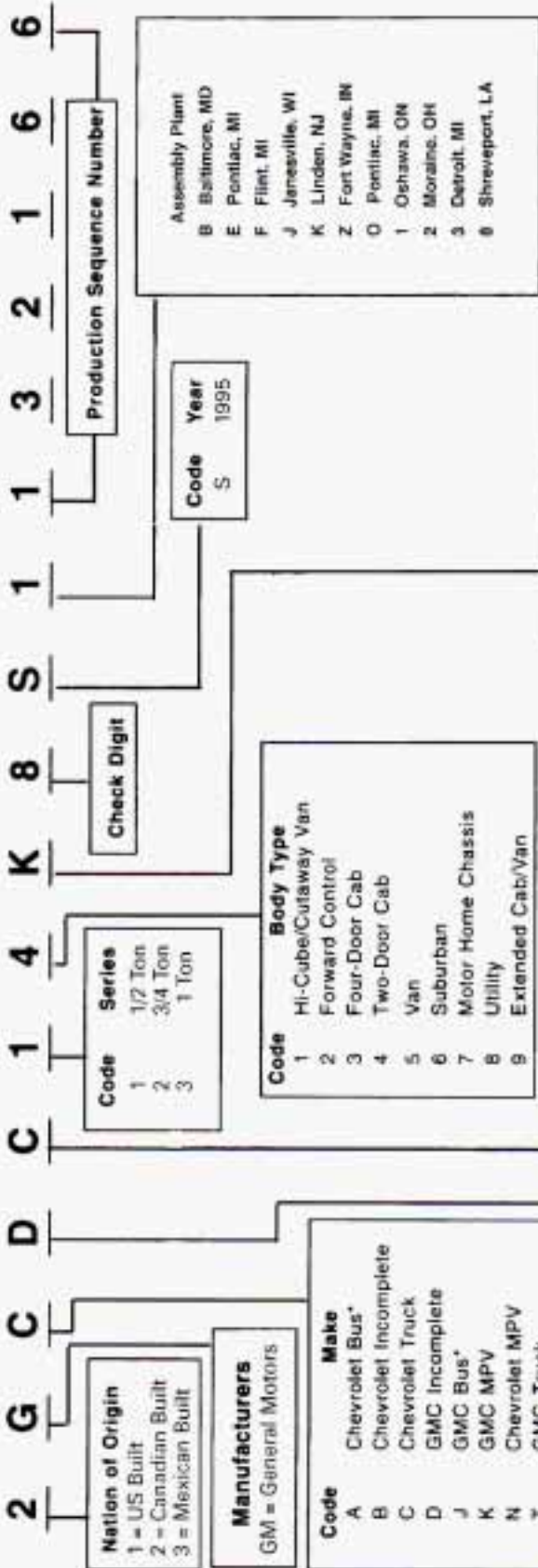

Engine Type and Make

Code	Producer	Type	RPO
4	GMPT	2.2L4MFI	LN2
F	GMPT	6.5L V8 DIESEL	L65
H	GMPT	5.0L V8 EFI	L03
K	GMPT	5.7L V8 EFI	L05
N	GMPT	7.4L V8 EFI	L19
P	GMPT	6.5L V8 DIESEL	L49
S	GMPT	6.5L V8 DIESEL	L56
W	GMPT	4.3L V6 CPI	L35
Y	GMPT	6.5L V8 DIESEL	L57
Z	GMPT	4.3L V6 EFI	LB4

Line and Chassis Type

Code	Line	Chassis Type
C	Conventional Cab	4x2
D	Military Truck	4x4
K	Conventional Cab	4x4
G	Van	4x2
P	Forward Control	4x2
S	Sm Conventional Cab	4x2
T	Sm Conventional Cab	4x4
M	Sm Van	4x2
L	Sm Van	4x4
H	Chassis Cutaway	4x2

GVWR/BRAKE SYSTEM

Code	GVWR Range	Brake System
B	3001-4000	Hydraulic
C	4001-5000	Hydraulic
D	5001-6000	Hydraulic
E	6001-7000	Hydraulic
F	7001-8000	Hydraulic
G	8001-9,000	Hydraulic
H	9,001-10,000	Hydraulic
J	10,001-14,000	Hydraulic
K	14,001-16,000	Hydraulic

Service Parts Identification Label

You'll find this label on the inside of the glove box.

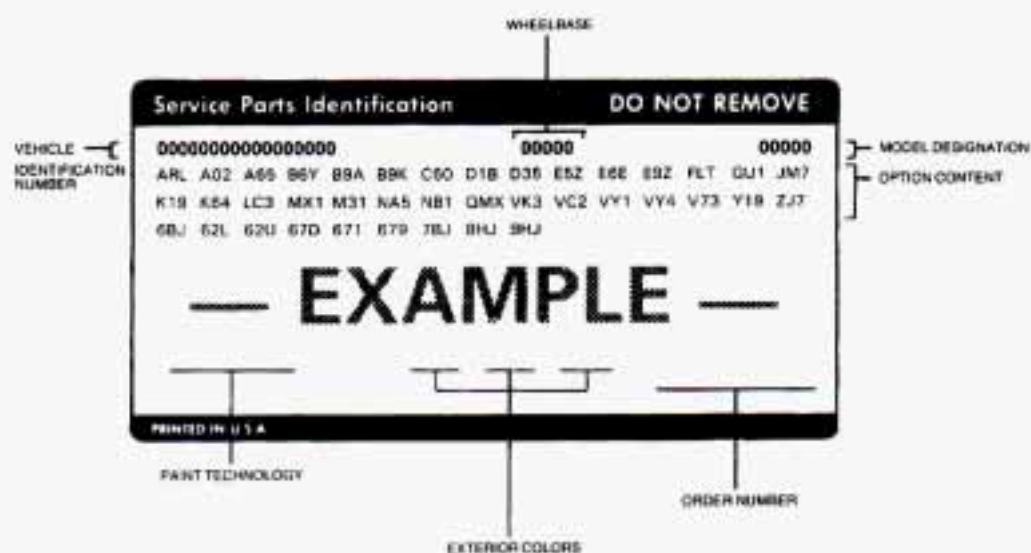

It's very helpful if you ever need to order parts. On this label is:

- your VIN,
- the model designation,
- paint information, and
- a list of all production options and special equipment.

Be sure that this label is not removed from the vehicle.

Add-On Electrical Equipment

NOTICE:

Don't add anything electrical to your vehicle unless you check with your dealer first. Some electrical equipment can damage your vehicle and the damage wouldn't be covered by your warranty. Some add-on electrical equipment can keep other components from working as they should.

Your vehicle has an air bag system. Before attempting to add anything electrical to your vehicle, see "Servicing Your Air Bag-Equipped Vehicle" in the Index.

Fuses and Circuit Breakers

The wiring circuits in your vehicle are protected from short circuits by a combination of fuses, circuit breakers, and fusible thermal links in the wiring itself. This greatly reduces the chance of fires caused by electrical problems. See “Fuses and Circuit Breakers” in the Index for more information.

Headlamps

The headlamp wiring is protected by a circuit breaker in the lamp switch. An electrical overload will cause the lamps to flicker on and off, or in some cases to remain off. If this happens, have your headlamp wiring checked right away.

Windshield Wipers

The windshield wiper motor is protected by a circuit breaker and a fuse. If the motor overheats due to heavy snow, etc., the wiper will stop until the motor cools. Although the circuit is protected from electrical overload, overload due to heavy snow, etc., may cause wiper linkage damage. Always clear ice and heavy snow from the the windshield before using the windshield wipers. If the overload is caused by some electrical problem and not snow, etc., be sure to get it fixed.

Power Windows and Other Power Options

Circuit breakers in the fuse panel protect the power windows and other power accessories. When the current load is too heavy, the circuit breaker opens and closes. This protects the circuit until the current load returns to normal or the problem is fixed.

Trailer Wiring Harness

The optional seven-wire trailer wiring harness is protected by an in-line fuse in the battery feed wire. This fuse is near the junction block. See “Trailer Wiring Harness” in the Index for more information.

Fuse Block



The fuse block access door is on the driver's side edge of the instrument panel. Pull off the cover to access the fuse block.

You can remove fuses with a fuse extractor. The fuse extractor is mounted to the fuse block access door.

To remove fuses if you don't have a fuse extractor, hold the end of the fuse between your thumb and index finger and pull straight out.

Be sure to use the correct fuse. If you ever have a problem on the road and don't have a spare fuse, you can "borrow" one of the correct value. Just pick some feature of your vehicle that you can get along without—like the radio or cigarette lighter—and use its fuse, if it is of the value you need. Replace it as soon as you can. See "Fuses and Circuit Breakers" in the Index for more information.

Specification Charts

Replacement Parts

Replacement part numbers listed in this section are based on the latest information available at the time of printing, and are subject to change. If a part listed in this manual is not the same as the part used in your vehicle when it was built, or if you have any questions, please contact your GM truck dealer.

These specifications are for information only. If you have any questions, see the service manual for the chassis or refer to the body manufacturer's publications.

Engine Identification — Gasoline Engines

Engine	4.3L	5.0L
Type	V6	V8
VIN Code	Z	H
Fuel System	TBI†	TBI†
Emissions	LD*/HD**	LD

*Light Duty Emissions with 8,500 lbs. (3 850 Kg) GVWR and below.

**Heavy Duty Emissions over 8,500 lbs. (3 850 Kg) GVWR.

†Throttle Body Injection

Engine Identification — Gasoline Engines (cont.)

Engine	5.7L	7.4L
Type	V8	V8
VIN Code	K	N
Fuel System	TBI†	TBI†
Emissions	LD*/HD**	LD*/HD**

*Light Duty Emissions with 8,500 lbs. (3 850 Kg) GVWR and below.

**Heavy Duty Emissions over 8,500 lbs. (3 850 Kg) GVWR.

†Throttle Body Injection

Engine Identification — Diesel Engines

Engine	6.5L	6.5L	6.5L
Type	V8	V8	V8
VIN Code	P	S	F
Fuel System	Diesel	Turbo Diesel	Turbo Diesel

Wheel Nut Torque

MODEL	DESCRIPTION	TORQUE
C 1500	5 bolts (14mm)	120 ft. lbs. (160 N•m)
K 1500 & C-K 2500	6 bolts (14mm)	120 ft. lbs. (160 N•m)
C-K 2500 (w/C6P)	8 bolts (14mm)	120 ft. lbs. (160 N•m)
C-K 3500		
—Single Rear Wheels	8 bolts (14mm)	120 ft. lbs. (160 N•m)
C3500		
—Dual Rear Wheels	8 bolts (14mm)	140 ft. lbs. (190 N•m)
C3500 HD		
—Front	5 bolts (5/8 in.)	175 ft. lbs. (240 N•m)
—Rear	10 bolts (5/8 in.)	175 ft. lbs. (240 N•m)

Cooling System Capacity

ENGINE	VIN	QUANTITY*
4.3L	Z	13 Quarts (12.3 Liters)
5.0L	H	17.5 Quarts (16.6 Liters)
5.7L	K	17.5 Quarts (16.5 Liters)
5.7L w/3500 HD	K	27 Quarts (25.5 Liters)
6.5L	P	23.5 Quarts (22.2 Liters)
6.5L	S	23.5 Quarts (22.2 Liters)
6.5L	F	23.5 Quarts (22.2 Liters)
7.4L	N	25 Quarts (23.5 Liters)
7.4L w/3500 HD	N	28.5 Quarts (27 Liters)

After refill, the level **MUST** be checked as outlined under “Engine Cooling System” in Section 5.

*All quantities are approximate.

Crankcase Capacity

ENGINE	VIN	QUANTITY WITH FILTER†
4.3L	Z	4.5 Quarts (4.3 Liters)
5.0L	H	5 Quarts (4.8 Liters)
5.7L*	K	5 Quarts (4.8 Liters)
6.5L	P	7 Quarts (6.5 Liters)
6.5L	S	7 Quarts (6.5 Liters)
6.5L	F	7 Quarts (6.5 Liters)
7.4L*	N	7 Quarts (6.5 Liters)

After refill, the level **MUST** be checked as outlined under “Engine Oil And Filter Recommendations” in Section 5.

All quantities are approximate.

*Add one additional quart for C3500 HD Models.

†Oil filter should be changed at **EVERY** oil change.

Fuel Tank Capacity

TYPE	QUANTITY
Gasoline/Diesel	
with Short Bed	26 Gallons (98 Liters)
with Long Bed	34 Gallons (128 Liters)
Crew Cab	
Standard	34 Gallons (128 Liters)
Chassis–Cab Models	
Standard (Side Tank)	23 Gallons (87 Liters)
Optional (Rear Tank)	31 Gallons (117 Liters)
3500 HD Models	
Standard (Side Tank)	23 Gallons (87 Liters)
Optional (Rear Tank)	31 Gallons (117 Liters)

All quantities are for a completely dry tank and are approximate.

Service Replacement Part and Filter Recommendations — Gasoline Engines

Engine	4.3L	5.0L	5.7L	7.4L
VIN	Z	H	K	N
Oil Filter	PF52	PF1218†	PF1218†	PF1218
Air Cleaner Filter	A178CW	A348C	A348C	A348C
PCV Valve	CV789C	CV774C	CV774C	CV774C
Spark Plugs*	.CR43TS	.CR43TS	.CR43TS	.CR43TS
Fuel Filter	GF481	GF481	GF481	GF481
Radiator Cap	RC36	RC36	RC36	RC36

†Four Wheel Drive Vehicle — use a PF52 oil filter

*Use AC copper-cored resistor type spark plugs

Service Replacement Part and Filter Recommendations — Diesel Engines

Engine	6.5L	6.5L	6.5L
VIN	P	S	F
Oil Filter	PF1218	PF1218	PF1218
Air Cleaner	A917C	A917C	A917C
Fuel Filter	TP1006	TP1006	TP1006
Surge Tank Cap	RC33	RC33	RC33

Air Conditioning Refrigerants

Not all air conditioning refrigerants are the same. If the air conditioning system in your vehicle needs refrigerant, be sure the proper refrigerant is used. If you're not sure, ask your GM dealer. For additional information, see your "Warranty and Owner Assistance Information" booklet.

NOTICE:

R-134A refrigerant is not compatible with R-12 refrigerant in an air conditioning system. R-12 in an R-134A system will cause compressor failure, refrigerant oil sludge, or poor air conditioning system performance.

Air Conditioning Refrigerant Capacity

TYPE	QTY
Refrigerant R-134A	2.25 lbs. (1.020 kg)

Fuse Block

FUSE LEGEND	
5 AMP	TAN
7.5 AMP	BROWN
10 AMP	RED
15 AMP	BLUE
20 AMP	YELLOW
25 AMP	CLEAR
30 AMP	GREEN

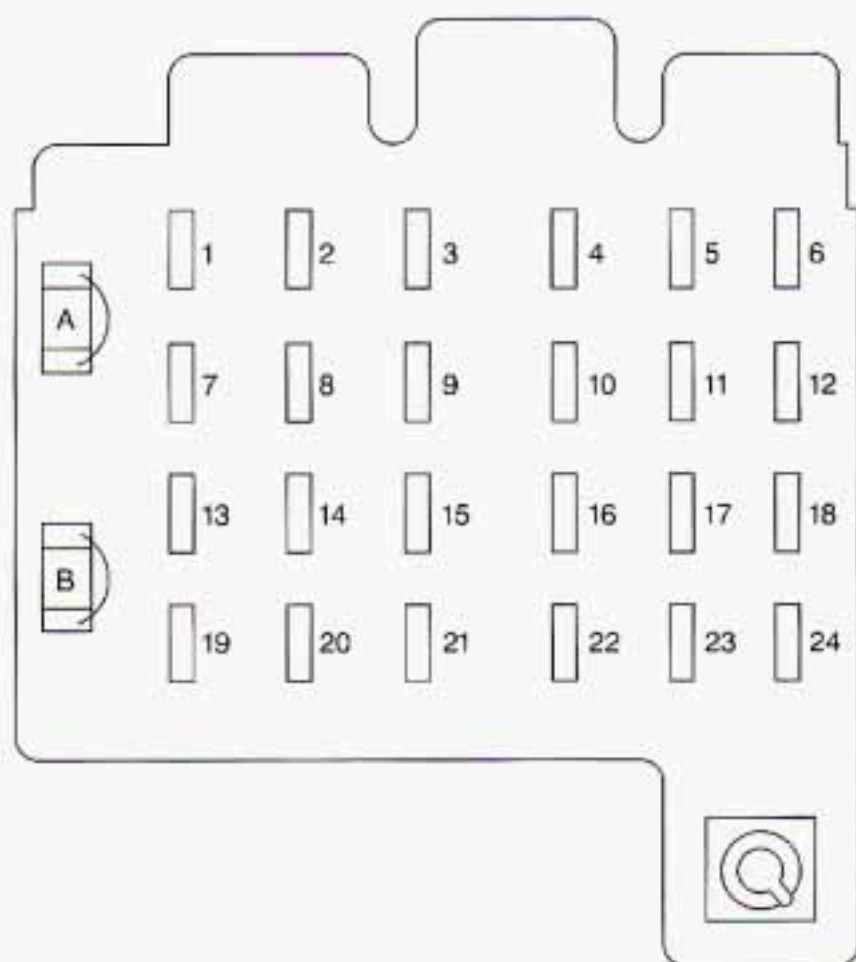

Fuses and Circuit Breakers

POSITION	NAME	CIRCUITS PROTECTED
1.	STOP/HAZ	Stop/TCC Switch, Buzzer, CHMSL, Hazard Lamps, Stop Lamps
2.	T CASE	Transfer Case
3.	CTSY	Courtesy Lamps, Cargo Lamp, Glove Box Light, Dome/RDG Lamps, Vanity Mirrors, Pwr Mirrors
4.	GAGES	IP Cluster, DRL Relay, HDLP Switch, Keyless Entry, Low Coolant Module
5.	RR HVAC	RR HVAC Controls
6.	CRUISE	Cruise Control
7.	AUX PWR	Aux Power Outlet
8.	CRANK	Diesel Fuel Pump, DERM, ECM
9.	PARK LPS	Lic Lamp, Park Lamp, Tail Lamp, Roof Marker Lamp, Tail Gate Lamps, Front Side Markers, Fog Lamp Relay, Door Switch Illum, Fender Lamps
10.	AIR BAG	DERM
11.	WIPER	Wiper Motor, Washer Pump
12.	HTR-A/C	A/C, A/C Blower, High Blower Relay
13.	CIG LTR	Power Amp, Rear Liftglass, Cig Lighter, Door Lock Relay, Pwr Lumbar Seat
14.	ILLUM	4WD, Indicator, LP Cluster, HVAC Controls, RR HVAC Controls, IP Switches, Radio Illumination
15.	DRL-FOG	DRL Relay, Fog Lamp Relay
16.	TURN-B/U	Frt Turn, RR Turn, B/U Lps
17.	RADIO	Radio (Ign)
18.	BRAKE	DRAC, 4WAL PCM, ABS, Cruise
19.	RADIO BATT	Radio (Batt)
20.	TRANS	PRNDL, Auto Transmission, Speedo, Check Gages Tell Tale
21.		Not Used
22.		Not Used

POSITION	NAME	CIRCUITS PROTECTED
23.	RR Wiper	Rear Wiper, Rear Wash Pump
24.	4WD	Frt Axle, 4WD Indicator Lamp
A.†	PWR ACCY	Pwr Door Lock, 6-Way Pwr Seat, Keyless Entry Module
B.†	PWR WDOS	Power Windows

†Circuit Breaker

Lamp and Bulb Data

LAMP OR BULB	TRADE NO.	POWER RATING AT 12.8V, WATTS	QTY
---------------------	------------------	-------------------------------------	------------

HEADLAMPS

2 Headlamp System (Sealed Beam)

Low/High Beam	H6054	35/65	2
---------------	-------	-------	---

4 Headlamp System (Composite)

Low/High Beam	6052	55/65	2
---------------	------	-------	---

High Beam	9005	65	2
-----------	------	----	---

LAMP OR BULB	TRADE NO.	QTY
---------------------	------------------	------------

EXTERIOR

Front Marker Lamp	194	2
-------------------	-----	---

Front Park and Turn Lamp	2357NA	4
--------------------------	--------	---

Rear Parking Lamp	3057	2
-------------------	------	---

Rear Stop and Turn Lamp	3057	2
-------------------------	------	---

Backup Lamp	3156	2
-------------	------	---

Backup Lamp	1156	2
-------------	------	---

Rear Park, Stop, and Turn Lamp*	1157	2
---------------------------------	------	---

LAMP OR BULB	TRADE NO.	QTY
EXTERIOR		
Fender Clearance Lamp	194	4
Roof Marker Lamp	194	5
Cargo Lamp/CHMSL	921	4
License Plate Lamp	194	2
Underhood Lamp	232	1
Reel Lamp	232	1

*Chassis Cab Only

LAMP OR BULB	TRADE NO.	QTY
INTERIOR		
Dome Lamps	211-2	2
Reading Lamps	211-2	4
Roof Console Lamps*	168	2
IP Courtesy Lamp	194	2
Door Courtesy Lamp	194	2*/4**
Four Wheel Drive Indicator	194	1
Four Wheel Drive Shift Lever	194	1
Instrument Panel Compartment Lamp	194	1
Ashtray Lamp	194	1
Sunshade Vanity Mirror	74	4

*Regular Pickup Model

**Crew Cab Model

LAMP OR BULB INSTRUMENT PANEL	TRADE NO.	QTY
Daytime Running Lamps Indicator†	74	1
Charging System Indicator Lamp	74	1
Instrument Cluster Illumination	194	6
Headlamp Beam Indicator	74	1
Directional Signal Indicator	74	2
Brake Warning Indicator	74	1
SIR (Air Bag)	74	1
Safety Belt Warning	74	1
Check Gages Indicator	74	1
Malfunction Indicator ("Service Engine Soon") Lamp	74	1
Upshift Indicator	74	1
Glow Plugs Lamp**	74	1
Low Coolant Lamp**	74	1
Water in Fuel Lamp**	74	1
Service Throttle Soon Lamp**	74	1

**Diesel only

†Canadian Vehicles only

Scheduled Maintenance Services

Section

7

IMPORTANT:

**KEEP ENGINE OIL
AT THE PROPER
LEVEL AND CHANGE
AS RECOMMENDED**

This section covers the maintenance required for your vehicle. Your vehicle needs these services to retain its safety, dependability and emission control performance.



Have you purchased the GM Protection Plan? The Plan supplements your new vehicle warranties. See your GM dealer for details.

Introduction

Your Vehicle and the Environment

Proper vehicle maintenance not only helps to keep your vehicle in good working condition, but also helps the environment. All recommended maintenance procedures are important. Improper vehicle maintenance or the removal of important components can significantly affect the quality of the air we breathe. Improper fluid levels or even the wrong tire inflation can increase the level of emissions from your vehicle. To help protect our environment, and to help keep your vehicle in good condition, please maintain your vehicle properly.

How This Section is Organized

The remainder of this section is divided into five parts:

“Part A: Scheduled Maintenance Services” shows what to have done and how often. Some of these services can be complex, so unless you are technically qualified and have the necessary equipment, you should let your dealer’s service department or another qualified service center do these jobs.



CAUTION:

Performing maintenance work on a vehicle can be dangerous. In trying to do some jobs, you can be seriously injured. Do your own maintenance work only if you have the required know-how and the proper tools and equipment for the job. If you have any doubt, have a qualified technician do the work.

If you are skilled enough to do some work on your vehicle, you will probably want to get the service information GM publishes. You will find a list of publications and how to get them in this manual. See “Service Publications” in the Index.

“Part B: Owner Checks and Services” tells you what should be checked whenever you stop for fuel. It also explains what you can easily do to help keep your vehicle in good condition.

“Part C: Periodic Maintenance Inspections” explains important inspections that your GM dealer’s service department or another qualified service center should perform.

“Part D: Recommended Fluids and Lubricants” lists some products GM recommends to help keep your vehicle properly maintained. These products, or their equivalents, should be used whether you do the work yourself or have it done.

“Part E: Maintenance Record” provides a place for you to record the maintenance performed on your vehicle. Whenever any maintenance is performed, be sure to write it down in this part. This will help you determine when your next maintenance should be done. In addition, it is a good idea to keep your maintenance receipts. They may be needed to qualify your vehicle for warranty repairs.

Part A: Scheduled Maintenance Services

Using Your Maintenance Schedule

We at General Motors want to help you keep your vehicle in good working condition. But we don't know exactly how you'll drive it. You may drive very short distances only a few times a week. Or you may drive long distances all the time in very hot, dusty weather. You may use your vehicle in making deliveries. Or you may drive it to work, to do errands or in many other ways.

Because of all the different ways people use their GM vehicles, maintenance needs vary. You may even need more frequent checks and replacements than you'll find in the schedules in this section. So please read this section and note how you drive. If you have any questions on how to keep your vehicle in good condition, see your GM dealer.

This part tells you the maintenance services you should have done and when you should schedule them. If you go to your dealer for your service needs, you'll know that GM-trained and supported service people will perform the work using genuine GM parts.

The proper fluids and lubricants to use are listed in Part D. Make sure whoever services your vehicle uses these. All parts should be replaced and all necessary repairs done before you or anyone else drives the vehicle.

These schedules are for vehicles that:

- carry passengers and cargo within recommended limits. You will find these limits on your vehicle's Certification/Tire label. See "Loading Your Vehicle" in the Index.
- are driven on reasonable road surfaces within legal driving limits.
- are driven off-road in the recommended manner. See "Off Road Driving With Your Four-Wheel Drive Vehicle" in the Index.
- use the recommended unleaded fuel. See "Fuel" in the Index.

Selecting the Right Schedule

The proper maintenance schedule for your vehicle depends on which engine you have in your vehicle and how you use your vehicle.

Gasoline engine vehicles and diesel engine vehicles have different maintenance requirements. If you have a diesel engine, follow a schedule designated for diesel engine vehicles only. If you have a gasoline engine, you must first determine whether your engine has a light duty or a heavy duty emissions classification. Follow a maintenance schedule designated for gasoline engines with the emissions classification (light duty or heavy duty) for your engine. See "Engine Identification" in the Index to find your engine's emission classification.

If your engine has more than one emissions classification, the classification is determined by the Gross Vehicle Weight Rating (GVWR) of your vehicle as shown on the Certification Label. See “Loading Your Vehicle” in the Index.

Once you’ve determined your engine type and, if necessary, emissions classification, you’ll need to decide which of the two schedules is right for your vehicle. See Definitions for Maintenance Schedule I and Maintenance Schedule II following.

Schedule I Definition – Gasoline Engines With Light Duty Emissions

Follow Maintenance Schedule I if any one of these is true for your vehicle:

- Most trips are less than 5 to 10 miles (8 to 16 km). This is particularly important when outside temperatures are below freezing.
- Most trips include extensive idling (such as frequent driving in stop-and-go traffic).
- You operate your vehicle in dusty areas or off-road frequently.
- You frequently tow a trailer.

Schedule I should also be followed if the vehicle is used for delivery service, police, taxi, or other commercial application.

Schedule I Intervals – Gasoline Engines With Light Duty Emissions

Every 3,000 Miles (5 000 km) or 3 Months

Engine Oil and Filter Change

Chassis Lubrication

Drive Axle Service

At 6,000 Miles (10 000 km) – Then Every 12,000 Miles (25 000 km)

Tire Rotation

Every 15,000 Miles (25 000 km)

Air Cleaner Filter Inspection, if driving in dusty conditions

Front Wheel Bearing Repack (or at each brake relining) (2WD Only)

Every 30,000 Miles (50 000 km)

Air Cleaner Filter Replacement

Spark Plug Replacement

Fuel Filter Replacement

Clutch Fork Ball Stud Lubrication (5-Speed Manual Transmission With Deep-Low Only)

Cooling System Service (or every 24 months)

Every 50,000 Miles (83 000 km)

Automatic Transmission Service (severe conditions)

Every 60,000 Miles (100 000 km)

Engine Accessory Drive Belt Inspection

Spark Plug Wire Inspection

Engine Timing Check

Fuel Tank, Cap and Lines Inspection

Schedule II Definition – Gasoline Engines With Light Duty Emissions

Follow Schedule II *only* if none of the conditions from Schedule I is true.

Schedule II Intervals – Gasoline Engines With Light Duty Emissions

Every 7,500 Miles (12 500 km)

Engine Oil and Filter Change (or every 12 months)

Chassis Lubrication (or every 12 months)

Drive Axle Service

At 7,500 Miles (12 500 km)

Rear Axle Fluid Change (Limited-Slip Differential)

At 7,500 Miles (12 500 km) – Then Every 15,000 Miles (25 000 km)

Tire Rotation

Every 15,000 Miles (25 000 km)

Front Wheel Bearing Repack (or at each brake relining) (2WD Only)

Every 30,000 Miles (50 000 km)

Cooling System Service (or every 24 months)

Spark Plug Replacement

Fuel Filter Replacement

Air Cleaner Filter Replacement

Front Wheel Bearing Repack

Every 50,000 Miles (83 000 km)

Automatic Transmission Service (severe conditions)

Every 60,000 Miles (100 000 km)

Spark Plug Wire Inspection

Engine Accessory Drive Belt Inspection

Fuel Tank, Cap and Lines Inspection

Engine Timing Check

Schedule I Definition – Gasoline Engines With Heavy Duty Emissions

Follow Maintenance Schedule I if any one of these is true for your vehicle:

- Most trips are less than 5 to 10 miles (8 to 16 km). This is particularly important when outside temperatures are below freezing.
- Most trips include extensive idling (such as frequent driving in stop and go traffic).
- You operate your vehicle in dusty areas or off-road frequently.
- You frequently tow a trailer.

Schedule I should also be followed if the vehicle is used for delivery service, police, taxi, or other commercial application.

Schedule I Intervals – Gasoline Engines with Heavy Duty Emissions

Every 3,000 Miles (5 000 km)

Engine Oil and Filter Change (or every 3 months)

Chassis Lubrication (or every 3 months)

Drive Axle Service

At 6,000 Miles (10 000 km) – Then Every 12,000 Miles (25 000 km)

Tire Rotation

Every 12,000 Miles (20 000 km)

Air Cleaner Filter Inspection, if Driving in Dusty Conditions

Front Wheel Bearing Repack (or at Each Brake Relining) (2–Wheel Drive Only)

Fuel Filter Replacement

Engine Accessory Drive Belt Inspection

Shields and Underhood Insulation Inspection

Thermostatically Controlled Engine Cooling Fan Check (or every 12 months)

Every 24,000 Miles (40 000 km)

Cooling System Service (or every 24 months)

Air Cleaner Filter Replacement

Engine Timing Check

Thermostatically Controlled Air Cleaner Inspection

Air Intake System Inspection

Every 27,000 Miles (45 000 km)

Spark Plugs Replacement

Every 30,000 Miles (50 000 km)

Clutch Fork Ball Stud Lubrication

Every 50,000 Miles (83 000 km)

Automatic Transmission Service

Every 60,000 Miles (100 000 km)

Spark Plug Wire Inspection

Exhaust Gas Recirculation (EGR) System Inspection

Fuel Tank, Cap and Lines Inspection

Evaporative Control System Inspection

Electronic Vacuum Regulator Valve (EVRV) Inspection

Schedule II Definition – Gasoline Engines With Heavy Duty Emissions

Follow Schedule II *only* if none of the conditions from Schedule I is true.

Schedule II Intervals – Gasoline Engines with Heavy Duty Emissions

Every 6,000 Miles (10 000 km)

Engine Oil and Filter Change (or every 3 months)

Chassis Lubrication (or every 3 months)

Drive Axle Service

At 6,000 Miles (10 000 km) – Then Every 12,000 Miles (20 000 km)

Tire Rotation

Every 12,000 Miles (20 000 km)

Engine Accessory Drive Belt Inspection

Shields and Underhood Insulation Inspection

Thermostatically Controlled Engine Cooling Fan Check (or every 12 months)

Every 24,000 Miles (40 000 km)

Cooling System Service (or every 24 months)

Air Cleaner Filter Replacement

Front Wheel Bearing Repack (or at Each Brake Relining) (2-Wheel Drive Only)

Fuel Filter Replacement

Engine Timing Check

Thermostatically Controlled Air Cleaner Inspection

Air Intake System Inspection

Every 27,000 Miles (45 000 km)

Spark Plugs Replacement

Every 30,000 Miles (50 000 km)

Clutch Fork Ball Stud Lubrication

Every 50,000 Miles (83 000 km)

Automatic Transmission Service

Every 60,000 Miles (100 000 km)

Spark Plug Wire Inspection

Exhaust Gas Recirculation (EGR) System Inspection

Fuel Tank, Cap and Lines Inspection

Evaporative Emission Control System Inspection

Electronic Vacuum Regulator Valve (EVRV) Inspection

Schedule I Definition – Diesel Engines

Follow Maintenance Schedule I if any one of these is true for your vehicle:

- Most trips are less than 5 to 10 miles (8 to 16 km). This is particularly important when outside temperatures are below freezing.
- Most trips include extensive idling (such as frequent driving in stop and go traffic).
- You operate your vehicle in dusty areas or off-road frequently.
- You frequently tow a trailer.

Schedule I should also be followed if the vehicle is used for delivery service, police, taxi, or other commercial application.

Schedule I Intervals – Diesel Engines

Every 2,500 Miles (4 000 km)

Engine Oil and Filter Change (or every 3 months)

Chassis Lubrication (or every 3 months)

Air Cleaner Filter Inspection, if Driving in Extremely Dusty or Dirty (Off-Road) Conditions

Every 5,000 Miles (8 000 km)

Drive Axle Service

Every 7,500 Miles (12 000 km)

Air Cleaner Filter Inspection, if Driving in Dusty Conditions

At 7,500 Miles (12 000 km) – Then Every 15,000 Miles (24 000 km)

Tire Rotation

Every 10,000 Miles (16 000 km)

Shields and Underhood Insulation Inspection

Thermostatically Controlled Engine Cooling Fan Check (or every 12 months)

Air Intake System Inspection

Every 15,000 Miles (24 000 km)

Air Cleaner Filter Replacement

Front Wheel Bearing Repack (or at Each Brake Relining) (2-Wheel Drive Only)

Every 30,000 Miles (50 000 km)

Clutch Fork Ball Stud Lubrication

Fuel Filter Replacement

Cooling System Service (or every 24 months)

Every 50,000 Miles (80 000 km)

Automatic Transmission Service

Every 60,000 Miles (100 000 km)

Crankcase Depression Regulator Valve (CDRV) System Check
Engine Accessory Drive Belt Inspection
Fuel Tank, Cap and Lines Inspection
Evaporative Control System Inspection
Exhaust Gas Recirculation (EGR) System Inspection (if equipped)
Exhaust Pressure Regulator Valve Inspection

Schedule II Definition – Diesel Engines

Follow Schedule II *only* if none of the conditions from Schedule I is true.

Schedule II Intervals – Diesel Engines

Every 5,000 Miles (8 000 km)

Engine Oil and Filter Change (or every 12 months)
Chassis Lubrication (or every 12 months)
Drive Axle Service

At 5,000 Miles (8 000 km) – Then Every 10,000 Miles (16 000 km)

Tire Rotation

Every 10,000 Miles (16 000 km)

Shields and Underhood Insulation Inspection
Air Intake System Inspection
Thermostatically Controlled Engine Cooling Fan Check (or every 12 months)

Every 30,000 Miles (48 000 km)

Cooling System Service (or every 24 months)
Front Wheel Bearing Repack (or at Each Brake Relining) (2-Wheel Drive Only)
Fuel Filter Replacement
Air Cleaner Filter Replacement
Clutch Fork Ball Stud Lubrication

Every 50,000 Miles (83 000 km)

Automatic Transmission Service

Every 60,000 Miles (100 000 km)

Crankcase Depression Regulator Valve (CDRV) System Inspection

Engine Accessory Drive Belt Inspection

Exhaust Gas Recirculation (EGR) System Inspection (if equipped)

Exhaust Pressure Regulator Valve Inspection

Maintenance Schedule I — Gasoline Engines With Light Duty Emissions

The services shown in this schedule up to 60,000 miles (100 000 km) should be performed after 60,000 miles (100 000 km) at the same intervals.

Footnotes

† The California Air Resources Board has determined that the failure to perform this maintenance item will not nullify the emission warranty or limit recall liability prior to the completion of vehicle useful life. We, however, urge that all recommended maintenance services be performed at the indicated intervals and the maintenance be recorded.

** Drive axle service:

- Locking Differential — Drain fluid and refill at first engine oil change. At subsequent oil changes, check fluid level and add fluid as needed. If driving in dusty areas or towing a trailer, drain fluid and refill every 15,000 miles (25 000 km).
 - Standard Differential — Check fluid level and add fluid as needed at every oil change. If driving in dusty areas or towing a trailer, drain fluid and refill every 15,000 miles (25 000 km).
 - More frequent lubrication may be required for heavy-duty or off-road use.
 - 3500 HD Models with applications requiring extreme overload/trailer towing conditions and high speed (above 45 mph or 72 km/h) conditions for extended periods of time must have the drive axle fluid changed every 3,000 miles (5 000 km) or 3 months, whichever occurs first, or must use 75W-140 synthetic fluid meeting GM specifications. See “Recommended Fluids and Lubricants” in this section.
-

Maintenance Schedule I — Gasoline Engines With Light Duty Emissions

3,000 Miles (5 000 km)

- Change engine oil and filter (or every 3 months, whichever occurs first). *An Emission Control Service.*
- Lubricate the front suspension, king pin bushings, steering linkage, transmission shift linkage, transfer case shift linkage, parking brake cable guides, rear driveline center splines, front axle propshaft splines, brake pedal springs and clutch pedal springs. Ball joints and king pin bushings should not be lubricated unless their temperature is 10° F (–12° C), or higher. When weather is cold, let the ball joints and king pin bushings warm up before lubrication or they could be damaged. Perform each of the listed lubrication service items at this mileage interval (or every 6 months, whichever occurs first).
- Check rear/front axle fluid level and add fluid as needed. Check constant velocity joints and axle seals for leaking. **

DATE	ACTUAL MILEAGE	SERVICED BY:

6,000 Miles (10 000 km)

- Change engine oil and filter (or every 3 months, whichever occurs first). *An Emission Control Service.*
- Lubricate the front suspension, king pin bushings, steering linkage, transmission shift linkage, transfer case shift linkage, parking brake cable guides, rear driveline center splines, front axle propshaft splines, brake pedal springs and clutch pedal springs. Ball joints and king pin bushings should not be lubricated unless their temperature is 10° F (–12° C), or higher. When weather is cold, let the ball joints and king pin bushings warm up before lubrication or they could be damaged. Perform each of the listed lubrication service items at this mileage interval (or every 6 months, whichever occurs first).
- Check rear/front axle fluid level and add fluid as needed. Check constant velocity joints and axle seals for leaking. **

(Continued)

Maintenance Schedule I — Gasoline Engines With Light Duty Emissions

(Continued)

- Rotate tires. See "Tire Inspection and Rotation" in the Index for proper rotation pattern and additional information.

DATE	ACTUAL MILEAGE	SERVICED BY:

9,000 Miles (15 000 km)

- Change engine oil and filter (or every 3 months, whichever occurs first). *An Emission Control Service.*
- Lubricate the front suspension, king pin bushings, steering linkage, transmission shift linkage, transfer case shift linkage, parking brake cable guides, rear driveline center splines, front axle propshaft splines, brake pedal springs and clutch pedal springs. Ball joints and king pin bushings should not be lubricated unless their temperature is 10° F (-12° C), or higher. When weather is cold, let the ball joints and king pin bushings warm up before lubrication or they could be damaged. Perform each of the listed lubrication service items at this mileage interval (or every 6 months, whichever occurs first).
- Check rear/front axle fluid level and add fluid as needed. Check constant velocity joints and axle seals for leaking. **

DATE	ACTUAL MILEAGE	SERVICED BY:

Maintenance Schedule I — Gasoline Engines With Light Duty Emissions

12,000 Miles (20 000 km)

- Change engine oil and filter (or every 3 months, whichever occurs first). *An Emission Control Service.*
- Lubricate the front suspension, king pin bushings, steering linkage, transmission shift linkage, transfer case shift linkage, parking brake cable guides, rear driveline center splines, front axle propshaft splines, brake pedal springs and clutch pedal springs. Ball joints and king pin bushings should not be lubricated unless their temperature is 10° F (-12° C), or higher. When weather is cold, let the ball joints and king pin bushings warm up before lubrication or they could be damaged. Perform each of the listed lubrication service items at this mileage interval (or every 6 months, whichever occurs first).
- Check rear/front axle fluid level and add fluid as needed. Check constant velocity joints and axle seals for leaking. **

DATE	ACTUAL MILEAGE	SERVICED BY:

15,000 Miles (25 000 km)

- Change engine oil and filter (or every 3 months, whichever occurs first). *An Emission Control Service.*
- Lubricate the front suspension, king pin bushings, steering linkage, transmission shift linkage, transfer case shift linkage, parking brake cable guides, rear driveline center splines, front axle propshaft splines, brake pedal springs and clutch pedal springs. Ball joints and king pin bushings should not be lubricated unless their temperature is 10° F (-12° C), or higher. When weather is cold, let the ball joints and king pin bushings warm up before lubrication or they could be damaged. Perform each of the listed lubrication service items at this mileage interval (or every 6 months, whichever occurs first).
- Inspect air cleaner filter if you are driving in dusty conditions. Replace filter if necessary. *An Emission Control Service.*

(Continued)

Maintenance Schedule I — Gasoline Engines With Light Duty Emissions

(Continued)

- Check rear/front axle fluid level and add fluid as needed. Check constant velocity joints and axle seals for leaking. **
- For 2-Wheel Drive vehicles only: Clean and repack the front wheel bearings (or at each brake relining, whichever occurs first).

DATE	ACTUAL MILEAGE	SERVICED BY:

18,000 Miles (30 000 km)

- Change engine oil and filter (or every 3 months, whichever occurs first). *An Emission Control Service.*
- Lubricate the front suspension, king pin bushings, steering linkage, transmission shift linkage, transfer case shift linkage, parking brake cable guides, rear driveline center splines, front axle propshaft splines, brake pedal springs and clutch pedal springs. Ball joints and king pin bushings should not be lubricated unless their temperature is 10° F (-12° C), or higher. When weather is cold, let the ball joints and king pin bushings warm up before lubrication or they could be damaged. Perform each of the listed lubrication service items at this mileage interval (or every 6 months, whichever occurs first).
- Check rear/front axle fluid level and add fluid as needed. Check constant velocity joints and axle seals for leaking. **
- Rotate tires. See "Tire Inspection and Rotation" in the Index for proper rotation pattern and additional information.

DATE	ACTUAL MILEAGE	SERVICED BY:

Maintenance Schedule I — Gasoline Engines With Light Duty Emissions

21,000 Miles (35 000 km)

- Change engine oil and filter (or every 3 months, whichever occurs first). *An Emission Control Service.*
- Lubricate the front suspension, king pin bushings, steering linkage, transmission shift linkage, transfer case shift linkage, parking brake cable guides, rear driveline center splines, front axle propshaft splines, brake pedal springs and clutch pedal springs. Ball joints and king pin bushings should not be lubricated unless their temperature is 10° F (-12° C), or higher. When weather is cold, let the ball joints and king pin bushings warm up before lubrication or they could be damaged. Perform each of the listed lubrication service items at this mileage interval (or every 6 months, whichever occurs first).
- Check rear/front axle fluid level and add fluid as needed. Check constant velocity joints and axle seals for leaking. **

DATE	ACTUAL MILEAGE	SERVICED BY:

24,000 Miles (40 000 km)

- Change engine oil and filter (or every 3 months, whichever occurs first). *An Emission Control Service.*
- Lubricate the front suspension, king pin bushings, steering linkage, transmission shift linkage, transfer case shift linkage, parking brake cable guides, rear driveline center splines, front axle propshaft splines, brake pedal springs and clutch pedal springs. Ball joints and king pin bushings should not be lubricated unless their temperature is 10° F (-12° C), or higher. When weather is cold, let the ball joints and king pin bushings warm up before lubrication or they could be damaged. Perform each of the listed lubrication service items at this mileage interval (or every 6 months, whichever occurs first).
- Check rear/front axle fluid level and add fluid as needed. Check constant velocity joints and axle seals for leaking. **

DATE	ACTUAL MILEAGE	SERVICED BY:

Maintenance Schedule I — Gasoline Engines With Light Duty Emissions

27,000 Miles (45 000 km)

- Change engine oil and filter (or every 3 months, whichever occurs first). *An Emission Control Service.*
- Lubricate the front suspension, king pin bushings, steering linkage, transmission shift linkage, transfer case shift linkage, parking brake cable guides, rear driveline center splines, front axle propshaft splines, brake pedal springs and clutch pedal springs. Ball joints and king pin bushings should not be lubricated unless their temperature is 10° F (–12° C), or higher. When weather is cold, let the ball joints and king pin bushings warm up before lubrication or they could be damaged. Perform each of the listed lubrication service items at this mileage interval (or every 6 months, whichever occurs first).
- Check rear/front axle fluid level and add fluid as needed. Check constant velocity joints and axle seals for leaking.**

DATE	ACTUAL MILEAGE	SERVICED BY:

30,000 Miles (50 000 km)

- Change engine oil and filter (or every 3 months, whichever occurs first). *An Emission Control Service.*
- Lubricate the front suspension, king pin bushings, steering linkage, transmission shift linkage, transfer case shift linkage, parking brake cable guides, rear driveline center splines, front axle propshaft splines, brake pedal springs and clutch pedal springs. Ball joints and king pin bushings should not be lubricated unless their temperature is 10° F (–12° C), or higher. When weather is cold, let the ball joints and king pin bushings warm up before lubrication or they could be damaged. Perform each of the listed lubrication service items at this mileage interval (or every 6 months, whichever occurs first).
- Check rear/front axle fluid level and add fluid as needed. Check constant velocity joints and axle seals for leaking.**

(Continued)

Maintenance Schedule I — Gasoline Engines With Light Duty Emissions

(Continued)

- Drain, flush and refill cooling system (or every 24 months, whichever occurs first). See “Engine Coolant” in the Index for what to use. Inspect hoses. Clean radiator, condenser, pressure cap and neck. Pressure test the cooling system and pressure cap. *An Emission Control Service.*
- For 2–Wheel Drive vehicles only: Clean and repack the front wheel bearings (or at each brake relining, whichever occurs first).
- Replace spark plugs. *An Emission Control Service.*
- Replace air cleaner filter. Replace filter more often under dusty conditions. *An Emission Control Service.*
- Rotate tires. See “Tire Inspection and Rotation” in the Index for proper rotation pattern and additional information.

DATE	ACTUAL MILEAGE	SERVICED BY:

33,000 Miles (55 000 km)

- Change engine oil and filter (or every 3 months, whichever occurs first). *An Emission Control Service.*
- Lubricate the front suspension, king pin bushings, steering linkage, transmission shift linkage, transfer case shift linkage, parking brake cable guides, rear driveline center splines, front axle propshaft splines, brake pedal springs and clutch pedal springs. Ball joints and king pin bushings should not be lubricated unless their temperature is 10° F (–12° C), or higher. When weather is cold, let the ball joints and king pin bushings warm up before lubrication or they could be damaged. Perform each of the listed lubrication service items at this mileage interval (or every 6 months, whichever occurs first).

(Continued)

Maintenance Schedule I — Gasoline Engines With Light Duty Emissions

(Continued)

- Check rear/front axle fluid level and add fluid as needed. Check constant velocity joints and axle seals for leaking.**

DATE	ACTUAL MILEAGE	SERVICED BY:

36,000 Miles (60 000 km)

- Change engine oil and filter (or every 3 months, whichever occurs first). *An Emission Control Service.*
- Lubricate the front suspension, king pin bushings, steering linkage, transmission shift linkage, transfer case shift linkage, parking brake cable guides, rear driveline center splines, front axle propshaft splines, brake pedal springs and clutch pedal springs. Ball joints and king pin bushings should not be lubricated unless their temperature is 10° F (-12° C), or higher. When weather is cold, let the ball joints and king pin bushings warm up before lubrication or they could be damaged. Perform each of the listed lubrication service items at this mileage interval (or every 6 months, whichever occurs first).
- Rotate tires. See "Tire Inspection and Rotation" in the Index for proper rotation pattern and additional information.
- Check rear/front axle fluid level and add fluid as needed. Check constant velocity joints and axle seals for leaking.**

DATE	ACTUAL MILEAGE	SERVICED BY:

Maintenance Schedule I — Gasoline Engines With Light Duty Emissions

39,000 Miles (65 000 km)

- Change engine oil and filter (or every 3 months, whichever occurs first). *An Emission Control Service.*
- Lubricate the front suspension, king pin bushings, steering linkage, transmission shift linkage, transfer case shift linkage, parking brake cable guides, rear driveline center splines, front axle propshaft splines, brake pedal springs and clutch pedal springs. Ball joints and king pin bushings should not be lubricated unless their temperature is 10° F (-12° C), or higher. When weather is cold, let the ball joints and king pin bushings warm up before lubrication or they could be damaged. Perform each of the listed lubrication service items at this mileage interval (or every 6 months, whichever occurs first).
- Check rear/front axle fluid level and add fluid as needed. Check constant velocity joints and axle seals for leaking.**

DATE	ACTUAL MILEAGE	SERVICED BY:

42,000 Miles (70 000 km)

- Change engine oil and filter (or every 3 months, whichever occurs first). *An Emission Control Service.*
- Lubricate the front suspension, king pin bushings, steering linkage, transmission shift linkage, transfer case shift linkage, parking brake cable guides, rear driveline center splines, front axle propshaft splines, brake pedal springs and clutch pedal springs. Ball joints and king pin bushings should not be lubricated unless their temperature is 10° F (-12° C), or higher. When weather is cold, let the ball joints and king pin bushings warm up before lubrication or they could be damaged. Perform each of the listed lubrication service items at this mileage interval (or every 6 months, whichever occurs first).
- Check rear/front axle fluid level and add fluid as needed. Check constant velocity joints and axle seals for leaking.**

(Continued)

Maintenance Schedule I — Gasoline Engines With Light Duty Emissions

(Continued)

- Rotate tires. See "Tire Inspection and Rotation" in the Index for proper rotation pattern and additional information.

DATE	ACTUAL MILEAGE	SERVICED BY:

45,000 Miles (75 000 km)

- Change engine oil and filter (or every 3 months, whichever occurs first). *An Emission Control Service.*
- Lubricate the front suspension, king pin bushings, steering linkage, transmission shift linkage, transfer case shift linkage, parking brake cable guides, rear driveline center splines, front axle propshaft splines, brake pedal springs and clutch pedal springs. Ball joints and king pin bushings should not be lubricated unless their temperature is 10° F (-12° C), or higher. When weather is cold, let the ball joints and king pin bushings warm up before lubrication or they could be damaged. Perform each of the listed lubrication service items at this mileage interval (or every 6 months, whichever occurs first).
- Check rear/front axle fluid level and add fluid as needed. Check constant velocity joints and axle seals for leaking.**
- For 2-Wheel Drive vehicles only: Clean and repack the front wheel bearings (or at each brake relining, whichever occurs first).
- Inspect air cleaner filter if you are driving in dusty conditions. Replace filter if necessary. *An Emission Control Service.*

DATE	ACTUAL MILEAGE	SERVICED BY:

Maintenance Schedule I — Gasoline Engines With Light Duty Emissions

48,000 Miles (80 000 km)

- Change engine oil and filter (or every 3 months, whichever occurs first). *An Emission Control Service.*
- Lubricate the front suspension, king pin bushings, steering linkage, transmission shift linkage, transfer case shift linkage, parking brake cable guides, rear driveline center splines, front axle propshaft splines, brake pedal springs and clutch pedal springs. Ball joints and king pin bushings should not be lubricated unless their temperature is 10° F (–12° C), or higher. When weather is cold, let the ball joints and king pin bushings warm up before lubrication or they could be damaged. Perform each of the listed lubrication service items at this mileage interval (or every 6 months, whichever occurs first).
- Check rear/front axle fluid level and add fluid as needed. Check constant velocity joints and axle seals for leaking.**

DATE	ACTUAL MILEAGE	SERVICED BY:

50,000 Miles (83 000 km)

- Change automatic transmission fluid and filter if the vehicle is mainly driven under one or more of these conditions:
 - In heavy city traffic where the outside temperature regularly reaches 90° F (32° C) or higher.
 - In hilly or mountainous terrain.
 - When doing frequent trailer towing.
 - Uses such as found in taxi, police or delivery service.

If you do not use your vehicle under any of these conditions, the fluid and filter do not require changing.

Manual transmission fluid doesn't require change.

DATE	ACTUAL MILEAGE	SERVICED BY:

Maintenance Schedule I — Gasoline Engines With Light Duty Emissions

51,000 Miles (85 000 km)

- Change engine oil and filter (or every 3 months, whichever occurs first). *An Emission Control Service.*
- Lubricate the front suspension, king pin bushings, steering linkage, transmission shift linkage, transfer case shift linkage, parking brake cable guides, rear driveline center splines, front axle propshaft splines, brake pedal springs and clutch pedal springs. Ball joints and king pin bushings should not be lubricated unless their temperature is 10° F (–12° C), or higher. When weather is cold, let the ball joints and king pin bushings warm up before lubrication or they could be damaged. Perform each of the listed lubrication service items at this mileage interval (or every 6 months, whichever occurs first).
- Check rear/front axle fluid level and add fluid as needed. Check constant velocity joints and axle seals for leaking. **

DATE	ACTUAL MILEAGE	SERVICED BY:

54,000 Miles (90 000 km)

- Change engine oil and filter (or every 3 months, whichever occurs first). *An Emission Control Service.*
- Lubricate the front suspension, king pin bushings, steering linkage, transmission shift linkage, transfer case shift linkage, parking brake cable guides, rear driveline center splines, front axle propshaft splines, brake pedal springs and clutch pedal springs. Ball joints and king pin bushings should not be lubricated unless their temperature is 10° F (–12° C), or higher. When weather is cold, let the ball joints and king pin bushings warm up before lubrication or they could be damaged. Perform each of the listed lubrication service items at this mileage interval (or every 6 months, whichever occurs first).

(Continued)

Maintenance Schedule I — Gasoline Engines With Light Duty Emissions

(Continued)

- Check rear/front axle fluid level and add fluid as needed. Check constant velocity joints and axle seals for leaking.**
- Rotate tires. See "Tire Inspection and Rotation" in the Index for proper rotation pattern and additional information.

DATE	ACTUAL MILEAGE	SERVICED BY:

57,000 Miles (95 000 km)

- Change engine oil and filter (or every 3 months, whichever occurs first). *An Emission Control Service.*
- Lubricate the front suspension, king pin bushings, steering linkage, transmission shift linkage, transfer case shift linkage, parking brake cable guides, rear driveline center splines, front axle propshaft splines, brake pedal springs and clutch pedal springs. Ball joints and king pin bushings should not be lubricated unless their temperature is 10° F (-12° C), or higher. When weather is cold, let the ball joints and king pin bushings warm up before lubrication or they could be damaged. Perform each of the listed lubrication service items at this mileage interval (or every 6 months, whichever occurs first).
- Check rear/front axle fluid level and add fluid as needed. Check constant velocity joints and axle seals for leaking.**

DATE	ACTUAL MILEAGE	SERVICED BY:

60,000 Miles (100 000 km)

- Change engine oil and filter (or every 3 months, whichever occurs first). *An Emission Control Service.*
- Lubricate the front suspension, king pin bushings, steering linkage, transmission shift linkage, transfer case shift linkage, parking brake cable guides, rear driveline center splines, front axle propshaft splines, brake pedal springs and clutch pedal springs. Ball joints and king pin bushings should not be lubricated unless their temperature is 10° F (-12° C), or higher. When weather is cold, let the ball joints and king pin bushings warm up before lubrication or they could be damaged. Perform each of the listed lubrication service items at this mileage interval (or every 6 months, whichever occurs first).
- Check rear/front axle fluid level and add fluid as needed. Check constant velocity joints and axle seals for leaking.**
- For 2-Wheel Drive vehicles only: Clean and repack the front wheel bearings (or at each brake relining, whichever occurs first).
- Inspect engine accessory drive belt. *An Emission Control Service.*
- Drain, flush and refill cooling system (or every 24 months, whichever occurs first). See "Engine Coolant" in the Index for what to use. Inspect hoses. Clean radiator, condenser, pressure cap and neck. Pressure test the cooling system and pressure cap. *An Emission Control Service.*
- Replace spark plugs. *An Emission Control Service.*
- Inspect spark plug wires . *An Emission Control Service.* †
- Replace air cleaner filter. Replace filter more often under dusty conditions. *An Emission Control Service.*
- Inspect fuel tank, cap and lines for damage or leaks . Inspect fuel cap gasket for any damage. Replace parts as needed. *An Emission Control Service.* †

DATE	ACTUAL MILEAGE	SERVICED BY:

Maintenance Schedule II — Gasoline Engines With Light Duty Emissions

The services shown in this schedule up to 60,000 miles (100 000 km) should be performed after 60,000 miles (100 000 km) at the same intervals.

Footnotes

† The California Air Resources Board has determined that the failure to perform this maintenance item will not nullify the emission warranty or limit recall liability prior to the completion of vehicle useful life. We, however, urge that all recommended maintenance services be performed at the indicated intervals and the maintenance be recorded.

** Drive axle service:

- Locking Differential — Drain fluid and refill at first engine oil change. At subsequent oil changes, check fluid level and add fluid as needed. If driving in dusty areas or towing a trailer, drain fluid and refill every 15,000 miles (25 000 km).
- Standard Differential — Check fluid level and add fluid as needed at every engine oil change. If driving in dusty areas or towing a trailer, drain fluid and refill every 15,000 miles (25 000 km).
- More frequent lubrication may be required for heavy-duty or off-road use.
- 3500 HD Models with applications requiring extreme overload/trailer towing conditions and high speed (above 45 mph or 72 km/h) conditions for extended periods of time must have the drive axle fluid changed every 3,000 miles (5 000 km) or 3 months, whichever occurs first, or must use 75W-140 synthetic fluid meeting GM specifications. See “Recommended Fluids and Lubricants” in this section.

7,500 Miles (12 500 km)

- Change engine oil and filter (or every 12 months, whichever occurs first). *An Emission Control Service.*
- Lubricate the front suspension, king pin bushings, steering linkage, transmission shift linkage, transfer case shift linkage, parking brake cable guides, rear driveline center splines, front axle propshaft splines, brake pedal springs and clutch pedal springs. Ball joints and king pin bushings should not be lubricated unless their temperature is 10° F (–12° C), or higher. When weather is cold, let the ball joints and king pin bushings warm up before lubrication or they could be damaged. Perform each of the listed lubrication service items at this mileage interval (or every 12 months, whichever occurs first).

(Continued)

Maintenance Schedule II — Gasoline Engines With Light Duty Emissions

(Continued)

- Check rear/front axle fluid level and add fluid as needed. Check constant velocity joints and axle seals for leaking.**
- Rotate tires. See "Tire Inspection and Rotation" in the Index for proper rotation pattern and additional information.

DATE	ACTUAL MILEAGE	SERVICED BY:

15,000 Miles (25 000 km)

- Change engine oil and filter (or every 12 months, whichever occurs first). *An Emission Control Service.*
- Lubricate the front suspension, king pin bushings, steering linkage, transmission shift linkage, transfer case shift linkage, parking brake cable guides, rear driveline center splines, front axle propshaft splines, brake pedal springs and clutch pedal springs. Ball joints and king pin bushings should not be lubricated unless their temperature is 10° F (-12° C), or higher. When weather is cold, let the ball joints and king pin bushings warm up before lubrication or they could be damaged. Perform each of the listed lubrication service items at this mileage interval (or every 12 months, whichever occurs first).
- Check rear/front axle fluid level and add fluid as needed. Check constant velocity joints and axle seals for leaking.**
- For 2-Wheel Drive vehicles only: Clean and repack the front wheel bearings (or at each brake relining, whichever occurs first).

DATE	ACTUAL MILEAGE	SERVICED BY:

Maintenance Schedule II — Gasoline Engines With Light Duty Emissions

22,500 Miles (37 500 km)

- Change engine oil and filter (or every 12 months, whichever occurs first). *An Emission Control Service.*
- Lubricate the front suspension, king pin bushings, steering linkage, transmission shift linkage, transfer case shift linkage, parking brake cable guides, rear driveline center splines, front axle propshaft splines, brake pedal springs and clutch pedal springs. Ball joints and king pin bushings should not be lubricated unless their temperature is 10° F (-12° C), or higher. When weather is cold, let the ball joints and king pin bushings warm up before lubrication or they could be damaged. Perform each of the listed lubrication service items at this mileage interval (or every 12 months, whichever occurs first).
- Check rear/front axle fluid level and add fluid as needed. Check constant velocity joints and axle seals for leaking.**
- Rotate tires. See "Tire Inspection and Rotation" in the Index for proper rotation pattern and additional information.

DATE	ACTUAL MILEAGE	SERVICED BY:

30,000 Miles (50 000 km)

- Change engine oil and filter (or every 12 months, whichever occurs first). *An Emission Control Service.*
- Lubricate the front suspension, king pin bushings, steering linkage, transmission shift linkage, transfer case shift linkage, parking brake cable guides, rear driveline center splines, front axle propshaft splines, brake pedal springs and clutch pedal springs. Ball joints and king pin bushings should not be lubricated unless their temperature is 10° F (-12° C), or higher. When weather is cold, let the ball joints and king pin bushings warm up before lubrication or they could be damaged. Perform each of the listed lubrication service items at this mileage interval (or every 12 months, whichever occurs first).

(Continued)

Maintenance Schedule II — Gasoline Engines With Light Duty Emissions

(Continued)

- Check rear/front axle fluid level and add fluid as needed. Check constant velocity joints and axle seals for leaking.**
- For 2-Wheel Drive vehicles only: Clean and repack the front wheel bearings (or at each brake relining, whichever occurs first).
- Drain, flush and refill cooling system (or every 24 months, whichever occurs first). See "Engine Coolant" in the Index for what to use. Inspect hoses. Clean radiator, condenser, pressure cap and neck. Pressure test the cooling system and pressure cap. *An Emission Control Service.*
- Replace spark plugs. *An Emission Control Service.*
- Replace air cleaner filter. *An Emission Control Service.*

DATE	ACTUAL MILEAGE	SERVICED BY:

37,500 Miles (62 500 km)

- Change engine oil and filter (or every 12 months, whichever occurs first). *An Emission Control Service.*
- Lubricate the front suspension, king pin bushings, steering linkage, transmission shift linkage, transfer case shift linkage, parking brake cable guides, rear driveline center splines, front axle propshaft splines, brake pedal springs and clutch pedal springs. Ball joints and king pin bushings should not be lubricated unless their temperature is 10° F (-12° C), or higher. When weather is cold, let the ball joints and king pin bushings warm up before lubrication or they could be damaged. Perform each of the listed lubrication service items at this mileage interval (or every 12 months, whichever occurs first).

(Continued)

Maintenance Schedule II — Gasoline Engines With Light Duty Emissions

(Continued)

- Check rear/front axle fluid level and add fluid as needed. Check constant velocity joints and axle seals for leaking.**
- Rotate tires. See "Tire Inspection and Rotation" in the Index for proper rotation pattern and additional information.

DATE	ACTUAL MILEAGE	SERVICED BY:

45,000 Miles (75 000 km)

- Change engine oil and filter (or every 12 months, whichever occurs first). *An Emission Control Service.*
- Lubricate the front suspension, king pin bushings, steering linkage, transmission shift linkage, transfer case shift linkage, parking brake cable guides, rear driveline center splines, front axle propshaft splines, brake pedal springs and clutch pedal springs. Ball joints and king pin bushings should not be lubricated unless their temperature is 10° F (-12° C), or higher. When weather is cold, let the ball joints and king pin bushings warm up before lubrication or they could be damaged. Perform each of the listed lubrication service items at this mileage interval (or every 12 months, whichever occurs first).
- For 2-Wheel Drive vehicles only: Clean and repack the front wheel bearings (or at each brake relining, whichever occurs first).
- Check rear/front axle fluid level and add fluid as needed. Check constant velocity joints and axle seals for leaking.**

DATE	ACTUAL MILEAGE	SERVICED BY:

Maintenance Schedule II — Gasoline Engines With Light Duty Emissions

50,000 Miles (83 000 km)

- Change automatic transmission fluid and filter if the vehicle is mainly driven under one or more of these conditions:
 - In heavy city traffic where the outside temperature regularly reaches 90°F (32°C) or higher.
 - In hilly or mountainous terrain.
 - When doing frequent trailer towing.
 - Uses such as found in taxi, police or delivery service.

If you do not use your vehicle under any of these conditions, the fluid and filter do not require changing.

Manual transmission fluid doesn't require change.

DATE	ACTUAL MILEAGE	SERVICED BY:

52,500 Miles (87 500 km)

- Change engine oil and filter (or every 12 months, whichever occurs first). *An Emission Control Service.*
- Lubricate the front suspension, king pin bushings, steering linkage, transmission shift linkage, transfer case shift linkage, parking brake cable guides, rear driveline center splines, front axle propshaft splines, brake pedal springs and clutch pedal springs. Ball joints and king pin bushings should not be lubricated unless their temperature is 10° F (-12° C), or higher. When weather is cold, let the ball joints and king pin bushings warm up before lubrication or they could be damaged. Perform each of the listed lubrication service items at this mileage interval (or every 12 months, whichever occurs first).

(Continued)

Maintenance Schedule II — Gasoline Engines With Light Duty Emissions

(Continued)

- Check rear/front axle fluid level and add fluid as needed. Check constant velocity joints and axle seals for leaking.**
- Rotate tires. See "Tire Inspection and Rotation" in the Index for proper rotation pattern and additional information.

DATE	ACTUAL MILEAGE	SERVICED BY:

60,000 Miles (100 000 km)

- Change engine oil and filter (or every 12 months, whichever occurs first). *An Emission Control Service.*
- Lubricate the front suspension, king pin bushings, steering linkage, transmission shift linkage, transfer case shift linkage, parking brake cable guides, rear driveline center splines, front axle propshaft splines, brake pedal springs and clutch pedal springs. Ball joints and king pin bushings should not be lubricated unless their temperature is 10° F (-12° C), or higher. When weather is cold, let the ball joints and king pin bushings warm up before lubrication or they could be damaged. Perform each of the listed lubrication service items at this mileage interval (or every 12 months, whichever occurs first).
- Check rear/front axle fluid level and add fluid as needed. Check constant velocity joints and axle seals for leaking.**
- For 2-Wheel Drive vehicles only: Clean and repack the front wheel bearings (or at each brake relining, whichever occurs first).
- Inspect engine accessory drive belt. *An Emission Control Service.*
- Drain, flush and refill cooling system (or every 24 months, whichever occurs first). See "Engine Coolant" in the Index for what to use. Inspect hoses. Clean radiator, condenser, pressure cap and neck. Pressure test the cooling system and pressure cap. *An Emission Control Service.*

(Continued)

Maintenance Schedule II — Gasoline Engines With Light Duty Emissions

(Continued)

- Replace spark plugs. *An Emission Control Service.*
- Inspect spark plug wires. *An Emission Control Service.* †
- Replace air cleaner filter. *An Emission Control Service.*
- Inspect fuel tank, cap and lines for damage or leaks. Inspect fuel cap gasket for any damage. Replace parts as needed. *An Emission Control Service.* †

DATE	ACTUAL MILEAGE	SERVICED BY:

Maintenance Schedule I — Gasoline Engines Heavy Duty Emissions

The services shown in this schedule up to 60,000 miles (100 000 km) should be performed after 60,000 miles (100 000 km) at the same intervals.

Footnotes

** Drive axle service:

- Locking Differential — Drain fluid and refill at first engine oil change. At subsequent oil changes, check fluid level and add fluid as needed. If driving in dusty areas or towing a trailer, drain fluid and refill every 15,000 miles (25 000 km).
- Standard Differential — Check fluid level and add fluid as needed at every engine oil change. If driving in dusty areas or towing a trailer, drain fluid and refill every 15,000 miles (25 00 km).
- More frequent lubrication may be required for heavy-duty or off-road use.
- 3500 HD Models with applications requiring extreme overload/trailer towing conditions and high speed (above 45 mph or 72 km/h) conditions for extended periods of time must have the drive axle fluid changed every 3,000 miles (5 000 km) or 3 months, whichever occurs first, or must use 75W-140 synthetic fluid meeting GM specifications. See "Recommended Fluids and Lubricants" in this section.

Maintenance Schedule I — Gasoline Engines Heavy Duty Emissions

3,000 Miles (5 000 km)

- Change engine oil and filter (or every 3 months, whichever occurs first). *An Emission Control Service.*
- Lubricate the front suspension, king pin bushings, steering linkage, transmission shift linkage, transfer case shift linkage, parking brake cable guides, rear driveline center splines, front axle propshaft splines, brake pedal springs and clutch pedal springs. Ball joints and king pin bushings should not be lubricated unless their temperature is 10° F (–12° C), or higher. When weather is cold, let the ball joints and king pin bushings warm up before lubrication or they could be damaged. Perform each of the listed lubrication service items at this mileage interval (or every 12 months, whichever occurs first).
- Check rear/front axle fluid level and add fluid as needed. Check constant velocity joints and axle seals for leaking.**

DATE	ACTUAL MILEAGE	SERVICED BY:

6,000 Miles (10 000 km)

- Change engine oil and filter (or every 3 months, whichever occurs first). *An Emission Control Service.*
- Lubricate the front suspension, king pin bushings, steering linkage, transmission shift linkage, transfer case shift linkage, parking brake cable guides, rear driveline center splines, front axle propshaft splines, brake pedal springs and clutch pedal springs. Ball joints and king pin bushings should not be lubricated unless their temperature is 10° F (–12° C), or higher. When weather is cold, let the ball joints and king pin bushings warm up before lubrication or they could be damaged. Perform each of the listed lubrication service items at this mileage interval (or every 12 months, whichever occurs first).

(Continued)

Maintenance Schedule I — Gasoline Engines Heavy Duty Emissions

(Continued)

- Check rear/front axle fluid level and add fluid as needed. Check constant velocity joints and axle seals for leaking.**
- Rotate tires. See "Tire Inspection and Rotation" in the Index for proper rotation pattern and additional information.

DATE	ACTUAL MILEAGE	SERVICED BY:

9,000 Miles (15 000 km)

- Change engine oil and filter (or every 3 months, whichever occurs first). *An Emission Control Service.*
- Lubricate the front suspension, king pin bushings, steering linkage, transmission shift linkage, transfer case shift linkage, parking brake cable guides, rear driveline center splines, front axle propshaft splines, brake pedal springs and clutch pedal springs. Ball joints and king pin bushings should not be lubricated unless their temperature is 10° F (-12° C), or higher. When weather is cold, let the ball joints and king pin bushings warm up before lubrication or they could be damaged. Perform each of the listed lubrication service items at this mileage interval (or every 12 months, whichever occurs first).
- Check rear/front axle fluid level and add fluid as needed. Check constant velocity joints and axle seals for leaking.**

DATE	ACTUAL MILEAGE	SERVICED BY:

Maintenance Schedule I — Gasoline Engines Heavy Duty Emissions

12,000 Miles (20 000 km)

- Change engine oil and filter (or every 3 months, whichever occurs first). *An Emission Control Service.*
- Lubricate the front suspension, king pin bushings, steering linkage, transmission shift linkage, transfer case shift linkage, parking brake cable guides, rear driveline center splines, front axle propshaft splines, brake pedal springs and clutch pedal springs. Ball joints and king pin bushings should not be lubricated unless their temperature is 10° F (-12° C), or higher. When weather is cold, let the ball joints and king pin bushings warm up before lubrication or they could be damaged. Perform each of the listed lubrication service items at this mileage interval (or every 12 months, whichever occurs first).
- Check rear/front axle fluid level and add fluid as needed. Check constant velocity joints and axle seals for leaking.**
- For 2-Wheel Drive vehicles only: Clean and repack the front wheel bearings (or at each brake relining, whichever occurs first).
- Inspect air cleaner filter if you are driving in dusty conditions. Replace filter if necessary. *An Emission Control Service.*
- Replace fuel filter. Replace filter sooner if it is clogged.†
- Inspect accessory drive (serpentine) belt for cracks, fraying and wear and check belt for proper tension. Adjust or replace belt as needed. *An Emission Control Service.*
- Inspect shields and underhood insulation for damage or looseness. Adjust or replace as required. **This is a Noise Emission Control Service. Applicable only to vehicles sold in the United States.**
- If your engine has a thermostatically controlled cooling fan, inspect all hoses and ducts for proper hook-up (or every 12 months, whichever occurs first). Be sure the valve works properly. **This is a Noise Emission Control Service. Applicable only to vehicles sold in the United States.**

DATE	ACTUAL MILEAGE	SERVICED BY:

Maintenance Schedule I — Gasoline Engines Heavy Duty Emissions

15,000 Miles (25 000 km)

- Change engine oil and filter (or every 3 months, whichever occurs first). *An Emission Control Service.*
- Lubricate the front suspension, king pin bushings, steering linkage, transmission shift linkage, transfer case shift linkage, parking brake cable guides, rear driveline center splines, front axle propshaft splines, brake pedal springs and clutch pedal springs. Ball joints and king pin bushings should not be lubricated unless their temperature is 10° F (-12° C), or higher. When weather is cold, let the ball joints and king pin bushings warm up before lubrication or they could be damaged. Perform each of the listed lubrication service items at this mileage interval (or every 12 months, whichever occurs first).
- Check rear/front axle fluid level and add fluid as needed. Check constant velocity joints and axle seals for leaking.**

DATE	ACTUAL MILEAGE	SERVICED BY:

18,000 Miles (30 000 km)

- Change engine oil and filter (or every 3 months, whichever occurs first). *An Emission Control Service.*
- Lubricate the front suspension, king pin bushings, steering linkage, transmission shift linkage, transfer case shift linkage, parking brake cable guides, rear driveline center splines, front axle propshaft splines, brake pedal springs and clutch pedal springs. Ball joints and king pin bushings should not be lubricated unless their temperature is 10° F (-12° C), or higher. When weather is cold, let the ball joints and king pin bushings warm up before lubrication or they could be damaged. Perform each of the listed lubrication service items at this mileage interval (or every 12 months, whichever occurs first).

(Continued)

Maintenance Schedule I — Gasoline Engines Heavy Duty Emissions

(Continued)

- Check rear/front axle fluid level and add fluid as needed. Check constant velocity joints and axle seals for leaking.**
- Rotate tires. See "Tire Inspection and Rotation" in the Index for proper rotation pattern and additional information.

DATE	ACTUAL MILEAGE	SERVICED BY:

21,000 Miles (35 000 km)

- Change engine oil and filter (or every 3 months, whichever occurs first). *An Emission Control Service.*
- Lubricate the front suspension, king pin bushings, steering linkage, transmission shift linkage, transfer case shift linkage, parking brake cable guides, rear driveline center splines, front axle propshaft splines, brake pedal springs and clutch pedal springs. Ball joints and king pin bushings should not be lubricated unless their temperature is 10° F (-12° C), or higher. When weather is cold, let the ball joints and king pin bushings warm up before lubrication or they could be damaged. Perform each of the listed lubrication service items at this mileage interval (or every 12 months, whichever occurs first).
- Check rear/front axle fluid level and add fluid as needed. Check constant velocity joints and axle seals for leaking.**

DATE	ACTUAL MILEAGE	SERVICED BY:

Maintenance Schedule I — Gasoline Engines Heavy Duty Emissions

24,000 Miles (40 000 km)

- Change engine oil and filter (or every 3 months, whichever occurs first). *An Emission Control Service.*
- Lubricate the front suspension, king pin bushings, steering linkage, transmission shift linkage, transfer case shift linkage, parking brake cable guides, rear driveline center splines, front axle propshaft splines, brake pedal springs and clutch pedal springs. Ball joints and king pin bushings should not be lubricated unless their temperature is 10° F (-12° C), or higher. When weather is cold, let the ball joints and king pin bushings warm up before lubrication or they could be damaged. Perform each of the listed lubrication service items at this mileage interval (or every 12 months, whichever occurs first).
- Check rear/front axle fluid level and add fluid as needed. Check constant velocity joints and axle seals for leaking.**
- Drain, flush and refill cooling system (or every 24 months, whichever occurs first). See "Engine Coolant" in the Index for what to use. Inspect hoses. Clean radiator, condenser, pressure cap and neck. Pressure test the cooling system and pressure cap.*
- Replace air cleaner filter. Replace filter more often under dusty conditions. *An Emission Control Service.*
- For 2-Wheel Drive vehicles only: Clean and repack the front wheel bearings (or at each brake relining, whichever occurs first).
- Replace fuel filter. Replace filter sooner if it is clogged.†
- Adjust timing to underhood label specifications. Inspect the inside and outside of the distributor cap and rotor for cracks, carbon tracking and corrosion. Clean or replace as needed. *An Emission Control Service.*
This is a Noise Emission Control Service.
- If your vehicle has a thermostatically controlled air cleaner, inspect all hoses and ducts for proper hook-up. Be sure the valve works properly. *An Emission Control Service.* **This is a Noise Emission Control Service.**
- Inspect accessory drive (serpentine) belt for cracks, fraying and wear and check belt for proper tension. Adjust or replace belt as needed. *An Emission Control Service.*
- Inspect shields and underhood insulation for damage or looseness. Adjust or replace as required. **This is a Noise Emission Control Service. Applicable only to vehicles sold in the United States.**

(Continued)

Maintenance Schedule I — Gasoline Engines Heavy Duty Emissions

(Continued)

- Check the air intake system installation to assure that gaskets are properly sealed and that all hose connections, fasteners and other components are tight. Also check to be sure that the air cleaner housing is properly seated, the cover fits tightly and the wing nuts are tight. Tighten connections and fasteners or replace damaged parts as necessary. **This is a Noise Emission Control Service. Applicable only to vehicles sold in the United States.**
- If your engine has a thermostatically controlled cooling fan, inspect all hoses and ducts for proper hook-up (or every 12 months, whichever occurs first). Be sure the valve works properly. **This is a Noise Emission Control Service. Applicable only to vehicles sold in the United States.**

DATE	ACTUAL MILEAGE	SERVICED BY:

27,000 Miles (45 000 km)

- Change engine oil and filter (or every 3 months, whichever occurs first). *An Emission Control Service.*
- Lubricate the front suspension, king pin bushings, steering linkage, transmission shift linkage, transfer case shift linkage, parking brake cable guides, rear driveline center splines, front axle propshaft splines, brake pedal springs and clutch pedal springs. Ball joints and king pin bushings should not be lubricated unless their temperature is 10° F (-12° C), or higher. When weather is cold, let the ball joints and king pin bushings warm up before lubrication or they could be damaged. Perform each of the listed lubrication service items at this mileage interval (or every 12 months, whichever occurs first).

(Continued)

Maintenance Schedule I — Gasoline Engines Heavy Duty Emissions

(Continued)

- Check rear/front axle fluid level and add fluid as needed. Check constant velocity joints and axle seals for leaking.**
- Replace spark plugs. *An Emission Control Service.*

DATE	ACTUAL MILEAGE	SERVICED BY:

30,000 Miles (50 000 km)

- Change engine oil and filter (or every 3 months, whichever occurs first). *An Emission Control Service.*
- Lubricate the front suspension, king pin bushings, steering linkage, transmission shift linkage, transfer case shift linkage, parking brake cable guides, rear driveline center splines, front axle propshaft splines, brake pedal springs and clutch pedal springs. Ball joints and king pin bushings should not be lubricated unless their temperature is 10° F (-12° C), or higher. When weather is cold, let the ball joints and king pin bushings warm up before lubrication or they could be damaged. Perform each of the listed lubrication service items at this mileage interval (or every 12 months, whichever occurs first).
- Check rear/front axle fluid level and add fluid as needed. Check constant velocity joints and axle seals for leaking.**
- For vehicles equipped with a 5-speed manual transmission with deep low: Lubricate the clutch fork ball stud through the fitting on the clutch housing. Lubricant must be added *sparingly* to the fitting, as very little is required to lubricate the ball stud surface. Do not add lubricant more often than specified. **Too much lubricant will damage the clutch assembly.**
- Rotate tires. See "Tire Inspection and Rotation" in the Index for proper rotation pattern and additional information.

DATE	ACTUAL MILEAGE	SERVICED BY:

Maintenance Schedule I — Gasoline Engines Heavy Duty Emissions

33,000 Miles (55 000 km)

- Change engine oil and filter (or every 3 months, whichever occurs first). *An Emission Control Service.*
- Lubricate the front suspension, king pin bushings, steering linkage, transmission shift linkage, transfer case shift linkage, parking brake cable guides, rear driveline center splines, front axle propshaft splines, brake pedal springs and clutch pedal springs. Ball joints and king pin bushings should not be lubricated unless their temperature is 10° F (-12° C), or higher. When weather is cold, let the ball joints and king pin bushings warm up before lubrication or they could be damaged. Perform each of the listed lubrication service items at this mileage interval (or every 12 months, whichever occurs first).
- Check rear/front axle fluid level and add fluid as needed. Check constant velocity joints and axle seals for leaking.**

DATE	ACTUAL MILEAGE	SERVICED BY:

36,000 Miles (60 000 km)

- Change engine oil and filter (or every 3 months, whichever occurs first). *An Emission Control Service.*
- Lubricate the front suspension, king pin bushings, steering linkage, transmission shift linkage, transfer case shift linkage, parking brake cable guides, rear driveline center splines, front axle propshaft splines, brake pedal springs and clutch pedal springs. Ball joints and king pin bushings should not be lubricated unless their temperature is 10° F (-12° C), or higher. When weather is cold, let the ball joints and king pin bushings warm up before lubrication or they could be damaged. Perform each of the listed lubrication service items at this mileage interval (or every 12 months, whichever occurs first).

(Continued)

Maintenance Schedule I — Gasoline Engines Heavy Duty Emissions

(Continued)

- Check rear/front axle fluid level and add fluid as needed. Check constant velocity joints and axle seals for leaking.^{**}
- For 2-Wheel Drive vehicles only: Clean and repack the front wheel bearings (or at each brake relining, whichever occurs first).
- Inspect air cleaner filter if you are driving in dusty conditions. Replace filter if necessary. *An Emission Control Service.*
- Replace fuel filter. Replace filter sooner if it is clogged.†
- Inspect accessory drive (serpentine) belt for cracks, fraying and wear and check belt for proper tension. Adjust or replace belt as needed. *An Emission Control Service.*
- Inspect shields and underhood insulation for damage or looseness. Adjust or replace as required. **This is a Noise Emission Control Service. Applicable only to vehicles sold in the United States.**
- If your engine has a thermostatically controlled cooling fan, inspect all hoses and ducts for proper hook-up (or every 12 months, whichever occurs first). Be sure the valve works properly. **This is a Noise Emission Control Service. Applicable only to vehicles sold in the United States.**

DATE	ACTUAL MILEAGE	SERVICED BY:

39,000 Miles (65 000 km)

- Change engine oil and filter (or every 3 months, whichever occurs first). *An Emission Control Service.*
- Lubricate the front suspension, king pin bushings, steering linkage, transmission shift linkage, transfer case shift linkage, parking brake cable guides, rear driveline center splines, front axle propshaft splines, brake pedal springs and clutch pedal springs. Ball joints and king pin bushings should not be lubricated unless their temperature is 10° F (-12° C), or higher. When weather is cold, let the ball joints and king pin bushings warm up before lubrication or they could be damaged. Perform each of the listed lubrication service items at this mileage interval (or every 12 months, whichever occurs first).

(Continued)

Maintenance Schedule I — Gasoline Engines Heavy Duty Emissions

(Continued)

- Check rear/front axle fluid level and add fluid as needed. Check constant velocity joints and axle seals for leaking.**

DATE	ACTUAL MILEAGE	SERVICED BY:

42,000 Miles (70 000 km)

- Change engine oil and filter (or every 3 months, whichever occurs first). *An Emission Control Service.*
- Lubricate the front suspension, king pin bushings, steering linkage, transmission shift linkage, transfer case shift linkage, parking brake cable guides, rear driveline center splines, front axle propshaft splines, brake pedal springs and clutch pedal springs. Ball joints and king pin bushings should not be lubricated unless their temperature is 10° F (-12° C), or higher. When weather is cold, let the ball joints and king pin bushings warm up before lubrication or they could be damaged. Perform each of the listed lubrication service items at this mileage interval (or every 12 months, whichever occurs first).
- Check rear/front axle fluid level and add fluid as needed. Check constant velocity joints and axle seals for leaking.**
- Rotate tires. See "Tire Inspection and Rotation" in the Index for proper rotation pattern and additional information.

DATE	ACTUAL MILEAGE	SERVICED BY:

Maintenance Schedule I — Gasoline Engines Heavy Duty Emissions

45,000 Miles (75 000 km)

- Change engine oil and filter (or every 3 months, whichever occurs first). *An Emission Control Service.*
- Lubricate the front suspension, king pin bushings, steering linkage, transmission shift linkage, transfer case shift linkage, parking brake cable guides, rear driveline center splines, front axle propshaft splines, brake pedal springs and clutch pedal springs. Ball joints and king pin bushings should not be lubricated unless their temperature is 10° F (-12° C), or higher. When weather is cold, let the ball joints and king pin bushings warm up before lubrication or they could be damaged. Perform each of the listed lubrication service items at this mileage interval (or every 12 months, whichever occurs first).
- Check rear/front axle fluid level and add fluid as needed. Check constant velocity joints and axle seals for leaking.**

DATE	ACTUAL MILEAGE	SERVICED BY:

48,000 Miles (80 000 km)

- Change engine oil and filter (or every 3 months, whichever occurs first). *An Emission Control Service.*
- Lubricate the front suspension, king pin bushings, steering linkage, transmission shift linkage, transfer case shift linkage, parking brake cable guides, rear driveline center splines, front axle propshaft splines, brake pedal springs and clutch pedal springs. Ball joints and king pin bushings should not be lubricated unless their temperature is 10° F (-12° C), or higher. When weather is cold, let the ball joints and king pin bushings warm up before lubrication or they could be damaged. Perform each of the listed lubrication service items at this mileage interval (or every 12 months, whichever occurs first).
- Check rear/front axle fluid level and add fluid as needed. Check constant velocity joints and axle seals for leaking.**

(Continued)

Maintenance Schedule I — Gasoline Engines Heavy Duty Emissions

(Continued)

- Drain, flush and refill the cooling system with new coolant (or every 24 months, whichever occurs first). See “Engine Coolant” in the Index for what to use. *An Emission Control Service.*

Also inspect the hoses and replace them if they are cracked, swollen or deteriorated. Tighten all hose clamps (except constant tension clamps). Remove debris and clean the outside of the radiator and air conditioning condenser. Wash the radiator neck. To ensure proper operation, pressure test the radiator and cap.

- Replace air cleaner filter. Replace filter more often under dusty conditions. *An Emission Control Service.*
- For 2-Wheel Drive vehicles only: Clean and repack the front wheel bearings (or at each brake relining, whichever occurs first).
- Replace fuel filter. Replace filter sooner if it is clogged.†
- Adjust timing to underhood label specifications. Inspect the inside and outside of the distributor cap and rotor for cracks, carbon tracking and corrosion. Clean or replace as needed. *An Emission Control Service.*
This is a Noise Emission Control Service.
- If your vehicle has a thermostatically controlled air cleaner, inspect all hoses and ducts for proper hook-up. Be sure the valve works properly. *An Emission Control Service.* **This is a Noise Emission Control Service.**
- Inspect accessory drive (serpentine) belt for cracks, fraying and wear and check belt for proper tension. Adjust or replace belt as needed. *An Emission Control Service.*
- Inspect shields and underhood insulation for damage or looseness. Adjust or replace as required. **This is a Noise Emission Control Service. Applicable only to vehicles sold in the United States.**
- Check the air intake system installation to assure that gaskets are properly sealed and that all hose connections, fasteners and other components are tight. Also check to be sure that the air cleaner housing is properly seated, the cover fits tightly and the wing nuts are tight. Tighten connections and fasteners or replace damaged parts as necessary. **This is a Noise Emission Control Service. Applicable only to vehicles sold in the United States.**

(Continued)

Maintenance Schedule I — Gasoline Engines Heavy Duty Emissions

(Continued)

- If your engine has a thermostatically controlled cooling fan, inspect all hoses and ducts for proper hook-up (or every 12 months, whichever occurs first). Be sure the valve works properly. **This is a Noise Emission Control Service. Applicable only to vehicles sold in the United States.**

DATE	ACTUAL MILEAGE	SERVICED BY:

50,000 Miles (83 000 km)

- Change transmission fluid and filter if the vehicle is mainly driven under one or more of these conditions:
- In heavy city traffic where the outside temperature regularly reaches 90°F (32°C) or higher.
 - In hilly or mountainous terrain.
 - When doing frequent trailer towing.
 - Uses such as found in taxi, police or delivery service.

If you do not use your vehicle under any of these conditions, the fluid and filter do not require changing.

Manual transmission fluid doesn't require change.

- Lubricate transmission shift linkage, parking brake cable guides and underbody contact points (or every 6 months, whichever occurs first).

DATE	ACTUAL MILEAGE	SERVICED BY:

Maintenance Schedule I — Gasoline Engines Heavy Duty Emissions

51,000 Miles (85 000 km)

- Change engine oil and filter (or every 3 months, whichever occurs first). *An Emission Control Service.*
- Lubricate the front suspension, king pin bushings, steering linkage, transmission shift linkage, transfer case shift linkage, parking brake cable guides, rear driveline center splines, front axle propshaft splines, brake pedal springs and clutch pedal springs. Ball joints and king pin bushings should not be lubricated unless their temperature is 10° F (-12° C), or higher. When weather is cold, let the ball joints and king pin bushings warm up before lubrication or they could be damaged. Perform each of the listed lubrication service items at this mileage interval (or every 12 months, whichever occurs first).
- Check rear/front axle fluid level and add fluid as needed. Check constant velocity joints and axle seals for leaking.**

DATE	ACTUAL MILEAGE	SERVICED BY:

54,000 Miles (90 000 km)

- Change engine oil and filter (or every 3 months, whichever occurs first). *An Emission Control Service.*
- Lubricate the front suspension, king pin bushings, steering linkage, transmission shift linkage, transfer case shift linkage, parking brake cable guides, rear driveline center splines, front axle propshaft splines, brake pedal springs and clutch pedal springs. Ball joints and king pin bushings should not be lubricated unless their temperature is 10° F (-12° C), or higher. When weather is cold, let the ball joints and king pin bushings warm up before lubrication or they could be damaged. Perform each of the listed lubrication service items at this mileage interval (or every 12 months, whichever occurs first).

(Continued)

Maintenance Schedule I — Gasoline Engines Heavy Duty Emissions

(Continued)

- Check rear/front axle fluid level and add fluid as needed. Check constant velocity joints and axle seals for leaking.**
- Replace spark plugs. *An Emission Control Service.*
- Rotate tires. See "Tire Inspection and Rotation" in the Index for proper rotation pattern and additional information

DATE	ACTUAL MILEAGE	SERVICED BY:

57,000 Miles (95 000 km)

- Change engine oil and filter (or every 3 months, whichever occurs first). *An Emission Control Service.*
- Lubricate the front suspension, king pin bushings, steering linkage, transmission shift linkage, transfer case shift linkage, parking brake cable guides, rear driveline center splines, front axle propshaft splines, brake pedal springs and clutch pedal springs. Ball joints and king pin bushings should not be lubricated unless their temperature is 10° F (-12° C), or higher. When weather is cold, let the ball joints and king pin bushings warm up before lubrication or they could be damaged. Perform each of the listed lubrication service items at this mileage interval (or every 12 months, whichever occurs first).
- Check rear/front axle fluid level and add fluid as needed. Check constant velocity joints and axle seals for leaking.**

DATE	ACTUAL MILEAGE	SERVICED BY:

Maintenance Schedule I — Gasoline Engines Heavy Duty Emissions

60,000 Miles (100 000 km)

- Change engine oil and filter (or every 3 months, whichever occurs first). *An Emission Control Service.*
- Lubricate the front suspension, king pin bushings, steering linkage, transmission shift linkage, transfer case shift linkage, parking brake cable guides, rear driveline center splines, front axle propshaft splines, brake pedal springs and clutch pedal springs. Ball joints and king pin bushings should not be lubricated unless their temperature is 10° F (–12° C), or higher. When weather is cold, let the ball joints and king pin bushings warm up before lubrication or they could be damaged. Perform each of the listed lubrication service items at this mileage interval (or every 12 months, whichever occurs first).
- Check rear/front axle fluid level and add fluid as needed. Check constant velocity joints and axle seals for leaking.**
- For vehicles equipped with a 5–speed manual transmission with deep low: Lubricate the clutch fork ball stud through the fitting on the clutch housing. Lubricant must be added *sparingly* to the fitting, as very little is required to lubricate the ball stud surface. Do not add lubricant more often than specified. **Too much lubricant will damage the clutch assembly.**
- Inspect air cleaner filter if you are driving in dusty conditions. Replace filter if necessary. *An Emission Control Service.*
- Replace fuel filter. Replace filter sooner if it is clogged.†
- Inspect spark plug wires. *An Emission Control Service.* †
- Inspect fuel tank, lines, rails, injection assembly, cap and cap gasket. *An Emission Control Service.* †*Fuel filter replacement is not required.*
- Inspect accessory drive (serpentine) belt for cracks, fraying and wear and check belt for proper tension. Adjust or replace belt as needed. *An Emission Control Service.*
- Inspect shields and underhood insulation for damage or looseness. Adjust or replace as required. **This is a Noise Emission Control Service. Applicable only to vehicles sold in the United States.**

(Continued)

Maintenance Schedule I — Gasoline Engines Heavy Duty Emissions

(Continued)

- If your engine has a thermostatically controlled cooling fan, inspect all hoses and ducts for proper hook-up (or every 12 months, whichever occurs first). Be sure the valve works properly. **This is a Noise Emission Control Service. Applicable only to vehicles sold in the United States.**

DATE	ACTUAL MILEAGE	SERVICED BY:

Maintenance Schedule II — Gasoline Engines With Heavy Duty Emissions

The services shown in this schedule up to 60,000 miles (100 000 km) should be performed after 60,000 miles (100 000 km) at the same intervals.

Footnotes

** Drive axle service:

- Locking Differential — Drain fluid and refill at first engine oil change. At subsequent oil changes, check fluid and add fluid as needed. If driving in dusty areas or towing a trailer, drain fluid and refill every 15,000 miles (25 000 km).
- Standard Differential — Check fluid level and add fluid as needed at every engine oil change. If driving in dusty areas or towing a trailer, drain fluid and refill every 15,000 miles (25 000 km).
- More frequent lubrication may be required for heavy-duty or off-road use.
- 3500 HD Models with applications requiring extreme overload/trailer towing conditions and high speed (above 45 mph or 72 km/h) conditions for extended periods of time must have the drive axle fluid changed every 3,000 miles (5 000 km) or 3 months, whichever occurs first, or must use 75W-140 synthetic fluid meeting GM specifications. See "Recommended Fluids and Lubricants" in this section.

Maintenance Schedule II — Gasoline Engines With Heavy Duty Emissions

6,000 Miles (10 000 km)

- Change engine oil and filter (or every 12 months, whichever occurs first). *An Emission Control Service.*
- Lubricate the front suspension, king pin bushings, steering linkage, transmission shift linkage, transfer case shift linkage, parking brake cable guides, rear driveline center splines, front axle propshaft splines, brake pedal springs and clutch pedal springs. Ball joints and king pin bushings should not be lubricated unless their temperature is 10° F (–12° C), or higher. When weather is cold, let the ball joints and king pin bushings warm up before lubrication or they could be damaged. Perform each of the listed lubrication service items at this mileage interval (or every 12 months, whichever occurs first).
- Check rear/front axle fluid level and add fluid as needed. Check constant velocity joints and axle seals for leaking.**
- Rotate tires. See “Tire Inspection and Rotation” in the Index for proper rotation pattern and additional information.

DATE	ACTUAL MILEAGE	SERVICED BY:

12,000 Miles (20 000 km)

- Change engine oil and filter (or every 12 months, whichever occurs first). *An Emission Control Service.*
- Lubricate the front suspension, king pin bushings, steering linkage, transmission shift linkage, transfer case shift linkage, parking brake cable guides, rear driveline center splines, front axle propshaft splines, brake pedal springs and clutch pedal springs. Ball joints and king pin bushings should not be lubricated unless their temperature is 10° F (–12° C), or higher. When weather is cold, let the ball joints and king pin bushings warm up before lubrication or they could be damaged. Perform each of the listed lubrication service items at this mileage interval (or every 12 months, whichever occurs first).

(Continued)

Maintenance Schedule II — Gasoline Engines With Heavy Duty Emissions

(Continued)

- Check rear/front axle fluid level and add fluid as needed. Check constant velocity joints and axle seals for leaking.**

DATE	ACTUAL MILEAGE	SERVICED BY:

18,000 Miles (30 000 km)

- Change engine oil and filter (or every 12 months, whichever occurs first). *An Emission Control Service.*
- Lubricate the front suspension, king pin bushings, steering linkage, transmission shift linkage, transfer case shift linkage, parking brake cable guides, rear driveline center splines, front axle propshaft splines, brake pedal springs and clutch pedal springs. Ball joints and king pin bushings should not be lubricated unless their temperature is 10° F (-12° C), or higher. When weather is cold, let the ball joints and king pin bushings warm up before lubrication or they could be damaged. Perform each of the listed lubrication service items at this mileage interval (or every 12 months, whichever occurs first).
- Check rear/front axle fluid level and add fluid as needed. Check constant velocity joints and axle seals for leaking.**
- Rotate tires. See "Tire Inspection and Rotation" in the Index for proper rotation pattern and additional information.

DATE	ACTUAL MILEAGE	SERVICED BY:

Maintenance Schedule II — Gasoline Engines With Heavy Duty Emissions

24,000 Miles (40 000 km)

- Change engine oil and filter (or every 12 months, whichever occurs first). *An Emission Control Service.*
- Lubricate the front suspension, king pin bushings, steering linkage, transmission shift linkage, transfer case shift linkage, parking brake cable guides, rear driveline center splines, front axle propshaft splines, brake pedal springs and clutch pedal springs. Ball joints and king pin bushings should not be lubricated unless their temperature is 10° F (-12° C), or higher. When weather is cold, let the ball joints and king pin bushings warm up before lubrication or they could be damaged. Perform each of the listed lubrication service items at this mileage interval (or every 12 months, whichever occurs first).
- Check rear/front axle fluid level and add fluid as needed. Check constant velocity joints and axle seals for leaking.**
- Inspect engine accessory drive belts (or every 24 months, whichever occurs first). *An Emission Control Service.*
- Drain, flush and refill cooling system (or every 24 months, whichever occurs first). See "Engine Coolant" in the Index for what to use. Inspect hoses. Clean radiator, condenser, pressure cap and neck. Pressure test the cooling system and pressure cap. *An Emission Control Service.*
- Replace air cleaner filter. *An Emission Control Service.*
- Replace fuel filter. *An Emission Control Service.*

DATE	ACTUAL MILEAGE	SERVICED BY:

Maintenance Schedule II — Gasoline Engines With Heavy Duty Emissions

27,000 Miles (45 000 km)

- Replace spark plugs. *An Emission Control Service.*

DATE	ACTUAL MILEAGE	SERVICED BY:

30,000 Miles (50 000 km)

- Change engine oil and filter (or every 12 months, whichever occurs first). *An Emission Control Service.*
- Lubricate the front suspension, king pin bushings, steering linkage, transmission shift linkage, transfer case shift linkage, parking brake cable guides, rear driveline center splines, front axle propshaft splines, brake pedal springs and clutch pedal springs. Ball joints and king pin bushings should not be lubricated unless their temperature is 10° F (-12° C), or higher. When weather is cold, let the ball joints and king pin bushings warm up before lubrication or they could be damaged. Perform each of the listed lubrication service items at this mileage interval (or every 12 months, whichever occurs first).
- Check rear/front axle fluid level and add fluid as needed. Check constant velocity joints and axle seals for leaking.**
- Rotate tires. See "Tire Inspection and Rotation" in the Index for proper rotation pattern and additional information.

DATE	ACTUAL MILEAGE	SERVICED BY:

Maintenance Schedule II — Gasoline Engines With Heavy Duty Emissions

36,000 Miles (60 000 km)

- Change engine oil and filter (or every 12 months, whichever occurs first). *An Emission Control Service.*
- Lubricate the front suspension, king pin bushings, steering linkage, transmission shift linkage, transfer case shift linkage, parking brake cable guides, rear driveline center splines, front axle propshaft splines, brake pedal springs and clutch pedal springs. Ball joints and king pin bushings should not be lubricated unless their temperature is 10° F (-12° C), or higher. When weather is cold, let the ball joints and king pin bushings warm up before lubrication or they could be damaged. Perform each of the listed lubrication service items at this mileage interval (or every 12 months, whichever occurs first).
- Check rear/front axle fluid level and add fluid as needed. Check constant velocity joints and axle seals for leaking.**

DATE	ACTUAL MILEAGE	SERVICED BY:

42,000 Miles (70 000 km)

- Change engine oil and filter (or every 12 months, whichever occurs first). *An Emission Control Service.*
- Lubricate the front suspension, king pin bushings, steering linkage, transmission shift linkage, transfer case shift linkage, parking brake cable guides, rear driveline center splines, front axle propshaft splines, brake pedal springs and clutch pedal springs. Ball joints and king pin bushings should not be lubricated unless their temperature is 10° F (-12° C), or higher. When weather is cold, let the ball joints and king pin bushings warm up before lubrication or they could be damaged. Perform each of the listed lubrication service items at this mileage interval (or every 12 months, whichever occurs first).

(Continued)

Maintenance Schedule II — Gasoline Engines With Heavy Duty Emissions

(Continued)

- Check rear/front axle fluid level and add fluid as needed. Check constant velocity joints and axle seals for leaking.**
- Rotate tires. See "Tire Inspection and Rotation" in the Index for proper rotation pattern and additional information.

DATE	ACTUAL MILEAGE	SERVICED BY:

48,000 Miles (80 000 km)

- Change engine oil and filter (or every 12 months, whichever occurs first). *An Emission Control Service.*
- Lubricate the front suspension, king pin bushings, steering linkage, transmission shift linkage, transfer case shift linkage, parking brake cable guides, rear driveline center splines, front axle propshaft splines, brake pedal springs and clutch pedal springs. Ball joints and king pin bushings should not be lubricated unless their temperature is 10° F (-12° C), or higher. When weather is cold, let the ball joints and king pin bushings warm up before lubrication or they could be damaged. Perform each of the listed lubrication service items at this mileage interval (or every 12 months, whichever occurs first).
- Check rear/front axle fluid level and add fluid as needed. Check constant velocity joints and axle seals for leaking.**
- Inspect engine accessory drive belts (or every 24 months, whichever occurs first). *An Emission Control Service.*
- Inspect camshaft timing belt. *An Emission Control Service.*
- Drain, flush and refill cooling system (or every 24 months, whichever occurs first). See "Engine Coolant" in the Index for what to use. Inspect hoses. Clean radiator, condenser, pressure cap and neck. Pressure test the cooling system and pressure cap. *An Emission Control Service.*

(Continued)

Maintenance Schedule II — Gasoline Engines With Heavy Duty Emissions

(Continued)

- Replace spark plugs. *An Emission Control Service.*
- Replace air cleaner filter. *An Emission Control Service.*
- Replace fuel filter. *An Emission Control Service.*

DATE	ACTUAL MILEAGE	SERVICED BY:

50,000 Miles (83 000 km)

- Change automatic transmission fluid and filter if the vehicle is mainly driven under one or more of these conditions:
 - In heavy city traffic where the outside temperature regularly reaches 90°F (32°C) or higher.
 - In hilly or mountainous terrain.
 - When doing frequent trailer towing.
 - Uses such as found in taxi, police or delivery service.

If you do not use your vehicle under any of these conditions, the fluid and filter do not require changing.

Manual transmission fluid doesn't require change.

DATE	ACTUAL MILEAGE	SERVICED BY:

Maintenance Schedule II — Gasoline Engines With Heavy Duty Emissions

54,000 Miles (90 000 km)

- Change engine oil and filter (or every 12 months, whichever occurs first). *An Emission Control Service.*
- Lubricate the front suspension, king pin bushings, steering linkage, transmission shift linkage, transfer case shift linkage, parking brake cable guides, rear driveline center splines, front axle propshaft splines, brake pedal springs and clutch pedal springs. Ball joints and king pin bushings should not be lubricated unless their temperature is 10° F (-12° C), or higher. When weather is cold, let the ball joints and king pin bushings warm up before lubrication or they could be damaged. Perform each of the listed lubrication service items at this mileage interval (or every 12 months, whichever occurs first).
- Check rear/front axle fluid level and add fluid as needed. Check constant velocity joints and axle seals for leaking.**
- Replace spark plugs. *An Emission Control Service.*
- Rotate tires. See "Tire Inspection and Rotation" in the Index for proper rotation pattern and additional information.

DATE	ACTUAL MILEAGE	SERVICED BY:

Maintenance Schedule II — Gasoline Engines With Heavy Duty Emissions

60,000 Miles (100 000 km)

- Change engine oil and filter (or every 12 months, whichever occurs first). *An Emission Control Service.*
- Lubricate the front suspension, king pin bushings, steering linkage, transmission shift linkage, transfer case shift linkage, parking brake cable guides, rear driveline center splines, front axle propshaft splines, brake pedal springs and clutch pedal springs. Ball joints and king pin bushings should not be lubricated unless their temperature is 10° F (-12° C), or higher. When weather is cold, let the ball joints and king pin bushings warm up before lubrication or they could be damaged. Perform each of the listed lubrication service items at this mileage interval (or every 12 months, whichever occurs first).
- Check rear/front axle fluid level and add fluid as needed. Check constant velocity joints and axle seals for leaking.**
- Inspect engine accessory drive belts (or every 24 months, whichever occurs first). *An Emission Control Service.*
- Inspect camshaft timing belt. *An Emission Control Service.*
- Inspect spark plug wires. *An Emission Control Service.* †
- Inspect fuel tank, lines, rails, injection assembly, cap and cap gasket. *An Emission Control Service.* †

DATE	ACTUAL MILEAGE	SERVICED BY:

Maintenance Schedule I — Diesel Engines

The services shown in this schedule up to 60,000 miles (100 000 km) should be performed after 60,000 miles (100 000 km) at the same intervals.

Footnotes

* When the vehicle is operated in extreme dust and dirt conditions (off-road), the air cleaner filter may need to be checked as often as every 300 miles (483 km) and replaced as necessary.

** Drive axle service:

- Locking Differential — Drain fluid and refill at first engine oil change. At subsequent oil changes, check fluid and add fluid as needed. If driving in dusty areas or towing a trailer, drain fluid and refill every 15,000 miles (25 000 km).
- Standard Differential — Check fluid level and add fluid as needed at every engine oil change. If driving in dusty areas or towing a trailer, drain fluid and refill every 15,000 miles (25 000 km).
- More frequent lubrication may be required for heavy-duty or off-road use.
- 3500 HD Models with applications requiring extreme overload/trailer towing conditions and high speed (above 45 mph or 72 km/h) conditions for extended periods of time must have the drive axle fluid changed every 3,000 miles (5 000 km) or 3 months, whichever occurs first, or must use 75W-140 synthetic fluid meeting GM specifications. See "Recommended Fluids and Lubricants" in this section.

2,500 Miles (4 000 km)

- Change engine oil and filter (or every 3 months, whichever occurs first). *An Emission Control Service.*
- Lubricate the front suspension, king pin bushings, steering linkage, transmission shift linkage, transfer case shift linkage, parking brake cable guides, rear driveline center splines, front axle propshaft splines, brake pedal springs and clutch pedal springs. Ball joints and king pin bushings should not be lubricated unless their temperature is 10° F (-12° C), or higher. When weather is cold, let the ball joints and king pin bushings warm up before lubrication or they could be damaged. Perform each of the listed lubrication service items at this mileage interval (or every 12 months, whichever occurs first).

DATE	ACTUAL MILEAGE	SERVICED BY:

Maintenance Schedule I — Diesel Engines

5,000 Miles (8 000 km)

- Change engine oil and filter (or every 3 months, whichever occurs first). *An Emission Control Service.*
- Lubricate the front suspension, king pin bushings, steering linkage, transmission shift linkage, transfer case shift linkage, parking brake cable guides, rear driveline center splines, front axle propshaft splines, brake pedal springs and clutch pedal springs. Ball joints and king pin bushings should not be lubricated unless their temperature is 10° F (-12° C), or higher. When weather is cold, let the ball joints and king pin bushings warm up before lubrication or they could be damaged. Perform each of the listed lubrication service items at this mileage interval (or every 12 months, whichever occurs first).
- Check rear/front axle fluid level and add fluid as needed. Check constant velocity joints and axle seals for leaking. **

DATE	ACTUAL MILEAGE	SERVICED BY:

7,500 Miles (12 000 km)

- Change engine oil and filter (or every 3 months, whichever occurs first). *An Emission Control Service.*
- Lubricate the front suspension, king pin bushings, steering linkage, transmission shift linkage, transfer case shift linkage, parking brake cable guides, rear driveline center splines, front axle propshaft splines, brake pedal springs and clutch pedal springs. Ball joints and king pin bushings should not be lubricated unless their temperature is 10° F (-12° C), or higher. When weather is cold, let the ball joints and king pin bushings warm up before lubrication or they could be damaged. Perform each of the listed lubrication service items at this mileage interval (or every 12 months, whichever occurs first).
- Rotate tires. See "Tire Inspection and Rotation" in the Index for proper rotation pattern and additional information. See "Tires" in the Index.

DATE	ACTUAL MILEAGE	SERVICED BY:

Maintenance Schedule I — Diesel Engines

10,000 Miles (16 000 km)

- Change engine oil and filter (or every 3 months, whichever occurs first). *An Emission Control Service.*
- Lubricate the front suspension, king pin bushings, steering linkage, transmission shift linkage, transfer case shift linkage, parking brake cable guides, rear driveline center splines, front axle propshaft splines, brake pedal springs and clutch pedal springs. Ball joints and king pin bushings should not be lubricated unless their temperature is 10° F (–12° C), or higher. When weather is cold, let the ball joints and king pin bushings warm up before lubrication or they could be damaged. Perform each of the listed lubrication service items at this mileage interval (or every 12 months, whichever occurs first).
- Inspect shields and underhood insulation for damage or looseness. Adjust or replace as required. **This is a Noise Emission Control Service. Applicable only to vehicles sold in the United States.**
- Check the air intake system installation to assure that gaskets are properly sealed and that all hose connections, fasteners and other components are tight. Also check to be sure that the air cleaner housing is properly seated, the cover fits tightly and the wing nuts are tight. Tighten connections and fasteners or replace damaged parts as necessary. **This is a Noise Emission Control Service. Applicable only to vehicles sold in the United States.**
- If your engine has a thermostatically controlled cooling fan, inspect all hoses and ducts for proper hook-up (or every 12 months, whichever occurs first). Be sure the valve works properly. **This is a Noise Emission Control Service. Applicable only to vehicles sold in the United States.**
- Check rear/front axle fluid level and add fluid as needed. Check constant velocity joints and axle seals for leaking. **

DATE	ACTUAL MILEAGE	SERVICED BY:

Maintenance Schedule I — Diesel Engines

12,500 Miles (20 000 km)

- Change engine oil and filter (or every 3 months, whichever occurs first). *An Emission Control Service.*
- Lubricate the front suspension, king pin bushings, steering linkage, transmission shift linkage, transfer case shift linkage, parking brake cable guides, rear driveline center splines, front axle propshaft splines, brake pedal springs and clutch pedal springs. Ball joints and king pin bushings should not be lubricated unless their temperature is 10° F (-12° C), or higher. When weather is cold, let the ball joints and king pin bushings warm up before lubrication or they could be damaged. Perform each of the listed lubrication service items at this mileage interval (or every 12 months, whichever occurs first).

DATE	ACTUAL MILEAGE	SERVICED BY:

15,000 Miles (24 000 km)

- Change engine oil and filter (or every 3 months, whichever occurs first). *An Emission Control Service.*
- Lubricate the front suspension, king pin bushings, steering linkage, transmission shift linkage, transfer case shift linkage, parking brake cable guides, rear driveline center splines, front axle propshaft splines, brake pedal springs and clutch pedal springs. Ball joints and king pin bushings should not be lubricated unless their temperature is 10° F (-12° C), or higher. When weather is cold, let the ball joints and king pin bushings warm up before lubrication or they could be damaged. Perform each of the listed lubrication service items at this mileage interval (or every 12 months, whichever occurs first).
- Replace air cleaner filter. Replace filter more often under dusty conditions. *An Emission Control Service.* *
- For 2-Wheel Drive vehicles only: Clean and repack the front wheel bearings (or at each brake relining, whichever occurs first).

(Continued)

Maintenance Schedule I — Diesel Engines

(Continued)

- Check rear/front axle fluid level and add fluid as needed. Check constant velocity joints and axle seals for leaking. **

DATE	ACTUAL MILEAGE	SERVICED BY:

17,500 Miles (28 000 km)

- Change engine oil and filter (or every 3 months, whichever occurs first). *An Emission Control Service.*
- Lubricate the front suspension, king pin bushings, steering linkage, transmission shift linkage, transfer case shift linkage, parking brake cable guides, rear driveline center splines, front axle propshaft splines, brake pedal springs and clutch pedal springs. Ball joints and king pin bushings should not be lubricated unless their temperature is 10° F (-12° C), or higher. When weather is cold, let the ball joints and king pin bushings warm up before lubrication or they could be damaged. Perform each of the listed lubrication service items at this mileage interval (or every 12 months, whichever occurs first).

DATE	ACTUAL MILEAGE	SERVICED BY:

Maintenance Schedule I — Diesel Engines

20,000 Miles (32 000 km)

- Change engine oil and filter (or every 3 months, whichever occurs first). *An Emission Control Service.*
- Lubricate the front suspension, king pin bushings, steering linkage, transmission shift linkage, transfer case shift linkage, parking brake cable guides, rear driveline center splines, front axle propshaft splines, brake pedal springs and clutch pedal springs. Ball joints and king pin bushings should not be lubricated unless their temperature is 10° F (-12° C), or higher. When weather is cold, let the ball joints and king pin bushings warm up before lubrication or they could be damaged. Perform each of the listed lubrication service items at this mileage interval (or every 12 months, whichever occurs first).
- Inspect shields and underhood insulation for damage or looseness. Adjust or replace as required. **This is a Noise Emission Control Service. Applicable only to vehicles sold in the United States.**
- Check the air intake system installation to assure that gaskets are properly sealed and that all hose connections, fasteners and other components are tight. Also check to be sure that the air cleaner housing is properly seated, the cover fits tightly and the wing nuts are tight. Tighten connections and fasteners or replace damaged parts as necessary. **This is a Noise Emission Control Service. Applicable only to vehicles sold in the United States.**
- If your engine has a thermostatically controlled cooling fan, inspect all hoses and ducts for proper hook-up (or every 12 months, whichever occurs first). Be sure the valve works properly. **This is a Noise Emission Control Service. Applicable only to vehicles sold in the United States.**
- Check rear/front axle fluid level and add fluid as needed. Check constant velocity joints and axle seals for leaking. **

DATE	ACTUAL MILEAGE	SERVICED BY:

Maintenance Schedule I — Diesel Engines

22,500 Miles (36 000 km)

- Change engine oil and filter (or every 3 months, whichever occurs first). *An Emission Control Service.*
- Lubricate the front suspension, king pin bushings, steering linkage, transmission shift linkage, transfer case shift linkage, parking brake cable guides, rear driveline center splines, front axle propshaft splines, brake pedal springs and clutch pedal springs. Ball joints and king pin bushings should not be lubricated unless their temperature is 10° F (-12° C), or higher. When weather is cold, let the ball joints and king pin bushings warm up before lubrication or they could be damaged. Perform each of the listed lubrication service items at this mileage interval (or every 12 months, whichever occurs first).
- Rotate tires. See "Tire Inspection and Rotation" in the Index for proper rotation pattern and additional information. See "Tires" in the Index.

DATE	ACTUAL MILEAGE	SERVICED BY:

25,000 Miles (40 000 km)

- Change engine oil and filter (or every 3 months, whichever occurs first). *An Emission Control Service.*
- Lubricate the front suspension, king pin bushings, steering linkage, transmission shift linkage, transfer case shift linkage, parking brake cable guides, rear driveline center splines, front axle propshaft splines, brake pedal springs and clutch pedal springs. Ball joints and king pin bushings should not be lubricated unless their temperature is 10° F (-12° C), or higher. When weather is cold, let the ball joints and king pin bushings warm up before lubrication or they could be damaged. Perform each of the listed lubrication service items at this mileage interval (or every 12 months, whichever occurs first).
- Check rear/front axle fluid level and add fluid as needed. Check constant velocity joints and axle seals for leaking. **

DATE	ACTUAL MILEAGE	SERVICED BY:

Maintenance Schedule I — Diesel Engines

27,500 Miles (44 000 km)

- Change engine oil and filter (or every 3 months, whichever occurs first). *An Emission Control Service.*
- Lubricate the front suspension, king pin bushings, steering linkage, transmission shift linkage, transfer case shift linkage, parking brake cable guides, rear driveline center splines, front axle propshaft splines, brake pedal springs and clutch pedal springs. Ball joints and king pin bushings should not be lubricated unless their temperature is 10° F (-12° C), or higher. When weather is cold, let the ball joints and king pin bushings warm up before lubrication or they could be damaged. Perform each of the listed lubrication service items at this mileage interval (or every 12 months, whichever occurs first).

DATE	ACTUAL MILEAGE	SERVICED BY:

30,000 Miles (48 000 km)

- Change engine oil and filter (or every 3 months, whichever occurs first). *An Emission Control Service.*
- Lubricate the front suspension, king pin bushings, steering linkage, transmission shift linkage, transfer case shift linkage, parking brake cable guides, rear driveline center splines, front axle propshaft splines, brake pedal springs and clutch pedal springs. Ball joints and king pin bushings should not be lubricated unless their temperature is 10° F (-12° C), or higher. When weather is cold, let the ball joints and king pin bushings warm up before lubrication or they could be damaged. Perform each of the listed lubrication service items at this mileage interval (or every 12 months, whichever occurs first).
- For vehicles equipped with a 5-speed manual transmission with deep low: Lubricate the clutch fork ball stud through the fitting on the clutch housing. Lubricant must be added *sparingly* to the fitting, as very little is required to lubricate the ball stud surface. Do not add lubricant more often than specified. **Too much lubricant will damage the clutch assembly.**

(Continued)

Maintenance Schedule I — Diesel Engines

(Continued)

- Drain, flush and refill the cooling system with new coolant (or every 24 months, whichever occurs first). See “Engine Coolant” in the Index for what to use. *An Emission Control Service.*

Also inspect the hoses and replace them if they are cracked, swollen or deteriorated. Tighten all hose clamps (except constant tension clamps). Remove debris and clean the outside of the radiator and air conditioning condenser. Wash the radiator neck. To ensure proper operation, pressure test the radiator and cap.

- Replace air cleaner filter. Replace filter more often under dusty conditions. *An Emission Control Service. **
- For 2-Wheel Drive vehicles only: Clean and repack the front wheel bearings (or at each brake relining, whichever occurs first).
- Replace fuel filter. Replace filter sooner if it is clogged.†
- Inspect shields and underhood insulation for damage or looseness. Adjust or replace as required. **This is a Noise Emission Control Service. Applicable only to vehicles sold in the United States.**
- Check the air intake system installation to assure that gaskets are properly sealed and that all hose connections, fasteners and other components are tight. Also check to be sure that the air cleaner housing is properly seated, the cover fits tightly and the wing nuts are tight. Tighten connections and fasteners or replace damaged parts as necessary. **This is a Noise Emission Control Service. Applicable only to vehicles sold in the United States.**
- If your engine has a thermostatically controlled cooling fan, inspect all hoses and ducts for proper hook-up (or every 12 months, whichever occurs first). Be sure the valve works properly. **This is a Noise Emission Control Service. Applicable only to vehicles sold in the United States.**
- Check rear/front axle fluid level and add fluid as needed. Check constant velocity joints and axle seals for leaking. **

DATE	ACTUAL MILEAGE	SERVICED BY:

Maintenance Schedule I — Diesel Engines

32,500 Miles (52 000 km)

- Change engine oil and filter (or every 3 months, whichever occurs first). *An Emission Control Service.*
- Lubricate the front suspension, king pin bushings, steering linkage, transmission shift linkage, transfer case shift linkage, parking brake cable guides, rear driveline center splines, front axle propshaft splines, brake pedal springs and clutch pedal springs. Ball joints and king pin bushings should not be lubricated unless their temperature is 10° F (-12° C), or higher. When weather is cold, let the ball joints and king pin bushings warm up before lubrication or they could be damaged. Perform each of the listed lubrication service items at this mileage interval (or every 12 months, whichever occurs first).

DATE	ACTUAL MILEAGE	SERVICED BY:

35,000 Miles (56 000 km)

- Change engine oil and filter (or every 3 months, whichever occurs first). *An Emission Control Service.*
- Lubricate the front suspension, king pin bushings, steering linkage, transmission shift linkage, transfer case shift linkage, parking brake cable guides, rear driveline center splines, front axle propshaft splines, brake pedal springs and clutch pedal springs. Ball joints and king pin bushings should not be lubricated unless their temperature is 10° F (-12° C), or higher. When weather is cold, let the ball joints and king pin bushings warm up before lubrication or they could be damaged. Perform each of the listed lubrication service items at this mileage interval (or every 12 months, whichever occurs first).
- Check rear/front axle fluid level and add fluid as needed. Check constant velocity joints and axle seals for leaking. **

DATE	ACTUAL MILEAGE	SERVICED BY:

Maintenance Schedule I — Diesel Engines

37,500 Miles (60 000 km)

- Change engine oil and filter (or every 3 months, whichever occurs first). *An Emission Control Service.*
- Lubricate the front suspension, king pin bushings, steering linkage, transmission shift linkage, transfer case shift linkage, parking brake cable guides, rear driveline center splines, front axle propshaft splines, brake pedal springs and clutch pedal springs. Ball joints and king pin bushings should not be lubricated unless their temperature is 10° F (-12° C), or higher. When weather is cold, let the ball joints and king pin bushings warm up before lubrication or they could be damaged. Perform each of the listed lubrication service items at this mileage interval (or every 12 months, whichever occurs first).
- Rotate tires. See "Tire Inspection and Rotation" in the Index for proper rotation pattern and additional information. See "Tires" in the Index.

DATE	ACTUAL MILEAGE	SERVICED BY:

40,000 Miles (64 000 km)

- Change engine oil and filter (or every 3 months, whichever occurs first). *An Emission Control Service.*
- Lubricate the front suspension, king pin bushings, steering linkage, transmission shift linkage, transfer case shift linkage, parking brake cable guides, rear driveline center splines, front axle propshaft splines, brake pedal springs and clutch pedal springs. Ball joints and king pin bushings should not be lubricated unless their temperature is 10° F (-12° C), or higher. When weather is cold, let the ball joints and king pin bushings warm up before lubrication or they could be damaged. Perform each of the listed lubrication service items at this mileage interval (or every 12 months, whichever occurs first).
- Inspect shields and underhood insulation for damage or looseness. Adjust or replace as required. **This is a Noise Emission Control Service. Applicable only to vehicles sold in the United States.**

(Continued)

Maintenance Schedule I — Diesel Engines

(Continued)

- Check the air intake system installation to assure that gaskets are properly sealed and that all hose connections, fasteners and other components are tight. Also check to be sure that the air cleaner housing is properly seated, the cover fits tightly and the wing nuts are tight. Tighten connections and fasteners or replace damaged parts as necessary. **This is a Noise Emission Control Service. Applicable only to vehicles sold in the United States.**
- If your engine has a thermostatically controlled cooling fan, inspect all hoses and ducts for proper hook-up (or every 12 months, whichever occurs first). Be sure the valve works properly. **This is a Noise Emission Control Service. Applicable only to vehicles sold in the United States.**
- Check rear/front axle fluid level and add fluid as needed. Check constant velocity joints and axle seals for leaking. **

DATE	ACTUAL MILEAGE	SERVICED BY:

42,500 Miles (68 000 km)

- Change engine oil and filter (or every 3 months, whichever occurs first). *An Emission Control Service.*
- Lubricate the front suspension, king pin bushings, steering linkage, transmission shift linkage, transfer case shift linkage, parking brake cable guides, rear driveline center splines, front axle propshaft splines, brake pedal springs and clutch pedal springs. Ball joints and king pin bushings should not be lubricated unless their temperature is 10° F (-12° C), or higher. When weather is cold, let the ball joints and king pin bushings warm up before lubrication or they could be damaged. Perform each of the listed lubrication service items at this mileage interval (or every 12 months, whichever occurs first).

DATE	ACTUAL MILEAGE	SERVICED BY:

Maintenance Schedule I — Diesel Engines

45,000 Miles (72 000 km)

- Change engine oil and filter (or every 3 months, whichever occurs first). *An Emission Control Service.*
- Lubricate the front suspension, king pin bushings, steering linkage, transmission shift linkage, transfer case shift linkage, parking brake cable guides, rear driveline center splines, front axle propshaft splines, brake pedal springs and clutch pedal springs. Ball joints and king pin bushings should not be lubricated unless their temperature is 10° F (-12° C), or higher. When weather is cold, let the ball joints and king pin bushings warm up before lubrication or they could be damaged. Perform each of the listed lubrication service items at this mileage interval (or every 12 months, whichever occurs first).
- Replace air cleaner filter. Replace filter more often under dusty conditions. *An Emission Control Service. **
- For 2-Wheel Drive vehicles only: Clean and repack the front wheel bearings (or at each brake relining, whichever occurs first).
- Check rear/front axle fluid level and add fluid as needed. Check constant velocity joints and axle seals for leaking. **

DATE	ACTUAL MILEAGE	SERVICED BY:

Maintenance Schedule I — Diesel Engines

47,500 Miles (76 000 km)

- Change engine oil and filter (or every 3 months, whichever occurs first). *An Emission Control Service.*
- Lubricate the front suspension, king pin bushings, steering linkage, transmission shift linkage, transfer case shift linkage, parking brake cable guides, rear driveline center splines, front axle propshaft splines, brake pedal springs and clutch pedal springs. Ball joints and king pin bushings should not be lubricated unless their temperature is 10° F (-12° C), or higher. When weather is cold, let the ball joints and king pin bushings warm up before lubrication or they could be damaged. Perform each of the listed lubrication service items at this mileage interval (or every 12 months, whichever occurs first).

DATE	ACTUAL MILEAGE	SERVICED BY:

50,000 Miles (80 000 km)

- Change engine oil and filter (or every 3 months, whichever occurs first). *An Emission Control Service.*
- Lubricate the front suspension, king pin bushings, steering linkage, transmission shift linkage, transfer case shift linkage, parking brake cable guides, rear driveline center splines, front axle propshaft splines, brake pedal springs and clutch pedal springs. Ball joints and king pin bushings should not be lubricated unless their temperature is 10° F (-12° C), or higher. When weather is cold, let the ball joints and king pin bushings warm up before lubrication or they could be damaged. Perform each of the listed lubrication service items at this mileage interval (or every 12 months, whichever occurs first).
- Change automatic transmission fluid and filter if the vehicle is mainly driven under one or more of these conditions:
 - In heavy city traffic where the outside temperature regularly reaches 90°F (32°C) or higher.
 - In hilly or mountainous terrain.

(Continued)

Maintenance Schedule I — Diesel Engines

(Continued)

- When doing frequent trailer towing.
- Uses such as found in taxi, police or delivery service. *If you do not use your vehicle under any of these conditions, the fluid and filter do not require changing.*

Manual transmission fluid doesn't require change.

- Inspect shields and underhood insulation for damage or looseness. Adjust or replace as required. **This is a Noise Emission Control Service. Applicable only to vehicles sold in the United States.**
- Check the air intake system installation to assure that gaskets are properly sealed and that all hose connections, fasteners and other components are tight. Also check to be sure that the air cleaner housing is properly seated, the cover fits tightly and the wing nuts are tight. Tighten connections and fasteners or replace damaged parts as necessary. **This is a Noise Emission Control Service. Applicable only to vehicles sold in the United States.**
- If your engine has a thermostatically controlled cooling fan, inspect all hoses and ducts for proper hook-up (or every 12 months, whichever occurs first). Be sure the valve works properly. **This is a Noise Emission Control Service. Applicable only to vehicles sold in the United States.**
- Check rear/front axle fluid level and add fluid as needed. Check constant velocity joints and axle seals for leaking. **

DATE	ACTUAL MILEAGE	SERVICED BY:

Maintenance Schedule I — Diesel Engines

52,500 Miles (84 000 km)

- Change engine oil and filter (or every 3 months, whichever occurs first). *An Emission Control Service.*
- Lubricate the front suspension, king pin bushings, steering linkage, transmission shift linkage, transfer case shift linkage, parking brake cable guides, rear driveline center splines, front axle propshaft splines, brake pedal springs and clutch pedal springs. Ball joints and king pin bushings should not be lubricated unless their temperature is 10° F (-12° C), or higher. When weather is cold, let the ball joints and king pin bushings warm up before lubrication or they could be damaged. Perform each of the listed lubrication service items at this mileage interval (or every 12 months, whichever occurs first).
- Rotate tires. See "Tire Inspection and Rotation" in the Index for proper rotation pattern and additional information. See "Tires" in the Index.

DATE	ACTUAL MILEAGE	SERVICED BY:

55,000 Miles (88 000 km)

- Change engine oil and filter (or every 3 months, whichever occurs first). *An Emission Control Service.*
- Lubricate the front suspension, king pin bushings, steering linkage, transmission shift linkage, transfer case shift linkage, parking brake cable guides, rear driveline center splines, front axle propshaft splines, brake pedal springs and clutch pedal springs. Ball joints and king pin bushings should not be lubricated unless their temperature is 10° F (-12° C), or higher. When weather is cold, let the ball joints and king pin bushings warm up before lubrication or they could be damaged. Perform each of the listed lubrication service items at this mileage interval (or every 12 months, whichever occurs first).
- Check rear/front axle fluid level and add fluid as needed. Check constant velocity joints and axle seals for leaking. **

DATE	ACTUAL MILEAGE	SERVICED BY:

Maintenance Schedule I — Diesel Engines

57,500 Miles (92 000 km)

- Change engine oil and filter (or every 3 months, whichever occurs first). *An Emission Control Service.*
- Lubricate the front suspension, king pin bushings, steering linkage, transmission shift linkage, transfer case shift linkage, parking brake cable guides, rear driveline center splines, front axle propshaft splines, brake pedal springs and clutch pedal springs. Ball joints and king pin bushings should not be lubricated unless their temperature is 10° F (-12° C), or higher. When weather is cold, let the ball joints and king pin bushings warm up before lubrication or they could be damaged. Perform each of the listed lubrication service items at this mileage interval (or every 12 months, whichever occurs first).

DATE	ACTUAL MILEAGE	SERVICED BY:

60,000 Miles (100 000 km)

- Change engine oil and filter (or every 3 months, whichever occurs first). *An Emission Control Service.*
- Lubricate the front suspension, king pin bushings, steering linkage, transmission shift linkage, transfer case shift linkage, parking brake cable guides, rear driveline center splines, front axle propshaft splines, brake pedal springs and clutch pedal springs. Ball joints and king pin bushings should not be lubricated unless their temperature is 10° F (-12° C), or higher. When weather is cold, let the ball joints and king pin bushings warm up before lubrication or they could be damaged. Perform each of the listed lubrication service items at this mileage interval (or every 12 months, whichever occurs first).
- For vehicles equipped with a 5-speed manual transmission with deep low: Lubricate the clutch fork ball stud through the fitting on the clutch housing. Lubricant must be added *sparingly* to the fitting, as very little is required to lubricate the ball stud surface. Do not add lubricant more often than specified. **Too much lubricant will damage the clutch assembly.**

(Continued)

Maintenance Schedule I — Diesel Engines

(Continued)

- Drain, flush and refill the cooling system with new coolant (or every 24 months, whichever occurs first). See “Engine Coolant” in the Index for what to use. *An Emission Control Service.*

Also inspect the hoses and replace them if they are cracked, swollen or deteriorated. Tighten all hose clamps (except constant tension clamps). Remove debris and clean the outside of the radiator and air conditioning condenser. Wash the radiator neck. To ensure proper operation, pressure test the radiator and cap.
- Replace air cleaner filter. Replace filter more often under dusty conditions. *An Emission Control Service.* *
- For 2-Wheel Drive vehicles only: Clean and repack the front wheel bearings (or at each brake relining, whichever occurs first).
- Check the crankcase depression regulator valve system for any worn, plugged or collapsed hoses. See service manual. *An Emission Control Service.*
- Replace fuel filter. Replace filter sooner if it is clogged. †
- Check the EGR System (if equipped) (except Code F engine) as described in the service manual. *An Emission Control Service.*
- Inspect accessory drive (serpentine) belt for cracks, fraying and wear and check belt for proper tension. Adjust or replace belt as needed. *An Emission Control Service.*
- Inspect shields and underhood insulation for damage or looseness. Adjust or replace as required. **This is a Noise Emission Control Service. Applicable only to vehicles sold in the United States.**
- Check the air intake system installation to assure that gaskets are properly sealed and that all hose connections, fasteners and other components are tight. Also check to be sure that the air cleaner housing is properly seated, the cover fits tightly and the wing nuts are tight. Tighten connections and fasteners or replace damaged parts as necessary. **This is a Noise Emission Control Service. Applicable only to vehicles sold in the United States.**
- If your engine has a thermostatically controlled cooling fan, inspect all hoses and ducts for proper hook-up (or every 12 months, whichever occurs first). Be sure the valve works properly. **This is a Noise Emission Control Service. Applicable only to vehicles sold in the United States.**

(Continued)

Maintenance Schedule I — Diesel Engines

(Continued)

- Check the exhaust pressure regulator valve for proper operation; correct any binding. Inspect hoses for cracks, chafing or decay. Replace parts as needed. *An Emission Control Service.*
- Check rear/front axle fluid level and add fluid as needed. Check constant velocity joints and axle seals for leaking. **

DATE	ACTUAL MILEAGE	SERVICED BY:

Maintenance Schedule II — Diesel Engines

The services shown in this schedule up to 60,000 miles (100 000 km) should be performed after 60,000 miles (100 000 km) at the same intervals.

Footnotes

** Drive axle service:

- Locking Differential — Drain fluid and refill at first engine oil change. At subsequent oil changes, check fluid level and add fluid as needed. If driving in dusty areas or towing a trailer, drain fluid and refill every 15,000 miles (25 000 km).
- Standard Differential — Check fluid level and add fluid as needed at every engine oil change. If driving in dusty areas or towing a trailer, drain fluid and refill every 15,000 miles (25 000 km).
- More frequent lubrication may be required for heavy-duty or off-road use.
- 3500 HD Models with applications requiring extreme overload/trailer towing conditions and high speed (above 45 mph or 72 km/h) conditions for extended periods of time must have the drive axle fluid changed every 3,000 miles (5 000 km) or 3 months, whichever occurs first, or must use 75W-140 synthetic fluid meeting GM specifications. See "Recommended Fluids and Lubricants" in this section.

Maintenance Schedule II — Diesel Engines

5,000 Miles (8 000 km)

- Change engine oil and filter (or every 12 months, whichever occurs first). *An Emission Control Service.*
- Lubricate the front suspension, king pin bushings, steering linkage, transmission shift linkage, transfer case shift linkage, parking brake cable guides, rear driveline center splines, front axle propshaft splines, brake pedal springs and clutch pedal springs. Ball joints and king pin bushings should not be lubricated unless their temperature is 10° F (-12° C), or higher. When weather is cold, let the ball joints and king pin bushings warm up before lubrication or they could be damaged. Perform each of the listed lubrication service items at this mileage interval (or every 12 months, whichever occurs first).
- Rotate tires. See "Tire Inspection and Rotation" in the Index for proper rotation pattern and additional information. See "Tires" in the Index.
- Check rear/front axle fluid level and add fluid as needed. Check constant velocity joints and axle seals for leaking. **

DATE	ACTUAL MILEAGE	SERVICED BY:

10,000 Miles (16 000 km)

- Change engine oil and filter (or every 12 months, whichever occurs first). *An Emission Control Service.*
- Lubricate the front suspension, king pin bushings, steering linkage, transmission shift linkage, transfer case shift linkage, parking brake cable guides, rear driveline center splines, front axle propshaft splines, brake pedal springs and clutch pedal springs. Ball joints and king pin bushings should not be lubricated unless their temperature is 10° F (-12° C), or higher. When weather is cold, let the ball joints and king pin bushings warm up before lubrication or they could be damaged. Perform each of the listed lubrication service items at this mileage interval (or every 12 months, whichever occurs first).

(Continued)

Maintenance Schedule II — Diesel Engines

(Continued)

- Inspect shields and underhood insulation for damage or looseness. Adjust or replace as required. **This is a Noise Emission Control Service. Applicable only to vehicles sold in the United States.**
- Check the air intake system installation to assure that gaskets are properly sealed and that all hose connections, fasteners and other components are tight. Also check to be sure that the air cleaner housing is properly seated, the cover fits tightly and the wing nuts are tight. Tighten connections and fasteners or replace damaged parts as necessary. **This is a Noise Emission Control Service. Applicable only to vehicles sold in the United States.**
- If your engine has a thermostatically controlled cooling fan, inspect all hoses and ducts for proper hook-up (or every 12 months, whichever occurs first). Be sure the valve works properly. **This is a Noise Emission Control Service. Applicable only to vehicles sold in the United States.**
- Check rear/front axle fluid level and add fluid as needed. Check constant velocity joints and axle seals for leaking. **

DATE	ACTUAL MILEAGE	SERVICED BY:

15,000 Miles (24 000 km)

- Change engine oil and filter (or every 3 months, whichever occurs first). *An Emission Control Service.*
- Lubricate the front suspension, king pin bushings, steering linkage, transmission shift linkage, transfer case shift linkage, parking brake cable guides, rear driveline center splines, front axle propshaft splines, brake pedal springs and clutch pedal springs. Ball joints and king pin bushings should not be lubricated unless their temperature is 10° F (-12° C), or higher. When weather is cold, let the ball joints and king pin bushings warm up before lubrication or they could be damaged. Perform each of the listed lubrication service items at this mileage interval (or every 12 months, whichever occurs first).

(Continued)

Maintenance Schedule II — Diesel Engines

(Continued)

- Rotate tires. See "Tire Inspection and Rotation" in the Index for proper rotation pattern and additional information. See "Tires" in the Index.
- Check rear/front axle fluid level and add fluid as needed. Check constant velocity joints and axle seals for leaking. **

DATE	ACTUAL MILEAGE	SERVICED BY:

20,000 Miles (32 000 km)

- Change engine oil and filter (or every 3 months, whichever occurs first). *An Emission Control Service.*
- Lubricate the front suspension, king pin bushings, steering linkage, transmission shift linkage, transfer case shift linkage, parking brake cable guides, rear driveline center splines, front axle propshaft splines, brake pedal springs and clutch pedal springs. Ball joints and king pin bushings should not be lubricated unless their temperature is 10° F (-12° C), or higher. When weather is cold, let the ball joints and king pin bushings warm up before lubrication or they could be damaged. Perform each of the listed lubrication service items at this mileage interval (or every 12 months, whichever occurs first).
- Inspect shields and underhood insulation for damage or looseness. Adjust or replace as required. **This is a Noise Emission Control Service. Applicable only to vehicles sold in the United States.**
- Check the air intake system installation to assure that gaskets are properly sealed and that all hose connections, fasteners and other components are tight. Also check to be sure that the air cleaner housing is properly seated, the cover fits tightly and the wing nuts are tight. Tighten connections and fasteners or replace damaged parts as necessary. **This is a Noise Emission Control Service. Applicable only to vehicles sold in the United States.**

(Continued)

Maintenance Schedule II — Diesel Engines

(Continued)

- If your engine has a thermostatically controlled cooling fan, inspect all hoses and ducts for proper hook-up (or every 12 months, whichever occurs first). Be sure the valve works properly. **This is a Noise Emission Control Service. Applicable only to vehicles sold in the United States.**
- Check rear/front axle fluid level and add fluid as needed. Check constant velocity joints and axle seals for leaking. **

DATE	ACTUAL MILEAGE	SERVICED BY:

25,000 Miles (40 000 km)

- Change engine oil and filter (or every 3 months, whichever occurs first). *An Emission Control Service.*
- Lubricate the front suspension, king pin bushings, steering linkage, transmission shift linkage, transfer case shift linkage, parking brake cable guides, rear driveline center splines, front axle propshaft splines, brake pedal springs and clutch pedal springs. Ball joints and king pin bushings should not be lubricated unless their temperature is 10° F (-12° C), or higher. When weather is cold, let the ball joints and king pin bushings warm up before lubrication or they could be damaged. Perform each of the listed lubrication service items at this mileage interval (or every 12 months, whichever occurs first).
- Rotate tires. See "Tire Inspection and Rotation" in the Index for proper rotation pattern and additional information. See "Tires" in the Index.
- Check rear/front axle fluid level and add fluid as needed. Check constant velocity joints and axle seals for leaking. **

DATE	ACTUAL MILEAGE	SERVICED BY:

Maintenance Schedule II — Diesel Engines

30,000 Miles (48 000 km)

- Change engine oil and filter (or every 3 months, whichever occurs first). *An Emission Control Service.*
- Lubricate the front suspension, king pin bushings, steering linkage, transmission shift linkage, transfer case shift linkage, parking brake cable guides, rear driveline center splines, front axle propshaft splines, brake pedal springs and clutch pedal springs. Ball joints and king pin bushings should not be lubricated unless their temperature is 10° F (-12° C), or higher. When weather is cold, let the ball joints and king pin bushings warm up before lubrication or they could be damaged. Perform each of the listed lubrication service items at this mileage interval (or every 12 months, whichever occurs first).
- For vehicles equipped with a 5-speed manual transmission with deep low: Lubricate the clutch fork ball stud through the fitting on the clutch housing. Lubricant must be added *sparingly* to the fitting, as very little is required to lubricate the ball stud surface. Do not add lubricant more often than specified. **Too much lubricant will damage the clutch assembly.**
- Drain, flush and refill the cooling system with new coolant (or every 24 months, whichever occurs first). See “Engine Coolant” in the Index for what to use. *An Emission Control Service.*

Also inspect the hoses and replace them if they are cracked, swollen or deteriorated. Tighten all hose clamps (except constant tension clamps). Remove debris and clean the outside of the radiator and air conditioning condenser. Wash the radiator neck. To ensure proper operation, pressure test the radiator and cap.

- Replace air cleaner filter. *An Emission Control Service.*
- For 2-Wheel Drive vehicles only: Clean and repack the front wheel bearings (or at each brake relining, whichever occurs first).
- Replace fuel filter. Replace filter sooner if it is clogged.†
- Inspect shields and underhood insulation for damage or looseness. Adjust or replace as required. **This is a Noise Emission Control Service. Applicable only to vehicles sold in the United States.**

(Continued)

Maintenance Schedule II — Diesel Engines

(Continued)

- Check the air intake system installation to assure that gaskets are properly sealed and that all hose connections, fasteners and other components are tight. Also check to be sure that the air cleaner housing is properly seated, the cover fits tightly and the wing nuts are tight. Tighten connections and fasteners or replace damaged parts as necessary. **This is a Noise Emission Control Service. Applicable only to vehicles sold in the United States.**
- If your engine has a thermostatically controlled cooling fan, inspect all hoses and ducts for proper hook-up (or every 12 months, whichever occurs first). Be sure the valve works properly. **This is a Noise Emission Control Service. Applicable only to vehicles sold in the United States.**
- Check rear/front axle fluid level and add fluid as needed. Check constant velocity joints and axle seals for leaking. **

DATE	ACTUAL MILEAGE	SERVICED BY:

35,000 Miles (56 000 km)

- Change engine oil and filter (or every 3 months, whichever occurs first). *An Emission Control Service.*
- Lubricate the front suspension, king pin bushings, steering linkage, transmission shift linkage, transfer case shift linkage, parking brake cable guides, rear driveline center splines, front axle propshaft splines, brake pedal springs and clutch pedal springs. Ball joints and king pin bushings should not be lubricated unless their temperature is 10° F (-12° C), or higher. When weather is cold, let the ball joints and king pin bushings warm up before lubrication or they could be damaged. Perform each of the listed lubrication service items at this mileage interval (or every 12 months, whichever occurs first).
- Rotate tires. See "Tire Inspection and Rotation" in the Index for proper rotation pattern and additional information. See "Tires" in the Index.

(Continued)

Maintenance Schedule II — Diesel Engines

(Continued)

- Check rear/front axle fluid level and add fluid as needed. Check constant velocity joints and axle seals for leaking. **

DATE	ACTUAL MILEAGE	SERVICED BY:

40,000 Miles (64 000 km)

- Change engine oil and filter (or every 3 months, whichever occurs first). *An Emission Control Service.*
- Lubricate the front suspension, king pin bushings, steering linkage, transmission shift linkage, transfer case shift linkage, parking brake cable guides, rear driveline center splines, front axle propshaft splines, brake pedal springs and clutch pedal springs. Ball joints and king pin bushings should not be lubricated unless their temperature is 10° F (-12° C), or higher. When weather is cold, let the ball joints and king pin bushings warm up before lubrication or they could be damaged. Perform each of the listed lubrication service items at this mileage interval (or every 12 months, whichever occurs first).
- Inspect shields and underhood insulation for damage or looseness. Adjust or replace as required. **This is a Noise Emission Control Service. Applicable only to vehicles sold in the United States.**
- Check the air intake system installation to assure that gaskets are properly sealed and that all hose connections, fasteners and other components are tight. Also check to be sure that the air cleaner housing is properly seated, the cover fits tightly and the wing nuts are tight. Tighten connections and fasteners or replace damaged parts as necessary. **This is a Noise Emission Control Service. Applicable only to vehicles sold in the United States.**
- If your engine has a thermostatically controlled cooling fan, inspect all hoses and ducts for proper hook-up (or every 12 months, whichever occurs first). Be sure the valve works properly. **This is a Noise Emission Control Service. Applicable only to vehicles sold in the United States.**

(Continued)

Maintenance Schedule II — Diesel Engines

(Continued)

- Check rear/front axle fluid level and add fluid as needed. Check constant velocity joints and axle seals for leaking. **

DATE	ACTUAL MILEAGE	SERVICED BY:

45,000 Miles (72 000 km)

- Change engine oil and filter (or every 3 months, whichever occurs first). *An Emission Control Service.*
- Lubricate the front suspension, king pin bushings, steering linkage, transmission shift linkage, transfer case shift linkage, parking brake cable guides, rear driveline center splines, front axle propshaft splines, brake pedal springs and clutch pedal springs. Ball joints and king pin bushings should not be lubricated unless their temperature is 10° F (-12° C), or higher. When weather is cold, let the ball joints and king pin bushings warm up before lubrication or they could be damaged. Perform each of the listed lubrication service items at this mileage interval (or every 12 months, whichever occurs first).
- Rotate tires. See "Tire Inspection and Rotation" in the Index for proper rotation pattern and additional information. See "Tires" in the Index.
- Check rear/front axle fluid level and add fluid as needed. Check constant velocity joints and axle seals for leaking. **

DATE	ACTUAL MILEAGE	SERVICED BY:

Maintenance Schedule II — Diesel Engines

50,000 Miles (80 000 km)

- Change engine oil and filter (or every 3 months, whichever occurs first). *An Emission Control Service.*
- Lubricate the front suspension, king pin bushings, steering linkage, transmission shift linkage, transfer case shift linkage, parking brake cable guides, rear driveline center splines, front axle propshaft splines, brake pedal springs and clutch pedal springs. Ball joints and king pin bushings should not be lubricated unless their temperature is 10° F (–12° C), or higher. When weather is cold, let the ball joints and king pin bushings warm up before lubrication or they could be damaged. Perform each of the listed lubrication service items at this mileage interval (or every 12 months, whichever occurs first).
- Change automatic transmission fluid and filter if the vehicle is mainly driven under one or more of these conditions:
 - In heavy city traffic where the outside temperature regularly reaches 90° F (32° C) or higher.
 - In hilly or mountainous terrain.
 - When doing frequent trailer towing.
 - Uses such as found in taxi, police or delivery service. **If you do not use your vehicle under any of these conditions, the fluid and filter do not require changing.** Manual transmission fluid doesn't require change.
- Inspect shields and underhood insulation for damage or looseness. Adjust or replace as required. **This is a Noise Emission Control Service. Applicable only to vehicles sold in the United States.**
- Check the air intake system installation to assure that gaskets are properly sealed and that all hose connections, fasteners and other components are tight. Also check to be sure that the air cleaner housing is properly seated, the cover fits tightly and the wing nuts are tight. Tighten connections and fasteners or replace damaged parts as necessary. **This is a Noise Emission Control Service. Applicable only to vehicles sold in the United States.**
- If your engine has a thermostatically controlled cooling fan, inspect all hoses and ducts for proper hook-up (or every 12 months, whichever occurs first). Be sure the valve works properly. **This is a Noise Emission Control Service. Applicable only to vehicles sold in the United States.**

(Continued)

Maintenance Schedule II — Diesel Engines

(Continued)

- Check rear/front axle fluid level and add fluid as needed. Check constant velocity joints and axle seals for leaking. **

DATE	ACTUAL MILEAGE	SERVICED BY:

55,000 Miles (88 000 km)

- Change engine oil and filter (or every 3 months, whichever occurs first). *An Emission Control Service.*
- Lubricate the front suspension, king pin bushings, steering linkage, transmission shift linkage, transfer case shift linkage, parking brake cable guides, rear driveline center splines, front axle propshaft splines, brake pedal springs and clutch pedal springs. Ball joints and king pin bushings should not be lubricated unless their temperature is 10° F (-12° C), or higher. When weather is cold, let the ball joints and king pin bushings warm up before lubrication or they could be damaged. Perform each of the listed lubrication service items at this mileage interval (or every 12 months, whichever occurs first).
- Rotate tires. See "Tire Inspection and Rotation" in the Index for proper rotation pattern and additional information. See "Tires" in the Index.
- Check rear/front axle fluid level and add fluid as needed. Check constant velocity joints and axle seals for leaking. **

DATE	ACTUAL MILEAGE	SERVICED BY:

Maintenance Schedule II — Diesel Engines

60,000 Miles (100 000 km)

- Change engine oil and filter (or every 3 months, whichever occurs first). *An Emission Control Service.*
- Lubricate the front suspension, king pin bushings, steering linkage, transmission shift linkage, transfer case shift linkage, parking brake cable guides, rear driveline center splines, front axle propshaft splines, brake pedal springs and clutch pedal springs. Ball joints and king pin bushings should not be lubricated unless their temperature is 10° F (-12° C), or higher. When weather is cold, let the ball joints and king pin bushings warm up before lubrication or they could be damaged. Perform each of the listed lubrication service items at this mileage interval (or every 12 months, whichever occurs first).
- For vehicles equipped with a 5-speed manual transmission with deep low: Lubricate the clutch fork ball stud through the fitting on the clutch housing. Lubricant must be added *sparingly* to the fitting, as very little is required to lubricate the ball stud surface. Do not add lubricant more often than specified. **Too much lubricant will damage the clutch assembly.**
- Drain, flush and refill the cooling system with new coolant (or every 24 months, whichever occurs first). See "Engine Coolant" in the Index for what to use. *An Emission Control Service.*

Also inspect the hoses and replace them if they are cracked, swollen or deteriorated. Tighten all hose clamps (except constant tension clamps). Remove debris and clean the outside of the radiator and air conditioning condenser. Wash the radiator neck. To ensure proper operation, pressure test the radiator and cap.

- Replace air cleaner filter. *An Emission Control Service.*
- For 2-Wheel Drive vehicles only: Clean and repack the front wheel bearings (or at each brake relining, whichever occurs first).
- Check the crankcase depression regulator valve system for any worn, plugged or collapsed hoses. See service manual. *An Emission Control Service.*
- Replace fuel filter. Replace filter sooner if it is clogged. †
- Check the EGR System (if equipped) (except Code F engine) as described in the service manual. *An Emission Control Service.*

(Continued)

Maintenance Schedule II — Diesel Engines

(Continued)

- Inspect accessory drive (serpentine) belt for cracks, fraying and wear and check belt for proper tension. Adjust or replace belt as needed. *An Emission Control Service.*
- Inspect shields and underhood insulation for damage or looseness. Adjust or replace as required. **This is a Noise Emission Control Service. Applicable only to vehicles sold in the United States.**
- Check the air intake system installation to assure that gaskets are properly sealed and that all hose connections, fasteners and other components are tight. Also check to be sure that the air cleaner housing is properly seated, the cover fits tightly and the wing nuts are tight. Tighten connections and fasteners or replace damaged parts as necessary. **This is a Noise Emission Control Service. Applicable only to vehicles sold in the United States.**
- If your engine has a thermostatically controlled cooling fan, inspect all hoses and ducts for proper hook-up (or every 12 months, whichever occurs first). Be sure the valve works properly. **This is a Noise Emission Control Service. Applicable only to vehicles sold in the United States.**
- Check the exhaust pressure regulator valve for proper operation; correct any binding. Inspect hoses for cracks, chafing or decay. Replace parts as needed. *An Emission Control Service.*
- Check rear/front axle fluid level and add fluid as needed. Check constant velocity joints and axle seals for leaking. **

DATE	ACTUAL MILEAGE	SERVICED BY:

Part B: Owner Checks and Services

Listed below are owner checks and services which should be performed at the intervals specified to help ensure the safety, dependability and emission control performance of your vehicle.

Be sure any necessary repairs are completed at once. Whenever any fluids or lubricants are added to your vehicle, make sure they are the proper ones, as shown in Part D.

At the First 100, 1,000 and 6,000 Miles (160, 1 600 and 10 000 km)

For vehicles with dual wheels, check dual wheel nut torque. For proper torque, see "Wheel Nut Torque" in the Index.

At Each Fuel Fill

It is important for you or a service station attendant to perform these underhood checks at each fuel fill.

Engine Oil Level

Check the engine oil level and add the proper oil if necessary. See "Engine Oil" in the Index for further details.

Engine Coolant Level

Check the engine coolant level and add the proper coolant mix if necessary. See "Coolant" in the Index for further details.

Windshield Washer Fluid Level

Check the windshield washer fluid level in the windshield washer tank and add the proper fluid if necessary. See "Windshield Washer Fluid" in the Index for further details.

At Least Once a Month

Tire Inflation

Check tire inflation. Make sure tires are inflated to the pressures specified on the Certification/Tire label which is located on the rear edge of the driver's door or on the incomplete vehicle document in the cab. See "Tires" in the Index for further details.

Cassette Deck

Clean cassette deck. Cleaning should be done every 50 hours of tape play. See "Audio Systems" in the Index for further details.

At Least Once a Year

Key Lock Cylinders

Lubricate the key lock cylinders with the lubricant specified in Part D.

Body Lubrication

Lubricate all fuel doors, body hood and body door hinges, tailgate and tailgate handle pivot points, latches, locks, and folding seat hardware. Part D tells you what to use. More frequent lubrication may be required when exposed to a corrosive environment.

Starter Switch



CAUTION:

When you are doing this check, the vehicle could move suddenly. If it does, you or others could be injured. Follow the steps below.

1. Before you start, be sure you have enough room around the vehicle. It should be parked on a level surface.
2. Firmly apply both the parking brake (see "Parking Brake" in the Index if necessary) and the regular brake.

NOTE: Do not use the accelerator pedal, and be ready to turn off the engine immediately if it starts.

3. On automatic transmission vehicles, try to start the engine in each gear. The starter should work only in PARK (P) or NEUTRAL (N). If the starter works in any other position, your vehicle needs service.

On manual transmission vehicles, put the shift lever in NEUTRAL (N), push the clutch down halfway and try to start the engine. The starter should work only when the clutch is pushed down all the way to the floor. If the starter works when the clutch isn't pushed all the way down, your vehicle needs service.

Steering Column Lock

While parked, and with the parking brake set, try to turn the key to LOCK in each shift lever position.

- With an automatic transmission, the key should turn to LOCK only when the shift lever is in PARK (P).
- With a manual transmission, the key should turn to LOCK only when the shift lever is in REVERSE (R).

On vehicles with a key release button, try to turn the key to LOCK without pressing the button. The key should turn to LOCK only with the key button depressed.

On all vehicles, the key should come out only in LOCK.

Parking Brake and Automatic Transmission PARK (P) Mechanism Check



CAUTION:

When you are doing this check, your vehicle could begin to move. You or others could be injured and property could be damaged. Make sure there is room in front of your vehicle in case it begins to roll. Be ready to apply the regular brake at once should the vehicle begin to move.

Park on a fairly steep hill, with the vehicle facing downhill. Keeping your foot on the regular brake, set the parking brake.

- To check the parking brake: With the engine running and transmission in NEUTRAL (N), slowly remove foot pressure from the regular brake pedal. Do this until the vehicle is held by the parking brake only.
- To check the PARK (P) mechanism's holding ability: Shift to PARK (P). Then release all brakes.

Lap and Shoulder Belts Condition and Operation

Inspect belt system, including: webbing, buckles, latch plates, retractors, guide loops and anchors. Have a belt assembly replaced if the webbing has been cut or otherwise damaged.

Part C: Periodic Maintenance Inspections

Listed below are inspections and services which should be performed at least twice a year (for instance, each spring and fall). You should let your GM dealer's service department or other qualified service center do these jobs. Make sure any necessary repairs are completed at once.

Steering and Suspension Inspection

Inspect the front and rear suspension and steering system for damaged, loose or missing parts, signs of wear, or lack of lubrication. Inspect power steering lines and hoses for proper hookup, binding, leaks, cracks, chafing, etc. (On vehicles equipped with manual steering gear, check for seal leakage.) Lubricate the steering linkage.

Exhaust System Inspection

Inspect the complete exhaust system. Inspect the body near the exhaust system. Look for broken, damaged, missing or out-of-position parts as well as open seams, holes, loose connections, or other conditions which could cause a heat build-up in the floor pan or could let exhaust fumes into the vehicle. See "Engine Exhaust" in the Index.

Accelerator Control System

On gasoline engines, lubricate the pivot at the TBI throttle lever stud with engine oil. Do not oil any accelerator or cruise control cables. Replace any cables that have high effort or excessive wear.

Drive Axle Service

Check rear/front axle fluid level and add as needed. Check constant velocity joints and axle seals for leaking.

Transfer Case (Four-Wheel Drive) Inspection

Every 12 months or at oil change intervals, check front axle and transfer case and add lubricant when necessary. Oil the control lever pivot point and all exposed control linkage. Check vent hose at transfer case for kinks and proper installation. More frequent lubrication may be required on off-road use.

Part D: Recommended Fluids and Lubricants

NOTE: Fluids and lubricants identified below by name, part number or specification may be obtained from your GM dealer.

USAGE	FLUID/LUBRICANT
Engine Oil (Gasoline Engine)	Engine oil with the American Petroleum Institute Certified For Gasoline Engines "Starburst" symbol of the proper viscosity. To determine the preferred viscosity for your vehicle's engine, see "Engine Oil" in the Index.
Engine Oil (Diesel Engine)	Engine oil with the letters CF-4/SH is best for your vehicle. However, if CF-4/SH is not available, you may use CF-4/SG or CE/SH or CE/SG oil. These letters show American Petroleum Institute (API) levels of quality. They may be listed in reverse order, SH/CF-4 or other letters such as, SH/CD, CE, CF-4. To determine the preferred viscosity for your vehicle's diesel engine, see "Engine Oil" in the Index.
Engine Coolant	50/50 mixture of water and a good quality ethylene glycol base anti-freeze or an approved recycled coolant conforming to GM Specification 6038-M.
Coolant Supplement	GM Part No. 3634621 or equivalent with a complete flush and refill.
Hydraulic Brake System	Delco Supreme 11 [®] Brake Fluid (GM Part No. 1052535 or equivalent DOT-3 brake fluid).
Hydraulic Clutch System	Hydraulic Clutch Fluid (GM Part No. 12345347 or equivalent).
Parking Brake Cables	Chassis Lubricant (GM Part No. 12346003 or equivalent) or lubricant meeting requirements of NLGI Grade 2, Category LB or GC-LB.

USAGE

Power Steering System

Manual Transmission (5-Speed with Low Gear, RPO MT8)

Manual Transmission (5-Speed without Low Gear, RPO MG5)

Automatic Transmission

Key Lock Cylinders

Automatic Transmission Shift Linkage

Clutch Fork Ball Stud (5-Speed with Low Gear)

Floor Shift Linkage

Chassis Lubrication

Front Wheel Bearings

Differential, Standard, Front and Rear Axle

Differential, Locking

Transfer Case

FLUID/LUBRICANT

GM Power Steering Fluid (GM Part No. 1050017 or equivalent) conforming to GM Specification 9985010.

Castrol Syntorq[®] LT or equivalent (GM Part No. 12346191 – 1 gal.) (GM Part No. 12346190 – 1 qt.).

Synchromesh Transmission Fluid (GM Part No. 12345349 or equivalent).

DEXRON[®]-III Automatic Transmission Fluid.

Lubricate with Multi-Purpose Lubricant (GM Part No. 12345120) or synthetic SAE 5W-30 engine oil.

Engine oil.

Chassis lubricant (GM Part No. 12346003 or equivalent) or lubricant meeting requirements of NLGI Grade 2, Category LB or GC-LB.

Engine oil.

Chassis lubricant (GM Part No. 12346003 or equivalent) or lubricant meeting requirements of NLGI Grade 2, Category LB or GC-LB.

Wheel bearing lubricant meeting requirements of NLGI Grade 2, Category GC or GC-LB (GM Part No. 12346003 or equivalent).

Axle Lubricant (GM Part No. 1052271) or SAE 80W-90 GL-5 Gear Lubricant.

Axle Lubricant (GM Part No. 1052271) or SAE 80W-90 GL-5 Gear Lubricant.

DEXRON[®]-III Automatic Transmission Fluid.

USAGE

Column Shift Lever and Propeller Shaft

Windshield Washer Solvent

Propeller Shaft Spline/Universal Joint

Hood Latch Assembly

a. Pivots and Spring Anchor

b. Release Pawl

Hood and Door Hinges

Body Door Hinge Pins, Tailgate Hinge and Linkage, Folding Seat, Fuel Door Hinge

Outer Tailgate Handle Pivot Points

Weatherstrip Conditioning

Weatherstrip Squeaks

Gas Line

FLUID/LUBRICANT

Chassis lubricant meeting requirements of NLGI Grade 2, Category LB or GC-LB (GM Part No. 12346003).

GM Optikleen[®] Washer Solvent (GM Part No. 1051515) or equivalent.

Chassis lubricant (GM Part No. 12346003 or equivalent) or lubricant meeting requirements of NLGI Grade 2, Category LB or GC-LB.

a. Engine oil.

b. Chassis lubricant (GM Part No. 12346003 or equivalent) or lubricant meeting requirements of NLGI Grade 2, Category LB or GC-LB.

Engine oil or Lubriplate Lubricant (GM Part No. 1050109).

Engine Oil.

Multi-Purpose Lubricant (GM Part No. 12345120 or equivalent).

Dielectric Silicone Grease (GM Part No. 12345579 or equivalent).

Spray-A-Squeek (GM Part No. 1052277).

Gas Line De-Icer (GM Part No. 1051516).

Part E: Maintenance Record

After the scheduled services are performed, record the date, odometer reading and who performed the service in the boxes provided after the maintenance interval. Any additional information from "Owner Checks and Services" or "Periodic Maintenance" can be added on the following record pages. Also, you should retain all maintenance receipts. Your owner information portfolio is a convenient place to store them.

Notes

Notes

Notes

Customer Assistance Information

Section

8

Here you will find out how to contact Chevrolet if you need assistance. This section also tells you how to obtain service publications and how to report any safety defects.

This section includes information on: The Customer Satisfaction Procedure, Customer Assistance for Hearing or Speech Impaired, BBB Auto Line – Alternative Dispute Resolution Program, Reporting Safety Defects, Roadside Assistance, and Service Publications.

Customer Satisfaction Procedure

Your satisfaction and goodwill are important to your dealer and Chevrolet. Normally, any concern with the sales transaction or the operation of your vehicle will be resolved by your dealer's Sales or Service Departments. Sometimes, however, despite the best intentions of all concerned, misunderstandings can occur. If your concern has not been resolved to your satisfaction, the following steps should be taken:

STEP ONE — Discuss your concern with a member of dealership management. Normally, concerns can be quickly resolved at that level. If the matter has already been reviewed with the Sales, Service, or Parts Manager, contact the owner of the dealership or the General Manager.

STEP TWO — If after contacting a member of dealership management, it appears your concern cannot be resolved by the dealership without further help, contact the Chevrolet Customer Assistance Center by calling 1-800-222-1020. In Canada, contact GM of Canada Customer Assistance Center in Oshawa by calling 1-800-263-3777 (English) or 1-800-263-7854 (French).

In Mexico, call (525) 254-3777. In Puerto Rico, call 1-800-496-9992 (English) or 1-800-496-9993 (Spanish). In the U.S. Virgin Islands, call 1-800-496-9994. In other overseas locations, contact GM North American Export Sales in Canada by calling 1-905-644-4112.

For prompt assistance, please have the following information available to give the Customer Assistance Representative:

- Your name, address, home and business telephone numbers
- Vehicle Identification Number (This is available from the vehicle registration or title, or the plate at the left top of the instrument panel and visible through the windshield.)
- Dealership name and location
- Vehicle delivery date and present mileage
- Nature of concern

We encourage you to call the toll free number listed previously in order to give your inquiry prompt attention. However, if you wish to write Chevrolet, write to:

Chevrolet Motor Division
Chevrolet Customer Assistance Center
P. O. Box 7047
Troy, MI 48007-7047

Refer to your Warranty and Owner Assistance Information booklet for addresses of Canadian and GM Overseas offices.

When contacting Chevrolet, please remember that your concern will likely be resolved in the dealership, using the dealership's facilities, equipment and personnel. That is why we suggest you follow Step One first if you have a concern.

Customer Assistance for the Hearing or Speech Impaired (TDD)

To assist customers who have hearing difficulties, Chevrolet has installed special TDD (Telecommunication Devices for the Deaf) equipment at its Customer Assistance Center. Any hearing or speech impaired customer who has access to a TDD or a conventional teletypewriter (TTY) can communicate with Chevrolet by dialing: 1-800-TDD-CHEV (1-800-833-2438). (TDD users in Canada can dial 1-800-263-3830.)

GM Participation in BBB AUTO LINE – Alternative Dispute Resolution Program*

*This program may not be available in all states, depending on state law. Canadian owners refer to your Warranty and Owner Assistance Information booklet. General Motors reserves the right to change eligibility limitations and/or to discontinue its participation in this program.

Both Chevrolet and your Chevrolet dealer are committed to making sure you are completely satisfied with your new vehicle. Our experience has shown that, if a situation arises where you feel your concern has not been adequately addressed, the Customer Satisfaction Procedure described earlier in this section is very successful.

There may be instances where an impartial third-party can assist in arriving at a solution to a disagreement regarding vehicle repairs or interpretation of the New Vehicle Limited Warranty. To assist in resolving these disagreements, Chevrolet voluntarily participates in BBB AUTO LINE.

BBB AUTO LINE is an out-of-court program administered by the Better Business Bureau system to settle disputes between customers and automobile manufacturers. This program is available free of charge to customers who currently own or lease a GM vehicle.

If you are not satisfied after following the Customer Satisfaction Procedure, you may contact the BBB using the toll-free telephone number, or write them at the following address:

BBB AUTO LINE
Council of Better Business Bureaus
4200 Wilson Boulevard
Suite 800
Arlington, VA 22203
Telephone: 1-800-955-5100

To file a claim, you will be asked to provide your name and address, your Vehicle Identification Number (VIN), and a statement of the nature of your complaint. Eligibility is limited by vehicle age and mileage, and other factors.

We prefer you utilize the Customer Satisfaction Procedure before you resort to AUTO LINE, but you may contact the BBB at any time. The BBB will attempt to resolve the complaint serving as an intermediary between you and Chevrolet. If this mediation is unsuccessful, an informal hearing will be scheduled where eligible customers may present their case to an impartial third-party arbitrator.

The arbitrator will make a decision which you may accept or reject. If you accept the decision, GM will be bound by that decision. The entire dispute resolution procedure should ordinarily take about forty days from the time you file a claim until a decision is made.

Some state laws may require you to use this program before filing a claim with a state-run arbitration program or in the courts. For further information, contact the BBB at 1-800-955-5100 or the Chevrolet Customer Assistance Center at 1-800-222-1020.

REPORTING SAFETY DEFECTS TO THE UNITED STATES GOVERNMENT

If you believe that your vehicle has a defect which could cause a crash or could cause injury or death, you should immediately inform the National Highway Traffic Safety Administration (NHTSA), in addition to notifying General Motors.

If NHTSA receives similar complaints, it may open an investigation, and if it finds that a safety defect exists in a group of vehicles, it may order a recall and remedy campaign. However, NHTSA cannot become involved in individual problems between you, your dealer, or General Motors.

To contact NHTSA, you may either call the Auto Safety Hotline toll-free at 1-800-424-9393 (or 366-0123 in the Washington, D.C. area) or write to:

NHTSA, U.S. Department of Transportation
Washington, D.C. 20590

You can also obtain other information about motor vehicle safety from the Hotline.

REPORTING SAFETY DEFECTS TO THE CANADIAN GOVERNMENT

If you live in Canada, and you believe that your vehicle has a safety defect, you should immediately notify Transport Canada, in addition to notifying General Motors of Canada Limited. You may write to:

Transport Canada
Box 8880
Ottawa, Ontario K1G 3J2.

REPORTING SAFETY DEFECTS TO GENERAL MOTORS

In addition to notifying NHTSA (or Transport Canada) in a situation like this, we certainly hope you'll notify us. Please call us at 1-800-222-1020, or write:

Chevrolet Motor Division
Chevrolet Customer Assistance Center
P. O. Box 7047
Troy, MI 48007-7047

In Canada, please call us at 1-800-263-3777 (English) or 1-800-263-7854 (French). Or, write:

General Motors of Canada Limited
Customer Assistance Center
1908 Colonel Sam Drive
Oshawa, Ontario L1H 8P7

Chevrolet Roadside Assistance Program

To enhance Chevrolet's strong commitment to customer satisfaction, Chevrolet is excited to provide the services of the Chevrolet/Geo Roadside Assistance Center.

24-Hour Roadside Assistance Number

Roadside Assistance is available 24 hours a day, 365 days a year, by calling 1-800-CHEV USA (1-800-243-8872). The call is toll-free and warranty repairs are covered at no cost. Additional services arranged by the Roadside representative may entail charges, and those charges, if any, will be fully explained to you before you authorize us to act in your behalf. Trained representatives are available to help you solve your problem or coordinate a variety of quality services through Chevrolet's dealer network and their preferred service providers. The following services are available:

- Towing
- Locksmith
- Tire repair
- Rental car or taxi
- Additional services as necessary

For prompt assistance when calling, please have the following available to give to the representative:

- Vehicle Identification Number
- License plate number
- Vehicle color
- Vehicle location
- Telephone number where you can be reached
- Vehicle mileage
- Description of the problem

Canadian Roadside Assistance

Vehicles purchased in Canada have an extensive Roadside Assistance program accessible from anywhere in Canada or the U.S.A. Please refer to the separate brochure provided by the dealer or call 1-800-268-6800 for emergency services.

Courtesy Transportation

Chevrolet/Geo offers Courtesy Transportation for customers needing warranty service. Courtesy Transportation will be offered in conjunction with the coverage provided by the BUMPER TO BUMPER New Vehicle Limited Warranty to retail purchasers of 1995 Chevrolet/Geo passenger car and light duty trucks.

In Canada, please consult your GM dealer for information on courtesy transportation.

COURTESY TRANSPORTATION INCLUDES:

- One way SHUTTLE RIDE for any warranty repair.
- Up to \$30 maximum daily VEHICLE RENTAL allowance for any overnight warranty repair up to 5 days.
- Up to \$30 maximum daily CAB, BUS, or OTHER transportation allowance in lieu of rental for any overnight warranty repair up to 5 days.
- Up to \$10 daily FUEL allowance for rides provided by another person (i.e., friend, neighbor, etc.) in lieu of rental for any overnight warranty repair up to 5 days.

Note: All Courtesy Transportation arrangements will be administered by your Chevrolet/Geo dealership service management. Claim amounts should reflect all actual costs.

The Chevrolet/Geo Courtesy Transportation Program is not part of the BUMPER TO BUMPER New Vehicle Limited Warranty. Chevrolet/Geo reserves the right to make any changes or discontinue the Courtesy Transportation Program at any time without notification.

For additional program details contact your Chevrolet/Geo dealer.

Service and Owner Publications

Service manuals, service bulletins, owner manuals and other service literature are available for purchase for all current and many past model General Motors' vehicles.

Toll-free telephone numbers for ordering information:

U.S. 1-800-551-4123

Canada 1-800-668-5539

Service Manuals

Service manuals contain diagnosis and repair information for all chassis and body systems. They may be useful for owners who wish to get a greater understanding of their vehicle. They are also useful for owners with the appropriate skill level or training who wish to perform “do-it-yourself” service. These are authentic General Motors’ service manuals meant for professional, qualified technicians. In some cases they refer to specialized tools, equipment and safety procedures necessary to service the vehicle.

Service Bulletins

Service bulletins covering various subjects are regularly sent to all General Motors’ dealerships. GM monitors product performance in the field. When service methods are found which promote better service on GM vehicles, bulletins are created to help the technician perform better service. Service bulletins may involve any number of vehicles. Some will describe inexpensive service, others will describe expensive service. Some will advise new or unexpected conditions, and others may help avoid future costly repairs. An important reminder . . . service bulletins are meant for qualified technicians. Since these bulletins are issued throughout the model year and beyond, an index is required and published quarterly to help identify specific bulletins. Subscriptions are available. You can order an index at the toll-free numbers listed, or ask a GM dealer/retailer to see an index or individual bulletin.

Owner Publications

Owner’s manuals, warranty folders and various owner assistance booklets provide owners with general operation and maintenance information.

Notes

1995 CHEVROLET SERVICE PUBLICATIONS ORDERING INFORMATION

The following publications covering the operation and servicing of your vehicle can be purchased by calling 1-800-782-4356 or by filling out the Service Publications Order Form in this book and mailing it with your check, money order or credit card information to Helm, Incorporated (address listed below).

GM SERVICE BULLETINS

GM Service Bulletins (GMSB) provide technical service information to knowledgeable service General Motors cars and trucks. See Service Publications listed previously in this section.

These bulletins may be purchased in a subscription package. Pricing and ordering information is available by requesting the Service Bulletin Order Form (Item # GMSB-ORD-94)...FREE.

SERVICE MANUALS

Service Manuals have the diagnosis, repair and overhaul information on engines, transmissions, axle, suspension, brakes, electrical, steering, body, etc.

NOTE: Please specify special body or engine types on order form. Write information in the Form Number column. For example: Turbo, Convertible.

OWNER'S INFORMATION

Owner publications are written directly for owners and intended to provide basic operational information about the vehicle. The Owner's Manual includes the Maintenance Schedule for all models.

Owner's Manuals are available by carline, both individually and as a complete portfolio.

CURRENT & PAST MODEL ORDER FORMS

Service Publications are available for current and past model General Motors vehicles. To request an order form, please specify year and model name of vehicle.

Address all inquiries to:

HELM, INCORPORATED, P.O. Box 07130, Detroit, MI 48207

For information and inquiries call: 1-800-782-4356

Index

A

Adding Equipment to Your Air Bag–Equipped Vehicle (See “Supplemental Inflatable Restraint System (SIR)”)	
Air Bag (See “Supplemental Inflatable Restraint System (SIR)”) Readiness Light (See “Lights”)	
Air Cleaner (See “Engine–Air Cleaner”)	
Air Conditioning (See “Heater/Air Conditioning Controls”)	
Antenna	3–25
Anti–Lock Brakes (See “Brakes”)	
Appearance Care	6–67
Materials Chart	6–75
Arbitration Program (See “Better Business Bureau Mediation”)	
Audio Systems	3–6
Care of Your Cassette Player and Tapes	3–24
Care of Compact Discs	3–25
ETR [®] AM–FM Stereo Audio Cassette System	3–9
ETR [®] AM–FM Stereo Audio Cassette ATC System	3–11
ETR [®] AM–FM Stereo Audio Compact Disc ATC System	3–16
Remote Cassette Player	3–22
ETR [®] AM–FM Stereo Audio System	3–7
THEFTLOCK Theft Deterrent Feature	3–14, 3–20
Understanding Radio Reception	3–23
Automatic Transmission (See “Transmission”)	
Axle	
Locking Rear	2–27
Front (See “Four–Wheel Drive”)	
Rear	6–32

B

Battery	6–47
Belts (See “Safety Belts”)	
Better Business Bureau Mediation	8–3
Blizzard (See “Driving–If You’re Caught in a Blizzard”)	
Brakes	
Adjustment	6–45
Anti–Lock (ABS)	4–6
Anti–Lock Warning Light (See “Lights”)	
Hydro–Boost Brake System	6–41
Master Cylinder	6–42
Parking	2–27
Pedal Travel	6–44
Propshaft Parking Brake Burnish Procedure	2–28
Replacing Parts	6–45
System Warning Light (See “Lights”)	
To Check Brake Fluid	6–43
Trailer (See “Trailer–Brakes”)	
Wear	6–44
What to Add	6–43
Braking	4–5
In Emergencies	4–7

Break-In, New Vehicle	2-9
Bulb Replacement	
Center High Mounted Stop Lamp (CHMSL)	6-54
Composite Headlamps	6-49
Fender Marker Lamps	6-53
Front Park/Turn Signal Lamps with Composite Headlamps	6-51
Front Park/Turn Signal Lamps with Sealed Beam Headlamps	6-50
Halogen Bulbs	6-48
Rear Lamps (Chassis Cab Models)	6-56
Rear Lamps (Pickup Models)	6-55
Replacement Chart	6-88
Roof Marker Lamps	6-54
Sealed Beam Headlamps	6-47
Side Marker Lamps	6-52
Tailgate Marker Lamps	6-53

C

Capacities and Specifications	6-80
Carbon Monoxide	2-32
Care of Your Cassette Tape Player (See "Audio Systems")	
Cassette Tape Player System (See "Audio Systems")	
Catalytic Converter	6-57
Center High Mounted Stop Lamp (CHMSL) (See "Lamps")	
Certification/Tire Label	4-37
Changing a Flat Tire	5-26
Chemical Paint Spotting	6-74
Child Restraints (See "Safety Belts")	
Cigarette Lighter/Ashtrays	2-58
Circuit Breakers (See "Fuses and Circuit Breakers")	
Cleaning	
Diesel Engine	6-14
Fabric Protection	6-69
Finish Care	6-72
Glass	6-71
Inside of Vehicle	6-68
Instrument Panel, Top	6-70
Leather	6-70
Outside of Vehicle	6-72
Outside of the Windshield and Wiper Blades	6-71
Special Problems	6-69
Underbody	6-74
Vinyl	6-70
Weatherstrips	6-71
Wheels and Tires	6-73
Clock, Setting the	
Audio System with AUTO TONE System	3-7
Audio System without AUTO TONE System	3-6
Comfort Controls	3-1
Compact Disc (CD) System (See "Audio Systems")	
Compass	2-54
Control of a Vehicle	4-4
Coolant (See "Engine")	
Cooling System Capacity	6-82
Crankcase Capacity	6-83

Cruise Control (Option)	2-43
On Hills	2-47
Passing Another Vehicle	2-46
To Erase Speed Memory	2-48
To Get Out Of	2-47
To Increase Speed	2-45
To Reduce Speed	2-46
To Resume	2-45
To Set	2-44
Customer Assistance for the Hearing or Speech Impaired	8-3
Customer Assistance Information	8-1
Customer Satisfaction Procedure	8-1

D

Daytime Running Lamps (See "Lamps-Daytime Running Lamps")	
Daytime Running Lamps (DRL) Indicator Light (See "Lights")	
Diesel Fuel Requirements and Fuel System (See "Fuel-Diesel")	
Differential (See "Axle")	
Doors	2-3
Locks	2-5
Power Door Locks	2-6
Side Doors	2-3
Drive Axle (See "Axle")	
Driving	
At Night	4-23
City	4-26
Defensive	4-1
Freeway	4-27
Hill and Mountain Roads	4-29
Highway Hypnosis	4-28
If You're Caught in a Blizzard	4-33
On Grades	4-47
Snow or Ice	4-31
In Snow (Diesel Engines)	2-14
In the Rain	4-24
Loss of Control	4-11
Night Vision	4-24
Off-Road Driving with Your Four-Wheel Drive Vehicle	4-12
After Off-Road Driving	4-23
Before You Go Off-Road	4-12
Passing	4-10
Through Deep Standing Water	2-14
Winter	4-31
Drunken Driving	4-2

E

Electrical System	
Add-On Equipment	6-78
Engine	
Adding Coolant-Diesel Engine	5-20
Adding Coolant-Gasoline Engine	5-13, 5-16
Air Cleaner	6-26

Engine (continued)	
Coolant	6-35
Coolant Heater	2-18, 3-4, 6-21
Coolant Temperature Gage (See "Gages")	
Control Module System	6-57
Diesel Heater Output	3-4
Exhaust	2-32
Fan Noise	5-25
Identification	6-76, 6-77, 6-81
Oil (See "Oil")	
Overheating	5-10
Running While Parked	2-32
Starting Your Gasoline Engine	2-12
Starting Your Diesel Engine	2-14
Exhaust System	6-56

F

Filter Replacement Chart (See "Service-Replacement Parts and Filter Recommendations")	
Finish Damage	6-74
Fluid Capacities (See "Capacities and Specification")	
Fluid Leak Check	6-46
Fluids (See "Scheduled Maintenance Services")	
Fog Lamps (See "Lamps-Fog")	
Four-Wheel Drive	2-33, 6-33
Front Axle Locking Feature	6-34
Transfer Case	2-34, 6-33
Fuel	
Canadian	6-5
Diesel	6-3
Filling Your Tank	6-11
Foreign Countries (Gasoline Engines)	6-11
Filter Replacement (Diesel Engines)	6-9
Gage (See "Gages")	
Gasoline	6-2
Gasolines for Cleaner Air	6-3
Running Out of Fuel (Diesel Engines)	6-8
Tank Capacity	6-83
Water in Fuel (Diesel Engines)	2-74, 6-5
Fuses and Circuit Breakers	6-79, 6-87
Fuse Block	6-80, 6-86

G

Gages	
Engine Coolant Temperature Gage	2-80
Fuel Gage	2-79
Oil Pressure Gage	2-81
Speedometer	2-69
Tachometer	2-70
Tamper Resistant Odometer	2-69
Trip Odometer	2-69
Voltmeter	2-82

H

Halogen Bulbs (See "Bulb Replacement")	
Hazard Warning Flashers	5-1
Head Restraints (See "Seats")	
Headlamps and Vehicle Lighting	2-48
Replacement (See "Bulb Replacement")	
High Beam Indicator Light (See "Lights")	
High-Low Beam Changer	2-40
Reminder	2-49
Heater Controls	3-1
Heater/Air Conditioning Controls	3-2, 6-46
Refrigerant Capacity	6-85
Highway Hypnosis (See "Driving-Highway Hypnosis")	
Hitches (See "Towing-Hitches")	
Hood	
Checking Under, Hood Release	6-13
Horn	2-38
Hydraulic Clutch	6-31
How to Check	6-32
When to Check and What to Use	6-32
Hydroplaning (See "Driving in the Rain")	

I

If You're Stuck in Sand, Mud, Ice, or Snow	5-39
Ignition Switch	2-10
Inflation-Tire Pressure (See "Tires")	
Instrument Cluster	2-68
Instrument Panel	2-68

J

Jacking Equipment Storage	5-27, 5-28
Jump Starting	5-2

K

Key Lock Cylinders	6-46, 7-94
Key Release Button	2-11
Keyless Entry System	2-7
Keys	2-1

L

Labels	
Certification/Tire (See "Certification/Tire Label")	
Lamps	
Cargo/Center High Mounted Stop Lamp	2-52
Daytime Running Lamps	2-50
Dome	2-51
Fog	2-49
Headlights (See "Headlamps")	

Lamps (continued)	
Lamp and Bulb Data	6-88
Reading	2-51
Replacement (See "Bulb Replacement")	
Underhood Reel Lamp	2-52
Lights	2-70
Air Bag Readiness Light	1-20, 2-71
Anti-Lock Brake System Warning Light	2-73
Brake System Warning Light	2-72
Charging System Warning Light	2-76
Check Gages Light	2-77
Daytime Running Lamps (DRL) Indicator Light	2-50, 2-77
Glow Plugs Light	2-75
Headlamp High Beam Indicator Light	2-78
Headlights (See "Headlamps")	
Low Coolant Warning Light	2-75, 6-38
Malfunction Indicator	2-76, 6-57
Safety Belt Reminder Light	2-71
Service Throttle Soon	2-74
Shift Light	2-25, 2-78
Turn Signal and Lane Change Indicator Light	2-40, 2-79
Water in Fuel (Diesel Engine)	2-74
Loading Your Vehicle	4-37
Trailering Package	4-39
Truck-Camper Loading	4-39
Lock Cylinders (See "Key Lock Cylinders")	
Loss of Control (See "Driving-Loss of Control")	
Lubrication (See "Recommended Fluids and Lubricants")	

M

Malfunction Indicator Lamp (See "Lights")	
Maintenance (See "Scheduled Maintenance Services")	
Master Cylinder (See "Brakes")	
Mirrors	
Convex Outside	2-56
Electric Outside Rearview Mirrors	2-56
Electrochromic Inside Rearview Mirror	2-54
Inside	2-53
Outside	2-56
Model Reference	iv
Multifunction Lever	2-39

N

Noise Control System	6-14
----------------------------	------

O

Odometer (See "Gages")	
Off-Road Driving (See "Driving-Off Road Driving")	
Off-Road Recovery	4-9

Oil	
Diesel Engines	6-21
Additives	6-25
Pressure Gage (See "Gages")	
To Check	6-22
What Kind to Use	6-23
When to Add	6-22
When to Change	6-25
What to Do with Used Oil	6-25
Gasoline Engines	6-16
Additives	6-20
Pressure Gage (See "Gages")	
To Check	6-16
What Kind to Use	6-17
When to Add	6-17
When to Change	6-20
What to Do with Used Oil	6-21
Owner Checks and Services	7-93

P

Parking	
Brake (See "Brakes-Parking")	
On Hills (See "Towing-Parking on Hills")	
Over Things That Burn	2-31
Passing (See "Driving-Passing")	
Periodic Maintenance Inspections (See "Scheduled Maintenance Services")	
Power	
Door Locks (See "Doors")	
Steering	4-7
Steering Fluid	6-40
Take-Off	4-35
Winches	4-34

R

Radiator Pressure Cap	6-39
Radio (See "Audio Systems")	
Rear Axle (See "Axle")	
Rear Window Defogger	3-4
Recommended Fluids and Lubricants (See "Scheduled Maintenance Services")	
Recovery Hooks	5-40
Replacement Parts	6-80
Reporting Safety Defects To The United States Government (See "Safety Defects")	
Roadside Assistance	8-5
Rocking Your Vehicle	5-39

S

Safety Belts	1-9
Adults	1-12
Center Passenger Position	1-25
Checking Restraint System	1-44

Child Restraints	1-33
Center Seat Position	1-38
Larger Children	1-41
Outside Seat Position (Crew Cab)	1-36
Rear Outside Seat Position (Extended Cab)	1-34
Right Front Seat Position	1-39
Top Strap	1-33
Where to Put the Restraints	1-33
Children	1-31
Cleaning	6-71
Driver Position	1-13
Extender	1-43
Lap Belt	1-25
Lap-Shoulder Belt	1-13, 1-27, 1-29
Proper Wear	1-12
Questions & Answers	1-12
Rear Seat Outside Passenger Positions (Crew Cab)	1-29
Rear Seat Outside Passenger Positions (Extended Cab)	1-26
Rear Seat Passengers	1-26
Reminder Light (See "Lights")	
Replacing Seat and Restraint Parts After a Crash	1-44
Right Front Passenger Position	1-25
Use During Pregnancy	1-24
Why Safety Belts Work	1-10
Safety Chains (See "Towing a Trailer")	
Safety Defects	
Reporting Safety Defects to Canada	8-5
Reporting Safety Defects to General Motors	8-5
Reporting Safety Defects to the United States Government	8-4
Safety Warnings and Symbols	v
Scheduled Maintenance Services	
Maintenance Record	7-99
Maintenance Schedule I	
Diesel Engines	7-9, 7-62
Gasoline Engines with Heavy Duty Emissions	7-6, 7-35
Gasoline Engines with Light Duty Emissions	7-4, 7-12
Maintenance Schedule II	
Diesel Engines	7-11, 7-80
Gasoline Engines with Heavy Duty Emissions	7-8, 7-52
Gasoline Engines with Light Duty Emissions	7-5, 7-27
Periodic Maintenance Inspections	7-96
Recommended Fluids and Lubricants	7-97
Selecting the Right Schedule	7-3
Using Your Maintenance Schedule	7-3
When Trailer Towing	4-49
Seats	1-1
Controls	1-1
Easy Entry Seat	1-5
Head Restraints	1-7
Manual Front Seat	1-1
Power Lumbar Adjustment	1-3
Power Seats	1-2
Rear Folding Seat	1-7
Rear Seat	1-8

Seats (continued)	
Reclining Front Seatbacks	1-3
Seatback Latches	1-4, 1-8
Service	
Doing Your Own Service Work	6-1
Parts Identification Label	6-78
Publications	8-7
Replacement Parts and Filter Recommendations	6-80, 6-84, 6-85
Service Engine Soon Light (See "Lights")	
Service Your Air Bag-Equipped Vehicle (See "Supplemental Inflatable Restraint System (SIR)")	
Shift Indicator Light (See "Lights")	
Shifting Into Park (P)	2-29
Shock Absorbers (Front)	6-45
Specifications Chart (See "Service - Replacement Parts and Filter Recommendations")	
Spare Tire	5-28, 5-29
Speedometer and Odometer (See "Gages")	
Starting Your Engine (See "Engine-Starting")	
Steering	4-7
Column Shift Lever	2-29
In Emergencies	4-8
Tips	4-7
Step-Bumper Pad	2-84
Storage Compartments	2-59
Sun Visors	2-57
Supplemental Inflatable Restraint System (SIR)	1-19
Adding Equipment to Your Facial Air Bag-Equipped Vehicle	1-23
How the Air Bag System Works	1-20
Service Your Air Bag-Equipped Vehicle	1-23
Surge Tank Pressure Cap	6-39

T

Tachometer (See "Gages")	
Tailgate	2-4
Removal	2-4
Theft	2-8
Thermostat	6-40
Tilt Wheel (Option)	2-38
Tires	6-58
Balancing (See "Wheel Alignment and Tire Balance")	
Chains	6-66
Dual Tire Operation	6-62
Flat (See "Changing a Flat Tire")	
Inspection and Rotation	6-59
Loading (See "Loading Your Vehicle")	
New	6-63
Pressure	6-58
Spare (See "Spare Tire")	
Uniform Tire Quality Grading	6-63
Top Strap (See "Safety Belts-Child Restraints")	
Torque Lock (See "Transmission-Torque Lock")	

Towing	
A Trailer	4-42
Driving on Grades	4-47
Driving with a Trailer	4-46
Parking on Hills	4-48
Passing	4-46
Safety Chains	4-45
Hitches	4-45
Towing Your Vehicle	5-7
Trailer	
Brakes	4-45
Recommendations	4-42
Towing (See "Towing")	
Wiring Harness	2-83, 6-79
Trailer Package (See "Loading Your Vehicle")	
Transmission	
Automatic	2-19, 6-27
How To Add Fluid	6-30
How To Check Fluid	6-27
When to Check and Change Fluid	6-27
Five-Speed Manual	2-22, 6-30
How To Add Fluid	6-31
How To Check	6-30
Shift Light (See "Lights")	
Shift Speeds	2-25
With Low Gear	2-22
Without Low Gear	2-24
When To Check	6-30
Torque Lock	2-28, 2-30
Trip Odometer (See "Gages")	
Turn Signal and Lane Change Indicator (See "Lights")	

V

Vehicle	
Damage Warnings	vi
Identification Number	6-76, 6-77
Loading (See "Loading Your Vehicle")	
Storage	6-47
Symbols	v, vi, vii, viii, ix
Ventilation System	3-5
Tips	3-5
Voltmeter (See "Gages")	

W

Warning	
Devices, Other	5-2
Hazard Flashers (See "Hazard Warning Flashers")	
Lights and Indicators	2-70

Wheels	
Alignment and Tire Balance	6-65
Aluminum	6-73
Hub Caps and Wheel Nut Caps	5-33
Nut Tightening Sequence	5-37
Nut Torque	6-82
Replacement	6-65
Used Replacement	6-66
Windows	2-36
Sliding Rear	2-37
Swing-Out	2-37
Windshield	
Washer	2-42
Washer Fluid	6-41
Wiper Blade Chatter	6-71
Wiper Blade Cleaning (See "Cleaning")	
Wiper Blade Replacement	6-46
Wipers	2-41

Notes

Notes

Notes

*

C9504

