

CADILLAC

CREATING A HIGHER STANDARD



FLEETWOOD

1995 OWNER'S LITERATURE

CADILLAC OWNER

Privileges



The PENALTY OF LEADERSHIP

IN every field of human endeavor, he that is first must perpetually live in the white light of publicity. ¶ Whether the leadership be vested in a man or in a manufactured product, emulation and envy are ever at work. ¶ In art, in literature, in music, in industry, the reward and the punishment are always the same. ¶ The reward is widespread recognition; the punishment, fierce denial and detraction. ¶ When a man's work becomes a standard for the whole world, it also becomes a target for the shafts of the envious few. ¶ If his work be merely mediocre, he will be left severely alone — if he achieve a masterpiece, it will set a million tongues a-wagging. ¶ Jealousy does not protrude its forked tongue at the artist who produces a commonplace painting. ¶ Whatever you write, or paint, or play, or sing, or build, no one will strive to surpass, or to slander you, unless your work be stamped with the seal of genius. ¶ Long, long after a great work or a good work has been done, those who are disappointed or envious continue to cry out that it can not be done. ¶ Spiteful little voices in the domain of art were raised against our own Whistler as a mountebank, long after the big world had acclaimed him its greatest artistic genius. ¶ Multitudes flocked to Bayreuth to worship at the musical shrine of Wagner, while the little group of those whom he had dethroned and displaced argued angrily that he was no musician at all. ¶ The little world continued to protest that Fulton could never build a steamboat, while the big world flocked to the river banks to see his boat steam by. ¶ The leader is assailed because he is a leader, and the effort to equal him is merely added proof of that leadership. ¶ Failing to equal or to excel, the follower seeks to depreciate and to destroy — but only confirms once more the superiority of that which he strives to supplant. ¶ There is nothing new in this. ¶ It is as old as the world and as old as the human passions — envy, fear, greed, ambition, and the desire to surpass. ¶ And it all avails nothing. ¶ If the leader truly leads, he remains — the leader. ¶ Master-poet, master-painter, master-workman, each in his turn is assailed, and each holds his laurels through the ages. ¶ That which is good or great makes itself known, no matter how loud the clamor of denial. ¶ That which deserves to live — lives.

Cadillac Motor Car Co. Detroit, Mich.



Henry M. Leland, founder of Cadillac, stands beside the 1905 "Osceola" which was built to evaluate the feasibility of a closed bodied car.



Few automobiles are fortunate enough to have the rich heritage that is Cadillac. The name Cadillac is appropriately that of Antoine de La Mothe Cadillac, the French military commander who founded the city of Detroit in 1701. What better name for the oldest automobile manufacturer in Detroit.

Henry M. Leland, known as the master of precision, initiated his precision manufacturing techniques at the founding of Cadillac in 1902. His exacting standards prompted the motto by which Cadillac has been guided over the years – "Craftsmanship A Creed – Accuracy A Law."

The introduction of the first four cylinder engine in 1905 led the industry and enabled Cadillacs to travel at speeds up to 50 mph.

For attention to quality and innovation, the Royal Automobile

Club of England awarded the prestigious **Dewar Trophy** to Cadillac twice . . .



first in 1908 for achieving perfect interchangeability of parts and again in 1912 for introducing the electric self starter, electric lighting and ignition system.

Cadillac is the only American manufacturer to win this honor and the only manufacturer in the world to win it twice. As commonplace as standardized parts are today, in 1908 parts were still individually hand fitted both in production and service.



Standardization opened the eyes of the industrial world and was the corner-stone of modern **assembly line** production. From this achievement evolved the reference to Cadillac as "Standard of the World."

In 1909 Cadillac was purchased by the then new General Motors Corporation. Convenience, cleanliness and all-weather comfort were greatly enhanced in 1910 when Cadillac became the first manufacturer to offer closed bodies as standard equipment.

"The Penalty of Leadership" first appeared in the January 2, 1915 issue of The Saturday Evening Post as an expression of the Cadillac commitment to leadership, quality, and innovation. It is widely regarded as one of the finest documents ever written and was published following the introduction of the first production V8 engine. The V8 was standard in all 1915 model Cadillacs.

Many Cadillac "firsts" have followed over the years, including the synchro-mech clashless transmission, a nation-wide comprehensive



45° V-16 Engine

service policy, security plate glass, chrome plating and the first car to be designed by a stylist (1927 LaSalle/Harley Earl). The '30s witnessed production of the smooth and quiet V12 and **V 16 engines.** The crisp, contemporary lines of the 1938 60 Special series ushered in a new era in styling.

During World War II, shortly after Pearl Harbor, Cadillac discontinued car production for the first time since 1902 in order to construct light tanks, combat vehicles and internal parts for Allison V1710 engines. Two Cadillac V8 engines and Hydra-Matic transmissions were used in each tank.



1931 V-16 Sport Phaeton

Cadillac



It Will Add to Your Happiness!

There is a great pleasure that comes with a Cadillac which is very difficult for anyone to purchase—except a Cadillac owner. To put it bluntly, a Cadillac adds a genuine measure of happiness to a family's daily existence. It is not just the satisfaction which comes from the performance and extraordinary comfort and out-

standing safety and handling you—driving through these things can be. It is when a sense of pride and dignity well beyond a job of possession—and a consciousness of membership in the world's most distinguished group of motorist owners. Although difficult to explain, and indescribable, it comes from all sources.

If the answer can easily be seen, it is very real and very reliable—a most exciting reason for moving up to Cadillac. And remember—if that is an added to the satisfaction found from the driving a Cadillac. It's not worth it—any longer. Come see your Cadillac dealer right now. He'll be delighted to see you.

CADILLAC MOTOR CAR DIVISION • GENERAL MOTORS CORPORATION

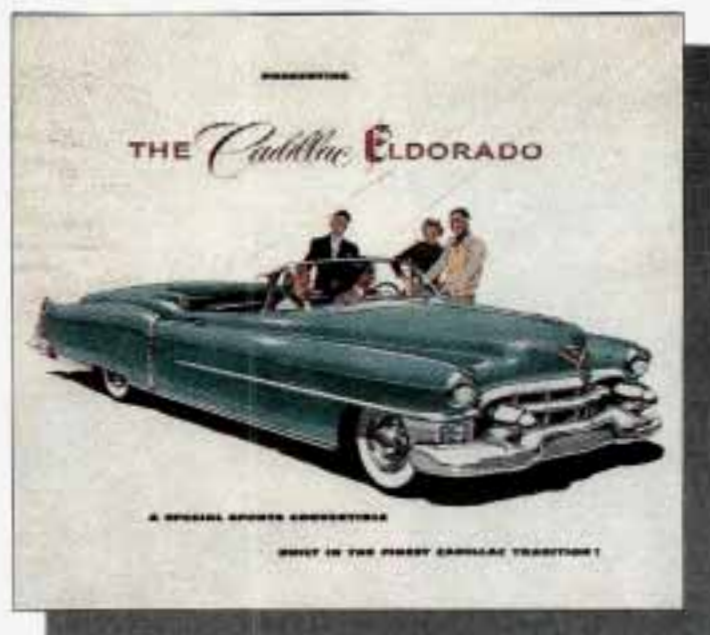

For the 1948 model, Cadillac introduced the **legendary tail fin** which set the trend in automotive styling for nearly two decades. This was followed by the 1949 model with the two door hardtop Coupe DeVille and the modern overhead valve, high compression V8 engine.

Engineering innovations, conveniences and styling dominated the '50s and '60s. Cruise control, automatic climate control, tilt and telescoping steering wheels, twilight sentinel and four door hard tops all debuted in these years. In 1957 the Eldorado Brougham featured advances such as air suspension, memory seat, automatic electric door locks, transistor radio, a brushed

stainless steel roof and low profile tires.

The Eldorado, introduced in 1953, was redesigned for 1967 as the first front wheel drive personal luxury car. The 472 cu. in. V8 engine used in all Cadillacs in 1968 and 1969 was enlarged to 500 cu. in. for all 1970 Eldorados.

An Air Cushion Restraint System (airbag) was available for 1974, 1975 and 1976 Cadillacs.

Analog Electronic Fuel Injection was available, on 1975 Cadillacs and was standard on the new international size 1976 Seville. In 1978, the Trip Computer option incorporated an on-board microprocessor.



1957 Eldorado Brougham



This rich tradition continues into the '90s as Cadillac became the first automobile manufacturer to be awarded the prestigious Malcolm Baldrige National Quality Award.

The 1992 Seville STS was the first car ever to win all three major automotive awards: Car of the Year, Motor Trend; Ten Best List, Car & Driver; Car of the Year, Automobile Magazine.



A 1993 Cadillac Allanté in stock technical configuration, was selected as the pace car for the 76th Indianapolis 500. The demanding pace car performance and handling requirements were met because of such advances as the Northstar system. The system includes the 32 valve, dual overhead camshaft, Northstar 4.6 liter V8 engine, 4T80 E electronically controlled automatic transaxle, road sensing suspension, speed sensitive steering, antilock brakes and traction control.

For more than nine decades Cadillac has been a leader in quality and technical innovation. Now more than ever, substance takes shape

... Cadillac Style



1993 Allanté pace car

1949 COUPE DE VILLE





1955 ELDORADO CONVERTIBLE



TABLE OF CONTENTS

This Cadillac Manual is divided into major sections.

Introduction – How to Use this Manual iii

This section tells you how to use your manual and includes safety and vehicle damage warnings and symbols.

Section 1 – Seats and Restraint Systems 1-1

This section tells you how to use your seats and safety belts properly. It also explains the “SIR” system.

Section 2 – Features and Controls 2-1

This section explains how to start and operate your Cadillac.

Section 3 – Comfort Controls and Audio Systems 3-1

This section tells you how to adjust the ventilation and comfort controls and how to operate your audio system.

Section 4 – Your Driving and the Road 4-1

Here you’ll find helpful information and tips about the road and how to drive under different conditions.

Section 5 – Problems on the Road 5-1

This section tells you what to do if you have a problem while driving, such as a flat tire, or engine overheating, etc.

Section 6 – Service and Appearance Care 6-1

Here the manual tells you how to keep your Cadillac running properly and looking good.

For more information on “Reporting Safety Defects”, see Owner Assistance, Page 4.

First Edition



THE 1995 FLEETWOOD AND FLEETWOOD BROUGHAM LITERATURE



Please keep this manual in your Cadillac, so it will be there if you ever need it when you're on the road. If you sell the vehicle, please leave this manual in it so the new owner can use it.

FOR CANADIAN OWNERS WHO PREFER A FRENCH LANGUAGE MANUAL:

Aux propriétaires canadiens: Vous pouvez vous procurer un exemplaire de ce guide en français chez votre concessionnaire ou au DGN Marketing Services Ltd., 1500 Bonhill Rd., Mississauga, Ontario L5T 1C7.

This manual includes the latest information at the time it was printed. We reserve the right to make changes in the product after that time without further notice. For vehicles first sold in Canada, substitute the name "General Motors of Canada Limited" for Cadillac Motor Car Division whenever it appears in this manual.

GENERAL MOTORS, GM and the GM Emblem, CADILLAC, and the CADILLAC Emblem are registered trademarks of General Motors Corporation.

© Copyright General Motors Corporation 1994. All Rights Reserved.



HOW TO USE THIS MANUAL

Many people read their owner's manual from beginning to end when they first receive their new vehicle. This will help you learn about the features and controls for your vehicle. In this manual, you'll find that pictures and words work together to explain things quickly.

INDEX: A good place to look for what you need is the Index in back of the manual. It's an alphabetical list of all that's in the manual, and the page number where you'll find it.

SAFETY WARNINGS AND SYMBOLS

You will find a number of safety cautions in this book. We use a box with gray background and the word **CAUTION** to tell you about things that could hurt you if you were to ignore the warning.



CAUTION:

These mean there is something that could hurt you or other people.

In the gray caution area, we tell you what the hazard is. Then we tell you what to do to help avoid or reduce the hazard. Please read these cautions. If you don't, you or others could be hurt.



You will also find a circle with a slash through it in this book. This safety symbol means “Don’t,” “Don’t do this,” or “Don’t let this happen.”

Vehicle Damage Warnings

Also, in this book you will find these notices:

NOTICE:

These mean there is something that could damage your vehicle.

In the notice area, we tell you about something that can damage your vehicle. Many times, this damage would not be covered by your warranty, and it could be costly. But the notice will tell you what to do to help avoid the damage.

When you read other manuals, you might see CAUTION and NOTICE warnings in different colors or in different words.

You’ll also see warning labels on your vehicle. They use yellow for cautions, blue for notices and the words CAUTION or NOTICE.

Vehicle Symbols

These are some of the symbols you will find on your vehicle. For example, these symbols are used on an original battery:

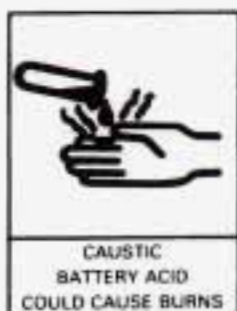

These symbols are important for you and your passengers whenever your vehicle is driven:

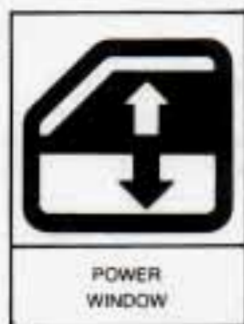

These symbols have to do with your lights:

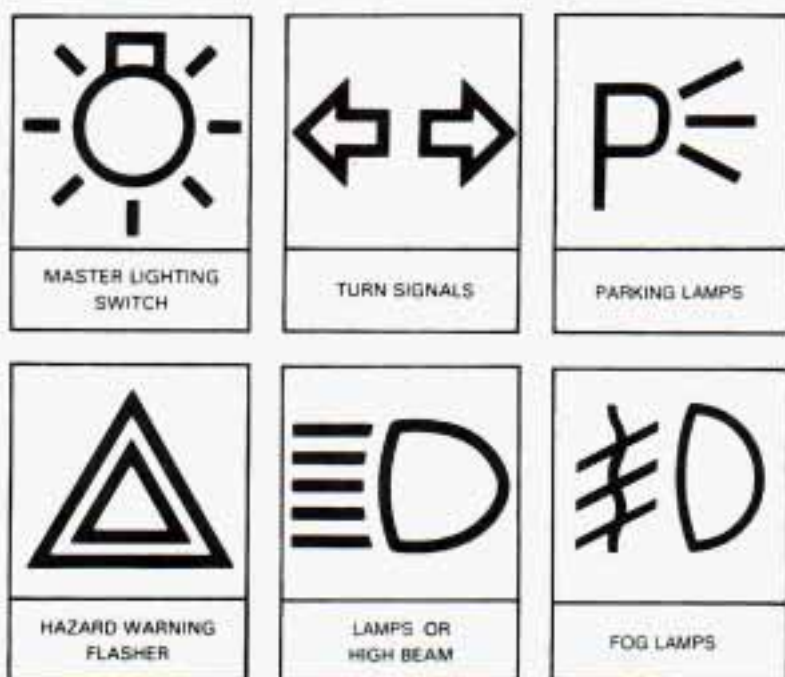

These symbols are on some of your controls:

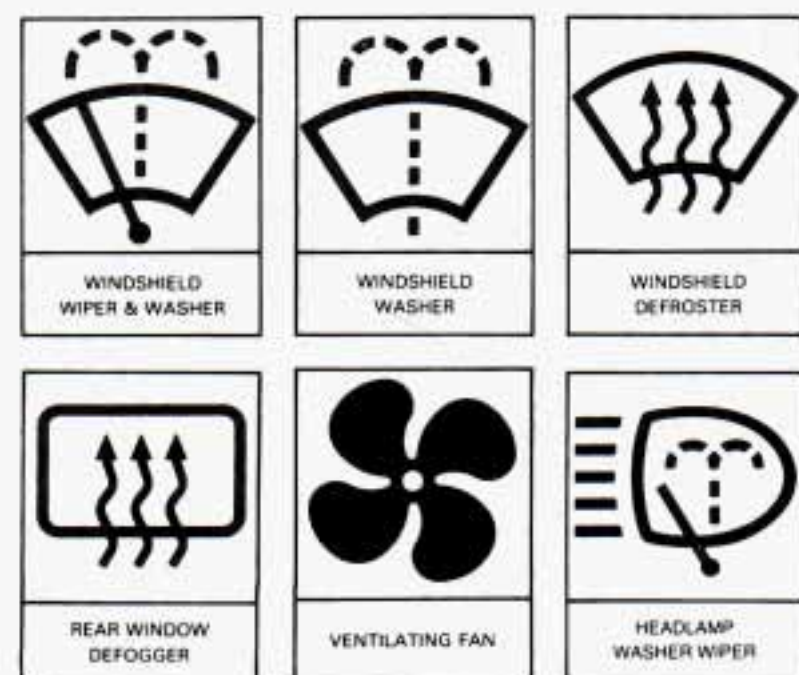

These symbols are used on warning and indicator lights:

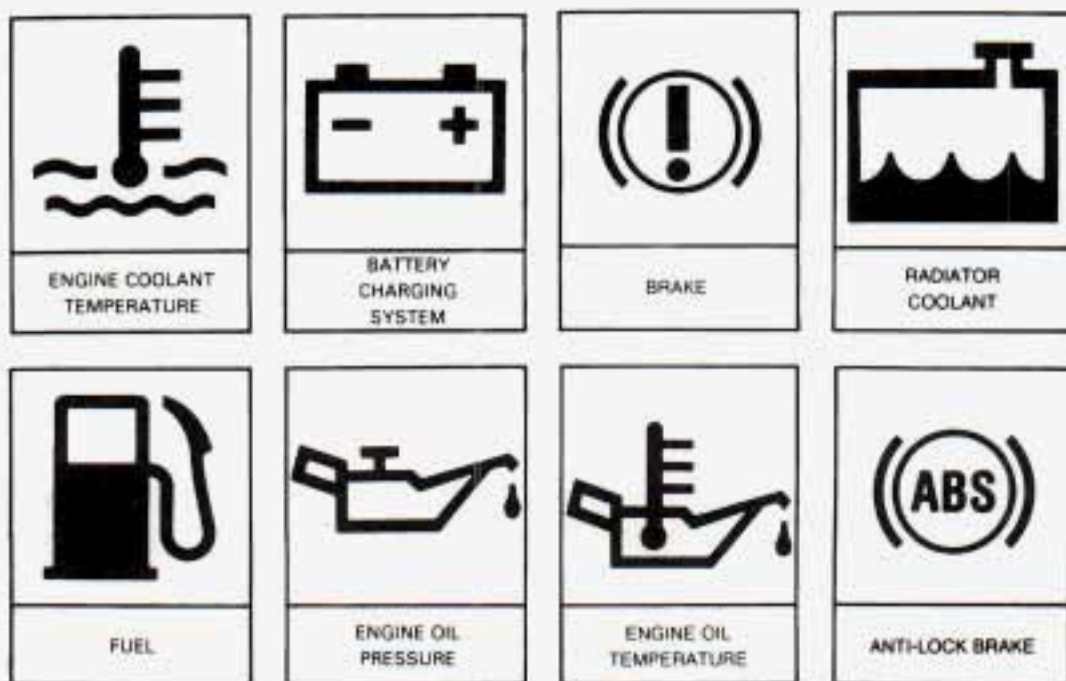

Here are some other symbols you may see:



NOTES

BRITISH MUSEUM LIBRARY, BRITISH LIBRARY, BRITISH MUSEUM LIBRARY, BRITISH MUSEUM LIBRARY





SECTION 1

SEATS AND RESTRAINT SYSTEMS

Here you'll find information about the seats in your Cadillac and how to use your safety belts properly. You can also learn about some things you should *not* do with air bags and safety belts.

SEATS AND SEAT CONTROLS

This section tells you about the seats -- how to adjust them, and also about reclining front seatbacks and head restraints.

Power Seat



The control is located on both front door armrests.

- The front TILT switch makes the front portion of the seat cushion move up and down.
- The rear TILT switch makes the rear portion of the seat cushion move up and down.
- Moving the center control switch to the right or left makes the whole seat cushion move up or down.
- Moving the center control switch back or forward makes the whole seat move rearward or forward.

Memory Seat

If your Fleetwood has this option, the control looks like this:



Here's how to make it work:

- You don't need to start your vehicle yet, just make sure it is in PARK (P).
- Adjust the driver's seat the way you want it.
- Press the SET button.
- Move the memory switch to 1 and your seating position is programmed.

Now it's set. When your Fleetwood is in PARK (P), and you move the memory switch to 1, the seat will go to where you have just set it. Do the same thing for a second driver following the steps above, but move the memory switch to 2.

The EXIT button allows you to get out of your vehicle more easily. The EXIT button is programmed the same as the memory selections. For easy entrance and exit, it is recommended that you position it fully back and fully down.

If you select the wrong memory switch or EXIT button, you can cancel it by just pressing any of the SEAT ADJUSTER switches.

Lumbar/Heater Seat Controls (Fleetwood Brougham)

With this feature, you can change the shape of the driver's or passenger's seatback. Adjust the power seat control first to get the proper position.



Move the lumbar control forward to increase lumbar support or rearward to decrease lumbar support.

Move the switch to either HI or LO to turn on the heating element in the seat.

Designed primarily for use on damp and chilly days, the LO setting warms the seatback and cushion until the seat approximates body temperature. On colder days, the HI setting heats the seats to an even higher temperature. To prevent uncomfortable overheating of the seats, the heating elements are thermostatically regulated to automatically maintain the temperature at the setting selected. A telltale light on the control switch reminds you that the heating system is in use. To preserve the battery, the heated seats can only be used when the ignition is turned on, and is deactivated when the ignition is turned off.

Reclining Front Seatbacks



To adjust the seatback, press the switch forward or rearward.



But don't have a seatback reclined if your vehicle is moving.

⚠ CAUTION:

Sitting in a reclined position when your vehicle is in motion can be dangerous. Even if you buckle up, your safety belts can't do their job when you're reclined like this.

The shoulder belt can't do its job because it won't be against your body. Instead, it will be in front of you. In a crash you could go into it, receiving neck or other injuries.

The lap belt can't do its job either. In a crash the belt could go up over your abdomen. The belt forces would be there, not at your pelvic bones. This could cause serious internal injuries.

For proper protection when the vehicle is in motion, have the seatback upright. Then sit well back in the seat and wear your safety belt properly.

Head Restraints

Slide the head restraint up or down so that the top of the restraint is closest to the top of your ears. This position reduces the chance of a neck injury in a crash.

The head restraint on a Fleetwood Brougham articulates. Hold both sides and gently rotate the restraint in a fore/aft direction.

SAFETY BELTS: THEY'RE FOR EVERYONE

This part of the manual tells you how to use safety belts properly. It also tells you some things you should not do with safety belts.

And it explains the Supplemental Inflatable Restraint, or "air bag" system.



CAUTION:

Don't let anyone ride where he or she can't wear a safety belt properly. If you are in a crash and you're not wearing a safety belt, your injuries can be much worse. You can hit things inside the vehicle or be ejected from it. You can be seriously injured or killed. In the same crash, you might not be if you are buckled up. Always fasten your safety belt, and check that your passengers' belts are fastened properly too.



Your vehicle has a light that comes on as a reminder to buckle up. (See “Safety Belt Reminder Light” in the Index.)

In many states and Canadian provinces, the law says to wear safety belts. Here’s why: *They work.*

You never know if you’ll be in a crash. If you do have a crash, you don’t know if it will be a bad one.

A few crashes are mild, and some crashes can be so serious that even buckled up a person wouldn’t survive. But most crashes are in between. In many of them, people who buckle up can survive and sometimes walk away. Without belts they could have been badly hurt or killed.

After more than 25 years of safety belts in vehicles, the facts are clear. In most crashes buckling up does matter ... a lot!

Why Safety Belts Work

When you ride in or on anything, you go as fast as it goes.

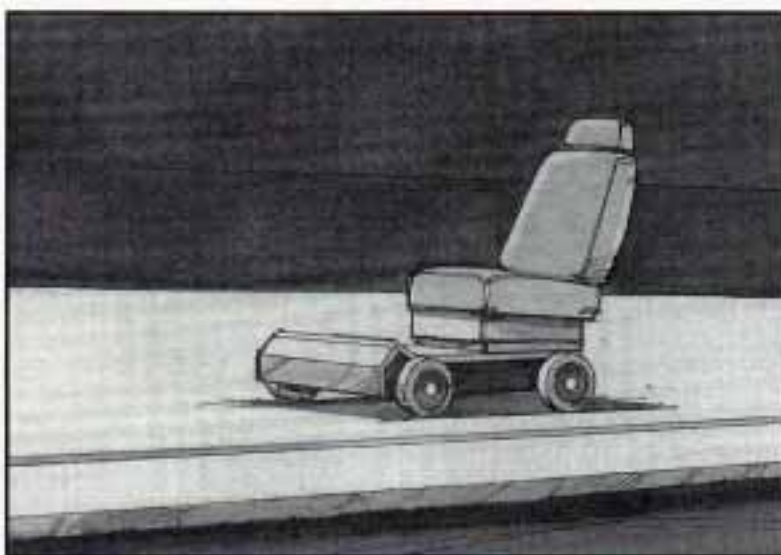

Take the simplest vehicle. Suppose it's just a seat on wheels.

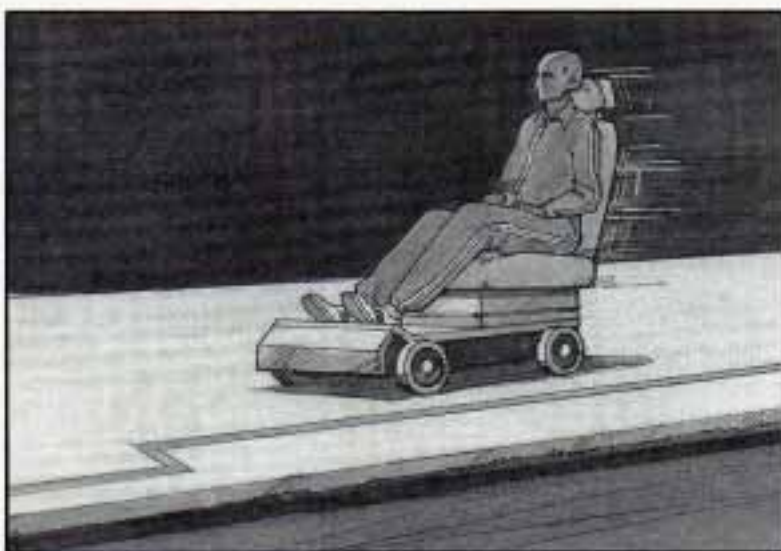

Put someone on it.

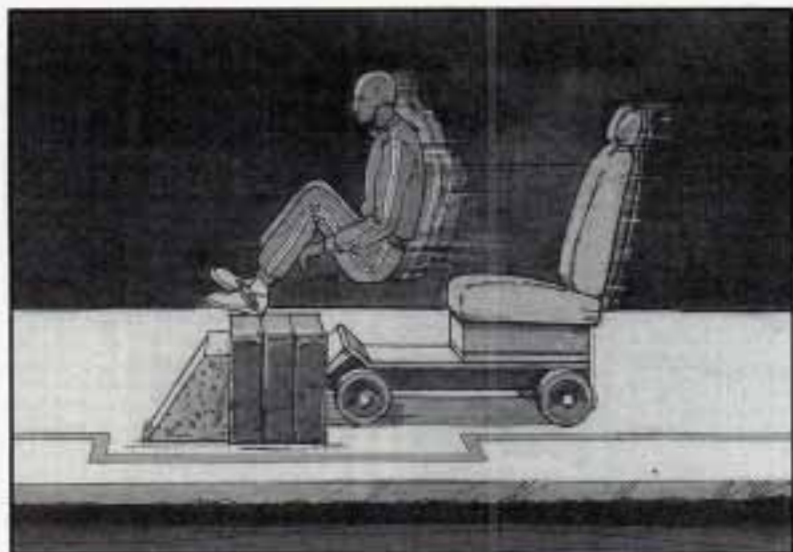

Get it up to speed.
Then stop the vehicle.
The rider doesn't stop.



The person keeps
going until stopped by
something.

In a real vehicle, it
could be the
windshield ...



or the instrument panel ...



or the safety belts!

With safety belts, you slow down as the vehicle does. You get more time to stop. You stop over more distance, and your strongest bones take the forces. That's why safety belts make such good sense.

HERE ARE QUESTIONS MANY PEOPLE ASK ABOUT SAFETY BELTS -- AND THE ANSWERS

Q: *Won't I be trapped in the vehicle after an accident if I'm wearing a safety belt?*

A: You *could* be -- whether you're wearing a safety belt or not. But you can unbuckle a safety belt, even if you're upside down. And your chance of being conscious during and after an accident, so you *can* unbuckle and get out, is *much* greater if you are belted.

Q: *Why don't they just put in air bags so people won't have to wear safety belts?*

A: Air bags are in many vehicles today and will be in more of them in the future. But they are supplemental systems only; so they work *with* safety belts -- not instead of them. Every air bag system ever offered for sale has required the use of safety belts. Even if you're in a vehicle that has air bags, you still have to buckle up to get the most protection. That's true not only in frontal collisions, but especially in side and other collisions.

Q: *If I'm a good driver, and I never drive far from home, why should I wear safety belts?*

A: You may be an excellent driver, but if you're in an accident -- even one that isn't your fault -- you and your passengers can be hurt. Being a good driver doesn't protect you from things beyond your control, such as bad drivers.

Most accidents occur within 25 miles (40 km) of home. And the greatest number of serious injuries and deaths occur at speeds of less than 40 mph (65 km/h).

Safety belts are for everyone.

HOW TO WEAR SAFETY BELTS PROPERLY

Adults

This part is only for people of adult size.

Be aware that there are special things to know about safety belts and children. And there are different rules for smaller children and babies. If a child will be riding in your Cadillac, see the part of this manual called "Children." Follow those rules for everyone's protection.

First, you'll want to know which restraint systems your vehicle has.

We'll start with the driver position.

DRIVER POSITION

This part describes the driver's restraint system.

Lap-Shoulder Belt

The driver has a lap-shoulder belt. Here's how to wear it properly.

1. Close and lock the door.
2. Adjust the seat (to see how, see "Seats" in the Index) so you can sit up straight.



3. Pick up the latch plate and pull the belt across you. Don't let it get twisted.

4. Push the latch plate into the buckle until it clicks.

Pull up on the latch plate to make sure it is secure. If the belt isn't long enough, see "Safety Belt Extender" at the end of this section.

Make sure the release button on the buckle is positioned so you would be able to unbuckle the safety belt quickly if you ever had to.

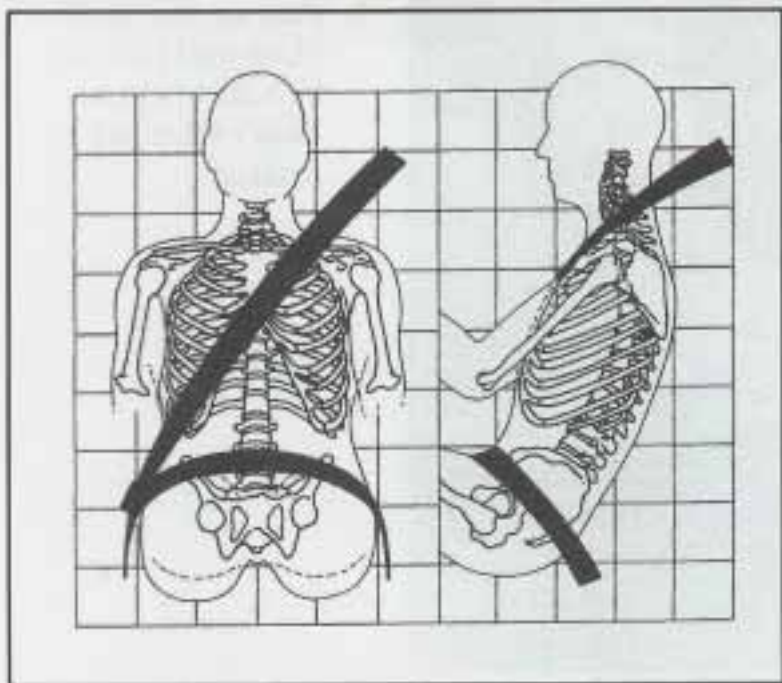

The lap part of the belt should be worn low and snug on the hips, just touching the thighs. In a crash, this applies force to the strong pelvic bones. And you'd be less likely to slide under the lap belt. If you slid under it, the belt would apply force at your abdomen. This could cause serious or even fatal injuries. The shoulder belt should go over the shoulder and across the chest. These parts of the body are best able to take belt restraining forces.

The safety belt locks if there's a sudden stop or crash.

Shoulder Belt Tightness Adjustment

Your car has a shoulder belt tightness adjustment feature. If the shoulder belt seems too tight, adjust it before you begin to drive.

1. Sit well back in the seat.
2. Start pulling the shoulder belt out.



3. Just before it reaches the end, give it a quick pull.

4. Let the belt go back all the way. You should hear a slight clicking sound. If you don't, the adjustment feature won't set, and you'll have to start again.



5. Now you can add a small amount of slack. Lean forward slightly, then sit back. If you've added more than 1 inch (25 mm) of slack, pull the shoulder belt out as you did before and start again.

If you move around in the vehicle enough, or if you pull out the shoulder belt, the belt will become tight again. If this happens, you can reset it.

Q: What's wrong with this?

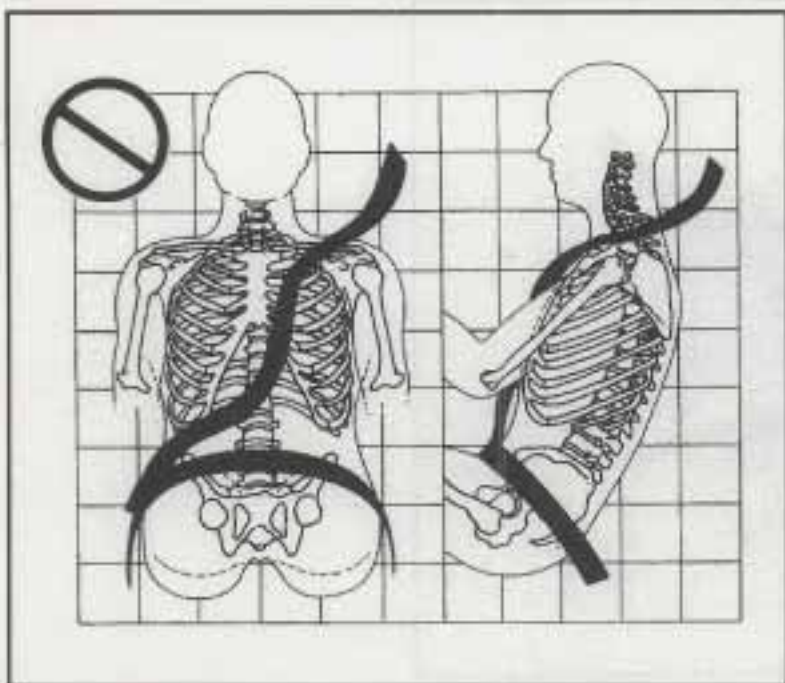

A: The shoulder belt is too loose. It won't give nearly as much protection this way.

⚠ CAUTION:

You can be seriously hurt if your shoulder belt is too loose. In a crash you would move forward too much, which could increase injury. The shoulder belt should fit against your body. Don't allow more than 1 inch (25 mm) of slack.

Q: What's wrong with this?

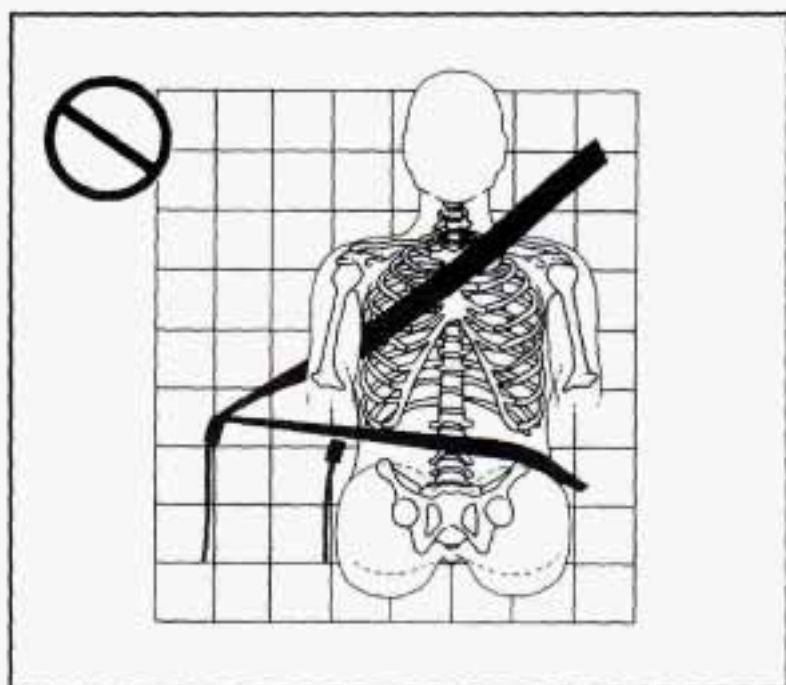

A: The belt is buckled in the wrong place.

⚠ CAUTION:

You can be seriously injured if your belt is buckled in the wrong place like this. In a crash, the belt would go up over your abdomen. The belt forces would be there, not at the pelvic bones. This could cause serious internal injuries. Always buckle your belt into the buckle nearest you.

Q: What's wrong with this?

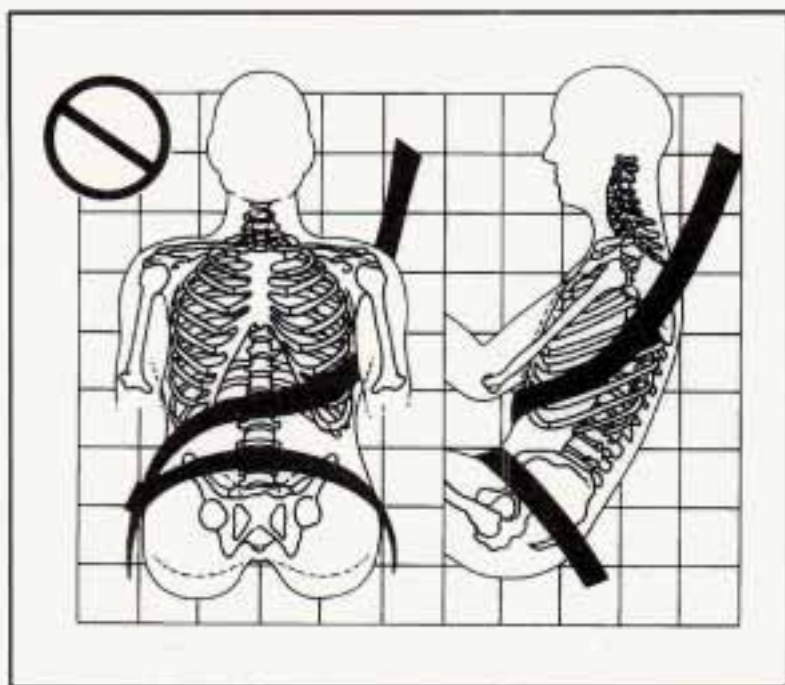

A: The shoulder belt is worn under the arm. It should be worn over the shoulder at all times.

⚠ CAUTION:

You can be seriously injured if you wear the shoulder belt under your arm. In a crash, your body would move too far forward, which would increase the chance of head and neck injury. Also, the belt would apply too much force to the ribs, which aren't as strong as shoulder bones. You could also severely injure internal organs like your liver or spleen.

Q: What's wrong with this?

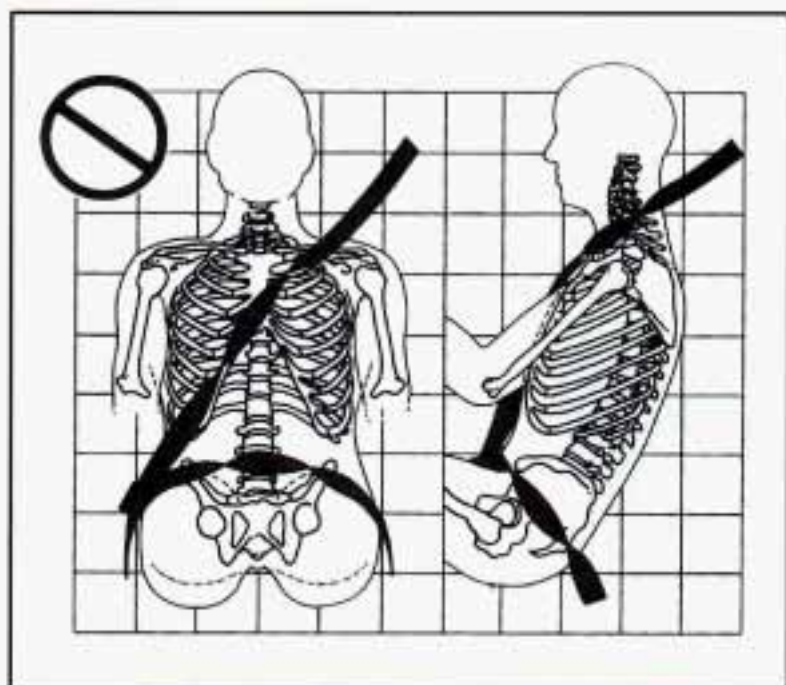

A: The belt is twisted across the body.

⚠ CAUTION:

You can be seriously injured by a twisted belt. In a crash, you wouldn't have the full width of the belt to spread impact forces. If a belt is twisted, make it straight so it can work properly, or ask your dealer to fix it.

To unlatch the belt, just push the button on the buckle. The belt should go back out of the way.



Before you close the door, be sure the belt is out of the way. If you slam the door on it, you can damage both the belt and your vehicle.

SUPPLEMENTAL INFLATABLE RESTRAINT SYSTEM (SIR)

This part explains the Supplemental Inflatable Restraint (SIR), or air bag, system.

Your Cadillac has two air bags -- one air bag for the driver and another air bag for the right front passenger.

Here are the most important things to know about the air bag system:

CAUTION:

You can be severely injured or killed in a crash if you aren't wearing your safety belt -- even if you have an air bag. Wearing your safety belt during a crash helps reduce your chance of hitting things inside the vehicle or being ejected from it. The air bag is only a "supplemental restraint." That is, it works with safety belts but doesn't replace them. Air bags are designed to work only in moderate to severe crashes where the front of your vehicle hits something. They aren't designed to inflate at all in rollover, rear, side, or low-speed frontal crashes. Everyone in your vehicle, including the driver, should wear a safety belt properly -- whether or not there's an air bag for that person.

CAUTION:

Air bags inflate with great force, faster than the blink of an eye. If you're too close to an inflating air bag, it could seriously injure you. Safety belts help keep you in position for an air bag inflation in a crash. Always wear your safety belt, even with an air bag. The driver should sit as far back as possible while still maintaining control of the vehicle.



CAUTION:

An inflating air bag can seriously injure small children. Always secure children properly in your vehicle. To read how, see the part of this manual called "Children" and the caution label on the right front passenger's safety belt.

AIR
BAG

There is an air bag readiness light on the instrument panel, which shows AIR BAG.

The system checks the air bag's electrical system for malfunctions. The light tells you if there is an electrical problem. See "Air Bag Readiness Light" in the Index for more information.

How the Air Bag System Works



Where is the air bag?

The driver's air bag is in the middle of the steering wheel. The right front passenger's air bag is in the instrument panel on the passenger's side.



CAUTION:

Don't put anything on, or attach anything to, the steering wheel or instrument panel. Also, don't put anything (such as pets, or objects) between any occupant and the steering wheel or instrument panel. If something is between an occupant and an air bag, it could affect the performance of the air bag -- or worse, it could cause injury.

When should an air bag inflate?

The air bag is designed to inflate in moderate to severe frontal or near-frontal crashes. The air bag will inflate only if the impact speed is above the system's designed "threshold level." If your vehicle goes straight into a wall that doesn't move or deform, the threshold level is about 9 to 15 mph (14 to 24 km/h). The threshold level can vary, however, with specific vehicle design, so that it can be somewhat above or below this range. If your vehicle strikes something that will move or deform, such as a parked car, the threshold level will be higher. The air bag is not designed to inflate in rollovers, side impacts, or rear impacts, because inflation would not help the occupant.

In any particular crash, no one can say whether an air bag should have inflated simply because of the damage to a vehicle or because of what the repair costs were. Inflation is determined by the angle of the impact and the vehicle's deceleration. Vehicle damage is only one indication of this.

What makes an air bag inflate?

In a frontal or near-frontal impact of sufficient severity, the air bag sensing system detects that the vehicle is suddenly stopping as a result of a crash. The sensing system triggers a chemical reaction of the sodium azide sealed in the inflator. The reaction produces nitrogen gas, which inflates the air bag. The inflator, air bag, and related hardware are all part of the air bag modules packed inside the steering wheel and in the instrument panel in front of the right front passenger.

How does an air bag restrain?

In moderate to severe frontal or near-frontal collisions, even belted occupants can contact the steering wheel or the instrument panel. The air bag supplements the protection provided by safety belts. Air bags distribute the force of the impact more evenly over the occupant's upper body, stopping the occupant more gradually. But air bags would not help you in many types of collisions, including rollovers and rear and side impacts, primarily because an occupant's motion is not toward the air bag. Air bags should never be regarded as anything more than a supplement to safety belts, and then only in moderate to severe frontal or near-frontal collisions.

What will you see after an air bag inflates?

After the air bag inflates, it quickly deflates. This occurs so quickly that some people may not even realize the air bag inflated. Some components of the air bag module in the steering wheel hub for the driver's air bag, or the instrument panel for the right front passenger's bag, will be hot for a short time, but the part of the bag that comes into contact with you will not be hot to the touch. There will be some smoke and dust coming from vents in the deflated air bags. Air bag inflation will not prevent the driver from seeing or from being able to steer the vehicle, nor will it stop people from leaving the vehicle.

 **CAUTION:**

When an air bag inflates, there is dust in the air. This dust could cause breathing problems for people with a history of asthma or other breathing trouble. To avoid this, everyone in the vehicle should get out as soon as it is safe to do so. If you have breathing problems but can't get out of the vehicle after an air bag inflates, then get fresh air by opening a window or door.

In many crashes severe enough to inflate an air bag, windshields are broken by vehicle deformation. Additional windshield breakage may also occur from the right front passenger air bag.

- The air bags are designed to inflate only once. After they inflate, you'll need some new parts for your air bag system. If you don't get them, the air bag system won't be there to help protect you in another crash. A new system will include air bag modules and possibly other parts. The service manual for your vehicle covers the need to replace other parts.
- Your vehicle is equipped with a diagnostic module, which records information about the air bag system. The module records information about the readiness of the system, when the sensors are activated and driver's safety belt usage at deployment.
- Let only qualified technicians work on your air bag system. Improper service can mean that your air bag system won't work properly. See your dealer for service.

NOTICE:

If you damage the cover for the driver's or the right front passenger's air bag, they may not work properly. You may have to replace the air bag module in the steering wheel or both the air bag module and the instrument panel for the right front passenger's air bag. Do not open or break the air bag covers.

Servicing Your Air Bag-Equipped Cadillac

Air bags affect how your Cadillac should be serviced. There are parts of the air bag system in several places around your vehicle. You don't want the system to inflate while someone is working on your vehicle. Your Cadillac dealer and the 1995 Fleetwood Service Manual have information about servicing your vehicle and the air bag system. To purchase a service manual, see "Service Publications" in the Index.

The air bag system does not need regular maintenance.

CAUTION:

For up to 10 seconds after the ignition key is turned off and the battery is disconnected, an air bag can still inflate during improper service. You can be injured if you are close to an air bag when it inflates. Avoid wires wrapped with yellow tape, or yellow connectors. They are probably part of the air bag system. Be sure to follow proper service procedures, and make sure the person performing work for you is qualified to do so.

SAFETY BELT USE DURING PREGNANCY

Safety belts work for everyone, including pregnant women. Like all occupants, they are more likely to be seriously injured if they don't wear safety belts.

A pregnant woman should wear a lap-shoulder belt, and the lap portion should be worn as low as possible throughout the pregnancy.

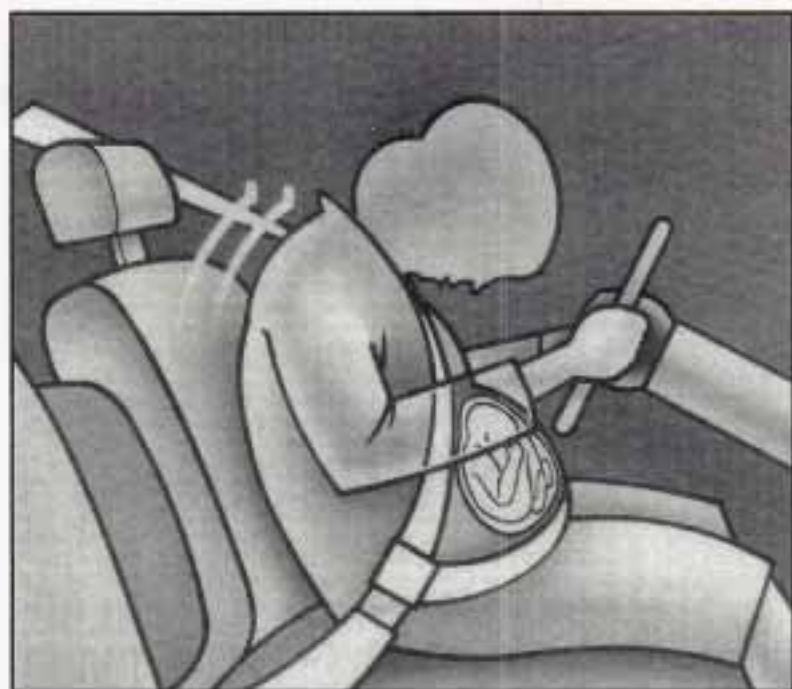

The best way to protect the fetus is to protect the mother. When a safety belt is worn properly, it's more likely that the fetus won't be hurt in a crash. For pregnant women, as for anyone, the key to making safety belts effective is wearing them properly.

RIGHT FRONT PASSENGER POSITION

The right front passenger's safety belt works the same way as the driver's safety belt. See "Driver Position," earlier in this section.

When the lap portion of the belt is pulled out all the way, it will lock. If it does, let it go back all the way and start again.

Be sure to use the correct buckle when buckling your lap-shoulder belt. If you find that the latch plate will not go fully into the buckle, see if you are using the buckle for the center passenger position.

CENTER FRONT PASSENGER POSITION

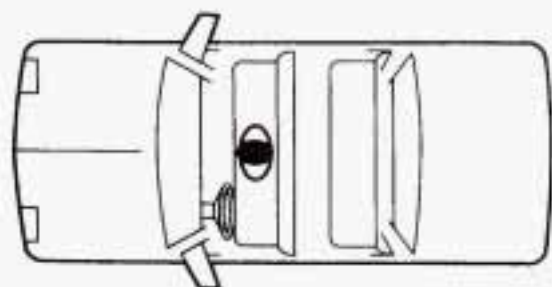

Lap Belt

If your vehicle has a front split seat and a rear bench seat, someone can sit in the center positions.

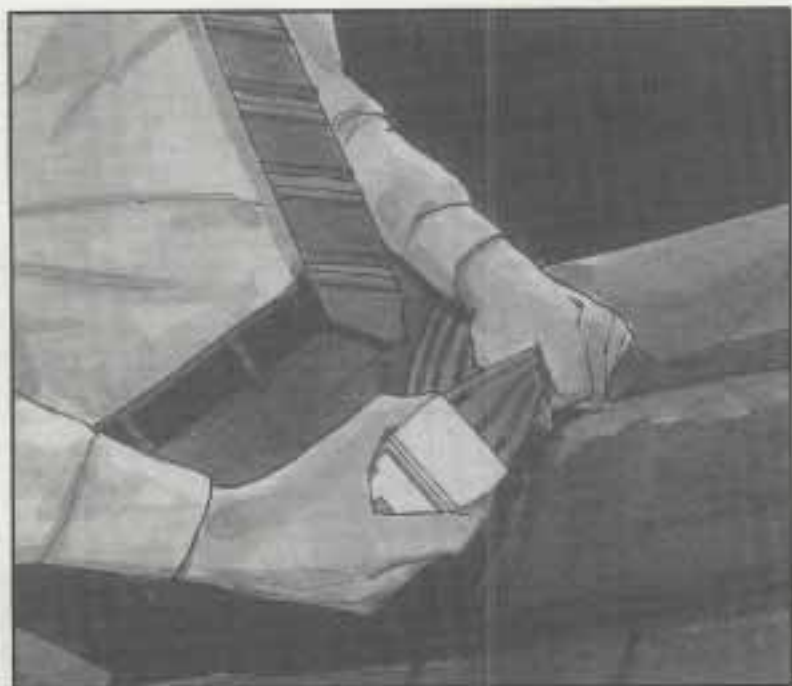

When you sit in the center front seating position, you have a lap safety belt, which has no retractor. To make the belt longer, tilt the latch plate and pull it along the belt.



To make the belt shorter, pull its free end as shown until the belt is snug.

Buckle, position and release it the same way as the lap part of a lap-shoulder belt. If the belt isn't long enough, see "Safety Belt Extender" at the end of this section.

Make sure the release button on the buckle is positioned so you would be able to unbuckle the safety belt quickly if you ever had to.

REAR SEAT PASSENGERS

It's very important for rear seat passengers to buckle up! Accident statistics show that unbelted people in the rear seat are hurt more often in crashes than those who are wearing safety belts.

Rear passengers who aren't safety belted can be thrown out of the vehicle in a crash. And they can strike others in the vehicle who are wearing safety belts.

Rear Seat Outside Passenger Positions

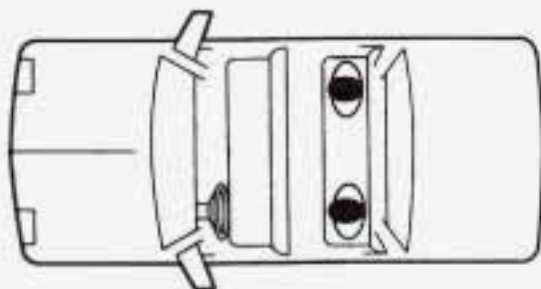

Lap-Shoulder Belt

The positions next to the windows have lap-shoulder belts. Here's how to wear one properly.



1. Pick up the latch plate and pull the belt across you. Don't let it get twisted.

2. Push the latch plate into the buckle until it clicks.



If the belt stops before it reaches the buckle, tilt the latch plate and keep pulling until you can buckle it.

Pull up on the latch plate to make sure it is secure.

If the belt is not long enough, see “Safety Belt Extender” at the end of this section. Make sure the release button on the buckle is positioned so you would be able to unbuckle the safety belt quickly if you ever had to.



3. To make the lap part tight, pull down on the buckle end of the belt as you pull up on the shoulder part.

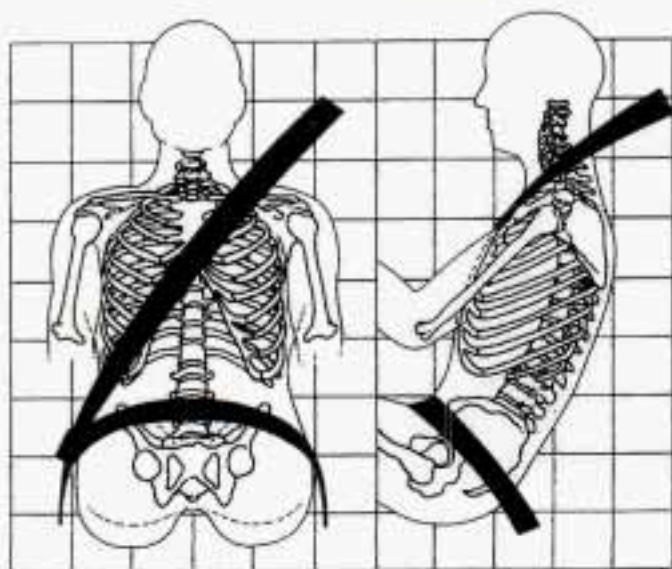

The lap part of the belt should be worn low and snug on the hips, just touching the thighs. In a crash, this applies force to the strong pelvic bones. And you'd be less likely to slide under the lap belt. If you slid

under it, the belt would apply force at your abdomen. This could cause serious or even fatal injuries. The shoulder belt should go over the shoulder and across the chest. These parts of the body are best able to take belt restraining forces.

The safety belt locks if there's a sudden stop or a crash.

⚠ CAUTION:

You can be seriously hurt if your shoulder belt is too loose. In a crash you would move forward too much, which could increase injury. The shoulder belt should fit against your body.



To unlatch the belt, just push the button on the buckle.

CENTER REAR PASSENGER POSITION

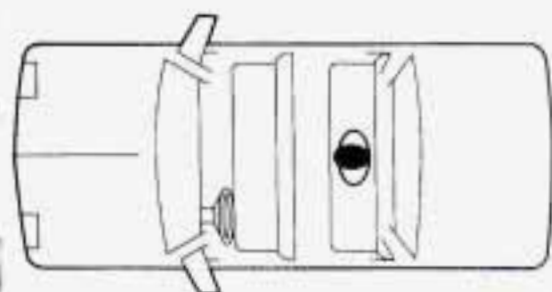

Lap Belt



When you sit in the center rear seating position, you have a lap safety belt which has a retractor.

1. Pick up the latch plate and, in a single motion, pull the belt across you. Don't let it get twisted.
2. Push the latch plate into the buckle until it clicks. If the belt stops before it reaches the buckle, let it go back into the retractor all the way and start again. Pull up on the latch plate to make sure it is secure.

3. Feed the lap belt into the retractor to tighten it.



4. Position and release it the same way as the lap part of a lap-shoulder belt.

If the belt isn't long enough, see "Safety Belt Extender" at the end of this section. Make sure the release button on the buckle is positioned so you would be able to unbuckle the safety belt quickly if you ever had to.

CHILDREN

Everyone in a vehicle needs protection! That includes infants and all children smaller than adult size. In fact, the law in every state in the United States and in every Canadian province says children up to some age must be restrained while in a vehicle.

Smaller Children and Babies

CAUTION:

Smaller children and babies should always be restrained in a child or infant restraint. The instructions for the restraint will say whether it is the right type and size for your child. A very young child's hip bones are so small that a regular belt might not stay low on the hips, as it should. Instead, the belt will likely be over the child's abdomen. In a crash the belt would apply force right on the child's abdomen, which could cause serious or fatal injuries. So, be sure that any child small enough for one is always properly restrained in a child or infant restraint.



 **CAUTION:**

Never hold a baby in your arms while riding in a vehicle. A baby doesn't weigh much -- until a crash. During a crash a baby will become so heavy you can't hold it. For example, in a crash at only 25 mph (40 km/h), a 12-pound (5.5 kg) baby will suddenly become a 240-pound (110 kg) force on your arms. The baby would be almost impossible to hold.

Secure the baby in an infant restraint.



CHILD RESTRAINTS

Be sure to follow the instructions for the restraint. You may find these instructions on the restraint itself or in a booklet, or both. These restraints use the belt system in your vehicle, but the child also has to be secured within the restraint to help reduce the chance of personal injury. The instructions that come with the infant or child restraint will show you how to do that.

Where to Put the Restraint

Accident statistics show that children are safer if they are restrained in the rear rather than the front seat. We at General Motors therefore recommend that you put your child restraint in the rear seat. *Never* put a rear-facing child restraint in the front passenger seat. Here's why:



CAUTION:

A child in a rear-facing child restraint can be seriously injured if the right front passenger's air bag inflates. This is because the back of a rear-facing child restraint would be very close to the inflating air bag. Always secure a rear-facing child restraint in the rear seat.

You may, however, secure a forward-facing child restraint in the right front seat. Before you secure a forward-facing child restraint, always move the front passenger seat as far back as it will go. Or, secure the child restraint in the rear seat.



CAUTION:

A child in a child restraint in the center front seat can be badly injured by the passenger air bag if it inflates. Never use a child restraint in the center front seat. It's always better to secure a child restraint in the rear seat. You may, however, secure a forward-facing child restraint in the right front passenger seat, but only with the seat moved all the way back.

Wherever you install it, be sure to secure the child restraint properly. Keep in mind that an unsecured child restraint can move around in a collision or sudden stop and injure people in the vehicle. Be sure to properly secure any child restraint in your vehicle -- even when no child is in it.

Top Strap

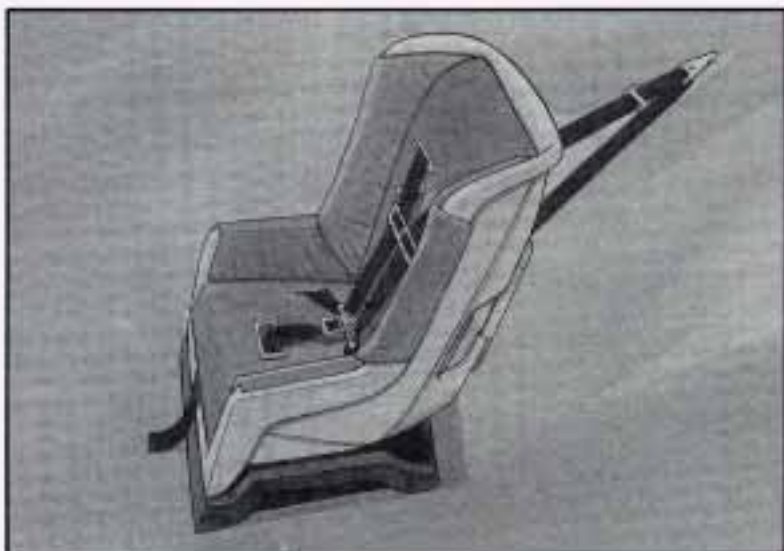

If your child restraint has a top strap, it should be anchored.

If you need to have an anchor installed, you can ask your Cadillac dealer to put it in for you. If you want to install an anchor yourself, your dealer can tell you how to do it.

For cars first sold in Canada, child restraints with a top strap must be anchored according to Canadian Law.

Your dealer can obtain the hardware kit and install it for you, or you may install it yourself using the instructions provided in the kit.

Use the tether hardware kit available from the dealer. The hardware and installation instructions were specifically designed for this vehicle.

Securing a Child Restraint in a Rear Outside Seat Position

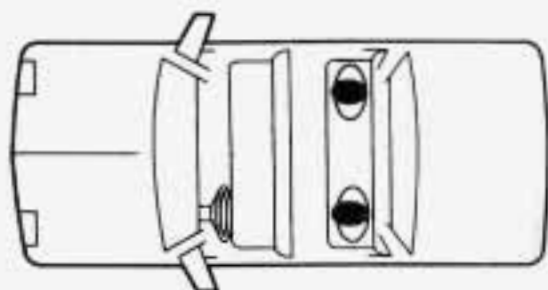

You'll be using the lap-shoulder belt. See the earlier part about the top strap if the child restraint has one.

1. Put the restraint on the seat. Follow the instructions for the child restraint.
2. Secure the child in the child restraint as the instructions say.
3. Pick up the latch plate, and run the lap and shoulder portions of the vehicle's safety belt through or around the restraint. The child restraint instructions will show you how. Tilt the latch plate to adjust the belt if needed.

If the shoulder belt goes in front of the child's face or neck, put it behind the child restraint.



4. Buckle the belt. Make sure the release button is positioned so you would be able to unbuckle the safety belt quickly if you ever had to.



5. To tighten the belt, pull up on the shoulder belt while you push down on the child restraint.

6. Push and pull the child restraint in different directions to be sure it is secure.

To remove the child restraint, just unbuckle the vehicle's safety belt and let it go back all the way. The safety belt will move freely again and be ready to work for an adult or larger child passenger.

Securing a Child Restraint in the Center Rear Seat Position

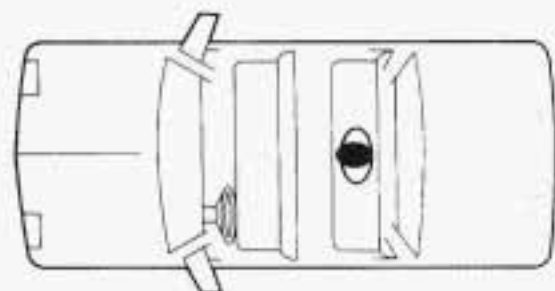

You'll be using the lap belt.

⚠ CAUTION:

A child in a child restraint in the center front seat can be badly injured by the right front passenger air bag if it inflates. Never secure a child restraint in the center front seat. It's always better to secure a child restraint in the rear seat. You may, however, secure a forward-facing child restraint in the right front passenger seat, but only with the seat moved all the way back.

See the earlier part about the top strap if the child restraint has one.

1. Put the restraint on the seat. Follow the instructions for the child restraint.
2. Secure the child in the child restraint as the instructions say.



3. Pull the lap belt all the way out without stopping.

4. While holding it out, run the belt through or around the child restraint. The child restraint instructions will show you how.



5. Buckle the belt. Make sure the release button is positioned so you would be able to unbuckle the safety belt quickly if you ever had to.



6. To tighten the belt, feed it back into the retractor while you push down on the child restraint.

7. Push and pull the child restraint in different directions to be sure it is secure.

To remove the child restraint, just unbuckle the vehicle's safety belt and let it go back all the way. The safety belt will move freely again and be ready to work for an adult or larger child passenger.

Securing a Child Restraint in the Right Front Seat Position

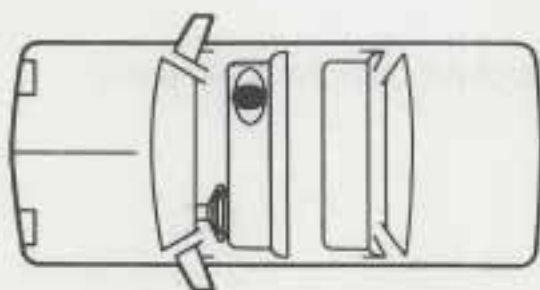

Your vehicle has a right front passenger air bag. *Never* put a rear-facing child restraint in this seat. Here's why:



CAUTION:

A child in a rear-facing child restraint can be seriously injured if the right front passenger's air bag inflates. This is because the back of a rear-facing child restraint would be very close to the inflating air bag. Always secure a rear-facing child restraint in the rear seat.

You'll be using the lap-shoulder belt. See the earlier part about the top strap if the child restraint has one.

1. Because your vehicle has a right front passenger air bag, always move the seat as far back as it will go before securing a forward-facing child restraint. (See "Seats" in the Index.)
2. Put the restraint on the seat. Follow the instructions for the child restraint.
3. Secure the child in the child restraint as the instructions say.
4. Pick up the latch plate, and run the lap and shoulder portions of the vehicle's safety belt through or around the restraint. The child restraint instructions will show you how.

If the shoulder belt goes in front of the child's face or neck, put it behind the child restraint.



5. Buckle the belt.

Make sure the release button is positioned so you would be able to unbuckle the safety belt quickly if you ever had to.



6. Pull the rest of the lap belt all the way out of the retractor to set the lock.



7. To tighten the belt, feed the lap belt back into the retractor while you push down on the child restraint.

8. Push and pull the child restraint in different directions to be sure it is secure.

To remove the child restraint, just unbuckle the vehicle's safety belt and let it go back all the way.

The safety belt will move freely again and be ready to work for an adult or larger child passenger.

Larger Children

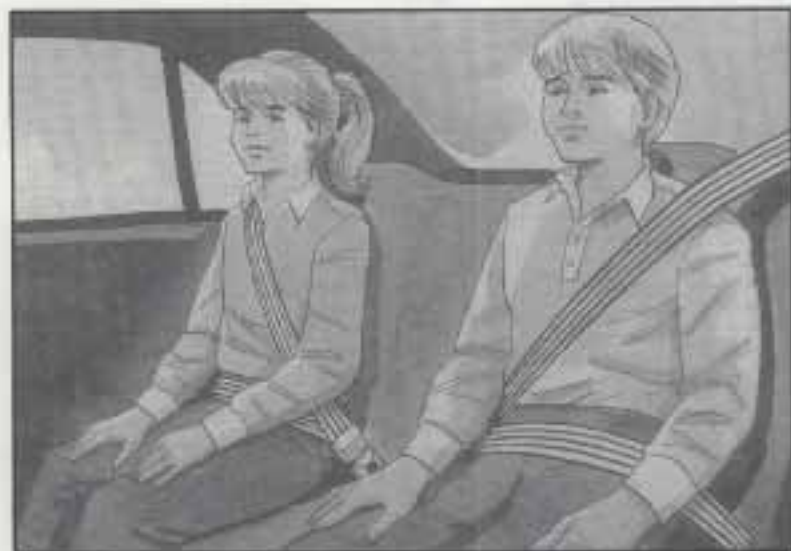

Children who have outgrown child restraints should wear the vehicle's safety belts.

If you have the choice, a child should sit next to a window so the child can wear a lap-shoulder belt and get the additional restraint a shoulder belt can provide.

Accident statistics show that children are safer if they are restrained in the rear seat. But they need to use the safety belts properly.

- Children who aren't buckled up can be thrown out in a crash.
- Children who aren't buckled up can strike other people who are.



 **CAUTION:**

Never do this.

Here two children are wearing the same belt. The belt can't properly spread the impact forces. In a crash, the two children can be crushed together and seriously injured. A belt must be used by only one person at a time.

Q: What if a child is wearing a lap-shoulder belt, but the child is so small that the shoulder belt is very close to the child's face or neck?

A: Move the child toward the center of the vehicle, but be sure that the shoulder belt still is on the child's shoulder, so that in a crash the child's upper body would have the restraint that belts provide. If the child is so small that the shoulder belt is still very close to the child's face or neck, you might want to place the child in the center seat position, the one that has only a lap belt.



⚠ CAUTION:

Never do this.

Here a child is sitting in a seat that has a lap-shoulder belt, but the shoulder part is behind the child. If the child wears the belt in this way, in a crash the child might slide under the belt. The belt's force would then be applied right on the child's abdomen. That could cause serious or fatal injuries.

Wherever the child sits, the lap portion of the belt should be worn low and snug on the hips, just touching the child's thighs. This applies belt force to the child's pelvic bones in a crash.

SAFETY BELT EXTENDER

If the vehicle's safety belt will fasten around you, you should use it.

But if a safety belt isn't long enough to fasten, your dealer will order you an extender. It's free. When you go in to order it, take the heaviest coat you will wear, so the extender will be long enough for you. The extender will be just for you, and just for the seat in your vehicle that you choose. Don't let someone else use it, and use it only for the seat it is made to fit. To wear it, just attach it to the regular safety belt.

CHECKING YOUR RESTRAINT SYSTEMS

Now and then, make sure all your belts, buckles, latch plates, retractors, anchorages and reminder systems are working properly. Look for any other loose or damaged restraint system parts. If you see anything that might keep a restraint system from doing its job, have it repaired.

Torn or frayed belts may not protect you in a crash. They can rip apart under impact forces. If a belt is torn or frayed, get a new one right away.

REPLACING SEAT AND RESTRAINT SYSTEM PARTS AFTER A CRASH

If you've had a crash, do you need new belts?

After a very minor collision, nothing may be necessary. But if the belts were stretched, as they would be if worn during a more severe crash, then you need new belts.

If belts are cut or damaged, replace them. Collision damage also may mean you will need to have safety belt or seat parts repaired or replaced. New parts and repairs may be necessary even if the belt wasn't being used at the time of the collision.



SECTION 2

FEATURES AND CONTROLS

Here you can learn about the many standard and optional features on your Cadillac, and information on starting, shifting and braking. Also explained are the instrument panel and the warning systems that tell you if everything is working properly -- and what to do if you have a problem.

KEYS

CAUTION:

Leaving young children in a vehicle with the ignition key is dangerous for many reasons. A child or others could be badly injured or even killed.

They could operate power windows or other controls or even make the vehicle move. If they turned the ignition to ON and moved the shift lever out of PARK (P), that would release the parking brake. Don't leave the keys in a vehicle with young children.



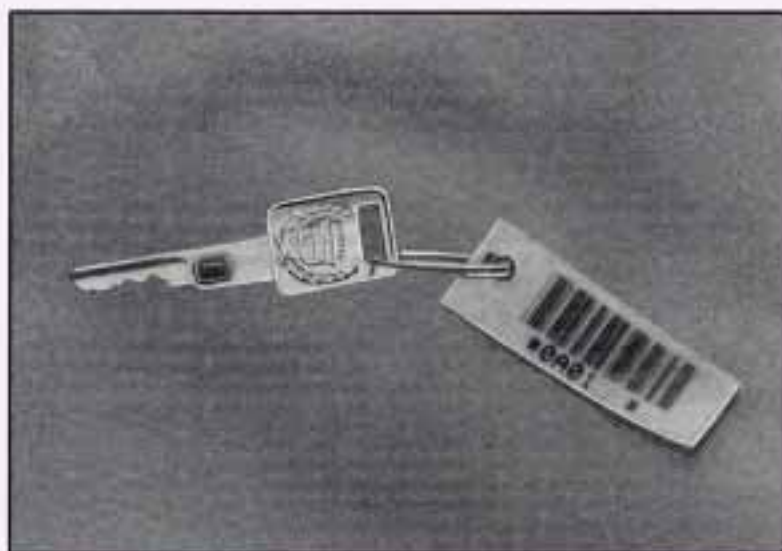

The square ignition keys are for the ignition only. They have resistor pellets which are part of the vehicle's PASS-Key[®] II system.



The round keys are for the doors and all other locks.

When a new Fleetwood is delivered, the dealer removes the plugs from the keys. Each plug has a code on it that tells the dealer or a qualified locksmith how to make extra keys. However, the ignition keys do not have plugs. The ignition keys come with a bar code tag attached to them. Your dealer or qualified locksmith by reading the number on the bar code tag can then make extra ignition keys.

There are 15 alternative ignition PASS-Key[®] II blanks to help discourage theft. Keep the bar code tag and the door key plugs in a safe place. If you lose your keys, you will be able to have new ones made easily using the plug or number on the bar code tag.

NOTICE:

Your Cadillac has a number of new features that can help prevent theft. But you can have a lot of trouble getting into your vehicle if you ever lock your keys inside. You may even have to damage your vehicle to get in. So be sure you have extra keys.

Your Cadillac has an ignition key anti-lockout feature. It doesn't allow you to use the door switches to lock your doors when any door is open and the key is turned to any position except RUN. Note that if your engine is running, this feature will not prevent you from locking your keys inside. In addition, you can still lock the doors using the Remote Keyless Entry System regardless of the key position.

DOOR LOCKS



CAUTION:

Unlocked doors can be dangerous.

Passengers -- especially children -- can easily open the doors and fall out. When a door is locked, the inside handle won't open it.

Outsiders can easily enter through an unlocked door when you slow down or stop your vehicle.

This may not be so obvious: You increase the chance of being thrown out of the vehicle in a crash if the doors aren't locked. Wear safety belts properly, lock your doors, and you will be far better off whenever you drive your vehicle.

There are several ways to lock and unlock your vehicle:

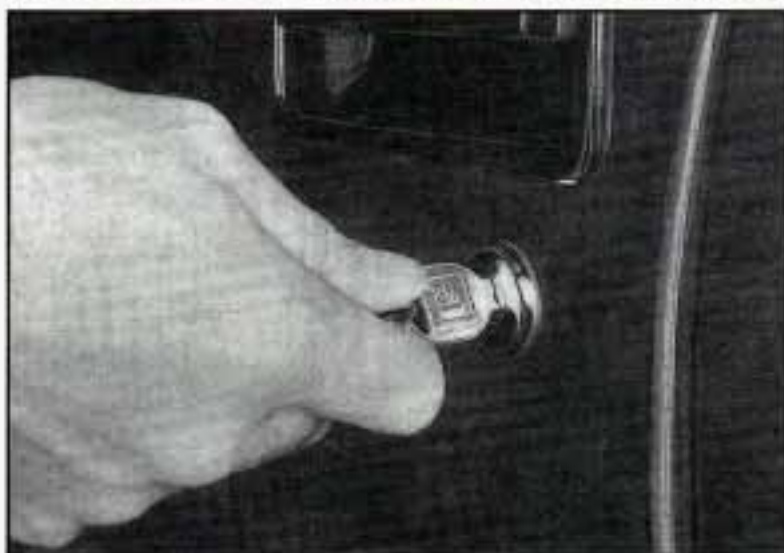

From the outside, use your door key.

If your vehicle has a Theft Deterrent system and it is armed, unlock the doors only with the key or Remote Keyless Entry System. This will avoid setting off the alarm.



From the inside, to lock the door, slide the control down.

To unlock the door, slide the control up.

Power Door Locks



Push the lower part of the switch marked **LOCK** to lock all doors at once. Push the upper part of the switch marked **UNLOCK** to unlock all the doors.

The switch on each rear door works only that door's lock. It won't lock all of the doors -- that's a safety feature.

Automatic Door Locks

Just close your doors and turn on the ignition. Every time you move your shift lever out of **PARK (P)** all of the doors will lock. In addition, every time you stop and move your shift lever into **PARK (P)**, your doors will unlock. If someone needs to get out while the vehicle is not in **PARK (P)**, have that person use the manual or power lock. When the door is closed again, it will not lock automatically. Just use the manual or power lock to lock the door again.

You can also have this feature changed where the doors will stay locked when you shift back into **PARK (P)**. Ask your dealer for details.

Central Door Unlocking Feature

With this feature you can unlock the doors from either front outside door lock. Hold the key in the turned position for a few seconds.

Rear Door Security Lock

Your Cadillac is equipped with rear door security locks that help prevent passengers from opening the rear doors of your car from the inside. To use this lock:



1. Move the lever on the door all the way up to the **ENGAGED** position.
2. Close the door.
3. Do the same thing to the other rear door lock.

The rear doors of your vehicle cannot be opened from the inside when this feature is in use.

When you want to open a rear door when the security lock is on:

1. Unlock the door from the inside.
2. Then open the door from the outside.

To cancel the rear door lock:

1. Unlock the door from the inside and open the door from the outside.
2. Move the lever all the way down.
3. Do the same for the other rear door.

The rear door locks will now work normally.

Illuminated Entry System

When you lift the door handle, the lamps inside your Cadillac will go on. They'll go off when you start your engine, or when 30 seconds have passed. You can turn on the interior lamps by pressing any button on the Remote Keyless Entry transmitter.

Leaving Your Vehicle

If you are leaving the vehicle, take your keys, open your door and set the locks from inside. Then get out and close the door.

If your vehicle has a theft deterrent system, see "Theft Deterrent" in the Index.

REMOTE KEYLESS ENTRY SYSTEM

Your Cadillac has this option which allows you to lock and unlock your doors or unlock your trunk from up to 30 feet (9 m) away using the key chain transmitter supplied with your vehicle.

Your Remote Keyless Entry System is intended to be used as a supplementary vehicle entry device. It is not intended to replace, but rather should be used in conjunction with a door lock key. It operates on a radio frequency subject to Federal Communications Commission (FCC) Rules.

This device complies with Part 15 of the FCC Rules. Operation is subject to the following two conditions: (1) This device may not cause harmful interference, and (2) This device must accept any interference received, including interference that may cause undesired operation.

Should interference to this system occur, try this:

- Check to determine if battery replacement is necessary. See the instructions on battery replacement.
- Check the distance. You may be too far from your vehicle. This product has a maximum range.
- Check the location. Other vehicles or objects may be blocking the signal.
- See your Cadillac dealer or a qualified technician for service.

Changes or modifications to this system by other than an authorized service facility could void authorization to use this equipment.

Operation



1. Press this symbol to unlock the driver's door. Press it again within five seconds to unlock the other doors. Pressing this symbol will also disarm the optional Theft Deterrent System and turn on the interior lamps.



2. Press this symbol to lock your doors. This also arms the optional Theft Deterrent System.



3. Press this symbol to open the trunk.



4. Press this symbol to turn on the interior lamps only.

Matching Transmitter(s) To Your Vehicle

Each key chain transmitter is coded to prevent another transmitter from unlocking your vehicle. If a transmitter is lost or stolen, a replacement can be purchased through your dealer. Remember to bring any remaining transmitters with you when you go to your dealer. When the dealer matches the replacement transmitter to your vehicle, the remaining transmitters must also be matched. Once the new transmitter is coded, the lost transmitter will not unlock your vehicle.

You can match a transmitter to as many different vehicles as you own, provided they are equipped with *exactly the same model system*. (General Motors offers several different models of these systems on their vehicles.) Each vehicle can have only two transmitters matched to it.

See your dealer to match transmitters to another vehicle.

Battery Replacement

Under normal use, the batteries in your key chain transmitter should last about two years.

You can tell the batteries are weak if the transmitter won't work at the normal range in any location. If you have to get close to your vehicle before the transmitter works, it's probably time to change the batteries.

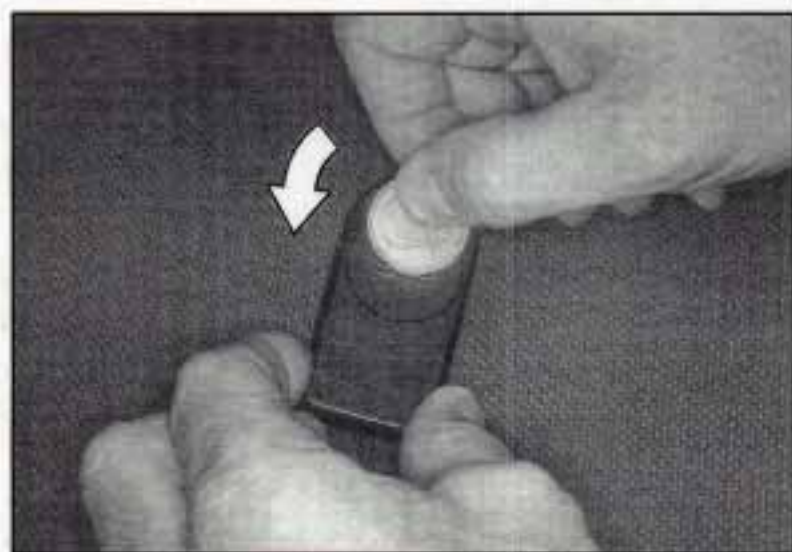

1. Use the round end of the door key, or a quarter to rotate the cover slightly counterclockwise.



2. Remove the battery and replace with CR2025 or an equivalent. Using the wrong size battery can damage the transmitter.



3. Make sure the battery is positioned with the "+" facing the cover.



4. Align the notches on the cover and transmitter and rotate the cover clockwise to reinstall.

AUTOMATIC PULL-DOWN FEATURE



CAUTION:

Your car has an automatic pull-down feature that helps close the trunk electronically. Your fingers can be trapped under the trunk lid as it goes down. Your fingers could be injured, and you would need someone to help you free them. Keep your fingers away from the trunk lid as you close it and as it is going down.

NOTICE:

If you have the automatic pull-down feature, don't slam the trunk lid down. If you slam it, you can damage the pull-down system.

Remote Trunk Release



You'll find the button in the glove box.

The button works only when the ignition is on. If you stop your vehicle and turn the ignition key to OFF you can still use the remote trunk release because your vehicle has Retained Accessory Power (RAP). The electrical power to the trunk release will not shut off until you open a door or 10 minutes have passed. If you want this power for another 10 minutes, just turn the key to RUN and then back to OFF.

CAUTION:

It can be dangerous to drive with the trunk lid open because carbon monoxide (CO) gas can come into your vehicle. You can't see or smell CO. It can cause unconsciousness and even death.

If you must drive with the trunk lid open or if electrical wiring or other cable connections must pass through the seal between the body and the trunk lid;

CAUTION: (Continued)

CAUTION: (Continued)

- Make sure all windows are shut.
- Turn the fan on your heating or cooling system to its highest speed with the setting on any temperature between 65° F (18° C) to 85° F (69° C). That will force outside air into your vehicle. See "Comfort Controls" in the Index.
- If you have air outlets on or under the instrument panel, open them all the way.

See "Engine Exhaust" in the Index.

Glove Box

The glove box is directly in front of the front passenger seat. To unlock the door, insert the door key into the lock cylinder and turn it to the left. To lock the door, turn the key to the right and remove the key. The key may be removed in the locked or unlocked position.

Securing Owner Manual Portfolio



To secure your portfolio, insert the edge of the portfolio in the groove of the glove box door as shown.

THEFT

Vehicle theft is big business, especially in some cities. Although your Cadillac has a number of theft deterrent features, we know that nothing we put on it can make it impossible to steal. However, there are ways you can help.

Key in the Ignition

If you walk away from your vehicle with the keys inside, it's an easy target for joy riders or professional thieves -- so don't do it.

When you park your Cadillac and open the driver's door, you'll hear a chime reminding you to remove your key from the ignition and take it with you. Always do this. Your steering wheel will be locked, and so will your ignition and transmission. And remember to lock the doors.

Parking at Night

Park in a lighted spot, close all windows and lock your vehicle. Remember to keep your valuables out of sight. Put them in a storage area, or take them with you.

Parking Lots

If you park in a lot where someone will be watching your vehicle, it's best to lock it up and take your keys. But what if you have to leave your ignition key? What if you have to leave something valuable in your vehicle?

- Put your valuables in a storage area, like your trunk or glove box.
- Lock the glove box.
- Lock all the doors except the driver's.
- Then take the door key with you.

THEFT DETERRENT (OPTION)



SECURITY SYSTEM

If your Cadillac has this option, it has a theft deterrent alarm system. With this system, the amber SECURITY SYSTEM light will flash as you open the door (if your ignition is off).

This light reminds you to arm the Theft Deterrent system. Here's how to do it:

1. Open the door.
2. Lock the door with the power door lock switch or Keyless Entry System. The SECURITY SYSTEM light should come on and stay on.
3. Close all doors. The SECURITY SYSTEM light should go off.

If a door or the trunk is opened without the key, the alarm will go off. It will also go off if a door lock or the trunk lock is damaged. Your vehicle's lamps will flash and the horn will sound.

Remember, the Theft Deterrent System won't arm if you lock the doors with a key or manual door lock. It arms only if you use a power door lock switch or the Remote Keyless Entry System.

Here's how to avoid setting off the alarm by accident:

- If you don't want to arm the Theft Deterrent system, the vehicle should be locked after the doors are closed.
- Always unlock a door with a key or the Remote Keyless Entry System. Unlocking a door any other way will set off the alarm.

If you set off the alarm by accident, unlock any door with your key or the Keyless Entry System.

The alarm won't stop if you try to unlock a door any other way.

How to Test the Alarm

1. From inside the vehicle roll down your window, then get out of your vehicle keeping the door open.
2. From outside the vehicle with the door open, lock the vehicle using the power door lock or the Remote Keyless Entry System and close the door.
3. Once the interior lamps are off, reach in and unlock the door using the manual lock. Open the door and the horn will sound and your headlamps will flash.

If the alarm does not sound when it should, check to see if the horn works. The horn fuse may be blown. To replace the fuse, see “Fuses and Circuit Breakers” in the Index.

To reduce the possibility of theft, always arm the Theft Deterrent system when leaving your vehicle.

PASS-KEY® II

Your vehicle is equipped with the PASS-Key® II (Personalized Automotive Security System) theft deterrent system. PASS-Key® II is a passive theft deterrent system. This means you don't have to do anything different to arm or disarm the system. It works when you insert or remove the key from the ignition. PASS-Key® II uses a resistor pellet in the ignition key that matches a decoder in your vehicle.

When the PASS-Key® II system senses that someone is using the wrong key, it shuts down the vehicle's starter and fuel systems. For about three minutes, the starter won't work and fuel won't go to the engine. If someone tries to start your vehicle again or uses another key during this time, the vehicle will not start. This discourages someone from randomly trying different keys with different resistor pellets in an attempt to make a match.

The ignition key must be clean and dry before it's inserted in the ignition or the engine may not start. If the engine does not start and the PASS KEY FAULT light comes on, the key may be dirty or wet. Turn the ignition off.

Clean and dry the key. If the starter still won't work, and the key appears to be clean and dry, wait about three minutes and try another ignition key. At this time, you may also want to check the fuse (see "Fuses and Circuit Breakers" in the Index). If the starter won't work with the other key, your vehicle needs service. If your vehicle does start, the first ignition key may be faulty. See your Cadillac dealer or a locksmith who can service the PASS-Key® II.

If you accidentally use a key that has a damaged or missing resistor pellet, the starter won't work. But you don't have to wait three minutes before trying another ignition key.

See your Cadillac dealer or a locksmith who can service the PASS-Key® II to have a new key made.

If you're ever driving and the PASS KEY FAULT light comes on and stays on, you will be able to restart your engine if you turn it off. Your PASS-Key® II system, however, is not working properly and must be serviced by your Cadillac dealer. Your vehicle is not protected by the PASS-Key® II system.

If you lose or damage a PASS-Key® II ignition key, see your Cadillac dealer or a locksmith who can service PASS-Key® II to have a new key made.

NEW VEHICLE “BREAK-IN”

NOTICE:

Your modern Cadillac doesn't need an elaborate “break-in.” But it will perform better in the long run if you follow these guidelines:

- **Keep your speed at 55 mph (88 km/h) or less for the first 500 miles (804 km).**
- **Don't drive at any one speed -- fast or slow -- for the first 500 miles (804 km). Don't make full-throttle starts.**
- **Avoid making hard stops for the first 200 miles (322 km) or so. During this time your new brake linings aren't yet broken in. Hard stops with new linings can mean premature wear and earlier replacement. Follow this “breaking-in” guideline every time you get new brake linings.**
- **Don't tow a trailer during “break-in.” See “Towing a Trailer” in the Index for more information.**

IGNITION SWITCH

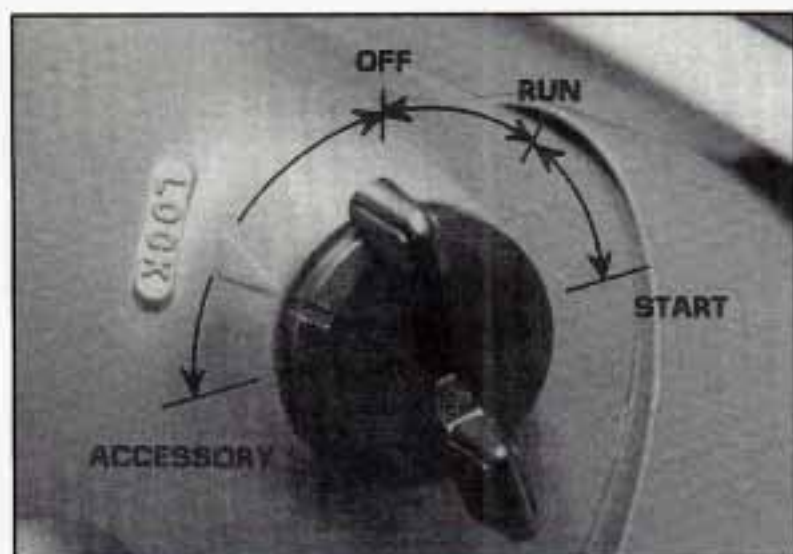

With the ignition key in the ignition switch, you can turn the switch to five different positions.

ACCESSORY: This position lets you use things like the radio and the windshield wipers when the engine is off. To use, push in the key and turn it toward you. Your steering wheel will remain locked, just as it was before you inserted the key.

LOCK: Before you put the key in, your ignition will be in the LOCK position. This is the only position in which you can remove the key. This position locks your ignition, steering wheel and transmission. It's a theft deterrent feature.

OFF: This position unlocks the steering wheel, ignition and transmission but doesn't send electrical power to any accessories. Turn the key to the OFF position if you must have your car in motion while the engine is off.

RUN: This is the position for driving.

START: This key position starts your engine.

Note that even if the engine is not running, ACCESSORY and RUN allow you to operate your electrical accessories, such as the radio and ventilation fan.

NOTICE:

If your key seems stuck in **LOCK** and you can't turn it, be sure it is all the way in. If it is, then turn the steering wheel left and right while you turn the key hard. But turn the key only with your hand. Using a tool to force it could break the key or the ignition switch. If none of this works, then your vehicle needs service.

STARTING YOUR ENGINE

Move your shift lever to **PARK (P)** or **NEUTRAL (N)**. Your engine won't start in any other position -- that's a safety feature. To restart when you're already moving, use **NEUTRAL (N)** only.

NOTICE:

Don't try to shift to **PARK (P) if your Cadillac is moving. If you do, you could damage the transmission. Shift to **PARK (P)** only when your vehicle is stopped.**

To start your 5.7 Liter LT1 engine:

1. Without pushing the accelerator pedal, turn the ignition key to **START**. When the engine starts, let go of the key. The idle speed will go down as your engine gets warm.

NOTICE:

Holding your key in **START for longer than 15 seconds at a time will cause your battery to be drained much sooner. And the excessive heat can damage your starter motor.**

2. If it doesn't start within 10 seconds, push the accelerator pedal all the way to the floor, while you hold the ignition key in **START**. When the engine starts, let go of the key and let up on the accelerator pedal. Wait about 15 seconds between each try to help avoid draining your battery.

When starting your engine in very cold weather (below 0° F or -18° C), do this:

1. With your foot off the accelerator pedal, turn the ignition key to **START** and hold it there. When the engine starts, let go of the key. Use the accelerator pedal to maintain engine speed, if you have to, until your engine has run for a while.
2. If your engine still won't start (or starts but then stops), it could be flooded with too much gasoline. Try pushing your accelerator pedal all the way to the floor and holding it there as you hold the key in **START** for about three seconds. If the vehicle starts briefly but then stops again, do the same thing, but this time keep the pedal down for five or six seconds. This clears the extra gasoline from the engine.

NOTICE:

Your engine is designed to work with the electronics in your vehicle. If you add electrical parts or accessories, you could change the way the fuel injection system operates. Before adding electrical equipment, check with your dealer. If you don't, your engine might not perform properly.

If you ever have to have your vehicle towed, see the part of this manual that tells how to do it without damaging your vehicle. See "Towing Your Vehicle" in the Index.

DRIVING THROUGH DEEP STANDING WATER

NOTICE:

If you drive too quickly through deep puddles or standing water, water can come in through your engine's air intake and badly damage your engine. Never drive through water that is slightly lower than the underbody of your vehicle. If you can't avoid deep puddles or standing water, drive through them very slowly.

ENGINE COOLANT HEATER (CANADA ONLY)

In very cold weather, 0° F (-18° C) or colder, the engine coolant heater can help. You'll get easier starting and better fuel economy during engine warm-up. Usually, the coolant heater should be plugged in a minimum of four hours prior to starting your vehicle.

To use the coolant heater:

1. Turn off the engine.
2. Open the hood and unwrap the electrical cord.
3. Plug it into a normal, grounded 110-volt outlet.



CAUTION:

Plugging the cord into an ungrounded outlet could cause an electrical shock. Also, the wrong kind of extension cord could overheat and cause a fire. You could be seriously injured. Plug the cord into a properly grounded three-prong 110-volt outlet. If the cord won't reach, use a heavy-duty three-prong extension cord rated for at least 15 amps.

NOTICE:

After you've used the coolant heater, be sure to store the cord as it was before to keep it away from moving engine parts. If you don't, it could be damaged.

How long should you keep the coolant heater plugged in? The answer depends on the weather, the kind of oil you have, and some other things. Instead of trying to list everything here, we ask that you contact your Cadillac dealer in the area where you'll be parking your vehicle. The dealer can give you the best advice for that particular area.

AUTOMATIC TRANSMISSION

There are several different positions for your shift lever.



PARK (P): This locks your transmission drive shaft. It's the best position to use when you start your engine because your vehicle can't move easily.

 **CAUTION:**

It is dangerous to get out of your vehicle if the shift lever is not fully in PARK (P) with the parking brake firmly set. Your vehicle can roll.

Don't leave your vehicle when the engine is running unless you have to. If you have left the engine running, the vehicle can move suddenly. You or others could be injured. To be sure your vehicle won't move, even when you're on fairly level ground, always set your parking brake and move the shift lever to PARK (P).

See "Shifting Into PARK (P)" in the Index. If you're pulling a trailer, see "Towing a Trailer" in the Index.

Ensure the shift lever is fully in PARK (P) range before starting the engine. Your Cadillac has a brake-transmission shift interlock. You have to fully apply your regular brakes before you can shift from PARK (P) when the ignition key is in the RUN position. If you cannot shift out of PARK (P), ease pressure on the shift lever -- push the shift lever all the way into PARK (P) as you maintain brake application. Then move the shift lever into the gear you wish. See "Shifting Out of PARK (P)" in this section.

REVERSE (R): Use this gear to back up.

NOTICE:

Shifting to REVERSE (R) while your vehicle is moving forward could damage your transmission. Shift to REVERSE (R) only after your vehicle is stopped.

To rock your vehicle back and forth to get out of snow, ice or sand without damaging your transmission, see "If You're Stuck: In Sand, Mud, Ice or Snow" in the Index.

NEUTRAL (N): In this position, your engine doesn't connect with the wheels. To restart when you're already moving, use NEUTRAL (N) only. Also, use NEUTRAL (N) when your vehicle is being towed.

 **CAUTION:**

Shifting out of PARK (P) or NEUTRAL (N) while your engine is "racing" (running at high speed) is dangerous. Unless your foot is firmly on the brake pedal, your vehicle could move very rapidly. You could lose control and hit people or objects. Don't shift out of PARK (P) or NEUTRAL (N) while your engine is racing.

NOTICE:

Damage to your transmission caused by shifting out of PARK (P) or NEUTRAL (N) with the engine racing isn't covered by your warranty.

AUTOMATIC OVERDRIVE (Ⓢ): This position is for normal driving. If you need more power for passing, and you're:

- Going less than about 35 mph (55 km/h), push your accelerator pedal about halfway down.
- Going about 35 mph (55 km/h) or more, push the accelerator all the way down.

You'll shift down to the next gear and have more power.

THIRD (D or 3) : This is like Ⓢ, but your vehicle will never go into Overdrive.

Here are some times you might choose THIRD (D or 3) instead of OVERDRIVE (Ⓢ):

- When driving on hilly, winding roads
- When towing a trailer, so there is less shifting between gears
- When going down a steep hill

SECOND (2): This position gives you more power but lower fuel economy. You can use SECOND (2) on hills. It can help control your speed as you go down steep mountain roads, but then you would also want to use your brakes off and on.

FIRST (1): This position gives you even more power (but lower fuel economy) than SECOND (2). You can use it on very steep hills, or in deep snow or mud. If the shift lever is put in FIRST (1), the transmission won't shift into first gear until the vehicle is going slowly enough.

NOTICE:

If your rear wheels can't rotate, don't try to drive. This might happen if you were stuck in very deep sand or mud or were up against a solid object. You could damage your transmission.

Also, if you stop when going uphill, don't hold your vehicle there with only the accelerator pedal. This could overheat and damage the transmission. Use your brakes to hold your vehicle in position on a hill.

TRAILER TOWING PACKAGE (OPTION)

If your Fleetwood is equipped with the V4P package, you can increase your vehicle's trailer towing capability to 7,000 pounds (3 180 kg). To determine if you have this package, see the Service Parts Label located on the underside of the trunk lid. This package includes a trailering harness located in the trunk, heavy-duty engine and transmission cooling. Also included are heavy-duty front and rear springs, 3.42:1 rear axle ratio and Eagle GA P235/70R15 tires.

PARKING BRAKE



The parking brake uses the brakes on the rear wheels.

To set the parking brake, hold the regular brake pedal down with your right foot. Push down the parking brake pedal with your left foot. If the ignition is on, the brake system warning light will come on.

When you shift out of PARK (P) or NEUTRAL (N), if your engine is running, your parking brake should release. If it doesn't, you have a parking brake problem and should have it fixed. In the meantime, you can still release your parking brake.



Just pull on the manual release lever, as shown.



CAUTION:

If your hand or arm is in the way of the pedal, you could be hurt. The pedal springs back quickly. Keep your hand and arm away when you use the manual release lever.

NOTICE:

Driving with the parking brake on can cause your rear brakes to overheat. You may have to replace them, and you could also damage other parts of your vehicle.

If you are towing a trailer and are parking on any hill, see "Towing a Trailer" in the Index. That section shows what to do first to keep the trailer from moving.

SHIFTING INTO PARK (P)

CAUTION:

It can be dangerous to get out of your vehicle if the shift lever is not fully in PARK (P) with the parking brake firmly set. Your vehicle can roll.

If you have left the engine running, the vehicle can move suddenly. You or others could be injured. To be sure your vehicle won't move, even when you're on fairly level ground, use the steps that follow. If you're pulling a trailer, see "Towing a Trailer" in the Index.

Steering Column Shift Lever

1. Hold the brake pedal down with your right foot.
2. Move the shift lever into PARK (P) position like this:



- Pull the lever toward you.



- Move the lever up as far as it will go.

3. With your right foot still holding the brake pedal down, set the parking brake.
4. Move the ignition key to LOCK.
5. Remove the key and take it with you. If you can walk away from your vehicle with the ignition key in your hand, your vehicle is in PARK (P).

Leaving Your Vehicle With the Engine Running

CAUTION:

It can be dangerous to leave your vehicle with the engine running. Your vehicle could move suddenly if the shift lever is not fully in PARK (P) with the parking brake firmly set. And, if you leave the vehicle with the engine running, it could overheat and even catch fire. You or others could be injured. Don't leave your vehicle with the engine running unless you have to.

Torque Lock

If you are parking on a hill and you don't shift your transmission into PARK (P) properly, the weight of the vehicle may put too much force on the parking pawl in the transmission. You may find it difficult to pull the shift lever out of PARK (P). This is called "torque lock." To prevent torque lock, set the parking brake and then shift into PARK (P) properly before you leave the driver's seat. To find out how, see "Shifting Into PARK (P)" in the Index.

If "torque lock" does occur, you may need to have another vehicle push yours a little uphill to take some of the pressure from the transmission, so you can pull the shift lever out of PARK (P).

SHIFTING OUT OF PARK (P)

Your Cadillac has a brake-transmission shift interlock. You have to fully apply your regular brakes before you can shift from PARK (P) when the ignition is in the RUN position. See "Automatic Transmission" in the Index.

If you cannot shift out of PARK (P), ease pressure on the shift lever -- push the shift lever all the way into PARK (P) as you maintain brake application. Then move the shift lever into the gear you want. If you ever hold the brake pedal down but still can't shift out of PARK (P), try this:

1. Turn the key to OFF. Open and close the driver's door to turn off the Retained Accessory Power feature.
2. Apply and hold the brake until the end of Step 4.
3. Shift to NEUTRAL (N).
4. Start the vehicle and then shift to the drive gear you want.

PARKING OVER THINGS THAT BURN



CAUTION:

Things that can burn could touch hot exhaust parts under your vehicle and ignite. Don't park over papers, leaves, dry grass or other things that can burn.

ENGINE EXHAUST



CAUTION:

Engine exhaust can kill. It contains the gas carbon monoxide (CO), which you can't see or smell. It can cause unconsciousness and death.

You might have exhaust coming in if:

- Your exhaust system sounds strange or different.
- Your vehicle gets rusty underneath.
- Your vehicle was damaged in a collision.
- Your vehicle was damaged when driving over high points on the road or over road debris.
- Repairs weren't done correctly.
- Your vehicle or exhaust system had been modified improperly.

If you ever suspect exhaust is coming into your vehicle:

- Drive it only with all the windows down to blow out any CO;
and
- Have your vehicle fixed immediately.

RUNNING YOUR ENGINE WHILE YOU'RE PARKED

It's better not to park with the engine running. But if you ever have to, here are some things to know.

CAUTION:

Idling the engine with the air system control off could allow dangerous exhaust into your vehicle (see the earlier Caution under "Engine Exhaust").

Also, idling in a closed-in place can let deadly carbon monoxide (CO) into your vehicle even if the fan switch is at the highest setting. One place this can happen is a garage. Exhaust -- with CO -- can come in easily. **NEVER** park in a garage with the engine running.

Another closed-in place can be a blizzard. (See "Blizzard" in the Index.)

CAUTION:

It can be dangerous to get out of your vehicle if the shift lever is not fully in PARK (P) with the parking brake firmly set. Your vehicle can roll. Don't leave your vehicle when the engine is running unless you have to. If you've left the engine running, the vehicle can move suddenly. You or others could be injured. To be sure your vehicle won't move, even when you're on fairly level ground, always set your parking brake after you move the shift lever to PARK (P).

Follow the proper steps to be sure your vehicle won't move. See "Shifting Into PARK (P)" in the Index.

If you are parking on a hill and if you're pulling a trailer, also see "Towing a Trailer" in the Index.

POWER WINDOWS

The controls are near each window. Here's how the master control works.

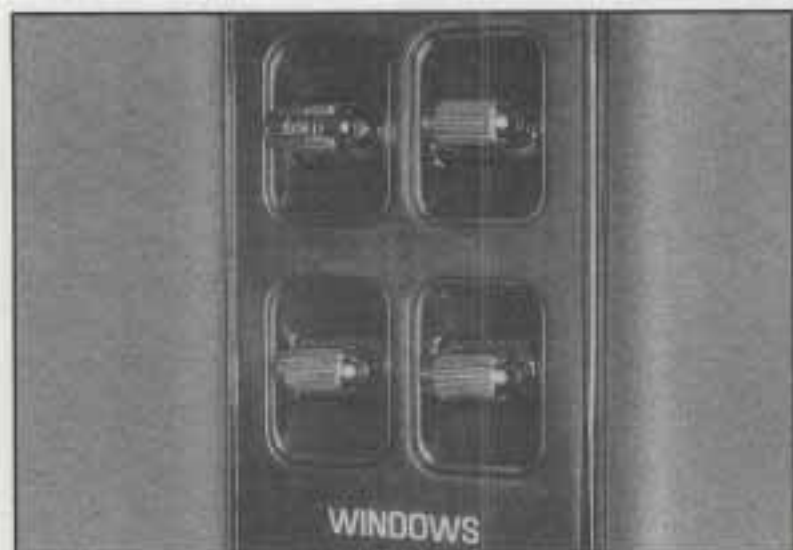

- Push the switch forward to close.
- Push the switch rearward to open.

Express Down Window (Driver's Side)

Just press the switch once -- for half a second or more -- and then let go. The window will go all the way down. If you want to stop the window as it is going down, press the switch again.

Your vehicle has Retained Accessory Power (RAP). When you stop your vehicle and turn the ignition key to OFF, you can still use your power windows. The electrical power to the power windows will not shut off until you open a door or 10 minutes have passed. If you want this power for another 10 minutes, just turn the key to RUN and then back to OFF.

Rear Window Lock Out



With this feature you can cut electrical power to the rear power windows by pressing the right end of the lock out switch. This feature is useful when you're transporting small children and you don't want them using the power windows.

HORN

To sound the horn, just press the steering wheel pad.

TILT WHEEL



A tilt steering wheel allows you to adjust the steering wheel before you drive.

You can also raise it to the highest level to give your legs more room when you exit and enter the vehicle.

To tilt the wheel, hold the steering wheel and pull the lever. Move the steering wheel to a comfortable level, then release the lever to lock the wheel in place.

POWER STEERING

Your Cadillac is equipped with Electronic Variable Assist power steering system. Steering is easier at a lower speed and when parallel parking. At higher speeds, steering efforts are increased to improve vehicle stability.

If your engine stops (or the power assist is reduced), you can still steer. But it will take more effort.

TURN SIGNAL/MULTIFUNCTION LEVER

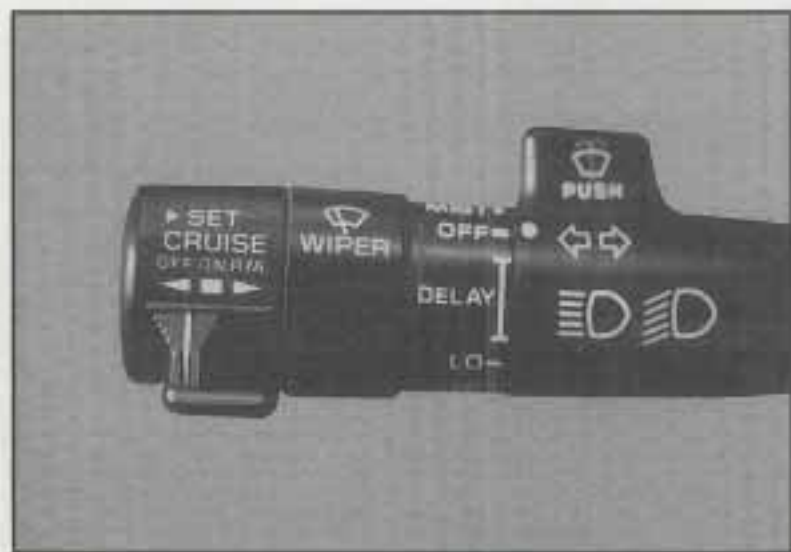

The lever on the left side of the steering column includes your:

- Turn Signal and Lane Change Indicator
- Headlamp High-Low Beam & Passing Signal
- Windshield Wipers
- Windshield Washer
- Cruise Control

Turn Signal and Lane Change Indicator

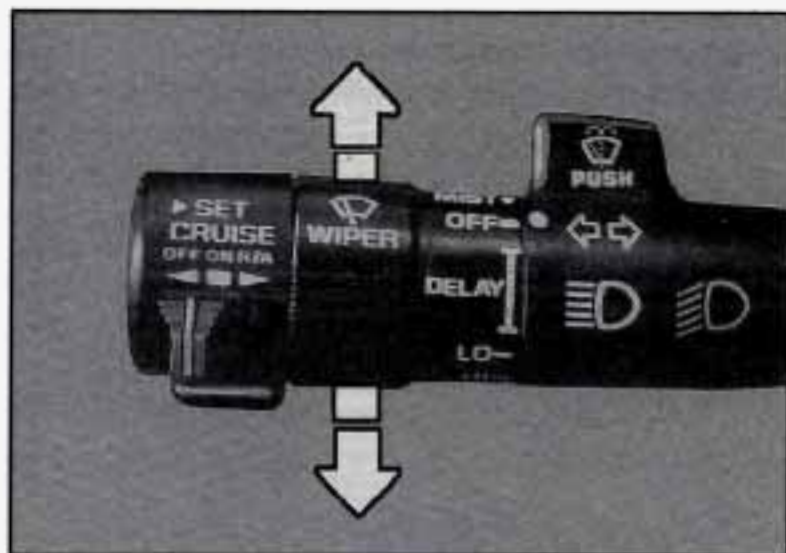

To signal a turn, move the lever all the way up or down. When the turn is finished, the lever will return automatically.



A green arrow on the instrument panel will flash in the direction of the turn or lane change.

To signal a lane change, just raise or lower the lever until the green arrow starts to flash. Hold it there until you complete your lane change. The lever will return by itself when you release it.

As you signal a turn or a lane change, if the arrows flash faster than normal, a signal bulb may be burned out and other drivers won't see your turn signal.

If a bulb is burned out, replace it to help avoid an accident. If the green arrows don't go on at all when you signal a turn, check the fuse (see "Fuses and Circuit Breakers" in the Index) and for burned-out bulbs.

If for some reason, your turn signal is left on, a chime will sound (after having driven about a half of a mile) to remind you to turn it off.

If you have a trailer towing option with added wiring for the trailer lamps, a different turn signal flasher is used. With this flasher installed, the signal indicator will flash even if a turn signal bulb is burned out. Check the front and rear turn signal lamps regularly to make sure they are working.

Headlamp High-Low Beam

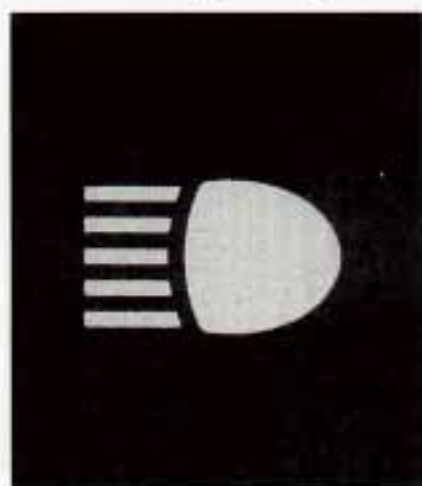

To change the headlamps from low beam to high or high to low, pull the turn signal lever all the way toward you. Then release it. When the high beams are on, this blue light on the instrument panel will also be on.

Flash-To-Pass

This lets you use your high beam headlamps to signal a driver in front of you that you want to pass. It works even if your headlamps are off.

To use Flash-To-Pass, pull the multifunction lever toward you. If your headlamps are off, your high beam headlamps will turn on. They will stay on as long as you hold the lever there. Release the lever to turn them off. If your headlamps are on, but on low beam the system works normally. Just pull the lever. Your headlamps will shift to high beam and stay there. To return to low beam, just pull the lever toward you. If your headlamps are on and on high beam, your headlamps will switch to low beam. To get back to high beam, pull the lever toward you.

Windshield Wipers



WIPER: To control the wipers, turn the band on the multifunction lever.

MIST: Turn the band to MIST and then release it for a single wipe cycle. For more cycles, hold the band on MIST longer.

LO or HI: Turn the band toward you to either LO (low speed) or to HI (high speed), depending on the wiper speed you want.

DELAY: With this you can set the wiper speed for a long or short delay between wipes. Move the band to DELAY for long delays. The closer you get to LO, the shorter the delay.

OFF: To turn the wipers off, turn the band to OFF.

Be sure to clear ice and snow from the wiper blades before using them. If they're frozen to the windshield, carefully loosen or thaw them. If your blades do become damaged, get new blades or blade inserts.

Heavy snow or ice can overload your wiper motor. A circuit breaker will stop the motor until it cools. Clear away snow or ice to prevent an overload.

Windshield Washer

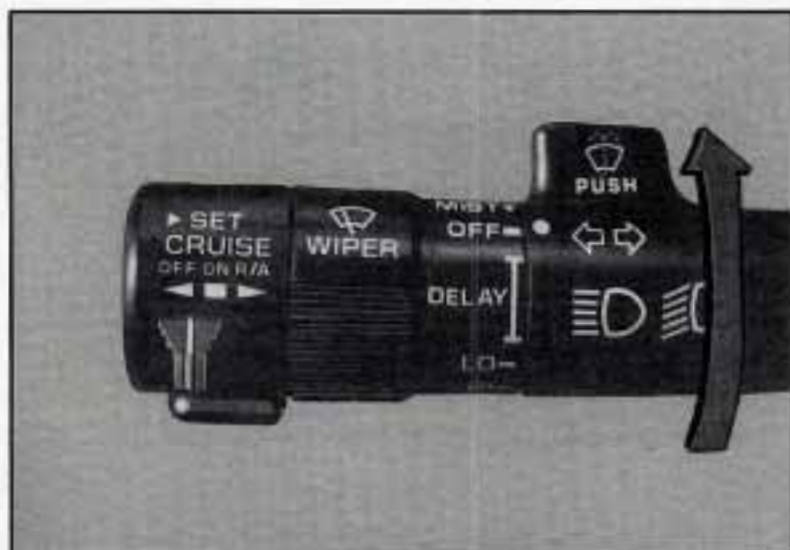

To wash your windshield, push the paddle labeled PUSH, then release it. After washing the windshield, the wipers will stop unless you were using your wipers. If you were, the wipers will resume the speed you were using. For more washer cycles, push and hold the paddle.



CAUTION:

In freezing weather, don't use your washer until the windshield is warmed. Otherwise the washer fluid can form ice on the windshield, blocking your vision.

NOTICE:

- **When using concentrated washer fluid, follow the manufacturer's instructions for adding water.**
- **Don't mix water with ready-to-use washer fluid. Water can cause the solution to freeze and damage your washer fluid tank and other parts of the washer system. Also, water doesn't clean as well as washer fluid.**
- **Fill your washer fluid tank only 3/4 full when it's very cold. This allows for expansion, which could damage the tank if it is completely full.**
- **Don't use radiator antifreeze in your windshield washer. It can damage your washer system and paint.**

CRUISE CONTROL

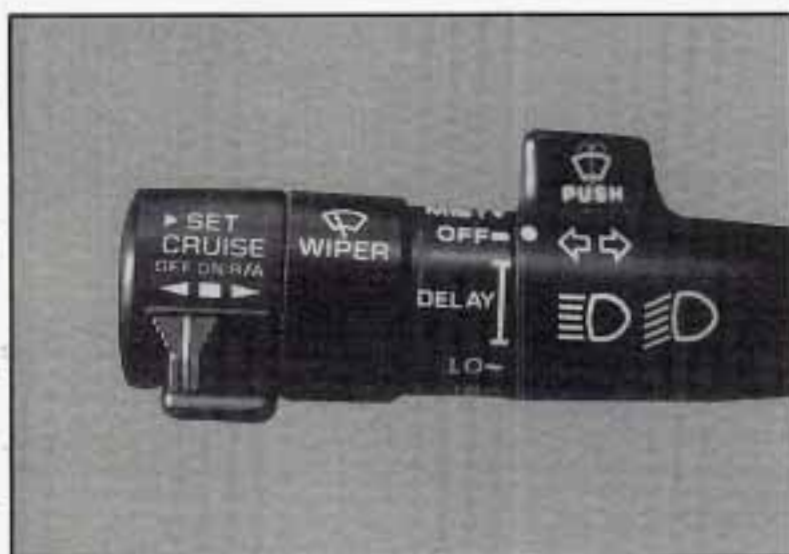

With cruise control, you can maintain a speed of about 25 mph (40 km/h) or more without keeping your foot on the accelerator. This can really help on long trips. Cruise control does not work at speeds below about 25 mph (40 km/h).

When you apply your brakes, the cruise control shuts off.

CAUTION:

- Cruise control can be dangerous where you can't drive safely at a steady speed. So, don't use your cruise control on winding roads or in heavy traffic.
- Cruise control can be dangerous on slippery roads. On such roads, fast changes in tire traction can cause needless wheel spinning, and you could lose control. Don't use cruise control on slippery roads.

If your vehicle is in cruise control when the traction control system begins to limit wheel spin, the cruise control will automatically disengage. (See "Traction Control System" in the Index.) When road conditions allow you to safely use it again, you may turn the cruise control back on. Traction Control is deleted on Coachbuilder limousines and funeral coach packages.

To Set Cruise Control

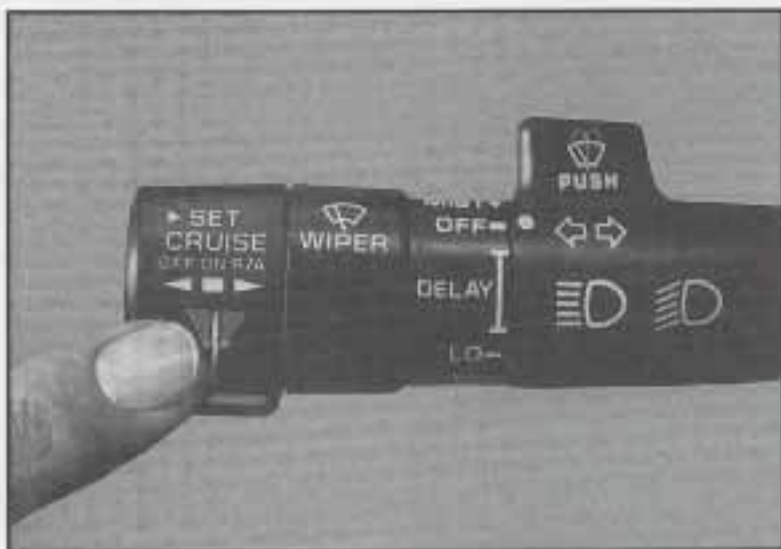

1. Move the cruise control switch to ON.



CAUTION:

If you leave your cruise control switch on when you're not using cruise, you might hit a button and go into cruise when you don't want to. You could be startled and even lose control. Keep the cruise control switch OFF until you want to use it.

2. Get up to the speed you want.

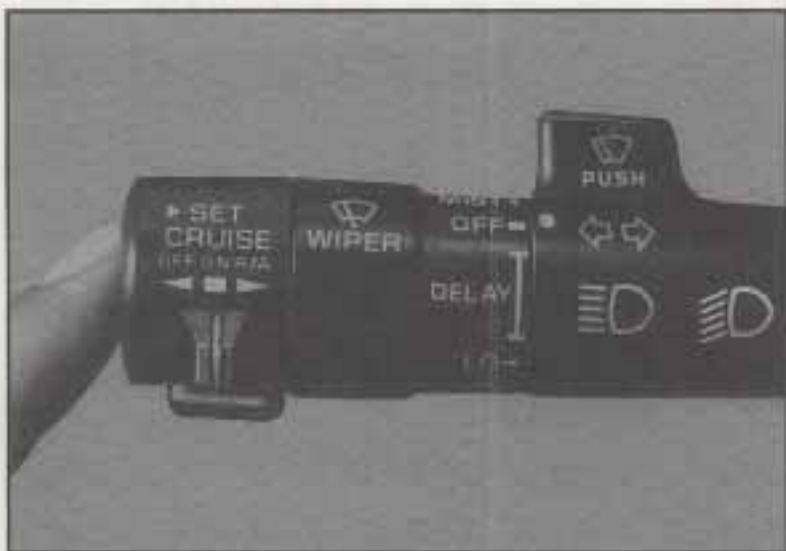

3. Push in the SET button at the end of the lever and release it. (The CRUISE ENGAGED light on the instrument panel will come on.)

4. Take your foot off the accelerator pedal.

To Resume a Set Speed

Suppose you set your cruise control at a desired speed and then you apply the brake. This, of course, shuts off the cruise control. But you don't need to reset it. Once you're going about 25 mph (40 km/h) or more, you can move the cruise control switch from ON to R/A (Resume/Accelerate) for about half a second.

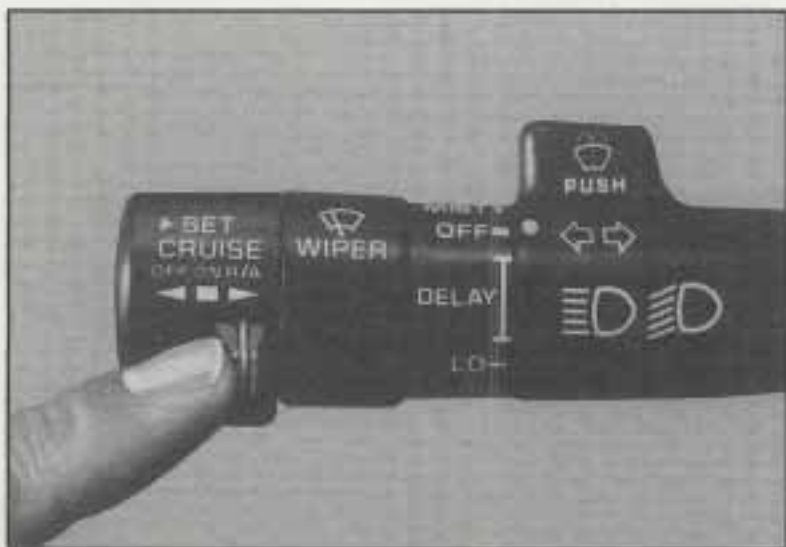

You'll go right back up to your chosen speed and stay there.

If you hold the switch at R/A longer than half a second, the vehicle will keep going faster until you release the switch or apply the brake. You could be startled and even lose control. So unless you want to go faster, don't hold the switch at R/A.

To Increase Speed While Using Cruise Control

There are two ways to go to a higher speed. Here's the first:

1. Use the accelerator pedal to get to the higher speed.
2. Push the button at the end of the lever, then release the button and the accelerator pedal. You'll now cruise at the higher speed.

Here's the second way to go to a higher speed:

- Move the CRUISE switch from ON to R/A. Hold it there until you get up to the speed you want, then release the switch.
- To increase your speed in very small amounts, move the switch to R/A for less than half a second and then release it. Each time you do this, your vehicle will go about 1 mph (1.6 km/h) faster.

To Reduce Speed While Using Cruise Control

There are two ways to reduce your speed while using cruise control:

- Push in the button at the end of the lever until you reach the lower speed you want, then release it.
- To slow down in very small amounts, push the button for less than half a second. Each time you do this, you'll go 1 mph (1.6 km/h) slower.

Passing Another Vehicle While Using Cruise Control

Use the accelerator pedal to increase your speed. When you take your foot off the pedal, your vehicle will slow down to the cruise control speed you set earlier.

Using Cruise Control on Hills

How well your cruise control will work on hills depends upon your speed, load, and the steepness of the hills. When going up steep hills, you may have to step on the accelerator pedal to maintain your speed. When going downhill, you may have to brake or shift to a lower gear to keep your speed down. Of course, applying the brake takes you out of cruise control. Many drivers find this to be too much trouble and don't use cruise control on steep hills.

To Get Out of Cruise Control

There are two ways to turn off the cruise control:

- Step lightly on the brake pedal
- Move the cruise switch to OFF

To Erase Speed Memory

When you turn off the cruise control or the ignition, your cruise control set speed memory is erased.

LAMPS



This knob controls these lamps:

- Headlamps
- Taillamps
- Parking Lamps
- License Lamps
- Sidemarker Lamps
- Instrument Panel Lamps
- Interior Courtesy Lamps

Here's how your lighting system works:

- Pull the knob out to the first stop to turn on your parking lamps, taillamps, sidemarker lamps and instrument panel lamps.
- Pull the knob out all the way to turn on the headlamps.
- You can brighten or dim your instrument cluster by rotating the headlamp knob.
- Push the knob all the way in to turn them off.

Headlamp "On" Warning

If the manual lamp switch is left on (as when someone has parked your vehicle), you'll hear a warning tone when you turn off the ignition and open the driver's door.

Retained Accessory Power

When you stop your Cadillac and turn the ignition to OFF, you can use these accessories for 10 more minutes.

- Radio
- Power Windows
- Astroroof
- Windshield Wipers
- Trunk Release

When you open a door, everything will go off. And, after 10 minutes everything will go off also.

If you want power for another 10 minutes, just turn the key to RUN and back to OFF.

Power Drain Protection

When the ignition is off and the interior lamps or underhood lamps are accidentally left on, they will automatically shut off after 10 minutes. This protects you from a possible dead battery. To turn power back on, lift up on the outside front door handle or turn the ignition to the RUN position.

Twilight Sentinel

Your Cadillac has this feature and the control is under the headlamp knob.



It switches your lamps on and off by sensing how dark it is outside.

To operate it, leave the lamp switch off and move the Twilight Sentinel control to any position but OFF.

If you move the control all the way to MAX, your lamps will stay on for about four minutes after you turn the ignition to OFF. If you move the control almost all the way in the other direction, so it's just on, the lamps will go off quickly when you turn the ignition to OFF.

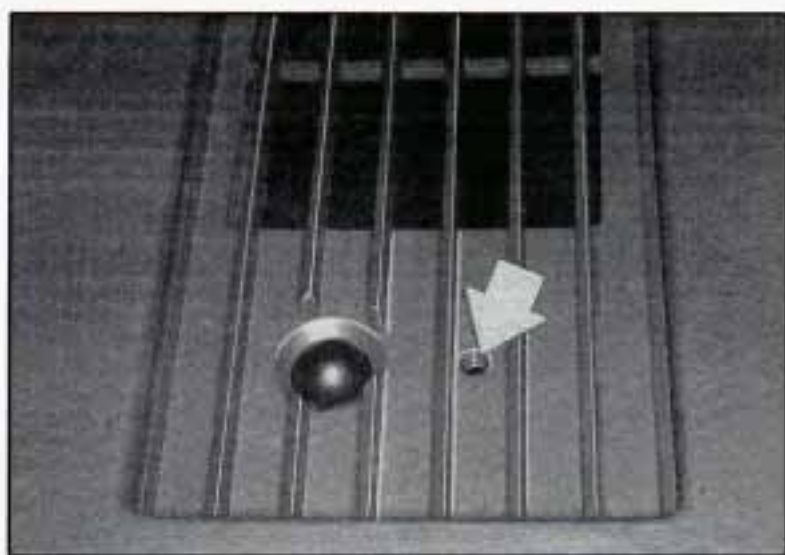

Please don't cover the light sensor. It is located on top of the instrument panel.

If you cover the sensor, it will sense that it is dark outside and your lamps will come on.

Cornering Lamps

If your exterior lamps are on, the cornering lamps will come on when you signal a turn. This will provide more light for cornering when it is dark.

Underhood Lamp

Your vehicle has a Delay Interior Lighting System (DIL). This system controls power to the underhood lamp. Just pull up on the door handle with the hood raised and the lamp will come on for about 10 minutes. Every time the door handle is pulled up the lamp will stay on for another 10 minutes. The lamp will go off when you close the hood.

Daytime Running Lamps (Canada Only)

Daytime Running Lamps (DRL) make it easier to see the front of your vehicle during the day. DRL can be helpful when it is raining and in the short periods after dawn and before sunset. Several countries, including Canada, require DRL.

A light sensor on top of the instrument panel makes the DRL work, so be sure it isn't covered.

The DRL system will make your low beam headlamps come on at reduced brightness in daylight when:

- the ignition is on
- the headlamp switch is off, and
- the transmission is not in PARK (P).

When the DRL are on, only your low beam headlamps will be on. The taillamps, sidemarker and other lamps won't be on. Your instrument panel won't be lit up either.

When it's dark enough outside, your low beam headlamps will change to full brightness. The other lamps that come on with your headlamps will also come on.

When it's bright enough outside, the regular lamps will go off, and your low beam headlamps change to the reduced brightness of DRL.

To idle your vehicle with the DRL off, apply your parking brake before you turn on the ignition. Once you release the parking brake, the DRL cannot be turned off as long as the ignition is on.

As with any vehicle, you should turn on the regular headlamp system any time you need it.

Reading Lamps

There are reading lights over each door.

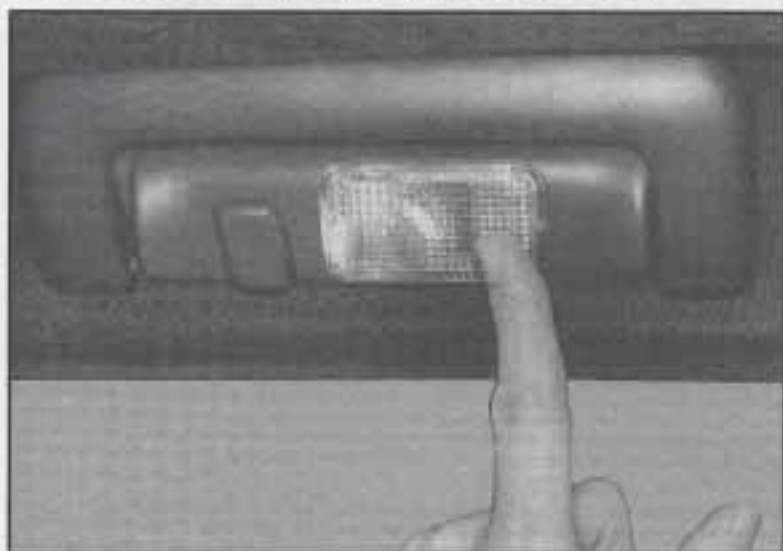

Press the lens to turn them on.

There are also reading lights located on the bottom of the rearview mirror. Each is illuminated by pressing the switch next to it.

Lamp Monitors



The front lamp monitors show that your headlamps, high beams and turn signals are working.

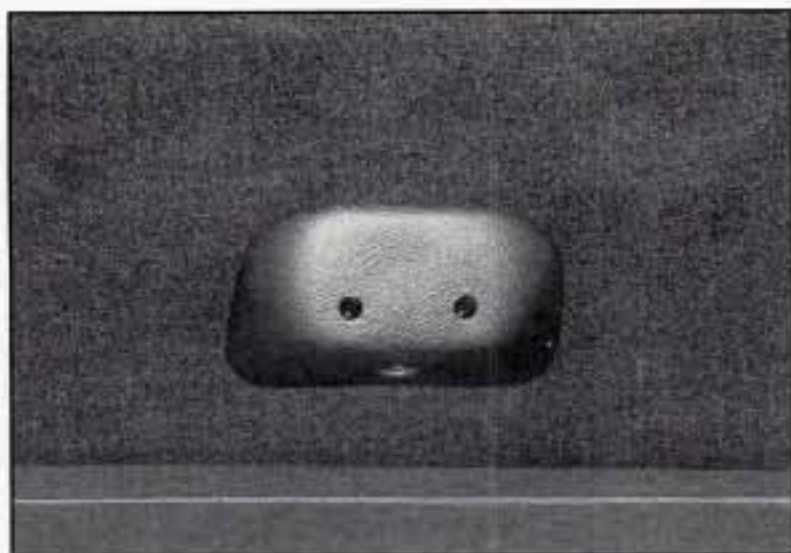

The rear lamp monitors show that your taillamps are working.

AUTOMATIC MIRROR

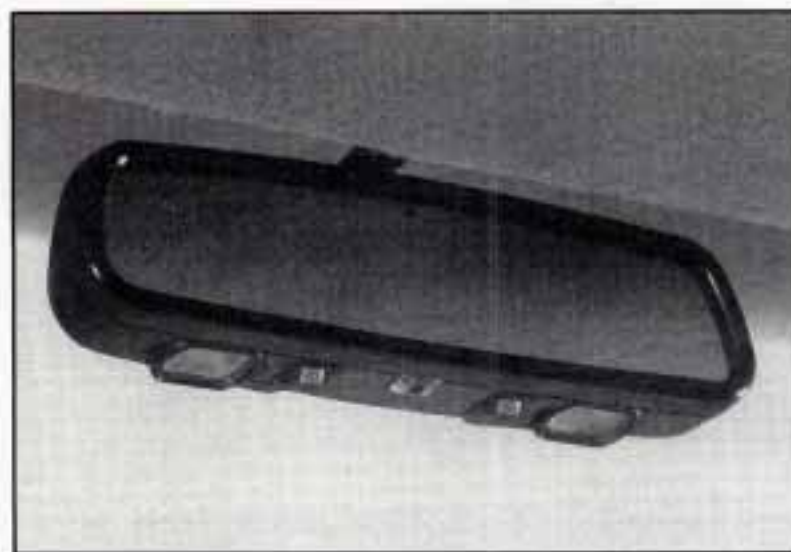

Your Cadillac has an automatic electrochromic rearview mirror.

This mirror automatically changes to reduce glare from headlamps behind you. A photocell on the back of the mirror senses when it is becoming dark outside. Another photocell built into the mirror surface senses the headlamps behind you.

The mirror will darken gradually to reduce glare. This change may take a few seconds. This delay prevents rapid changing of the mirror as you drive under lights and through traffic.

Automatic/Off Switch

There is an automatic and an off position for this mirror. When the button on the bottom of the mirror is pressed up and has a green halo, the mirror is on automatic. Press again to turn off.

Reverse Gear Day Mode

The reverse mode is another important feature of the automatic mirror. When the shift lever is placed in REVERSE (R), the mirror changes to the daytime mode for a bright image in the mirror as you back up.

Front Reading Lamps



There are two reading lamps located on the rearview mirror. Press the switch next to the lamp that you want to turn on or off.

Cleaning Photocells

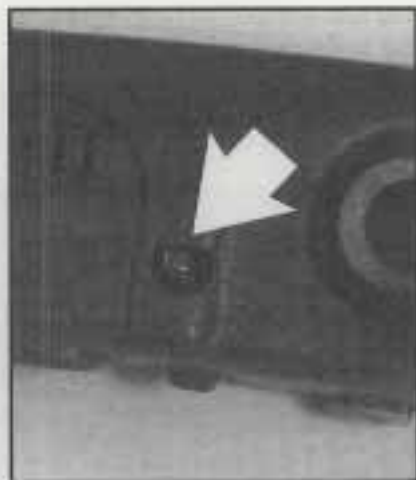
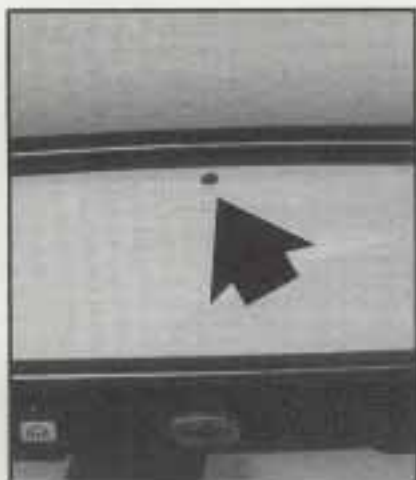

Use a cotton swab and glass cleaner to clean the front and rear photocells that make the electrochromic mirror work.

FOLDAWAY OUTSIDE MIRRORS

Your Cadillac has electric mirror controls.



Rotate the knob to choose either the driver's side or passenger's side mirror. Then move the knob to adjust the mirror.

CONVEX OUTSIDE MIRROR

Your passenger's side mirror is convex.

A convex mirror's surface is curved so you can see more from the driver's seat.



CAUTION:

A convex mirror can make things (like other vehicles) look farther away than they really are. If you cut too sharply into the right lane, you could hit a vehicle on your right. Check your inside mirror or glance over your shoulder before changing lanes.

FLOOR MATS

Your Cadillac is equipped with rubber-backed front and rear floor mats. Keep floor mats vacuumed and use a spot cleaner, if necessary. Do not machine wash.

CONVENIENCE NET

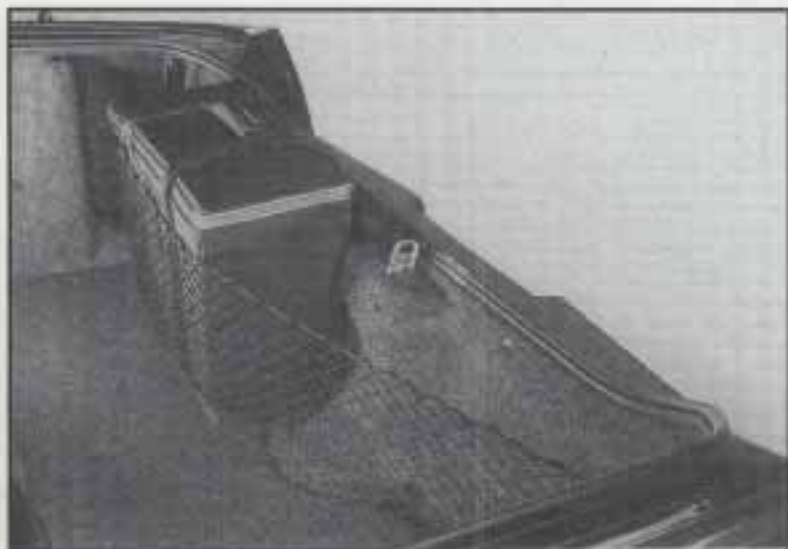

You'll find the convenience net just inside the back wall of the trunk.

Put small loads, like grocery bags, behind the net. It can help keep them from falling over during sharp turns or quick starts and stops.

The net is not for larger, heavier loads. Store them in the trunk as far forward as you can. You can unhook the net so that it will lie flat when you are not using it.

FRONT STORAGE ARMREST



The armrest between the front seats opens into a storage area. To open it, lift the cover toward the passenger side. Inside you will also find a coin holder and a cassette and CD holder. To access the dual cup holder, slide the lever (located on the passenger side of the armrest) rearward.

Rear Storage Armrest (Fleetwood Brougham)



The Fleetwood Brougham has a rear seat armrest that opens into a storage area with a dual cup holder. Just push on the front of the armrest to access this feature.

FRONT SEAT ILLUMINATED VANITY MIRRORS

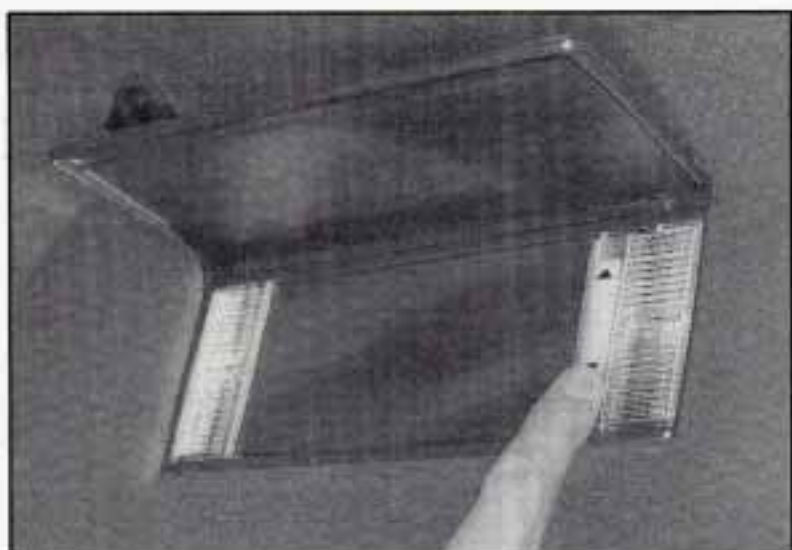

To use one, turn the sunshade down. Then lift the cover up to see the mirror. The switch makes the lamp brighter.

REAR SEAT VANITY MIRRORS

The Fleetwood Brougham has these unless you have an astroroof. Press the button to bring a mirror down. The switch makes the lamp brighter.

ASTROROOF

If you have this option, the switch is in the overhead console.

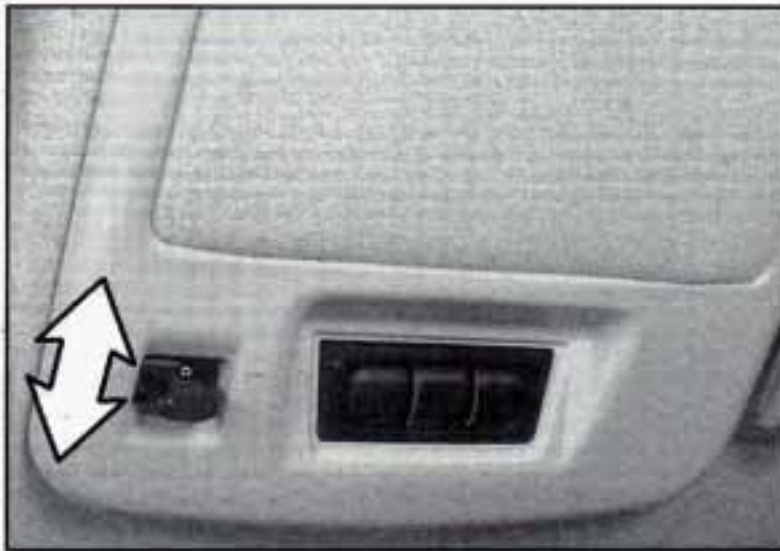

If you have this option, you have a safety glass panel and a sunshade. With the handle, you can slide your sunshade open or closed. When your ignition is in RUN, move the switch toward the rear of the car to open the roof. To close it, move the switch toward the front of your car. Once the roof is closed, you can let go of the switch and then push the front of it again. This opens the roof at the rear to a vent position.

HomeLink™ Universal Transmitter (Option)

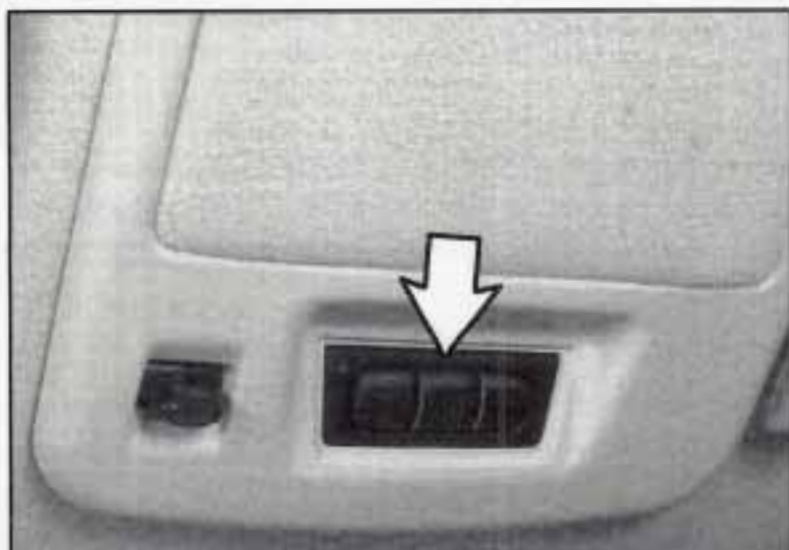

The HomeLink™ Universal Transmitter provides a convenient way to consolidate the functions of up to three individually held transmitters into a single built-in device. The transmitter will operate garage doors and gates, or with the available accessory package, other devices controlled by radio frequency such as home/office lighting systems and security systems. It will actually learn and transmit the frequencies of most current transmitters and is powered by your vehicle's battery and charging system.

This device complies with Part 15 of the FCC Rules. Operation is subject to the following two conditions: (1) This device may not cause harmful interference, and (2) This device must accept any interference received, including interference that may cause undesired operation.

Programming the HomeLink™ Universal Transmitter

Ensure that people and objects are clear of the garage door you are programming!

Then follow these steps.

1. Hold down the two outside buttons on the HomeLink™ Universal Transmitter until the red light begins to flash rapidly. Then release the buttons. This procedure initializes the memory and erases any previous settings for all three channels.
2. Decide which one of the three channels you want to program.
3. Hold the end of your hand-held transmitter against the bottom surface of the HomeLink™ Universal Transmitter so that you can still see the red light.
4. Using both hands, push the hand-held transmitter button and the desired button on the HomeLink™ Universal Transmitter. Continue to press both buttons through Step 5.
5. Hold down both buttons until you see the red light on the HomeLink™ Universal Transmitter flash slowly, then rapidly. The rapid flashing, which could take up to a minute or more, indicates that the HomeLink™ Universal Transmitter has been programmed. Release both buttons once the light starts to flash rapidly.

The HomeLink™ Universal Transmitter can now be used in place of your hand-held transmitter. Additionally, the procedure noted above can be repeated to program up to two other hand-held units that you may own.

If you have trouble programming the garage door opener, make sure that you have followed the directions exactly as described and that the batteries in the hand-held transmitter are not dead. If you still cannot program it, rotate your hand-held transmitter end over end and try again. In a limited number of older installations, due to legislated changes in the transmission frequencies, it may also be necessary to obtain a new receiver and have it connected to your existing garage door opener. *If you cannot program the transmitter after repeated attempts, consult your Cadillac dealer.*

Operating the HomeLink™ Universal Transmitter

Simply press the appropriate button on the HomeLink™ Universal Transmitter. The red light comes on while the signal is being transmitted.

Erasing Channels

To erase all three programmed channels, hold down the two outside buttons until the red light begins to flash. Individual channels cannot be erased, but can be reprogrammed using the procedure for programming the transmitter explained earlier.

Accessories

Accessories for your HomeLink™ Universal Transmitter are available from the manufacturer of the unit. If you would like additional information or are interested in purchasing other home lighting or security products, please call 1-800-355-3515.

ASHTRAYS

Front Center Ashtray

Here's how to take it out for cleaning:



1. Lift it out by pulling on the snuffer.
2. If it won't come out, reach under the drawer and push up on the ashtray bowl and remove it.

Rear Door Ashtrays

Here's how to remove them:



Grabbing the snuffer gently, pull up.

NOTICE:

Don't put papers or other flammable things into your ashtrays. Hot cigarettes or other smoking materials could ignite them, causing damage.

CIGARETTE LIGHTER

It's near the ashtray. To use a lighter, just push it in all the way. When it's ready, it will pop back out by itself.

NOTICE:

If you hold a cigarette lighter in with your hand while it is heating, it won't be able to back away from the heating element when it's ready. That can make it overheat, damaging the lighter and the heating element.

ASSIST HANDLES

A folding handle over each rear door and the front passenger's door can be used when getting out of your vehicle.

THE INSTRUMENT PANEL: YOUR INFORMATION CENTER



Your instrument panel is designed to let you know at a glance how your Cadillac is running. You'll know how fast you're going, how much fuel you're using, and many of other things you'll need to know to drive safely and economically.

English/Metric Button



You can change from English (miles) to metric (kilometers) by pushing this button.

The same button also makes other readings (like temperature, fuel and odometer) go between English and metric.

Speedometer and Odometer

Your speedometer lets you see your speed in both miles per hour (mph) and kilometers per hour (km/h). Your odometer shows how far your vehicle has been driven, in either miles (used in the United States) or kilometers (used in Canada).

Your Cadillac Brougham has a tamper-resistant odometer. If your odometer displays ERROR, someone has probably tampered with it.

You may wonder what happens if a car has to have a new odometer installed. The new speedometer has to be programmed with the correct mileage as the old one. If it can't be, then it is set at zero, but a label on the driver's door must show the old reading and when the new one was installed.

Trip Odometer



You can tell how far you've gone since you last set it back to zero. To reset, push the button.

WARNING AND INDICATOR LIGHTS

This part describes the warning lights that are on your vehicle. The pictures will help you locate them.

Warning lights can signal that something is wrong before it becomes serious enough to cause an expensive repair or replacement. Paying attention to your warning lights could also save you or others from injury.

Warning lights come on when there may be or is a problem with one of your vehicle's functions. As you will see in the details on the next few pages, some warning lights come on briefly when you start the engine just to let you know they're working. If you are familiar with this section, you should not be alarmed when this happens.

When one of the warning lights comes on and stays on when you are driving, check the section that tells you what to do about it. Please follow this manual's advice. Waiting to do repairs can be costly -- and even dangerous. So please get to know your warning lights. They're a big help.

Safety Belt Reminder Light



When the key is turned to RUN or START, a chime will come on for about eight seconds to remind people to fasten their safety belts, unless the driver's safety belt is already buckled. The safety belt light will also come on and stay on until the driver's belt is buckled.

Air Bag Readiness Light

There is an air bag readiness light on the instrument panel, which shows AIR BAG. The system checks the air bag's electrical system for malfunctions. The light tells you if there is an electrical problem. The system check includes the air bag sensors and modules, the wiring and the diagnostic module. For more information on the air bag system, see "Air Bag" in the Index.



You will see this light flash for a few seconds when you turn your ignition to RUN or START. Then the light should go out. This means the system is ready.

If the air bag readiness light doesn't come on when you start your vehicle, or stays on, or comes on when you are driving, your air bag system may not work properly. Have your vehicle serviced right away.

Charge Light



When you turn the key to RUN or START, this light will come on briefly, to show that your alternator and battery charging systems are working.

If a light stays on, you need service, and you should take your Cadillac to the dealer at once. To save your battery until you get there, turn off all accessories and set your Electronic Climate Control system to OFF.

Brake System Warning Light



Your Cadillac's hydraulic brake system is divided into two parts. If one part isn't working, the other part can still work and stop you. For good braking, though, you need both parts working well.

If the warning light comes on, there could be a brake problem.

Have your brake system inspected right away.

This light should come on briefly as you start the vehicle. If it doesn't come on then, have it fixed so it will be ready to warn you if there's a problem.

If the light comes on while you are driving, pull off the road and stop carefully. You may notice that the pedal is harder to push. Or, the pedal may go closer to the floor. It may take longer to stop. If the light is still on, have the vehicle towed for service. (See "Towing Your Vehicle" in the Index.)



CAUTION:

Your brake system may not be working properly if the brake system warning light is on. Driving with the brake system warning light on can lead to an accident. If the light is still on after you've pulled off the road and stopped carefully, have the vehicle towed for service.

The brake system warning light will also come on when you set your parking brake, and it will stay on if your parking brake doesn't release fully. If it stays on after your parking brake is fully released, it means you have a brake problem.

Anti-Lock Brake System Warning Light

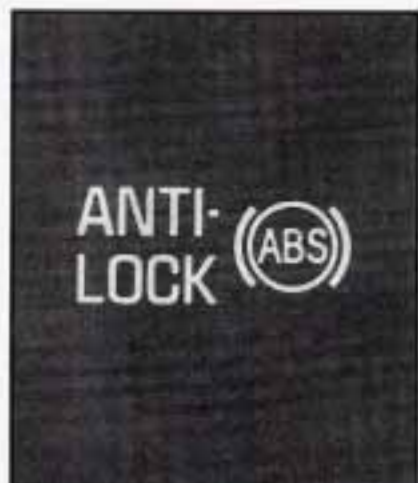

With the anti-lock brake system, this light will come on when you start your engine and may stay on for several seconds. That's normal. If the light doesn't come on, have it fixed so it will be ready to warn you if there is a problem.

If the light stays on, turn the ignition off. Or, if the light comes on when you're driving, stop as soon as possible and turn the ignition off. Then start the engine again to reset the system. If the light still stays on, or comes on again while you're driving, your Cadillac needs service. If the regular brake system warning light isn't on, you still have brakes, but you don't have anti-lock brakes. If the regular brake system warning light is also on, you don't have anti-lock brakes and there's a problem with your regular brakes. See "Brake System Warning Light" earlier in this part.

The anti-lock brake system warning light may also come on when you are driving with a compact spare tire. If this happens, the light means you won't have anti-lock until you replace the compact spare with a full-size tire. If the warning light stays on after you replace the compact spare with a full-size tire, or if it comes on again when you're driving, your Cadillac needs service.

Traction Control System Warning Light



**TRACTION
CONTROL**

This warning light should come on briefly as you start the engine. If it doesn't come on then, have it fixed so it will be ready to warn you if there's a problem.

If it stays on, or comes on when you're driving, there may be a problem with your traction control system and your vehicle may need service. When this warning light is on, the system will not limit wheel spin. Adjust your driving accordingly.

If you turn the system off by pressing the button located in the glove box, the warning light will come on and stay on. To turn the system back on, press the button again. The warning light should go off. (See "Traction Control System" in the Index for more information.)

If the traction control system warning light comes on and stays on for an extended period of time when the system is turned on, your vehicle needs service.

Traction Control System Active Light



**TRACTION
ENGAGED**

When your traction control system is limiting wheel spin, the TRACTION ENGAGED light will come on.

Slippery road conditions may exist if this light comes on, so adjust your driving accordingly. The light will stay on for a few seconds after the traction control system stops limiting wheel spin.

The TRACTION ENGAGED light also comes on briefly, as a bulb check, when the engine is started. If the light doesn't come on then, have it fixed so it will be there to tell you when the system is active.

These lights are deleted on Coachbuilder limousines and funeral coach packages.

Engine Coolant Temperature Warning Light



This red light should come on briefly as a bulb check when you start the engine.

This light tells you that your engine coolant has overheated. If you have been operating your vehicle under normal driving conditions, you should pull off the road, stop your vehicle and turn the engine off as soon as possible.

Hot coolant can burn you badly!

In "Problems on the Road," this manual shows what to do. See "Engine Overheating" in the Index.

Low Coolant Warning Light

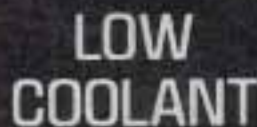

This amber light comes on briefly as a bulb check when you start the engine. If the coolant level in the radiator is low, this light will come on and stay on until you add coolant.

Continuing to drive your vehicle with the LOW COOLANT warning light on may result in damage to your engine.

See "Engine Coolant" in the Index and have your vehicle serviced as soon as you can.

Malfunction Indicator Lamp

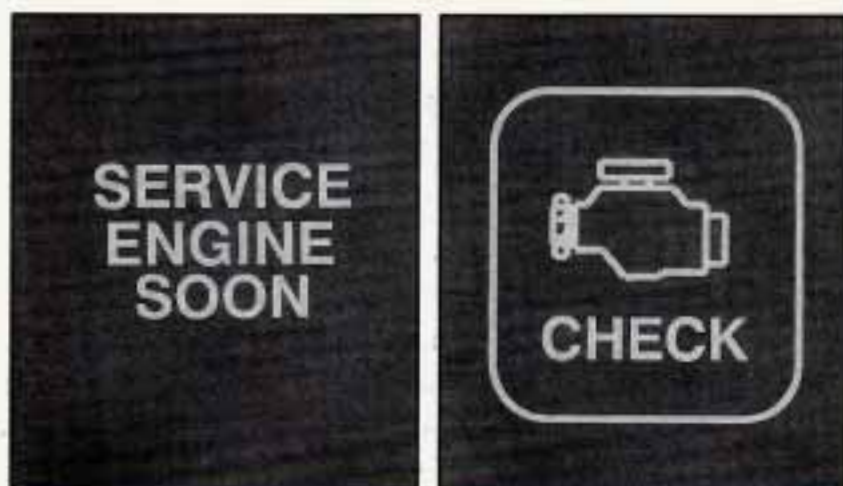

Your vehicle could be equipped with either one of these amber indicator lamps.

A computer monitors operation of your fuel, ignition and emission control systems. The malfunction indicator lamp should come on when you turn the ignition to RUN or START as a check to show you it is working. If it does not come on at all, have it fixed right away. If it stays on, or it comes on while you are driving, the computer is indicating that you have a problem. You should take your vehicle in for service soon.

NOTICE:

If you keep driving your vehicle with this light on, after a while the emission controls won't work as well, your fuel economy won't be as good and your engine may not run as smoothly. This could lead to costly repairs not covered by your warranty.

Brake To Shift Light

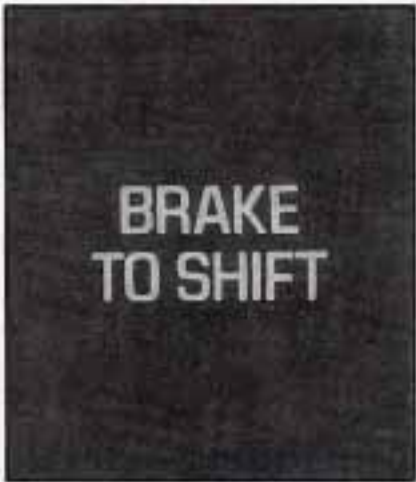
A black rectangular box with the text "BRAKE TO SHIFT" in white, bold, sans-serif capital letters, centered within the box.

**BRAKE
TO SHIFT**

This amber light will come on to remind you that you must press the brake pedal to shift out of PARK (P).

Pass Key Fault Light

A black rectangular box with the text "PASS KEY FAULT" in white, bold, sans-serif capital letters, centered within the box.

**PASS KEY
FAULT**

If this amber light comes on while driving and stays on, you will be able to restart your vehicle. If you turn it off, your vehicle will not be protected by the PASS-Key[®] II feature. Have it serviced by your Cadillac dealership.

Cruise Engaged Light



This green light will come on when your cruise control is set to a selected speed.

Washer Fluid Low Light



If this amber light comes on when your washers are turned on, you're low on washer fluid.

Driving without washer fluid can be dangerous. A bad mud splash can block your vision. You could hit another vehicle or go off the road. Check your washer fluid level often.

Door Ajar Light (Option)



DOOR
AJAR

This amber light will come on if a door is not completely closed.

Trunk Ajar Light



TRUNK
AJAR

This amber light will come on if your trunk is not closed.

Oil Pressure Light



This red light tells you if there could be a problem with your engine oil pressure.

The light goes on when you turn your key to RUN or START. It goes off once you start your engine. That's just a check to be sure the light works. If it doesn't, be sure to have it fixed so it will be there to warn you if something goes wrong.

When this light comes on and stays on, it means oil isn't going through your engine properly. You could be low on oil, or you might have some other oil problem.

CAUTION:

Don't keep driving if the oil pressure is low. If you do, your engine can become so hot that it catches fire. You or others could be burned. Check your oil as soon as possible and have your vehicle serviced.

NOTICE:

Damage to your engine from neglected oil problems can be costly and is not covered by your warranty.

Low Oil Level Light



**LOW
OIL LEVEL**

This amber light should come on while you are starting your engine provided that your engine has been off long enough to let most of the oil drain back into the oil pan. During frequent stopping and starting, the light will not always come on as you start the engine.

If it doesn't come on, have it repaired. If the light comes on and stays on, your engine oil level is too low. Check your oil level and add enough oil to bring the engine oil level up to the proper level. See "Engine Oil" in the Index.

Change Oil Light



**CHANGE
OIL**

This amber light comes on and stays on for 20 seconds after you turn on the ignition when the engine oil needs changing.

See "Oil Life Indicator" in the Index.

Oil Life Indicator

Your Cadillac has an Oil Life Indicator feature. This tells you when you need to change your engine oil. It's based upon the engine oil temperatures and your driving patterns.

Your Oil Life Indicator may say to change the oil sooner than your maintenance schedule. This can happen if driving conditions, such as short trips in cold weather, cause shorter oil life. Always keep a written record of the mileage and date when you last changed your oil. For more information on when to change your oil, see the Cadillac Maintenance Schedule Booklet.

The system probably will say to change the oil between 3,000 miles (5 000 km) and 7,500 miles (12 500 km), but it may even say to change it before 3,000 miles under severe conditions. It all depends on your driving patterns. (If it doesn't, or if it doesn't even light up, then something is wrong. You will need to have it serviced.)

There are two things the system won't do: It can't sense heavy dust in the places where you drive. If you drive in a dusty area, you should change your oil every 3,000 miles (5 000 km) or three months (whichever comes first), unless the CHANGE OIL light comes on sooner. In addition, it doesn't check how much oil you have so you will still have to check for that. To check it, see "Engine Oil" in the Index.

When You've Changed the Oil

When new oil is put in, you'll need to reset your system. To do that, turn the ignition switch to the RUN position with the engine stopped. Fully push and release the accelerator pedal three times within five seconds. The light should flash, then go out if it is reset.

If the CHANGE OIL light comes on and stays on, it did not reset. You'll need to reset the system again.

Fuel Gage



Your fuel gage shows about how much fuel is in your tank. It works only when the ignition is in the RUN position. The 17 bar segments show the fuel remaining in your tank.

When only one bar segment is still lit, the LOW message will appear. If the fuel supply gets critically low, none of the bar segments will be lit and LOW will flash. You should get fuel immediately.

Here are a few concerns some owners have had about the fuel gage. All these situations are normal and indicate nothing wrong with the fuel gage.

- The pump at the gas station shuts off before the fuel gage reads F.
- It takes more (or less) gas to fill up than the gage indicated. For example, the gage indicated 1/2, but it took more or less than half the tank capacity to fill it.
- The gage changes when you turn (or stop, or speed up).

NOTES

1. The first part of the paper is devoted to a discussion of the various methods of determining the critical point of a function of two variables. The second part is devoted to a discussion of the various methods of determining the critical point of a function of three variables.



2. The first part of the paper is devoted to a discussion of the various methods of determining the critical point of a function of two variables. The second part is devoted to a discussion of the various methods of determining the critical point of a function of three variables.



SECTION 3

COMFORT CONTROLS AND AUDIO SYSTEMS

In this section you'll find out how to operate the comfort control systems and audio systems offered with your Cadillac.

ELECTRONIC CLIMATE CONTROL (ECC)



With this system you can control the ventilation, heating and air conditioning in your vehicle automatically by setting the desired temperature. The digital screen displays the outside temperature, the inside temperature setting, fan speed, and the ECC selection.

Outside Air

Outside air always flows through your Cadillac when the car is moving. Even if the car is not moving, you can always get outside air to flow through by selecting any air choice.

The Electronic Climate Control System may automatically recirculate the inside air of your vehicle, to provide maximum air conditioning. During recirculation, a louder blower noise may be heard until the system returns to outside air.

Air Outlets



Air outlets are located in the center and in the driver's and passenger's side of the instrument panel. You can adjust the direction of airflow by moving the control levers. The lever at the bottom of the air outlet opens or stops the air flow from that outlet.

System Controls

OUT TEMP: Press this to display the outside temperature. Press it again to return to the regular system display.

TEMP: This sets the interior temperature you want. Press the lower portion to lower the inside temperature setting. Press the upper portion to raise the temperature setting. Once you set the temperature, the system will automatically maintain the set temperature.

You can change the temperature from 65° F (18° C) to 85° F (29° C), one degree at a time. You may also choose 60° F (16° C), for maximum cooling, and 90° F (33° C), for maximum heating; the fan will stay on high speed unless you select a different speed. In maximum heating, most of the air will flow out the heater ducts. In maximum cooling, the system will recirculate the air inside your vehicle instead of pulling air from outside.

OFF: This turns off anything set in the ECC, but air will flow through your Cadillac if the the car is moving. The airflow will be felt through the heater ducts.

ECON: Use this in cold or cool weather to save fuel. It won't cool or remove humidity from the air. However, the system will try to keep the air at the chosen temperature.

If it's so warm outside that you need to cool the air, use **AUTO**.

AUTO: With this setting the system automatically controls the temperature, air distribution and fan speeds. In cold conditions, the fan will not come on until the system senses that the engine has started to warm up. This prevents cold air from blowing on you and your occupants.

DEFOG: Press this button to divide the air between the windshield and the heater ducts. This is useful when fog appears on the windshield or side glass due to a sudden rain or snowy conditions.

Fan



The fan speed is controlled automatically if you have the Electronic Climate Control set on **AUTO**. However, if you want the fan to run at a lower speed, Press the lower portion of the fan switch.

If you want the blower to run at a fixed higher speed, press the upper portion of the fan switch until you see **HI** on the display.

If you want the fan to run at a fixed low speed, press the switch until **LO** is shown on the display.

If you want the fan speed to be automatic but you like the fan to be higher or lower than the **AUTO** settings, just press the switch until either **HI**, **AUTO** or **AUTO LO** is displayed.

If the Fahrenheit (F°) or Celsius (C°) symbol begins to flash, or flashes when you turn on the ignition, it indicates an electrical problem with your air conditioning system. The flashing will continue for about two minutes. It means you should have your system serviced.

Defrost



To get fog or ice off the windshield, press this button.

The fan speed will work automatically or you can choose another fan speed if you want. It will work better if you first clear any ice and snow from the hood and the air inlet (it's between the hood and the windshield).

Electronic Solar Sensor

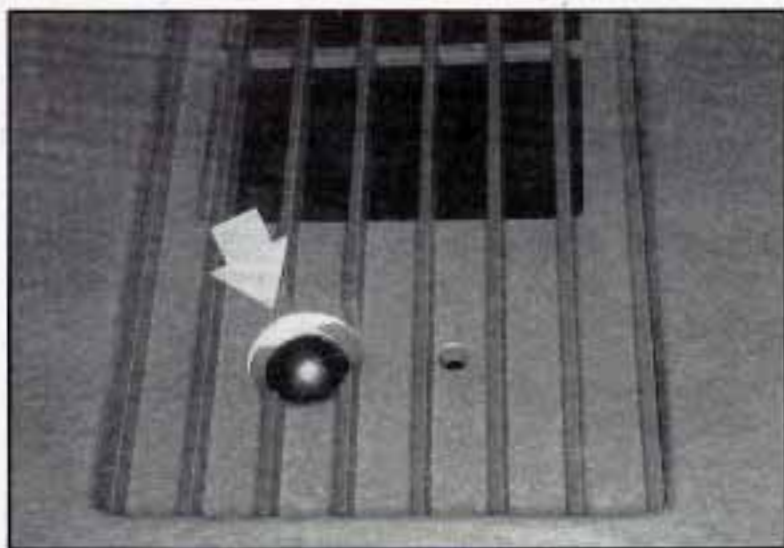

The Electronic Solar Sensor is part of the Electronic Climate Control System (ECC). The sensor monitors the sun's solar radiation by telling the ECC system at what intensity the sun is. The ECC uses this information to automatically make the necessary temperature adjustments. The sensor is located in the defroster grille.

Rear Window Defogger



To get fog or ice off the rear window, press this button. It warms your rear window and both outside rearview mirrors.

To turn it off, press the button again. After 10 minutes, it will go off by itself. If you still need to use it, just press the button again.

NOTICE:

Scraping the inside of your rear window could cut and damage the heater. Your warranty would not cover this damage. And don't put decals there; you might have to scrape them off later.

AUDIO SYSTEMS

Your Delco® audio system has been designed to operate easily and give years of listening pleasure. You will get the most enjoyment out of it if you acquaint yourself with it first. Find out what your Delco® system can do and how to operate all its controls to be sure you're getting the most out of the advanced engineering that went into it.

Setting the Clock

Turn the ignition and radio on. Then:

To Set the Hour

1. Press SET, and within 5 seconds,
2. Press and hold SEEK up or down. When the clock gets to the correct hour, let go.

To Set the Minutes

1. Press SET, and within 5 seconds,
2. Press and hold SCAN up or down. When the clock gets to the correct minute, let go.

Your clock is set.

DNR®

This feature automatically removes noise on Dolby encoded tapes (no button is required). Dolby® is a registered trademark of Dolby Laboratories. DNR® is a registered trademark of National Semiconductor Corporation.

Speed Sensitive Volume

Your Delco® audio system automatically adjusts the volume level to compensate for road and wind noise as you are driving.

Operating Your Audio System

Your Cadillac will have one of these Delco[®] audio systems.



Please read the following to operate the radio portion of your Delco[®] audio system.

Upper Knob

The upper knob does these four things:

- It turns the radio on and off.
- It controls the volume.
- Volume level automatically adjusts to compensate for road and wind noise as you're driving your Cadillac. Adjust the volume to the listening level you want at any time. Then, as you drive, the volume will change to match the noise present at any particular speed. The volume should always sound close to the same level as you drive.
- It lets you see what station you have. (When the radio is on, press the knob to display the station.)
- It tells you the time. (When the ignition is off, press the upper knob to display the time.)

Behind the upper knob is a balance control. It moves the sound between the left and right speakers.

Lower Knob

Turn the lower knob to choose radio stations. Press the knob to switch from AM to FM.

The control behind the lower knob moves the sound between your front and rear speakers.

SCAN: When you press this switch either up or down, SCAN will appear in the display and the radio will find the next station and stay there for five to 10 seconds. Then it will go to the next station and pause, and keep doing that. When you want it to stop, just press either the SCAN switch again or the upper knob.

SEEK: This switch chooses stations, but it doesn't keep moving as SCAN does. When you press SEEK up or down, the radio will automatically go to the next strongest station and stay there.

Pushbuttons



You can set the pushbuttons to get up to 10 favorite stations (five on AM and five on FM.) Just:

1. Choose either AM or FM.
2. Tune in the station.
3. Press the SET button.
4. Within five seconds, press one of the five pushbuttons.
5. Repeat these steps for each of the five pushbuttons.

Preset Equalization

The Preset Equalization buttons let you adjust the tone to sound just the way you want it. Each individual auto-equalization button (A through E) contains a separate equalization adjustment feature.

When your vehicle is new, the auto-equalization is already preset. Preset A has more bass and treble tone than mid-range tone. Preset B has more bass than treble and mid-range tone. Use Preset C for an overall flat response in sound. Preset D has more treble than bass and mid-range. Choose Preset E for more mid-range sound than bass and treble. These preset settings can be modified individually for AM, FM, cassette or CD play.

Follow these steps to modify each of the Preset Equalization buttons.

1. First, select one of the Preset Equalization buttons.

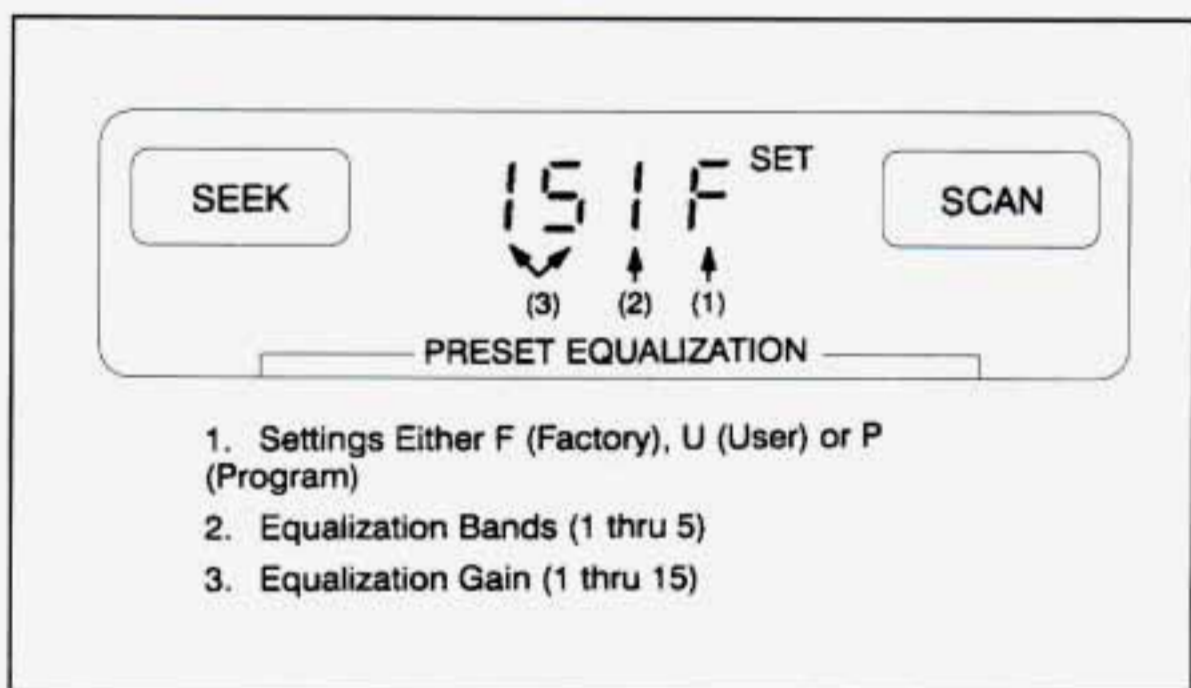

2. Press the SET button, and then press and hold the Preset Equalization button you have selected, until either an F or U is displayed (about 10 seconds).

The display will show either 3 or 4 digits and the preset button LED will flash. In the farthest right position of the display will be an F (for factory setting), or if the equalization has been modified, a U (for user setting).

3. Press the SCAN switch up or down to select the band you prefer.

The middle digit indicates the equalization band. There are five bands: 60Hz, 250Hz, 1kHz, 3.5Hz and 10kHz, numbered 1 through 5 respectively. The band will display band 1 when the mode is first entered.

- Press the SEEK switch up or down to select the gain setting you want.

The left digit, or two digits are the equalization gain settings (0-15) for each band. The display will indicate the active setting (F or U) when the mode is first entered. A typical setting for a flat response is 7.

- Press the upper radio knob to compare the factory setting to your setting. Once you are satisfied with your selection, press and hold the preset equalization button for about 4 seconds, “Pr” (program) will display indicating that your selection is programmed.



If you have programmed the preset equalization buttons and set the pushbuttons to the stations you've selected, you can preset the five Preset Equalization buttons to a particular station. Just:

1. Tune in a station using one of the preset pushbuttons.
2. Press one of the Preset Equalization buttons (A through E) until you like the sound.
3. Press the SET button.
4. Press the same Preset Equalization button you've selected.
5. Press the preset pushbutton again to set the Preset Equalization tone.

Now each time you press that pushbutton, the Preset Equalization is set in memory for that station.

For example, suppose you like classical music with a flat sounding tone. The station has already been preset to pushbutton 3. Since the flat response is on button C, you would just:

1. Press the preset pushbutton 3.
2. Next, press the tone control button C.
3. Then, press the SET button.
4. Press the tone control button C again.
5. Press the preset pushbutton 3 again and your Preset Equalization is set in memory.

Now every time you press the preset pushbutton 3, the Preset Equalization tone is programmed to that preset pushbutton. Tuning to the station already preset to 3 using the knob, or SEEK or SCAN, the tone control will automatically change to C. The Preset Equalization button will light when it is programmed to a particular pushbutton or when manually pushed in.

Playing a Cassette Tape

Your cassette tape player works best with tapes that are 30 to 45 minutes long on each side. Tapes longer than that are so thin that they may not work well in this player.

1. Turn the radio on.
2. Insert the cassette squarely through the tape door. (TP will appear in the display.)

If you hear nothing or hear just a garbled sound, the cassette may not be in squarely. Press the EJECT button to remove the tape and start over. The tape equalization is automatically sensed and set. Inserting the cassette also automatically disables DNR[®] and activates Dolby[®] noise reduction. DNR[®] is a registered trademark of National Semiconductor Corporation.

- Once the tape is playing, use the upper and lower knobs to adjust the volume and balance, just as you do for the radio. Press the upper knob to change tape direction. The arrows show which direction the tape is being played.
- To go forward rapidly to another part of the tape, press FWD. To go backward, press REV. To stop the tape, press the same button lightly or any of the other buttons. The radio will play during fast forward or reverse.
- To go from one side of the tape to the other, press in the upper knob on your radio. To remove the tape, press EJECT. The tape can be ejected when the ignition is turned off.

SCAN: Press this button up to skip ahead to the next selection or down to return to the beginning of the selection you just heard. The tape will play for approximately 15 seconds to sample a selection before going on to the next selection. To stop the SCAN function, just press the button up or down again or use the upper knob. If the selection is at the end of the tape, the tape will reverse directions and begin playing at a normal speed. During the SCAN function the radio will not play.

SEEK: Press this button up to go quickly to the beginning of the next selection. Press the SEEK button down to go back to the beginning of the selection you are listening to. During the SCAN function the radio will not play.

ST-PLAY: Press this to switch back to the radio without ejecting the tape. In ST-PLAY function only the tuning knob can be used for selecting stations.

EJECT: Press this to remove the tape once it is stopped.

Automatic CrO₂ Tape Equalization

This allows equalization for metal, chromium or normal bias tapes.

Delco® Cassette and Compact Disc Music System (Option)

This audio system combines an AM/FM stereo radio with a cassette tape player and a compact disc player in a single unit.

To operate the radio and cassette tape player portion of this music system, please read “Operating Your Audio System” and “Playing a Cassette Tape” earlier in this section.

Playing a Compact Disc

Don't use the mini-discs that are called “singles”. They won't eject. Use full-size compact discs only.

Turn the radio on.

Insert a disc (label side up) partway into the slot. The player will pull it in. Wait a few seconds and the disc will play. The DNR® will be disabled and the display will show 1 TRK CD for about five seconds, then CD will show in the display.

If the disc comes back out, check to see if:

- The disc is upside down.
- The disc is dirty, scratched, or wet.
- There's too much moisture in the air. (If there is, wait about one hour and try again).

RCL/PROG: Press once to see which track is being played. (It also allows for disc programming.) Within five seconds, press it a second time to see how long the disc has been playing. Press it a third time to see the time of day.

Programming Tracks

You can program up to 10 tracks for your listening pleasure.

1. Press the RCL/PROG knob. CD and TRACK will appear in the display. This also allows you to program disc track playback.
2. Within five seconds, turn the lower TUNE knob to the track you want to hear first. The track number will flash.
3. Press the SET button and the track number will stop flashing. This indicates that the track is programmed.
4. Repeat Steps 2 and 3 to program up to 9 more tracks.
5. Press the RCL/PROG knob a second time to begin playing the first programmed track.

To cancel the programming mode, press RCL/PROG and SET. If ALL is showing on the display, allow 10 seconds to pass. You can also cancel the programming mode by ejecting the disc.

SEEK: Press this switch up or down to go to the beginning of the next or previous track. At least eight seconds must have played for the SEEK function to find the start of the current track.

SCAN: Press this switch up or down to sample about 15 seconds of the beginning of each track. Press it again or the upper knob to stop the SCAN function.

Note that if you are in the program mode, it is possible to modify the playback order by using the TUNE knob. If you need to review the playback order, use either the SEEK or SCAN switch. This review can be stopped by pressing the SCAN switch.

REV: Press and hold this button to return rapidly to a favorite passage. Release it to play the passage. The elapsed time will be displayed to show the reverse progress of the CD.

FWD: Press and hold this button to advance quickly within a track. Release it to resume playing. Elapsed time will be displayed to show the forward progress of the CD.

ST-EJECT: When you press this, the disc or tape will stop without ejecting and the radio will start to play. Press it again and the disc or tape will eject.

PLAY: Press this to restart the disc or tape. It will begin playing at the point where it had stopped. If the CD and cassette tape are inserted at the same time, press the play button to switch between the disc and tape.

COMP: Press this to make soft and loud passages more nearly equal in volume (for example, playing classical or jazz music with very quiet and very loud passages in the same tune). COMP will appear in the display as long as COMP is on.

Tips About Your Audio System

Be aware that hearing damage from loud noise is almost undetectable until it is too late. Your hearing can adapt to higher volumes of sound. Sound that seems normal can be loud and harmful to your hearing. Take precautions by adjusting the volume control on your radio to a safe sound level before your hearing adapts to it.

To help avoid hearing loss or damage:

1. Adjust the volume control to the lowest setting.
2. Increase volume slowly until you hear comfortably and clearly.

NOTICE:

Before you add any sound equipment to your vehicle -- like a tape player, CB radio, mobile telephone or two-way radio -- be sure you can add what you want. If you can, it's very important to do it properly. Added sound equipment may interfere with the operation of your vehicle's engine, Delco[®] radio or other systems, and even damage them. And, your vehicle's systems may interfere with the operation of sound equipment that has been added improperly.

So, before adding sound equipment, check with your dealer and be sure to check Federal rules covering mobile radio and telephone units.

Understanding Radio Reception

FM Stereo

FM stereo will give you the best sound, but FM signals will reach only about 10 to 40 miles (16 to 65 km). Tall buildings or hills can interfere with FM signals, causing a popping, crackling, or momentary hissing sound.

AM

The range for most AM stations is greater than for FM, especially at night. The longer range, however, can cause stations to interfere with each other. AM can also pick up noise from things like storms and power lines. To lower this noise, try reducing the treble level. This means the Delco[®] system can receive C-QUAM[®] stereo broadcasts. Many AM stations around the country use C-QUAM[®] to produce stereo, though some do not. (C-QUAM[®] is a registered trademark of Motorola, Inc.) If your Delco[®] system can get C-QUAM[®], your ST light will come on when you're receiving it.

AM Stereo

This means the Delco[®] system can receive C-QUAM[®] stereo broadcasts. Many AM stations around the country use C-QUAM[®] to produce stereo, though some do not. (C-QUAM[®] is a registered trademark of Motorola, Inc.) If your Delco[®] system can get C-QUAM[®], your ST light will come on when you're receiving it.

AMAX[®]

This means that your audio system can produce quality AM sound comparable to FM stereo. AMAX[®] reduces noise without reducing the high frequencies you need for the best sound. In addition to improved sound quality, AMAX[®] includes more stations on the AM band. You don't have to do anything to your radio because AMAX[®] is automatic.

Care of Your Cassette Tape Player

A tape player that is not cleaned regularly can cause reduced sound quality, ruined cassettes, or a damaged mechanism. Cassette tapes should be stored in their cases away from contaminants, direct sunlight, and extreme heat. If they aren't, they may not operate properly or cause failure of the tape player.

Your tape player should be cleaned after every 50 hours of use. If you notice a reduction in sound quality, try a known good cassette to see if the tape or the tape player is at fault. If this other cassette has no improvement in sound quality, clean the tape player.

Cleaning may be done with a scrubbing action, non-abrasive cleaning cassette. This system uses a cleaning cassette with pads which scrub the tape head as the hubs of the cleaner cassette turn. It is normal for the cartridge to eject while cleaning. Insert the cassette at least three times to ensure thorough cleaning. A scrubbing action cleaning cassette is available through your Cadillac dealership.

You may also choose a non-scrubbing action, wet-type cleaner which uses a cassette with a fabric belt to clean the tape head. This type of cleaning cassette will not eject. It may not clean as thoroughly as the scrubbing type cleaner.

Cassettes are subject to wear and the sound quality may degrade over time. Always make sure that the cassette tape is in good condition before you have your tape player serviced.

Care of Your Compact Discs

Handle discs carefully. Store them in their original cases or other protective cases and away from direct sunlight and dust. If the surface of a disc is soiled, dampen a clean, soft cloth in a mild, neutral detergent solution and clean it, wiping from the center to the edge.

Be sure never to touch the signal surface when handling discs. Pick up discs by grasping the outer edges or the edge of the hole and the outer edge.

Power Antenna Mast Care

Your power antenna will look its best and work well if it's cleaned from time to time.

Follow these steps to clean the power antenna mast:

1. Turn on the ignition and radio to raise the antenna to full mast extension.
2. Dampen a clean cloth with mineral spirits or equivalent solvent.
3. Wipe cloth over the mast sections, removing any dirt.
4. Wipe dry with a clean cloth before retracting.
5. Make the antenna go up and down by turning the radio or ignition on and off.
6. Repeat if necessary.

NOTICE:

Don't lubricate the power antenna. Lubrication could damage it.

NOTICE:

Before entering an automatic car wash, turn off your radio to make the power antenna go down. This will prevent the mast from possibly getting damaged. If the antenna does not go down when you turn the radio off, it may be damaged or need to be cleaned. In either case, lower the antenna by hand by carefully pressing the antenna down.

If the mast portion of your antenna is damaged, you can easily replace it. See your dealer for a replacement kit and follow the instructions in the kit.

NOTES

Page 1 of 1

1. Introduction
2. Objectives
3. Scope
4. Methodology
5. Results
6. Discussion
7. Conclusion
8. References

1. Introduction
2. Objectives
3. Scope
4. Methodology
5. Results
6. Discussion
7. Conclusion
8. References

1. Introduction
2. Objectives
3. Scope
4. Methodology
5. Results
6. Discussion
7. Conclusion
8. References

1. Introduction
2. Objectives
3. Scope
4. Methodology
5. Results
6. Discussion
7. Conclusion
8. References



SECTION 4

YOUR DRIVING AND THE ROAD



Here you'll find information about driving on different kinds of roads and in varying weather conditions. We've also included many other useful tips on driving.

DEFENSIVE DRIVING

The best advice anyone can give about driving is: Drive defensively.

Please start with a very important safety device in your Cadillac: Buckle up. (See "Safety Belts" in the Index.)

Defensive driving really means "be ready for anything." On city streets, rural roads, or freeways, it means "always expect the unexpected."

Assume that pedestrians or other drivers are going to be careless and make mistakes. Anticipate what they might do. Be ready for their mistakes.

Rear-end collisions are about the most preventable of accidents. Yet they are common. Allow enough following distance. It's the best defensive driving maneuver, in both city and rural driving. You never know when the vehicle in front of you is going to brake or turn suddenly.

DRUNKEN DRIVING

Death and injury associated with drinking and driving is a national tragedy. It's the number one contributor to the highway death toll, claiming thousands of victims every year.

Alcohol affects four things that anyone needs to drive a vehicle:

- Judgment
- Muscular Coordination
- Vision
- Attentiveness

Police records show that almost half of all motor vehicle-related deaths involve alcohol. In most cases, these deaths are the result of someone who was drinking and driving. In recent years, some 18,000 annual motor vehicle-related deaths have been associated with the use of alcohol, with more than 300,000 people injured.

Many adults -- by some estimates, nearly half the adult population -- choose never to drink alcohol, so they never drive after drinking. For persons under 21, it's against the law in every U.S. state to drink alcohol. There are good medical, psychological and developmental reasons for these laws.

The obvious way to solve this highway safety problem is for people never to drink alcohol and then drive. But what if people do? How much is "too much" if the driver plans to drive? It's a lot less than many might think. Although it depends on each person and situation, here is some general information on the problem.

The Blood Alcohol Concentration (BAC) of someone who is drinking depends upon four things:

- How much alcohol consumed
- The drinker's body weight
- The amount of food that is consumed before and during drinking
- The length of time it has taken the drinker to consume the alcohol

According to the American Medical Association, a 180-pound (82 kg) person who drinks three 12-ounce (355 ml) bottles of beer in an hour will end up with a BAC of about 0.06 percent. The person would reach the same BAC by drinking three 4-ounce (120 ml) glasses of wine or three mixed drinks if each had 1-1/2 ounces (45 ml) of a liquor like whiskey, gin or vodka.



It's the amount of alcohol that counts. For example, if the same person drank three double martinis (3 ounces or 90 ml of liquor each) within an hour, the person's BAC would be close to 0.12 percent. A person who consumes food just before or during drinking will have a somewhat lower BAC level.

There is a gender difference, too. Women generally have a lower relative percentage of body water than men. Since alcohol is carried in body water, this means that a woman generally will reach a higher BAC level than a man of her same body weight when each has the same number of drinks.

The law in many U.S. states sets the legal limit at a BAC of 0.10 percent. In a growing number of U.S. states, and throughout Canada, the limit is 0.08 percent. In some other countries it's even lower. The BAC limit for all commercial drivers in the U.S. is 0.04 percent.

The BAC will be over 0.10 percent after three to six drinks (in one hour). Of course, as we've seen, it depends on how much alcohol is in the drinks, and how quickly the person drinks them.

But the ability to drive is affected well below a BAC of 0.10 percent. Research shows that the driving skills of many people are impaired at a BAC approaching 0.05 percent, and that the effects are worse at night. All drivers are impaired at BAC levels above 0.05 percent. Statistics show that the chance of being in a collision increases sharply for drivers who have a BAC of 0.05 percent or above. A driver with a BAC level of 0.06 percent has doubled his or her chance of having a collision. At a BAC level of 0.10 percent, the chance of this driver having a collision is twelve times greater; at a level of 0.15 percent, the chance is twenty-five times greater!

The body takes about an hour to rid itself of the alcohol in one drink. No amount of coffee or number of cold showers will speed that up. "I'll be careful" isn't the right answer. What if there's an emergency, a need to take sudden action, as when a child darts into the street? A person with even a moderate BAC might not be able to react quickly enough to avoid the collision.

There's something else about drinking and driving that many people don't know. Medical research shows that alcohol in a person's system can make crash injuries worse, especially injuries to the brain, spinal cord or heart. This means that when anyone who has been drinking -- driver or passenger -- is in a crash, that person's chance of being killed or permanently disabled is higher than if the person had not been drinking.



CAUTION:

Drinking and then driving is very dangerous. Your reflexes, perceptions, attentiveness and judgment can be affected by even a small amount of alcohol. You can have a serious -- or even fatal -- collision if you drive after drinking. Please don't drink and drive or ride with a driver who has been drinking. Ride home in a cab; or if you're with a group, designate a driver who will not drink.

CONTROL OF A VEHICLE

You have three systems that make your vehicle go where you want it to go. They are the brakes, the steering and the accelerator. All three systems have to do their work at the places where the tires meet the road.

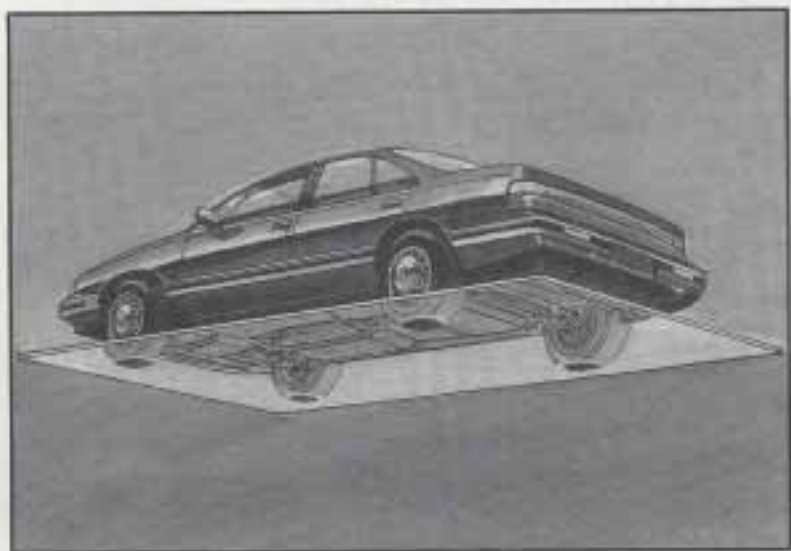

Sometimes, as when you're driving on snow or ice, it's easy to ask more of those control systems than the tires and road can provide. That means you can lose control of your vehicle.

BRAKING

Braking action involves *perception time* and *reaction time*.

First, you have to decide to push on the brake pedal. That's *perception time*. Then you have to bring up your foot and do it. That's *reaction time*.

Average *reaction time* is about 3/4 of a second. But that's only an average. It might be less with one driver and as long as two or three seconds or more with another. Age, physical condition, alertness, coordination, and eyesight all play a part. So do alcohol, drugs and frustration. But even in 3/4 of a second, a vehicle moving at 60 mph (100 km/h) travels 66 feet (20 m). That could be a lot of distance in an emergency, so keeping enough space between your vehicle and others is important.

And, of course, actual stopping distances vary greatly with the surface of the road (whether it's pavement or gravel); the condition of the road (wet, dry, icy); tire tread; and the condition of your brakes.

Avoid needless heavy braking. Some people drive in spurts -- heavy acceleration followed by heavy braking -- rather than keeping pace with traffic. This is a mistake. Your brakes may not have time to cool between hard stops. Your brakes will wear out much faster if you do a lot of heavy braking. If you keep pace with the traffic and allow realistic following distances, you will eliminate a lot of unnecessary braking. That means better braking and longer brake life.

If your engine ever stops while you're driving, brake normally but don't pump your brakes. If you do, the pedal may get harder to push down. If your engine stops, you will still have some power brake assist. But you will use it when you brake. Once the power assist is used up, it may take longer to stop and the brake pedal will be harder to push.

Anti-Lock Brakes (ABS)

Your Cadillac has an advanced electronic braking system that will help prevent a braking skid.

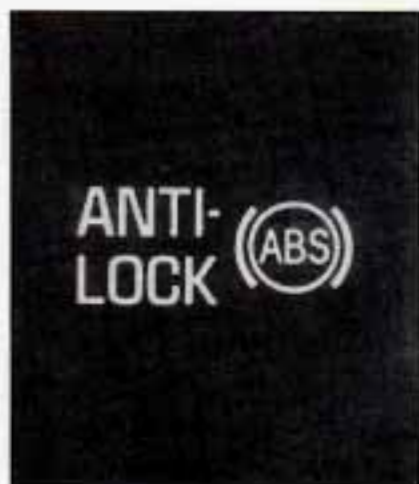

This light on the instrument panel will come on briefly when you start your vehicle.

When you start your vehicle and begin to drive away, you may hear a momentary motor or clicking noise. And you may even notice that your brake pedal moves a little while this is going on. This is the ABS system testing itself. If there's a problem with the anti-lock brake system, the anti-lock brake system warning light will stay on.

See "Anti-Lock Brake System Warning Light" in the Index.



Here's how anti-lock works. Let's say the road is wet. You're driving safely. Suddenly an animal jumps out in front of you.

You slam on the brakes. Here's what happens with ABS.

A computer senses that wheels are slowing down. If one of the wheels is about to stop rolling, the computer will separately work the brakes at each front wheel and at the rear wheels.

The anti-lock system can change the brake pressure faster than any driver could. The computer is programmed to make the most of available tire and road conditions.



You can steer around the obstacle while braking hard.

As you brake, your computer keeps receiving updates on wheel speed and controls braking pressure accordingly.

Remember: Anti-lock doesn't change the time you need to get your foot up to the brake pedal. If you get too close to the vehicle in front of you, you won't have time to apply your brakes if that vehicle suddenly slows or stops. Always leave enough room up ahead to stop, even though you have anti-lock brakes.

To Use Anti-Lock

Don't pump the brakes. Just hold the brake pedal down and let anti-lock work for you. You may hear the anti-lock pump or motor operate, and feel the brake pedal pulsate, but this is normal.

Traction Control System

Your vehicle has a traction control system that limits wheel spin. This is especially useful in slippery road conditions. The system operates only if it senses that the rear wheels are spinning or beginning to lose traction. When this happens, the system works the rear brakes and reduces engine power (by closing the throttle and managing engine spark) to limit wheel spin.

**TRACTION
ENGAGED**

The TRACTION ENGAGED light will come on when the traction control system is limiting wheel spin. See "Traction Control System Active Light" in the Index. You may feel the system working, or you may notice some noise, but this is normal.

If your vehicle is in cruise control when the traction control system begins to limit wheel spin, the cruise control will automatically disengage. When road conditions allow you to safely use it again, you may re-engage the cruise control. (See "Cruise Control" in the Index.)

**TRACTION
CONTROL**

When the system is on, the TRACTION CONTROL warning light will come on to let you know if there's a problem with your traction control system. When this warning light is on, the system will not limit wheel spin. Adjust your driving accordingly.

The traction control system automatically comes on whenever you start your vehicle. To limit wheel spin, especially in slippery road conditions, you should always leave the system on. But you can turn the traction control system off if you ever need to. (You should turn the system off if your vehicle ever gets stuck in sand, mud, ice or snow. See “Rocking Your Vehicle” in the Index.)

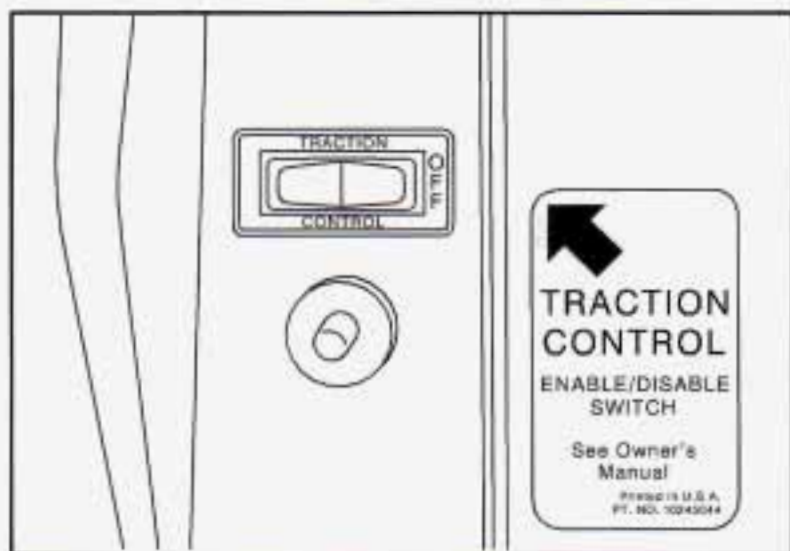

To turn the system off, press the button in the glove box. The TRACTION CONTROL light will come on and stay on. If the traction control system is limiting wheel spin when you press the button, the system won't turn off right away.

It will wait until there's no longer a current need to limit wheel spin.

You can turn the system back on at any time by pressing the button again. The TRACTION CONTROL warning light should go off.

Traction control is deleted on Coachbuilder limousines and funeral coach packages.

Braking in Emergencies

Use your anti-lock braking system when you need to. With anti-lock, you can steer and brake at the same time. In many emergencies, steering can help you more than even the very best braking.

STEERING

Power Steering

If you lose power steering assist because the engine stops or the system is not functioning, you can steer but it will take much more effort.

Steering Tips

Driving on Curves

It's important to take curves at a reasonable speed.

A lot of the "driver lost control" accidents mentioned on the news happen on curves. Here's why:

Experienced driver or beginner, each of us is subject to the same laws of physics when driving on curves. The traction of the tires against the road surface makes it possible for the vehicle to change its path when you turn the front wheels. If there's no traction, inertia will keep the vehicle going in the same direction. If you've ever tried to steer a vehicle on wet ice, you'll understand this.

The traction you can get in a curve depends on the condition of your tires and the road surface, the angle at which the curve is banked, and your speed. While you're in a curve, speed is the one factor you can control.

Suppose you're steering through a sharp curve. Then you suddenly accelerate. Both control systems -- steering and acceleration -- have to do their work where the tires meet the road. Unless your traction control system is on, adding the sudden acceleration can demand too much of those places. You can lose control.

What should you do if this ever happens? Ease up on the accelerator pedal, steer the vehicle the way you want it to go, and slow down.

Speed limit signs near curves warn that you should adjust your speed. Of course, the posted speeds are based on good weather and road conditions. Under less favorable conditions you'll want to go slower.

If you need to reduce your speed as you approach a curve, do it before you enter the curve, while your front wheels are straight ahead.

Try to adjust your speed so you can "drive" through the curve. Maintain a reasonable, steady speed. Wait to accelerate until you are out of the curve, and then accelerate gently into the straightaway.

Steering in Emergencies

There are times when steering can be more effective than braking. For example, you come over a hill and find a truck stopped in your lane, or a car suddenly pulls out from nowhere, or a child darts out from between parked cars and stops right in front of you. You can avoid these problems by braking -- if you can stop in time. But sometimes you can't; there isn't room. That's the time for evasive action -- steering around the problem.

Your Cadillac can perform very well in emergencies like these. First apply your brakes. (See "Braking in Emergencies" earlier in this section.) It is better to remove as much speed as you can from a possible collision. Then steer around the problem, to the left or right depending on the space available.

An emergency like this requires close attention and a quick decision. If you are holding the steering wheel at the recommended 9 and 3 o'clock positions, you can turn it a full 180 degrees very quickly without removing either hand. But you have to act fast, steer quickly, and just as quickly straighten the wheel once you have avoided the object.

The fact that such emergency situations are always possible is a good reason to practice defensive driving at all times and wear safety belts properly.

OFF-ROAD RECOVERY

You may find sometime that your right wheels have dropped off the edge of a road onto the shoulder while you're driving.

If the level of the shoulder is only slightly below the pavement, recovery should be fairly easy. Ease off the accelerator and then, if there is nothing in the way, steer so that your vehicle straddles the edge of the pavement. You can turn the steering wheel up to 1/4 turn until the right front tire contacts the pavement edge. Then turn your steering wheel to go straight down the roadway.

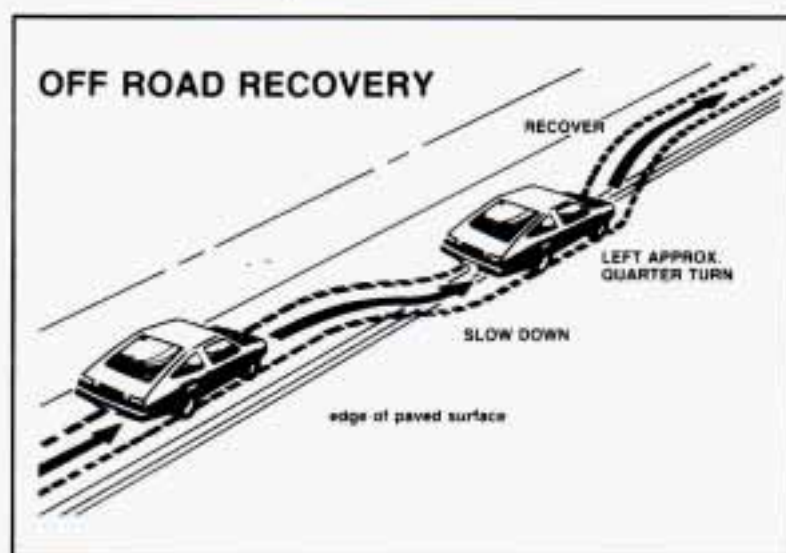

PASSING

The driver of a vehicle about to pass another on a two-lane highway waits for just the right moment, accelerates, moves around the vehicle ahead, then goes back into the right lane again. A simple maneuver?

Not necessarily! Passing another vehicle on a two-lane highway is a potentially dangerous move, since the passing vehicle occupies the same lane as oncoming traffic for several seconds. A miscalculation, an error in judgment, or a brief surrender to frustration or anger can suddenly put the passing driver face to face with the worst of all traffic accidents -- the head-on collision.

So here are some tips for passing:

- “Drive ahead.” Look down the road, to the sides, and to crossroads for situations that might affect your passing patterns. If you have any doubt whatsoever about making a successful pass, wait for a better time.
- Watch for traffic signs, pavement markings, and lines. If you can see a sign up ahead that might indicate a turn or an intersection, delay your pass. A broken center line usually indicates it’s all right to pass (providing the road ahead is clear). Never cross a solid line on your side of the lane or a double solid line, even if the road seems empty of approaching traffic.
- Do not get too close to the vehicle you want to pass while you’re awaiting an opportunity. For one thing, following too closely reduces your area of vision, especially if you’re following a larger vehicle. Also, you won’t have adequate space if the vehicle ahead suddenly slows or stops. Keep back a reasonable distance.
- When it looks like a chance to pass is coming up, start to accelerate but stay in the right lane and don’t get too close. Time your move so you will be increasing speed as the time comes to move into the other lane. If the way is clear to pass, you will have a “running start” that more than makes up for the distance you would lose by dropping back. And if something happens to cause you to cancel your pass, you need only slow down and drop back again and wait for another opportunity.

- If other cars are lined up to pass a slow vehicle, wait your turn. But take care that someone isn't trying to pass you as you pull out to pass the slow vehicle. Remember to glance over your shoulder and check the blind spot.
- Check your mirrors, glance over your shoulder, and start your left lane change signal before moving out of the right lane to pass. When you are far enough ahead of the passed vehicle to see its front in your inside mirror, activate your right lane change signal and move back into the right lane. (Remember that your right outside mirror is convex. The vehicle you just passed may seem to be farther away from you than it really is.)
- Try not to pass more than one vehicle at a time on two-lane roads. Reconsider before passing the next vehicle.
- Don't overtake a slowly moving vehicle too rapidly. Even though the brake lamps are not flashing, it may be slowing down or starting to turn.
- If you're being passed, make it easy for the following driver to get ahead of you. Perhaps you can ease a little to the right.

LOSS OF CONTROL

Let's review what driving experts say about what happens when the three control systems (brakes, steering and acceleration) don't have enough friction where the tires meet the road to do what the driver has asked.

In any emergency, don't give up. Keep trying to steer and constantly seek an escape route or area of less danger.

Skidding

In a skid, a driver can lose control of the vehicle. Defensive drivers avoid most skids by taking reasonable care suited to existing conditions, and by not “overdriving” those conditions. But skids are always possible.

The three types of skids correspond to your Cadillac’s three control systems. In the braking skid your wheels aren’t rolling. In the steering or cornering skid, too much speed or steering in a curve causes tires to slip and lose cornering force. And in the acceleration skid too much throttle causes the driving wheels to spin.

A cornering skid is best handled by easing your foot off the accelerator pedal.

Remember: Any traction control system helps avoid only the acceleration skid.

If your traction control system is off, then an acceleration skid is also best handled by easing your foot off the accelerator pedal.

If your vehicle starts to slide, ease your foot off the accelerator pedal and quickly steer the way you want the vehicle to go. If you start steering quickly enough, your vehicle may straighten out. Always be ready for a second skid if it occurs.

Of course, traction is reduced when water, snow, ice, gravel, or other material is on the road. For safety, you’ll want to slow down and adjust your driving to these conditions. It is important to slow down on slippery surfaces because stopping distance will be longer and vehicle control more limited.

While driving on a surface with reduced traction, try your best to avoid sudden steering, acceleration, or braking (including engine braking by shifting to a lower gear). Any sudden changes could cause the tires to slide. You may not realize the surface is slippery until your vehicle is skidding. Learn to recognize warning clues -- such as enough water, ice or packed snow on the road to make a “mirrored surface” -- and slow down when you have any doubt.

Remember: Any anti-lock brake system (ABS) helps avoid only the braking skid.

DRIVING AT NIGHT

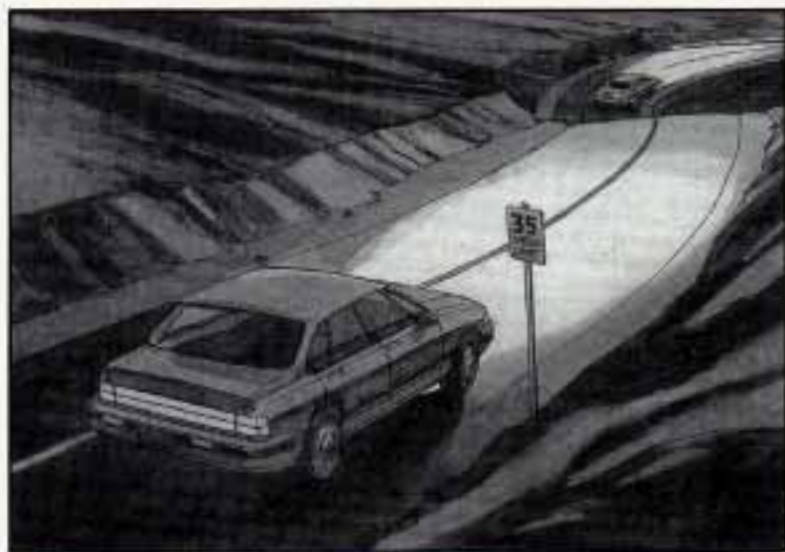

Night driving is more dangerous than day driving. One reason is that some drivers are likely to be impaired -- by alcohol or drugs, with night vision problems, or by fatigue.

Here are some tips on night driving.

- Drive defensively.
- Don't drink and drive.
- Adjust your inside rearview mirror to reduce the glare from headlamps behind you.
- Since you can't see as well, you may need to slow down and keep more space between you and other vehicles.
- Slow down, especially on higher speed roads. Your headlamps can light up only so much road ahead.
- In remote areas, watch for animals.
- If you're tired, pull off the road in a safe place and rest.

Night Vision

No one can see as well at night as in the daytime. But as we get older these differences increase. A 50-year-old driver may require at least twice as much light to see the same thing at night as a 20-year-old.

What you do in the daytime can also affect your night vision. For example, if you spend the day in bright sunshine you are wise to wear sunglasses. Your eyes will have less trouble adjusting to night. But if you're driving, don't wear sunglasses at night. They may cut down on glare from headlamps, but they also make a lot of things invisible.

You can be temporarily blinded by approaching lights. It can take a second or two, or even several seconds, for your eyes to readjust to the dark. When you are faced with severe glare (as from a driver who doesn't lower the high beams, or a vehicle with misaimed headlamps), slow down a little. Avoid staring directly into the approaching lights.

Keep your windshield and all the glass on your vehicle clean -- inside and out. Glare at night is made much worse by dirt on the glass. Even the inside of the glass can build up a film caused by dust. Dirty glass makes lights dazzle and flash more than clean glass would, making the pupils of your eyes contract repeatedly.

Remember that your headlamps light up far less of a roadway when you are in a turn or curve. Keep your eyes moving; that way, it's easier to pick out dimly lighted objects. Just as your headlamps should be checked regularly for proper aim, so should your eyes be examined regularly. Some drivers suffer from night blindness -- the inability to see in dim light -- and aren't even aware of it.

DRIVING IN THE RAIN



Rain and wet roads can mean driving trouble. On a wet road you can't stop, accelerate or turn as well because your tire-to-road traction isn't as good as on dry roads. And, if your tires don't have much tread left, you'll get even less traction. It's always wise to go slower and be cautious if rain starts to fall while you are driving. The surface may get wet suddenly when your reflexes are tuned for driving on dry pavement.

The heavier the rain, the harder it is to see. Even if your windshield wiper blades are in good shape, a heavy rain can make it harder to see road signs and traffic signals, pavement markings, the edge of the road, and even people walking.

It's wise to keep your wiping equipment in good shape and keep your windshield washer tank filled. Replace your windshield wiper inserts when they show signs of streaking or missing areas on the windshield, or when strips of rubber start to separate from the inserts.



Driving too fast through large water puddles or even going through some car washes can cause problems, too. The water may affect your brakes. Try to avoid puddles. But if you can't, try to slow down before you hit them.

 **CAUTION:**

Wet brakes can cause accidents. They won't work well in a quick stop and may cause pulling to one side. You could lose control of the vehicle.

After driving through a large puddle of water or a car wash, apply your brake pedal lightly until your brakes work normally.

Hydroplaning

Hydroplaning is dangerous. So much water can build up under your tires that they can actually ride on the water. This can happen if the road is wet enough and you're going fast enough. When your vehicle is hydroplaning, it has little or no contact with the road.

Hydroplaning doesn't happen often. But it can if your tires haven't much tread or if the pressure in one or more is low. It can happen if a lot of water is standing on the road. If you can see reflections from trees, telephone poles, or other vehicles, and raindrops "dimple" the water's surface, there could be hydroplaning.

Hydroplaning usually happens at higher speeds. There just isn't a hard and fast rule about hydroplaning. The best advice is to slow down when it is raining.

Some Other Rainy Weather Tips

- Turn on your low-beam headlamps -- not just your parking lamps -- to help make you more visible to others.
- Besides slowing down, allow some extra following distance. And be especially careful when you pass another vehicle. Allow yourself more clear room ahead, and be prepared to have your view restricted by road spray.
- Have good tires with proper tread depth. (See "Tires" in the Index.)

CITY DRIVING



One of the biggest problems with city streets is the amount of traffic on them. You'll want to watch out for what the other drivers are doing and pay attention to traffic signals.

Here are ways to increase your safety in city driving:

- Know the best way to get to where you are going. Get a city map and plan your trip into an unknown part of the city just as you would for a cross-country trip.
- Try to use the freeways that rim and crisscross most large cities. You'll save time and energy. (See the next part, "Freeway Driving.")
- Treat a green light as a warning signal. A traffic light is there because the corner is busy enough to need it. When a light turns green, and just before you start to move, check both ways for vehicles that have not cleared the intersection or may be running the red light.

FREEWAY DRIVING

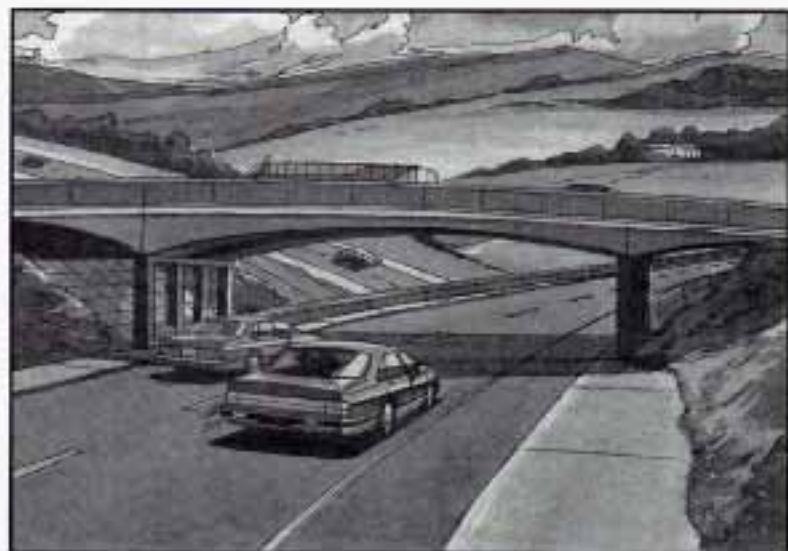

Mile for mile, freeways (also called thruways, parkways, expressways, turnpikes, or superhighways) are the safest of all roads. But they have their own special rules.

The most important advice on freeway driving is: Keep up with traffic and keep to the right. Drive at the same speed most of the other drivers are driving. Too-fast or too-slow driving breaks a smooth traffic flow. Treat the left lane on a freeway as a passing lane.

At the entrance there is usually a ramp that leads to the freeway. If you have a clear view of the freeway as you drive along the entrance ramp, you should begin to check traffic. Try to determine where you expect to blend with the flow. Try to merge into the gap at close to the prevailing speed. Switch on your turn signal, check your mirrors and glance over your shoulder as often as necessary. Try to blend smoothly with the traffic flow.

Once you are on the freeway, adjust your speed to the posted limit or to the prevailing rate if it's slower. Stay in the right lane unless you want to pass.

Before changing lanes, check your mirrors. Then use your turn signal.

Just before you leave the lane, glance quickly over your shoulder to make sure there isn't another vehicle in your "blind" spot.

Once you are moving on the freeway, make certain you allow a reasonable following distance. Expect to move slightly slower at night.

When you want to leave the freeway, move to the proper lane well in advance. If you miss your exit do not, under any circumstances, stop and back up. Drive on to the next exit.

The exit ramp can be curved, sometimes quite sharply.

The exit speed is usually posted.

Reduce your speed according to your speedometer, not to your sense of motion. After driving for any distance at higher speeds, you may tend to think you are going slower than you actually are.

BEFORE LEAVING ON A LONG TRIP

Make sure you're ready. Try to be well rested. If you must start when you're not fresh -- such as after a day's work -- don't plan to make too many miles that first part of the journey. Wear comfortable clothing and shoes you can easily drive in.

Is your vehicle ready for a long trip? If you keep it serviced and maintained, it's ready to go. If it needs service, have it done before starting out. Of course, you'll find experienced and able service experts in Cadillac dealers all across North America. They'll be ready and willing to help if you need it.

Here are some things you can check before a trip:

- *Windshield Washer Fluid:* Is the reservoir full? Are all windows clean inside and outside?
- *Wiper Blades:* Are they in good shape?
- *Fuel, Engine Oil, Other Fluids:* Have you checked all levels?
- *Lamps:* Are they all working? Are the lenses clean?
- *Tires:* They are vitally important to a safe, trouble-free trip. Is the tread good enough for long-distance driving? Are the tires all inflated to the recommended pressure?
- *Weather Forecasts:* What's the weather outlook along your route? Should you delay your trip a short time to avoid a major storm system?
- *Maps:* Do you have up-to-date maps?

HIGHWAY HYPNOSIS

Is there actually such a condition as “highway hypnosis”? Or is it just plain falling asleep at the wheel? Call it highway hypnosis, lack of awareness, or whatever.

There is something about an easy stretch of road with the same scenery, along with the hum of the tires on the road, the drone of the engine, and the rush of the wind against the vehicle that can make you sleepy. Don't let it happen to you! If it does, your vehicle can leave the road in *less than a second*, and you could crash and be injured.

What can you do about highway hypnosis? First, be aware that it can happen.

Then here are some tips:

- Make sure your vehicle is well ventilated, with a comfortably cool interior.
- Keep your eyes moving. Scan the road ahead and to the sides. Check your rearview mirrors and your instruments frequently.
- If you get sleepy, pull off the road into a rest, service, or parking area and take a nap, get some exercise, or both. For safety, treat drowsiness on the highway as an emergency.

HILL AND MOUNTAIN ROADS



Driving on steep hills or mountains is different from driving in flat or rolling terrain.

If you drive regularly in steep country, or if you're planning to visit there, here are some tips that can make your trips safer and more enjoyable.

- Keep your vehicle in good shape. Check all fluid levels and also the brakes, tires, cooling system and transmission. These parts can work hard on mountain roads.
- Know how to go down hills. The most important thing to know is this: let your engine do some of the slowing down. Shift to a lower gear when you go down a steep or long hill.

 **CAUTION:**

If you don't shift down, your brakes could get so hot that they wouldn't work well. You would then have poor braking or even none going down a hill. You could crash. Shift down to let your engine assist your brakes on a steep downhill slope.

 **CAUTION:**

Coasting downhill in NEUTRAL (N) or with the ignition off is dangerous. Your brakes will have to do all the work of slowing down. They could get so hot that they wouldn't work well. You could crash. Always have your engine running and your vehicle in gear when you go downhill.

- Know how to go uphill. You may want to shift down to a lower gear. The lower gears help cool your engine and transmission, and you can climb the hill better.
- Stay in your own lane when driving on two-lane roads in hills or mountains. Don't swing wide or cut across the center of the road. Drive at speeds that let you stay in your own lane.
- As you go over the top of a hill, be alert. There could be something in your lane, like a stalled car or an accident.
- You may see highway signs on mountains that warn of special problems. Examples are long grades, passing or no-passing zones, a falling rocks area, or winding roads. Be alert to these and take appropriate action.

WINTER DRIVING



Here are some tips for winter driving:

- Have your Cadillac in good shape for winter. Be sure your engine coolant mix is correct.
- You may want to put winter emergency supplies in your trunk.



Include an ice scraper, a small brush or broom, a supply of windshield washer fluid, a rag, some winter outer clothing, a small shovel, a flashlight, a red cloth, and a couple of reflective warning triangles. And, if you will be driving under severe conditions, include a small bag of sand, a piece of old carpet or a couple of burlap bags to help provide traction. Be sure you properly secure these items in your vehicle.

Driving on Snow or Ice

Most of the time, those places where your tires meet the road probably have good traction.

However, if there is snow or ice between your tires and the road, you can have a very slippery situation. You'll have a lot less traction or "grip" and will need to be very careful.



What's the worst time for this? "Wet ice." Very cold snow or ice can be slick and hard to drive on. But wet ice can be even more trouble because it may offer the least traction of all. You can get "wet ice" when it's about freezing (32° F; 0° C) and freezing rain begins to fall. Try to avoid driving on wet ice until salt and sand crews can get there.

Whatever the condition -- smooth ice, packed, blowing or loose snow -- drive with caution.

Keep your traction control system on. It improves your ability to accelerate when driving on a slippery road. Even though your vehicle has a traction control system, you'll want to slow down and adjust your driving to the road conditions. See "Traction Control System" in the Index.

Your anti-lock brakes improve your ability to make a hard stop on a slippery road. Even though you have the anti-lock braking system, you'll want to begin stopping sooner than you would on dry pavement. See "Anti-Lock" in the Index.

- Allow greater following distance on any slippery road.

- Watch for slippery spots. The road might be fine until you hit a spot that's covered with ice. On an otherwise clear road, ice patches may appear in shaded areas where the sun can't reach: around clumps of trees, behind buildings, or under bridges. Sometimes the surface of a curve or an overpass may remain icy when the surrounding roads are clear. If you see a patch of ice ahead of you, brake before you are on it. Try not to brake while you're actually on the ice, and avoid sudden steering maneuvers.

If You're Caught in a Blizzard

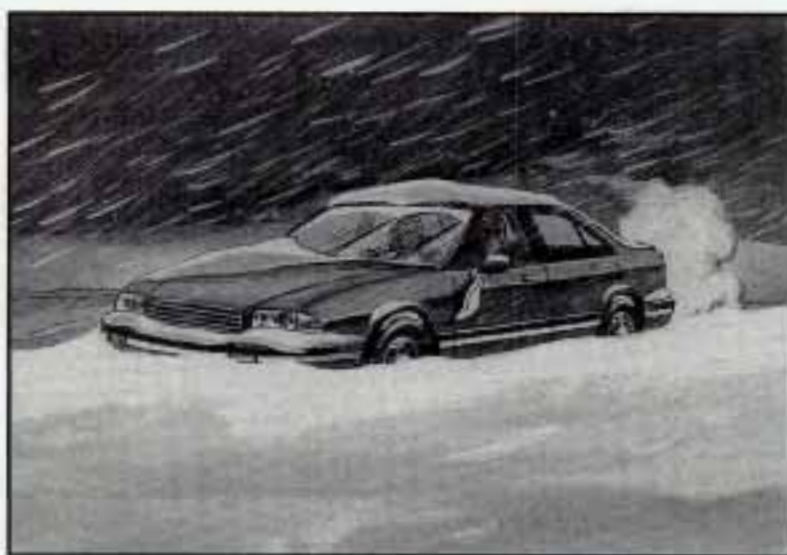

If you are stopped by heavy snow, you could be in a serious situation. You should probably stay with your vehicle unless you know for sure that you are near help and you can hike through the snow. Here are some things to do to summon help and keep yourself and your passengers safe: Turn on your hazard flashers. Tie a red cloth to your vehicle to alert police that you've been stopped by the snow. Put on extra clothing or wrap a blanket around you. If you have no blankets or extra clothing, make body insulators from newspapers, burlap bags, rags, floor mats -- anything you can wrap around yourself or tuck under your clothing to keep warm.

You can run the engine to keep warm, but be careful.



⚠ CAUTION:

Snow can trap exhaust gases under your vehicle. This can cause deadly CO (carbon monoxide) gas to get inside. CO could overcome you and kill you. You can't see it or smell it, so you might not know it is in your vehicle. Clear away snow from around the base of your vehicle, especially any that is blocking your exhaust pipe. And check around again from time to time to be sure snow doesn't collect there.

Open a window just a little on the side of the vehicle that's away from the wind. This will help keep CO out.

Run your engine only as long as you must. This saves fuel. When you run the engine, make it go a little faster than just idle. That is, push the accelerator slightly. This uses less fuel for the heat that you get and it keeps the battery charged. You will need a well-charged battery to restart the vehicle, and possibly for signaling later on with your headlamps. Let the heater run for awhile.

Then, shut the engine off and close the window almost all the way to preserve the heat. Start the engine again and repeat this only when you feel really uncomfortable from the cold. But do it as little as possible. Preserve the fuel as long as you can. To help keep warm, you can get out of the vehicle and do some fairly vigorous exercises every half hour or so until help comes.

LOADING YOUR VEHICLE



TIRE-LOADING INFORMATION

OCCUPANTS VEHICLE CAP. WT.

FRT. CTR. RR. TOTAL LBS. KG

MAX. LOADING & GVWR SAME AS VEHICLE

CAPACITY WEIGHT XXX COLD TIRE

TIRE SIZE SPEED PRESSURE

RTG PSI/KPa

FRT.

RR.

SPA.

IF TIRES ARE HOT, ADD 4PSI/28KPa SEE

OWNER'S MANUAL FOR ADDITIONAL

INFORMATION

GEN GME

Two labels on your vehicle show how much weight it may properly carry. The Tire-Loading Information label found on the driver's door tells you the proper size, speed rating and recommended inflation pressures for the tires on your vehicle. It also gives you important information about the number of people that can be in your vehicle and the total weight that you can carry. This weight is called the Vehicle Capacity Weight and includes the weight of all occupants, cargo and all options not installed in the factory.



MFD BY GENERAL MOTORS CORP
DATE GVWR GAWR FRT GAWR RR

THIS VEHICLE CONFORMS TO ALL APPLICABLE U.S. FEDERAL MOTOR VEHICLE SAFETY, BUMPER, AND THEFT PREVENTION STANDARDS IN EFFECT ON THE DATE OF MANUFACTURE SHOWN ABOVE.

GEN GME

The other label is the Certification label, found on the rear edge of the driver's door. It tells you the gross weight capacity of your vehicle, called the GVWR (Gross Vehicle Weight Rating). The GVWR includes the weight of the vehicle, all occupants, fuel and cargo. Never exceed the GVWR for your vehicle nor the GAWR (Gross Axle Weight Rating) for either the front or rear axle.

And, if you do have a heavy load, you should spread it out. Don't carry more than 200 pounds (90 kg) in your trunk.



CAUTION:

Do not load your vehicle any heavier than the GVWR, or either the maximum front or rear GAWR. If you do, parts on your vehicle can break, or it can change the way your vehicle handles. These could cause you to lose control. Also, overloading can shorten the life of your vehicle.

NOTICE:

Your warranty does not cover parts or components that fail because of overloading.

If you put things inside your vehicle -- like suitcases, tools, packages, or anything else -- they will go as fast as the vehicle goes. If you have to stop or turn quickly, or if there is a crash, they'll keep going.



CAUTION:

Things you put inside your vehicle can strike and injure people in a sudden stop or turn, or in a crash.

- Put things in the trunk of your vehicle. In a trunk, put them as far forward as you can. Try to spread the weight evenly.
- Never stack heavier things, like suitcases, inside the vehicle so that some of them are above the tops of the seats.
- Don't leave an unsecured child restraint in your vehicle.
- When you carry something inside the vehicle, secure it whenever you can.

TOWING A TRAILER



CAUTION:

If you don't use the correct equipment and drive properly, you can lose control when you pull a trailer. For example, if the trailer is too heavy, the brakes may not work well -- or even at all. You and your passengers could be seriously injured. Pull a trailer only if you have followed all the steps in this section. Ask your Cadillac dealer for advice and information about towing a trailer with your vehicle.

NOTICE:

Pulling a trailer improperly can damage your vehicle and result in costly repairs not covered by your warranty. To pull a trailer correctly, follow the advice in this part.

Your vehicle can tow a trailer if it is equipped with proper towing equipment. To identify what the vehicle trailering capacity is for your vehicle, you should read the information in "Weight of the Trailer" that appears later in this section. But trailering is different than just driving your vehicle by itself. Trailering means changes in handling, durability, and fuel economy. Successful, safe trailering takes correct equipment, and it has to be used properly.

That's the reason for this part. In it are many time-tested, important trailering tips and safety rules. Many of these are important for your safety and that of your passengers. So please read this section carefully before you pull a trailer.

Your Cadillac is a passenger vehicle. Trailer towing can change the way your vehicle performs on the road. The loads and forces created when trailering subject the vehicle to significant levels of stress.

Load-pulling components such as the engine, transmission, rear axle, wheel assemblies, and tires are forced to work harder against the drag of the added weight. The engine is required to operate at relatively higher speeds and under greater loads, generating extra heat. What's more, the trailer adds considerably to wind resistance, increasing the pulling requirements.

If You Do Decide To Pull A Trailer

If you do, here are some important points.

- There are many different laws, including speed limit restrictions, having to do with trailering. Make sure your rig will be legal, not only where you live but also where you'll be driving. A good source for this information can be state or provincial police.
- You should always use a weight distributing (equalizing) hitch if your trailer will weigh more than 3,000 pounds (1 362 kg). Consider using sway control if your loaded trailer will weigh 3,000 pounds (1 362 kg) or more. You can ask a hitch dealer about sway controls.
- Trailers that weigh more than 1,000 pounds (454 kg) should be equipped with trailer brakes.
- Surge brakes may be used on some trailers (e.g. boat trailers). However, surge brakes do not work well with most sway control devices. Do not use sway control devices on trailers equipped with surge brakes.
- Don't tow a trailer at all during the first 1,000 miles (1 600 km) your new vehicle is driven. Your engine, axle or other parts could be damaged.
- Then, during the first 500 miles (800 km) that you tow a trailer, don't drive over 50 mph (80 km/h) and don't make starts at full throttle. This helps your engine and other parts of your vehicle wear in at the heavier loads.
- Obey speed limit restrictions when towing a trailer. Don't drive faster than the maximum posted speed for trailers (or no more than 55 mph (90 km/h)) to save wear on your vehicle's parts. Avoid continuous operation in mountainous areas that have grades greater than 2% for longer than 5 miles.
- Change axle lubricant annually or every 7,500 miles (12 500 km) of trailer towing, whichever occurs first.

Three important considerations have to do with weight:

Weight of the Trailer

How heavy can a trailer safely be?

It should never weigh more than 2,000 pounds (900 kg) including the load or 7,000 pounds (3 180 kg) if you have the optional trailer towing package. But even that can be too heavy.

It also depends on how you plan to use your rig. For example, speed, altitude, road grades, outside temperature and how much your vehicle is used to pull a trailer are all important. And, it can also depend on any special equipment that you have on your vehicle.

You can ask your dealer for our trailering information or advice, or you can write us at:

Consumer Relations Center
Cadillac Motor Car Division
30009 Van Dyke
P.O. Box 9025
Warren, MI 48090-9025.

In Canada, write to:

General Motors of Canada Limited
Customer Assistance Center
1908 Colonel Sam Drive
Oshawa, Ontario L1H 8P7.

Weight of the Trailer Tongue

The tongue load (A) of any trailer is an important weight to measure because it affects the total capacity weight of your vehicle. The capacity weight includes the curb weight of the vehicle, any cargo you may carry in it, and the people who will be riding in the vehicle. And if you will tow a trailer, you must subtract the tongue load from your vehicle's capacity weight because your vehicle will be carrying that weight, too. See "Loading Your Vehicle" in the Index for more information about your vehicle's maximum load capacity.

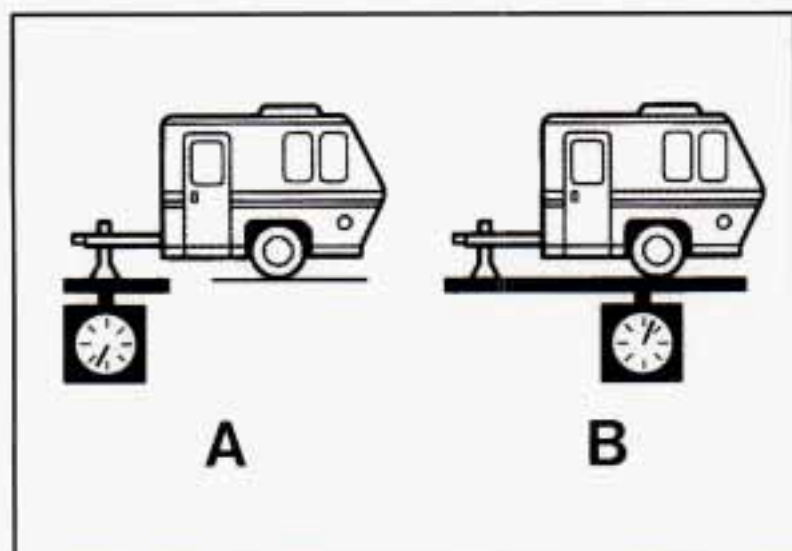

If you're using a "dead-weight" hitch, the trailer tongue (A) should weigh 10% of the total loaded trailer weight (B). If you have a "weight-distributing" hitch, the trailer tongue (A) should weigh 12% of the total loaded trailer weight (B).

After you've loaded your trailer, weigh the trailer and then the tongue, separately, to see if the weights are proper. If they aren't, you may be able to get them right simply by moving some items around in the trailer.

Total Weight on Your Vehicle's Tires

Be sure your vehicle's tires are inflated to the recommended pressure for cold tires. You'll find these numbers on the Certification label at the rear edge of the driver's door or see "Loading Your Vehicle" in the Index. Then be sure you don't go over the GVW limit for your vehicle, including the weight of the trailer tongue.

Gross Combined Vehicle Weight Rating (GCVWR)

GCVWR = Curb Weight + 2 Passengers + Cargo + Trailer

WHERE: Vehicle Curb Weight = 4,370 pounds
 2 Passengers = 150 pounds (Each)
 Cargo = 200 pounds + Safety Factor

How Equipped GCVWR

Standard Vehicle Up to 2,000 pounds (900 kg)

Trailer 7,450 pounds (3 178 kg)

With 7,000 pounds (3 180 kg)

Trailer Tow Option (V4P) 12,100 pounds (5 490 kg)

To determine how your Fleetwood is equipped, see the Service Parts Identification label on the underside of the trunk lid.

NOTICE:

Do not exceed the gross vehicle weight rating (GVWR) for your vehicle.

Hitches

It's important to have the correct hitch equipment. Crosswinds, large trucks going by, and rough roads are a few reasons why you'll need the right hitch. Here are some rules to follow:

- If you'll be pulling a trailer that, when loaded, will weigh more than 2,000 pounds (900 kg), be sure to use a properly mounted, weight-distributing hitch and sway control of the proper size. This equipment is very important for proper vehicle loading and good handling when you're driving.
- Will you have to make any holes in the body of your vehicle when you install a trailer hitch? If you do, then be sure to seal the holes later when you remove the hitch. If you don't seal them, deadly carbon monoxide (CO) from your exhaust can get into your vehicle (see "Carbon Monoxide" in the Index). Dirt and water can, too.
- Don't let the steel in a hitch contact the aluminum on your bumper. If you do, the two will corrode. You can use something like paint or plastic tape to separate the steel and aluminum. The same steel to aluminum problem can happen with fasteners, too.

Using A Dead Weight Trailer Hitch

(Recommended for loaded trailers weighing less than 3,000 lbs.)

- The trailer tongue should weigh 10% of the total trailer load (maximum 300 lbs.) or as specified by the trailer manufacturer to minimize sway.
- Trailers that weigh more than 1,000 pounds (454 kg) should be equipped with trailer brakes.
- Consider using sway control if your loaded trailer will weigh 3,000 pounds (1 362 kg) or more.

Trailer Hitching Procedure Using A Weight Distributing (Equalizing) Hitch

(Recommended for loaded trailers weighing 3,000 lbs. to 7,000 lbs.)

Using a weight distributing hitch without disabling the Electronic Level Control (ELC) system may defeat the purpose of the weight distributing hitch. Also, your rear tires may become overloaded. A weight distributing hitch should spread the load to all axles. If you use a weight distributing hitch, always disable the ELC by following the proper steps.

Your vehicle is equipped with an Electronic Level Control (ELC) feature. When hooking up a trailer using a weight distributing hitch, always use the following procedure:

- Place the vehicle on a level surface without the trailer hitched. With the ignition off, and all doors closed, allow the vehicle to level automatically.
- Disable the Electronic Level Control (ELC) by pulling the LEVEL CTRL fuse #9 (30 AMP) from the underhood electrical center located on the passenger side wheel housing in the engine compartment. Remove the cover to gain access.
- Attach the trailer to the vehicle. The trailer tongue should weigh 12% of the total loaded trailer weight.
- Level the vehicle with the load leveling spring bars (equalizers).
- Leave the fuse out while towing your trailer.

Once you have completed towing your trailer, be sure to reinstall the Electronic Level Control (ELC) fuse.

In Addition

- Use two friction sway controls if your trailer is over 5,000 lbs. (2 270 kg) loaded weight, and/or is over 24 ft. (7.3 m) long.
- Use at least one friction sway control if your trailer is over 2,000 lbs. (900 kg) loaded weight, and consider using one for trailers under 2,000 lbs. (900 kg).
- Trailers that weigh more than 1,000 pounds (454 kg) should be equipped with trailer brakes.
- Surge brakes work with most weight distributing hitches as long as all the equipment is properly installed. Check with the hitch manufacturer for advice and installation instructions.
- If a trailer is over 5,000 lbs. (2 270 kg), adjust the vehicle rear tire pressure to 35 psi (240 kPa) (cold tire pressure).

Safety Chains

You should always attach chains between your vehicle and your trailer. Cross the safety chains under the tongue of the trailer so that the tongue will not drop to the road if it becomes separated from the hitch. Instructions about safety chains may be provided by the hitch manufacturer or by the trailer manufacturer. Follow the manufacturer's recommendation for attaching safety chains and do not attach them to the bumper. Always leave just enough slack so you can turn with your rig. And, never allow safety chains to drag on the ground.

Trailer Brakes

If your trailer weighs more than 1,000 pounds (450 kg) when loaded, it needs to be equipped with adequate brakes. Be sure to read and follow the instructions for the trailer brakes so you'll be able to maintain them properly.

Because you have anti-lock brakes, do not try to tap into your vehicle hydraulic brake system. If you do, both brake systems won't work well, or at all.

Trailer Wiring Harness

If your Fleetwood is equipped with the heavy duty trailering option, a five wire trailering harness is located in the trunk. You may have to have it wired to your vehicle.

These trailer harness color codes should be followed when connecting to your trailer:

- *White*: Direct Trailer Ground for Trailer Lamps
- *Brown*: Park Lamps
- *Yellow*: Left Turn and Stoplamps
- *Dark Green*: Right Turn and Stoplamps
- *Dark Blue*: Auxiliary Circuit

Driving with a Trailer

Towing a trailer requires a certain amount of experience. Before setting out for the open road, you'll want to get to know your rig. Acquaint yourself with the feel of handling and braking with the added weight of the trailer. And always keep in mind that the vehicle you are driving is now a good deal longer and not nearly as responsive as your vehicle is by itself.

Before you start, check the trailer hitch and platform (and attachments), safety chains, electrical connector, lamps, tires and mirror adjustment. If the trailer has electric brakes, start your vehicle and trailer moving and then apply the trailer brake controller by hand to be sure the brakes are working. This lets you check your electrical connection at the same time.

During your trip, check occasionally to be sure that the load is secure, and that the lamps and any trailer brakes are still working.

Following Distance

Stay at least twice as far behind the vehicle ahead as you would when driving your vehicle without a trailer. This can help you avoid situations that require heavy braking and sudden turns.

Passing

You'll need more passing distance up ahead when you're towing a trailer. And, because you're a good deal longer, you'll need to go much farther beyond the passed vehicle before you can return to your lane.

Backing Up

Hold the bottom of the steering wheel with one hand. Then, to move the trailer to the left, just move that hand to the left. To move the trailer to the right, move your hand to the right. Always back up slowly and, if possible, have someone guide you.

Making Turns

NOTICE:

Making very sharp turns while trailering could cause the trailer to come in contact with the vehicle. Your vehicle could be damaged. Avoid making very sharp turns while trailering.

When you're turning with a trailer, make wider turns than normal. Do this so your trailer won't strike soft shoulders, curbs, road signs, trees, or other objects. Avoid jerky or sudden maneuvers. Signal well in advance.

Turn Signals When Towing a Trailer

When you tow a trailer, your vehicle has to have a different turn signal flasher and extra wiring. The green arrows on your instrument panel will flash whenever you signal a turn or lane change. Properly hooked up, the trailer lamps will also flash, telling other drivers you're about to turn, change lanes or stop.

When towing a trailer, the green arrows on your instrument panel will flash for turns even if the bulbs on the trailer are burned out. Thus, you may think drivers behind you are seeing your signal when they are not. It's important to check occasionally to be sure the trailer bulbs are still working.

Driving On Grades

Reduce speed and shift to a lower gear *before* you start down a long or steep downgrade. If you don't shift down, you might have to use your brakes so much that they would get hot and no longer work well.

On a long uphill grade, shift down to a lower gear and reduce your speed to around 45 mph (70 km/h) to reduce the possibility of engine and transmission overheating.

If your trailer weighs more than 2,000 pounds (900 kg), you should drive in DRIVE (D or 3) instead of OVERDRIVE (Ⓢ). This allows the torque convertor clutch to engage and the transmission to run cooler.

Parking on Hills

You really should not park your vehicle, with a trailer attached, on a hill. If something goes wrong, your rig could start to move. People can be injured, and both your vehicle and the trailer can be damaged.

But if you ever have to park your rig on a hill, here's how to do it:

1. Apply your regular brakes, but don't shift into PARK (P) yet.
2. Have someone place chocks under the downhill side of the trailer wheels.
3. When the wheel chocks are in place, release the regular brakes until the chocks absorb the load.
4. Reapply the regular brakes. Then shift into PARK (P) and apply the parking brake.
5. Release the regular brakes.

When You Are Ready to Leave After Parking on a Hill

1. Apply your regular brakes and hold the pedal down while you:
 - Start your engine;
 - Shift into a gear; and
 - Be sure the parking brake has released.
2. Let up on the brake pedal.
3. Drive slowly until the trailer is clear of the chocks.
4. Stop and have someone pick up and store the chocks.

Engine Cooling When Trailering

Your cooling system may temporarily overheat during severe operating conditions such as:

- Climbing grades steeper than 4% at temperatures above 90° F (32° C) with a loaded vehicle and trailer.
- Stopping after high-speed driving.
- Idling for long periods in stop and go traffic.

If the TEMP warning light comes on, pull to the side of the road as soon as it is safe to do so. When the vehicle is at a complete stop, shift the transmission selector to PARK (P) and allow the engine to idle. If your Electronic Climate Control system is on, shut it off. Do not turn off the engine or increase engine speed above a normal idle. Within two or three minutes, the system should cool sufficiently, and you can turn on the Electronic Climate Control. At that time, resume driving at a reduced speed. Return to normal driving after 10 minutes if the TEMP warning light is not displayed.

Maintenance When Trailer Towing

Your vehicle will need service more often when you're pulling a trailer. See the Maintenance Schedule for more on this. Things that are especially important in trailer operation are automatic transmission fluid (don't overfill), engine oil, axle lubricant, belt, cooling system, and brake adjustment. Each of these is covered in this manual, and the Index will help you find them quickly. If you're trailering, it's a good idea to review these sections before you start your trip.

Check periodically to see that all hitch nuts and bolts are tight.



SECTION 5

PROBLEMS ON THE ROAD

Here you'll find what to do about some problems that can occur on the road.

HAZARD WARNING FLASHERS



Your hazard warning flashers let you warn others. They also let police know you have a problem. Your front and rear turn signal lamps will flash on and off.



Press the button in to make your front and rear turn signal lamps flash on and off.

Your hazard warning flashers work no matter what position your key is in, and even if the key isn't in.



To turn off the flashers, pull out on the collar. When the hazard warning flashers are on, your turn signals won't work.

OTHER WARNING DEVICES

If you carry reflective triangles, you can set one up at the side of the road about 300 feet (100 m) behind your vehicle.

JUMP STARTING

If your battery has run down, you may want to use another vehicle and some jumper cables to start your Cadillac. But please follow the steps below to do it safely.

CAUTION:

Batteries can hurt you. They can be dangerous because:

- They contain acid that can burn you.
- They contain gas that can explode or ignite.
- They contain enough electricity to burn you.

If you don't follow these steps exactly, some or all of these things can hurt you.

NOTICE:

Ignoring these steps could result in costly damage to your vehicle that wouldn't be covered by your warranty.

Trying to start your Cadillac by pushing or pulling it won't work, and it could damage your vehicle.

TO JUMP START YOUR CADILLAC

1. Check the other vehicle. It must have a 12-volt battery with a negative ground system.

NOTICE:

If the other system isn't a 12-volt system with a negative ground, both vehicles can be damaged.

2. Get the vehicles close enough so the jumper cables can reach, but be sure the vehicles aren't touching each other. If they are, it could cause a ground connection you don't want. You wouldn't be able to start your Cadillac, and the bad grounding could damage the electrical systems.

You could be injured if the vehicles roll. Set the parking brake firmly on each vehicle. Shift into PARK (P).

3. Turn off the ignition on both vehicles. Turn off all lamps that aren't needed, and radios. This will avoid sparks and help save both batteries. And it could save your radio!

NOTICE:

If you leave your radio on, it could be badly damaged. The repairs wouldn't be covered by your warranty.

4. Open the hoods and locate the batteries.

Find the positive (+) and negative (-) terminals on each battery.

 **CAUTION:**

Using a match near a battery can cause battery gas to explode. People have been hurt doing this, and some have been blinded. Use a flashlight if you need more light.

Be sure the battery has enough water. You don't need to add water to the Delco Freedom[®] battery installed in every new GM vehicle. But if a battery has filler caps, be sure the right amount of fluid is there. If it is low, add water to take care of that first. If you don't, explosive gas could be present.

Battery fluid contains acid that can burn you. Don't get it on you. If you accidentally get it in your eyes or on your skin, flush the place with water and get medical help immediately.

5. Check that the jumper cables don't have loose or missing insulation. If they do, you could get a shock. The vehicles could be damaged, too.

Before you connect the cables, here are some basic things you should know. Positive (+) will go to positive (+) and negative (-) will go to negative (-) or a metal engine part. Don't connect (+) to (-) or you'll get a short that would damage the battery and maybe other parts, too.

 **CAUTION:**

Fans or other moving engine parts can injure you badly. Keep your hands away from moving parts once the engines are running.



6. Connect the red positive (+) cable to the positive (+) terminal of the vehicle with the dead battery.

7. Don't let the other end touch metal. Connect it to the positive (+) terminal of the good battery. Use a remote positive (+) terminal if the vehicle has one.
8. Now connect the black negative (-) cable to the good battery's negative (-) terminal.

Don't let the other end touch anything until the next step. The other end of the negative cable *doesn't* go to the dead battery. It goes to a heavy unpainted metal part on the engine of the vehicle with the dead battery.

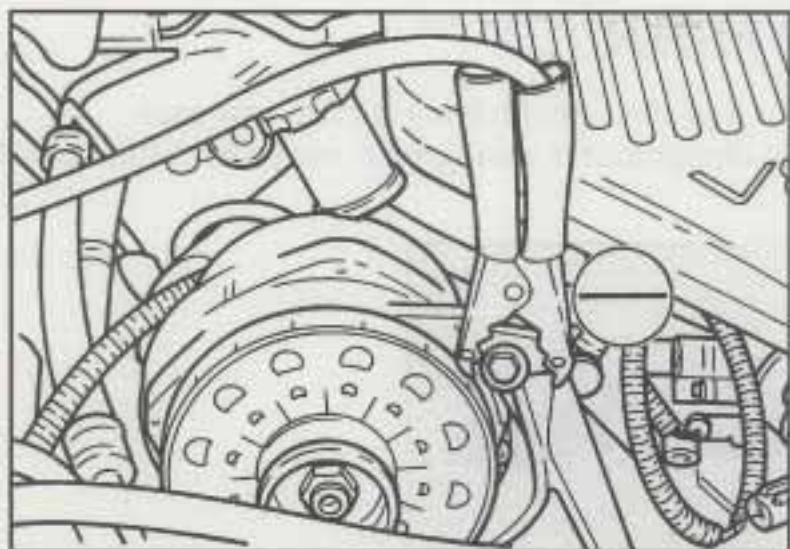

9. Attach the cable at least 18 inches (45 cm) away from the dead battery, but not near engine parts that move. The electrical connection is just as good there, but the chance of sparks getting back to the battery is much less.

10. Now start the vehicle with the good battery and run the engine for a while.

11. Try to start the vehicle with the dead battery.

If it won't start after a few tries, it probably needs service.

12. Remove the cables in reverse order to prevent electrical shorting. Take care that they don't touch each other or any other metal.

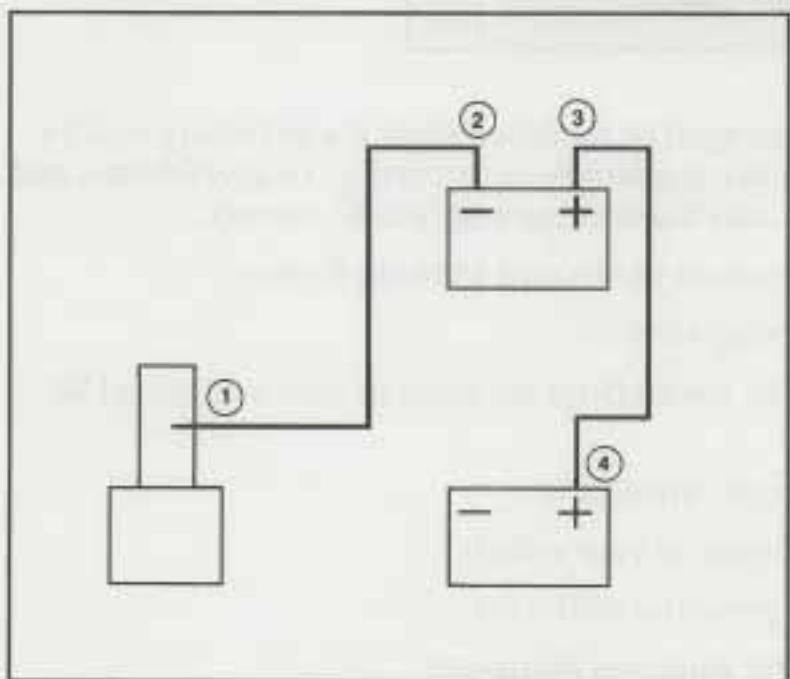

Follow this order.

TOWING YOUR VEHICLE

Try to have a GM dealer or a professional towing service tow your Cadillac. The usual towing equipment is a sling-type, or a wheel-lift, or car carrier tow truck.

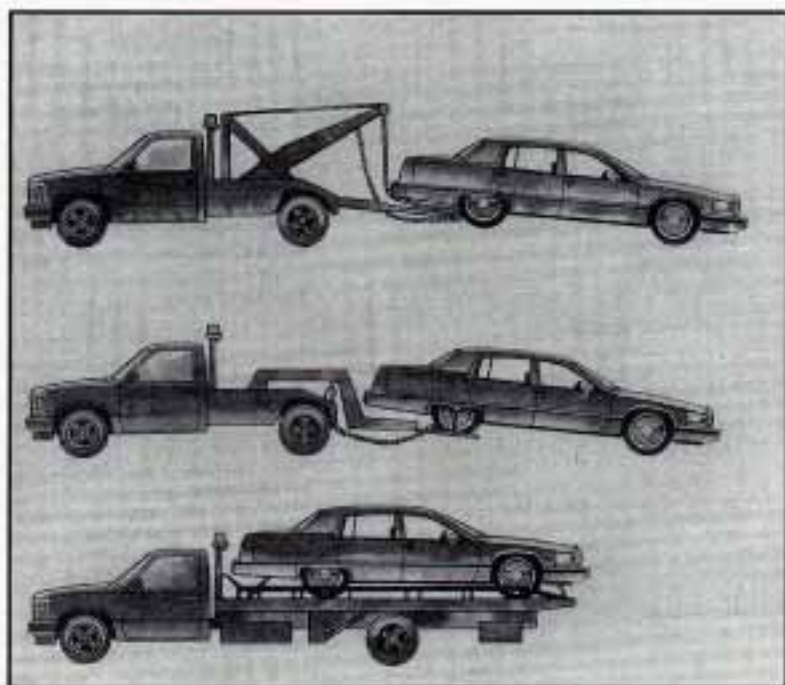

If your vehicle has been changed or modified since it was factory-new by adding aftermarket items like fog lamps, aero skirting, or special tires and wheels, these instructions and illustrations may not be correct.

Before you do anything, turn on the hazard warning flashers.

When you call, tell the towing service:

- That your vehicle can be towed from the front or rear with wheel lift equipment.
- That your vehicle has rear-wheel drive.
- The make, model, and year of your vehicle.
- Whether you can still move the shift lever.
- If there was an accident, what was damaged.

When the towing service arrives, let the tow operator know that this manual contains detailed towing instructions and illustrations. The operator may want to see them.

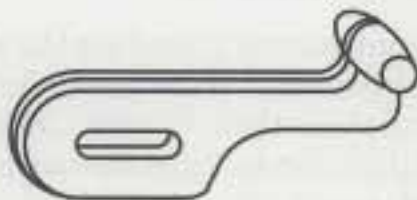

CAUTION:

To help avoid injury to you or others:

- Never let passengers ride in a vehicle that is being towed.
- Never tow faster than safe or posted speeds.
- Never tow with damaged parts not fully secured.
- Never get under your vehicle after it has been lifted by the tow truck.
- Always secure the vehicle on each side with separate safety chains when towing it.
- Never use J-hooks. Use T-hooks instead.

When your vehicle is being towed, have the ignition key off. The steering wheel should be clamped in a straight-ahead position, with a clamping device designed for towing service. Do not use the vehicle's steering column lock for this. The transmission should be in NEUTRAL (N) and the parking brake released.

Don't have your vehicle towed on the rear wheels, unless you must. If the vehicle must be towed on the rear wheels, don't go more than 35 mph (55 km/h) or farther than 50 miles (80 km) or your transmission will be damaged. If these limits must be exceeded, then the rear wheels have to be supported on a dolly.

 **CAUTION:**

A vehicle can fall from a car carrier if it isn't adequately secured. This can cause a collision, serious personal injury and vehicle damage. The vehicle should be tightly secured with chains or steel cables before it is transported.

Don't use substitutes (ropes, leather straps, canvas webbing, etc.) that can be cut by sharp edges underneath the towed vehicle. Always use T-hooks inserted in the T-hook slots. Never use J-hooks. They will damage drivetrain and suspension components.

Front Sling-Type Hookups

No 4 x 4 wood beam is required. Position the cross bar just behind the rear edge of the front bumper.

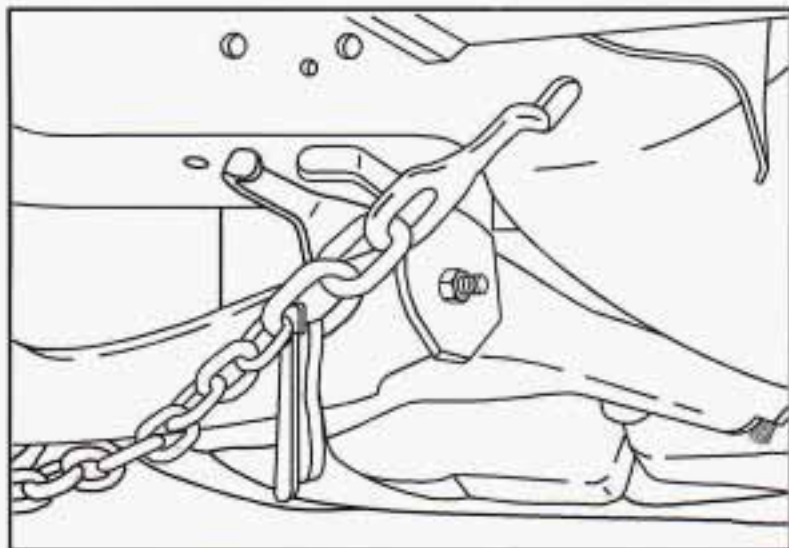

Attach T-hook chains into the bottom slots on both frame rails.

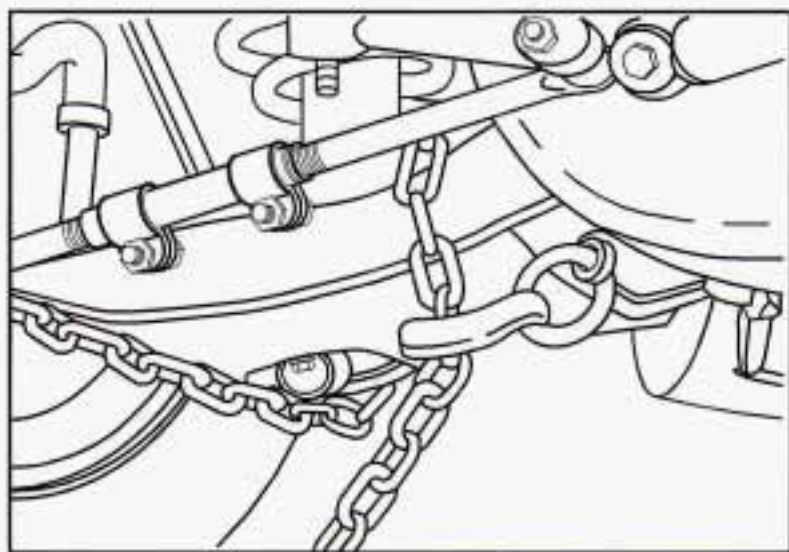

Attach a separate safety chain around the outboard end of each lower control arm.

Rear Sling-Type Hookups

No 4 x 4 wood beam is required. Position the cross bar directly under the rear bumper.

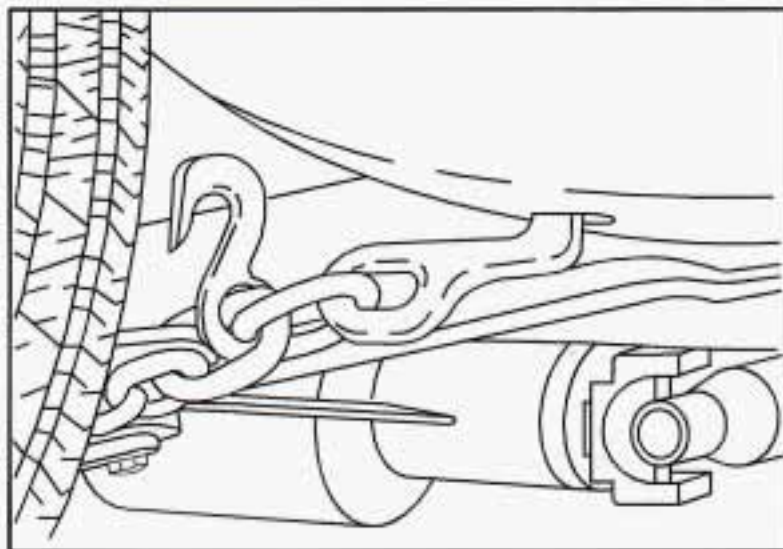

Attach T-hook chains to the slots in frame rails just ahead of the rear wheels.

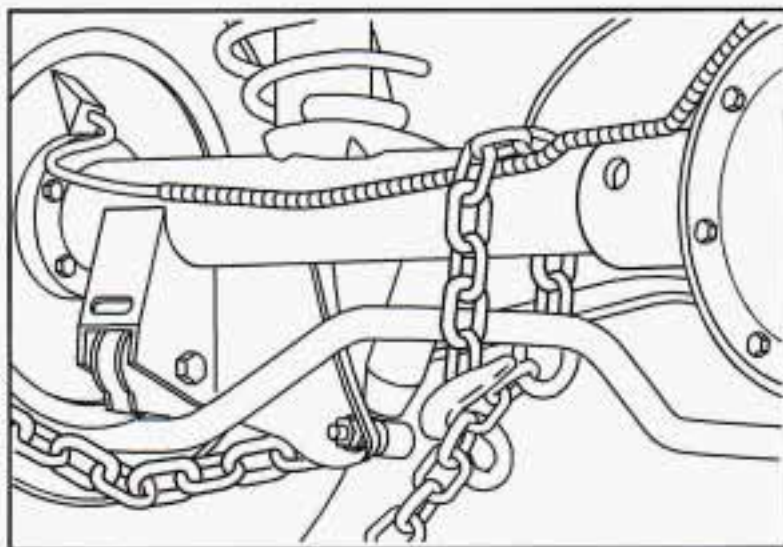

Attach a separate safety chain around each side of the axle inboard of the springs.

ENGINE OVERHEATING

You will find the warning light about a hot engine on your Cadillac instrument panel.

If Steam Is Coming From Your Engine

CAUTION:

Steam from an overheated engine can burn you badly, even if you just open the hood. Stay away from the engine if you see or hear steam coming from it. Just turn it off and get everyone away from the vehicle until it cools down. Wait until there is no sign of steam or coolant before opening the hood.

If you keep driving when your engine is overheated, the liquids in it can catch fire. You or others could be badly burned. Stop your engine if it overheats, and get out of the vehicle until the engine is cool.

NOTICE:

If your engine catches fire because you keep driving with no coolant, your vehicle can be badly damaged. The costly repairs would not be covered by your warranty.

If No Steam Is Coming From Your Engine

If you get the overheat warning but see or hear no steam, the problem may not be too serious. Sometimes the engine can get a little too hot when you:

- Climb a long hill on a hot day.
- Stop after high speed driving.
- Idle for long periods in traffic.
- Tow a trailer.

If you get the overheat warning with no sign of steam, try this for a minute or so:

1. Turn off your air conditioner.
2. Turn on your heater to full hot at the highest fan speed and open the window as necessary.
3. If you're in a traffic jam, shift to NEUTRAL (N); otherwise, shift to the highest gear while driving -- AUTOMATIC OVERDRIVE (Ⓢ) or DRIVE (D).

If you no longer have the overheat warning, you can drive. Just to be safe, drive slower for about ten minutes. If the warning doesn't come back on, you can drive normally.

If the warning continues, pull over, stop, and park your vehicle right away.

If there's still no sign of steam, you can idle the engine for two or three minutes while you're parked, to see if the warning stops. But then, if you still have the warning, *turn off the engine and get everyone out of the vehicle until it cools down.*

You may decide not to lift the hood but to get service help right away.

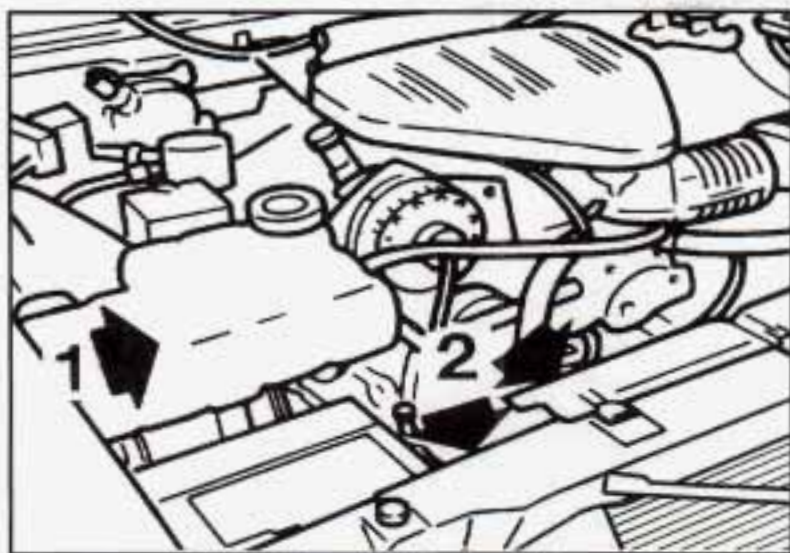

When you decide it's safe to lift the hood, here's what you'll see:

1. Coolant Surge Tank
2. Electric Engine Fan(s)



CAUTION:

An electric fan under the hood can start up even when the engine is not running and can injure you. Keep hands, clothing and tools away from any underhood electric fan.

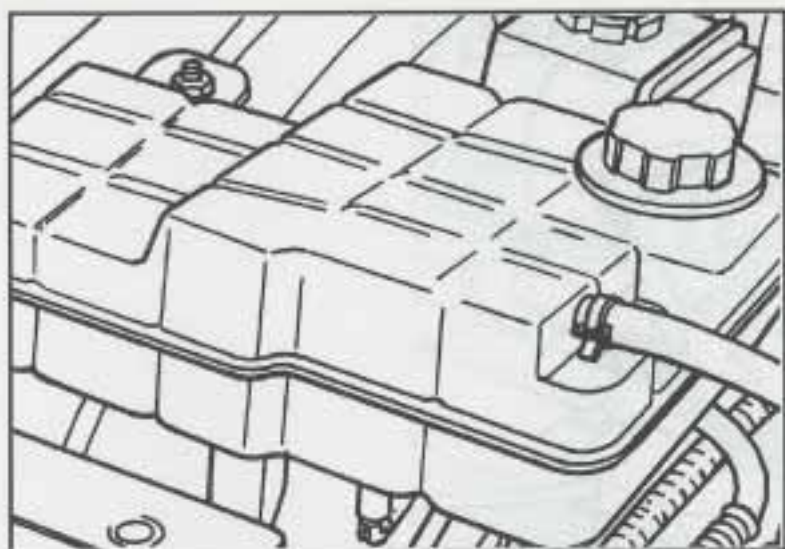

If the coolant inside the coolant surge tank is boiling, don't do anything else until it cools down.

The coolant level should be at or above the FULL COLD mark. If it isn't, you may have a leak in the radiator hoses, heater hoses, radiator, water pump or somewhere else in the cooling system.



CAUTION:

Heater and radiator hoses, and other engine parts, can be very hot. Don't touch them. If you do, you can be burned.

Don't run the engine if there is a leak. If you run the engine, it could lose all coolant. That could cause an engine fire, and you could be burned. Get any leak fixed before you drive the vehicle.

NOTICE:

Engine damage from running your engine without coolant isn't covered by your warranty.

If there seems to be no leak, with the engine on check to see if the electric engine fan(s) are running. If the engine is overheating, both fan(s) should be running. If they aren't, your vehicle needs service.

How to Add Coolant to the Coolant Surge Tank

If you haven't found a problem yet, but the coolant level isn't at the FULL COLD mark, add a 50/50 mixture of *clean water* (preferably distilled) and a proper antifreeze at the coolant surge tank, but be sure the cooling system, including the coolant surge tank pressure cap, is cool before you do it. (See "Engine Coolant" in the Index for more information about the proper coolant mix.)

CAUTION:

Steam and scalding liquids from a hot cooling system can blow out and burn you badly. They are under pressure, and if you turn the coolant surge tank pressure cap -- even a little -- they can come out at high speed. Never turn the cap when the cooling system, including the coolant surge tank pressure cap, is hot. Wait for the cooling system and coolant surge tank pressure cap to cool if you ever have to turn the pressure cap.



 **CAUTION:**

Adding only plain water to your cooling system can be dangerous. Plain water, or some other liquid like alcohol, can boil before the proper coolant mix will. Your vehicle's coolant warning system is set for the proper coolant mix. With plain water or the wrong mix, your engine could get too hot but you wouldn't get the overheat warning. Your engine could catch fire and you or others could be burned. Use a 50/50 mix of clean water and a proper antifreeze.

NOTICE:

In cold weather, water can freeze and crack the engine, radiator, heater core and other parts. So use the recommended coolant.

 **CAUTION:**

You can be burned if you spill coolant on hot engine parts. Coolant contains ethylene glycol and it will burn if the engine parts are hot enough. Don't spill coolant on a hot engine.

1. You can remove the coolant surge tank pressure cap when the cooling system, including the coolant surge tank pressure cap and upper radiator hose, is no longer hot.



Turn the pressure cap slowly about one-quarter turn to the left and then stop.

If you hear a hiss, wait for that to stop. A hiss means there is still some pressure left.

2. Then keep turning the pressure cap slowly, and remove it.
3. Then fill the coolant surge tank with the proper mix, up to FULL COLD mark.



4. With the coolant surge tank pressure cap off, start the engine and let it run until you can feel the upper radiator hose getting hot. Watch out for the engine fans.

By this time, the coolant level inside the coolant surge tank may be lower. If the level is lower, add more of the proper mix to the coolant surge tank until the level reaches **FULL COLD**.



5. Then replace the pressure cap. Be sure the pressure cap is tight.

IF A TIRE GOES FLAT

It's unusual for a tire to "blow out" while you're driving, especially if you maintain your tires properly. If air goes out of a tire, it's much more likely to leak out slowly. But if you should ever have a "blowout," here are a few tips about what to expect and what to do:

If a front tire fails, the flat tire will create a drag that pulls the vehicle toward that side. Take your foot off the accelerator pedal and grip the steering wheel firmly. Steer to maintain lane position, then gently brake to a stop well out of the traffic lane.

A rear blowout, particularly on a curve, acts much like a skid and may require the same correction you'd use in a skid. In any rear blowout, remove your foot from the accelerator pedal. Get the vehicle under control by steering the way you want the vehicle to go. It may be very bumpy and noisy, but you can still steer. Gently brake to a stop, well off the road if possible.

If a tire goes flat, the next part shows how to use your jacking equipment to change a flat tire safely.

CHANGING A FLAT TIRE

If a tire goes flat, avoid further tire and wheel damage by driving slowly to a level place. Turn on your hazard warning flashers.

⚠ CAUTION:

Changing a tire can cause an injury. The vehicle can slip off the jack and roll over you or other people. You and they could be badly injured. Find a level place to change your tire. To help prevent the vehicle from moving:

1. Put the shift lever in PARK (P).
2. Set the parking brake firmly.
3. Turn off the engine.

To be even more certain the vehicle won't move, you can put blocks at the front and rear of the tire farthest away from the one being changed. That would be the tire on the other side of the vehicle, at the opposite end.



The following steps will tell you how to use the jack and change a tire.



The equipment you'll need is in the trunk.

Your vehicle may be equipped with the optional full size spare tire.

Remove the spare tire cover. Then remove the spare and jack.

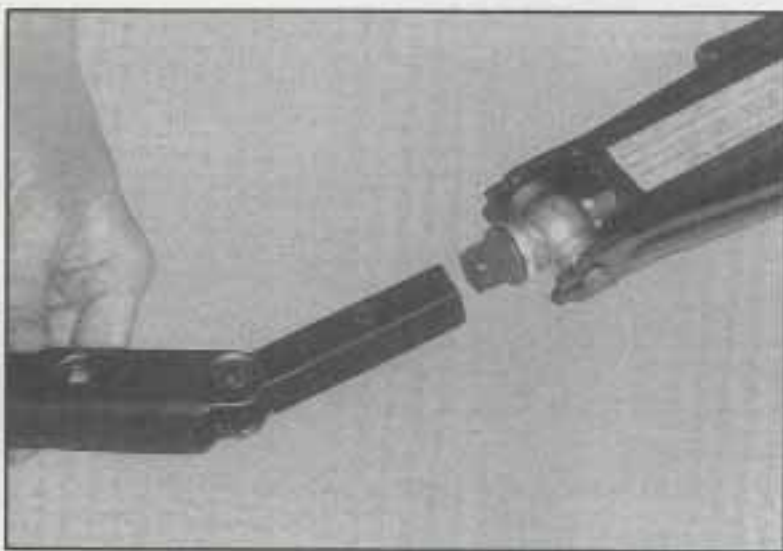

Attach the wheel wrench to the jack bolt and rotate it clockwise. That will raise the lift head.

If the flat tire is at the rear wheel, you have to remove the fender skirt first.

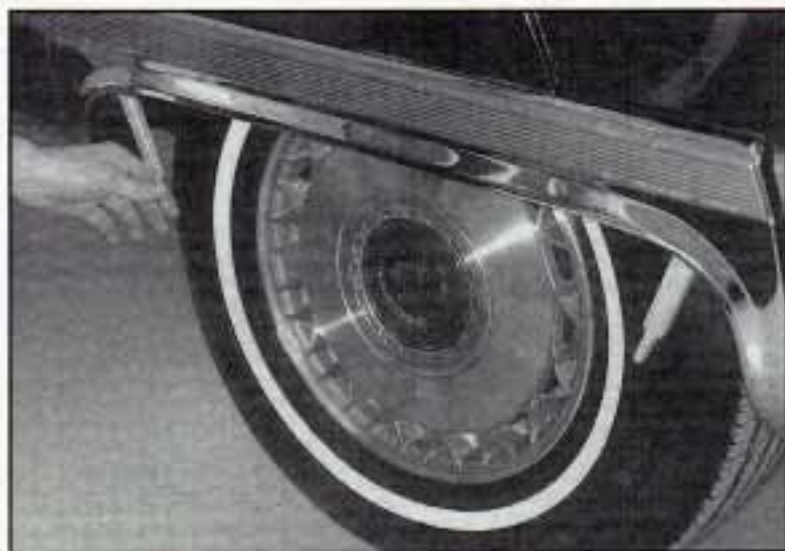

To unlock the fender skirt, locate the handles inside the fender skirt. Push the handles up and inward, and then pull them down. Gently remove the skirt by pulling it toward you. Place it to one side.

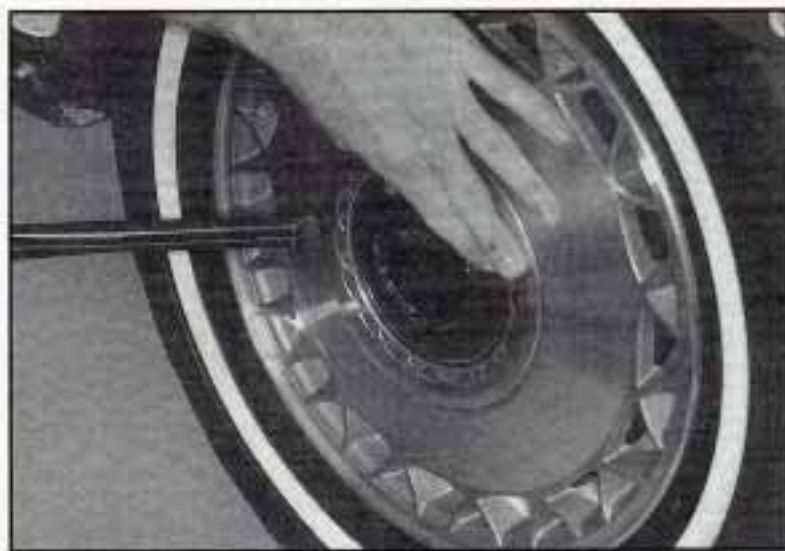

Use the flat end of the wheel wrench. Insert it into the small slot on the wheel and gently remove the center cover. Be careful not to drop the cover on the ground or you could scratch it.

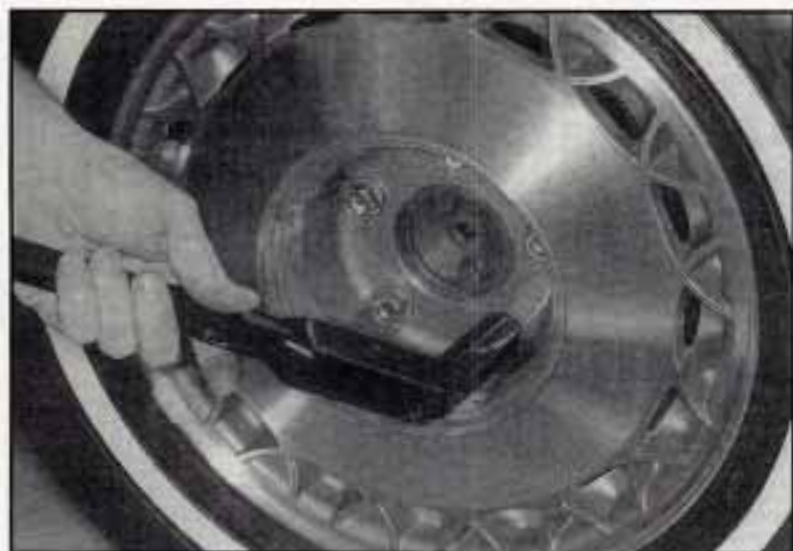

Using the wheel wrench, loosen all the wheel nuts. Don't remove them, yet.

Now move the jack over to where the flat tire is.

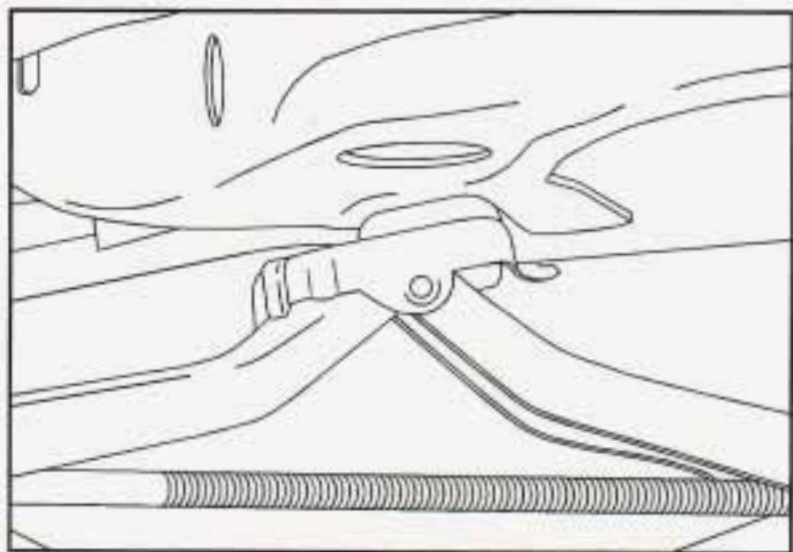

Fit the lift head into the large circular hole in the vehicle's frame.



CAUTION:

Getting under a vehicle when it is jacked up is dangerous. If the vehicle slips off the jack, you could be badly injured or killed. Never get under a vehicle when it is supported only by a jack.

NOTICE:

Raising your vehicle with the jack improperly positioned will damage the vehicle or may allow the vehicle to fall off the jack. Be sure to fit the jack lift head into the proper location before raising your vehicle.

Raise the vehicle by rotating the wheel wrench clockwise. Raise the vehicle far enough off the ground so there is enough room for the spare tire to fit.

Remove the wheel nuts and take off the flat tire.



CAUTION:

Rust or dirt on the wheel, or on the parts to which it is fastened, can make the wheel nuts become loose after a time. The wheel could come off and cause an accident. When you change a wheel, remove any rust or dirt from the places where the wheel attaches to the vehicle. In an emergency, you can use a cloth or a paper towel to do this; but be sure to use a scraper or wire brush later, if you need to, to get all the rust or dirt off.

Remove any rust or dirt from the wheel bolts, mounting surfaces and spare wheel. Place the spare on the wheel mounting surface.



CAUTION:

Never use oil or grease on studs or nuts. If you do, the nuts might come loose. Your wheel could fall off, causing a serious accident.

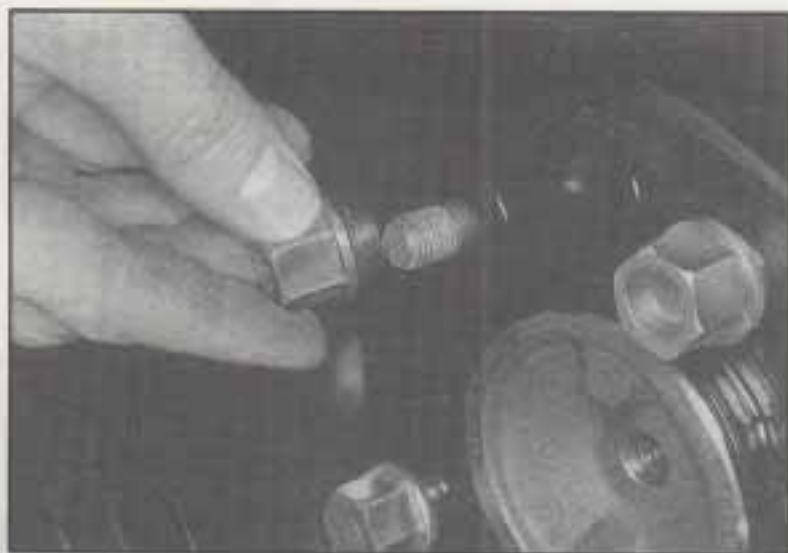

Replace the wheel nuts with the rounded end of the nuts toward the wheel. Tighten each nut by hand until the wheel is held against the hub.

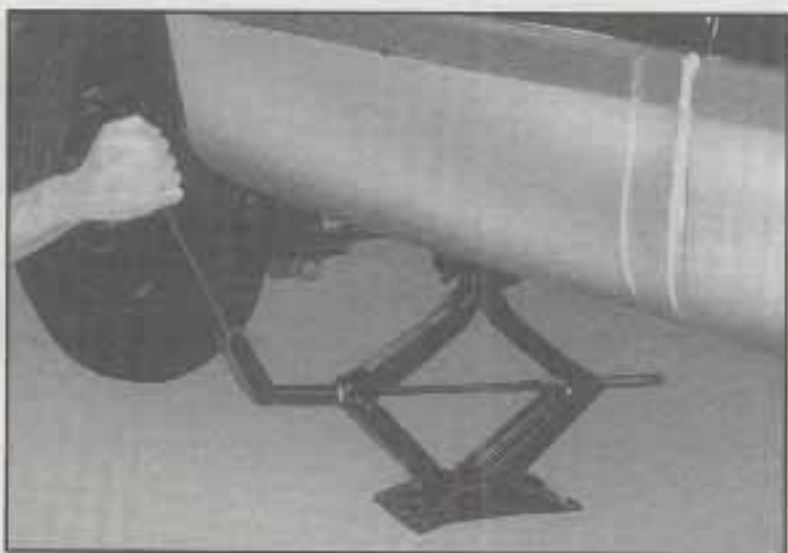

Lower the vehicle by rotating the wheel wrench counterclockwise. Lower the vehicle completely.

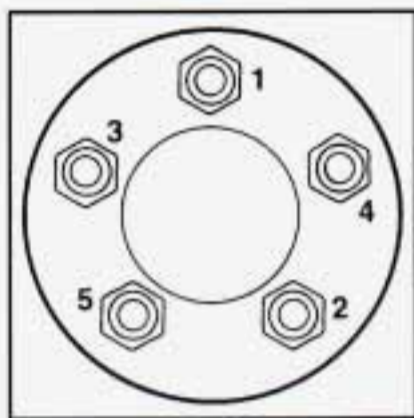

Tighten the wheel nuts firmly in a criss-cross sequence as shown.



CAUTION:

Incorrect wheel nuts or improperly tightened wheel nuts can cause the wheel to become loose and even come off. This could lead to an accident. Be sure to use the correct wheel nuts. If you have to replace them, be sure to get the right kind.

Stop somewhere as soon as you can and have the nuts tightened with a torque wrench to 100 lb. ft. (140 N·m).

Don't try to put a wheel cover on your compact spare tire. It won't fit. Store the wheel cover in the trunk until you have the flat tire repaired or replaced.

NOTICE:

Wheel covers won't fit on your compact spare. If you try to put a wheel cover on your compact spare, you could damage the cover or the spare.

Now put all the equipment back in your vehicle.

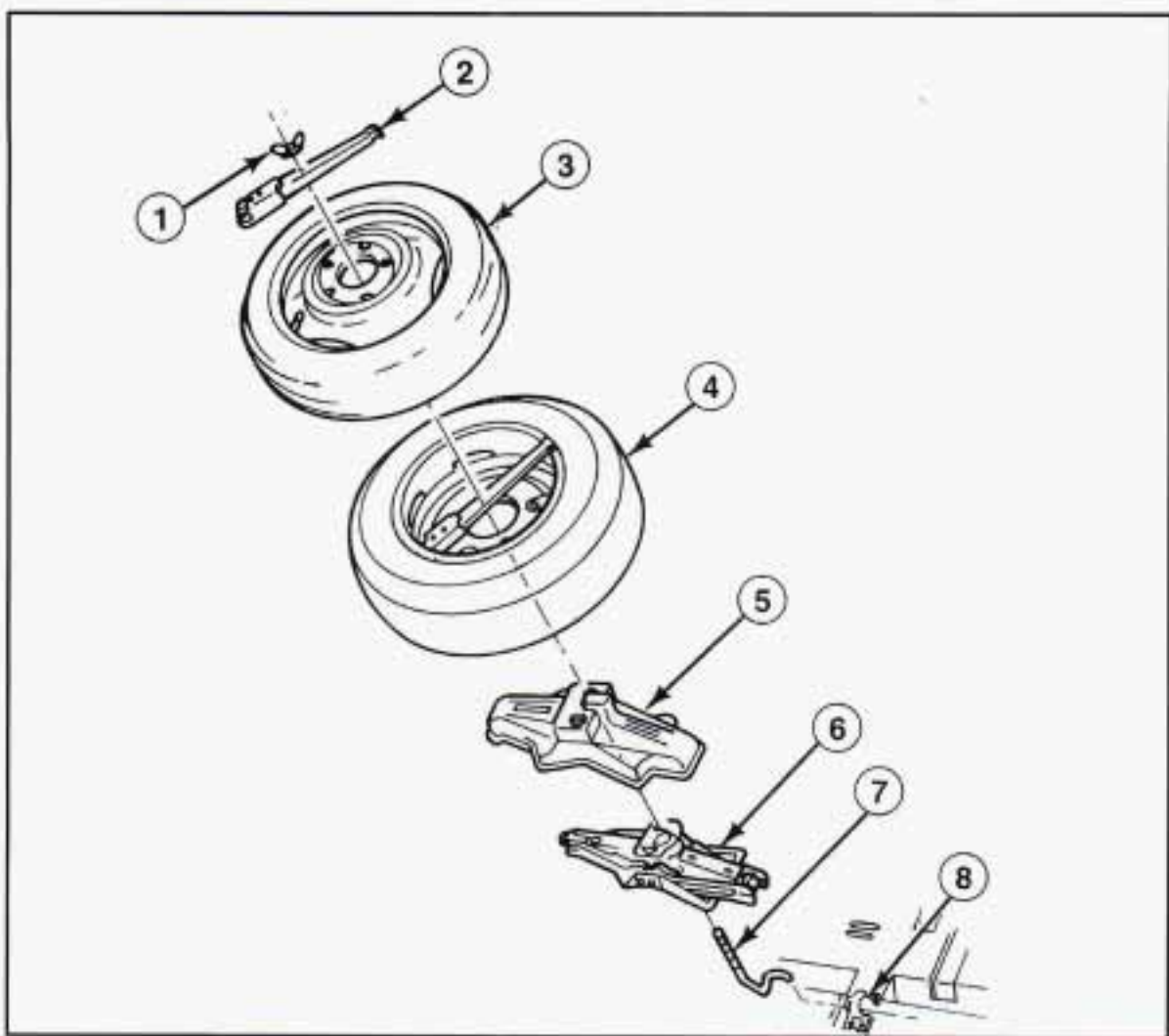

1. Wing Nut
2. Wrench
3. Compact Spare
4. Full Size Spare
5. Jack Cover (If Provided)
6. Jack
7. Bolt Screw (Hold-down)
8. Floor Bracket



CAUTION:

Storing a jack, a tire or other equipment in the passenger compartment of the vehicle could cause injury. In a sudden stop or collision, loose equipment could strike someone. Store all these in the proper place.

Reinstall Fender Skirt

Here's how to put your rear fender skirt back on:

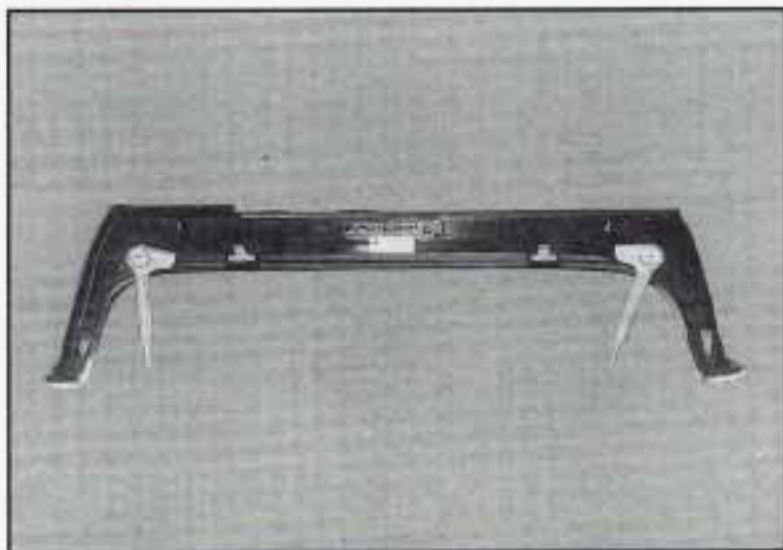

Pull the handles down.



Align the lower locator pins on each side to the skirt.



Align the upper locator pins and insert the pins into the holes.

Push the handles up to lock the skirt in place.

COMPACT SPARE TIRE (IF SO EQUIPPED)

Although the compact spare was fully inflated when your vehicle was new, it can lose air after a time. Check the inflation pressure regularly. It should be 60 psi (420 kPa). After installing the compact spare on your vehicle, you should stop as soon as possible and make sure your spare tire is correctly inflated. The compact spare is made to perform well at posted speed limits for distances up to 3,000 miles (5 000 km), so you can finish your trip and have your full-size tire repaired or replaced where you want. Of course, it's best to replace your spare with a full-size tire as soon as you can. Your spare will last longer and be in good shape in case you need it again.

Your anti-lock brake system warning light may come on when you are driving with a compact spare. See "Anti-Lock Brake System Warning Light" in the Index.

NOTICE:

Don't take your compact spare through an automatic car wash with guide rails. The compact spare can get caught on the rails. That can damage the tire and wheel, and maybe other parts of your vehicle.

Don't use your compact spare on some other vehicle.

And don't mix your compact spare or wheel with other wheels or tires. They won't fit. Keep your spare and its wheel together.

NOTICE:

Tire chains won't fit your compact spare. Using them will damage your vehicle and destroy the chains too. Don't use tire chains on your compact spare.

IF YOU'RE STUCK: IN SAND, MUD, ICE OR SNOW

What you don't want to do when your vehicle is stuck is to spin your wheels too fast. The method known as "rocking" can help you get out when you're stuck, but you must use caution.



CAUTION:

If you let your tires spin at high speed, they can explode and you or others could be injured. And, the transmission or other parts of the vehicle can overheat. That could cause an engine compartment fire or other damage. When you're stuck, spin the wheels as little as possible. Don't spin the wheels above 35 mph (55 km/h) as shown on the speedometer.

NOTICE:

Spinning your wheels can destroy parts of your vehicle as well as the tires. If you spin the wheels too fast while shifting your transmission back and forth, you can destroy your transmission.

For information about using tire chains on your vehicle, see "Tire Chains" in the Index.

Rocking your vehicle to get it out:

First, turn your steering wheel left and right. That will clear the area around your front wheels. You should turn your traction control system off. (See “Traction Control System” in the Index.) Then shift back and forth between REVERSE (R) and a forward gear, spinning the wheels as little as possible. Release the accelerator pedal while you shift, and press lightly on the accelerator pedal when the transmission is in gear. If that doesn't get you out after a few tries, you may need to be towed out. If you do need to be towed out, see “Towing Your Vehicle” in the Index.



SECTION 6

SERVICE AND APPEARANCE CARE

Here you will find information about the care of your Cadillac. This section begins with service and fuel information, and then it shows how to check important fluid and lubricant levels. There is also technical information about your vehicle, and a part devoted to its appearance care.

SERVICE

Your Cadillac dealer knows your vehicle best and wants you to be happy with it. We hope you'll go to your dealer for all your service needs. You'll get genuine GM parts and GM-trained and supported service people.

We hope you'll want to keep your GM vehicle all GM. Genuine GM parts have one of these marks:



Doing Your Own Service Work

If you want to do some of your own service work, you'll want to get the proper Cadillac Service Manual. It tells you much more about how to service your Cadillac than this manual can. To order the proper service manual, see "Service Publications" in the Index.

Your vehicle has an air bag system. Before attempting to do your own service work, see "Servicing Your Air Bag-Equipped Cadillac" in the Index.

You should keep a record with all parts receipts and list the mileage and the date of any service work you perform. See "Maintenance Record" in your Cadillac Maintenance Schedule Booklet.



CAUTION:

You can be injured if you try to do service work on a vehicle without knowing enough about it.

- **Be sure you have sufficient knowledge, experience, and the proper replacement parts and tools before you attempt any vehicle maintenance task.**
- **Be sure to use the proper nuts, bolts and other fasteners. "English" and "metric" fasteners can be easily confused. If you use the wrong fasteners, parts can later break or fall off. You could be hurt.**

NOTICE:

If you try to do your own service work without knowing enough about it, your vehicle could be damaged.

FUEL

Use regular unleaded gasoline rated at 87 octane or higher. It should meet specifications ASTM D4814 in the United States and CGSB 3.5-92 in Canada. These fuels should have the proper additives, so you should not have to add anything to the fuel.

In the United States and Canada, it's easy to be sure you get the right kind of gasoline (unleaded). You'll see UNLEADED right on the pump. And only unleaded nozzles will fit into your vehicle's filler neck.

Be sure the posted octane is at least 87. If the octane is less than 87, you may get a heavy knocking noise when you drive. If it's bad enough, it can damage your engine.

If you're using fuel rated at 87 octane or higher and you still hear heavy knocking, your engine needs service. But don't worry if you hear a little pinging noise when you're accelerating or driving up a hill. That's normal, and you don't have to buy a higher octane fuel to get rid of pinging. It's the heavy, constant knock that means you have a problem.

What about gasoline with blending materials that contain oxygen (oxygenates), such as MTBE or alcohol?

MTBE is "methyl tertiary-butyl ether." Fuel that is no more than 15% *MTBE* is fine for your vehicle.

Ethanol is ethyl or grain alcohol. Properly-blended fuel that is no more than 10% *ethanol* is fine for your vehicle.

Methanol is methyl or wood alcohol.

NOTICE:

Fuel that is more than 5% methanol is bad for your vehicle. Don't use it. It can corrode metal parts in your fuel system and also damage plastic and rubber parts. That damage wouldn't be covered under your warranty. And even at 5% or less, there must be "cosolvents" and corrosion preventers in this fuel to help avoid these problems.

Gasolines for Cleaner Air

Your use of gasoline with deposit control additives will help prevent deposits from forming in your engine and fuel system. That helps keep your engine in tune and your emission control system working properly. It's good for your vehicle, and you'll be doing your part for cleaner air.

Many gasolines are now blended with oxygenates. General Motors recommends that you use gasolines with these blending materials, such as MTBE and ethanol. By doing so, you can help clean the air, especially in those parts of the country that have high carbon monoxide levels.

In addition, some gasoline suppliers are now producing reformulated gasolines. These gasolines are specially designed to reduce vehicle emissions. General Motors recommends that you use reformulated gasoline. By doing so, you can help clean the air, especially in those parts of the country that have high ozone levels.

You should ask your service station operators if their gasolines contain deposit control additives and oxygenates, and if they have been reformulated to reduce vehicle emissions.

FUELS IN FOREIGN COUNTRIES

If you plan on driving in another country outside the U.S. or Canada, unleaded fuel may be hard to find. Do not use leaded gasoline. If you use even one tankful, your emission controls won't work well or at all. With continuous use, spark plugs can get fouled, the exhaust system can corrode, and your engine oil can deteriorate quickly. Your vehicle's oxygen sensor will be damaged. All of that means costly repairs that wouldn't be covered by your warranty.

To check on fuel availability, ask an auto club, or contact a major oil company that does business in the country where you'll be driving.

You can also write us at the following address for advice. Just tell us where you're going and give your Vehicle Identification Number (VIN).

General Motors Overseas Distribution Corporation,
North American Export Sales (NAES)
1908 Colonel Sam Drive
Oshawa, Ontario L1H 8P7

FILLING YOUR TANK



⚠ CAUTION:

Gasoline vapor is highly flammable. It burns violently, and that can cause very bad injuries. Don't smoke if you're near gasoline or refueling your vehicle. Keep sparks, flames, and smoking materials away from gasoline.

If you're refueling your tank using a hydrocarbon recovery nozzle, the fuel pump may shut off before the fuel capacity of your tank reaches full. This is a normal condition. If you slow the flow of fuel going into the tank, it is more likely to fill to capacity without shutting off.

Your vehicle has the locking fuel filler door.

The cap is behind the license plate. Pull down from the top of the license plate bracket door to open.



The filler door is locked and unlocked every time you use the power door locks. If pushing the power lock switch doesn't unlock or lock the fuel filler door, you can use the manual lock release lever, in the trunk. Move the lever to the left to unlock the fuel filler door.

To take off the cap, turn it slowly to the left (counterclockwise).

CAUTION:

If you get gasoline on yourself and then something ignites it, you could be badly burned. Gasoline can spray out on you if you open the fuel filler cap too quickly. This spray can happen if your tank is nearly full, and is more likely in hot weather. Open the fuel filler cap slowly and wait for any "hiss" noise to stop. Then unscrew the cap all the way.

Be careful not to spill gasoline. Clean gasoline from painted surfaces as soon as possible. See "Cleaning the Outside of Your Cadillac" in the Index.

When you put the cap back on, turn it to the right until you hear at least three clicks.

NOTICE:

If you need a new cap, be sure to get the right type. Your dealer can get one for you. If you get the wrong type, it may not fit or have proper venting, and your fuel tank and emissions system might be damaged.

CHECKING THINGS UNDER THE HOOD



To open the hood, first pull the handle inside the vehicle.



Then go to the front of the vehicle and release the secondary hood release.

Lift the hood.

**CAUTION:**

An electric fan under the hood can start up and injure you even when the engine is not running. Keep hands, clothing and tools away from any underhood electric fan.

**CAUTION:**

Things that burn can get on hot engine parts and start a fire. These include liquids like gasoline, oil, coolant, brake fluid, windshield washer and other fluids, and plastic or rubber. You or others could be burned. Be careful not to drop or spill things that will burn onto a hot engine.

Before closing the hood, be sure all the filler caps are on properly. Then just pull the hood down and close it firmly.

ENGINE OIL

LOW OIL LEVEL

If the LOW OIL LEVEL light on the instrument panel comes on, it means you need to check your engine oil level right away.

For more information, see “Low Oil Level Light” in the Index. You should check your engine oil level regularly; this is an added reminder.

It’s a good idea to check your engine oil every time you get fuel. In order to get an accurate reading, the oil must be warm and the vehicle must be on level ground.



The dipstick is located on the passenger side of the engine.

Turn off the engine and give the oil a few minutes to drain back into the oil pan. If you don’t, the oil dipstick might not show the actual level.

To Check Engine Oil

Pull out the dipstick and clean it with a paper towel or cloth, then push it back in all the way. Remove it again, keeping the tip down, and check the level.

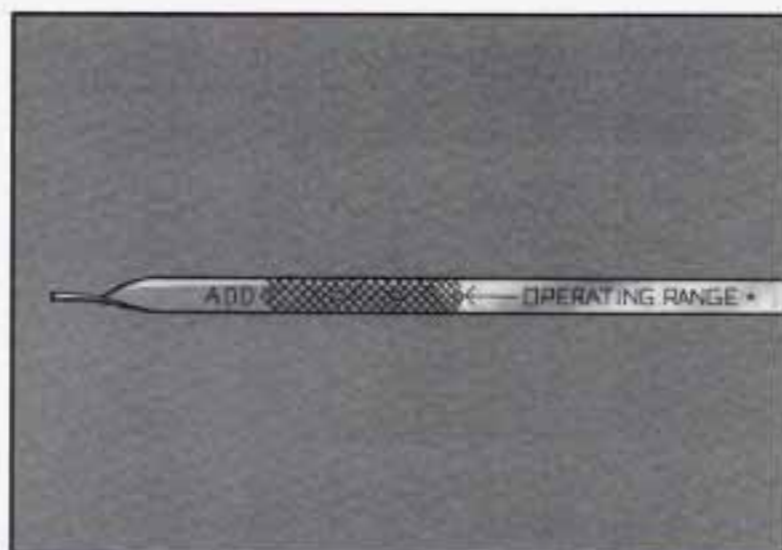

When to Add Oil

If the oil is at or below the ADD line, then you'll need to add some oil. But you must use the right kind. This part explains what kind of oil to use. For crankcase capacity, see "Capacities and Specifications" in the Index.

NOTICE:

Don't add too much oil. If your engine has so much oil that the oil level gets above the cross-hatched area that shows the proper operating range, your engine could be damaged.

Just fill it enough to put the level somewhere in the proper operating range. Push the dipstick all the way back in when you're through.

What Kind of Oil to Use

Oils of the proper quality for your vehicle can be identified by looking for the “Starburst” symbol. The “Starburst” symbol indicates that the oil has been certified by the American Petroleum Institute (API), and is preferred for use in your gasoline engine.



If you change your own oil, be sure you use oil that has the “Starburst” symbol on the front of the oil container. If you have your oil changed for you, be sure the oil put into your engine is American Petroleum Institute certified for gasoline engines.

You should also use the proper viscosity oil for your vehicle, as shown in the following chart:

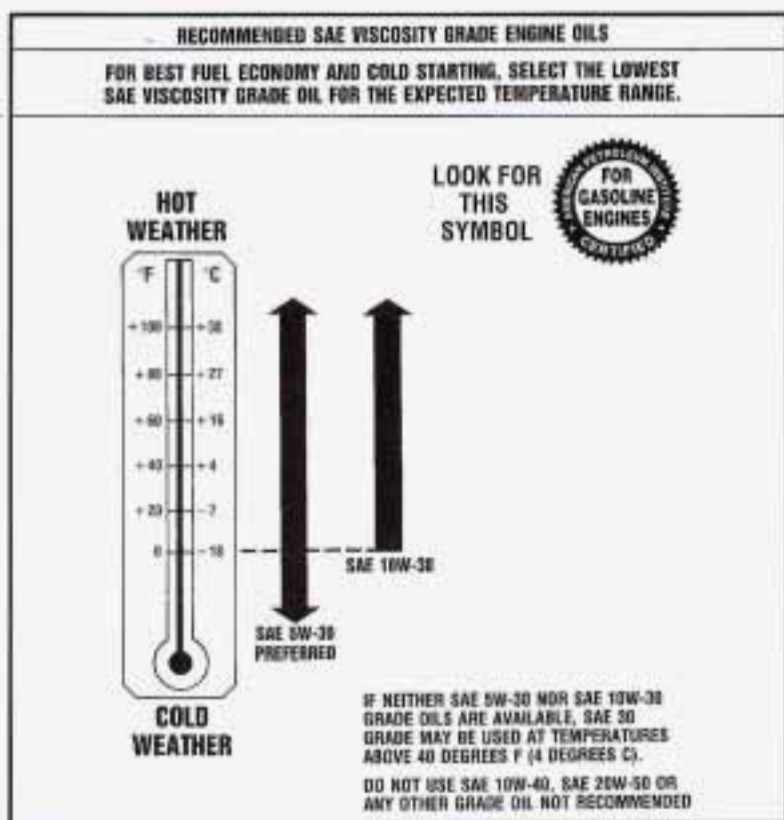

As shown in the chart, SAE 5W-30 is best for your vehicle. However, you can use SAE 10W-30 if it's going to be 0° F (-18° C) or above. These numbers on an oil container show its viscosity, or thickness. Do not use other viscosity oils, such as SAE 20W-50.

NOTICE:

Use only engine oil with the American Petroleum Institute Certified For Gasoline Engines “Starburst” symbol. Failure to use the proper oil can result in engine damage not covered by your warranty.

GM Goodwrench[®] oil (in Canada, GM Engine Oil) meets all the requirements for your vehicle.

Engine Oil Additives

Don't add anything to your oil. Your Cadillac dealer is ready to advise if you think something should be added.

When to Change Engine Oil

Your Cadillac has an “Oil Life Indicator.” This feature will let you know when to change your oil and filter -- usually between 3,000 miles (5 000 km) and 7,500 miles (12 500 km) since your last oil change. Under severe conditions, the indicator may come on before 3,000 miles (5 000 km). Never drive your vehicle more than 7,500 miles (12 500 km) or 12 months without an oil change.

The system won't detect dust in the oil. So, if you drive in a dusty area, be sure to change your oil every 3,000 miles (5 000 km) or sooner if the CHANGE OIL SOON light comes on. Remember to reset the Oil Life Indicator when the oil has been changed. For more information, see “Oil Life Indicator” in the Index.

How to Reset the Oil Life Indicator

After the oil has been changed, you'll need to reset your system. To do that, turn the ignition switch to the ON position with the engine stopped. Fully push and release the accelerator pedal 3 times within 5 seconds. The CHANGE OIL light should flash two times and then go out. If the CHANGE OIL light comes on and stays on for 5 seconds, it did not reset. You'll need to reset the system again.

Engine Coolant Heater

An engine coolant heater can be a big help if you have to park outside in very cold weather, 0° F (-18° C) or colder. If your vehicle has this option, see "Engine Coolant Heater" in the Index.

What to Do with Used Oil

Did you know that used engine oil contains certain elements that may be unhealthy for your skin and could even cause cancer? Don't let used oil stay on your skin for very long. Clean your skin and nails with soap and water, or a good hand cleaner. Wash or properly throw away clothing or rags containing used engine oil. (See the manufacturer's warnings about the use and disposal of oil products.)

Used oil can be a real threat to the environment. If you change your own oil, be sure to drain all free-flowing oil from the filter before disposal. Don't ever dispose of oil by putting it in the trash, pouring it on the ground, into sewers, or into streams or bodies of water. Instead, recycle it by taking it to a place that collects used oil. If you have a problem properly disposing of your used oil, ask your dealer, a service station or a local recycling center for help.

AIR CLEANER

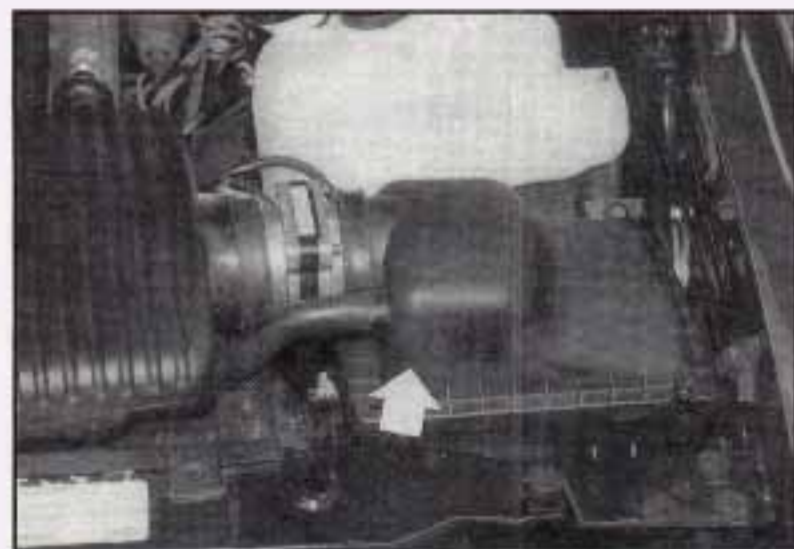

Refer to the Maintenance Schedule to determine when to replace the air filter.

⚠ CAUTION:

Operating the engine with the air cleaner off can cause you or others to be burned. The air cleaner not only cleans the air, it stops flame if the engine backfires. If it isn't there, and the engine backfires, you could be burned. Don't drive with it off, and be careful working on the engine with the air cleaner off.

NOTICE:

If the air cleaner is off, a backfire can cause a damaging engine fire. And, dirt can easily get into your engine, which will damage it. Always have the air cleaner in place when you're driving.

AUTOMATIC TRANSMISSION FLUID

When to Check and Change

A good time to check your automatic transmission fluid level is when the engine oil is changed. Refer to the Maintenance Schedule to determine when to change your fluid.

How to Check

Because this operation can be a little difficult, you may choose to have this done at your Cadillac dealer Service Department.

If you do it yourself, be sure to follow all the instructions here, or you could get a false reading on the dipstick.

NOTICE:

Too much or too little fluid can damage your transmission. Too much can mean that some of the fluid could come out and fall on hot engine parts or exhaust system parts, starting a fire. Be sure to get an accurate reading if you check your transmission fluid.

Wait at least 30 minutes before checking the transmission fluid level if you have been driving:

- When outside temperatures are above 90° F (32° C).
- At high speed for quite a while.
- In heavy traffic -- especially in hot weather.
- While pulling a trailer.

To get the right reading, the fluid should be at normal operating temperature, which is 180° F to 200° F (82° C to 93° C).

To check transmission fluid hot: Get the vehicle warmed up by driving about 15 miles (24 km) when outside temperatures are above 50° F (10° C). If it's colder than 50° F (10° C), drive the vehicle in DRIVE (D) until the engine temperature gage moves and then remains steady for ten minutes. Then follow the hot check procedures.

To check transmission fluid cold: A cold check is made after the vehicle has been sitting for eight hours or more with the engine off and is used only as a reference. Let the engine run at idle for five minutes if outside temperatures are 50° F (10° C) or more. If it's colder than 50° F (10° C), you may have to idle the engine longer. Should the fluid level be low during a cold check, you *must* perform a hot check before adding fluid. This will give you a more accurate reading of the fluid level.

To check the fluid hot or cold

- Park your vehicle on a level place. Keep the engine running.
- With the parking brake applied, place the shift lever in PARK (P).
- With your foot on the brake pedal, move the shift lever through each gear range, pausing for about three seconds in each range. Then, position the shift lever in PARK (P).
- Let the engine run at idle for three minutes or more.



Then, without shutting off the engine, follow these steps:

1. Flip the handle up and then pull out the dipstick and wipe it with a clean rag or paper towel.
2. Push it back in all the way, wait three seconds and then pull it back out again.

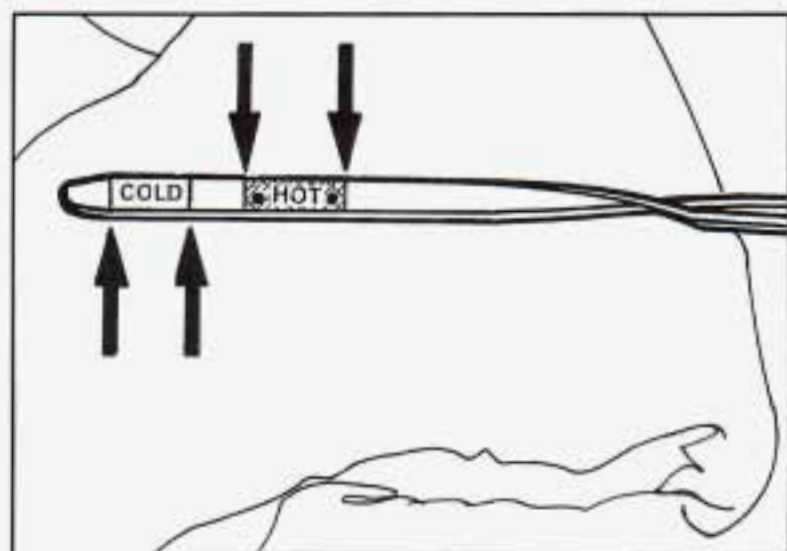

3. Check both sides of the dipstick, and read the lower level. The fluid level must be in the COLD area for a cold check or in the HOT area or cross-hatched area for a hot check.
4. If the fluid level is in the acceptable range, push the dipstick back in all the way; then flip the handle down to lock the dipstick in place.

How to Add Fluid

Refer to the Maintenance Schedule to determine what kind of transmission fluid to use.

Add fluid only after checking the transmission fluid HOT. (A COLD check is used only as a reference.) If the fluid level is low, add only enough of the proper fluid to bring the level up to the HOT area for a hot check. It doesn't take much fluid, generally less than a pint. *Don't overfill.* We recommend you use only fluid labeled DEXRON[®]-III, because fluid with that label is made especially for your automatic transmission. Damage caused by fluid other than DEXRON[®]-III is not covered by your new vehicle warranty.

- After adding fluid, recheck the fluid level as described under "How to Check."
- When the correct fluid level is obtained, push the dipstick back in all the way; then flip the handle down to lock the dipstick in place.

REAR AXLE

When to Check and Change Lubricant

Refer to the Maintenance Schedule to determine how often to check the lubricant and when to change it. See “Periodic Maintenance Inspections” in the Index.

How to Check Lubricant

If the level is below the bottom of the filler plug hole, you'll need to add some lubricant. Add enough lubricant to raise the level to the bottom of the filler plug hole.

What to Use

Use Axle Lubricant (GM Part No. 1052271) or SAE 80W-90 GL-5 gear lubricant.

ENGINE COOLANT

The following explains your cooling system and how to add coolant when it is low. If you have a problem with engine overheating, see “Engine Overheating” in the Index.

The proper coolant for your Cadillac will:

- Give freezing protection down to -34° F (-37° C).
- Give boiling protection up to 262° F (128° C).
- Protect against rust and corrosion.
- Help keep the proper engine temperature.
- Let the warning lights work as they should.

What to Use

Use a mixture of one-half *clean water* (preferably distilled) and one-half antifreeze that meets “GM Specification 1825-M,” which won’t damage aluminum parts. You can also use a recycled coolant conforming to GM Specification 1825-M with a complete coolant flush and refill. Use GM Engine Coolant Supplement (sealer) with any complete coolant flush and refill. If you use this mixture, you don’t need to add anything else.

CAUTION:

Adding only plain water to your cooling system can be dangerous. Plain water, or some other liquid like alcohol, can boil before the proper coolant mix will. Your vehicle’s coolant warning system is set for the proper coolant mix. With plain water or the wrong mix, your engine could get too hot but you wouldn’t get the overheat warning. Your engine could catch fire and you or others could be burned. Use a 50/50 mix of clean water and a proper antifreeze.

NOTICE:

If you use an improper coolant mix, your engine could overheat and be badly damaged. The repair cost wouldn’t be covered by your warranty. Too much water in the mix can freeze and crack the engine, radiator, heater core and other parts.

Adding Coolant

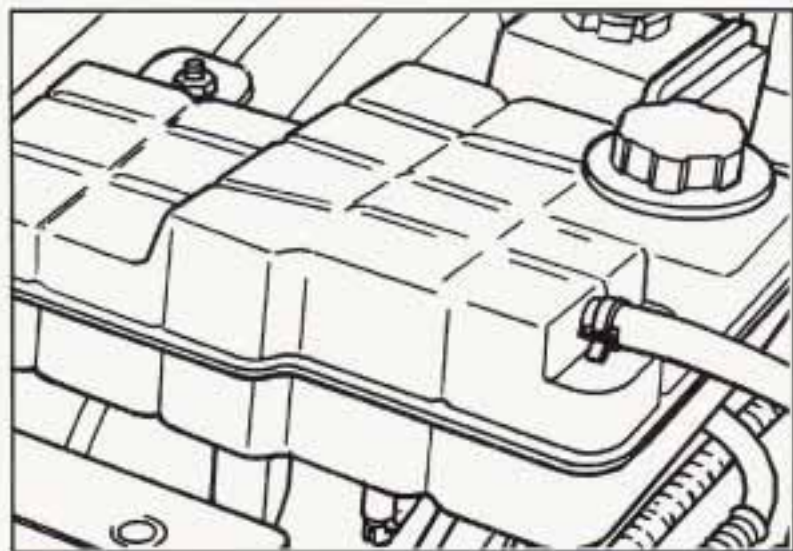

Your cooling system when hot is under a lot of pressure. If the LOW COOLANT light should appear, you need to add coolant. If it doesn't, the coolant is at the proper fill level.

To Check Coolant



CAUTION:

Turning the surge tank pressure cap when the engine and radiator are hot can allow steam and scalding liquids to blow out and burn you badly. Never turn the surge tank pressure cap -- even a little -- when the engine and radiator are hot.

When your engine is cold, the coolant level should be at the FULL COLD line.

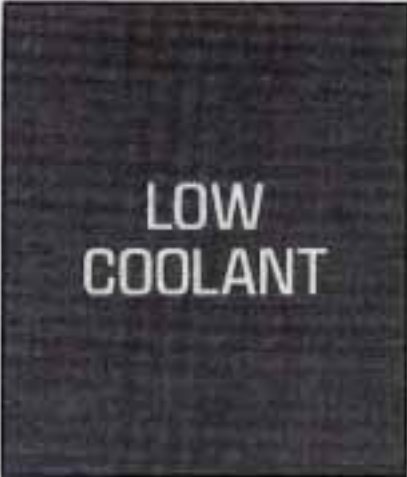

**LOW
COOLANT**

If this light comes on, it means you're low on engine coolant.

See "Low Coolant Light" in the Index.

To Add Coolant

If you need more coolant, add the proper mix *at the surge tank*, but only when the engine is cool.



CAUTION:

You can be burned if you spill coolant on hot engine parts. Coolant contains ethylene glycol, and it will burn if the engine parts are hot enough. Don't spill coolant on a hot engine.

When replacing the pressure cap, make sure it is tight.

SURGE TANK PRESSURE CAP

NOTICE:

Your surge tank pressure cap is a 15 psi (105 kPa) pressure-type cap and must be tightly installed to prevent coolant loss and possible engine damage from overheating. Be sure the arrows on the cap line up with the overflow tube on the radiator filler neck.

When you replace your radiator pressure cap, a GM cap is recommended.

THERMOSTAT

Engine coolant temperature is controlled by a thermostat in the engine coolant system. The thermostat stops the flow of coolant through the radiator until the coolant reaches a preset temperature.

When you replace your thermostat, an AC[®] thermostat is recommended.

POWER STEERING FLUID



How To Check Power Steering Fluid

When the engine compartment is cool, unscrew the cap and wipe the dipstick with a clean rag. Replace the cap and completely tighten it. Then remove the cap again and look at the fluid level on the dipstick.

When the engine compartment is hot, the level should be at the H mark.

When the engine compartment is cool, the level should be at the C mark.

A fluid loss in this system could indicate a problem. Have the system inspected and repaired.

What to Add

Refer to the Maintenance Schedule to determine what kind of fluid to use.

NOTICE:

When adding power steering fluid or making a complete fluid change, always use the proper fluid. Failure to use the proper fluid can cause leaks and damage hoses and seals.

WINDSHIELD WASHER FLUID

To Add



Open the cap labeled **WASHER FLUID ONLY**. Add washer fluid until the tank is full.

NOTICE:

- **When using concentrated washer fluid, follow the manufacturer's instructions for adding water.**
- **Don't mix water with ready-to-use washer fluid. Water can cause the solution to freeze and damage your washer fluid tank and other parts of the washer system. Also, water doesn't clean as well as washer fluid.**
- **Fill your washer fluid tank only 3/4 full when it's very cold. This allows for expansion, which could damage the tank if it is completely full.**
- **Don't use radiator antifreeze in your windshield washer. It can damage your washer system and paint.**

BRAKES

Brake Master Cylinder

Your brake master cylinder is here. It is filled with DOT-3 brake fluid.



There are only two reasons why the brake fluid level in your master cylinder might go down. The first is that the brake fluid goes down to an acceptable level during normal brake lining wear. When new linings are put in, the fluid level goes back up. The other reason is that fluid is leaking out of the brake system. If it is, you should have your brake system fixed, since a leak means that sooner or later your brakes won't work well, or won't work at all. So, it isn't a good idea to "top off" your brake fluid. Adding brake fluid won't correct a leak. If you add fluid when your linings are worn, then you'll have too much fluid when you get new brake linings. You should add (or remove) brake fluid, as necessary, only when work is done on the brake hydraulic system.

⚠ CAUTION:

If you have too much brake fluid, it can spill on the engine. The fluid will burn if the engine is hot enough. You or others could be burned, and your vehicle could be damaged. Add brake fluid only when work is done on the brake hydraulic system.

Refer to the Maintenance Schedule to determine when to check your brake fluid.

To Check Brake Fluid

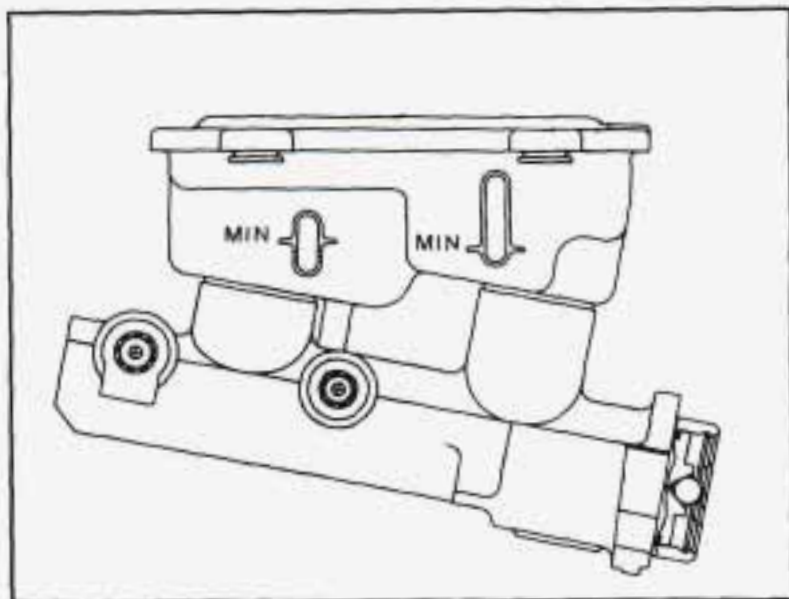

You can check the brake fluid without taking off the cap. Just look at the windows on the brake fluid reservoir. The fluid levels should be above MIN. If they aren't, have your brake system checked to see if there is a leak.

After work is done on the brake hydraulic system, make sure the levels are above MIN and below the top of each window.

What to Add

When you do need brake fluid, use only DOT-3 brake fluid -- such as Delco Supreme 11[®] (GM Part No. 1052535). Use new brake fluid from a sealed container only, and always clean the brake fluid reservoir cap before removing it.

NOTICE:

- **Don't let someone put in the wrong kind of fluid. For example, just a few drops of mineral-based oil, such as engine oil, in your brake system can damage brake system parts so badly that they'll have to be replaced.**
- **Brake fluid can damage paint, so be careful not to spill brake fluid on your vehicle. If you do, wash it off immediately. See "Appearance Care" in the Index.**

Brake Wear

Your Cadillac has front disc brakes and rear drum brakes.

Disc brake pads have built-in wear indicators that make a high-pitched warning sound when the brake pads are worn and new pads are needed. The sound may come and go or be heard all the time your vehicle is moving (except when you are pushing on the brake pedal firmly).



CAUTION:

The brake wear warning sound means that sooner or later your brakes won't work well. That could lead to an accident. When you hear the brake wear warning sound, have your vehicle serviced.

NOTICE:

Continuing to drive with worn-out brake pads could result in costly brake repair.

Some driving conditions or climates may cause a brake squeal when the brakes are first applied or lightly applied. This does not mean something is wrong with your brakes.

Your rear drum brakes don't have wear indicators, but if you ever hear a rear brake rubbing noise, have the rear brake linings inspected. Also, the rear brake drums should be removed and inspected each time the tires are removed for rotation or changing. When you have the front brakes replaced, have the rear brakes inspected, too.

Brake linings should always be replaced as complete axle sets.

Brake Pedal Travel

See your dealer if the brake pedal does not return to normal height, or if there is a rapid increase in pedal travel. This could be a sign of brake trouble.

Brake Adjustment

Every time you make a moderate brake stop, your disc brakes adjust for wear. If you rarely make a moderate or heavier stop, then your brakes might not adjust correctly. If you drive in that way, then -- very carefully -- make a few moderate brake stops about every 1,000 miles (1600 km), so your brakes will adjust properly.

If your brake pedal goes down farther than normal, your rear drum brakes may need adjustment. Adjust them by backing up and firmly applying the brakes a few times.

Replacing Brake System Parts

The braking system on a modern vehicle is complex. Its many parts have to be of top quality and work well together if the vehicle is to have really good braking. Vehicles we design and test have top-quality GM brake parts in them, as your Cadillac does when it is new. When you replace parts of your braking system -- for example, when your brake linings wear down and you have to have new ones put in -- be sure you get new genuine GM replacement parts. If you don't, your brakes may no longer work properly. For example, if someone puts in brake linings that are wrong for your vehicle, the balance between your front and rear brakes can change -- for the worse. The braking performance you've come to expect can change in many other ways if someone puts in the wrong replacement brake parts.

BATTERY

Every new Cadillac has a Delco Freedom[®] battery. You never have to add water to one of these. When it's time for a new battery, we recommend a Delco Freedom[®] battery. Get one that has the replacement number shown on the original battery's label.

Vehicle Storage

If you're not going to drive your vehicle for 25 days or more, take off the black, negative (-) cable from the battery. This will help keep your battery from running down.



CAUTION:

Batteries have acid that can burn you and gas that can explode. You can be badly hurt if you aren't careful. See "Jump Starting" in the Index for tips on working around a battery without getting hurt.

Contact your dealer to learn how to prepare your vehicle for longer storage periods.

HALOGEN BULBS

⚠ CAUTION:

Halogen bulbs have pressurized gas inside and can burst if you drop or scratch the bulb. You or others could be injured. Take special care when handling and disposing of halogen bulbs.

EXTERIOR LAMP HOUSINGS

Your Cadillac's lamp housings are designed with small vents so moisture will be removed when the lamps are on, or after driving for a short time. If an excessive amount of moisture is present which does not clear, see your Cadillac dealership for service.

Cornering Lamp Bulb Removal

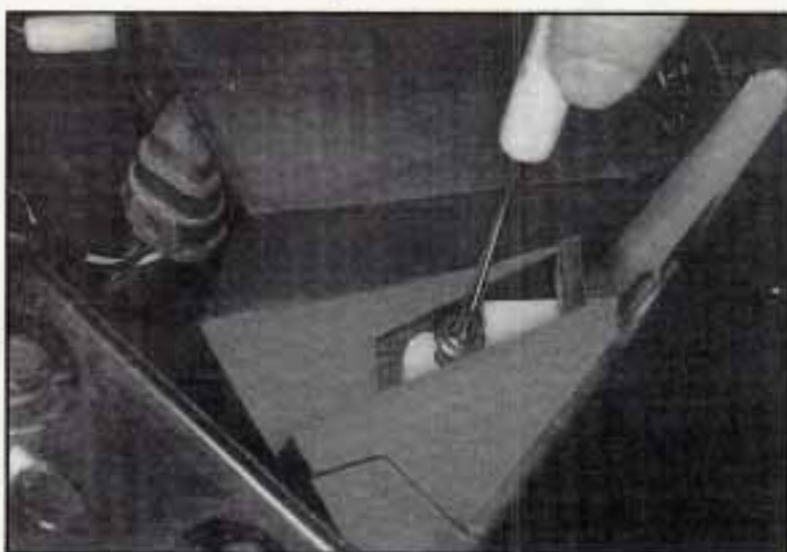

1. Open the hood and remove the screw securing the cornering lamp housing.



2. Gently pull out the cornering lamp.



3. Remove the socket by rotating it counterclockwise slightly, then gently push and rotate the bulb counterclockwise and remove it.

4. Once you have replaced the bulb just reverse the steps to reassemble the cornering lamp.

Halogen Headlamp Bulb Removal



1. Rotate the headlamp housing socket counterclockwise to unlock the socket from the lamp housing.



2. Gently remove the headlamp housing socket and bulb.

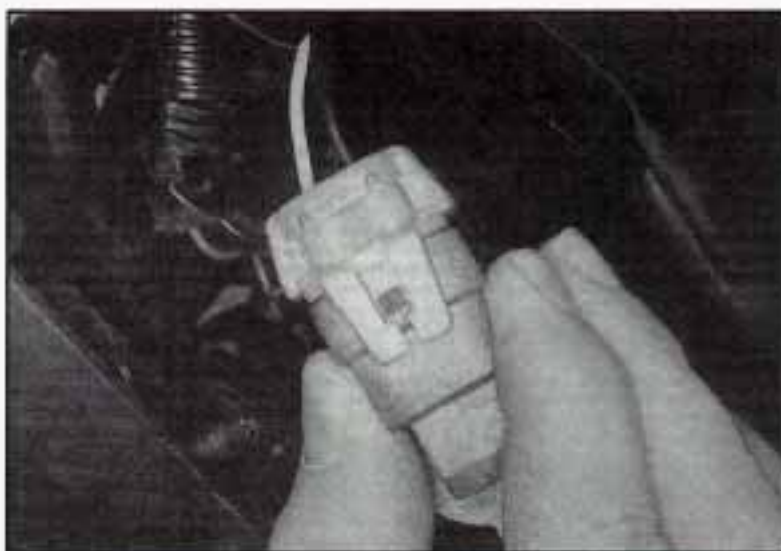

3. Disconnect the socket from the harness by separating the locking clip.



4. Install the new bulb and socket and connect the wiring harness. Make sure that the harness is locked to the bulb socket.

NOTICE:

Do not touch the glass portion of the new halogen bulb! The oil from your fingers will shorten the life of your new halogen bulb.

5. Install the headlamp housing socket into the headlamp assembly.

Taillamp Bulb Replacement



1. Remove the upper screw from the bezel.

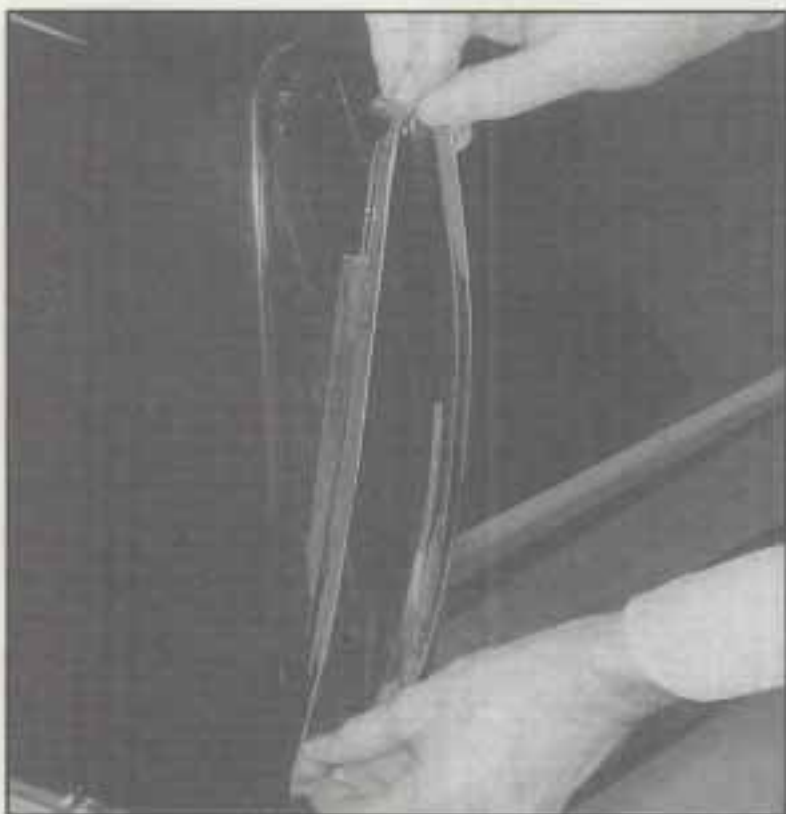

2. Pull the upper portion from the extension housing, then gently lift up to remove the bezel.

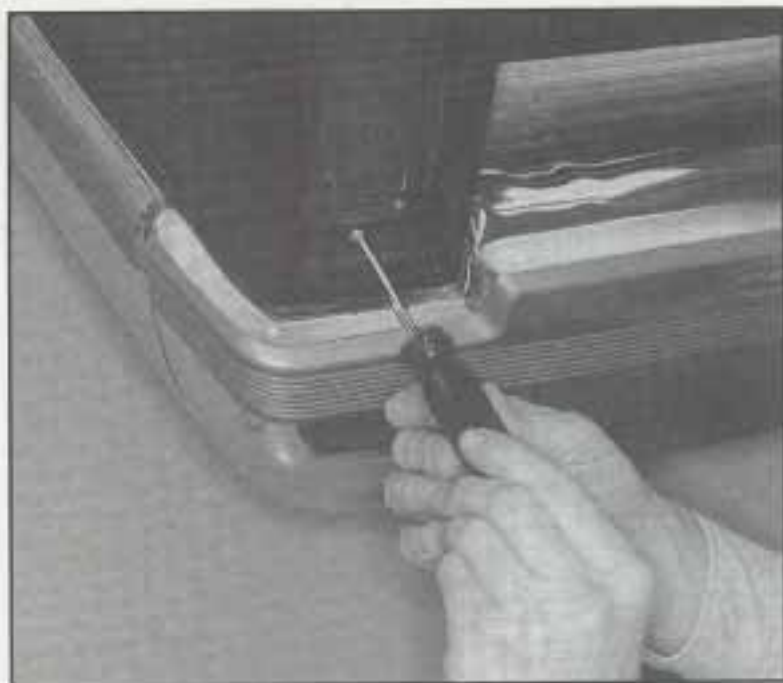

3. Remove the lower taillamp housing screw.



4. Gently tilt the top portion of the taillamp housing out first, and then gently remove it.



5. Press the bulb socket housing lever and rotate the socket housing counterclockwise to remove it.



6. To remove the bulb, push it in and rotate it counterclockwise.



7. Install the bulb and socket into the taillamp housing by turning it clockwise. Be sure it locks into place.



8. Once you have installed the new bulb and socket into the housing, just reverse the steps to reassemble the taillamp. Make sure when installing the chrome bezel that you insert the two prongs at the bottom first.

Center High-Mounted Stoplamp Bulb Replacement

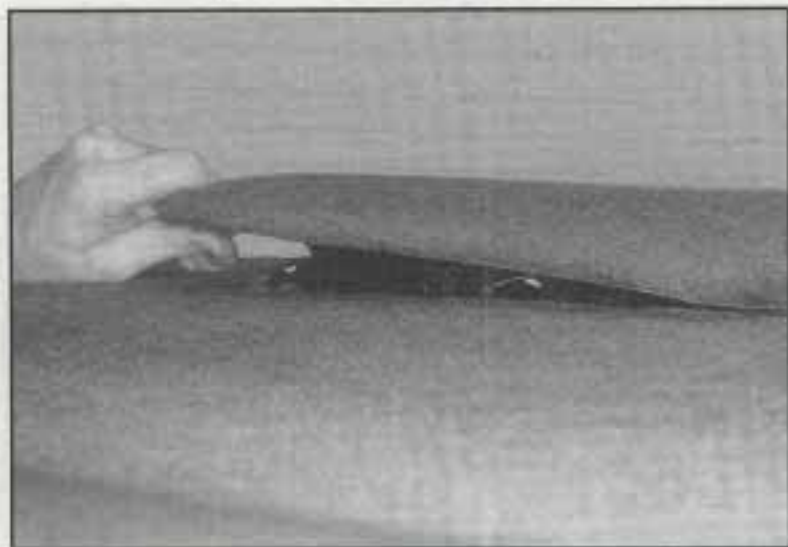

1. Gently pry up on the trim, like this.

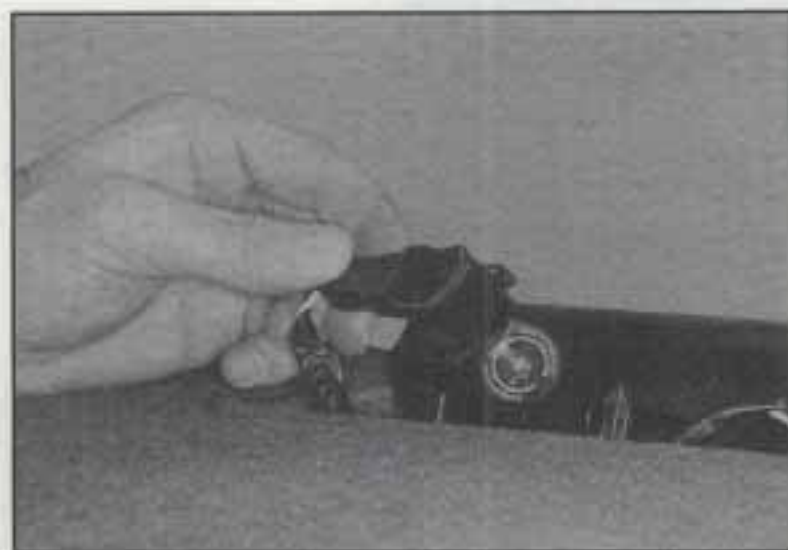

2. Twist the socket counterclockwise and remove the socket and bulb from the housing.

3. Replace the bulb.

WIPER BLADE REPLACEMENT

To replace the entire wiper blade, follow these steps:

1. Position the windshield wipers on the windshield in the "mid" wiper position. To do this, turn the ignition key to **ACCESSORY** and turn the wipers on. Then with the door open, turn the ignition key to **OFF**.

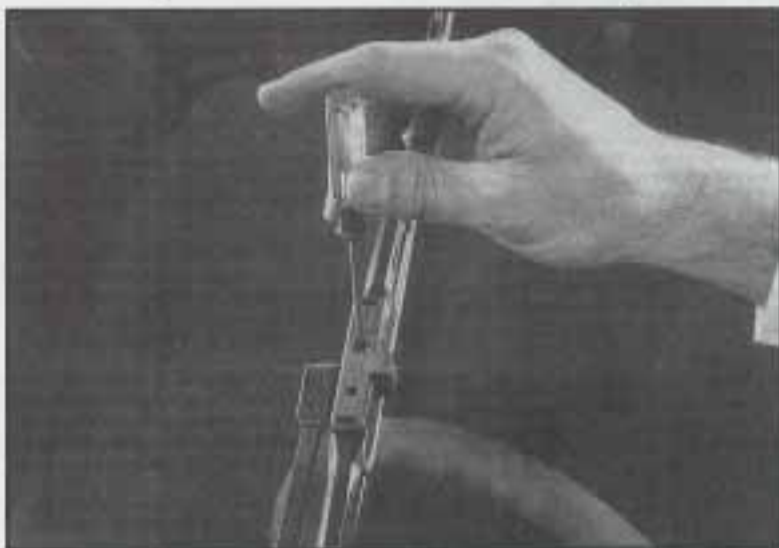

2. Insert the tip of a small screwdriver into the slot as shown and gently press down to release the wiper blade from the arm.

3. To install the wiper blade, align the wiper arm pin with the hole on the wiper blade assembly and snap it into place. Return the wipers to their normal position.

If you only want to replace the wiper insert, follow these steps:

1. Position the windshield wipers on the windshield in the "mid" wiper position. To do this, turn the ignition key to **ACCESSORY** and turn the wipers on. Then with the door open, turn the ignition key to **OFF**.
2. Insert the tip of a small screwdriver into the slot as shown and gently press down to release the wiper blade from the arm.
3. Insert a small coin between the edge of the blade housing and the rubber blade insert.
4. Carefully apply pressure until the insert clears one side of the housing tabs.
5. Now pull the insert from the blade housing.

6. Reinstall the new insert by aligning the blade housing tabs and the edge of the insert, starting with the second set from the outer edge. Make sure that the insert is connected to all of the housing tabs and that it moves freely back and forth.
7. To install the wiper blade, align the wiper arm pin with the hole on the wiper blade assembly and snap it into place. Return the wipers to their normal position.

TIRES

We don't make tires. Your Cadillac comes with high-quality tires made by a leading tire manufacturer. If you ever have questions about your tire warranty and where to obtain service, see your Cadillac warranty booklet for details.

CAUTION:

Poorly maintained and improperly used tires are dangerous.

- **Overloading your tires can cause overheating as a result of too much friction. You could have an air-out and a serious accident. See "Loading Your Vehicle" in the Index.**
- **Underinflated tires pose the same danger as overloaded tires. The resulting accident could cause serious injury. Check all tires frequently to maintain the recommended pressure. Tire pressure should be checked when your tires are cold.**
- **Overinflated tires are more likely to be cut, punctured, or broken by a sudden impact, such as when you hit a pothole. Keep tires at the recommended pressure.**
- **Worn, old tires can cause accidents. If your tread is badly worn, or if your tires have been damaged, replace them.**

Inflation - Tire Pressure

The Tire-Loading Information label which is located on the driver's door shows the correct inflation pressures for your tires, when they're cold. "Cold" means your vehicle has been sitting for at least three hours or driven no more than a mile.

NOTICE:

Don't let anyone tell you that underinflation or overinflation is all right. It's not. If your tires don't have enough air (underinflation) you can get:

- Too much flexing
- Too much heat
- Tire overloading
- Bad wear
- Bad handling
- Bad fuel economy.

If your tires have too much air (overinflation), you can get:

- Unusual wear
- Bad handling
- Rough ride
- Needless damage from road hazards.

When to Check

Check your tires once a month or more. Also, check the tire pressure of the spare tire.

If you have a compact spare tire, it should be at 60 psi (420 kPa).

How to Check

Use a good quality pocket-type gage to check tire pressure. Simply looking at the tires will not tell you the pressure, especially if you have radial tires -- which may look properly inflated even if they're underinflated.

If your tires have valve caps, be sure to put them back on. They help prevent leaks by keeping out dirt and moisture.

Tire Inspection and Rotation

Tires should be inspected every 6,000 to 8,000 miles (10 000 to 13 000 km) for any signs of unusual wear. If unusual wear is present, rotate your tires as soon as possible and check wheel alignment. Also check for damaged tires or wheels. See "When it's Time for New Tires" and "Wheel Replacement" later in this section for more information.

The purpose of regular rotation is to achieve more uniform wear for all tires on the vehicle. The first rotation is the most important. See the Cadillac Maintenance Schedule Booklet for scheduled rotation intervals.

When rotating your tires, always use one of the correct rotation patterns shown here.

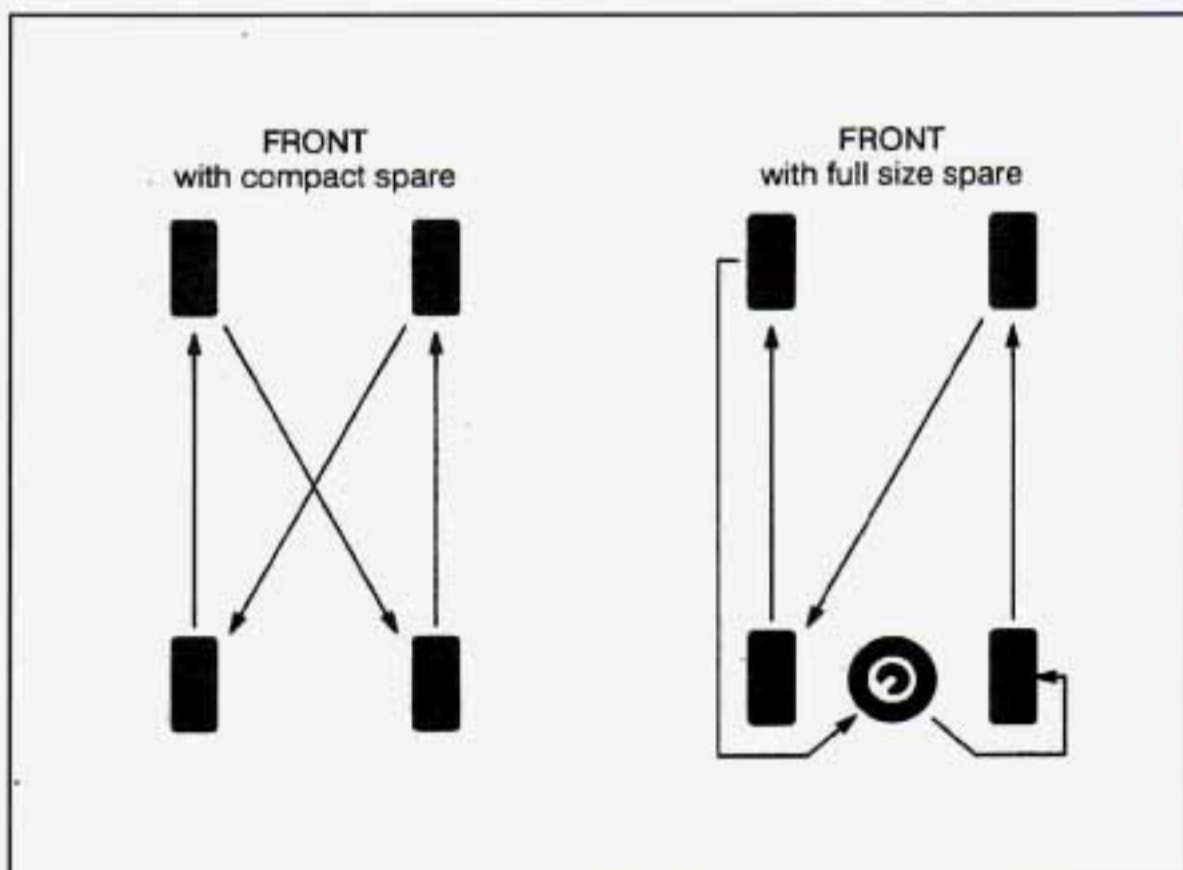

If your vehicle has a compact spare tire, don't include it in your tire rotation.

After the tires have been rotated, adjust the front and rear inflation pressures as shown on the Tire-Loading Information label. Make certain that all wheel nuts are properly tightened. See "Wheel Nut Torque" in the Index.

 **CAUTION:**

Rust or dirt on a wheel, or on the parts to which it is fastened, can make wheel nuts become loose after a time. The wheel could come off and cause an accident. When you change a wheel, remove any rust or dirt from places where the wheel attaches to the vehicle. In an emergency, you can use a cloth or a paper towel to do this; but be sure to use a scraper or wire brush later, if you need to, to get all the rust or dirt off. (See "Changing a Flat Tire" in the Index.)

When it's Time for New Tires

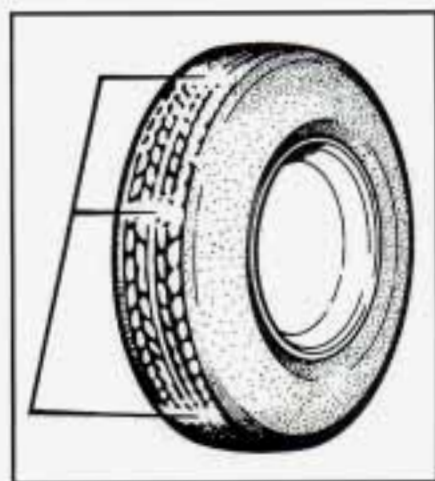

One way to tell when it's time for new tires is to check the treadwear indicators, which will appear when your tires have only 1/16 inch (1.6 mm) or less of tread remaining.

You need a new tire if:

- You can see the indicators at three or more places around the tire.
- You can see cord or fabric showing through the tire's rubber.
- The tread or sidewall is cracked, cut or snagged deep enough to show cord or fabric.
- The tire has a bump, bulge or split.
- The tire has a puncture, cut, or other damage that can't be repaired well because of the size or location of the damage.

Buying New Tires

To find out what kind and size of tires you need, look at the Tire-Loading Information label.

The tires installed on your vehicle when it was new had a Tire Performance Criteria Specification (TPC Spec) number on each tire's sidewall. When you get new tires, get ones with that same TPC Spec number. That way, your vehicle will continue to have tires that are designed to give proper endurance, handling, speed rating, traction, ride and other things during normal service on your vehicle. If your tires have an all-season tread design, the TPC number will be followed by an "MS" (for mud and snow).

If you ever replace your tires with those not having a TPC Spec number, make sure they are the same size, load range, speed rating and construction type (bias, bias-belted or radial) as your original tires.

CAUTION:

Mixing tires could cause you to lose control while driving. If you mix tires of different sizes or types (radial and bias-belted tires), the vehicle may not handle properly, and you could have a crash. Be sure to use the same size and type tires on all four wheels.

It's all right to drive with your compact spare (if you have one). It was developed for use on your vehicle.

Uniform Tire Quality Grading

The following information relates to the system developed by the United States National Highway Traffic Safety Administration which grades tires by treadwear, traction and temperature performance. (This applies only to vehicles sold in the United States.)

Treadwear

The treadwear grade is a comparative rating based on the wear rate of the tire when tested under controlled conditions on a specified government test course. For example, a tire graded 150 would wear one and a half (1 1/2) times as well on the government course as a tire graded 100. The relative performance of tires depends upon the actual conditions of their use, however, and may depart significantly from the norm due to variations in driving habits, service practices and differences in road characteristics and climate.

Traction - A, B, C

The traction grades, from highest to lowest are: A, B, and C. They represent the tire's ability to stop on wet pavement as measured under controlled conditions on specified government test surfaces of asphalt and concrete. A tire marked C may have poor traction performance.

Warning: The traction grade assigned to this tire is based on braking (straight-ahead) traction tests and does not include cornering (turning) traction.

Temperature - A, B, C

The temperature grades are A (the highest), B, and C, representing the tire's resistance to the generation of heat and its ability to dissipate heat when tested under controlled conditions on a specified indoor laboratory test wheel. Sustained high temperature can cause the material of the tire to degenerate and reduce tire life, and excessive temperature can lead to sudden tire failure. The grade C corresponds to a level of performance which all passenger car tires must meet under the Federal Motor Vehicle Safety Standard No. 109. Grades B and A represent higher levels of performance on the laboratory test wheel than the minimum required by law.

Warning: The temperature grade for this tire is established for a tire that is properly inflated and not overloaded. Excessive speed, underinflation, or excessive loading, either separately or in combination, can cause heat buildup and possible tire failure.

These grades are molded on the sidewalls of passenger car tires.

While the tires available as standard or optional equipment on General Motors vehicles may vary with respect to these grades, all such tires meet General Motors performance standards and have been approved for use on General Motors vehicles. All passenger type (P Metric) tires must conform to Federal safety requirements in addition to these grades.

Wheel Alignment and Tire Balance

The wheels on your vehicle were aligned and balanced carefully at the factory to give you the longest tire life and best overall performance.

In most cases, you will not need to have your wheels aligned again. However, if you notice unusual tire wear or your vehicle pulling one way or the other, the alignment may need to be reset. If you notice your vehicle vibrating when driving on a smooth road, your wheels may need to be rebalanced.

Wheel Replacement

Replace any wheel that is bent, cracked, or badly rusted or corroded. If wheel nuts keep coming loose, the wheel, wheel bolts, and wheel nuts should be replaced. If the wheel leaks air, replace it (except some aluminum wheels, which can sometimes be repaired). See your Cadillac dealer if any of these conditions exist.

Your dealer will know the kind of wheel you need.

Each new wheel should have the same load carrying capacity, diameter, width, offset, and be mounted the same way as the one it replaces.

If you need to replace any of your wheels, wheel bolts, or wheel nuts, replace them only with new GM original equipment parts. This way, you will be sure to have the right wheel, wheel bolts, and wheel nuts for your Cadillac model.

 **CAUTION:**

Using the wrong replacement wheels, wheel bolts, or wheel nuts on your vehicle can be dangerous. It could affect the braking and handling of your vehicle, make your tires lose air and make you lose control. You could have a collision in which you or others could be injured. Always use the correct wheel, wheel bolts, and wheel nuts for replacement.

NOTICE:

The wrong wheel can also cause problems with bearing life, brake cooling, speedometer/odometer calibration, headlamp aim, bumper height, vehicle ground clearance, and tire or tire chain clearance to the body and chassis.

Used Replacement Wheels

 **CAUTION:**

Putting a used wheel on your vehicle is dangerous. You can't know how it's been used or how many miles it's been driven. It could fail suddenly and cause an accident. If you have to replace a wheel use a new GM original equipment wheel.

Tire Chains

NOTICE:

Use tire chains only where legal and only when you must. Use only SAE Class "S" type chains that are the proper size for your tires. Install them on the rear tires and tighten them as tightly as possible with the ends securely fastened. Drive slowly and follow the chain manufacturer's instructions. If you can hear the chains contacting your vehicle, stop and retighten them. If the contact continues, slow down until it stops. Driving too fast or spinning the wheels with chains on will damage your vehicle.

APPEARANCE CARE

Remember, cleaning products can be hazardous. Some are toxic. Others can burst into flame if you strike a match or get them on a hot part of the vehicle. Some are dangerous if you breathe their fumes in a closed space. When you use anything from a container to clean your Cadillac, be sure to follow the manufacturer's warnings and instructions. And always open your doors or windows when you're cleaning the inside.

Never use these to clean your vehicle:

- Gasoline
- Benzene
- Naphtha
- Carbon Tetrachloride
- Acetone
- Paint Thinner
- Turpentine
- Lacquer Thinner
- Nail Polish Remover

They can all be hazardous -- some more than others -- and they can all damage your vehicle, too.

Don't use any of these unless this manual says you can. In many uses, these will damage your vehicle:

- Alcohol
- Laundry Soap
- Bleach
- Reducing Agents

CLEANING THE INSIDE OF YOUR CADILLAC

Use a vacuum cleaner often to get rid of dust and loose dirt. Wipe vinyl or leather with a clean, damp cloth.

Your Cadillac dealer has two GM cleaners, a solvent-type spot lifter and a foam-type powdered cleaner. They will clean normal spots and stains very well. Do not use them on vinyl or leather.

Here are some cleaning tips:

- Always read the instructions on the cleaner label.
- Clean up stains as soon as you can -- before they set.
- Use a clean cloth or sponge, and change to a clean area often. A soft brush may be used if stains are stubborn.
- Use solvent-type cleaners in a well-ventilated area only. If you use them, don't saturate the stained area.
- If a ring forms after spot cleaning, clean the entire area immediately or it will set.

Using Foam-Type Cleaner on Fabric

- Vacuum and brush the area to remove any loose dirt.
- Always clean a whole trim panel or section. Mask surrounding trim along stitch or welt lines.

- Mix Multi-Purpose Powdered Cleaner following the directions on the container label.
- Use suds only and apply with a clean sponge.
- Don't saturate the material.
- Don't rub it roughly.
- As soon as you've cleaned the section, use a sponge to remove the suds.
- Rinse the section with a clean, wet sponge.
- Wipe off what's left with a slightly damp paper towel or cloth.
- Then dry it immediately with a blow dryer or a heat lamp.

NOTICE:

Be careful. A blow dryer may scorch the fabric.

- Wipe with a clean cloth.

Using Solvent-Type Cleaner on Fabric

First, see if you have to use solvent-type cleaner at all. Some spots and stains will clean off better with just water and mild soap.

If you need to use a solvent:

- Gently scrape excess soil from the trim material with a clean, dull knife or scraper. Use very little cleaner, light pressure and clean cloths (preferably cheesecloth). Cleaning should start at the outside of the stain, "feathering" toward the center. Keep changing to a clean section of the cloth.
- When you clean a stain from fabric, immediately dry the area with a blow dryer to help prevent a cleaning ring. (See the previous NOTICE.)

Special Cleaning Problems

Greasy or Oily Stains

Stains caused by grease, oil, butter, margarine, shoe polish, coffee with cream, chewing gum, cosmetic creams, vegetable oils, wax crayon, tar and asphalt can be removed as follows:

- Carefully scrape off excess stain.
- Follow the solvent-type instructions described earlier.
- Shoe polish, wax crayon, tar and asphalt will stain if left on a vehicle seat fabric. They should be removed as soon as possible. Be careful, because the cleaner will dissolve them and may cause them to spread.

Non-Greasy Stains

Stains caused by catsup, coffee (black), egg, fruit, fruit juice, milk, soft drinks, wine, vomit, urine and blood can be removed as follows:

- Carefully scrape off excess stain, then sponge the soiled area with cool water.
- If a stain remains, follow the foam-type instructions described earlier.
- If an odor lingers after cleaning vomit or urine, treat the area with a water/baking soda solution: 1 teaspoon (5 ml) of baking soda to 1 cup (250 ml) of lukewarm water.
- If needed, clean lightly with solvent-type cleaner.

Combination Stains

Stains caused by candy, ice cream, mayonnaise, chili sauce and unknown stains can be removed as follows:

- Carefully scrape off excess stain, then clean with cool water and allow to dry.
- If a stain remains, clean it with solvent-type cleaner.

Cleaning Vinyl

Use warm water and a clean cloth.

- Rub with a clean, damp cloth to remove dirt. You may have to do it more than once.
- Things like tar, asphalt and shoe polish will stain if you don't get them off quickly. Use a clean cloth and a solvent-type vinyl cleaner.

Cleaning Leather

Use a soft cloth with lukewarm water and a mild soap or saddle soap.

- For stubborn stains, use a mild solution of 10% isopropyl alcohol (rubbing alcohol) and 90% water.
- *Never* use oils, varnishes, solvent-based or abrasive cleaners, furniture polish or shoe polish on leather.
- Soiled leather should be cleaned immediately. If dirt is allowed to work into finish, it can harm the leather.

Cleaning the Top of the Instrument Panel

Use only mild soap and water to clean the top surfaces of the instrument panel. Sprays containing silicones or waxes may cause annoying reflections in the windshield and even make it difficult to see through the windshield under certain conditions.

Care Of Wood Panels

- Use a clean cloth moistened in warm soapy water, (use mild dish washing soap). Dry the wood immediately with a clean cloth.

CARE OF SAFETY BELTS

Keep belts clean and dry.



CAUTION:

Do not bleach or dye safety belts. If you do, it may severely weaken them. In a crash they might not be able to provide adequate protection. Clean safety belts only with mild soap and lukewarm water.

GLASS

Glass should be cleaned often. GM Glass Cleaner (GM Part No. 1050427) or a liquid household glass cleaner will remove normal tobacco smoke and dust films.

Don't use abrasive cleaners on glass, because they may cause scratches. Avoid placing decals on the inside rear window, since they may have to be scraped off later. If abrasive cleaners are used on the inside of the rear window, an electric defogger element may be damaged. Any temporary license should not be attached across the defogger grid.

CLEANING THE OUTSIDE OF THE WINDSHIELD AND WIPER BLADES

If the windshield is not clear after using the windshield washer, or if the wiper blade chatters when running, wax or other material may be on the blade or windshield.

Clean the outside of the windshield with GM Windshield Cleaner, Bon-Ami Powder[®] (GM Part No. 1050011). The windshield is clean if beads do not form when you rinse it with water.

Clean the blade by wiping vigorously with a cloth soaked in full strength windshield washer solvent. Then rinse the blade with water.

Wiper blades should be checked on a regular basis and replaced when worn.

WEATHERSTRIPS

Silicone grease on weatherstrips will make them last longer, seal better, and not stick or squeak. Apply silicone grease with a clean cloth at least every six months. During very cold, damp weather more frequent application may be required. (See "Recommended Fluids and Lubricants" in the Index.)

CLEANING THE OUTSIDE OF YOUR CADILLAC

The paint finish on your vehicle provides beauty, depth of color, gloss retention and durability.

Washing Your Vehicle

The best way to preserve your vehicle's finish is to keep it clean by washing it often with lukewarm or cold water.

Don't wash your vehicle in the direct rays of the sun. Don't use strong soaps or chemical detergents. Use liquid hand, dish or car washing (mild detergent) soaps. Don't use cleaning agents that are petroleum based, or that contain acid or abrasives. All cleaning agents should be flushed promptly and not allowed to dry on the surface, or they could stain. Dry the finish with a soft, clean chamois or a 100% cotton towel to avoid surface scratches and water spotting.

High pressure car washes may cause water to enter your vehicle.

Finish Care

Occasional waxing or mild polishing of your Cadillac by hand may be necessary to remove residue from the paint finish. You can get GM approved cleaning products from your dealer. (See "Appearance Care and Materials" in the Index.)

Your Cadillac has a "basecoat/clearcoat" paint finish. The clearcoat gives more depth and gloss to the colored basecoat. Always use waxes and polishes that are non-abrasive and made for a basecoat/clearcoat paint finish.

NOTICE:

Machine compounding or aggressive polishing on a basecoat/clearcoat paint finish may dull the finish or leave swirl marks.

Foreign materials such as calcium chloride and other salts, ice melting agents, road oil and tar, tree sap, bird droppings, chemicals from industrial chimneys, etc. can damage your vehicle's finish if they remain on painted surfaces. Wash the vehicle as soon as possible. If necessary, use non-abrasive cleaners that are marked safe for painted surfaces to remove foreign matter.

Exterior painted surfaces are subject to aging, weather and chemical fallout that can take their toll over a period of years. You can help to keep the paint finish looking new by keeping your Cadillac garaged or covered whenever possible.

ALUMINUM WHEELS

Your aluminum wheels have a protective coating similar to the painted surface of your vehicle. Don't use strong soaps, chemicals, chrome polish, abrasive cleaners or abrasive cleaning brushes on them because you could damage this coating. After rinsing thoroughly, a wax may be applied.

NOTICE:

Don't use an automatic car wash that has hard silicon carbide cleaning brushes. These brushes can take the protective coating off your aluminum wheels.

TIRES

To clean your tires, use a stiff brush with a tire cleaner.

When applying a tire dressing always take care to wipe off any overspray or splash from painted surfaces. Petroleum-based products may damage the paint finish.

SHEET METAL DAMAGE

If your vehicle is damaged and requires sheet metal repair or replacement, make sure the body repair shop applies anti-corrosion material to the parts repaired or replaced to restore corrosion protection.

FINISH DAMAGE

Any stone chips, fractures or deep scratches in the finish should be repaired right away. Bare metal will corrode quickly and may develop into a major repair expense.

Minor chips and scratches can be repaired with touch-up materials available from your dealer or other service outlets. Larger areas of finish damage can be corrected in your dealer's body and paint shop.

UNDERBODY MAINTENANCE

Chemicals used for ice and snow removal and dust control can collect on the underbody. If these are not removed, accelerated corrosion (rust) can occur on the underbody parts, such as fuel lines, frame, floor pan, and exhaust system even though they have corrosion protection.

At least every spring, flush these materials from the underbody with plain water. Clean any areas where mud and other debris can collect. Dirt packed in closed areas of the frame should be loosened before being flushed. Your dealer or an underbody vehicle washing system can do this for you.

CHEMICAL PAINT SPOTTING

Some weather and atmospheric conditions can create a chemical fallout. Airborne pollutants can fall upon and attack painted surfaces on your vehicle. This damage can take two forms: blotchy, ringlet-shaped discolorations, and small irregular dark spots etched into the paint surface.

Although no defect in the paint job causes this, Cadillac will repair, at no charge to the owner, the surfaces of new vehicles damaged by this fallout condition within 12 months or 12,000 miles (20 000 km) of purchase, whichever comes first.

APPEARANCE CARE MATERIALS CHART

GM PART NUMBER	SIZE	DESCRIPTION	USAGE
1050172	16 Oz. (0.473 L)	Tar and Road Oil Remover	Removes Old Waxes, Polishes, Tar and Road Oil
1050173	16 Oz. (0.473 L)	Chrome Cleaner and Polish	Removes Rust and Corrosion on Chrome and Stainless Steel
1050174	16 Oz. (0.473 L)	White Sidewall Tire Cleaner	Cleans White and Black Tires
1050214	32 Oz. (0.946 L)	Vinyl/Leather Cleaner	Spot and Stain Removal on Leather or Vinyl
1050427	23 Oz. (0.680 L)	Glass Cleaner	Glass Cleaning and Spot Cleaning on Vinyls
1050429	6 Lbs. (2.72 Kg)	Multi-Purpose Powdered	Cleans Vinyl and Cloth on Door Trim, Seats, and Carpet -- Also, Tires and Mats
1052349	12 Oz. (0.354 L)	Lubriplate	Grease for Hood, Trunk and Door Hinges and Latches
1052870	16 Oz. (0.473 L)	Wash-Wax (Conc.)	Exterior Wash
1051398	8 Oz. (0.237 L)	Spot Lifter	Spot and Stain Removal on Cloth and Fabric
1051515	32 Oz. (0.946 L)	GM Optikleen	Windshield Washer Solvent and Anti-Freeze
1050201	16 Oz. (0.473 L)	Magic Mirror Cleaner Polish	Exterior Cleaner and Polish

VEHICLE IDENTIFICATION NUMBER (VIN)

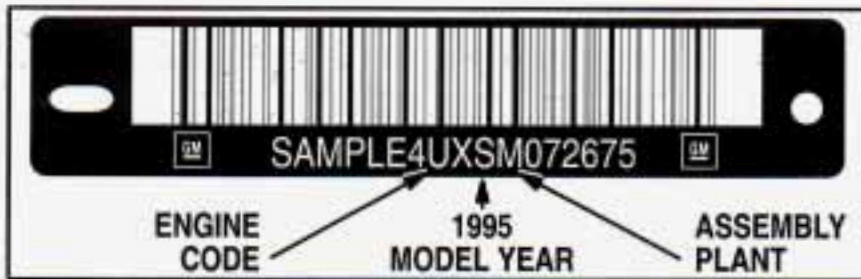

This is the legal identifier for your Cadillac. It appears on a plate in the front corner of the instrument panel, on the driver's side. You can see it if you look through the windshield from outside your vehicle. The VIN also appears on the Vehicle Certification and Service Parts labels and the certificates of title and registration.

Engine Identification

The eighth character in your VIN is the engine code. This code will help you identify your engine, specifications, and replacement parts.

SERVICE PARTS IDENTIFICATION LABEL

You'll find this label on the underside of the trunk lid. It's very helpful if you ever need to order parts. On this label is:

- your VIN,
- the model designation,
- paint information, and
- a list of all production options and special equipment.

Be sure that this label is not removed from the vehicle.

ADD-ON ELECTRICAL EQUIPMENT

NOTICE:

Don't add anything electrical to your Cadillac unless you check with your dealer first. Some electrical equipment can damage your vehicle and the damage wouldn't be covered by your warranty. Some add-on electrical equipment can keep other components from working as they should.

Your vehicle has an air bag system. Before attempting to add anything electrical to your Cadillac, see "Servicing Your Air Bag-Equipped Cadillac" in the Index.

FUSES AND CIRCUIT BREAKERS

The wiring circuits in your vehicle are protected from short circuits by a combination of mini fuses, circuit breakers, and maxi fuses. This greatly reduces the chance of fires caused by electrical problems.

If you ever have a problem on the road and don't have a spare fuse, you can "borrow" one of the correct value. Select a feature that you can get along without that is the same value you need -- like the radio or cigarette lighter -- and use its fuse. Be sure to use a fuse with the same amperage rating number on it (for example, 10A). Replace it as soon as you can.

Instrument Panel Fuse Block

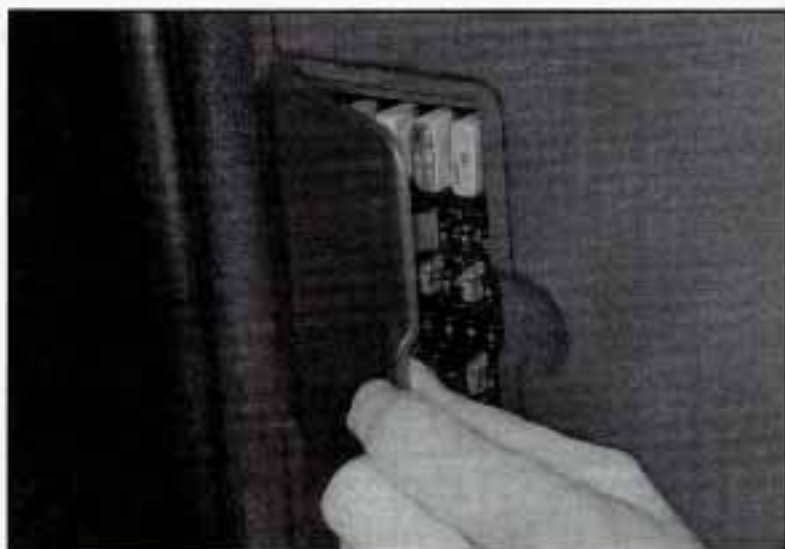

To gain access to the fuse block, remove the cover on the driver's side of the instrument panel.

Underhood (U/H) Electrical Center

The U/H electrical center is located on the passenger side wheel housing in the engine compartment.



Remove the cover to gain access.

Headlamps

The headlamp wiring is protected by a circuit breaker in the instrument panel fuse block. An electrical overload will cause the lamps to go on and off, or in some cases to remain off. If this happens, have your headlamp wiring checked right away.

Windshield Wipers

The windshield wiper motor is protected by a circuit breaker and a fuse. If the motor overheats due to heavy snow, etc., the wiper will stop until the motor cools. If the overload is caused by some electrical problem and not snow, etc., be sure to get it fixed.

Power Windows and Other Power Options

Circuit breakers in the fuse panel protect the power windows and other power accessories. When the current load is too heavy, the circuit breaker opens and closes, protecting the circuit until the problem is fixed or goes away.

Instrument Panel Fuse Block

1	X	2	X	3	X	4	X	5	X	CIRCUIT BREAKERS
6	X	7	X	8	RAP WPR	9	RADIO	10	WPER	
11	I/P INDC	12	T/SIG	13	CHIME	14	CCM IGN 1	15	AIR BAG	2 RAP RLY
16	GEN	17	MEM SEAT	18	CCM IGN 3	19	RAP PWR	20	A/C COMP	3 PWR SEAT
21	RAP BATT	22	HVAC MDL	23	TRK REL	24	STARTER	25	HVAC IGN	4 FR DEFOG
26	ELC SENS	27	DRVT LYS	28	FRY CIG	29	RR CIG	30	X	5 HD LYS
31	FRNK LYS	32	HORN	33	HVAC BAT	34	CCM BAT	35	PWR MFR	
36	TRK PDWN	37	HANDL LYS	38	STOP-LYS	39	PWR LK	40	HTD SEAT	
41	CORNR LYS	42	I/P DIM LYS	43	TAL LYS	44	MFR DEFG	45	X	

PRINTED IN U.S.A. FOR MORE INFORMATION, SEE OWNER'S MANUAL

FUSE	USAGE
RAP WPR	Component Center (RAP Wiper) Relay
RADIO	Radio Receiver
WIPER	Windshield Wiper/Washer Switch
I/P INDC	Inflatable Restraint Diagnostic Energy Reserve (with Sensor) Module, Instrument Panel Cluster
T/SIG	Park/Neutral Position and Backup Lamp Switch, Turn Signal Lamp Flasher
CHIME	Warning Alarm, Cruise Control Release Switch, Inside Rearview Mirror, Rear Window Defogger Relay, Park/Neutral Position and Backup Lamp Switch, Automatic Level Control Sensor
CCM IGN 1	Central Control Module (CCM)
AIR BAG	Inflatable Restraint Diagnostic Energy Reserve (with Sensor) Module
GEN	Generator, Secondary Engine Cooling Fan Relay
MEM SEAT	Driver's Seat Adjuster Memory Module, Heated Driver's Seat Switch, Heated Passenger's Seat Switch
CCM IGN 3	Central Control Module (CCM), Remote Control Door Lock Receiver and Theft Deterrent Module, Cruise Control Module, Cruise Control Switch
RAP PWR	Accessory Time Delay Cut-Off (RAP Power) Relay
A/C COMP	A/C Compressor Relay, Primary Engine Cooling Fan Relay
RAP BATT	Component Center (RAP Wiper) Relay
HVAC MDL	Blower Motor Control Module

FUSE	USAGE
TRK REL	Rear Compartment Lid Release Switch
STARTER	Theft Deterrent Relay, Inflatable Restraint Diagnostic Energy Reserve (with Sensor) Module
HVAC IGN	Instrument Cluster, Heater-A/C Control, Vacuum/Electric Solenoid, Electric Actuator
ELC SENS	Automatic Level Control Sensor, Rear Compartment Courtesy Lamp
D/INT LTS	Component Center Relay
FRT CIG	Front Cigar Lighter
RR CIG	Rear Cigar Lighters
PARK LTS	Park Lamp Relay
HORN	Horn Relay
HVAC BAT	Warning Alarm, Heater-A/C Control, Instrument Cluster, Headlamp Switch, Radio Receiver
CCM BAT	Center Control Module (CCM)
PWR MIR	Door Lock Switches, Outside Rearview Mirrors, Ignition Key Disable Relay Assembly
TRK PDWN	Rear Compartment Lid Pull-Down Actuator
HAZRD LTS	Hazard Lamp Flasher
STOP-LTS	Stoplamps Switch
PWR LK	Door Lock Relay
HTD SEAT	Heated Driver's and Passenger's Seat Control Modules
CORNR LTS	Instrument Cluster, Radio Control, Cornering Lamps, Turn Signal Switch, Front Park Lamps
I/P DIM LTS	Headlamp Switch Control for Interior Lamps, Dimming
TAIL LTS	Rear Taillamps, Rear Side Marker Lamps, License Lamp
MIR DEFG	Outside Rearview Mirror Defoggers

CIRCUIT BREAKER	USAGE
PWR RECL	Lumbar, Power Antenna
RAP RLY	Accessory Time Delay Cut-Off (RAP Power) Relay
PWR SEAT	Driver's and Passenger's Seat Adjuster Switches, Driver's Seat Adjuster Memory Module, Driver's and Passenger's Seats Recline Switches
RR DEFOG	Rear Defogger Relay
HD LTS	Headlamp Relay, Daytime Running Lamps (DRL) Relay

Underhood Electrical Center

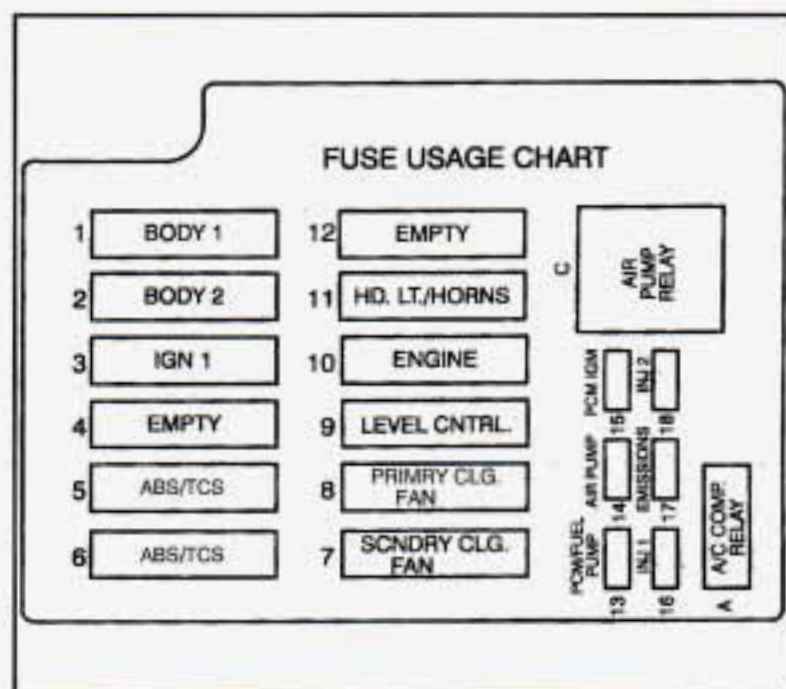

MAXI FUSE	POWER TO
BODY 1	Circuit Breakers: PWR SEAT, RR DEFOG; I/P Fuses: TRK PDWN, HAZRD LTS, HTD SEAT, STOP-LTS, PWR LK
BODY 2	Circuit Breaker: RAP RLY; I/P Fuses: RAP BATT, HVAC MDL, ELC SENS, D/INT LTS, FRT CIG, RR CIG, HVAC BAT, CCM BAT, PWR MIR
IGN 1	Concealed Fuse; I/P Fuses: RAP WPR, RADIO, WIPER, I/P INDC, T/SIG, CHIME, CCM IGN 1, AIR BAG, STARTER; U/H Electrical Center: PCM IGN, INJ1, EMISSIONS, INJ 2
ABS/TCS (#5)	ABS/TCS Brake Pressure Modulator Valve
ABS/TCS (#6)	ABS/TCS Brake Pressure Modulator Valve
SCNDRY CLG FAN	Secondary Engine Cooling Fan Relay
PRIMRY CLG FAN	Primary Engine Cooling Fan Relay
LEVEL CONTROL	Automatic Level Control Air Compressor
ENGINE	U/H Electrical Center: PCM/FUEL PUMP, AIR PUMP
HEADLIGHTS/ HORNS	Circuit Breaker: HD LTS; I/P Fuses: PARK LTS, HORN

MINI FUSE	POWER TO
PCM/FUEL PUMP	Fuel Pump Relay, Fuel Pump/Engine Oil Pressure Indicator Switch, Powertrain Control Module (PCM)
AIR PUMP	Secondary Air Injection (AIR) Pump Relay
PCM/IGN	Powertrain Control Module (PCM), Ignition Coil
INJ 1	Fuel Injectors Cylinders 1, 4, 6, 7
EMISSIONS	Exhaust Gas Recirculation (EGR), Vacuum Control Signal Solenoid Valve, Secondary Air Injection (AIR), Pump Relay (Coil), Mass Air Flow Sensor, Electronic Transmission, Left and Right Heated Oxygen Sensors, Evaporative Emission (EVAP) Canister Purge Solenoid Valve
INJ 2	Fuel Injectors Cylinders 2, 3, 5, 8

RELAY	USAGE
A/C COMP RELAY	A/C Compressor Relay
AIR PUMP RELAY	Secondary Air Injection (AIR) Pump Relay

BULB CHART

You can get these from your Cadillac dealer.

Description	Bulb No.
Ashtray Illumination	1445
Backup Lamps	2057
Center High-Mounted Stoplamp	1156
Cornering Lamp	2057
Front Parking and Directional Signal	2057NA
Front Sidemarker Lamp	194
Glove Box	194
Headlamp High Beam	9005
Headlamp Low Beam	9006
License Plate Lamp	194
Parking Lamp	2057
Side Marker Lamps	194
Stop, Tail, and Directional Signal Lamp	2057
Trunk Lamp	920
Underhood Lamp	561

CAPACITIES AND SPECIFICATIONS

5.7L Engine

Displacement	5.7L (350 cubic inches)
No. of Cylinders	8 - 90 degree V
Power (Acc. to SAE J1349)	260 (bhp) @ 5000 rpm 194 (kW) @ 5000 rpm
Torque (Acc. to SAE J1349)	330 (lb. ft.) @ 3200 rpm 447 (N•m) @ 3200 rpm
Bore	101.6 mm (4.00 inches)
Stroke	88.4 mm (3.48 inches)
Compression Ratio	10.5:1
Cylinder Block	Cast Iron
Cylinder Head	Cast Iron
Intake Manifold	Cast Aluminum
Lifter Assembly	Hydraulic
Intake Valve	49.3 mm (1.94 inches)
Exhaust Valve	38.1 mm (1.50 inches)
Pistons	Cast Aluminum
Firing Order	1-8-4-3-6-5-7-2
Left Bank	1-3-5-7
Right Bank	2-4-6-8
Crankshaft	Cast Iron
Main Bearings	Five

Engine Lubrication System

Oil Pressure @ 1000 rpm	6 psi (41 kPa)
Type of Intake	Stationary
Filter System	Full-Flow

Engine Cooling System

Surge Tank Cap Relief Pressure	15 psi (104 kPa)
Thermostat Starts To Open	180° F (82° C)
Water Pump Type	Centrifugal
Drive Belt	Serpentine
Radiator Core	Hi-Efficiency Aluminum
Radiator Cooling Fans	Electric
Radiator Cooling Fan (Heavy-Duty)	Centrifugal

Fuel System

Induction Type	Sequential Port Fuel Injection (SPFI)
Idle Speed	PCM Controlled
Filter Type	Paper Type Element
Fuel Pump	Electric (In Tank)
Fuel Required	Unleaded (87 Octane)

Automatic Transmission

Trade Name	Hydra-Matic (4L60-E)
Type	4-Speed Electronic Automatic Torque Converter Clutch
Fluid Required	DEXRON®-III

Rear Drive Axle

Description	Semi-Floating Hypoid
No. of Differential Pinions	2
Driving Wheel Bearing Type	Roller
Axle Ratio (Fleetwood)	2.56:1
Axle Ratio (Fleetwood Brougham)	2.93:1
Axle Ratio (Trailer Towing Option)	3.42:1
Axle Ratio (Coachbuilder)	2.93:1

Emission Control Systems

Air Injection	Air Injection with Computer Command Control
Exhaust Gas Recirculation	Controlled Flow
Catalytic Converter	Warm-up 3-Way
Evaporative Emission Control	Charcoal Canister
Crankcase Emission	Positive Crankcase Ventilation
Electronic System	Closed Loop

Exhaust System

Type	Dual with Crossover Pipe
Muffler	Two-Reverse Flow
Resonator	Two-Straight Through
Exhaust Pipe	Stainless Steel
Intermediate Pipe	Stainless Steel
Tail Pipe	Stainless Steel

Electrical System

Voltage	12
Ground	Negative
Generator	140 Amp

Air Conditioning System

Refrigerant -- R-134a 1.75 pounds (0.79 kg)

Not all air conditioning refrigerants are the same. If the air conditioning system in your vehicle needs refrigerant, be sure the proper refrigerant is used. If you're not sure, ask your Cadillac dealership.

Fluid Capacities

Auto Trans (4L60-E) Pan Removal	5.0 quarts (4.7 L)
Auto Trans (4L60-E) Overhaul (298 mm Torque Conv.)	11.2 quarts (10.6 L)
Engine Oil & Filter Change	5.0 quarts (4.7 L)
Engine Cooling	14.0 quarts (13.2 L)
Engine Cooling with A/C	15.1 quarts (14.3 L)
Engine Cooling Heavy-Duty	16.8 quarts (15.9 L)
Fuel Tank	23 gallons (87 L)
Power Steering	1.4 quarts (0.65 L)
Rear Axle	4.3 pints (2.0 L)

Tighten Torque

Spark Plug	11 lb. ft. (15 N·m)
Oil Filter	14 lb. ft. (19 N·m)
Oil Pan Drain Plug	30 lb. ft. (41 N·m)
Wheel Lug Nut	100 lb. ft. (140 N·m)
Rear Axle Filler Plug	26 lb. ft. (35 N·m)

Vehicle Dimensions

Shipping Weight	4,369 pounds (1 982 kg)
Shipping Weight (Brougham)	4,389 pounds (1 991 kg)
Wheel Base	122 inches (3 085 mm)
Length	224 inches (5 696 mm)
Height	57 inches (1 451 mm)
Width	77 inches (1 952 mm)
Front Tread	62 inches (1 568 mm)
Rear Tread	61 inches (1 552 mm)

NORMAL MAINTENANCE REPLACEMENT PARTS

Air Cleaner Element	AC Type A1096C 25096932
Battery	78A-72
Fuel Filter Element	AC Type GF-624K 25121978
Engine Oil Filter	AC Type PF52 25160560
PCV Valve	AC Type CV895C 25095452
Spark Plugs (Gap 0.052 inches)	AC Type 41-906 5614244
Serpentine Drive Belt	10186120
Upper Radiator Hose	10260864
Lower Radiator Hose	10237350
Lower Radiator Hose (Heavy-Duty)	10237349
Surge Tank Cap	10244485
Thermostat	10128336



We employ technicians certified by the
National Institute for

**AUTOMOTIVE
SERVICE
EXCELLENCE**

Let us show you their credentials



Part Number 3547054 • A First Edition

1956 SEDAN DE VILLE





1957 ELDORADO BROUGHAM



TOLL-FREE HOTLINE
1-800-882-1112

Roadside Service represents the spirit of luxury leadership at Cadillac Motor Car Division. We hope the need never arises, but if it does, Roadside Service is there for you!! Roadside Service covers you on the road, far from home, all day and night, weekends and holidays. **THERE ARE NO MEMBERSHIP OR ENROLLMENT CHARGES.** Any Cadillac is eligible under this program.

- ROADSIDE SERVICE AVAILABILITY -

TYPE OF ASSISTANCE	DAILY INCLUDING HOLIDAYS
Phone Advisor	24 Hours
Dealer Technician	8 a.m. - 12 midnight
Towing Battery Jump Start Lockout Assistance Fuel Delivery Tire Change	24 Hours

Cadillac Roadside Service is just one of your Cadillac Owner PrivilegesSM that leads to peace of mind.

- Cadillac Owner Privilegessm -

Roadside Service provides several Cadillac Owner Privilegessm at "no charge", throughout your 1995 Cadillac Warranty Period - 48 Months, or 50,000 Miles/80,000 Kilometers.

- **EMERGENCY ROAD SERVICE** - is performed on site for the following situations:
 - **TOWING SERVICE**
 - **BATTERY JUMP START**
 - **LOCK OUT ASSISTANCE**
 - **FUEL DELIVERY**
 - **FLAT TIRE CHANGE (* Covers change only)**
 - * Tire replacement/warranty coverage must be determined by a Cadillac dealer or appropriate tire manufacturer.



- Cadillac Owner Privilegessm -

- **TRIP INTERRUPTION** – If your trip is interrupted due to a warranty failure, incidental expenses may be reimbursed during the 48 months or 50,000 miles/80,000 kilometers warranty period. Items covered are hotel, meals and rental car.
- **TRIP ROUTING** – Free trip routing assistance is available during the 48 months or 50,000 miles/80,000 kilometers warranty period. Within a week of contacting Roadside Service with your travel plans, Cadillac will provide a detailed trip routing. Along with your first trip routing, you will receive a Rand McNally North American Road Atlas.



What Will Roadside Service Cost You ? ? ?

There is no cost to call the toll-free Roadside Service number. Many times Roadside Advisors can assist you over the phone.

There is no cost for Roadside Service if the repair is under warranty or the provided service is one of the covered Emergency Road Services.

If a dealership Service Technician travels to your location, and the repair is not covered under warranty, there is a nominal service fee to cover the technician's travel to and from your location. Labor is charged at one and one half times the Cadillac dealership retail labor rate, with a 30 minute minimum. There is also a charge for any parts used and a mileage fee if the technician travels beyond 30 miles.

How Do You Pay For Roadside Service ? ? ?

Payment is due at the time services are performed if it is determined they are non-warranty related. Payment may be made by cash, personal check or any major credit card honored by the participating Cadillac dealership, tow service or locksmith.

In some instances where warranty determination cannot be made, the charges must still be paid. Retain the bill and submit it to an authorized Cadillac dealership Service Department for review. If the repair is determined to be covered by warranty the dealer will expedite reimbursement directly to you.

Where Is Roadside Service Available ? ? ?

Wherever you drive in the United States or Canada, an advisor is available to assist you over the phone. If needed, a dealer technician will travel to your location within a 30 miles/50 kilometers radius, of a participating Cadillac dealership. If beyond this radius, we will arrange to have your car towed to the nearest Cadillac dealership.

How Do You Reach Roadside Service ? ? ?

Dial the toll-free Roadside Service number: 1-800-882-1112. An experienced Roadside Service Advisor will assist you and request the following information:

- *A description of the problem*
- *Name, home address, home telephone number*
- *Location of your Cadillac, and number you are calling from*
- *The model year, vehicle identification number, and date of delivery*



Who Will Repair Your Cadillac At Roadside ? ? ?

In many cases, the advisor at the Roadside Service Center can provide instructions to get you back on the road.

To resolve more complex problems, the advisor will page an experienced Cadillac dealership Service Technician. The technician will call you and evaluate the possible cause. If a roadside repair is possible, the technician will come to your location and provide a permanent or temporary repair.

What If Your Cadillac Is In An Unsafe Location Or On A Limited Access Highway ? ? ?

If your car is located in an area that is determined to be unsafe (by you, the advisor or the technician) or if the vehicle is on a limited access freeway or regulated highway, the advisor will arrange to tow your Cadillac to a safe location, where service can be performed. Additional assistance will be provided if necessary.

What If Your Cadillac Cannot Be Repaired At Roadside ? ? ?

If your car cannot be repaired at roadside within a reasonable period of time (approximately 45 minutes) or requires the resources of a Cadillac dealership service facility, the advisor will arrange a tow service for you. Towing may also be necessary after the technician has attempted a repair, but determines that your car cannot be repaired at roadside.

Tow services are provided by independent companies, so therefore, Cadillac is not responsible for the tow company. During the 48 months, or 50,000 miles/80,000 kilometers warranty period, towing services are covered for any disablement.

What If You Have Difficulty Hearing Or Speaking And Need Roadside Service ???

Roadside Service is prepared to assist owners who have hearing difficulties or are speech impaired. Cadillac has installed special Telecommunication Devices for the Deaf (TDD) in the Roadside Service Center.

Any customer who has access to a TDD or a conventional teletypewriter can communicate with Cadillac by dialing from the United States or Canada: 1-800-TDD-CMCC or 1-800-833-2622 - daily, 24 hours.

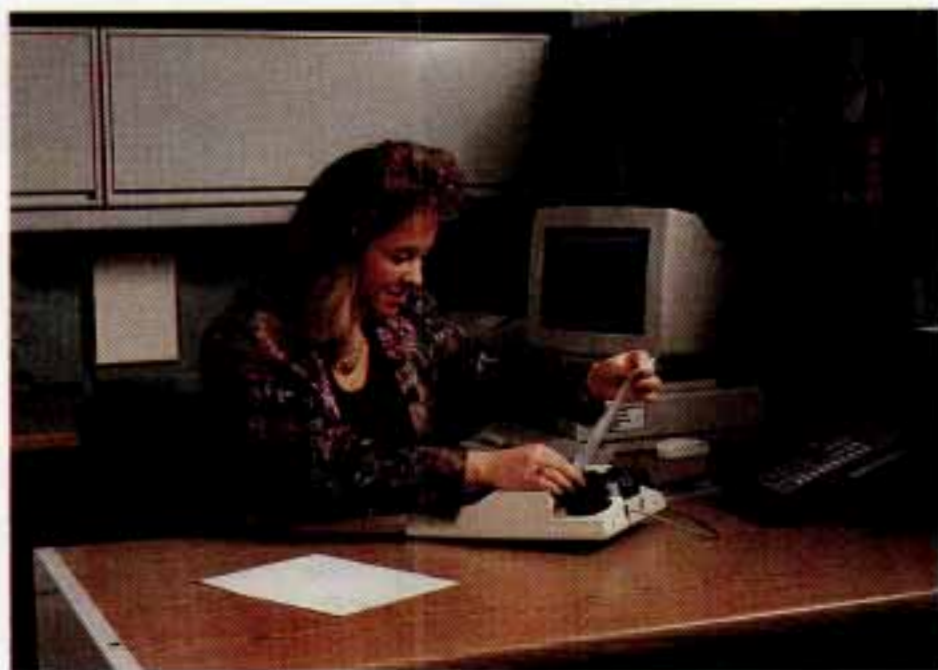

What If You Do Not Speak English Fluently ???

Cadillac offers a multi-lingual approach in assisting you. Roadside Advisors are conversant in a number of languages and utilize the AT&T Language Line Interpreter available 24-hours a day. Just another way Cadillac says "we care".



*Our Cadillac Dealer Technician network is ready
and able to assist Cadillac customers at roadside.*



**TOLL-FREE HOTLINE
1-800-882-1112**

1959 DE VILLE CONVERTIBLE





1960 ELDORADO BIARRITZ CONVERTIBLE



Gold Key Courtesy Transportation

One of your Cadillac Owner Privileges is Gold Key Courtesy Transportation. It's one more example of Cadillac's commitment to provide the services you expect and deserve as a Cadillac owner.

Gold Key Courtesy Transportation helps you get where you need to be when your Cadillac is in the dealership for warranty service.*

**Please ask about the specific Gold Key Courtesy Transportation benefits offered by your Cadillac Dealer.*



Courtesy Vehicle

Gold Key Courtesy Transportation provides you with a Cadillac if your car requires warranty repairs.

Your dealer will provide you with a courtesy vehicle if one is available.

Shuttle Service

Warranty work can frequently be handled in one day, but there is no reason for you to wait around. Cadillac helps eliminate inconvenience to you with transportation alternatives.

Gold Key Courtesy Transportation provides shuttle service for same day warranty work. Your Cadillac Dealer can get you where you need to be with minimal interruption of your daily schedule.





Plan Ahead When Possible

Whenever possible, schedule an appointment for your vehicle's warranty work. Your Cadillac Dealer can then prepare to meet your alternative transportation needs and minimize inconveniences typically associated with warranty repairs.

Owner Responsibilities

There are only two things which you will be responsible for during the use of your courtesy vehicle. You are required to provide insurance coverage and replenish the fuel used.

In many cases your own auto insurance policy may provide primary coverage for the courtesy vehicle, similar to rental car agreements. Please, check with your insurance company to be certain what's covered.



Gold Key Courtesy Transportation -- Just one more way your Cadillac Dealer is committed to you.

THEORY OF RELATIVITY

The theory of relativity, developed by Albert Einstein, is a fundamental theory of physics that describes the relationship between space and time. It is based on the principle that the laws of physics are the same for all observers, regardless of their relative motion.

There are two main parts to the theory: special relativity and general relativity. Special relativity deals with objects moving at constant speeds, while general relativity deals with objects in free fall and the effects of gravity.



Special relativity is based on two postulates: the principle of relativity and the constancy of the speed of light. These postulates lead to the famous equation $E=mc^2$, which shows that energy and mass are equivalent.

General relativity is based on the equivalence principle, which states that the effects of gravity are indistinguishable from the effects of acceleration. This theory predicts the bending of light by gravity and the existence of black holes.

1963 FLEETWOOD 60 SPECIAL





1966 DE VILLE CONVERTIBLE/FLEETWOOD BROUGHAM SEDAN



OWNER ASSISTANCE

CUSTOMER ASSISTANCE INFORMATION

Here you will find out how to contact Cadillac if you need assistance. This section also tells you how to obtain service publications and how to report any safety defects.

This section includes information on: The Customer Satisfaction Procedure, Customer Assistance for Hearing or Speech Impaired, BBB Auto Line - Alternative Dispute Resolution Program, Reporting Safety Defects, Roadside Assistance, and Service Publications.

CUSTOMER SATISFACTION PROCEDURE

Your satisfaction and goodwill are important to your dealer and Cadillac. Normally, any concern with the sales transaction or the operation of your vehicle will be resolved by your dealer's Sales or Service Departments. Sometimes, however, despite the best intentions of all concerned, misunderstandings can occur. If your concern has not been resolved to your satisfaction, the following steps should be taken:

STEP ONE -- Discuss your concern with a member of dealer management. Normally, concerns can be quickly resolved at that level. If the matter has already been reviewed with the Sales, Service, or Parts Manager, contact the owner of the dealer or the General Manager.

STEP TWO -- If after contacting a member of dealer management, it appears your concern cannot be resolved by the dealer without further help, contact the Cadillac Consumer Relations Center 24 hours a day by calling 1-800-458-8006. In Canada, contact GM of Canada Customer Assistance Center in Oshawa by calling 1-800-263-3777 (English) or 1-800-263-7854 (French).

In Mexico, call (525) 254-3777. In Puerto Rico, call 1-800-496-9992 (English) or 1-800-496-9993 (Spanish). In the U.S. Virgin Islands, call 1-800-496-9994. In other overseas locations, contact GM North American Export Sales in Canada by calling 1-905-644-4112.

For prompt assistance, please have the following information available to give the Customer Assistance Representative:

- Your name, address, home and business telephone numbers
- Vehicle Identification Number (This is available from the vehicle registration or title, or the plate at the left top of the instrument panel and visible through the windshield.)
- Dealer name and location
- Vehicle delivery date and present mileage
- Nature of concern

We encourage you to call the toll-free number listed previously in order to give your inquiry prompt attention. However, if you wish to write Cadillac, write to:

Cadillac Consumer Relations Center
Cadillac Motor Car Division
30009 Van Dyke
P.O. Box 9025
Warren, MI 48090-9025

Refer to your Warranty and Owner Assistance Information booklet for addresses of Canadian and GM Overseas offices.

When contacting Cadillac, please remember that your concern will likely be resolved in the dealership, using the dealer's facilities, equipment and personnel. That is why we suggest you follow Step One first if you have a concern.

CUSTOMER ASSISTANCE FOR THE HEARING OR SPEECH IMPAIRED (TDD)

To assist customers who have hearing difficulties, Cadillac has installed special TDD (Telecommunication Devices for the Deaf) equipment at its Customer Assistance Center. Any hearing or speech impaired customer who has access to a TDD or a conventional teletypewriter (TTY) can communicate with Cadillac by dialing: 1-800-TDD-CMCC. (TDD users in Canada can dial 1-800-263-3830.)

GM PARTICIPATION IN BBB AUTO LINE - ALTERNATIVE DISPUTE RESOLUTION PROGRAM*

*This program may not be available in all states, depending on state law. Canadian owners refer to your Warranty and Owner Assistance Information booklet. General Motors reserves the right to change eligibility limitations and/or to discontinue its participation in this program.

Both Cadillac and your Cadillac dealer are committed to making sure you are completely satisfied with your new vehicle. Our experience has shown that, if a situation arises where you feel your concern has not been adequately addressed, the Customer Satisfaction Procedure described earlier in this section is very successful.

There may be instances where an impartial third-party can assist in arriving at a solution to a disagreement regarding vehicle repairs or interpretation of the New Vehicle Limited Warranty. To assist in resolving these disagreements, Cadillac voluntarily participates in BBB AUTO LINE.

BBB AUTO LINE is an out-of-court program administered by the Better Business Bureau system to settle disputes between customers and automobile manufacturers. This program is available free of charge to customers who currently own or lease a GM vehicle.

If you are not satisfied after following the Customer Satisfaction Procedure, you may contact the BBB using the toll-free telephone number, or write them at the following address:

BBB AUTO LINE
Council of Better Business Bureaus
4200 Wilson Boulevard
Suite 800
Arlington, VA 22203
Telephone: 1-800-955-5100

To file a claim, you will be asked to provide your name and address, your Vehicle Identification Number (VIN), and a statement of the nature of your complaint. Eligibility is limited by vehicle age and mileage, and other factors.

We prefer you utilize the Customer Satisfaction Procedure before you resort to AUTO LINE, but you may contact the BBB at any time. The BBB will attempt to resolve the complaint serving as an intermediary between you and Cadillac. If this mediation is unsuccessful, an informal hearing will be scheduled where eligible customers may present their case to an impartial third-party arbitrator.

The arbitrator will make a decision which you may accept or reject. If you accept the decision, GM will be bound by that decision. The entire dispute resolution procedure should ordinarily take about forty days from the time you file a claim until a decision is made.

Some state laws may require you to use this program before filing a claim with a state-run arbitration program or in the courts. For further information, contact the BBB at 1-800-955-5100 or the Cadillac Customer Assistance Center at 1-800-458-8006.

REPORTING SAFETY DEFECTS TO THE UNITED STATES GOVERNMENT

If you believe that your vehicle has a defect which could cause a crash or could cause injury or death, you should immediately inform the National Highway Traffic Safety Administration (NHTSA), in addition to notifying General Motors.

If NHTSA receives similar complaints, it may open an investigation, and if it finds that a safety defect exists in a group of vehicles, it may order a recall and remedy campaign. However, NHTSA cannot become involved in individual problems between you, your dealer, or General Motors.

To contact NHTSA, you may either call the Auto Safety Hotline toll-free at 1-800-424-9393 (or 366-0123 in the Washington, D.C. area) or write to:

NHTSA, U.S. Department of Transportation
Washington, D.C. 20590

You can also obtain other information about motor vehicle safety from the Hotline.

REPORTING SAFETY DEFECTS TO THE CANADIAN GOVERNMENT

If you live in Canada, and you believe that your vehicle has a safety defect, you should immediately notify Transport Canada, in addition to notifying General Motors of Canada Limited. You may write to:

Transport Canada
Box 8880
Ottawa, Ontario K1G 3J2

REPORTING SAFETY DEFECTS TO GENERAL MOTORS

In addition to notifying NHTSA (or Transport Canada) in a situation like this, we certainly hope you'll notify us. Please call us at our Consumer Relations Center, 1-800-458-8006, or write:

Cadillac Consumer Relations Center
Cadillac Motor Car Division
30009 Van Dyke
P.O. Box 9025
Warren, MI 48090-9025

In Canada, please call us at 1-800-263-3777 (English) or 1-800-263-7854 (French). Or, write:

General Motors of Canada Limited
Customer Assistance Center
1908 Colonel Sam Drive
Oshawa, Ontario L1H 8P7

SERVICE AND OWNER PUBLICATIONS

Service manuals, service bulletins, owner's manuals and other service literature are available for purchase for all current and many past model General Motors vehicles.

Toll-free telephone numbers for ordering information:

United States 1-800-551-4123
Canada 1-800-668-5539

SERVICE MANUALS

Service manuals contain diagnosis and repair information for all chassis and body systems. They may be useful for owners who wish to get a greater understanding of their vehicle. They are also useful for owners with the appropriate skill level or training who wish to perform "do-it-yourself" service. These are authentic General Motors service manuals meant for professional, qualified technicians. In some cases they refer to specialized tools, equipment and safety procedures necessary to service the vehicle.

SERVICE BULLETINS

Service bulletins covering various subjects are regularly sent to all General Motors dealerships/retail facilities. GM monitors product performance in the field. When service methods are found which promote better service on GM vehicles, bulletins are created to help the technician perform better service. Service bulletins may involve any number of vehicles. Some will describe inexpensive service, others will describe expensive service. Some will advise new or unexpected conditions, and others may help avoid future costly repairs. An important reminder -- service bulletins are meant for qualified technicians. Since these bulletins are issued throughout the model year and beyond, an index is required and published quarterly to help identify specific bulletins. Subscriptions are available. You can order an index at the toll-free numbers listed previously, or ask a GM dealer/retailer to see an index or individual bulletin.

OWNER PUBLICATIONS

Owner's manuals, warranty folders and various owner assistance booklets provide owners with general operation and maintenance information.

SERVICE MANUALS

MODEL YEAR	FORM NO.	DESCRIPTION	PRICE EACH
1995	GMP/95EK	Deville/Concours/Eldorado/Seville Service Information Manual (Includes Book 1 & 2) (Available 5/95)	\$90.00
1995	GMP/95D	Fleetwood Service Information Manual (Includes Book 1 & 2) (Available 4/95)	90.00
1995 and Prior	CPCH-095	Order Form for Past Model Service Manuals	FREE

OWNER'S LITERATURE

MODEL YEAR	FORM NO.	DESCRIPTION	PRICE EACH
1995	3547054	Fleetwood Owner Information	\$15.00
1995	3547065	Deville Owner Information	15.00
1995	3547068	Concours Owner Information	15.00
1995	3547060	Seville Owner Information	15.00
1995	3547057	Eldorado Owner Information	15.00
1995	3547081	Maintenance Coupon Booklet	4.00
1995	3547051	Warranty Booklet (All Models)	2.00
1995 and Prior	CPCH-095	Order Form for Past Model Owner's Literature	FREE

NOTE: Owner Literature Portfolios, Vehicle and Owner Information Labels and Gold Keys are available by contacting your Cadillac dealership.

SERVICE BULLETIN INFORMATION

MODEL YEAR	FORM NO.	DESCRIPTION	PRICE EACH
1994	GMSB-ORD-94	Pricing and ordering information for GM Service Bulletin Subscriptions	FREE
1991	H-2855	Service Bulletin Index: A listing of all Service Bulletins released by Cadillac during the model year listed. For 1994, the index contains a listing of all Service Bulletins released by General Motors.	\$4.00
1992	H-2955		4.00
1993	H-30055		4.00
1994	GM-SBI-94		4.00
1991	H-2852B	Bound PSP Edition – includes Index plus complete PSPs	20.00
1992	H-2952B	Bound PSP Edition – includes Index plus complete PSPs	20.00
1993	H-3052B	Bound PSP Edition – includes Index plus complete PSPs	20.00

SERVICE BULLETIN SUBSCRIPTION INFORMATION

MODEL YEAR	FORM NO.	DESCRIPTION	PRICE EACH
1994	94-CAD-SB	Four quarterly mailings containing all Service Bulletins produced by Cadillac. Also, includes a copy of the Bulletin Index	\$75.00
1994	94-CAD-SB()	First, Second, Third and Fourth Quarter packages can be purchased for Cadillac (use appropriate Item/Model #). Indicate Quarter # in (). Also, includes a copy of the Bulletin Index.	25.00
	GM-BB	GM Corporate Bulletin Binder for Product Service Publications. Includes a set of Index Tabs.	20.00

NOTE: Please fill in order form and MAIL TO:

Cadillac Service Publications

Post Office Box 07130, Detroit, Michigan 48207

ORDER TOLL FREE: 1-800-782-4356

Monday-Friday 8:00 A.M.-6:00 P.M. EST

If further information is needed, write to the address shown above or call 1-800-782-4356. Orders cannot be returned without prior authorization. A re-stocking fee may apply.

1 9 9 5 C P C O	PUBLICATION FORM NUMBER	VEHICLE MODEL		QTY.	PRICE EACH	TOTAL PRICE
		NAME	YEAR			
					TOTAL MATERIAL	
					Michigan Purchasers add 6% sales tax	
					Handling Charge	\$4.00
					GRAND TOTAL	

* Prices are subject to change without notice and without incurring obligation.
Please allow adequate time for postal service.

**S
H
I
P
T
O**

NOTE: Dealers and Companies please provide dealer or company name, and also the name of the person whose attention the shipment should be sent. For purchases outside U.S.A. please write to the above address for quotation.

(CUSTOMER NAME) (ATTENTION)

(STREET ADDRESS - NO P.O. BOX NUMBERS) (APT.NO.)

(CITY) (STATE) (ZIP CODE)

DAYTIME TELEPHONE NO. AREA CODE () _____

**P
A
Y
M
E
N
T**

Check or MoneyOrder payable to Helm, Inc. (USA funds only - do not send cash.)

MasterCard VISA Discover Card

Account Number

Expiration Date mo/yr

(CUSTOMER SIGNATURE)

NOTES

1957

NOTES

25106

NOTES

NOTES

12/10/19

NOTES

34834

1970 DE VILLE CONVERTIBLE





1974 FLEETWOOD ELDORADO CONVERTIBLE



FLEETWOOD INDEX

A

Adding

Automatic Transmission Fluid	6-18
Brake Fluid	6-27
Electrical Equipment	2-21, 3-16, 6-61
Engine Coolant	6-21
Engine Oil	6-10
Power Steering Fluid	6-24
Sound Equipment	3-16
Windshield Washer Fluid	2-42, 6-25
Air Bag	1-22
How Does It Restrain	1-26
How It Works	1-24
Location	1-25
Readiness Light	1-23, 2-69
Servicing	1-28
What Makes It Inflate	1-26
What Will You See After It Inflates	1-26
When Should It Inflate	1-25
Air Cleaner	6-14
Air Conditioning Systems Chart	6-71
Air Outlets	3-2
Alarm, Theft Deterrent System	2-15
Alignment and Balance, Tires	6-48
Aluminum Wheels, Cleaning	6-57
AM	3-17
AMAX	3-17
Antenna, Power Mast Care	3-19
Antifreeze	6-20
Anti-Lock	4-6
Anti-Lock Brake System Warning Light	2-72, 4-7

Anti-Lock Brakes	4-6
Appearance Care	6-50
Appearance Care and Materials	6-59
Armrest, Storage	2-58
Ashtrays	2-65
Assist Handles	2-66
Astrorooft	2-60
Audio Systems	3-6
AUTO Button	3-3
Automatic Door Locks	2-5
Automatic Overdrive (Ⓓ)	2-25
Automatic Pull-Down Feature	2-11
Automatic Rearview Mirror	2-53
Automatic Transmission	2-23, 6-70
Automatic Transmission Fluid	6-16
Axle, Rear	6-19

B

Battery	6-30
Charge Light	2-70
Warnings	5-3, 5-5
Battery Replacement, Remote Keyless Entry	2-9
BBB Auto Line	See Owner Assistance
Blizzard	4-31
Brakes	
Adjustment	6-29
Anti-Lock	4-6
Fluid, Adding	6-27
Master Cylinder	6-26
Parking	2-27
Pedal Travel	6-29
Replacing Parts	6-30
Trailer	4-42
Transmission Shift Interlock	2-31
Warning Light	2-71
Wear	6-28
Brake To Shift Light	2-77
Braking	4-6

Braking in Emergencies	4-11
Break-In, New Vehicle	2-18
BTSI (Brake-Transmission Shift Interlock)	2-31
Bulb Replacement	6-68
Center High-Mounted Stoplamp	6-39
Headlamps	6-33
Taillamps	6-35

C

Capacities and Specifications	6-69
Carbon Monoxide	2-33, 4-34, 4-42
Cassette Tape Player Care	3-18
Center High-Mounted Stoplamp Bulb Replacement	6-39
Central Door Unlocking System	2-5
Certification/Tire Label	4-35, 4-36
Chains, Safety	4-42
Chains, Tire	5-32, 6-50
Change Oil Light	2-81
Changing a Flat Tire	5-21
Charging System Light	2-70
Check Engine Light	2-76
Checking	
Automatic Transmission Fluid	6-16
Brake Fluid	6-27
Engine Coolant	6-21
Engine Oil	6-10
Power Steering Fluid	6-24
Restraint Systems	1-54
Under the Hood	6-7
Chemical Paint Spotting	6-58
Child Restraints	1-41
Securing in a Rear Outside Seat Position	1-43
Securing in the Center Rear Seat Position	1-45
Securing in the Right Front Seat Position	1-47
Top Strap	1-42
Where to Put	1-41
Cigarette Lighter	2-65
Circuit Breakers	6-61, 6-63

Cleaning	
Aluminum Wheels	6-57
Fabric	6-51
Glass	6-55
Inside of Your Cadillac	6-51
Leather	6-54
Outside of the Windshield and Wiper Blades	6-55
Outside of Your Cadillac	6-56
Photocells	2-55
Stains	6-53
Tires	6-57
Top of the Instrument Panel	6-54
Vinyl	6-54
Climate Control System	3-2
Clock, Setting the	3-6
Comfort Controls	3-1
Compact Disc Care	3-18
Compact Disc Playing	3-14
Compact Spare Tire	5-28, 5-32
Control of a Vehicle	4-5
Control, Loss of	4-16
Convenience Net	2-57
Convex Outside Mirror	2-56
Coolant	6-19
Coolant Heater, Engine	2-22, 6-14
Coolant Surge Tank	5-15, 5-17
Cooling System	5-15, 6-70
Cornering Lamps	2-50, 6-31
Cruise Control	2-43
Erasing Speed Memory	2-47
Getting Out of	2-47
Increasing Speed	2-46
Passing Another Vehicle	2-46
Reducing Speed	2-46
Resuming a Set Speed	2-45
Setting	2-44
Use on Hills	2-47
Cruise Engaged Message	2-78
Customer Assistance Information	See Owner Assistance
Customer Satisfaction Procedure	See Owner Assistance

D

Damage, Finish	6-58
Damage, Sheet Metal	6-58
Daytime Running Lamps	2-51
Dead Battery	5-3
Defects, Reporting	See Owner Assistance
Defensive Driving	4-1
Defog	3-3, 3-5
Defrost	3-4
Delco Audio Systems	3-6
DNR	3-6
Door	
Central Unlocking System	2-5
Locks	2-3
Door Ajar Light	2-79
Driving	
Blizzard Conditions	4-31
City	4-23
Curves	4-13
Defensive	4-1
Drunken	4-2
Foreign Countries	6-4
Freeway	4-24
Grades	4-45
Hill and Mountain Roads	4-27
Night	4-19
Rainy Conditions	4-20
Snow and Ice Conditions	4-30
Through Deep Standing Water	2-21
Trailer Attached	4-43
Winter	4-29
Drunken Driving	4-2

E

ECON Button	3-3
Electrical Equipment, Adding	2-21, 3-16, 6-61
Electrical Systems Chart	6-71

Electrochromic Mirror	2-53
Electronic Climate Control (ECC)	3-1
Electronic Solar Sensor	3-4
Emission Control Systems Chart	6-71
Engine	
Exhaust	2-33
Identification	6-60
Lubrication System Chart	6-69
Overheating	5-13
Running It While You're Parked	2-34
Specifications	6-69
Starting	2-20
Engine Coolant	6-19
Heater	2-22, 6-14
Temperature Light	2-75
Engine Oil	6-9
Adding	6-10
Additives	6-13
Checking	6-10
Kind to Use	6-10
Used Oil	6-14
When to Change	6-13
English/Metric Button	2-67
Ethanol (In Fuel)	6-3
Exhaust	2-33, 6-71
Express Down Window	2-35
Extender, Safety Belt	1-54
Exterior Lamp Housings	6-31

F

Fabric Cleaning	6-51
Fan	3-3
Fender Skirt	5-24, 5-30
Filling Your Tank	6-5
Filter, Air	6-14
Finish Care	6-56
Finish Damage	6-58
First (1)	2-28

Flash-To-Pass Feature	2-39
Flashers, Hazard Warning	5-1
Flat Tire, Changing	5-21
Floor Mats	2-56
Fluid Capacities Chart	6-72
FM Stereo	3-17
Foreign Countries, Fuel	6-4
Fran ais, Guide en	ii
Front Towing Hookups	5-11
Fuel	6-3, 6-70
Door Release, Remote	6-4
Filling Your Tank	6-5
Foreign Countries	6-4
Gage	2-83
System Chart	6-70
Fuses and Circuit Breakers	6-61

G

Gage, Fuel	2-83
Garage Door Opener	2-61
GAWR (Gross Axle Weight Rating)	4-36
Glass, Cleaning	6-55
Glove Box	2-13
GVWR (Gross Vehicle Weight Rating)	4-40

H

Halogen Bulbs	6-31
Hazard Warning Flashers	5-1
Head Restraints	1-6
Headlamp High-Low Beam Changer	2-39
Headlamp, Wiring	6-61
Headlamps	2-47, 6-33
Hearing or Speech Impaired, Customer Assistance	See Owner Assistance
Highway Hypnosis	4-26
Hill and Mountain Roads	4-27
Hitches, Trailer	4-41

HomeLink Universal Transmitter	2-61
Hood Release	6-7
Horn	2-36
Hydroplaning	4-22

I

If You're Stuck: In Sand, Mud, Ice or Snow	5-33
Ignition Switch	2-19
Illuminated Entry System	2-7
Instrument Panel	2-66, 6-54

J

Jack, Tire	5-23
J-Hooks	5-9
Jump Starting	5-3

K

Keys	2-1
------------	-----

L

Lamps	2-47
Exterior Housings	6-31
Monitors	2-52
Daytime Running	2-51
Lane Change Indicator	2-38
Leaving Your Vehicle	2-7
Engine Running	2-30
Light Sensor, Twilight Sentinel	2-50
Lights, Warning	2-68
Air Bag Readiness	1-23, 2-69
Anti-Lock Brake System Warning	2-72, 4-7
Battery Charge	2-70
Brake System Warning	2-71
Brake To Shift	2-77
Change Oil	2-81

Check Engine	2-76
Cruise Engaged	2-78
Door Ajar	2-79
Engine Oil Pressure	2-80
Engine Temperature Warning	2-75
Low Coolant	2-75
Low Oil Level	2-81
Pass Key Fault	2-77
Safety Belt Reminder	1-7, 2-69
Traction Control	2-73, 4-10
Traction Engaged	2-74, 4-10
Trunk Ajar	2-79
Lighter	2-65
Loading Your Vehicle	4-43
Lock Out, Rear Window	2-36
Locks	
Door	2-3
Fuel Door	6-4
Rear Door Security	2-6
Low Coolant Light	2-75
Low Oil Level Light	2-81
Low Washer Fluid Warning Light	2-78
Lumbar Controls	1-3

M

Maintenance

Normal Replacement Parts	6-73
Underbody	6-58
When Trailer Towing	4-46
Malfunction Indicator Lamp	2-76
Mats, Floor	2-56
Memory Seat	1-2
Methanol (In Fuel)	6-3
Mirrors	
Automatic Rearview	2-53
Convex Outside	2-56
Visor Vanity	2-59
MTBE (In Fuel)	6-3

N

Net, Convenience	2-57
Neutral (N)	2-25
New Vehicle "Break-In"	2-18
Night Vision	4-19

O

Odometer	2-67
Odometer, Trip	2-68
Off-Road Recovery	4-14
Oil, Engine	6-9
Oil Life Indicator	2-82
Ordering Owner and Service Publications	See Owner Assistance
OUT TEMP	3-2
Overdrive (Ⓣ)	2-25
Overheated Engine	5-13
Owner Manual Portfolio, Securing	2-13
Owner Publications, Ordering	See Owner Assistance

P

Paint Spotting, Chemical	6-58
Park (P)	2-24
Shifting Into	2-29
Shifting Out of	2-31
Parking	
At Night	2-14
Brake	2-27
Lots	2-14
On Hills (Towing a Trailer)	4-45
Over Things That Burn	2-32
PASS-Key	2-16
Pass Key Fault Light	2-77
Passing	4-15
Photocells	2-55
Power Antenna	3-19

Power Door Locks	2-5
Power Drain Protection	2-48
Power Remote Control Mirrors	2-55
Power Seat	1-1
Power Steering	2-37, 4-12
Power Steering Fluid	6-24
Power Windows	2-35
Pregnancy, Use of Safety Belts	1-29
Preset Equalization	3-9
Pressure (Oil) Light	2-80
Problems on the Road	5-1
Publications, Service and Owner	See Owner Assistance
Pull-Down Feature, Automatic	2-11

R

Radio Reception	3-17
Radios	3-6
Rain, Driving	4-20
Rear Axle	6-19, 6-70
Rear Defogger	3-5
Rear Door Security Lock	2-6
Rear Towing Hookups	5-12
Rear Window Lock Out	2-36
Rearview Mirror	2-53
Reclining Front Seatbacks	1-4
Remote Keyless Entry	2-7
Remote Trunk Release	2-12
Replacement Bulbs	6-68
Replacement Parts	6-73
Replacement, Wheel	6-48
Replacing Safety Belts	1-54
Replacing Seat and Restraint System Parts	1-54
Restraints, Child	1-41
Restraints, Replacing Parts After a Crash	1-54
Retained Accessory Power	2-48
Reverse (R)	2-24
Rocking Your Vehicle	5-33
Rotation, Tire	6-43

S

Safety Belts	1-6
Adults	1-12
Care	6-54
Center Passenger Position	1-30
Driver Position	1-12
Extender	1-54
How to Wear Properly	1-12
Lap Belt	1-30
Lap-Shoulder Belt	1-12, 1-32
Questions People Ask	1-12
Rear Seat Passengers	1-32
Reminder Light	1-7, 2-69
Replacing After a Crash	1-54
Right Front Passenger Position	1-30
Shoulder Belt Height Adjuster	1-15
Use by Children	1-38
Use During Pregnancy	1-29
Why They Work	1-8
Safety Chains	4-44
Safety Defects, Reporting	See Owner Assistance
Safety Warnings and Symbols	iii
Seats	1-1
Second (2)	2-26
Security System (PASS-Key)	2-16
Service and Appearance Care	6-1
Service and Owner Publications	See Owner's Assistance
Service Parts Identification Label	6-60
Service Publications	See Owner's Assistance
Service Work, Doing Your Own	6-2
Servicing Your Air Bag-Equipped Cadillac	1-28
Sheet Metal Damage	6-58
Shifting	2-23
Into Park (P)	2-29
Out of Park (P)	2-31
Skidding	4-17
Sound Equipment, Adding	3-16
Spare Tire, Location	5-23

Specifications Chart	6-69
Speedometer	2-67
Stains	6-53
Starting Your Engine	2-20
Steam, If Coming From Your Engine	5-13
Steering	4-12
Steering in Emergencies	4-13
Steering Wheel, Tilt	2-36
Storage Armrests	2-58
Storage of Your Vehicle	6-30
Stuck, If You Are	5-33
Supplemental Inflatable Restraint	1-22
Surge Tank Pressure Cap	6-23
Symbols, Vehicle	v

T

Taillamps, Bulb Replacement	6-35
Tape Player	3-12, 3-18
Temperature Adjustment	3-2
Theft	2-14
Theft Deterrent Alarm System	2-15
Thermostat	6-23
Third (3)	2-25
Tilt Steering Wheel	2-36
Time, Setting the	3-6
Tire Chains	5-32, 6-50
Tire Loading	4-35
Tires	6-41
Alignment and Balance	6-48
Changing a Flat	5-21
Inflation	6-42
Inspection and Rotation	6-43
Temperature	6-47
Traction	6-47
Treadwear	6-45
Wheel Replacement	6-48
Top Strap	1-42
Torque Lock	2-31

Torque, Wheel Nut	5-28
Towing a Trailer	4-38
Towing Your Vehicle	5-9
Traction Control Disable Switch	4-11
Traction Control Engaged Light	2-74, 4-10
Traction Control Light	2-73, 4-10
Traction Control System	4-10
Trailer Tongue Weight	4-38
Trailer Towing	2-27, 4-36
Brakes	4-42
Driving on Grades	4-45
Driving with a Trailer	4-43
Engine Cooling When Towing	4-46
Hitches	4-41
Maintenance	4-46
Parking on Hills	4-45
Safety Chains	4-42
Turn Signals	4-44
Weight of a Trailer	4-38
Weight on Your Vehicle's Tires	4-39
Wiring Harness	4-43
Transmission Fluid	6-16
Transmitter, HomeLink	2-61
Transmitters, Matching (RKE)	2-9
Trip, Before Leaving	4-25
Trip Odometer	2-68
Trunk Ajar Light	2-79
Trunk Release, Remote	2-12
Turn Signal/Multifunction Lever	2-37
Turn Signals When Towing a Trailer	4-45
Twilight Sentinel	2-49

U

Underbody Maintenance	6-58
Underhood Lamp	2-50
Used Replacement Wheels	6-49

V

Vehicle Damage Warnings	iv
Vehicle Dimensions Chart	6-72
Vehicle Identification Number (VIN)	6-60
Vehicle Loading	4-33
Vehicle Symbols	v
Viscosity	6-12
Vision, Night	4-19
Visor Vanity Mirrors	2-59

W

Warning Devices	5-1, 5-3
Warning Flashers, Hazard	5-1
Warning Lights	2-69
Washing Your Vehicle	6-56
Water, Driving Through Deep Standing	2-21
Weatherstrips	6-56
Wheel Nut Torque	5-28
Wheel Replacement	6-48
Windows	2-35
Windshield Washer Fluid	2-41, 6-25
Windshield Washers	2-44
Windshield Wiper Blade Replacement	6-40
Windshield Wipers	2-40, 6-63
Winter Driving	4-29
Wiring, Headlamp	6-61
Wood Panels, Care	6-54
Wrecker Towing	5-8

NOTES

1978 SEVILLE ELEGANTE



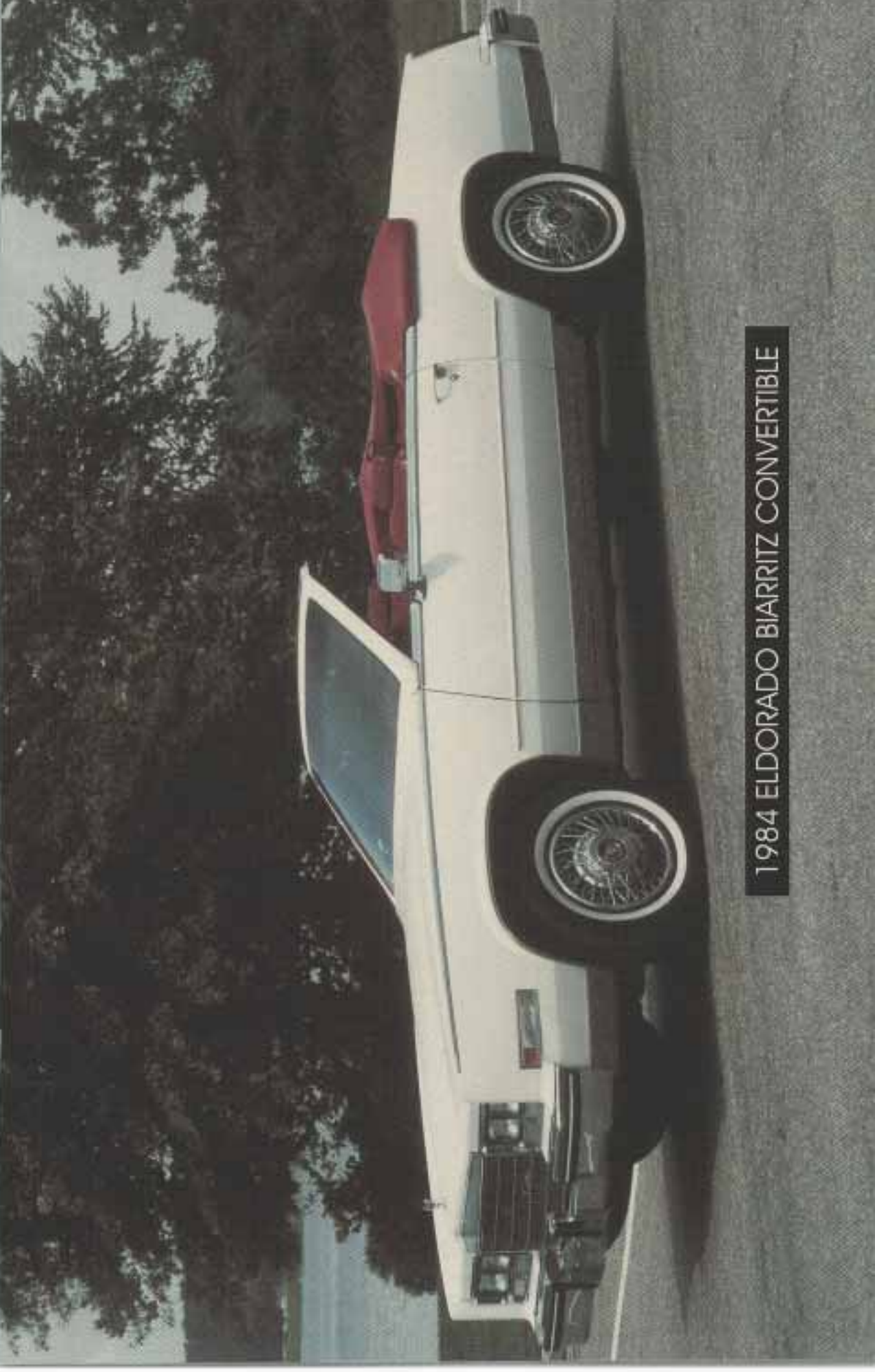

1984 ELDORADO BIARRITZ CONVERTIBLE

