



PONTIAC



1994 FIREBIRD OWNER'S MANUAL

1994 Owner's Manual
Table of Contents

Firebird

Introduction	How to Use This Manual	3
Part 1	Seats & Restraint Systems	7
Part 2	Features & Controls	41
Part 3	Comfort Controls & Audio Systems	103
Part 4	Your Driving and the Road	125
Part 5	Problems on the Road	151
Part 6	Service & Appearance Care	183
Part 7	Maintenance Schedule	239
Part 8	Customer Assistance Information	259
	Including "Reporting Safety Defects" on page 261.	
Part 9	Index	269
	Service Station Information	Last Page

How to Use This Manual

Important Notes about This Manual

Please keep this manual in your Pontiac, so it will be there if you ever need it when you're on the road. If you sell the vehicle, please leave this manual in it so the new owner can use it.

This manual includes the latest information at the time it was printed. We reserve the right to make changes in the product after that time without further notice. For vehicles first sold in Canada, substitute the name "General Motors of Canada Limited" for Pontiac Motor Division wherever it appears in this manual.

For Canadian Owners Who Prefer a French Language Manual

Aux propriétaires canadiens: Vous pouvez vous procurer un exemplaire de ce guide en français chez votre concessionnaire ou au DGN Marketing Services Ltd., 1500 Bonhill Rd., Mississauga, Ontario L5T 1C7.

Published by:

**Pontiac Motor Division
General Motors Corporation**

Pontiac Motors, GM and the GM emblem, **Pontiac** and the Pontiac emblem, and **Firebird** and the Firebird emblem are registered trademarks of General Motors Corporation.

©Copyright 1993 General Motors Corporation, Pontiac Motor Division.
All Rights Reserved.

■ *How to Use This Manual*

Many people read their owner's manual from beginning to end when they first receive their new vehicle. This will help you learn about the features and controls for your vehicle. In this manual, you'll find that pictures and words work together to explain things quickly.

Index: A good place to look for what you need is the Index in back of the manual. It's an alphabetical list of all that's in the manual, and the page number where you'll find it.

Parts 1-8: Each part of this manual begins with a brief list of its contents, so you can often find at a glance if a part contains the information you want.

How to Use This Manual: This part tells you how to use your manual and includes safety and vehicle damage warnings and symbols.

Part 1 – Seats & Restraint Systems:

This part tells you how to use your seats and safety belts properly. It also explains the air bag system.

Part 2 – Features & Controls: This part explains how to start and operate your Pontiac.

Part 3 – Comfort Controls & Audio Systems: This part tells you how to adjust the comfort controls and how to operate your sound system.

Part 4 – Your Driving and the Road: Here you'll find helpful information and tips about the road and how to drive under different conditions.

Part 5 – Problems on the Road: This part tells you what to do if you have a problem while driving, such as a flat tire or engine overheating, etc.

Part 6 – Service & Appearance Care: Here the manual tells you how to keep your Pontiac running properly and looking good.

Part 7 – Maintenance Schedule:

This part tells when to perform vehicle maintenance and what fluids and lubricants to use.

Part 8 – Customer Assistance

Information: This part includes important information about reporting safety defects and gives you details about the "Roadside Assistance" program. You will also find customer satisfaction phone numbers (including customer satisfaction numbers for the hearing and speech impaired), as well as the mediation/arbitration procedure. We've also included ordering information for service publications in this part.

Service Station Information: This is a quick reference of service information. You can find it on the last page of this manual.

How to Use This Manual



CAUTION:

These mean there is something that could hurt you or other people.

Safety Warnings and Symbols

You will find a number of safety cautions in this book. We use a box with a gray background and the word CAUTION to tell you about things that could hurt you if you were to ignore the warning.

In the gray caution area, we tell you what the hazard is. Then we tell you what to do to help avoid or reduce the hazard. Please read these cautions. If you don't, you or others could be hurt.



You will also find a circle with a slash through it in this book. This safety symbol means "Don't," "Don't do this," or "Don't let this happen."

NOTICE:

These mean there is something that could damage your vehicle.

Vehicle Damage Warnings

Also, in this book you will find these notices.

In the notice area, we tell you about something that can damage your vehicle. Many times, this damage would not be covered by your warranty, and it could be costly. But the notice will tell you what to do to help avoid the damage.

When you read other manuals, you might see CAUTION and NOTICE warnings in different colors or in different words.

You'll also see warning labels on your vehicle. They use yellow for cautions, blue for notices and the words CAUTION or NOTICE.

Vehicle Symbols

These are some of the symbols you will find on your vehicle. For example, these symbols are used on an original battery:

Caution Possible Injury 

Protect Eyes by Shielding 

Caustic Battery Acid Could Cause Burns 

Avoid Sparks or Flames 

Sparks or Flame Could Explode Battery 

These symbols are important for you and your passengers whenever your vehicle is driven:

Fasten Safety Belts 

Door Lock/Unlock 

Window Up/Down 

These symbols have to do with your lights:

Master Lighting Switch 

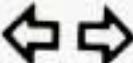
Turn Signal Direction 

Hazard Warning Flashers 

Headlight High Beam 

Parking Lights 

Courtesy Lights 

Fog Lamps 

These symbols are on some of your controls:

Windshield Wiper 

Windshield Washer 

Windshield Defroster 

How to Use This Manual

Rear Window Defogger



Ventilating Fan



Bi-Level



Vent



Heater



Blend



These symbols are used on warning and indicator lights:

Engine Coolant Temperature



Battery Charging System

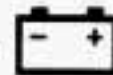

Fuel



Engine Oil Pressure



Brake (Canada)



Anti-Lock Brake System (Canada)



Low Coolant



Here are some other symbols you may see:

Hatch/Trunk Release



Hood Release



Lighter



Horn



Speaker



Convertible Top Switch





Part 1

Seats & Restraint Systems

Here you'll find information about the seats in your Pontiac and how to use your safety belts properly. You can also learn about some things you should not do with safety belts.

Seats and Seat Controls	8
Safety Belts: They're for Everyone	14
Why Safety Belts Work	15
Here Are Questions Many People Ask about Safety Belts — and the Answers ..	17
Safety Belt Reminder Light	18
How to Wear Safety Belts Properly	19
Children	30
Child Restraints	31
Larger Children	38
Safety Belt Extender	39
Checking Your Restraint Systems	40
Replacing Safety Belts after a Crash	40

Seats and Restraint Systems

■ *Seats and Seat Controls*

This section tells you about the seats — how to adjust them, and also about reclining front seatbacks, seatback latches and the folding rear seatback.

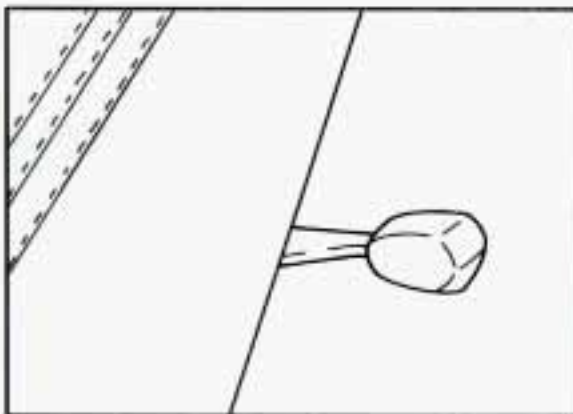

Manual Front Seat

Move the lever under the passenger's front seat to unlock it. Slide the seat to where you want it. Then release the lever and try to move the seat with your body, to make sure the seat is locked into place. Be sure the lever returns to its original position after moving the seat.

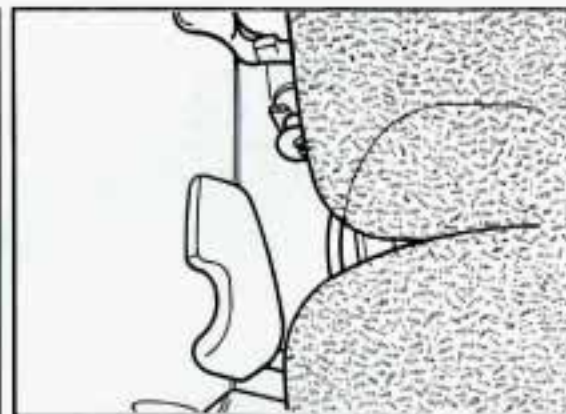

Four-Way Manual Seat

To move the driver's seat forward or backward, lift the lever under the left front of the seat. Slide the seat to where you want it. Then release the lever and try to move the seat with your body to make sure the seat is locked into place.

To tilt the entire seat, lift the lever under the right front of the seat.

⚠ CAUTION:

You can lose control of the vehicle if you try to adjust a manual driver's seat while the vehicle is moving. The sudden movement could startle and confuse you, or make you push a pedal when you don't want to. Adjust the driver's seat only when the vehicle is not moving.

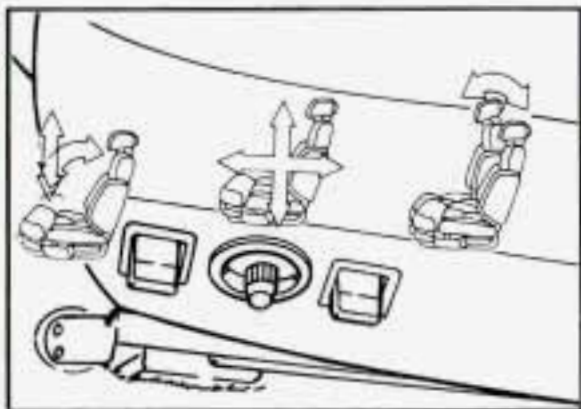

Six-Way Power Seat (Option)

The driver's seat has three controls on the left side.

The front control makes the front of the seat go up and down.

The back control makes the back of the seat go up and down.

The center control makes the whole seat go up and down or forward and backward.



Fully Articulating Sport Seat (Option)

If your Pontiac has these seats, the driver's seat has the four-way manual seat adjuster. See "Four-Way Manual Seat" earlier in this part. The passenger seat has the two-way manual seat adjuster. See "Manual Front Seat" earlier in this part.

Seats and Restraint Systems

To adjust the thigh support, pull up on the front of your seat cushion and move the support to the position you want. To release the support, continue pulling up. To engage it again, push down firmly.



The switch pads on the outer sides of the seats "inflate" and "deflate" parts of your seatback.



The two buttons that have "dots" inflate and deflate the outer parts of the seatback. To inflate, push the raised button. To deflate, push the indented button.



The two buttons without “dots” inflate and deflate the lumbar (lower part of the seatback) support. To inflate, push the raised button. To deflate, push the indented button.



To adjust the seatback, lift the lever on the outer side of the seat. Release the lever to lock the seatback where you want it. Pull up on the lever, and the seat will go to its original upright position. But don't have the seatback reclined if your vehicle is moving.

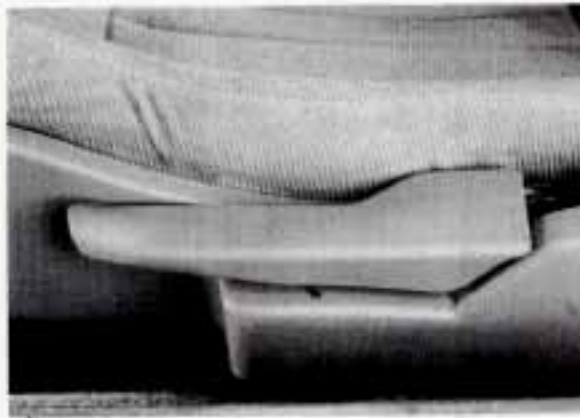

If you have fully articulating sport seats, your recliner lever looks like this.

Seats and Restraint Systems



CAUTION:

Sitting in a reclined position when your vehicle is in motion can be dangerous. Even if you buckle up, your safety belts can't do their job when you're reclined like this.

The shoulder belt can't do its job. In a crash you could go into it, receiving neck or other injuries.

The lap belt can't do its job either. In a crash the belt could go up over your abdomen. The belt forces would be there, not at your pelvic bones. This could cause serious internal injuries.

For proper protection when the vehicle is in motion, have the seatback upright. Then sit well back in the seat and wear your safety belt properly.



Head Restraints

Slide the head restraints up or down so that the top of the restraint is closest to the top of your ears.

This position reduces the chance of a neck injury in a crash.

If you have the fully articulating sport seat, you have a six-way head restraint. It can be adjusted up and down, forward and rearward, or tilted.

To adjust it forward, pull the restraint forward. To adjust it rearward, pull the restraint forward all the way to release it. Then move it to the position you want.



The front seatback folds forward to let people get into the back seat. To fold a seatback forward, push the seatback toward the rear as you lift this latch. Then the seatback will fold forward.

When you return the seatback to its original position, make sure the seatback is locked. The latch must be down for the seat to work properly.



CAUTION:

If the seatback isn't locked, it could move forward in a sudden stop or crash. That could cause injury to the person sitting there. Always press rearward on the seatback to be sure it is locked.

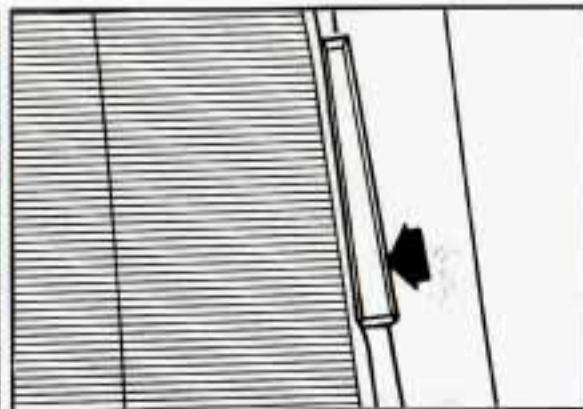

Folding Rear Seatback

The rear seatback in your Pontiac folds down to provide more storage space.

To fold the seatback down:

1. Pull forward on both levers.
2. Fold the seatback down.

To raise the seatback:

1. Pull it up to the locked, upright position.
2. Be sure both latches hold the seatback in place. Have them fixed if they don't.

Seats and Restraint Systems

■ *Safety Belts: They're for Everyone*

This part of the manual tells you how to use safety belts properly. It also tells you some things you should not do with safety belts. And it explains the Supplemental Inflatable Restraint, or "air bag" system.



CAUTION:

Don't let anyone ride where they can't wear a safety belt properly. If you are in a crash and you're not wearing a safety belt, your injuries can be much worse. You can hit things inside the vehicle or be ejected from it. You can be seriously injured or killed. In the same crash, you might not be if you are buckled up. Always fasten your safety belt, and check that your passengers' belts are fastened properly too.



This figure lights up as a reminder to buckle up. (See "Safety Belt Reminder Light" in the Index.)

In many states and Canadian provinces, the law says to wear safety belts. Here's why: They work.



You never know if you'll be in a crash. If you do have a crash, you don't know if it will be a bad one.

A few crashes are mild, and some crashes can be so serious that even buckled up a person wouldn't survive. But most crashes are in between. In many of them, people who buckle up can survive and sometimes walk away. Without belts they could have been badly hurt or killed.

After more than 25 years of safety belts in vehicles, the facts are clear. In most crashes buckling up does matter ... a lot!



■ *Why Safety Belts Work*

When you ride in or on anything, you go as fast as it goes.

For example, if the bike is going 10 mph (16 km/h), so is the child.

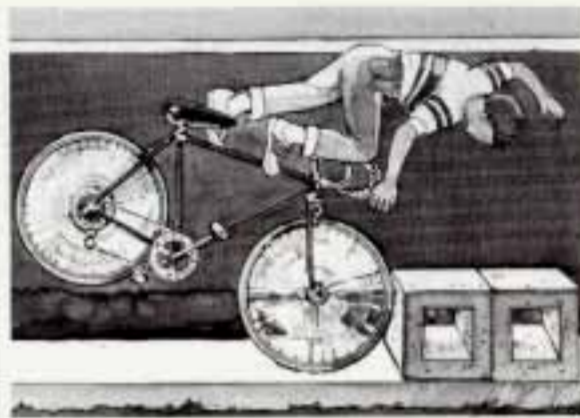

When the bike hits the block, it stops. But the child keeps going!

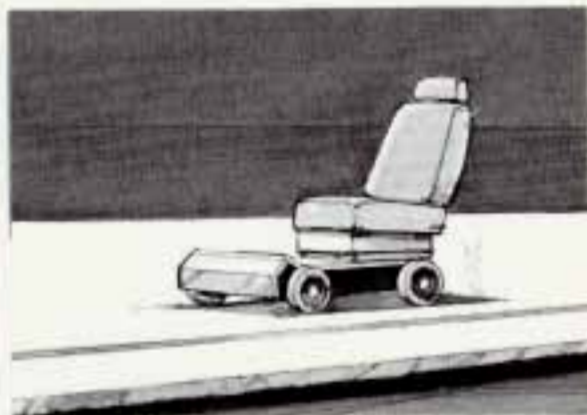

Take the simplest vehicle. Suppose it's just a seat on wheels.

Seats and Restraint Systems



Put someone on it.

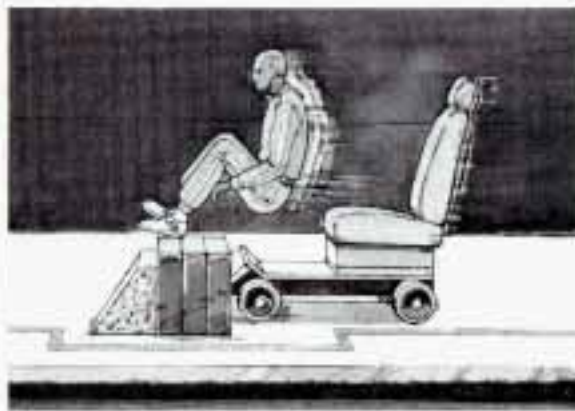

Get it up to speed. Then stop the vehicle.
The rider doesn't stop.



The person keeps going until stopped by something.

In a real vehicle, it could be the windshield ...



or the instrument panel ...



or the safety belts!

With safety belts, you slow down as the vehicle does. You get more time to stop. You stop over more distance, and your strongest bones take the forces. That's why safety belts make such good sense.

■ *Here Are Questions Many People Ask about Safety Belts — and the Answers*

Q: Won't I be trapped in the vehicle after an accident if I'm wearing a safety belt?

A: You could be — whether you're wearing a safety belt or not. But you can easily unbuckle a safety belt, even if you're upside down. And your chance of being conscious during and after an accident, so you can unbuckle and get out, is much greater if you are belted.

Seats and Restraint Systems

Q: Why don't they just put in air bags so people won't have to wear safety belts?

A: Air bags, or Supplemental Inflatable Restraint systems, are in some vehicles today and will be in more of them in the future. But they are supplemental systems only — so they work with safety belts, not instead of them. Every air bag system ever offered for sale has required the use of safety belts. Even if you're in a vehicle that has air bags, you still have to buckle up to get the most protection. That's true not only in frontal collisions, but especially in side and other collisions.

Q: If I'm a good driver, and I never drive far from home, why should I wear safety belts?

A: You may be an excellent driver, but if you're in an accident — even one that isn't your fault — you and your passengers can be hurt. Being a good driver doesn't protect you from things beyond your control, such as bad drivers.

Most accidents occur within 25 miles (40 km) of home. And the greatest number of serious injuries and deaths occur at speeds of less than 40 mph (65 km/h).

Safety belts are for everyone.



■ *Safety Belt Reminder Light*

When the key is turned to “Run” or “Start,” a chime will come on for about eight seconds to remind people to fasten their safety belts, unless the driver's safety belt is already buckled. The safety belt light will also come on and stay on until the driver's belt is buckled.

■ *How to Wear Safety Belts Properly*

Adults

This section is only for people of adult size.

Be aware that there are special things to know about safety belts and children. And there are different rules for smaller children and babies. If a child will be riding in your Pontiac, see the section after this one, called "Children." Follow those rules for everyone's protection.

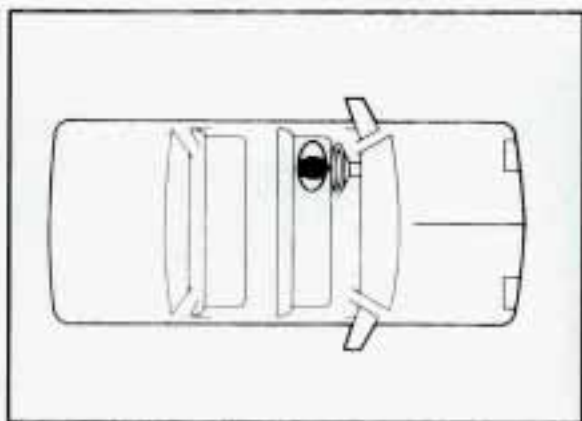

First, you'll want to know which restraint systems your vehicle has.

We'll start with the driver position.

Driver Position

This section describes the driver's restraint system.



Lap-Shoulder Belt

The driver has a lap-shoulder belt. Here's how to wear it properly.

1. Close and lock the door.
2. Adjust the seat (to see how, see "Seats" in the Index) so you can sit up straight.

Seats and Restraint Systems



3. Pick up the latch plate and pull the belt across you. Don't let it get twisted.
4. Push the latch plate into the buckle until it clicks.

Pull up on the latch plate to make sure it is secure. If the belt isn't long enough, see "Safety Belt Extender" at the end of this section.

Make sure the release button on the buckle is positioned so you would be able to unbuckle the safety belt quickly if you ever had to.



5. To make the lap part tight, pull down on the buckle end of the belt as you pull up on the shoulder belt.

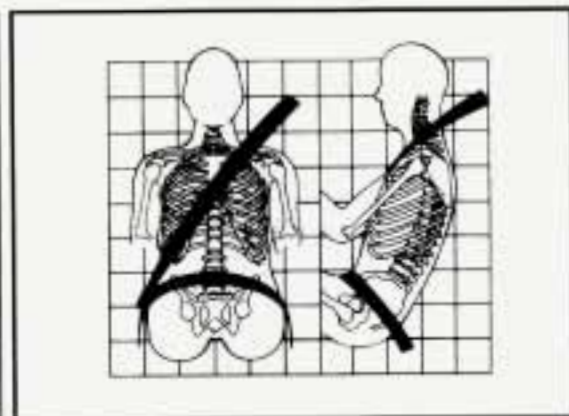

The lap part of the belt should be worn low and snug on the hips, just touching the thighs. In a crash, this applies force to the strong pelvic bones. And you'd be less likely to slide under the lap belt. If you slid under it, the belt would apply force at your abdomen. This could cause serious or even fatal injuries. The shoulder belt should go over the shoulder and across the chest. These parts of the body are best able to take belt restraining forces.

The safety belt locks if there's a sudden stop or crash.

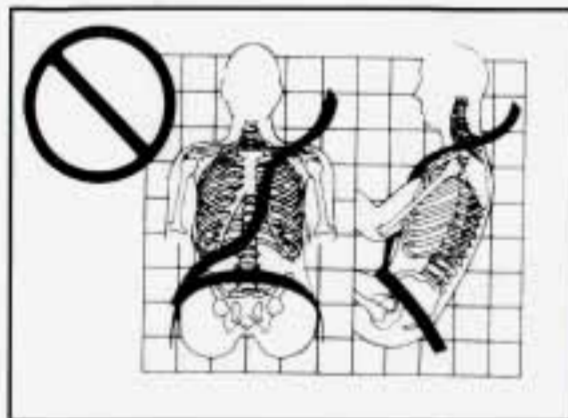

Q: What's wrong with this?

A: The shoulder belt is too loose. It won't give nearly as much protection this way.

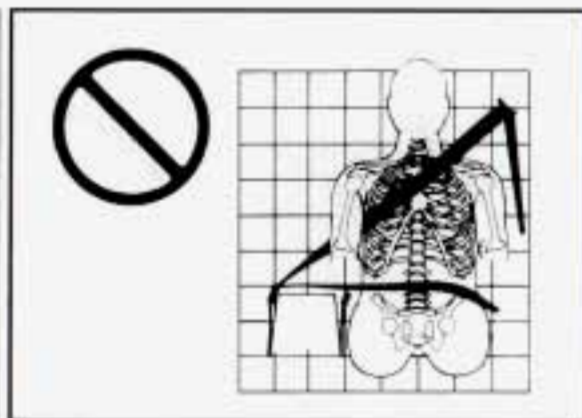

Q: What's wrong with this?

A: The belt is buckled in the wrong place.

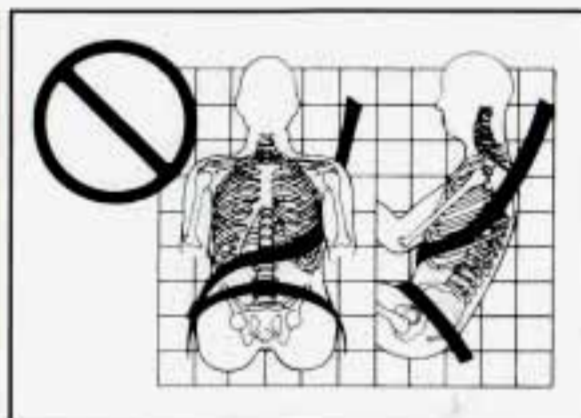

Q: What's wrong with this?

A: The shoulder belt is worn under the arm. It should be worn over the shoulder at all times.

⚠ CAUTION:

You can be seriously hurt if your shoulder belt is too loose. In a crash you would move forward too much, which could increase injury. The shoulder belt should fit against your body.

⚠ CAUTION:

You can be seriously injured if your belt is buckled in the wrong place like this. In a crash, the belt would go up over your abdomen. The belt forces would be there, not at the pelvic bones. This could cause serious internal injuries. Always buckle your belt into the buckle nearest you.

Seats and Restraint Systems

CAUTION:

You can be seriously injured if you wear the shoulder belt under your arm. In a crash, your body would move too far forward, which would increase the chance of head and neck injury. Also, the belt would apply too much force to the ribs, which aren't as strong as shoulder bones. You could also severely injure internal organs like your liver or spleen.

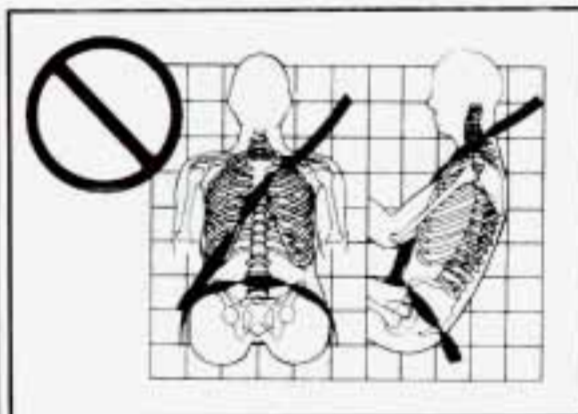

Q: What's wrong with this?

A: The belt is twisted across the body.

CAUTION:

You can be seriously injured by a twisted belt. In a crash, you wouldn't have the full width of the belt to spread impact forces. If a belt is twisted, make it straight so it can work properly, or ask your dealer to fix it.



To unlatch the belt, just push the button on the buckle. The belt should go back out of the way.

Before you close the door, be sure the belt is out of the way. If you slam the door on it, you can damage both the belt and your vehicle.

This vehicle has **AIR BAGS** for front occupants.

 **CAUTION: YOU NEED YOUR SAFETY BELT, EVEN WITH AN AIR BAG. AND HERE'S WHY:**

- Air bags are not designed to inflate in rollovers or in rear, side or low-speed frontal crashes.
- Air bags inflate with great force, faster than the blink of an eye. If you're too close to an inflating air bag, it could seriously injure you. Safety belts help keep you in position for air bag inflation in a crash.
- An inflating air bag can seriously injure small children. Follow the instructions on the passenger safety belt Caution label.

REGULAR MAINTENANCE OF THE AIR BAG SYSTEM IS NOT REQUIRED. If the air bag readiness light comes on while you are driving, or doesn't come on when you first start your vehicle, see your dealer for service.

PRINTED IN U.S.A.

See your Owner's Manual for more information.

PART NO. C20-30-355

Supplemental Inflatable Restraint System (Air Bags)

This section explains the Supplemental Inflatable Restraint (SIR), or "air bag," system. Your Pontiac has an air bag for both the driver and the right-front passenger.

Here are the most important things to know:

 **CAUTION:**

Even with an air bag, if you're not wearing a safety belt and you're in a crash, your injuries may be much worse. Air bags are not designed to inflate in rollovers or in rear, side or low-speed frontal crashes. You need to wear your safety belt to reduce the chance of hitting things inside the vehicle or being ejected from it. Always wear your safety belt, even with an air bag.

 **CAUTION:**

Air bags inflate with great force, faster than the blink of an eye. If you're too close to an inflating air bag, it could seriously injure you. Safety belts help keep you in position for an air bag inflation in a crash. Always wear your safety belt, even with an air bag, and the driver should sit as far back as possible while still maintaining control of the vehicle.

 **CAUTION:**

An inflating air bag can seriously injure small children. Always secure children properly in your vehicle. To read how, see the "Children and Safety Belts" section of this manual, and read the caution label on the front-passenger's safety belt.

Seats and Restraint Systems

CAUTION:

When an air bag inflates, there is dust in the air. This dust could cause breathing problems for people with a history of asthma or other breathing trouble. To avoid this, everyone in the vehicle should get out as soon as it is safe to do so. If you have breathing problems but can't get out of the vehicle after an air bag inflates, then get fresh air by opening a window or door.

CAUTION:

Don't put anything on, or attach anything to, the driver air bag or instrument panel. Also, don't put anything (such as pets, or objects) between any occupant and the driver air bag or instrument panel. If something is between an occupant and an air bag, it could affect the performance of the air bag, or, worse, it could cause injury.



**AIR
BAG**

Air Bag Readiness Light

There is an air bag readiness light on the instrument panel, which shows "AIR BAG" on it. The system checks for electrical malfunctions, and the light tells you if there is a problem.

You will see this light flash for a few seconds when you turn your ignition to "Run" or "Start." Then the light should go out, which means the system is ready.

Remember, if the air bag readiness light doesn't come on when you start your vehicle, or stays on, or comes on when you are driving, your air bag system may not work properly. Have your vehicle serviced right away.



How the Air Bag System Works

Where is the air bag?

The driver's air bag is in the middle of the steering wheel.



The right-front passenger's air bag is located in the instrument panel on the passenger's side.

When is an air bag expected to inflate?

The air bag is designed to inflate in moderate to severe frontal or near-frontal crashes. The air bag will only inflate if the velocity of the impact is above the designed threshold level. When impacting straight into a wall that does not move or deform, the threshold level for most GM vehicles is between 9 and 15 mph (14 and 23 km/h). However, this velocity threshold depends on the vehicle design and may be several miles-per-hour faster or slower. In addition, this threshold velocity will be considerably higher if the vehicle strikes an object such as a parked car which will move and deform on impact. The air bag is also not designed to inflate in rollovers, side impacts, or rear impacts where the inflation would provide no occupant protection benefit.

It is possible that in a crash, only one of the two air bags in your Firebird will deploy. This is rare, but can happen in a crash just severe enough to make an air bag inflate.

In any particular crash, the determination of whether the air bag should have inflated cannot be based solely on the level of damage on the vehicle(s). Inflation is determined by the angle of the

impact and the vehicle's deceleration, of which vehicle damage is only one indication. Repair cost is not a good indicator of whether an air bag should have deployed.

What makes an air bag inflate?

In a frontal or near-frontal impact of sufficient severity, the air bag sensing system detects that the vehicle is suddenly stopping as a result of a crash. The sensing system triggers a chemical reaction of the sodium azide sealed in the inflator. The reaction produces nitrogen gas, which inflates a cloth bag. The inflator, cloth bag, and related hardware are all part of the air bag inflator modules packed inside the steering wheel and in the instrument panel in front of the passenger.

How does an air bag restrain?

In moderate to severe frontal or near-frontal collisions, even belted occupants can contact the steering wheel or the instrument panel. The air bag supplements the protection provided by safety belts. Air bags distribute the force of the impact more evenly over the occupant's upper body, stopping the occupant more gradually. But air bags would not provide protection in many

Seats and Restraint Systems

types of collisions, including rollovers and rear and side impacts, primarily because an occupant's motion is not toward the air bag. Air bags should never be regarded as anything more than a supplement to safety belt protection in moderate to severe frontal and near-frontal collisions.

What will you see after an air bag inflation?

After the air bag has inflated, it will then quickly deflate. This occurs so quickly that some people may not even realize that the air bag inflated. Some components of the air bag module in the steering wheel hub for the driver's air bag or the instrument panel for the passenger's bag may be hot for a short time, but the portion of the bag that comes into contact with you will not be hot to the touch. There will be small amounts of smoke and dust coming from vents in the deflated air bags. The air bag will not impede the driver's vision or ability to steer the vehicle, nor will it hinder the occupants from exiting the vehicle.

In many crashes severe enough to inflate an air bag, windshields are broken by vehicle deformation. Additional

windshield breakage may occur in vehicles with passenger air bags because the windshield acts as a reaction surface for the inflating air bag.

- The air bags are designed to inflate only once. After they inflate you'll need some new parts for your air bag system. If you don't get them, the air bag system won't be there to help protect you in another crash. A new system will include air bag modules and possibly other parts. The service manual has information about the need to replace other parts.
- Your vehicle is equipped with a diagnostic module, which records information about the air bag system if the air bag deploys in a crash. The module records information about the readiness of the system, which sensors activated the deployment, and whether the driver's safety belt was in use.
- Let only qualified technicians work on your air bag system. Improper service can mean that your air bag system won't work properly. See your dealer for service.

NOTICE:

If you damage the cover for the driver's or the right-front passenger's air bag, they may not work properly. You may have to replace the air bag on the steering wheel or both the air bag and the instrument panel for the passenger's air bag. Do not open or break the air bag covers.

Is the smoke from an air bag inflation harmful?

The particles emitted during air bag inflation are not harmful to most people. Some people with respiratory ailments may experience difficulty breathing if they stay in the vehicle with the windows closed after air bag inflation. So, if your air bag inflates, you and any passengers should exit the vehicle if and when it is safe to do so. If you or your passengers can't get out of the vehicle, try to get fresh air by opening a window, turning on the fan, or opening a door.

Servicing Your Air Bag-Equipped Pontiac

Air bags affect how your Pontiac should be serviced. There are parts of the air bag system in several places around your vehicle. You don't want the system to inflate while someone is working on your vehicle. Your Pontiac dealer and the 1994 Firebird Service Manual have information about servicing your vehicle and the air bag system. The air bag system does not need regular maintenance.



CAUTION:

For up to 2 minutes after the ignition key is turned off and the battery is disconnected, an air bag can still inflate during improper service. You can be injured if you are close to an air bag when it inflates. Avoid wires wrapped with yellow tape, or yellow connectors. They are probably part of the air bag system. Be sure to follow proper service procedures, and make sure the person performing work for you is qualified to do so.



Safety Belt Use during Pregnancy

Safety belts work for everyone, including pregnant women. Like all occupants, they are more likely to be seriously injured if they don't wear safety belts.

A pregnant woman should wear a lap-shoulder belt, and the lap portion should be worn as low as possible throughout the pregnancy.

The best way to protect the fetus is to protect the mother. When a safety belt is worn properly, it's more likely that the fetus won't be hurt in a crash. For pregnant women, as for anyone, the key to making safety belts effective is wearing them properly.

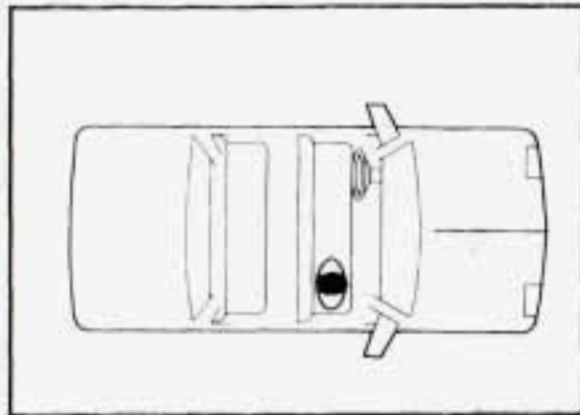

Passenger Positions

Right Front Passenger Position

The right front passenger's safety belt works the same way as the driver's safety belt. See "Driver Position," earlier in this part.

Seats and Restraint Systems

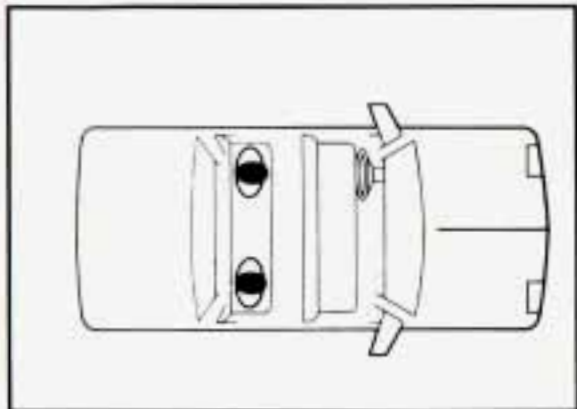

Rear Seat Passengers

It's very important for rear seat passengers to buckle up! Accident statistics show that unbelted people in the rear seat are hurt more often in crashes than those who are wearing safety belts.

Rear passengers who aren't safety belted can be thrown out of the vehicle in a crash. And they can strike others in the vehicle who are wearing safety belts.

Lap-Shoulder Belt

The rear seats have lap-shoulder belts. Here's how to wear one properly.



1. Pick up the latch plate and pull the belt across you. Don't let it get twisted.
2. Push the latch plate into the buckle until it clicks.



If the belt stops before it reaches the buckle, tilt the latch plate and keep pulling until you can buckle it.

Pull up on the latch plate to make sure it is secure.

If the belt is not long enough, see "Safety Belt Extender" at the end of this section.

Make sure the release button on the buckle is positioned so you would be able to unbuckle the safety belt quickly if you ever had to.



3. To make the lap part tight, pull down on the buckle end of the belt as you pull up on the shoulder part.

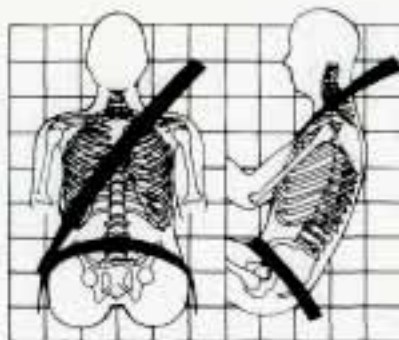

The lap part of the belt should be worn low and snug on the hips, just touching the thighs. In a crash, this applies force to the strong pelvic bones. And you'd be less likely to slide under the lap belt. If you slid under it, the belt would apply force at your abdomen. This could cause serious or even fatal injuries. The shoulder belt should go over the shoulder and across the chest. These parts of the body are best able to take belt restraining forces.

The safety belt locks if there's a sudden stop or a crash.



CAUTION:

You can be seriously hurt if your shoulder belt is too loose. In a crash you would move forward too much, which could increase injury. The shoulder belt should fit against your body.

Seats and Restraint Systems



- To unlatch the belt, just push the button on the buckle.



■ *Children*

Everyone in a vehicle needs protection! That includes infants and all children smaller than adult size. In fact, the law in every state in the United States and in every Canadian province says children up to some age must be restrained while in a vehicle.

Smaller Children and Babies



CAUTION:

Smaller children and babies should always be restrained in a child or infant restraint. The instructions for the restraint will say whether it is the right type and size for your child. A very young child's hip bones are so small that a regular belt might not stay low on the hips, as it should. Instead, the belt will likely be over the child's abdomen. In a crash the belt would apply force right on the child's abdomen, which could cause serious or fatal injuries. So, be sure that any child small enough for one is always properly restrained in a child or infant restraint.



⚠ CAUTION:

Never hold a baby in your arms while riding in a vehicle. A baby doesn't weigh much — until a crash. During a crash a baby will become so heavy you can't hold it. For example, in a crash at only 25 mph (40 km/h), a 12-pound (5.5 kg) baby will suddenly become a 240-pound (110 kg) force on your arms. The baby would be almost impossible to hold.

Secure the baby in an infant restraint.

■ *Child Restraints*

Be sure to follow the instructions for the restraint. You may find these instructions on the restraint itself or in a booklet, or both. These restraints use the belt system in your vehicle, but the child also has to be secured within the restraint to help reduce the chance of personal injury. The instructions that come with the infant or child restraint will show you how to do that.

Where to Put the Restraint

Accident statistics show that children are safer if they are restrained in the rear rather than the front seat. We at General Motors therefore recommend that you put your child restraint in the rear seat. **NEVER** put a rear-facing child restraint in the front passenger seat. Here's why:

Seats and Restraint Systems



CAUTION:

A child in a rear-facing child restraint can be seriously injured if the right-front passenger's air bag inflates. This is because the back of a rear-facing child restraint would be very close to the inflating air bag. Always secure a rear-facing restraint in the rear seat.

You may, however, secure a forward-facing child restraint in the right-front seat. Before you secure a forward-facing child restraint, ALWAYS move the front passenger seat as far back as it will go. Or, secure the child restraint in the rear seat.

Wherever you install it, be sure to secure the child restraint properly.

Keep in mind that an unsecured child restraint can move around in a collision or sudden stop and injure people in the vehicle. Be sure to properly secure any child restraint in your vehicle – even when no child is in it.

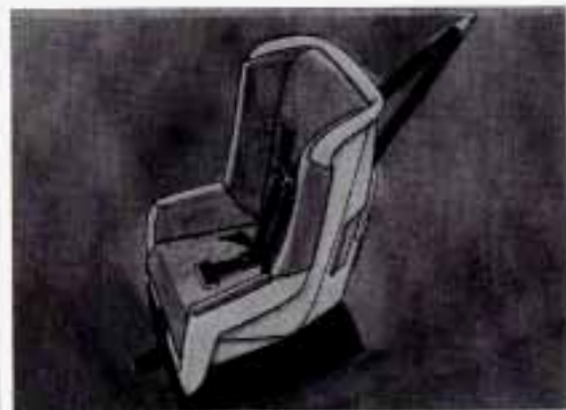

Top Strap

If your child restraint has a top strap, it should be anchored.

If you need to have an anchor installed, you can ask your Pontiac dealer to put it in for you. If you want to install an anchor yourself, your dealer can tell you how to do it.

If you have a convertible, don't use a restraint that has a top strap in your vehicle because the top strap anchor cannot be installed properly.



CAUTION:

The place where the anchor has to go is quite close to your fuel tank. If the anchor isn't installed correctly, it can make a hole in the fuel tank — either then, or in a later collision. Gasoline could leak out and be ignited, and people in the vehicle or outside it could be badly burned. Don't install the anchor yourself unless you know you can do it correctly.

For cars first sold in Canada, child restraints with a top strap must be anchored according to Canadian Law.

Your dealer can obtain the hardware kit and install it for you, or you may install it yourself using the instructions provided with the kit.

Use the tether hardware kit available from the dealer. The hardware and installation instructions were specifically designed for this vehicle.

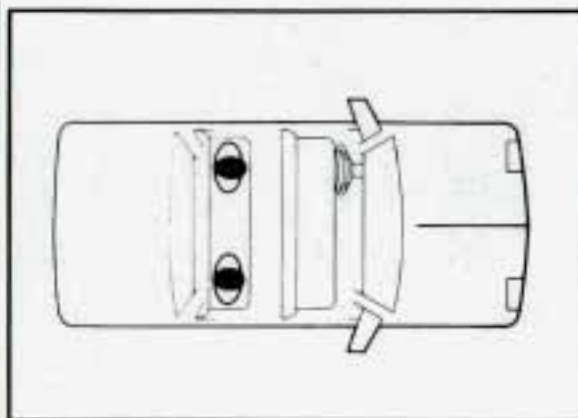

Securing a Child Restraint in the Rear Seat

You'll be using the lap-shoulder belt. See the earlier section about the top strap if the child restraint has one.

1. Put the restraint on the seat. Follow the instructions for the child restraint.
2. Secure the child in the child restraint as the instructions say.
3. Pick up the latch plate, and run the lap and shoulder portions of the vehicle's safety belt through or around the restraint. The child restraint instructions will show you how. Tilt the latch plate to adjust the belt if needed.

If the shoulder belt goes in front of the child's face or neck, put it behind the child restraint.

Seats and Restraint Systems

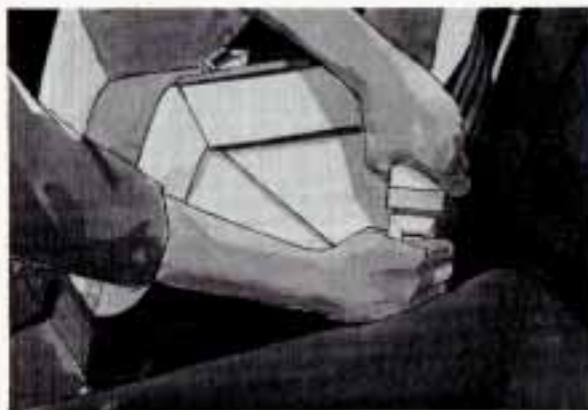

- 4.** Buckle the belt. Make sure the release button is positioned so you would be able to unbuckle the safety belt quickly if you ever had to.

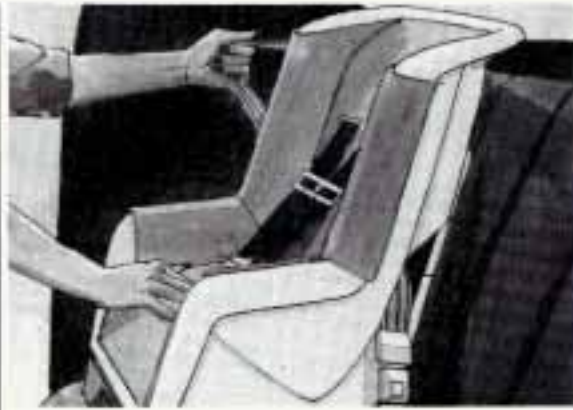

- 5.** To tighten the belt, pull up on the shoulder belt while you push down on the child restraint.



- 6.** Push and pull the child restraint in different directions to be sure it is secure.

To remove the child restraint, just unbuckle the vehicle's safety belt and let it go back all the way. The safety belt will move freely again and be ready to work for an adult or larger child passenger.

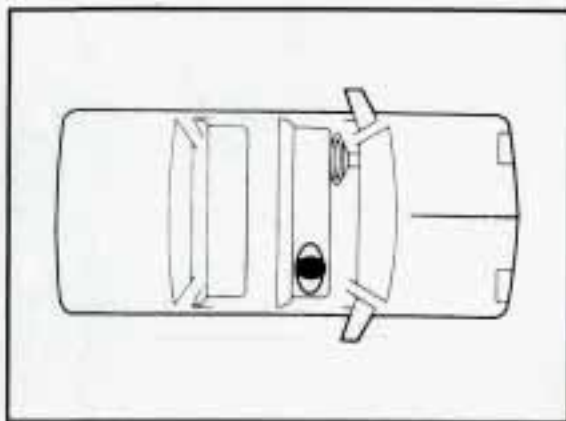

Securing a Child Restraint in the Right Front Seat

Your vehicle has a right-front passenger's air bag. **NEVER** put a rear-facing child restraint in this seat. Here's why:



CAUTION:

A rear-facing child restraint in the front seat could be pushed into the seatback by the right-front passenger's air bag if it inflates. A child in a rear-facing child restraint can be seriously injured if this happens. Always secure a rear-facing child restraint in the rear seat.

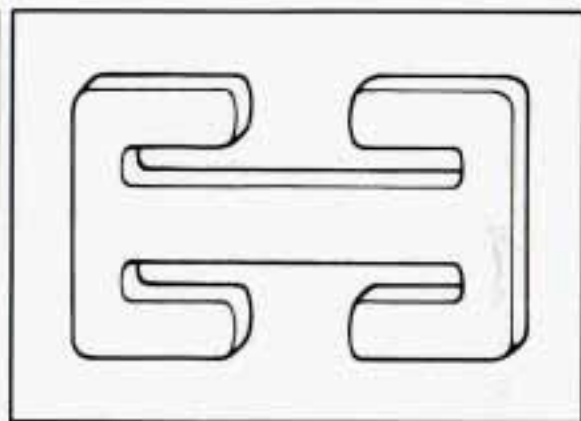

You'll be using the lap-shoulder belt. See the earlier section about the top strap if the child restraint has one.

You'll need a safety locking clip to properly secure a child restraint in this position. You can get a locking clip where child restraints are sold, or from your Pontiac dealer (GM Part No. 94844571). The locking clip must be the same as the one shown here.

Seats and Restraint Systems

Until you have this clip, secure a child restraint only in the rear seat. See the earlier section about securing a child restraint in the rear seat. Once you have the clip, follow these instructions:

1. Because your vehicle has a right-front passenger's air bag, always move the seat as far back as it will go before securing a front-facing child restraint.
2. Put the restraint on the seat. Follow the instructions for the child restraint.
3. Secure the child in the child restraint as the instructions say.
4. Pick up the latch plate, and run the lap and shoulder portions of the vehicle's safety belt through or around the restraint. The child restraint instructions will show you how.

If the shoulder belt goes in front of the child's face or neck, put it behind the child restraint.

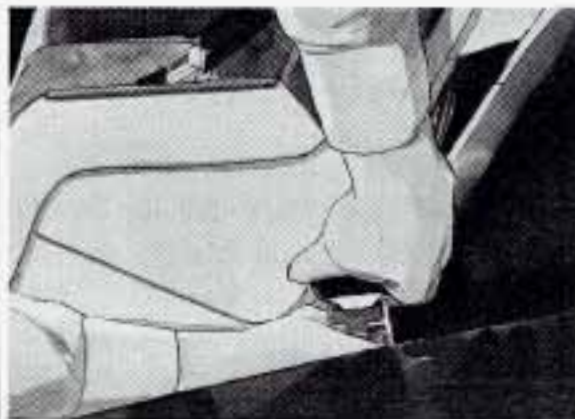

5. Buckle the belt.

Make sure the release button is positioned so you would be able to unbuckle the safety belt quickly if you ever had to.

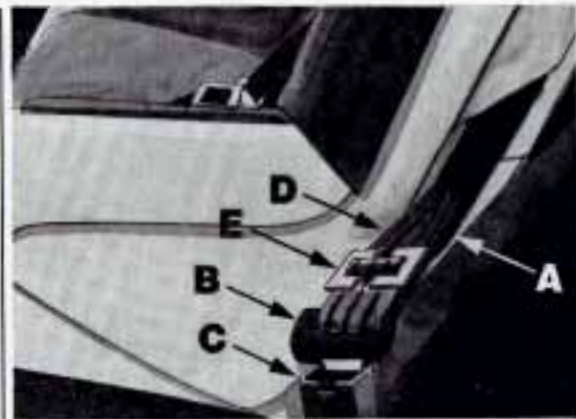

- A. Lap Belt Portion
 - B. Latch Plate
 - C. Buckle
 - D. Shoulder Belt Portion
 - E. Locking Clip
6. Then thread both lap and shoulder belt portions through the locking clip.

⚠ CAUTION:

If a locking clip is not used or is not installed properly, the child restraint may move or tip over when your vehicle turns or stops quickly. The child or others could be injured. When you secure a child restraint with a lap-shoulder belt, always thread both the lap and shoulder belt portions through a locking clip.



7. Push and pull the child restraint in different directions to be sure it is secure.

To remove the child restraint, just unbuckle the vehicle's safety belt and remove the locking clip. Let the safety belt go back all the way.

⚠ CAUTION:

When not used with a child restraint seat, a safety belt with a child restraint locking clip still attached can cause serious injury in a crash. Always remove the clip when you are not using it with a child restraint.

The safety belt will move freely again and be ready to work for an adult or larger child passenger.

Seats and Restraint Systems



■ *Larger Children*

Children who have outgrown child restraints should wear the vehicle's safety belts.

Accident statistics show that children are safer if they are restrained in the rear seat. But they need to use the safety belts properly.

- Children who aren't buckled up can be thrown out in a crash.



- Children who aren't buckled up can strike other people who are.



CAUTION:

Never do this. Here two children are wearing the same belt. The belt can't properly spread the impact forces. In a crash, the two children can be crushed together and seriously injured. A belt must be used by only one person at a time.

Q. What if a child is wearing a lap-shoulder belt, but the child is so small that the shoulder belt is very close to the child's face or neck?

A: Move the child toward the center of the vehicle, but be sure that the shoulder belt still is on the child's shoulder, so that in a crash the child's upper body would have the restraint that belts provide.



CAUTION:

Never do this. Here a child is sitting in a seat that has a lap-shoulder belt, but the shoulder part is behind the child. If the child wears the belt in this way, in a crash the child might slide under the belt. The belt's force would then be applied right on the child's abdomen. That could cause serious or fatal injuries.

Wherever the child sits, the lap portion of the belt should be worn low and snug on the hips, just touching the child's thighs. This applies belt force to the child's pelvic bones in a crash.

■ *Safety Belt Extender*

If the vehicle's safety belt will fasten around you, you should use it.

But if a safety belt isn't long enough to fasten, your dealer will order you an extender. It's free. When you go in to order it, take the heaviest coat you will wear, so the extender will be long enough for you. The extender will be just for you, and just for the seat in your vehicle that you choose. Don't let someone else use it, and use it only for the seat it is made to fit. To wear it, just attach it to the regular safety belt.

Seats and Restraint Systems

■ *Checking Your Restraint Systems*

Now and then, make sure all your belts, buckles, latch plates, retractors, anchorages and reminder systems are working properly. Look for any loose parts or damage. If you see anything that might keep a restraint system from doing its job, have it repaired.

■ *Replacing Safety Belts after a Crash*

If you've had a crash, do you need new belts?

After a very minor collision, nothing may be necessary. But if the belts were stretched, as they would be if worn during a more severe crash, then you need new belts.

If belts are cut or damaged, replace them. Collision damage also may mean you will need to have safety belt or seat parts repaired or replaced. New parts and repairs may be necessary even if the belt wasn't being used at the time of the collision.

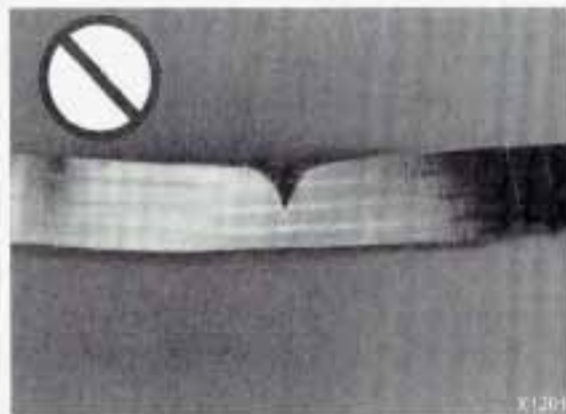

Q: What's wrong with this?

A: The belt is torn.

Torn or frayed belts may not protect you in a crash. They can rip apart under impact forces. If a belt is torn or frayed, get a new one right away.

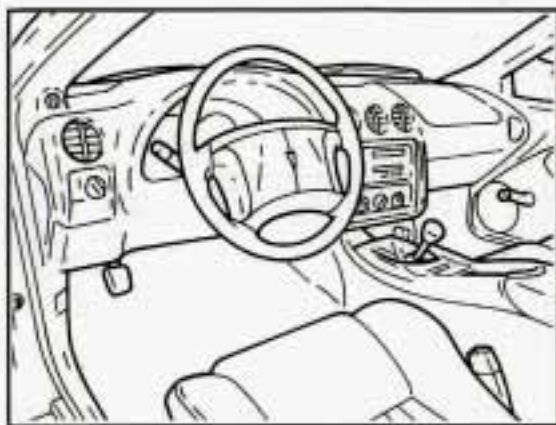

Here you can learn about the many standard and optional features on your Pontiac, and information on starting, shifting and braking. Also explained are the instrument panel and the warning systems that tell you if everything is working properly — and what to do if you have a problem.

Part 2 Features & Controls

Keys	42
Door Locks	43
Theft and Theft Deterrents	48
New Vehicle "Break-In"	50
Ignition Switch	51
Starting Your Engine	52
Automatic Transmission	56
Manual Transmission	59
Limited-Slip Rear Axle	62
Parking	63
Engine Exhaust	66
Windows	67
Horn	68
Tilt Wheel	69
The Turn Signal/Headlight Beam Lever	69
Operation of Lights	76
Mirrors	79
Twin Lift-Off Roof Panels	80
Storage and Compartments	83
Sun Visors	85
Ashtray and Lighter	85
Instrument Panel and Cluster	89
Convertible Top	98

Features and Controls

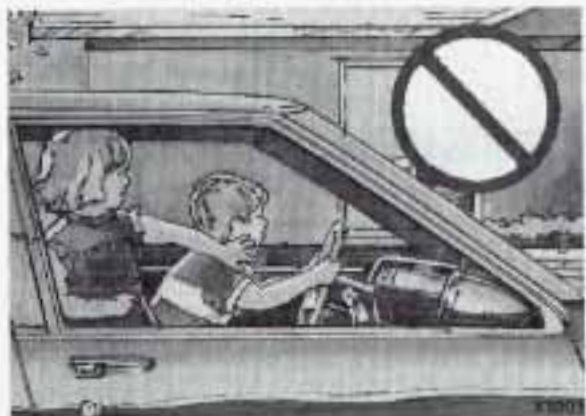

■ *Keys*



CAUTION:

Leaving young children in a vehicle with the ignition key is dangerous for many reasons. A child or others could be badly injured or even killed.

They could operate power windows or other controls or even make the vehicle move. Don't leave the keys in a vehicle with young children.

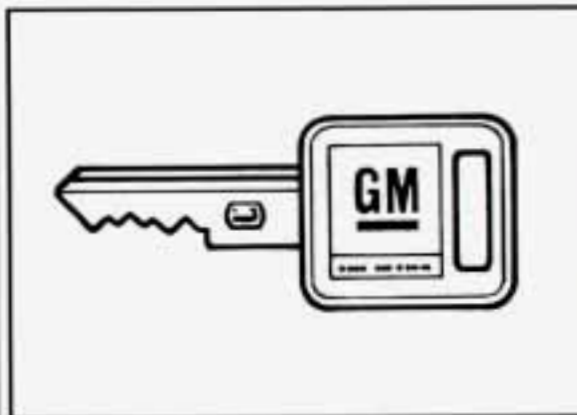

The ignition keys are for the ignition only.

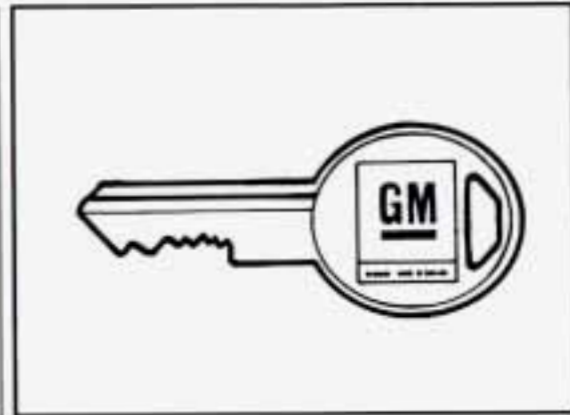

The door keys are for the doors and all other locks.

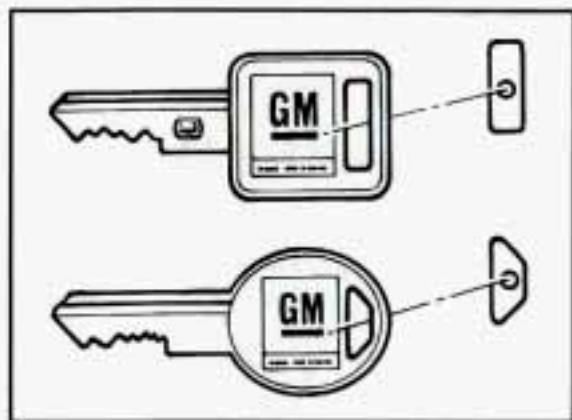

When a new Firebird is delivered, the dealer removes the plugs from the door keys and gives them to the first owner.

The ignition keys don't have plugs. Instead they have bar-coded key tags. These tags may be removed by your dealer or even before the car is delivered to your dealer.

Each plug has a code on it that tells your dealer or a qualified locksmith how to make extra door keys. Keep the plugs in a safe place. If you lose your door keys, you'll be able to have new ones made using these plugs.

If you need a new ignition key, go to your Pontiac dealer who can obtain the correct key code. In an emergency, call Pontiac Roadside Assistance at 1-800-ROADSIDE.

NOTICE:

Your Pontiac has a number of new features that can help prevent theft. But you can have a lot of trouble getting into your vehicle if you ever lock your keys inside. You may even have to damage your vehicle to get in. So be sure you have extra keys. Pontiac also supplies a key card that you can use if you don't have your keys, so be sure to keep this key card with you at all times.

■ *Door Locks*

CAUTION:

Unlocked doors can be dangerous.

Passengers — especially children — can easily open the doors and fall out. When a door is locked, the inside handle won't open it.

Outsiders can easily enter through an unlocked door when you slow down or stop your vehicle.

This may not be so obvious: You increase the chance of being thrown out of the vehicle in a crash if the doors aren't locked. Wear safety belts properly, lock your doors, and you will be far better off whenever you drive your vehicle.

There are several ways to lock and unlock your vehicle:

From the outside: Use your door key.

Features and Controls

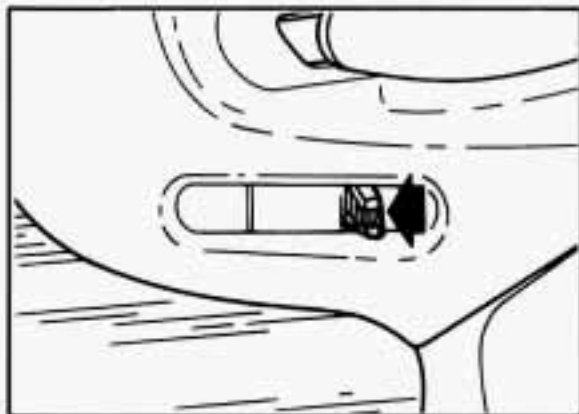

From the inside: To lock the door, move the lock control on the door back.

To unlock the door, move the lock control on the door forward.



Power Door Locks (Option)

Push the power door lock switch to lock or unlock both doors at once.

The switch only works when the ignition switch is in "Run" or "Acc", or when RAP is present. (See "Retained Accessory Power" in the Index.)

Leaving Your Vehicle

If you are leaving the vehicle, take your keys, open your door and set the locks from inside. Then get out and close the door.



Remote Lock Control (Option)

If your Pontiac has this option, you can lock and unlock your doors or unlock your hatch from about 30 feet (9 m) using the key chain transmitter supplied with your vehicle.

Your Remote Lock Control operates on a radio frequency subject to Federal Communications Commission (FCC) Rules.

This device complies with Part 15 of the FCC Rules. Operation is subject to the following two conditions: (1) This device may not cause harmful interference, and (2) This device must accept any interference received, including interference that may cause undesired operation.

Should interference to this system occur, try this:

- Check to determine if battery replacement is necessary. See the instructions on battery replacement.
- Check the distance. You may be too far from your vehicle. This product has a maximum range.
- Check the location. Other vehicles or objects may be blocking the signal.
- See your Pontiac dealer or a qualified technician for service.

Changes or modifications to this system by other than an authorized service facility could void authorization to use this equipment.

Operation

The driver's door will unlock automatically when "UNLOCK" is pressed. If "UNLOCK" is pressed again within five seconds, the passenger door will also unlock. All doors will lock when "DOOR" is pressed. The hatch will unlock when the opened trunk symbol is pressed, but only when the ignition switch

is not in "Run", and the transmission is in "P" (Park) if you have an automatic transmission. If you have a manual transmission, the parking brake must be set.

The system will turn on the interior lights for about 40 seconds, or until the ignition switch is turned to "Run", when you unlock the doors or hatch. The interior lights will come on for about two seconds when you lock the doors.

Matching Transmitter(s) to Your Vehicle

Each key chain transmitter is coded to prevent another transmitter from unlocking your vehicle. If a transmitter is lost or stolen, a replacement can be purchased through your dealer. Remember to bring any remaining transmitters with you when you go to your dealer. When the dealer matches the replacement transmitter to your vehicle, the remaining transmitter must also be matched. Once the new transmitter is coded, the lost transmitter will not unlock your vehicle.

You can match a transmitter to as many different vehicles as you own, provided they are equipped with exactly the same model system. (General Motors offers several different models of these systems on their vehicles.) Each vehicle can have only two transmitters matched to it.

Features and Controls

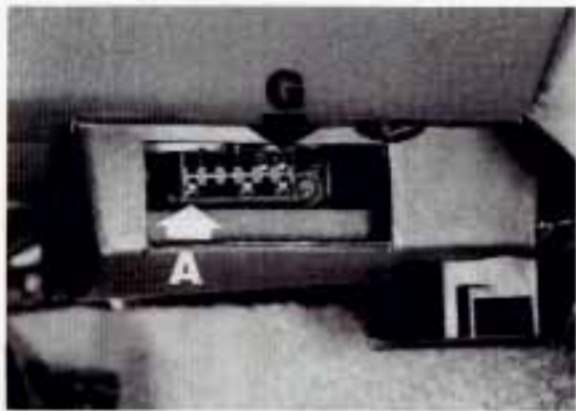

To match transmitters to your vehicle:

1. Find the Data Link Connector (DLC). It is in the bottom of the instrument panel near the steering column.
2. Insert one end of a fused jumper into terminal "G." Terminal "G" is the top terminal on the far right.
3. Insert the other end of the fused jumper into terminal "A." Terminal "A" is the bottom terminal on the far left.

You have grounded the program input line. You should hear the door locks lock and unlock within one to three seconds.

When matching transmitters, the first transmitter code matched will be stored in both memories until a second transmitter is matched. This means that the second transmitter will not work until it is matched in step 5.

4. Press any button on the first transmitter. The door locks should lock and unlock.
5. Press any button on the second transmitter. The door locks should lock and unlock.
6. Remove the fused jumper from the DLC. The system will not work unless the jumper is removed.
7. Check that all the buttons on both transmitters work correctly.

If the transmitters don't work, or if you'd rather not match the transmitters yourself, see your Pontiac dealer.

Battery Replacement

Under normal use, the batteries in your key chain transmitter should last about two years.

You can tell the batteries are weak if the transmitter won't work at the normal range in any location. If you have to get close to your vehicle before the transmitter works, it's probably time to change the batteries.

To replace batteries in the Remote Lock Control:

1. Pop the cover off by inserting a dime (or similar object) in the slot between the covers and twisting.
2. Lift off the front cover, bottom half first.



3. Remove and replace the batteries. Use two Duracell[®] batteries, type DL2016, or a similar type. Put new batteries in printed side down.
4. Replace the front cover. Make sure the cover is on tightly so water won't get in.

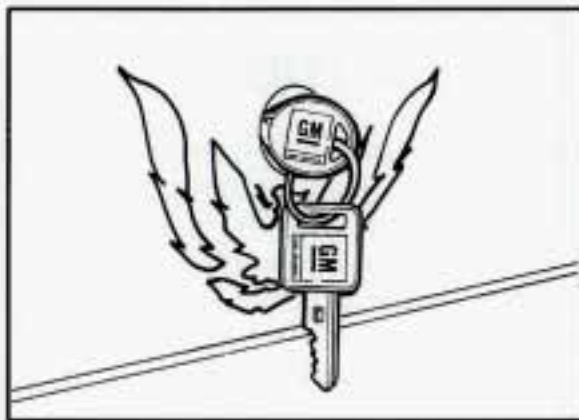

Hatch Release

Your door key opens the hatch.

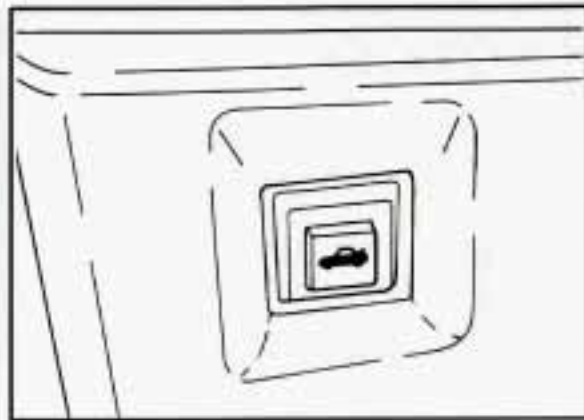

Remote Hatch Release (Option)

Press the switch under the light controls to unlock the hatch from inside your vehicle. If you have an automatic transmission, your shift lever must be in "P" (Park) or "N" (Neutral) to use the switch. If you have a manual transmission and the ignition switch is in "Run", you must set the parking brake before you can use the switch.

The switch only works when the ignition switch is in "Run" or "Acc", or when RAP is present. (See "Retained Accessory Power" in the Index.)

Features and Controls

NOTICE:

If you put things in the hatchback area, be sure they won't break the glass when you close it. Never slam the hatch down. You could break the glass or damage the defogger grid (if equipped).



CAUTION:

It can be dangerous to drive with the hatch open because carbon monoxide (CO) gas can come into your vehicle. You can't see or smell CO. It can cause unconsciousness and even death.

If you must drive with the hatch open or if electrical wiring or other cable connections must pass through the seal between the body and the hatch:

- Make sure all windows are shut.
- Turn the fan on your heating or cooling system to its highest speed with the setting on . That will force outside air into your vehicle. See "Comfort Controls" in the Index.
- If you have air vents on or under the instrument panel, open them all the way.

See "Engine Exhaust" in the Index.

■ Theft

Vehicle theft is big business, especially in some cities. Although your Pontiac has a number of theft-deterrent features, we know that nothing we put on it can make it impossible to steal. However, there are ways you can help.

Key in the ignition: If you walk away from your vehicle with the keys inside, it's an easy target for joy riders or professional thieves — so don't do it.

When you park your Pontiac and open the driver's door, you'll hear a tone reminding you to remove your key from the ignition and take it with you. Always do this. Your steering wheel will be locked, and so will your ignition. If you have an automatic transmission, taking your key out also locks your transmission. And remember to lock the doors.

Parking at Night: Park in a lighted spot, close all windows and lock your vehicle. Remember to keep your valuables out of sight. Put them in a storage area, or take them with you.

Parking Lots: If you park in a lot where someone will be watching your vehicle, it's best to lock it up and take your keys. But what if you have to leave your ignition key? What if you have to leave something valuable in your vehicle?

- Put your valuables in a storage area, like your glove box.
- Lock the glove box.
- Lock all the doors except the driver's.
- Then take the door key with you.

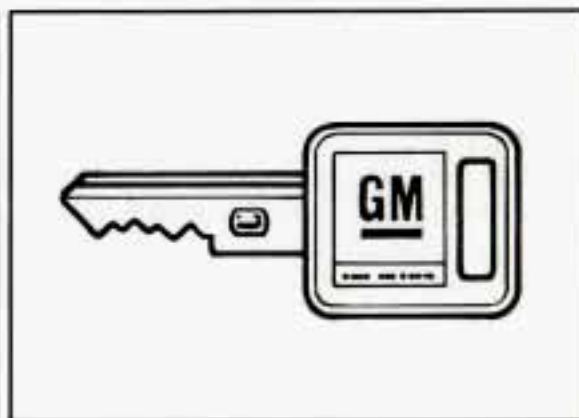

■ *PASS-Key® II*

Your vehicle is equipped with the PASS-Key® II (Personalized Automotive Security System) theft-deterrent system. PASS-Key® II is a passive theft-deterrent system. This means you don't have to do anything different to arm or disarm the system. It works when you insert or remove the key from the ignition. PASS-Key® II uses a resistor pellet in the ignition key that matches a decoder in your vehicle.

When the PASS-Key® II system senses that someone is using the wrong key, it shuts down the vehicle's starter and fuel systems. For about three minutes, the starter won't work and fuel won't go to the engine. If someone tries to start your vehicle again or uses another key during this time, the vehicle will not start. This discourages someone from randomly trying different keys with different resistor pellets in an attempt to make a match.

Features and Controls



SECURITY

The ignition key must be clean and dry before it's inserted in the ignition or the engine may not start. If the engine does not start and the "SECURITY" light stays on when you try to start the vehicle, the key may be dirty or wet. Turn the ignition off.

Clean and dry the key. Wait about three minutes and try again. The security light will remain on during this time. If the starter still won't work, and the key appears to be clean and dry, wait about three minutes and try another ignition key. At this time, you may also want to check the fuses (see "Fuses and Circuit Breakers" in the Index). If the starter won't work with the other key, your vehicle needs service. If your vehicle does start, the first ignition key may be

faulty. See your Pontiac dealer or a locksmith who can service the PASS-Key[®] II.

If you accidentally use a key that has a damaged or missing resistor pellet, the starter won't work and the security light will flash. But you don't have to wait three minutes before trying another ignition key.

See your Pontiac dealer or a locksmith who can service the PASS-Key[®] II to have a new key made.

If you're ever driving and the "SECURITY" light comes on and stays on, you will be able to restart your engine if you turn it off. Your PASS-Key[®] II system, however, is not working properly and must be serviced by your Pontiac dealer. Your vehicle is not protected by the PASS-Key[®] II system.

If you lose or damage a PASS-Key[®] II ignition key, see your Pontiac dealer or a locksmith who can service PASS-Key[®] II to have a new key made. In an emergency, call the Pontiac Roadside Assistance Program on 1-800-ROADSIDE or 1-800-762-3743.

■ *New Vehicle "Break-In"*

NOTICE:

Your modern Pontiac doesn't need an elaborate "break-in." But it will perform better in the long run if you follow these guidelines:

- Keep your speed at 55 mph (88 km/h) or less for the first 500 miles (804 km).
- Don't drive at any one speed — fast or slow — for the first 500 miles (804 km). Don't make full-throttle starts.
- Avoid making hard stops for the first 200 miles (322 km) or so. During this time your new brake linings aren't yet broken in. Hard stops with new linings can mean premature wear and earlier replacement. Follow this "breaking-in" guideline every time you get new brake linings.

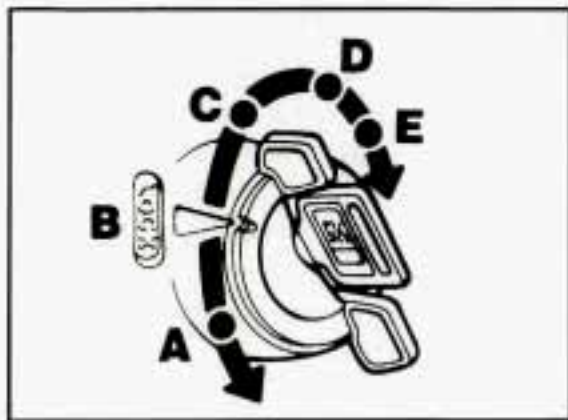

■ Ignition Switch

With the ignition key in the ignition switch, you can turn the switch to five positions:

Acc (A): Position in which you can operate your electrical power accessories. Press in the ignition switch as you turn the top of it toward you.

LOCK (B): The only position in which you can remove the key. This locks your steering wheel, ignition and automatic transmission.

If you have an automatic transmission, the ignition switch can't be turned to "LOCK" unless the shift lever is in the "P" (Park) position.

Off (C): Unlocks the steering wheel, ignition and automatic transmission, but does not send electrical power to any accessories. Use this position if your vehicle must be pushed or towed. A warning tone will sound if you open the driver's door when the ignition is in "Off" and the key is in the ignition.

Run (D): Position to which the switch returns after you start your engine and release the switch. The switch stays in the "Run" position when the engine is running. But even when the engine is not running, you can use "Run" to operate your electrical power accessories and to display some instrument panel warning and indicator lights.

Start (E): Starts the engine. When the engine starts, release the key. The ignition switch will return to "Run" for normal driving.

Note that even if the engine is not running, "Acc" and "Run" allow you to operate your electrical accessories, such as the radio and ventilation fan.

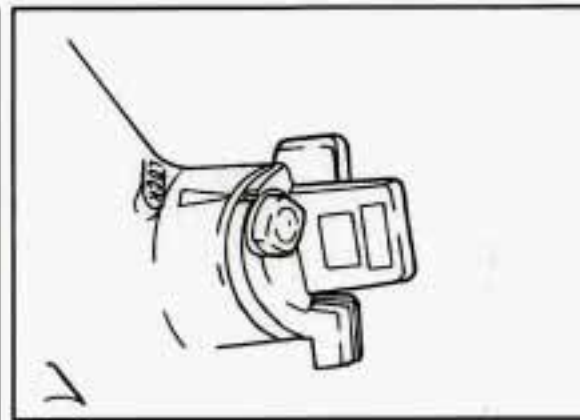

Key Release Button: If you have a manual transmission, your ignition lock has a key release button. You must press the button before you can take your key out of the ignition lock.

Features and Controls



CAUTION:

On manual transmission vehicles, turning the key to "Lock" will lock the steering column and result in a loss of ability to steer the vehicle. This could cause a collision. If you need to turn the engine off while the vehicle is moving, turn the key only to "Off." Don't press the key release button while the vehicle is moving.

NOTICE:

If your key seems stuck in "Lock" and you can't turn it, be sure it is all the way in. If it is, then turn the steering wheel left and right while you turn the key hard. But turn the key only with your hand. Using a tool to force it could break the key or the ignition switch. If none of this works, then your vehicle needs service.

Retained Accessory Power (RAP)

If you have power door locks, your vehicle has a feature called Retained Accessory Power (RAP). With RAP your power door locks, electric mirrors, power windows, audio system and remote hatch release will continue to work up to 10 minutes after the ignition key is turned to "Off" and neither door is opened.

If a door is opened, the audio system and power windows will shut off. The power door locks, electric mirrors and remote hatch release will work until you shut the door. Once you have shut the door, these accessories will continue to work for approximately 35 seconds. After this time you will not be able to use these accessories until the next time you open a door or turn on the ignition.

■ Starting Your Engine

Automatic Transmission: Move your shift lever to "P" (Park) or "N" (Neutral). Your engine won't start in any other position — that's a safety feature. To restart when you're already moving, use "N" (Neutral) only.

NOTICE:

Don't try to shift to "P" (Park) if your Pontiac is moving. If you do, you could damage the transmission. Shift to "P" (Park) only when your vehicle is stopped.

Manual Transmission: The gear selector should be in neutral. Hold the clutch pedal to the floor and start the engine. Your vehicle won't start if the clutch pedal is not all the way down — that's a safety feature.

To start your V6 engine:

1. Without pushing the accelerator pedal, turn your ignition key to "Start." When the engine starts, let go of the key. The idle speed will go down as your engine gets warm.

NOTICE:

Holding your key in "Start" for longer than 15 seconds at a time will cause your battery to be drained much sooner. And the excessive heat can damage your starter motor.

2. If your engine won't start (or starts but then stops), it could be flooded with too much gasoline. Try pushing your accelerator pedal all the way to the floor and holding it there as you hold the key in "Start" for about three seconds. If the vehicle starts briefly but then stops again, do the same thing, but this time keep the pedal down for five or six seconds. This clears the extra gasoline from the engine

NOTICE:

Your engine is designed to work with the electronics in your vehicle. If you add electrical parts or accessories, you could change the way the fuel injection system operates. Before adding electrical equipment, check with your dealer. If you don't, your engine might not perform properly.

If you ever have to have your vehicle towed, see the part of this manual that tells how to do it without damaging your vehicle. See "Towing Your Vehicle" in the Index.

To start your V8 engine:

1. Without pushing the accelerator pedal, turn the ignition key to "Start." When the engine starts, let go of the key. The idle speed will go down as your engine gets warm.

NOTICE:

Holding your key in "Start" for longer than 15 seconds at a time will cause your battery to be drained much sooner. And the excessive heat can damage your starter motor.

2. If it doesn't start within 10 seconds, push the accelerator pedal all the way to the floor, while you hold the ignition key in "Start." When the engine starts, let go of the key and let up on the accelerator pedal. Wait about 15 seconds between each try to help avoid draining your battery.

Features and Controls

When starting your engine in very cold weather (below 0°F or -18°C), do this:

1. With your foot off the accelerator pedal, turn the ignition key to "Start" and hold it there. When the engine starts, let go of the key. Use the accelerator pedal to maintain engine speed, if you have to, until your engine has run for a while.
2. If your engine still won't start (or starts but then stops), it could be flooded with too much gasoline. Try pushing your accelerator pedal all the way to the floor and holding it there as you hold the key in "Start" for about three seconds. If the vehicle starts briefly but then stops again, do the same thing, but this time keep the pedal down for five or six seconds. This clears the extra gasoline from the engine.

NOTICE:

Your engine is designed to work with the electronics in your vehicle. If you add electrical parts or accessories, you could change the way the fuel injection system operates. Before adding electrical equipment, check with your dealer. If you don't, your engine might not perform properly.

If you ever have to have your vehicle towed, see the part of this manual that tells how to do it without damaging your vehicle. See "Towing Your Vehicle" in the Index.

■ *Driving through Deep Standing Water*

NOTICE:

If you drive too quickly through deep puddles or standing water, water can come in through your engine's air intake and badly damage your engine. If you can't avoid deep puddles or standing water, drive through them very slowly.

Performance Mode Switch (Option)

This switch lets you change from a normal driving mode to a performance mode. When you start the engine, the switch will be in normal mode. For general driving conditions, use the normal mode. It will remain in normal unless you select the "PERFORM" feature.

For a firmer shift and increased performance, you may choose the "PERFORM" mode. The light in the center of the switch will light up when selected. The switch will then remain in "PERFORMANCE" mode until the engine is shut off, when it will go back to normal mode.

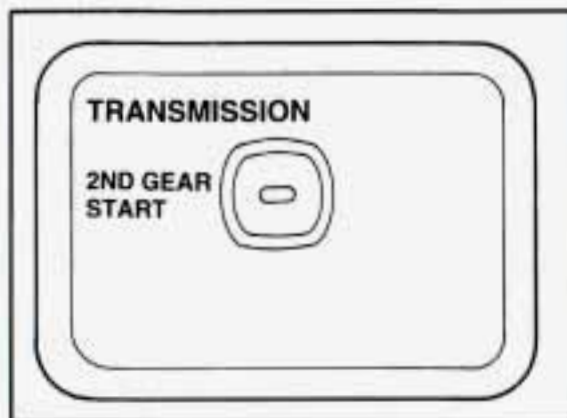

Second-Gear Start

Your vehicle may be equipped with a Second-Gear Start feature. Press "2ND GEAR START" to provide more traction when you are starting on ice or other slippery surfaces. The transmission will be in second gear when the vehicle begins to move. After starting in second gear, the vehicle will upshift normally.

This feature is only for improved traction when the road surface is slippery and is not intended for continuous use. Always use "NORMAL" for normal road conditions. You may press "2ND GEAR START" again to turn off this feature. Whenever you start your vehicle, the transmission is in the "NORMAL" mode.

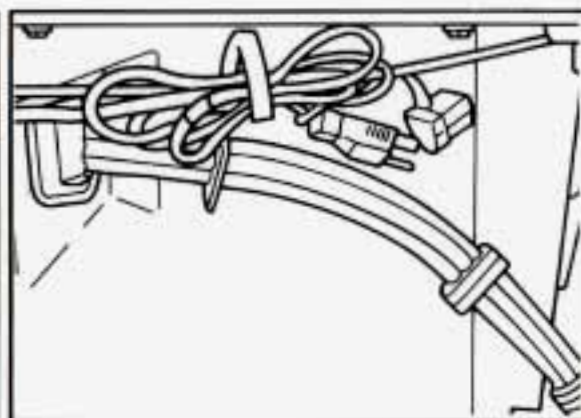

■ **Engine Coolant Heater (Engine Block Heater) (OPTION)**

In very cold weather, 0°F (-18°C) or colder, the engine coolant heater can help. You'll get easier starting and better fuel economy during engine warm-up. Usually, the coolant heater should be plugged in a minimum of four hours prior to starting your vehicle.

To use the coolant heater:

1. Turn off the engine.
2. Open the hood and unwrap the electrical cord.
3. Plug it into a normal, grounded 110-volt outlet.

⚠ CAUTION:

Plugging the cord into an ungrounded outlet could cause an electrical shock. Also, the wrong kind of extension cord could overheat and cause a fire. You could be seriously injured. Plug the cord into a properly grounded three-prong 110-volt outlet. If the cord won't reach, use a heavy-duty three-prong extension cord rated for at least 15 amps.

NOTICE:

After you've used the coolant heater, be sure to store the cord as it was before to keep it away from moving engine parts. If you don't, it could be damaged.

Features and Controls

How long should you keep the coolant heater plugged in? The answer depends on the weather, the kind of oil you have, and some other things. Instead of trying to list everything here, we ask that you contact a Pontiac dealer in the area where you'll be parking your vehicle. The dealer can give you the best advice for that particular area.

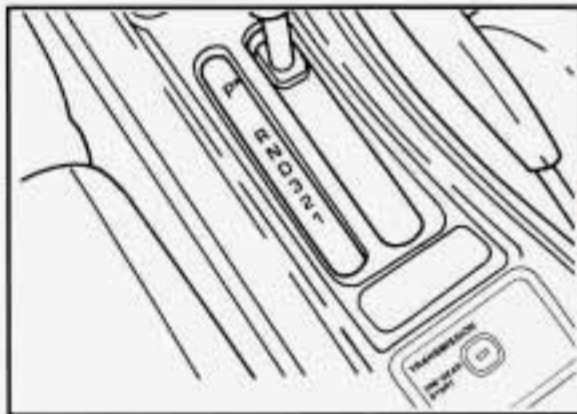

■ *Automatic Transmission*

There are several different positions for your shift lever.

● **P (Park)**

This locks your rear wheels. It's the best position to use when you start your engine because your vehicle can't move easily.



CAUTION:

It is dangerous to get out of your vehicle if the shift lever is not fully in "P" (Park) with the parking brake firmly set. Your vehicle can roll.

Don't leave your vehicle when the engine is running unless you have to. If you have left the engine running, the vehicle can move suddenly. You or others could be injured. To be sure your vehicle won't move, even when you're on fairly level ground, always set your parking brake and move the shift lever to "P" (Park). See "Shifting into "P" (Park)" in the Index.

If you're pulling a trailer, see "Towing a Trailer" in the Index.

Ensure the shift lever is fully in “P” (Park) range before starting the engine. Your Pontiac has a brake-transmission shift interlock. You have to fully apply your regular brakes before you can shift from “P” (Park) when the ignition key is in the “Run” position. If you cannot shift out of “P” (Park), ease pressure on the shift lever — push the shift lever all the way into “P” (Park) and also release the shift lever button on floor shift console models as you maintain brake application. Then move the shift lever into the gear you wish. (Press the shift lever button before moving the shift lever on floor shift console models.) See “Shifting out of “P” (Park)” in this part.

- **R (Reverse)**

Use this gear to back up.

NOTICE:

Shifting to “R” (Reverse) while your vehicle is moving forward could damage your transmission. Shift to “R” only after your vehicle is stopped.

To rock your vehicle back and forth to get out of snow, ice or sand without damaging your transmission, see “Stuck: In Sand, Mud, Ice or Snow, If You’re” in the Index.

- **N (Neutral)**

In this position, your engine doesn’t connect with the wheels. To restart when you’re already moving, use “N” (Neutral) only. Also, use “N” when your vehicle is being towed.



CAUTION:

Shifting out of “P” (Park) or “N” (Neutral) while your engine is “racing” (running at high speed) is dangerous. Unless your foot is firmly on the brake pedal, your vehicle could move very rapidly. You could lose control and hit people or objects. Don’t shift out of “P” (Park) or “N” (Neutral) while your engine is racing.

NOTICE:

Damage to your transmission caused by shifting out of “P” (Park) or “N” (Neutral) with the engine racing isn’t covered by your warranty.

Features and Controls

- **Ⓧ Automatic Overdrive**

This position is for normal driving. If you need more power for passing, and you're:

- Going less than about 35 mph (56 km/h), push your accelerator pedal about halfway down.
- Going about 35 mph (56 km/h) or more, push the accelerator all the way down.

You'll shift down to the next gear and have more power.

- **D (Third Gear)**

This is like Ⓧ, but you never go into Overdrive.

Here are some times you might choose "D" instead of Ⓧ :

- When driving on hilly, winding roads
- When towing a trailer, so there is less shifting between gears
- When going down a steep hill

- **2 (Second Gear)**

This position gives you more power but lower fuel economy. You can use "2" on hills. It can help control your speed as you go down steep mountain roads, but then you would also want to use your brakes off and on.

NOTICE:

Don't drive in "2" (Second Gear) for more than 5 miles (8 km), or at speeds over 55 mph (88 km/h), or you can damage your transmission. Use Ⓧ or "D" as much as possible.

Don't shift into "2" unless you are going slower than 65 mph (105 km/h), or you can damage your engine.

- **1 (First Gear)**

This position gives you even more power (but lower fuel economy) than "2." You can use it on very steep hills, or in deep snow or mud. If the selector lever is put in "1," the transmission won't shift into first gear until the vehicle is going slowly enough.

NOTICE:

If your rear wheels can't rotate, don't try to drive. This might happen if you were stuck in very deep sand or mud or were up against a solid object. You could damage your transmission.

Also, if you stop when going uphill, don't hold your vehicle there with only the accelerator pedal. This could overheat and damage the transmission. Use your brakes or shift into "P" (Park) to hold your vehicle in position on a hill.

Maximum engine speed is limited to protect driveline components from improper operation.



■ *Manual Transmission*

Five-Speed

This is your shift pattern. Here's how to operate your transmission:

- **1 (First Gear)** — Press the clutch pedal and shift into “1.” Then, slowly let up on the clutch pedal as you press the accelerator pedal.

You can shift into “1” when you’re going less than 20 mph (32 km/h). If you’ve come to a complete stop and it’s hard to shift into “1,” put the shift lever in “Neutral” and let up on the clutch. Press the clutch pedal back down. Then shift into “1.”

- **2 (Second Gear)** — Press the clutch pedal as you let up on the accelerator pedal and shift into “2.” Then, slowly let up on the clutch pedal as you press the accelerator pedal.
- **3, 4 and 5 (Third, Fourth and Fifth Gears)** — Shift into “3,” “4” and “5” the same way you do for “2.” Slowly let up on the clutch pedal as you press the accelerator pedal.
- **To Stop** — Let up on the accelerator pedal and press the brake pedal. Just before the vehicle stops, press the clutch pedal and the brake pedal, and shift to “Neutral.”
- **Neutral** — Use this position when you start or idle your engine.
- **R (Reverse)** — To back up, press down the clutch pedal and shift into “R.” Let up on the clutch pedal slowly while pressing the accelerator pedal.

NOTICE:

Shift to “R” (Reverse) only after your vehicle is stopped. Shifting to “R” (Reverse) while your vehicle is moving could damage your transmission.

Also, use Reverse, along with the parking brake, for parking your vehicle.

Features and Controls

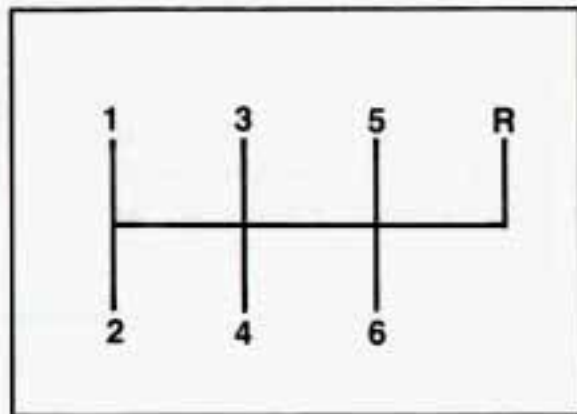

Six-Speed

This is your shift pattern. Here's how to operate your transmission:

- **1 (First Gear)** — Press the clutch pedal and shift into “1.” Then, slowly let up on the clutch pedal as you press the accelerator pedal.

You can shift into “1” when you’re going less than 20 mph (30 km/h). If you’ve come to a complete stop and it’s hard to shift into “1,” put the shift lever in “Neutral” and let up on the clutch. Press the clutch pedal back down. Then shift into “1.”

- **2 (Second Gear)** — Press the clutch pedal as you let up on the accelerator pedal and shift into “2.” Then, slowly let up on the clutch pedal as you press the accelerator pedal.
- **3, 4, 5 and 6 (Third, Fourth, Fifth and Sixth Gears)** — Shift into “3,” “4,” “5” and “6” the same way you do for “2.” Slowly let up on the clutch pedal as you press the accelerator pedal.
- **To Stop** — Let up on the accelerator pedal and press the brake pedal. Just before the vehicle stops, press the clutch pedal and the brake pedal, and shift to “Neutral.”
- **Neutral** — Use this position when you start or idle your engine.
- **R (Reverse)** — To back up, press down the clutch pedal and shift into “R.” Let up on the clutch pedal slowly while pressing the accelerator pedal.

Your six-speed manual transmission has a feature that allows you to safely shift into "R" (Reverse) while the vehicle is rolling (at less than 3 mph). You will be "locked-out" if you try to shift into "R" (Reverse) while your vehicle is moving faster than 3 mph.

If you have turned your ignition off and wish to park your vehicle in Reverse, you will have to move the shift lever quickly to the right, "crashing" through the high load spring and then into gear.



Skip Shift Light (5.7L LT1 Engine)

When this light comes on, you can only shift from "1" (First) to "4" (Fourth) gear instead of "1" (First) to "2" (Second) gear. This helps you to get the best possible fuel economy.

This light will come on under these conditions:

- The engine coolant temperature is greater than 170°F (77°C),
- You are going 15-20 mph (24-32 km/h), and
- You are at 35% throttle or less.

When this light is on, the gear shift lever will let you shift from "1" (First) gear to "4" (Fourth) gears only. Once you are in "4" (Fourth) gear, you can press the clutch again and shift into another gear.

Follow the shift speeds in this chart when the "SKIP SHIFT" light is on.

Computer Aided Manual Transmission Shift Speeds:

1st to 4th 15 mph (24 km/h)

4th to 5th 25 mph (40 km/h)*

5th to 6th 40 mph (64 km/h)**

Each time you come to a stop, the engine's Electronic Control Module (ECM) determines when to activate the "SKIP SHIFT" upshift system. Use "2" (Second) gear only when you accelerate very quickly from a stop. You can then follow the full gear shift pattern.

***30 mph (48 km/h) when accelerating to highway speeds.**

****45 mph (72 km/h) when accelerating to highway speeds.**

Features and Controls

Shift Speeds (MANUAL TRANSMISSION)

This chart shows when to shift to the next higher gear for best fuel economy.

MANUAL TRANSMISSION RECOMMENDED SHIFT SPEEDS, IN MPH (km/h)

Engine	Acceleration Shift Speed				
	1 to 2	2 to 3	3 to 4	4 to 5	5 to 6
3.4L L32 (Code S)	13–16 (21–25)	21–28 (34–35)	32–37 (51–59)	45–47 (72–75)	N/A
5.7L LT1 (Code P)	15 (24)	25 (40)	40 (64)	45 (72)	50 (80)

If your speed drops below 20 mph (30 km/h), or if the engine is not running smoothly, you should downshift to the next lower gear. You may have to downshift two or more gears to keep the engine running smoothly or for good performance.



CAUTION:

If you skip more than one gear when you downshift, you could lose control of your vehicle. And you could injure yourself or others. Don't shift from "6" to "3," "5" to "2" or "4" to "1."

NOTICE:

If you skip more than one gear when you downshift, or if you race the engine when you downshift, you can damage the clutch or transmission.

■ *Limited-Slip Rear Axle*

If you have this feature, your rear axle can give you additional traction on snow, mud, ice, sand or gravel. It works like a standard axle most of the time, but when one of the rear wheels has no traction and the other does, the limited-slip feature will allow the wheel with traction to move the vehicle.



■ *Parking*

Parking Brake

The parking brake uses the brakes on the rear wheels.

To set the parking brake: Hold the brake pedal down and pull up on the parking brake lever. If the ignition is on, the brake system warning light will come on.



To release the parking brake: Hold the brake pedal down. Pull the parking brake lever up until you can push in the release button. Hold the release button in as you move the brake lever all the way down.

NOTICE:

Driving with the parking brake on can cause your rear brakes to overheat. You may have to replace them, and you could also damage other parts of your vehicle.

If you are towing a trailer and are parking on any hill: See "Towing a Trailer" in the Index. That section shows what to do first to keep the trailer from moving.

Features and Controls

Shifting into P (Park) (AUTOMATIC TRANSMISSION)

CAUTION:

It can be dangerous to get out of your vehicle if the shift lever is not fully in "P" (Park) with the parking brake firmly set. Your vehicle can roll.

If you have left the engine running, the vehicle can move suddenly. You or others could be injured. To be sure your vehicle won't move, even when you're on fairly level ground, use the steps that follow. If you're pulling a trailer, see "Towing a Trailer" in the Index.

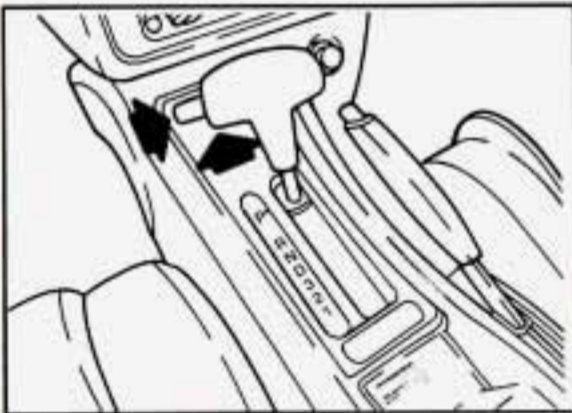

1. Hold the brake pedal down with your right foot and set the parking brake.
2. Move the shift lever into "P" (Park) position like this:
 - Hold in the button on the lever, and push the lever all the way toward the front of your vehicle.
3. Move the ignition key to "LOCK."
4. Remove the key and take it with you. If you can walk away from your vehicle with the ignition key in your hand, your vehicle is in "P" (Park).

Leaving Your Vehicle with the Engine Running (AUTOMATIC TRANSMISSION)

CAUTION:

It can be dangerous to leave your vehicle with the engine running. Your vehicle could move suddenly if the shift lever is not fully in "P" (Park) with the parking brake firmly set. And, if you leave the vehicle with the engine running, it could overheat and even catch fire. You or others could be injured. Don't leave your vehicle with the engine running unless you have to.

If you have to leave your vehicle with the engine running, be sure your vehicle is in "P" (Park) and your parking brake is firmly set before you leave it. After you've moved the shift lever into the "P" (Park) position, hold the regular brake pedal down. Then, see if you can move the shift lever away from "P" (Park) without first pushing the button. If you can, it means that the shift lever wasn't fully locked into "P" (Park).

Torque Lock

(AUTOMATIC TRANSMISSION)

If you are parking on a hill and you don't shift your transmission into "P" (Park) properly, the weight of the vehicle may put too much force on the parking pawl in the transmission. You may find it difficult to pull the shift lever out of "P" (Park). This is called "torque lock." To prevent torque lock, set the parking brake and then shift into "P" (Park) properly before you leave the driver's seat. To find out how, see "Shifting Into "P" (Park)" in the Index.

When you are ready to drive, move the shift lever out of "P" (Park) BEFORE you release the parking brake.

If "torque lock" does occur, you may need to have another vehicle push yours a little uphill to take some of the pressure from the transmission, so you can pull the shift lever out of "P" (Park).

Shifting out of P (Park)

(AUTOMATIC TRANSMISSION)

Your Pontiac has a brake-transmission shift interlock. You have to fully apply your regular brake before you can shift from "P" (Park) when the ignition is in the "Run" position. See "Automatic Transmission" in the Index.

If you cannot shift out of "P" (Park), ease pressure on the shift lever — push the shift lever all the way into "P" (Park) and release the shift lever button as you maintain brake application. Then press the shift lever button and move the shift lever into the gear you wish.

If you ever hold the brake pedal down but still can't shift out of "P" (Park), try this:

1. Turn the key to "Off."
2. Apply and hold the brake until the end of Step 4.
3. Shift to "N" (Neutral).
4. Start the vehicle and then shift to the drive gear you want.
5. Have the vehicle fixed as soon as you can.

Parking Your Vehicle

(MANUAL TRANSMISSION)

Before you get out of your vehicle, put your manual transmission in "R" (Reverse) and firmly apply the parking brake.

If your vehicle is equipped to tow a trailer, see "Towing a Trailer" in the Index.

Features and Controls



Parking over Things That Burn

CAUTION:

Things that can burn could touch hot exhaust parts under your vehicle and ignite. Don't park over papers, leaves, dry grass or other things that can burn.

■ *Engine Exhaust*

CAUTION:

Engine exhaust can kill. It contains the gas carbon monoxide (CO), which you can't see or smell. It can cause unconsciousness and death.

You might have exhaust coming in if:

- Your exhaust system sounds strange or different.
- Your vehicle gets rusty underneath.
- Your vehicle was damaged in a collision.
- Your vehicle was damaged when driving over high points on the road or over road debris.
- Repairs weren't done correctly.
- Your vehicle or exhaust system had been modified improperly.

If you ever suspect exhaust is coming into your vehicle:

- Drive it only with all the windows down to blow out any CO; and
- Have your vehicle fixed immediately.

Running Your Engine While You're Parked (AUTOMATIC TRANSMISSION)

It's better not to park with the engine running. But if you ever have to, here are some things to know.

CAUTION:

Idling the engine with the air system control off could allow dangerous exhaust into your vehicle. (See the earlier caution under "Engine Exhaust.")

Also, idling in a closed-in place can let deadly carbon monoxide (CO) into your vehicle even if the fan switch is at the highest setting. One place this can happen is a garage. Exhaust — with CO — can come in easily. **NEVER** park in a garage with the engine running.

Another closed-in place can be a blizzard. (See "Blizzard" in the Index.)

CAUTION:

It can be dangerous to get out of your vehicle if the shift lever is not fully in "P" (Park) with the parking brake firmly set. Your vehicle can roll. Don't leave your vehicle when the engine is running unless you have to. If you've left the engine running, the vehicle can move suddenly. You or others could be injured. To be sure your vehicle won't move, even when you're on fairly level ground, always set your parking brake and move the shift lever to "P" (Park).

Follow the proper steps to be sure your vehicle won't move. See "Shifting Into "P" (Park)" in the Index.

If you are parking on a hill and if you're pulling a trailer, also see "Towing a Trailer" in the Index.



■ ***Windows***

Manual Windows

Use the window crank to open and close each door window.

Features and Controls

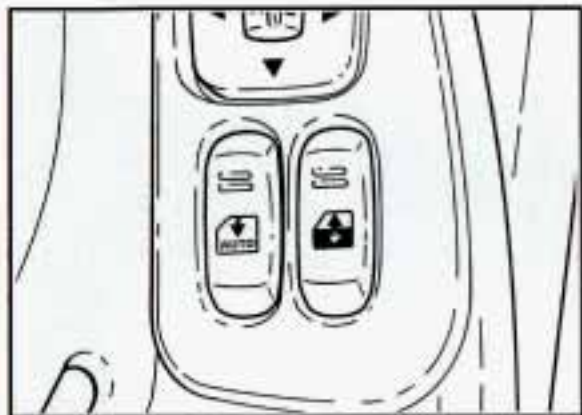

Power Windows (Option)

With power windows, switches on the door control each window when the ignition is on or when RAP is present. (See "Retained Accessory Power" in the Index.)

You can also open the passenger window any amount by pressing the switch and releasing it when the window has lowered to the position you want.

The switch for the driver's window has an Express Down feature. Quickly press and release the switch for the driver's window and the window will lower completely. You can also open the driver's window any amount by pressing the switch again while the window is in the Express Down mode when it has lowered to the position you want.



■ *Horn*

To sound the horn, press either horn symbol on your steering wheel.

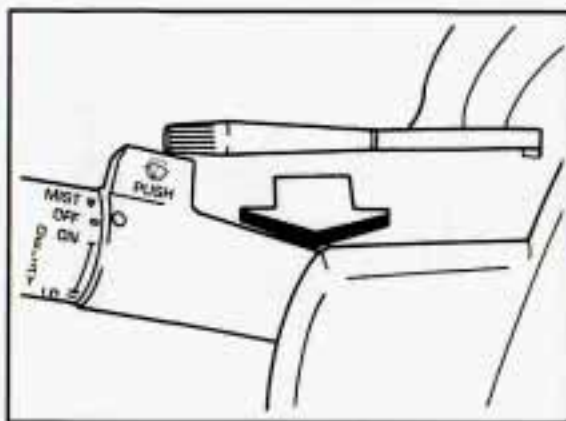

■ *Tilt Wheel*

A tilt steering wheel allows you to adjust the steering wheel before you drive.

You can also raise it to the highest level to give your legs more room when you exit and enter the vehicle.

To tilt the wheel, hold the steering wheel and pull the lever. Move the steering wheel to a comfortable level, then release the lever to lock the wheel in place.

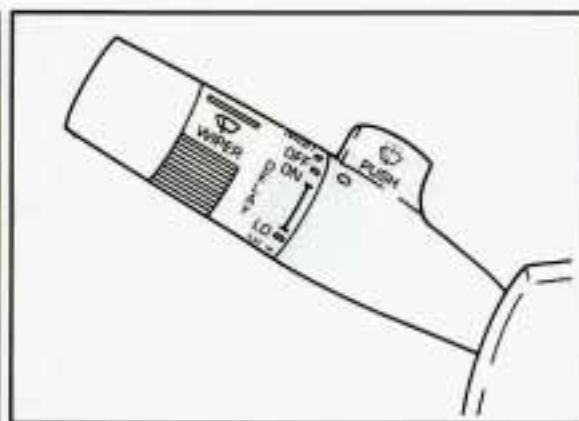

■ *The Turn Signal/Headlight Beam Lever*

The lever on the left side of the steering column includes your:

- Turn Signal and Lane Change Indicator
- Headlight High/Low Beam and Passing Signal
- Windshield Wipers
- Windshield Washer
- Cruise Control (Option)

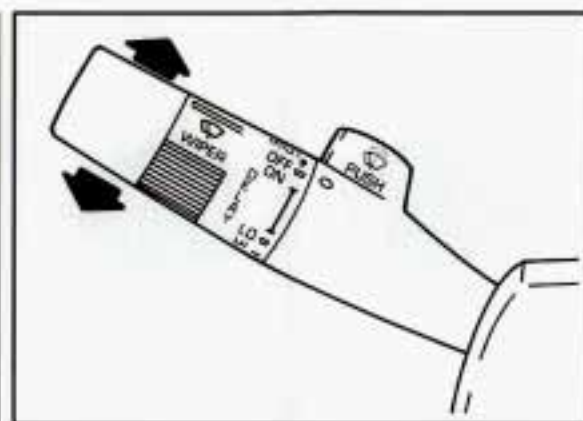

Turn Signal and Lane Change Indicator

The turn signal has two upward (for Right) and two downward (for Left) positions. These positions allow you to signal a turn or a lane change.

To signal a turn, move the lever all the way up or down. When the turn is finished, the lever will return automatically.

Features and Controls

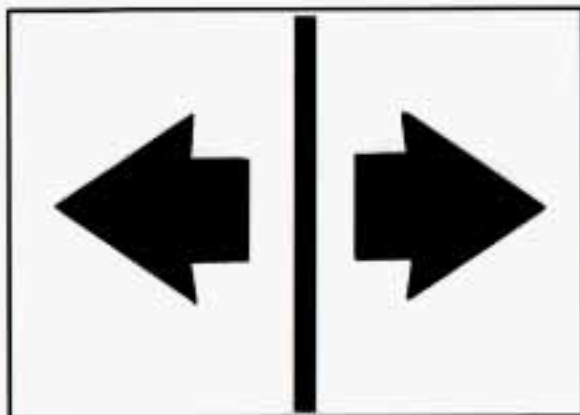

A green arrow on the instrument panel will flash in the direction of the turn or lane change.

To signal a lane change, just raise or lower the lever until the green arrow starts to flash. Hold it there until you complete your lane change. The lever will return by itself when you release it.

As you signal a turn or a lane change, if the arrows don't flash but just stay on, a signal bulb may be burned out and other drivers won't see your turn signal.

If a bulb is burned out, replace it to help avoid an accident. If the green arrows don't go on at all when you signal a turn, check the fuse (see "Fuses" in the Index) and for burned-out bulbs.

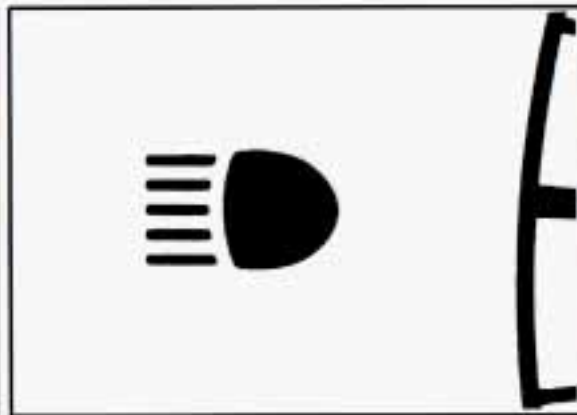

Headlight High/Low Beam

To change the headlights from low beam to high or high to low, pull the turn signal lever all the way toward you. Then release it. When the high beams are on, this blue light on the instrument panel also will be on.

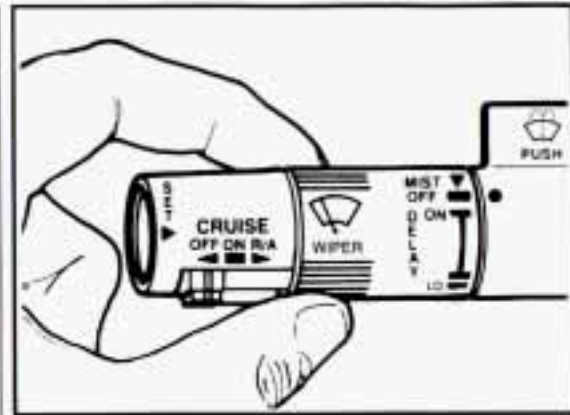

Windshield Wipers

You control the windshield wipers by turning the band with the wiper symbol on it.

For a single wiping cycle, turn the band to "MIST." Hold it there until the wipers start, then let go. The wipers will stop after one cycle. If you want more cycles, hold the band on "MIST" longer.

You can set the wiper speed for a long or short delay between wipes. This can be very useful in light rain or snow. Turn the band to choose the delay time. The closer to "LO," the shorter the delay.

For steady wiping at low speed, turn the band away from you to the "LO" position. For high speed wiping, turn the band further, to "HI." To stop the wipers, move the band to "OFF."

Heavy snow or ice can overload your wipers. A circuit breaker will stop them until the motor cools. Clear away snow or ice to prevent an overload.

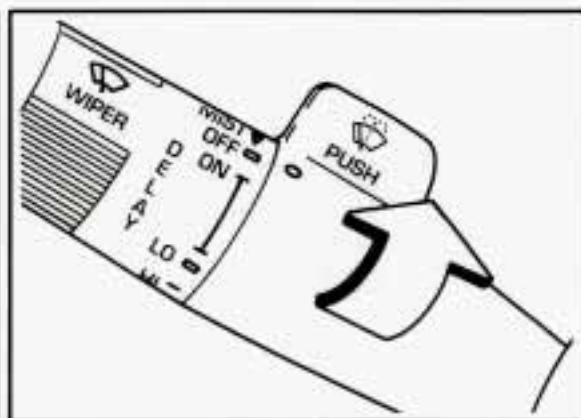

Windshield Washer

At the top of the turn signal lever there's a paddle with the word "PUSH" on it. To spray washer fluid on the windshield, just push the paddle. The washer will continue to spray until you release the paddle. The wipers will clear the window and wipe a few more times before stopping or returning to the previous setting.



CAUTION:

In freezing weather, don't use your washer until the windshield is warmed. Otherwise the washer fluid can form ice on the windshield, blocking your vision.

Features and Controls

NOTICE:

- When using concentrated washer fluid, follow the manufacturer's instructions for adding water.
- Don't mix water with ready-to-use washer fluid. Water can cause the solution to freeze and damage your washer fluid tank and other parts of the washer system. Also, water doesn't clean as well as washer fluid.
- Fill your washer fluid tank only 3/4 full when it's very cold. This allows for expansion, which could damage the tank if it is completely full.
- Don't use radiator antifreeze in your windshield washer. It can damage your washer system and paint.

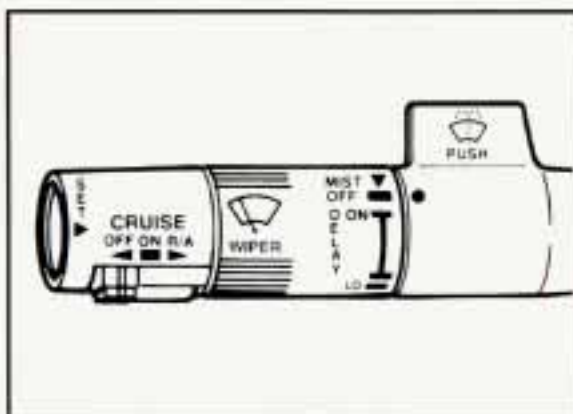

Cruise Control (OPTION)

With Cruise Control, you can maintain a speed of about 25 mph (40 km/h) or more without keeping your foot on the accelerator. This can really help on long trips. Cruise Control does not work at speeds below about 25 mph (40 km/h).

When you apply your brakes, or push the clutch pedal, if you have a manual transmission, the Cruise Control shuts off.



CAUTION:

- Cruise Control can be dangerous where you can't drive safely at a steady speed. So, don't use Cruise Control on winding roads or in heavy traffic.
- Cruise Control can be dangerous on slippery roads. On such roads, fast changes in tire traction can cause needless wheel spinning, and you could lose control. Don't use Cruise Control on slippery roads.

To Set Cruise Control

1. Move the Cruise Control switch to "ON."

CAUTION:

If you leave your Cruise Control switch on when you're not using Cruise, you might hit a button and go into Cruise when you don't want to. You could be startled and even lose control. Keep the Cruise Control switch "OFF" until you want to use it.

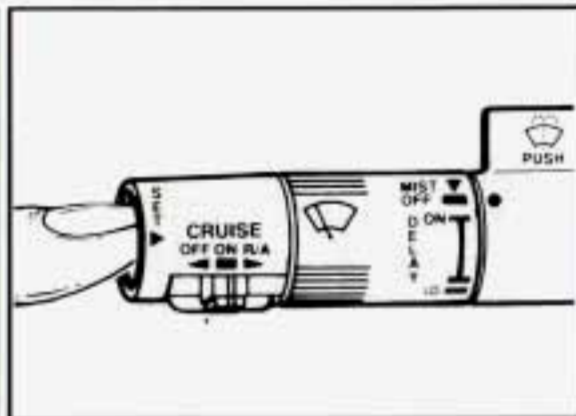

2. Get up to the speed you want.
3. Push in the set button at the end of the lever and release it.
4. Take your foot off the accelerator pedal.

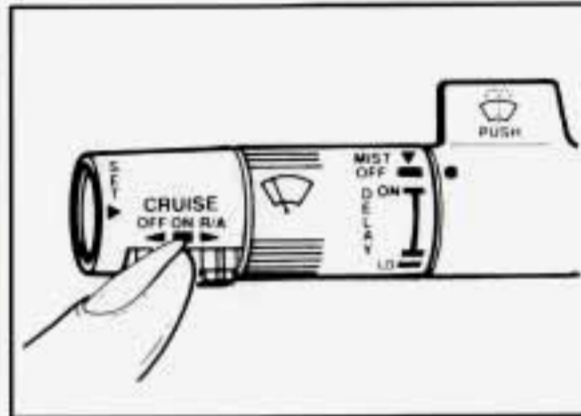

To Resume a Set Speed

Suppose you set your Cruise Control at a desired speed and then you apply the brake. This, of course, shuts off the Cruise Control. But you don't need to reset it. Once you're going about 25 mph (40 km/h) or more, you can move the Cruise Control switch from "ON" to "R/A" (Resume/Accelerate) for about half a second.

You'll go right back up to your chosen speed and stay there.

Features and Controls

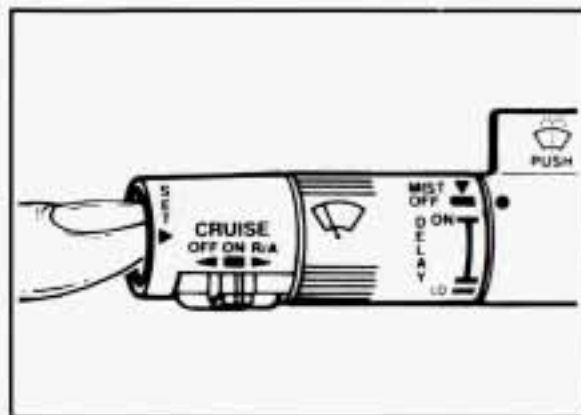

To Increase Speed While Using Cruise Control

There are two ways to go to a higher speed. Here's the first:

1. Use the accelerator pedal to get to the higher speed.
2. Push the button at the end of the lever, then release the button and the accelerator pedal. You'll now cruise at the higher speed.

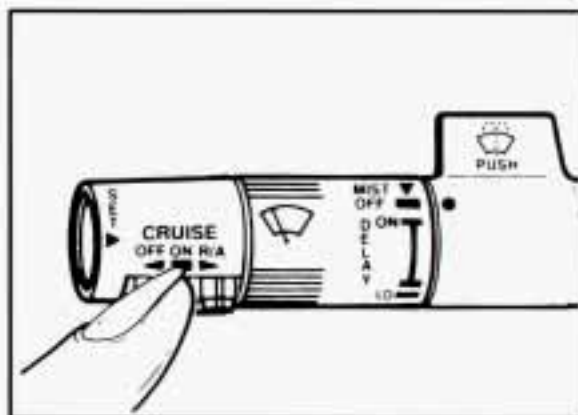

Here's the second way to go to a higher speed:

1. Move the Cruise switch from "ON" to "R/A." Hold it there until you get up to the speed you want, and then release the switch.
- To increase your speed in very small amounts, move the switch to "R/A" for less than half a second and then release it. Each time you do this, your vehicle will go about 1 mph (1.6 km/h) faster.

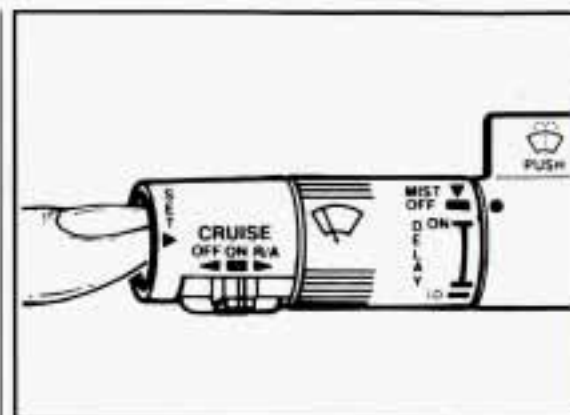

To Reduce Speed While Using Cruise Control

There are two ways to reduce your speed while using cruise control:

1. Push in the button at the end of the lever until you reach the lower speed you want, then release it.
2. To slow down in very small amounts, push the button for less than half a second. Each time you do this, you'll go 1 mph (1.6 km/h) slower.

Passing Another Vehicle While Using Cruise Control

Use the accelerator pedal to increase your speed. When you take your foot off the pedal, your vehicle will slow down to the Cruise Control speed you set earlier.

Using Cruise Control on Hills

How well your Cruise Control will work on hills depends upon your speed, load, and the steepness of the hills. When going up steep hills, you may have to step on the accelerator pedal to maintain your speed. When going downhill, you may have to brake or shift to a lower gear to keep your speed down. Of course, applying the brake takes you out of Cruise Control. Many drivers find this to be too much trouble and don't use Cruise Control on steep hills.



To Get Out of Cruise Control

There are several ways to turn off the Cruise Control:

1. Step lightly on the brake pedal or push the clutch pedal, if you have a manual transmission; OR

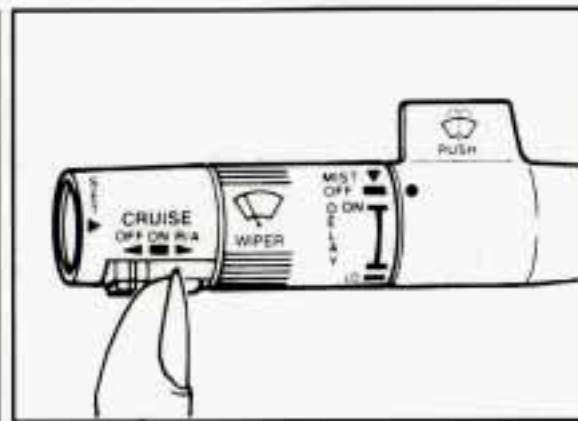

2. Move the Cruise switch to "OFF."

To Erase Speed Memory

When you turn off the Cruise Control or the ignition, your Cruise Control set speed memory is erased.

Traction Control System and Cruise Control

If your traction control system engages while your Cruise Control is set, Cruise Control will disengage. Your speed will be set in memory, though. When Cruise Control engages again, use "R/A" (Resume/Accelerate) to go back to your set speed.

Features and Controls

■ Operation of Lights

Although your vehicle's lighting system (headlights, parking lights, fog lamps, side marker lights and taillights) meets all applicable federal lighting requirements, certain states and provinces may apply their own lighting regulations that may require special attention before you operate these lights.

For example, some jurisdictions may require that you operate your fog lamps only when your lower beam headlights are also on, or that headlights be turned on whenever you must use your windshield wipers. In addition, most jurisdictions prohibit driving solely with parking lights, especially at dawn or dusk. It is recommended that you check with your own state or provincial highway authority for applicable lighting regulations.

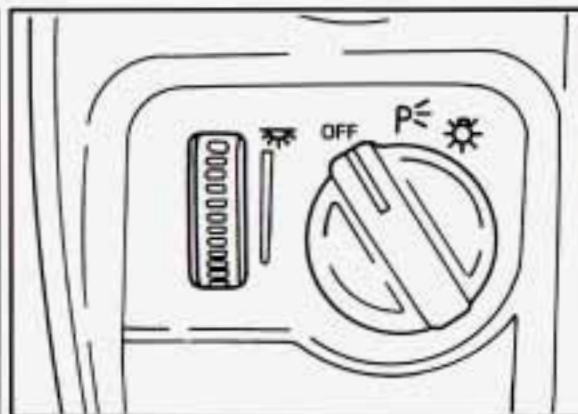

Main Light Control

The main light control is a knob that works these lights:

- Headlights
- Taillights
- Parking lights
- License lights
- Sidemarket lights
- Instrument panel lights

Turn the knob to  to turn on your headlights and other operating lights.

Turn the knob to  to turn on your parking lights without your headlights.

Turn the knob to "OFF" to turn off the lights.

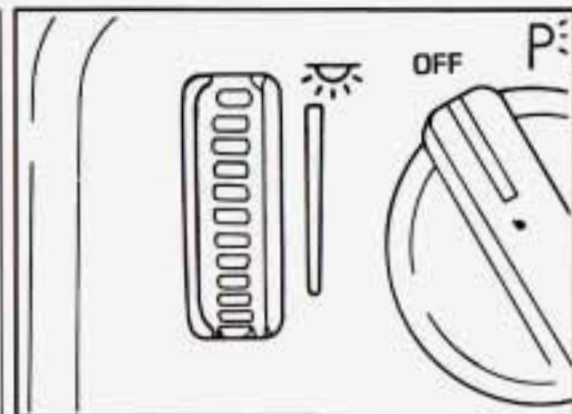

Brightness Control

This switch controls the brightness of your instrument panel lights. Turn the switch to brighten or dim the lights. If you turn the switch all the way up to , your courtesy lights will come on.

Lights On Reminder

If you turn the ignition "Off" and leave the lights on, you will hear a chime when you open the driver's door.

Headlight Doors

The headlight doors are designed to open when you turn the headlights on and close when you turn the headlights off. The headlight doors can be opened without

turning on the headlights by turning the headlights on, then turning the switch back to the parking lights position.

The headlight doors should be open when driving in icy or snowy conditions to prevent the doors from freezing when closed and when washing the vehicle to help clean the headlights.

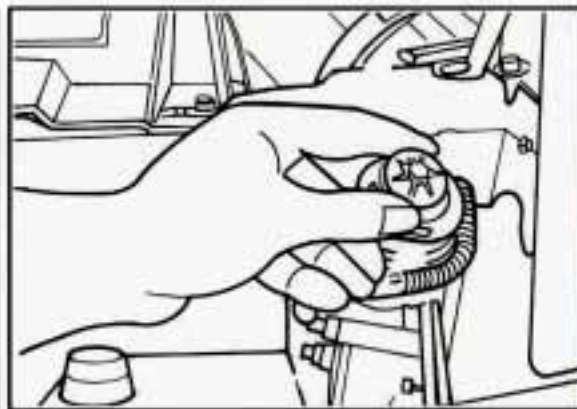

You can open the headlight doors manually:

1. Turn on the headlights.
2. Open the hood.
3. Remove the plastic cover from the retractor motor knob.
4. Turn the retractor motor knob counterclockwise until the headlight door is fully open. The knob will get harder to turn when the headlight door is all the way up.
5. Replace the plastic cover on the retractor motor knob.

To manually close the headlight doors, turn the lights off and turn the knob clockwise. If the headlight doors aren't

working properly, see your Pontiac dealer for help.

Daytime Running Lights (Canada)

The Canadian Federal Government has decided that "Daytime Running Lights" (DRL) are a useful feature, in that DRL can make your vehicle more visible to pedestrians and other drivers during daylight hours. DRL are required on new vehicles sold in Canada.

Your DRL work with a light sensor on top of the instrument panel. Don't cover it up.

The front turn signal lights will come on in daylight when:

- The ignition is on
- The headlight switch is off, and
- The parking brake is released.

At dusk, the exterior lights will come on automatically and the front turn signal lights will go out. At dawn, the exterior lights will go out and the front turn signal lights will come on (if the headlight switch is off).

Of course, you may still turn on the headlights any time you need to.

Features and Controls

To idle your vehicle with the DRL off, set the parking brake while the ignition is in the "Off" or "LOCK" position. Then start the vehicle. The DRL will stay off until you release the parking brake.

Fog Lights (Option)

Use your fog lights for better vision in foggy or misty conditions. Your parking lights must be on or your fog lights won't work.

To turn the fog lights on, push the right side of the switch. Push  to turn the fog lights off. A light on the switch will come on when the fog lights are on.

Fog lights will go off whenever your high beams come on. When the high beams go off, the fog lights will come on again.



■ Interior Lights

Courtesy Lights

When any door is opened, several interior lights go on. These lights are courtesy lights. They make it easier for you to enter and leave your vehicle.

Courtesy lights include the dome light and other lights throughout the interior of your vehicle.

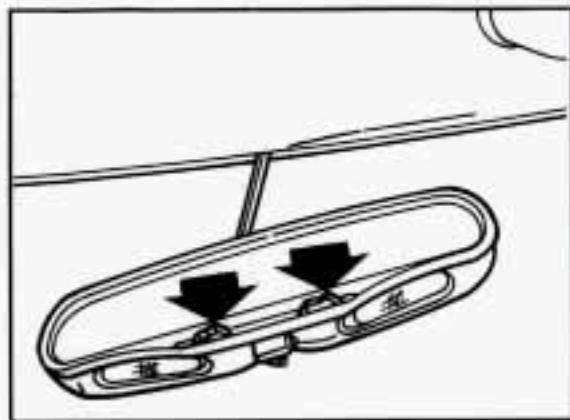

Front Map Lights

Your inside rearview mirror includes two map lights. Each light has its own switch. Use the switch closest to the light to turn it on. The lights will also go on when a door is opened.

■ Floor Mats

Your Firebird's floor mats are custom-fitted to the foot wells. Be sure the driver's floor mat is in place. If it isn't, it could interfere with the accelerator or brake pedals.

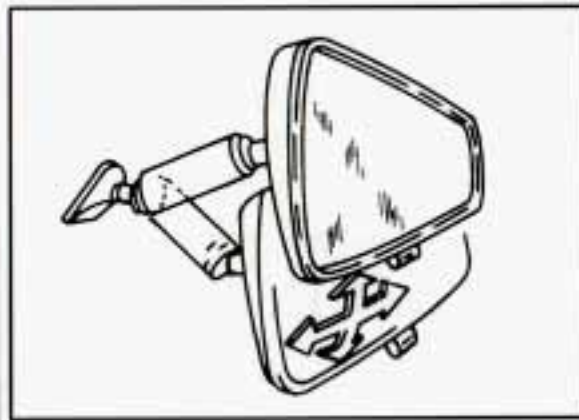

■ Mirrors

Inside Day/Night Rearview Mirror

An inside rearview mirror is attached to your windshield. The mirror has pivots so that you can adjust it up and down or side to side.

You can adjust the mirror for day or night driving. Pull the tab for night driving to reduce glare. Push the tab for daytime driving.

Manual Adjust Mirror

Adjust the passenger side outside mirror by hand so that you can just see the side of your vehicle when you are sitting in a comfortable driving position.

Convex Outside Mirror

Your right side mirror is convex.

A convex mirror's surface is curved so you can see more from the driver's seat.



CAUTION:

If you aren't used to a convex mirror, you can hit another vehicle. A convex mirror can make things (like other vehicles) look farther away than they really are. If you cut too sharply into the right lane, you could hit a vehicle on your right. Check your inside mirror or glance over your shoulder before changing lanes.

Manual Remote Control Mirror

Adjust the driver side outside mirror with the lever on the door. Adjust the mirror so that you can just see the side of your vehicle when you are sitting in a comfortable driving position.

Features and Controls

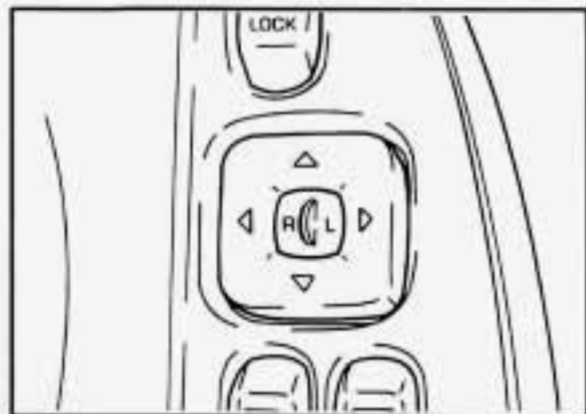

Electric Mirror Control (Option)

The electric mirror control is on the driver's door. To adjust either mirror, move the center switch to "LEFT" or "RIGHT." Then use the touch pad to adjust the mirror.

The control only works when the ignition switch is in "Run" or "Acc," or when RAP is present. (See "Retained Accessory Power" in the Index.)

■ *Twin Lift-Off Roof Panels (OPTION)*

If you have this option, you can remove one or both lift-off roof panels.

CAUTION:

Don't try to remove the T-top panels while the vehicle is moving. Trying to remove a T-top panel while the vehicle is moving could cause an accident. The panel could fall into the vehicle and cause you to lose control, or it could fly off and strike another vehicle. You or others could be injured. Remove a T-top panel only when the vehicle is parked.

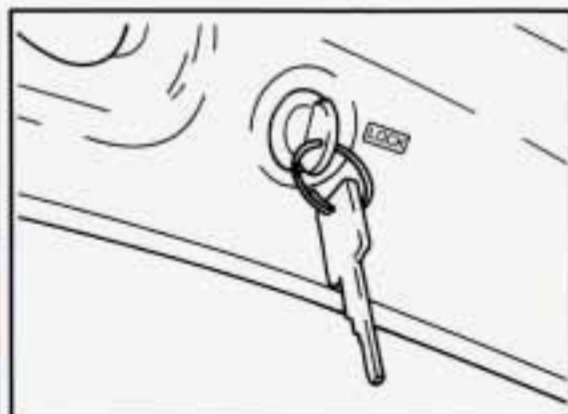

The door key unlocks the panels. The lock is over the front door window. Turn the key to the left to unlock the panel.

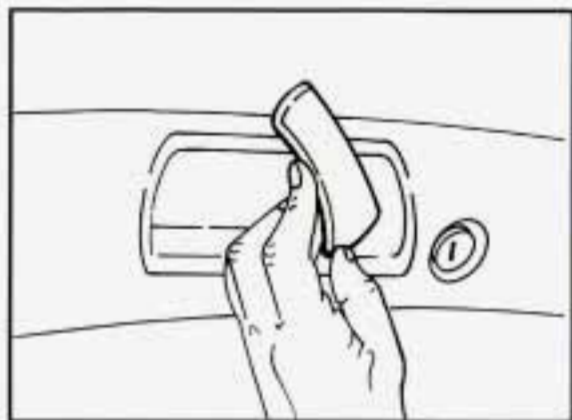

Then push on the release handle to unlatch the panel. Lift the outer edge of the panel and pull it toward you.

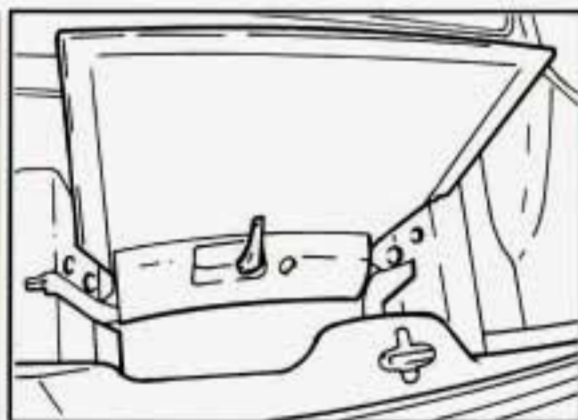

Open the close-out panel completely. Place the panel in the correct slot ("DRIVER" or "PASSENGER") in the rear area of your vehicle. Make sure the handle is open and facing you when you put it in the storage slot.

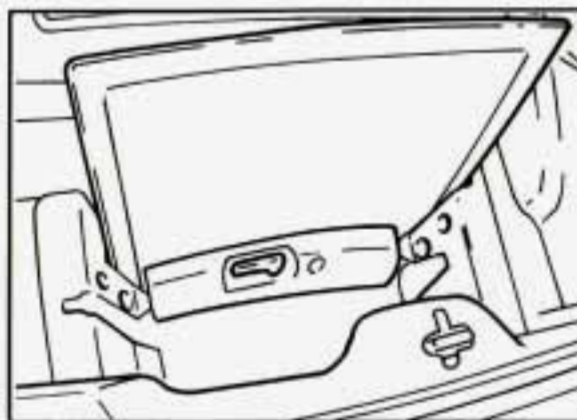

Push the handle closed to secure the panel in the slot. To lock each panel in the storage area, use your door key.

⚠ CAUTION:

If a T-top panel is not stored properly, it could be thrown about the vehicle in a crash or sudden maneuver. People in the vehicle could be injured. Whenever you store a T-top panel in the vehicle, always be sure that it is stored securely in the correct storage slot with the T-top handle closed.

⚠ CAUTION:

An improperly installed T-top panel may fall into or fly off the vehicle. You or others could be injured. After installing a T-top panel, always check that it is firmly attached by pushing up on the underside of the panel.

Features and Controls

Reverse the steps above to install the T-top panels.

When installing panels, be sure to align weatherstrips properly. Panels incorrectly installed may leak.

NOTICE:

High pressure car washes may cause water to enter your vehicle. Never spray water directly at the roof panel joints. This will cause leaks.

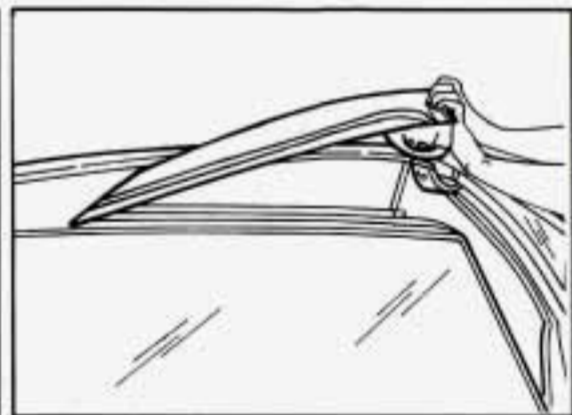
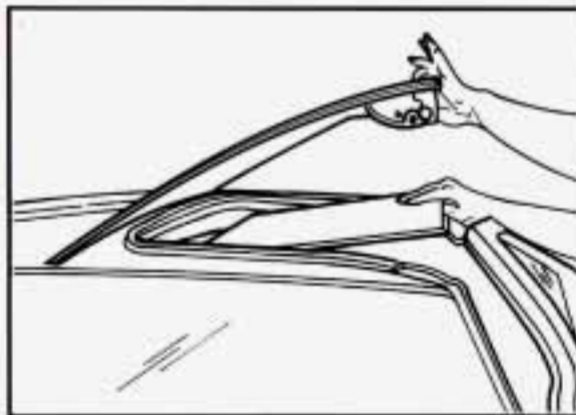

T-Top Sunshades

1. Start with the panel marked "DRIVER FRONT." Unlatch the driver-side T-top, raise it halfway and close the latch handle.
2. With the top raised and resting on the center roof rail, slide the flat edge of the sunshade panel (with the vinyl side to the glass) between the glass and plastic trim, making sure the edge marked "DRIVER FRONT" is pointing to the front of the vehicle.
3. Open the latch and close the T-top. Check to see if there are any gaps showing. Unlatch the T-top and adjust the sunshade as required.
4. Once the sunshade is installed properly, you can stick the velcro® buttons on the glass for a proper fit every time you install the sunshades. To do this, first remove the T-top with the sunshade installed and place it upside down on a table or bench. Take care not to scratch the glass.

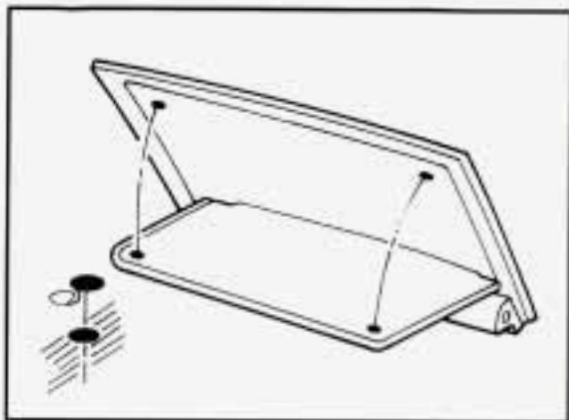

5. Pull the sunshade back a little and remove the backing paper from the velcro® buttons. Push the sunshade back into place sticking the velcro® to the glass.
6. Install the T-top, close the latch and lock the T-top. Repeat the above steps for the passenger-side sunshade.



You can store the sunshades two different ways:

1. When the T-tops are in use, store the sunshades in their storage area in the rear of the vehicle, and make sure the close-out panel is in its closed, upright position.
2. When you have the T-tops off and in their storage slots, store the sunshades on the T-tops, in their installed position.

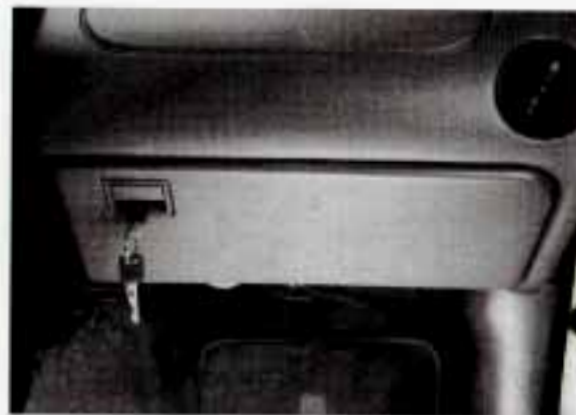

■ *Storage and Compartments*

Glove Box

To open the glove box, lift up on the lever. Use your door key to lock and unlock it. The glove box has a light inside.

Features and Controls



Map Pocket

Each door has a map pocket. There may also be a map pocket on the back of the seats.

Front Console

To use the storage area, push the tabs and pull up on the front end of the console. There is a cupholder and light and may be a coinholder in the console.

The console will also have a storage area for either cassette tapes or compact discs.

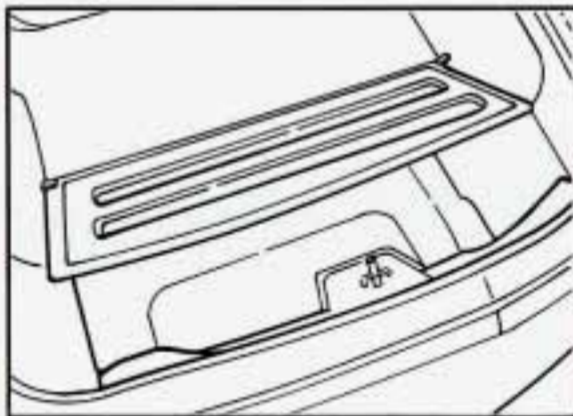

Close-Out Panel

The close-out panel can be closed for hidden storage in the rear area of your vehicle.

To remove the close-out panel:

1. Close the panel. If the close-out panel is not closed and resting on the trim panel, it cannot be removed.
2. Pull the panel toward you to unsnap it. Then slide the close-out panel along the groove in the trim panel.

Reverse the steps to install the panel.



When carrying large or heavy items, it is a good idea to open the panel and place the items in the rear area.



CAUTION:

An improperly stored close-out panel could be thrown about the vehicle during a collision or sudden maneuver. You or others could be injured. If you remove the cover, don't store it in your vehicle. When you put it back, always be sure that it is securely attached with both sides snapped in place.

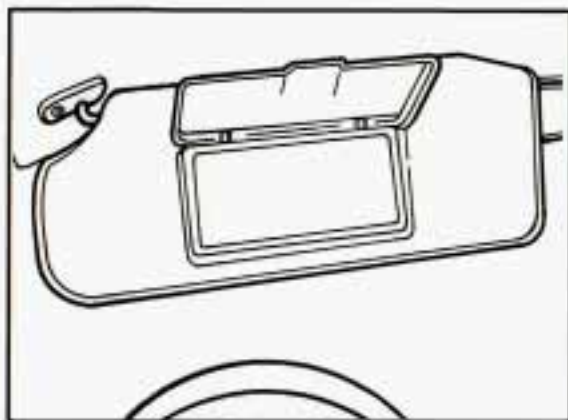

■ *Sun Visors*

To block out glare, you can swing down the visors. You can also swing them to the side. The elastic bands on your visor provide extra storage for maps or papers.

Covered Visor Vanity Mirror

Pull down the sun visor and lift the cover to expose the vanity mirror.

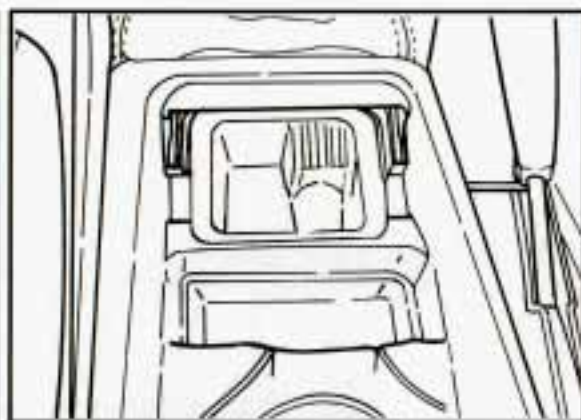

■ *Ashtray and Lighter*

Front Ashtray

Lift up the cover to open the ashtray. To remove it, lift up on either side of the ashtray. If you have an automatic transmission, the ashtray is near the front of your console. If you have a manual transmission, the ashtray is near your cupholder.

NOTICE:

Don't put papers and other things that burn into your ashtray. If you do, cigarettes or other smoking materials could set them on fire, causing damage.

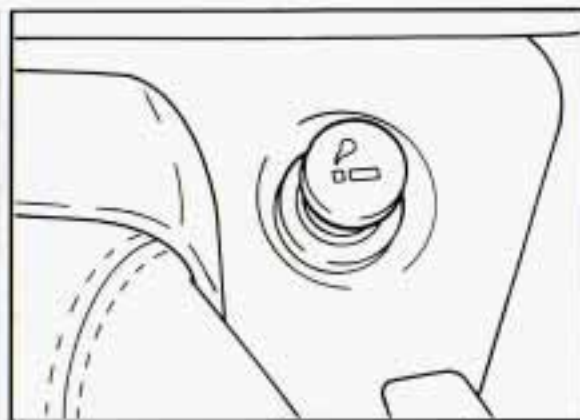

Cigarette Lighter

To use the lighter, push it in all the way and let go. When it's ready, it will pop back by itself.

NOTICE:

Don't hold a cigarette lighter in with your hand while it is heating. If you do, it won't be able to back away from the heating element when it's ready. That can make it overheat, damaging the lighter and the heating element.

If you plug accessories into your cigarette lighter, such as heating devices or air compressors, these accessories should have a rated current of less than 15 amps. Exceeding this limit will result in a blown fuse.

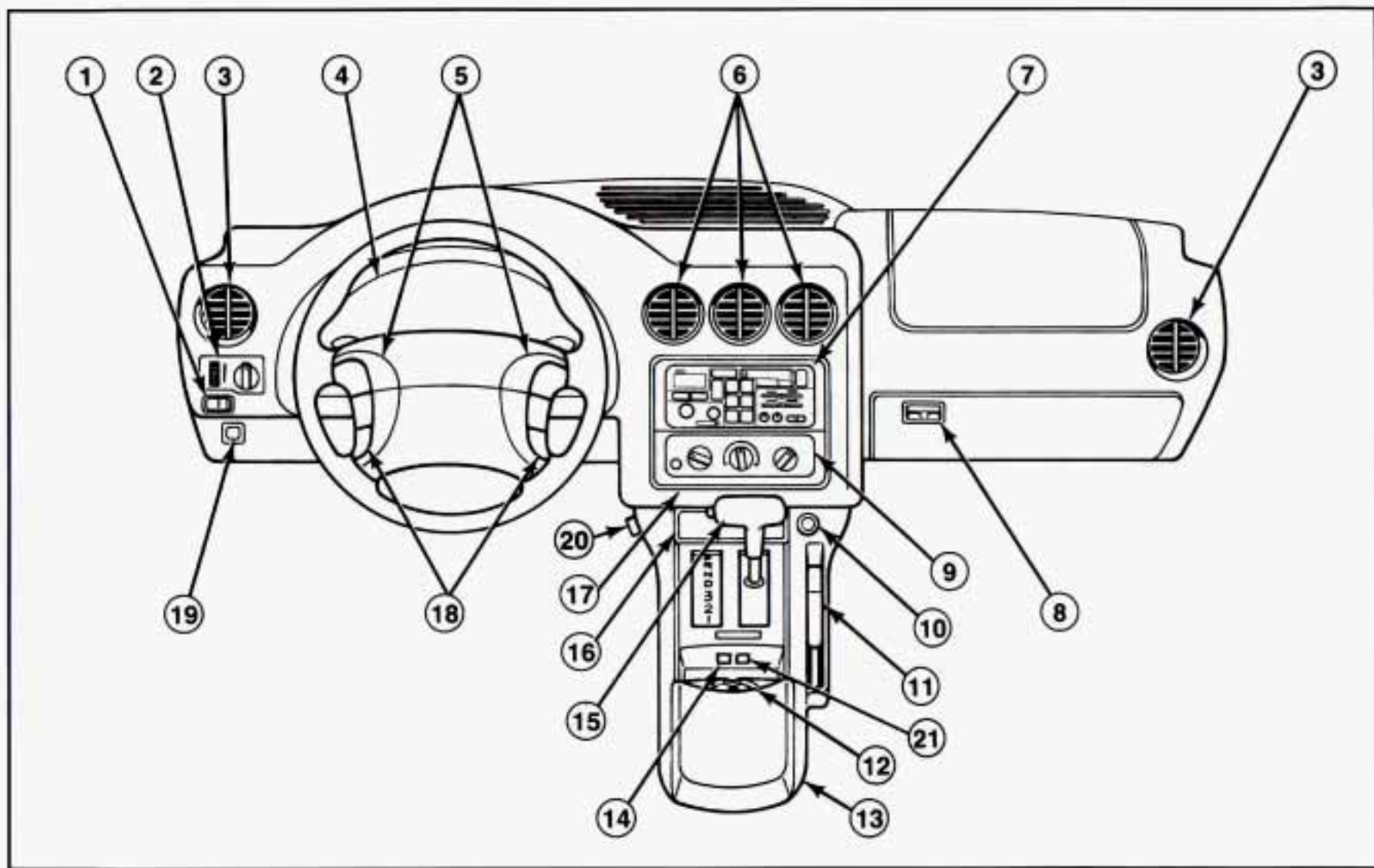

Instrument Panel

- 1.** Fog Lamp Switch (if equipped)
- 2.** Main Light Control
- 3.** Side Upper Air Vent
- 4.** Instrument Cluster
- 5.** Horn
- 6.** Center Upper Air Vent
- 7.** Audio System
- 8.** Glove Box

- 9.** Comfort Controls
- 10.** Cigarette Lighter
- 11.** Parking Brake Lever
- 12.** Cupholder
- 13.** Storage Console and Cassette Tape/
Compact Disc Storage (as equipped)
- 14.** Transmission Mode Switch
(Automatic Transmission)
- 15.** Shift Lever
- 16.** Ashtray (Automatic Transmission)

- 17.** Rear Window Defogger Switch
- 18.** Steering Wheel Controls
- 19.** Remote Hatch Release
- 20.** Convertible Top Switch
(if equipped)
- 21.** Traction Control Switch
(if equipped)
- 22.** Ashtray (Manual Transmission)

Features and Controls

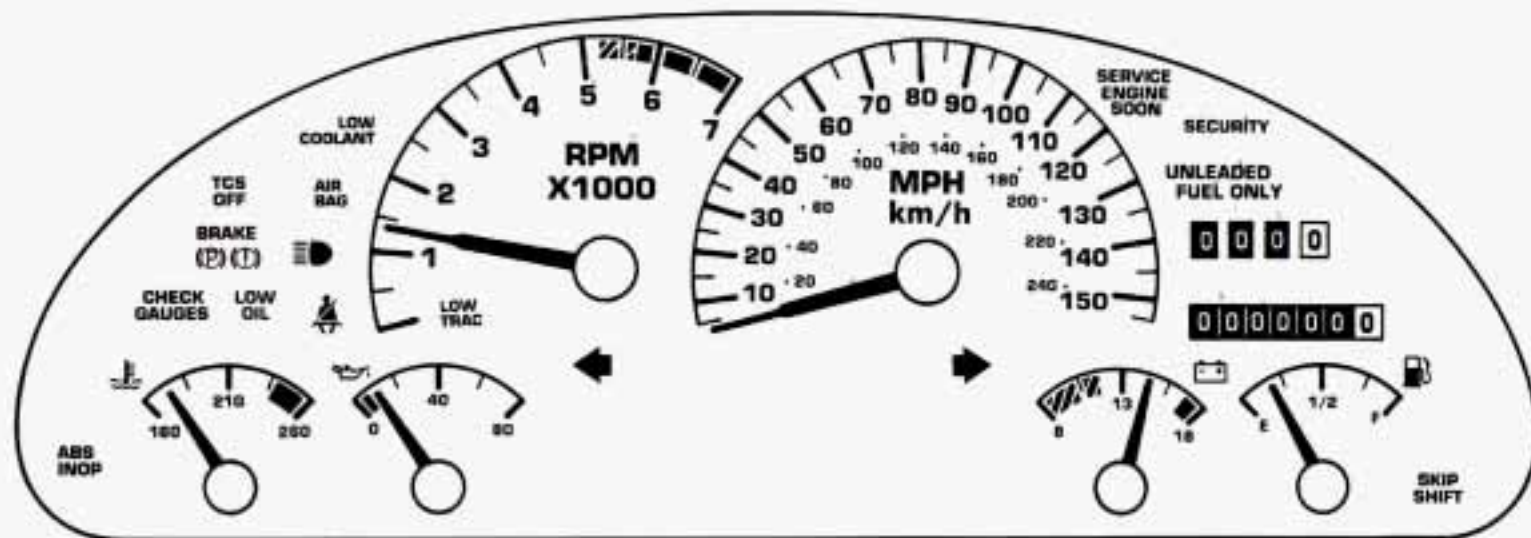

U.S. shown, Canada similar

■ *Instrument Panel and Cluster*

Your instrument cluster is designed to let you know at a glance how your vehicle is running. You'll know how fast you're going, about how much fuel you have left and many other things you'll need to know to drive safely and economically.

Speedometer and Odometer

Your speedometer lets you see your speed in both miles per hour (mph) and kilometers per hour (km/h). Your odometer shows how far your vehicle has been driven, in either miles (used in the U.S.) or kilometers (used in Canada).

Your Pontiac's odometer is tamper-resistant. If you can see silver lines between the numbers, probably someone has tried to turn it back. The numbers may not be true.

You may wonder what happens if your Pontiac needs a new odometer installed. If possible, the new one has to be set to the same reading the old one had. If it can't be, then it's set at zero, but a label on the driver's door must show the old reading and when the new one was installed.

Trip Odometer

The trip odometer can tell you how far your vehicle has been driven since you last set the trip odometer to zero.

To set the trip odometer to zero, press the knob.

Tachometer

The tachometer displays the engine speed in thousands of revolutions per minute (rpm).

NOTICE:

Do not operate the engine with the tachometer in the red area, or engine damage may occur.

■ ***Warning Lights, Gages and Indicators***

This section describes the warning lights and gages that may be on your vehicle. The pictures will help you locate them.

Warning lights and gages can signal that something is wrong before it becomes serious enough to cause an expensive repair or replacement. Paying attention to your warning lights and gages could also save you or others from injury.

Warning lights go on when there may be or is a problem with one of your vehicle's functions. As you will see in the details on the next few pages, some warning lights come on briefly when you turn the ignition key just to let you know they're working. If you are familiar with this section, you should not be alarmed when this happens.

Gages can indicate when there may be or is a problem with one of your vehicle's functions. Often gages and warning lights work together to let you know when there's a problem with your vehicle.

When one of the warning lights comes on and stays on when you are driving, or when one of the gages shows there may be a problem, check the section that tells you what to do about it. Please follow the manual's advice. Waiting to do repairs can be costly — and even dangerous. So please get to know your warning lights and gages. They're a big help.

Features and Controls

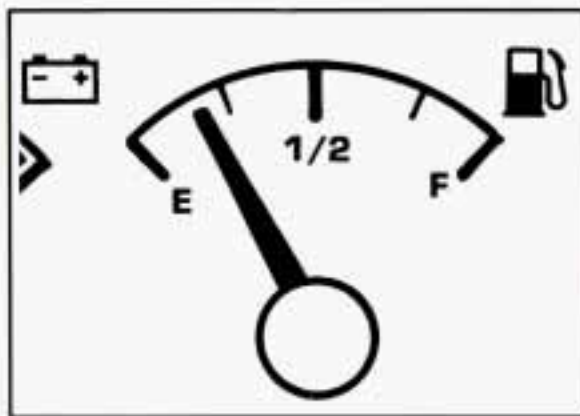

Fuel Gage

Your fuel gage shows about how much fuel is in your tank. The fuel gage works only when the ignition switch is in the "Run" position. When the gage pointer first indicates "E," you still have a little fuel left (about one to two gallons), but you need to get more right away.

Here are four concerns some owners have had about the fuel gage. All these situations are normal and do not indicate that anything is wrong with the fuel gage.

- At the gas station, the gas pump shuts off before the gage reads "F."
- It takes more (or less) gas to fill up than the gage reads. For example, the gage reads 1/2 full, but it took more (or less) than half of the tank's capacity to fill it.
- The gage moves a little when you turn, stop or speed up.
- When you turn the engine off, the gage doesn't go back to "E."



Brake System Warning Light

Your Pontiac's hydraulic brake system is divided into two parts. If one part isn't working, the other part can still work and stop you. For good braking, though, you need both parts working well.

If the warning light comes on, there could be a brake problem. Have your brake system inspected right away.

This light should come on as you start the vehicle. If it doesn't come on then, have it fixed so it will be ready to warn you if there's a problem.

If the light comes on while you are driving, pull off the road and stop carefully. You may notice that the pedal is harder to push. Or, the pedal may go closer to the floor. It may take longer to stop. If the light is still on, or if the anti-lock brake system warning light is flashing, have the vehicle towed for service. (See "Anti-Lock Brake System Warning Light" and "Towing Your Vehicle" in the Index.)

The brake system warning light will also come on when you set your parking brake, and it will stay on if your parking brake doesn't release fully. If it stays on after your parking brake is fully released, it means you have a brake problem.



CAUTION:

Your brake system may not be working properly if the brake system warning light is on. Driving with the brake system warning light on can lead to an accident. If the light is still on or if the anti-lock brake system warning light is flashing after you've pulled off the road and stopped carefully, have the vehicle towed for service.

Anti-Lock Brake System Warning Light

With anti-lock, this light will come on when you start your engine and it will stay on for three seconds. That's normal. If the light doesn't come on, have it fixed so it will be ready to warn you if there is a problem.

If the light flashes when you're driving, you don't have anti-lock brakes and there's a problem with your regular brakes. Pull off the road and stop carefully. You may notice that the pedal is harder to push. Or, the pedal may go closer to the floor. It may take longer to stop. Have the vehicle towed for service. (See "Towing Your Vehicle" in the Index.)

Features and Controls



CAUTION:

Your regular brake system may not be working properly if the anti-lock brake system warning light is flashing. Driving with the anti-lock brake system warning light flashing can lead to an accident. After you've pulled off the road and stopped carefully, have the vehicle towed for service.



**ABS
INOP**

If the anti-lock brake system warning light stays on longer than normal after you've started your engine, turn the ignition off. Or, if the light comes on and stays on when you're driving, stop as soon as possible and turn the ignition off. Then start the engine again to reset the system. If the light still stays on, or comes on again while you're driving, your Pontiac needs service. If the light is on but not flashing and the regular brake system warning light isn't on, you still have brakes, but you don't have anti-lock brakes.



**TCS
OFF**

Traction Control System Warning Light (Option)

When the traction control system is off, the "TCS OFF" light will come on. This light will also come on for three seconds each time you start your vehicle as a bulb check and if there's a system failure. See "Traction Control System" in the Index.

The traction control system will shut down partially due to brake overheating but the "TCS OFF" light will not come on. If there is throttle relaxer overheating, the "TCS OFF" light will illuminate and the system will shut down. Once everything cools off, the system will operate normally again.

When this warning light is on, the system will not limit wheel spin. Adjust your driving accordingly.

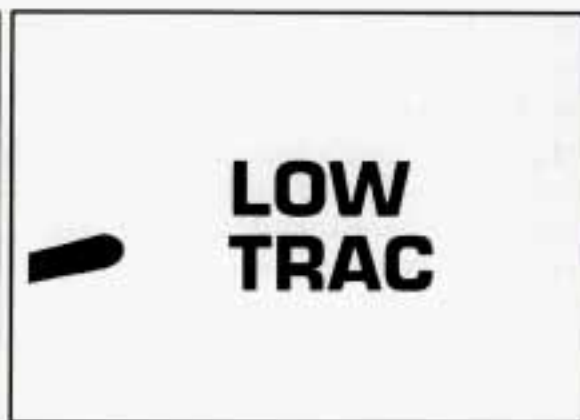

Low Traction Light

When your anti-lock system is adjusting brake pressure to help avoid a braking skid, the "LOW TRAC" light will appear on your instrument cluster. If you have the traction control system, this light will also come on when the system is limiting wheel spin. Slippery road conditions may exist if this light comes on, so adjust your driving accordingly. The light will stay on for a few seconds after the anti-lock system stops adjusting brake pressure or the traction control system stops limiting wheel spin. The "LOW TRAC" light also comes on briefly, as a bulb check, when the engine is started.

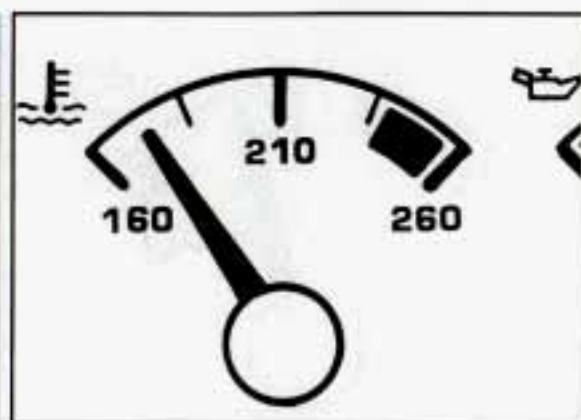

Engine Coolant Temperature Gage

This gage shows the engine coolant temperature. If the gage pointer moves into the red area, your engine is too hot! It means that your engine coolant has overheated. If you have been operating your vehicle under normal driving conditions, you should pull off the road, stop your vehicle and turn off the engine as soon as possible.

HOT COOLANT CAN BURN YOU BADLY!

In "Problems on the Road," this manual shows what to do. See "Engine Overheating" in the Index.

Features and Controls

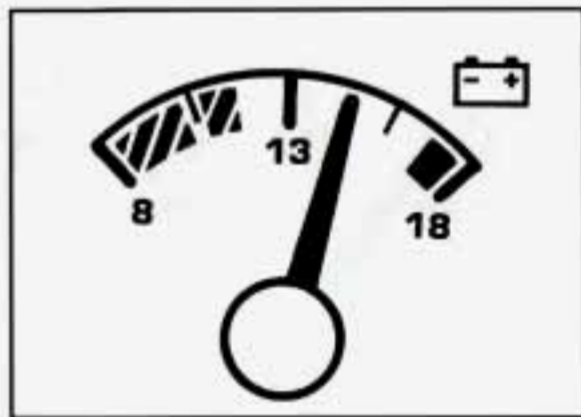

Voltmeter

You can read battery voltage on your voltmeter. If it reads less than 11 volts or more than 16 volts while your engine is running, and it stays there, you may have a problem with the electrical charging system. Have it checked right away. Driving with the voltmeter reading in a warning zone could drain your battery.

If you idle your engine for a while, the voltmeter reading might move into the yellow zone. If the reading stays in the yellow zone while you are driving, you may have a problem with the electrical charging system. Have it checked. While the voltmeter reads in the yellow zone, your battery may not be able to power certain electrical accessories, like ABS.

(If this happens, your "ABS INOP" light will come on. See "Anti-Lock Brake System Warning Light" in this part.)

If you must drive a short distance with the voltmeter reading in a warning zone, turn off all your accessories, including your comfort control and audio systems.



Malfunction Indicator Lamp (Service Engine Soon Light)

A computer monitors operation of your fuel, ignition and emission control systems. This light should come on when the ignition is on, but the engine is not running, as a check to show you it is working. If it does not come on at all, have it fixed right away. If it stays on, or it comes on while you are driving, the computer is indicating that you have a problem. You should take your vehicle in for service soon.

NOTICE:

If you keep driving your vehicle with this light on, after a while the emission controls won't work as well, your fuel economy won't be as good and your engine may not run as smoothly. This could lead to costly repairs not covered by your warranty.

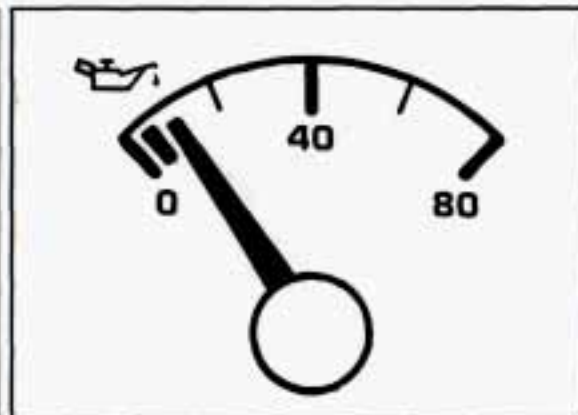

Engine Oil Pressure Gage

This gage tells you if there could be a problem with your engine oil pressure.

The engine oil pressure gage shows the engine oil pressure in psi (pounds per square inch) in the U.S., or kPa (kilopascals) in Canada, when the engine is running. Oil pressure should be 20 to 80 psi (140 to 550 kPa). It may vary with engine speed, outside temperature and oil viscosity, but readings above the red area show the normal operating range. Readings in the red area tell you that the engine is low on oil, or that you might have some other oil problem. See "Engine Oil" in the Index.



CAUTION:

Don't keep driving if the oil pressure is low. If you do, your engine can become so hot that it catches fire. You or others could be burned. Check your oil as soon as possible and have your vehicle serviced.

NOTICE:

Damage to your engine from neglected oil problems can be costly and is not covered by your warranty.

Features and Controls

CHECK GAUGES

Check Gages Light

This light will come on briefly when you are starting the engine. If the light comes on and stays on while you are driving, check your gages to see if they are in the warning areas.

LOW OIL

Low Oil Light

Your vehicle is equipped with an oil level monitoring system. When you start your engine, the light will come on briefly. If the light doesn't come on, have it repaired. If the light stays on after starting your engine, your engine oil level may be too low. You may need to add oil. See "Engine Oil" in the Index.

NOTICE:

The oil level monitoring system only checks the oil level when you are starting your engine. It does not keep monitoring the level once your engine is running. Also, the oil level check only works when the engine has been turned off long enough for the oil to drain back into the oil pan.

LOW COOLANT

Low Coolant Light (V8 Engine)

This light should come on while you are starting your engine. If the light doesn't come on, have it repaired. The light also comes on when the coolant in your radiator is low. You may need to add coolant. See "Engine Coolant" in the Index.

NOTICE:

Driving with the "LOW COOLANT" light on could cause your Pontiac to overheat. See "Engine Overheating" in the Index. Your Pontiac could be damaged, and it wouldn't be covered by your warranty.



■ *Convertible Top*

The following procedures explain the proper operation of your convertible top.

To Lower Your Convertible Top

NOTICE:

Don't leave your convertible out with the top down for any long periods of time. The sun and the rain can damage your seat material and other things inside your vehicle.

Features and Controls

1. Park on a level surface. Set the parking brake firmly, shift an automatic transmission into "P" (Park) or a manual transmission into "R" (Reverse). The ignition must be in the "Acc" or "Run" position. Lower both sun visors.

NOTICE:

Don't lower the top if it is damp or wet. When the top is down, trapped water can cause stains, mildew and damage to the inside of your vehicle. Be sure to dry off the top before you lower it.

NOTICE:

It is not recommended to lower the top if your vehicle is out in cold weather, 0°F (-18°C) or lower.

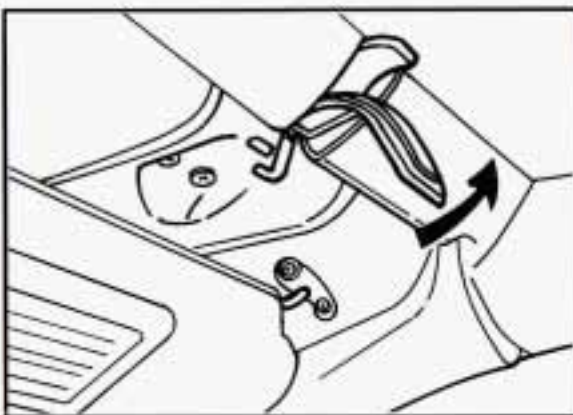

NOTICE:

Before lowering the convertible top into the storage area, be sure there are no objects in the way of the folded, stored top. The weight of a stored top on items in the storage area will cause the convertible top back glass to break.

2. Unlock the front of the convertible top by pushing on the smaller part of the latch, then pulling down on the larger part of the latch. Be sure the hook on the latch that attaches into the hole at the windshield releases.

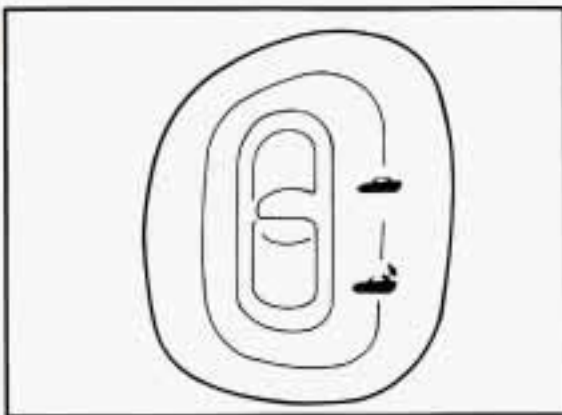

3. Be sure no one or nothing is on or around the top. Push and hold the bottom of the convertible top switch. The switch is on the left side of your console. The top will automatically lower into the storage area.

Installing the Boot Cover

After lowering the convertible top, you may want to install the boot cover. The three-piece boot cover is stored in a bag in the trunk.

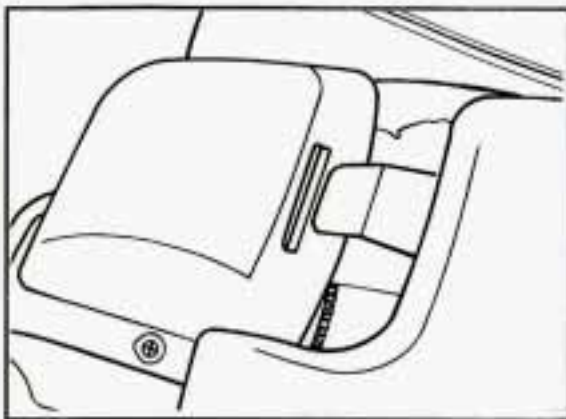

1. Open the trunk and remove the two side covers from the storage bag.
2. Install the two side covers by engaging the tab into the front seatbelt cover. Lower the covers onto vehicle.

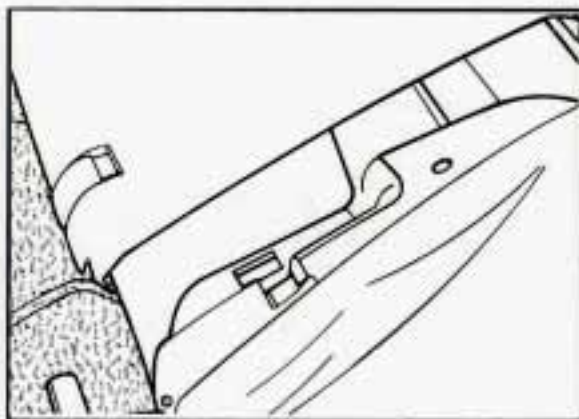

3. Install middle section of cover by sliding tabs into slots on right side cover. Lower cover and engage latch.
4. Close the trunk.

To Raise Your Convertible Top

1. Park on a level surface. Set the parking brake firmly. If you have an automatic transmission, shift into "P" (Park). If you have a manual transmission, shift into "R" (Reverse). The ignition must be in the "ACC" or "Run" position. Lower both sun visors. Lower both windows at least three inches. If the boot cover is in place, it must be removed first.

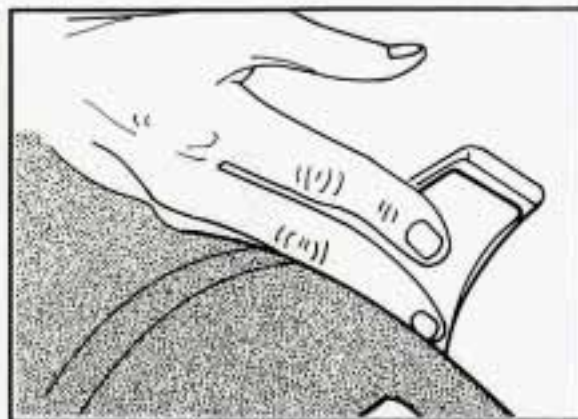

2. Open the trunk. Remove the middle piece of the cover by pushing in on the latch and lifting up on the cover.

Features and Controls

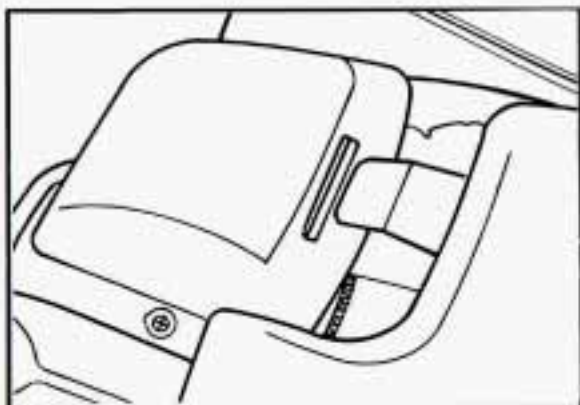

- 3.** Remove the two side pieces of the boot cover by lifting rear cover and sliding them out of their slots.

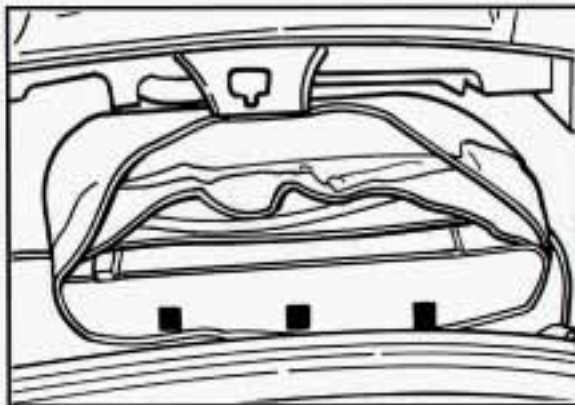

- 4.** Store each piece of the cover in its separate compartment in the storage bag. Store in the trunk and close the trunk.

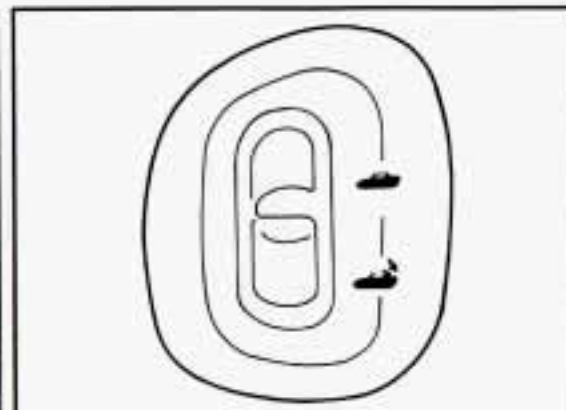

- 5.** Push and hold the top of the convertible top switch.

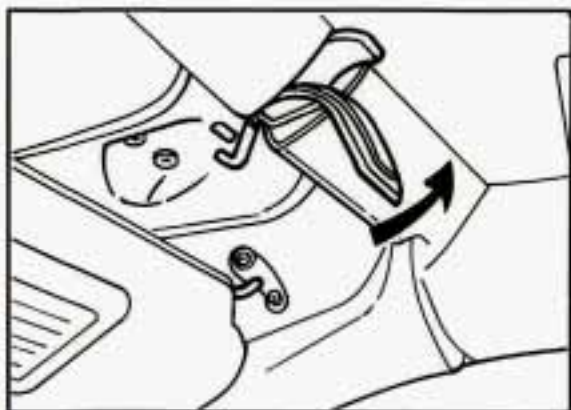

- 6.** Pull down on the latches and align hooks with holes. Push forward on the larger part of the latch until it clicks. Do not force the latch. If it is hard to lock, the top is not properly aligned.

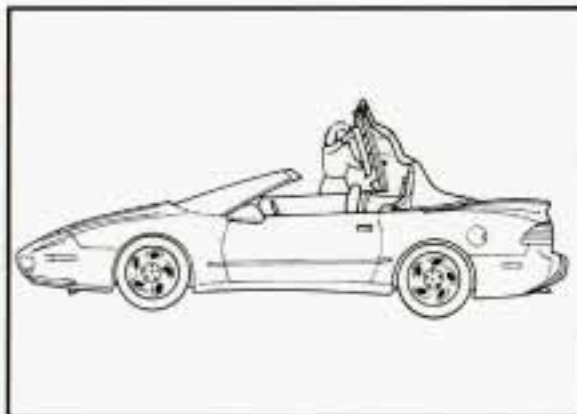

If your vehicle suffers a power loss, such as a dead battery, you can still raise or lower the top manually by rotating the valve in the left side of the trunk.

Open the trunk and find the tab along the left side trim panel. Lift up the tab and turn the valve clockwise to release the hydraulic pressure. Turn the ignition key to the "LOCK" position. You can now raise or lower your top manually. Be sure to close the valve after installing your top so you can raise or lower it electronically later.

Notes

Part 3

Comfort Controls & Audio Systems

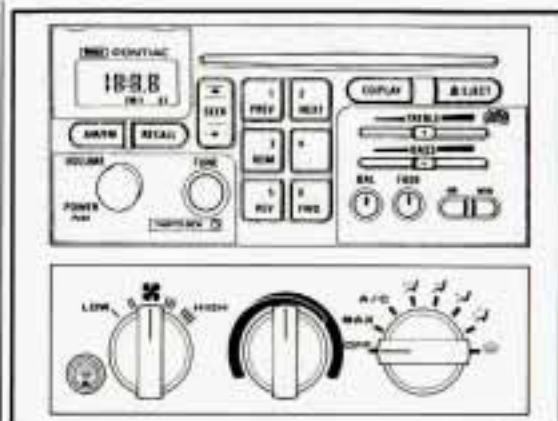

In this part you'll find out how to operate the comfort control systems and audio systems offered with your Pontiac. Be sure to read about the particular system supplied with your vehicle.

Comfort Controls	104
Heater Controls	104
Heating	104
Bi-Level Heating	105
Ventilation	105
Defogging and Defrosting Windows	105
Air Conditioner Controls	106
Cooling	106
Rear Window Defogger	107
Flow-Through Ventilation System	107
Audio Systems	108
Setting the Clock	109
AM/FM Stereo with Cassette Tape Player	109
AM/FM Stereo with Cassette Tape Player and Graphic Equalizer	112
AM/FM Stereo with Compact Disc Player	115
AM/FM Stereo with Compact Disc Player and Graphic Equalizer	118
Understanding Radio Reception	121
Care of Your Cassette Tape Player	122
Care of Your Compact Discs	123
Fixed Mast Antenna	123

Comfort Controls and Audio Systems

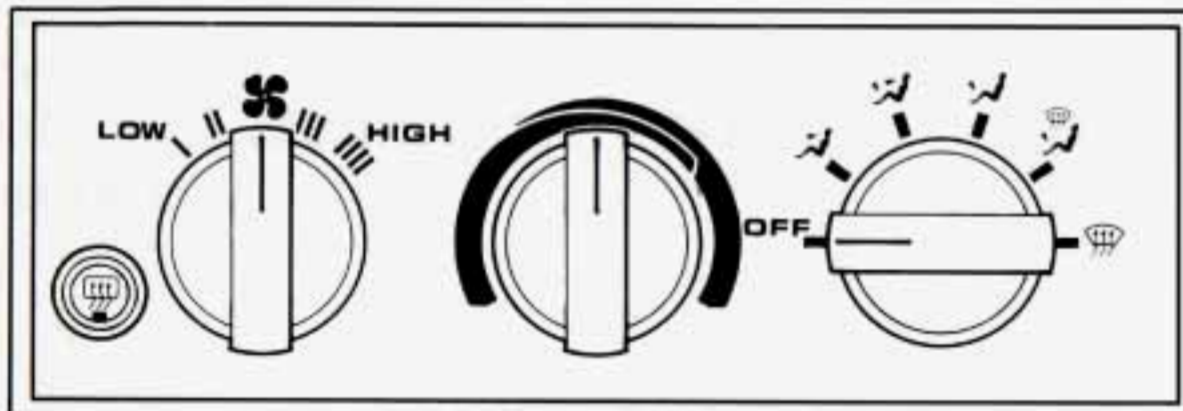

■ *Comfort Controls*

With this system, you can control the heating and ventilation in your Pontiac. If you have the air conditioning option, you can also control cooling.

Your vehicle also has the flow-through ventilation system described later in this section.

Heater Controls

Fan Control Knob

 : Turn this knob to select the force of air you want.

Temperature Control Knob

Turn the knob to change the temperature of the air flowing from the heating system. Turn it to the right for warmer air and to the left for cooler air. The temperature of the air can not be less than the temperature of the outside air.

Air Control Knob

OFF: The system is off.

 : Air flows through the upper air vents.

 : Air is directed through the upper air vents and the heater ducts.

 : This setting directs most of the air through the heater ducts and some of the air through the windshield defroster vents.

 : Air is directed through the windshield defroster vents and the heater ducts.

 : This setting directs most of the air through the windshield defroster vents and some of the air through the heater ducts.

Heating

The heater works best if you keep your windows closed while using it.

1. Turn the air control knob to .
2. Turn the fan control knob to the right.
3. Turn the temperature control knob to a comfortable setting.

During initial start-up only, if your vehicle is equipped with an optional engine coolant heater, you can use it in cold weather (around +20°F/-8°C or lower) to heat the passenger area better than without it. Because an engine coolant heater warms the engine coolant, your vehicle's heating system can more efficiently provide heat for the passenger area of your vehicle. See "Engine Coolant Heater" in the Index.

Bi-Level Heating

You may want to use bi-level heating on cool, but sunny days. This setting directs cool air toward your body and warmer air toward your feet.

1. Turn the air control knob to .
2. Turn the temperature control knob to a comfortable setting.
3. Turn the fan control knob to the right.

Ventilation

For mild outside temperatures when little heating or cooling is needed, you can still direct outside air through your vehicle.

1. Turn the air control knob to .
2. Turn the temperature control knob to a comfortable setting.
3. Turn the fan control knob to the right.

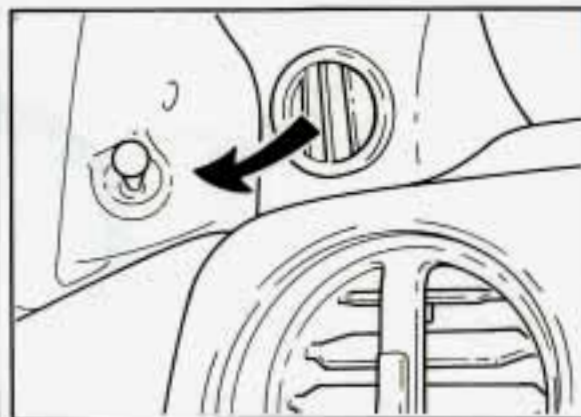

Defogging and Defrosting Windows

1. Turn the air control knob to .
2. Turn the temperature control knob all the way to the right.
3. Turn the fan control knob to the right.

Comfort Controls and Audio Systems

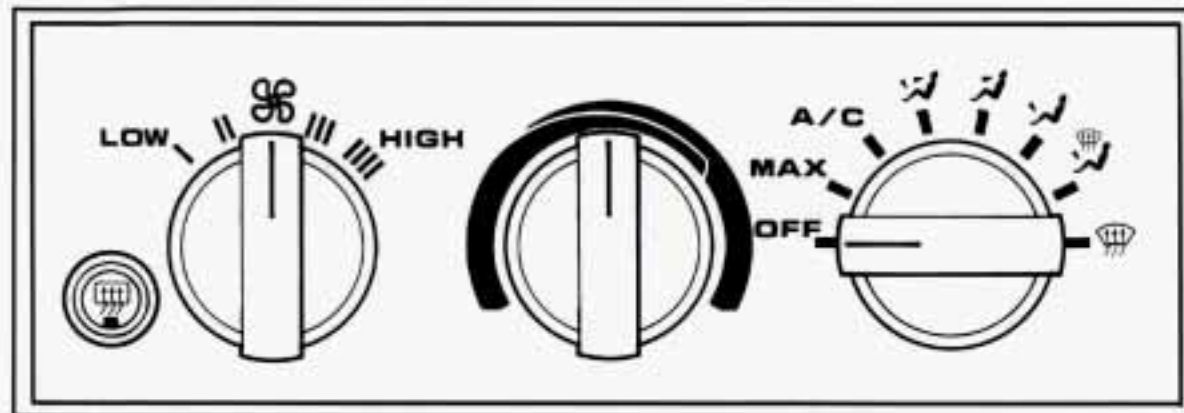



Air Conditioner Controls (OPTION)

The air conditioning system uses the same controls as the heating system, except that the air control knob has two extra settings, described below. For an explanation of all the controls, see "Heater Controls" earlier in this part.

MAX: Provides maximum cooling or quick cool-down on very hot days. This setting recirculates most of the air inside your vehicle. If it is used for long periods of time, the air may become dry. This setting directs air through the upper air vents.

A/C: Use for normal cooling on hot days. This setting cools outside air and directs it through the upper air vents.

The air conditioner compressor operates in "MAX," "A/C" and in  and  when the outside temperature is above freezing. When the air conditioner is on, you may sometimes notice slight changes in your vehicle's engine speed and power. This is normal because the system is designed to cycle the compressor on and off to keep the desired cooling and help fuel economy.

Cooling

The air conditioner works best if you keep your windows closed. On very hot days, open the windows just long enough for the hot air to escape.

1. Turn the air control knob to "A/C" for normal cooling. For faster cooling move the knob to "MAX."
2. Turn the temperature control knob to a comfortable setting.
3. Turn the fan control knob to the right.

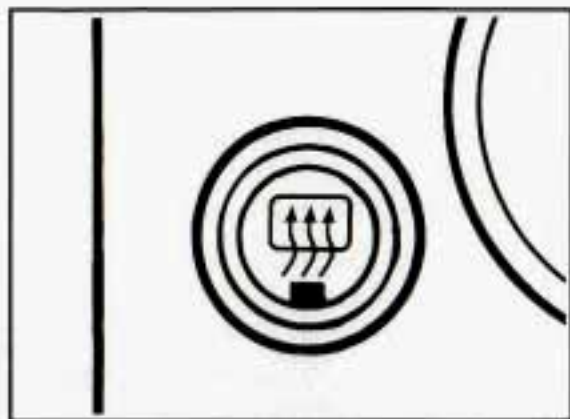

Rear Window Defogger (OPTION)

The rear window defogger uses a warming grid to remove fog from the rear window.

Press the switch to turn on the defogger. An indicator light will come on to remind you that the defogger is on. The defogger will turn off automatically after about ten minutes of use. If you turn it on again, the defogger will operate for about five minutes only. You can also turn the defogger off by pressing the switch again.

Do not attach anything like a temporary vehicle license or a decal across the defogger grid on the rear window.

NOTICE:

Don't use a razor blade or something else sharp on the inside of the rear window. If you do, you could cut or damage the warming grid, and the repairs wouldn't be covered by your warranty.

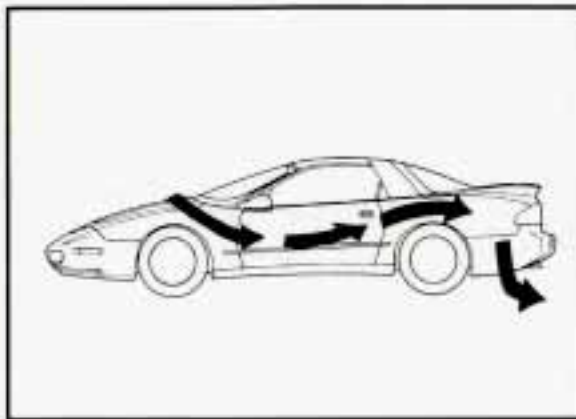

Flow-Through Ventilation System

Your Pontiac's flow-through ventilation system supplies outside air into the vehicle when it is moving. Outside air will also enter the vehicle when the heater or the air conditioning fan is running.

Comfort Controls and Audio Systems

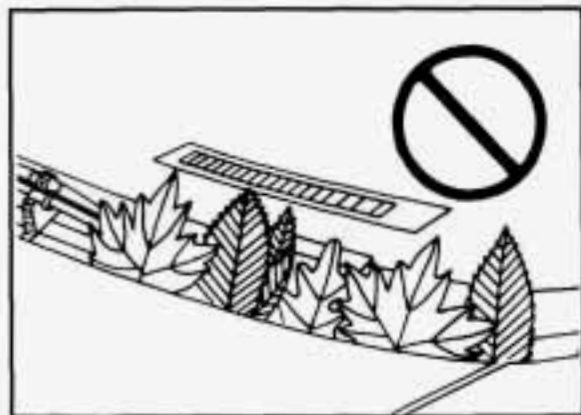

Ventilation Tips

- Keep the hood and front air inlet free of ice, snow, or any other obstruction (such as leaves). The heater and defroster will work far better, reducing the chance of fogging the inside of your windows.
- When you enter a vehicle in cold weather, turn the fan control knob to the right for a few moments before driving off. This helps clear the intake ducts of snow and moisture, and reduces the chance of fogging the inside of your windows.
- Keep the air path under the front seats clear of objects. This helps air to circulate throughout your vehicle.

■ Audio Systems

Your Delco® audio system has been designed to operate easily and give years of listening pleasure. But you will get the most enjoyment out of it if you acquaint yourself with it first. Find out what your Delco® system can do and how to operate all its controls, to be sure you're getting the most out of the advanced engineering that went into it.

If you have power door locks, your vehicle has a feature called Retained Accessory Power (RAP). With RAP you can play your audio system even after the ignition is off. See the Index under "Retained Accessory Power."

NOTICE:

Before you add any sound equipment to your vehicle — like a tape player, CB radio, mobile telephone or two-way radio — be sure you can add what you want. If you can, it's very important to do it properly. Added sound equipment may interfere with the operation of your vehicle's engine, Delco® radio or other systems, and even damage them. And, your vehicle's systems may interfere with the operation of sound equipment that has been added improperly.

So, before adding sound equipment, check with your dealer and be sure to check Federal rules covering mobile radio and telephone units.

Setting the Clock

The clock may be set with the ignition on or off.

1. Press and hold "HR" until the correct hour appears.
2. Press and hold "MIN" until the correct minute appears.

NOTE: There will be a two second delay before the clock goes into the time-set mode.

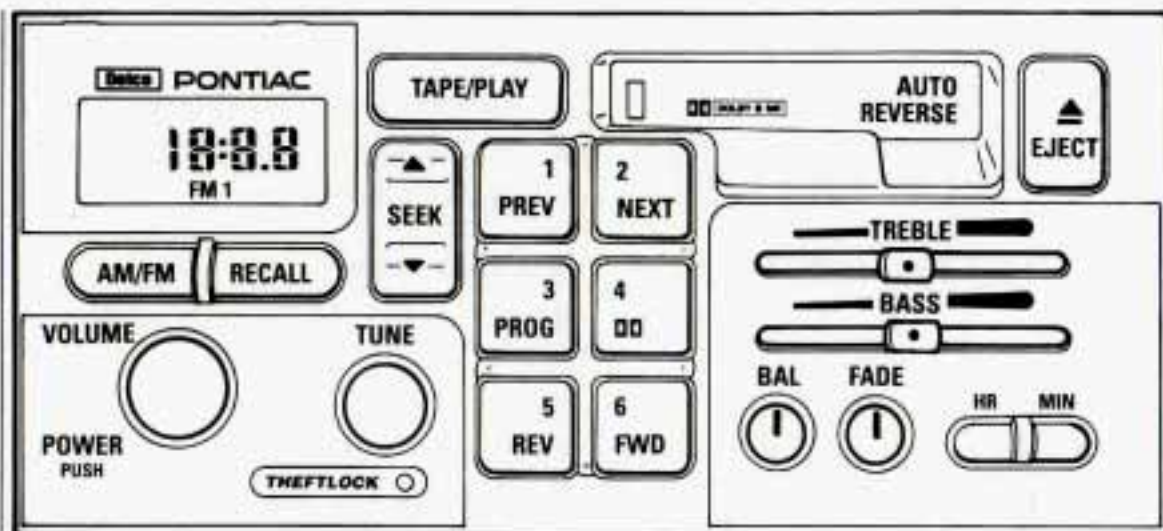

AM/FM Stereo with Cassette Tape Player

To Play the Radio

Push "POWER" to turn the system on or off.

Volume

Turn the "VOLUME" knob to adjust the sound.

AM-FM

Press "AM/FM" to get AM, FM1 or FM2. The lighted display shows your selection.

Tune

Press "TUNE" to release the knob. Turn the knob to choose radio stations. Push "TUNE" back in to store it when not tuning.

Recall

Press "RECALL" to recall the station being played or the clock display. You can also press "RECALL" to display the time when the ignition is off.

Seek

Press "SEEK ▼ or ▲" and the radio will tune to the next lower or higher station and stay there.

Comfort Controls and Audio Systems

Pushbuttons

The six pushbuttons let you return to your favorite stations. You can preset up to 18 stations (6 AM, 6 FM1 and 6 FM2).

1. Press "AM/FM" to choose AM, FM1 or FM2.
2. Tune in the station.
3. Press and hold one of the six pushbuttons until the display shows "SET." Whenever you press that button, the preset station will return.

Repeat these steps for each pushbutton.

Steering Wheel Controls

Your vehicle may be equipped with steering wheel controls for this audio system. With steering wheel controls, you can use the buttons on your steering wheel to:

- Turn the audio system on or off.
- Adjust the volume.

- Choose AM, FM1 or FM2.
- Use the seek and recall functions.
- Choose one of the preset stations on your pushbuttons.

Setting the Tone

Bass: Slide the "BASS" lever to the right to hear more bass.

Treble: Slide the "TREBLE" lever to the right to hear more treble.

If a station is weak and noisy, slide "TREBLE" to the left to reduce the noise.

Adjusting the Speakers

Balance: Press "BAL" to release the knob. Turn the knob to move the sound between the right and left speakers. Push "BAL" back in to store it when not adjusting.

Fade: Press "FADE" to release the knob. Turn the knob to move the sound between the front and rear speakers. Push "FADE" back in to store it when not adjusting.

To Play a Cassette Tape

Your tape player is built to work best with tapes that are 30 to 45 minutes long on each side. Tapes longer than that are so thin they may not work well in this player. A cassette symbol will appear in the upper left corner of the display whenever a tape is inserted.

The longer side with the tape visible goes in first. If you hear nothing or hear just a garbled sound, it may not be in squarely. Press "EJECT" to remove the tape and start over.

Once the tape is playing, use "VOLUME," "FADE," "TREBLE" and "BASS" just as you do for the radio. The arrows show which side of the tape is playing.

Forward

Press "FWD" to rapidly advance to another part of the tape. Press "PROG" or "FWD" again to stop it. The radio will play during this operation.

Reverse

Press "REV" to rapidly rewind the tape. Press "PROG" or "REV" again to stop it. The radio will play during this operation.

To Play the Next Selection

Press "NEXT" or "SEEK ▲" to hear the next selection (instead of waiting until the current selection is finished.)

For "NEXT" to work properly, your tape must have at least three seconds of silence between each selection.

The radio will not play during this operation.

To Replay the Current Selection

Press "PREV" or "SEEK ▼" to play a selection again.

For "PREV" to work properly, your tape must have at least three seconds of silence between each selection.

The radio will not play during this operation.

Program

Press "PROG" to switch from one side of the tape to the other or to stop the tape from searching.

Noise Reduction

Press **NR** to reduce tape noise. This symbol will appear in the display.

To Stop the Tape Player

- Turn the power off or turn the ignition key off. The cassette stays in the player and will resume playing at the point where it stopped.
- Press "AM/FM" to stop playing the cassette and switch to the radio. Press "TAPE-PLAY" to restart the cassette at the point where it stopped.
- Press "EJECT" to remove the cassette or stop the cassette and switch to radio. "EJECT" will work with the ignition or radio off. Press "EJECT" to load a cassette when the radio is off.

NOTE: This radio has a "broken tape" feature that will eject broken or misfed tapes. Because of this feature, CD changers that plug into the tape deck will not work in this system.

Theft-Deterrent System

Your audio system is equipped with the "THEFTLOCK" theft-deterrent system. See "Theft-Deterrent System" at the end of this section.

Comfort Controls and Audio Systems

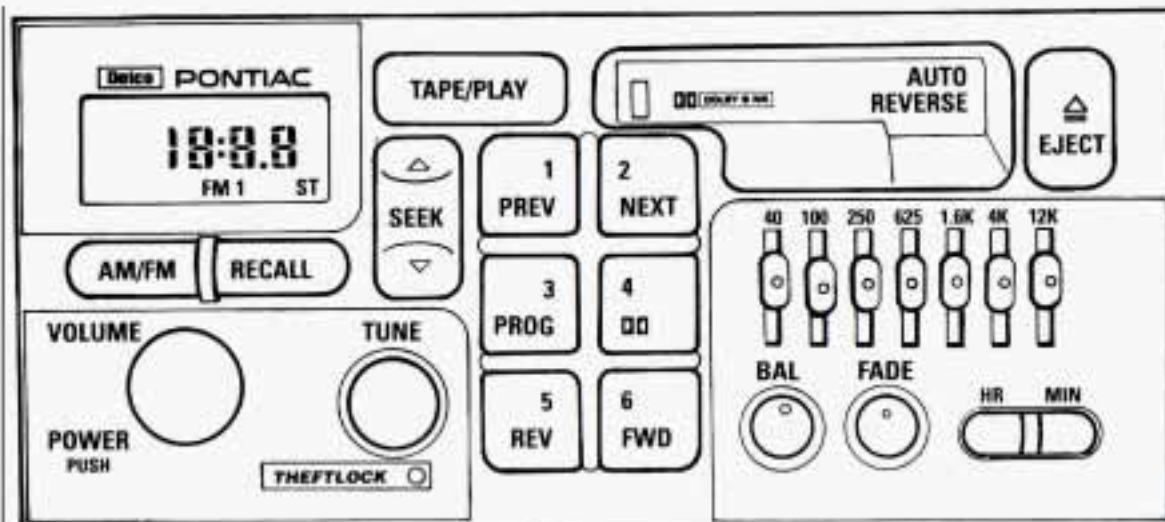

AM/FM Stereo with Cassette Tape Player and Graphic Equalizer

To Play the Radio

Push "POWER" to turn the system on or off.

Volume

Turn the "VOLUME" knob to adjust the sound.

AM-FM

Press "AM/FM" to get AM, FM1 or FM2. The lighted display shows your selection.

Tune

Press "TUNE" to release the knob. Turn the knob to choose radio stations. Push "TUNE" back in to store it when not tuning.

Recall

Press "RECALL" to recall the station being played or the clock display. You can also press "RECALL" to display the time when the ignition is off.

Seek

Press "SEEK ▲" or "SEEK ▼" to go to the next lower or higher station and stay there.

Pushbuttons

The six pushbuttons let you return to your favorite stations. To set the pushbuttons for up to 18 stations (6 AM, 6 FM1 and 6 FM2).

1. Press "AM/FM" to choose AM, FM1 or FM2.
2. Tune in the station.
3. Press and hold one of the six pushbuttons until the display shows "SET." Whenever you press that button, the preset station will return.

Steering Wheel Controls

Your vehicle may be equipped with steering wheel controls for this audio system. With steering wheel controls, you can use the buttons on your steering wheel to:

- Turn the audio system on or off.
- Adjust the volume.
- Choose AM, FM1 or FM2.
- Use the seek and recall functions.
- Choose one of the preset stations on your pushbuttons.

Setting the Tone

Use the levers to set the bass, midrange and treble until you get the sound you want. The "40," "100," "250" and "625" levers adjust the bass. "1.6K" is midrange, and "4K" and "12K" control the treble. We suggest setting the "1.6K" lever in the middle position and then moving the other levers up or down until you get the amount of bass and treble you like.

Adjusting the Speakers

Balance: Press "BAL" to release the knob. Turn the knob to move the sound between the right and left speakers. Push "BAL" back in to store it when not adjusting.

Fade: Press "FADE" to release the knob. Turn the knob to move the sound between the front and rear speakers. Push "FADE" back in to store it when not adjusting.

To Play a Cassette Tape

Your tape player is built to work best with tapes that are 30 to 45 minutes long on each side. Tapes longer than that are so thin they may not work well in this player. A cassette symbol will appear in the upper left corner of the display whenever a tape is inserted.

The longer side with the tape visible goes in first. If you hear nothing or hear just a garbled sound, it may not be in squarely. Press "EJECT" to remove the tape and start over.

Once the tape is playing, use "VOLUME," "BAL" and "FADE" just as you do for the radio. The arrows show which side of the tape is playing.

Forward

Press "FWD" to rapidly advance to another part of the tape. Press "PROG" or "FWD" again to stop it. The radio will play during this operation.

Reverse

Press "REV" to rapidly rewind the tape. Press "PROG" or "REV" again to stop it. The radio will play during this operation.

To Play the Next Selection

Press "NEXT" or "SEEK ▲" to hear the next selection (instead of waiting until the current selection is finished.)

For "NEXT" to work properly, your tape must have at least three seconds of silence between each selection.

The radio will not play during this operation.

To Replay the Current Selection

Press "PREV" or "SEEK ▼" to play a selection again.

Comfort Controls and Audio Systems

For "PREV" to work properly, your tape must have at least three seconds of silence between each selection.

The radio will not play during this operation.

Program

Press "PROG" to switch from one side of the tape to the other or to stop the tape from searching.

Noise Reduction

Press **NR** to reduce tape noise. This symbol will appear in the display.

To Stop the Tape Player

- Turn the power off or turn the ignition key off. The cassette stays in the player and will resume playing at the point where it stopped.
- Press "AM/FM" to stop playing the cassette and switch to the radio. Press "TAPE-PLAY" to restart the cassette at the point where it stopped.
- Press "EJECT" to remove the cassette or stop the cassette and switch to radio. "EJECT" will work with the ignition or radio off. Press "EJECT" to load a cassette when the radio is off.

NOTE: This radio has a "broken tape" feature that will eject broken or misfed tapes. Because of this feature, CD changers that plug into the tape deck will not work in this system.

Theft-Deterrent System

Your audio system is equipped with the "THEFTLOCK" theft-deterrent system. See "Theft-Deterrent System" at the end of this section.

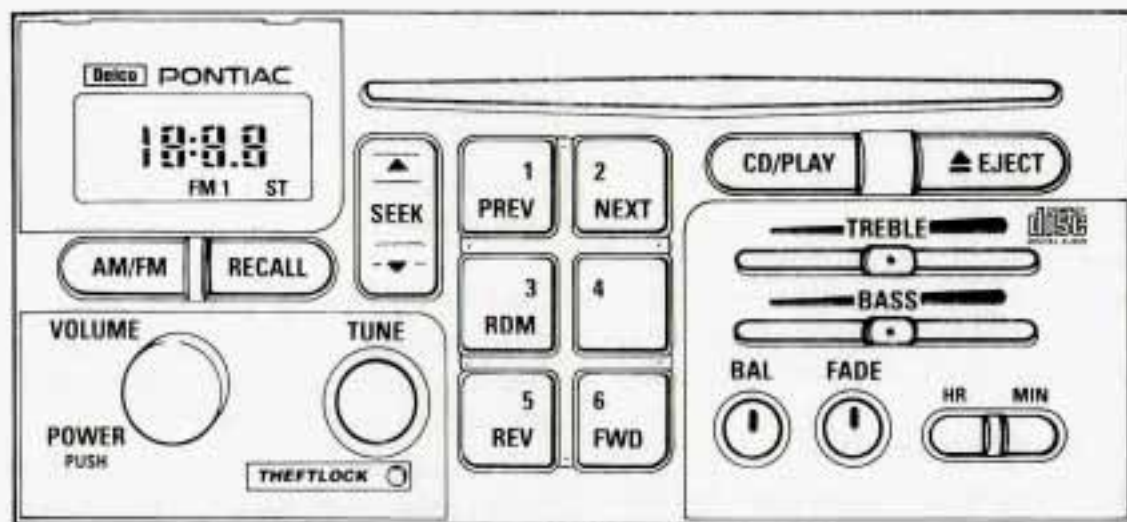

AM/FM Stereo with Compact Disc Player

To Play the Radio

Push "POWER" to turn the system on or off.

Volume

Turn the "VOLUME" knob to adjust the sound.

AM-FM

Press "AM/FM" to get AM, FM1 or FM2. The lighted display shows your selection.

Tune

Press "TUNE" to release the knob. Turn the knob to choose radio stations. Push "TUNE" back in to store it when not tuning.

Recall

Press "RECALL" to recall the station being played or the clock display. You can also press "RECALL" to display the time when the ignition is off.

Seek

Press "SEEK ▲" or "SEEK ▼" to go to the next lower or higher station and stay there.

Pushbuttons

The six pushbuttons let you return to your favorite stations. To set the pushbuttons for up to 18 stations (6 AM, 6 FM1 and 6 FM2):

1. Press "AM/FM" to choose AM, FM1 or FM2.
2. Tune in the station.
3. Press and hold one of the six pushbuttons until the display shows "SET." Whenever you press that button, the preset station will return.

Comfort Controls and Audio Systems

Steering Wheel Controls

Your vehicle may be equipped with steering wheel controls for this audio system. With steering wheel controls, you can use the buttons on your steering wheel to:

- Turn the audio system on or off.
- Adjust the volume.
- Choose AM, FM1 or FM2.
- Use the seek and recall functions.
- Choose one of the preset stations on your pushbuttons.

Setting the Tone

Bass: Slide the "BASS" lever to the right to hear more bass.

Treble: Slide the "TREBLE" lever to the right to hear more treble.

If a station is weak and noisy, slide "TREBLE" to the left to reduce the noise.

Adjusting the Speakers

Balance: Press "BAL" to release the knob. Turn the knob to move the sound between the right and left speakers. Push "BAL" back in to store it when not adjusting.

Fade: Press "FADE" to release the knob. Turn the knob to move the sound between the front and rear speakers. Push "FADE" back in to store it when not adjusting.

To Play a Compact Disc

Before you begin, please note: don't use the mini-discs that are called "singles." They won't eject. Use full-size compact discs.

With the audio system on, insert a disc into the slot with the label side up. "CD" will appear on the display and track 1 will begin to play.

If the disc comes back out and "ERR" appears on the display, it could be that:

- The disc is upside down.
- It is dirty, scratched, or wet.
- There's too much moisture in the air.
- You are driving on a very rough road.
- The temperature is too hot or too cold.

Recall

Press "RECALL" to see what track is playing. Press it again within five seconds to see how long it has been playing.

The track number also appears when the disc is inserted.

To Play the Next Selection

Press "NEXT" or "SEEK ▲" to hear the next track now (instead of waiting until the present track is finished).

If you press and hold this button or press it more than once, the disc will advance further.

To Replay the Current Selection

Press "PREV" or "SEEK ▼" to hear a track again.

If you press and hold this button, or press it more than once, the disc will return to previous tracks.

Reverse

Press and hold "REV" to rapidly return to a favorite passage. Release it to play the passage. The radio will play during this operation.

Forward

Press and hold "FWD" to quickly advance within a track. Release it to resume playing. The radio will play during this operation.

Random

Press "RDM" to hear a random selection of tracks.

To Stop the Disc Player

- Turn the power off or turn the ignition key off. The disc stays in the player and will resume playing at the point where it stopped.
- Press "AM/FM" to stop playing the disc and switch to radio. Press "CD/PLAY" to restart the disc at the point where it stopped.
- Press "EJECT" to eject the disc or stop the disc and switch to radio. "EJECT" will work with the ignition or radio off. Press "EJECT" to load a disc when the audio system is off.

Theft-Deterrent System

Your audio system is equipped with the "THEFTLOCK" theft-deterrent system. See "Theft-Deterrent System" at the end of this section.

Comfort Controls and Audio Systems

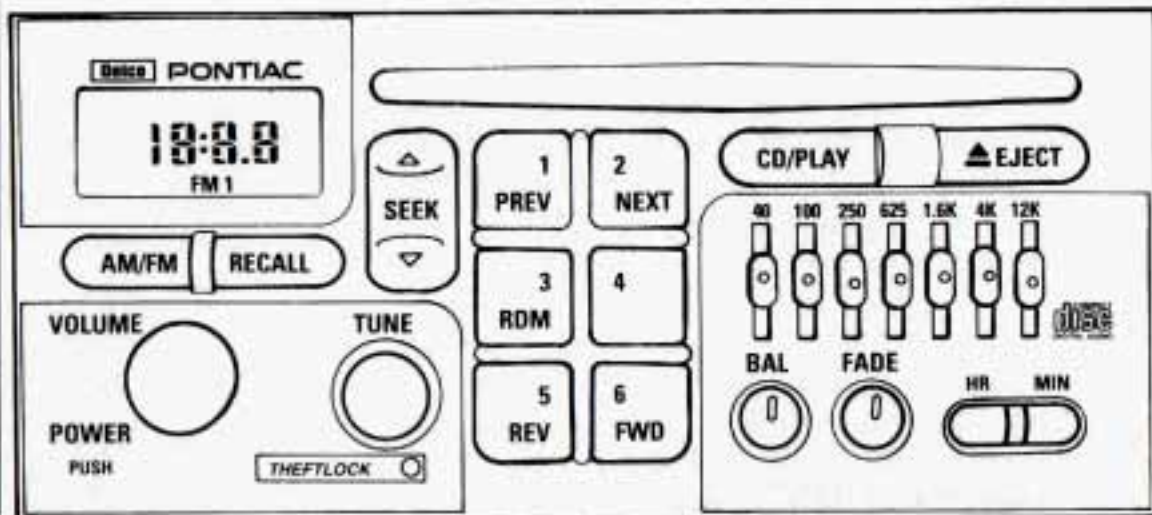

AM/FM Stereo with Compact Disc Player and Graphic Equalizer

To Play the Radio

Push "POWER" to turn the system on or off.

Volume

Turn the "VOLUME" knob to adjust the sound.

AM-FM

Press "AM/FM" to get AM, FM1 or FM2. The lighted display shows your selection.

Tune

Press "TUNE" to release the knob. Turn the knob to choose radio stations. Push "TUNE" back in to store it when not tuning.

Recall

Press "RECALL" to recall the station being played or the clock display. You can also press "RECALL" to display the time when the ignition is off.

Seek

Press "SEEK ▲" or "SEEK ▼" to go to the next lower or higher station and stay there.

Pushbuttons

The six pushbuttons let you return to your favorite stations. To set the pushbuttons for up to 18 stations (6 AM, 6 FM1 and 6 FM2):

1. Press "AM/FM" to choose AM, FM1 or FM2.
2. Tune in the station.
3. Press and hold one of the six pushbuttons until the display shows "SET." Whenever you press that button, the preset station will return.

Steering Wheel Controls

Your vehicle has steering wheel controls for this audio system. With steering wheel controls, you can use the buttons on your steering wheel to:

- Turn the audio system on or off.
- Adjust the volume.
- Choose AM, FM1 or FM2.
- Use the seek and recall functions.
- Choose one of the preset stations on your pushbuttons.

Setting the Tone

Use the levers to set the bass, midrange and treble until you get the sound you want. The "40," "100," "250" and "625" levers adjust the bass. "1.6K" is midrange, and "4K" and "12K" control the treble. We suggest setting the "1.6K" lever in the middle position and then moving the other levers up or down until you get the amount of bass and treble you like.

Adjusting the Speakers

Balance: Press "BAL" to release the knob. Turn the knob to move the sound between the right and left speakers. Push "BAL" back in to store it when not adjusting.

Fade: Press "FADE" to release the knob. Turn the knob to move the sound between the front and rear speakers. Push "FADE" back in to store it when not adjusting.

To Play a Compact Disc

Before you begin, please note: don't use the mini-discs that are called "singles." They won't eject. Use full-size compact discs.

With the audio system on, insert a disc into the slot with the label side up. "CD" will appear on the display and track 1 will begin to play.

If the disc comes back out and "ERR" appears on the display, it could be that:

- The disc is upside down.
- It is dirty, scratched, or wet.
- There's too much moisture in the air.
- You are driving on a very rough road.
- The temperature is too hot or too cold.

Recall

Press "RECALL" to see what track is playing. Press it again within five seconds to see how long it has been playing.

The track number also appears when the disc is inserted.

To Play the Next Selection

Press "NEXT" or "SEEK ▲" to hear the next track now (instead of waiting until the present track is finished).

If you press and hold this button or press it more than once, the disc will advance further.

To Replay the Current Selection

Press "PREV" or "SEEK ▼" to hear a track again.

If you press and hold this button, or press it more than once, the disc will return to previous tracks.

Reverse

Press and hold "REV" to rapidly return to a favorite passage. Release it to play the passage. The radio will play during this operation.

Comfort Controls and Audio Systems

Forward

Press and hold "FWD" to quickly advance within a track. Release it to resume playing. The radio will play during this operation.

Random

Press "RDM" to hear a random selection of tracks.

To Stop the Disc Player

- Turn the power off or turn the ignition key off. The disc stays in the player and will resume playing at the point where it stopped.
- Press "AM/FM" to stop playing the disc and switch to radio. Press "CD/PLAY" to restart the disc at the point where it stopped.
- Press "EJECT" to eject the disc or stop the disc and switch to radio. "EJECT" will work with the ignition or radio off. Press "EJECT" to load a disc when the audio system is off.

Theft-Deterrent System

Your audio system is equipped with the "THEFTLOCK" theft-deterrent system. See "Theft-Deterrent System" at the end of this section.

Theft-Deterrent Feature

THEFTLOCK is a security feature for the cassette tape and compact disc player. It can be used or ignored. If ignored, the system functions normally. If it is used, your system won't be usable if it's ever stolen. When the system is active, the indicator light will flash while the ignition is off.

Setting Your Security Code

The instructions below tell you how to enter a security code into the system. If your vehicle loses battery power for any reason, you must enter the security code again before the system will turn on.

1. Write down any number from 000 to 1999 and keep it in a safe place.
2. Turn the ignition switch to the "Acc" or "Run" position.
3. Turn the audio system off.
4. Press and hold pushbuttons "1" and "4" together until "----" shows on the display.

You are now ready to enter your security code. Don't wait more than 15 seconds between steps.

5. Press "MIN" and "000" will appear on the display.
6. Press "MIN" again and hold until the last two digits of your code appear. Release the button.
7. Press "HR" until the first one or two digits of your code appears.
8. Press "AM/FM." "rEP" will appear on the display.
9. Repeat steps 5 through 7 for verification.
10. Press "AM/FM." "SEC" will appear on the display. This means that your audio system is secured.

Shutting Off the Theft-Deterrent Feature

If your audio system is secured ("SEC" shows on display) and you wish to disable it, enter your security code as follows, pausing no more than 15 seconds between steps:

1. Turn the ignition on. Make sure the audio system is off. The time will show on the display.
2. Press pushbuttons "1" and "4" together until "SEC" shows on the display.
3. Press "MIN." "000" will appear on the display.
4. Press "MIN" again and hold until the last two digits of your code appear. Release the button.
5. Press "HR" until the first one or two digits of your code appear.
6. Press "AM/FM." If "--" shows, you have shut off the theft-deterrent feature. If "SEC" shows, your audio system is still secured.

NOTE: If you lose or forget your security code, see your dealer for assistance.

Unlocking the Audio System after a Power Failure

If power is disrupted to the audio system while in the "SEC" mode, the unit will not work and "LOC" will show on the display whenever the ignition is on. To unlock the unit:

1. Press "MIN." "000" will appear on the display.
2. Press "MIN" again and hold until the last two digits of your code appear. Release the button.
3. Press "HR" until the first one or two digits of your code appear.
4. Press "AM/FM." "SEC" will appear on the display and the unit will work. If "LOC" shows, the numbers did not match and the unit is still locked.

How to Change Your Security Code

You can change your security code by following these steps:

1. Using your old code, follow the directions given under "Shutting Off the Theft-Deterrent Feature."
2. Repeat directions of "Setting Your Security Code" with your new security code.

Understanding Radio Reception

FM Stereo

FM stereo will give you the best sound. But FM signals will reach only about 10 to 40 miles (16 to 65 km). And, tall buildings or hills can interfere with FM signals, causing the sound to come and go.

AM

The range for most AM stations is greater than for FM, especially at night. The longer range, however, can cause stations to interfere with each other. AM can pick up noise from things like storms and power lines. Try reducing the treble to reduce this noise if you ever get it.

AM Stereo

This means the Delco[®] system can receive C-QUAM[®] stereo broadcasts. Many AM stations around the country use C-QUAM[®] to produce stereo, though some do not. (C-QUAM[®] is a registered trademark of Motorola, Inc.) If your Delco[®] system can get C-QUAM[®], your "STEREO" light will come on when you're receiving it.

Comfort Controls and Audio Systems



Care of Your Cassette Tape Player

A tape player that is not cleaned regularly can cause reduced sound quality, ruined cassettes, or a damaged mechanism.

Cassette tapes should be stored in their cases away from contaminants, direct sunlight, and extreme heat. If they aren't, they may not operate properly or cause failure of the tape player.

Cassettes are subject to wear and the sound quality may degrade over time. Always make sure that the cassette tape is in good condition before you have your tape player serviced.

Your tape player should be cleaned after every 50 hours of use for best performance. If you notice a reduction in sound quality, regardless of when the tape player was last cleaned, try a known good cassette to see if the tape or the tape player is at fault. If this other cassette has no improvement in sound quality, clean the tape player.

Clean your tape player with a scrubbing-action, non-abrasive cleaning cassette. This wet-type cleaning system uses a cleaning cassette with pads which scrub the tape head as the hubs of the cleaner cassette turn.

If you use this type of cleaner, the radio may eject the cartridge. This is normal, and is the result of a feature in the tape player that ejects broken tapes. If this happens, you will need to insert the cleaning cassette three times to thoroughly clean the tape player.

You may prefer to use a non-scrubbing action wet-type cleaner. This type of cleaning cassette, which uses a fabric belt to clean the tape head, will not be ejected but may not clean the tape player as thoroughly as the scrubbing type cleaner.

Whichever method you choose, follow the instructions provided with the cleaning cassette. Cleaning cassettes are available in most stores that sell audio products. A scrubbing action cleaning cassette is available from your dealer (GM Part No. 12344600).

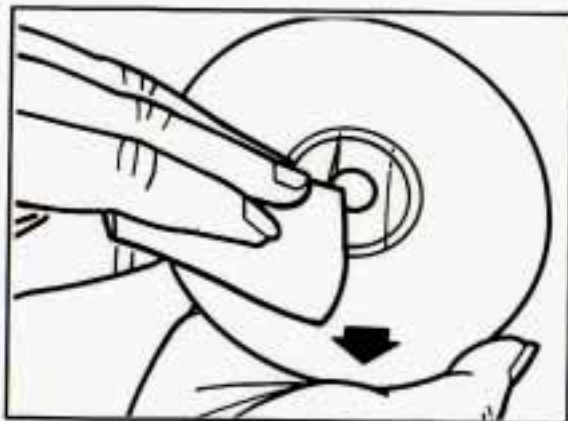

Fixed Mast Antenna

The fixed mast antenna can withstand most car washes without being damaged. If the mast should ever become slightly bent, you can straighten it out by hand. If the mast is badly bent, as it might be by vandals, you should replace it.

Check every once in a while to be sure the mast is still tightened to the fender.

Care of Your Compact Discs

Handle discs carefully. Store them in their original cases or other protective cases and away from direct sunlight and dust. If the surface of a disc is soiled, dampen a clean, soft cloth in a mild, neutral detergent solution and clean it, wiping from the center to the edge.

Be sure never to touch the signal surface when handling discs. Pick up discs by grasping the outer edges or the edge of the hole and the outer edge.

Notes



Here you'll find information about driving on different kinds of roads and in varying weather conditions. We've also included many other useful tips on driving.

Part 4 Your Driving and the Road

Defensive Driving	126
Drunken Driving	126
Control of a Vehicle	128
Driving at Night	136
Driving in the Rain	137
City Driving	138
Freeway Driving	139
Hill and Mountain Roads	141
Winter Driving	142
Towing a Trailer	144

Your Driving and the Road

■ *Defensive Driving*

The best advice anyone can give about driving is: Drive defensively.

Please start with a very important safety device in your Pontiac: Buckle up. (See "Safety Belts" in the Index.)

Defensive driving really means "be ready for anything." On city streets, rural roads, or freeways, it means "always expect the unexpected."

Assume that pedestrians or other drivers are going to be careless and make mistakes. Anticipate what they might do. Be ready for their mistakes.

Rear-end collisions are about the most preventable of accidents. Yet they are common. Allow enough following distance. It's the best defensive driving maneuver, in both city and rural driving. You never know when the vehicle in front of you is going to brake or turn suddenly.

■ *Drunken Driving*

Death and injury associated with drinking and driving is a national tragedy. It's the number one contributor to the highway death toll, claiming thousands of victims

every year. Alcohol takes away three things that anyone needs to drive a vehicle:

- Judgment
- Muscular Coordination
- Vision

Police records show that almost half of all motor vehicle-related deaths involve alcohol — a driver, a passenger or someone else, such as a pedestrian, had been drinking. In most cases, these deaths are the result of someone who was drinking and driving. About 20,000 motor vehicle-related deaths occur each year because of alcohol, and thousands of people are injured.

Just how much alcohol is too much if a person plans to drive? Ideally, no one should drink alcohol and then drive. But if one does, then what's "too much"? It can be a lot less than many might think. Although it depends on each person and situation, here is some general information on the problem.

The Blood Alcohol Content (BAC) of someone who is drinking depends upon four things:

- How much alcohol is in the drink.
- The drinker's body weight.
- The amount of food that is consumed before and during drinking.
- The length of time it has taken the drinker to consume the alcohol.



According to the American Medical Association, a 180-pound (82 kg) person who drinks three 12-ounce (355 ml) bottles of beer in an hour will end up with a BAC of about 0.06 percent. The person would reach the same BAC by drinking three 4-ounce (120 ml) glasses of wine or three mixed drinks if each had 1-1/2 ounces (45 ml) of a liquor like whiskey, gin or vodka.

It's the amount of alcohol that counts. For example, if the same person drank three double martinis (3 ounces or 90 ml of liquor each) within an hour, the person's BAC would be close to 0.12 percent. A person who consumes food just before or during drinking will have a slightly lower BAC level.

DRINKING THAT WILL RESULT IN A BAC OF .05% IN THE TIME SHOWN

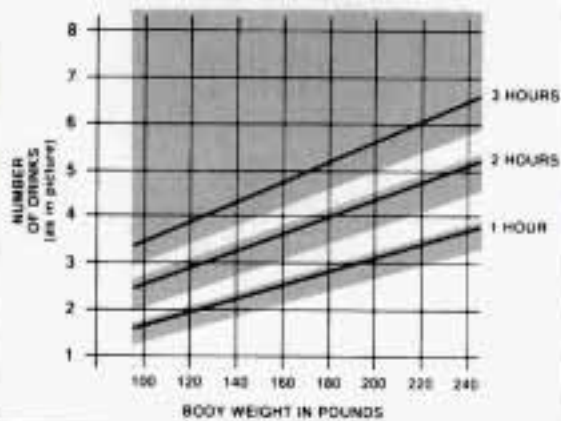

The law in most U.S. states sets the legal limit at a BAC of 0.10 percent. In Canada the limit is 0.08 percent, and in some other countries it's lower than that. The BAC will be over 0.10 percent after three to six drinks (in one hour). Of course, as we've seen, it depends on how much alcohol is in the drinks, and how quickly the person drinks them.

But it's very important to keep in mind that the ability to drive is affected well below a BAC of 0.10 percent. Research shows that the driving skills of many people are impaired at a BAC approaching 0.05 percent, and that the effects are worse at night. All drivers are impaired at BAC levels above 0.05 percent. Statistics show that the chance of being in an accident increases sharply for drivers who have a BAC of 0.05 percent or above. A driver with a BAC level of 0.06 percent (three beers in one hour for a 180-pound or 82 kg person) has doubled his or her chance of having an accident. At a BAC level of 0.10 percent, the chance of that driver having an accident is six times greater; at a level of 0.15 percent, the chances are twenty-five times greater! And, the body takes about an hour to rid itself of the alcohol in one drink. No amount of coffee or number of cold showers will speed that up.

"I'll be careful" isn't the right answer. What if there's an emergency, a need to take sudden action, as when a child darts into the street? A person with a higher BAC might not be able to react quickly enough to avoid the collision.

Your Driving and the Road

There's something else about drinking and driving that many people don't know. Medical research shows that alcohol in a person's system can make crash injuries worse. That's especially true for brain, spinal cord and heart injuries. That means that if anyone who has been drinking — driver or passenger — is in a crash, the chance of being killed or permanently disabled is higher than if that person had not been drinking. And we've already seen that the chance of a crash itself is higher for drinking drivers.



CAUTION:

Drinking and then driving is very dangerous. Your reflexes, perceptions, and judgment will be affected by even a small amount of alcohol. You could have a serious — or even fatal — accident if you drive after drinking. Please don't drink and drive or ride with a driver who has been drinking. Ride home in a cab; or if you're with a group, designate a driver who will not drink.

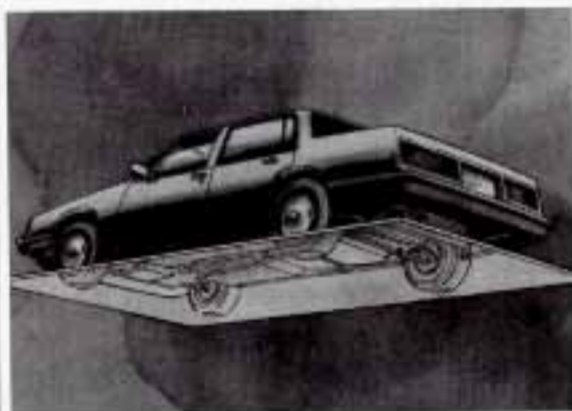

■ *Control of a Vehicle*

You have three systems that make your vehicle go where you want it to go. They are the brakes, the steering and the accelerator. All three systems have to do their work at the places where the tires meet the road.

Sometimes, as when you're driving on snow or ice, it's easy to ask more of those control systems than the tires and road can provide. That means you can lose control of your vehicle.

Braking

Braking action involves perception time and reaction time.

First, you have to decide to push on the brake pedal. That's perception time. Then you have to bring up your foot and do it. That's reaction time.

Average reaction time is about 3/4 of a second. But that's only an average. It might be less with one driver and as long as two or three seconds or more with another. Age, physical condition, alertness, coordination, and eyesight all play a part. So do alcohol, drugs and frustration. But even in 3/4 of a second, a vehicle moving at 60 mph (100 km/h) travels 66 feet (20 m). That could be a lot of distance in an emergency, so keeping enough space between your vehicle and others is important.

And, of course, actual stopping distances vary greatly with the surface of the road (whether it's pavement or gravel); the condition of the road (wet, dry, icy); tire tread; and the condition of your brakes.

Avoid needless heavy braking. Some people drive in spurts — heavy acceleration followed by heavy braking — rather than keeping pace with traffic.

This is a mistake. Your brakes may not have time to cool between hard stops. Your brakes will wear out much faster if you do a lot of heavy braking. If you keep pace with the traffic and allow realistic following distances, you will eliminate a lot of unnecessary braking. That means better braking and longer brake life.

If your engine ever stops while you're driving, brake normally but don't pump your brakes. If you do, the pedal may get harder to push down. If your engine stops, you will still have some power brake assist. But you will use it when you brake. Once the power assist is used up, it make take longer to stop and the brake pedal will be harder to push.

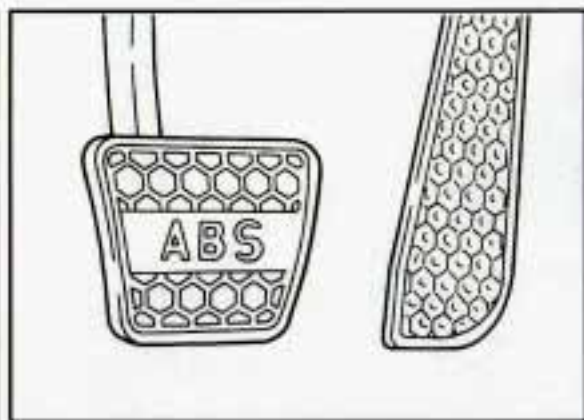

Anti-Lock Brakes (ABS)

Your Pontiac has an advanced electronic braking system that will help prevent skidding.

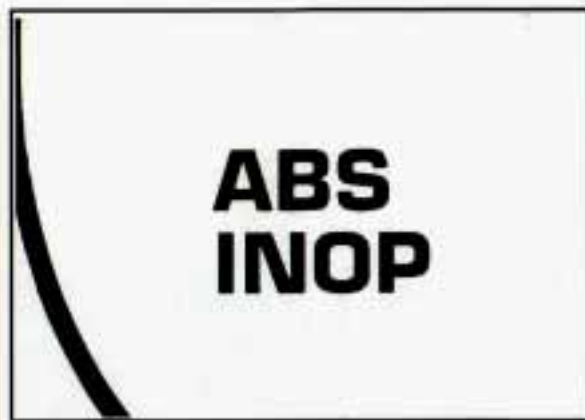

This light on the instrument panel will go on when you start your vehicle. When you start your vehicle, or when you begin to drive away, you may hear a momentary motor or clicking noise. And you may even notice that your brake pedal moves a little while this is going on. This is the ABS system testing itself. If there's a problem with the anti-lock brake system, the anti-lock brake system warning light will stay on or flash.

Your Driving and the Road



Here's how anti-lock works. Let's say the road is wet. You're driving safely. Suddenly an animal jumps out in front of you.

You slam on the brakes. Here's what happens with ABS.

A computer senses that wheels are slowing down. If one of the wheels is about to stop rolling, the computer will separately work the brakes at each front wheel and at the rear wheels.

The anti-lock system can change the brake pressure faster than any driver could. The computer is programmed to make the most of available tire and road conditions.



You can steer around the obstacle while braking hard.

As you brake, your computer keeps receiving updates on wheel speed and controls braking pressure accordingly.

Remember: Anti-lock doesn't change the time you need to get your foot up to the brake pedal. If you get too close to the vehicle in front of you, you won't have time to apply your brakes if that vehicle suddenly slows or stops. Always leave enough room up ahead to stop, even though you have anti-lock brakes.

To Use Anti-Lock

Don't pump the brakes. Just hold the brake pedal down and let anti-lock work for you. You may feel the system working, or you may notice some noise, but this is normal. When your anti-lock

system is adjusting brake pressure to help avoid a braking skid, the "LOW TRAC" light will come on. See "Low Traction Light" in the Index.

Traction Control System (Option: LT1 V8 Engine)

Your vehicle may have a traction control system that limits wheel spin. This is especially useful in slippery road conditions. The system operates only if it senses that one or both of the rear wheels are spinning or beginning to lose traction.

When this happens, the system works the rear brakes and reduces engine power (by closing the throttle and managing spark) to limit wheel spin.

The "LOW TRAC" light will come on when your traction control system is limiting wheel spin. See "Low Traction Light" in the Index. You may feel the system working, or you may notice some noise, but this is normal.

The traction control system may operate on dry roads under some conditions, and you may notice a reduction in acceleration when this happens. This is normal and doesn't mean there's a problem with your vehicle. Examples of these conditions include a hard acceleration in a turn, or an abrupt upshift or downshift.

A rectangular box with a black border. In the top-left corner, there is a black diagonal line. In the center, the words "TCS" and "OFF" are stacked vertically in a large, bold, sans-serif font.

**TCS
OFF**

If your vehicle is in cruise control when the traction control system begins to limit wheel spin, the cruise control will automatically disengage. When road conditions allow you to safely use it again, you may re-engage the cruise control. (See "Cruise Control" in the Index.)

The "TCS OFF" warning light will come on when you turn the traction control system off. When the system is on, this light will come on to let you know if there's a problem with your traction control system. See "Traction Control System Warning Light" in the Index.

When this warning light is on, the system will not limit wheel spin. Adjust your driving accordingly.

A rectangular box with a black border. In the center, there is a button icon consisting of a rounded rectangle with a horizontal line through its center. Above the button, the word "TRACTION" is written in a bold, sans-serif font.

TRACTION

The traction control system automatically comes on whenever you start your vehicle.

To limit wheel spin, especially in slippery road conditions, you should always leave the system on. But you can turn the traction control system off if you ever need to. (You should turn the system off if your vehicle ever gets stuck in sand, mud, ice or snow. See "Rocking Your Vehicle" in the Index.)

To turn the system off, press the button near the center of the console behind the shift lever. The light on the button will go off, and the "TCS OFF" warning light will come on and stay on. If the traction control system is limiting wheel spin when you press the button, the system

won't turn off right away. It will wait until there's no longer a current need to limit wheel spin.

You can turn the system back on at any time by pressing the button again. The light on the button should come on, and the "TCS OFF" warning light should go off.

If your car is equipped with P245/50ZR16 tires, the traction control system will automatically turn off at speeds above 108 mph (173 km/h). (The "TCS OFF" warning light will not come on.) When the vehicle speed drops below 103 mph (165 km/h), the system will automatically turn on again.

Your Driving and the Road

Braking in Emergencies

Use your anti-lock braking system when you need to. With anti-lock, you can steer and brake at the same time. In many emergencies, steering can help you more than even the very best braking.

Steering

Power Steering

If you lose power steering assist because the engine stops or the system is not functioning, you can steer but it will take much more effort.

Steering Tips

Driving on Curves

It's important to take curves at a reasonable speed.

A lot of the "driver lost control" accidents mentioned on the news happen on curves. Here's why:

Experienced driver or beginner, each of us is subject to the same laws of physics when driving on curves. The traction of the tires against the road surface makes it possible for the vehicle to change its path when you turn the front wheels. If there's

no traction, inertia will keep the vehicle going in the same direction. If you've ever tried to steer a vehicle on wet ice, you'll understand this.

The traction you can get in a curve depends on the condition of your tires and the road surface, the angle at which the curve is banked, and your speed. While you're in a curve, speed is the one factor you can control.

Suppose you're steering through a sharp curve. Then you suddenly accelerate. Both control systems — steering and acceleration — have to do their work where the tires meet the road. Unless you have traction control and the system is on, adding the sudden acceleration can demand too much of those places. You can lose control.

What should you do if this ever happens? Ease up on the accelerator pedal, steer the vehicle the way you want it to go, and slow down.

Speed limit signs near curves warn that you should adjust your speed. Of course, the posted speeds are based on good weather and road conditions. Under less favorable conditions you'll want to go slower.

If you need to reduce your speed as you approach a curve, do it before you enter the curve, while your front wheels are straight ahead.

Try to adjust your speed so you can "drive" through the curve. Maintain a reasonable, steady speed. Wait to accelerate until you are out of the curve, and then accelerate gently into the straightaway.



Steering in Emergencies

There are times when steering can be more effective than braking. For example, you come over a hill and find a truck stopped in your lane, or a car suddenly pulls out from nowhere, or a child darts out from between parked cars and stops right in front of you. You can avoid these problems by braking — if you can stop in time. But sometimes you can't; there isn't room. That's the time for evasive action — steering around the problem.

Your Pontiac can perform very well in emergencies like these. First apply your brakes. It is better to remove as much speed as you can from a possible collision. Then steer around the problem,

to the left or right depending on the space available.

An emergency like this requires close attention and a quick decision. If you are holding the steering wheel at the recommended 9 and 3 o'clock positions, you can turn it a full 180 degrees very quickly without removing either hand. But you have to act fast, steer quickly, and just as quickly straighten the wheel once you have avoided the object.

The fact that such emergency situations are always possible is a good reason to practice defensive driving at all times and wear safety belts properly.

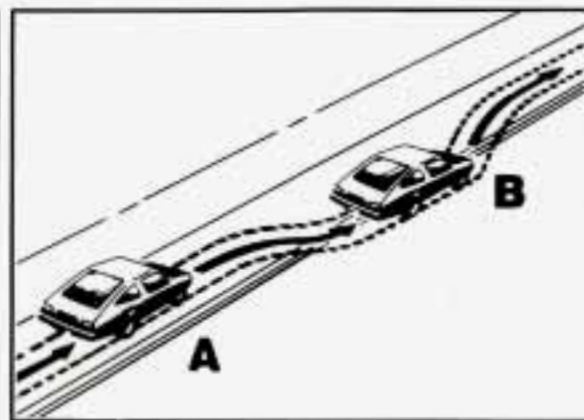

Off-Road Recovery

You may find sometime that your right wheels have dropped off the edge of a road onto the shoulder (A) while you're driving.

If the level of the shoulder is only slightly below the pavement, recovery should be fairly easy. Ease off the accelerator and then, if there is nothing in the way, steer so that your vehicle straddles the edge of the pavement. You can turn the steering wheel up to 1/4 turn (B) until the right front tire contacts the pavement edge. Then turn your steering wheel to go straight down the roadway.

Your Driving and the Road

Passing

The driver of a vehicle about to pass another on a two-lane highway waits for just the right moment, accelerates, moves around the vehicle ahead, then goes back into the right lane again. A simple maneuver?

Not necessarily! Passing another vehicle on a two-lane highway is a potentially dangerous move, since the passing vehicle occupies the same lane as oncoming traffic for several seconds. A miscalculation, an error in judgment, or a brief surrender to frustration or anger can suddenly put the passing driver face to face with the worst of all traffic accidents — the head-on collision.

So here are some tips for passing:

- “Drive ahead.” Look down the road, to the sides, and to crossroads for situations that might affect your passing patterns. If you have any doubt whatsoever about making a successful pass, wait for a better time.
- Watch for traffic signs, pavement markings, and lines. If you can see a sign up ahead that might indicate a turn or an intersection, delay your pass. A broken center line usually

indicates it’s all right to pass (providing the road ahead is clear). Never cross a solid line on your side of the lane or a double solid line, even if the road seems empty of approaching traffic.

- Do not get too close to the vehicle you want to pass while you’re awaiting an opportunity. For one thing, following too closely reduces your area of vision, especially if you’re following a larger vehicle. Also, you won’t have adequate space if the vehicle ahead suddenly slows or stops. Keep back a reasonable distance.
- When it looks like a chance to pass is coming up, start to accelerate but stay in the right lane and don’t get too close. Time your move so you will be increasing speed as the time comes to move into the other lane. If the way is clear to pass, you will have a “running start” that more than makes up for the distance you would lose by dropping back. And if something happens to cause you to cancel your pass, you need only slow down and drop back again and wait for another opportunity.

- If other cars are lined up to pass a slow vehicle, wait your turn. But take care that someone isn’t trying to pass you as you pull out to pass the slow vehicle. Remember to glance over your shoulder and check the blind spot.
- Check your mirrors, glance over your shoulder, and start your left lane change signal before moving out of the right lane to pass. When you are far enough ahead of the passed vehicle to see its front in your inside mirror, activate your right lane change signal and move back into the right lane. (Remember that your right outside mirror is convex. The vehicle you just passed may seem to be farther away from you than it really is.)
- Try not to pass more than one vehicle at a time on two-lane roads. Reconsider before passing the next vehicle.
- Don’t overtake a slowly moving vehicle too rapidly. Even though the brake lights are not flashing, it may be slowing down or starting to turn.
- If you’re being passed, make it easy for the following driver to get ahead of you. Perhaps you can ease a little to the right.

Loss of Control

Let's review what driving experts say about what happens when the three control systems (brakes, steering and acceleration) don't have enough friction where the tires meet the road to do what the driver has asked.

In any emergency, don't give up. Keep trying to steer and constantly seek an escape route or area of less danger.

Skidding

In a skid, a driver can lose control of the vehicle. Defensive drivers avoid most skids by taking reasonable care suited to existing conditions, and by not "overdriving" those conditions. But skids are always possible.

The three types of skids correspond to your Pontiac's three control systems. In the braking skid your wheels aren't rolling. In the steering or cornering skid, too much speed or steering in a curve causes tires to slip and lose cornering force. And in the acceleration skid too much throttle causes the driving wheels to spin.

A cornering skid is best handled by easing your foot off the accelerator pedal. If you have the traction control system, remember: It helps avoid only the acceleration skid. If you do not have traction control, or if the system is off, then an acceleration skid is also best handled by easing your foot off the accelerator pedal.

If your vehicle starts to slide, ease your foot off the accelerator pedal and quickly steer the way you want the vehicle to go. If you start steering quickly enough, your vehicle may straighten out. Always be ready for a second skid if it occurs.

Of course, traction is reduced when water, snow, ice, gravel, or other material is on the road. For safety, you'll want to slow down and adjust your driving to these conditions. It is important to slow down on slippery surfaces because stopping distance will be longer and vehicle control more limited.

While driving on a surface with reduced traction, try your best to avoid sudden steering, acceleration, or braking (including engine braking by shifting to a lower gear). Any sudden changes could cause the tires to slide. You may not realize the surface is slippery until your vehicle is skidding. Learn to recognize warning clues — such as enough water, ice or packed snow on the road to make a "mirrored surface" — and slow down when you have any doubt.

Remember: Any anti-lock braking system (ABS) helps avoid only the braking skid.

Your Driving and the Road



■ *Driving at Night*

Night driving is more dangerous than day driving. One reason is that some drivers are likely to be impaired — by alcohol or drugs, with night vision problems, or by fatigue.

Here are some tips on night driving.

- Drive defensively.
- Don't drink and drive.
- Adjust your inside rearview mirror to reduce the glare from headlights behind you.
- Since you can't see as well, you may need to slow down and keep more space between you and other vehicles.

- Slow down, especially on higher speed roads. Your headlights can light up only so much road ahead.
- In remote areas, watch for animals.
- If you're tired, pull off the road in a safe place and rest.

Night Vision

No one can see as well at night as in the daytime. But as we get older these differences increase. A 50-year-old driver may require at least twice as much light to see the same thing at night as a 20-year-old.

What you do in the daytime can also affect your night vision. For example, if you spend the day in bright sunshine you are wise to wear sunglasses. Your eyes will have less trouble adjusting to night.

But if you're driving, don't wear sunglasses at night. They may cut down on glare from headlights, but they also make a lot of things invisible.

You can be temporarily blinded by approaching lights. It can take a second or two, or even several seconds, for your eyes to readjust to the dark. When you are faced with severe glare (as from a driver who doesn't lower the high beams, or a

vehicle with misaimed headlights), slow down a little. Avoid staring directly into the approaching lights.

Keep your windshield and all the glass on your vehicle clean — inside and out. Glare at night is made much worse by dirt on the glass. Even the inside of the glass can build up a film caused by dust. Dirty glass makes lights dazzle and flash more than clean glass would, making the pupils of your eyes contract repeatedly.

Remember that your headlights light up far less of a roadway when you are in a turn or curve.

Keep your eyes moving; that way, it's easier to pick out dimly lighted objects. Just as your headlights should be checked regularly for proper aim, so should your eyes be examined regularly. Some drivers suffer from night blindness — the inability to see in dim light — and aren't even aware of it.



■ *Driving in the Rain*

Rain and wet roads can mean driving trouble. On a wet road you can't stop, accelerate or turn as well because your tire-to-road traction isn't as good as on dry roads. And, if your tires don't have much tread left, you'll get even less traction. It's always wise to go slower and be cautious if rain starts to fall while you are driving. The surface may get wet suddenly when your reflexes are tuned for driving on dry pavement.

The heavier the rain, the harder it is to see. Even if your windshield wiper blades are in good shape, a heavy rain can make it harder to see road signs and traffic signals, pavement markings, the edge of the road, and even people walking.

It's wise to keep your wiping equipment in good shape and keep your windshield washer tank filled. Replace your windshield wiper inserts when they show signs of streaking or missing areas on the windshield, or when strips of rubber start to separate from the inserts.



Driving too fast through large water puddles or even going through some car washes can cause problems, too. The water may affect your brakes. Try to avoid puddles. But if you can't, try to slow down before you hit them.

Your Driving and the Road



CAUTION:

Wet brakes can cause accidents. They won't work well in a quick stop and may cause pulling to one side. You could lose control of the vehicle.

After driving through a large puddle of water or a car wash, apply your brake pedal lightly until your brakes work normally.

Hydroplaning

Hydroplaning is dangerous. So much water can build up under your tires that they can actually ride on the water. This can happen if the road is wet enough and you're going fast enough. When your vehicle is hydroplaning, it has little or no contact with the road.

Hydroplaning doesn't happen often. But it can if your tires haven't much tread or if the pressure in one or more is low. It can happen if a lot of water is standing on the road. If you can see reflections from trees, telephone poles, or other vehicles, and raindrops "dimple" the water's surface, there could be hydroplaning.

Hydroplaning usually happens at higher speeds. There just isn't a hard and fast rule about hydroplaning. The best advice is to slow down when it is raining.

Some Other Rainy Weather Tips

- Turn on your low-beam headlights — not just your parking lights — to help make you more visible to others.
- Besides slowing down, allow some extra following distance. And be especially careful when you pass another vehicle. Allow yourself more clear room ahead, and be prepared to have your view restricted by road spray.
- Have good tires with proper tread depth. (See "Tires" in the Index.)



■ *City Driving*

One of the biggest problems with city streets is the amount of traffic on them. You'll want to watch out for what the other drivers are doing and pay attention to traffic signals.

Here are ways to increase your safety in city driving:

- Know the best way to get to where you are going. Get a city map and plan your trip into an unknown part of the city just as you would for a cross-country trip.
- Try to use the freeways that rim and crisscross most large cities. You'll save time and energy. (See the next section, "Freeway Driving.")

- Treat a green light as a warning signal. A traffic light is there because the corner is busy enough to need it. When a light turns green, and just before you start to move, check both ways for vehicles that have not cleared the intersection or may be running the red light.

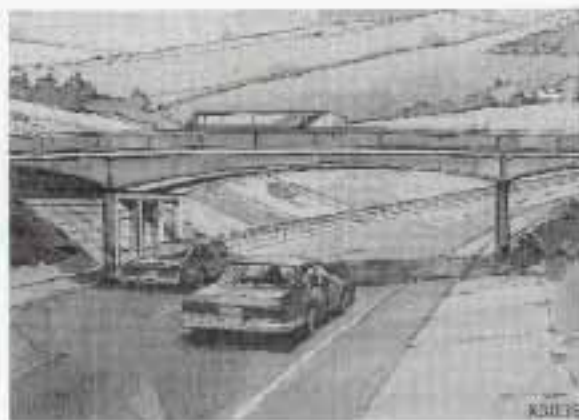

■ *Freeway Driving*

Mile for mile, freeways (also called thruways, parkways, expressways, turnpikes, or superhighways) are the safest of all roads. But they have their own special rules.

The most important advice on freeway driving is: Keep up with traffic and keep to the right. Drive at the same speed most of the other drivers are driving. Too-fast or too-slow driving breaks a smooth traffic flow. Treat the left lane on a freeway as a passing lane.

At the entrance there is usually a ramp that leads to the freeway. If you have a clear view of the freeway as you drive along the entrance ramp, you should

begin to check traffic. Try to determine where you expect to blend with the flow. Try to merge into the gap at close to the prevailing speed. Switch on your turn signal, check your mirrors and glance over your shoulder as often as necessary. Try to blend smoothly with the traffic flow.

Once you are on the freeway, adjust your speed to the posted limit or to the prevailing rate if it's slower. Stay in the right lane unless you want to pass.

Before changing lanes, check your mirrors. Then use your turn signal.

Just before you leave the lane, glance quickly over your shoulder to make sure there isn't another vehicle in your "blind" spot.

Once you are moving on the freeway, make certain you allow a reasonable following distance. Expect to move slightly slower at night.

When you want to leave the freeway, move to the proper lane well in advance. If you miss your exit do not, under any circumstances, stop and back up. Drive on to the next exit.

Your Driving and the Road

The exit ramp can be curved, sometimes quite sharply. The exit speed is usually posted. Reduce your speed according to your speedometer, not to your sense of motion. After driving for any distance at higher speeds, you may tend to think you are going slower than you actually are.

Before Leaving on a Long Trip

Make sure you're ready. Try to be well rested. If you must start when you're not fresh — such as after a day's work — don't plan to make too many miles that first part of the journey. Wear comfortable clothing and shoes you can easily drive in.

Is your vehicle ready for a long trip? If you keep it serviced and maintained, it's ready to go. If it needs service, have it done before starting out. Of course, you'll find experienced and able service experts in Pontiac dealerships all across North America. They'll be ready and willing to help if you need it.

Here are some things you can check before a trip:

- **Windshield Washer Fluid:** Is the reservoir full? Are all windows clean inside and outside?

- **Wiper Blades:** Are they in good shape?
- **Fuel, Engine Oil, Other Fluids:** Have you checked all levels?
- **Lights:** Are they all working? Are the lenses clean?
- **Tires:** They are vitally important to a safe, trouble-free trip. Is the tread good enough for long-distance driving? Are the tires all inflated to the recommended pressure?
- **Weather Forecasts:** What's the weather outlook along your route? Should you delay your trip a short time to avoid a major storm system?
- **Maps:** Do you have up-to-date maps?

Highway Hypnosis

Is there actually such a condition as "highway hypnosis"? Or is it just plain falling asleep at the wheel? Call it highway hypnosis, lack of awareness, or whatever.

There is something about an easy stretch of road with the same scenery, along with the hum of the tires on the road, the drone of the engine, and the rush of the wind against the vehicle that can make you

sleepy. Don't let it happen to you! If it does, your vehicle can leave the road in less than a second, and you could crash and be injured.

What can you do about highway hypnosis? First, be aware that it can happen.

Then here are some tips:

- Make sure your vehicle is well ventilated, with a comfortably cool interior.
- Keep your eyes moving. Scan the road ahead and to the sides. Check your rearview mirrors and your instruments frequently.
- If you get sleepy, pull off the road into a rest, service, or parking area and take a nap, get some exercise, or both. For safety, treat drowsiness on the highway as an emergency.



■ *Hill and Mountain Roads*

Driving on steep hills or mountains is different from driving in flat or rolling terrain. If you drive regularly in steep country, or if you're planning to visit there, here are some tips that can make your trips safer and more enjoyable.

- Keep your vehicle in good shape. Check all fluid levels and also the brakes, tires, cooling system and transmission. These parts can work hard on mountain roads.

- Know how to go down hills. The most important thing to know is this: let your engine do some of the slowing down. Shift to a lower gear when you go down a steep or long hill.



CAUTION:

If you don't shift down, your brakes could get so hot that they wouldn't work well. You would then have poor braking or even none going down a hill. You could crash. Shift down to let your engine assist your brakes on a steep downhill slope.



CAUTION:

Coasting downhill in "N" (Neutral) or with the ignition off is dangerous. Your brakes will have to do all the work of slowing down. They could get so hot that they wouldn't work well. You could crash. Always have your engine running and your vehicle in gear when you go downhill.

- Know how to go uphill. You may want to shift down to a lower gear. The lower gears help cool your engine and transmission, and you can climb the hill better.
- In hilly terrain, you may want to switch to the "PERFORMANCE" mode for better performance.
- Stay in your own lane when driving on two-lane roads in hills or mountains. Don't swing wide or cut across the center of the road. Drive at speeds that let you stay in your own lane.
- As you go over the top of a hill, be alert. There could be something in your lane, like a stalled car or an accident.
- You may see highway signs on mountains that warn of special problems. Examples are long grades, passing or no-passing zones, a falling rocks area, or winding roads. Be alert to these and take appropriate action.

Your Driving and the Road



■ *Winter Driving*

Here are some tips for winter driving:

- Have your Pontiac in good shape for winter. Be sure your engine coolant mix is correct.



- You may want to put winter emergency supplies in your vehicle. Include an ice scraper, a small brush or broom, a supply of windshield washer fluid, a rag, some winter outer clothing, a small shovel, a flashlight, a red cloth, and a couple of reflective warning triangles. And, if you will be driving under severe conditions, include a small bag of sand, a piece of old carpet or a couple of burlap bags to help provide traction. Be sure you properly secure these items in your vehicle.

Driving on Snow or Ice

Most of the time, those places where your tires meet the road probably have good traction.

However, if there is snow or ice between your tires and the road, you can have a very slippery situation. You'll have a lot less traction or "grip" and will need to be very careful.



What's the worst time for this? "Wet ice." Very cold snow or ice can be slick and hard to drive on. But wet ice can be even more trouble because it may offer the least traction of all. You can get "wet ice" when it's about freezing (32°F; 0°C) and freezing rain begins to fall. Try to avoid driving on wet ice until salt and sand crews can get there.

Whatever the condition — smooth ice, packed, blowing or loose snow — drive with caution. If you have traction control, keep the system on. It will improve your ability to accelerate when driving on a slippery road. Even though your vehicle has a traction control system, you'll want to slow down and adjust your driving to the road conditions. See "Traction Control System" in the Index.

If you don't have the traction control system, accelerate gently. Try not to break the fragile traction. If you accelerate too fast, the drive wheels will spin and polish the surface under the tires even more.

Your anti-lock brakes improve your ability to make a hard stop on a slippery road. Even though you have the anti-lock braking system, you'll want to begin stopping sooner than you would on dry pavement. See "Anti-Lock" in the Index.

- Allow greater following distance on any slippery road.
- Watch for slippery spots. The road might be fine until you hit a spot that's covered with ice. On an otherwise clear road, ice patches may appear in shaded areas where the sun can't reach: around clumps of trees, behind buildings, or under bridges. Sometimes the surface of a curve or an overpass may remain icy when the surrounding roads are clear. If you see a patch of ice ahead of you, brake before you are on it. Try not to brake while you're actually on the ice, and avoid sudden steering maneuvers.



If You're Caught in a Blizzard

If you are stopped by heavy snow, you could be in a serious situation. You should probably stay with your vehicle unless you know for sure that you are near help and you can hike through the snow. Here are some things to do to summon help and keep yourself and your passengers safe: Turn on your hazard flashers. Tie a red cloth to your vehicle to alert police that you've been stopped by the snow. Put on extra clothing or wrap a blanket around you. If you have no blankets or extra clothing, make body insulators from newspapers, burlap bags, rags, floor mats — anything you can wrap around yourself or tuck under your clothing to keep warm.

Your Driving and the Road

You can run the engine to keep warm, but be careful.



CAUTION:

Snow can trap exhaust gases under your vehicle. This can cause deadly CO (carbon monoxide) gas to get inside. CO could overcome you and kill you. You can't see it or smell it, so you might not know it is in your vehicle. Clear away snow from around the base of your vehicle, especially any that is blocking your exhaust pipe. And check around again from time to time to be sure snow doesn't collect there.

Open a window just a little on the side of the vehicle that's away from the wind. This will help keep CO out.



Run your engine only as long as you must. This saves fuel. When you run the engine, make it go a little faster than just idle. That is, push the accelerator slightly. This uses less fuel for the heat that you get and it keeps the battery charged. You will need a well-charged battery to restart the vehicle, and possibly for signaling later on with your headlights. Let the heater run for awhile.

Then, shut the engine off and close the window almost all the way to preserve the heat. Start the engine again and repeat this only when you feel really uncomfortable from the cold. But do it as little as possible. Preserve the fuel as long as you can. To help keep warm, you can get out of the vehicle and do some fairly vigorous exercises every half hour or so until help comes.

■ *Towing a Trailer*



CAUTION:

If you don't use the correct equipment and drive properly, you can lose control when you pull a trailer. For example, if the trailer is too heavy, the brakes may not work well — or even at all. You and your passengers could be seriously injured. Pull a trailer only if you have followed all the steps in this section. Ask your Pontiac dealer for advice and information about towing a trailer with your vehicle.

NOTICE:

Pulling a trailer improperly can damage your vehicle and result in costly repairs not covered by your warranty. To pull a trailer correctly, follow the advice in this section, and see your Pontiac dealer for important information about towing a trailer with your vehicle.

Your vehicle can tow a trailer if it is equipped with the proper trailer towing equipment. To identify what the vehicle trailering capacity is for your vehicle, you should read the information in "Weight of the Trailer" that appears later in this section. But trailering is different than just driving your vehicle by itself. Trailering means changes in handling, durability, and fuel economy. Successful, safe trailering takes correct equipment, and it has to be used properly.

That's the reason for this section. In it are many time-tested, important trailering tips and safety rules. Many of these are important for your safety and that of your passengers. So please read this section carefully before you pull a trailer.

Load-pulling components such as the engine, transmission, rear axle, wheel assemblies, and tires are forced to work harder against the drag of the added weight. The engine is required to operate at relatively higher speeds and under greater loads, generating extra heat. What's more, the trailer adds considerably to wind resistance, increasing the pulling requirements.

If You Do Decide to Pull a Trailer

If you do, here are some important points.

- There are many different laws, including speed limit restrictions, having to do with trailering. Make sure your rig will be legal, not only where you live but also where you'll be driving. A good source for this information can be state or provincial police.
- Consider using a sway control. You can ask a hitch dealer about sway controls.
- Don't tow a trailer at all during the first 1,000 miles (1 600 km) your new vehicle is driven. Your engine, axle or other parts could be damaged.

- Then, during the first 500 miles (800 km) that you tow a trailer, don't drive over 50 mph (80 km/h) and don't make starts at full throttle. This helps your engine and other parts of your vehicle wear in at the heavier loads.
- Obey speed limit restrictions when towing a trailer. Don't drive faster than the maximum posted speed for trailers (or no more than 55 mph (90 km/h)) to save wear on your vehicle's parts.

Three important considerations have to do with weight:

Weight of the Trailer

How heavy can a trailer safely be?

It should never weigh more than 1,500 pounds (680 kg) under normal driving conditions. It should never weigh more than 1,000 pounds (450 kg) when driven on long grades at high ambient temperatures. But even that can be too heavy.

Your Driving and the Road

It depends on how you plan to use your rig. For example, speed, altitude, road grades, outside temperature and how much your vehicle is used to pull a trailer are all important. And, it can also depend on any special equipment that you have on your vehicle.

You can ask your dealer for our trailering information or advice, or you can write us at:

Pontiac Division
Customer Assistance Center
One Pontiac Plaza
Pontiac, MI 48340-2952

In Canada, write to:

General Motors of Canada Limited
Customer Assistance Center
1908 Colonel Sam Drive
Oshawa, Ontario L1H 8P7

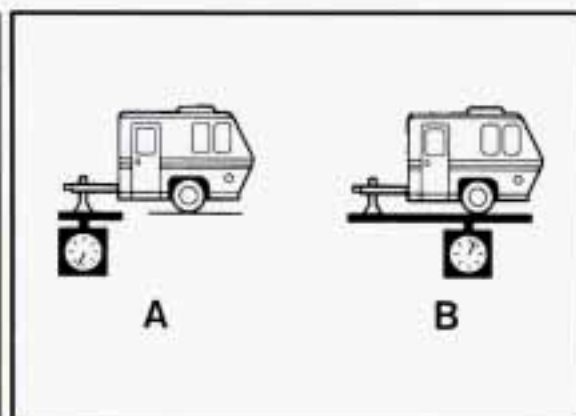

Weight of the Trailer Tongue

The tongue load (A) of any trailer is an important weight to measure because it affects the total capacity weight of your vehicle. The capacity weight includes the curb weight of the vehicle, any cargo you may carry in it, and the people who will be riding in the vehicle. And if you will tow a trailer, you must subtract the tongue load from your vehicle's capacity weight because your vehicle will be carrying that weight, too. See "Loading Your Vehicle" in the Index for more information about your vehicle's maximum load capacity.

If you're using a "dead-weight" hitch, the trailer tongue (A) should weigh 10% of the total loaded trailer weight (B). If you have a "weight-distributing" hitch, the trailer tongue (A) should weigh 12% of the total loaded trailer weight (B).

After you've loaded your trailer, weigh the trailer and then the tongue, separately, to see if the weights are proper. If they aren't, you may be able to get them right simply by moving some items around in the trailer.

Total Weight on Your Vehicle's Tires

Be sure your vehicle's tires are inflated to the limit for cold tires. You'll find these numbers on the Certification label at the rear edge of the driver's door or see "Loading Your Vehicle" in the Index. Then be sure you don't go over the GVW limit for your vehicle.

Hitches

It's important to have the correct hitch equipment. Crosswinds, large trucks going by, and rough roads are a few reasons why you'll need the right hitch. Here are some rules to follow:

- Will you have to make any holes in the body of your vehicle when you install a trailer hitch? If you do, then be sure to seal the holes later when you remove the hitch. If you don't seal them, deadly carbon monoxide (CO) from your exhaust can get into your vehicle (see "Carbon Monoxide" in the Index). Dirt and water can, too.
- The bumpers on your vehicle are not intended for hitches. Do not attach rental hitches or other bumper-type hitches to them. Use only a frame-mounted hitch that does not attach to the bumper.

Safety Chains

You should always attach chains between your vehicle and your trailer. Cross the safety chains under the tongue of the trailer so that the tongue will not drop to the road if it becomes separated from the hitch. Instructions about safety chains may be provided by the hitch

manufacturer or by the trailer manufacturer. Follow the manufacturer's recommendation for attaching safety chains. Always leave just enough slack so you can turn with your rig. And, never allow safety chains to drag on the ground.

Trailer Brakes

If your trailer weighs more than 1,000 pounds (450 kg) loaded, then it needs its own brakes — and they must be adequate. Be sure to read and follow the instructions for the trailer brakes so you'll be able to install, adjust and maintain them properly. Because you have anti-lock brakes, do not try to tap into your vehicle's brake system. If you do, both brake systems won't work well, or at all.

Driving with a Trailer

Towing a trailer requires a certain amount of experience. Before setting out for the open road, you'll want to get to know your rig. Acquaint yourself with the feel of handling and braking with the added weight of the trailer. And always keep in mind that the vehicle you are driving is now a good deal longer and not nearly as responsive as your vehicle is by itself.

Before you start, check the trailer hitch and platform, safety chains, electrical connector, lights, tires and mirror adjustment. If the trailer has electric brakes, start your vehicle and trailer moving and then apply the trailer brake controller by hand to be sure the brakes are working. This lets you check your electrical connection at the same time.

During your trip, check occasionally to be sure that the load is secure, and that the lights and any trailer brakes are still working.

Following Distance

Stay at least twice as far behind the vehicle ahead as you would when driving your vehicle without a trailer. This can help you avoid situations that require heavy braking and sudden turns.

Passing

You'll need more passing distance up ahead when you're towing a trailer. And, because you're a good deal longer, you'll need to go much farther beyond the passed vehicle before you can return to your lane.

Your Driving and the Road

Backing Up

Hold the bottom of the steering wheel with one hand. Then, to move the trailer to the left, just move that hand to the left. To move the trailer to the right, move your hand to the right. Always back up slowly and, if possible, have someone guide you.

Making Turns

When you're turning with a trailer, make wider turns than normal. Do this so your trailer won't strike soft shoulders, curbs, road signs, trees, or other objects. Avoid jerky or sudden maneuvers. Signal well in advance.

Turn Signals When Towing a Trailer

When you tow a trailer, your vehicle has to have a different turn signal flasher and extra wiring. The green arrows on your instrument panel will flash whenever you signal a turn or lane change. Properly hooked up, the trailer lights will also flash, telling other drivers you're about to turn, change lanes or stop.

When towing a trailer, the green arrows on your instrument panel will flash for turns even if the bulbs on the trailer are burned out. Thus, you may think drivers behind you are seeing your signal when they are not. It's important to check occasionally to be sure the trailer bulbs are still working.

Driving on Grades

Reduce speed and shift to a lower gear before you start down a long or steep downgrade. If you don't shift down, you might have to use your brakes so much that they would get hot and no longer work well.

On a long uphill grade, shift down and reduce your speed to around 45 mph (70 km/h) to reduce the possibility of engine and transmission overheating.

If you are towing a trailer and you have an automatic transmission with Overdrive, you may prefer to drive in "D" instead of Overdrive (or, as you need to, a lower gear). Or, if you have a manual transmission with fifth (or sixth) gear and you are towing a trailer, it's better not to use fifth (or sixth) gear. Just drive in fourth gear (fifth gear if you have a

six-speed manual transmission) or, as you need to, a lower gear.

Parking on Hills

You really should not park your vehicle, with a trailer attached, on a hill. If something goes wrong, your rig could start to move. People can be injured, and both your vehicle and the trailer can be damaged.

But if you ever have to park your rig on a hill, here's how to do it:

1. Apply your regular brakes, but don't shift into "P" (Park) yet, or into gear for a manual transmission.
2. Have someone place chocks under the trailer wheels.
3. When the wheel chocks are in place, release the regular brakes until the chocks absorb the load.
4. Reapply the regular brakes. Then apply your parking brake, and then shift to "P" (Park), or "R" (Reverse) for a manual transmission.
5. Release the regular brakes.

When You Are Ready to Leave after Parking on a Hill

1. Apply your regular brakes and hold the pedal down while you:
 - Start your engine;
 - Shift into a gear; and
 - Release the parking brake.
2. Let up on the brake pedal.
3. Drive slowly until the trailer is clear of the chocks.
4. Stop and have someone pick up and store the chocks.

Maintenance When Trailer Towing

Your vehicle will need service more often when you're pulling a trailer. See the Maintenance Schedule for more on this. Things that are especially important in trailer operation are automatic transmission fluid (don't overfill), engine oil, axle lubricant, belts, cooling system, and brake adjustment. Each of these is covered in this manual, and the Index will help you find them quickly. If you're trailering, it's a good idea to review these sections before you start your trip.

Check periodically to see that all hitch nuts and bolts are tight.

Notes



Here you'll find what to do about some problems that can occur on the road.

Part 5 Problems on the Road

Hazard Warning Flashers	152
Jump Starting	153
Towing Your Vehicle	156
Engine Overheating	161
If a Tire Goes Flat	170
If You're Stuck: In Sand, Mud, Ice or Snow	180

Problems on the Road



■ *Hazard Warning Flashers*

Your hazard warning flashers let you warn others. They also let police know you have a problem. Your front and rear turn signal lights will flash on and off.

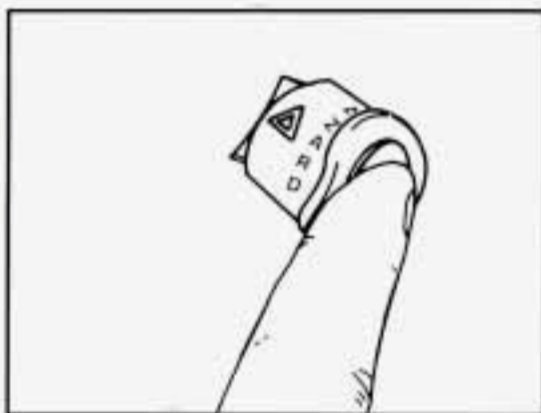

Press the button in to make your front and rear turn signal lights flash on and off.

Your hazard warning flashers work no matter what position your key is in, and even if the key isn't in.

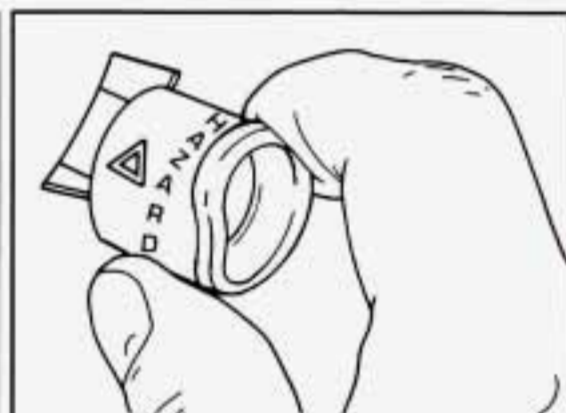

To turn off the flashers, pull out on the collar.

When the hazard warning flashers are on, your turn signals won't work.

Other Warning Devices

If you carry reflective triangles, you can set one up at the side of the road about 300 feet (100 m) behind your vehicle.

■ *Jump Starting*

If your battery has run down, you may want to use another vehicle and some jumper cables to start your Pontiac. But please follow the steps below to do it safely.

CAUTION:

Batteries can hurt you. They can be dangerous because:

- They contain acid that can burn you.
- They contain gas that can explode or ignite.
- They contain enough electricity to burn you.

If you don't follow these steps exactly, some or all of these things can hurt you.

NOTICE:

Ignoring these steps could result in costly damage to your vehicle that wouldn't be covered by your warranty. Trying to start your Pontiac by pushing or pulling it could damage your vehicle, even if you have a manual transmission. And if you have an automatic transmission, it won't start that way.

To Jump Start Your Pontiac:

1. Check the other vehicle. It must have a 12-volt battery with a negative ground system.

NOTICE:

If the other system isn't a 12-volt system with a negative ground, both vehicles can be damaged.

2. Get the vehicles close enough so the jumper cables can reach, but be sure the vehicles aren't touching each

other. If they are, it could cause a ground connection you don't want. You wouldn't be able to start your Pontiac, and the bad grounding could damage the electrical systems.

3. Turn off the ignition on both vehicles. Turn off all lights that aren't needed, and radios. This will avoid sparks and help save both batteries. And it could save your radio!

NOTICE:

If you leave your radio on, it could be badly damaged. The repairs wouldn't be covered by your warranty.

4. Open the hoods and locate the batteries.

Problems on the Road



CAUTION:

An electric fan can start up even when the engine is not running and can injure you. Keep hands, clothing and tools away from any underhood electric fan.

Find the positive (+) and negative (-) terminals on each battery.



CAUTION:

Using a match near a battery can cause battery gas to explode. People have been hurt doing this, and some have been blinded. Use a flashlight if you need more light.

Be sure the battery has enough water. You don't need to add water to the Delco Freedom[®] battery installed in every new GM vehicle. But if a battery has filler caps, be sure the right amount of fluid is there. If it is low, add water to take care of that first. If you don't, explosive gas could be present.

Battery fluid contains acid that can burn you. Don't get it on you. If you accidentally get it in your eyes or on your skin, flush the place with water and get medical help immediately.

5. Check that the jumper cables don't have loose or missing insulation. If they do, you could get a shock. The vehicles could be damaged, too.

Before you connect the cables, here are some basic things you should know. Positive (+) will go to positive (+) and negative (-) will go to negative (-) or a metal engine part. Don't connect (+) to (-) or you'll get a short that would damage the battery and maybe other parts, too.



CAUTION:

Fans or other moving engine parts can injure you badly. Keep your hands away from moving parts once the engines are running.

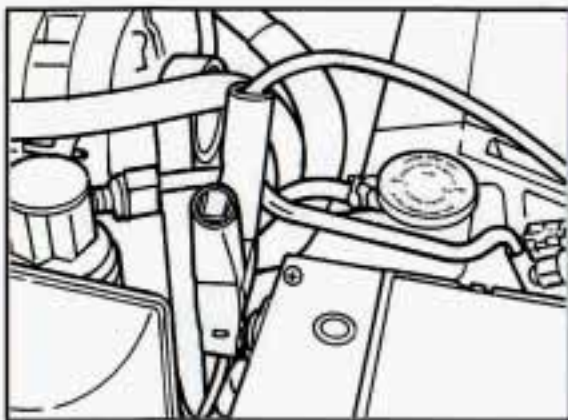

- 6.** Connect the red positive (+) cable to the positive (+) terminal of the vehicle with the dead battery. Use a remote positive (+) terminal if the vehicle has one.

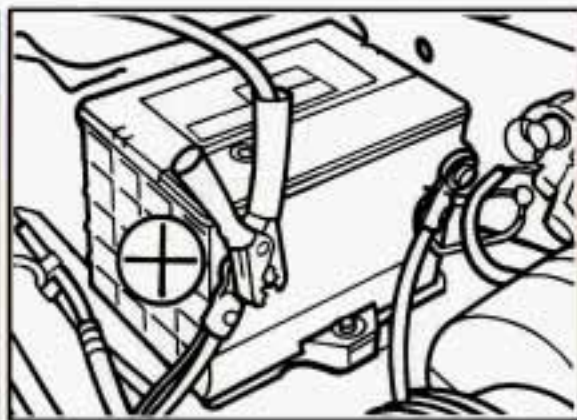

- 7.** Don't let the other end touch metal. Connect it to the positive (+) terminal of the good battery. Use a remote positive (+) terminal if the vehicle has one. But don't use the junction block on your Pontiac.

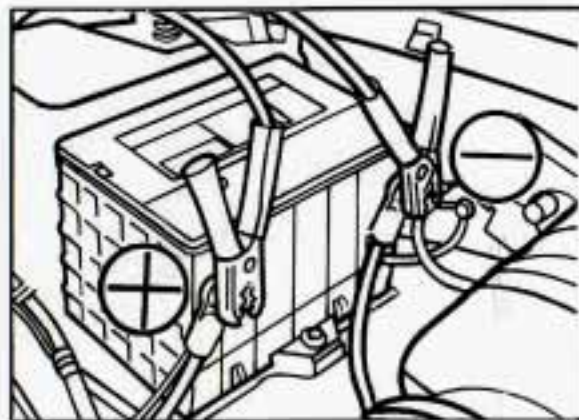

- 8.** Now connect the black negative (-) cable to the good battery's negative (-) terminal.
- Don't let the other end touch anything until the next step. The other end of the negative cable doesn't go to the dead battery. It goes to a heavy unpainted metal part on the engine of the vehicle with the dead battery.

Problems on the Road

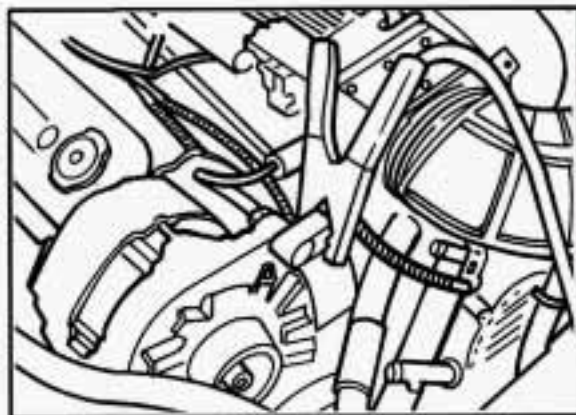

9. Attach the cable at least 18 inches (45 cm) away from the dead battery, but not near engine parts that move. The electrical connection is just as good there, but the chance of sparks getting back to the battery is much less.
10. Now start the vehicle with the good battery and run the engine for a while.

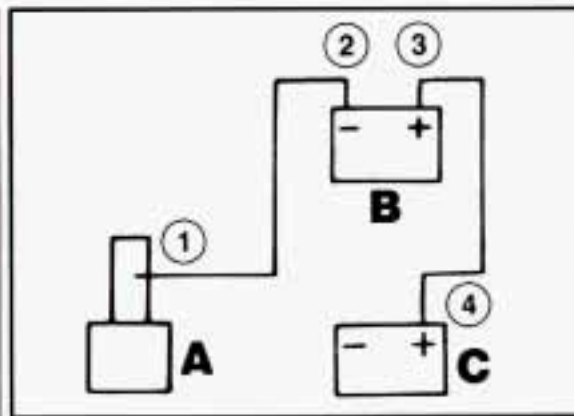

11. Try to start the vehicle with the dead battery.
If it won't start after a few tries, it probably needs service.
12. Remove the cables in reverse order to prevent electrical shorting. Take care that they don't touch each other or any other metal.
 - A. Heavy Metal Engine Part
 - B. Good Battery
 - C. Dead Battery

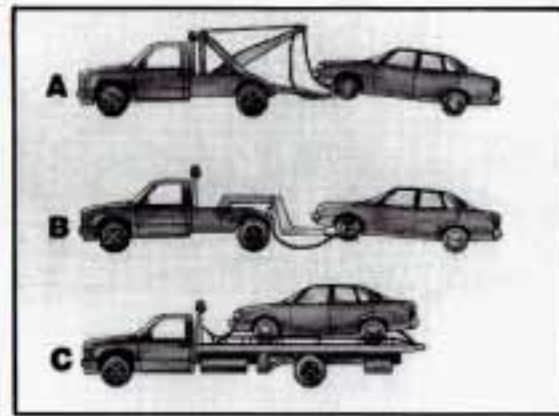

■ *Towing Your Vehicle*

Try to have a GM dealer or a professional towing service tow your Pontiac. The usual towing equipment is a sling-type (A) or a wheel-lift (B) or car carrier (C) tow truck.

If your vehicle has been changed or modified since it was factory-new by adding aftermarket items like fog lamps, aero skirting, or special tires and wheels, these instructions and illustrations may not be correct.

Before you do anything, turn on the hazard warning flashers.

When you call, tell the towing service:

- That your vehicle cannot be towed from the front or rear with sling-type equipment.
- That your vehicle has rear-wheel drive.
- The make, model, and year of your vehicle.
- Whether you can still move the shift lever.
- If there was an accident, what was damaged.

When the towing service arrives, let the tow operator know that this manual contains detailed towing instructions and illustrations. The operator may want to see them.

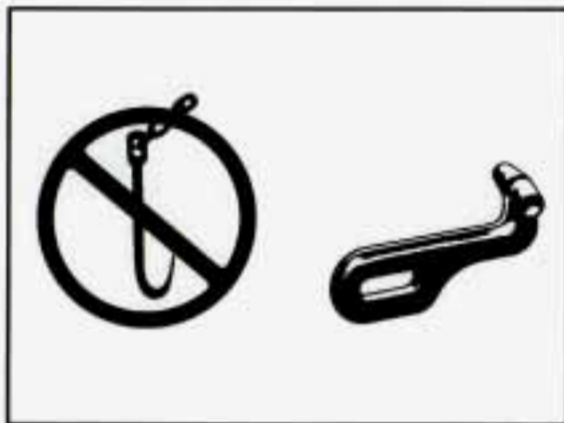

 **CAUTION:**

To help avoid injury to you or others:

- Never let passengers ride in a vehicle that is being towed.
- Never tow faster than safe or posted speeds.
- Never tow with damaged parts not fully secured.
- Never get under your vehicle after it has been lifted by the tow truck.
- Always secure the vehicle on each side with separate safety chains when towing it.
- Never use “J” hooks. Use T-hooks instead.

Problems on the Road

When your vehicle is being towed, have the ignition key off. The steering wheel should be clamped in a straight-ahead position, with a clamping device designed for towing service. Do not use the vehicle's steering column lock for this. The transmission should be in "Neutral" and the parking brake released.

Don't have your vehicle towed on the rear wheels, unless you must. If the vehicle must be towed on the rear wheels, don't go more than 35 mph (55 km/h) or farther than 50 miles (80 km) or your transmission will be damaged. If these limits must be exceeded, then the rear wheels have to be supported on a dolly.



CAUTION:

A vehicle can fall from a car carrier if it isn't adequately secured. This can cause a collision, serious personal injury and vehicle damage. The vehicle should be tightly secured with chains or steel cables before it is transported.

Don't use substitutes (ropes, leather straps, canvas webbing, etc.) that can be cut by sharp edges underneath the towed vehicle. Always use T-hooks inserted in the T-hook slots. Never use J-hooks. They will damage drivetrain and suspension components.

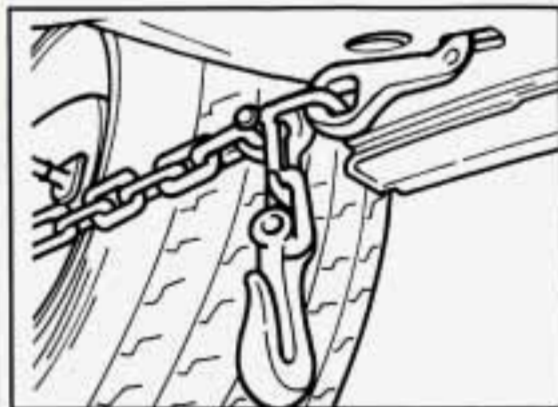

Front Towing Hook-Ups

Attach T-hook chains to slots in frame rearward of front wheels on both sides.

NOTICE:

Do not attach winch cables or "J" hooks to suspension components when using car carrier equipment. Always use T-hooks inserted in the T-hook slots.



NOTICE:

Do not tow with sling-type equipment or fascia/fog light damage will occur.

Use wheel lift or car carrier equipment. Additional ramping may be required for car carrier equipment.

Use safety chains and wheel straps.

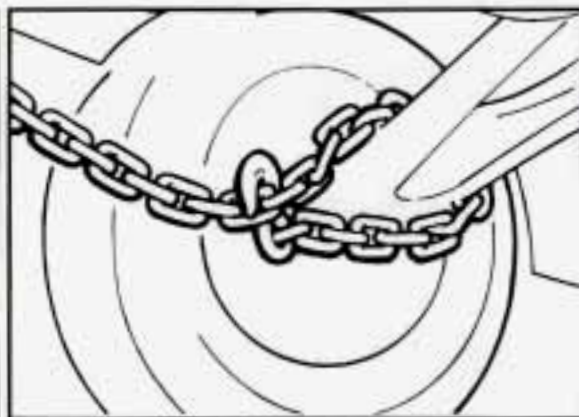

Attach a separate safety chain around outboard end of each lower control arm.

NOTICE:

Take care not to damage the brake pipes and hoses or the ABS sensor and wiring.

NOTICE:

Towing a vehicle over rough surfaces could damage a vehicle. Damage can occur from vehicle-to-ground or vehicle-to-wheel-lift-equipment contact. To help avoid damage, install a towing dolly and raise vehicle until adequate clearance is obtained between the ground and/or wheel-lift equipment.

Problems on the Road

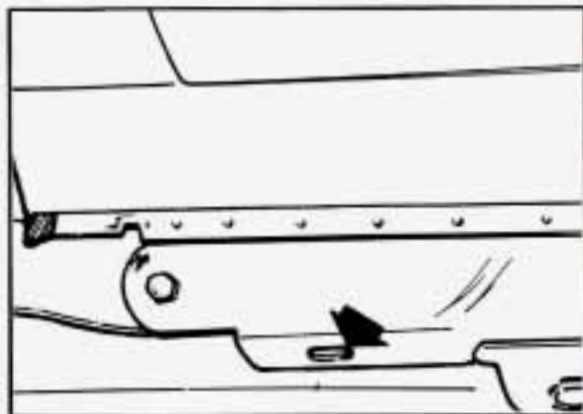

Rear Towing Hook-Ups

Attach T-hook chains in front of rear wheels in bottom of frame rail on both sides.

NOTICE:

Do not attach winch cables or "J" hooks to suspension components when using car carrier equipment. Always use T-hooks inserted in the T-hook slots.

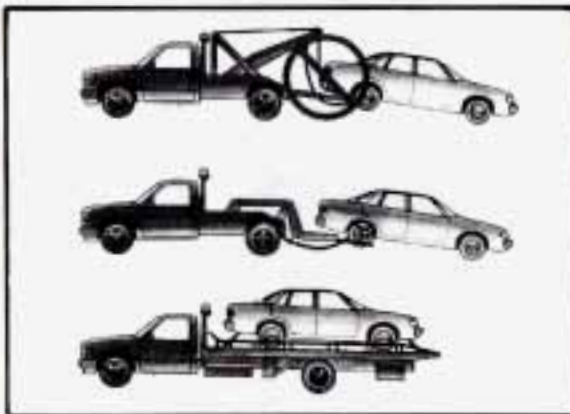

NOTICE:

Do not tow with sling-type equipment or rear bumper valance will be damaged.

Use wheel lift or car carrier equipment. Additional ramping may be required for car carrier equipment.

Use safety chains and wheel straps.

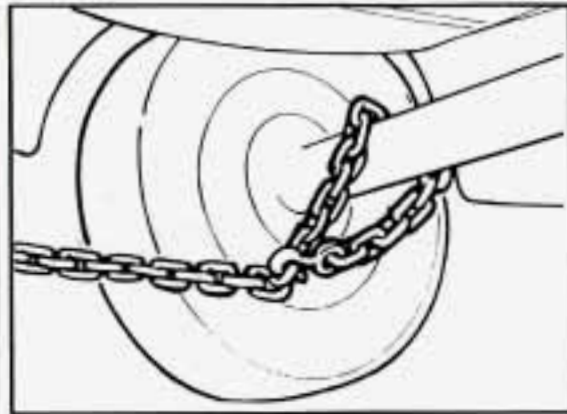

Attach a separate safety chain around outboard end of the rear axle.

NOTICE:

Take care not to damage the brake pipes and cables.

NOTICE:

Towing a vehicle over rough surfaces could damage a vehicle. Damage can occur from vehicle-to-ground or vehicle-to-wheel-lift-equipment contact. To help avoid damage, install a towing dolly and raise vehicle until adequate clearance is obtained between the ground and/or wheel-lift equipment.

■ *Engine Overheating*

You will find a coolant temperature gage on your Pontiac's instrument panel.

You may also find a low coolant warning light on your Pontiac instrument panel.

If Steam Is Coming from Your Engine:



CAUTION:

Steam from an overheated engine can burn you badly, even if you just open the hood. Stay away from the engine if you see or hear steam coming from it. Just turn it off and get everyone away from the vehicle until it cools down. Wait until there is no sign of steam or coolant before opening the hood.

If you keep driving when your engine is overheated, the liquids in it can catch fire. You or others could be badly burned. Stop your engine if it overheats, and get out of the vehicle until the engine is cool.

Problems on the Road

NOTICE:

If your engine catches fire because you keep driving with no coolant, your vehicle can be badly damaged. The costly repairs would not be covered by your warranty.

If No Steam Is Coming from Your Engine:

If you get the overheat warning but see or hear no steam, the problem may not be too serious. Sometimes the engine can get a little too hot when you:

- Climb a long hill on a hot day.
- Stop after high speed driving.
- Idle for long periods in traffic.
- Tow a trailer.

If you get the overheat warning with no sign of steam, try this for a minute or so:

1. If you have an air conditioner, turn it off.
2. Turn on your heater to full hot at the highest fan speed and open the window as necessary.
3. Try to keep your engine under load (in a drive gear where the engine runs slower).

If you no longer have the overheat warning, you can drive. Just to be safe, drive slower for about ten minutes. If the warning doesn't come back on, you can drive normally.

If the warning continues, pull over, stop, and park your vehicle right away.

If there's still no sign of steam, you can idle the engine for two or three minutes while you're parked, to see if the warning stops. But then, if you still have the warning, **TURN OFF THE ENGINE AND GET EVERYONE OUT OF THE VEHICLE** until it cools down.

You may decide not to lift the hood but to get service help right away.

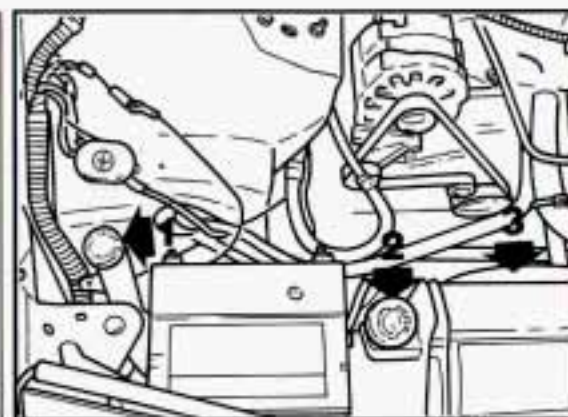

Cooling System

When you decide it's safe to lift the hood, here's what you'll see on the V6 engine:

1. Coolant recovery tank
2. Radiator pressure cap
3. Electric engine fan

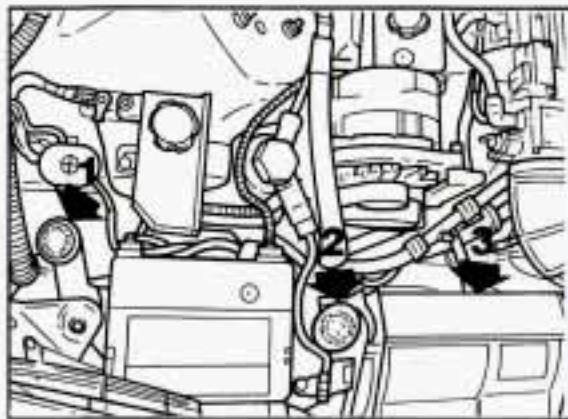

On the V8 engine you'll see this:

1. Coolant recovery tank
2. Radiator pressure cap
3. Electric engine fans

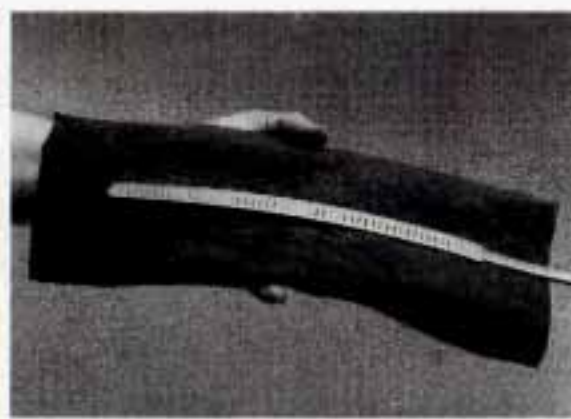

If the coolant inside the coolant recovery tank is boiling, don't do anything else until it cools down.

When it is cool, remove the coolant recovery tank cap and look at the dipstick. The coolant level should be at or above "FULL COLD." If it isn't, you may have a leak in the radiator hoses, heater hoses, radiator, water pump or somewhere else in the cooling system.

 **CAUTION:**

An electric fan under the hood can start up even when the engine is not running and can injure you. Keep hands, clothing and tools away from any underhood electric fan.

 **CAUTION:**

Heater and radiator hoses, and other engine parts, can be very hot. Don't touch them. If you do, you can be burned.

Don't run the engine if there is a leak. If you run the engine, it could lose all coolant. That could cause an engine fire, and you could be burned. Get any leak fixed before you drive the vehicle.

NOTICE:

Engine damage from running your engine without coolant isn't covered by your warranty.

If there seems to be no leak, check to see if the electric engine fan is running. If the engine is overheating, the fan should be running. If it isn't, your vehicle needs service.

Problems on the Road



How to Add Coolant to the Coolant Recovery Tank

If you haven't found a problem yet, but the coolant level isn't at or above the "FULL COLD" mark, add a 50/50 mixture of clean water (preferably distilled) and a proper antifreeze at the coolant recovery tank. (See "Engine Coolant" in the Index for more information about the proper coolant mix.)

CAUTION:

Adding only plain water to your cooling system can be dangerous. Plain water, or some other liquid like alcohol, can boil before the proper coolant mix will. Your vehicle's coolant warning system is set for the proper coolant mix. With plain water or the wrong mix, your engine could get too hot but you wouldn't get the overheat warning. Your engine could catch fire and you or others could be burned. Use a 50/50 mix of clean water and a proper antifreeze.

NOTICE:

In cold weather, water can freeze and crack the engine, radiator, heater core and other parts. Use the recommended coolant.

CAUTION:

You can be burned if you spill coolant on hot engine parts. Coolant contains ethylene glycol and it will burn if the engine parts are hot enough. Don't spill coolant on a hot engine.

When the coolant in the coolant recovery tank is at or above the "FULL COLD" mark, start your vehicle.

If the overheat warning continues, there's one more thing you can try. You can add the proper coolant mix directly to the radiator, but be sure the cooling system is cool before you do it.

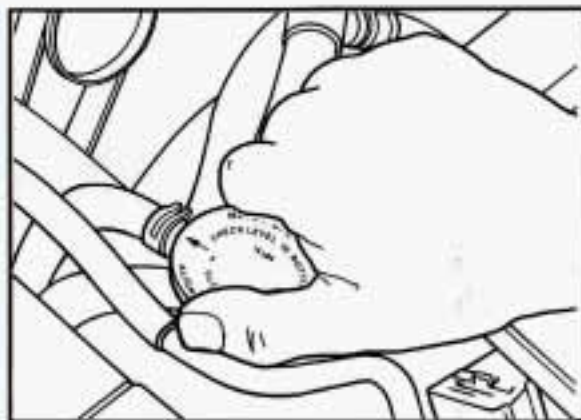
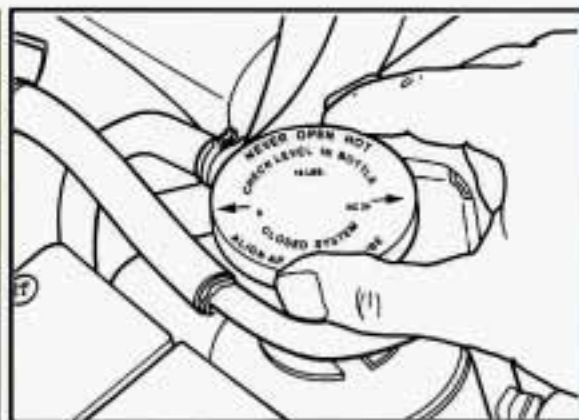

⚠ CAUTION:

Steam and scalding liquids from a hot cooling system can blow out and burn you badly. They are under pressure, and if you turn the radiator pressure cap — even a little — they can come out at high speed. Never turn the cap when the cooling system, including the radiator pressure cap, is hot. Wait for the cooling system and radiator pressure cap to cool if you ever have to turn the pressure cap.

**How to Add Coolant to the Radiator
(3.4L L32 (Code S) Engine)**

1. You can remove the radiator pressure cap when the cooling system, including the radiator pressure cap and upper radiator hose, is no longer hot. Turn the pressure cap slowly to the left until it first stops. (Don't press down while turning the pressure cap.)
If you hear a hiss, wait for that to stop. A hiss means there is still some pressure left.

2. Then keep turning the pressure cap, but now push down as you turn it. Remove the pressure cap.

Problems on the Road

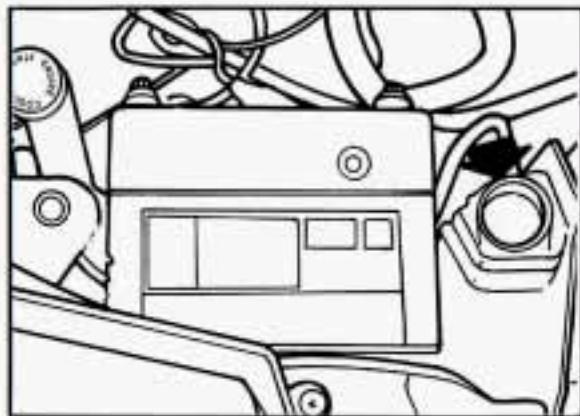

- 3.** Fill the radiator with the proper mix, up to the base of the filler neck.

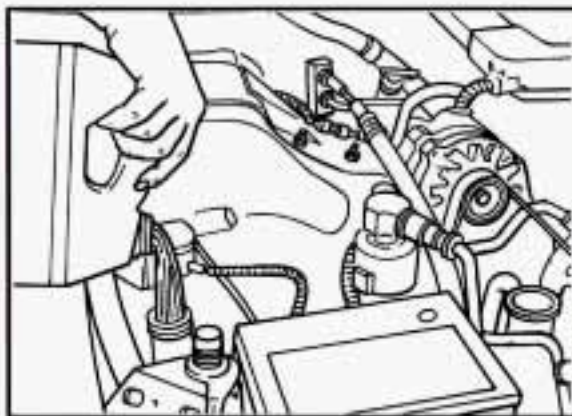

- 4.** Then fill the coolant recovery tank to "FULL COLD."

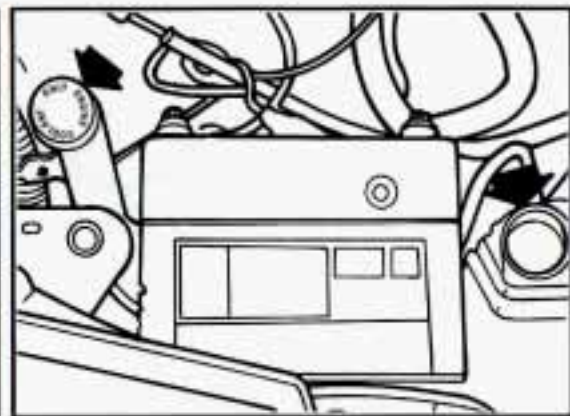

- 5.** Put the cap back on the coolant recovery tank, but leave the radiator pressure cap off.

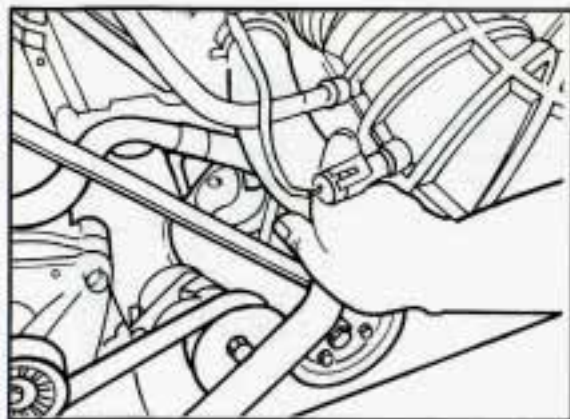

6. Start the engine and let it run until you can feel the upper radiator hose getting hot. Watch out for the engine fan(s).
7. By this time the coolant level inside the radiator filler neck may be lower. If the level is lower, add more of the proper mix through the filler neck until the level reaches the base of the filler neck.

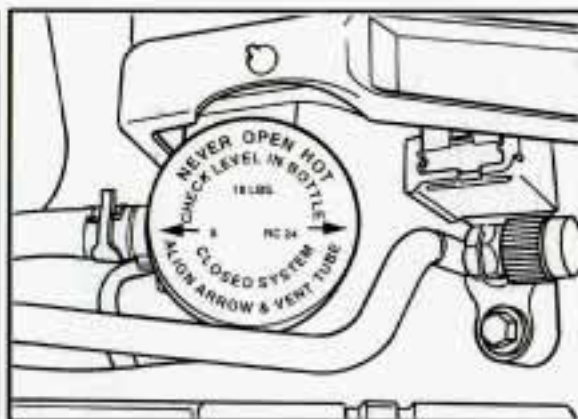

8. Then replace the pressure cap. At any time during this procedure if coolant begins to flow out of the filler neck, reinstall the pressure cap. Be sure the arrows on the pressure cap line up like this.

How to Add Coolant to the Radiator (5.7L LT1 (Code P) Engine)

NOTICE:

The LT1 engine (Code P) has a specific radiator fill procedure. Failure to follow this procedure could cause your engine to overheat and be severely damaged.

4. Fill with the proper mix. Add coolant until you see a steady stream of coolant coming from the bleed valves.
5. Close the bleed valves.

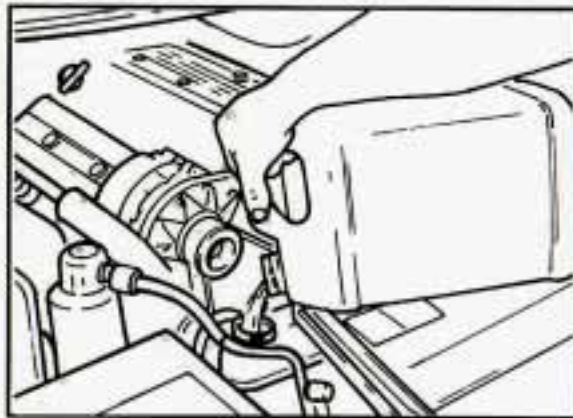

6. Continue to fill the radiator up to the base of the filler neck.
7. Rinse or wipe the spilled coolant from the engine and compartment.

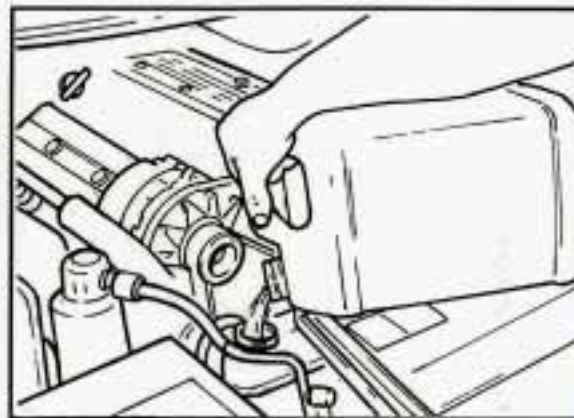

8. Start the engine and allow it to run in idle for approximately four minutes. By this time, the coolant level inside the radiator will be lower. Add more of the proper mix through the filler neck until the level reaches the base of the filler neck.

Problems on the Road

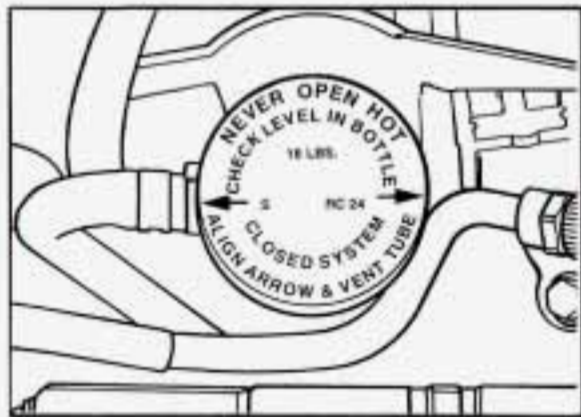

9. Shut the engine off and replace the pressure cap. Be sure the arrows on the cap line up like this.

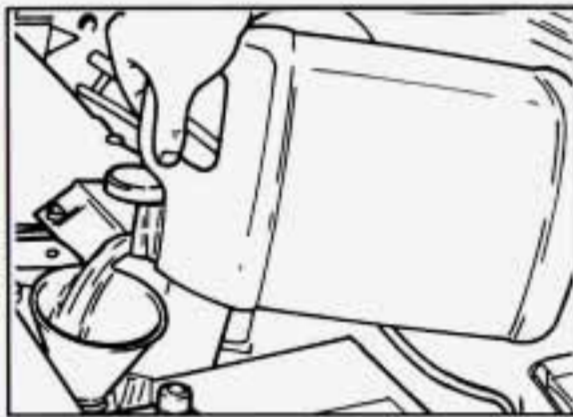

10. Then fill the coolant recovery tank to the proper level.

For a complete drain, flush and refill, see your Pontiac dealer or a Pontiac Firebird Service Manual. To purchase a service manual, see "Service Publications" in the Index.

■ *If a Tire Goes Flat*

It's unusual for a tire to "blow out" while you're driving, especially if you maintain your tires properly. If air goes out of a tire, it's much more likely to leak out slowly. But if you should ever have a "blowout," here are a few tips about what to expect and what to do:

If a front tire fails, the flat tire will create a drag that pulls the vehicle toward that side. Take your foot off the accelerator pedal and grip the steering wheel firmly. Steer to maintain lane position, then gently brake to a stop well out of the traffic lane.

A rear blowout, particularly on a curve, acts much like a skid and may require the same correction you'd use in a skid. In any rear blowout, remove your foot from the accelerator pedal. Get the vehicle under control by steering the way you want the vehicle to go. It may be very bumpy and noisy, but you can still steer. Gently brake to a stop, well off the road if possible.

If a tire goes flat, the next section shows how to use your jacking equipment to change a flat tire safely.



Changing a Flat Tire

If a tire goes flat, avoid further tire and wheel damage by driving slowly to a level place. Turn on your hazard warning flashers.

CAUTION:

Changing a tire can cause an injury. The vehicle can slip off the jack and roll over you or other people. You and they could be badly injured. Find a level place to change your tire. To help prevent the vehicle from moving:

1. Set the parking brake firmly.
2. Put an automatic transmission shift lever in "P" (Park), or shift a manual transmission to "1" (First) or "R" (Reverse).
3. Turn off the engine.

To be even more certain the vehicle won't move, you can put chocks at the front and rear of the tire farthest away from the one being changed. That would be the tire on the other side of the vehicle, at the opposite end.



The following steps will tell you how to use the jack and change a tire.

The equipment you'll need is in the rear area.

First you must remove the close-out panel. See "Close-Out Panel" in the Index.

On convertible models, you must also remove the trunk access panel. It's at the upper back of the trunk. Turn the two screw knobs under the trunk edge a quarter turn counterclockwise to remove the panel.

Find the plastic screw heads in the trim panel over the spare tire. Use a coin or a key to turn the screw heads until the slots point front and back. Lift the trim panel and move it out of the way.

Problems on the Road

If you have speakers in the trim panel, you will have to disconnect the speaker wire before completely removing the trim panel.

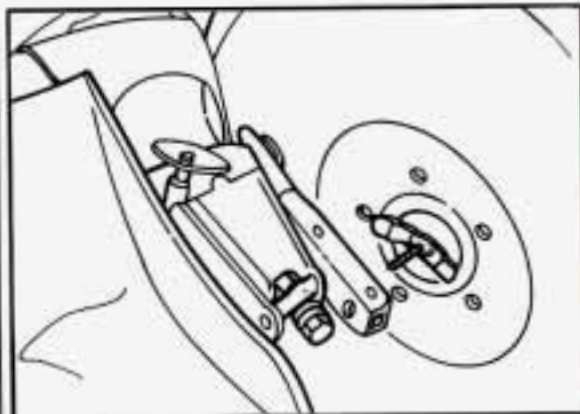

To remove the jack and wheel wrench, loosen and remove the bolt and remove the plastic cover.



Remove the wing nut and adapter and pull out the spare.

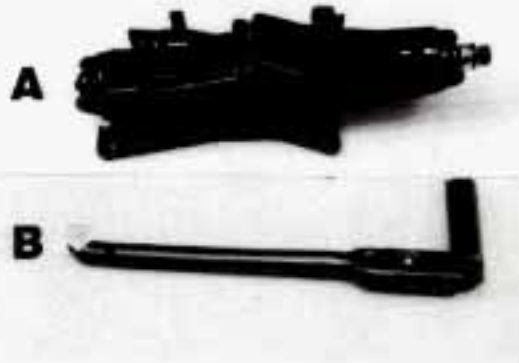

Start with the jack (A) and wheel wrench (B).

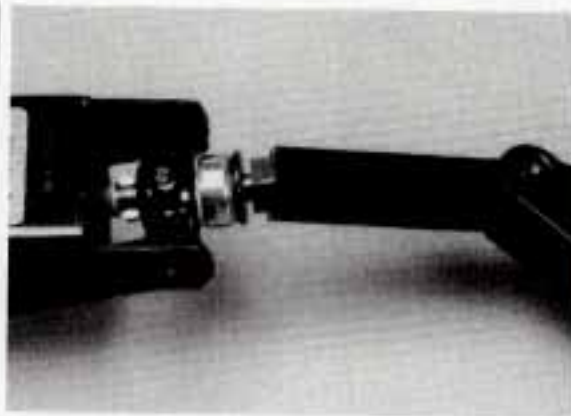

The jack has a bolt at the end. Attach the wheel wrench to the jack bolt.

Turn the wheel wrench to the right to raise the lift head a little.

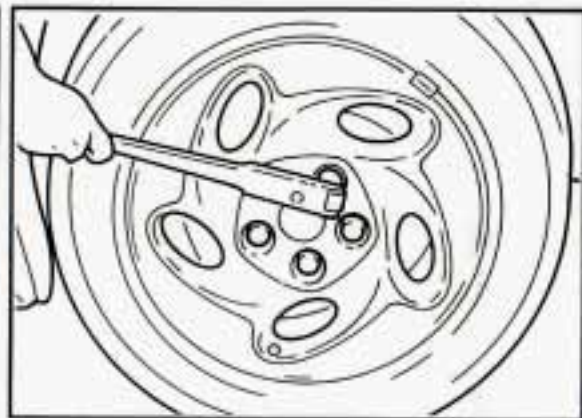

If your wheel has a bolt-on center cap, loosen the plastic caps using the wheel wrench.

Problems on the Road

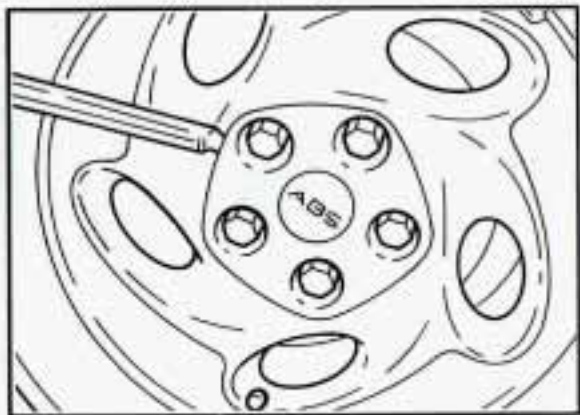

Then pry off the center cap with the wheel wrench.

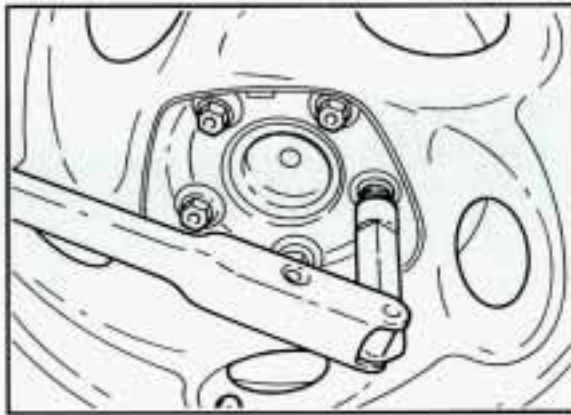

If your vehicle has optional alloy wheels, each wheel may have one locknut in place of the standard wheel nut. A special wheel lock key (removal tool) and instructions are located in the center console. Attach the wheel lock key to the socket of the wheel wrench. Remove the locking wheel nut by turning counterclockwise.

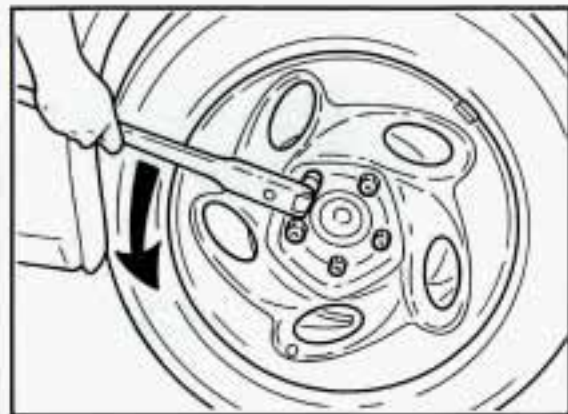

Using the wheel wrench, loosen all the wheel nuts. Don't remove them yet.

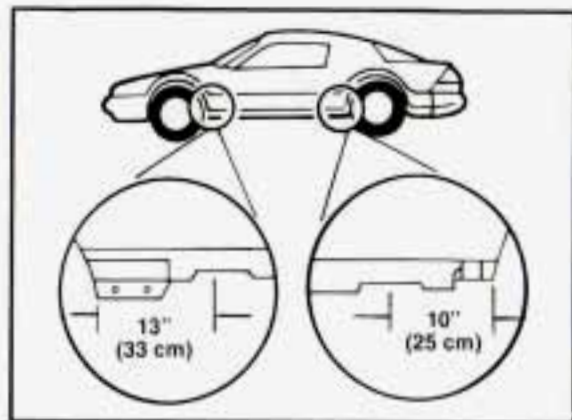

Position the jack under the vehicle. There is a notch in the vehicle's rocker flange on the coupe model. Raise the jack head until it fits firmly into the notch nearest the flat tire.

On convertible models, place the jack in a similar location.

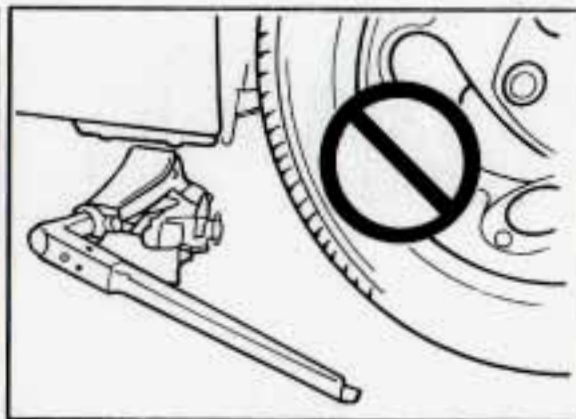

Stay away from the moldings or fender flanges to avoid damaging them.



CAUTION:

Getting under a vehicle when it is jacked up is dangerous. If the vehicle slips off the jack, you could be badly injured or killed. Never get under a vehicle when it is supported only by a jack.

NOTICE:

Raising your vehicle with the jack improperly positioned will damage the vehicle or may allow the vehicle to fall off the jack. Be sure to fit the jack lift head into the proper location before raising your vehicle.

Problems on the Road

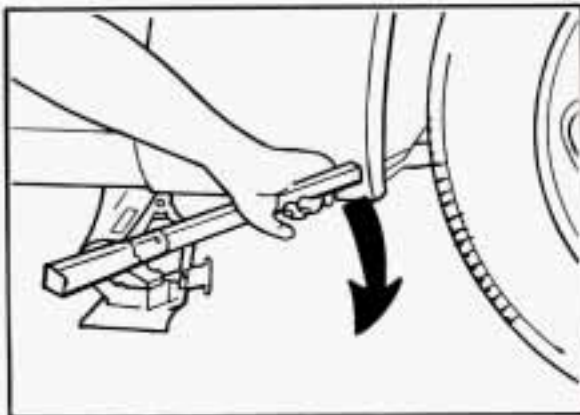

Raise the vehicle by rotating the wheel wrench clockwise. Raise the vehicle far enough off the ground so there is enough room for the spare tire to fit.



Remove all the wheel nuts and take off the flat tire.

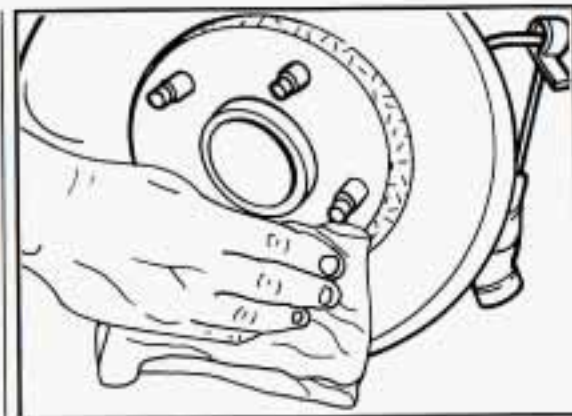

CAUTION:

Rust or dirt on the wheel, or on the parts to which it is fastened, can make the wheel nuts become loose after a time. The wheel could come off and cause an accident. When you change a wheel, remove any rust or dirt from the places where the wheel attaches to the vehicle. In an emergency, you can use a cloth or a paper towel to do this; but be sure to use a scraper or wire brush later, if you need to, to get all the rust or dirt off.

Remove any rust or dirt from the wheel bolts, mounting surfaces and spare wheel. Place the spare on the wheel mounting surface.

 **CAUTION:**

Never use oil or grease on studs or nuts. If you do, the nuts might come loose. Your wheel could fall off, causing a serious accident.

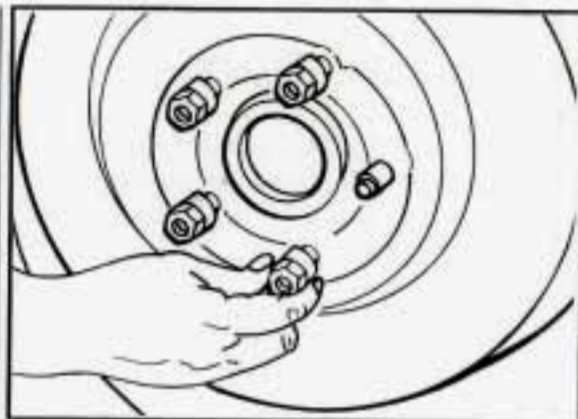

Replace the wheel nuts with the rounded end of the nuts toward the wheel. Tighten each nut by hand until the wheel is held against the hub.

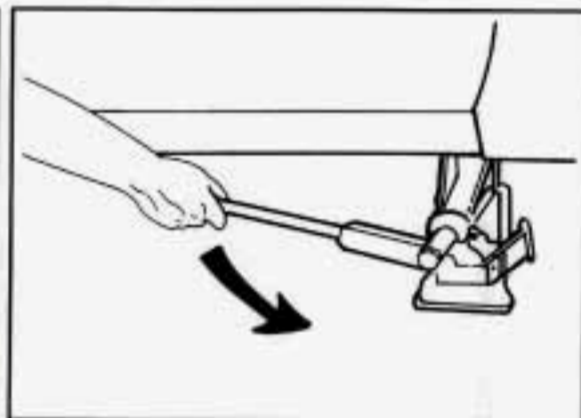

Lower the vehicle by rotating the wheel wrench counterclockwise. Lower the jack completely.

Problems on the Road

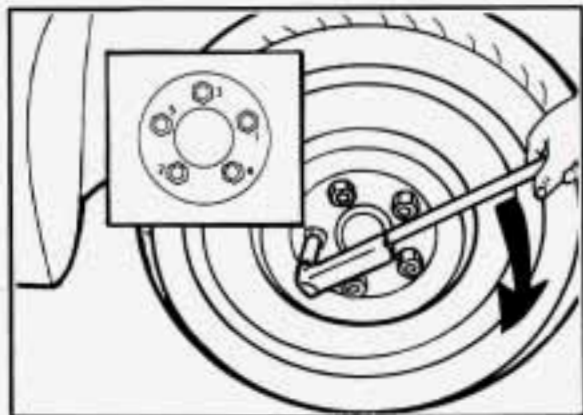

Tighten the wheel nuts firmly in a criss-cross sequence as shown.

CAUTION:

Incorrect wheel nuts or improperly tightened wheel nuts can cause the wheel to become loose and even come off. This could lead to an accident. Be sure to use the correct wheel nuts. If you have to replace them, be sure to get the right kind.

Stop somewhere as soon as you can and have the nuts tightened with a torque wrench to 100 pound-feet (140 N•m).

Don't try to put a center cap on your compact spare tire. It won't fit. Store the center cap in the rear area until you have the flat tire repaired or replaced.

NOTICE:

Center caps won't fit on your compact spare. If you try to put a center cap on your compact spare, you could damage the cover or the spare.

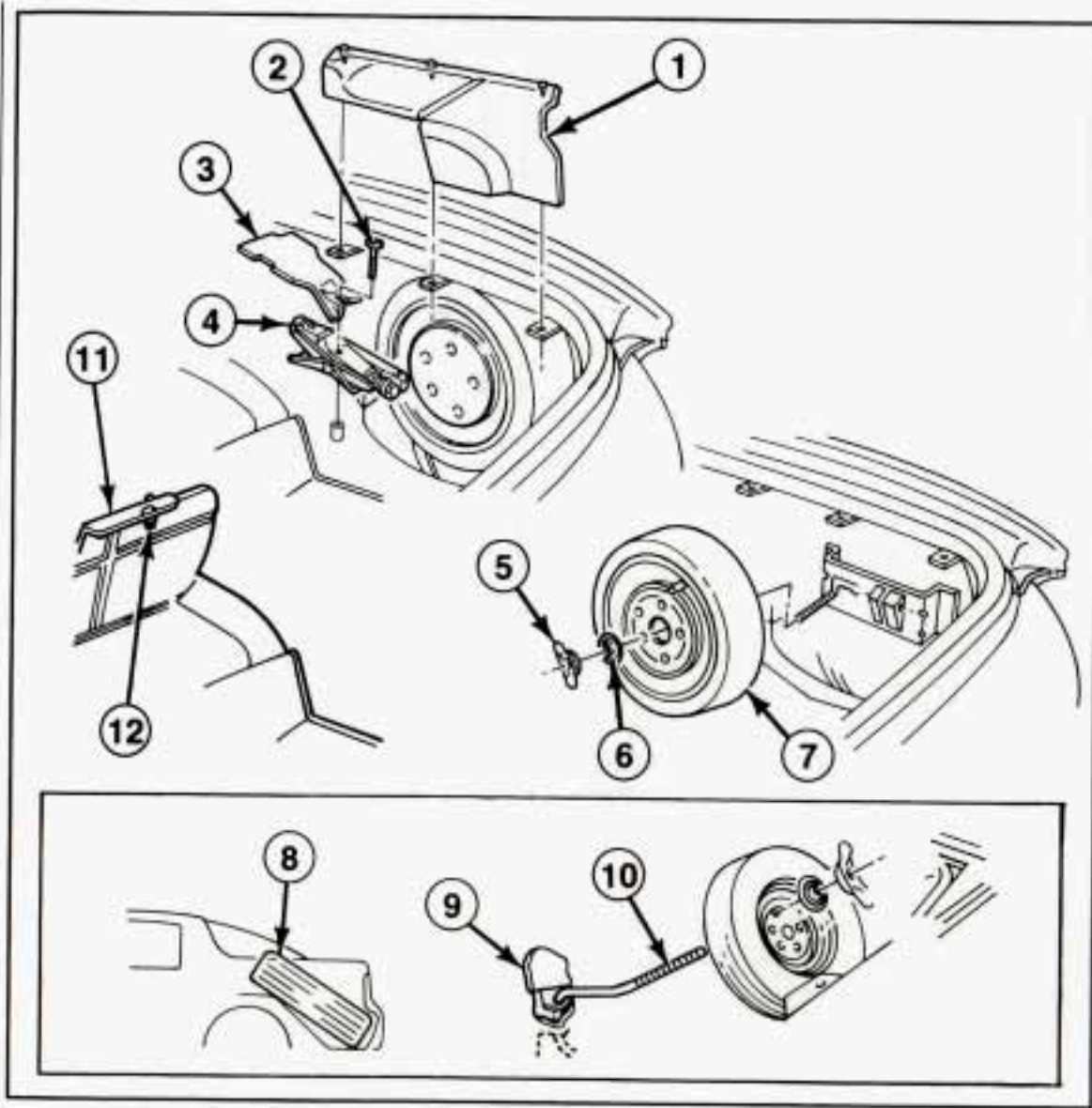

Replace the jack, wheel wrench and flat tire using the storage instructions. When you replace the trim panel, be sure to tuck it under the weatherstrip.

- 1. Trim Panel
- 2. Bolt
- 3. Cover
- 4. Jack
- 5. Wing Nut
- 6. Adapter
- 7. Compact Spare Tire
- 8. Full-Size Tire
- 9. Carpet Flap
- 10. Tire Storage Bolt
- 11. Trunk Access Panel (Convertible Only)
- 12. Knob

Problems on the Road



CAUTION:

Storing a jack, a tire or other equipment in the passenger compartment of the vehicle could cause injury. In a sudden stop or collision, loose equipment could strike someone. Store all these in the proper place.

Compact Spare Tire

Although the compact spare was fully inflated when your vehicle was new, it can lose air after a time. Check the inflation pressure regularly. It should be 60 psi (420 kPa). After installing the compact spare on your vehicle, you should stop as soon as possible and make sure your spare tire is correctly inflated. The compact spare is made to perform well at posted speed limits for distances up to 3,000 miles (5 000 km), so you can finish your trip and have your full-size tire repaired or replaced where you want. Of course, it's best to replace your spare with a full-size tire as soon as you can. Your spare will last longer and be in good shape in case you need it again.

NOTICE:

If the compact spare is used as a rear tire, do not drive faster than 50 mph (80 km/h). Damage to the rear axle may occur if the compact spare is driven faster than 50 mph (80 km/h). This speed limitation does not apply when the compact spare is used as a front tire.

NOTICE:

Don't take your compact spare through an automatic car wash with guide rails. The compact spare can get caught on the rails. That can damage the tire and wheel, and maybe other parts of your vehicle.

Don't use your compact spare on some other vehicle.

And don't mix your compact spare or wheel with other wheels or tires. They won't fit. Keep your spare and its wheel together.

NOTICE:

Tire chains won't fit your compact spare. Using them will damage your vehicle and destroy the chains too. Don't use tire chains on your compact spare.

■ *If You're Stuck: In Sand, Mud, Ice or Snow*

What you don't want to do when your vehicle is stuck is to spin your wheels. The method known as "rocking" can help you get out when you're stuck, but you must use caution.



CAUTION:

If you let your tires spin at high speed, they can explode and you or others could be injured. And, the transmission or other parts of the vehicle can overheat. That could cause an engine compartment fire or other damage. When you're stuck, spin the wheels as little as possible. Don't spin the wheels above 35 mph (55 km/h) as shown on the speedometer.

NOTICE:

Spinning your wheels can destroy parts of your vehicle as well as the tires. If you spin the wheels too fast while shifting your transmission back and forth, you can destroy your transmission.

Rocking your vehicle to get it out:

First, turn your steering wheel left and right. That will clear the area around your front wheels. If your vehicle has traction control, you should turn the system off. (See "Traction Control System" in the Index.) Then shift back and forth between "R" (Reverse) and a forward gear (or with a manual transmission, between First or Second gear and Reverse), spinning the wheels as little as possible. Release the accelerator pedal while you shift, and press lightly on the accelerator pedal when the transmission is in gear. If that doesn't get you out after a few tries, you may need to be towed out. If you do need to be towed out, see "Towing Your Vehicle" in the Index.

Notes



Here you will find information about the care of your Pontiac. This part begins with service and fuel information, and then it shows how to check important fluid and lubricant levels. There is also technical information about your vehicle, and a section devoted to its appearance care.

Part 6 Service & Appearance Care

Service	184
Fuel	185
Checking Things under the Hood	188
Hood Release	188
Engine Oil	191
Air Cleaner	195
Automatic Transmission Fluid	198
Manual Transmission Fluid	200
Hydraulic Clutch	201
Rear Axle	201
Engine Coolant	201
Power Steering Fluid	204
Windshield Washer Fluid	205
Brake Master Cylinder	206
Battery	208
Bulb Replacement	209
Loading Your Vehicle	213
Tires	215
Appearance Care	221
Appearance Care and Maintenance Materials	227
Vehicle Identification Number (VIN)	228
Service Parts Identification Label	228
Add-On Electrical Equipment	228
Fuses and Circuit Breakers	228
Replacement Bulbs	232
Capacities and Specifications	233

Service and Appearance Care



■ *Service*

Your Pontiac dealer knows your vehicle best and wants you to be happy with it. We hope you'll go to your dealer for all your service needs. You'll get genuine GM parts and GM-trained and supported service people.

We hope you'll want to keep your GM vehicle all GM. Genuine GM parts have one of these marks.

Doing Your Own Service Work

If you want to do some of your own service work, you'll want to get the proper Pontiac Service Manual. It tells you much more about how to service your Pontiac than this manual can. To order the proper service manual, see "Service Publications" in the Index.

Your vehicle has an air bag system. Before attempting to do your own service work, see "Servicing Your Air Bag-Equipped Pontiac" in the Index.

You should keep a record with all parts receipts and list the mileage and the date of any service work you perform. See "Maintenance Record" in the Index.



CAUTION:

You can be injured if you try to do service work on a vehicle without knowing enough about it.

- Be sure you have sufficient knowledge, experience, and the proper replacement parts and tools before you attempt any vehicle maintenance task.
- Be sure to use the proper nuts, bolts and other fasteners. "English" and "metric" fasteners can be easily confused. If you use the wrong fasteners, parts can later break or fall off. You could be hurt.

NOTICE:

If you try to do your own service work without knowing enough about it, your vehicle could be damaged.

■ Fuel

The 8th digit of your Vehicle Identification Number (VIN) shows the code letter for your engine. You will find the VIN at the top left of your instrument panel. (See "Vehicle Identification Number" in the Index.)

3.4L L32 (Code S)

Use regular unleaded gasoline rated at 87 octane or higher. It should meet specifications ASTM D4814 in the U.S. and CGSB 3.5-92 in Canada. These fuels should have the proper additives, so you should not have to add anything to the fuel.

In the U.S. and Canada, it's easy to be sure you get the right kind of gasoline (unleaded). You'll see "UNLEADED" right on the pump. And only unleaded nozzles will fit into your vehicle's filler neck.

Be sure the posted octane is at least 87. If the octane is less than 87, you may get a heavy knocking noise when you drive. If it's bad enough, it can damage your engine.

If you're using fuel rated at 87 octane or higher and you still hear heavy knocking, your engine needs service. But don't worry if you hear a little pinging noise when you're accelerating or driving up a hill. That's normal, and you don't have to buy a higher octane fuel to get rid of pinging. It's the heavy, constant knock that means you have a problem.

5.7L LT1 (Code P)

Use premium unleaded gasoline rated at 91 octane or higher. You may use middle grade or regular unleaded gasolines, but your vehicle may not accelerate as well. The gasoline you use should meet specifications ASTM D4814 in the U.S. and CGSB 3.5-92 in Canada. These fuels should have the proper additives, so you should not have to add anything to the fuel.

In the U.S. and Canada, it's easy to be sure you get the right kind of gasoline (unleaded). You'll see "UNLEADED" right on the pump. And only unleaded nozzles will fit into your vehicle's filler neck.

Be sure the posted octane for premium is at least 91 (at least 89 for middle grade and 87 for regular). If the octane is less than 87, you may get a heavy knocking noise when you drive. If it's bad enough, it can damage your engine.

If you're using fuel rated at 91 octane or higher and you still hear heavy knocking, your engine needs service. But don't worry if you hear a little pinging noise when you're accelerating or driving up a hill. That's normal and you don't have to buy a higher octane fuel to get rid of pinging. It's the heavy, constant knock that means you have a problem.

All Engines

What about gasoline with blending materials that contain oxygen (oxygenates), such as MTBE or alcohol?

MTBE is "methyl tertiary-butyl ether." Fuel that is no more than 15% MTBE is fine for your vehicle.

Ethanol is ethyl or grain alcohol. Properly-blended fuel that is no more than 10% ethanol is fine for your vehicle.

Methanol is methyl or wood alcohol.

Service and Appearance Care

NOTICE:

Fuel that is more than 5% methanol is bad for your vehicle. Don't use it. It can corrode metal parts in your fuel system and also damage plastic and rubber parts. That damage wouldn't be covered under your warranty. And even at 5% or less, there must be "cosolvents" and corrosion preventers in this fuel to help avoid these problems.

Gasolines for Cleaner Air

Your use of gasoline with deposit control additives will help prevent deposits from forming in your engine and fuel system. That helps keep your engine in tune and your emission control system working properly. It's good for your vehicle, and you'll be doing your part for cleaner air.

Many gasolines are now blended with oxygenates. General Motors recommends that you use gasolines with these blending materials, such as MTBE and ethanol. By doing so, you can help clean the air, especially in those parts of the country that have high carbon monoxide levels.

In addition, some gasoline suppliers are now producing reformulated gasolines. These gasolines are specially designed to reduce vehicle emissions. General Motors recommends that you use reformulated gasoline. By doing so, you can help clean the air, especially in those parts of the country that have high ozone levels.

You should ask your service station operators if their gasolines contain deposit control additives and oxygenates, and if they have been reformulated to reduce vehicle emissions.

Fuels in Foreign Countries

If you plan on driving in another country outside the U.S. or Canada, unleaded fuel may be hard to find. Do not use leaded gasoline. If you use even one tankful, your emission controls won't work well or at all. With continuous use, spark plugs can get fouled, the exhaust system can corrode, and your engine oil can deteriorate quickly. Your vehicle's oxygen sensor will be damaged. All of that means costly repairs that wouldn't be covered by your warranty.

To check on fuel availability, ask an auto club, or contact a major oil company that does business in the country where you'll be driving.

You can also write us at the following address for advice. Just tell us where you're going and give your Vehicle Identification Number (VIN).

General Motors Overseas Distribution
Corporation
North American Export Sales (NAES)
1908 Colonel Sam Drive
Oshawa, Ontario L1H 8P7
Canada

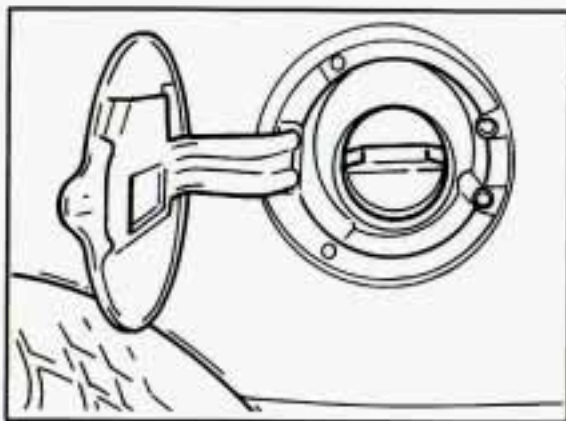

Filling Your Tank

CAUTION:

Gasoline vapor is highly flammable. It burns violently, and that can cause very bad injuries. Don't smoke if you're near gasoline or refueling your vehicle. Keep sparks, flames, and smoking materials away from gasoline.

The cap is behind a hinged door on the left side of your vehicle.

To take off the cap, turn it slowly to the left (counterclockwise).

CAUTION:

If you get gasoline on you and then something ignites it, you could be badly burned. Gasoline can spray out on you if you open the fuel filler cap too quickly. This spray can happen if your tank is nearly full, and is more likely in hot weather. Open the fuel filler cap slowly and wait for any "hiss" noise to stop. Then unscrew the cap all the way.

Be careful not to spill gasoline. Clean gasoline from painted surfaces as soon as possible. See "Cleaning the Outside of Your Pontiac" in the Index.

When you put the cap back on, turn it to the right until you hear at least three clicks.

NOTICE:

If you need a new cap, be sure to get the right type. Your dealer can get one for you. If you get the wrong type, it may not fit and your fuel tank and emissions system might be damaged.

Service and Appearance Care

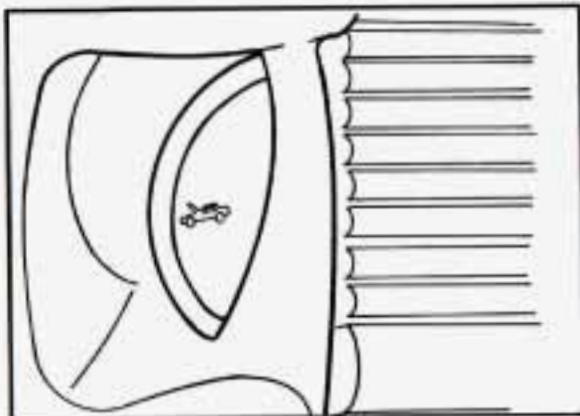

■ *Checking Things under the Hood*

Hood Release

To open the hood, first pull the handle inside the vehicle.

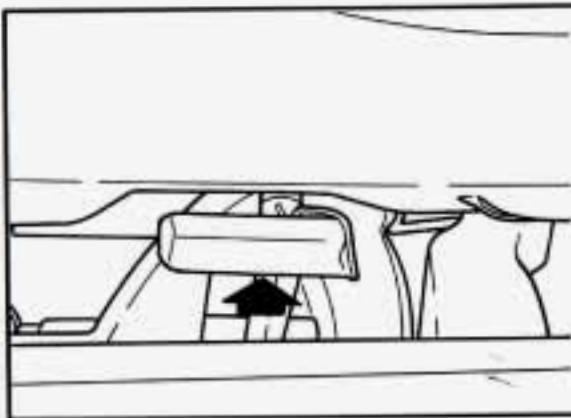

Then go to the front of the vehicle and pull up on the hood release.

Lift the hood.



CAUTION:

An electric fan under the hood can start up and injure you even when the engine is not running. Keep hands, clothing and tools away from any underhood electric fan.

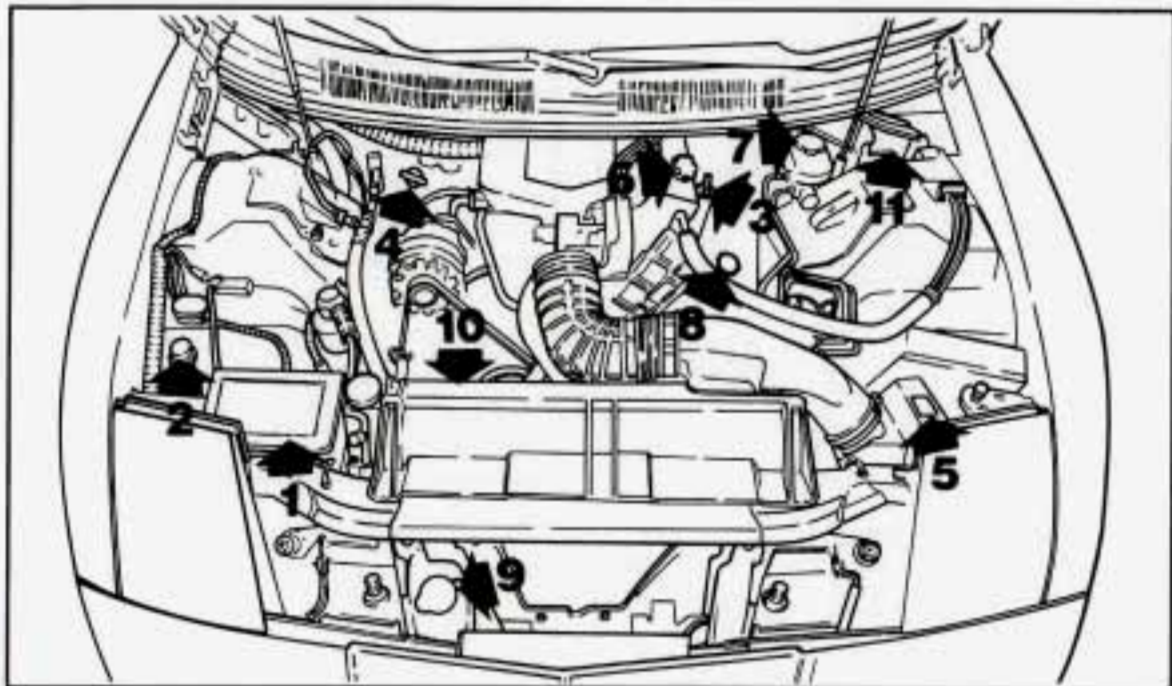

X4L L32 (Code S)

When you open the hood you'll see.

1. Battery
2. Engine Coolant Reservoir
3. Engine Oil Dipstick
4. Automatic Transmission Dipstick (if equipped)
5. Air Cleaner
6. Oil Fill Cap
7. Brake Fluid Reservoir
8. Power Steering Reservoir
9. Windshield Washer Reservoir
10. Engine Fan
11. Clutch Fluid Reservoir (if equipped)

Service and Appearance Care

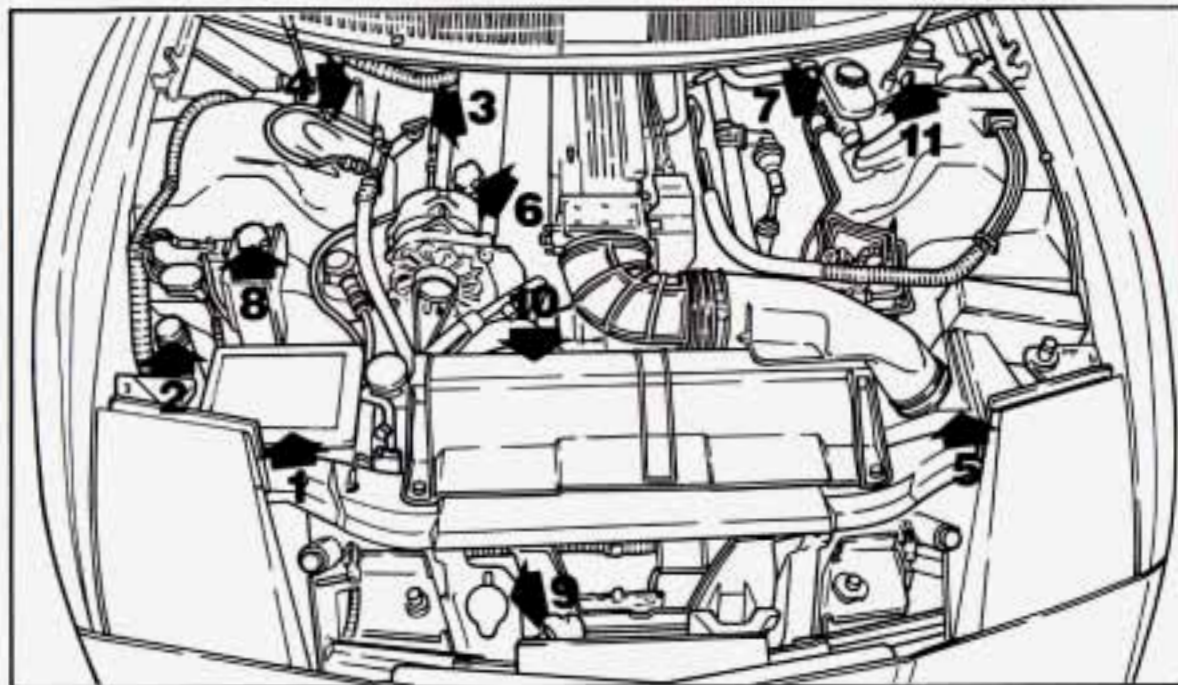

5.7L LT1 (Code P)

When you open the hood you'll see:

1. Battery
2. Engine Coolant Reservoir
3. Engine Oil Dipstick
4. Automatic Transmission Dipstick (if equipped)
5. Air Cleaner
6. Oil Fill Cap
7. Brake Fluid Reservoir
8. Power Steering Reservoir
9. Windshield Washer Reservoir
10. Engine Fans
11. Clutch Fluid Reservoir (if equipped)



CAUTION:

Things that burn can get on hot engine parts and start a fire. These include liquids like gasoline, oil, coolant, brake fluid, windshield washer and other fluids, and plastic or rubber. You or others could be burned. Be careful not to drop or spill things that will burn onto a hot engine.

Before closing the hood, be sure all the filler caps are on.

Then just pull the hood down and close it firmly.

LOW OIL

Engine Oil

If the "LOW OIL" light on the instrument panel comes on, it means you need to check your engine oil level right away. For more information, see "Low Oil Light" in the Index. You should check your engine oil level regularly; this is an added reminder.

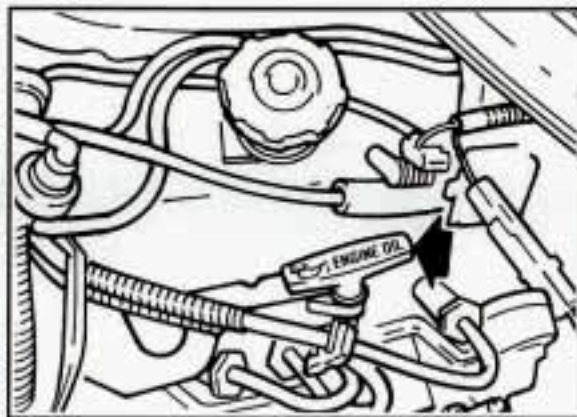

3.4L L32 (Code S)

It's a good idea to check your engine oil every time you get fuel. In order to get an accurate reading, the oil must be warm and the vehicle must be on level ground.

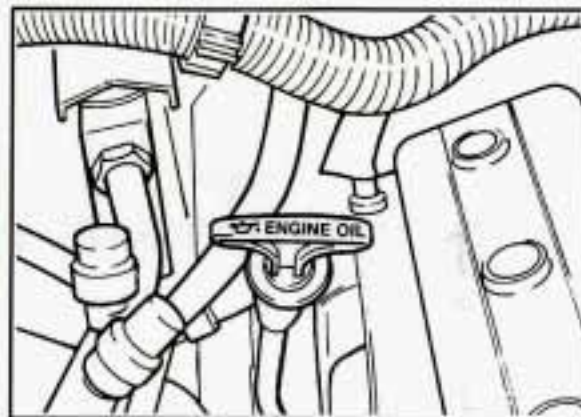

5.7L ET1 (Code P)

Turn off the engine and give the oil a few minutes to drain back into the oil pan. If you don't, the oil dipstick might not show the actual level.

Service and Appearance Care



To Check Engine Oil (3.4L L32 (Code S) Engine)

Pull out the dipstick and clean it with a paper towel or cloth, then push it back in all the way. Remove it again, keeping the tip lower, and check the level.



To Check Engine Oil (5.7L LT1 (Code P) Engine)

Pull out the dipstick slightly. Pinch the end of the dipstick tube as you remove the dipstick to wipe the oil from it. Then push it all the way back in. Now remove it without pinching the tube, keeping the tip lower.

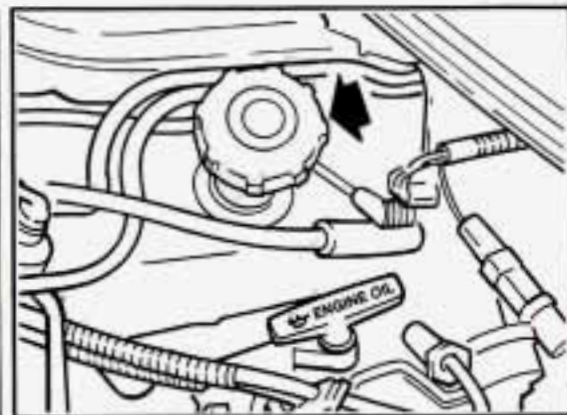

3.4L L32 (Code S)

When to Add Oil:

If the oil is at or below the "ADD" line, then you'll need to add some oil. But you must use the right kind. This section explains what kind of oil to use. For crankcase capacity, see "Capacities and Specifications" in the Index.

NOTICE:

Don't add too much oil. If your engine has so much oil that the oil level gets above the cross-hatched area that shows the proper operating range, your engine could be damaged.



5.7L LFI (Code P)

Just fill it enough to put the level somewhere in the proper operating range. Push the dipstick all the way back in when you're through.



What Kind of Oil to Use:

Beginning midyear 1993, oils of the proper quality for your vehicle will be identified with this new "starburst" symbol. The "starburst" symbol indicates that the oil has been certified by the American Petroleum Institute (API), and is preferred for use in your gasoline engine.

You should look for this on the front of the oil container, and use only oils that display this new symbol.

You should also use the proper viscosity oil for your vehicle, as shown in the following chart.

Service and Appearance Care

Recommended SAE Viscosity Grade Engine Oils

For best fuel economy and cold starting, select the lowest SAE viscosity grade oil for the expected temperature range.

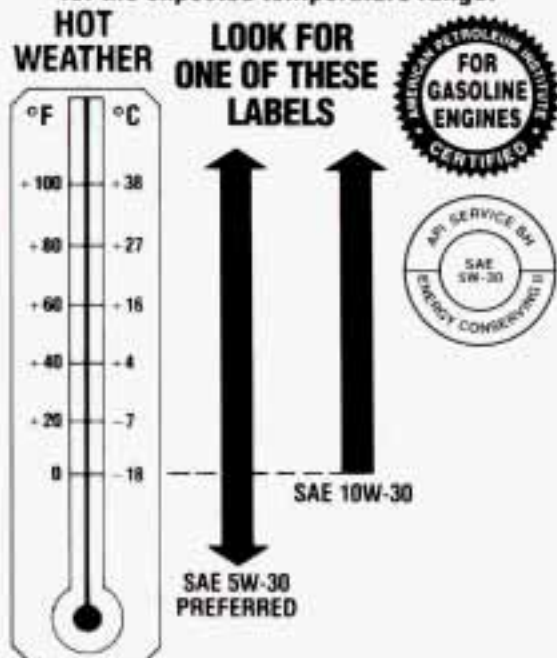

COLD WEATHER

IF NEITHER SAE 5W-30 NOR SAE 10W-30 GRADE OILS ARE AVAILABLE, SAE 30 GRADE MAY BE USED AT TEMPERATURES ABOVE 40 DEGREES F (4 DEGREES C).

DO NOT USE SAE 10W-40, SAE 20W-50 OR ANY OTHER GRADE OIL NOT RECOMMENDED.

As shown in the chart, SAE 5W-30 is best for your vehicle. However, you can use SAE 10W-30 if it's going to be 0°F (-18°C) or above.

These numbers on an oil container show its viscosity, or thickness. Do not use other viscosity oils such as SAE 10W-40 or SAE 20W-50.

If you cannot find oils with the new "starburst" symbol on the front of the container, you should look for and use oils containing the following three things:

- SH or SG
"SH" or "SG" must be on the oil container, either by itself or combined with other quality designations, such as "SH/CD," "SH, SG, CD," "SG/CD," etc. These letters show American Petroleum Institute (API) levels of quality.
- SAE 5W-30
- Energy Conserving II
Oils with these words on the container will help you save fuel.

These three things are usually included in a doughnut shaped logo (symbol) on most containers. If you cannot find oils with the "starburst" symbol, you should look for oils with the doughnut shaped symbol, containing the three things noted above.

NOTICE:

If you use oils that do not have either the "starburst" symbol or an API SH or SG designation, you can cause engine damage not covered by your warranty.

GM Goodwrench[®] oil (in Canada, GM Engine Oil) meets all the requirements for your vehicle.

Engine Oil Additives:

Don't add anything to your oil. Your Pontiac dealer is ready to advise if you think something should be added.

When to Change Engine Oil:

See if any one of these is true for you:

- Most trips are less than 4 miles (6 km).
- It's below freezing outside and most trips are less than 10 miles (16 km).
- The engine is at low speed most of the time (as in door-to-door delivery, or in stop-and-go traffic).
- You tow a trailer often.
- Most trips are through dusty places.

If any one of these is true for your vehicle, then you need to change your oil and filter every 3,000 miles (5 000 km) or 3 months — whichever comes first.

If none of them is true, change the oil every 7,500 miles (12 500 km) or 12 months — whichever comes first.

Change the filter at the first oil change and at every other oil change after that.

Engine Coolant Heater (Engine Block Heater):

An engine coolant heater can be a big help if you have to park outside in very cold weather, 0°F (-18°C) or colder. If your vehicle has this option, see "Engine Coolant Heater" in the Index.

What to Do with Used Oil:

Did you know that used engine oil contains elements that may be unhealthy for your skin and could even cause cancer? Don't let used oil stay on your skin for very long. Clean your skin and nails with soap and water, or a good hand cleaner. Wash or properly throw away clothing or rags containing used engine oil. (See the manufacturer's warnings about the use and disposal of oil products.)

Used oil can be a real threat to the environment. If you change your own oil, be sure to drain all free-flowing oil from the filter before disposal. Don't ever dispose of oil by putting it in the trash, pouring it on the ground, into sewers, or into streams or bodies of water. Instead, recycle it by taking it to a place that collects used oil. If you have a problem properly disposing of your used oil, ask your dealer, a service station or a local recycling center for help.

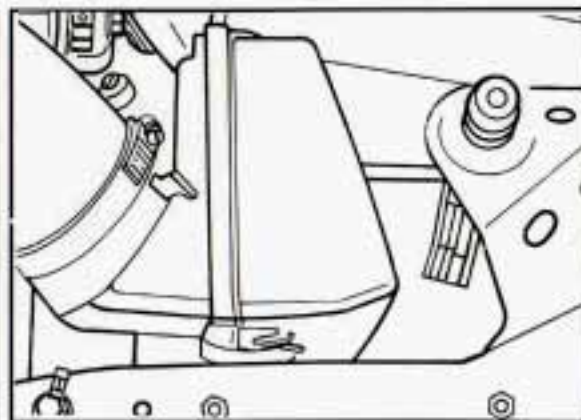

3.4L I,32 (Code S)

Air Cleaner

Refer to the Maintenance Schedule to determine when to replace the air filter. See "Scheduled Maintenance Services" in the Index.

Service and Appearance Care

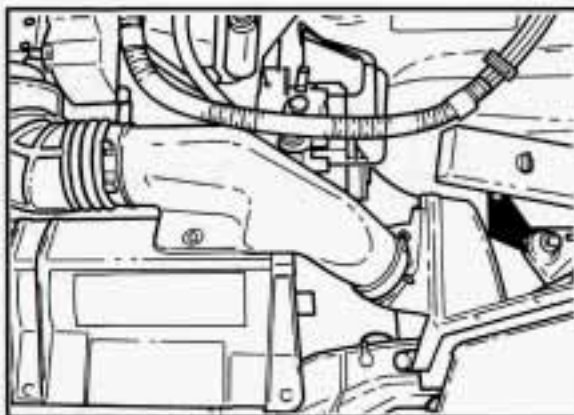

5.7L LT1 (Code P)



CAUTION:

Operating the engine with the air cleaner off can cause you or others to be burned. The air cleaner not only cleans the air, it stops flame if the engine backfires. If it isn't there, and the engine backfires, you could be burned. Don't drive with it off, and be careful working on the engine with the air cleaner off.

NOTICE:

If the air cleaner is off, a backfire can cause a damaging engine fire. And, dirt can easily get into your engine, which will damage it. Always have the air cleaner in place when you're driving.



Air Filter Replacement

To remove the air filter:

1. Remove the plastic pin by pulling it straight up.

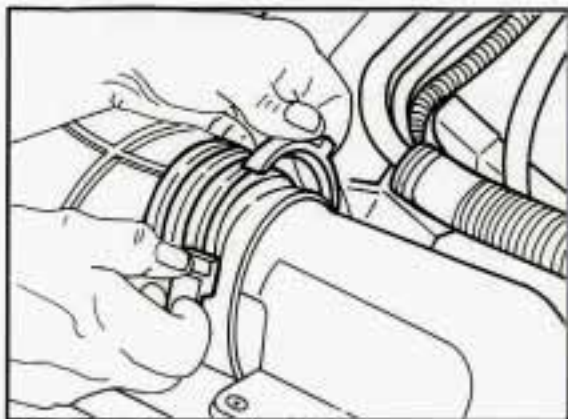

- 2.** Disconnect the plastic clamp on the duct. Pull apart the connection.



- 3.** Pull the air cleaner straight up. Unclamp the metal clips.

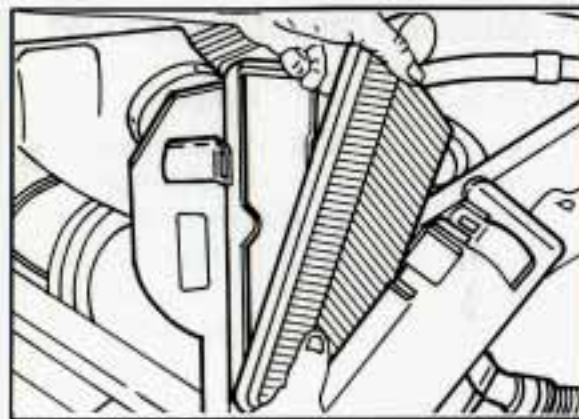

- 4.** Open the air cleaner and remove the filter.

Service and Appearance Care

Automatic Transmission Fluid

When to Check and Change:

A good time to check your automatic transmission fluid level is when the engine oil is changed. Refer to the Maintenance Schedule to determine when to change your fluid. See "Scheduled Maintenance Services" in the Index.

How to Check:

Because this operation can be a little difficult, you may choose to have this done at a Pontiac dealership Service Department.

If you do it yourself, be sure to follow all the instructions here, or you could get a false reading on the dipstick.

NOTICE:

Too much or too little fluid can damage your transmission. Too much can mean that some of the fluid could come out and fall on hot engine parts or exhaust system, starting a fire. Be sure to get an accurate reading if you check your transmission fluid.

Wait at least 30 minutes before checking the transmission fluid level if you have been driving:

- When outside temperatures are above 90°F (32°C).
- At high speed for quite a while.
- In heavy traffic — especially in hot weather.
- While pulling a trailer.

To get the right reading, the fluid should be at normal operating temperature, which is 180°F to 200°F (82°C to 93°C).

To check transmission fluid hot: Get the vehicle warmed up by driving about 15 miles (24 km) when outside temperatures are above 50°F (10°C). If it's colder than 50°F (10°C), drive the vehicle in "D" (Third Gear) until the engine temperature gage moves and then remains steady for ten minutes. Then follow the hot check procedures.

To check transmission fluid cold: A cold check is made after the vehicle has been sitting for eight hours or more with the engine off and is used only as a reference. Let the engine run at idle for five minutes if outside temperatures are 50°F (10°C) or more. If it's colder than 50°F (10°C), you may have to idle the engine longer. Should the fluid level be low during a cold check, you must perform a hot check before adding fluid. This will give you a more accurate reading of the fluid level.

To check the fluid hot or cold:

- Park your vehicle on a level place.
- With the parking brake applied, place the shift lever in "P" (Park).
- With your foot on the brake pedal, move the shift lever through each gear range, pausing for about three seconds in each range. Then, position the shift lever in "P" (Park).
- Let the engine run at idle for three minutes or more.



3.4L L32 (Code S)

Then, without shutting off the engine, follow these steps:

1. Pull out the dipstick and wipe it with a clean rag or paper towel.

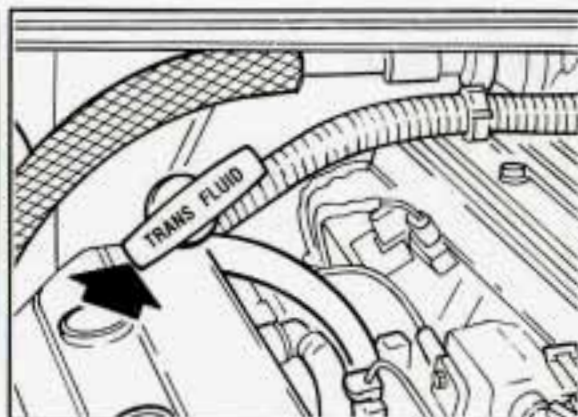

5.7L 1T1 (Code P)

2. Push it back in all the way, wait three seconds and then pull it back out again.

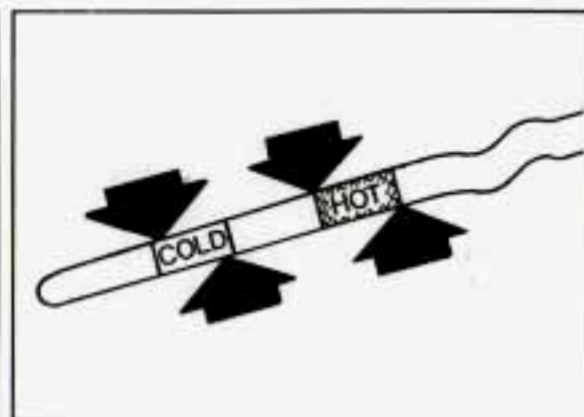

3. Check both sides of the dipstick, and read the lower level. The fluid level must be in the "COLD" area for a cold check or in the "HOT" area or cross-hatched area for a hot check.
4. If the fluid level is in the acceptable range, push the dipstick back in all the way.

How to Add Fluid:

Refer to the Maintenance Schedule to determine what kind of transmission fluid to use. See "Recommended Fluids and Lubricants" in the Index.

Service and Appearance Care

If the fluid level is low, add only enough of the proper fluid to bring the level up to the "COLD" area for a cold check or the "HOT" area for a hot check. It doesn't take much fluid, generally less than a pint. Don't overfill. We recommend you use only fluid labeled DEXRON®-III or DEXRON®-IIE, because fluids with that label are made especially for your automatic transmission. Damage caused by fluid other than DEXRON®-III or DEXRON®-IIE is not covered by your new vehicle warranty.

- After adding fluid, recheck the fluid level as described under "How to Check."
- When the correct fluid level is obtained, push the dipstick back in all the way.

Manual Transmission Fluid

How to Check:

Because this operation can be difficult, you may choose to have this done at a Pontiac dealership Service Department.

If you do it yourself, be sure to follow all the instructions here, or you could get a false reading.

NOTICE:

Too much or too little fluid can damage your transmission. Too much can mean that some of the fluid could come out and fall on hot engine parts or exhaust system, starting a fire. Be sure to get an accurate reading if you check your transmission fluid.

Check the fluid level only when your engine is off, the vehicle is parked on a level place and the transmission is cool enough for you to rest your fingers on the transmission case.

Then, follow these steps:

1. Remove the filler plug.
2. Check that the lubricant level is up to the bottom of the filler plug hole.
3. If the fluid level is good, install the plug and be sure it is fully seated. If the fluid level is low, add more fluid as described in the next steps.

How to Add Fluid:

Here's how to add fluid. Refer to the Maintenance Schedule to determine what kind of fluid to use. See "Recommended Fluids and Lubricants" in the Index.

1. Remove the filler plug.
2. Add fluid at the filler plug hole. Add only enough fluid to bring the fluid level up to the bottom of the filler plug hole.
3. Install the filler plug. Be sure the plug is fully seated.

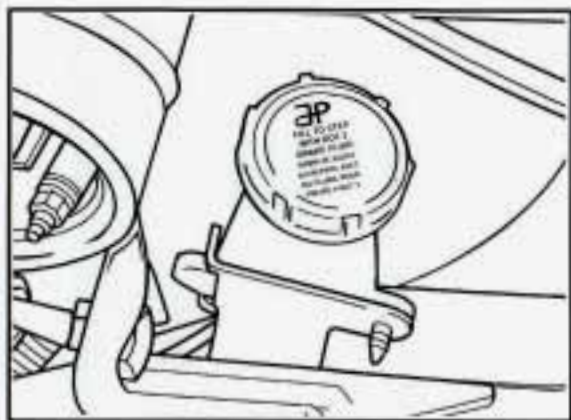

Hydraulic Clutch

The hydraulic clutch in your vehicle is self-adjusting. The clutch master cylinder reservoir is filled with hydraulic clutch fluid.

It isn't a good idea to "top off" your clutch fluid. Adding fluid won't correct a leak.

A fluid loss in this system could indicate a problem. Have the system inspected and repaired.

When to Check and What to Use:

Refer to the Maintenance Schedule to determine how often you should check the fluid level in your clutch master cylinder reservoir and for the proper fluid. See "Owner Checks and Services" and "Recommended Fluids and Lubricants" in the Index.

How to Check:

The proper fluid should be added if the level is below the "STEP" mark on the reservoir. See the instructions on the reservoir cap.

Rear Axle

When to Check and Change Lubricant:

Refer to the Maintenance Schedule to determine how often to check the lubricant and when to change it. See "Periodic Maintenance Inspections" in the Index.

How to Check Lubricant:

If the level is below the bottom of the filler plug hole, you'll need to add some lubricant. Add enough lubricant to raise the level to the bottom of the filler plug hole.

What to Use

Standard Differential

Use Axle Lubricant (GM Part No. 1052271) or SAE 80W-90 GL-5 gear lubricant.

Limited-Slip Differential

To add lubricant when the level is low, use Axle Lubricant (GM Part No. 1052271) or SAE 80W-90 GL-5 gear lubricant. To completely refill after draining, add 4 ounces (118 ml) of Limited-Slip Differential Lubricant Additive (GM Part No. 1052358). Then fill to the bottom of the filler plug hole with Axle Lubricant (GM Part No. 12345977) or SAE 80W-90 GL-5 gear lubricant.

Engine Coolant

The following explains your cooling system and how to add coolant when it is low. If you have a problem with engine overheating or if you need to add coolant to your radiator, see "Engine Overheating" in the Index.

Service and Appearance Care

The proper coolant for your Pontiac will:

- Give freezing protection down to -34°F (-37°C).
- Give boiling protection up to 262°F (128°C).
- Protect against rust and corrosion.
- Help keep the proper engine temperature.
- Let the warning lights work as they should.

What to Use:

Use a mixture of one-half clean water (preferably distilled) and one-half antifreeze that meets "GM Specification 1825M," which won't damage aluminum parts. You can also use a recycled coolant conforming to GM Specification 1825M with a complete coolant flush and refill. If you use this mixture, you don't need to add anything else.



CAUTION:

Adding only plain water to your cooling system can be dangerous. Plain water, or some other liquid like alcohol, can boil before the proper coolant mix will. Your vehicle's coolant warning system is set for the proper coolant mix. With plain water or the wrong mix, your engine could get too hot but you wouldn't get the overheat warning. Your engine could catch fire and you or others could be burned. Use a 50/50 mix of clean water and a proper antifreeze.

NOTICE:

If you use an improper coolant mix, your engine could overheat and be badly damaged. The repair cost wouldn't be covered by your warranty. Too much water in the mix can freeze and crack the engine, radiator, heater core and other parts.

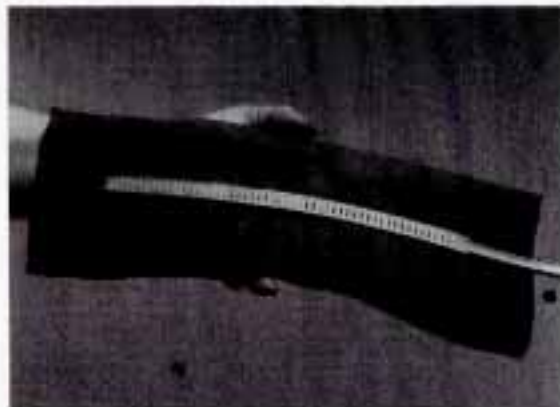

Adding Coolant

To Check Coolant: When your engine is cold, check the dipstick on the cap of the coolant recovery tank. The coolant level should be "COLD," or a little higher. When your engine is warm, the level on the dipstick should be up to "HOT," or a little higher.

LOW COOLANT

If you have the 5.7L LT1 (Code P) engine and this light comes on, it means you're low on engine coolant.

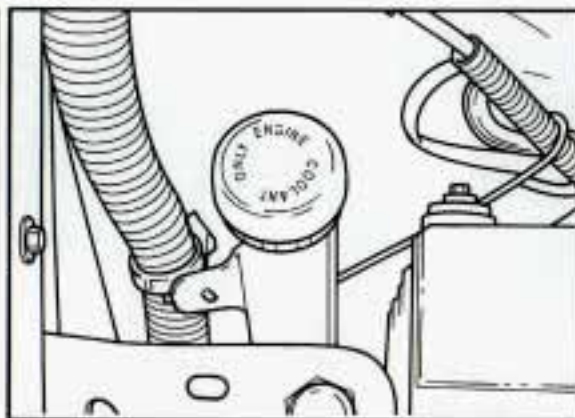

To Add Coolant to the Recovery Tank: If you need more coolant, add the proper mix at the coolant recovery tank, but only when your engine is cool. If the tank is very low or empty, also add coolant to the radiator, see "Engine Overheating" in the Index for information.

CAUTION:

Turning the radiator pressure cap when the engine and radiator are hot can allow steam and scalding liquids to blow out and burn you badly. Never turn the pressure cap — even a little — when the engine and radiator are hot.

Add coolant mix at the recovery tank, but be careful not to spill it.

CAUTION:

You can be burned if you spill coolant on hot engine parts. Coolant contains ethylene glycol, and it will burn if the engine parts are hot enough. Don't spill coolant on a hot engine.

Service and Appearance Care

Radiator Pressure Cap (All Engines)

NOTICE:

Your radiator cap is a 18 psi (124 kPa) pressure-type cap and must be tightly installed to prevent coolant loss and possible engine damage from overheating. Be sure the arrows on the cap line up with the overflow tube on the radiator filler neck.

When you replace your radiator pressure cap, an AC® cap is recommended.

Thermostat

Engine coolant temperature is controlled by a thermostat in the engine coolant system. The thermostat stops the flow of coolant through the radiator until the coolant reaches a preset temperature.

When you replace your thermostat, an AC® thermostat is recommended.



3.4L I32 (Code S)

Power Steering Fluid

How to Check Power Steering Fluid:

Unscrew the cap and wipe the dipstick with a clean rag. Replace the cap and completely tighten it. Then remove the cap again and look at the fluid level on the dipstick.



5.7L I32 (Code P)

- When the engine compartment is hot, the level should be at the "H" or "HOT" mark.
- When the engine compartment is cool, the level should be at the "C" or "FULL COLD" mark.

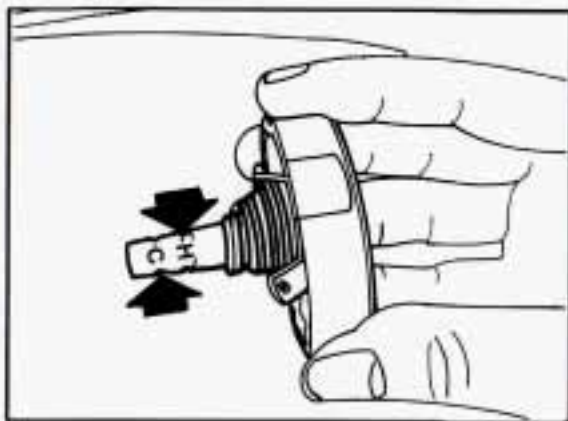
**What to Add:**

Refer to the Maintenance Schedule to determine what kind of fluid to use. See "Recommended Fluids and Lubricants" in the Index.

NOTICE:

When adding power steering fluid or making a complete fluid change, always use the proper fluid. Failure to use the proper fluid can cause leaks and damage hoses and seals.

**Windshield Washer Fluid****To Add:**

Open the cap labeled "WASHER FLUID ONLY." Add washer fluid until the bottle is full.

NOTICE:

- When using concentrated washer fluid, follow the manufacturer's instructions for adding water.
- Don't mix water with ready-to-use washer fluid. Water can cause the solution to freeze and damage your washer fluid tank and other parts of the washer system. Also, water doesn't clean as well as washer fluid.
- Fill your washer fluid tank only 3/4 full when it's very cold. This allows for expansion, which could damage the tank if it is completely full.
- Don't use radiator antifreeze in your windshield washer. It can damage your washer system and paint.

Service and Appearance Care

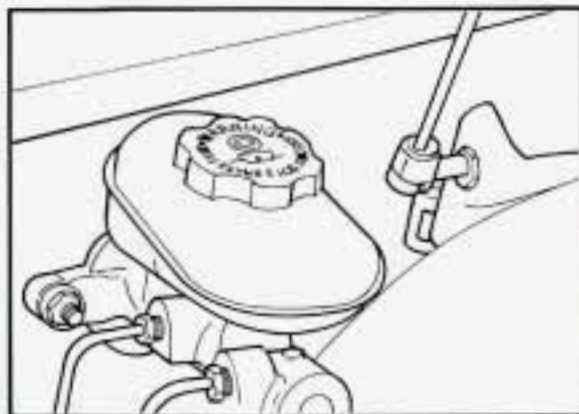

Brake Master Cylinder

Your brake master cylinder is here. It is filled with DOT-3 brake fluid.

There are only two reasons why the brake fluid level in your master cylinder might go down. The first is that the brake fluid goes down to an acceptable level during normal brake lining wear. When new linings are put in, the fluid level goes back up. The other reason is that fluid is leaking out of the brake system. If it is, you should have your brake system fixed, since a leak means that sooner or later your brakes won't work well, or won't work at all.

So, it isn't a good idea to "top off" your brake fluid. Adding brake fluid won't correct a leak. If you add fluid when your linings are worn, then you'll have too much fluid when you get new brake linings. You should add (or remove) brake fluid, as necessary, only when work is done on the brake hydraulic system.



CAUTION:

If you have too much brake fluid, it can spill on the engine. The fluid will burn if the engine is hot enough. You or others could be burned, and your vehicle could be damaged. Add brake fluid only when work is done on the brake hydraulic system.

Refer to the Maintenance Schedule to determine when to check your brake fluid. See "Periodic Maintenance Inspections" in the Index.

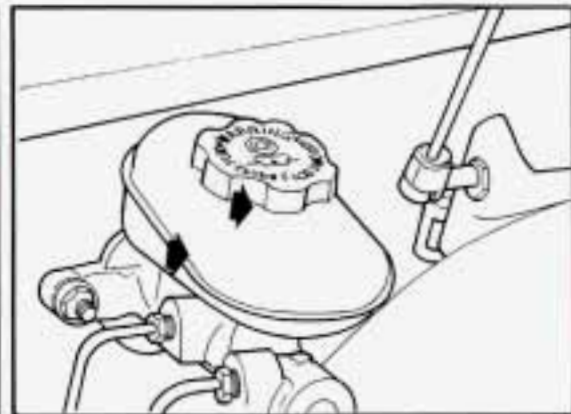

To Check Brake Fluid:

You can check the brake fluid without taking off the cap. Just look at the brake fluid reservoir. The fluid level should be above the plastic seam in the reservoir. If it isn't, have your brake system checked to see if there is a leak.

After work is done on the brake hydraulic system, make sure the level is above the plastic seam, near the base of the filler neck.

What to Add:

When you do need brake fluid, use only DOT-3 brake fluid — such as Delco-Supreme 11® (GM Part No. 1052535). Use new brake fluid from a sealed container only, and always clean the brake fluid reservoir cap before removing it.

NOTICE:

- Don't let someone put in the wrong kind of fluid. For example, just a few drops of mineral-based oil, such as engine oil, in your brake system can damage brake system parts so badly that they'll have to be replaced.
- Brake fluid can damage paint, so be careful not to spill brake fluid on your vehicle. If you do, wash it off immediately. See "Appearance Care" in the Index.

Brake Wear

Unless you have the four-wheel disc brake option, your Pontiac has front disc brakes and rear drum brakes.

Disc brake pads have built-in wear indicators that make a high-pitched warning sound when the brake pads are worn and new pads are needed. The sound may come and go or be heard all the time your vehicle is moving (except when you are pushing on the brake pedal firmly).



CAUTION:

The brake wear warning sound means that sooner or later your brakes won't work well. That could lead to an accident. When you hear the brake wear warning sound, have your vehicle serviced.

NOTICE:

Continuing to drive with worn-out brake pads could result in costly brake repair.

Some driving conditions or climates may cause a brake squeal when the brakes are first applied or lightly applied. This does not mean something is wrong with your brakes.

If you have rear drum brakes, they don't have wear indicators, but if you ever hear a rear brake rubbing noise, have the rear brake linings inspected. Also, the rear brake drums should be removed and inspected each time the tires are removed for rotation or changing. When you have the front brakes replaced, have the rear brakes inspected, too.

Brake linings should always be replaced as complete axle sets.

Brake Pedal Travel

See your dealer if the brake pedal does not return to normal height, or if there is a rapid increase in pedal travel. This could be a sign of brake trouble.

Service and Appearance Care

Brake Adjustment

Every time you make a moderate brake stop, your disc brakes adjust for wear. If you rarely make a moderate or heavier stop, then your brakes might not adjust correctly. If you drive in that way, then — very carefully — make a few moderate brake stops about every 1,000 miles (1 600 km), so your brakes will adjust properly.

If your brake pedal goes down farther than normal, your rear drum brakes may need adjustment. Adjust them by backing up and firmly applying the brakes a few times.

Replacing Brake System Parts

The braking system on a modern vehicle is complex. Its many parts have to be of top quality and work well together if the vehicle is to have really good braking. Vehicles we design and test have top-quality GM brake parts in them, as your Pontiac does when it is new. When you replace parts of your braking system — for example, when your brake linings wear down and you have to have new ones put in — be sure you get new genuine GM replacement parts. If you don't, your brakes may no longer work

properly. For example, if someone puts in brake linings that are wrong for your vehicle, the balance between your front and rear brakes can change, for the worse. The braking performance you've come to expect can change in many other ways if someone puts in the wrong replacement brake parts.

Battery

Every new Pontiac has a Delco Freedom® battery. You never have to add water to one of these. When it's time for a new battery, we recommend a Delco Freedom® battery. Get one that has the catalog number shown on the original battery's label.

Vehicle Storage

If you're not going to drive your vehicle for 25 days or more, take off the black, negative (-) cable from the battery. This will help keep your battery from running down.



CAUTION:

Batteries have acid that can burn you and gas that can explode. You can be badly hurt if you aren't careful. See "Jump Starting" in the Index for tips on working around a battery without getting hurt.

Contact your dealer to learn how to prepare your vehicle for longer storage periods.

■ *Bulb Replacement*

For the proper type of replacement bulb, see "Replacement Bulbs" in the Index.

Halogen Bulbs

CAUTION:

Halogen bulbs have pressurized gas inside and can burst if you drop or scratch the bulb. You or others could be injured. Take special care when handling and disposing of halogen bulbs.

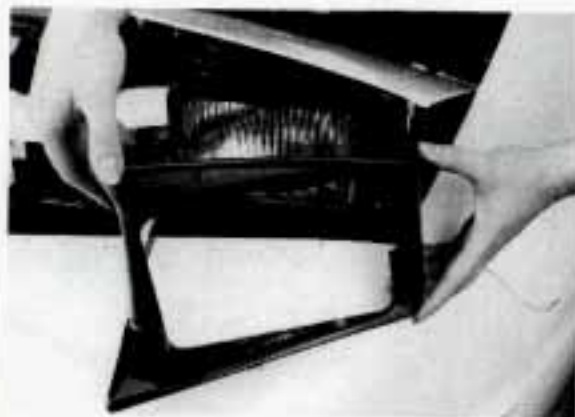

Headlights

To replace a headlight:

1. Open the headlight door by hand. See "Headlight Doors" in the Index.
2. Unscrew the bezel with a screwdriver and remove it.

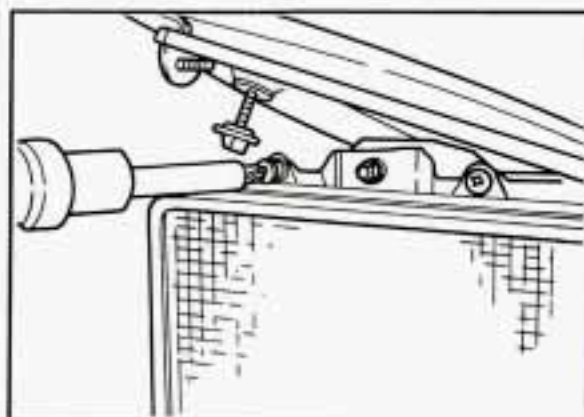

3. Remove the screws and pull out the bulb housing.

Service and Appearance Care

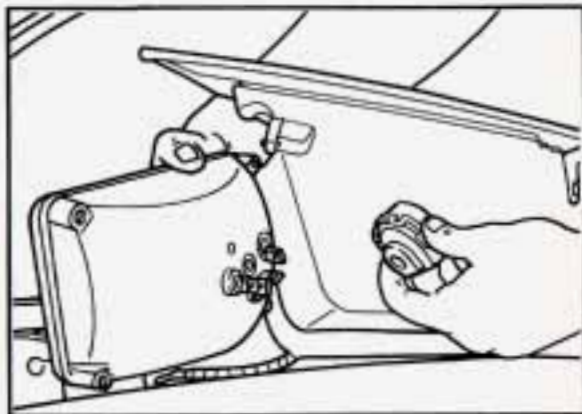

4. Pull out the bulb and disconnect the electrical connector.
5. Reverse the steps with a new bulb.

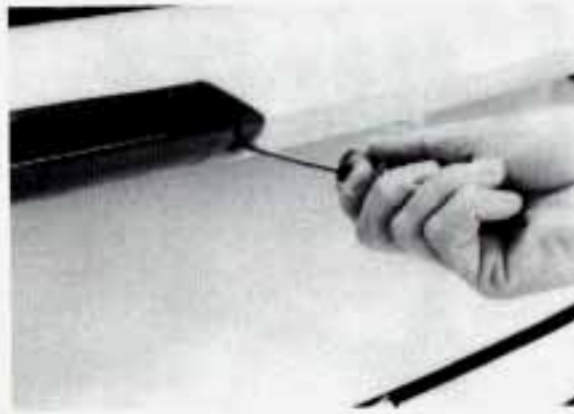

Center High-Mounted Stoplight

To replace the bulb:

1. Remove the two screws in the stoplight lens.



2. Gently pull the assembly out and remove the bulb from the back of the assembly.
3. Reverse the steps with a new bulb.

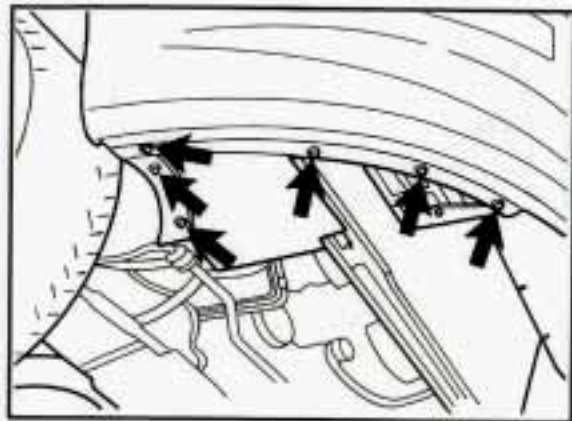

Front Turn Signal

1. Using a screwdriver, remove the plastic screws from the deflector under the vehicle. Move the deflector out of the way.

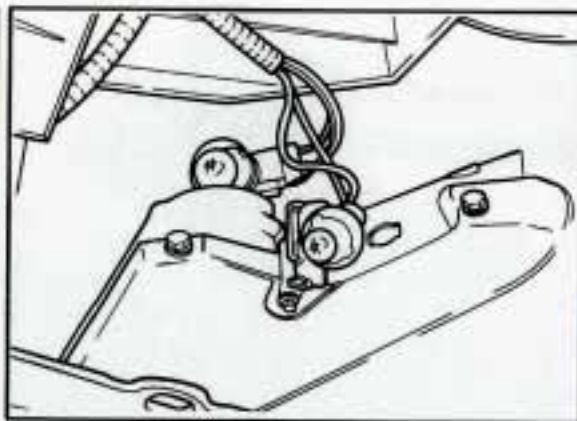

2. Turn and pull out the socket and the bulb.
3. Pull out the bulb.
4. Reverse the steps with a new bulb.

Rear Lights

To change any rear bulb, you have to remove the entire housing.

1. Remove the trim panel from the side that you are replacing the bulb.
2. Pull the carpet back.

Service and Appearance Care

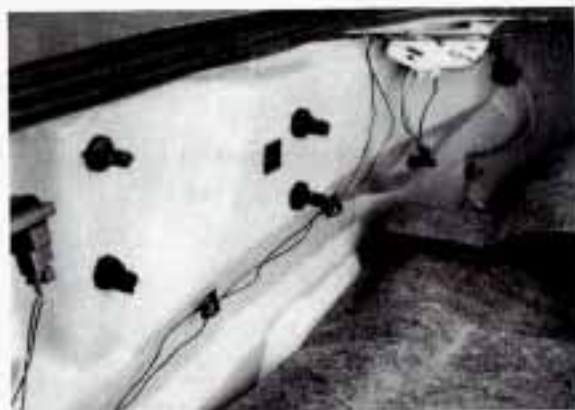

3. Remove the wing nuts.

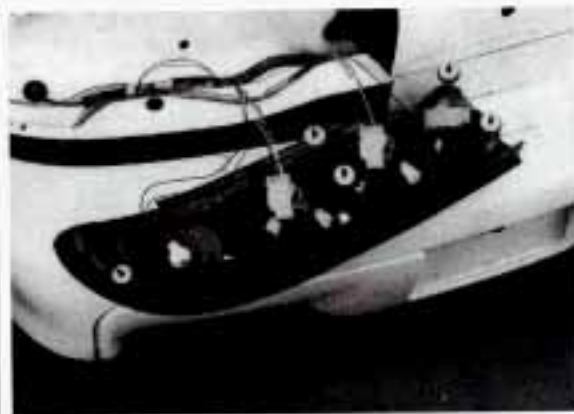

4. Pull off the assembly from the outside.
5. To remove a socket with a tab, press the tab and turn the socket counterclockwise. To remove a socket without a tab, turn the socket counterclockwise.
6. To remove the bulb, push in and turn it counterclockwise, then pull it out.
7. Reverse the steps with a new bulb.

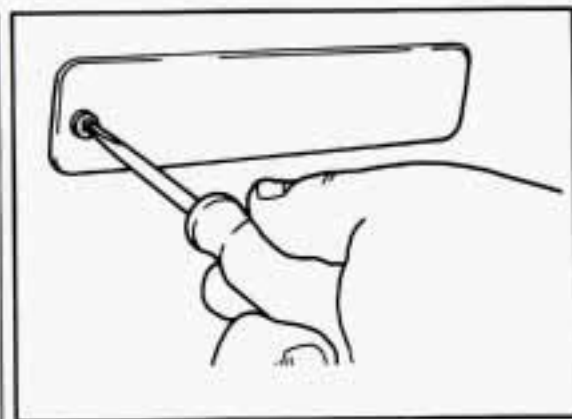

Rear Sidemarker

To replace a rear sidemarker bulb:

1. Remove the screw from the sidemarker assembly.
2. To pull out the bulb housing, tilt the housing to remove the tabbed end.

Service and Appearance Care



CAUTION:

Do not load your vehicle any heavier than the GVWR or the maximum front and rear GAWRs.

If you do, parts on your vehicle can break, or it can change the way your vehicle handles. These could cause you to lose control. Also, overloading can shorten the life of your vehicle.

NOTICE:

Your warranty does not cover parts or components that fail because of overloading.

If you put things inside your vehicle — like suitcases, tools, packages, or anything else — they will go as fast as the vehicle goes. If you have to stop or turn quickly, or if there is a crash, they'll keep going.

 **CAUTION:**

Things you put inside your vehicle can strike and injure people in a sudden stop or turn, or in a crash.

- Put things in the rear area of your vehicle. Try to spread the weight evenly.
- Never stack heavier things, like suitcases, inside the vehicle so that some of them are above the tops of the seats.
- Don't leave an unsecured child restraint in your vehicle.
- When you carry something inside the vehicle, secure it whenever you can.
- Don't leave a seat folded down unless you need to.

■ *Tires*

We don't make tires. Your new vehicle comes with high quality tires made by a leading tire manufacturer. These tires are warranted by the tire manufacturers and their warranties are delivered with every new Pontiac. If your spare tire is a different brand than your road tires, you will have a tire warranty folder from each of these manufacturers.

 **CAUTION:**

Poorly maintained and improperly used tires are dangerous.

- Overloading your tires can cause overheating as a result of too much friction. You could have an air-out and a serious accident. See "Loading Your Vehicle" in the Index.
- Underinflated tires pose the same danger as overloaded tires. The resulting accident could cause serious injury. Check all tires frequently to maintain the recommended pressure. Tire pressure should be checked when your tires are cold.
- Overinflated tires are more likely to be cut, punctured, or broken by a sudden impact, such as when you hit a pothole. Keep tires at the recommended pressure.
- Worn, old tires can cause accidents. If your tread is badly worn, or if your tires have been damaged, replace them. See "Inflation-Tire Pressure" in this section for inflation pressure adjustment for higher speed driving.

Service and Appearance Care

Inflation — Tire Pressure

The Tire-Loading Information label which is on the driver's door shows the correct inflation pressures for your tires, when they're cold. "Cold" means your vehicle has been sitting for at least three hours or driven no more than a mile.

If your vehicle is equipped with P245/50ZR16 tires and you'll be driving at speeds higher than 100 mph (160 km/h) where it is legal, raise the "cold" inflation pressure of each tire to 35 psi (240 kPa). When you end this very high speed driving, reduce the "cold" inflation pressures to those listed on the Tire Loading Information label.

NOTICE:

Don't let anyone tell you that underinflation or overinflation is all right. It's not. If your tires don't have enough air (underinflation) you can get:

- Too much flexing
- Too much heat
- Tire overloading
- Bad wear
- Bad handling
- Bad fuel economy.

If your tires have too much air (overinflation), you can get:

- Unusual wear
- Bad handling
- Rough ride
- Needless damage from road hazards.

When to Check: Check your tires once a month or more. Don't forget your compact spare tire. It should be at 60 psi (420 kPa).

How to Check: Use a good quality pocket-type gage to check tire pressure. Simply looking at the tires will not tell you the pressure, especially if you have radial tires — which may look properly inflated even if they're underinflated.

If your tires have valve caps, be sure to put them back on. They help prevent leaks by keeping out dirt and moisture.

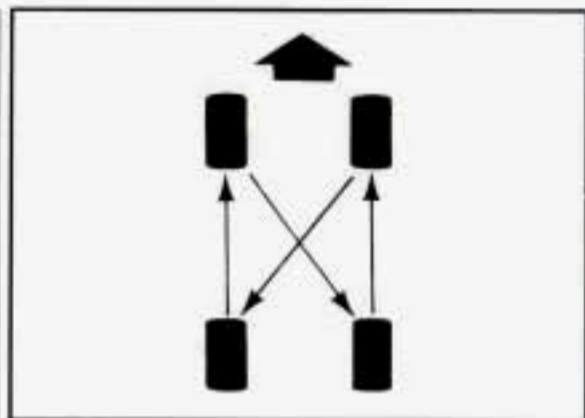

Tire Inspection and Rotation

To make your tires last longer, have them inspected and rotated at the mileages recommended in the Maintenance Schedule. See "Scheduled Maintenance Services" in the Index.

If you don't have P245/50ZR16 size tires, use the rotation pattern shown above for your size tires.

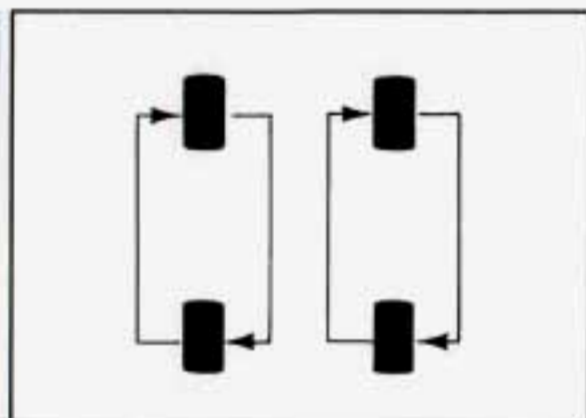

If you have P245/50ZR16 size tires, they must roll in a certain direction for the best overall performance. The direction is shown by an arrow on both sidewalls. Because these tires are directional, they should be rotated as shown in the example above. These tires should only be moved from front to rear and rear to front on the same side of the vehicle.

After the tires have been rotated, adjust the front and rear inflation pressure as shown on the Tire-Loading Information label. Make certain that all wheel nuts are properly tightened. See "Wheel Nut Torque" in the Index.

Service and Appearance Care



CAUTION:

Rust or dirt on a wheel, or on the parts to which it is fastened, can make wheel nuts become loose after a time. The wheel could come off and cause an accident. When you change a wheel, remove any rust or dirt from places where the wheel attaches to the vehicle. In an emergency, you can use a cloth or a paper towel to do this; but be sure to use a scraper or wire brush later, if you need to, to get all the rust or dirt off. (See "Changing a Flat Tire" in the Index.)

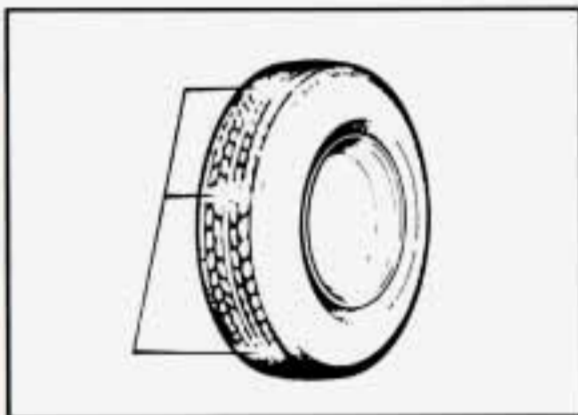

When It's Time for New Tires

One way to tell when it's time for new tires is to check the treadwear indicators, which will appear when your tires have only 2/32 inch (1.6 mm) or less of tread remaining.

You need a new tire if:

- You can see the indicators at three or more places around the tire.
- You can see cord or fabric showing through the tire's rubber.
- The tread or sidewall is cracked, cut or snagged deep enough to show cord or fabric.
- The tire has a bump, bulge or split.

- The tire has a puncture, cut, or other damage that can't be repaired well because of the size or location of the damage.

Buying New Tires

To find out what kind and size of tires you need, look at the Tire-Loading Information label.

The tires installed on your vehicle when it was new had a Tire Performance Criteria Specification (TPC Spec) number on each tire's sidewall. When you get new tires, get ones with that same TPC Spec number. That way, your vehicle will continue to have tires that are designed to give proper endurance, handling, speed rating, traction, ride and other things during normal service on your vehicle. If your tires have an all-season tread design, the TPC number will be followed by a "MS" (for mud and snow).

If you ever replace your tires with those not having a TPC Spec number, make sure they are the same size, load range, speed rating and construction type (bias, bias-belted or radial) as your original tires.

**CAUTION:**

Mixing tires could cause you to lose control while driving. If you mix tires of different sizes or types (radial and bias-belted tires), the vehicle may not handle properly, and you could have a crash. Be sure to use the same size and type tires on all four wheels.

It's all right to drive with your compact spare, though. It was developed for use on your vehicle.

Uniform Tire Quality Grading

The following information relates to the system developed by the United States National Highway Traffic Safety Administration which grades tires by treadwear, traction and temperature performance. (This applies only to vehicles sold in the United States.)

Treadwear

The treadwear grade is a comparative rating based on the wear rate of the tire when tested under controlled conditions on a specified government test course.

For example, a tire graded 150 would wear one and a half (1 1/2) times as well on the government course as a tire graded 100. The relative performance of tires depends upon the actual conditions of their use, however, and may depart significantly from the norm due to variations in driving habits, service practices and differences in road characteristics and climate.

Traction — A, B, C

The traction grades, from highest to lowest are: A, B, and C. They represent the tire's ability to stop on wet pavement as measured under controlled conditions on specified government test surfaces of asphalt and concrete. A tire marked C may have poor traction performance.

Warning: The traction grade assigned to this tire is based on braking (straight-ahead) traction tests and does not include cornering (turning) traction.

Temperature — A, B, C

The temperature grades are A (the highest), B, and C, representing the tire's resistance to the generation of heat and its ability to dissipate heat when tested under controlled conditions on a specified

indoor laboratory test wheel. Sustained high temperature can cause the material of the tire to degenerate and reduce tire life, and excessive temperature can lead to sudden tire failure. The grade C corresponds to a level of performance which all passenger car tires must meet under the Federal Motor Vehicle Safety Standard No. 109. Grades B and A represent higher levels of performance on the laboratory test wheel than the minimum required by law.

Warning: The temperature grade for this tire is established for a tire that is properly inflated and not overloaded. Excessive speed, underinflation, or excessive loading, either separately or in combination, can cause heat buildup and possible tire failure.

Those grades are molded on the sidewalls of passenger car tires.

While the tires available as standard or optional equipment on General Motors vehicles may vary with respect to these grades, all such tires meet General Motors performance standards and have been approved for use on General Motors vehicles. All passenger type (P Metric) tires must conform to Federal safety requirements in addition to these grades.

Service and Appearance Care

Wheel Alignment and Tire Balance

The wheels on your vehicle were aligned and balanced carefully at the factory to give you the longest tire life and best overall performance.

In most cases, you will not need to have your wheels aligned again. However, if you notice unusual tire wear or your vehicle pulling one way or the other, the alignment may need to be reset. If you notice your vehicle vibrating when driving on a smooth road, your wheels may need to be rebalanced.

Wheel Replacement

Replace any wheel that is bent, cracked or badly rusted. If wheel nuts keep coming loose, the wheel, wheel bolts, and wheel nuts should be replaced. If the wheel leaks air out, replace it (except some aluminum wheels, which can sometimes be repaired). See your Pontiac dealer if any of these conditions exist.

Your dealer will know the kind of wheel you need.

Each new wheel should have the same load carrying capacity, diameter, width, offset, and be mounted the same way as the one it replaces.

If you need to replace any of your wheels, wheel bolts, or wheel nuts, replace them only with new GM original equipment parts. This way, you will be sure to have the right wheel, wheel bolts, and wheel nuts for your Pontiac model.



CAUTION:

Using the wrong replacement wheels, wheel bolts, or wheel nuts on your vehicle can be dangerous. It could affect the braking and handling of your vehicle, make your tires lose air and make you lose control. You could have a collision in which you or others could be injured. Always use the correct wheel, wheel bolts, and wheel nuts for replacement.

NOTICE:

The wrong wheel can also cause problems with bearing life, brake cooling, speedometer/odometer calibration, headlight aim, bumper height, vehicle ground clearance, and tire or tire chain clearance to the body and chassis.

Used Replacement Wheels



CAUTION:

Putting a used wheel on your vehicle is dangerous. You can't know how it's been used or how many miles it's been driven. It could fail suddenly and cause an accident. If you have to replace a wheel use a new GM original equipment wheel.

Tire Chains

NOTICE:

If your Pontiac has P235/55R16 or P245/50ZR16 size tires, don't use tire chains; they can damage your vehicle.

If you have other tires, use tire chains only where legal and only when you must. Use only SAE Class "S" type chains that are the proper size for your tires. Install them on the rear tires and tighten them as tightly as possible with the ends securely fastened.

Drive slowly and follow the chain manufacturer's instructions. If you can hear the chains contacting your vehicle, stop and retighten them. If the contact continues, slow down until it stops. Driving too fast with chains on will damage your vehicle.

■ *Appearance Care*

Remember, cleaning products can be hazardous. Some are toxic. Others can burst into flame if you strike a match or get them on a hot part of the vehicle. Some are dangerous if you breathe their fumes in a closed space. When you use anything from a container to clean your Pontiac, be sure to follow the manufacturer's warnings and instructions. And always open your doors or windows when you're cleaning the inside.

Never use these to clean your vehicle:

- Gasoline
- Benzene
- Naphtha
- Carbon Tetrachloride
- Acetone
- Paint Thinner
- Turpentine
- Lacquer Thinner
- Nail Polish Remover

They can all be hazardous – some more than others – and they can all damage your vehicle, too.

Service and Appearance Care

Don't use any of these unless this manual says you can. In many uses, these will damage your vehicle:

- Alcohol
- Laundry Soap
- Bleach
- Reducing Agents

Cleaning the Inside of Your Pontiac

Use a vacuum cleaner often to get rid of dust and loose dirt. Wipe vinyl or leather with a clean, damp cloth.

Your Pontiac dealer has two GM cleaners, a solvent-type spot lifter and a foam-type powdered cleaner. They will clean normal spots and stains very well. Do not use them on vinyl or leather.

Here are some cleaning tips:

- Always read the instructions on the cleaner label.
- Clean up stains as soon as you can — before they set.
- Use a clean cloth or sponge, and change to a clean area often. A soft brush may be used if stains are stubborn.

- Use solvent-type cleaners in a well-ventilated area only. If you use them, don't saturate the stained area.
- If a ring forms after spot cleaning, clean the entire area immediately or it will set.

Using Foam-Type Cleaner on Fabric

- Vacuum and brush the area to remove any loose dirt.
- Always clean a whole trim panel or section. Mask surrounding trim along stitch or welt lines.
- Mix Multi-Purpose Powdered Cleaner following the directions on the container label.
- Use suds only and apply with a clean sponge.
- Don't saturate the material.
- Don't rub it roughly.
- As soon as you've cleaned the section, use a sponge to remove the suds.
- Rinse the section with a clean, wet sponge.
- Wipe off what's left with a slightly damp paper towel or cloth.

- Then dry it immediately with a blow dryer or a heat lamp.

NOTICE:

Be careful with a hair dryer or heat lamp. You could scorch the fabric.

- Wipe with a clean cloth.

Using Solvent-Type Cleaner on Fabric

First, see if you have to use solvent-type cleaner at all. Some spots and stains will clean off better with just water and mild soap.

If you need to use a solvent:

- Gently scrape excess soil from the trim material with a clean, dull knife or scraper. Use very little cleaner, light pressure and clean cloths (preferably cheesecloth). Cleaning should start at the outside of the stain, "feathering" toward the center. Keep changing to a clean section of the cloth.

- When you clean a stain from fabric, immediately dry the area with an air hose, hair dryer, or heat lamp to help prevent a cleaning ring. (See the previous NOTICE.)

Special Cleaning Problems

Greasy or oily stains: Such as grease, oil, butter, margarine, shoe polish, coffee with cream, chewing gum, cosmetic creams, vegetable oils, wax crayon, tar and asphalt.

- Carefully scrape off excess stain.
- Follow the solvent-type instructions described earlier.
- Shoe polish, wax crayon, tar and asphalt will stain if left on a vehicle seat fabric. They should be removed as soon as possible. Be careful, because the cleaner will dissolve them and may cause them to spread

Non-greasy stains: Such as catsup, coffee (black), egg, fruit, fruit juice, milk, soft drinks, wine, vomit, urine and blood.

- Carefully scrape off excess stain, then sponge the soiled area with cool water.
- If a stain remains, follow the foam-type instructions described earlier.

- If an odor lingers after cleaning vomit or urine, treat the area with a water/baking soda solution:
1 teaspoon (5 ml) of baking soda to 1 cup (250 ml) of lukewarm water.
- If needed, clean lightly with solvent-type cleaner.

Combination stains: Such as candy, ice cream, mayonnaise, chili sauce and unknown stains.

- Carefully scrape off excess stain, then clean with cool water and allow to dry.
- If a stain remains, clean it with solvent-type cleaner.

Cleaning Vinyl

Use warm water and a clean cloth.

- Rub with a clean, damp cloth to remove dirt. You may have to do it more than once.
- Things like tar, asphalt and shoe polish will stain if you don't get them off quickly. Use a clean cloth and a solvent-type vinyl cleaner.

Cleaning Leather

Use a soft cloth with lukewarm water and a mild soap or saddle soap.

- For stubborn stains, use a mild solution of 10% isopropyl alcohol (rubbing alcohol) and 90% water.
- Never use oils, varnishes, solvent-based or abrasive cleaners, furniture polish or shoe polish on leather.
- Soiled leather should be cleaned immediately. If dirt is allowed to work into finish, it can harm the leather.

Cleaning the Top of the Instrument Panel

Use only mild soap and water to clean the top surfaces of the instrument panel. Sprays containing silicones or waxes may cause annoying reflections in the windshield and even make it difficult to see through the windshield under certain conditions.

Service and Appearance Care

Care of Safety Belts

Keep belts clean and dry.



CAUTION:

Do not bleach or dye safety belts. If you do, it may severely weaken them. In a crash they might not be able to provide adequate protection. Clean safety belts only with mild soap and lukewarm water.

Glass

Glass should be cleaned often. GM Glass Cleaner (GM Part No. 1050427) or a liquid household glass cleaner will remove normal tobacco smoke and dust films.

Don't use abrasive cleaners on glass, because they may cause scratches. Avoid placing decals on the inside rear window, since they may have to be scraped off later. If abrasive cleaners are used on the inside of the rear window, an electric defogger element may be damaged. Any temporary license should not be attached across the defogger grid.

Cleaning the Outside of the Windshield and Wiper Blades

If the windshield is not clear after using the windshield washer, or if the wiper blade chatters when running, wax or other material may be on the blade or windshield.

Clean the outside of the windshield with GM Windshield Cleaner, Bon-Ami Powder[®] (GM Part No. 1050011). The windshield is clean if beads do not form when you rinse it with water.

Clean the blade by wiping vigorously with a cloth soaked in full strength windshield washer solvent. Then rinse the blade with water.

Wiper blades should be checked on a regular basis and replaced when worn.

Cleaning Twin Lift-Off Roof Panels

Special care is necessary when cleaning, removing and/or storing the roof panels.

- Flush with water to remove dust and dirt, then dry the panels.
- Clean the panels with GM Glass Cleaner (GM Part No. 1050427) or a liquid household glass cleaner. Leave the cleaner on the panel for

one minute, then wipe the panel with a soft, lint-free cloth.

- Don't use abrasive cleaning materials.

Cleaning the Outside of Your Pontiac

The paint finish on your vehicle provides beauty, depth of color, gloss retention and durability.

Washing Your Vehicle

The best way to preserve your vehicle's finish is to keep it clean by washing it often with lukewarm or cold water.

Don't wash your vehicle in the direct rays of the sun. Don't use strong soaps or chemical detergents. Use liquid hand, dish or car washing (mild-detergent) soaps. Don't use cleaning agents that are petroleum based, or contain acid or abrasives. All cleaning agents should be flushed promptly and not allowed to dry on the surface, or they could stain. Dry the finish with a soft, clean chamois or a 100% cotton towel to avoid surface scratches and water spotting.

High pressure car washes may cause water to enter your vehicle.

Finish Care

Occasional waxing or mild polishing of your Pontiac may be necessary to remove residue from the paint finish. You can get GM approved cleaning products from your dealer. (See "Appearance Care and Maintenance Materials" in the Index.)

Your Pontiac has a "basecoat/clearcoat" paint finish. The clearcoat gives more depth and gloss to the colored basecoat. Always use waxes and polishes that are non-abrasive and made for a basecoat/clearcoat paint finish.

NOTICE:

Machine compounding or aggressive polishing on a basecoat/clearcoat paint finish may dull the finish or leave swirl marks.

Cleaning Your Convertible Top

NOTICE:

When using an automatic car wash, set your heating or cooling system to "VENT" with the fan speed set to the second highest speed. This will prevent high pressure water from entering around your top.

Your convertible top should be cleaned often. Use a mild soap, lukewarm water and a soft brush. Don't use any harsh cleaners or bleaching agents on the top. They can damage the material.

When the top is really dirty, use a mild foam-type cleaner. Use a cloth or sponge to remove the dirt.

Thoroughly rinse the top and dry it before lowering it. A damp top causes wrinkles.

Aluminum Wheels (If So Equipped)

Your aluminum wheels have a protective coating similar to the painted surface of your vehicle. Don't use strong soaps, chemicals, chrome polish, abrasive cleaners, or abrasive cleaning brushes on them because you could damage this

coating. After rinsing thoroughly, a wax may be applied.

NOTICE:

If you have aluminum wheels, don't use an automatic car wash that has hard silicon carbide cleaning brushes. These brushes can take off the protective coating.

Tires

Your Pontiac dealer has a GM White Sidewall Tire Cleaner. You can use a stiff brush with the cleaner.

When applying a tire dressing always take care to wipe off any overspray or splash from painted surfaces. Petroleum-based products may damage the paint finish.

Weatherstrips

Silicone grease on weatherstrips will make them last longer, seal better, and not stick or squeak. Apply silicone grease with a clean cloth at least every six months. During very cold, damp weather more frequent application may be required. (See "Recommended Fluids and Lubricants" in the Index.)

Service and Appearance Care

Sheet Metal Damage

If your vehicle is damaged and requires sheet metal repair or replacement, make sure the body repair shop applies anti-corrosion material to the parts repaired or replaced to restore corrosion protection.

Foreign Material

Calcium chloride and other salts, ice melting agents, road oil and tar, tree sap, bird droppings, chemicals from industrial chimneys, and other foreign matter can damage your vehicle's finish if they remain on painted surfaces. Use cleaners that are marked safe for painted surfaces to remove foreign matter.

Finish Damage

Any stone chips, fractures or deep scratches in the finish should be repaired right away. Bare metal will corrode quickly and may develop into a major repair expense.

Minor chips and scratches can be repaired with touch-up materials available from your dealer or other service outlets. Larger areas of finish damage can be

corrected in your dealer's body and paint shop.

Underbody Maintenance

Chemicals used for ice and snow removal and dust control can collect on the underbody. If these are not removed, accelerated corrosion (rust) can occur on the underbody parts such as fuel lines, frame, floor pan, and exhaust system even though they have corrosion protection.

At least every spring, flush these materials from the underbody with plain water. Clean any areas where mud and other debris can collect. Dirt packed in closed areas of the frame should be loosened before being flushed. Your dealer or an underbody vehicle washing system can do this for you.

Chemical Paint Spotting

Some weather and atmospheric conditions can create a chemical fallout. Airborne pollutants can fall upon and attack painted surfaces on your vehicle. This damage can take two forms: blotchy, ringlet-shaped discolorations, and small irregular dark spots etched into the paint surface.

Although no defect in the paint job causes this, Pontiac will repair, at no charge to the owner, the surfaces of new vehicles damaged by this fallout condition within 12 months or 12,000 miles (20 000 km) of purchase, whichever comes first.

■ Appearance Care and Maintenance Materials

PART NUMBER	SIZE	DESCRIPTION	USAGE
1051516	32 oz. (0.946 L)	Washer Solvent and Gas Liner De-Icer	Windshield washing system and gas line
1050172	16 oz. (0.473 L)	Tar and Road Oil Remover	Also old waxes, polishes
1050173	16 oz. (0.473 L)	Cleaner and Polish	Removes rust and corrosion on chrome and steel
1050174	16 oz. (0.473 L)	White Sidewall Tire Cleaner	Cleans white and black tires
1050214	32 oz. (0.946 L)	Vinyl/Leather Cleaner*	Spot and stain removal on leather and vinyl
1050244	16 oz. (0.473 L)	Fabric Cleaner*	Spot and stain removal on cloth and fabric
1050427	24 oz. (0.680 L)	Glass Cleaner	Glass cleaning and spot cleaning on vinyls
1050429	6 lb. (2.72 kg)	Multi-Purpose Powdered Cleaner	Vinyl, cloth, door trims, seats, carpet, tires, mats
1052870	16 oz. (0.473 L)	Wash-Wax (Concentrated)	Exterior wash
1051398	8 oz. (0.237 L)	Spot Lifter*	Spot and stain removal on cloth and fabric
1050201	16 oz. (0.473 L)	Magic Mirror Cleaner-Polish	Exterior cleaner and polish
1050011	12 oz. (0.340 kg)	Bon-Ami Powder*	Windshield cleaner

*Not recommended for pigskin suede leather.

See your General Motors Dealer for these products. See the Index under "Recommended Fluids and Lubricants" for other products.

Service and Appearance Care

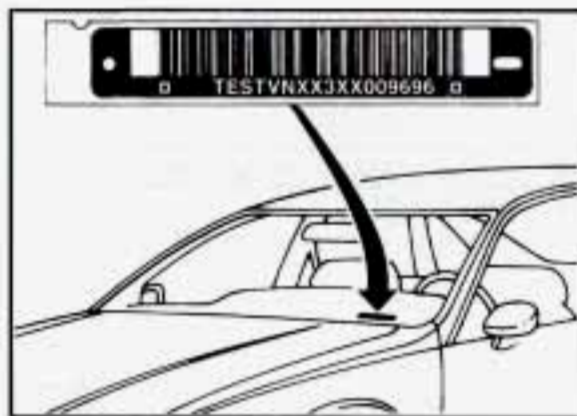

■ *Vehicle Identification Number (VIN)*

This is the legal identifier for your Pontiac. It appears on a plate in the front corner of the instrument panel, on the driver's side. You can see it if you look through the windshield from outside your vehicle. The VIN also appears on the Vehicle Certification and Service Parts labels and the certificates of title and registration.

Engine Identification

The eighth character in your VIN is the engine code. This code will help you identify your engine, specifications, and replacement parts.

■ *Service Parts Identification Label*

You'll find this label inside your console storage compartment. It's very helpful if you ever need to order parts. On this label is:

- your VIN,
- the model designation,
- paint information, and
- a list of all production options and special equipment.

Be sure that this label is not removed from the vehicle.

■ *Add-On Electrical Equipment*

NOTICE:

Don't add anything electrical to your Pontiac unless you check with your dealer first. Some electrical equipment can damage your vehicle and the damage wouldn't be covered by your warranty. Some add-on electrical equipment can keep other components from working as they should.

Your vehicle has an air bag system. Before attempting to add anything electrical to your Pontiac, see "Servicing Your Air Bag-Equipped Pontiac" in the Index.

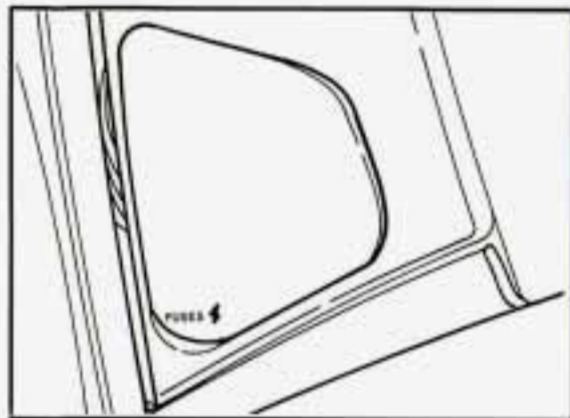

■ *Fuses and Circuit Breakers*

The wiring circuits in your vehicle are protected from short circuits by a combination of fuses, circuit breakers, and fusible thermal links in the wiring itself. This greatly reduces the chance of fires caused by electrical problems.

There are two fuse centers on your vehicle. One is in the left side of your instrument panel.

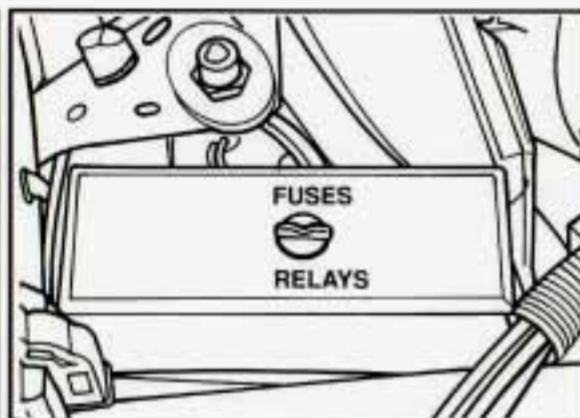

The other is in the engine compartment. Open the cover on either of the boxes to expose the fuses.

Look at the silver-colored band inside the fuse. If the band is broken or melted, replace the fuse. Be sure you replace a bad fuse with a new one of the correct size.

If you ever have a problem on the road and don't have a spare fuse, you can borrow one. Just pick some feature of your vehicle that you can get along without — like the radio or cigarette lighter — and use its fuse, if it is the size you need. Replace it as soon as you can.

Headlights

The headlight wiring is protected by a circuit breaker. An electrical overload will cause the lights to go on and off, or in some cases to remain off. If this happens, have your headlight wiring checked right away.

Windshield Wipers

The windshield wiper motor is protected by a circuit breaker and a fuse. If the motor overheats due to heavy snow, etc., the wiper will stop until the motor cools. If the overload is caused by some electrical problem and not snow, etc., be sure to get it fixed.

Power Windows and Other Power Options

Circuit breakers protect the power windows and other power accessories. When the current load is too heavy, the circuit breaker opens and closes, protecting the circuit until the problem is fixed or goes away.

Service and Appearance Care

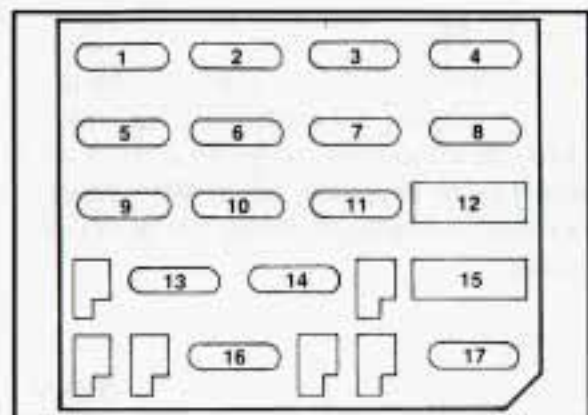

Main Fuse Block

- 1** — Air Bag; SIR Components (15 Amp.)
- 2** — Backup Lights; Daytime Running Lights Module (Canada); Turn Flasher (20 Amp.)
- 3** — HVAC Selector Switch (Heater/Air Conditioner); Rear Defogger (25 Amp.)
- 4** — Powertrain Control Module; Instrument Cluster; PASS-Key II® Decoder Module (10 Amp.)
- 5** — Powertrain Control Module; PASS-Key II® Decoder Module; Fuel Pump Relay (15 Amp.)
- 6** — Brake Light/Cruise Release Switch; Hazard Flasher (20 Amp.)
- 7** — Power Door Locks; Power Mirrors; Hatch Release (15 Amp.)
- 8** — Audio Alarm Module; Bose® Relay; Courtesy Lights: Console Compartment, Glove Box, Dome, Trunk, Rear Courtesy, Rearview Mirror and Radio (15 Amp.)
- 9** — Audio Alarm Module; Daytime Running Lights Module (Canada); Diagnostic Energy Reserve Module; Instrument Cluster; Remote Lock Control Module (10 Amp.)
- 10** — Exterior Lighting (20 Amp.)
- 11** — Cigarette Lighter; Horn Relay (25 Amp.)
- 12** — Power Seats; Rear Defogger (30 Amp. Circuit Breaker)
- 13** — Brightness Control (5 Amp.)
- 14** — Windshield Wiper/Washer (25 Amp.)
- 15** — Power Windows, Convertible Top Switch (30 Amp. Circuit Breaker)
- 16** — Diagnostic Energy Reserve Module (3 Amp.)
- 17** — Radio; Steering Wheel Controls (15 Amp.)

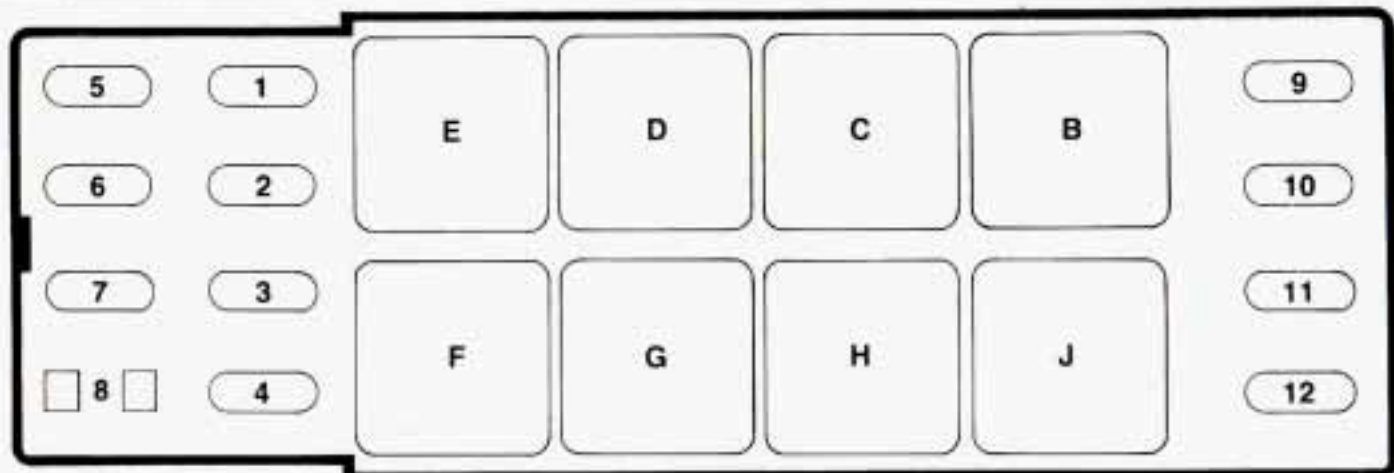

Underhood Electrical Center

Fuses

- 1** — Electronic Brake Control Module (5 Amp.)
- 2** — Fog Lamps (20 Amp.)
- 3** — Headlight Doors Module (15 Amp.)
- 4** — Headlight Doors Module (15 Amp.)
- 5** — Anti-Lock Brake System (5 Amp.)
- 6** — Coolant Fan Relays; EVAP Canister Purge Solenoid; Exhaust Gas Recirculation; Low Coolant Relay; Reverse Lockout Solenoid (10 Amp.)

- 7** — Air Injection Pump Assembly; Air Pump Relay (20 Amp.)
- 8** — Not Used
- 9** — Fuel Injectors (7.5 Amp.)
- 10** — Fuel Injectors (7.5 Amp.)
- 11** — VIN Engine Code S: Camshaft Position Sensor; Crankshaft Position Sensor; Electronic Ignition Module (10 Amp.)
VIN Engine Code P: Ignition Coil; Ignition Coil Driver (10 Amp.)
- 12** — Air Conditioning Compressor Relay; Cruise Control Switches and Module (20 Amp.)

Relays

- B** — Air Conditioning Compressor
- C** — Anti-Lock Brake System
- D** — Primary Coolant Fan (Driver Side)
- E** — Air Pump
- F** — Secondary Coolant Fan (Passenger Side)
- G** — Traction Control System
- H** — Fog Lamps
- J** — Not Used

Service and Appearance Care

■ *Replacement Bulbs*

Ashtray*	194
Automatic Transmission Indicator	73
Backup	1156
Center High-Mounted Stoplight	921
Cluster	161
Console	194
Dome	906
Door Courtesy	74
Fog	885
Front Parking and Turn Signal	2397
Glove Box	194
Headlight	H-6545
Heater and A/C Control	37
Indicator Lights	PC74
Interior Door Handle	74
License	194
Reading	212-2
Rear Courtesy	562
Sidemarkers	194
Tail Only	194
Tail/Stop/Turn	2057
Trunk	562
Turn Signal Indicators	161

*Manual transmission only.

■ Capacities and Specifications

Engine

Type	
VIN Engine Code S	V6
VIN Engine Code P	V8
Fuel Delivery	Fuel Injection
Valve Arrangement	In-Head
Piston Displacement	
VIN Engine Code S	207 CID (3.4L)
VIN Engine Code P	350 CID (5.7L)
Compression Ratio	
VIN Engine Code S	9.0:1
VIN Engine Code P	10.5:1
Firing Order	
VIN Engine Code S	1-2-3-4-5-6
VIN Engine Code P	1-8-4-3-6-5-7-2

Service and Appearance Care

Replacement Parts

Air Cleaner Filter	A1163C
Battery	75-60
Engine Oil Filter	
VIN Engine Code S	PF47
VIN Engine Code P	PF25
Fuel Filter	GF578
PCV Valve	
VIN Engine Code S	CV789C
VIN Engine Code P	CV895C
Radiator Cap	RC24
Spark Plug	
VIN Engine Code S	•R43TSK (0.045" Gap)
VIN Engine Code P	•R45LTSP (0.050" Gap)
Thermostat Temperature Specification	180°F (82°C)

Wheel Nuts

Wheel Nut Torque	100 lb. ft. (140 N•m)
------------------------	-----------------------

Capacities (Approximate)

The following approximate capacities are given in U.S. and metric conversions.

Air Conditioning† See the refrigerant information label under the hood.

Automatic Transmission

Drain and Refill 10 pt. (4.7 L)*

Overhaul

VIN Engine Code S 17.6 pt. (8.3 L)*

VIN Engine Code P 21.6 pt. (10.2 L)*

Cooling System

VIN Engine Code S

With Manual Transmission 12.5 qt. (11.8 L)

With Automatic Transmission 12.3 qt. (11.6 L)

VIN Engine Code P

With Manual Transmission 15.3 qt. (14.5 L)

With Automatic Transmission 15.1 qt. (14.3 L)

†Not all air conditioning refrigerants are the same. If the air conditioning system in your vehicle needs refrigerant, be sure the proper refrigerant is used. If you're not sure, ask your Pontiac dealer.

*Recheck fluid level after filling. See "Automatic Transmission Fluid" in the Index.

Service and Appearance Care

Crankcase

VIN Engine Code S	4.0 qt. (3.8 L)**
VIN Engine Code P	
Without Filter Change	4.0 qt. (3.8 L)**
With Filter Change	5.0 qt. (4.7 L)**
Fuel Tank	15.5 gal. (58.7 L)
Manual Transmission	
Five-Speed	5.9 pt. (2.8 L)*
Six-Speed	8.0 pt. (3.8 L)*
Rear Axle Lubricant	3.5 pt. (1.7L)

Vehicle Dimensions

Wheelbase	101.1" (2 566 mm)
Tread	
Front	60.7" (1 542 mm)
Rear	60.6" (1 540 mm)
Length	193.2" (4 908 mm)
Firebird and Formula	195.6" (4 968 mm)
Trans Am	197.0" (5 005 mm)
Width	74.5" (1 893 mm)
Height	
Firebird and Formula	
Coupe	52.0" (1 322 mm)
Convertible	52.7" (1 340 mm)
Trans Am	
Coupe	51.7" (1 312 mm)
Convertible	52.4" (1 331 mm)

*Recheck fluid level after filling. See "Manual Transmission Fluid" in the Index.

**Recheck oil level after filling. See "Engine Oil" in the Index.

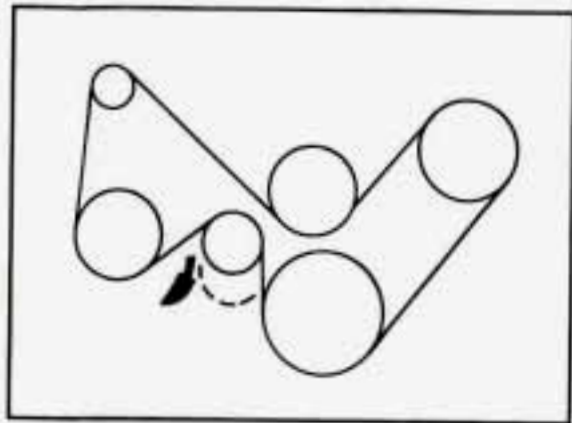

Belt Routing - L32 (Code S) Engine

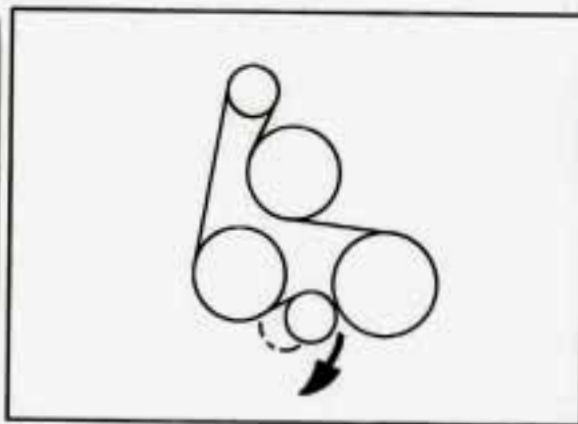

Belt Routing - LT1 (Code P) Engine

Notes

**IMPORTANT:
KEEP THE ENGINE OIL
AT THE PROPER
LEVEL AND CHANGE AS
RECOMMENDED**

This part covers the maintenance required for your Pontiac. Your vehicle needs these services to retain its safety, dependability and emission control performance.

Part 7

Maintenance Schedule

Section

Introduction: A Word about Maintenance	240
Your Vehicle and the Environment	240
How This Part Is Organized	240
A. Scheduled Maintenance Services	242
Using Your Maintenance Schedules	241
Selecting the Right Schedule	241
Schedule I	242
Schedule II	244
Explanation of Scheduled Maintenance Services	246
B. Owner Checks and Services	248
At Each Fuel Fill	248
At Least Once a Month	248
At Least Twice a Year	248
At Least Once a Year	249
C. Periodic Maintenance Inspections	251
D. Recommended Fluids and Lubricants	253
E. Maintenance Record	255



**Protection
Plan**

*Have you purchased the GM Protection Plan? The Plan
supplements your new car warranties.
See your GM dealer for details.*

Maintenance Schedule

Introduction: A Word about Maintenance

We at General Motors want to help you keep your vehicle in good working condition. But we don't know exactly how you'll drive it. You may drive very short distances only a few times a week. Or you may drive long distances all the time in very hot, dusty weather. You may use your vehicle in making deliveries. Or you may drive it to work, to do errands, or in many other ways.

Because of all the different ways people use their GM vehicles, maintenance needs vary. You may even need more frequent checks and replacements than you will find in the schedules in this part. So please read this part and note how you drive. If you have any questions on how to keep your vehicle in good condition, see your Pontiac dealer, the place many GM owners choose to have their maintenance work done. Your dealer can be relied upon to use proper parts and practices.

Your Vehicle and the Environment

Proper vehicle maintenance not only helps to keep your vehicle in good working condition, but also helps the environment. All recommended maintenance procedures are important. Improper vehicle maintenance or the removal of important components can significantly affect the quality of the air we breathe. Improper fluid levels or even the wrong tire inflation can increase the level of emissions from your vehicle. To help protect our environment, and to help keep your vehicle in good condition, please maintain your vehicle properly.

How This Part is Organized

The remainder of this part is divided into five sections:

"Section A: Scheduled Maintenance Services" shows what to have done and how often. Some of these services can be complex, so unless you are technically qualified and have the necessary equipment, you should let your dealer's

service department or another qualified service center do these jobs.



CAUTION

Performing maintenance work on a vehicle can be dangerous. In trying to do some jobs, you can be seriously injured. Do your own maintenance work only if you have the required know-how and the proper tools and equipment for the job. If you have any doubt, have a qualified technician do the work.

If you are skilled enough to do some work on your vehicle, you will probably want to get the service information GM publishes. You will find a list of publications and how to get them in this manual. See "Service Publications" in the Index.

"Section B: Owner Checks and Services" tells you what should be checked whenever you stop for fuel. It also explains what you can easily do to help keep your vehicle in good condition.

“Section C: Periodic Maintenance Inspections” explains important inspections that your Pontiac dealer’s service department or another qualified service center should perform.

“Section D: Recommended Fluids and Lubricants” lists some products GM recommends to help keep your vehicle properly maintained. These products, or their equivalents, should be used whether you do the work yourself or have it done.

“Section E: Maintenance Record” provides a place for you to record the maintenance performed on your vehicle. Whenever any maintenance is performed, be sure to write it down in this section. This will help you determine when your next maintenance should be done. In addition, it is a good idea to keep your maintenance receipts. They may be needed to qualify your vehicle for warranty repairs.

Using Your Maintenance Schedules

This section tells you the maintenance services you should have done and when you should schedule them. Your Pontiac dealer knows your vehicle best and wants you to be happy with it. If you go to your dealer for your service needs, you’ll know that GM-trained and supported service people will perform the work using genuine GM parts.

These schedules are for vehicles that:

- carry passengers and cargo within recommended limits. You will find these limits on your vehicle’s Tire-Loading Information label. See “Loading Your Vehicle” in the Index.
- are driven on reasonable road surfaces within legal driving limits.
- use the recommended unleaded fuel. See “Fuel” in the Index.

Selecting the Right Schedule

First you’ll need to decide which of the two schedules is right for your vehicle. Here’s how to decide which schedule to follow:

Schedule I

Is any one of these true for your vehicle?

- Most trips are less than 4 miles (6 km).
- Most trips are less than 10 miles (16 km) when outside temperatures are below freezing.
- The engine is at low speed most of the time (as in door-to-door delivery, or in stop-and-go traffic).
- You operate your vehicle in dusty areas.
- You tow a trailer.

If any one (or more) of these is true for your driving, follow Schedule I.

Schedule II

Follow Schedule II only if none of the above conditions is true.

Maintenance Schedule

Section A: Scheduled Maintenance Services

Schedule I

Follow Schedule I if your vehicle is MAINLY driven under one or more of the following conditions:

- When most trips are less than 4 miles (6 km).
- When most trips are less than 10 miles (16 km) and outside temperatures remain below freezing.
- When most trips include extended idling and/or frequent low-speed operation, as in stop-and-go traffic.
- When towing a trailer.
- When operating in dusty areas.

Schedule I should also be followed if the vehicle is used for delivery service, police, taxi or other commercial applications.

* An Emission Control Service.

† The U.S. Environmental Protection Agency or the California Air Resources Board has determined that the failure to perform this maintenance item will not nullify the emission warranty or limit recall liability prior to the completion of vehicle useful life. General Motors, however, urges that all recommended maintenance services be performed at the indicated intervals and the maintenance be recorded in "Section E: Maintenance Record."

ITEM NO.	WHAT TO SERVICE <i>See "Explanation of Scheduled Maintenance Services" following Schedules I and II.</i>	WHEN TO PERFORM <i>Miles (kilometers) or Months (whichever occurs first).</i>
1	Engine Oil & Oil Filter Change*	Every 3,000 miles (5 000 km) or 3 months.
2	Chassis Lubrication	Every other oil change.
3	Tire and Wheel Rotation & Inspection	At 6,000 miles (10 000 km) and every 15,000 miles (25 000 km) or as necessary.
4	Engine Accessory Drive Belt Inspection*	Every 30,000 miles (50 000 km) or 24 months.
5	Cooling System Service*	
6	Transmission Service	See "Explanation of Scheduled Maintenance Services" following Schedules I and II.
7	Spark Plug Replacement (3.4L L32 (Code S) Engine)*	Every 30,000 miles (50 000 km).
	Spark Plug Replacement (5.7L LT1 (Code P) Engine)*	Every 100,000 miles (166 000 km).
8	Spark Plug Wire Inspection*†	Every 30,000 miles (50 000 km).
9	Air Cleaner Filter Replacement*	See "Explanation of Scheduled Maintenance Services" following Schedules I and II.
10	Fuel Tank, Cap & Lines Inspection*†	Every 30,000 miles (50 000 km).
11	Rear Axle Fluid Change (For Vehicles Towing Trailers or for Vehicles with Limited-Slip Differentials)	See "Explanation of Scheduled Maintenance Services" following Schedules I and II.

The services shown on this chart up to 48,000 miles (80 000 km) should be performed after 48,000 miles (80 000 km) at the same intervals.

MILES (000)

3	6	9	12	15	18	21	24	27	30	33	36	39	42	45	48
---	---	---	----	----	----	----	----	----	----	----	----	----	----	----	----

KILOMETERS (000)

5	10	15	20	25	30	35	40	45	50	55	60	65	70	75	80
---	----	----	----	----	----	----	----	----	----	----	----	----	----	----	----

•	•	•	•	•	•	•	•	•	•	•	•	•	•	•	•
	•		•		•		•		•		•		•		•
	•					•					•				
									•						
									•						
									•						
									•						
									•						
									•						

Maintenance Schedule

Section A: Scheduled Maintenance Services (Cont.)

Schedule II

Follow Schedule II **ONLY** if none of the driving conditions specified in Schedule I apply.

* An Emission Control Service.

† The U.S. Environmental Protection Agency or the California Air Resources Board has determined that the failure to perform this maintenance item will not nullify the emission warranty or limit recall liability prior to the completion of vehicle useful life. General Motors, however, urges that all recommended maintenance services be performed at the indicated intervals and the maintenance be recorded in "Section E: Maintenance Record."

ITEM NO.	WHAT TO SERVICE <i>"Explanation of Scheduled Maintenance Services" following Schedules I and II.</i>	WHEN TO PERFORM <i>Miles (kilometers) or Months (whichever occurs first).</i>
1	Engine Oil Change*	Every 7,500 miles (12 500 km) or 12 months.
	Oil Filter Change*	At first and every other oil change.
2	Chassis Lubrication	Every 7,500 miles (12 500 km) or 12 months.
3	Tire and Wheel Rotation & Inspection	At 7,500 miles (12 500 km) and then every 15,000 miles (25 000 km) or as necessary.
4	Engine Accessory Drive Belt Inspection*	Every 30,000 miles (50 000 km) or 24 months.
5	Cooling System Service*	
6	Transmission Service	See "Explanation of Scheduled Maintenance Services" following Schedules I and II.
7	Spark Plug Replacement (3.4L L32 (Code S) Engine)*	Every 30,000 miles (50 000 km).
	Spark Plug Replacement (5.7L LT1 (Code P) Engine)*	Every 100,000 miles (166 000 km).
8	Spark Plug Wire Inspection*†	Every 30,000 miles (50 000 km).
9	Air Cleaner Filter Replacement*	See "Explanation of Scheduled Maintenance Services" following Schedules I and II.
10	Fuel Tank, Cap & Lines Inspection*†	Every 30,000 miles (50 000 km).
11	Rear Axle Fluid Change (For Vehicles with Limited-Slip Differentials)	See "Explanation of Scheduled Maintenance Services" following Schedules I and II.

The services shown on this chart up to 48,000 miles (80 000 km) should be performed after 48,000 miles (80 000 km) at the same intervals.

MILES (000)

7.5	15	22.5	30	37.5	45
-----	----	------	----	------	----

KILOMETERS (000)

12.5	25	37.5	50	62.5	75
•	•	•	•	•	•
•		•		•	
•	•	•	•	•	•
•		•		•	
			•		
			•		
			•		
			•		
			•		

Maintenance Schedule

Section A: Scheduled Maintenance Services (Cont.)

Explanation of Scheduled Maintenance Services

Following are explanations of the services listed in Schedule I and Schedule II.

The proper fluids and lubricants to use are listed in Section D. Make sure whoever services your vehicle uses these. All parts should be replaced and all necessary repairs done before you or anyone else drives the vehicle.

NOTE: To determine your engine's displacement and code, see "Engine Identification" in the Index.

ITEM NO. SERVICE

- 1** Engine Oil and Filter Change* – Always use SH or SG Energy Conserving II oils of proper viscosity. The "SH" or "SG" designation may be shown alone or in combination with others, such as "SH/CD," "SH, SG, CD," "SG/CD," etc. To determine the preferred viscosity for your vehicle's engine (e.g., SAE

ITEM NO. SERVICE

- 5W-30 or SAE 10W-30), see "Engine Oil" in the Index.
- 2** Chassis Lubrication – Lubricate the suspension and steering linkage. Lubricate the transmission shift linkage.
- 3** Tire and Wheel Rotation and Inspection – For proper wear and maximum tire life, rotate your tires following the instructions in this manual. See "Tires, Inspection and Rotation" in the Index. Check the tires for uneven wear or damage. If you see irregular or premature wear, check the wheel alignment. Check for damaged wheels also.
- 4** Engine Accessory Drive Belt(s) Inspection – Inspect the belt(s) for cracks, fraying, wear and proper tension. Replace as needed. (Belts can have many small cracks in individual ribs without affecting performance.)

ITEM NO. SERVICE

- 5** Cooling System Service* – Drain, flush and refill the system with new or approved recycled coolant conforming to GM Specification 1825M. Keep coolant at the proper mixture as specified. See "Coolant" in the Index. This provides proper freeze and boil protection, corrosion inhibitor level and maintains proper engine operating temperature.

Inspect hoses and replace if they are cracked, swollen or deteriorated. Tighten screw-type hose clamps. Clean the outside of the radiator and air conditioning condenser. Wash the pressure cap and neck.

To help ensure proper operation, we recommend a pressure test of both the cooling system and the pressure cap.

* An Emission Control Service.

**ITEM
NO. SERVICE**

- 6** Transmission Service – For manual transmissions, fluid doesn't require changing. See "Periodic Maintenance Inspections."
- For automatic transmissions, change both the fluid and filter every 15,000 miles (25 000 km) if the vehicle is mainly driven under one or more of these conditions:
- In heavy city traffic where the outside temperature regularly reaches 90°F (32°C) or higher.
 - In hilly or mountainous terrain.
 - When doing frequent trailer towing.
 - Uses such as found in taxi, police car or delivery service.

If you do not use your vehicle under any of these conditions, change both the fluid and filter every 100,000 miles (166 000 km).

**ITEM
NO. SERVICE**

- 7** Spark Plug Replacement* – Replace spark plugs with the proper type. See "Replacement Parts" in the Index.
- 8** Spark Plug Wire Inspection*† – Inspect for burns, cracks or other damage. Check the boot fit at the distributor and at the spark plugs. Replace wires as needed.
- 9** Air Cleaner Filter Replacement* – Replace every 30,000 miles (50 000 km) or more often under dusty conditions. Ask your dealer for the proper replacement intervals for your driving conditions.
- 10** Fuel Tank, Cap and Lines Inspection*† – Inspect fuel tank, cap and lines (including fuel rails and injection assembly) for damage or leaks. Inspect fuel cap gasket for an even filler neck imprint or any damage. Replace parts as needed. Periodic replacement of the fuel filter is not required.

**ITEM
NO. SERVICE**

- 11** Rear Axle Fluid Change – If your vehicle is used to pull a trailer, have the rear axle gear lubricant changed every 7,500 miles (12 500 km).
- If your vehicle is not used to pull a trailer, but has a limited-slip differential, have the rear axle gear lubricant changed once, after the first 7,500 miles (12 500 km).

* An Emission Control Service.

† The U.S. Environmental Protection Agency or the California Air Resources Board has determined that the failure to perform this maintenance item will not nullify the emission warranty or limit recall liability prior to the completion of vehicle useful life. General Motors, however, urges that all recommended maintenance services be performed at the indicated intervals and the maintenance be recorded in "Section E: Maintenance Record."

Maintenance Schedule

Section B: Owner Checks and Services

Listed below are owner checks and services which should be performed at the intervals specified to help ensure the safety, dependability and emission control performance of your vehicle. Be sure any necessary repairs are completed at once. Whenever any fluids or lubricants are added to your vehicle, make sure they are the proper ones, as shown in Section D.

At Each Fuel Fill *(It is important for you or a service station attendant to perform these underhood checks at each fuel fill.)*

CHECK OR SERVICE	WHAT TO DO
Engine Oil Level	Check the engine oil level and add the proper oil if necessary. See "Engine Oil" in the Index for further details.
Engine Coolant Level	Check the engine coolant level and add the proper coolant mix if necessary. See "Coolant" in the Index for further details.
Windshield Washer Fluid Level	Check the windshield washer fluid level in the windshield washer tank and add the proper fluid if necessary. See "Windshield Washer Fluid" in the Index for further details.

At Least Once a Month

CHECK OR SERVICE	WHAT TO DO
Tire Inflation	Check tire inflation. Make sure they are inflated to the pressures specified on the Tire-Loading Information label located on the rear edge of the driver's door. See "Tires" in the Index for further details.
Cassette Deck	Clean cassette deck. Cleaning should be done every 15 hours of tape play. See "Audio Systems" in the Index for further details.

At Least Twice a Year

CHECK OR SERVICE	WHAT TO DO
Hydraulic Clutch System Inspection	Check the fluid level in the clutch reservoir. See "Hydraulic Clutch Fluid" in the Index. A fluid loss in this system could indicate a problem. Have the system inspected and repaired at once.

At Least Once a Year

CHECK OR SERVICE	WHAT TO DO
Key Lock Cylinders	Lubricate the key lock cylinders with the lubricant specified in Section D.
Body Lubrication	Lubricate all body door hinges. Also lubricate all hinges and latches, including those for the hood, headlight door assemblies, rear compartment, console doors and any folding seat hardware. Section D tells you what to use.
Starter Switch	 CAUTION: When you are doing this check, the vehicle could move suddenly. If it does, you or others could be injured. Follow the steps below.
	<ol style="list-style-type: none">1. Before you start, be sure you have enough room around the vehicle.2. Firmly apply both the parking brake (see "Parking Brake" in the Index if necessary) and the regular brake. <p>NOTE: Do not use the accelerator pedal, and be ready to turn off the engine immediately if it starts.</p> <ol style="list-style-type: none">3. On automatic transmission vehicles, try to start the engine in each gear. The starter should work only in "P" (Park) or "N" (Neutral). If the starter works in any other position, your vehicle needs service. On manual transmission vehicles, put the shift lever in "N" (Neutral), push the clutch down halfway and try to start the engine. The starter should work only when the clutch is pushed down all the way to the floor. If the starter works when the clutch isn't pushed all the way down, your vehicle needs service.

Maintenance Schedule

Section B: Owner Checks and Services (Cont.)

At Least Once a Year (CONT.)

CHECK OR SERVICE	WHAT TO DO
Steering Column Lock	<p>While parked, and with the parking brake set, try to turn the key to "LOCK" in each shift lever position.</p> <ul style="list-style-type: none">● With an automatic transmission, the key should turn to "LOCK" only when the shift lever is in "P" (Park).● With a manual transmission, the key should turn to "LOCK" only when the shift lever is in "R" (Reverse). <p>On vehicles with a key release button, try to turn the key to "LOCK" without pressing the button. The key should turn to "LOCK" only with the key button depressed. On all vehicles, the key should come out only in "LOCK."</p>
Parking Brake and Automatic Transmission "P" (Park) Mechanism Check	<p> CAUTION:</p> <p>When you are doing this check, your vehicle could begin to move. You or others could be injured and property could be damaged. Make sure there is room in front of your vehicle in case it begins to roll. Be ready to apply the regular brake at once should the vehicle begin to move.</p> <p>Park on a fairly steep hill, with the vehicle facing downhill. Keeping your foot on the regular brake, set the parking brake.</p> <ul style="list-style-type: none">● To check the parking brake: With the engine running and transmission in "N" (Neutral), slowly remove foot pressure from the regular brake pedal. Do this until the vehicle is held by the parking brake only.● To check the "P" (Park) mechanism's holding ability: Shift to "P" (Park). Then release all brakes.
Underbody Flushing	At least every spring, use plain water to flush any corrosive materials from the underbody. Take care to clean thoroughly any areas where mud and other debris can collect.

Section C: Periodic Maintenance Inspections

Listed below are inspections and services which should be performed at least twice a year (for instance, each spring and fall). You should let your GM dealer's service department or other qualified service center do these jobs. Make sure any necessary repairs are completed at once.

INSPECTION OR SERVICE	WHAT SHOULD BE DONE
Restraint Systems	Now and then, make sure all your belts, buckles, latch plates, retractors, anchorages and reminder systems are working properly. Look for any loose parts or damage. If you see anything that might keep a restraint system from doing its job, have it repaired.
Steering and Suspension Inspection	Inspect the front and rear suspension and steering system for damaged, loose or missing parts, signs of wear, or lack of lubrication. Inspect the power steering lines and hoses for proper hookup, binding, leaks, cracks, chafing, etc.
Exhaust System Inspection	Inspect the complete exhaust system. Inspect the body near the exhaust system. Look for broken, damaged, missing or out-of-position parts as well as open seams, holes, loose connections or other conditions which could cause a heat build-up in the floor pan or could let exhaust fumes into the vehicle. See "Engine Exhaust" in the Index.
Throttle Linkage Inspection	Inspect the throttle linkage for interference or binding, and for damaged or missing parts. Replace parts as needed.

Maintenance Schedule

Section C: Periodic Maintenance Inspections (Cont.)

INSPECTION OR SERVICE	WHAT SHOULD BE DONE
Manual Transmission	Check the transmission fluid level; add if needed. See "Manual Transmission" in the Index. A fluid loss may indicate a problem. Check the system and repair if needed.
Rear Axle Service	Check the gear lubricant level in the rear axle and add if needed. See "Rear Axle" in the Index. A fluid loss may indicate a problem. Check the axle and repair it if needed. If your vehicle is used to pull a trailer, have the rear axle gear lubricant changed every 7,500 miles (12 500 km).
Brake System Inspection	Inspect the complete system. Inspect brake lines and hoses for proper hookup, binding, leaks, cracks, chafing, etc. Inspect disc brake pads for wear and rotors for surface condition. Also inspect drum brake linings for wear and cracks. Inspect other brake parts, including drums, wheel cylinders, calipers, parking brake, etc. The parking brake is self-adjusting and no manual adjustment is required. You may need to have your brakes inspected more often if your driving habits or conditions result in frequent braking. <u>NOTE:</u> A low brake fluid level can indicate worn disc brake pads which may need to be serviced. Also, if the brake system warning light stays on or comes on, something may be wrong with the brake system. See "Brake System Warning Light" in the Index. If your anti-lock brake system warning light stays on, comes on or flashes, something may be wrong with the anti-lock brake system. See "Anti-Lock Brake System Warning Light" in the Index.

Section D: Recommended Fluids & Lubricants

NOTE: Fluids and lubricants identified below by name, part number or specification may be obtained from your GM Dealer.

USAGE	FLUID/LUBRICANT
Engine Oil	API service SH or SG Energy Conserving II oils of the proper viscosity. The "SH" designation may be shown alone or in combination with others, such as "SH/CD," "SH, SG, CD," "SG/CD," etc. To determine the preferred viscosity for your vehicle's engine, see "Engine Oil" in the Index.
Engine Coolant	50/50 mixture of water (preferably distilled) and good quality ethylene glycol base antifreeze (GM Part No. 1052753 or equivalent) conforming to GM Specification 1825M or approved recycled coolant conforming to GM Specification 1825M.
Hydraulic Brake System	Delco-Supreme 11 [®] Brake Fluid (GM Part No. 1052535 or equivalent DOT-3 Brake Fluid).
Hydraulic Clutch System	Hydraulic Clutch Fluid (GM Part. No. 12345347 or equivalent).
Power Steering System	GM Hydraulic Power Steering Fluid (GM Part No. 1052884 or equivalent).
Manual Transmission	DEXRON [®] -IIE Automatic Transmission Fluid.
Automatic Transmission	DEXRON [®] -III or DEXRON [®] -IIE Automatic Transmission Fluid.
Key Lock Cylinders	Lubricate with Multi-Purpose Lubricant (GM Part No. 12345120) or synthetic SAE 5W-30 engine oil.
Automatic Transmission Shift Linkage	Engine oil.
Clutch Linkage Pivot Points	Engine oil.

Maintenance Schedule

Section D: Recommended Fluids & Lubricants (Cont.)

USAGE	FLUID/LUBRICANT
Floor Shift Linkage	Engine oil.
Chassis Lubrication	Chassis lubricant (GM Part No. 1052497 or equivalent) or lubricant meeting requirements of NLGI Grade 2, Category LB or GC-LB.
Rear Axle (Standard Differential)	Axle Lubricant (GM Part No. 1052271) or SAE 80W-90 GL-5 Gear Lubricant.
Rear Axle (Limited-Slip Differential)	Axle Lubricant (GM Part No. 12345977) or SAE 80W-90 GL-5 Gear Lubricant, and Limited-Slip Differential Lubricant Additive (GM Part No. 1052358 or equivalent) where required. See "Rear Axle" in the Index.
Windshield Washer Solvent	GM Optikleen [®] Washer Solvent (GM Part No. 1051515 or equivalent).
Hood Latch Assembly a. Pivots and Spring Anchor b. Release Pawl	a. Engine oil. b. Chassis lubricant (GM Part No. 1052497 or equivalent) or lubricant meeting requirements of NLGI Grade 2, Category LB or GC-LB.
Hood and Door Hinges, Headlight Door Assemblies, Rear Folding Seat, Fuel Door Hinge, Rear Compartment Lid Hinges	Engine oil or Lubriplate Lubricant (GM Part No. 1050109).
Weatherstrips	Dielectric Silicone Grease (GM Part No. 12345579 or equivalent).

See "Replacement Parts" in the Index for recommended replacement filters, valves and spark plugs.

Section E: Maintenance Record

After the scheduled services are performed, record the date, odometer reading and who performed the service in the columns indicated. When completing the Maintenance Performed column, insert the numbers from the Schedule I or Schedule II maintenance charts which correspond to the maintenance performed. Also, you should retain all maintenance receipts. Your owner information portfolio is a convenient place to store them.

DATE	ODOMETER READING	SERVICED BY	MAINTENANCE PERFORMED

Maintenance Schedule

Section E: Maintenance Record (Cont.)

DATE	ODOMETER READING	SERVICED BY	MAINTENANCE PERFORMED

DATE	ODOMETER READING	SERVICED BY	MAINTENANCE PERFORMED

Maintenance Schedule

Section E: Maintenance Record (Cont.)

DATE	ODOMETER READING	SERVICED BY	MAINTENANCE PERFORMED



Here you will find out how to contact Pontiac if you need assistance. This part also tells you how to obtain service publications and how to report any safety defects.

Part 8 Customer Assistance Information

Customer Satisfaction Procedure	260
GM Participation in BBB AUTO LINE—Alternative Dispute Resolution Program	261
Reporting Safety Defects to the United States Government	262
Reporting Safety Defects to the Canadian Government	262
Reporting Safety Defects to General Motors	262
Pontiac Roadside Assistance	263
Canadian Roadside Assistance	263
Pontiac Courtesy Transportation	264
Service Publications.	264

Customer Assistance Information

■ *Customer Satisfaction Procedure*

Your satisfaction and goodwill are important to your dealer and Pontiac. Normally, any concern with the sales transaction or the operation of your vehicle will be resolved by your dealer's Sales or Service Departments. Sometimes, however, despite the best intentions of all concerned, misunderstandings can occur. If your concern has not been resolved to your satisfaction, the following steps should be taken:

STEP ONE: Discuss your concern with a member of dealership management. Normally, concerns can be quickly resolved at that level. If the matter has already been reviewed with the Sales, Service, or Parts Manager, contact the owner of the dealership or the General Manager.

STEP TWO: If after contacting a member of dealership management, it appears your concern cannot be resolved by the dealership without further help, contact the Pontiac Customer Assistance Center by calling 1-800-PM-CARES.

In Canada, contact GM of Canada Customer Assistance Center in Oshawa by calling 1-800-263-3777 (English) or 1-800-263-7854 (French). In Mexico, call (525) 254-3777. In Puerto Rico or U.S. Virgin Islands, call 1-809-763-1315. In all other overseas locations, contact GM North American Export Sales in Canada by calling 1-905-644-4112.

For prompt assistance, please have the following information available to give the Customer Assistance Representative:

- Your name, address, home and business telephone numbers
- Vehicle Identification Number (This is available from the vehicle registration or title, or the plate attached to the left top of the instrument panel and visible through the windshield.)
- Dealership name and location
- Vehicle delivery date and present mileage
- Nature of concern

We encourage you to call the toll-free number listed previously in order to give your inquiry prompt attention. However, if you wish to write Pontiac, write to:

United States
Pontiac Division
Customer Assistance Center
One Pontiac Plaza
Pontiac, MI 48340-2952

Canada
General Motors of Canada Limited
Customer Assistance Center, 163-005
1908 Colonel Sam Drive
Oshawa, Ontario L1H 8P7

Refer to your Warranty and Owner Assistance Information booklet for addresses of Canadian and GM Overseas offices.

When contacting Pontiac, please remember that your concern will likely be resolved in the dealership, using the dealership's facilities, equipment and personnel. That is why we suggest you follow Step One first if you have a concern.

Customer Assistance for the Hearing or Speech Impaired (TDD)

To assist customers who have hearing difficulties, Pontiac has installed special TDD (Telecommunication Devices for the Deaf) equipment at its Customer Assistance Center. Any hearing or speech

impaired customer who has access to a TDD or a conventional teletypewriter (TTY) can communicate with Pontiac by dialing: 1-800-TDD-PONT (TDD users in Canada can dial 1-800-263-3830.)

■ *GM Participation in BBB AUTO LINE —Alternative Dispute Resolution Program* *

Both Pontiac and your Pontiac dealer are committed to making sure you are completely satisfied with your new vehicle. Our experience has shown that, if a situation arises where you feel your concern has not been adequately addressed, the Customer Satisfaction Procedure described earlier in this section is very successful.

There may be instances where an impartial third-party can assist in arriving at a solution to a disagreement regarding vehicle repairs or interpretation of the New Vehicle Limited Warranty. To assist in resolving these disagreements Pontiac voluntarily participates in BBB AUTO LINE.

BBB AUTO LINE is an out-of-court program administered by the Better Business Bureau system to settle disputes between customers and automobile manufacturers. This program is available free of charge to customers who currently own or lease a GM vehicle.

If you are not satisfied after following the Customer Satisfaction Procedure, you may contact the BBB using the toll-free telephone number, or write them at the following address:

BBB AUTO LINE
Council of Better Business Bureaus
4200 Wilson Boulevard
Suite 800
Arlington, VA 22203

Telephone: 1-800-955-5100

To file a claim, you will be asked to provide your name and address, your vehicle identification number (VIN), and a statement of the nature of your complaint. Eligibility is limited by vehicle age and mileage, and other factors.

We prefer you utilize the Customer Satisfaction Procedure before you resort to AUTO LINE, but you may contact the BBB at any time. The BBB will attempt to resolve the complaint serving as an

intermediary between you and Pontiac. If this mediation is unsuccessful, an informal hearing will be scheduled where eligible customers may present their case to an impartial third-party arbitrator.

The arbitrator will make a decision which you may accept or reject. If you accept the decision, GM will be bound by that decision. The entire dispute resolution procedure should ordinarily take about forty days from the time you file a claim until a decision is made.

Some state laws may require you to use this program before filing a claim with a state-run arbitration program or in the courts. For further information, contact the BBB at 1-800-955-5100 or the Pontiac Customer Assistance Center at 1-800-PM-CARES.

* This program may not be available in all states, depending on state law. Canadian owners refer to your Warranty and Owner Assistance information booklet. General Motors reserves the right to change eligibility limitations and/or to discontinue its participation in this program.

Customer Assistance Information

■ *Reporting Safety Defects to the United States Government*

If you believe that your vehicle has a defect which could cause a crash or could cause injury or death, you should immediately inform the National Highway Traffic Safety Administration (NHTSA), in addition to notifying General Motors.

If NHTSA receives similar complaints, it may open an investigation, and if it finds that a safety defect exists in a group of vehicles, it may order a recall and remedy campaign. However, NHTSA cannot become involved in individual problems between you, your dealer, or General Motors.

To contact NHTSA, you may either call the Auto Safety Hotline toll-free at 1-800-424-9393 (or 366-0123 in the Washington, D.C. area) or write to:

NHTSA
U.S. Department of Transportation
Washington, D.C. 20590

You can also obtain other information about motor vehicle safety from the Hotline.

■ *Reporting Safety Defects to the Canadian Government*

If you live in Canada, and you believe that your vehicle has a safety defect, you should immediately notify Transport Canada, in addition to notifying General Motors of Canada Limited. You may write to:

Transport Canada
Box 8880
Ottawa, Ontario K1G 3J2

■ *Reporting Safety Defects to General Motors*

In addition to notifying NHTSA (or Transport Canada) in a situation like this, we certainly hope you'll notify us. Please call us at 1-800-PM-CARES, or write:

Pontiac Division
Customer Assistance Center
One Pontiac Plaza
Pontiac, MI 48340-2952

In Canada, please call us at 1-800-263-3777 (English) or 1-800-263-7854 (French). Or, write:

General Motors of Canada Limited
Customer Assistance Center, 163-005
1908 Colonel Sam Drive
Oshawa, Ontario L1H 8P7



■ *Pontiac Roadside Assistance*

Security While You Travel 1-800-ROADSIDE (1-800-762-3743)

As the proud owner of a new Pontiac vehicle, you are automatically enrolled in the Pontiac Roadside Assistance Program*. This value-added service is intended to provide you with peace of mind as you drive in the city or travel the open road.

Pontiac's Roadside Assistance toll-free number is staffed by a team of trained technical advisors who are available 24 hours a day, 365 days a year. We take the anxiety out of uncertain situations by providing minor repair information over the phone or making arrangements to tow your vehicle to the nearest Pontiac dealer.

We will provide the following services for 3 years/36,000 miles, at no expense to you:

- Vehicle out of fuel
- Keys locked in car
- Tow to the nearest dealer for warranty
- Change a flat tire
- Jump starts

We have quick easy access to telephone numbers of the following services depending on your needs:

- Hotels
- Glass replacement
- Rental vehicles or taxis
- Police, fire department or hospitals

In many instances, mechanical failures are covered under Pontiac's comprehensive warranty. However, when other services are utilized, our advisors will explain any payment obligations you might incur.

Pontiac reserves the right to limit services or reimbursement to an owner or driver when in Pontiac's judgment the claims become obsessive in frequency or type of occurrence.

While we hope you never have the occasion to use our service, it is added security while traveling for you and your family. Remember, we're only a phone call away. Pontiac Roadside Assistance—1-800-ROADSIDE or 1-800-762-3743.

■ *Canadian Roadside Assistance*

Vehicles purchased in CANADA have an extensive ROADSIDE ASSISTANCE Program accessible from anywhere in Canada or the U.S.A. Please refer to the separate brochure provided by the dealer or call 1-800-268-6800 for emergency services.

Customer Assistance Information

■ *Pontiac Courtesy Transportation*

For warranty repairs during the BUMPER TO BUMPER coverage period, interim transportation may be available under the Pontiac Courtesy Transportation Program. Please consult your dealer for details.

In Canada, please consult your GM Dealer for information on courtesy transportation.

■ *Service Publications*

Information on how to obtain Product Service Publications and Indexes as described below is applicable only in the fifty U.S. states (and the District of Columbia) and only for cars and light trucks with GVWR less than 10,000 pounds (4 536 kg).

In Canada, information pertaining to Product Service Bulletins and Indexes can be obtained by writing to:

General Motors of Canada Limited
Service Publications Department
1908 Colonel Sam Dr.
Oshawa, Ontario L1H 8P7

Pontiac regularly sends its dealers useful service bulletins about Pontiac products. Pontiac monitors product performance in the field. We then prepare bulletins for servicing our products better. Now, you can get these bulletins too.

Bulletins cover various subjects. Some pertain to the proper use and care of your vehicle. Some describe costly repairs. Others describe inexpensive repairs which, if done on time with the latest parts, may avoid future costly repairs. Some bulletins tell a technician how to repair a new or unexpected condition. Others describe a quicker way to fix your vehicle. They can help a technician service your vehicle better.

Most bulletins apply to conditions affecting a small number of cars or trucks. Your Pontiac dealer or a qualified technician may have to determine if a specific bulletin applies to your vehicle.

Individual PSP's

If you don't want to buy all the PSP's issued by Pontiac for all car or truck models in the model year, you can buy individual PSP's, such as those which may pertain to a particular model. To do this, you will first need to see our index

of PSP's. It provides a variety of information. Here's what you'll find in the index and how you can get one:

What You'll Find in the Index:

- A list of all PSP's published by Pontiac in a model year (1990 or later). PSP's covering all models of Pontiac vehicles are listed in the same index.
- Ordering information so you can buy the specific PSP's you may want.
- Price information for the PSP's you may want to buy.

How You Can Get an Index:

Indexes are published periodically. Most of the PSP's which could potentially apply to the most recent Pontiac models will be listed in the most recent publication for that model year. This means you may want to wait until the end of the model year before ordering an index, if you are interested in buying PSP's pertaining to a current model year car or truck.

Some PSP's pertaining to a particular model year vehicle may be published in later years, and these would be listed in the later year's index. When you order an index for a model year that is not over yet, we'll send you the most recently published issue. Check the ordering form for indexes for earlier model years.

Cut out the ordering form, fill it out, and mail it in. We will then see to it that an index is mailed to you. There is no charge for indexes for the 1990-1994 model years.

Toll-Free Telephone Number

If you want an additional ordering form for an index, just call toll-free and we'll be happy to send you one. Automated recording equipment will take your name and mailing address. The number to call is 1-800-551-4123.

A VERY IMPORTANT REMINDER:

These PSP's are meant for technicians. They are not meant for the "do-it-yourselfer." Technicians have the equipment, tools, safety instructions, and know-how to do a job quickly and safely.

Pontiac Service Publications

You can get these by using the order form. Pontiac Division Service Manuals are intended for use by professional qualified technicians. Attempting repairs or service without the appropriate training, tools, and equipment could cause injury to you or others and damage to your vehicle that may cause it not to operate properly.

Customer Assistance Information

PONTIAC SERVICE PUBLICATIONS ORDER FORM
NOTE: Please complete form below (Print or Type) and MAIL TO:

HELM

Post Office Box 07130, Detroit, Michigan 48207

ORDER TOLL FREE 1-800-782-4356 (Monday-Friday 8:00 A.M.-6:00 P.M. EST)					
--	--	--	--	--	--

PUBLICATION FORM NUMBER	ITEM DESCRIPTION	VEHICLE MODEL		QTY.	PRICE EACH*	TOTAL PRICE
		NAME	YEAR			
S-9410-F	Service Manual	Pontiac Firebird	1994		TBA**	
10260930	Owner's Manual In-Portfolio	Pontiac Firebird	1994		\$15.00	
10260939	Owner's Manual Without-Portfolio	Pontiac Firebird	1994		\$10.00	

SHIP TO	NOTE: Dealers and Companies please provide dealer or company name, and also the name of the person to whose attention the shipment should be sent. For purchases outside U.S.A. please write to the above address for quotation.	
	_____ (CUSTOMER NAME)	_____ (ATTENTION)
	_____ (STREET ADDRESS—NO P.O. BOX NUMBERS)	_____ (APT. NO.)
	_____ (CITY)	_____ (STATE) _____ (ZIP CODE)
	_____ DAYTIME TELEPHONE NO.	_____ AREA CODE ()

PAYMENT	<input type="checkbox"/> Check or Money Order payable to Helm, Inc. (USA funds only — do not send cash.)	TOTAL MATERIAL Michigan Purchasers add 4% sales tax Handling Charge \$4.00 Canadian Postage (See Note Below) GRAND TOTAL
	<input type="checkbox"/> MasterCard <input type="checkbox"/> VISA <input type="checkbox"/> Discover Card	
	Account Number: _____	
	Expiration Date mo/yr: _____	<input type="checkbox"/> Check here if your billing address is different from your shipping address shown.
	_____ (CUSTOMER SIGNATURE)	

* Prices are subject to change without notice and without incurring obligation.
 ** Price to be announced at a later date. Call 1-800-782-4356 for further information.
 Orders cannot be returned without prior authorization. A restocking fee may apply.

NOTE TO CANADIAN CUSTOMERS: All listed prices are quoted in U.S. funds. Canadian residents are to make checks payable in U.S. funds. To cover Canadian postage, add \$11.50 plus the U.S. Handling Charge. Requests for manuals printed in French should be directed to Canadian General Motors dealerships. **Please allow adequate time for postal service.**

1994 PONTIAC SERVICE PUBLICATIONS ORDERING INFORMATION

The following publications covering the operation and servicing of your vehicle can be purchased by filling out the Service Publications Order Form in this book and mailing it with your check, money order or credit card information to Helm, Incorporated (address listed below).

CURRENT PUBLICATIONS FOR 1994 PONTIAC FIREBIRD

PRODUCT SERVICE PUBLICATIONS

Product Service Publications (PSP's), are bulletins, letters and articles published for trained dealer service personnel. See Service Publications listed previously in this section.

A cumulative index is published quarterly during the current model year. The indexes list all PSP's published by Pontiac in the model year.

PSP Index

Year	Form Number	Price
1994	PSPI-94-P	Free
1993	PSPI-93-P	Free
1992	PSPI-92-P	Free
1991	PSPI-91-P	Free

PSP Bound Bulletin Book (Complete Year Bulletins)

Year	Description	Form Number	Price
1992	All PSP's	S-92-PSP-4	15.00
1991	All PSP's	S-91-PSP-4	15.00

For subscription information call Helm, Incorporated.

SERVICE MANUALS

Service Manuals have the diagnosis, repair and overhaul information on engines, transmission, axle, suspension, brakes, electrical, steering, body, etc.

Model	Form Number	Price
1994 Pontiac Firebird	S-9410-F	TBA*

NOTE: Please specify special body or engine types on order form. Write information in the Form Number column. For example: Turbo, Convertible.

*Price to be announced at a later date. Call 1-800-782-4356 for further information.

OWNER'S INFORMATION

Owner publications are written directly for owners and intended to provide basic operational information about the vehicle. The Owner's Manual includes the Maintenance Schedule for all models.

1994 Pontiac Firebird Owner's Manual

In Portfolio: Includes Portfolio, Owner's Manual and Warranty Booklet.

1994 Pontiac Firebird In-Portfolio	10260930	\$15.00
--	----------	---------

Without Portfolio: Includes Owner's Manual.

1994 Pontiac Firebird Without Portfolio	10260939	\$10.00
---	----------	---------

CURRENT & PAST MODEL ORDER FORMS

Service Publications are available for current and past model Pontiac vehicles. To request an order form, please specify year and model name of vehicle.

Address all inquiries to: HELM, INCORPORATED
P.O. Box 07130
Detroit, MI 48207

For information and inquiries call: 1-800-782-4356

Notes

A BS	129	Appearance Care, Service and	183	Brakes	
Accessory Power, Retained	52	Ashtray and Lighter	85	Fluid	207
Add-On Electrical Equipment	228	Ashtray, Front	85	Master Cylinder	206
Adding Coolant	202	Audio Systems	108	Parking	63
Additives, Engine Oil	194	Audio Systems, Comfort		Pedal Travel	207
Air Bags	23	Controls and	103	System Parts, Replacing	208
How the System Works	24	Automatic		System Warning Light	90
Servicing Your Air Bag-Equipped		Transmission	56	Trailer	147
Pontiac	27	Transmission Fluid	198	Wear	207
Readiness Light	24	Axle, Limited-Slip Rear	62	Braking (Control of a Vehicle)	128
Air Cleaner	195	Axle, Rear	201	Braking in Emergencies	132
Air Conditioner Controls	106	B abies, Smaller Children		"Break-In," New Vehicle	50
Air Control Knob	104	and (Safety Belts)	30	Brightness Control	76
Air Filter Replacement	196	Balance, Wheel Alignment		Bulb Replacement	209
Alignment and Tire Balance,		and Tire	220	Center High-Mounted	
Wheel	220	Battery	208	Stoplight	210
Aluminum Wheels	225	Battery Replacement, Remote Lock		Front Turn Signal	211
AM/FM Stereo		Control	45	Headlights	209
With Cassette Tape Player	109	BBB Auto Line – Alternative Dispute		Rear Lights	211
With Cassette Tape Player and		Resolution Program,		Rear Sidemarker	212
Graphic Equalizer	112	GM Participation in	261	Bulbs, Halogen	209
With Compact Disc Player	115	Before Leaving on a Long Trip	140	Bulbs, Replacement	232
With Compact Disc Player and		Belt Routing	237	C anadian Roadside Assistance ...	263
Graphic Equalizer	118	Belt, Lap-Shoulder	19	Capacities and Specifications	233
Antenna, Fixed Mast	123	Bi-Level Heating	105	Carbon Monoxide	48
Anti-Lock Brakes	129	Blizzard, If You're Caught in a ...	143	Care	
System Warning Light	91	Box, Glove	83	Appearance	221
To Use	130	Brakes		Cassette Tape Player	122
Appearance Care	221	Adjustment	208	Compact Discs	122
Appearance Care and Materials	227	Anti-Lock (ABS)	129	Safety Belts	224

Index

Cassette Tape Player and Graphic Equalizer, AM/FM Stereo with ..	112	Cleaning		Controls	
Cassette Tape Player, AM/FM Stereo with ..	109	Leather	223	Remote Lock	44
Cassette Tape Player, Care of Your	122	Outside of Your Pontiac	224	Seat	8
Chains, Tire	221	Problems, Special	223	Convertible Top	98
Changing a Flat Tire	171	Twin Lift-Off Roof Panels	224	Installing the Boot Cover	99
Check Gages Light	97	Vinyl	223	To Lower	98
Checking Things under the Hood ..	18	Windshield and Wiper Blades ...	224	To Raise	100
Checking Your Restraint Systems ..	40	Clock, Setting the	109	Convex Outside Mirror	79
Chemical Paint Spotting	226	Close-Out Panel	84	Coolant	
Child Restraints	31	Clutch, Hydraulic	201	Adding	202
Rear Seat	33	Comfort Controls	104	Engine	201
Right Front Seat	35	Comfort Controls and Audio Systems	103	Heater, Engine	55
Top Strap	32	Compact Disc, To Play a	116, 119	How to Add to the Coolant Recovery Tank	164
Where to Put the	31	Compact Disc Player and Graphic Equalizer, AM/FM Stereo with ..	118	How to Add to the Radiator ..	165, 167
Children (Safety Belts)	30	Compact Disc Player, AM/FM Stereo with	115	Temperature Gage, Engine	94
Children, Larger (Safety Belts)	38	Compact Discs, Care of Your	122	Cooling	106
Cigarette Lighter	86	Compact Spare Tire	180	Cooling System	162
Circuit Breakers, Fuses and	229	Compartments, Storage and	83	Courtesy Lights	78
City Driving	138	Console, Front	84	Courtesy Transportation	263
Cleaner, Air	195	Control of a Vehicle	128	Covered Visor Vanity Mirror	85
Cleaning		Control, Loss of	135	Cruise Control	72
Aluminum Wheels	225	Controls		Passing Another Vehicle	
Convertible Top	225	Air Conditioner	106	While Using	75
Fabric	222	Brightness	76	To Erase Speed Memory	75
Glass	224	Comfort	104	To Get Out of	75
Inside of Your Pontiac	222	Features and	41	To Increase Speed While Using ..	74
Instrument Panel, Top of	223	Heater	104	To Reduce Speed While Using ..	74
		Main Light	76	To Resume a Set Speed	73
				To Set	72
				Traction Control System and	75

Cruise Control	
Using on Hills	75
Curves, Driving on	132
Customer Assistance for the Hearing or Speech Impaired (TDD)	260
Customer Assistance Information	259
Customer Satisfaction Procedure	260

D aytime Running Lights	77
Deep Standing Water, Driving through	54
Defects, Safety	
Reporting to General Motors	262
Reporting to the Canadian Government	262
Reporting to the United States Government	261
Defensive Driving	126
Defogger, Rear Window	107
Defogging and Defrosting Windows	105
Dimensions, Vehicle	236
Doing Your Own Service Work	184
Door Locks	43
Door Locks, Power	44
Doors, Headlight	76
Driver Position (Safety Belts)	19
Driving	
At Night	136
City	138
Defensive	126

Driving	
Drunken	126
Freeway	139
In the Rain	137
On Curves	132
On Snow or Ice	142
Through Deep Standing Water	54
Winter	142
With a Trailer	147
Drunken Driving	126

E lectrical Center, Underhood	231
Electrical Equipment, Add-On	228
Electric Mirror Control	80
Emergencies, Braking in	132
Emergencies, Steering in	133
Engine	
Coolant	201
Coolant (Block) Heater	55
Coolant Temperature Gage	93
Exhaust	66
Identification	228
Oil	191
Oil Pressure Gage	95
Overheating	161
Specifications	233
Starting Your	52
Environment, Your Vehicle and the	240
Exhaust, Engine	66
Extender, Safety Belt	39

F an Control Knob	104
Features and Controls	41
Filling Your Tank	187
Filter, Air, Replacement	196
Finish Care (Paint)	225
Finish Damage (Paint)	226
Fixed Mast Antenna	123
Flashers, Hazard Warning	152
Flat Tire, Changing a	171
Flat, If a Tire Goes	170
Floormats	79
Flow-Through Ventilation System	107
Fluid	
Automatic Transmission	198
Brake	207
Manual Transmission	200
Power Steering	204
Recommended	253
Windshield Washer	205
Fog Lights	78
Folding Rear Seatback	13
Foreign Countries, Fuels in	186
Foreign Material Paint Damage	226
Four-Way Manual Seat	8
Freeway Driving	139
Front	
Ashtray	85
Console	84
Map Lights	79
Seat, Manual	8

Index

- Front
Towing Hook-ups 158
- Fuel 185
- Fuel Gage 90
- Fuels in Foreign Countries 186
- Fully Articulating Sport Seat 9
- Fuse Block, Main 230
- Fuse Block, Underhood 231
- Fuses and Circuit Breakers 229
- G**ages
Engine Coolant Temperature 93
- Engine Oil Pressure 95
- Fuel 90
- Warning Lights and Indicators 89
- Gasolines for Cleaner Air 186
- Glass 224
- Glove Box 83
- GM Participation in BBB Auto Line –
Alternative Dispute Resolution
Program 261
- H**alogen Bulbs 209
- Hatch Release 47
- Hatch Release, Remote 47
- Hazard Warning Flashers 152
- Head Restraints 12
- Headlight Doors 76
- Headlight High/Low Beam 70
- Headlights 209
- Heater Controls 104
- Heater, Engine Coolant (Block) 56
- Heating 104
- Highway Hypnosis 140
- Hill and Mountain Roads 141
- Hitches 147
- Hood Release 188
- Hood, Checking Things under the 188
- Hook-Ups, Front Towing 158
- Hook-Ups, Rear Towing 160
- Horn 68
- How to Add Coolant to the
Coolant Recovery Tank 164
- How to Add Coolant to the
Radiator 165, 167
- Hydraulic Clutch 201
- Hydroplaning 138
- Hypnosis, Highway 140
- I**dentification Number, Vehicle 228
- Identification, Engine 228
- If a Tire Goes Flat 170
- If You're Stuck: In Sand, Mud, Ice
or Snow 180
- Ignition Switch 51
- Inflatable Restraint System,
Supplemental 23
- Inflation – Tire Pressure 216
- Inside Day/Night Rearview
Mirror 79
- Instrument Cluster 88
- Instrument Panel 87
- Instrument Panel, Cleaning the
Top of 223
- Interior Lights 78
- J**ump Starting 153
- K**ey Release Button 51
- Keys 42
- L**abel, Service Parts
Identification 228
- Lane Change Indicator,
Turn Signal and 69
- Lap-Shoulder Belt (Safety Belts) 19
- Larger Children (Safety Belts) 38
- Leaving Your Vehicle 44
- Leaving Your Vehicle with the
Engine Running 64
- Lighter, Ashtray and 85
- Lighter, Cigarette 85
- Lights
Air Bag Readiness 24
- Anti-Lock Brake System
Warning 91
- Brake System Warning 90
- Bulb Replacement 232
- Check Gages 96
- Courtesy 78
- Daytime Running 77
- Fog 78
- Front Map 79

Lights		Maintenance		Night Vision	136
Gages and Indicators, Warning	90	Record	255	Nuts, Wheel	234
Interior	78	Schedule	239	O dometer, Speedometer and	89
Low Coolant	98	Services, Scheduled	242	Odometer, Trip	90
Low Oil	97	Underbody	226	Off-Road Recovery	133
Low Traction	94	When Trailer Towing	149	Oil, Engine	191
Main Control	76	Malfunction Indicator Lamp	95	Operation of Lights	76
Malfunction Indicator Lamp	95	Manual		Overheating, Engine	161
Operation of	76	Adjust Mirrors	79	Owner Checks and Services	248
Safety Belt Reminder	18	Front Seat	8	P (Park) Shifting into	64
Service Engine Soon	95	Remote Control Mirror	79	P (Park), Shifting out of	65
Skip Shift	61	Seat, Four-Way	8	Paint	
Traction Control System		Transmission (Five-Speed)	59	Chemical Spotting	226
Warning	93	Transmission (Six-Speed)	60	Finish Care	225
Lights On Reminder	76	Transmission Fluid	200	Finish Damage	226
Limited-Slip Rear Axle	62	Windows	67	Foreign Material	226
Loading Your Vehicle	213	Map Lights, Front	79	Parking	
Lock Control, Remote	44	Map Pocket	84	Brake	63
Locks, Door	43	Master Cylinder, Brake	206	On Hills (Trailer Towing)	148
Locks, Power Door	44	Mirrors		Over Things That Burn	66
Loss of Control	135	Control, Electric	80	Your Vehicle	65
Low Coolant Light	98	Convex Outside	79	Parts, Replacement	234
Low Oil Light	97	Inside Day/Night Rearview	79	PASS-Key II	49
Low Traction Light	94	Manual Adjust	79	Passenger Positions (Safety Belts)	27
Lubricant, Rear Axle	201	Manual Remote Control	79	Rear Seat	28
Lubricants, Recommended	253	Visor Vanity, Covered	85	Right Front	27
M ain Fuse Block	230	Mode Switch, Performance	54	Passengers, Rear Seat	
Main Light Control	76	Mountain Roads, Hill and	14	(Safety Belts)	28
Maintenance		N ew Vehicle "Break-In"	50	Passing	134
Inspections, Periodic	251	Night Driving	136		

Index

- Pedal Travel, Brake 207
Performance Mode Switch 54
Periodic Maintenance Inspections .. 251
Pontiac Roadside Assistance 262
Pontiac Service Publications
(Ordering Information) 265
Power
Door Locks 44
Retained Accessory 52
Seat, Six-Way 9
Steering 132
Steering Fluid 204
Windows 68
Pregnancy, Safety Belt Use
during 27
Pressure Cap, Radiator 204
Problems on the Road 151
Publications, Service 263
- Q**uestions Many People Ask about
Safety Belts – and the Answers,
Here are 17
- R**adiator Pressure Cap 204
Radiator, How to Add Coolant
to the 165, 167
Radio Reception, Understanding ... 121
Radio, To Play the
AM/FM Stereo with Cassette
Tape Player 109
Radio, To Play the
AM/FM Stereo with Cassette
Tape Player and Graphic
Equalizer 112
AM/FM Stereo with Compact
Disc Player 115
AM/FM Stereo with Compact
Disc Player and Graphic
Equalizer 118
Rain, Driving in the 137
Rainy Weather Tips, Some Other ... 138
Rear
Axle 201
Axle, Limited-Slip 62
Seat Passengers (Safety Belts) ... 28
Seat, Securing a Child Restraint
in the 33
Seatback, Folding 13
Towing Hook-Ups 160
Window Defogger 107
Rearview Mirror, Inside
Day/Night 79
Recommended Fluids
and Lubricants 253
Recovery, Off-Road 133
Release
Hatch 47
Hatch, Remote 47
Hood 188
Reminder Light, Safety Belt 18
Reminder, Lights On 76
Remote Hatch Release 47
Remote Lock Control 44
Replacement
Air Filter 196
Battery, Remote Lock Control ... 44
Bulbs (Part Numbers) 232
Bulbs (Service) 209
Parts 234
Wheel 220
Wheels, Used 220
Replacing Brake System Parts 208
Replacing Safety Belts after
a Crash 40
Reporting Safety Defects 261
Restraint Systems, Seats and 7
Restraints
Checking Your System 40
Child 31
Head 12
Where to Put the 31
Retained Accessory Power 52
Right Front Passenger Position
(Safety Belts) 27
Right Front Seat, Securing a Child
Restraint in the 35
Road, Problems on the 151
Road, Your Driving and the 125
Roads, Hill and Mountain 141
Roadside Assistance, Canadian 263
Roadside Assistance, Pontiac 262

Rocking Your Vehicle to Get It Out	181	Schedule, Maintenance	239	Six-Way Power Seat	9
Roof Panels, Twin Lift-Off	80	Scheduled Maintenance Services	242	Skidding	135
Rotation, Tire	217	Scheduled Maintenance Services, Explanation of	246	Skip Shift Light	61
Running Lights, Daytime	77	Seats		Smaller Children and Babies (Safety Belts)	30
Running Your Engine while You're Parked	67	And Restraint Systems	7	Snow or Ice, Driving on	142
S afety Belts		And Seat Controls	8	Spare Tire, Compact	180
Adults	19	Four-Way Manual	8	Speakers, Adjusting the AM/FM Stereo with Cassette Tape Player	110
Air Bag System	23	Fully Articulating Sport	9	AM/FM Stereo with Cassette Tape Player and Graphic Equalizer	113
Care of	224	Manual Front	8	AM/FM Stereo with Compact Disc Player	116
Children	30	Six-Way Power	9	AM/FM Stereo with Compact Disc Player and Graphic Equalizer	119
Extender	39	Seatback, Folding Rear	13	Specifications, Capacities and	233
How to Wear Properly	19	Second-Gear Start	55	Speedometer and Odometer	88
Lap-Shoulder	19	Securing a Child Restraint		Sport Seat, Fully Articulating	9
Larger Children	38	Rear Seat	33	Start, Second-Gear	55
Questions People Ask	17	Right Front Seat	35	Starting Your Engine	52
Reminder Light	18	Service	184	Starting, Jump	153
Replacing after a Crash	40	and Appearance Care	183	Steam Coming from Your Engine, If There Is	161
Smaller Children and Babies	30	Engine Soon Light	94	Steam, If There Is No	162
They're for Everyone	14	Parts Identification Label	228	Steering	132
Use during Pregnancy	27	Publications	263	Fluid, Power	204
Why They Work	15	Publications Ordering Information, Pontiac	265	In Emergencies	133
Safety Defects		Work, Doing Your Own	184	Power	132
Reporting to General Motors	262	Servicing Your Air Bag-Equipped Pontiac	27		
Reporting to the Canadian Government	262	Setting the Clock	109		
Reporting to the United States Government	261	Sheet Metal Damage	226		
Safety Warnings and Symbols	4	Shift Speeds	62		
		Shifting into P (Park)	64		
		Shifting out of P (Park)	65		

Index

- | | | | |
|-----------------------------------|-----|---------------------------------|-----|
| Steering | | | |
| Tips | 132 | Tires | |
| Storage | | Chains | 221 |
| Compartments | 83 | Changing a Flat | 171 |
| Vehicle | 208 | Inflation Pressure | 216 |
| Stuck: In Sand, Mud, Ice or Snow | 180 | Inspection and Rotation | 217 |
| Sun Visors | 85 | Temperature Grades | 219 |
| Sunshades, T-Top | 82 | Traction Grades | 219 |
| Supplemental Inflatable Restraint | | Treadwear | 219 |
| System (Air Bags) | 23 | Uniform Quality Grading | 219 |
| Switch, Ignition | 51 | When It's Time for New | 218 |
| Switch, Performance Mode | 54 | Tone, Setting the | |
| Symbols, Safety Warnings and | 4 | AM/FM Stereo with Cassette Tape | |
| Symbols, Vehicle | 5 | Player | 110 |
| T -Top Sunshades | 82 | AM/FM Stereo with Cassette | |
| Tachometer | 89 | Tape Player and Graphic | |
| Tank, Filling Your | 187 | Equalizer | 113 |
| Temperature Control Knob | 104 | AM/FM Stereo with Compact Disc | |
| Theft | 48 | Player | 116 |
| Theft Deterrent Feature/ | | AM/FM Stereo with Compact | |
| THEFTLOCK | 120 | Disc Player and Graphic | |
| Theft-Deterrent, PASS-Key II | 49 | Equalizer | 119 |
| Thermostat | 204 | Top Strap (Child Restraints) | 32 |
| Tilt Wheel | 69 | Torque Lock | 65 |
| Tips, Steering | 132 | Towing | |
| Tips, Ventilation | 108 | A Trailer | 144 |
| Tire Loading | 213 | Front Hook-Ups | 158 |
| Tires | 215 | Rear Hook-Ups | 160 |
| Balance, Wheel Alignment and | 220 | Your Vehicle | 156 |
| Buying New | 218 | Traction Control System | 130 |
| | | And Cruise Control | 75 |
| | | Warning Light | 92 |
| | | Trailer Brakes | 147 |
| | | Trailer, Towing a | 144 |
| | | Transmission | |
| | | Automatic | 56 |
| | | Fluid, Automatic | 198 |
| | | Fluid, Manual | 200 |
| | | Manual, Five-Speed | 59 |
| | | Manual, Six-Speed | 60 |
| | | Transmitters, Matching to Your | |
| | | Vehicle (Remote Lock Control) | 45 |
| | | Transportation, Courtesy | 263 |
| | | Trip Odometer | 89 |
| | | Trip, Before Leaving on a Long | 140 |
| | | Turn Signal and Lane Change | |
| | | Indicator | 69 |
| | | Turn Signal/Headlight | |
| | | Beam Lever | 69 |
| | | Twin Lift-Off Roof Panels | 80 |
| | | U nderbody Maintenance | 226 |
| | | Underhood Electrical Center | 231 |
| | | Understanding Radio Reception | 121 |
| | | Uniform Tire Quality Grading | 219 |
| | | Used Oil, What to Do With | 195 |
| | | Used Replacement Wheels | 220 |
| | | V ehicle | |
| | | Control of a | 128 |
| | | Damage Warnings | 4 |
| | | Dimensions | 236 |
| | | Environment and Your | 240 |

Vehicle		Weight of the Trailer	145
Identification Number (VIN)	228	Wheel Nut Torque	234
Leaving Your	44	Wheels	
Loading Your	213	Alignment and Tire Balance	220
Parking Your	65	Aluminum	225
Rocking	181	Replacement	220
Storage	208	Tilt	69
Symbols	5	Used Replacement	220
Towing Your	156	Where to Put the Restraint	
Washing Your	224	(Child Restraints)	31
Ventilation	105	Why Safety Belts Work	15
Ventilation System,		Windows	67
Flow-Through	107	Defogging and Defrosting	105
Ventilation Tips	108	Manual	67
Vision, Night	136	Power	68
Visor Vanity Mirror, Covered	85	Rear Defogger	107
Visors, Sun	85	Windshield	
Voltmeter	94	Cleaning	224
W arning		Washers	71
Devices, Other	152	Washer Fluid	205
Hazard Flashers	152	Wipers	70
Lights, Gages and Indicators	89	Winter Driving	142
Safety	4	Wipers, Windshield	70
Vehicle Damage	4	Y our Driving and the Road	125
Washer Fluid, Windshield	205		
Washers, Windshield	71		
Washing Your Vehicle	224		
Water, Driving Through			
Deep Standing	54		
Weatherstrips	225		

Notes

Notes

Notes

Notes

... 284

Notes

Service Station Information

