

OLDSMOBILE



1994 EIGHTY EIGHT
OWNER'S MANUAL



REPRODUCTION

22586099



Table of Contents

	<i>The Heritage of Oldsmobile</i>	<i>3</i>	
	<i>How to Use this Manual</i>	<i>6</i>	
Part 1	<i>Seats & Restraint Systems</i>	<i>11</i>	
	<i>2 Features & Controls</i>	<i>41</i>	
	<i>3 Comfort Controls & Audio Systems</i>	<i>109</i>	
	<i>4 Your Driving and the Road</i>	<i>135</i>	
	<i>5 Problems on the Road</i>	<i>159</i>	
	<i>6 Service & Appearance Care</i>	<i>183</i>	
	<i>7 Maintenance Schedule</i>	<i>233</i>	
	<i>8 Customer Assistance Information</i>	<i>253</i>	
	<i>Includes "Reporting Safety Defects" on page 256</i>		
	<i>9 Index</i>	<i>263</i>	
	<i>Service Station Information</i>	<i>Last Page</i>	

Important Notes About this Manual

Please keep this manual in your Oldsmobile, so it will be there if you ever need it when you're on the road. If you sell the vehicle, please leave this manual in it so the new owner can use it.

This manual includes the latest information at the time it was printed. We reserve the right to make changes in the product after that time without further notice.

Note to Canadian Owners

For vehicles first sold in Canada, substitute the name "General Motors of Canada Limited" for Oldsmobile Division whenever it appears in this manual.

For Canadian Owners Who Prefer a French Language Manual

Aux propriétaires canadiens: Vous pouvez vous procurer un exemplaire de ce guide en français chez votre concessionnaire ou au DGN Marketing Services Ltd., 1500 Bonhill Rd., Mississauga, Ontario L5T 1C7.

Published by
Oldsmobile Division
General Motors Corporation
920 Townsend Street
Lansing, Michigan 48921

The word *Oldsmobile* and the Oldsmobile rocket emblem are registered trademarks of General Motors Corporation.

The word *Delco* is a registered trademark of General Motors Corporation.

The Heritage of Oldsmobile

Engineering with a purpose. It's at the heart of every Oldsmobile. Your new Oldsmobile continues a 97-year tradition of engineering excellence.

That tradition was born in Lansing, Michigan, on August 21, 1897, when Ransom E. Olds began building a horseless carriage "in as nearly a perfect manner as possible." Soon, Oldsmobiles rolled off the nation's first assembly line.

Innovation and refinement have always set Oldsmobiles apart. In 1939, Oldsmobile introduced the celebrated Hydra-Matic transmission, a four-speed forerunner of today's advanced systems. In 1948, the high-spirited Rocket V8 engine set standards for performance.



1941

1931

A Step Ahead

In 1966, Toronado made front-wheel-drive news, including Motor Trend's "Car of the Year." Still breaking new ground, the 1974 "Toro" became the first car equipped with a production "air bag."

Recent Oldsmobile engineering has created exciting advancements like the responsive Quad 4 engine. Versions of the 4-cylinder, 16-valve Quad 4 propelled Oldsmobiles on roads and racetracks to new standards of economy and performance.

Today, the all-wheel-drive security of SmartTrak in the Oldsmobile Bravada continues that proud tradition of meaningful technology.





The Security of Owner Satisfaction

The quality we built into your new Oldsmobile gives us the confidence to back it with the Oldsmobile Edge—the most comprehensive owner satisfaction program in the industry. The Edge gives you 24-hour roadside assistance, Bumper-to-Bumper Warranty protection, even free transportation while your vehicle is in for warranty service. With the Oldsmobile Edge, we've pledged to make your ownership experience a great one.



J. D. Rock
General Manager

How to Use this Manual

MANY PEOPLE READ THEIR OWNER'S manual from beginning to end when they first receive their new vehicle. This will help you learn about the features and controls for your vehicle. In this manual, you'll find that pictures and words work together to explain things quickly.

There are nine parts with thumb-tabbed pages in this manual. Each part begins with a brief list of contents, so you can usually tell at a glance if that part contains the information you want.

You can bend the manual slightly to reveal the tabs that help you find a part.

Part 1: Seats & Restraint Systems

This part tells you how to use your seats and safety belts properly.

Part 2: Features & Controls

This part explains how to start and operate your Oldsmobile.

Part 3: Comfort Controls & Audio Systems

This part tells you how to adjust the ventilation and comfort controls and how to operate your audio system.

Part 4: Your Driving and the Road

Here you'll find helpful information and tips about the road and how to drive under different conditions.

Part 5: Problems on the Road

This part tells you what to do if you have a problem while driving, such as a flat tire or engine overheating.

Part 6: Service & Appearance Care

Here the manual tells you how to keep your Oldsmobile running properly and looking good.

Part 7: Maintenance Schedule

This part tells you when to perform vehicle maintenance and what fluids and lubricants to use.

Part 8: Customer Assistance Information

This part includes important information about reporting safety defects and gives you details about the "Roadside Assistance" program. You will also find customer satisfaction phone numbers (including customer satisfaction numbers for the hearing and speech impaired) as well as the mediation/arbitration procedure. We've also included ordering information for service publications in this part.

Part 9: Index

Here's an alphabetical listing of almost every subject in this manual. You can use it to quickly find something you want to read.

Service Station Information:

This is a quick reference of service information. You can find it on the last page of this manual.

How to Use this Manual

Safety Warnings and Symbols

You will find a number of safety cautions in this book. We use a box with gray background and the word CAUTION to tell you about things that could hurt you if you were to ignore the warning.

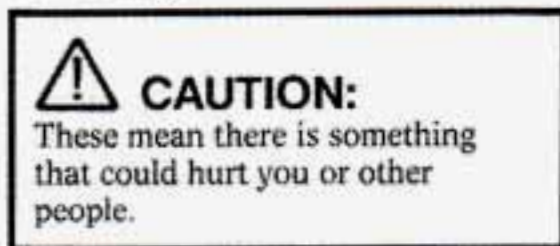

In the gray caution area, we tell you what the hazard is. Then we tell you what to do to help avoid or reduce the hazard. Please read these cautions. If you don't, you or others could be hurt.

You will also find a circle with a slash through it in this book. This safety symbol means:

Don't
Don't do this
Don't let this happen



Vehicle Damage Warnings

Also, in this book you will find these notices:

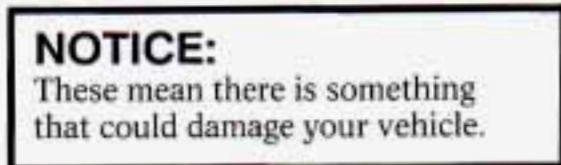

In the notice area, we tell you about something that can damage your vehicle. Many times, this damage would not be covered by your warranty, and it could be costly. But the notice will tell you what to do to help avoid the damage.

When you read other manuals, you might see CAUTION and NOTICE warnings in different colors or in different words.

You'll also see warning labels on your vehicle. They use yellow for cautions, blue for notices and the words CAUTION or NOTICE.

Vehicle Symbols

These are some of the symbols you will find on your vehicle. For example, these symbols are used on an original battery:

<i>Caution Possible Injury</i>	
<i>Protect Eyes by Shielding</i>	
<i>Caustic Battery Acid Could Cause Burns</i>	
<i>Avoid Sparks or Flames</i>	
<i>Spark or Flame Could Explode Battery</i>	

These symbols are important for you and your passengers whenever your vehicle is driven:

<i>Fasten Safety Belts</i>	
<i>Air Bag(s)</i>	
<i>Door Lock/Unlock</i>	

These symbols have to do with your lights:

<i>Master Lighting Switch</i>	
<i>Turn Signal Direction</i>	
<i>Hazard Warning Flashers</i>	
<i>Headlight High Beam</i>	
<i>Parking Lights</i>	

How to Use this Manual

These symbols are on some of your controls:

Windshield Wipers



Windshield Washer



Windshield Defroster



Rear Window Defogger

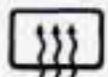

Ventilating Fan



Power Window



These symbols are used on warning and indicator lights:

Engine Coolant Temperature



Battery Charging System



Fuel



Engine Oil Pressure



Brake



Anti-Lock Brakes



Here are some other symbols you may see:

Fuse



Trunk Release



Lighter



Horn



Speaker



Hood Release





Here you'll find information about the seats in your Oldsmobile and how to use your safety belts properly. You can also learn about some things you should not do with safety belts.

Part 1

Seats & Restraint Systems

Seats and Seat Controls.....	12
Safety Belts.....	14
How to Wear Safety Belts Properly.....	18
Driver Position.....	18
Supplemental Restraint System (Air Bags).....	22
Safety Belt Use During Pregnancy.....	27
Right Front Passenger Position.....	27
Center Passenger Position.....	27
Rear Seat Passengers.....	28
Children.....	30
Smaller Children and Babies.....	31
Child Restraints.....	31
Larger Children.....	38
Safety Belt Extender.....	40
Replacing Safety Belts After a Crash.....	40

Seats & Restraint Systems

■ Seats and Seat Controls

This section tells you about the seats—how to adjust them—and also about reclining seatbacks and head restraints.

Manual Front Seat



CAUTION:

You can lose control of the vehicle if you try to adjust a manual driver's seat while the vehicle is moving. The sudden movement could startle and confuse you, or make you push a pedal when you don't want to. Adjust the driver's seat only when the vehicle is not moving.

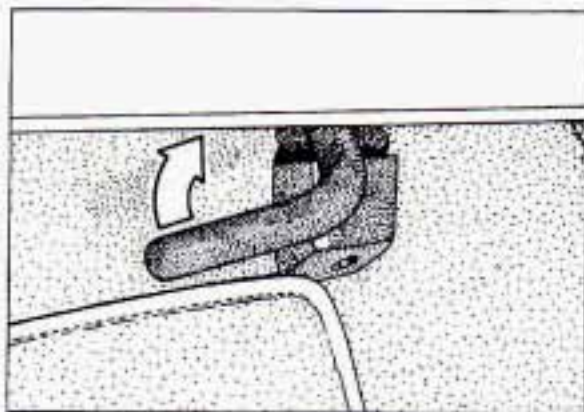

Move the control lever under the front of the seat to unlock it. Slide the seat to where you want it. Then release the lever and try to move the seat with your body, to make sure the seat is locked into place.

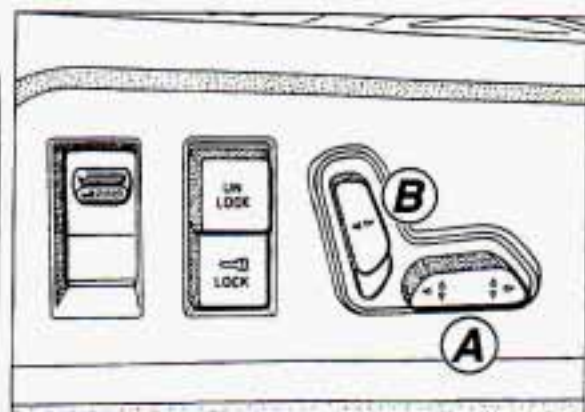

Power Seat (OPTION)

To adjust the power seat:

Seat Control (A): Raise the front of the seat by holding the front of the switch up. Lower the front of the seat by holding the front of the switch down.

Raise the rear of the seat by holding the rear of the switch up. Lower the rear of the seat by holding the rear of the switch down.

Move the seat higher by holding the switch up. Lower the seat by holding the switch down.

Move the seat forward by holding the switch forward. Move the seat back by holding the switch back.

Seatback Control (B): Tilt the seatback forward by holding the switch forward. Tilt the seatback backward by holding the switch back.

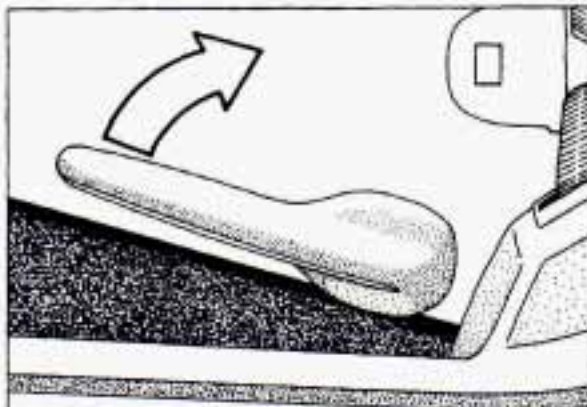

Manual Reclining Seatback

Lift the lever to release the seatback, then tilt the seatback forward or backward, as desired. Release the lever to lock the seatback in place.

But don't have a seatback reclined if your vehicle is moving.

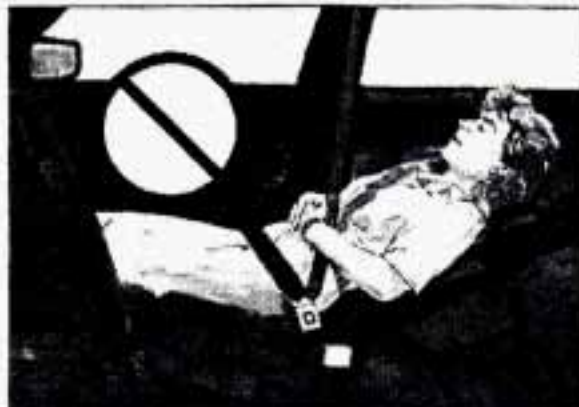

CAUTION:

Sitting in a reclined position when your vehicle is in motion can be dangerous. Even if you buckle up, your safety belts can't do their job when you're reclined like this. The shoulder belt can't do its job because it won't be against your body. Instead, it will be in front of you. In a crash you could go into it, receiving neck or other injuries.

CAUTION (Continued)

Seats & Restraint Systems

CAUTION (Continued)

The lap belt can't do its job either. In a crash the belt could go up over your abdomen. The belt forces would be there, not at your pelvic bones. This could cause serious internal injuries.

For proper protection when the vehicle is in motion, have the seatback upright. Then sit well back in the seat and wear your safety belt properly.



Head Restraints

Slide the head restraint up or down so that the top of the restraint is closest to the top of your ears.

This position reduces the chance of a neck injury in a crash.

■ Safety Belts: They're For Everyone

This part of the manual tells you how to use safety belts properly. It also tells you some things you should not do with safety belts.

And it explains the Supplemental Restraint System, or "air bag" system.



CAUTION:

Don't let anyone ride where they can't wear a safety belt properly. If you are in a crash and you're not wearing a safety belt, your injuries can be **much** worse. You can hit things inside the vehicle or be ejected from it. You can be seriously injured or killed. In the same crash, you might not be if you are buckled up. Always fasten your safety belt, and check that your passengers' belts are fastened properly too.



This figure lights up as a reminder to buckle up. (See *Safety Belt Reminder Light* in the *Index*.)

In many states and Canadian provinces, the law says to wear safety belts. Here's why: **They work.**



You never know if you'll be in a crash. If you do have a crash, you don't know if it will be a bad one.

A few crashes are mild, and some crashes can be so serious that even buckled up a person wouldn't survive. But most crashes are in between. In many of them, people who buckle up can survive and sometimes walk away. Without belts they could have been badly hurt or killed.

After more than 25 years of safety belts in vehicles, the facts are clear. In most crashes buckling up does matter... a lot!

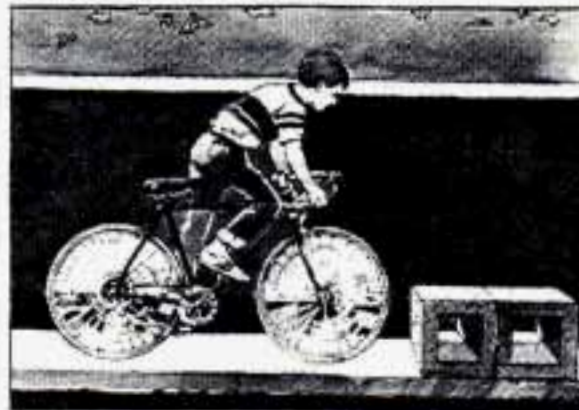

Why Safety Belts Work

When you ride in or on anything, you go as fast as it goes.

1. For example, if the bike is going 10 mph (16 km/h), so is the child.

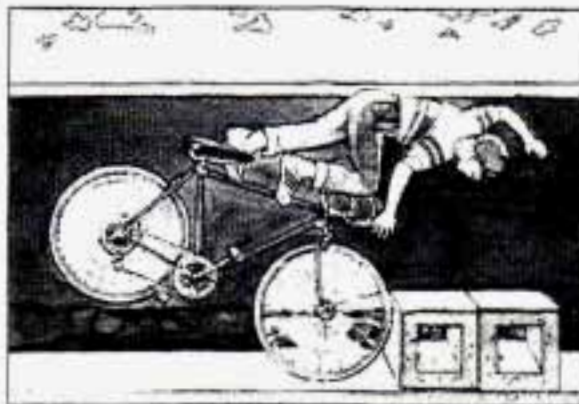

2. When the bike hits the block, it stops. But the child keeps going!

Seats & Restraint Systems

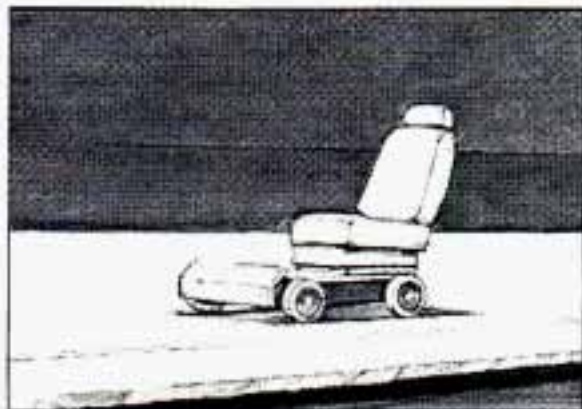

3. Take the simplest vehicle. Suppose it's just a seat on wheels.



4. Put someone on it.

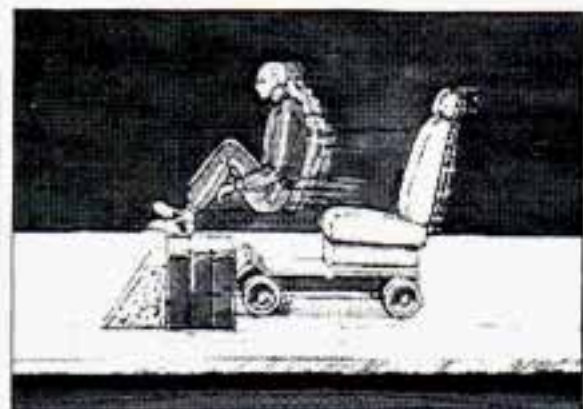

5. Get it up to speed. Then stop the vehicle. The rider doesn't stop.



6. The person keeps going until stopped by something.

In a real vehicle, it could be the windshield...

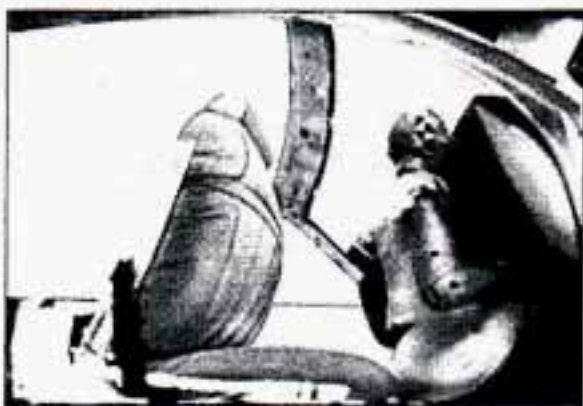

7. or the instrument panel...



8. or the safety belts!

With safety belts, you slow down as the vehicle does. You get more time to stop. You stop over more distance, and your strongest bones take the forces. That's why safety belts make such good sense.

■ *Here Are Questions Many People Ask About Safety Belts — and the Answers*

Q: Won't I be trapped in the vehicle after an accident if I'm wearing a safety belt?

A: You **could** be — whether you're wearing a safety belt or not. But you can easily unbuckle a safety belt, even if you're upside down. And your chance of being conscious during and after an accident, so you can unbuckle and get out, is **much** greater if you are belted.

Q: Why don't they just put in air bags so people won't have to wear safety belts?

A: Air bags, or Supplemental Restraint Systems, are in some vehicles today and will be in more of them in the future. But they are supplemental

systems only — so they work **with** safety belts, not instead of them. Every air bag system ever offered for sale has required the use of safety belts. Even if you're in a vehicle that has air bags, you still have to buckle up to get the most protection. That's true not only in frontal collisions, but especially in side and other collisions.

Q: If I'm a good driver, and I never drive far from home, why should I wear safety belts?

A: You may be an excellent driver, but if you're in an accident — even one that isn't your fault — you and your passengers can be hurt. Being a good driver doesn't protect you from things beyond your control, such as bad drivers. Most accidents occur within 25 miles (40 km) of home. And the greatest number of serious injuries and deaths occur at speeds of less than 40 mph (65 km/h). Safety belts are for everyone.

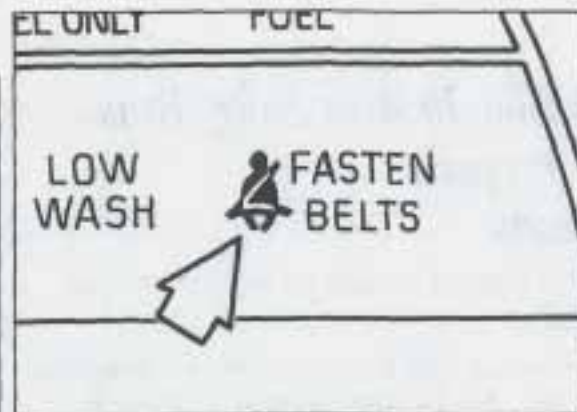

Safety Belt Reminder Light

When the key is turned to **Run** or **Start**, a chime will come on for about eight seconds to remind people to fasten their safety belts. The safety belt light will also come on and stay on for about 70 seconds. If the driver's belt is already buckled, neither the chime nor the light will come on.

Seats & Restraint Systems

■ *How To Wear Safety Belts Properly*

Adults

This section is only for people of adult size.

Be aware that there are special things to know about safety belts and children. And there are different rules for smaller children and babies. If a child will be riding in your Oldsmobile, see the section after this one, called *Children*. Follow those rules for everyone's protection.

First, you'll want to know which restraint systems your vehicle has. We'll start with the driver position.

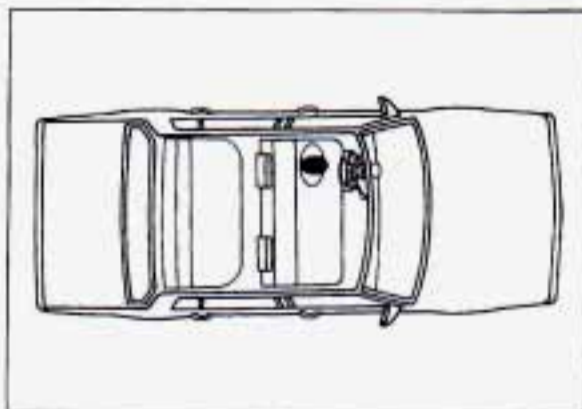

■ *Driver Position*

This section describes the driver's restraint system.



Lap-Shoulder Belt

The driver has a lap-shoulder belt. Here's how to wear it properly.

1. Close and lock the door.
2. Adjust the seat (to see how, see *Seats* in the *Index*) so you can sit up straight.



3. Pick up the latch plate and pull the belt across you. Don't let it get twisted.
4. Push the latch plate into the buckle until it clicks.

Pull up on the latch plate to make sure it is secure. If the belt isn't long enough, see *Safety Belt Extender* at the end of this section.

Make sure the release button on the buckle is positioned so you would be able to unbuckle the safety belt quickly if you ever had to.

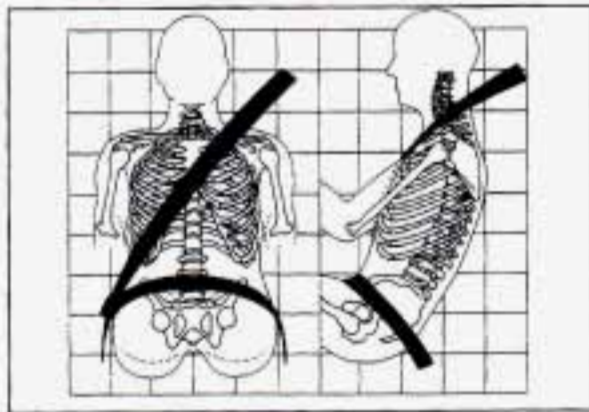

The lap part of the belt should be worn low and snug on the hips, just touching the thighs. In a crash, this applies force to the strong pelvic bones. And you'd be less likely to slide under the lap belt. If you slid under it, the belt would apply force at your abdomen. This could cause serious or even fatal injuries. The shoulder belt should go over the shoulder and across the chest. These parts of the body are best able to take belt restraining forces.

The safety belt locks if there's a sudden stop or crash.



Shoulder Belt Height Adjuster

You can move the shoulder belt adjuster to the height that is right for you.

Seats & Restraint Systems



To move it up or down, squeeze the release handle. When you release the handle, try to move it down a little to make sure it has locked into position.

You can move the adjuster up from a lower position by pushing the bottom of the release handle.



Adjust the height so that the shoulder portion of the belt is properly positioned on your shoulder, away from your face and neck.

To help you find a height that is right for you, follow these guidelines:

For a tall person: Use the upper or upper-middle position.

For a person of average height: Use a position somewhere in the middle.

For a short person: Use the lower or lower-middle position.

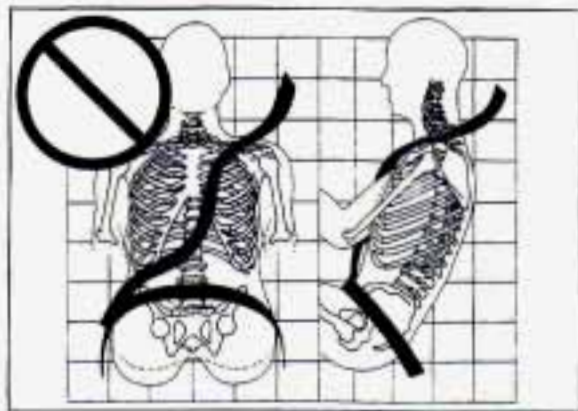

Q: What's wrong with this?

A: The shoulder belt is too loose. It won't give nearly as much protection this way.



CAUTION:

You can be seriously hurt if your shoulder belt is too loose. In a crash you would move forward too much, which could increase injury. The shoulder belt should fit against your body.

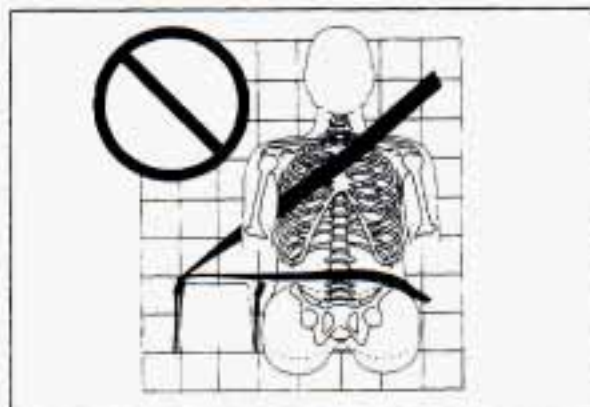

Q: What's wrong with this?

A: The belt is buckled in the wrong place.

 **CAUTION:**

You can be seriously injured if your belt is buckled in the wrong place like this. In a crash, the belt would go up over your abdomen. The belt forces would be there, not at the pelvic bones. This could cause serious internal injuries. Always buckle your belt into the buckle nearest you.

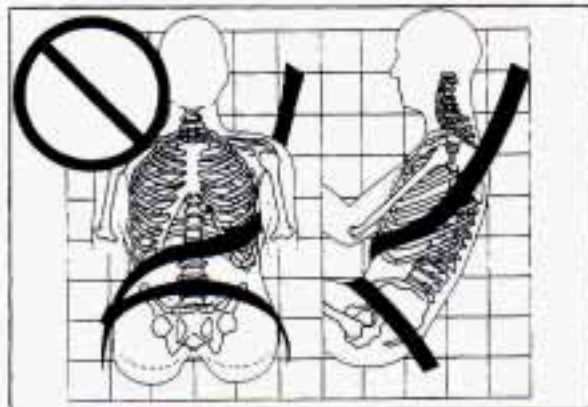

Q: What's wrong with this?

A: The shoulder belt is worn under the arm. It should be worn over the shoulder at all times.

 **CAUTION:**

You can be seriously injured if you wear the shoulder belt under your arm. In a crash, your body would move too far forward, which would increase the chance of head and neck injury. Also, the belt would apply too much force to the ribs, which aren't as strong as shoulder bones. You could also severely injure internal organs like your liver or spleen.

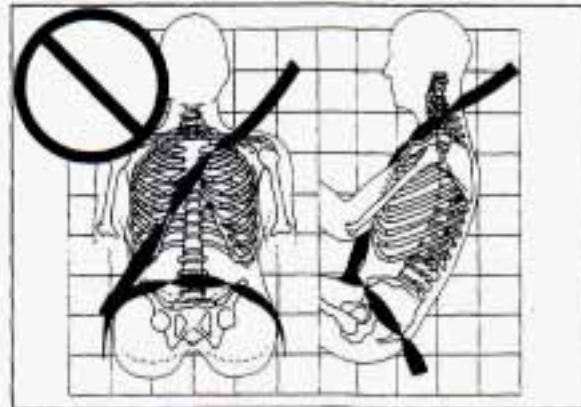

Q: What's wrong with this?

A: The belt is twisted across the body.

 **CAUTION:**

You can be seriously injured by a twisted belt. In a crash, you wouldn't have the full width of the belt to spread impact forces. If a belt is twisted, make it straight so it can work properly, or ask your dealer to fix it.

Seats & Restraint Systems



To unlatch the belt, just push the button on the buckle. The belt should go back out of the way.

Before you close the door, be sure the belt is out of the way. If you slam the door on it, you can damage both the belt and your vehicle.

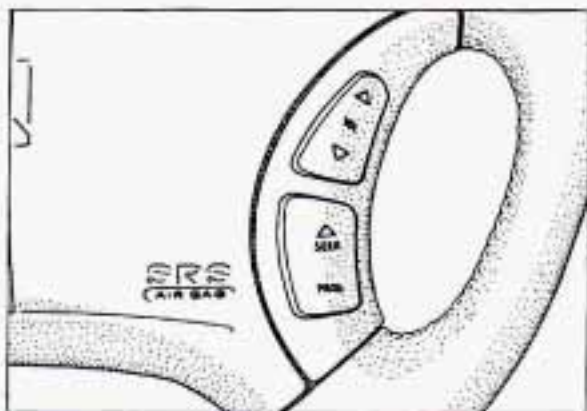

■ *Supplemental Restraint System (Air Bags)*

This section explains the Supplemental Restraint System (SRS), or "air bag," system. Your Oldsmobile has an air bag for the driver and for the right-front passenger.

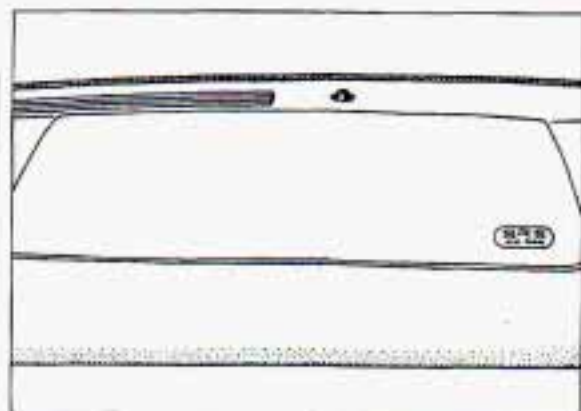

Here are the most important things to know:



CAUTION:

Even with an air bag, if you're not wearing a safety belt and you're in a crash, your injuries may be much worse. Air bags are not designed to inflate in rollovers or in rear, side or low-speed frontal crashes. You need to wear your safety belt to reduce the chance of hitting things inside the vehicle or being ejected from it. Always wear your safety belt, even with an air bag.

 **CAUTION:**

Air bags inflate with great force, faster than the blink of an eye. If you're too close to an inflating air bag, it could seriously injure you. Safety belts help keep you in position for an air bag inflation in a crash. Always wear your safety belt, even with an air bag, and the driver should sit as far back as possible while still maintaining control of the vehicle.

 **CAUTION:**

An inflating air bag can seriously injure small children. Always secure children properly in your vehicle. To read how, see the *Children and Safety Belts* section of this manual, and read the caution label on the front-passenger's safety belt.

 **CAUTION:**

When an air bag inflates, there is dust in the air. This dust could cause breathing problems for people with a history of asthma or other breathing trouble. To avoid this, everyone in the vehicle should get out as soon as it is safe to do so. If you have breathing problems but can't get out of the vehicle after an air bag inflates, then get fresh air by opening a window or door.

 **CAUTION:**

Don't put anything on, or attach anything to, the driver air bag or instrument panel. Also, don't put anything (such as pets, or objects) between any occupant and the driver air bag or instrument panel. If something is between an occupant and an air bag, it could affect the performance of the air bag, or, worse, it could cause injury.

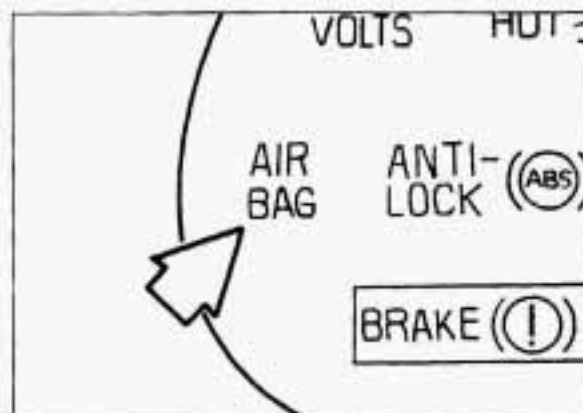

Air Bag Readiness Light

There is an air bag readiness light on the instrument panel, which shows **AIR BAG**. The system checks for electrical malfunctions, and the light tells you if there is a problem.

You will see this light flash for a few seconds when you turn your ignition to **Run** or **Start**. Then the light should go out, which means the system is ready.

Remember, if the air bag readiness light doesn't come on when you start your vehicle, or stays on, or comes on when you are driving, your air bag system may not work properly. Have your vehicle serviced right away.

Seats & Restraint Systems



How The Air Bag System Works

Where is the air bag?

The driver's air bag is in the middle of the steering wheel.



The right-front passenger's air bag is located in the instrument panel on the passenger's side.

When is an air bag expected to inflate?

The air bag is designed to inflate in moderate to severe frontal or near-frontal crashes. The air bag will only inflate if the velocity of the impact is above the designed threshold level. When impacting straight into a wall that does not move or deform, the threshold level for most GM vehicles is between 9 and 15 mph (14 and 23 km/h). However, this velocity threshold depends on the vehicle design and may be several miles-per-hour faster or slower. In addition, this threshold velocity will be considerably higher if the vehicle strikes an object such as a parked

car which will move and deform on impact. The air bag is also not designed to inflate in rollovers, side impacts, or rear impacts where the inflation would provide no occupant protection benefit.

It is possible that in a crash, only one of the two air bags in your Eighty Eight will deploy. This is rare, but can happen in a crash just severe enough to make an air bag inflate.

In any particular crash, the determination of whether the air bag should have inflated cannot be based solely on the level of damage on the vehicle(s). Inflation is determined by the angle of the impact and the vehicle's deceleration, of which vehicle damage is only one indication. Repair cost is not a good indicator of whether an air bag should have deployed.

What makes an air bag inflate?

In a frontal or near-frontal impact of sufficient severity, the air bag sensing system detects that the vehicle is suddenly stopping as a result of a crash. The sensing system triggers a chemical reaction of the sodium azide sealed in the inflator. The reaction produces

nitrogen gas, which inflates a cloth bag. The inflator, cloth bag, and related hardware are all part of the air bag inflator modules packed inside the steering wheel and in the instrument panel in front of the passenger.

How does an air bag restrain?

In moderate to severe frontal or near-frontal collisions, even belted occupants can contact the steering wheel or the instrument panel. The air bag supplements the protection provided by safety belts. Air bags distribute the force of the impact more evenly over the occupant's upper body, stopping the occupant more gradually. But air bags would not provide protection in many types of collisions, including rollovers and rear and side impacts, primarily because an occupant's motion is not toward the air bag. Air bags should never be regarded as anything more than a supplement to safety belt protection in moderate to severe frontal and near-frontal collisions.

What will you see after an air bag inflation?

After the air bag has inflated, it will then quickly deflate. This occurs so

quickly that some people may not even realize that the air bag inflated. Some components of the air bag module in the steering wheel hub for the driver's air bag or the instrument panel for the passenger's bag may be hot for a short time, but the portion of the bag that comes into contact with you will not be hot to the touch. There will be small amounts of smoke and dust coming from vents in the deflated air bags. The air bag will **not** impede the driver's vision or ability to steer the vehicle, nor will it hinder the occupants from exiting the vehicle.

In many crashes severe enough to inflate an air bag, windshields are broken by vehicle deformation. Additional windshield breakage may occur in vehicles with passenger air bags because the windshield acts as a reaction surface for the inflating air bag.

- The air bags are designed to inflate only once. After they inflate, you'll need some new parts for your air bag system. If you don't get them, the air bag system won't be there to help protect you in another crash. A new system will include air bag modules

and possibly other parts. The service manual has information about the need to replace other parts.

- Your vehicle is equipped with a diagnostic module, which records information about the air bag system if the air bag deploys in a crash. The module records information about the readiness of the system, which sensors activated the deployment, and whether the driver's safety belt was in use.
- Let only qualified technicians work on your air bag system. Improper service can mean that your air bag system won't work properly. See your dealer for service.

NOTICE:

If you damage the cover for the driver's or the right-front passenger's air bag, they may not work properly. You may have to replace the air bag on the steering wheel or both the air bag and the instrument panel for the passenger's air bag. Do not open or break the air bag covers.

Seats & Restraint Systems

Is the smoke from an air bag inflation harmful?

The particles emitted during air bag inflation are not harmful to most people. Some people with respiratory ailments may experience difficulty breathing if they stay in the vehicle with the windows closed after air bag inflation. So, if your air bag inflates, you and any passengers should exit the vehicle if and when it is safe to do so. If you or your passengers can't get out of the vehicle, try to get fresh air by opening a window, turning on the fan, or opening a door.

Servicing Your Air Bag-Equipped Oldsmobile

Air bags affect how your Oldsmobile should be serviced. There are parts of the air bag system in several places around your vehicle. You don't want the system to inflate while someone is working on your vehicle. Your Oldsmobile dealer and the 1994 Eighty Eight Service Manual have information about servicing your vehicle and the air bag system. The air bag system does not need regular maintenance.



CAUTION:

For up to 2 minutes after the ignition key is turned off and the battery is disconnected, an air bag can still inflate during improper service. You can be injured if you are close to an air bag when it inflates. Avoid wires wrapped with yellow tape, or yellow connectors. They are probably part of the air bag system. Be sure to follow the proper service procedures, and make sure the person performing work for you is qualified to do so.



■ *Safety Belt Use During Pregnancy*

Safety belts work for everyone, including pregnant women. Like all occupants, they are more likely to be seriously injured if they don't wear safety belts.

A pregnant woman should wear a lap-shoulder belt, and the lap portion should be worn as low as possible throughout the pregnancy.

The best way to protect the fetus is to protect the mother. When a safety belt is worn properly, it's more likely that the fetus won't be hurt in a crash. For pregnant women, as for anyone, the key to making safety belts effective is wearing them properly.

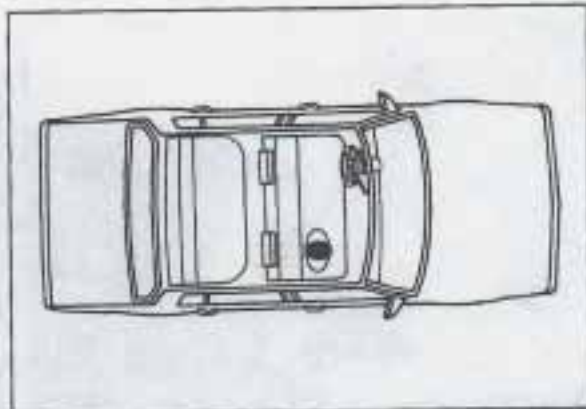

■ *Right Front Passenger Position*

The right front passenger's safety belt works the same way as the driver's safety belt. See *Driver Position*, earlier in this part.

When the lap portion of the belt is pulled out all the way, it will lock. If it does, let it go back all the way and start again.

If your vehicle has a center passenger position, be sure to use the correct buckle when buckling your lap-shoulder belt. If you find that the latch plate will not go fully into the buckle, see if you are using the buckle for the center passenger position.

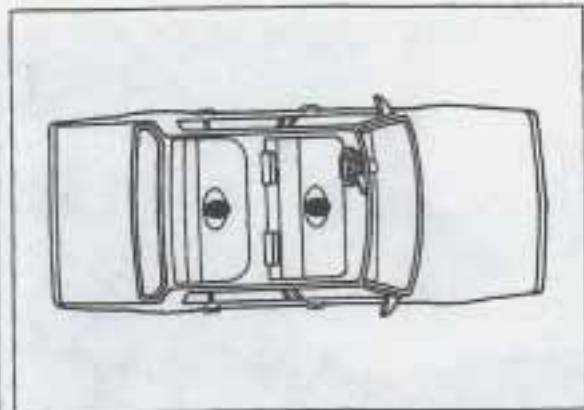

■ *Center Passenger Position Lap Belt*

If your vehicle has front and rear bench seats, someone can sit in the center positions.

Seats & Restraint Systems



When you sit in a center seating position, you have a lap safety belt, which has no retractor. To make the belt longer, tilt the latch plate and pull it along the belt.



To make the belt shorter, pull its free end as shown until the belt is snug. Buckle, position and release it the same way as the lap part of a lap-shoulder belt. If the belt isn't long enough, see *Safety Belt Extender* at the end of this section.

Make sure the release button on the buckle is positioned so you would be able to unbuckle the safety belt quickly if you ever had to.

■ *Rear Seat Passengers*

It's very important for rear seat passengers to buckle up! Accident statistics show that unbelted people in the rear seat are hurt more often in crashes than those who are wearing safety belts.

Rear passengers who aren't safety belted can be thrown out of the vehicle in a crash. And they can strike others in the vehicle who are wearing safety belts.

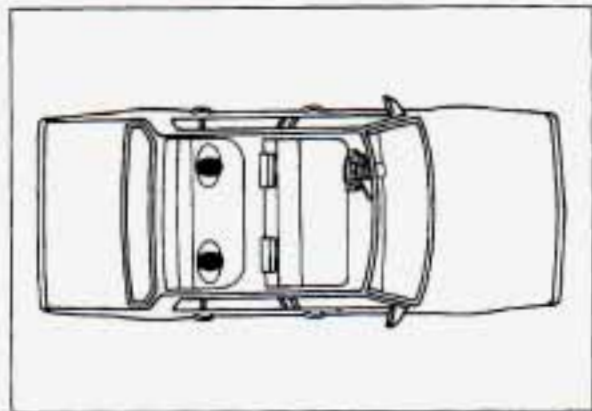

Rear Seat Outside Passenger Positions

Lap-Shoulder Belt

The positions next to the windows have lap-shoulder belts. Here's how to wear one properly.



1. Pick up the latch plate and pull the belt across you. Don't let it get twisted.
2. Push the latch plate into the buckle until it clicks. Pull up on the latch plate to make sure it is secure.

When the lap belt is pulled out all the way, it will lock. If it does, let it go back all the way and start again. If the belt is not long enough, see *Safety Belt Extender* at the end of this section. Make sure the release button on the buckle is positioned so you would be able to unbuckle the safety belt quickly if you ever had to.

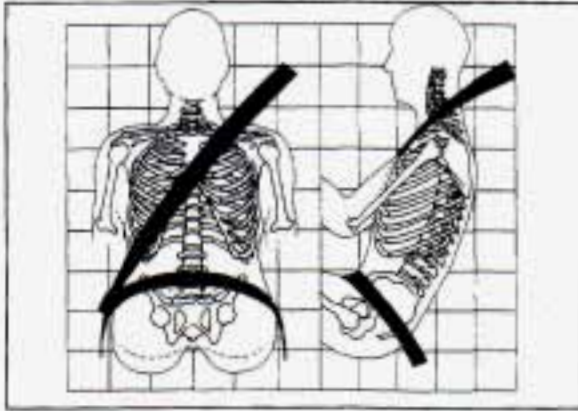

The lap part of the belt should be worn low and snug on the hips, just touching the thighs. In a crash, this applies force to the strong pelvic bones. And you'd be less likely to slide under the lap belt. If you slid under it, the belt would apply force at your abdomen. This could cause serious or even fatal injuries. The shoulder belt should go over the shoulder and across the chest. These parts of the body are best able to take belt restraining forces.

The safety belt locks if there's a sudden stop or a crash.

Seats & Restraint Systems



CAUTION:

You can be seriously hurt if your shoulder belt is too loose. In a crash you would move forward too much, which could increase injury. The shoulder belt should fit against your body.



To unlatch the belt, just push the button on the buckle.



■ Children

Everyone in a vehicle needs protection! That includes infants and all children smaller than adult size. In fact, the law in every state in the United States and in every Canadian province says children up to some age must be restrained while in a vehicle.

Smaller Children and Babies

CAUTION:

Smaller children and babies should always be restrained in a child or infant restraint. The instructions for the restraint will say whether it is the right type and size for your child. A very young child's hip bones are so small that a regular belt might not stay low on the hips, as it should. Instead, the belt will likely be over the child's abdomen. In a crash the belt would apply force right on the child's abdomen, which could cause serious or fatal injuries. So, be sure that any child small enough for one is always properly restrained in a child or infant restraint.



CAUTION:

Never hold a baby in your arms while riding in a vehicle. A baby doesn't weigh much — until a crash. During a crash a baby will become so heavy you can't hold it. For example, in a crash at only 25 mph (40 km/h), a 12-pound (5.5 kg) baby will suddenly become a 240-pound (110 kg) force on your arms. The baby would be almost impossible to hold.

CAUTION (Continued)



CAUTION (Continued)

Secure the baby in an infant restraint.

■ *Child Restraints*

Be sure to follow the instructions for the restraint. You may find these instructions on the restraint itself or in a booklet, or both. These restraints use the belt system in your vehicle, but the child also has to be secured within the restraint to help reduce the chance of personal injury. The instructions that come with the infant or child restraint will show you how to do that.

Seats & Restraint Systems

Where to Put the Restraint

Accident statistics show that children are safer if they are restrained in the rear rather than the front seat. We at General Motors therefore recommend that you put your child restraint in the rear seat. NEVER put a rear-facing child restraint in the front passenger seat. Here's why:

CAUTION:

A child in a **rear-facing** child restraint can be seriously injured if the right-front passenger's air bag inflates. This is because the back of a rear-facing child restraint would be very close to the inflating air bag. If your vehicle has a right-front passenger's air bag, always secure a rear-facing child restraint in the rear seat. You may, however, secure a **forward-facing** child restraint in the right-front seat. Before you secure a forward-facing child restraint, **ALWAYS** move the front passenger seat as far back as it will go. Or, secure the child restraint in the rear seat.



CAUTION:

A child in a child restraint in the front-center seat can be badly injured by the passenger air bag if it inflates. **NEVER** use a child restraint in the front-center seat. It's always better to secure a child restraint in the rear seat. You may, however, secure a forward-facing child restraint in the right-front passenger seat only with the seat moved all the way back.

Wherever you install it, be sure to secure the child restraint properly.

Keep in mind that an unsecured child restraint can move around in a collision or sudden stop and injure people in the vehicle. Be sure to properly secure any child restraint in your vehicle — even when no child is in it.

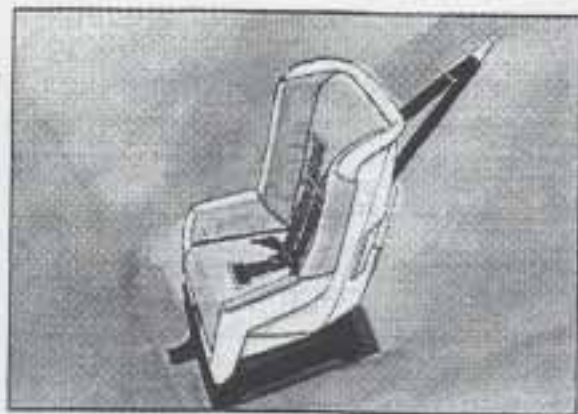

Top Strap

If your child restraint has a top strap, it should be anchored.

If you need to have an anchor installed, you can ask your Oldsmobile dealer to put it in for you. If you want to install an anchor yourself, your dealer can tell you how to do it.

For cars first sold in Canada, child restraints with a top strap must be anchored according to Canadian Law.

Your dealer can obtain the hardware kit and install it for you, or you may install it yourself using the instructions provided in the kit.

Use the tether hardware kit available from the dealer. The hardware and installation instructions were specifically designed for this vehicle.

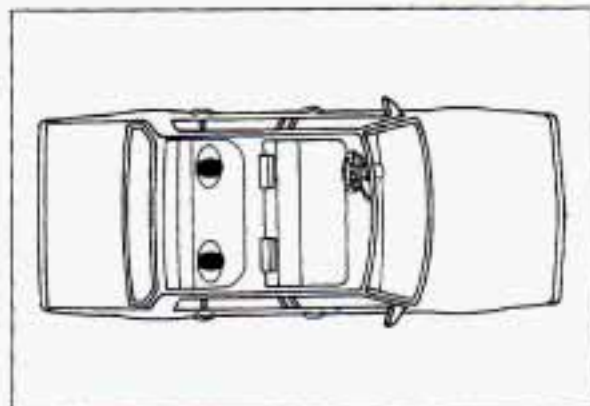

Securing a Child Restraint in a Rear Outside Position

You'll be using the lap-shoulder belt. See the earlier section about the top strap if the child restraint has one.

1. Put the restraint on the seat. Follow the instructions for the child restraint.
2. Secure the child in the child restraint as the instructions say.
3. Pick up the latch plate, and run the lap and shoulder portions of the vehicle's safety belt through or around the restraint. The child restraint instructions will show you how. If the shoulder belt goes in front of the child's face or neck, put it behind the child restraint.



4. Buckle the belt. Make sure the release button is positioned so you would be able to unbuckle the safety belt quickly if you ever had to.



5. Pull the rest of the lap belt all the way out of the retractor to set the lock.

Seats & Restraint Systems



6. To tighten the belt, feed the lap belt into the retractor while you push down on the child restraint.



7. Push and pull the child restraint in different directions to be sure it is secure.

To remove the child restraint, just unbuckle the vehicle's safety belt and let it go back all the way. The safety belt will move freely again and be ready to work for an adult or larger child passenger.

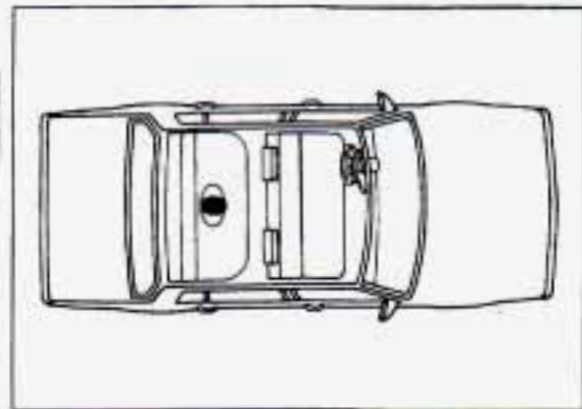

Securing a Child Restraint in the Rear Center Seat Position

When you secure a child restraint in a center seating position, you'll be using the lap belt.



CAUTION:

A child in a child restraint in the front-center seat can be badly injured by the passenger air bag if it inflates. **NEVER** use a child restraint in the front-center seat. It's always better to secure a child restraint in the rear seat. You may, however, secure a forward-facing child restraint in the right-front passenger seat, but only with the seat moved all the way back.

See the earlier section about the top strap if the child restraint has one.



1. Make the belt as long as possible by tilting the latch plate and pulling it along the belt.
2. Put the restraint on the seat. Follow the instructions for the child restraint.
3. Secure the child in the child restraint as the instructions say.



4. Run the vehicle's safety belt through or around the restraint. The child restraint instructions will show you how.
5. Buckle the belt. Make sure the release button is positioned so you would be able to unbuckle the safety belt quickly if you ever had to.
6. To tighten the belt, pull its free end while you push down on the child restraint.

Seats & Restraint Systems

7. Push and pull the child restraint in different directions to be sure it is secure. If the child restraint isn't secure, turn the latch plate over and buckle it again. Then see if it is secure. If it isn't, secure the restraint in a different place in the vehicle and contact the child restraint maker for their advice about how to attach the child restraint properly.

To remove the child restraint, just unbuckle the vehicle's safety belt. It will be ready to work for an adult or larger child passenger.

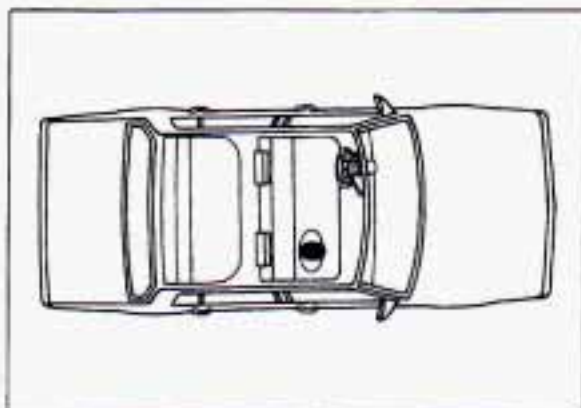

Securing a Child Restraint in the Right Front Seat

Your vehicle has a right-front passenger's air bag. NEVER put a rear-facing child restraint in this seat. Here's why:



CAUTION:

A rear-facing child restraint in the front seat could be pushed into the seatback by the right-front passenger's air bag if it inflates. A child in a rear-facing child restraint can be seriously injured if this happens. Always secure a rear-facing child restraint in the rear seat.

You'll be using the lap-shoulder belt. See the earlier section about the top strap if the child restraint has one.

1. Because your vehicle has a right-front passenger's air bag, always move the seat as far back as it will go before securing a front-facing child restraint.
2. Put the restraint on the seat. Follow the instructions for the child restraint.
3. Secure the child in the child restraint as the instructions say.
4. Pick up the latch plate, and run the lap and shoulder portions of the vehicle's safety belt through or around the restraint. The child restraint instructions will show you how. If the shoulder belt goes in front of the child's face or neck, put it behind the child restraint.



5. Buckle the belt. Make sure the release button is positioned so you would be able to unbuckle the safety belt quickly if you ever had to.



6. Pull the rest of the lap belt all the way out of the retractor to set the lock.



7. To tighten the belt, feed the lap belt back into the retractor while you push down on the child restraint.

Seats & Restraint Systems



8. Push and pull the child restraint in different directions to be sure it is secure.

To remove the child restraint, just unbuckle the vehicle's safety belt and let it go back all the way.

The safety belt will move freely again and be ready to work for an adult or larger child passenger.



Larger Children

Children who have outgrown child restraints should wear the vehicle's safety belts.

If you have the choice, a child should sit next to a window so the child can wear a lap-shoulder belt and get the additional restraint a shoulder belt can provide.

Accident statistics show that children are safer if they are restrained in the rear seat. But they need to use the safety belts properly.

- Children who aren't buckled up can be thrown out in a crash.

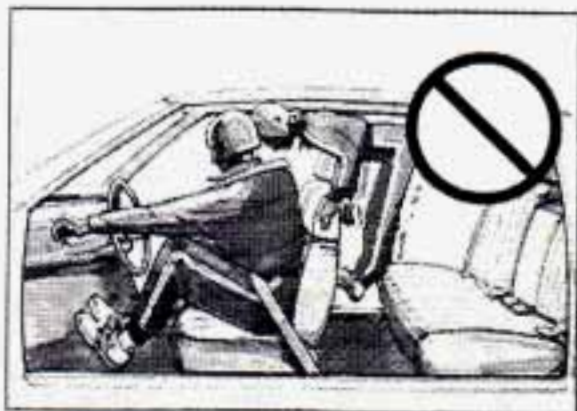

- Children who aren't buckled up can strike other people who are.

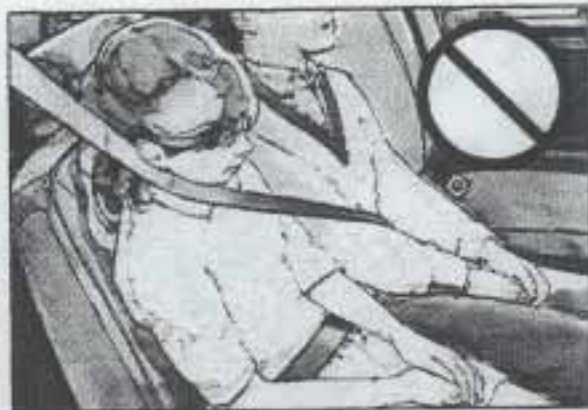

 **CAUTION:**

Never do this. Here two children are wearing the same belt. The belt can't properly spread the impact forces. In a crash, the two children can be crushed together and seriously injured. A belt must be used by only one person at a time.

Q: What if a child is wearing a lap-shoulder belt, but the child is so small that the shoulder belt is very close to the child's face or neck?

A: Move the child toward the center of the vehicle, but be sure that the shoulder belt still is on the child's shoulder, so that in a crash the child's upper body would have the restraint that belts provide. If the child is so small that the shoulder belt is still very close to the child's face or neck, you might want to place the child in the center seat position, the one that has only a lap belt.



 **CAUTION:**

Never do this. Here a child is sitting in a seat that has a lap-shoulder belt, but the shoulder part is behind the child. If the child wears the belt in this way, in a crash the child might slide under the belt. The belt's force would then be applied right on the child's abdomen. That could cause serious or fatal injuries.

Wherever the child sits, the lap portion of the belt should be worn low and snug on the hips, just touching the child's thighs. This applies belt force to the child's pelvic bones in a crash.

Seats & Restraint Systems

■ *Safety Belt Extender*

If the vehicle's safety belt will fasten around you, you should use it.

But if a safety belt isn't long enough to fasten, your dealer will order you an extender. It's free. When you go in to order it, take the heaviest coat you will wear, so the extender will be long enough for you. The extender will be just for you, and just for the seat in your vehicle that you choose. Don't let someone else use it, and use it only for the seat it is made to fit. To wear it, just attach it to the regular safety belt.

■ *Checking Your Restraint Systems*

Now and then, make sure all your belts, buckles, latch plates, retractors, anchorages and reminder systems are working properly. Look for any loose parts or damage. If you see anything that might keep a restraint system from doing its job, have it repaired.

■ *Replacing Safety Belts After a Crash*

If you've had a crash, do you need new belts?

After a very minor collision, nothing may be necessary. But if the belts were stretched, as they would be if worn during a more severe crash, then you need new belts.

If belts are cut or damaged, replace them. Collision damage also may mean you will need to have safety belt or seat parts repaired or replaced. New parts and repairs may be necessary even if the belt wasn't being used at the time of the collision.

If your seat adjuster won't work after a crash, the special part of the safety belt that goes through the seat to the adjuster may need to be replaced.

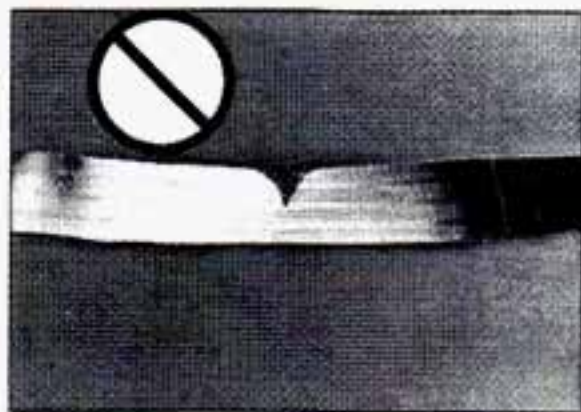

Q: What's wrong with this?

A: The belt is torn.

Torn or frayed belts may not protect you in a crash. They can rip apart under impact forces. If a belt is torn or frayed, get a new one right away.

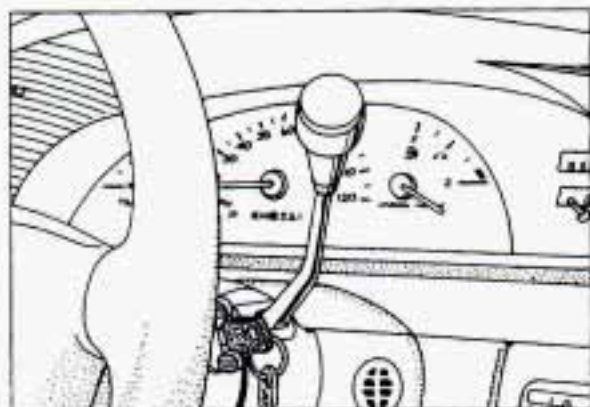

Here you can learn about the many standard and optional features on your Oldsmobile, and information on starting, shifting and braking. Also explained are the instrument panel and the warning systems that tell you if everything is working properly — and what to do if you have a problem.

Part 2

Features & Controls

Keys	42
Locks.....	43
Glove Box.....	52
Ignition Switch.....	52
Starting Your Engine	53
Engine Coolant Heater.....	54
Shifting the Transaxle.....	55
Parking Brake.....	60
Shifting into Park	61
Windows.....	65
Turn Signal and Lane Change Indicator.....	66
Windshield Wipers	67
Windshield Washer	68
Cruise Control.....	69
Headlights.....	72
Interior Lights	74
Mirrors.....	75
Sun Visors	78
Ashtrays and Lighter.....	80
Instrument Panel.....	82
Warning Lights, Gages and Indicators.....	88
Driver Information Center.....	101

Features & Controls

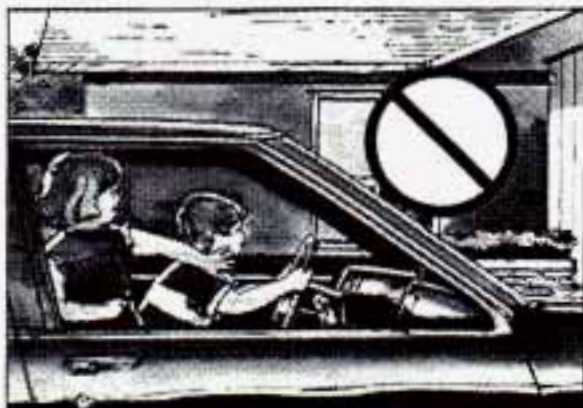

■ Keys



CAUTION:

Leaving young children in a vehicle with the ignition key is dangerous for many reasons. A child or others could be badly injured or even killed. They could operate power windows or other controls or even make the vehicle move. Don't leave the keys in a vehicle with young children.

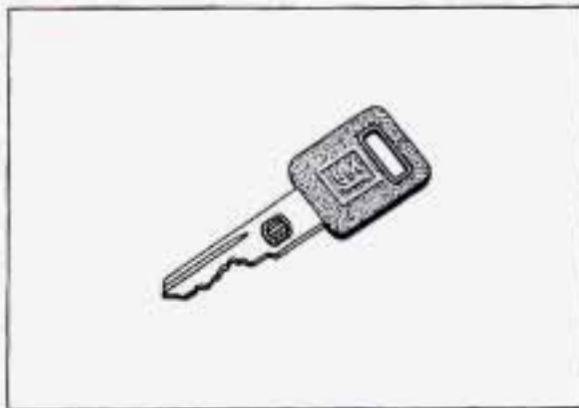

The ignition keys are for the ignition only.

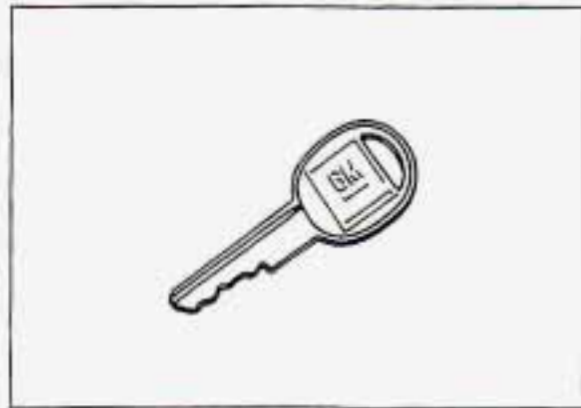

The door keys are for the doors and all other locks.

When a new Oldsmobile is delivered, the dealer removes the plugs from the keys and gives them to the first owner. However, the ignition key may not have a plug. If the ignition key doesn't have a plug, it will have a bar-coded key tag.

Each plug or tag has a code on it that tells your dealer or a qualified locksmith how to make extra keys. Keep the plugs or key tag in a safe place. If you lose your keys, you'll be able to have new ones made easily using these plugs or tags. If your ignition keys don't have plugs or tags, go to your Oldsmobile dealer for the correct key code if you need a new ignition key.

There are 15 alternative PASS-Key® blanks, to help discourage theft. Your dealer can help determine which blank you need.

NOTICE:

Your Oldsmobile has a number of new features that can help prevent theft. But you can have a lot of trouble getting into your vehicle if you ever lock your keys inside. You may even have to damage your vehicle to get in. So be sure you have extra keys.

■ *Door Locks*



CAUTION:

Unlocked doors can be dangerous. Passengers — especially children — can easily open the doors and fall out. When a door is locked, the inside handle won't open it.

Outsiders can easily enter through an unlocked door when you slow down or stop your vehicle.

This may not be so obvious: You increase the chance of being thrown out of the vehicle in a crash if the doors aren't locked. Wear safety belts properly, lock your doors, and you will be far better off whenever you drive your vehicle.

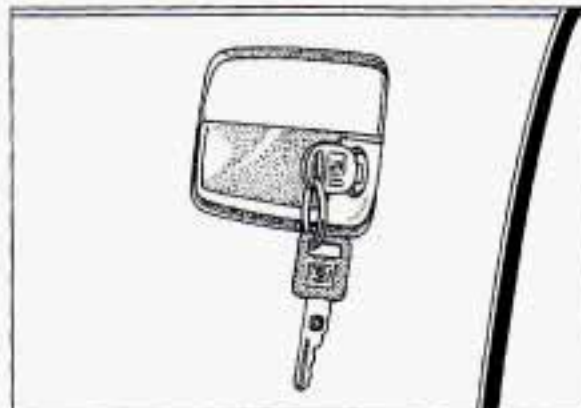

There are several ways to lock and unlock your vehicle.

From the Outside:

Use your door key or Remote Lock Control, if your vehicle has this option.

Features & Controls

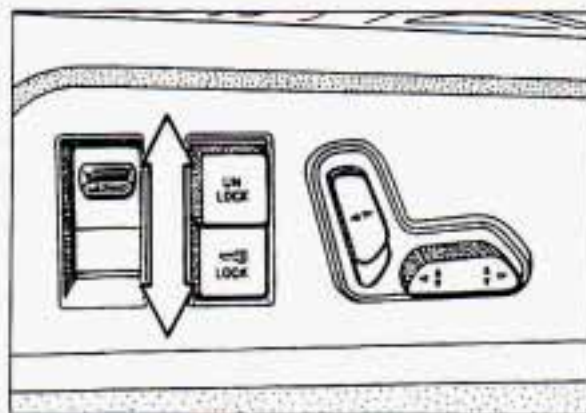

From the Inside:

To lock the door, slide the locking lever down.

To unlock the door, slide the locking lever up.

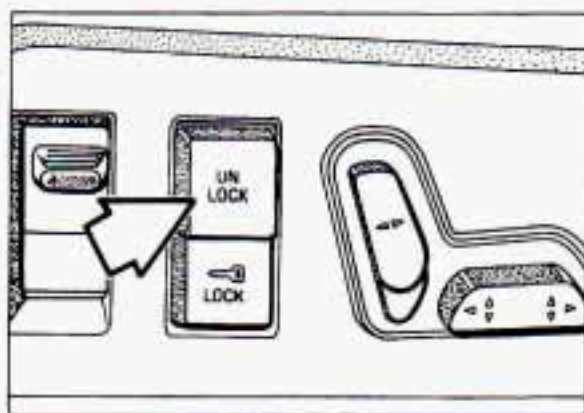

Power Door Locks

With power door locks, you can lock or unlock all the doors of your vehicle from the driver or front passenger door lock switch.

The switch on each rear door works only that door's lock. It won't lock (or unlock) all of the doors—that's a safety feature.

Door Open Reminder

If you have the information center and a door is not fully closed when the transaxle is in gear, a chime will sound and the information center will display one of these messages:

DRIVER DOOR AJAR
PASSENGER DOOR AJAR
REAR DOOR AJAR

Programmable Automatic Door Locks (OPTION)

Just close your doors and turn on the ignition. Every time you move your shift lever out of **P** (Park) all of the doors will lock. And, every time you stop and move your shift lever into **P** (Park), your doors will unlock. If someone needs to get out while you're not in **P** (Park), have that person use the manual or power lock. When the door is closed again, it will not lock automatically. Just use the manual or power lock to lock the door again. You can program the automatic door lock feature to allow the doors to remain locked after you shift into **P** (Park).

To do this:

1. Close your doors and turn the ignition **On**.
2. Keep your foot on the brake pedal.
3. Press and hold the driver's power door lock switch.
4. Move your shift lever out of **P** (Park), then move the shift lever back into **P** (Park).
5. Release the lock switch.

Your doors will now lock when you shift out of **P** (Park), and remain locked until you use the manual or power door unlock switch.

To reprogram the door locks to lock and unlock when you shift in and out of **P** (Park) do the following:

1. Close your doors and turn the ignition **On**.
2. Keep your foot on the brake pedal.
3. Press and hold the driver's power door unlock switch.
4. Move the shift lever out of **P** (Park), then move the shift lever back into **P** (Park).
5. Release the unlock switch.

Leaving Your Vehicle

If you are leaving the vehicle, open your door and set the locks from inside, then get out and close the door.

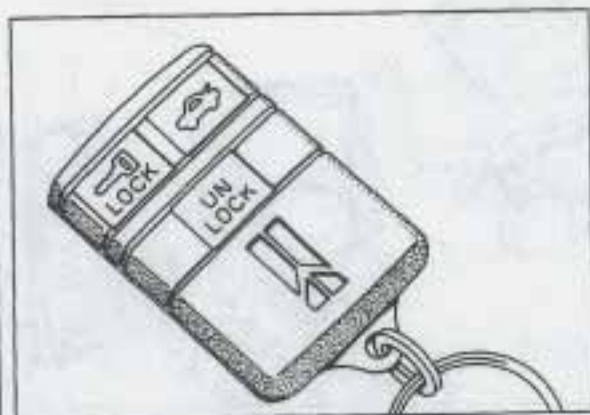

■ **Remote Lock Control (OPTION)**

If your Oldsmobile has this option, you can lock and unlock your doors or unlock your trunk from about 15 feet (4.5 m) away using the key chain transmitter supplied with your vehicle.

Your Remote Lock Control operates on a radio frequency subject to Federal Communications Commission (FCC) Rules.

This device complies with Part 15 of the FCC Rules. Operation is subject to the following two conditions: (1) This device may not cause harmful interference, and (2) This device must accept any interference received, including interference that may cause undesired operation.

Should interference to this system occur, try this:

- Check to determine if battery replacement is necessary. See the instructions on battery replacement.
- Check the distance. You may be too far from your vehicle. This product has a maximum range.
- Check the location. Other vehicles or objects may be blocking the signal.
- See your Oldsmobile dealer or a qualified technician for service.

Changes or modifications to this system by other than an authorized service facility could void authorization to use this equipment.

Operation

The driver's door will unlock when **UNLOCK** is pressed. If pressed again within 25 seconds, all doors will unlock. All doors will lock when **LOCK** is pressed.

The trunk will unlock when  is pressed, but only when the ignition is off.

Press any button to illuminate the interior lights (see *Illuminated Entry System* later in this section).

Features & Controls

Matching Transmitter(s) To Your Vehicle

Each key chain transmitter is coded to prevent another transmitter from unlocking your vehicle. If a transmitter is lost or stolen, a replacement can be purchased through your dealer. Remember to bring any remaining transmitters with you when you go to your dealer. When the dealer matches the replacement transmitter to your vehicle, the remaining transmitters must also be matched. Once the new transmitter is coded, the lost transmitter will not unlock your vehicle.

You can match a transmitter to as many different vehicles as you own, provided they are equipped with **exactly the same model system**. (General Motors offers several different models of these systems on their vehicles.) Each vehicle can have only two transmitters matched to it.

See your dealer to match transmitters to another vehicle.

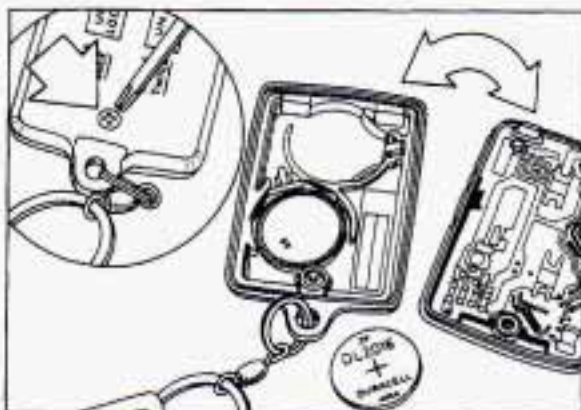

Battery Replacement

Under normal use, the batteries in your key chain transmitter should last about two years.

You can tell the batteries are weak if the transmitter won't work at the normal range in any location. If you have to get close to your vehicle before the transmitter works, it's probably time to change the batteries.

To Replace Batteries in the Remote Lock Control:

1. Remove the screw from back cover.
2. Lift the front cover off, bottom half first.
3. Remove and replace the two batteries (2016).
4. Reassemble the transmitter.
5. Check the transmitter operation.

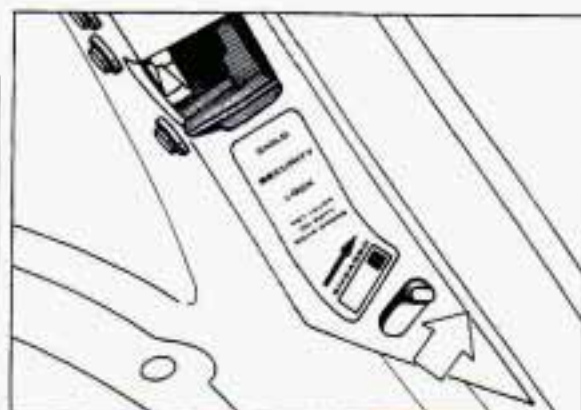

Rear Door Security Locks

Your Oldsmobile is equipped with rear door security locks that help prevent passengers from opening the rear doors of your vehicle from the inside. To use one of these locks:

1. Move the lever on the door all the way up to the **ENGAGED** position.
2. Close the door.
3. Do the same thing to the other rear door lock.

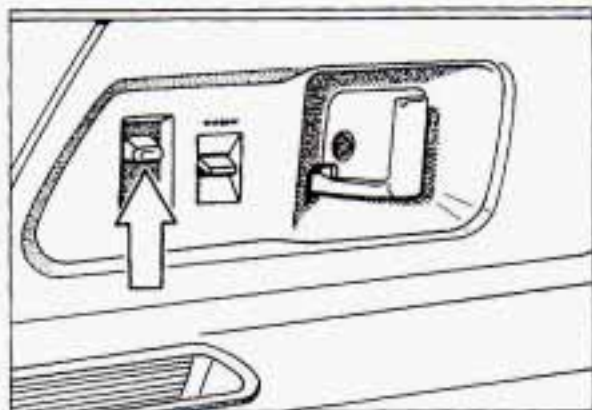

The rear doors of your vehicle cannot be opened from inside when this feature is in use. If you want to open a rear door when the security lock is on:

1. Unlock the door from the inside.

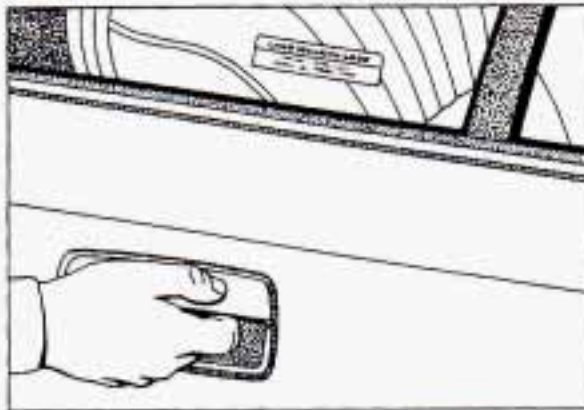

2. Then open the door from the outside.

If you don't cancel the security lock feature, adults or older children who ride in the rear won't be able to open the rear door from the inside. You should let adults and older children know how these security locks work, and how to cancel the locks.

To cancel the rear door security lock:

1. Unlock the door from the inside and open the door from the outside.

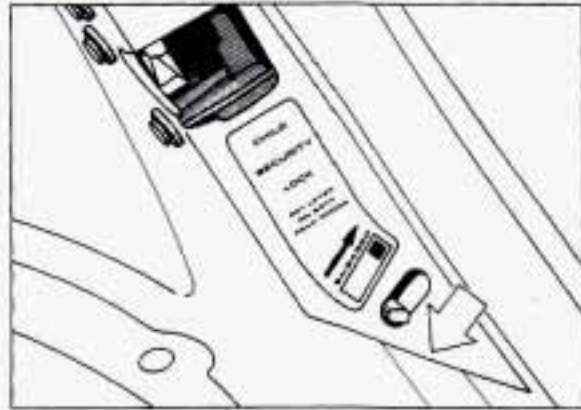

2. Move the lever all the way down.

3. Do the same for the other rear door.

The rear door locks will now work normally.

Features & Controls

■ *Theft*

Vehicle theft is big business, especially in some cities. Although your Oldsmobile has a number of theft deterrent features, we know that nothing we put on it can make it impossible to steal. However, there are ways you can help.

Key in the Ignition

If you walk away from your vehicle with the keys inside, it's an easy target for joy riders or professional thieves — so don't do it.

When you park your Oldsmobile and open the driver's door, you'll hear a chime reminding you to remove your key from the ignition and take it with you. Always do this. Your steering wheel will be locked, and so will your ignition and transaxle. And remember to lock the doors.

Parking at Night

Park in a lighted spot, close all windows and lock your vehicle. Remember to keep your valuables out of sight. Put them in a storage area, or take them with you.

Parking Lots

If you park in a lot where someone will be watching your vehicle, it's best to lock it up and take your keys. But what if you have to leave your ignition key? What if you have to leave something valuable in your vehicle?

- Put your valuables in a storage area, like your trunk or glove box.
- Lock the glove box.
- Lock all the doors except the driver's.
- Then take the door key with you.

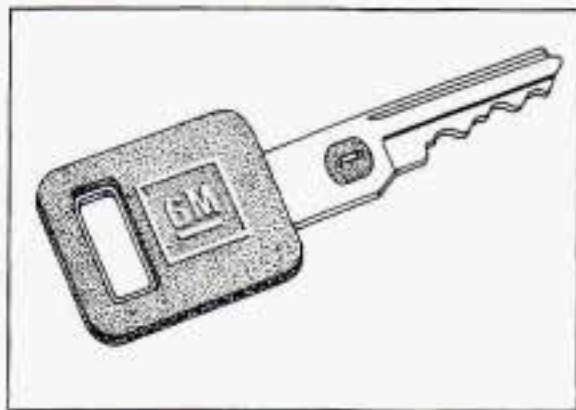

■ **PASS-Key® II**

Your vehicle is equipped with the PASS-Key® II (Personalized Automotive Security System) theft deterrent system. PASS-Key® II is a passive theft deterrent system. This means you don't have to do anything different to arm or disarm the system. It works when you insert or remove the key from the ignition. PASS-Key® II uses a resistor pellet in the ignition key that matches a decoder in your vehicle.

When the PASS-Key®II system senses that someone is using the wrong key, it shuts down the vehicle's starter and fuel systems. For about three minutes, the starter won't work and fuel won't go to the engine. If someone tries to start your vehicle again or uses another key during this time, the vehicle will not start. This discourages someone from randomly trying different keys with different resistor pellets in an attempt to make a match.



The ignition key must be clean and dry before it's inserted in the ignition or the engine may not start. If the engine does not start and the **SECURITY** light is on, or if you have the information center and you get the **CLEAN KEY-WAIT 3 MIN** message, the key may be dirty or wet. Turn the ignition off.

Clean and dry the key. Wait about three minutes and try again. The security light may remain on during this time. If the starter still won't work, and the key appears to be clean and dry, wait about three minutes and try the other ignition key. At this time, you may also want to check the fuse (see *Fuses and Circuit Breakers* in the *Index*). If the starter won't work with the other key, your vehicle needs service. If your vehicle does start, the first ignition key may be

faulty. See your Oldsmobile dealer or a locksmith who can service the PASS-Key®II.

If you accidentally use a key that has a damaged or missing resistor pellet, the starter won't work and the **SECURITY** light will flash or, if you have the information center, the **CLEAN KEY-WAIT 3 MIN** message will appear. But you don't have to wait three minutes before trying one of the other ignition keys.

See your Oldsmobile dealer or a locksmith who can service the PASS-Key®II to have a new key made.

If you're ever driving and the **SECURITY** light comes on, or with the information center you get the **PASS-KEY SYSTEM PROB** message, you will be able to restart your engine if you turn it off. Your PASS-Key®II system, however, is not working properly and must be serviced by your Oldsmobile dealer. Your vehicle is not protected by the PASS-Key®II system.

If you lose or damage a PASS-Key®II ignition key, see your Oldsmobile dealer or a locksmith who can service PASS-Key®II to have a new key made.

Features & Controls

Illuminated Entry System (OPTION)

When you lift the handle of either front door, lights inside your vehicle will go on. These lights will go off after about 20 seconds, or when you start your engine. The lights will also go on when you press any button on the optional Remote Lock Control transmitter. If a door is left ajar, your interior lights will turn off after ten minutes to save your battery.



Trunk Lock

To unlock the trunk from the outside, insert the door key and turn it.



CAUTION:

It can be dangerous to drive with the trunk lid open because carbon monoxide (CO) gas can come into your vehicle. You can't see or smell CO. It can cause unconsciousness and even death. If you must drive with the trunk lid open or if electrical wiring or other cable connections must pass through the seal between the body and the trunk lid:

- Make sure all windows are shut.
- Turn the fan on your heating or cooling system to its highest speed with the setting on any air flow selection except **RECIRC**. That will force outside air into your vehicle. See *Comfort Controls* in the *Index*.
- If you have air vents on or under the instrument panel, open them all the way.

See *Engine Exhaust* in the *Index*.

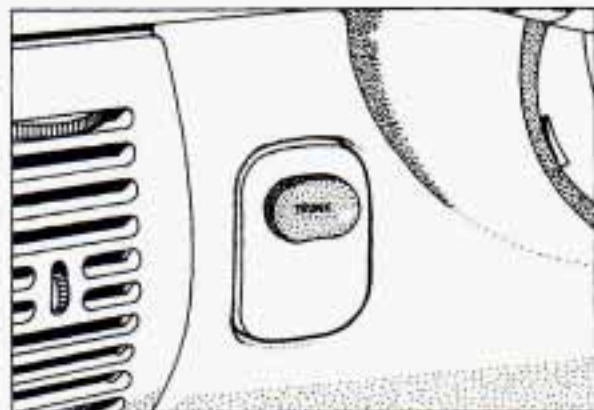

Remote Trunk Release (OPTION)

Press the release button located to the left of the steering column to release the trunk lid. The Trunk Security override switch must be in the **ON** position, and the transaxle in **P** (Park).

The system also works with the Remote Lock Control.

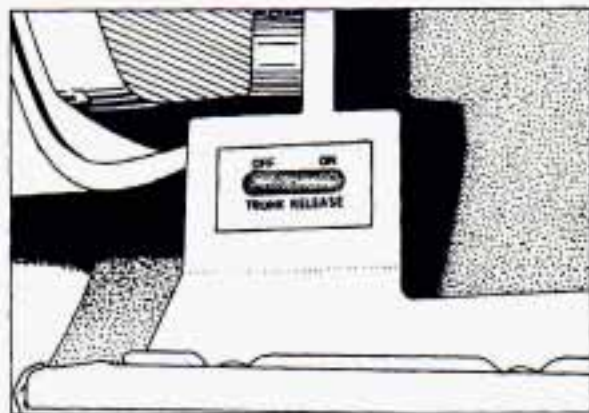

Trunk Security Override (OPTION)

This feature is standard with vehicles equipped with Remote Trunk Release. Inside the glove box is an override switch that is useful if you want to leave valuables in the trunk when using a commercial parking lot.

Move the switch to **OFF** to override the Remote Trunk Release. If you lock your glove box door and take the door key with you (and your Remote Lock Control if so equipped), this will help keep someone from getting into your trunk. Move the switch to **ON** to again make the Remote Trunk Release usable.

The optional Remote Lock Control transmitter will open the trunk even if the override switch is in the **OFF** position.

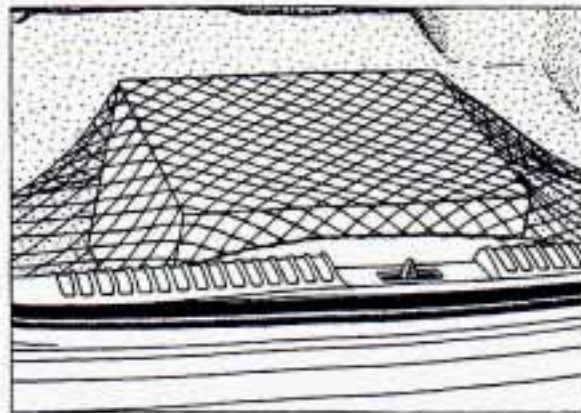

Convenience Net (OPTION)

Your vehicle may have a convenience net. You'll see it just inside the back wall of the trunk.

Put small loads, like grocery bags, behind the net to help keep them from falling over during sharp turns or quick starts and stops.

The net isn't for larger, heavier loads. Store them in the trunk as far forward as you can. You can unhook the net so that it will lie flat when you're not using it.

Features & Controls

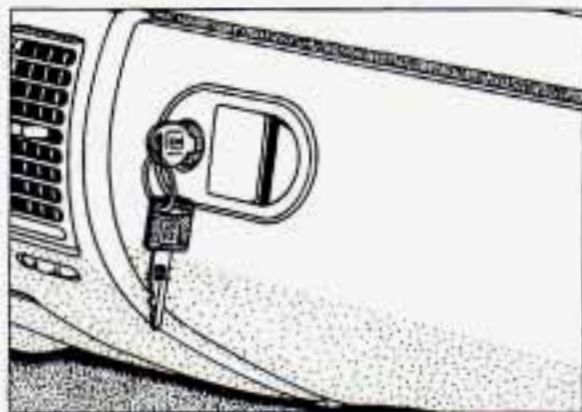

Glove Box

Use the door key to lock and unlock the glove box. To open, lift the latch release on the left side of the glove box door.

■ *New Vehicle "Break-In"*

NOTICE:

Your modern Oldsmobile doesn't need an elaborate "break-in." But it will perform better in the long run if you follow these guidelines:

- Don't drive at any one speed — fast or slow — for the first 500 miles (804 km). Don't make full-throttle starts.
- Avoid making hard stops for the first 200 miles (322 km) or so. During this time your new brake linings aren't yet broken in. Hard stops with new linings can mean premature wear and earlier replacement. Follow this "breaking-in" guideline every time you get new brake linings.

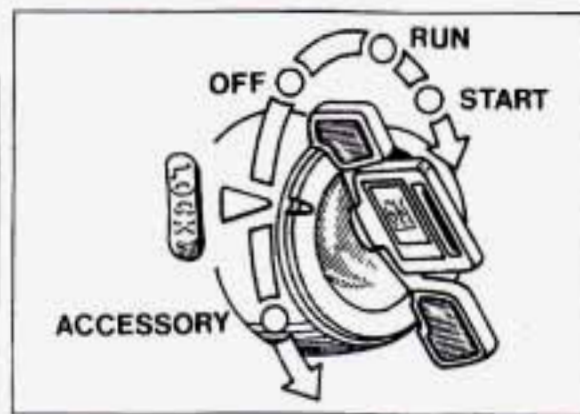

■ *Ignition Switch*

With the ignition key in the ignition switch, you can turn the switch to five positions:

Accessory: An "on" position in which you can operate your electrical power accessories. Press in the ignition switch as you turn the top of it toward you.

Lock: The only position in which you can remove the key. This locks your steering wheel, ignition and transaxle.

Off: Unlocks the steering wheel, ignition, and transaxle, but does not send electrical power to any accessories. Use this position if your vehicle must be pushed or towed, but never try to push-start your vehicle. A warning chime will sound if you open the driver's door

when the ignition is off and the key is in the ignition.

Run: An "on" position to which the switch returns after you start your engine and release the switch. The switch stays in the **Run** position when the engine is running. But even when the engine is not running, you can use **Run** to operate your electrical power accessories, and to display some instrument panel warning lights.

Start: Starts the engine. When the engine starts, release the key. The ignition switch will return to **Run** for normal driving.

Note that even if the engine is not running, the positions **Accessory** and **Run** are "on" positions that allow you to operate your electrical accessories, such as the radio.

Key Reminder Warning:

If you leave your key in the ignition, in the **Off** position, you will hear a warning tone when you open the driver's door.

Retained Accessory Power: If you have the optional Remote Lock Control, after you turn your ignition off and even

remove the key, you will still have electrical power to such accessories as the radio and power windows for up to 10 minutes. But if you open a door, power is shut off.

NOTICE:

If your key seems stuck in **Lock** and you can't turn it, be sure it is all the way in. If it is, then turn the steering wheel left and right while you turn the key hard. But turn the key only with your hand. Using a tool to force it could break the key or the ignition switch. If none of this works, then your vehicle needs service.

■ ***Starting Your Engine***

Move your shift lever to **P** (Park) or **N** (Neutral). Your engine won't start in any other position — that's a safety feature. To restart when you're already moving, use **N** (Neutral) only.

NOTICE:

Don't try to shift to **P** (Park) if your Oldsmobile is moving. If you do, you could damage the transaxle. Shift to **P** (Park) only when your vehicle is stopped.

To start your 3.8 Liter engine:

1. Without pushing the accelerator pedal, turn your ignition key to **Start**. When the engine starts, let go of the key. The idle speed will go down as your engine gets warm.

NOTICE:

Holding your key in **Start** for longer than 15 seconds at a time will cause your battery to be drained much sooner. And the excessive heat can damage your starter motor.

2. If it doesn't start right away, hold your key in **Start** for about three to five seconds at a time until your engine starts. Wait about 15 seconds between each try to help avoid draining your battery.

Features & Controls

3. If your engine still won't start (or starts but then stops), it could be flooded with too much gasoline. Try pushing your accelerator pedal all the way to the floor and holding it there as you hold the key in **Start** for about three seconds. If the vehicle starts briefly but then stops again, do the same thing, but this time keep the pedal down for five or six seconds. This clears the extra gasoline from the engine. After waiting about 15 seconds, repeat the normal starting procedure.

NOTICE:

Your engine is designed to work with the electronics in your vehicle. If you add electrical parts or accessories, you could change the way the fuel injection system operates. Before adding electrical equipment, check with your dealer. If you don't, your engine might not perform properly. If you ever have to have your vehicle towed, see the part of this manual that tells how to do it without damaging your vehicle. See *Towing Your Vehicle* in the *Index*.

■ *Driving Through Deep Standing Water*

NOTICE:

If you drive too quickly through deep puddles or standing water, water can come in through your engine's air intake and badly damage your engine. If you can't avoid deep puddles or standing water, drive through them very slowly.

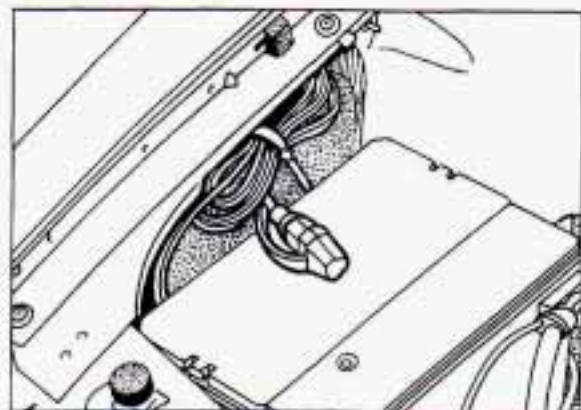

■ *Engine Coolant Heater* *(Engine Block Heater)* (OPTION)

In very cold weather, 0°F (-18°C) or colder, the engine coolant heater can help. You'll get easier starting and better fuel economy during engine warm-up. Usually, the coolant heater should be plugged in a minimum of four hours prior to starting your vehicle.

To use the coolant heater:

1. Turn off the engine.
2. Open the hood and unwrap the electrical cord.
3. Plug it into a normal, grounded 110-volt outlet.

 **CAUTION:**

Plugging the cord into an ungrounded outlet could cause an electrical shock. Also, the wrong kind of extension cord could overheat and cause a fire. You could be seriously injured. Plug the cord into a properly grounded three-prong 110-volt outlet. If the cord won't reach, use a heavy-duty three-prong extension cord rated for at least 15 amps.

NOTICE:

After you've used the coolant heater, be sure to store the cord as it was before to keep it away from moving engine parts. If you don't, it could be damaged.

How long should you keep the coolant heater plugged in? The answer depends on the weather, the kind of oil you have, and some other things. Instead of trying to list everything here, we ask that you contact an Oldsmobile dealer in the area where you'll be parking your vehicle. The dealer can give you the best advice for that particular area.

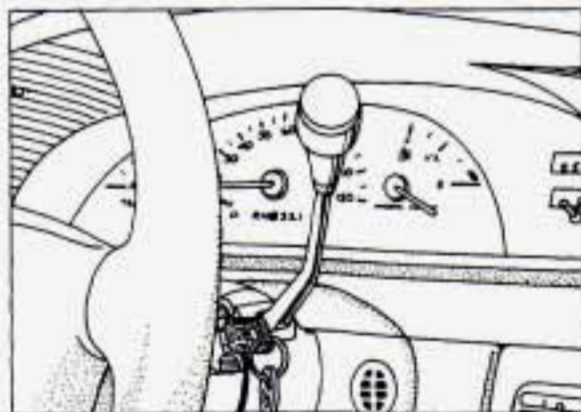

■ ***Automatic Transaxle***

Your automatic transaxle may have a shift lever located on the steering column or on the console between the seats. Both are shown.

Features & Controls

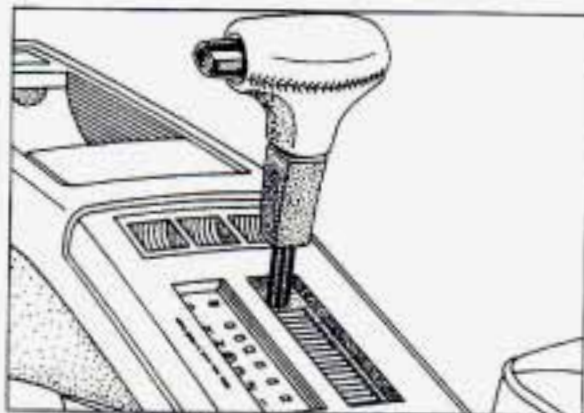

There are several shift positions. In this manual, these are referred to by the commonly used symbols in the right column below:

Park	P
Reverse	R
Neutral	N
Overdrive	D
Third	3
Second	2
First	1

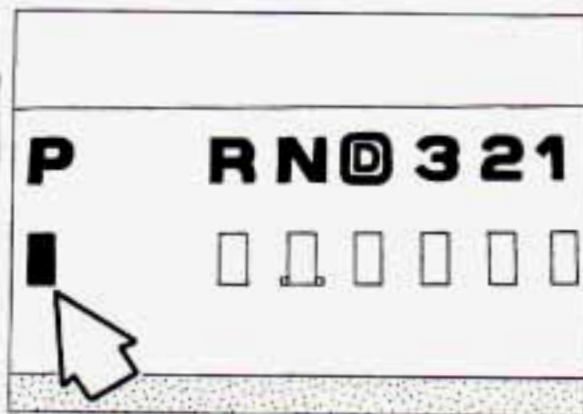

Park

P (Park): This locks your front wheels. It's the best position to use when you start your engine because your vehicle can't move easily.

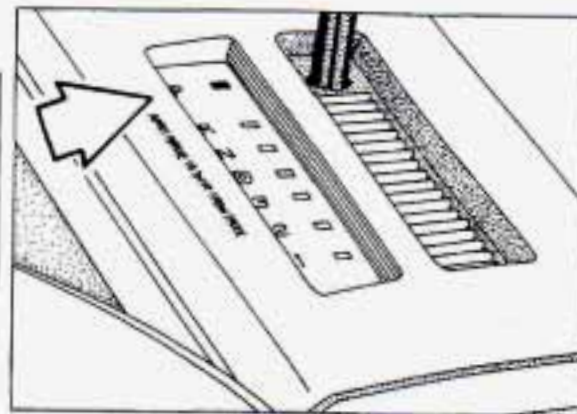

CAUTION:

It is dangerous to get out of your vehicle if the shift lever is not fully in **P (Park)** with the parking brake firmly set. Your vehicle can roll. Don't leave your vehicle when the engine is running unless you have to. If you have left the engine running, the vehicle can move suddenly. You or others could be injured. To be sure your vehicle won't move, even when you're on fairly level ground, always set your parking brake and move the shift lever to **P (Park)**.

CAUTION (Continued)

CAUTION (Continued)

See *Shifting Into P (Park)* in the *Index*. If you're pulling a trailer, see *Towing a Trailer* in the *Index*.

Ensure the shift lever is fully in **P** (Park) range before starting the engine. Your Oldsmobile has a brake-transaxle shift interlock. You have to fully **apply** your regular brakes **before** you can shift from **P** (Park) when the ignition key is in the **On** position. If you cannot shift out of **P** (Park), ease pressure on the shift lever—push the shift lever all the way into **P** (Park) and also release the shift lever button on floor shift console models as you maintain brake application. Then move the shift lever into the gear you wish. (Press the shift lever button before moving the shift lever on floor shift console models.) See the *Index* under *Shifting Out of P (Park)*.

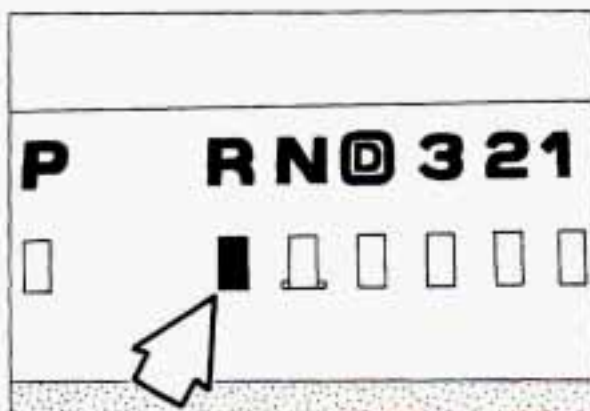

Reverse

R (Reverse): Use this gear to back up.

NOTICE:

Shifting to **R** (Reverse) while your vehicle is moving forward could damage your transaxle. Shift to **R** only after your vehicle is stopped.

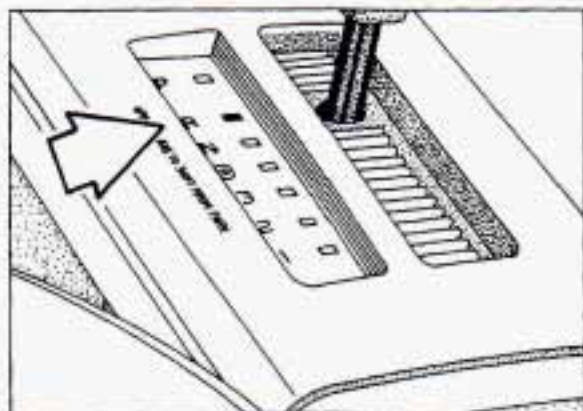

To rock your vehicle back and forth to get out of snow, ice or sand without damaging your transaxle, see the *Index* under *If You're Stuck: In Sand, Mud, Ice or Snow*.

Features & Controls

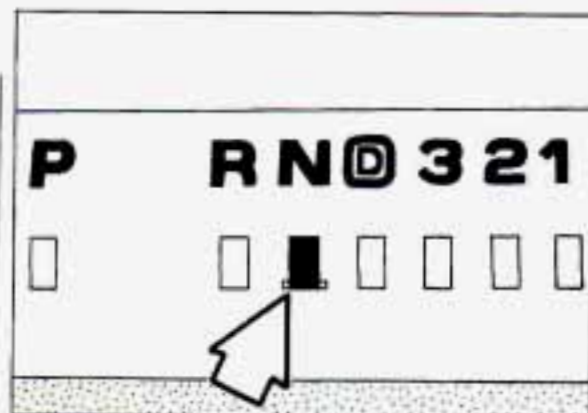

Neutral

N (Neutral): In this position, your engine doesn't connect with the wheels. To restart when you're already moving, use **N** (Neutral) only. Also, use **N** when your vehicle is being towed.

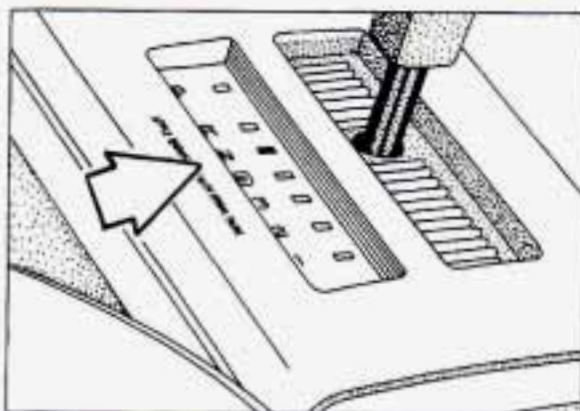

CAUTION:

Shifting out of **P** (Park) or **N** (Neutral) while your engine is "racing" (running at high speed) is dangerous. Unless your foot is firmly on the brake pedal, your vehicle could move very rapidly. You could lose control and hit people or objects. Don't shift out of **P** (Park) or **N** (Neutral) while your engine is racing.

NOTICE:

Damage to your transaxle caused by shifting out of **P** (Park) or **N** (Neutral) with the engine racing isn't covered by your warranty.

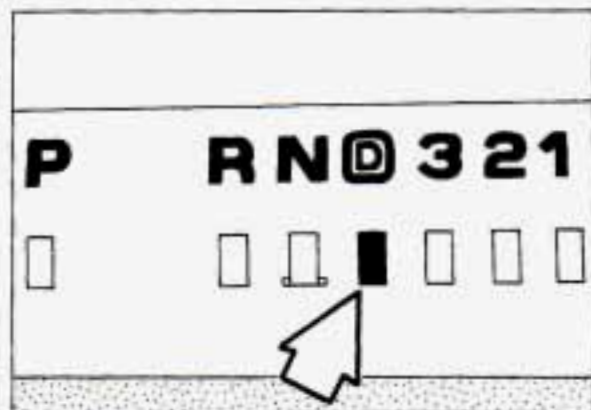

Forward Gears

D (Automatic Overdrive): This position is for normal driving. If you need more power for passing, and you're:

- Going less than about 35 mph (56 km/h), push your accelerator pedal about halfway down.
- Going about 35 mph (56 km/h) or more, push the accelerator all the way down.

You'll shift down to the next gear and have more power.

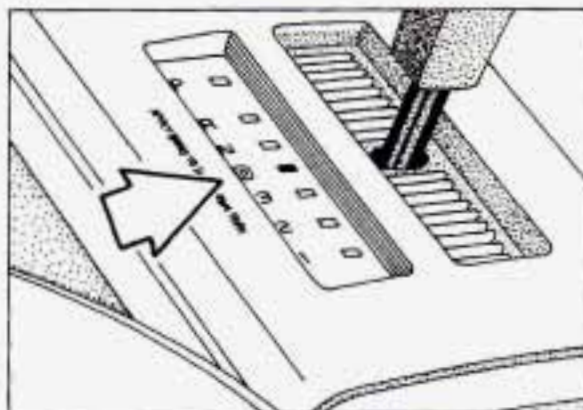

NOTICE:

If your vehicle seems to start up rather slowly, or if it seems not to shift gears as you go faster, something may be wrong with a transaxle system sensor. If you drive very far that way, your vehicle can be damaged. So, if this happens, have your vehicle serviced right away. Until then, you can use **2 (Second Gear)** when you are driving less than 35 mph (56 km/h) and **D (Overdrive)** for higher speeds.

3 (Third Gear): This is like **D**, but you never go into Overdrive. Here are some times you might choose **3** instead of **D**:

- When driving on hilly, winding roads.
- When towing a trailer, so there is less shifting between gears.
- When going down a steep hill.

2 (Second Gear): This position gives you more power but lower fuel economy. You can use **2** on hills. It can help control your speed as you go down steep mountain roads, but then you would also want to use your brakes off and on.

NOTICE:

Don't drive in **2 (Second Gear)** for more than 5 miles (8 km), or at speeds over 55 mph (88 km/h), or you can damage your transaxle. Use **D** or **3** as much as possible.

Don't shift into **2** unless you are going slower than 65 mph (105 km/h), or you can damage your engine.

1 (First Gear): This position gives you even more power (but lower fuel economy) than **2**. You can use it on very steep hills, or in deep snow or mud. If the selector lever is put in **1**, the

Features & Controls

transaxle won't shift into first gear until the vehicle is going slowly enough.

NOTICE:

If your front wheels can't rotate, don't try to drive. This might happen if you were stuck in very deep sand or mud or were up against a solid object. You could damage your transaxle.

Also, if you stop when going uphill, don't hold your vehicle there with only the accelerator pedal. This could overheat and damage the transaxle. Use your brakes or shift into **P** (Park) to hold your vehicle in position on a hill.

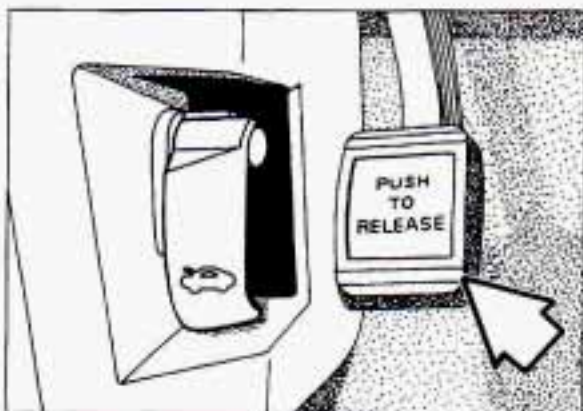

Parking Brake

To Set the Parking Brake:

Hold the regular brake pedal down with your right foot. Push down the parking brake pedal with your left foot. If the ignition is on, the brake system warning light will come on.

To Release the Parking Brake:

This vehicle has a "push to release" park brake pedal. Hold the regular brake pedal down and push the park brake pedal with your left foot. This will unlock the pedal. When you lift your left foot, the park brake pedal will follow it to the released position. If you try to drive off with the parking brake on, the brake light stays on and a chime sounds until you release the parking brake or recycle the ignition. If you

have the electronic cluster, the chime can be shut off by pressing **RESET**, but the **PARK BRAKE SET** message will remain.

NOTICE:

Driving with the parking brake on can cause your rear brakes to overheat. You may have to replace them, and you could also damage other parts of your vehicle.

If You are Towing a Trailer and are Parking on Any Hill:

See the *Index* under *Towing a Trailer*. That section shows what to do first to keep the trailer from moving.

■ Shifting Into “P” (Park)

CAUTION:

It can be dangerous to get out of your vehicle if the shift lever is not fully in **P** (Park) with the parking brake firmly set. Your vehicle can roll. If you have left the engine running, the vehicle can move suddenly. You or others could be injured. To be sure your vehicle won't move, even when you're on fairly level ground, use the steps that follow. If you're pulling a trailer, see *Towing a Trailer* in the *Index*.

Steering Column Shift Lever

1. Hold the brake pedal down with your right foot and set the parking brake.

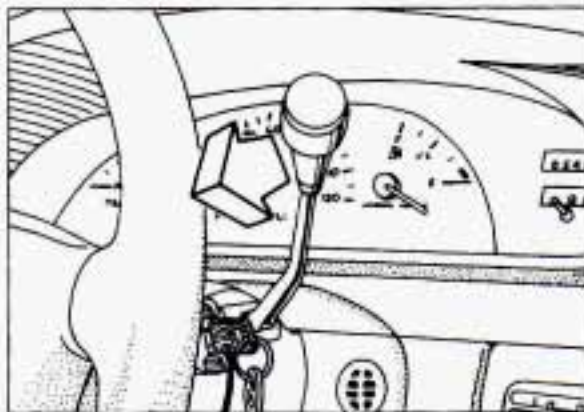

2. Move the shift lever into the **P** (Park) position as follows:
 - Pull the lever toward you.

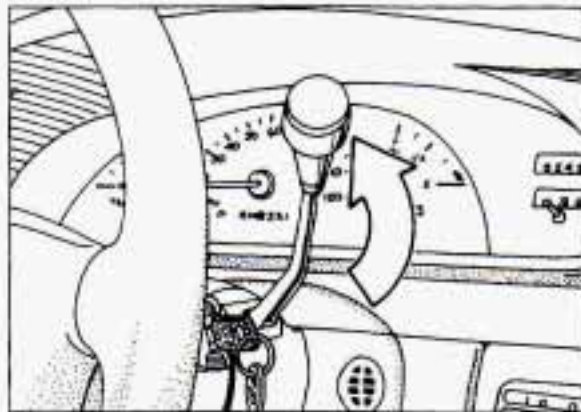

- Move the lever up as far as it will go.
3. Move the ignition key to **Lock**.
 4. Remove the key and take it with you. If you can walk away from your vehicle with the ignition key in your hand, your vehicle is in **P** (Park).

Console Shift Lever

1. Hold the brake pedal down with your right foot and set the parking brake.

Features & Controls

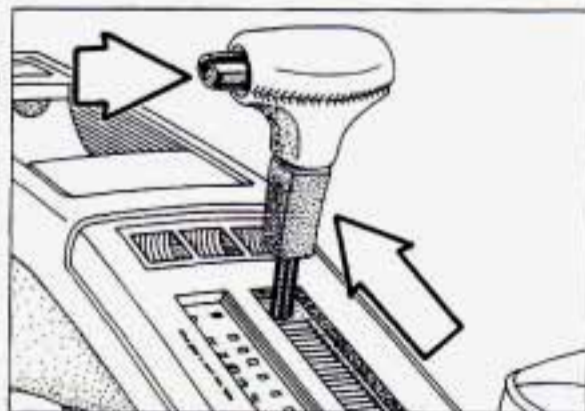

2. Move the shift lever into the **P** (Park) position as follows:
 - Hold in the button on the lever;
 - Push the lever all the way toward the front of your vehicle.
3. Move the ignition key to **Lock**.
4. Remove the key and take it with you. If you can walk away from your vehicle with the ignition key in your hand, your vehicle is in **P** (Park).

Leaving Your Vehicle With the Engine Running



CAUTION:

It can be dangerous to leave your vehicle with the engine running. Your vehicle could move suddenly if the shift lever is not fully in **P** (Park) with the parking brake firmly set. And, if you leave the vehicle with the engine running, it could overheat and even catch fire. You or others could be injured. Don't leave your vehicle with the engine running unless you have to.

If you have to leave your vehicle with the engine running, be sure your vehicle is in **P** (Park) and your parking brake is firmly set before you leave it. After you've moved the shift lever into the **P** (Park) position, hold the regular brake pedal down. Then, see if you can move the shift lever away from **P** (Park) without first pulling it toward you (or, if you have the console shift lever, without first pushing the button).

If you can, it means that the shift lever wasn't fully locked into **P** (Park).

Torque Lock

If you are parking on a hill and you don't shift your transaxle into **P** (Park) properly, the weight of the vehicle may put too much force on the parking pawl in the transaxle. You may find it difficult to pull the shift lever out of **P** (Park). This is called "torque lock." To prevent torque lock, set the parking brake and then shift into **P** (Park) properly before you leave the driver's seat. To find out how, see *Shifting Into P (Park)* in the *Index*.

When you are ready to drive, move the shift lever out of **P** (Park) **BEFORE** you release the parking brake.

If "torque lock" does occur, you may need to have another vehicle push yours a little uphill to take some of the pressure from the transaxle, so you can pull the shift lever out of **P** (Park).

Shifting Out of P (Park)

Your Oldsmobile has a brake-transaxle shift interlock. You have to fully **apply** your regular brake **before** you can shift

from **P** (Park) when the ignition is in the **On** position. See the *Index* under *Shifting the Automatic Transaxle*.

If you cannot shift out of **P** (Park), ease pressure on the shift lever—push the shift lever all the way into **P** (Park) as you maintain brake application. Then move the shift lever into the gear you wish. (Press the shift lever button before moving the shift lever on floor shift console models.)

If you ever hold the brake pedal down but still can't shift out of **P** (Park), try this:

1. Turn the key to **Off**. Open and close the driver's door to turn off the Retained Accessory Power feature.
2. Apply and hold the brake until the end of step 4.
3. Shift to **N** (Neutral).
4. Start the vehicle and then shift to the drive gear you want.
5. Have the vehicle fixed as soon as you can.



■ *Parking Over Things That Burn*

CAUTION:

Things that can burn could touch hot exhaust parts under your vehicle and ignite. Don't park over papers, leaves, dry grass or other things that can burn.

■ *Engine Exhaust*

CAUTION:

Engine exhaust can kill. It contains the gas carbon monoxide (CO), which you can't see or smell. It can cause unconsciousness and death. You might have exhaust coming in if:

- Your exhaust system sounds strange or different.
- Your vehicle gets rusty underneath.
- Your vehicle was damaged in a collision.
- Your vehicle was damaged when driving over high points on the road or over road debris.
- Repairs weren't done correctly.
- Your vehicle or exhaust system had been modified improperly.

If you **ever** suspect exhaust is coming into your vehicle:

- Drive it only with all the windows down to blow out any CO; and
- Have your vehicle fixed **immediately**.

Features & Controls

■ *Running Your Engine While You're Parked*

It's better not to park with the engine running. But if you ever have to, here are some things to know.

CAUTION:

Idling the engine with the air system control off could allow dangerous exhaust into your vehicle. (See the earlier caution under *Engine Exhaust*.) Also, idling in a closed-in place can let deadly carbon monoxide (CO) into your vehicle even if the fan switch is at the highest setting. One place this can happen is a garage.

Exhaust — with CO — can come in easily. NEVER park in a garage with the engine running.

Another closed-in place can be a blizzard. (See *Blizzard* in the *Index*.)

CAUTION:

It can be dangerous to get out of your vehicle if the shift lever is not fully in **P** (Park) with the parking brake firmly set. Your vehicle can roll. Don't leave your vehicle when the engine is running unless you have to. If you've left the engine running, the vehicle can move suddenly. You or others could be injured. To be sure your vehicle won't move, even when you're on fairly level ground, always set your parking brake and move the shift lever to **P** (Park).

Follow the proper steps to be sure your vehicle won't move. See *Shifting Into P (Park)* in the *Index*.

If you are parking on a hill and if you're pulling a trailer, also see *Towing a Trailer* in the *Index*.

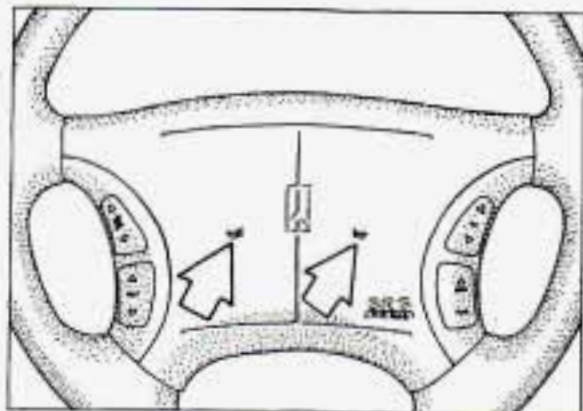

Horn

You can sound the horn by pressing the horn symbols on your steering wheel.

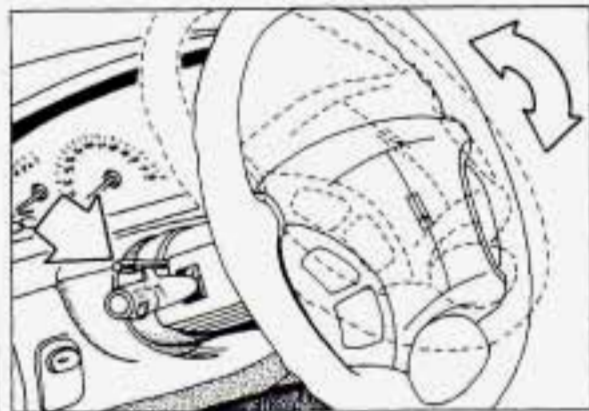

Tilt Steering Wheel

A tilt steering wheel allows you to adjust the steering wheel before you drive. You can also raise it to the highest level to give your legs more room when you exit and enter the vehicle.

To tilt the wheel, hold the steering wheel and pull the lever. Move the steering wheel to a comfortable level, then release the lever to lock the wheel in place.

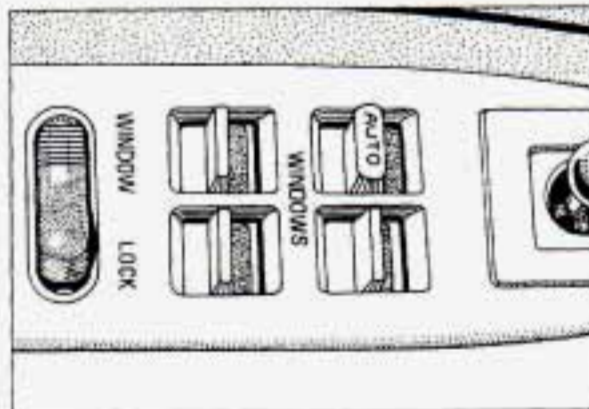

Power Windows

Switches on the driver's armrest control each of the windows when the ignition is on. In addition, each passenger door has a control switch for its own window.

When the driver's window switch is held rearward for more than a half second, the window will lower completely. The window can be opened in smaller amounts by pressing the switch rearward and releasing it immediately.

To stop the window while it is lowering, press the switch again, then release. To raise the window, hold the switch forward.

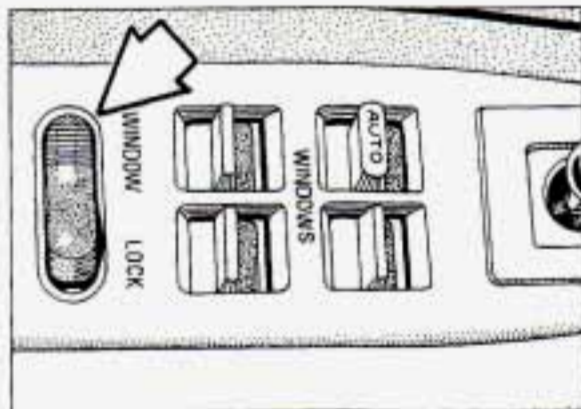

Window Lock

Press the right side of the switch to disable all passenger window switches. This is a useful feature when you have children as passengers.

Features & Controls

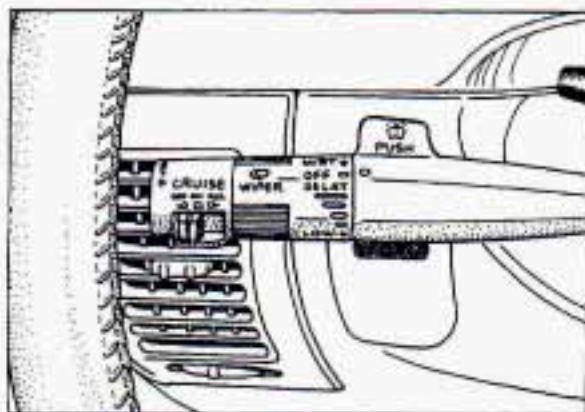

■ Turn Signal/Multifunction Lever

The lever on the left side of the steering column includes your:

- Turn Signal and Lane Change Indicator
- Headlight High-Low Beam
- Windshield Wipers
- Windshield Washer
- Cruise Control (Option)

The High-Low Beam feature is discussed under *Headlights*. See the *Index* under *Headlights*.

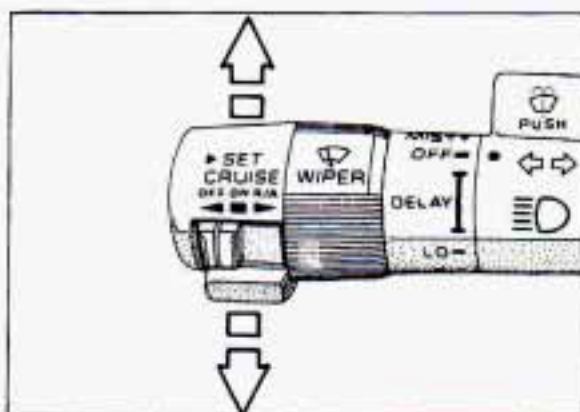

Turn Signal and Lane Change Indicator

The turn signal has two upward (for Right) and two downward (for Left) positions. These positions allow you to signal a turn or a lane change.

To signal a turn, move the lever all the way up or down. When the turn is finished, the lever will return automatically.

If you leave the turn signal on, a chime will sound after you drive $\frac{1}{2}$ of a mile.

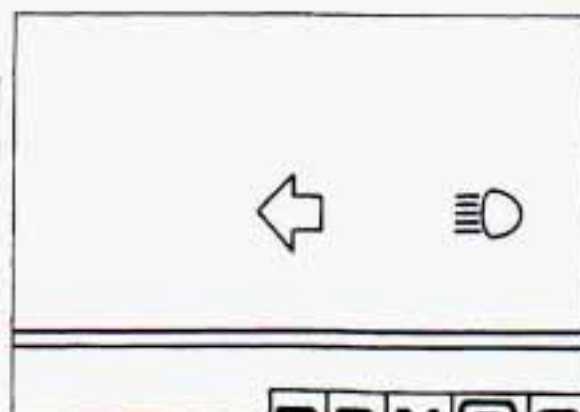

A green arrow on the instrument panel will flash in the direction of the turn or lane change.

To signal a lane change, just raise or lower the lever until the green arrow starts to flash. Hold it there until you complete your lane change. The lever will return by itself when you release it.

As you signal a turn or a lane change, if the arrows don't flash but just stay on, a signal bulb may be burned out and other drivers won't see your turn signal.

If a bulb is burned out, replace it to help avoid an accident.

If the green arrows don't go on at all when you signal a turn, check the fuse (see the *Index* under *Fuses & Circuit Breakers*) and for burned-out bulbs.

If you have a trailer towing option with added wiring for the trailer lights, a different turn signal flasher is used. With this flasher installed, the signal indicator will flash even if a turn signal bulb is burned out. Check the front and rear turn signal lights regularly to make sure they are working.

Operation of Lights

Although your vehicle's lighting system (headlights, parking lights, fog lamps, side marker lights and taillights) meets all applicable federal lighting requirements, certain states and provinces may apply their own lighting regulations that may require special attention before you operate these lights.

For example, some jurisdictions may require that you operate your fog lamps only when your lower beam headlights are also on, or that headlights be turned on whenever you must use your windshield wipers. In addition, most jurisdictions prohibit driving solely with parking lights, especially at dawn or dusk. It is recommended that you check with your own state or provincial highway authority for applicable lighting regulations.

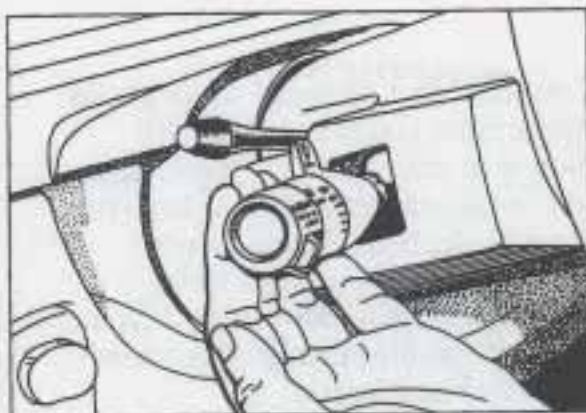

Headlight High-Low Beam Changer

To change the headlights from low beam to high or high to low, pull the turn signal lever all the way toward you. Then release it.

When the high beams are on, a blue light on the instrument panel also will be on.

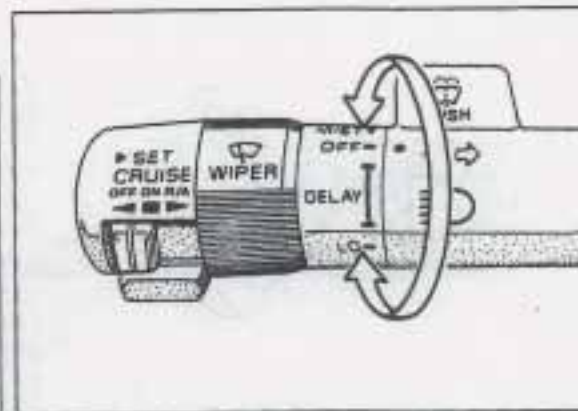

Windshield Wipers

You control the windshield wipers by turning the band marked **WIPER**.

For a single wiping cycle, turn the band to **MIST**. Hold it there until the wipers start, then let go. The wipers will stop after one cycle. If you want more cycles, hold the band on **MIST** longer.

Features & Controls

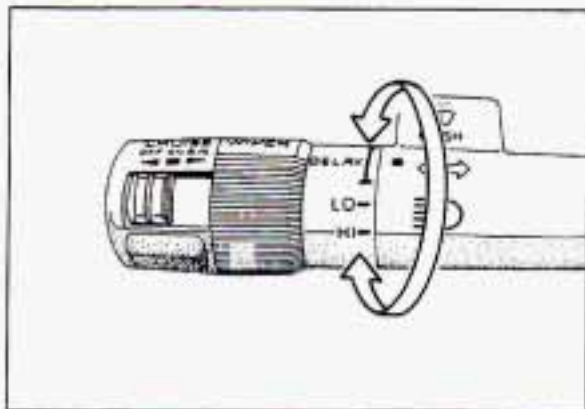

For steady wiping at low speed, turn the band away from you to the **LO** position. For high speed wiping, turn the band further, to **HI**. To stop the wipers, move the band to **OFF**.

You can set the wiper speed for a long or short delay between wipes. This can be very useful in light rain or snow. Turn the band to choose the delay time. The closer to **LO**, the shorter the delay.

Remember that damaged wiper blades may prevent you from seeing well enough to drive safely. To avoid damage, be sure to clear ice and snow from the wiper blades before using them. If they're frozen to the windshield, carefully loosen or thaw them. If your blades do become damaged, get new blades or blade inserts.

Heavy snow or ice can overload your wipers. A circuit breaker will stop them until the motor cools. Clear away snow or ice to prevent an overload.

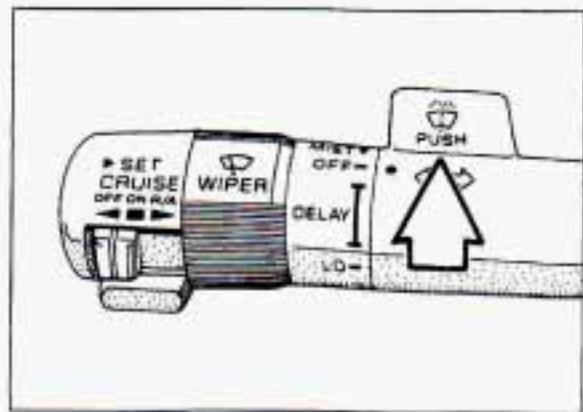

■ *Windshield Washer*

At the top of the turn signal/multi-function lever there's a paddle with the word **PUSH** on it. To spray washer fluid on the windshield, push the paddle for less than one second. The wipers will clear the window and then either stop or return to your preset speed. For more washer cycles, push and hold the paddle.

If the fluid level in the windshield washer is low, vehicles with the Standard Cluster have a **LOW WASH FLUID** light that will come on. On vehicles with the Electronic Cluster, if the fluid level in the windshield washer bottle is low, the message **LOW WASHER FLUID** will appear in the information center. See the *Index* under *Low Washer Fluid Warning*.

Driving without washer fluid can be dangerous. A bad mud splash can block your vision. You could hit another vehicle or go off the road. Check your washer fluid level often.



CAUTION:

In freezing weather, don't use your washer until the windshield is warmed. Otherwise the washer fluid can form ice on the windshield, blocking your vision.

NOTICE:

- When using concentrated washer fluid, follow the manufacturer's instructions for adding water.
- Don't mix water with ready-to-use washer fluid. Water can cause the solution to freeze and damage your washer fluid tank and other parts of the washer system. Also, water doesn't clean as well as washer fluid.
- Fill your washer fluid tank only $\frac{3}{4}$ full when it's very cold. This allows for expansion, which could damage the tank if it is completely full.
- Don't use radiator antifreeze in your windshield washer. It can damage your washer system and paint.

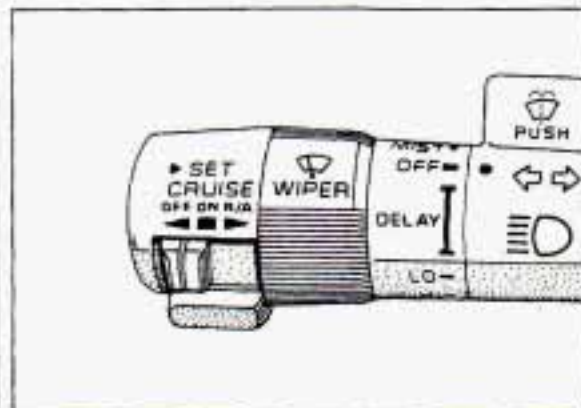

■ Cruise Control (OPTION)

With cruise control, you can maintain a speed of about 25 mph (40 km/h) or more without keeping your foot on the accelerator. This can really help on long trips.

Cruise control does not work at speeds below about 25 mph (40 km/h).

When you apply your brakes, the cruise control shuts off. Cruise control will also shut off when traction control is engaged. You will be able to operate cruise control again once the traction control system disengages.

Features & Controls



CAUTION:

- Cruise Control can be dangerous where you can't drive safely at a steady speed. So, don't use your Cruise Control on winding roads or in heavy traffic.
- Cruise Control can be dangerous on slippery roads. On such roads, fast changes in tire traction can cause needless wheel spinning, and you could lose control. Don't use Cruise Control on slippery roads.

To Set Cruise Control

1. Move the cruise control switch to **ON**.



CAUTION:

If you leave your Cruise Control switch on when you're not using Cruise, you might hit a button and go into Cruise when you don't want to. You could be startled and even lose control. Keep the Cruise Control switch **OFF** until you want to use it.

2. Get up to the speed you want.

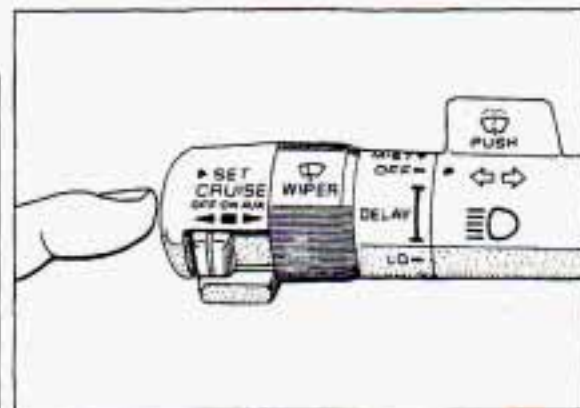

3. Push in the **SET** button at the end of the lever and release it.
4. Take your foot off the accelerator pedal.

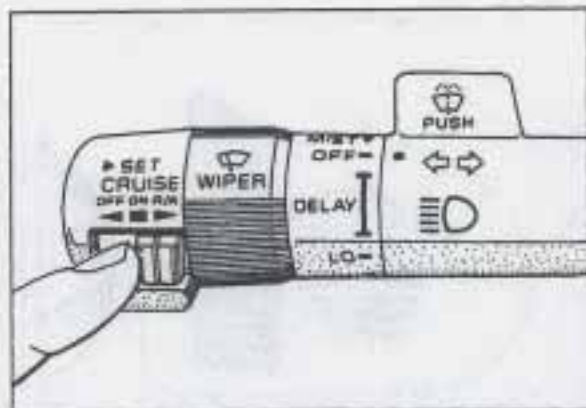

To Resume a Set Speed

Suppose you set your cruise control at a desired speed and then you apply the brake. This, of course, shuts off the cruise control. But you don't need to reset it. Once you're going about 25 mph (40 km/h) or more, you can move the cruise control switch from **ON** to **R/A** (which stands for Resume/Accelerate) for about half a second.

You'll go right back up to your chosen speed and stay there.

If you hold the switch at **R/A** longer than half a second, the vehicle will keep going faster until you release the switch or apply the brake. You could be startled and even lose control. So unless you want to go faster, don't hold the switch at **R/A**.

To Increase Speed While Using Cruise Control

There are two ways to go to a higher speed. Here's the first:

1. Use the accelerator pedal to get to the higher speed.
2. Push the button at the end of the lever, then release the button and the accelerator pedal. You'll now cruise at the higher speed.

Here's the second way to go to a higher speed:

- Move the cruise switch from **ON** to **R/A**. Hold it there until you get up to the speed you want, and then release the switch.
- To increase your speed in very small amounts, move the switch to **R/A** for less than half a second and then release it. Each time you do this, your vehicle will go about 1 mph (1.6 km/h) faster.

The accelerate feature will only work after you turn on the cruise control by pushing the **SET** button.

To Reduce Speed While Using Cruise Control

There are two ways to reduce your speed while using cruise control:

- Push in the button at the end of the lever until you reach the lower speed you want, then release it.
- To slow down in very small amounts, push the button for less than half a second. Each time you do this, you'll go 1 mph (1.6 km/h) slower.

Passing Another Vehicle While Using Cruise Control

Use the accelerator pedal to increase your speed. When you take your foot off the pedal, your vehicle will slow down to the cruise control speed you set earlier.

Using Cruise Control on Hills

How well your cruise control will work on hills depends upon your speed, load, and the steepness of the hills. When going up steep hills, you may have to step on the accelerator pedal to maintain your speed. When going downhill, you may have to brake or shift to a lower gear to keep your speed down. Of

Features & Controls

course, applying the brake takes you out of cruise control. Many drivers find this to be too much trouble and don't use cruise control on steep hills.

To Get Out of Cruise Control

There are two ways to turn off the cruise control:

- Step lightly on the brake pedal; OR
- Move the cruise switch to **OFF**.

To Erase Cruise Control Memory

When you turn off the cruise control or the ignition, or shift into **P** (Park), your cruise control set speed memory is erased.

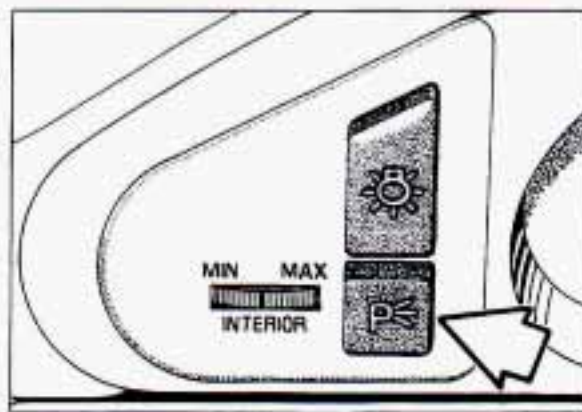

Headlights

Push the switch marked $P \leq$ to turn on:

- Parking Lights
- Side Marker Lights
- Taillights
- Instrument Panel Lights

Push the switch again to turn off the lights.

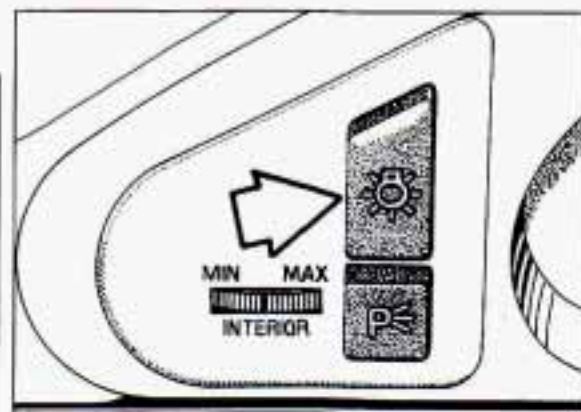

Push the switch marked \odot to turn on the headlights, together with:

- Parking Lights
- Side Marker Lights
- Taillights
- Instrument Panel Lights

Push the switch again to turn off the lights.

Lights On Reminder

If you open the door while leaving the lights on, you will hear a continuous warning tone.

Light Warning System

If you have the Driver Information System, it provides a warning when a headlight or other exterior light is not working. These are the warnings that could appear in the information center:

HIGH BEAM LAMP OUT
LOW BEAM LAMP OUT
CENTER STOP LAMP OUT
TAIL LAMP OUT
BACK-UP LAMP OUT
REAR LAMP OUT
REAR TURN LAMP OUT
FRONT TURN LAMP OUT
FRONT PARK LAMP OUT

If there is a malfunction in the monitoring system, the message **LAMP MON LINK PROB** will appear in the information center.

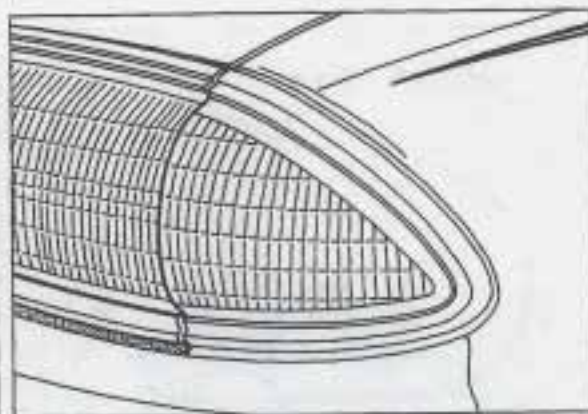

Cornering Lights (OPTION)

The cornering lights are designed to come on when you signal a turn. This will provide more light for cornering at night.

Daytime Running Lights (CANADA ONLY)

The Canadian federal government has decided that Daytime Running Lights (DRL) are a useful feature, in that DRL can make your vehicle more visible to pedestrians and other drivers during daylight hours. DRL are required on new vehicles sold in Canada.

Your DRL work with a light sensor on top of the instrument panel. Don't cover it up. The low beam headlights

will come on at reduced brightness in daylight when:

- The ignition is on
- The headlight switch is off, and
- The transaxle is not in **P** (Park).

At dusk, the exterior lights will come on automatically and the low beams will change to full brightness. At dawn, the exterior lights will go out and the low beams will change to the reduced brightness of DRL (if the headlight switch is off).

Of course, you may still turn on the headlights any time you need to.

To idle your vehicle with the DRL off, shift the transaxle into **P** (Park). The DRL will stay off until you shift out of **P** (Park).

Features & Controls

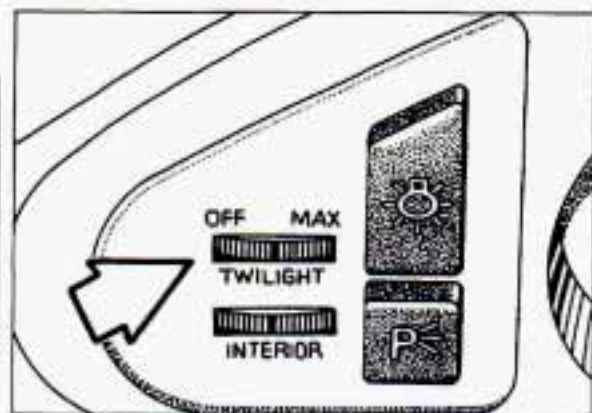

At night, you can turn off all exterior lights when you are in **P** (Park) by moving the Twilight Sentinel control all the way past **OFF** to turn it off, if it was on. If it was off, move the control to the right to turn it on, then back off. The lights will come back on when you put the transaxle in gear.

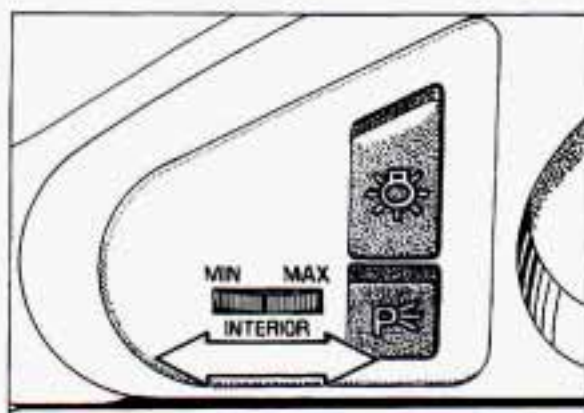

Instrument Panel Intensity Control

You can brighten or dim your instrument cluster, radio, climate control, and interior lights by rotating the **INTERIOR** control between **MIN** and **MAX** when your lights are on. Rotate the control all the way to **MAX** and you will turn on the interior courtesy lights.

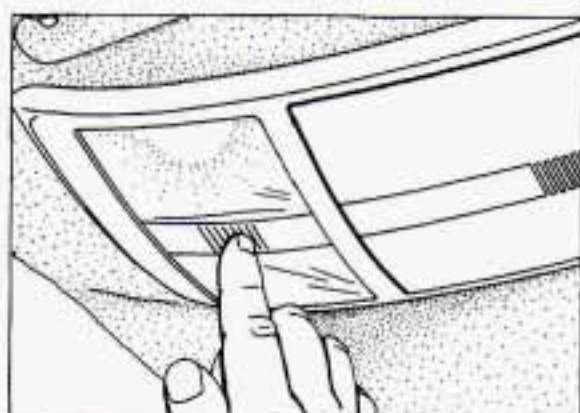

Front Reading Lights (OPTION)

These lights and the interior courtesy lights will come on when you open a door. They will turn off when you turn on the ignition, or if the door is left open, they will turn off after about ten minutes.

To turn on the reading lights when the doors are closed, press the lens of the light you want on. Press it again to turn the light off.

To avoid draining your vehicle's battery, be sure to turn off all front and rear reading lights when leaving your vehicle.

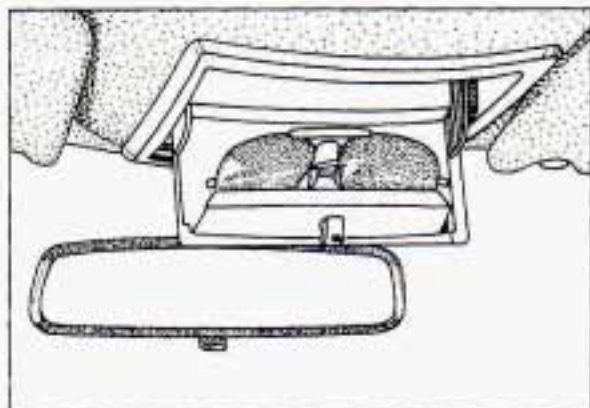

Sunglasses Storage (OPTION)

Some models have a storage compartment for glasses in your overhead console. Press the release button to lower the door. Place your glasses inside the door. To close the door, raise it and press it into position.

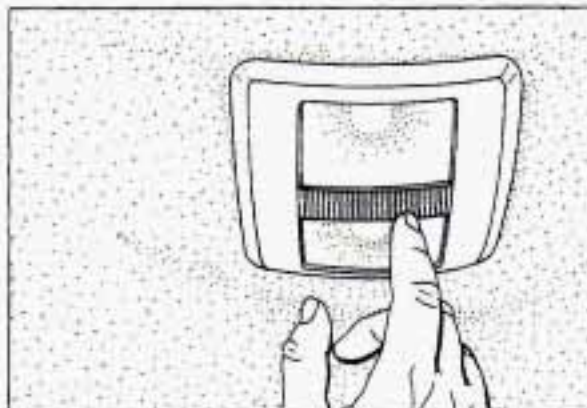

Rear Reading Lights (OPTION)

These lights go on when you open a door. To turn on a reading light when the doors are closed, press the lens of the light you want on. Press it again to turn the light off.

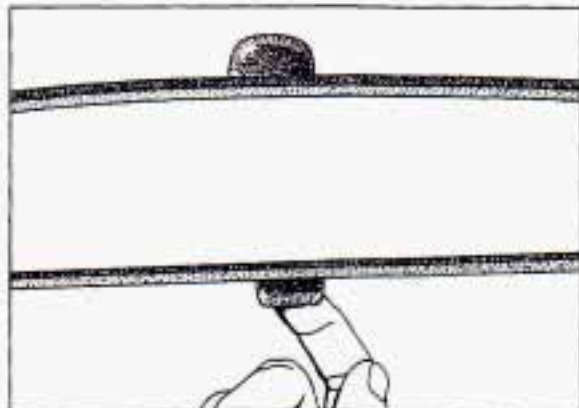

Inside Manual Day/Night Rearview Mirror

To reduce glare from lights behind you, pull the lever toward you to the night position.

Features & Controls

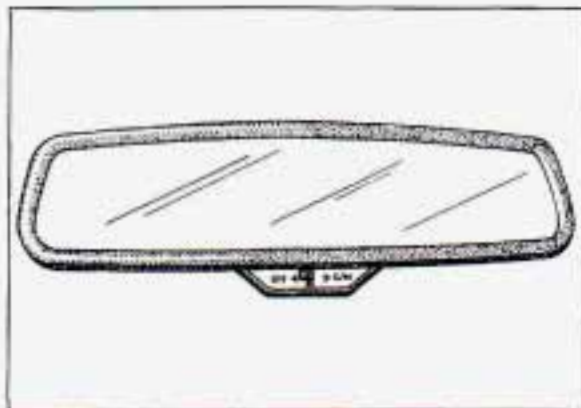

Electrochromic Day/Night Rearview Mirror with Compass (OPTION)

This mirror automatically changes to reduce glare when set in the **M** or **C/M** positions. One photocell on the back of the mirror senses when it is becoming dark outside. Another photocell is built into the mirror surface to sense headlights behind you.

The mirror will darken gradually to reduce glare. This change may take a few moments.

The mirror goes to a clear position whenever you shift to **R** (Reverse).

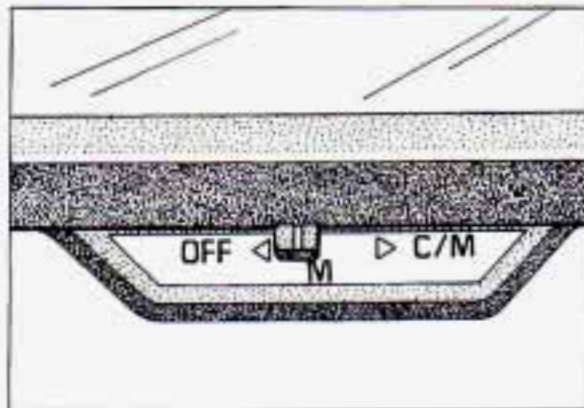

OFF: Shuts off the Day/Night function and compass. The mirror will stay in the Day setting.

To keep the photocells operating well, occasionally clean them with a cotton swab and glass cleaner.

C/M: This setting turns the compass on, in addition to the Day/Night function.

Once the compass is calibrated, it does not need to be recalibrated as long as the mirror is left in your vehicle.

If a compass mirror is ever removed from a vehicle and placed onto another vehicle, it should be recalibrated again to the new vehicle. There could be errors in compass readings if not recalibrated.

To calibrate the compass:

1. Set the switch on the mirror control to **C/M**.
2. Turn vehicle ignition switch **On**. The letter **C** should be displayed in the mirror compass window. If not, hold the **Cal** switch (bottom of the mirror) for more than ten seconds, and the letter **C** will appear. To hold in the **Cal** switch, insert a paper clip into the small hole on the bottom of the mirror housing. The display will show a number first, but keep holding until the letter **C** appears.
3. **Quick Calibration:** Drive the vehicle in a 360-degree circle at less than 5 mph (8 km/h) until the display reads a compass direction. **Normal Calibration:** Drive the vehicle on your everyday routine, and the compass will eventually calibrate.

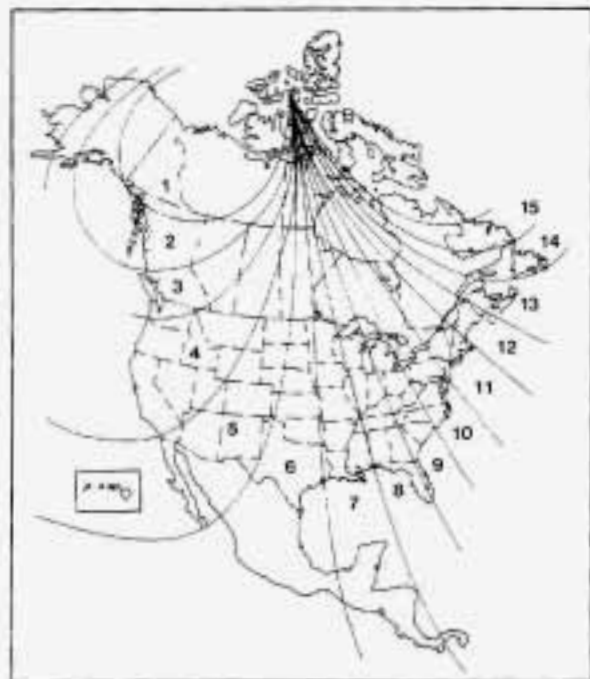

Compass Variance:

Variance is the difference between magnetic north and geographic north. In some areas the difference between the two can be great enough to cause false compass readings. If this happens, follow these instructions to set the variance for your particular location:

1. Locate your location on the zone map. Note your zone number.
2. Hold in the **Cal** switch (bottom of the mirror housing) for five seconds until the last zone entry number appears in the display. To hold in the **Cal** switch, insert a paper clip into the small hole on the bottom of the mirror housing.
3. Repeatedly press the **Cal** switch until the number for the new zone entry is displayed.

Once the desired zone number is displayed, stop pressing the **Cal** switch and the display will show compass direction within a few seconds.



■ Convex Outside Mirror

Your right side mirror is convex.

A convex mirror's surface is curved so you can see more from the driver's seat.

CAUTION:

If you aren't used to a convex mirror, you can hit another vehicle. A convex mirror can make things (like other vehicles) look farther away than they really are. If you cut too sharply into the right lane, you could hit a vehicle on your right. Check your inside mirror or glance over your shoulder before changing lanes.

Features & Controls

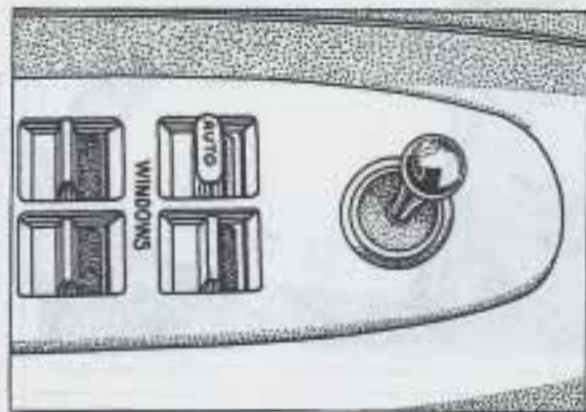

Manual Remote Control Mirrors

The outside rearview mirrors should be adjusted so you can just see the side of your vehicle when you are sitting in a comfortable driving position.

Adjust the driver's side outside mirror with the lever on the driver's door.

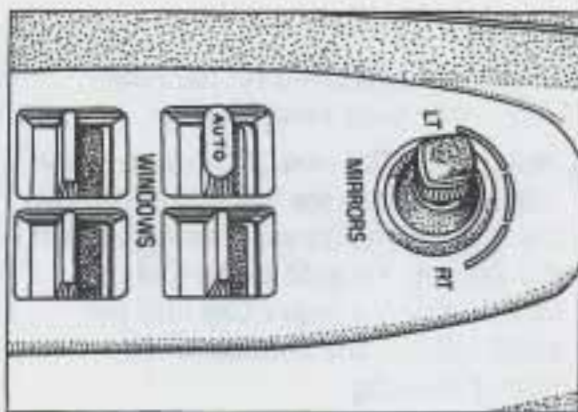

Power Remote Control Mirrors (OPTION)

The lever on the driver's door armrest controls both outside rearview mirrors. Turn the lever to the left to select the driver side rearview mirror, or to the right to select the passenger side rearview mirror. Then move the lever to adjust each mirror so that you can just see the side of your vehicle when you are sitting in a comfortable driving position.

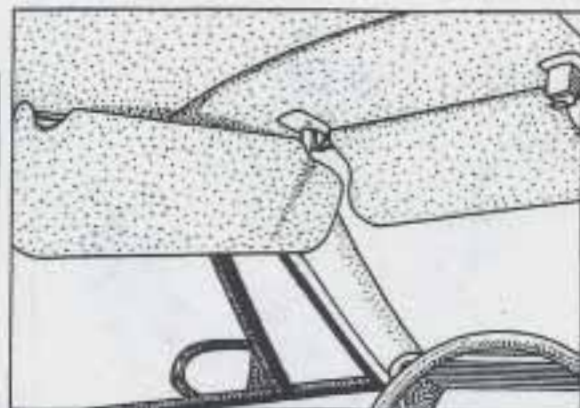

Sun Visors

To block out glare, you can swing down the visors. You can also remove them from the center mount and swing them to the side, while the auxiliary sunshade remains to block glare from the front.

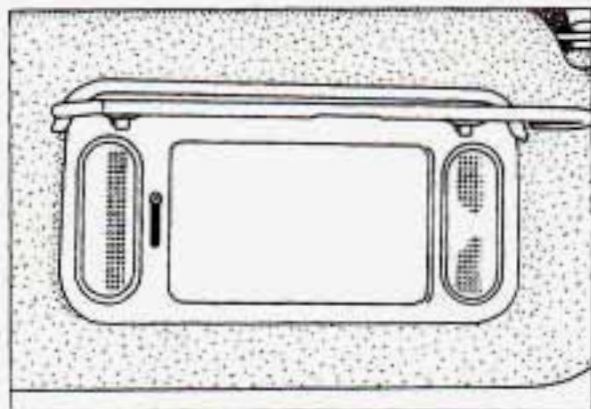

Visor Vanity Mirrors

Standard Mirrors:

Open the cover to expose the vanity mirror.

Lighted Mirrors:

If your vehicle has the optional lighted vanity mirrors, the lights come on when you open the cover. These can even be used for reading. You can adjust the brightness of the lights with the switch.

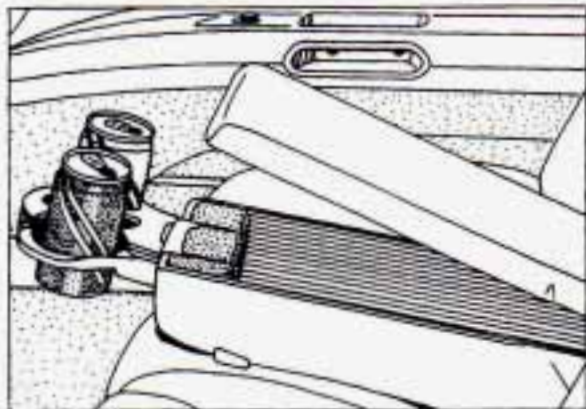

Front Storage Armrest (OPTION)

The front armrest opens into a storage area for cassette tapes, gloves, etc. To open it, lift the front edge. You can store coins in the removable coin holder, and the dual cup holder flips forward for use.

The cup holder is designed to “break away” should it receive excessive pressure. If it breaks away, snap the edges back into place.

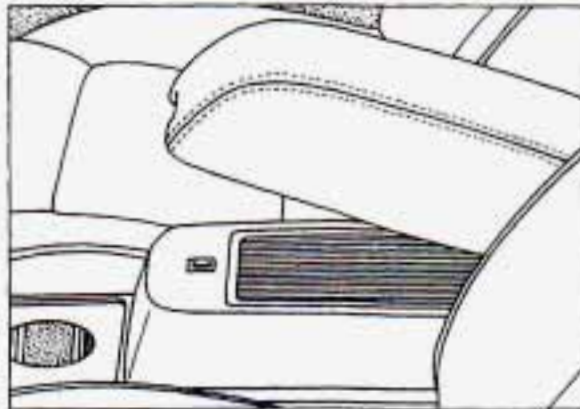

Front Storage Armrest (LSS ONLY)

There are two levels of storage in the armrest. To raise the top cover, pull up the front edge.

Features & Controls

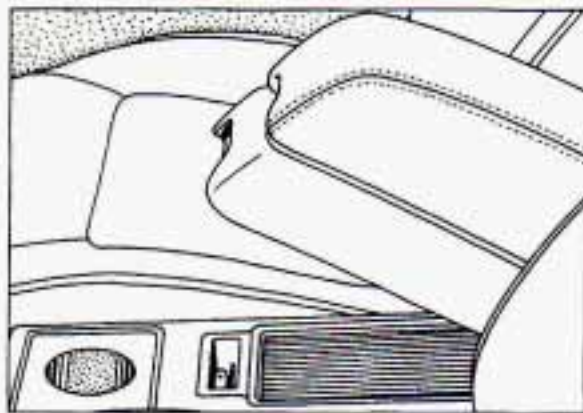

To open the lower storage compartment, press the release lever under the front edge of the lower cover.

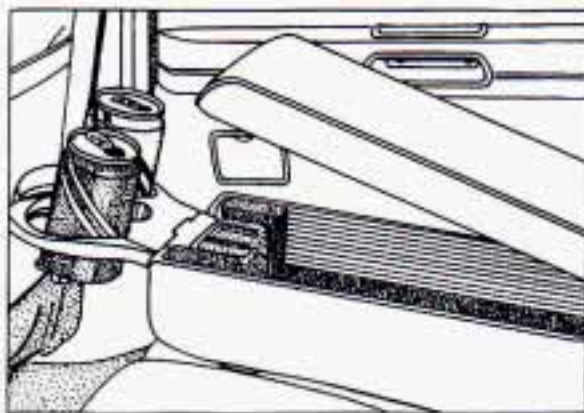

Rear Storage Armrest (OPTION)

To open, fold down the armrest console, press the latch on the underside and pull up the top.

In addition to storage space there is a fold-out cup holder. The cup holder is designed to “break away” should it receive excessive pressure. If it breaks away, snap the edges back into place.

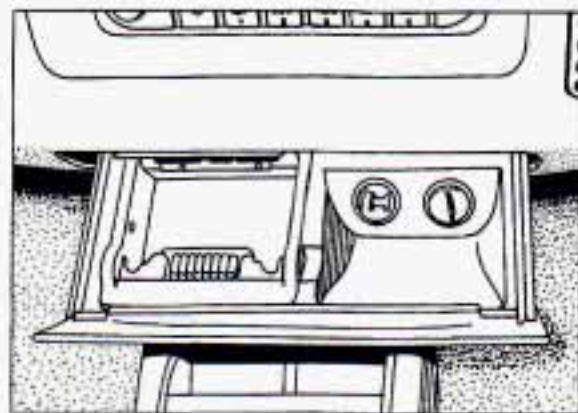

Ashtrays and Lighter

Pull out the front ashtray to reveal the ashtray, lighter and accessory power outlet.

To clean the ashtray, open it fully and lift it out by pulling on the snuffer.

To use the lighter, just push it in all the way and let go. When it's ready, it will pop back by itself.

NOTICE:

Don't hold a cigarette lighter in with your hand while it is heating. If you do, it won't be able to back away from the heating element when it's ready. That can make it overheat, damaging the lighter and the heating element.

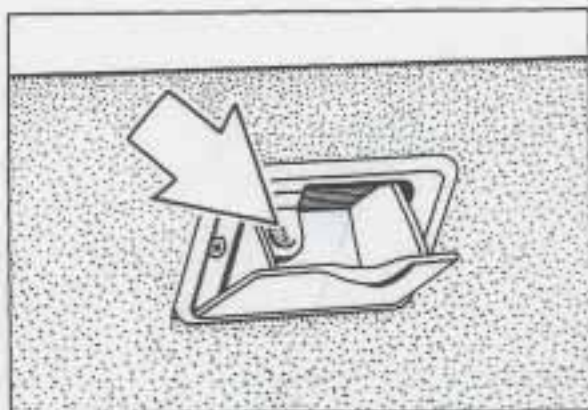

To clean the rear ashtray, open it, push down on the snuffer and pull out.

NOTICE:

Don't put papers and other things that burn into your ashtrays. If you do, cigarettes or other smoking materials could set them on fire, causing damage.

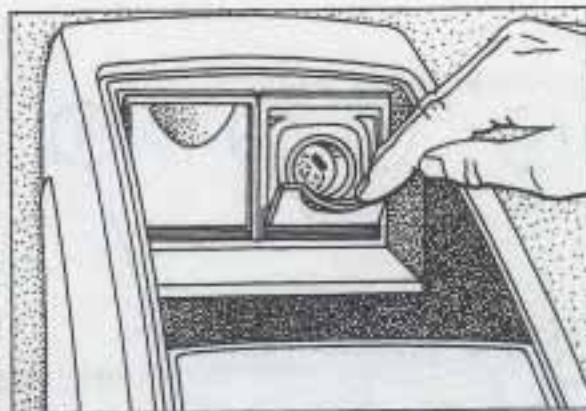

Accessory Power Outlets

If you have a bench front seat, you have one accessory power outlet next to the ashtray and lighter. If you have a center console, you also have two power outlets in the console.

The power outlets can be used to plug in electrical equipment such as a cellular telephone, CB radio, etc. Follow the proper installation instructions that are included with any electrical equipment you install.

NOTICE:

When using the accessory power outlets, the maximum total load of any electrical equipment on all outlets should not exceed 20 amps.

Features & Controls

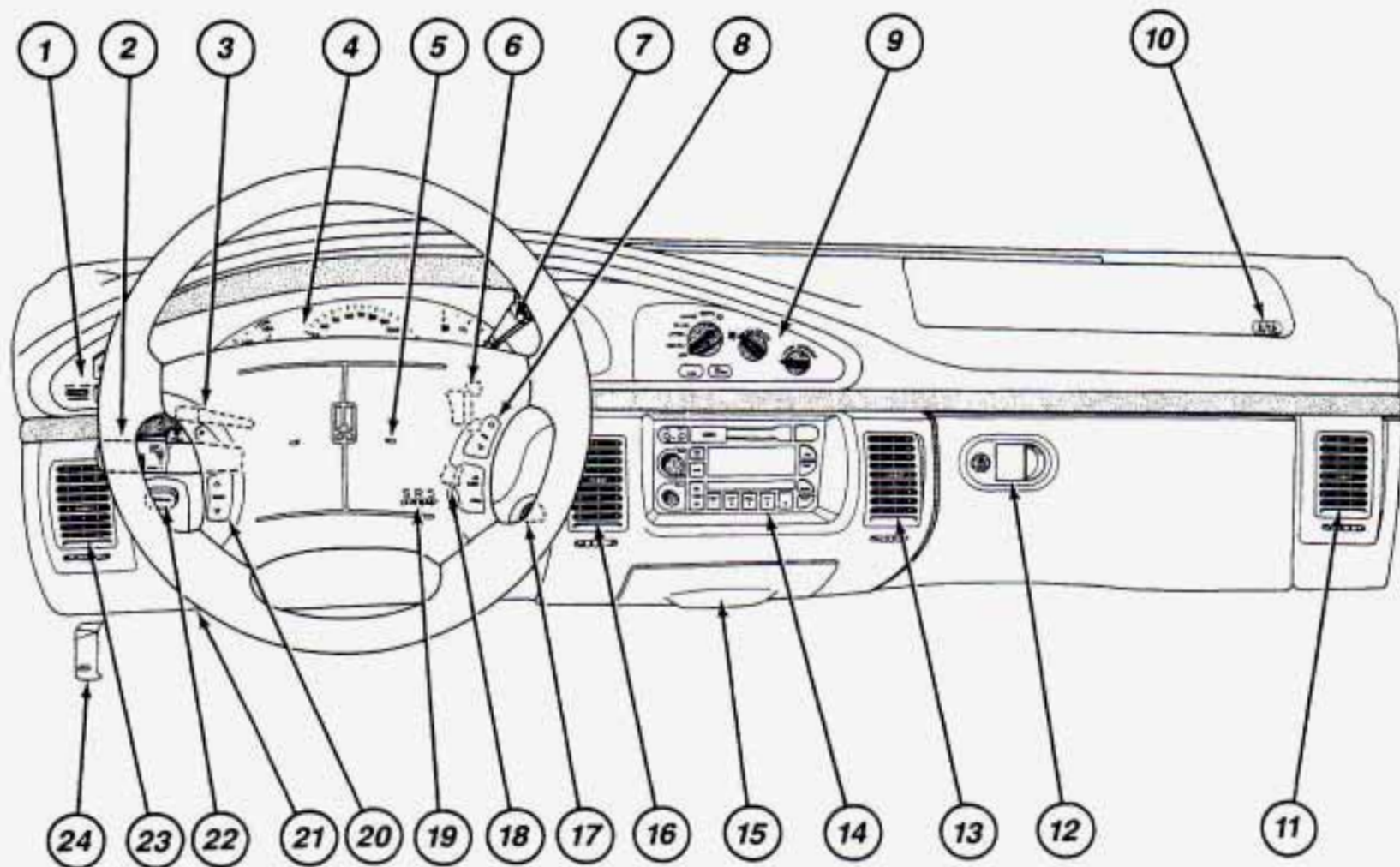

Eighty Eight Royale ***The Instrument Panel—*** ***Your Information System***

Your instrument panel is designed to let you know at a glance how your vehicle is running. You'll know how fast you're going, how much fuel you're using, and many other things you'll need to drive safely and economically.

The main components of your instrument panel are:

1. Light Controls
2. Turn Signal/Multifunction Lever
3. Tilt Steering Wheel Lever
4. Instrument Cluster
5. Horn
6. Ignition Switch
7. Gearshift Lever
8. Steering Wheel Touch Controls for Audio System
9. Climate Controls & Driver Information Center (Option)
10. Passenger Side Air Bag
11. Air Outlet
12. Glove Box Release
13. Air Outlet
14. Audio System
15. Ashtray, Lighter and Auxiliary Power Outlet
16. Air Outlet
17. Traction Control Switch
18. Hazard Warning Flashers Switch
19. Driver Side Air Bag
20. Steering Wheel Touch Controls for Climate Control System
21. Fuse Panel (under instrument panel)
22. Trunk Release Switch
23. Air Outlet
24. Hood Release

Features & Controls

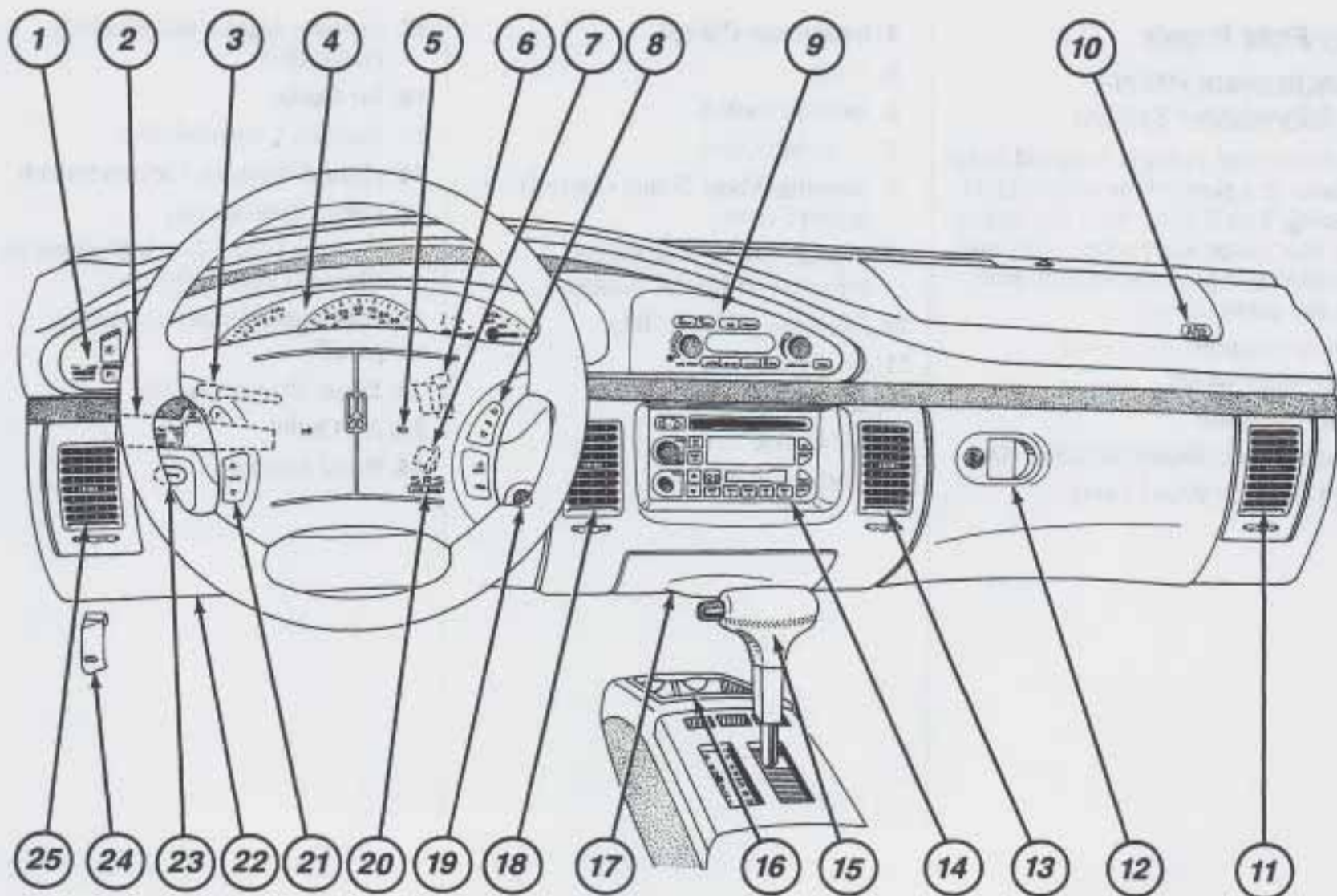

Eighty Eight LSS

The Instrument Panel— Your Information System

The instrument panel is designed to let you know at a glance how your vehicle is running. You'll know how fast you're going, how much fuel you're using, and many other things you'll need to drive safely and economically.

The main components of your instrument panel are:

1. Light Controls
2. Turn Signal/Multifunction Lever
3. Tilt Steering Wheel Lever
4. Instrument Cluster/Gages

5. Horn
6. Ignition Switch
7. Hazard Warning Flashers Switch
8. Steering Wheel Touch Controls for Audio System
9. Climate Controls & Driver Information Center (Option)
10. Passenger Side Air Bag
11. Air Outlet
12. Glove Box Release
13. Air Outlet
14. Audio System
15. Gearshift Lever
16. Auxiliary Power Outlets
17. Ashtray, Lighter and Auxiliary Power Outlet
18. Air Outlet
19. Traction Control Switch
20. Driver Side Air Bag
21. Steering Wheel Touch Controls for Climate Control System
22. Fuse Panel (under instrument panel)
23. Trunk Release Switch
24. Hood Release
25. Air Outlet

Features & Controls

■ Instrument Panel Clusters

Your Oldsmobile is equipped with one of these instrument panel clusters, which includes indicator warning lights and gages that are explained on the following pages. Be sure to read about those that apply to the instrument panel cluster for your vehicle.

STANDARD CLUSTER

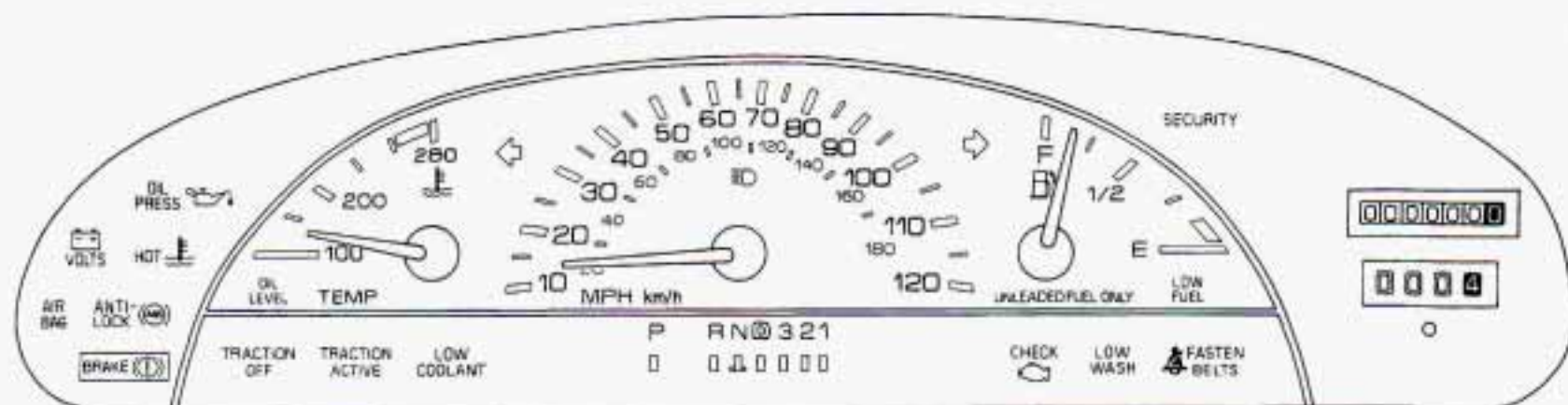

ELECTRONIC CLUSTER

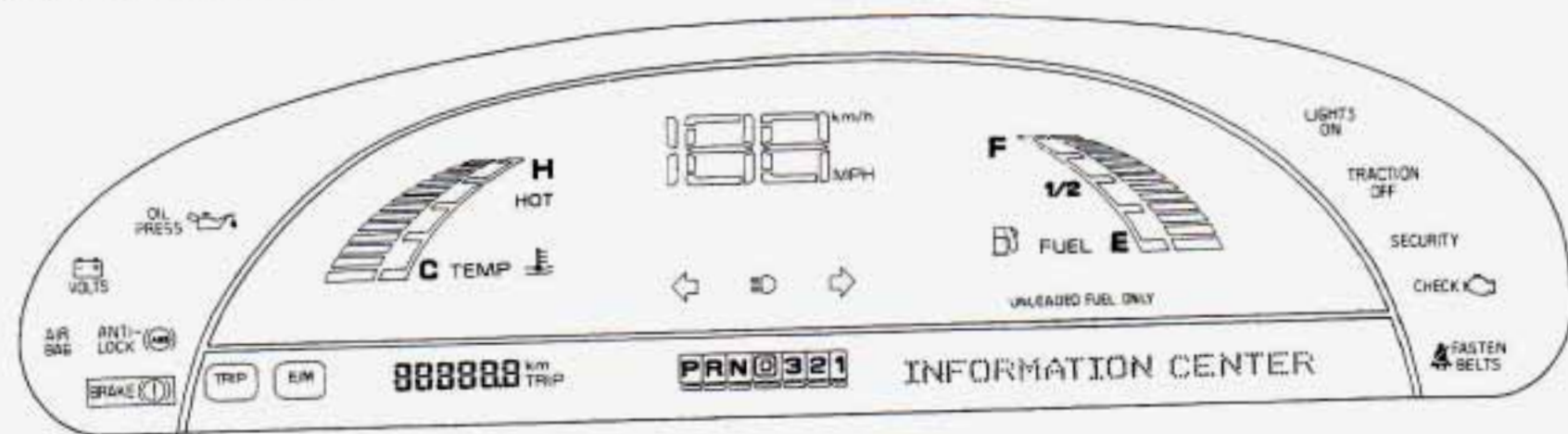

LSS CLUSTER

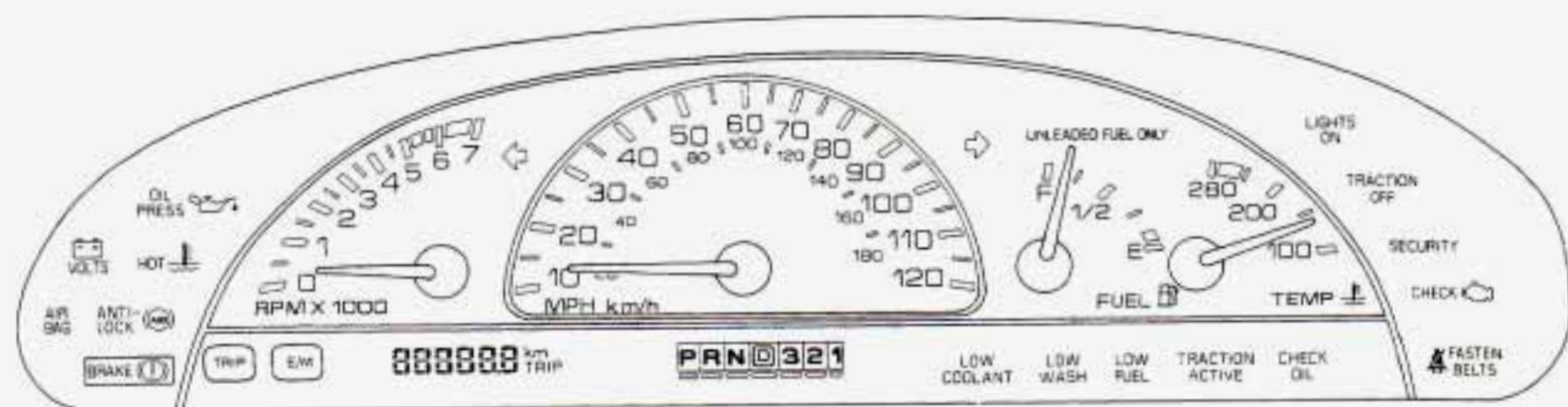

Features & Controls

■ *Warning Lights, Gages and Indicators*

This section describes the warning lights and gages that may be on your vehicle. The pictures will help you locate them.

Warning lights and gages can signal that something is wrong before it becomes serious enough to cause an expensive repair or replacement. Paying attention to your warning lights and gages could also save you or others from injury.

Warning lights go on when there may be or is a problem with one of your vehicle's functions. As you will see in the details on the next few pages, some warning lights come on briefly when you turn the ignition key just to let you know they're working. If you are familiar with this section, you should not be alarmed when this happens.

Gages can indicate when there may be or is a problem with one of your vehicle's functions. Often gages and warning lights work together to let you know when there's a problem with your vehicle.

When one of the warning lights comes on and stays on when you are driving, or when one of the gages shows there may be a problem, check the section that tells you what to do about it. Please follow the manual's advice. Waiting to do repairs can be costly — and even dangerous. So please get to know your warning lights and gages. They're a big help.

Your vehicle may also have a driver information system that works along with the warning lights and gages. See *Driver Information System* in the *Index*.

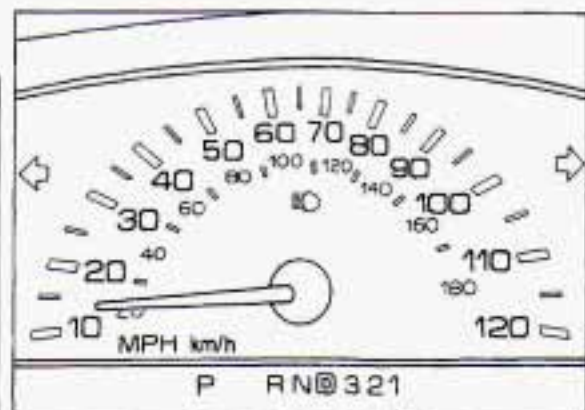

Speedometer (STANDARD AND LSS CLUSTERS)

Your speedometer lets you see your speed in both miles per hour (mph) and kilometers per hour (km/h).

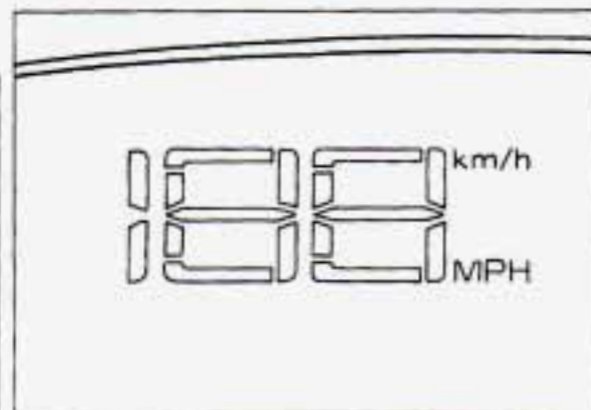

Speedometer (ELECTRONIC CLUSTER)

Your speed is displayed in either miles per hour (mph) or kilometers per hour (km/h).

Press the **E/M** (English/Metric) button on the left side of the instrument cluster to switch the display between miles per hour (mph) and kilometers per hour (km/h). Pressing the **E/M** button will also cycle all other displays, including the optional automatic electronic climate control display, through English and metric units.

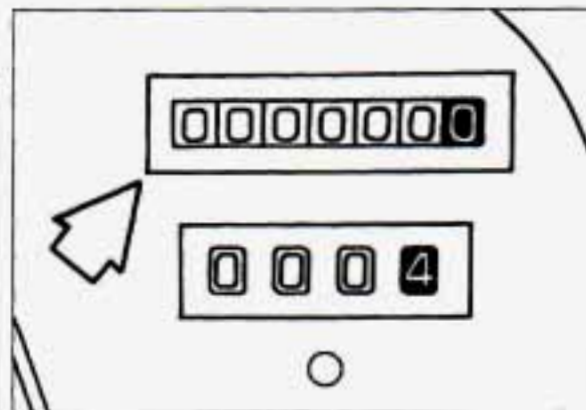

Odometer (STANDARD CLUSTER)

Your odometer shows how far your vehicle has been driven in either miles (used in the U.S.) or kilometers (used in Canada).

Your Oldsmobile has a tamper resistant odometer. If you see silver lines between the numbers, you'll know someone has probably tampered with it and the numbers may not be true.

You may wonder what happens if your vehicle needs a new odometer installed. If the new one can be set to the mileage total of the old odometer, then it must be. But if it can't, then it's set at zero and a label must be put on the driver's door to show the old mileage reading when the new odometer was installed.

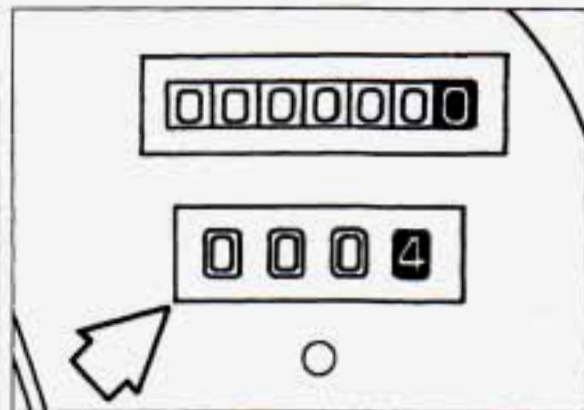

Trip Odometer (STANDARD CLUSTER)

Your trip odometer tells how far you have driven since you last reset it. To set it to zero, press the trip reset button located below the trip odometer.

Features & Controls



54238

Odometer (ELECTRONIC AND LSS CLUSTERS)

Your odometer shows how far your vehicle has been driven in either miles (used in the U.S.) or kilometers (used in Canada). Press the **E/M** (English/Metric) button on the left side of the instrument cluster to switch the display between miles and kilometers (km). Pressing the **E/M** button will also cycle all other displays through English and metric units.

Your Oldsmobile has a tamper resistant odometer. The odometer will read **ERROR** if someone has tampered with it.

You may wonder what happens if your vehicle needs a new odometer installed. If the new one can be set to the mileage total of the old odometer, then it must be. But if it can't, then it's set at zero and a label must be put on the driver's door to show the old mileage reading when the new odometer was installed.

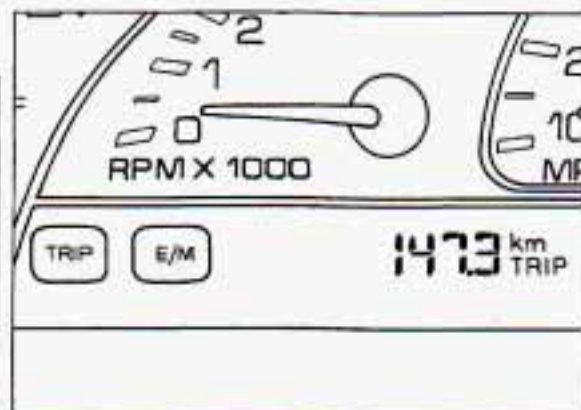

Trip Odometer (ELECTRONIC AND LSS CLUSTERS)

Your trip odometer tells how far you have driven, in either miles or kilometers, since you last reset it. Press the **E/M** (English/Metric) button on the left side of the instrument cluster to switch the display between miles and kilometers (km).

The trip odometer is displayed by pressing the **TRIP** button. To reset it to zero, press **TRIP** to display the trip odometer, then hold the button for about three seconds until the display resets.

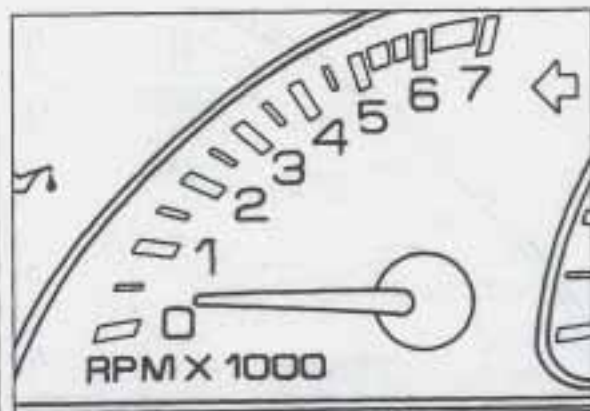

Tachometer (LSS CLUSTER)

The tachometer displays the engine speed in revolutions per minute (rpm).

NOTICE:

Do not operate the engine with the tachometer in the red area. Engine damage may occur.

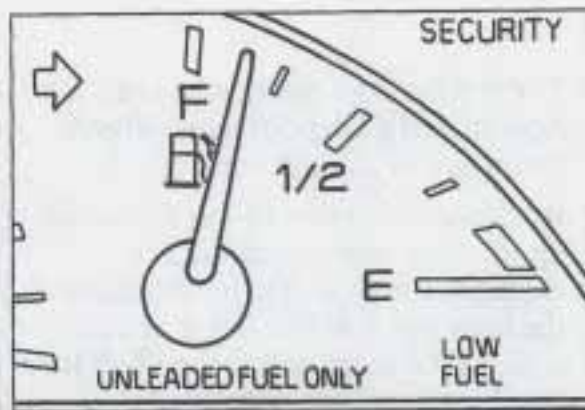

Fuel Gauge and Low Fuel Light (STANDARD AND LSS CLUSTERS)

Your fuel gage tells you about how much fuel you have left, when the ignition is on. If you have the optional reminder package, the **LOW FUEL** warning light will come on in your instrument panel and a warning chime may sound when the gage pointer nears **E** (Empty). You still have a little fuel, but will need more soon.

Here are four things that some owners ask about. None of these show a problem with your fuel gage:

- At the service station, the gas pump shuts off before the gage reads **F** (Full).

- It takes a little more or less fuel to fill up than the gage indicated. For example, the gage may have indicated the tank was half full, but it actually took a little more or less than half the tank's capacity to fill the tank.
- The gage moves a little when you turn a corner or speed up.
- The tank is not necessarily empty when the pointer is over the **E** mark. There is up to 1.5 gallons (5.6 L) of reserve in the tank.

For your fuel tank capacity, see *Service Station Information* on the last page of this manual.

Features & Controls

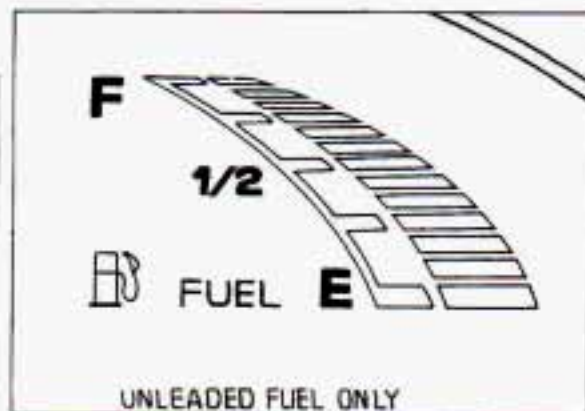

Fuel Gage (ELECTRONIC CLUSTER)

Your fuel gage bars light up when the ignition is on to show you about how much fuel you have left, when the ignition is on.

When the third bar goes off, you have 3 gallons (11 L) of fuel remaining. The message **LOW FUEL** will be displayed in the information center and a chime will sound. Press **RESET** to stop the warning.

Here are five things that some owners ask about. None of these show a problem with your fuel gage:

- At the service station, the gas pump shuts off before the gage reads **F** (Full).

- The top bar does not go out until you have driven a long distance—about 50 miles (80 kilometers).
- It takes a little more or less fuel to fill up than the gage indicated. For example, the gage may have indicated the tank was half full, but it actually took a little more or less than half the tank's capacity to fill the tank.
- The gage moves a little when you turn a corner or speed up.
- The tank is not necessarily empty when the last bar goes out. There is a 1 to 1.5 gallon (4 to 5.6 L) fuel reserve.

For your fuel tank capacity, see *Service Station Information* on the last page of this manual.

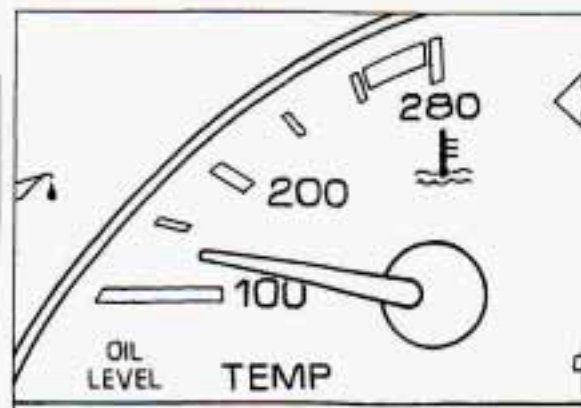

Engine Coolant Temperature Gage and Light (STANDARD AND LSS CLUSTERS)

This gage shows the engine coolant temperature.

If the gage pointer moves into the red warning zone and the **HOT** warning light on your instrument cluster goes on, your engine is too hot! It means your engine coolant has overheated. A warning chime may also sound. If you have been operating your vehicle under normal driving conditions, you should

pull off the road, stop your vehicle and turn the engine off as soon as possible.

HOT COOLANT CAN BURN YOU BADLY!

In *Problems on the Road*, this manual shows what to do. See the *Index* under *Engine Overheating*.

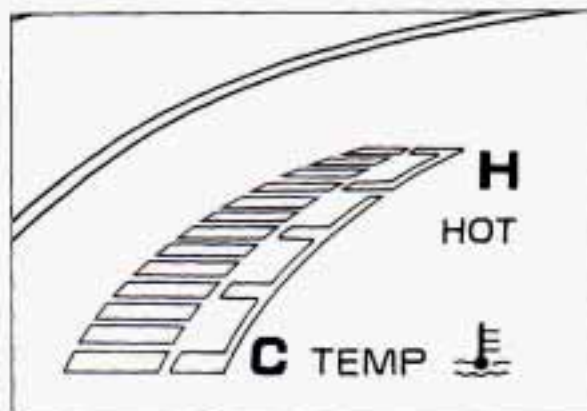

Engine Coolant Temperature Gage and Light (ELECTRONIC CLUSTER)

This gage has bars that show the engine coolant temperature.

If all bars light up, it indicates the coolant temperature is about 255°F (124°C). A slow chime will sound for five seconds and the **HOT** warning light will come on. The message **HOT...AC DISABLED** will appear in the information center.

If the coolant temperature is over 261°F (127°C), the message **HOT...STOP ENGINE** will appear and a fast-pulsed chime will sound. It means that your engine coolant has overheated. If you have been operating your vehicle under

normal driving conditions, you should pull off the road, stop your vehicle and turn the engine off as soon as possible.

HOT COOLANT CAN BURN YOU BADLY!

In *Problems on the Road*, this manual shows what to do. See the *Index* under *Engine Overheating*.

If your coolant level is low, the message **LOW ENGINE COOLANT** will appear. Add coolant. See the *Index* under *Engine Coolant*.

When the engine is warm, but off, and the ignition is on, the word **HOT** will flash. This is normal.

Features & Controls

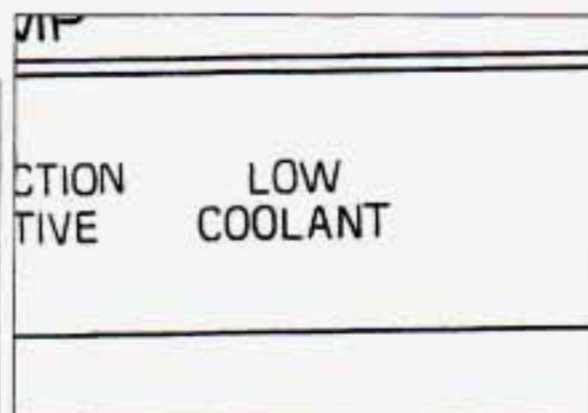

Low Coolant Warning Light or Message

If the engine is running and this warning light comes on, or the information center displays **LOW ENGINE COOLANT**, your system may be low on coolant and the engine may overheat. A warning chime will also sound. See the *Index* under *Engine Coolant* and check your coolant level at the coolant recovery tank. If the level is low, bring it up to its proper level. If the level is not low, have your low coolant warning system serviced.

The **LOW COOLANT** warning light will also come on when you turn on the ignition as a bulb check to show you it is working. If it doesn't come on then, have it fixed right away. After the bulb check, the light will go out for 20 seconds. If the light comes back on after 20 seconds, the system may be low on coolant.

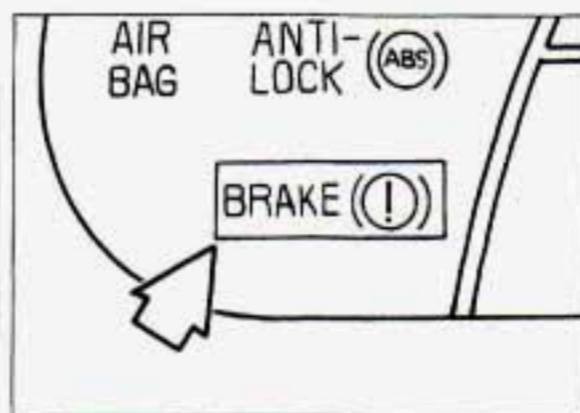

Brake System Warning Light

Your Oldsmobile's hydraulic brake system is divided into two parts. If one part isn't working, the other part can still work and stop you. For good braking, though, you need both parts working well.

If the warning light comes on, there could be a brake problem. If the problem is low brake fluid and you have the electronic cluster, the message **LOW BRAKE FLUID** will appear in the information center, the **BRAKE** light will come on, and a fast warning chime will sound. You can stop the chime by pressing **RESET**. The **BRAKE** light and message will continue to be displayed. Have your brake system inspected right away.

This light should come on as you start the vehicle. If it doesn't come on then, have it fixed so it will be ready to warn you if there's a problem.

If the light and chime come on while you are driving, pull off the road and stop carefully. You may notice that the pedal is harder to push. Or, the pedal may go closer to the floor. It may take longer to stop. If the light is still on, have the vehicle towed for service. (See *Towing Your Vehicle* in the *Index*.)



CAUTION:

Your brake system may not be working properly if the brake system warning light is on. Driving with the brake system warning light on can lead to an accident. If the light is still on after you've pulled off the road and stopped carefully, have the vehicle towed for service.

The brake system warning light will also come on when you set your parking brake, and it will stay on if your parking brake doesn't release fully. If you try to drive off with the parking brake set, a chime will also come on until you release the parking brake. If you have the electronic cluster, the message **PARK BRAKE SET** will appear in the information center and a fast warning chime will sound. You can stop the chime by pressing **RESET**, but the message will remain in the information center. If the light and chime stay on after your parking brake is fully released, it means you have a brake problem.

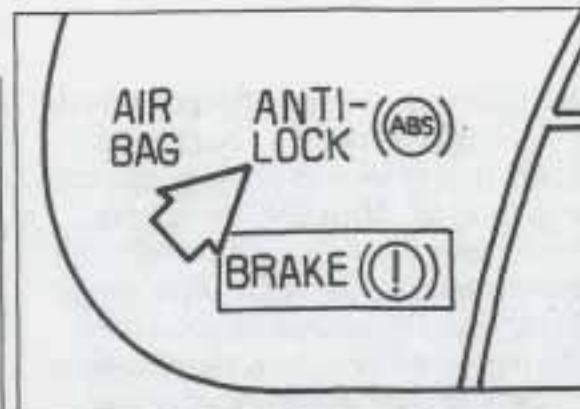

Anti-Lock Brake System Warning Light

With anti-lock, this light will come on when you start your engine and may stay on for several seconds. That's normal. If the light doesn't come on, have it fixed so it will be ready to warn you if there is a problem.

Features & Controls

If the light stays on, turn the ignition off. Or, if the light comes on when you're driving, stop as soon as possible and turn the ignition off. Then start the engine again to reset the system. If the light still stays on, or comes on again while you're driving, your Oldsmobile needs service. If the regular brake system warning light isn't on, you still have brakes, but you don't have anti-lock brakes. If the regular brake system warning light is also on, you don't have anti-lock brakes and there's a problem with your regular brakes. See *Brake System Warning Light* earlier in this part.

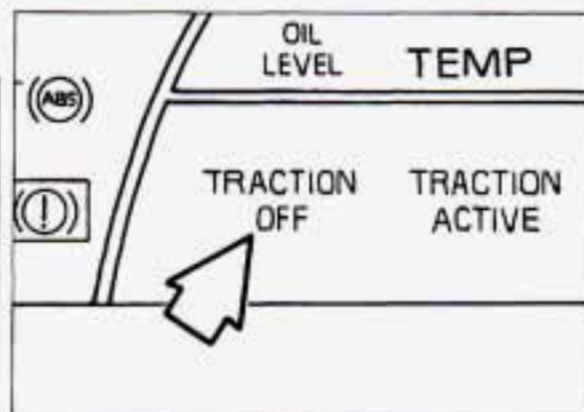

Traction Control System Warning Light (OPTION)

The **TRACTION OFF** warning light means that the system is not working. When this warning light is on, the system will not limit wheel spin. Adjust your driving accordingly. This warning light may come on for the following reasons:

- If your brakes overheat, the traction control system will go off and the warning light will come on until your brakes cool down.
- If you turn the system off by pressing the switch to the right of the steering column, the warning light will come on and stay on. To turn the system back on, press the switch again. The warning light should go off. The

system will also turn itself on if you turn your ignition off and back on again.

- There are some engine-related problems that may cause the **TRACTION OFF** warning light to come on.



CAUTION:

If you let your tires spin at high speed when the **TRACTION OFF** warning light is on, your tires can explode and you or others could be injured. And, spinning your tires with this warning light on can cause the transaxle to overheat or can cause other problems. There could be an engine fire or other damage that you may not be able to see. This damage could cause an accident later. When you're stuck, spin the wheels as little as possible. Don't spin the wheels above 35 mph (55 km/h) as shown on the speedometer.

NOTICE:

Spinning your wheels when the **TRACTION OFF** warning light is on can destroy parts of your vehicle as well as the tires. If you spin your wheels too fast while shifting your transaxle back and forth, you can destroy your transaxle. When you're stuck, spin the wheels as little as possible.

If the **TRACTION OFF** warning light comes on and stays on for an extended period of time, even when you've switched the system on, your vehicle needs service.

Also see the *Index* under *Traction Control*.

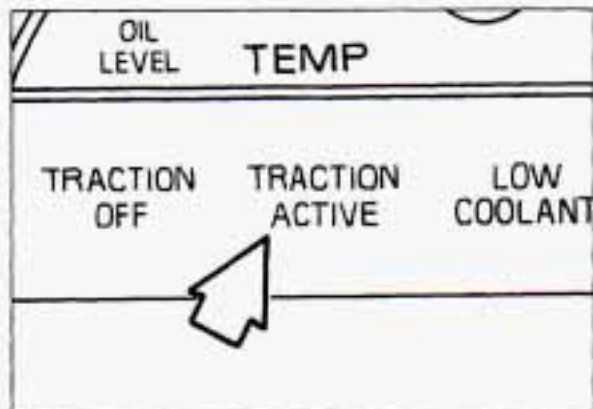

Traction Active Light (STANDARD AND LSS CLUSTERS)

When your traction control system is limiting wheel spin, the **TRACTION ACTIVE** light will come on. Slippery road conditions may exist if this light is on, so adjust your driving accordingly. The light will stay on for a few seconds after the traction control system stops limiting wheel spin.

The **TRACTION ACTIVE** light also comes on briefly, as a bulb check, when the engine is started.

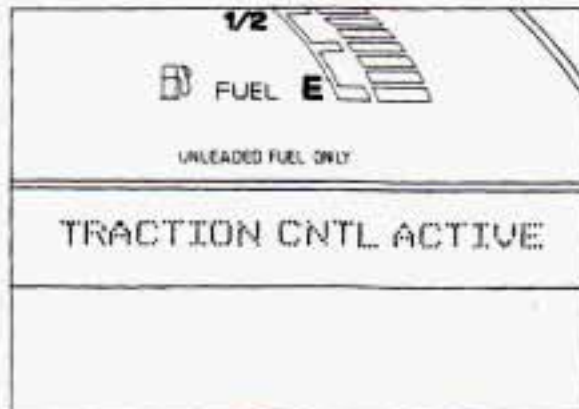

Traction Control System Active Message (ELECTRONIC CLUSTER)

When your traction control system is limiting wheel spin, the **TRACTION CNTL ACTIVE** message will be displayed. Slippery road conditions may exist if this message is displayed, so adjust your driving accordingly. The message will stay on for a few seconds after the traction control system stops limiting wheel spin.

Features & Controls

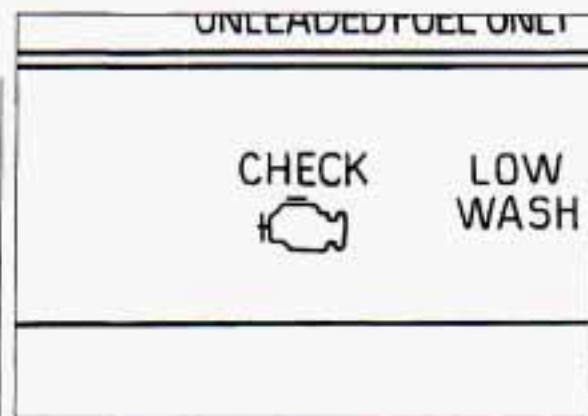

Malfunction Indicator Light (CHECK ENGINE LIGHT)

A computer monitors operation of your fuel, ignition and emission controls systems. This warning light should come on when the ignition is on but the engine is not running, as a check to show you it is working. If it does not come on at all, have it fixed right away. If it stays on, or it comes on while you are driving, the computer is indicating that you have a problem. You should take your vehicle in for service soon.

NOTICE:

If you keep driving your vehicle with this warning light on, after awhile the emission controls won't work as well, your fuel economy won't be as good, and your engine may not run as smoothly. This could lead to costly repairs not covered by your warranty.

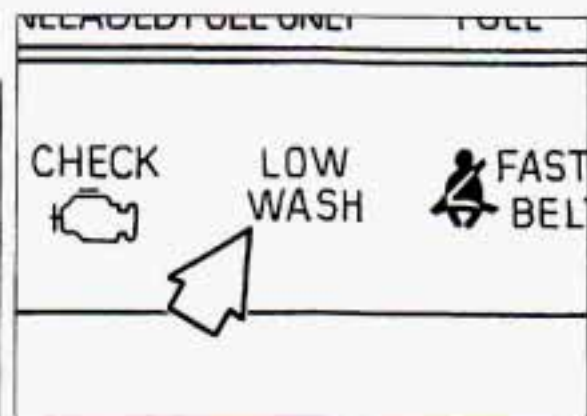

Low Washer Fluid Warning Light or Message

If you have the base or LSS cluster with the optional reminder package, the **LOW WASH** warning light will come on when the ignition is on and the fluid container is less than one-third full. If you have the electronic cluster, **LOW WASHER FLUID** will be displayed in the information center when the ignition is on and the fluid container is less than one-third full. A warning chime may also sound. Driving without washer fluid can be dangerous. A bad mud splash can block your vision. You could collide with another vehicle. Check your washer fluid often.

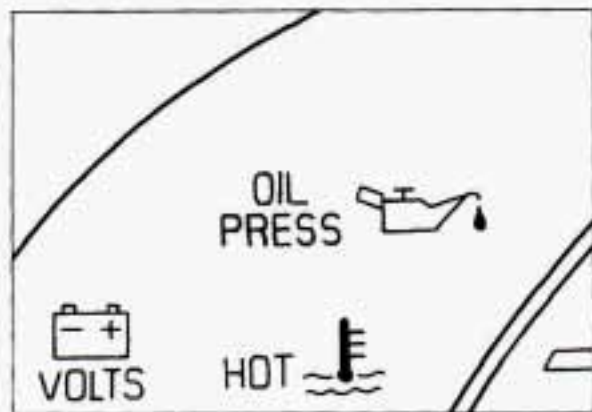

Oil Pressure Light

If you have a problem with your oil, this warning light may stay on after you start your engine, or come on when you are driving. A fast warning chime may also sound. If you have the electronic cluster, **LOW PRES STOP ENGINE** will be displayed in the information center. These indicate that oil is not going through your engine quickly enough to keep it cool. The engine could be low on oil, or could have some other oil problem. Have it fixed right away.



CAUTION:

Don't keep driving if the oil pressure is low. If you do, your engine can become so hot that it catches fire. You or others could be burned. Check your oil as soon as possible and have your vehicle serviced.

NOTICE:

Damage to your engine from neglected oil problems can be costly and is not covered by your warranty.

The oil pressure warning light could also come on in three other situations:

- When the ignition is on but the engine is not running, the light will come on as a test to show you it is working, but the light will go out when you turn the ignition to **Start**. If it doesn't come on with the ignition on, you may have a problem with the fuse or bulb. Have it fixed right away.
- Sometimes when the engine is idling at a stop, the light may blink on and off. This is normal.
- If you make a hard stop, the light may come on for a moment. This is normal.

Features & Controls

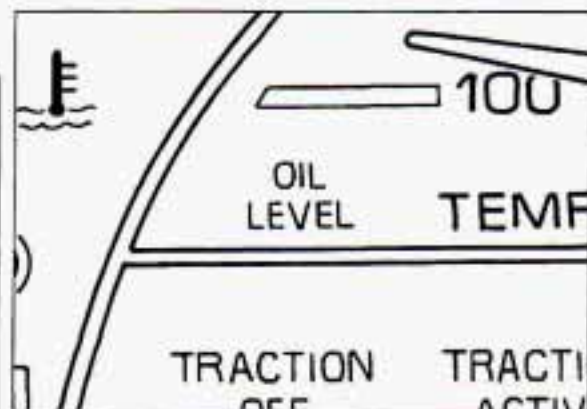

Oil Level Warning Light or Message

When the **CHECK OIL** or **OIL LEVEL** warning light comes on, or the information center displays **CHECK OIL LEVEL**, it indicates that the engine oil level is 1 to 1 1/2 quarts (.95 L to 1.4 L) low. A warning chime may also sound. The warning light or message will come on for two to four seconds when the ignition is turned on, as a bulb check to show you it is working. If it doesn't come on, have it fixed right away. It will then go off. Even if you have a low oil level, it will go off for 15 to 25 seconds. Then, if the oil level is low, the warning light or message will come on for 20 to 40 seconds and a warning chime may sound. If the oil

level is okay, the warning light or message will remain off.

If the warning light or message comes on after the 15 to 25 second delay, check the dipstick level. If it reads low, the engine oil should be brought up to the proper level (see the *Index* under *Engine Oil*). The warning light or message will remain off after the engine oil has been brought to the proper level and the ignition has been off for eight minutes. The eight-minute delay allows the majority of the oil to drain back into the oil pan to prevent a false low condition.

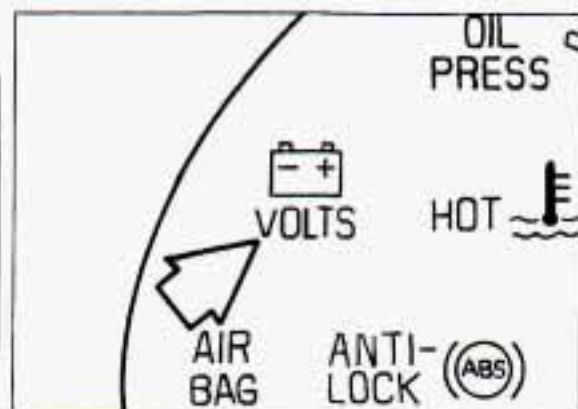

Battery Warning Light

This warning light will come on briefly when you start the vehicle, as a check to show you it is working; then it should go out. If it stays on, or comes on while you are driving, you may have a problem with the electrical charging system. If you have the electronic cluster, the warning light may be accompanied by the message **CHECK CHARGE SYSTEM** in the information center. Have it checked right away. Driving while this light is on could drain your battery.

If you must drive a short distance with the warning light on, turn off all your electrical accessories, such as the radio and climate control.

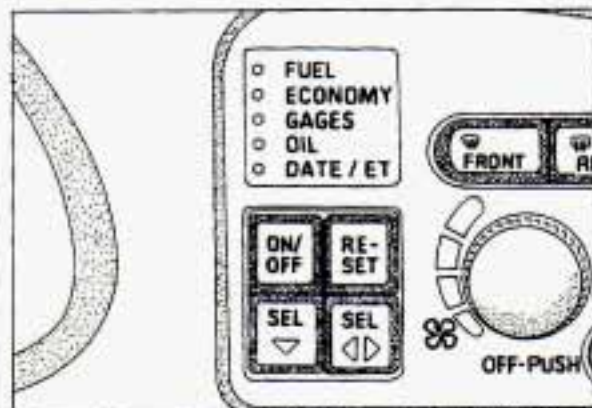

■ *Driver Information Center* (OPTION)

The Driver Information Center provides useful information on:

- Fuel Used and Range
- Instantaneous Fuel Economy
- Average Fuel Economy
- Tachometer (Engine RPM)
- Battery Voltage
- Oil Pressure
- Oil Life
- Date
- Elapsed Time
- Vehicle System Diagnostics

Explanation of Controls

There are four buttons that control the

functions of the Driver Information Center.

SEL ▼: Press this button to select one of the five information categories.

SEL ◀▶: Press this button to change between the two functions in each category. The functions found in each category are:

- Fuel: Fuel Used and Fuel Range
- Economy: Instant and Average Fuel Economy since last reset
- Gages: Tachometer and Battery Voltage
- Oil: Oil Pressure and Oil Life since last reset
- Date/ET: Date and Elapsed Time since last reset

ON/OFF: Press this button to turn the system on or off. When off, the DIC will continue to display diagnostic messages as necessary. When you turn the system back on, any current diagnostic messages will be displayed again. If there are no current messages, **MONITORED SYSTEMS OK** will be displayed.

RE-SET: This button is used with other buttons to reset system functions. It is also used to shut off the chime with most diagnostic messages.

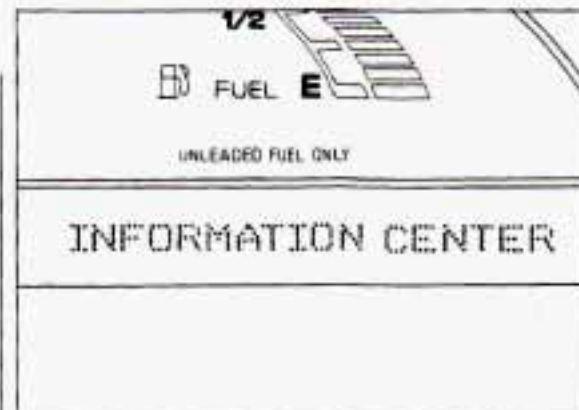

Driver Information Center Displays

When you turn on the ignition, the Driver Information Center (DIC) displays:

INFORMATION CENTER

If no problems are detected, the screen will return to the mode selected when the ignition was turned off.

If a problem is detected, a chime will sound and the diagnostic message will be displayed. Except for the messages **HOT...STOP ENGINE, LOW BRAKE FLUID, LOW PRES STOP ENGINE** (low oil pressure), and **PARKING BRAKE SET**, the message and chime can be shut off by pressing **RESET**. If the message **PARKING BRAKE SET**

Features & Controls

or **LOW BRAKE FLUID** is displayed, only the chime can be shut off by pressing **RESET**. If the message **HOT...STOP ENGINE** or **LOW PRES STOP ENGINE** is displayed, neither the chime nor the message can be shut off; the problem requires immediate attention. The chime associated with a diagnostic message will shut off when either **SEL ▼** or **SEL ◀▶** is pressed to view other functions.

If there are multiple diagnostic messages, each will be displayed for two seconds; then the system will display the next message.

All displays are updated continuously.

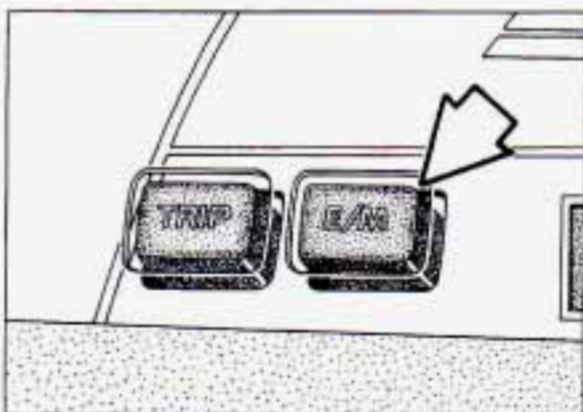

To change the DIC display, and all other displays, to English or metric units, press the **E/M** button.

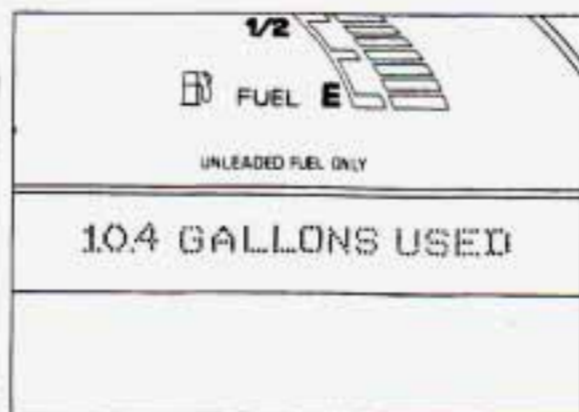

Fuel Used

Press **SEL ▼** until **FUEL** is selected in the display directly above the DIC controls. Press **SEL ◀▶** if necessary to display how much fuel has been used since you last pressed the reset button. The display will show a reading such as:

10.4 GALLONS USED or
39.3 LITERS USED

To learn how much fuel will be used from a new starting point, first display fuel used, then press **RESET** until **RESET** appears in the display (about one second).

If **RESET** is pressed and held for at least five seconds, fuel used, fuel range, average fuel economy, and elapsed time will all be reset and **TRIP FUNCTIONS RESET** will be displayed.

Do not confuse fuel used with the amount of fuel remaining in your tank.

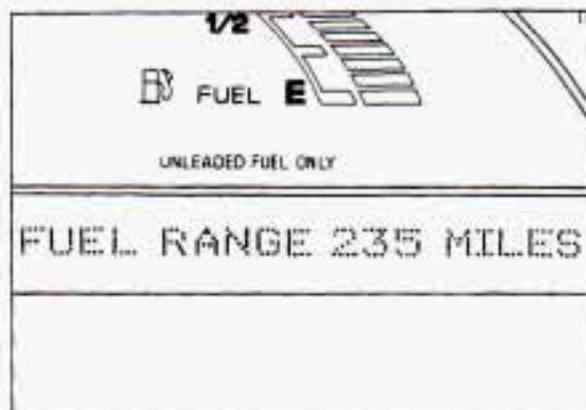

Fuel Range

Press **SEL** ▼ to select **FUEL**. Press **SEL** ◀▶ if necessary to display the fuel range. The display will show a reading such as:

FUEL RANGE 235 MI or
FUEL RANGE 378 KM

Fuel range calculates the remaining distance you can drive without refueling, allowing a 1 gallon (4 liter) reserve. It's based on average fuel economy and the fuel remaining in the tank.

If **RESET** is pressed and held for at least five seconds, fuel used, average fuel economy, and elapsed time will all be reset. **TRIP FUNCTIONS RESET** will be displayed briefly. Because fuel range is based on average fuel economy, the fuel range will also change.

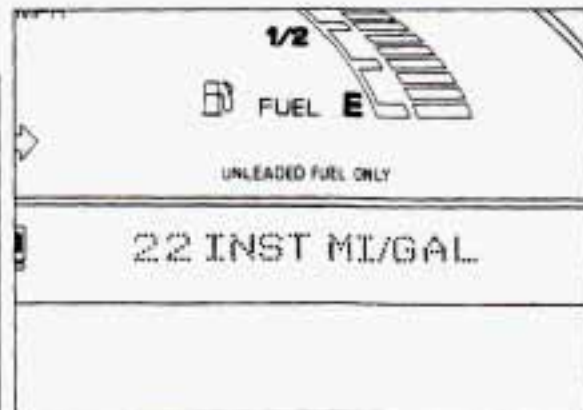

Instantaneous Fuel Economy

Press **SEL** ▼ to select **ECONOMY**. Press **SEL** ◀▶ if necessary to display the instantaneous fuel economy. The display will show a reading such as:

22 INST MI/GAL or
31 INST L/100 KM

Instantaneous fuel economy varies with your driving conditions (accelerating, braking, hills, etc.). **RESET** does not function in this mode.

Features & Controls

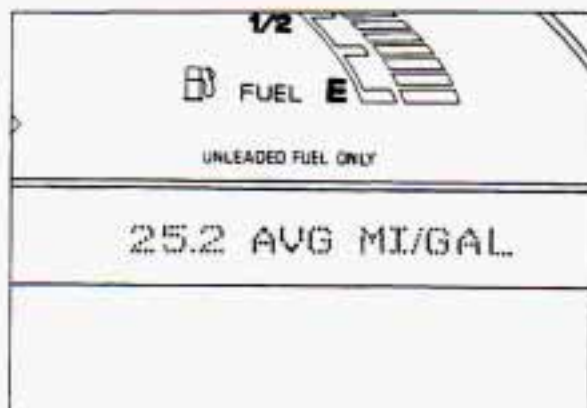

Average Fuel Economy

Press **SEL** ▼ to select **ECONOMY**. Press **SEL** ◀▶ if necessary to display the average fuel economy. The display will show a reading such as:

25.2 AVG MI/GAL or
35.1 AVG L/100 KM

Average fuel economy is viewed as a long term approximation of your driving over all driving conditions. Press **RESET** until **RESET** appears in the display (about one second) to learn the average fuel economy from a new starting point.

If **RESET** is pressed and held for at least five seconds, fuel used, fuel range, average fuel economy, and elapsed time will all be reset and **TRIP FUNCTIONS RESET** will be displayed.

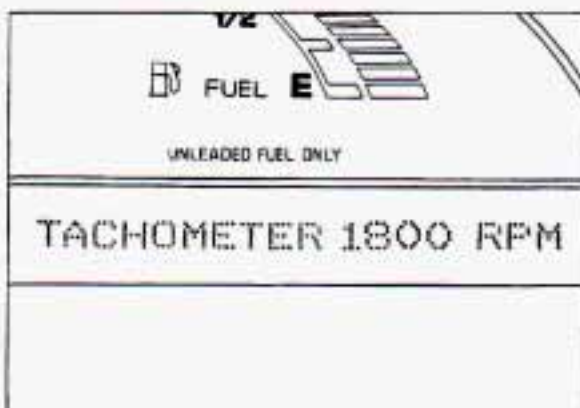

Tachometer (Engine RPM)

Press **SEL** ▼ to select **GAGES**. Press **SEL** ◀▶ if necessary to display the engine rpm. The display will show a reading such as:

TACHOMETER 1800 RPM

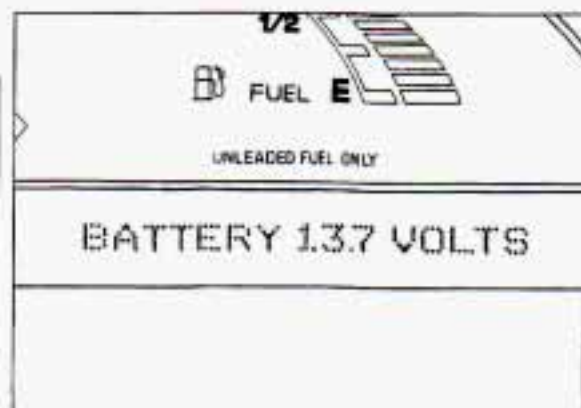

Battery Voltage

Press **SEL** ▼ to select **GAGES**. Press **SEL** ◀▶ if necessary to display the electrical system voltage. The display will show a reading such as:

BATTERY 13.7 VOLTS

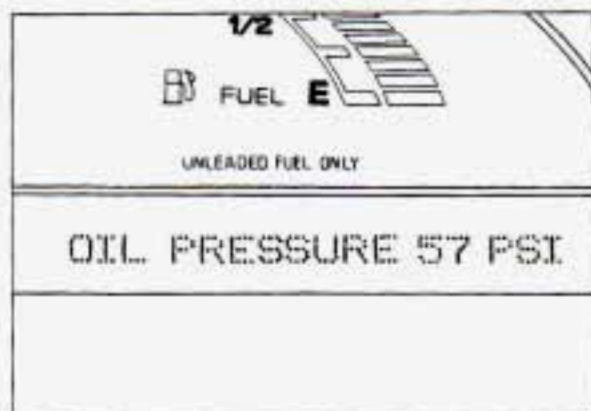

Oil Pressure

Press **SEL** ▼ to select **OIL**. Press **SEL** ◀▶ if necessary to display the oil pressure. The display will show a reading such as:

OIL PRESSURE 57 PSI
OIL PRESSURE 393 KPA

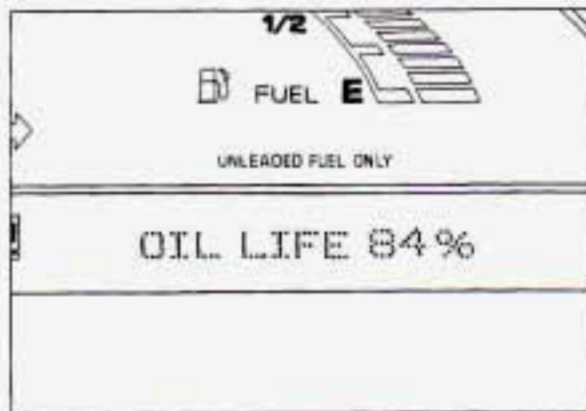

Oil Life

Press **SEL** ▼ to select **OIL**. Press **SEL** ◀▶ if necessary to display the oil life. The display will show a reading such as:

OIL LIFE 84%

This is an estimate of the oil's remaining useful life. The system predicts remaining oil life using inputs from coolant temperature, engine rpm, and vehicle speed. It alerts you to change the oil on a schedule consistent with your vehicle's driving conditions.

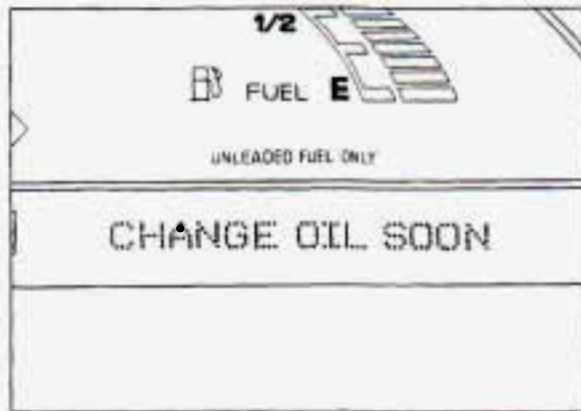

When remaining oil life is 9% or less, the display will show:

CHANGE OIL SOON

Then, when you start the vehicle, a tone will sound and the **CHANGE OIL SOON** message will display each time the vehicle is started. Your vehicle's engine oil is almost spent and you should schedule an oil change soon.

Features & Controls

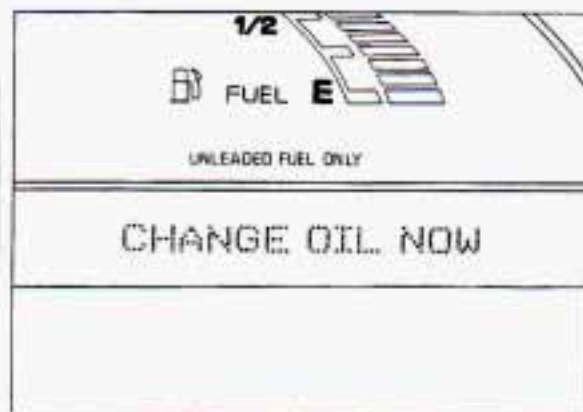

When the oil life is zero, a tone will sound and the display will show:

CHANGE OIL NOW

Then, when you start the vehicle, a tone will sound and the **CHANGE OIL NOW** message will display each time the vehicle is started.

To reset the oil life display after each oil change:

1. Acknowledge all diagnostic messages by pressing **RESET**.
2. Press **SEL** ▼ to select **OIL**. Press **SEL** ◀▶ if necessary to display the oil life.
3. Press and hold the **RESET** button for about five seconds. Once the oil life index has been reset, a **RESET**

message will be displayed and then oil life will change to 100%.

Be careful not to reset the oil life accidentally at any time other than when the oil has just been changed. It can't be reset accurately until the next oil change.

The DIC does not replace the Maintenance Schedule in this manual. The oil change reminder will not detect dusty conditions or engine malfunctions that may affect the oil. If you drive in dusty areas, change your oil every 3,000 miles (5 000 km) or three months, whichever comes first, unless the DIC instructs you to do so sooner.

The DIC does not measure how much oil is in the engine. So, be sure to check your oil level often. See the *Index* under *Engine Oil*.

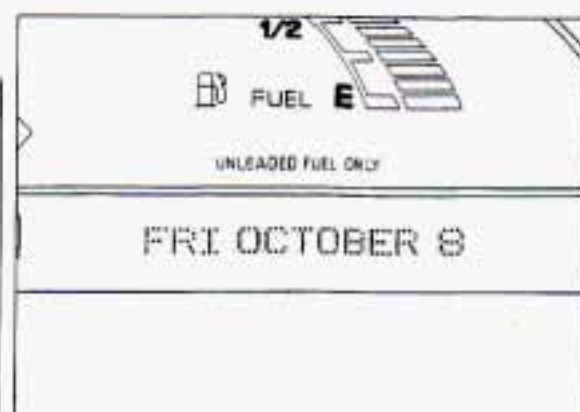

Date

Press **SEL** ▼ to select **DATE/ET**. Press **SEL** ◀▶ if necessary to display the date. The display will show a reading such as:

FRI OCTOBER 8

To change the date:

1. Display the date as described above.
2. Press and hold **RESET** for about one second until the display shows **MONTH? MM/DD/YY** with **MM/DD/YY** representing the date currently stored in the DIC.

Note: If you allow more than 10 seconds to elapse between steps, the DIC automatically reverts to the last date stored in the DIC. You would have to start this procedure over.

- The numbers for the month should be flashing. Press **SEL** ▼ to decrease these numbers. Press **SEL** ◀▶ to increase these numbers. Press and hold either button for more than one second to change the numbers more rapidly. The display will scroll from 01 to 12. When the month displayed is correct, press **RESET** to enter the month.
- The display should show **DAY?** **MM/DD/YY**. **DD** should be flashing. Using both **SEL** buttons, set the day using the procedure described in step 3. The display will scroll from 1 to 29, 30, or 31, depending on the month selected. When the day displayed is correct, press **RESET** to enter the day.

- The display should show **YEAR?** **MM/DD/YY**. **YY** should be flashing. Using both **SEL** buttons, set the year using the procedure described in step 3. The display will scroll from 00 to 99. When the year displayed is correct, press **RESET** to enter the year.

If a valid date is set, the display will automatically exit to the date mode. If February 29 is set and the year selected is not a leap year, the setting will be changed to February 28.

If the radio is removed or replaced with a non-GM radio, the DIC will ask for the time before exiting to the date mode. The procedure for setting the time is very similar to the procedure for setting the date.

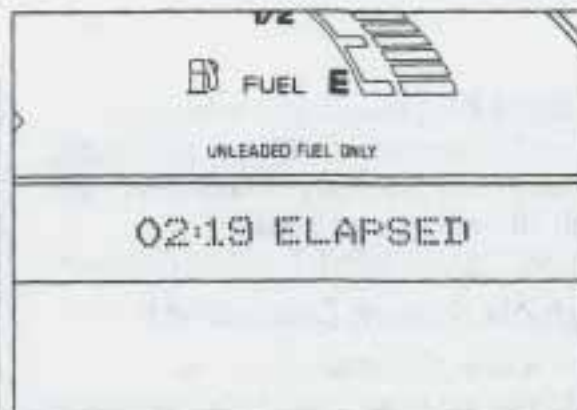

Elapsed Time

Press **SEL** ▼ to select **DATE/ET**. Press **SEL** ◀▶ if necessary to display the elapsed time. The display will show a reading such as:

02:19 ELAPSED

The display shows hours and minutes elapsed while the ignition is on. The DIC can be used as a stopwatch to determine trip length, for example. The DIC will record up to 100 hours, then it will reset to zero and continue counting.

To reset elapsed time to zero, press and hold **RESET** for about two seconds until **00:00 ELAPSED** is displayed.

Features & Controls

If **RESET** is pressed and held for at least five seconds, fuel used, fuel range, average fuel economy, and elapsed time will all be reset and **TRIP FUNCTIONS RESET** will be displayed.

Vehicle System Diagnostics

The following messages in your information center mean that there may be a problem with the vehicle's electronic systems. See your dealer as soon as possible.

- CHECK CHARGE SYSTEM
- AIR BAG PROBLEM
- COOLANT SENDER PROB
- OIL PRES SENDER PROB
- PASSKEY SYSTEM PROB
- OIL LVL SYS PROB
- COOLANT LVL SYS PROB

The DIC will display many other messages, such as **TURN SIGNAL ON?**, **LOW BEAM LAMP OUT**, and **REAR DOOR AJAR**, of value to the driver. For more information on bulb messages, see the *Index* under *Replacement Bulbs*.

Canadian & Export Vehicles Only

English messages will appear in the information center for two seconds. Then the numeric equivalent will appear for two seconds.

NO.	MESSAGE		
1	HOT...STOP ENGINE	21	COOLANT SENDER PROB
2	PARK BRAKE SET	22	OIL PRES SENDER PROB
3	LOW BRAKE FLUID	24	TRACTION CNTL ACTIVE
4	LOW PRES STOP ENGINE	25	TURN SIGNAL ACTIVE
5	CLEAN KEY-WAIT 3 MIN	26	DRIVER DOOR AJAR
9	HOT...AC DISABLED	27	PASSENGER DOOR AJAR
10	CHECK OIL LEVEL	28	REAR DOOR AJAR
11	CHANGE OIL SOON	29	PASSKEY SYSTEM PROB
12	CHANGE OIL NOW	30	HIGH BEAM LAMP OUT
13	LOW FUEL	31	LOW BEAM LAMP OUT
14	LOW AC REFRIGERANT	32	CENTER STOP LAMP OUT
15	CHECK CHARGE SYSTEM	33	TAIL LAMP OUT
16	LOW ENGINE COOLANT	34	BACK-UP LAMP OUT
17	LOW WASHER FLUID	35	REAR LAMP OUT
18	P R N D 3 2 1 PROB	36	FRONT TURN LAMP OUT
19	DATE FUNCTION PROB	37	FRONT PARK LAMP OUT
20	AIR BAG PROB	38	LAMP MON LINK PROB
		39	OIL LVL SYS PROB
		40	COOLANT LVL SYS PROB
		49	BATTERY RECONNECT
		50	MONITORED SYSTEMS OK
		51	INFORMATION CENTER



In this part you'll find out how to operate the comfort control systems and audio systems offered with your Oldsmobile. Be sure to read about the particular system supplied with your vehicle.

Part 3

Comfort Controls & Audio Systems

Four Season Climate Control	110
Automatic Electronic Climate Control	113
Steering Wheel Touch Controls For Climate Control	119
Setting the Clock	121
AM/FM Stereo Radio	122
AM/FM Stereo Radio with Cassette Tape Player	124
AM/FM Stereo with Cassette Tape and Compact Disc Player	128
Steering Wheel Touch Controls for Audio System	132
Understanding Radio Reception	132
Care of Your Cassette Tape Player	133
Care of Your Compact Discs	133
Antenna Mast Care	134

Comfort Controls & Audio Systems

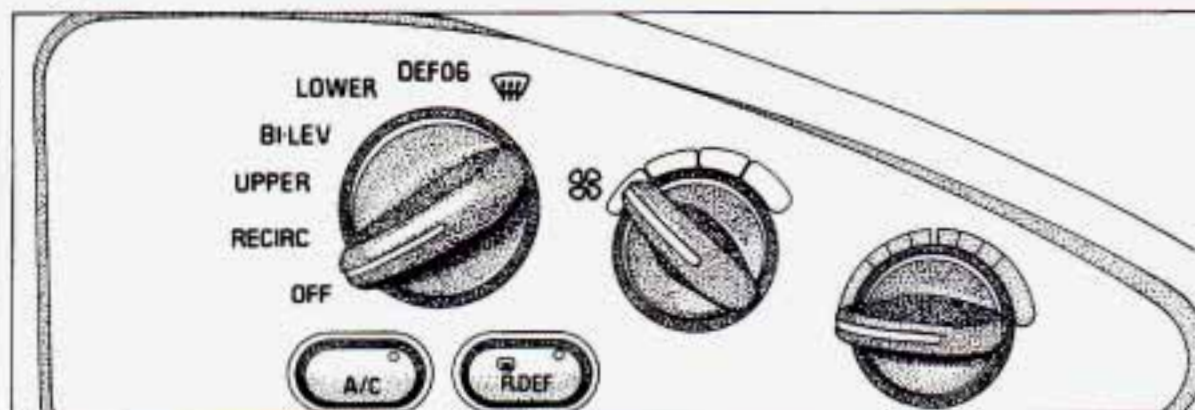

■ *Four Season Climate Control*

The air conditioner and heater work best if you keep the windows closed while using them. Your vehicle has the flow-through ventilation system described later in this section.

Temperature Control: This knob changes the temperature of the air coming through the system. Turn the knob toward the red zone (clockwise) for warmer air. Turn the knob toward the blue zone (counterclockwise) for cooler air.

: This knob manually selects the force of air you want. Turn the knob clockwise for more air flow. Turn the knob counterclockwise for less air flow.

Directional Controls

Turn the directional control knob to select the desired air flow.

The following illustration summarizes your air flow choices.

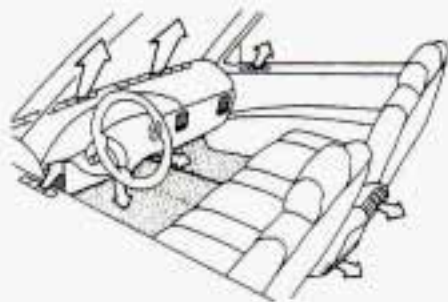

 (Defrost)

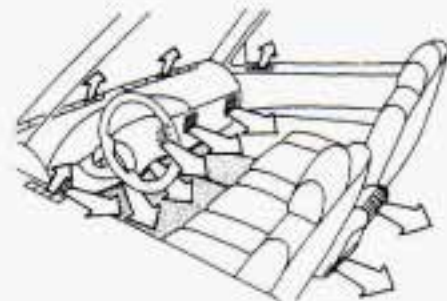

BI-LEV (Bi-Level)

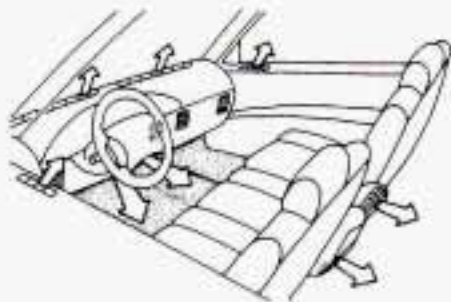

LOWER

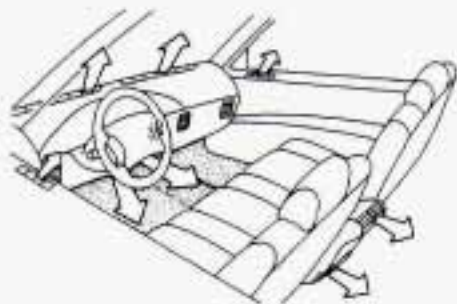

DEFOG

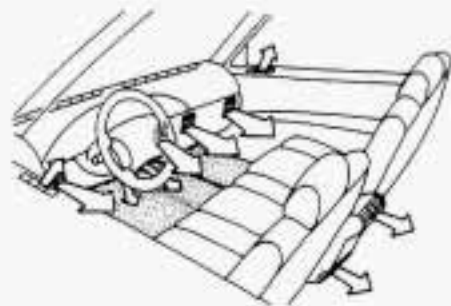

UPPER or RECIRC

Comfort Controls & Audio Systems

 **(Defrost):** Use to direct most of the air to the windshield and side window vents. The air conditioning may run if the temperature is above 40°F (4°C) to dehumidify the air.

DEFOG: Use on cold, humid days with two or more passengers when the windows fog. The air is directed through the windshield, side window, and lower vents.

LOWER: Use to direct most of the air through the lower vents. Some air will flow through the windshield and side window vents.

BI-LEV (Bi-Level): Use on cool, sunny days. This setting directs air in two ways. Cool outside air is directed to the upper portion of your body through the upper vents in the instrument panel. Warmed air is directed through the lower vents, with a little air flow through the windshield and side window vents. At times this temperature difference may be more apparent than others.

UPPER: Use to direct air flow through the upper vents in the instrument panel.

Some air will also flow through the lower outlets.

RECIRC (Recirculate): Use when entering a smoky or dusty area. Air flow is directed through the upper instrument panel vents.

OFF: Turns off the climate control system. This is the only setting which fully shuts off the fan.

Air Conditioning



The air conditioning may run in **Defrost** if the temperature is above 40°F (4°C). In any other mode, you can select or shut off air conditioning as desired by pressing **A/C**. The indicator light will glow while the air conditioning is operating.

For maximum cooling, place the directional control in **RECIRC**, turn the fan knob clockwise for highest fan speed, and turn the temperature knob counterclockwise to the coldest setting.

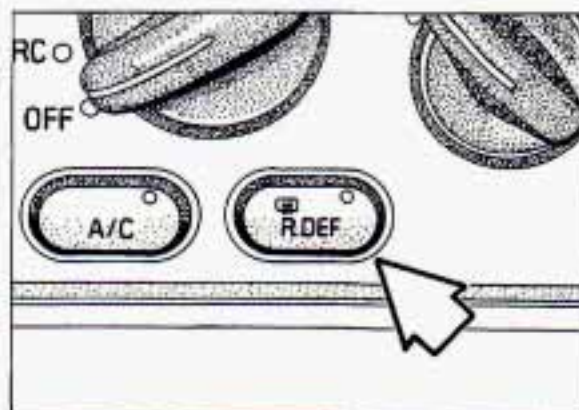
On very hot days, open the windows long enough to let the hot inside air out. This reduces the time the air conditioner's compressor will have to run, which should help fuel economy.



Rear Window Defogger (OPTION)

 **R. DEF:** Press to warm the defogger grid on the rear window. The indicator light will glow while the rear window defogger is operating. The rear window defogger will turn off automatically after about 10 minutes of use. If you turn it on again, the defogger will operate for about 5 minutes. You can also turn off the defogger by turning off the ignition or pressing  **R. DEF** again.

Do not attach a temporary vehicle license across the defogger grid on the rear window.

NOTICE:

Don't use a razor blade or something else sharp on the inside of the rear window. If you do, you could cut or damage the warming grid. The repairs wouldn't be covered by your warranty.

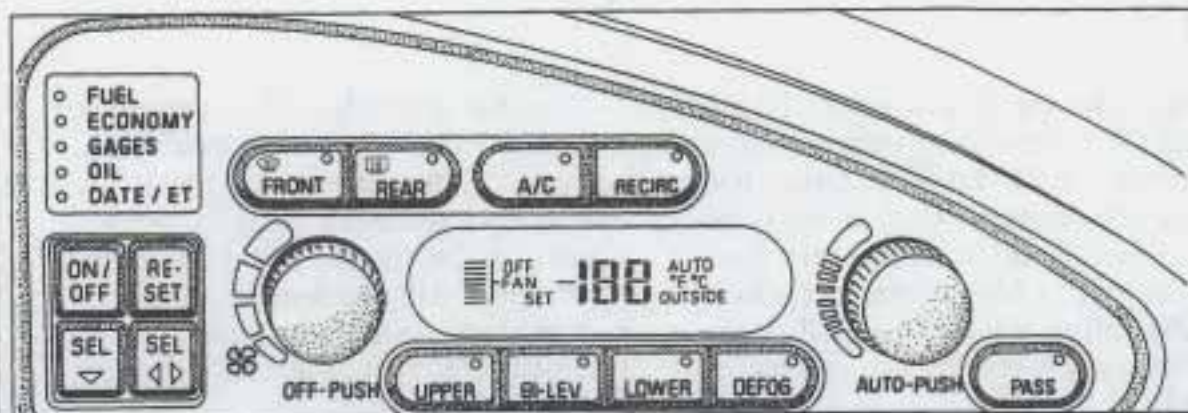

■ Automatic Electronic Climate Control (OPTION)

Overview

This climate control system is designed for set-and-forget operation. Fiddling with the temperature setting causes erratic operation. Allow about 20 minutes after starting the vehicle for the system to regulate before making additional temperature setting adjustments. Immediately selecting 90°F (32°C) will not warm the vehicle any faster than selecting 75°F (16°C).

With this system, you can manually control the ventilation, heating, and air conditioning in your vehicle, or you can use the automatic setting. Your control setting is remembered for the next time

you start your car. If the system was in **Front** , however, it comes back on in **AUTO** if the engine is shut off for more than 40 minutes.

The air conditioner and heater work best if you keep the windows closed while using them. Your vehicle has the flow-through ventilation system described later in this section.

The digital display shows the inside temperature setting or the outside temperature. The outside temperature sensor is most accurate when the vehicle is moving. During stops, the outside temperature display shows the previous driving temperature for best accuracy and system control.

The display also shows the fan speed when it is in manual mode, **AUTO**

Comfort Controls & Audio Systems

when the system is in automatic mode, and **OFF** when the system is shut off. Press the **E/M** (English/Metric) button near the odometer to cycle the display between °F and °C. If you have the electronic or LSS cluster, pressing the **E/M** button will also cycle all other displays between English and metric units.

Manual Mode

In manual mode, you select the direction of air flow and fan speed. The system will determine the amount of heating or cooling needed to maintain the temperature you select. Except for **Defog** and **Front** , air conditioning can be selected or turned off as desired.

Automatic Mode

In automatic mode, the amount of air conditioning or heating, direction of air flow, and fan speed are automatically controlled to maintain the temperature you select. You can also manually control either the fan speed or direction of air flow, leaving the other function in automatic. Except in **Defog** and **Front** , air conditioning can also be selected or turned off as desired.

When the engine is cold, fan speed is kept low until warm air is available.

Front  fan speed starts low to reduce windshield fogging from any snow on the hood as you start driving. Fan speed will increase briefly after short stops when the engine has been turned off to reduce any stuffy feeling.

Controls

Temperature Control: Turn this knob to set the interior temperature you want. Turn the knob toward the red zone (clockwise) for warmer air. Turn the knob toward the blue zone (counterclockwise) for cooler air. The temperature you set will be displayed on the screen for five seconds. Then the outside air temperature will be displayed. Rotate the knob one click to recall the set temperature for five seconds. Turning the knob past 90°F (32°C) or 60°F (16°C) has no effect on the temperature setting. We suggest starting with the midpoint temperature setting of 75°F (24°C) until you find your comfort zone.

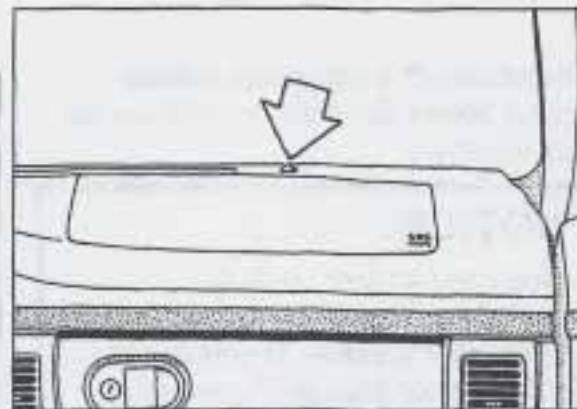

Your system has two sun sensors on top of the instrument panel that detect direct sunlight and the increased warming caused by it. To keep you comfortable on a sunny day, the system may reduce the interior temperature by as much as 5°F (3°C) below the setting on the display. Be careful not to put anything over the two sun sensors on the dash. If you do, the system will think it's night and the vehicle will get warmer.

Push the temperature control knob to place the entire system in automatic mode. The word **AUTO** will be displayed. The system will try to maintain the set temperature. If you set the temperature for 60°F (16°C) or 90°F (32°C), the fan will go to its highest speed, unless you manually select a lower speed. The system will maintain

full cold or full hot operation at these settings.

The direction of air flow will vary with your conditions. For example, when you start the vehicle in cold weather, the system will direct air through the lower vents. As the vehicle warms up, the warm air will be split between the windshield and lower vents. Once the set temperature is reached, warm air will be directed through the lower vents, with cooler air directed through the instrument panel vents.

: This knob manually selects the force of air you want. Turn the knob clockwise for more air flow. Turn the knob counterclockwise for less air flow. In automatic, fan speed is controlled automatically. Turning this knob places the fan in manual. Although the knob can be turned continuously, continuing to turn the knob when the display shows maximum or minimum has no effect on fan speed.

Push this knob to turn the climate control system off. When off, the system's blend doors will still adjust to attempt to maintain the inside temperature you have set.

Directional Controls

Except in **Defog** and **Front** , air conditioning can be selected or turned off as desired.

The following illustration summarizes your air flow choices.

Comfort Controls & Audio Systems

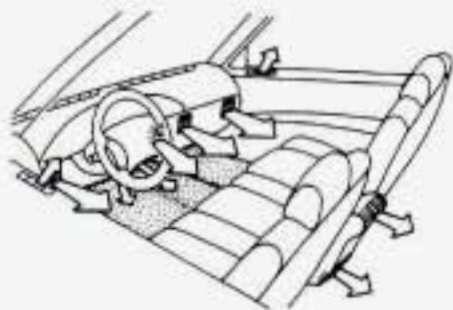

UPPER

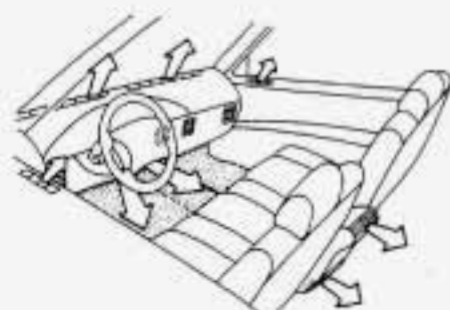

DEFOG

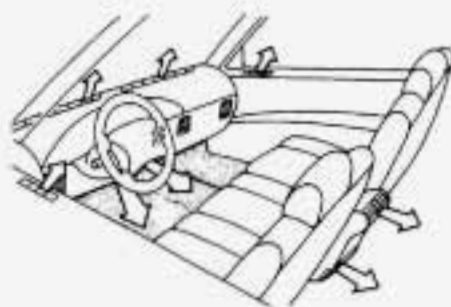

LOWER

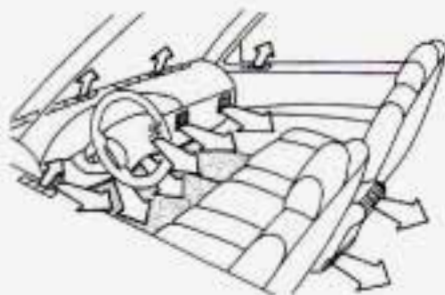

BI-LEV (Bi-Level)

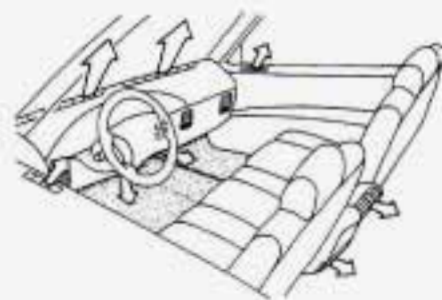

FRONT  (Defrost)

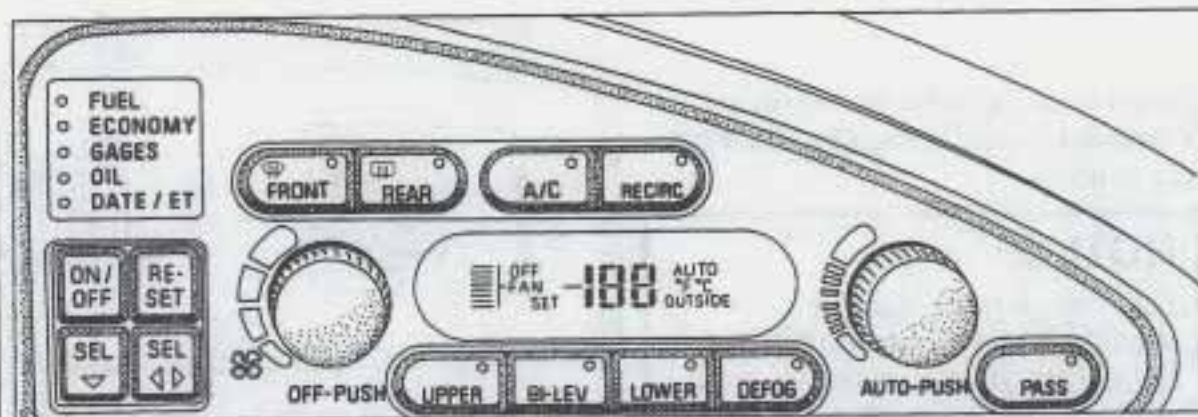

Press one of the buttons listed below to select the desired air flow. An indicator light will show the current selection. Pressing the button for the selection in use will display the inside temperature setting.

UPPER: Use to direct air flow through the upper vents in the instrument panel. Some air will also flow through the lower outlets.

BI-LEV (Bi-Level): Use on cool, sunny days. This setting directs air in two ways. Cool outside air is directed to the upper portion of your body through the upper vents in the instrument panel. Warmed air is directed through the lower vents, with a little air flow through the windshield and side window vents. At times this

temperature difference may be more apparent than others.

LOWER: Use to direct most of the air through the lower vents. Some air will flow through the windshield and side window vents.

DEFOG: Use on cold, humid days with two or more passengers when the windows fog. The air is directed through the windshield, side window, and lower vents. The air conditioning may run if the temperature is above 40°F (4°C) to dehumidify the air.

FRONT  (Defrost): Use to direct most of the air to the windshield and side window vents. Use the fan knob to lower the fan speed if desired. The air conditioning may run if the temperature

is above 40°F (4°C) to dehumidify the air.

RECIRC (Recirculate): Use when entering a smoky or dusty area or for maximum cooling when using the air conditioning. This control does not affect air flow direction. Defog and Front  will not recirculate.

Air Conditioning

The air conditioner cools, dehumidifies, and filters the air for the inside of the vehicle. The air conditioning will not run below 40°F (4°C).

The air conditioning is always enabled in Defog or Front . In any other mode, you can select or shut off the air conditioning as desired by pressing A/C. The indicator light will glow while the air conditioning is enabled.



For maximum cooling, turn the temperature knob counterclockwise to the coldest setting. Do not select RECIRC while the inside air is hotter than the outside air. In manual, also select A/C and LOWER. Using the lower vents will cause you to feel cooler more quickly.

Comfort Controls & Audio Systems

The direction of the cool air can be controlled by adjusting, or turning off, the outlets in the dash. Aiming them over your shoulder will benefit both front and rear passengers. Back seat passengers can also redirect airflow at the rear of the center console.

On very hot days, open the windows long enough to let the hot inside air out. This reduces the time the air conditioner's compressor will have to run, which should help fuel economy.

Rear Window Defogger (OPTION)

 **REAR:** Press to warm the defogger grid on the rear window. The indicator light will glow while the rear window defogger is operating. The rear window defogger will turn off automatically after about 10 minutes of use. If you turn it on again, the defogger will operate for about five minutes. You can also turn off the defogger by turning off the ignition or pressing  **REAR** again.

Do not attach a temporary vehicle license across the defogger grid on the rear window.

NOTICE:

Don't use a razor blade or something else sharp on the inside of the rear window. If you do, you could cut or damage the warming grid. The repairs wouldn't be covered by your warranty.

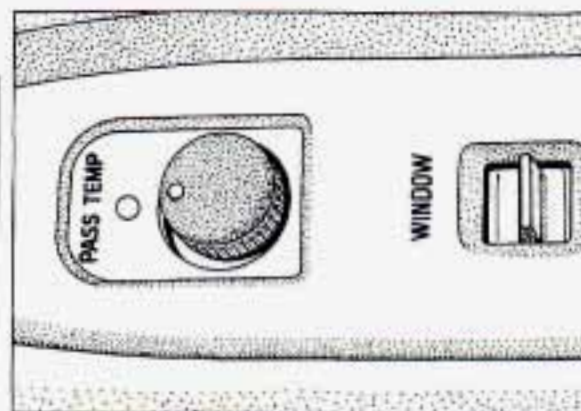

Passenger Temperature Control

With this feature, the right front seat passenger can control the temperature of his/her zone. The passenger temperature setting can be up to 5°F (3°C) cooler or warmer than the primary setting.

To use this feature, turn the **PASS TEMP** (passenger temperature) knob on the passenger's armrest to the desired setting or press **PASS** (passenger). If the climate control system is off, actuating either control will place the system in automatic mode.

If you have this feature, sun on one side of the vehicle will cause the climate control system to automatically supply cooler air to that side.

Extended Idling with Automatic Electronic Climate Control

When the engine idles for a long time, the outside temperature sensor may be affected by warm air from the engine. The climate control system may blow air that is too cool. This should stop once the vehicle is moving again. Extended idling is not recommended. See the *Index* under *Engine Exhaust*.

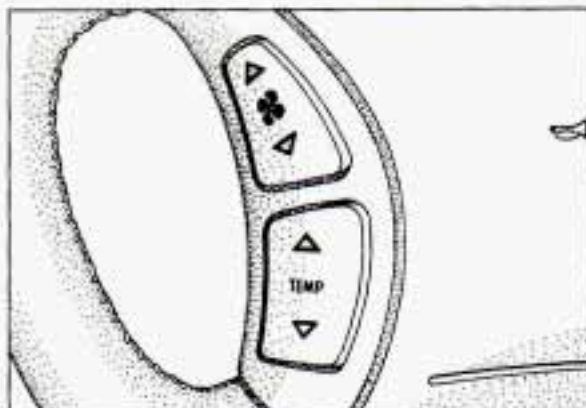

Steering Wheel Touch Controls for Climate Control (OPTION)

Some heating and cooling controls can be adjusted at the steering wheel. Other touch controls also operate some audio controls. See *Steering Wheel Touch Controls for Audio System* later in this section.

Fan Icon: Press the upper part of the control to increase the fan speed; press the lower part to reduce the fan speed.

TEMP: Press the upper part of the control to raise the inside temperature setting; press the lower part to lower the setting.

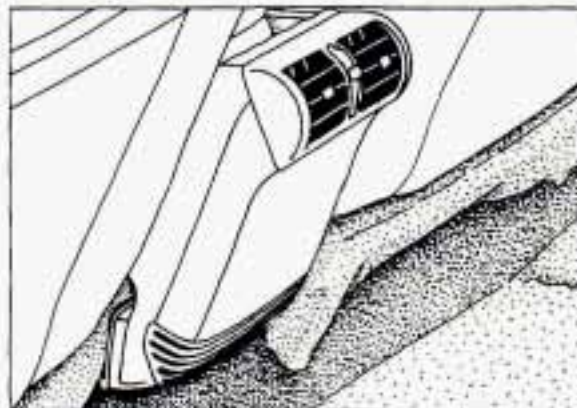

Rear Outlets (OPTION)

Slide the center control up to direct air upward. Slide it down to direct air downward. The center position will direct air both up and down.

Comfort Controls & Audio Systems

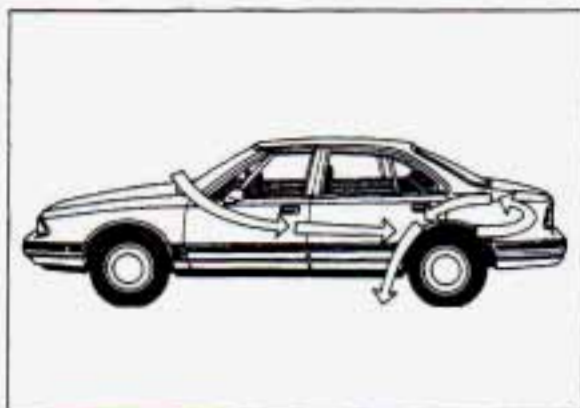

Flow-Through Ventilation System

Your Oldsmobile's flow-through ventilation system supplies outside air into the vehicle when it is moving. Outside air will also enter the vehicle when the heater or the air conditioning fan is running.



Ventilation Tips

- Keep the hood and front air inlet free of ice, snow, or any other obstruction (such as leaves). The heater and defroster will work far better, reducing the chance of fogging the inside of your windows.

- When you enter a vehicle in cold weather, select the **LOWER** setting, then turn the blower fan to high for a few moments before driving off. This will blow moist air from intake ducts toward the floor, not the windshield. It reduces the chance of fogging the inside of your windows.
- Keep the air path under the front seats clear of objects. This helps air to circulate throughout your vehicle.

■ *Audio Systems*

The following pages describe the audio systems available for your Oldsmobile, and how to get the best performance from them. Please read about the system in your vehicle.

Hearing damage from loud noise is almost undetectable until it is too late. Your hearing can adapt to higher volumes of sound. Sound that seems normal can be loud and harmful to your hearing. Take precautions by adjusting the volume control on your radio to a safe sound level before your hearing adapts to it. To help avoid hearing loss or damage:

- Adjust the volume control to the lowest setting.
- Increase volume slowly until you hear comfortably and clearly.

NOTICE:

Before you add any sound equipment to your vehicle — like a tape player, CB radio, mobile telephone or two-way radio — be sure you can add what you want. If you can, it's very important to do it properly. Added sound equipment may interfere with the operation of your vehicle's engine, Delco® radio or other systems, and even damage them. And, your vehicle's systems may interfere with the operation of sound equipment that has been added improperly. So, before adding sound equipment, check with your dealer and be sure to check Federal rules covering mobile radio and telephone units.

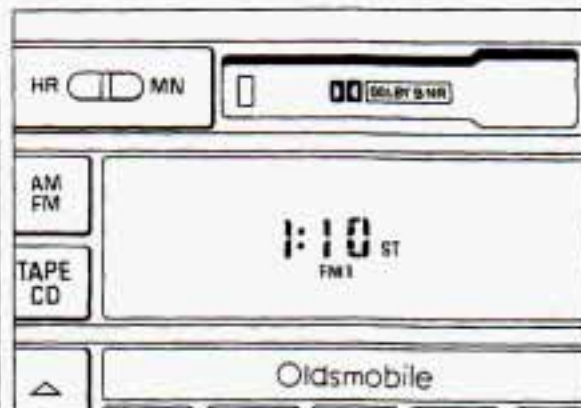

Setting the Clock

No matter which audio system you have in your vehicle, setting the clock is easy.

To set the clock, press and hold the **HR** or **MN** button until it begins to change. Let up as it gets close to the correct time. There will be an initial 2-second delay before the clock goes into the time-set mode. The **A** or **P** in the display designates AM or PM in clock adjust mode. The **A** or **P** replaces the channel momentarily. The clock may be set with the ignition off.

Comfort Controls & Audio Systems

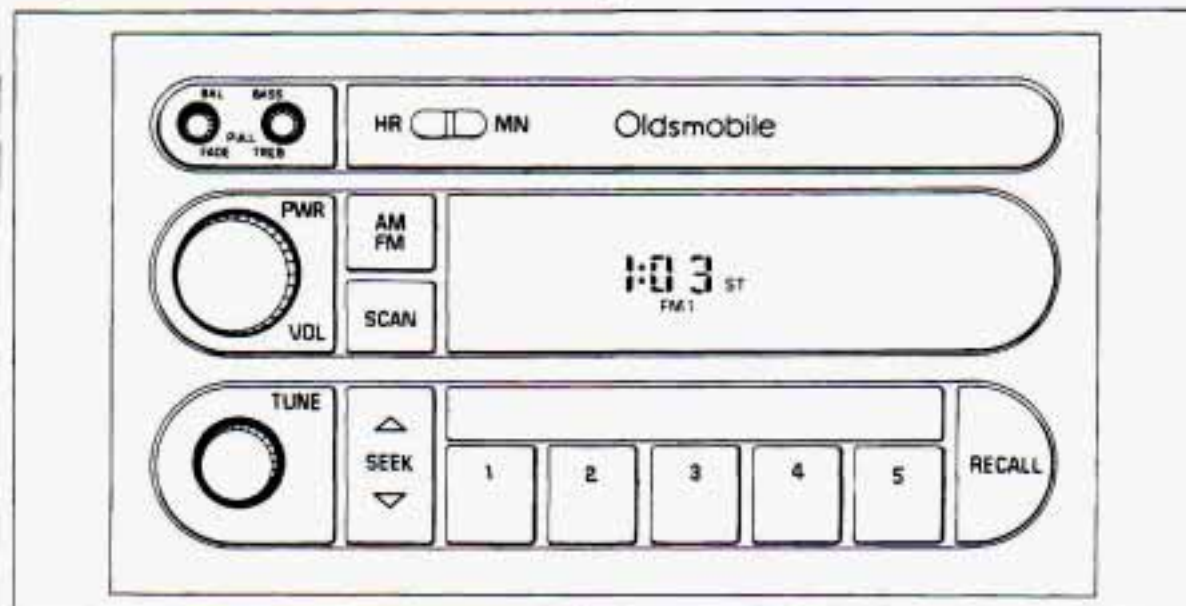

AM/FM Stereo Radio

The digital display indicates information on time or radio station frequency, the AM or FM radio band, whether the station is in stereo, and other audio system functions.

PWR/VOL (Power/Volume): With the ignition on, push this knob to turn the system on or off. Turn it clockwise to increase the volume. Turn it counterclockwise to decrease the volume.

AM/FM: Press this button to change between the AM, FM1, and FM2 bands. The display will show which band you are on.

TUNE: Press lightly on this knob to release it from its recessed position. Turn it to tune in radio stations. You may push the knob back in to return it to its recessed position when not in use.

To Preset Radio Stations:

The five pushbuttons labeled 1-5 can be used to preset up to 15 radio stations (five AM, five FM1, and five FM2).

1. Tune in the station you want to store.
2. Press and hold one of the five pushbuttons until the display shows a channel number. The radio will mute until the channel number is displayed. Whenever you press that button again, the preset station will return. Always check whether you're in AM, FM1, or FM2.

RECALL: When the ignition is off, press **RECALL** to display the time. When the radio is on, press **RECALL** to switch the display between the radio station and the time. After five seconds the display will return to its normal display.

The radio can be set so that either the time or radio station is normally displayed when the radio is playing. To do this, press **RECALL** to display the time or radio station as desired, then hold **RECALL** down until the display flashes.

SEEK ▲/▼: When you press **SEEK ▲/▼** while playing the radio, the radio will search for the next higher or lower station and stop. The radio will be muted while seeking.

SCAN: When you press **SCAN** while playing the radio, the radio will go through each station, pausing for a few seconds at each station. Press **SCAN** again to stop on a station. The radio will be muted while scanning and **SCAN** will appear on the display.

When you press **SCAN** and hold it for about two seconds until the display shows **PSCAN (Preset Scan)**, the radio will scan only stations that you've

preset with your radio pushbuttons. Press **SCAN** again to stop on a station.

BASS: Press this button lightly to release it from its recessed position. Turn it to adjust bass response. As you turn the knob you will feel the center position. Push the knob back in to return it to its recessed position.

TREB (Treble): Press this button lightly to release it from its recessed position, then pull it out to its fully extended position. Turn it to adjust treble response. As you turn the knob you will feel the center position. Push the knob back in to return it to its recessed position.

BAL (Balance): Press this button lightly to release it from its recessed position. Turn it to adjust the right and left speaker balance. As you turn the knob you will feel the center position. Push the knob back in to return it to its recessed position.

FADE: Press this button lightly to release it from its recessed position, then pull it out to its fully extended position. Turn it to the right to increase front speaker volume. Turn it to the left to increase rear speaker volume. As you turn the knob you will feel the center position. Push the knob back in to return it to its recessed position.

Comfort Controls & Audio Systems

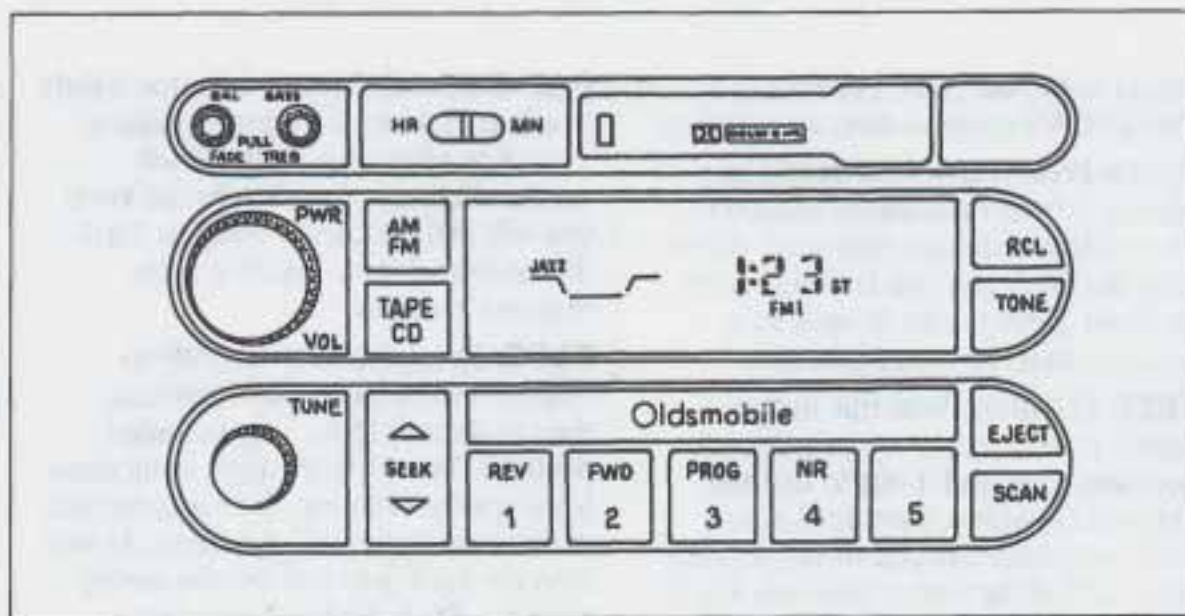

AM/FM Stereo Radio with Automatic Tone Control and Cassette Tape Player

The digital display indicates information on time or radio station frequency, the AM or FM radio band, whether the station is in stereo, and other audio system functions.

PWR/VOL (Power/Volume): With the ignition on, push this knob to turn the system on or off. Turn it clockwise to increase the volume. Turn it counterclockwise to decrease the volume.

AM/FM: Press this button to change between the AM, FM1, and FM2 bands. The display will show which band you are on. If you press this button while a tape is playing, the tape will stop and the radio will return to the AM or FM band that you were on.

TUNE: Press lightly on this knob to release it from its recessed position. Turn it to tune in radio stations. You may push the knob back in to return it to its recessed position when not in use.

To Preset Radio Stations:

The five pushbuttons labeled 1-5 can be used to preset up to 15 radio stations (five AM, five FM1, and five FM2).

1. Tune in the station you want to store.
2. Press **TONE** to select the setting that you prefer.
3. Press and hold one of the five pushbuttons until the display shows a channel number. The radio will mute until the channel number is displayed. Whenever you press that button again, the preset station and tone setting will return. Always check whether you're in AM, FM1, or FM2.

SEEK ▲/▼: When you press **SEEK ▲/▼** while playing the radio, the radio will search for the next higher or lower station and stop. The radio will be muted while seeking.

SCAN: When you press **SCAN** while playing the radio, the radio will go through each station, pausing for a few seconds at each station. Press **SCAN** again to stop on a station. The radio will be muted while scanning and **SCAN** will appear on the display.

When you press **SCAN** and hold it for about two seconds until the display shows **PSCAN (Preset Scan)**, the radio will scan only stations that you've preset with your radio pushbuttons. Press **SCAN** again to stop on a station.

RCL (Recall): When the ignition is off, press **RCL** to display the time. When the radio is on, press **RCL** to switch the display between the radio station and the time. After five seconds the display will return to its normal display.

The radio can be set so that either the time or radio station is normally displayed when the radio is playing. To do this, press **RCL** to display the time or radio station as desired, then hold **RCL** down until the display flashes.

TONE: This button controls the Automatic Tone Control (ATC) feature which lets you select an equalization for the type of music or voice being heard. For example, **JAZZ** emphasizes bass and treble while **ROCK** emphasizes bass. Press **TONE** to step through the six settings: **JAZZ**, **VOCAL**, **POP**, **ROCK**, **CLASSIC**, and **MANUAL**. Each setting will appear on the display. In **MANUAL** you can adjust tone with the **TREB** and **BASS** controls. Any time **TREB** or **BASS** is turned, **TONE** will automatically go to the **MANUAL** setting. Radio and cassette tape tone settings are set separately, and you can set separate tone settings with each radio station preset. If you've selected a tone setting for your tape, then play the radio, the tone you set for your tape will be reactivated when the tape is played again.

Comfort Controls & Audio Systems

BASS: Press this button lightly to release it from its recessed position. Turn it to adjust bass response. As you turn the knob you will feel the center position. Push the knob back in to return it to its recessed position. Turning **BASS** will change the radio's Automatic Tone Control feature to **MANUAL**.

TREB (Treble): Press this button lightly to release it from its recessed position, then pull it out to its fully extended position. Turn it to adjust treble response. As you turn the knob you will feel the center position. Push the knob back in to return it to its recessed position. Turning **TREB** will change the radio's Automatic Tone Control feature to **MANUAL**.



BAL (Balance): Press this button lightly to release it from its recessed position. Turn it to adjust the right and left speaker balance. As you turn the knob you will feel the center position. Push the knob back in to return it to its recessed position.

FADE: Press this button lightly to release it from its recessed position, then pull it out to its fully extended position. Turn it to the right to increase front speaker volume. Turn it to the left to increase rear speaker volume. As you turn the knob you will feel the center position. Push the knob back in to return it to its recessed position.

To Play a Cassette Tape:

With the ignition on, insert the tape and it will begin playing. The audio system will turn on automatically. Your tape player is designed to work best with tapes that are 30 to 45 minutes long on each side. Longer tapes may not work as well.

Note that when a tape is inserted, **TP** will be displayed. When the tape is playing, **[TP]** will be displayed, along with an arrow to show whether the top or bottom of the tape is playing. Any time a tape is inserted, the top side will play first. If a high bias metal or CrO₂ tape is played, **HI-BIAS** will appear in the display and the equalization will be adjusted automatically. If you select a tone setting, it will be remembered when you play a tape.

NR (Noise Reduction): This radio has Dolby® B Noise Reduction to reduce background noise on Dolby® B encoded tapes. Press this button to reduce background noise on your tape. The Dolby symbol  will appear in the display. Dolby® Noise Reduction is manufactured under license from Dolby Laboratories Licensing Corporation. Dolby® and the  symbol are trademarks of Dolby Laboratories Licensing Corporation.

SEEK ▲/▼: When you press **SEEK ▲/▼** while playing a tape, it will search for the next higher or lower selection and stop. There must be at least a four-second gap between selections on the tape.

SCAN: When you press **SCAN** while playing a tape, you'll hear the first few seconds of each selection. Press **SCAN** again to stop on a selection. The tape will be muted while scanning and **SCAN** will appear on the display.

FWD (Fast Forward): Press to advance a cassette tape rapidly; press again to play the tape.

REV (Reverse): Press to reverse a cassette tape rapidly; press again to play the tape.

PROG (Program): Press to play the other side of the tape.

TAPE/CD: If you have a tape inserted and the radio is playing, press **TAPE/CD** to play your tape. To return to the radio while the tape is playing, press **AM/FM**. The tape will remain safely inside the radio for future listening.

EJECT: Press to eject the cassette tape. The radio will then play.

Comfort Controls & Audio Systems

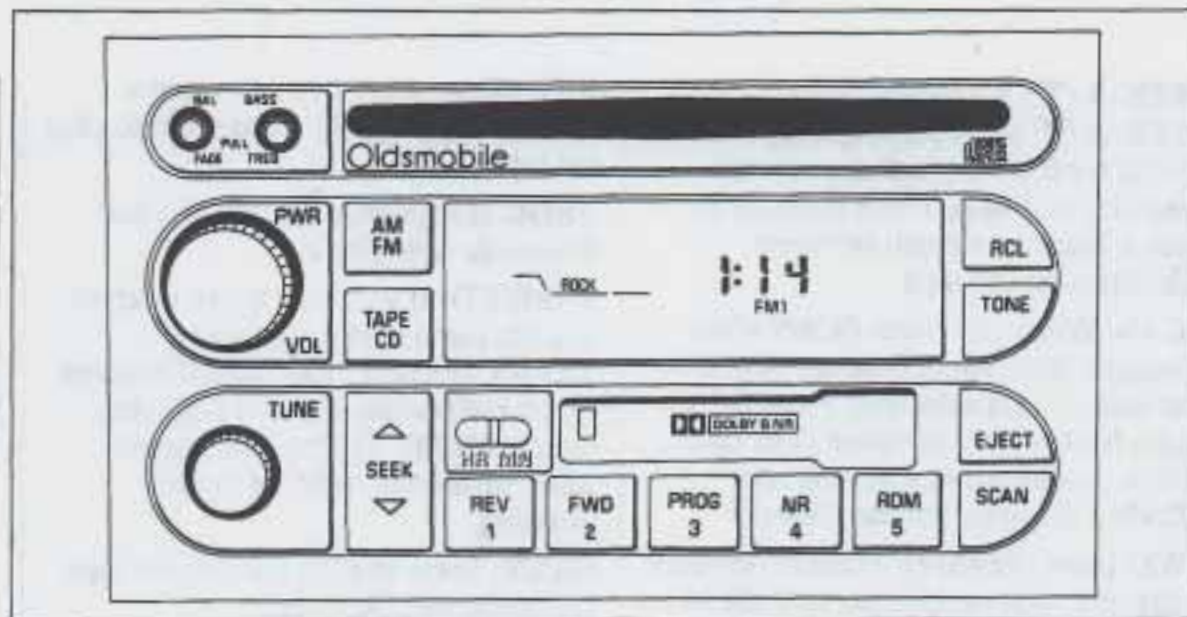

AM/FM Stereo Radio with Automatic Tone Control, Cassette Tape and Compact Disc Player

The digital display indicates information on time or radio station frequency, the AM or FM radio band, whether the station is in stereo, and other audio system functions.

PWR/VOL (Power/Volume): With the ignition on, push this knob to turn the system on or off. Turn it clockwise to increase the volume. Turn it counterclockwise to decrease the volume.

AM/FM: Press this button to change between the AM, FM1, and FM2 bands. The display will show which band you are on. If you press this button while a tape or CD is playing, the tape or CD will stop and the radio will return to the AM or FM band that you were on.

TUNE: Press lightly on this knob to release it from its recessed position. Turn it to tune in radio stations. You may push the knob back in to return it to its recessed position when not in use.

To Preset Radio Stations:

The five pushbuttons labeled 1-5 can be used to preset up to 15 radio stations (five AM, five FM1, and five FM2).

1. Tune in the station you want to store.
2. Press **TONE** to select the setting that you prefer.
3. Press and hold one of the five pushbuttons until the display shows a channel number. The radio will mute until the channel number is displayed. Whenever you press that button again, the preset station and tone setting will return. Always check whether you're in AM, FM1, or FM2.

SEEK ▲/▼: When you press **SEEK ▲/▼** while playing the radio, the radio will search for the next higher or lower station and stop. The radio will be muted while seeking.

SCAN: When you press **SCAN** while playing the radio, the radio will go through each station, pausing for a few seconds at each station. Press **SCAN** again to stop on a station. The radio will be muted while scanning and **SCAN** will appear on the display.

When you press **SCAN** and hold it for about two seconds until the display shows **PSCAN (Preset Scan)**, the radio will scan only stations that you've preset with your radio pushbuttons. Press **SCAN** again to stop on a station.

RCL (Recall): When the ignition is off, press **RCL** to display the time. When the radio is on, press **RCL** to switch the display between the radio station and the time. After five seconds the display will return to its normal display.

The radio can be set so that either the time or radio station is normally displayed when the radio is playing. To do this, press **RCL** to display the time or radio station as desired, then hold **RCL** down until the display flashes.

This button scrolls through three functions when a CD is playing:

- Press to see which track is playing.
- Press again while the track is displayed (within about five seconds), and **EL TM (Elapsed Time)** will appear in the display together with how much time has elapsed since the track started playing.
- Press again to view the time.

You can select which function is normally displayed when a CD is playing. To do this, press **RCL** until the display shows the desired function, then hold **RCL** down until the display flashes.

TONE: This button controls the Automatic Tone Control (ATC) feature which lets you select an equalization for the type of music or voice being heard. For example, **JAZZ** emphasizes bass and treble while **ROCK** emphasizes bass. Press **TONE** to step through the six settings: **JAZZ**, **VOCAL**, **POP**, **ROCK**, **CLASSIC**, and **MANUAL**. Each setting will appear on the display. In **MANUAL** you can adjust tone with the **TREB** and **BASS** controls. Any time **TREB** or **BASS** is turned, **TONE** will automatically go to the **MANUAL** setting. Radio, cassette tape and CD player tone settings are set separately, and you can set separate tone settings with each radio station preset. If you've selected a tone setting for a tape or CD, then play the radio, the tone you set for the tape or CD will be reactivated when the tape or CD is played again.

BASS: Press this button lightly to release it from its recessed position. Turn it to adjust bass response. As you turn the knob, you will feel the center position. Push the knob back in to return it to its recessed position. Turning **BASS** will change the radio's Automatic Tone Control feature to **MANUAL**.

TREB (Treble): Press this button lightly to release it from its recessed position, then pull it out to its fully extended position. Turn it to adjust treble response. As you turn the knob you will feel the center position. Push the knob back in to return it to its recessed position. Turning **TREB** will change the radio's Automatic Tone Control feature to **MANUAL**.

BAL (Balance): Press this button lightly to release it from its recessed position. Turn it to adjust the right and left speaker balance. As you turn the knob you will feel the center position. Push the knob back in to return it to its recessed position.



Comfort Controls & Audio Systems

FADE: Press this button lightly to release it from its recessed position, then pull it out to its fully extended position. Turn it to the right to increase front speaker volume. Turn it to the left to increase rear speaker volume. As you turn the knob you will feel the center position. Push the knob back in to return it to its recessed position.

To Play a Cassette Tape:

With the ignition on, insert the tape and it will begin playing. The audio system will turn on automatically. Your tape player is designed to work best with tapes that are 30 to 45 minutes long on each side. Longer tapes may not work as well.

Note that when a tape is inserted, **TP** will be displayed. When the tape is playing, **TP** will be displayed, along with an arrow to show whether the top or bottom of the tape is playing. Any time a tape is inserted, the top side will play first. If a high bias metal or CrO₂ tape is played, **HI-BIAS** will appear in the display and the equalization will be adjusted automatically.

NR (Noise Reduction): This radio has Dolby® B Noise Reduction to reduce background noise on Dolby® B encoded tapes. When playing a cassette tape, press this button to reduce background noise on your tape. The Dolby symbol  will appear in the display. Dolby® Noise Reduction is manufactured under license from Dolby Laboratories Licensing Corporation. Dolby® and the  symbol are trademarks of Dolby Laboratories Licensing Corporation.

SEEK ▲/▼: When you press **SEEK ▲/▼** while playing a tape, it will search for the next higher or lower selection and stop. There must be at least a four-second gap between selections on the tape.

SCAN: When you press **SCAN** while playing a tape, you'll hear the first few seconds of each selection. Press **SCAN** again to stop on a selection. The tape will be muted while scanning and **SCAN** will appear on the display.

FWD (Fast Forward): Press to advance a cassette tape rapidly; press again to play the tape.

REV (Reverse): Press to reverse a cassette tape rapidly; press again to play the tape.

PROG (Program): Press to play the other side of the tape.

TAPE/CD: If you have a tape inserted and the radio is playing, press **TAPE/CD** to play your tape. To return to the radio while the tape is playing, press **AM/FM**. You can also press **TAPE/CD** to switch between a tape and a compact disc if both are inserted. The tape or CD that's not being played will remain safely inside the radio for future listening.

EJECT: Press to eject the cassette tape. The radio will then play.

To Play A Compact Disc:

The CD player will play either normal-size discs or the smaller 8 cm discs without an adapter.

With the ignition on, insert the disc partway into the slot, with the label side up. The player should pull it in and it will begin playing.

Note that when the disc is inserted, **CD** will be displayed. When the disc is playing, **[CD]** will be displayed. If you select a Tone setting on your CD, it will be activated each time you play a CD.

As each new track starts to play, the track number will appear in the display.

If **Err (Error)** appears on the display, the disc can't play temporarily. If the disc comes out or doesn't play, check to see if:

- The road is too rough. The disc should play when the road is smoother.
- The disc is upside down.
- The disc is dirty, scratched, or wet.
- The air is very humid. If so, wait about one hour and try again.

SEEK ▲/▼: When you press **SEEK ▼** while playing a CD, it will go back to the start of the current track if more than eight seconds have played. When you press **SEEK ▲**, it will search for the next higher track and stop. There must be at least a three-second gap between selections on the CD.

SCAN: When you press **SCAN** while playing a CD, you'll hear the first few seconds of each selection. Press **SCAN** again to stop on a selection. The CD will be muted while scanning and **SCAN** will appear on the display.

FWD (Fast Forward): To advance a CD, press and hold this button. While the CD advances, elapsed time will be displayed to help you find the desired passage.

REV (Reverse): To reverse a CD, press and hold this button. While the CD reverses, elapsed time will be displayed to help you find the desired passage.

TAPE/CD: If you have a CD inserted and the radio is playing, press **TAPE/CD** to play your CD. To return to the radio while the CD is playing, press **AM/FM**. You can also press **TAPE/CD** to switch between a tape and a compact disc if both are inserted. The tape or CD that's not being played will remain safely inside the radio for future listening.

RDM (Random): Press to play the CD tracks in random order. **RDM** will appear on the display. Press again to play the tracks in disc order.

EJECT: Press to eject the CD. The radio will then play. If both a tape and CD are inserted, the last one played will eject.

Comfort Controls & Audio Systems

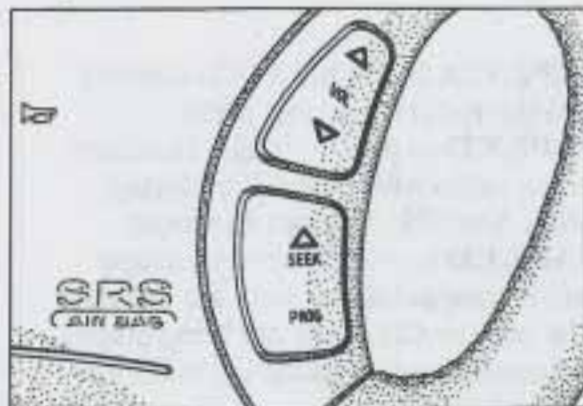

Steering Wheel Touch Controls for Audio System (OPTION)

Some audio system functions described in the previous pages can also be operated with the Steering Wheel Touch Controls option. Other touch controls also operate some climate controls. See *Steering Wheel Touch Controls for Climate Control* earlier in this section.

VOL (Volume): Press the top part of the switch to increase volume, the bottom part to decrease volume.

SEEK: Each time you press **SEEK**, you will tune in a radio station higher on the AM or FM band.

When playing a tape or CD, press **SEEK** to listen to the next selection.

PROG (Program): Press **PROG** to tune in a preset radio station higher on the AM or FM band.

When playing a tape, press **PROG** to play the other side of the tape.

Understanding Radio Reception

FM Stereo

FM stereo will give you the best sound, but FM signals will reach only about 10 to 40 miles (16 to 65 km). Tall buildings or hills can interfere with FM signals, causing the sound to come and go.

AM

The range for most AM stations is greater than for FM, especially at night. The longer range, however, can cause stations to interfere with each other. AM can also pick up noise from things like storms and power lines. To lower this noise, try reducing the treble level.



Care of Your Cassette Tape Player

A tape player that is not cleaned regularly is subject to reduced sound quality, ruining the cassette, or damaging the mechanism. Tape cassettes that are not properly stored in their plastic cases away from contaminants, direct sunlight, and extreme heat may not operate properly and could cause premature failure of the tape player.

Your tape player should be cleaned monthly or with every 15 hours of use, as regular maintenance. If you notice a reduction in sound quality, try a good cassette to see if the tape or the tape player is at fault. If the second cassette results in no improvement in sound quality, try cleaning the tape player.

Proper tape player cleaning should be done with a **wiping action** nonabrasive cleaner cassette. To properly clean your tape player, you should follow the directions on the cleaning cassette.

Cassettes are subject to wear and the sound quality may degrade over time. Always verify that the cassette tape is in good condition before obtaining service on your tape player.



Care of Your Compact Discs

Handle discs carefully. Store them in their original cases or other protective cases and away from direct sunlight and dust. If the surface of a disc is soiled, dampen a clean, soft cloth in a mild, neutral detergent solution and clean it, wiping from the center to the edge.

Be sure never to touch the signal surface when handling discs. Pick up discs by grasping the outer edges or the edge of the hole and the outer edge.

Comfort Controls & Audio Systems

Fixed Mast Antenna

The fixed mast antenna can withstand most car washes without being damaged. If the mast should ever become slightly bent, you can straighten it out by hand. If the mast is badly bent, as it might be by vandals, you should replace it.

Check every once in a while to be sure the mast is still tightened to the fender.

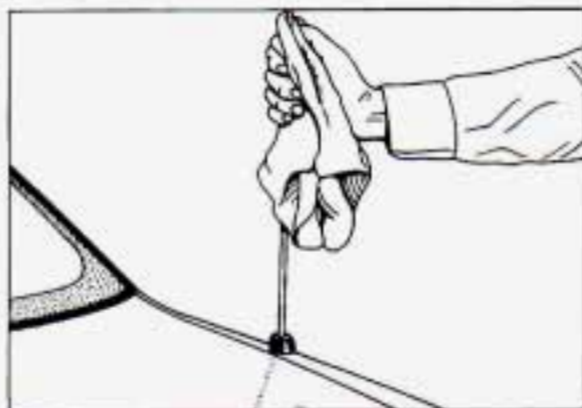

Power Antenna Mast Care

Your power antenna will look its best and work well if it's cleaned from time to time.

To Clean the Antenna Mast:

1. Turn on the ignition and radio to raise the antenna to full mast extension.
2. Dampen a clean cloth with mineral spirits or equivalent solvent.
3. Wipe cloth over the mast sections, removing any dirt.
4. Wipe dry with clean cloth before retracting.

5. Make the antenna go up and down by turning the radio or ignition on and off.
6. Then repeat if necessary.

NOTICE:

Don't lubricate the power antenna. Lubrication could damage it.

NOTICE:

Before entering an automatic car wash, turn off your radio to make the power antenna go down. This will prevent the mast from possibly getting damaged. If the antenna does not go down when you turn the radio off, it may be damaged or need to be cleaned. In either case, lower the antenna by hand by carefully pressing the antenna down.

If the mast portion of your antenna is damaged, you can easily replace it. See your dealer for a replacement kit and follow the instructions in the kit.



Here you'll find information about driving on different kinds of roads and in varying weather conditions. We've also included many other useful tips on driving.

Part 4

Your Driving and the Road

Defensive Driving.....	136
Drunken Driving.....	136
Control of a Vehicle	
Braking.....	138
Anti-Lock Brakes.....	139
Steering Tips.....	142
Steering in Emergencies.....	142
Passing.....	143
Driving at Night.....	145
Driving in the Rain.....	146
City Driving.....	148
Freeway Driving.....	149
Hill and Mountain Roads.....	150
Winter Driving.....	151
Towing a Trailer.....	154

■ *Defensive Driving*

The best advice anyone can give about driving is: Drive defensively.

Please start with a very important safety device in your Oldsmobile: Buckle up. (See *Safety Belts* in the *Index*.)

Defensive driving really means "be ready for anything." On city streets, rural roads, or freeways, it means "always expect the unexpected."

Assume that pedestrians or other drivers are going to be careless and make mistakes. Anticipate what they might do. Be ready for their mistakes.

Rear-end collisions are about the most preventable of accidents. Yet they are common. Allow enough following distance. It's the best defensive driving maneuver, in both city and rural driving. You never know when the vehicle in front of you is going to brake or turn suddenly.

■ *Drunken Driving*

Death and injury associated with drinking and driving is a national tragedy. It's the number one contributor to the highway death toll, claiming thousands of victims every year. Alcohol takes away three things that anyone needs to drive a vehicle:

- Judgment
- Muscular Coordination
- Vision

Police records show that almost half of all motor vehicle-related deaths involve alcohol — a driver, a passenger or someone else, such as a pedestrian, had been drinking. In most cases, these deaths are the result of someone who was drinking and driving. About 20,000 motor vehicle-related deaths occur each year because of alcohol, and thousands of people are injured.

Just how much alcohol is too much if a person plans to drive? Ideally, no one should drink alcohol and then drive. But if one does, then what's "too much"? It can be a lot less than many might think. Although it depends on each person and situation, here is some general information on the problem.

The Blood Alcohol Content (BAC) of someone who is drinking depends upon four things:

- How much alcohol is in the drink.
- The drinker's body weight.
- The amount of food that is consumed before and during drinking.
- The length of time it has taken the drinker to consume the alcohol.

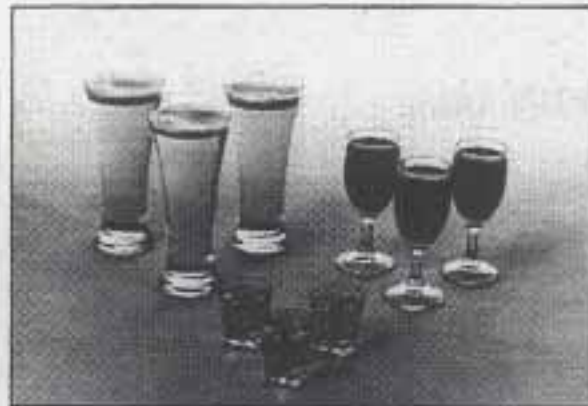

According to the American Medical Association, a 180-pound (82 kg) person who drinks three 12-ounce (355 ml) bottles of beer in an hour will end up with a BAC of about 0.06 percent. The person would reach the same BAC by drinking three 4-ounce (120 ml) glasses of wine or three mixed drinks if each had 1-1/2 ounces (45 ml) of a liquor like whiskey, gin or vodka.

It's the amount of alcohol that counts. For example, if the same person drank three double martinis (3 ounces or 90 ml of liquor each) within an hour, the person's BAC would be close to 0.12 percent. A person who consumes food just before or during drinking will have a slightly lower BAC level.

Drinking That Will Result in a BAC of .05% in the Time Shown

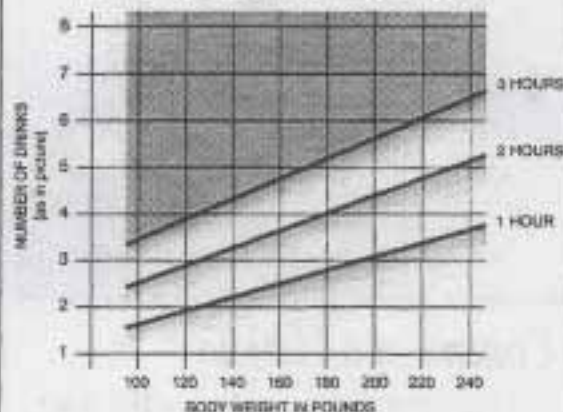

The law in most U.S. states sets the legal limit at a BAC of 0.10 percent. In Canada the limit is 0.08 percent, and in some other countries it's lower than that. The BAC will be over 0.10 percent after three to six drinks (in one hour). Of course, as we've seen, it depends on how much alcohol is in the drinks, and how quickly the person drinks them.

But it's very important to keep in mind that the ability to drive is affected well below a BAC of 0.10 percent. Research shows that the driving skills of many people are impaired at a BAC approaching 0.05 percent, and that the

effects are worse at night. All drivers are impaired at BAC levels above 0.05 percent. Statistics show that the chance of being in an accident increases sharply for drivers who have a BAC of 0.05 percent or above. A driver with a BAC level of 0.06 percent (three beers in one hour for a 180-pound or 82 kg person) has doubled his or her chance of having an accident. At a BAC level of 0.10 percent, the chance of that driver having an accident is six times greater; at a level of 0.15 percent, the chances are twenty-five times greater! And, the body takes about an hour to rid itself of the alcohol in one drink. No amount of coffee or number of cold showers will speed that up.

"I'll be careful" isn't the right answer. What if there's an emergency, a need to take sudden action, as when a child darts into the street? A person with a higher BAC might not be able to react quickly enough to avoid the collision.

There's something else about drinking and driving that many people don't know. Medical research shows that alcohol in a person's system can make crash injuries worse. That's especially

Your Driving and the Road

true for brain, spinal cord and heart injuries. That means that if anyone who has been drinking — driver or passenger — is in a crash, the chance of being killed or permanently disabled is higher than if that person had not been drinking. And we've already seen that the chance of a crash itself is higher for drinking drivers.



CAUTION:

Drinking and then driving is very dangerous. Your reflexes, perceptions, and judgment will be affected by even a small amount of alcohol. You could have a serious — or even fatal — accident if you drive after drinking. Please don't drink and drive or ride with a driver who has been drinking. Ride home in a cab; or if you're with a group, designate a driver who will not drink.

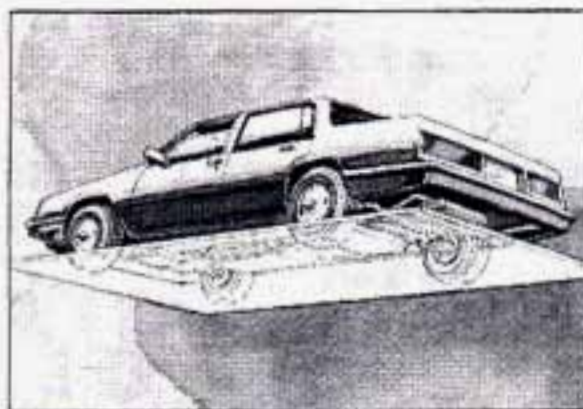

■ Control of a Vehicle

You have three systems that make your vehicle go where you want it to go. They are the brakes, the steering and the accelerator. All three systems have to do their work at the places where the tires meet the road.

Sometimes, as when you're driving on snow or ice, it's easy to ask more of those control systems than the tires and road can provide. That means you can lose control of your vehicle.

■ Braking

Braking action involves **perception time** and **reaction time**.

First, you have to decide to push on the brake pedal. That's **perception time**. Then you have to bring up your foot and do it. That's **reaction time**.

Average **reaction time** is about 3/4 of a second. But that's only an average. It might be less with one driver and as long as two or three seconds or more with another. Age, physical condition, alertness, coordination, and eyesight all play a part. So do alcohol, drugs and frustration. But even in 3/4 of a second, a vehicle moving at 60 mph (100 km/h) travels 66 feet (20 m). That could be a lot of distance in an emergency, so keeping enough space between your vehicle and others is important.

And, of course, actual stopping distances vary greatly with the surface of the road (whether it's pavement or gravel); the condition of the road (wet, dry, icy); tire tread; and the condition of your brakes.

Avoid needless heavy braking. Some people drive in spurts — heavy acceleration followed by heavy braking — rather than keeping pace with traffic. This is a mistake. Your brakes may not have time to cool between hard stops. Your brakes will wear out much faster if you do a lot of heavy braking. If you keep pace with the traffic and allow realistic following distances, you will eliminate a lot of unnecessary braking. That means better braking and longer brake life.

If your engine ever stops while you're driving, brake normally but don't pump your brakes. If you do, the pedal may get harder to push down. If your engine stops, you will still have some power brake assist. But you will use it when you brake. Once the power assist is used up, it may take longer to stop and the brake pedal will be harder to push.

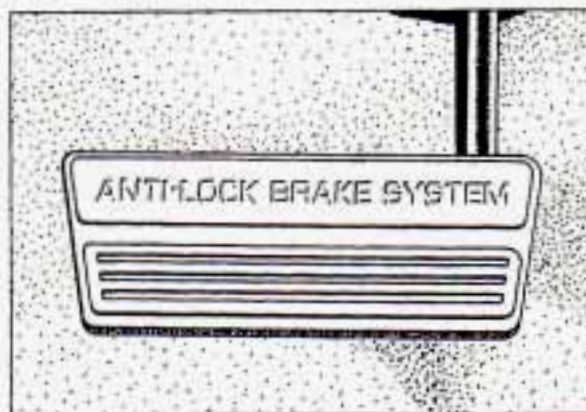

Anti-Lock Brakes (ABS)

Your Oldsmobile has an advanced electronic braking system that will help prevent skidding.

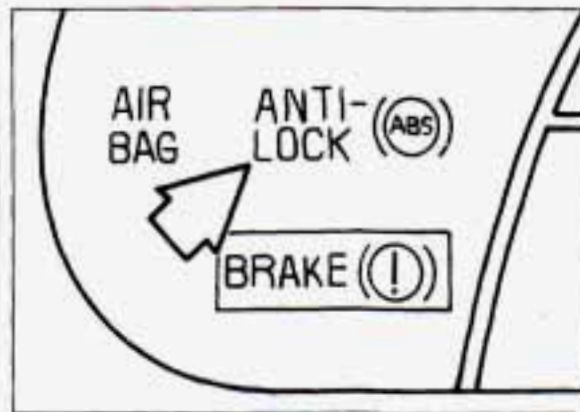

This light on the instrument panel will go on when you start your vehicle. When you start your vehicle and begin to drive away, you may hear a momentary motor or clicking noise. And you may even notice that your brake pedal moves a little while this is going on. This is the ABS system testing itself. If there's a problem with the anti-lock brake system, the anti-lock brake system warning light will stay on. See *Anti-Lock Brake System Warning Light* in the *Index*.

Your Driving and the Road



Here's how anti-lock works. Let's say the road is wet. You're driving safely. Suddenly an animal jumps out in front of you.

You slam on the brakes. Here's what happens with ABS.

A computer senses that wheels are slowing down. If one of the wheels is about to stop rolling, the computer will separately work the brakes at each front wheel and at the rear wheels.

The anti-lock system can change the brake pressure faster than any driver could. The computer is programmed to make the most of available tire and road conditions.



You can steer around the obstacle while braking hard.

As you brake, your computer keeps receiving updates on wheel speed and controls braking pressure accordingly.

Remember: Anti-lock doesn't change the time you need to get your foot up to the brake pedal. If you get too close to the vehicle in front of you, you won't have time to apply your brakes if that vehicle suddenly slows or stops. Always leave enough room up ahead to stop, even though you have anti-lock brakes.

To Use Anti-Lock

Don't pump the brakes. Just hold the brake pedal down and let anti-lock work for you. You may hear a motor or clicking noise during a hard stop, but this is normal.

Traction Control System (Option)

Your vehicle may have a traction control system that limits wheel spin. This is especially useful in slippery road conditions. The system operates only if it senses that one or both of the front wheels are spinning or beginning to lose traction. When this happens, the system works the front brakes and reduces engine power (by shutting off fuel injectors and managing spark) to limit wheel spin.

The **TRACTION ACTIVE** light will come on when your traction control system is limiting wheel spin. See *Traction Control System Active Light* in the *Index*.

If your vehicle has the Driver Information System, the **TRACTION CNTL ACTIVE** message will appear when your traction control system is limiting wheel spin. See *Driver Information System* in the *Index*.

You may feel the system working, or you may notice some noise, but this is normal. If your vehicle is in cruise control when the traction control system begins to limit wheel spin, the cruise control will automatically disengage. When road conditions allow you to safely use it again, you may re-engage the cruise control. (See *Cruise Control* in the *Index*.)

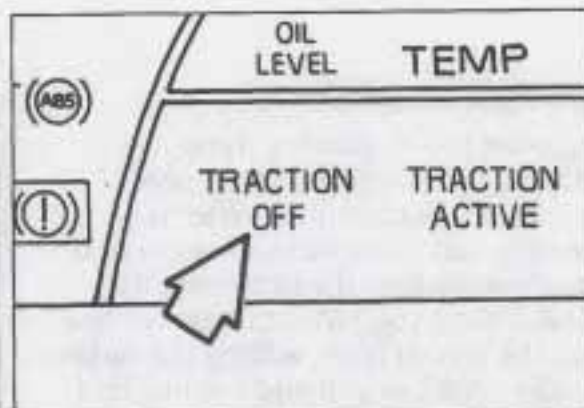

The **TRACTION OFF** warning light will come on when you turn the traction control system off. When the system is on, this light will come on to let you know if there's a problem with your traction control system. See *Traction Control System Warning Light* in the *Index*. When this warning light is on, the system will not limit wheel spin. Adjust your driving accordingly.

The traction control system automatically comes on whenever you start your vehicle. To limit wheel spin, especially in slippery road conditions, you should always leave the system on. But you can turn the traction control system off if you ever need to. (You should turn the system off if your vehicle ever gets stuck in sand, mud, ice or snow. See *Rocking Your Vehicle* in the *Index*.)

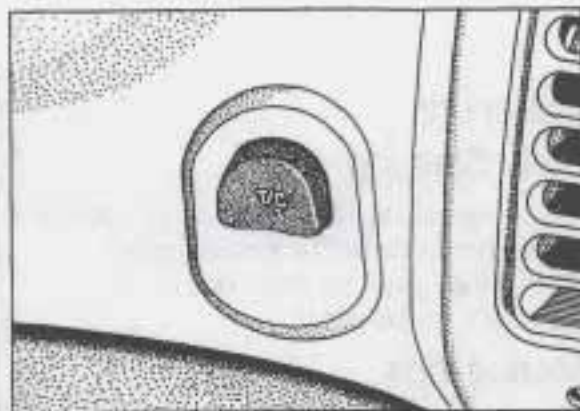

To turn the system off, press the T/C button located to the right of the steering wheel.

The **TRACTION OFF** warning light will come on and stay on. If the system is limiting wheel spin when you press the button, the system won't turn off right away. It will wait until there's no longer a current need to limit wheel spin.

You can turn the system back on at any time by pressing the button again. The **TRACTION OFF** warning light should go off.

Braking in Emergencies

Use your anti-lock braking system when you need to. With anti-lock, you can steer and brake at the same time. In many emergencies, steering can help you more than even the very best braking.

Your Driving and the Road

■ *Steering*

Power Steering

If you lose power steering assist because the engine stops or the system is not functioning, you can steer but it will take much more effort.

Steering Tips

Driving on Curves

It's important to take curves at a reasonable speed.

A lot of the "driver lost control" accidents mentioned on the news happen on curves. Here's why:

Experienced driver or beginner, each of us is subject to the same laws of physics when driving on curves. The traction of the tires against the road surface makes it possible for the vehicle to change its path when you turn the front wheels. If there's no traction, inertia will keep the vehicle going in the same direction. If you've ever tried to steer a vehicle on wet ice, you'll understand this.

The traction you can get in a curve depends on the condition of your tires and the road surface, the angle at which the curve is banked, and your speed. While you're in a curve, speed is the one

factor you can control.

Suppose you're steering through a sharp curve. Then you suddenly accelerate. Both control systems — steering and acceleration — have to do their work where the tires meet the road. Unless you have traction control and the system is on, adding the sudden acceleration can demand too much of those places. You can lose control.

What should you do if this ever happens? Ease up on the accelerator pedal, steer the vehicle the way you want it to go, and slow down.

Speed limit signs near curves warn that you should adjust your speed. Of course, the posted speeds are based on good weather and road conditions. Under less favorable conditions you'll want to go slower.

If you need to reduce your speed as you approach a curve, do it before you enter the curve, while your front wheels are straight ahead.

Try to adjust your speed so you can "drive" through the curve. Maintain a reasonable, steady speed. Wait to accelerate until you are out of the curve, and then accelerate gently into the straightaway.



Steering in Emergencies

There are times when steering can be more effective than braking. For example, you come over a hill and find a truck stopped in your lane, or a car suddenly pulls out from nowhere, or a child darts out from between parked cars and stops right in front of you. You can avoid these problems by braking — if you can stop in time. But sometimes you can't; there isn't room. That's the time for evasive action — steering around the problem.

Your Oldsmobile can perform very well in emergencies like these. First apply your brakes. It is better to remove as much speed as you can from a possible collision. Then steer around the problem, to the left or right depending on the space available.

An emergency like this requires close attention and a quick decision. If you are holding the steering wheel at the recommended 9 and 3 o'clock positions, you can turn it a full 180 degrees very quickly without removing either hand. But you have to act fast, steer quickly, and just as quickly straighten the wheel once you have avoided the object.

The fact that such emergency situations are always possible is a good reason to practice defensive driving at all times and wear safety belts properly.



■ *Off-Road Recovery*

You may find sometime that your right wheels have dropped off the edge of a road onto the shoulder while you're driving.

If the level of the shoulder is only slightly below the pavement, recovery should be fairly easy. Ease off the accelerator and then, if there is nothing in the way, steer so that your vehicle straddles the edge of the pavement. You can turn the steering wheel up to $\frac{1}{4}$ turn until the right front tire contacts the pavement edge. Then turn your steering wheel to go straight down the roadway.

■ *Passing*

The driver of a vehicle about to pass another on a two-lane highway waits for just the right moment, accelerates, moves around the vehicle ahead, then goes back into the right lane again. A simple maneuver?

Not necessarily! Passing another vehicle on a two-lane highway is a potentially dangerous move, since the passing vehicle occupies the same lane as oncoming traffic for several seconds. A miscalculation, an error in judgment, or a brief surrender to frustration or anger can suddenly put the passing driver face to face with the worst of all traffic accidents — the head-on collision.

So here are some tips for passing:

- "Drive ahead." Look down the road, to the sides, and to crossroads for situations that might affect your passing patterns. If you have any doubt whatsoever about making a successful pass, wait for a better time.
- Watch for traffic signs, pavement markings, and lines. If you can see a sign up ahead that might indicate a turn or an intersection, delay your

Your Driving and the Road

pass. A broken center line usually indicates it's all right to pass (providing the road ahead is clear). Never cross a solid line on your side of the lane or a double solid line, even if the road seems empty of approaching traffic.

- Do not get too close to the vehicle you want to pass while you're awaiting an opportunity. For one thing, following too closely reduces your area of vision, especially if you're following a larger vehicle. Also, you won't have adequate space if the vehicle ahead suddenly slows or stops. Keep back a reasonable distance.
- When it looks like a chance to pass is coming up, start to accelerate but stay in the right lane and don't get too close. Time your move so you will be increasing speed as the time comes to move into the other lane. If the way is clear to pass, you will have a "running start" that more than makes up for the distance you would lose by dropping back. And if something happens to cause you to cancel your pass, you need only slow down and drop back again and wait for another opportunity.

- If other cars are lined up to pass a slow vehicle, wait your turn. But take care that someone isn't trying to pass you as you pull out to pass the slow vehicle. Remember to glance over your shoulder and check the blind spot.
- Check your mirrors, glance over your shoulder, and start your left lane change signal before moving out of the right lane to pass. When you are far enough ahead of the passed vehicle to see its front in your inside mirror, activate your right lane change signal and move back into the right lane. (Remember that your right outside mirror is convex. The vehicle you just passed may seem to be farther away from you than it really is.)
- Try not to pass more than one vehicle at a time on two-lane roads. Reconsider before passing the next vehicle.
- Don't overtake a slowly moving vehicle too rapidly. Even though the brake lights are not flashing, it may be slowing down or starting to turn.
- If you're being passed, make it easy for the following driver to get ahead of you. Perhaps you can ease a little to the right.

■ *Loss of Control*

Let's review what driving experts say about what happens when the three control systems (brakes, steering and acceleration) don't have enough friction where the tires meet the road to do what the driver has asked.

In any emergency, don't give up. Keep trying to steer and constantly seek an escape route or area of less danger.

Skidding

In a skid, a driver can lose control of the vehicle. Defensive drivers avoid most skids by taking reasonable care suited to existing conditions, and by not "overdriving" those conditions. But skids are always possible.

The three types of skids correspond to your Oldsmobile's three control systems. In the braking skid your wheels aren't rolling. In the steering or cornering skid, too much speed or steering in a curve causes tires to slip and lose cornering force. And in the acceleration skid too much throttle causes the driving wheels to spin.

A cornering skid is best handled by easing your foot off the accelerator pedal.

If you have the traction control system, remember: It helps avoid only the acceleration skid.

If you do not have traction control, or if the system is off, then an acceleration skid is also best handled by easing your foot off the accelerator pedal.

If your vehicle starts to slide, ease your foot off the accelerator pedal and quickly steer the way you want the vehicle to go. If you start steering quickly enough, your vehicle may straighten out. Always be ready for a second skid if it occurs.

Of course, traction is reduced when water, snow, ice, gravel, or other material is on the road. For safety, you'll want to slow down and adjust your driving to these conditions. It is important to slow down on slippery surfaces because stopping distance will be longer and vehicle control more limited.

While driving on a surface with reduced traction, try your best to avoid sudden steering, acceleration, or braking (including engine braking by shifting to a lower gear). Any sudden changes could cause the tires to slide. You may not realize the surface is slippery until your vehicle is skidding. Learn to recognize warning clues — such as enough water, ice or packed snow on the road to make a “mirrored surface” — and slow down when you have any doubt.

Remember: Any anti-lock braking system (ABS) helps avoid only the braking skid.

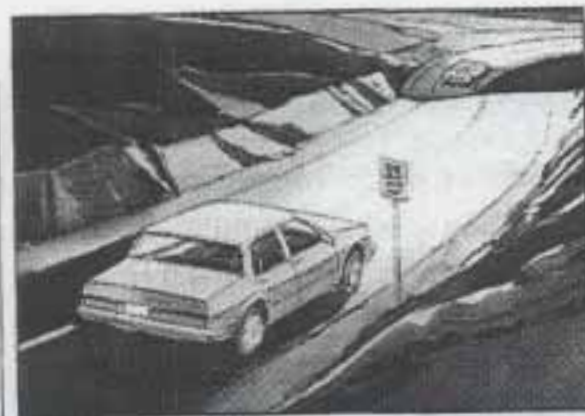

■ *Driving at Night*

Night driving is more dangerous than day driving. One reason is that some drivers are likely to be impaired — by alcohol or drugs, with night vision problems, or by fatigue.

Here are some tips on night driving.

- Drive defensively.
- Don't drink and drive.
- Adjust your inside rearview mirror to reduce the glare from headlights behind you.
- Since you can't see as well, you may need to slow down and keep more space between you and other vehicles.

Your Driving and the Road

- Slow down, especially on higher speed roads. Your headlights can light up only so much road ahead.
- In remote areas, watch for animals.
- If you're tired, pull off the road in a safe place and rest.

Night Vision

No one can see as well at night as in the daytime. But as we get older these differences increase. A 50-year-old driver may require at least twice as much light to see the same thing at night as a 20-year-old.

What you do in the daytime can also affect your night vision. For example, if you spend the day in bright sunshine you are wise to wear sunglasses. Your eyes will have less trouble adjusting to night. But if you're driving, don't wear sunglasses at night. They may cut down on glare from headlights, but they also make a lot of things invisible.

You can be temporarily blinded by approaching lights. It can take a second or two, or even several seconds, for your eyes to readjust to the dark. When you are faced with severe glare (as from a driver who doesn't lower the high

beams, or a vehicle with misaimed headlights), slow down a little. Avoid staring directly into the approaching lights.

Keep your windshield and all the glass on your vehicle clean — inside and out. Glare at night is made much worse by dirt on the glass. Even the inside of the glass can build up a film caused by dust. Dirty glass makes lights dazzle and flash more than clean glass would, making the pupils of your eyes contract repeatedly.

Remember that your headlights light up far less of a roadway when you are in a turn or curve. Keep your eyes moving; that way, it's easier to pick out dimly lighted objects. Just as your headlights should be checked regularly for proper aim, so should your eyes be examined regularly. Some drivers suffer from night blindness — the inability to see in dim light — and aren't even aware of it.



■ Driving in the Rain

Rain and wet roads can mean driving trouble. On a wet road you can't stop, accelerate or turn as well because your tire-to-road traction isn't as good as on dry roads. And, if your tires don't have much tread left, you'll get even less traction. It's always wise to go slower and be cautious if rain starts to fall while you are driving. The surface may get wet suddenly when your reflexes are tuned for driving on dry pavement.

The heavier the rain, the harder it is to see. Even if your windshield wiper blades are in good shape, a heavy rain can make it harder to see road signs and traffic signals, pavement markings, the edge of the road, and even people walking.

It's wise to keep your wiping equipment in good shape and keep your windshield washer tank filled. Replace your windshield wiper inserts when they show signs of streaking or missing areas on the windshield, or when strips of rubber start to separate from the inserts.



Driving too fast through large water puddles or even going through some car washes can cause problems, too. The water may affect your brakes. Try to avoid puddles. But if you can't, try to slow down before you hit them.



CAUTION:

Wet brakes can cause accidents. They won't work well in a quick stop and may cause pulling to one side. You could lose control of the vehicle. After driving through a large puddle of water or a car wash, apply your brake pedal lightly until your brakes work normally.

Hydroplaning

Hydroplaning is dangerous. So much water can build up under your tires that they can actually ride on the water. This can happen if the road is wet enough and you're going fast enough. When your vehicle is hydroplaning, it has little or no contact with the road.

Hydroplaning doesn't happen often. But it can if your tires haven't much tread or if the pressure in one or more is low. It can happen if a lot of water is standing on the road. If you can see reflections from trees, telephone poles, or other vehicles, and raindrops "dimple" the water's surface, there could be hydroplaning.

Hydroplaning usually happens at higher speeds. There just isn't a hard and fast rule about hydroplaning. The best advice is to slow down when it is raining.

Some Other Rainy Weather Tips

- Turn on your low-beam headlights — not just your parking lights — to help make you more visible to others.
- Besides slowing down, allow some extra following distance. And be

Your Driving and the Road

especially careful when you pass another vehicle. Allow yourself more clear room ahead, and be prepared to have your view restricted by road spray.

- Have good tires with proper tread depth. (See *Tires* in the *Index*.)



■ *City Driving*

One of the biggest problems with city streets is the amount of traffic on them. You'll want to watch out for what the other drivers are doing and pay attention to traffic signals.

Here are ways to increase your safety in city driving:

- Know the best way to get to where you are going. Get a city map and plan your trip into an unknown part of the city just as you would for a cross-country trip.
- Try to use the freeways that rim and crisscross most large cities. You'll save time and energy. (See the next section, *Freeway Driving*.)

- Treat a green light as a warning signal. A traffic light is there because the corner is busy enough to need it. When a light turns green, and just before you start to move, check both ways for vehicles that have not cleared the intersection or may be running the red light.

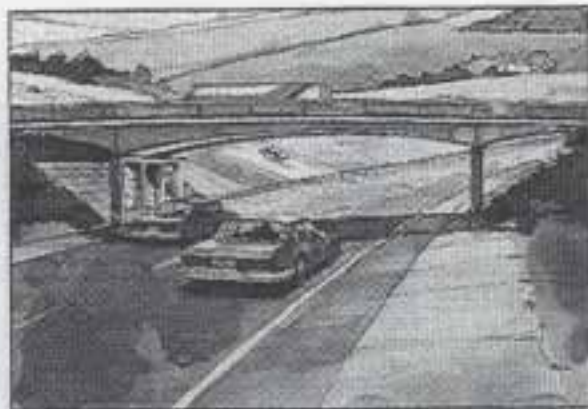

■ *Freeway Driving*

Mile for mile, freeways (also called thruways, parkways, expressways, turnpikes, or superhighways) are the safest of all roads. But they have their own special rules.

The most important advice on freeway driving is: **Keep up with traffic and keep to the right.** Drive at the same speed most of the other drivers are driving. Too-fast or too-slow driving breaks a smooth traffic flow. Treat the left lane on a freeway as a passing lane.

At the entrance there is usually a ramp that leads to the freeway. If you have a clear view of the freeway as you drive along the entrance ramp, you should begin to check traffic. Try to determine where you expect to blend with the

flow. Try to merge into the gap at close to the prevailing speed. Switch on your turn signal, check your mirrors and glance over your shoulder as often as necessary. Try to blend smoothly with the traffic flow.

Once you are on the freeway, adjust your speed to the posted limit or to the prevailing rate if it's slower. Stay in the right lane unless you want to pass.

Before changing lanes, check your mirrors. Then use your turn signal.

Just before you leave the lane, glance quickly over your shoulder to make sure there isn't another vehicle in your "blind" spot.

Once you are moving on the freeway, make certain you allow a reasonable following distance. Expect to move slightly slower at night.

When you want to leave the freeway, move to the proper lane well in advance. If you miss your exit do not, under any circumstances, stop and back up. Drive on to the next exit.

The exit ramp can be curved, sometimes quite sharply.

The exit speed is usually posted.

Reduce your speed according to your speedometer, not to your sense of motion. After driving for any distance at higher speeds, you may tend to think you are going slower than you actually are.

■ *Before Leaving on a Long Trip*

Make sure you're ready. Try to be well rested. If you must start when you're not fresh — such as after a day's work — don't plan to make too many miles that first part of the journey. Wear comfortable clothing and shoes you can easily drive in.

Is your vehicle ready for a long trip? If you keep it serviced and maintained, it's ready to go. If it needs service, have it done before starting out. Of course, you'll find experienced and able service experts in Oldsmobile dealerships all across North America. They'll be ready and willing to help if you need it.

Your Driving and the Road

Here are some things you can check before a trip:

- **Windshield Washer Fluid:** Is the reservoir full? Are all windows clean inside and outside?
- **Wiper Blades:** Are they in good shape?
- **Fuel, Engine Oil, Other Fluids:** Have you checked all levels?
- **Lights:** Are they all working? Are the lenses clean?
- **Tires:** They are vitally important to a safe, trouble-free trip. Is the tread good enough for long-distance driving? Are the tires all inflated to the recommended pressure?
- **Weather Forecasts:** What's the weather outlook along your route? Should you delay your trip a short time to avoid a major storm system?
- **Maps:** Do you have up-to-date maps?

■ *Highway Hypnosis*

Is there actually such a condition as "highway hypnosis"? Or is it just plain falling asleep at the wheel? Call it highway hypnosis, lack of awareness, or whatever.

There is something about an easy stretch of road with the same scenery, along with the hum of the tires on the road, the drone of the engine, and the rush of the wind against the vehicle that can make you sleepy. Don't let it happen to you! If it does, your vehicle can leave the road in **less than a second**, and you could crash and be injured.

What can you do about highway hypnosis? First, be aware that it can happen.

Then here are some tips:

- Make sure your vehicle is well ventilated, with a comfortably cool interior.
- Keep your eyes moving. Scan the road ahead and to the sides. Check your rearview mirrors and your instruments frequently.
- If you get sleepy, pull off the road into a rest, service, or parking area and take a nap, get some exercise, or both. For safety, treat drowsiness on the highway as an emergency.



■ *Hill and Mountain Roads*

Driving on steep hills or mountains is different from driving in flat or rolling terrain.

If you drive regularly in steep country, or if you're planning to visit there, here are some tips that can make your trips safer and more enjoyable.

- Keep your vehicle in good shape. Check all fluid levels and also the brakes, tires, cooling system and transaxle. These parts can work hard on mountain roads.
- Know how to go down hills. The most important thing to know is this: let your engine do some of the slowing down. Shift to a lower gear when you go down a steep or long hill.



CAUTION:

If you don't shift down, your brakes could get so hot that they wouldn't work well. You would then have poor braking or even none going down a hill. You could crash. Shift down to let your engine assist your brakes on a steep downhill slope.



CAUTION:

Coasting downhill in **N** (Neutral) or with the ignition off is dangerous. Your brakes will have to do all the work of slowing down. They could get so hot that they wouldn't work well. You could crash. Always have your engine running and your vehicle in gear when you go downhill.

- Know how to go uphill. Shift down to **3** (Third). This will help cool your engine and transaxle, and you can climb the hill better.
- Stay in your own lane when driving on two-lane roads in hills or mountains. Don't swing wide or cut across the center of the road. Drive at speeds that let you stay in your own lane.
- As you go over the top of a hill, be alert. There could be something in your lane, like a stalled car or an accident.
- You may see highway signs on mountains that warn of special problems. Examples are long grades, passing or no-passing zones, a falling rocks area, or winding roads. Be alert to these and take appropriate action.



■ *Winter Driving*

Here are some tips for winter driving:

- Have your Oldsmobile in good shape for winter. Be sure your engine coolant mix is correct.

Your Driving and the Road

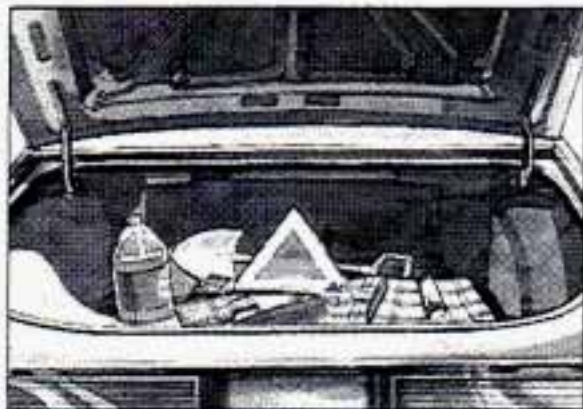

- You may want to put winter emergency supplies in your trunk.

Include an ice scraper, a small brush or broom, a supply of windshield washer fluid, a rag, some winter outer clothing, a small shovel, a flashlight, a red cloth, and a couple of reflective warning triangles. And, if you will be driving under severe conditions, include a small bag of sand, a piece of old carpet or a couple of burlap bags to help provide traction. Be sure you properly secure these items in your vehicle.



Driving on Snow or Ice

Most of the time, those places where your tires meet the road probably have good traction.

However, if there is snow or ice between your tires and the road, you can have a very slippery situation. You'll have a lot less traction or "grip" and will need to be very careful.

What's the worst time for this? "Wet ice." Very cold snow or ice can be slick and hard to drive on. But wet ice can be even more trouble because it may offer the least traction of all. You can get "wet ice" when it's about freezing (32°F; 0°C) and freezing rain begins to fall. Try to avoid driving on wet ice until salt and sand crews can get there.

Whatever the condition — smooth ice, packed, blowing or loose snow — drive with caution.

If you have traction control, keep the system on. It will improve your ability to accelerate when driving on a slippery road. Even though your vehicle has a traction control system, you'll want to slow down and adjust your driving to the road conditions. See *Traction Control System* in the *Index*.

If you don't have the traction control system, accelerate gently. Try not to break the fragile traction. If you accelerate too fast, the drive wheels will spin and polish the surface under the tires even more.

Your anti-lock brakes improve your ability to make a hard stop on a slippery road. Even though you have the anti-lock braking system, you'll want to begin stopping sooner than you would on dry pavement. See *Anti-Lock Brakes* in the *Index*.

- Allow greater following distance on any slippery road.
- Watch for slippery spots. The road might be fine until you hit a spot that's covered with ice. On an otherwise clear road, ice patches may appear in shaded areas where the sun can't reach: around clumps of trees, behind buildings, or under bridges. Sometimes the surface of a curve or an overpass may remain icy when the surrounding roads are clear. If you see a patch of ice ahead of you, brake before you are on it. Try not to brake while you're actually on the ice, and avoid sudden steering maneuvers.



If You're Caught in a Blizzard

If you are stopped by heavy snow, you could be in a serious situation. You should probably stay with your vehicle unless you know for sure that you are near help and you can hike through the snow. Here are some things to do to summon help and keep yourself and your passengers safe: Turn on your hazard flashers. Tie a red cloth to your vehicle to alert police that you've been stopped by the snow. Put on extra clothing or wrap a blanket around you. If you have no blankets or extra clothing, make body insulators from newspapers, burlap bags, rags, floor mats — anything you can wrap around yourself or tuck under your clothing to keep warm.

You can run the engine to keep warm, but be careful.



CAUTION:

Snow can trap exhaust gases under your vehicle. This can cause deadly CO (carbon monoxide) gas to get inside. CO could overcome you and kill you. You can't see it or smell it, so you might not know it is in your vehicle. Clear away snow from around the base of your vehicle, especially any that is blocking your exhaust pipe. And check around again from time to time to be sure snow doesn't collect there. Open a window just a little on the side of the vehicle that's away from the wind. This will help keep CO out.

Run your engine only as long as you must. This saves fuel. When you run the engine, make it go a little faster than just idle. That is, push the accelerator slightly. This uses less fuel for the heat that you get and it keeps the battery charged. You will need a well-charged battery to restart the vehicle, and possibly for signaling later on with your headlights. Let the heater run for awhile. Then, shut the engine off and close the window almost all the way to preserve the heat. Start the engine again and repeat this only when you feel really uncomfortable from the cold. But do it as little as possible. Preserve the fuel as long as you can. To help keep warm, you can get out of the vehicle and do some fairly vigorous exercises every half hour or so until help comes.

■ Towing a Trailer



CAUTION:

If you don't use the correct equipment and drive properly, you can lose control when you pull a trailer. For example, if the trailer is too heavy, the brakes may not work well — or even at all. You and your passengers could be seriously injured. Pull a trailer only if you have followed all the steps in this section. Ask your Oldsmobile dealer for advice and information about towing a trailer with your vehicle.

NOTICE:

Pulling a trailer improperly can damage your vehicle and result in costly repairs not covered by your warranty. To pull a trailer correctly, follow the advice in this section, and see your Oldsmobile dealer for important information about towing a trailer with your vehicle.

Your vehicle can tow a trailer if it is equipped with either the 3800 engine (Code L) or the optional 3800 supercharged engine (Code 1) and proper trailer towing equipment. To identify what the vehicle trailering capacity is for your vehicle, you should read the information in *Weight of the Trailer* that appears later in this section. But trailering is different than just driving your vehicle by itself. Trailering means changes in handling, durability, and fuel economy. Successful, safe trailering takes correct equipment, and it has to be used properly.

That's the reason for this section. In it are many time-tested, important trailering tips and safety rules. Many of these are important for your safety and that of your passengers. So please read this section carefully before you pull a trailer.

Load-pulling components such as the engine, transaxle, wheel assemblies, and tires are forced to work harder against the drag of the added weight. The engine is required to operate at relatively higher speeds and under greater loads, generating extra heat. What's more, the trailer adds considerably to wind resistance, increasing the pulling requirements.

If You Do Decide To Pull A Trailer

If you do, here are some important points.

- There are many different laws having to do with trailering. Make sure your rig will be legal, not only where you live but also where you'll be driving. A good source for this information can be state or provincial police.
- Consider using a sway control. You can ask a hitch dealer about sway controls.
- Don't tow a trailer at all during the first 500 miles (800 km) your new vehicle is driven. Your engine, axle or other parts could be damaged.
- Then, during the first 500 miles (800 km) that you tow a trailer, don't drive over 50 mph (80 km/h) and don't make starts at full throttle. This helps your engine and other parts of your vehicle wear in at the heavier loads.

Three important considerations have to do with weight:

Weight of the Trailer

How heavy can a trailer safely be?

It should never weigh more than 1,000 pounds (450 kg). But even that can be too heavy.

It depends on how you plan to use your rig. For example, speed, altitude, road grades, outside temperature and how much your vehicle is used to pull a trailer are all important. And, it can also depend on any special equipment that you have on your vehicle.

You can ask your dealer for our trailering information or advice, or you can write us at:

Oldsmobile Customer Assistance
Network
P.O. Box 30095
Lansing, MI 48909

In Canada, write to:

General Motors of Canada Limited
Customer Assistance Center
1908 Colonel Sam Drive
Oshawa, Ontario L1H 8P7

Your Driving and the Road

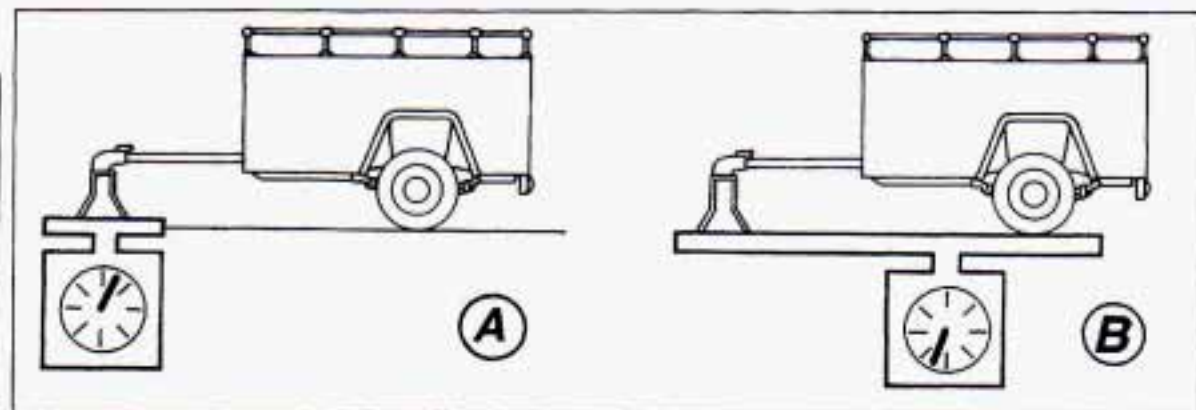

Weight of the Trailer Tongue

The tongue load (A) of any trailer is an important weight to measure because it affects the total capacity weight of your vehicle. The capacity weight includes the curb weight of the vehicle, any cargo you may carry in it, and the people who will be riding in the vehicle. And if you will tow a trailer, you must subtract the tongue load from your vehicle's capacity weight because your vehicle will be carrying that weight, too. See *Loading Your Vehicle* in the *Index* for more information about your vehicle's maximum load capacity.

If you're using a "dead-weight" hitch, the trailer tongue (A) should weigh 10% of the total loaded trailer weight (B). If you have a "weight-distributing"

hitch, the trailer tongue (A) should weigh 12% of the total loaded trailer weight (B).

After you've loaded your trailer, weigh the trailer and then the tongue, separately, to see if the weights are proper. If they aren't, you may be able to get them right simply by moving some items around in the trailer.

Total Weight on Your Vehicle's Tires

Be sure your vehicle's tires are inflated to the limit for cold tires. You'll find these numbers on the Tire-Loading Information label at the rear edge of the driver's door or see *Loading Your Vehicle* in the *Index*. Then be sure you don't go over the GVW limit for your vehicle.

Hitches

It's important to have the correct hitch equipment. Crosswinds, large trucks going by, and rough roads are a few reasons why you'll need the right hitch. Here are some rules to follow:

- Will you have to make any holes in the body of your vehicle when you install a trailer hitch? If you do, then be sure to seal the holes later when you remove the hitch. If you don't seal them, deadly carbon monoxide (CO) from your exhaust can get into your vehicle (see *Carbon Monoxide* in the *Index*). Dirt and water can, too.
- The bumpers on your vehicle are not intended for hitches. Do not attach rental hitches or other bumper-type hitches to them. Use only a frame-mounted hitch that does not attach to the bumper.

Safety Chains

You should always attach chains between your vehicle and your trailer. Cross the safety chains under the tongue of the trailer so that the tongue will not drop to the road if it becomes separated from the hitch. Instructions

about safety chains may be provided by the hitch manufacturer or by the trailer manufacturer. Follow the manufacturer's recommendation for attaching safety chains. Always leave just enough slack so you can turn with your rig. And, never allow safety chains to drag on the ground.

Trailer Brakes

Does your trailer have its own brakes?

Be sure to read and follow the instructions for the trailer brakes so you'll be able to install, adjust and maintain them properly.

Because you have anti-lock brakes, do not try to tap into your vehicle's brake system. If you do, both brake systems won't work well, or at all.

Driving with a Trailer

Towing a trailer requires a certain amount of experience. Before setting out for the open road, you'll want to get to know your rig. Acquaint yourself with the feel of handling and braking with the added weight of the trailer. And always keep in mind that the vehicle you are driving is now a good

deal longer and not nearly so responsive as your vehicle is by itself.

Before you start, check the trailer hitch and platform, safety chains, electrical connector, lights, tires and mirror adjustment. If the trailer has electric brakes, start your vehicle and trailer moving and then apply the trailer brake controller by hand to be sure the brakes are working. This lets you check your electrical connection at the same time.

During your trip, check occasionally to be sure that the load is secure, and that the lights and any trailer brakes are still working.

Following Distance

Stay at least twice as far behind the vehicle ahead as you would when driving your vehicle without a trailer. This can help you avoid situations that require heavy braking and sudden turns.

Passing

You'll need more passing distance up ahead when you're towing a trailer. And, because you're a good deal longer, you'll need to go much farther beyond

the passed vehicle before you can return to your lane.

Backing Up

Hold the bottom of the steering wheel with one hand. Then, to move the trailer to the left, just move that hand to the left. To move the trailer to the right, move your hand to the right. Always back up slowly and, if possible, have someone guide you.

Making Turns

When you're turning with a trailer, make wider turns than normal. Do this so your trailer won't strike soft shoulders, curbs, road signs, trees, or other objects. Avoid jerky or sudden maneuvers. Signal well in advance.

Turn Signals When Towing a Trailer

When you tow a trailer, your vehicle has to have a different turn signal flasher and extra wiring. The green arrows on your instrument panel will flash whenever you signal a turn or lane change. Properly hooked up, the trailer lights will also flash, telling other drivers you're about to turn, change lanes or stop.

Your Driving and the Road

When towing a trailer, the green arrows on your instrument panel will flash for turns even if the bulbs on the trailer are burned out. Thus, you may think drivers behind you are seeing your signal when they are not. It's important to check occasionally to be sure the trailer bulbs are still working.

Your vehicle may have bulb warning messages. When you plug trailer lights into your vehicle's lighting system, its bulb warning messages may not let you know if one of your lights goes out. So, when you have trailer lights plugged in, be sure to check your vehicle and trailer lights from time to time to be sure they're all working. Once you disconnect the trailer lights, the bulb warning messages again can tell you if one of your vehicle lights is out.

Driving On Grades

Reduce speed and shift to a lower gear **before** you start down a long or steep downgrade. If you don't shift down, you might have to use your brakes so much that they would get hot and no longer work well.

On a long uphill grade, shift down to **3** (Third) and reduce your speed to around 45 mph (70 km/h) to reduce the possibility of engine and transaxle overheating.

Parking on Hills

You really should not park your vehicle, with a trailer attached, on a hill. If something goes wrong, your rig could start to move. People can be injured, and both your vehicle and the trailer can be damaged.

But if you ever have to park your rig on a hill, here's how to do it:

1. Apply your regular brakes, but don't shift into **P** (Park) yet.
2. Have someone place chocks under the trailer wheels.
3. When the wheel chocks are in place, release the regular brakes until the chocks absorb the load.
4. Reapply the regular brakes. Then apply your parking brake, and then shift to **P** (Park).
5. Release the regular brakes.

When You Are Ready to Leave After Parking on a Hill

1. Apply your regular brakes and hold the pedal down while you:
 - Start your engine;
 - Shift into a gear; and
 - Release the parking brake.
2. Let up on the brake pedal.
3. Drive slowly until the trailer is clear of the chocks.
4. Stop and have someone pick up and store the chocks.

Maintenance When Trailer Towing

Your vehicle will need service more often when you're pulling a trailer. See the Maintenance Schedule for more on this. Things that are especially important in trailer operation are automatic transaxle fluid (don't overfill), engine oil, belt, cooling system, and brake adjustment. Each of these is covered in this manual, and the *Index* will help you find them quickly. If you're trailering, it's a good idea to review these sections before you start your trip. Check periodically to see that all hitch nuts and bolts are tight.



Here you'll find what to do about some problems that can occur on the road.

Part 5

Problems on the Road

Hazard Warning Flashers	160
Jump Starting	161
Towing Your Oldsmobile.....	164
Engine Overheating.....	167
If a Tire Goes Flat	173
Changing a Flat Tire.....	173
Compact Spare Tire	180
If You're Stuck: In Sand, Mud, Ice or Snow	181

Problems on the Road

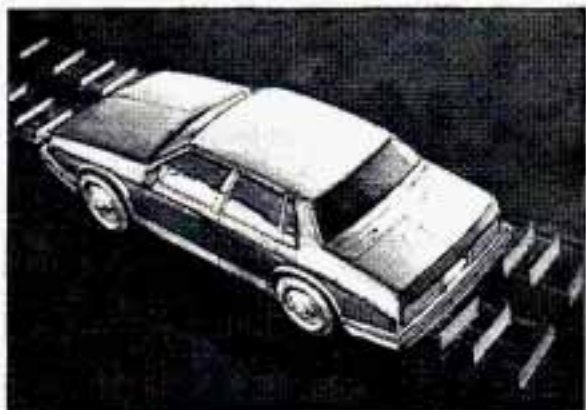

■ Hazard Warning Flashers

Your hazard warning flashers let you warn others. They also let police know you have a problem. Your front and rear turn signal lights will flash on and off.

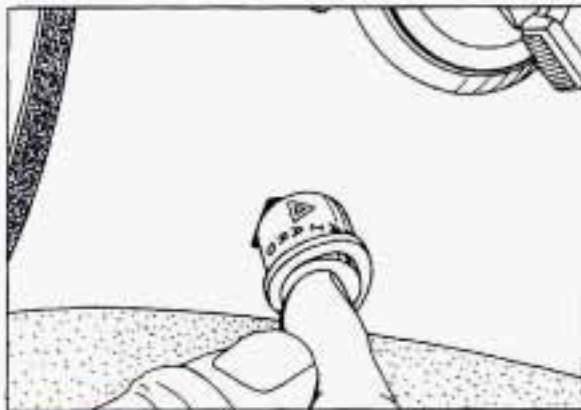

Press the button in to make your front and rear turn signal lights flash on and off.

Your hazard warning flashers work no matter what position your key is in, and even if the key isn't in.

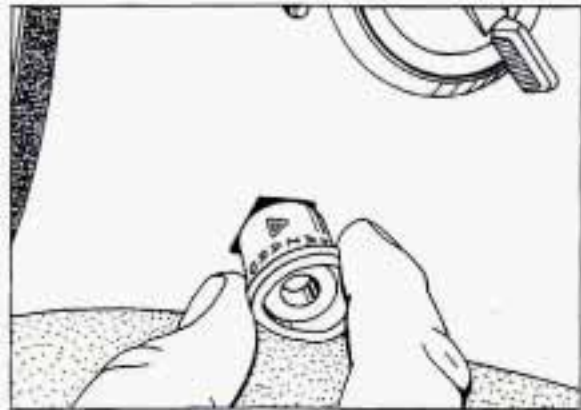

To turn off the flashers, pull out on the collar.

When the hazard warning flashers are on, your turn signals won't work.

Other Warning Devices

If you carry reflective triangles, you can set one up at the side of the road about 300 feet (100 m) behind your vehicle.

■ Jump Starting

If your battery has run down, you may want to use another vehicle and some jumper cables to start your Oldsmobile. But please follow the steps below to do it safely.



CAUTION:

Batteries can hurt you. They can be dangerous because:

- They contain **acid** that can burn you.
- They contain **gas** that can explode or ignite.
- They contain enough **electricity** to burn you.

If you don't follow these steps exactly, some or all of these things can hurt you.

NOTICE:

Ignoring these steps could result in costly damage to your vehicle that wouldn't be covered by your warranty. Trying to start your Oldsmobile by pushing or pulling it won't work, and it could damage your vehicle.

To Jump Start Your Oldsmobile:

1. Check the other vehicle. It must have a 12-volt battery with a negative ground system.

NOTICE:

If the other system isn't a 12-volt system with a negative ground, both vehicles can be damaged.

2. Get the vehicles close enough so the jumper cables can reach, but be sure the vehicles aren't touching each other. If they are, it could cause a ground connection you don't want. You wouldn't be able to start your Oldsmobile, and the bad grounding could damage the electrical systems.

You could be injured if the vehicles roll. Set the parking brake firmly on each vehicle. Put an automatic transaxle in **P** (Park) or a manual transaxle in **N** (Neutral).

3. Turn off the ignition on both vehicles. Turn off all lights that aren't needed, and radios. This will avoid sparks and help save both batteries. And it could save your radio!

NOTICE:

If you leave your radio on, it could be badly damaged. The repairs wouldn't be covered by your warranty.

Problems on the Road

4. Open the hoods and locate the batteries.



CAUTION:

An electric fan can start up even when the engine is not running and can injure you. Keep hands, clothing and tools away from any underhood electric fan.

Find the positive (+) and negative (-) terminals on each battery.



CAUTION:

Using a match near a battery can cause battery gas to explode. People have been hurt doing this, and some have been blinded. Use a flashlight if you need more light. Be sure the battery has enough water. You don't need to add water to the Delco Freedom® battery installed in every new GM vehicle. But if a battery has filler caps, be sure the right amount of fluid is there. If it is low, add water to take care of that first. If you don't, explosive gas could be present.

Battery fluid contains acid that can burn you. Don't get it on you. If you accidentally get it in your eyes or on your skin, flush the place with water and get medical help immediately.

5. Check that the jumper cables don't have loose or missing insulation. If they do, you could get a shock. The vehicles could be damaged, too. Before you connect the cables, here are some basic things you should know. Positive (+) will go to positive (+) and negative (-) will go to negative (-) or a metal engine part. Don't connect (+) to (-) or you'll get a short that would damage the battery and maybe other parts, too.



CAUTION:

Fans or other moving engine parts can injure you badly. Keep your hands away from moving parts once the engines are running.

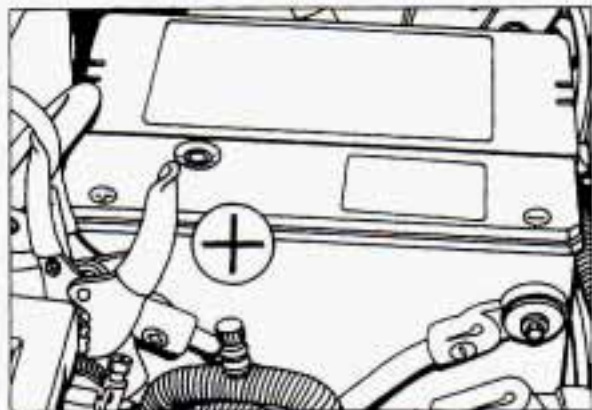

6. Connect the red positive (+) cable to the positive (+) terminal of the vehicle with the dead battery. Use a remote positive (+) terminal if the vehicle has one.

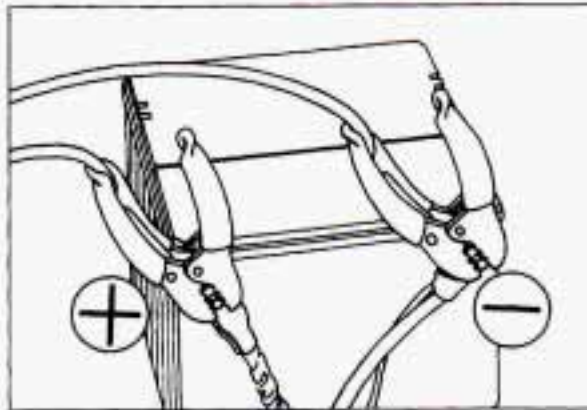

7. Don't let the other end touch metal. Connect it to the positive (+) terminal of the good battery. Use a remote positive (+) terminal if the vehicle has one.

8. Now connect the black negative (-) cable to the good battery's negative (-) terminal. Don't let the other end touch anything until the next step. The other end of the negative cable **doesn't** go to the dead battery. It goes to a heavy unpainted metal part on the engine of the vehicle with the dead battery.

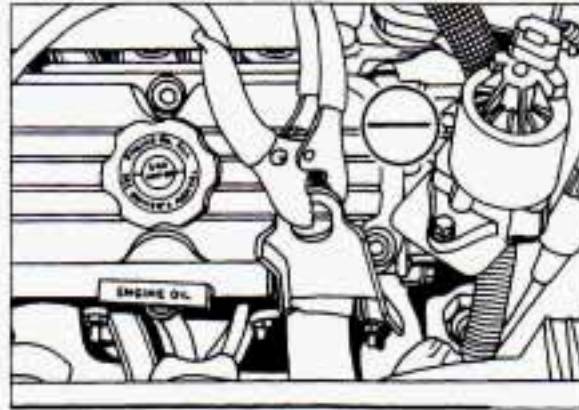

9. Attach the cable at least 18 inches (45 cm) away from the dead battery, but not near engine parts that move. The electrical connection is just as good there, but the chance of sparks getting back to the battery is much less.

10. Now start the vehicle with the good battery and run the engine for a while.

11. Try to start the vehicle with the dead battery. If it won't start after a few tries, it probably needs service.

Problems on the Road

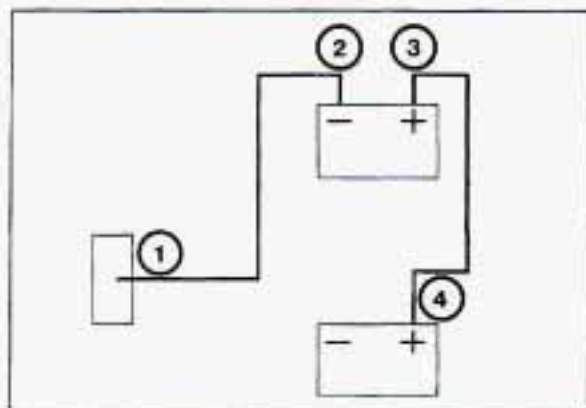

12. Remove the cables in reverse order to prevent electrical shorting. Take care that they don't touch each other or any other metal.

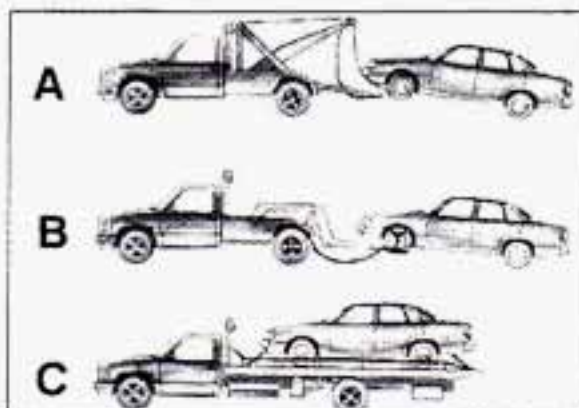

■ Towing Your Oldsmobile

Try to have a GM dealer or a professional towing service tow your Oldsmobile. The usual towing equipment is:

- (A) Sling-type tow truck
- (B) Wheel-lift tow truck
- (C) Car carrier

If your vehicle has been changed or modified since it was factory-new by adding aftermarket items like fog lamps, aero skirting, or special tires and wheels, these instructions and illustrations may not be correct.

Before you do anything, turn on the hazard warning flashers.

When you call, tell the towing service:

- That your vehicle can only be towed with certain equipment, as described later in this section.
- That your vehicle has front-wheel drive.
- The make, model and year of your vehicle.
- Whether you can still move the shift lever.
- If there was an accident, what was damaged.

When the towing service arrives, let the tow operator know that this manual contains detailed towing instructions and illustrations. The operator may want to see them.



CAUTION:

To help avoid injury to you or others:

- Never let passengers ride in a vehicle that is being towed.
- Never tow faster than safe or posted speeds.
- Never tow with damaged parts not fully secured.
- Never get under your vehicle after it has been lifted by the tow truck.
- Always secure the vehicle on each side with separate safety chains when towing it.
- Never use "J" hooks. Use T-hooks instead.

When your vehicle is being towed, have the ignition key off. The steering wheel should be clamped in a straight-ahead position, with a clamping device designed for towing service. Do not use the vehicle's steering column lock for this. The transaxle should be in Neutral and the parking brake released.

Don't have your vehicle towed on the front wheels, unless you must. If the vehicle must be towed on the front wheels, don't go more than 55 mph (88 km/h) or farther than 500 miles (800 km) or your transaxle will be damaged. If these limits must be exceeded, then the front wheels have to be supported on a dolly.



CAUTION:

A vehicle can fall from a car carrier if it isn't adequately secured. This can cause a collision, serious personal injury and vehicle damage. The vehicle should be tightly secured with chains or steel cables before it is transported. Don't use substitutes (ropes, leather straps, canvas webbing, etc.) that can be cut by sharp edges underneath the towed vehicle. Always use T-hooks inserted in the T-hook slots. Never use J-hooks. They will damage drivetrain and suspension components.

Problems on the Road

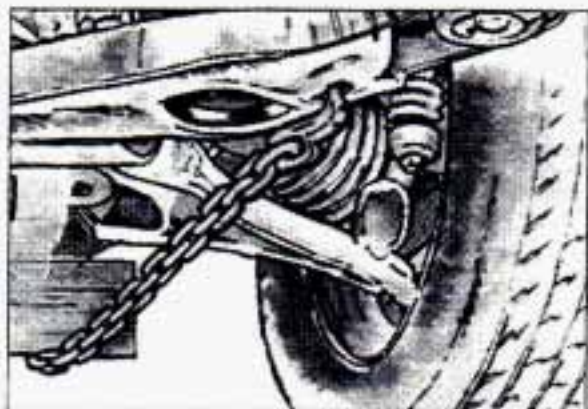

Towing from the Front—Vehicle Hook-up

Before hooking up to a tow truck, be sure to read all the information on *Towing Your Oldsmobile* earlier in this section.

1. Attach T-hook chains into the bottom slots in the cradle behind the front wheels, on both sides.

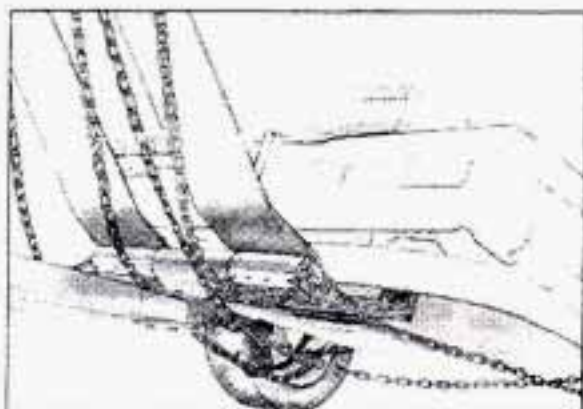

2. Across sling chains, position a 4x4 wood beam against the bottom of the radiator support behind the front bumper.

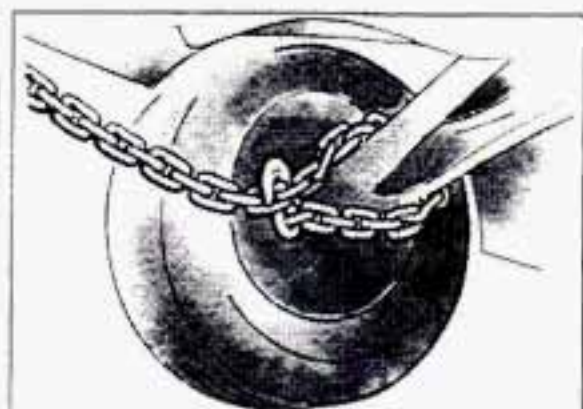

3. Attach a separate safety chain around the outboard end of each control arm.

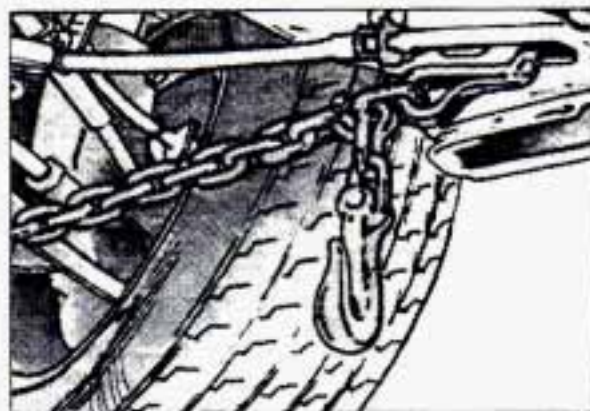

Towing from the Rear—Vehicle Hook-up

Before hooking up to a tow truck, be sure to read all the information on *Towing Your Oldsmobile* earlier in this section.

1. Attach T-hook chains on both sides in the slotted holes in the floor pan support rails just ahead of the rear wheels.

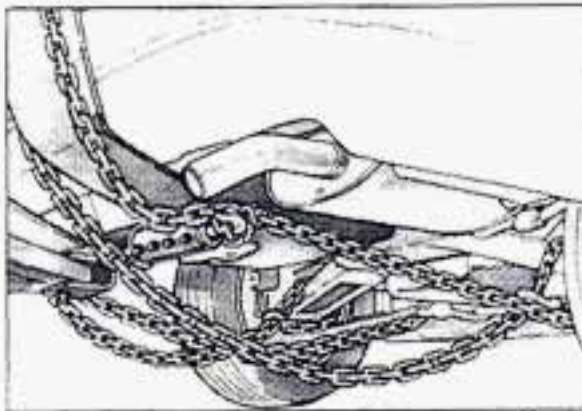

2. Position the lower sling crossbar directly under the rear bumper.

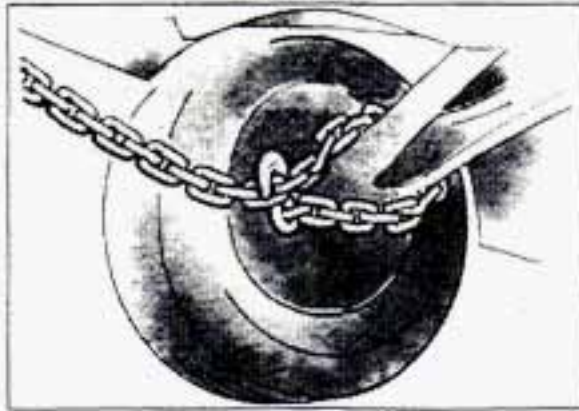

3. Attach a separate safety chain around the outboard end of each lower control arm.

■ Engine Overheating

You will find a coolant temperature gage or warning light about a hot engine on your Oldsmobile's instrument panel. If you have the Electronic Cluster, your information center will also display messages about engine overheating. See the *Index* under *Coolant Temperature Gage* or *Coolant Temperature Warning Light*.



If Steam Is Coming From Your Engine



CAUTION:

Steam from an overheated engine can burn you badly, even if you just open the hood. Stay away from the engine if you see or hear steam coming from it. Just turn it off and get everyone away from the vehicle until it cools down. Wait until there is no sign of steam or coolant before opening the hood. If you keep driving when your engine is overheated, the liquids in it can catch fire. You or others could be badly burned. Stop your engine if it overheats, and get out of the vehicle until the engine is cool.

NOTICE:

If your engine catches fire because you keep driving with no coolant, your vehicle can be badly damaged. The costly repairs would not be covered by your warranty.

If No Steam Is Coming From Your Engine

If you get the overheat warning but see or hear no steam, the problem may not be too serious. Sometimes the engine can get a little too hot when you:

- Climb a long hill on a hot day.
- Stop after high speed driving.
- Idle for long periods in traffic.
- Tow a trailer.

If you get the overheat warning with no sign of steam, try this for a minute or so:

1. Turn off your air conditioner.
2. Turn on your heater to full hot at the highest fan speed and open the window as necessary.
3. If you're in a traffic jam, shift to **N** (Neutral).

If you no longer have the overheat warning, you can drive. Just to be safe, drive slower for about ten minutes. If the warning doesn't come back on, you can drive normally.

If the warning continues, pull over, stop, and park your vehicle right away.

If there's still no sign of steam, you can idle the engine for two or three minutes while you're parked, to see if the warning stops. But then, if you still have the warning, **TURN OFF THE ENGINE AND GET EVERYONE OUT OF THE VEHICLE** until it cools down.

You may decide not to lift the hood but to get service help right away.

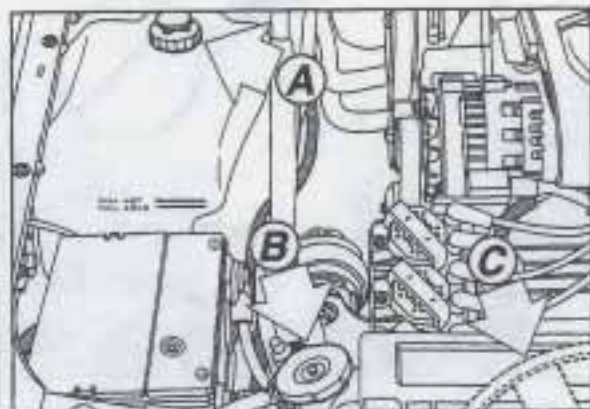

■ Cooling System

When you decide it's safe to lift the hood, here's what you'll see:

- (A) Coolant recovery tank
- (B) Radiator pressure cap
- (C) Electric engine fans

CAUTION:

An electric fan under the hood can start up even when the engine is not running and can injure you. Keep hands, clothing and tools away from any underhood electric fan.

If the coolant inside the coolant recovery tank is boiling, don't do anything else until it cools down.

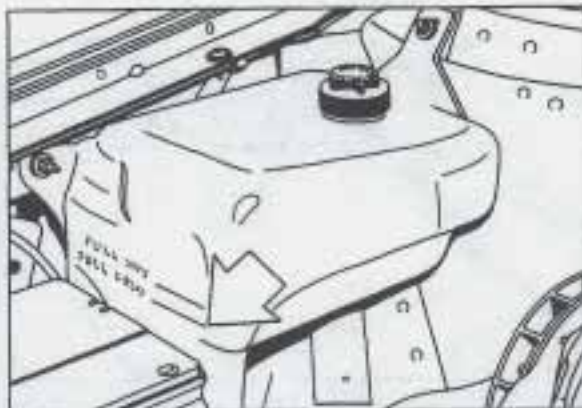

The coolant level should be at or above the **FULL COLD** mark. If it isn't, you may have a leak in the radiator hoses, heater hoses, radiator, water pump or somewhere else in the cooling system.

CAUTION:

Heater and radiator hoses, and other engine parts, can be very hot. Don't touch them. If you do, you can be burned. Don't run the engine if there is a leak. If you run the engine, it could lose all coolant. That could cause an engine fire, and you could be burned. Get any leak fixed before you drive the vehicle.

NOTICE:

Engine damage from running your engine without coolant isn't covered by your warranty.

If there seems to be no leak, check to see if the electric engine fans are running. If the engine is overheating, both fans should be running. If they aren't, your vehicle needs service.

How to Add Coolant to the Coolant Recovery Tank

If you haven't found a problem yet, but the coolant level isn't at or above the **FULL COLD** mark, add a 50/50 mixture of **clean water** (preferably distilled) and a proper antifreeze at the coolant recovery tank. (See *Engine Coolant* in the *Index* for more information about the proper coolant mix.)

CAUTION:

Adding only plain water to your cooling system can be dangerous. Plain water, or some other liquid like alcohol, can boil before the proper coolant mix will. Your vehicle's coolant warning system is set for the proper coolant mix. With plain water or the wrong mix, your engine could get too hot but you wouldn't get the overheat warning. Your engine could catch fire and you or others could be burned. Use a 50/50 mix of **clean water** and a proper antifreeze.

NOTICE:

In cold weather, water can freeze and crack the engine, radiator, heater core and other parts. Use the recommended coolant.

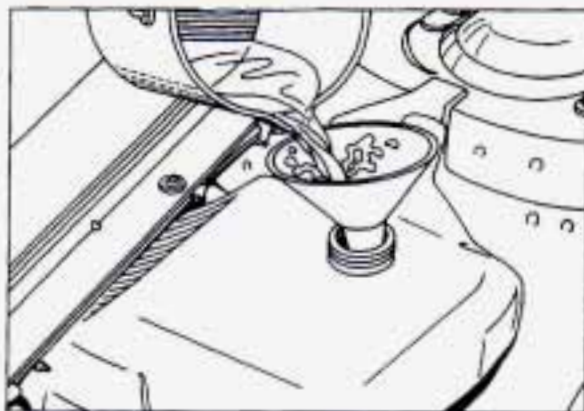

CAUTION:

You can be burned if you spill coolant on hot engine parts. Coolant contains ethylene glycol and it will burn if the engine parts are hot enough. Don't spill coolant on a hot engine.

When the coolant in the coolant recovery tank is at or above the **FULL COLD** mark, start your vehicle.

If the overheat warning continues, there's one more thing you can try. You can add the proper coolant mix directly to the radiator, but be sure the cooling system is cool before you do it.



CAUTION:

Steam and scalding liquids from a hot cooling system can blow out and burn you badly. They are under pressure, and if you turn the radiator pressure cap — even a little — they can come out at high speed. Never turn the cap when the cooling system, including the radiator pressure cap, is hot. Wait for the cooling system and radiator pressure cap to cool if you ever have to turn the pressure cap.

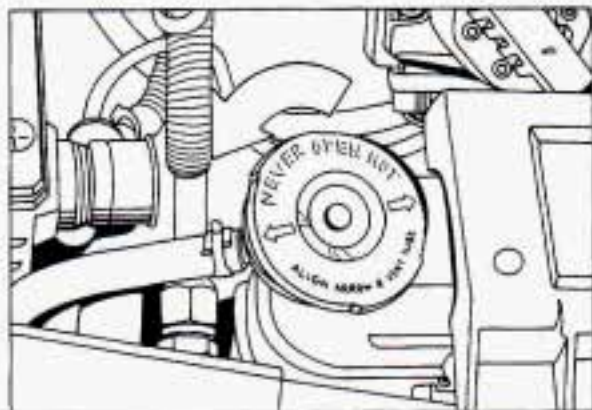

How to Add Coolant to the Radiator

1. You can remove the radiator pressure cap when the cooling system, including the radiator pressure cap and upper radiator hose, is no longer hot. Turn the pressure cap slowly to the left until it first stops. (Don't press down while turning the pressure cap.) If you hear a hiss, wait for that to stop. A hiss means there is still some pressure left.

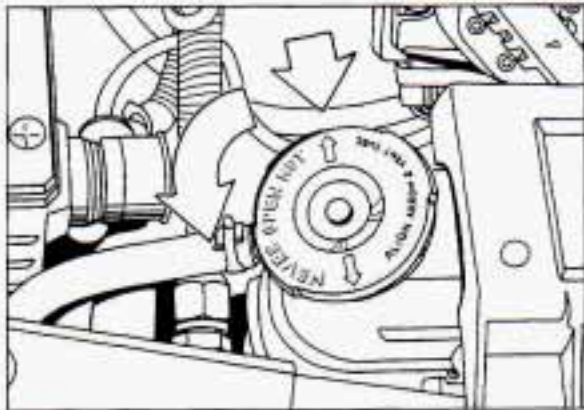

2. Then keep turning the pressure cap, but now push down as you turn it. Remove the pressure cap.

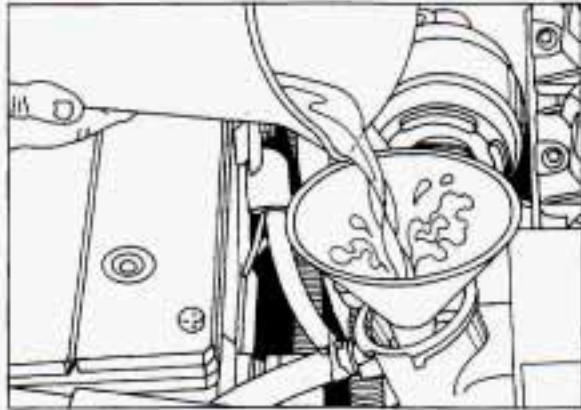

3. Fill the radiator with the proper mix, up to the base of the filler neck.

Problems on the Road

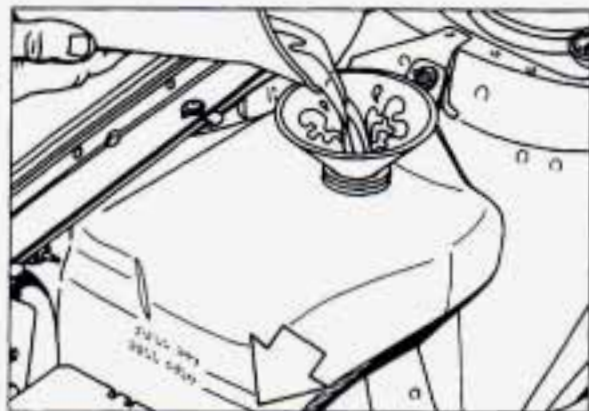

4. Then fill the coolant recovery tank to the **FULL COLD** mark.

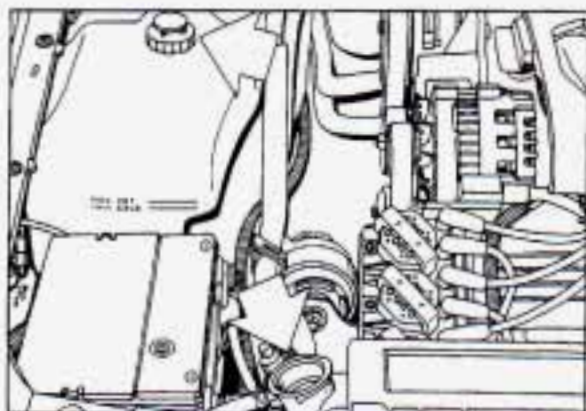

5. Put the cap back on the coolant recovery tank, but leave the radiator pressure cap off.

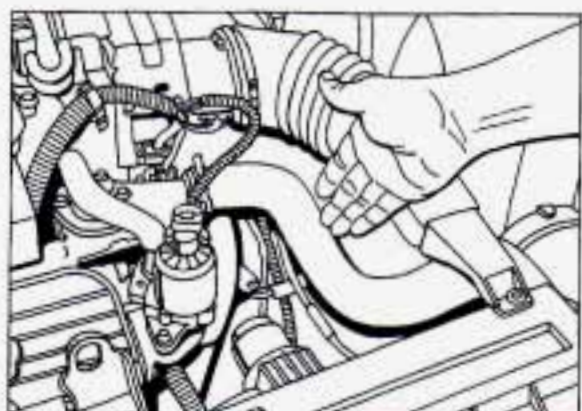

6. Start the engine and let it run until you can feel the upper radiator hose getting hot. Watch out for the engine fans.
7. By this time the coolant level inside the radiator filler neck may be lower. If the level is lower, add more of the proper mix through the filler neck until the level reaches the base of the filler neck.

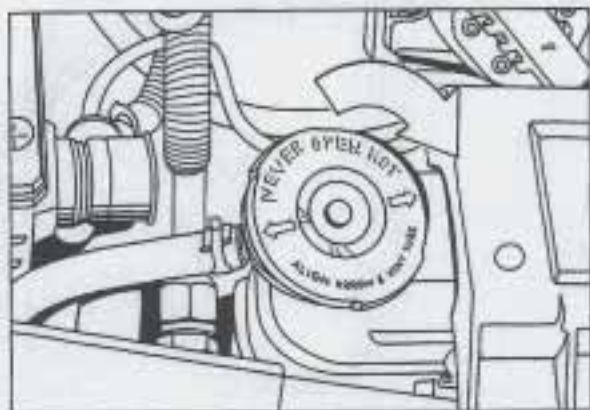

8. Then replace the pressure cap. At any time during this procedure if coolant begins to flow out of the filler neck, reinstall the pressure cap. Be sure the arrows on the pressure cap line up like this.

■ *If a Tire Goes Flat*

It's unusual for a tire to "blow out" while you're driving, especially if you maintain your tires properly. If air goes out of a tire, it's much more likely to leak out slowly. But if you should ever have a "blowout," here are a few tips about what to expect and what to do:

If a front tire fails, the flat tire will create a drag that pulls the vehicle toward that side. Take your foot off the accelerator pedal and grip the steering

wheel firmly. Steer to maintain lane position, then gently brake to a stop well out of the traffic lane.

A rear blowout, particularly on a curve, acts much like a skid and may require the same correction you'd use in a skid. In any rear blowout, remove your foot from the accelerator pedal. Get the vehicle under control by steering the way you want the vehicle to go. It may be very bumpy and noisy, but you can still steer. Gently brake to a stop, well off the road if possible.

If a tire goes flat, the next section shows how to use your jacking equipment to change a flat tire safely.

■ *Changing a Flat Tire*

If a tire goes flat, avoid further tire and wheel damage by driving slowly to a level place. Turn on your hazard warning flashers.



CAUTION:

Changing a tire can cause an injury. The vehicle can slip off the jack and roll over you or other people. You and they could be badly injured. Find a level place to change your tire. To help prevent the vehicle from moving:

1. Set the parking brake firmly.
2. Put the shift lever in **P** (Park).
3. Turn off the engine.

To be even more certain the vehicle won't move, you can put chocks at the front and rear of the tire farthest away from the one being changed. That would be the tire on the other side of the vehicle, at the opposite end.

Problems on the Road

The following steps will tell you how to use the jack and change a tire.

The equipment you'll need is in the trunk.

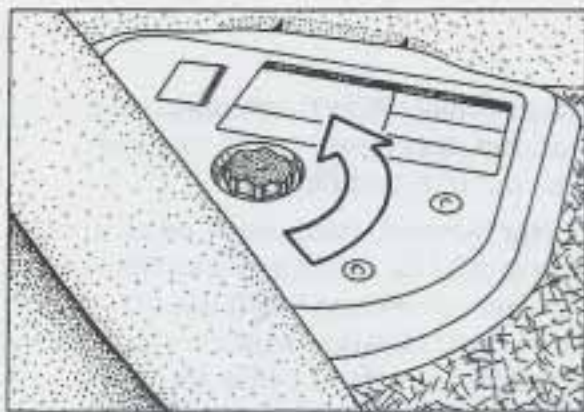

1. Turn the center retainer bolt on the spare tire cover counterclockwise to remove it, then lift the tire cover.
2. Remove the spare tire from the trunk.

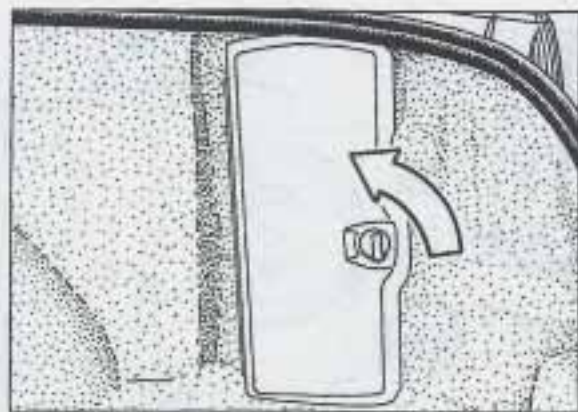

3. Open the jack storage cover by twisting the knob 1/4 turn counterclockwise.

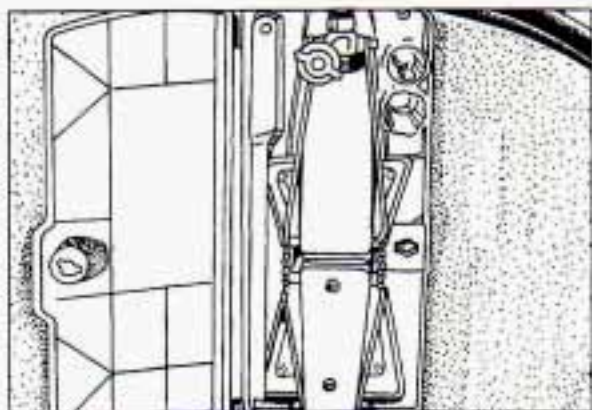

4. Remove the jack and wheel wrench.

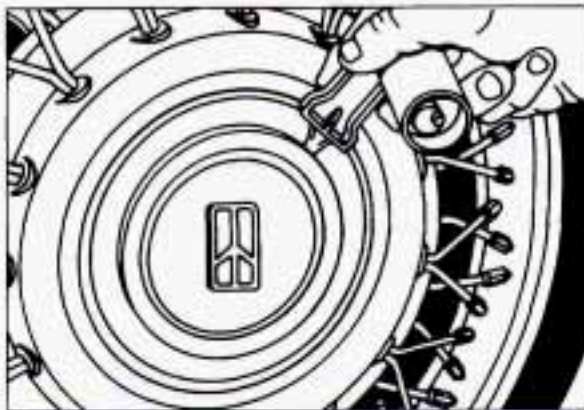

5. The following (a-d) are necessary only if you have wire wheel covers:

a) Remove the special key wrench that's attached to the trunk sidewall.

b) Using the handle of the special key wrench, pry off the center emblem cover to reveal the theft-deterrent wheel nut.

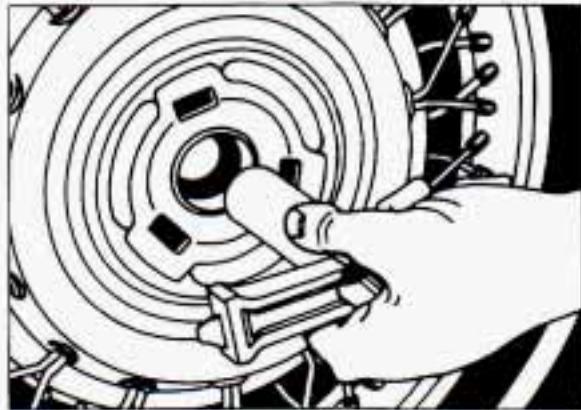

c) Push the end of the special key wrench onto the theft-deterrent wheel nut and twist it counterclockwise to remove the nut.

d) Do not pry the wheel cover off. Remove the wheel cover by hand.

Problems on the Road

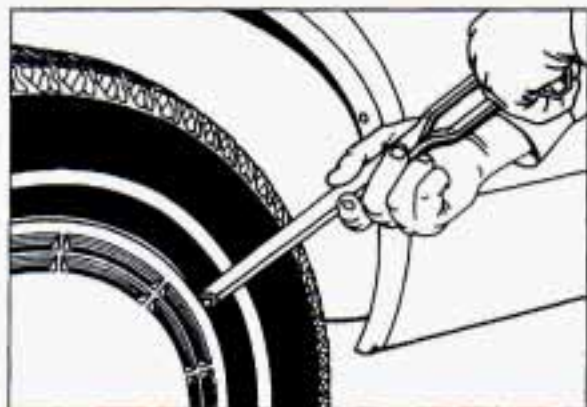

6. Remove the wheel cover. Non-wire stainless finish full wheel covers are removed by using the end of the wheel wrench handle to pry around the edge of the wheel cover until it comes loose. If you have wire wheels, do not pry the cover off. Remove the cover by hand.

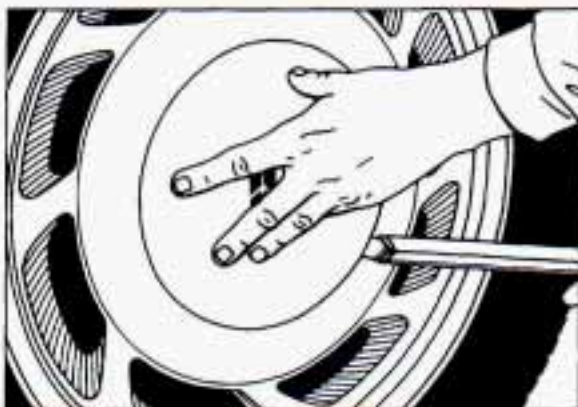

7. The following is necessary if you have an alloy (aluminum) wheel with a center cover that conceals the wheel nuts.

- a)** Insert the flat end of the wheel wrench in the notch and pry off the center cover. Do not drop the cover or lay it face down, as it could be scratched or damaged.
- b)** When replacing the cover after the wheel is put back on the vehicle, do not use a hammer or mallet to install the cover.

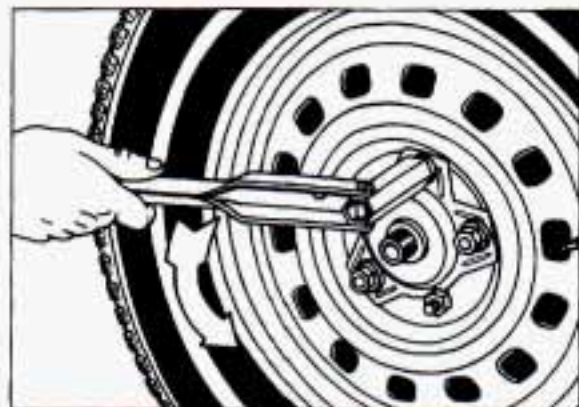

8. Use the wheel wrench to loosen the wheel nuts, but don't remove them. (The bracket shown is on wheels with wire wheel covers only. It's needed to anchor wire wheel covers to the wheel. Do not misplace it while using your temporary spare tire.)

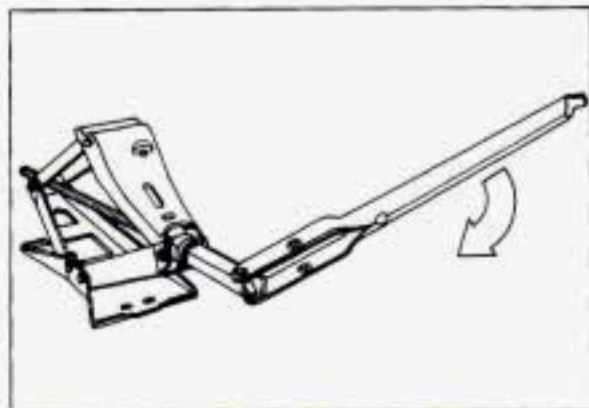

9. Attach the wheel wrench to the jack, and rotate the wrench clockwise to raise the jack head a few inches.

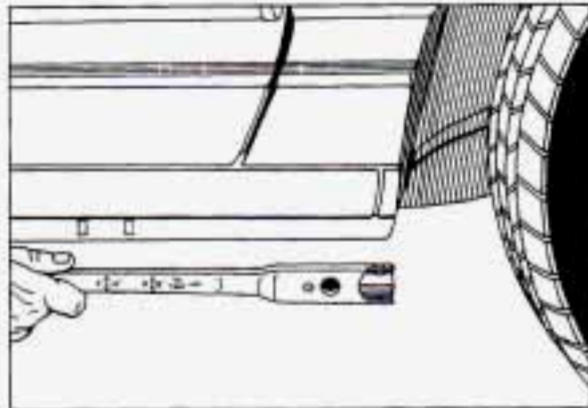

10. Near each wheel well is a notch in the frame into which to put the jack head. The front notch is 10 inches back from the front wheel well. The rear notch is 8 inches forward from the rear wheel well. The wheel wrench has these 8 and 10 inch distances stamped on the handle. Use the wheel wrench to measure to the notch by flipping the socket into the handle, then measure from the socket end of the wrench.

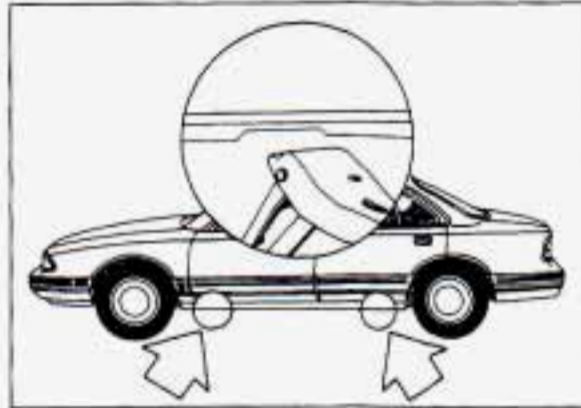

11. Position the jack and raise the jack head until it fits firmly on the ridge in the vehicle's frame nearest the flat tire. Do not raise the vehicle yet. Put the compact spare tire near you.



CAUTION:

Getting under a vehicle when it is jacked up is dangerous. If the vehicle slips off the jack, you could be badly injured or killed. Never get under a vehicle when it is supported only by a jack.

Problems on the Road

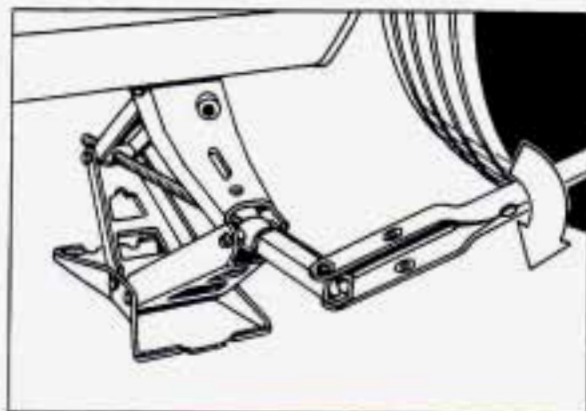

12. Raise the vehicle by rotating the wheel wrench clockwise in the jack. Raise the jack far enough so there's enough room for the spare tire to fit.

NOTICE:

Raising your vehicle with the jack improperly positioned will damage the vehicle or may allow the vehicle to fall off the jack. Be sure to fit the jack lift head into the proper location before raising your vehicle.

13. Remove all the wheel nuts and take off the flat tire.



CAUTION:

Rust or dirt on the wheel, or on the parts to which it is fastened, can make the wheel nuts become loose after a time. The wheel could come off and cause an accident. When you change a wheel, remove any rust or dirt from the places where the wheel attaches to the vehicle. In an emergency, you can use a cloth or a paper towel to do this; but be sure to use a scraper or wire brush later, if you need to, to get all the rust or dirt off.



14. Remove any rust or dirt from the wheel bolts, mounting surfaces and spare wheel. Place the spare on the wheel mounting surface.

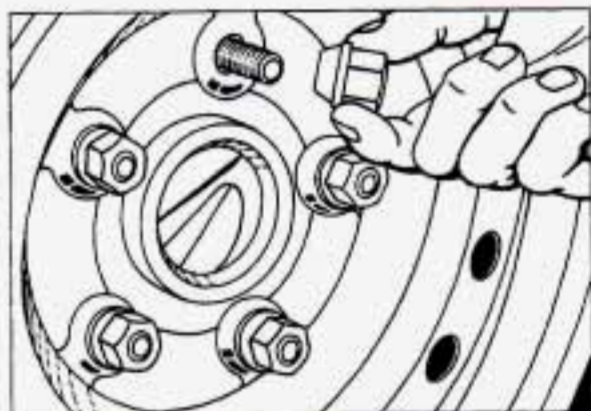

⚠ CAUTION:

Never use oil or grease on studs or nuts. If you do, the nuts might come loose. Your wheel could fall off, causing a serious accident.

15. Replace the wheel nuts with the rounded end of the nuts toward the wheel. Tighten each nut by hand until the wheel is held against the hub.

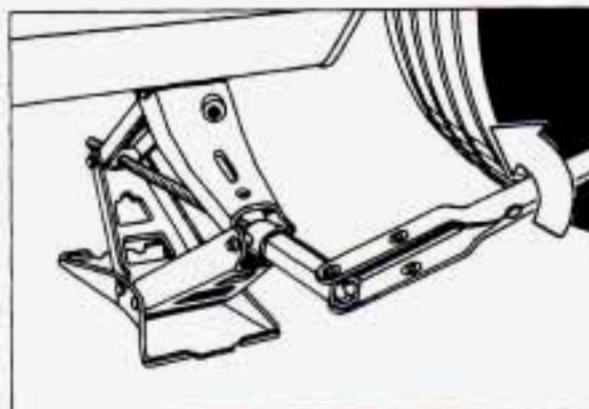

16. Lower the vehicle by rotating the wheel wrench counterclockwise on the jack. Lower the jack completely.

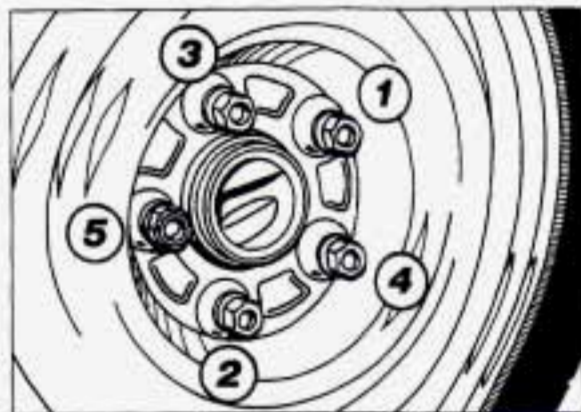

17. In a crisscross sequence, tighten the wheel nuts firmly.

⚠ CAUTION:

Incorrect wheel nuts or improperly tightened wheel nuts can cause the wheel to become loose and even come off. This could lead to an accident. Be sure to use the correct wheel nuts. If you have to replace them, be sure to get the right kind. Stop somewhere as soon as you can and have the nuts tightened with a torque wrench to 100 pound-feet (140 N•m).

Problems on the Road

Don't try to put the wheel cover on the compact spare tire. It won't fit. Store the wheel cover in the trunk until you have replaced the compact spare tire with a regular tire.

NOTICE:

Wheel covers won't fit on your compact spare. If you try to put a wheel cover on your compact spare, you could damage the cover or the spare.

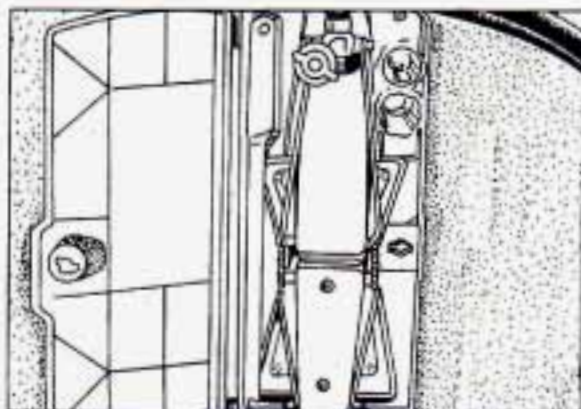

18. Store the flat tire as far forward in the trunk as possible. Store the jack and wheel wrench in their compartment in the trunk.

The compact spare is for temporary use only. Replace the compact spare tire with a full-size tire as soon as you can. See *Compact Spare Tire* later in this section.



CAUTION:

Storing a jack, a tire or other equipment in the passenger compartment of the vehicle could cause injury. In a sudden stop or collision, loose equipment could strike someone. Store all these in the proper place.

■ Compact Spare Tire

Although the compact spare was fully inflated when your vehicle was new, it can lose air after a time. Check the inflation pressure regularly. It should be 60 psi (420 kPa). After installing the compact spare on your vehicle, you should stop as soon as possible and make sure your spare tire is correctly inflated. The compact spare is made to perform well at posted speed limits for distances up to 3,000 miles (5 000 km). The compact spare is made to go up to 3,000 miles (5 000 km), so you can finish your trip and have your full-size tire repaired or replaced where you want. Of course, it's best to replace your spare with a full-size tire as soon as you can. Your spare will last longer and be in good shape in case you need it again.

NOTICE:

Don't take your compact spare through an automatic car wash with guide rails. The compact spare can get caught on the rails. That can damage the tire and wheel, and maybe other parts of your vehicle.

Don't use your compact spare on some other vehicle.

And don't mix your compact spare or wheel with other wheels or tires. They won't fit. Keep your spare and its wheel together.

NOTICE:

Tire chains won't fit your compact spare. Using them will damage your vehicle and destroy the chains too. Don't use tire chains on your compact spare.

■ *If You're Stuck: In Sand, Mud, Ice or Snow*

What you don't want to do when your vehicle is stuck is to spin your wheels. The method known as "rocking" can help you get out when you're stuck, but you must use caution.



CAUTION:

If you let your tires spin at high speed, they can explode and you or others could be injured. And, the transaxle or other parts of the vehicle can overheat. That could cause an engine compartment fire or other damage. When you're stuck, spin the wheels as little as possible. Don't spin the wheels above 35 mph (55 km/h) as shown on the speedometer.

NOTICE:

Spinning your wheels can destroy parts of your vehicle as well as the tires. If you spin the wheels too fast while shifting your transaxle back and forth, you can destroy your transaxle.

Rocking your vehicle to get it out:

First, turn your steering wheel left and right. That will clear the area around your front wheels. You should turn your traction control system off. (See *Traction Control System* in the *Index*.) Then shift back and forth between **R** (Reverse) and a forward gear, spinning the wheels as little as possible. Release the accelerator pedal while you shift, and press lightly on the accelerator pedal when the transaxle is in gear. If that doesn't get you out after a few tries, you may need to be towed out. If you do need to be towed out, see *Towing Your Vehicle* in the *Index*.



Here you will find information about the care of your Oldsmobile. This part begins with service and fuel information, and then it shows how to check important fluid and lubricant levels. There is also technical information about your vehicle, and a section devoted to its appearance care.

Part 6

Service & Appearance Care

Service	184
Fuel.....	185
Hood Release	188
Engine Oil	192
Air Cleaner	195
Supercharger Oil.....	198
Transaxle Fluid	198
Engine Coolant	200
Power Steering Fluid	202
Windshield Washer Fluid	203
Brakes.....	204
Battery.....	206
Bulb Replacement.....	206
Windshield Wiper Blade Replacement.....	208
Loading Your Vehicle.....	208
Tires.....	209
Appearance Care.....	214
Vehicle Identification Number (VIN)	220
Add-On Electrical Equipment.....	221
Fuses & Circuit Breakers	221
Capacities & Specifications.....	226
Normal Maintenance Replacement Parts	227
Fluids & Lubricants.....	228
Replacement Bulbs	229



■ Service

Your Oldsmobile dealer knows your vehicle best and wants you to be happy with it. We hope you'll go to your dealer for all your service needs. You'll get genuine GM parts and GM-trained and supported service people.

We hope you'll want to keep your GM vehicle all GM. Genuine GM parts have one of these marks.

Doing Your Own Service Work

If you want to do some of your own service work, you'll want to get the proper Oldsmobile Service Manual. It tells you much more about how to service your Oldsmobile than this manual can. To order the proper service manual, see *Service Publications* in the *Index*.

Your vehicle has an air bag system. Before attempting to do your own service work, see *Servicing Your Air Bag-Equipped Oldsmobile* in the *Index*.

You should keep a record with all parts receipts and list the mileage and the date of any service work you perform. See *Maintenance Record* in the *Index*.



CAUTION:

You can be injured if you try to do service work on a vehicle without knowing enough about it.

- Be sure you have sufficient knowledge, experience, and the proper replacement parts and tools before you attempt any vehicle maintenance task.
- Be sure to use the proper nuts, bolts and other fasteners. "English" and "metric" fasteners can be easily confused. If you use the wrong fasteners, parts can later break or fall off. You could be hurt.

NOTICE:

If you try to do your own service work without knowing enough about it, your vehicle could be damaged.



■ Fuel

The 8th digit of your Vehicle Identification Number (VIN) shows the code letter for your engine. You will find the VIN at the top left of your instrument panel. (See *Vehicle Identification Number* in the *Index*.)

3800 Tuned Port Engine (Code L)

Use regular unleaded gasoline rated at 87 octane or higher. It should meet specifications ASTM D4814 in the U.S. and CGSB 3.5-92 in Canada. These fuels should have the proper additives, so you should not have to add anything to the fuel.

In the U.S. and Canada, it's easy to be sure you get the right kind of gasoline (unleaded). You'll see "UNLEADED"

right on the pump. And only unleaded nozzles will fit into your vehicle's filler neck.

Be sure the posted octane is at least 87. If the octane is less than 87, you may get a heavy knocking noise when you drive. If it's bad enough, it can damage your engine.

If you're using fuel rated at 87 octane or higher and you still hear heavy knocking, your engine needs service. But don't worry if you hear a little pinging noise when you're accelerating or driving up a hill. That's normal, and you don't have to buy a higher octane fuel to get rid of pinging. It's the heavy, constant knock that means you have a problem.

3800 Supercharged Engine (Code 1) (Optional)

Use premium unleaded gasoline rated at 91 octane or higher. You may use middle grade or regular unleaded gasolines, but your vehicle may not accelerate as well. The gasoline you use should meet specifications ASTM D4814 in the U.S. and CGSB 3.5-92 in Canada. These fuels should have the

proper additives, so you should not have to add anything to the fuel.

In the U.S. and Canada, it's easy to be sure you get the right kind of gasoline (unleaded). You'll see "UNLEADED" right on the pump. And only unleaded nozzles will fit into your vehicle's filler neck.

Be sure the posted octane for premium is at least 91 (at least 89 for middle grade and 87 for regular). If the octane is less than 87, you may get a heavy knocking noise when you drive. If it's bad enough, it can damage your engine.

If you're using fuel rated at 91 octane or higher and you still hear heavy knocking, your engine needs service. But don't worry if you hear a little pinging noise when you're accelerating or driving up a hill. That's normal and you don't have to buy a higher octane fuel to get rid of pinging. It's the heavy, constant knock that means you have a problem.

All Engines

What about gasoline with blending materials that contain oxygen (oxygenates), such as MTBE or alcohol?

Service & Appearance Care

MTBE is "methyl tertiary-butyl ether." Fuel that is no more than 15% MTBE is fine for your vehicle.

Ethanol is ethyl or grain alcohol. Properly-blended fuel that is no more than 10% **ethanol** is fine for your vehicle.

Methanol is methyl or wood alcohol.

NOTICE:

Fuel that is more than 5% **methanol** is bad for your vehicle. Don't use it. It can corrode metal parts in your fuel system and also damage plastic and rubber parts. That damage wouldn't be covered under your warranty. And even at 5% or less, there must be "cosolvents" and corrosion preventers in this fuel to help avoid these problems.

Gasolines for Cleaner Air

Your use of gasoline with deposit control additives will help prevent deposits from forming in your engine and fuel system. That helps keep your engine in tune and your emission

control system working properly. It's good for your vehicle, and you'll be doing your part for cleaner air.

Many gasolines are now blended with oxygenates. General Motors recommends that you use gasolines with these blending materials, such as MTBE and ethanol. By doing so, you can help clean the air, especially in those parts of the country that have high carbon monoxide levels.

In addition, some gasoline suppliers are now producing reformulated gasolines. These gasolines are specially designed to reduce vehicle emissions. General Motors recommends that you use reformulated gasoline. By doing so, you can help clean the air, especially in those parts of the country that have high ozone levels.

You should ask your service station operators if their gasolines contain deposit control additives and oxygenates, and if they have been reformulated to reduce vehicle emissions.



■ Fuels in Foreign Countries

If you plan on driving in another country outside the U.S. or Canada, unleaded fuel may be hard to find. Do not use leaded gasoline. If you use even one tankful, your emission controls won't work well or at all. With continuous use, spark plugs can get fouled, the exhaust system can corrode, and your engine oil can deteriorate quickly. Your vehicle's oxygen sensor will be damaged. All of that means costly repairs that wouldn't be covered by your warranty.

To check on fuel availability, ask an auto club, or contact a major oil company that does business in the country where you'll be driving.

You can also write us at the following address for advice. Just tell us where you're going and give your Vehicle Identification Number (VIN).

General Motors Overseas Distribution Corporation
North American Export Sales (NAES)
1908 Colonel Sam Drive
Oshawa, Ontario
L1H 8P7

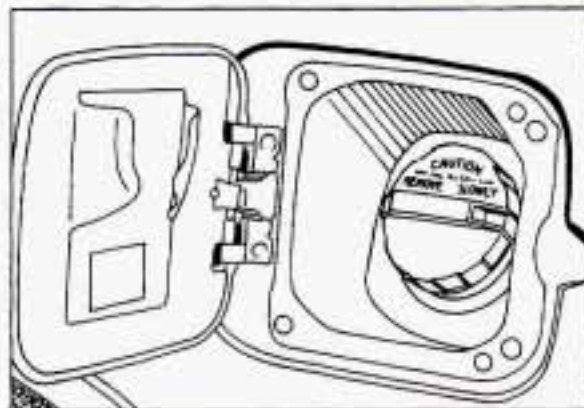

■ *Filling Your Tank*

Fuel Capacity: 18 U.S. Gallons (68L).
Use unleaded fuel only.

The cap is behind a hinged door on the left side of your vehicle.

CAUTION:

Gasoline vapor is highly flammable. It burns violently, and that can cause very bad injuries. Don't smoke if you're near gasoline or refueling your vehicle. Keep sparks, flames, and smoking materials away from gasoline.

To take off the cap, turn it slowly to the left (counterclockwise).

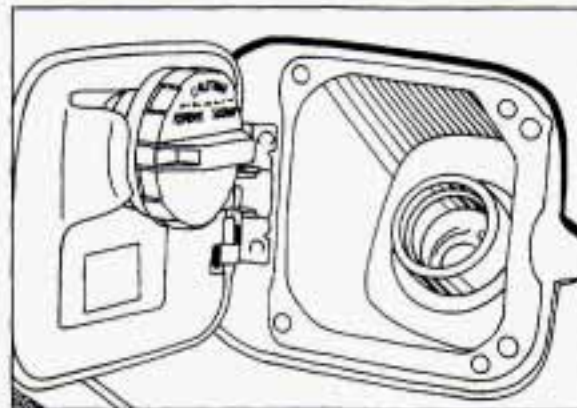

While refueling, hang the cap inside the fuel door.

Twist it clockwise to secure it, if necessary.

CAUTION:

If you get gasoline on you and then something ignites it, you could be badly burned. Gasoline can spray out on you if you open the fuel filler cap too quickly. This spray can happen if your tank is nearly full, and is more likely in hot weather. Open the fuel filler cap slowly and wait for any "hiss" noise to stop. Then unscrew the cap all the way.

Service & Appearance Care

Be careful not to spill gasoline. Clean gasoline from painted surfaces as soon as possible. See *Cleaning the Outside of Your Oldsmobile* in the *Index*.

When you put the cap back on, turn it to the right until you hear at least three clicks.

NOTICE:

If you need a new cap, be sure to get the right type. Your dealer can get one for you. If you get the wrong type, it may not fit or have proper venting, and your fuel tank and emissions system might be damaged.

■ *Checking Things Under the Hood*

The following sections tell you how to check fluids, lubricants and important parts underhood.

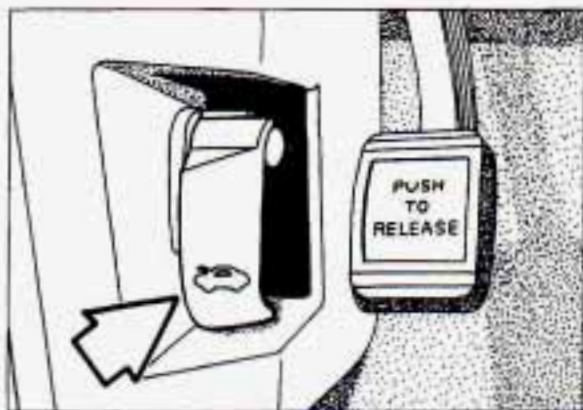

Hood Release

To open the hood, first pull the hood release handle inside the vehicle.

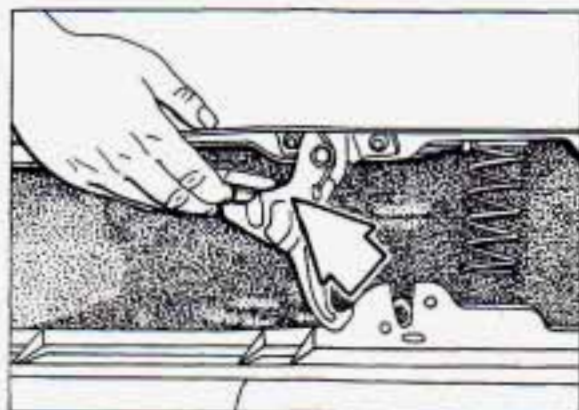

Then go to the front of the vehicle and pull up on the underhood release. Lift the hood.

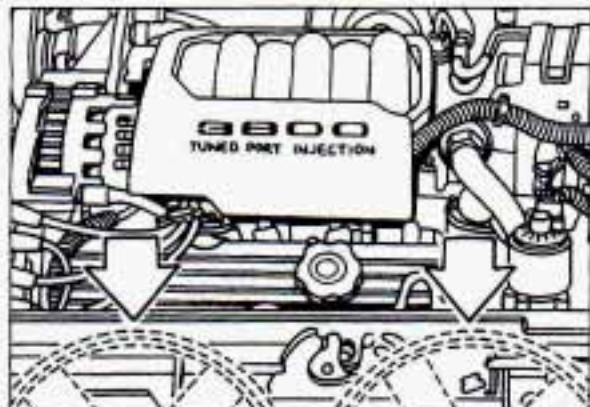

CAUTION:

An electric fan under the hood can start up and injure you even when the engine is not running. Keep hands, clothing and tools away from any underhood electric fan.



CAUTION:

Things that burn can get on hot engine parts and start a fire. These include liquids like gasoline, oil, coolant, brake fluid, windshield washer and other fluids, and plastic or rubber. You or others could be burned. Be careful not to drop or spill things that will burn onto a hot engine.

Before closing the hood, be sure all the filler caps are on properly. Then just pull the hood down and close it firmly.

Underhood Light

Your parking lights or headlights must be on for the underhood light to function when you open the hood.

Service & Appearance Care

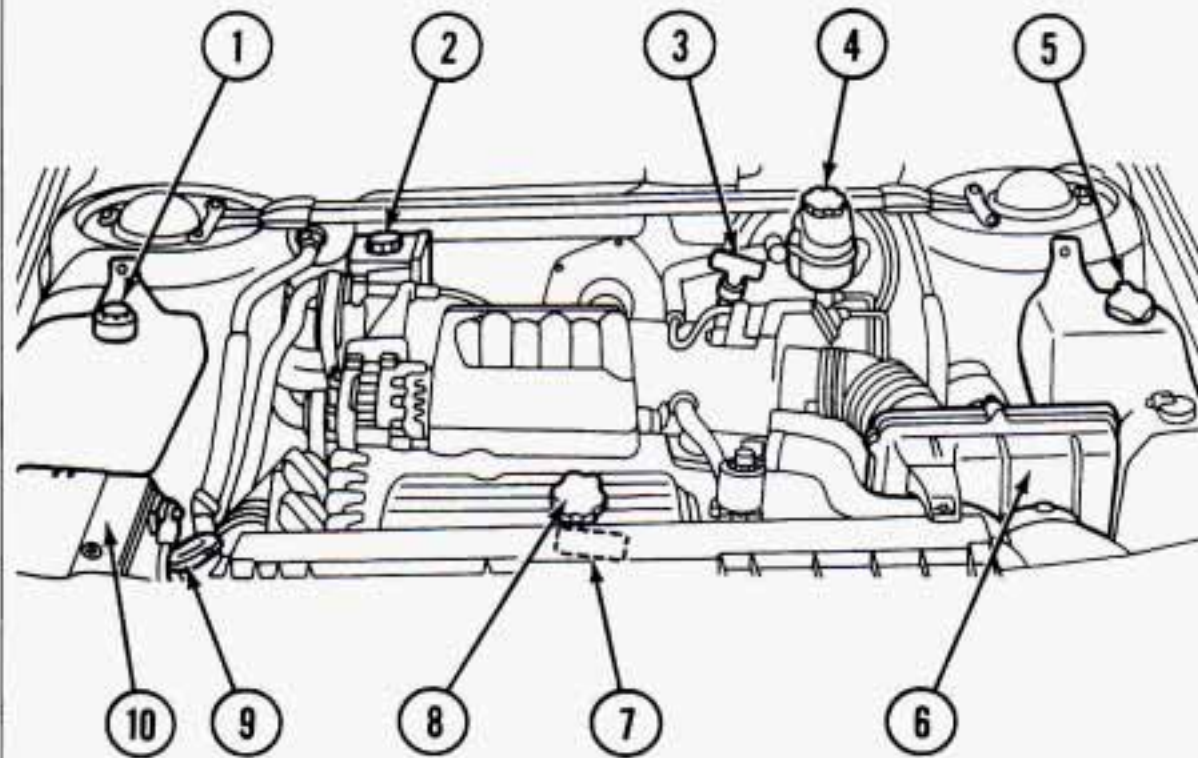

3800 Engine (Code L)

When you open the hood, you'll see:

1. Engine Coolant Recovery Tank
2. Power Steering Fluid Reservoir
3. Automatic Transaxle Fluid Dipstick
4. Brake Fluid Reservoir
5. Windshield Washer Fluid Reservoir
6. Air Cleaner
7. Engine Oil Dipstick
8. Engine Oil Fill Cap
9. Radiator Pressure Cap
10. Battery

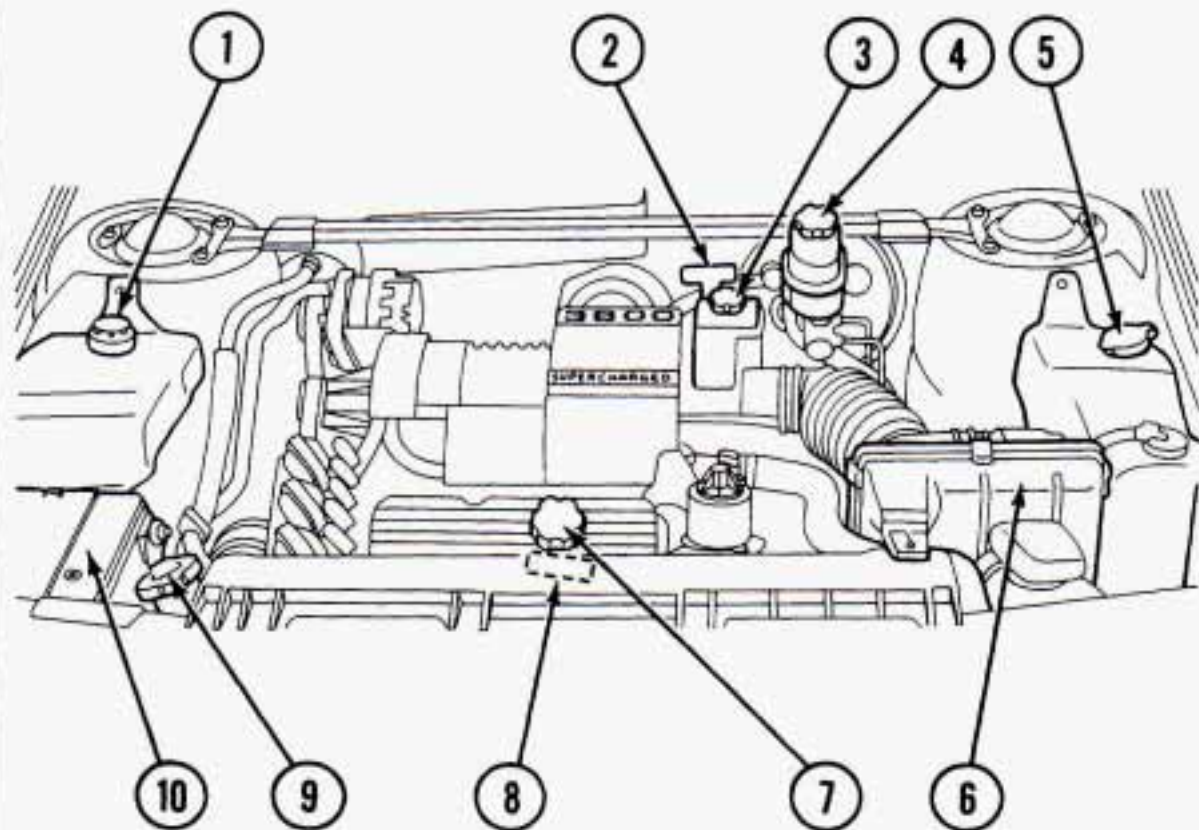

3800 SC Engine (Code 1)

When you open the hood, you'll see:

1. Engine Coolant Recovery Tank
2. Automatic Transaxle Fluid Dipstick
3. Power Steering Fluid Reservoir
4. Brake Fluid Reservoir
5. Windshield Washer Fluid Reservoir
6. Air Cleaner
7. Engine Oil Fill Cap
8. Engine Oil Dipstick
9. Radiator Pressure Cap
10. Battery

■ Engine Oil

If the **Check Oil Level** message, **Oil Level** light, or **Check Oil** light on the instrument panel comes on, it means you need to check your engine oil level right away. For more information, see *Check Oil Level Message*, *Oil Level Light*, or *Check Oil Light* in the *Index*. You should check your engine oil level regularly; this is an added reminder.

It's a good idea to check your engine oil every time you get fuel. In order to get an accurate reading, the oil must be warm and the vehicle must be on level ground.

Turn off the engine and give the oil a few minutes to drain back into the oil pan. If you don't, the oil dipstick might not show the actual level.

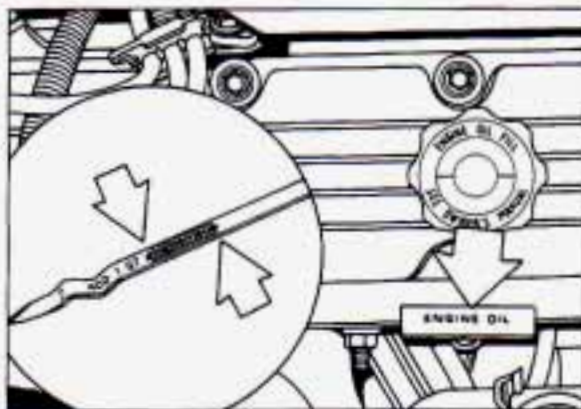

To Check Engine Oil

Pull out the dipstick and clean it with a paper towel or cloth, then push it back in all the way. Remove it again, keeping the tip lower, and check the level.

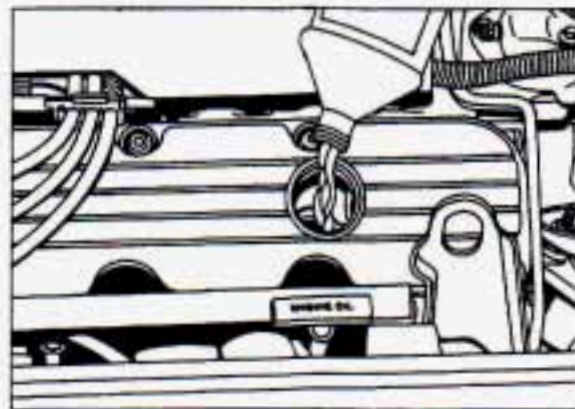

When to Add Oil

If the oil is at or below the **ADD** mark, then you'll need to add some oil. But you must use the right kind. This section explains what kind of oil to use. For crankcase capacity, see *Capacities and Specifications* in the *Index*.

NOTICE:

Don't add too much oil. If your engine has so much oil that the oil level gets above the cross-hatched area that shows the proper operating range, your engine could be damaged.

Just fill it enough to put the level somewhere in the proper operating range. Push the dipstick all the way back in when you're through.



What Kind of Oil to Use

Beginning midyear 1993, oils of the proper quality for your vehicle will be identified with this new "starburst" symbol. The "starburst" symbol indicates that the oil has been certified by the American Petroleum Institute (API), and is preferred for use in your gasoline engine.

You should look for this on the front of the oil container, and use only oils that display this new symbol.

You should also use the proper viscosity oil for your vehicle, as shown in the following chart.

RECOMMENDED SAE VISCOSITY GRADE ENGINE OILS

FOR BEST FUEL ECONOMY AND COLD STARTING, SELECT THE LOWEST SAE VISCOSITY GRADE OIL FOR THE EXPECTED TEMPERATURE RANGE.

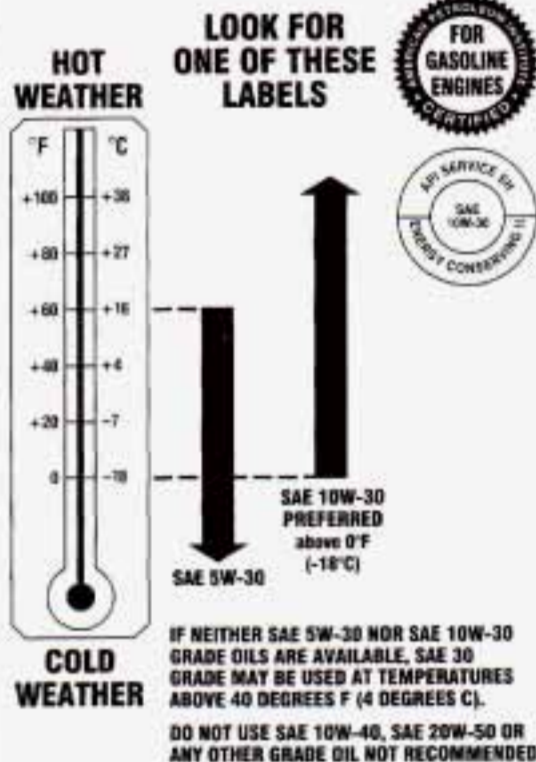

As shown in the chart, SAE 10W-30 is best for your vehicle. However, you can use SAE 5W-30 if it's going to be colder than 60°F (16°C) before your next oil change. When it's very cold, you should use SAE 5W-30. These numbers on an oil container show its viscosity, or thickness. Do not use other viscosity oils, such as SAE 10W-40 or SAE 20W-50.

If you cannot find oils with the new "starburst" symbol on the front of the container, you should look for and use oils containing the following three things:

- **SH or SG**

"SH" or "SG" must be on the oil container, either by itself or combined with other quality designations, such as "SH/CD," "SH,SG,CD," "SG/CD," etc. These letters show American Petroleum Institute (API) levels of quality.

- **SAE 10W-30**

- **Energy Conserving II**

Oils with these words on the container will help you save fuel.

Service & Appearance Care

These three things are usually included in a doughnut shaped logo (symbol) on most containers. If you cannot find oils with the “starburst” symbol, you should look for oils with the doughnut shaped symbol, containing the three things noted above.



NOTICE:

If you use oils that do not have either the “starburst” symbol or an API SH or SG designation, you can cause engine damage not covered by your warranty.

GM Goodwrench® oil (in Canada, GM Engine Oil) meets all the requirements for your vehicle.

Engine Oil Additives

Don't add anything to your oil. Your Oldsmobile dealer is ready to advise if you think something should be added.

When to Change Engine Oil

See if any one of these is true for you:

- Most trips are less than 4 miles (6 km).
- It's below freezing outside and most trips are less than 10 miles (16 km).
- The engine is at low speed most of the time (as in door-to-door delivery, or in stop-and-go traffic).
- You tow a trailer often.
- Most trips are through dusty places.

If any one of these is true for your vehicle, then you need to change your **oil and filter** every 3,000 miles (5 000 km) or 3 months — whichever comes first. (See *Change Oil Indicator* in the *Index*.) If the **CHANGE OIL NOW** message appears in the optional Driver Information Center, you should change your oil.

If none of them is true, change the oil every 7,500 miles (12 500 km) or 12 months — whichever comes first. Change the filter at the first oil change and at every other oil change after that. (See *Change Oil Indicator* in the *Index*.) If your vehicle is equipped with the Driver Information Center, always reset the engine oil life to 100% after every oil change.

Engine Coolant Heater (Engine Block Heater)

An engine coolant heater can be a big help if you have to park outside in very cold weather, 0°F (-18°C) or colder. If your vehicle has this option, see *Engine Coolant Heater* in the *Index*.

What to Do with Used Oil

Did you know that used engine oil contains certain elements that may be unhealthy for your skin and could even cause cancer? Don't let used oil stay on your skin for very long. Clean your skin and nails with soap and water, or a good hand cleaner. Wash or properly throw away clothing or rags containing used engine oil. (See the manufacturer's warnings about the use and disposal of oil products.)

Used oil can be a real threat to the environment. If you change your own oil, be sure to drain all free-flowing oil from the filter before disposal. Don't ever dispose of oil by putting it in the trash, pouring it on the ground, into sewers, or into streams or bodies of water. Instead, recycle it by taking it to a place that collects used oil. If you have a problem properly disposing of your used oil, ask your dealer, a service station or a local recycling center for help.

■ **Air Cleaner**

Refer to the Maintenance Schedule to determine when to replace the air filter. See *Scheduled Maintenance Services* in the *Index*.



CAUTION:

Operating the engine with the air cleaner off can cause you or others to be burned. The air cleaner not only cleans the air, it stops flame if the engine backfires. If it isn't there, and the engine backfires, you could be burned. Don't drive with it off, and be careful working on the engine with the air cleaner off.

NOTICE:

If the air cleaner is off, a backfire can cause a damaging engine fire. And, dirt can easily get into your engine, which will damage it. Always have the air cleaner in place when you're driving.

Service & Appearance Care

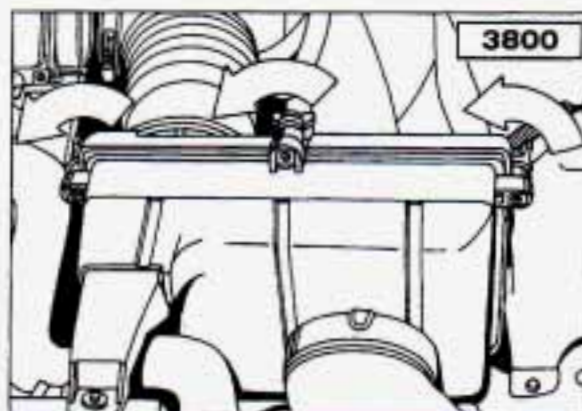

To Check or Replace the Air Cleaner (3800 Tuned Port Engine):

1. Unscrew the three wingscrews in the housing cover and pull back.

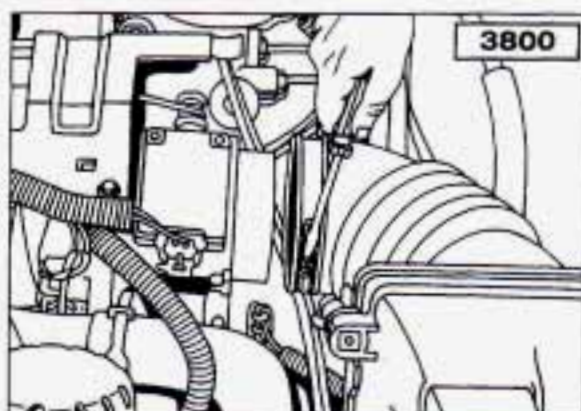

2. Unscrew the clamp on the air intake hose where the hose attaches to the throttle body near the top of the engine. Detach the hose from the throttle body, then pull back the rear of the housing cover.

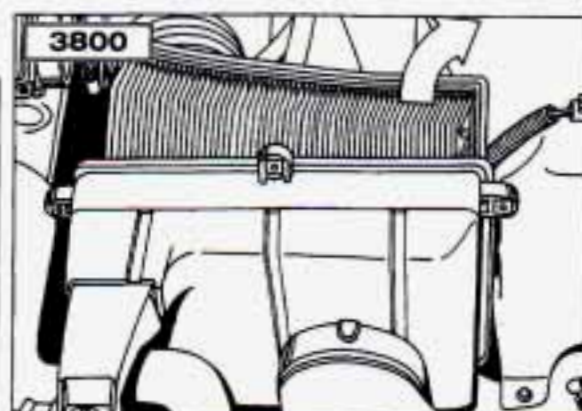

3. Remove the air filter.
4. Be sure to install the air filter and replace the cover tightly.
5. Reattach the air intake hose and tighten the clamp.

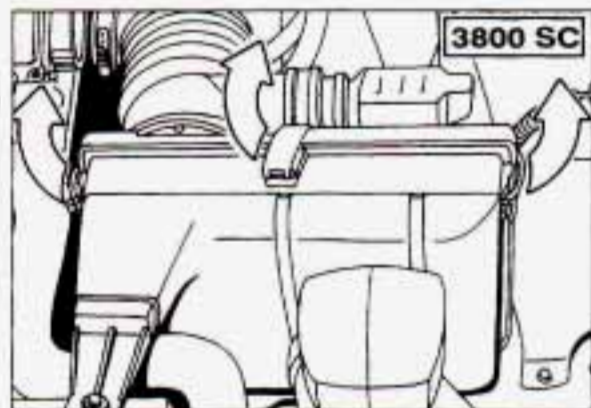

**To Check or Replace the Air Cleaner
(3800 Supercharged Engine):**

1. Unsnap the three clips in the housing cover.

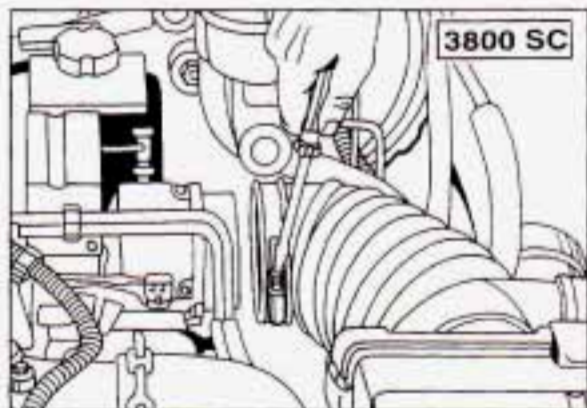

2. Unscrew the clamp on the air intake hose where the hose attaches to the throttle body near the top of the engine. Detach the hose from the throttle body, then pull back the rear of the housing cover.

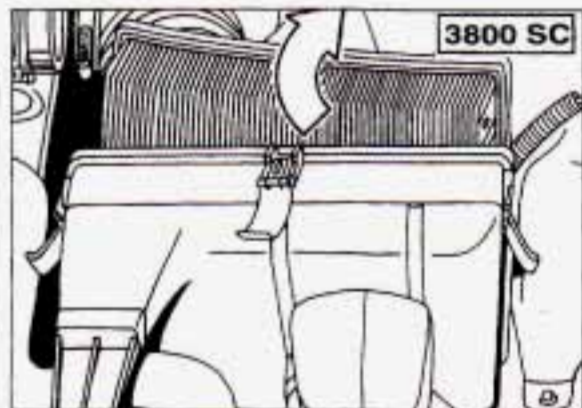

3. Remove the air filter.
4. Be sure to install the new air filter and replace the cover tightly.
5. Reattach the air intake hose and tighten the clamp.



■ Supercharger Oil

Unless you are technically qualified and have the proper tools, you should let your dealer or qualified service center perform this maintenance.

When to Check

Check oil level every 30,000 miles (50 000 km) or 36 months. See *Scheduled Maintenance Services* in the *Index*.

What Kind of Oil to Use

See *Recommended Fluids and Lubricants* in the *Index*. Use only the recommended oil.

How to Check and Add Oil

Check oil only when the engine is cold. Allow the engine to cool two to three hours after running.



CAUTION:

If you remove the supercharger oil fill plug while the engine is hot, pressure may cause hot oil to blow out of the oil fill hole. You may be burned. Do not remove the plug until the engine cools.

1. Remove the wiring harness shield.
2. Clean the area around the oil fill plug before removing it.
3. Remove the oil fill plug using a $\frac{3}{8}$ " allen wrench.
4. The oil level is correct when it just reaches the bottom of the threads of the inspection hole.
5. Replace the oil plug with the o-ring in place. Torque to 10 N•m (88 lb. in.).
6. Replace the wiring harness shield.

■ Automatic Transaxle Fluid When to Check and Change

A good time to check your automatic transaxle fluid level is when the engine oil is changed. Refer to the Maintenance Schedule to determine when to change your fluid. See *Scheduled Maintenance Services* in the *Index*.

How to Check

Because this operation can be a little difficult, you may choose to have this done at an Oldsmobile dealership Service Department.

If you do it yourself, be sure to follow all the instructions here, or you could get a false reading on the dipstick.

NOTICE:

Too much or too little fluid can damage your transaxle. Too much can mean that some of the fluid could come out and fall on hot engine parts or exhaust system, starting a fire. Be sure to get an accurate reading if you check your transaxle fluid.

Wait at least 30 minutes before checking the transaxle fluid level if you have been driving:

- When outside temperatures are above 90°F (32°C).
- At high speed for quite a while.
- In heavy traffic — especially in hot weather.
- While pulling a trailer.

To get the right reading, the fluid should be at normal operating temperature, which is 180°F to 200°F (82°C to 93°C).

Get the vehicle warmed up by driving about 15 miles (24 km) when outside temperatures are above 50°F (10°C). If it's colder than 50°F (10°C), you may have to drive longer.

To check the fluid level:

- Park your vehicle on a level place.
- With the parking brake applied, place the shift lever in **P** (Park).
- With your foot on the brake pedal, move the shift lever through each gear range, pausing for about three seconds in each range. Then, position the shift lever in **P** (Park).
- Let the engine run at idle for three to five minutes.

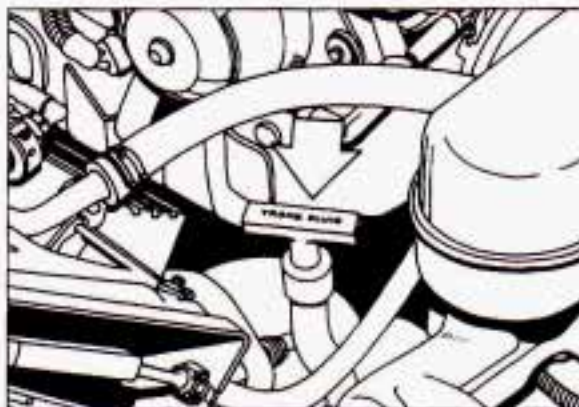

Then, without shutting off the engine, follow these steps:

1. Pull out the dipstick and wipe it with a clean rag or paper towel.
2. Push it back in all the way, wait three seconds and then pull it back out again.

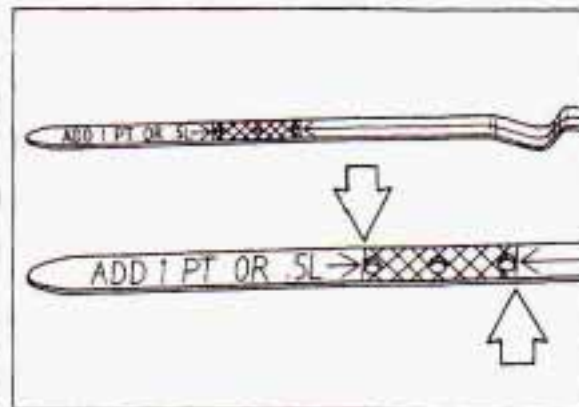

3. Check both sides of the dipstick, and read the lower level. The fluid level must be in the cross-hatched area.
4. If the fluid level is in the acceptable range, push the dipstick back in all the way.

Service & Appearance Care



How to Add Fluid

Refer to the Maintenance Schedule to determine what kind of transaxle fluid to use. See *Recommended Fluids and Lubricants* in the *Index*.

If the fluid level is low, add only enough of the proper fluid to bring the level into the cross-hatched area on the dipstick.

1. Pull out the dipstick.
2. Using a long-neck funnel, add enough fluid at the dipstick hole to bring it to the proper level.

It doesn't take much fluid, generally less than a pint (0.5L). **Don't overfill.** We recommend you use only fluid labeled DEXRON®-III or DEXRON®-IIE, because fluids with that label are made especially for your automatic transaxle.

Damage caused by fluid other than DEXRON®-III or DEXRON®-IIE is not covered by your new vehicle warranty.

- After adding fluid, recheck the fluid level as described under *How to Check*.
- When the correct fluid level is obtained, push the dipstick back in all the way.

■ Engine Coolant

The following explains your cooling system and how to add coolant when it is low. If you have a problem with engine overheating, see *Engine Overheating* in the *Index*.

The proper coolant for your Oldsmobile will:

- Give freezing protection down to -34°F (-37°C).
- Give boiling protection up to 262°F (128°C).
- Protect against rust and corrosion.
- Help keep the proper engine temperature.
- Let the warning lights work as they should.

What to Use

Use a mixture of one-half **clean water** (preferably distilled) and one-half antifreeze that meets "GM Specification 1825-M," which won't damage aluminum parts. You can also use a recycled coolant conforming to GM Specification 1825-M with a complete coolant flush and refill. If you use this mixture, you don't need to add anything else.



CAUTION:

Adding only plain water to your cooling system can be dangerous. Plain water, or some other liquid like alcohol, can boil before the proper coolant mix will. Your vehicle's coolant warning system is set for the proper coolant mix. With plain water or the wrong mix, your engine could get too hot but you wouldn't get the overheat warning. Your engine could catch fire and you or others could be burned. Use a 50/50 mix of clean water and a proper antifreeze.

NOTICE:

If you use an improper coolant mix, your engine could overheat and be badly damaged. The repair cost wouldn't be covered by your warranty. Too much water in the mix can freeze and crack the engine, radiator, heater core and other parts.

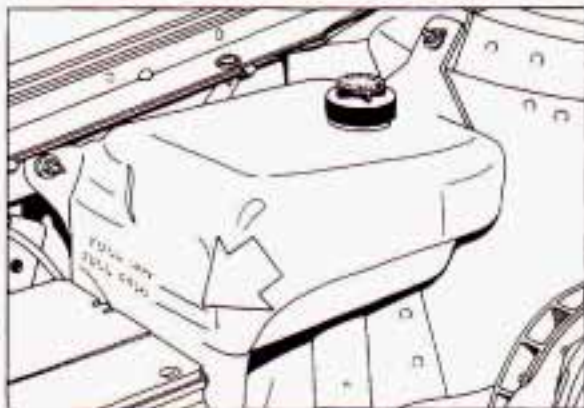

Adding Coolant

To Check Coolant

When your engine is cold, the coolant level should be at **FULL COLD** or a little higher. When your engine is warm, the level should be up to **FULL HOT** or a little higher.

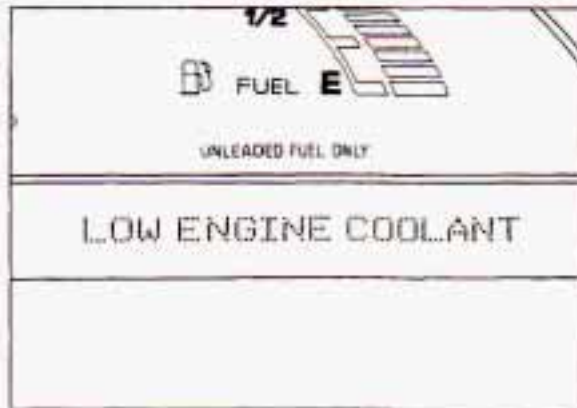

If you have the electronic cluster and your coolant level is low, the information center display will show:

LOW ENGINE COOLANT

If this light comes on, it means you're low on engine coolant.

To Add Coolant

If you need more coolant, add the proper mix **at the coolant recovery tank**.



CAUTION:

Turning the radiator pressure cap when the engine and radiator are hot can allow steam and scalding liquids to blow out and burn you badly. With the coolant recovery tank, you will almost never have to add coolant at the radiator. Never turn the radiator pressure cap — even a little — when the engine and radiator are hot.

Add coolant mix at the recovery tank, but be careful not to spill it.



CAUTION:

You can be burned if you spill coolant on hot engine parts. Coolant contains ethylene glycol, and it will burn if the engine parts are hot enough. Don't spill coolant on a hot engine.

■ Radiator Pressure Cap

NOTICE:

Your radiator cap is a 15 psi (105 kPa) pressure-type cap and must be tightly installed to prevent coolant loss and possible engine damage from overheating. Be sure the arrows on the cap line up with the overflow tube on the radiator filler neck.

When you replace your radiator pressure cap, an AC® cap is recommended.

■ Thermostat

Engine coolant temperature is controlled by a thermostat in the engine coolant system. The thermostat stops the flow of coolant through the radiator until the coolant reaches a preset temperature.

When you replace your thermostat, an AC® thermostat is recommended.

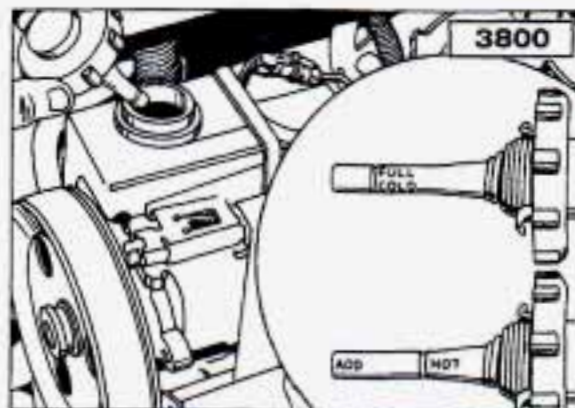

■ Power Steering Fluid

How To Check Power Steering Fluid

Unscrew the cap and wipe the dipstick with a clean rag. Replace the cap and completely tighten it. Then remove the cap again and look at the fluid level on the dipstick.

- When the engine compartment is hot, the level should be at the **HOT** mark.
- When the engine compartment is cool, the level should be at the **FULL COLD** mark.

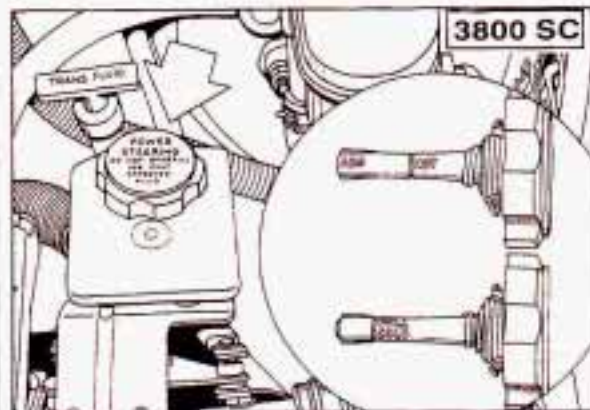

What to Add

Refer to the Maintenance Schedule to determine what kind of fluid to use. See *Recommended Fluids and Lubricants* in the *Index*.

NOTICE:

When adding power steering fluid or making a complete fluid change, always use the proper fluid. Failure to use the proper fluid can cause leaks and damage hoses and seals.

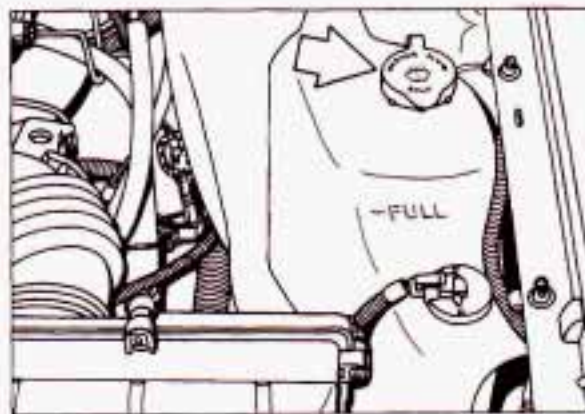

■ Windshield Washer Fluid

To Add

Open the cap labeled **WASHER FLUID ONLY**. Add washer fluid until the bottle is full.

NOTICE:

- When using concentrated washer fluid, follow the manufacturer's instructions for adding water.
- Don't mix water with ready-to-use washer fluid. Water can cause the solution to freeze and damage your washer fluid tank and other parts of the washer system. Also, water doesn't clean as well as washer fluid.
- Fill your washer fluid tank only $\frac{3}{4}$ full when it's very cold. This allows for expansion, which could damage the tank if it is completely full.
- Don't use radiator antifreeze in your windshield washer. It can damage your washer system and paint.

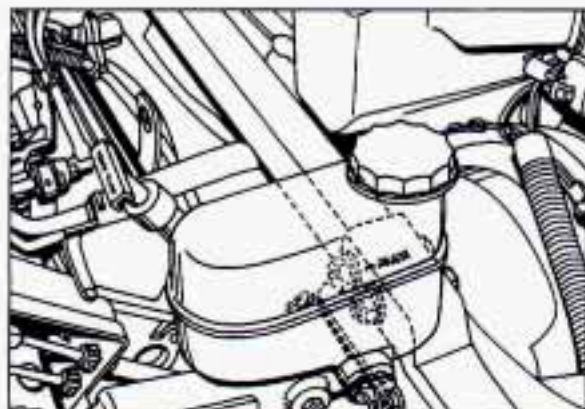

■ Brakes

Brake Master Cylinder

Your brake master cylinder is here. It is filled with DOT-3 brake fluid.

There are only two reasons why the brake fluid level in your master cylinder might go down. The first is that the brake fluid goes down to an acceptable level during normal brake lining wear. When new linings are put in, the fluid level goes back up. The other reason is that fluid is leaking out of the brake system. If it is, you should have your brake system fixed, since a leak means that sooner or later your brakes won't work well, or won't work at all. So, it isn't a good idea to "top off" your brake fluid. Adding brake fluid won't correct a

leak. If you add fluid when your linings are worn, then you'll have too much fluid when you get new brake linings. You should add (or remove) brake fluid, as necessary, only when work is done on the brake hydraulic system.



CAUTION:

If you have too much brake fluid, it can spill on the engine. The fluid will burn if the engine is hot enough. You or others could be burned, and your vehicle could be damaged. Add brake fluid only when work is done on the brake hydraulic system.

When your brake fluid falls to a low level, your brake warning light will come on. A chime will sound if you try to drive with this warning light on. See *Brake System Warning Light* in the *Index*.

What to Add

When you do need brake fluid, use only DOT-3 brake fluid — such as Delco Supreme 11[®] (GM Part No.1052535). Use new brake fluid from a sealed

container only, and always clean the brake fluid reservoir cap before removing it.

NOTICE:

- DOT-5 silicone brake fluid can damage your vehicle. Don't use it.
- Don't let someone put in the wrong kind of fluid. For example, just a few drops of mineral-based oil, such as engine oil, in your brake system can damage brake system parts so badly that they'll have to be replaced.
- Brake fluid can damage paint, so be careful not to spill brake fluid on your vehicle. If you do, wash it off immediately. See *Appearance Care* in the *Index*.

Brake Wear

Your Oldsmobile has front disc brakes and rear drum brakes.

Disc brake pads have built-in wear indicators that make a high-pitched warning sound when the brake pads are worn and new pads are needed. The

sound may come and go or be heard all the time your vehicle is moving (except when you are pushing on the brake pedal firmly).



CAUTION:

The brake wear warning sound means that sooner or later your brakes won't work well. That could lead to an accident. When you hear the brake wear warning sound, have your vehicle serviced.

NOTICE:

Continuing to drive with worn-out brake pads could result in costly brake repair.

Some driving conditions or climates may cause a brake squeal when the brakes are first applied or lightly applied. This does not mean something is wrong with your brakes.

Your rear drum brakes don't have wear indicators, but if you ever hear a rear brake rubbing noise, have the rear brake

linings inspected. Also, the rear brake drums should be removed and inspected each time the tires are removed for rotation or changing. When you have the front brakes replaced, have the rear brakes inspected, too.

Brake linings should always be replaced as complete axle sets.

Brake Pedal Travel

See your dealer if the brake pedal does not return to normal height, or if there is a rapid increase in pedal travel. This could be a sign of brake trouble.

Brake Adjustment

Every time you apply the brakes moderately, with or without the vehicle moving, your brakes adjust for wear.

Replacing Brake System Parts

The braking system on a modern vehicle is complex. Its many parts have to be of top quality and work well together if the vehicle is to have really good braking. Vehicles we design and test have top-quality GM brake parts in them, as your Oldsmobile does when it is new. When you replace parts of your braking system — for example, when your brake linings wear down and you have to have new ones put in — be sure you get new genuine GM replacement parts. If you don't, your brakes may no longer work properly. For example, if someone puts in brake linings that are wrong for your vehicle, the balance between your front and rear brakes can change, for the worse. The braking performance you've come to expect can change in many other ways if someone puts in the wrong replacement brake parts.

Service & Appearance Care

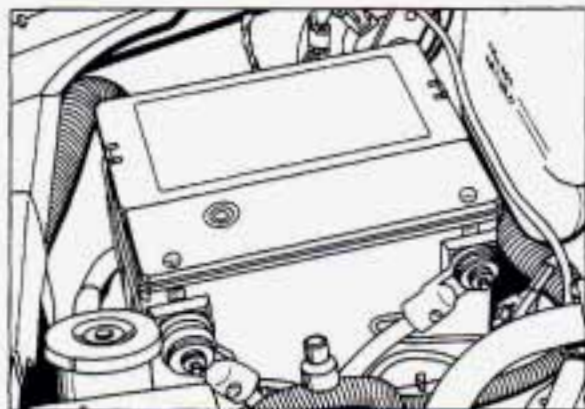

■ Battery

Every new Oldsmobile has a Delco Freedom® battery. You never have to add water to one of these. When it's time for a new battery, we recommend a Delco Freedom® battery. Get one that has the catalog number shown on the original battery's label.

Vehicle Storage

If you're not going to drive your vehicle for 25 days or more, take off the black, negative (-) cable from the battery. This will help keep your battery from running down.

CAUTION:

Batteries have acid that can burn you and gas that can explode. You can be badly hurt if you aren't careful. See *Jump Starting* in the *Index* for tips on working around a battery without getting hurt.

Contact your dealer to learn how to prepare your vehicle for longer storage periods.

■ Halogen Bulbs

CAUTION:

Halogen bulbs have pressurized gas inside and can burst if you drop or scratch the bulb. You or others could be injured. Take special care when handling and disposing of halogen bulbs.

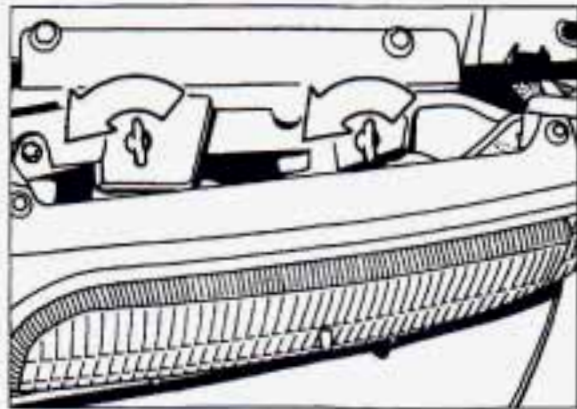

Headlight Bulb Replacement

For the type of bulb, see the *Index* under *Replacement Bulbs*.

1. Remove the two quarter-turn wing screws from the top of the headlight housing.
2. Lift the headlight up, then pull the bottom of the headlight forward. This will release the tabs at the back of the headlight.
3. Pull the inboard side of the headlight forward until all of the glass is past the grille. Slide the headlight toward the grille. Pull the outboard side of the headlight forward. The headlight should come out.

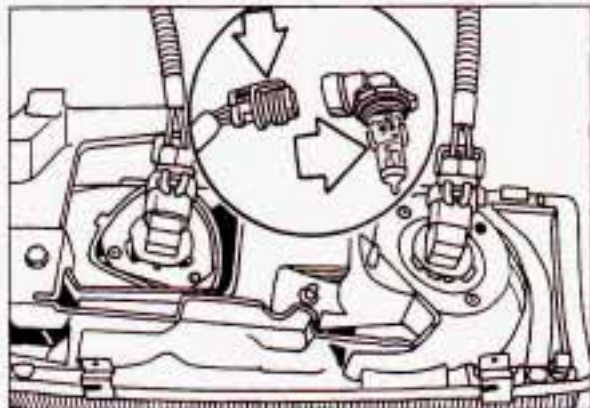

4. Twist the bulb assembly $\frac{1}{2}$ turn and pull out the bulb assembly.
5. Unclip the bulb assembly from the wiring harness and replace the bulb assembly.

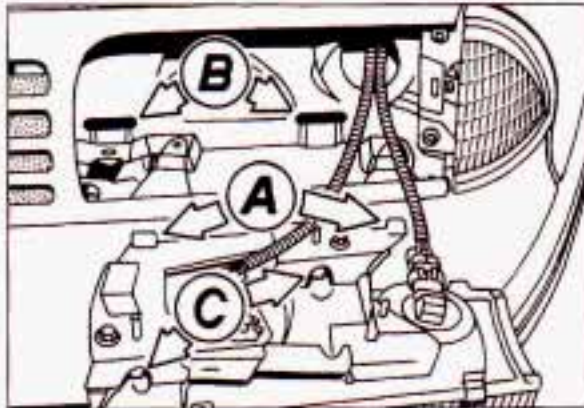

6. Reverse steps 1-5 to replace the bulb assembly and headlight housing. Make sure the tabs (A) are locked into slots (B) before tightening the screws.

The Torx[®] screws (C) are headlight aiming screws. Do not turn these screws. Only a qualified service technician using proper equipment should adjust these screws.

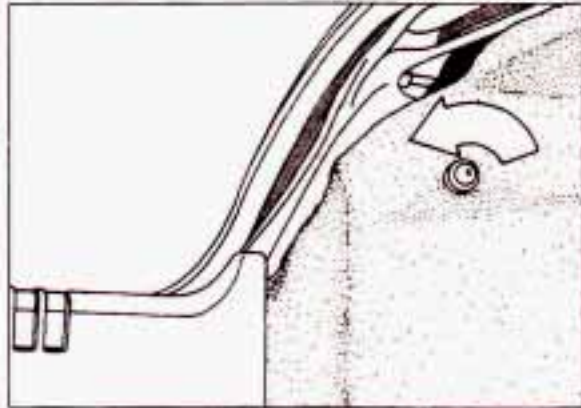

Taillight Bulb Replacement

For the type of bulb, see the *Index* under *Replacement Bulbs*.

1. In the trunk, remove the plastic screw holding the carpeting in place and pull back the carpeting. If you have the optional convenience net, you must first remove it from the hooks.
2. Pull the carpet away from the rear corner of the trunk.

Service & Appearance Care

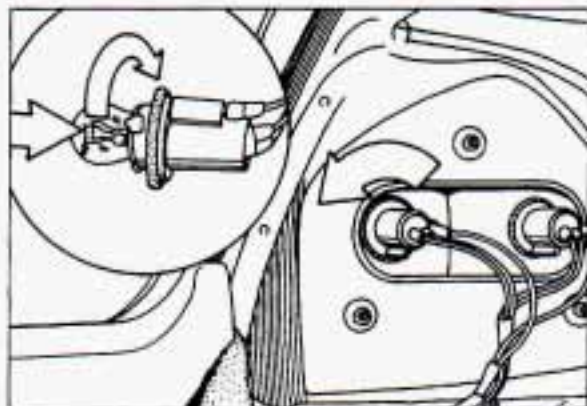

3. Rotate the bulb housing $\frac{1}{2}$ turn and remove it.
4. To remove the bulb, push in and rotate it counterclockwise.
5. Replace the bulb.
6. Reverse the steps to reassemble the taillight.

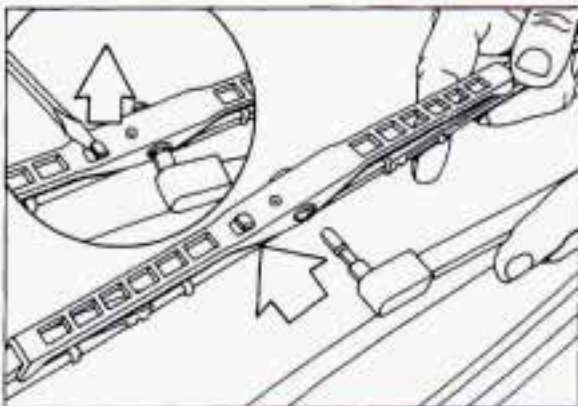

Windshield Wiper Blade Replacement

Replacement blades come in different types and are removed in different ways. Here's how to remove the type with a release clip:

1. Pull the windshield wiper arm away from the windshield.
2. Lift the release clip with a screwdriver and pull the blade assembly off the wiper arm.
3. Push the new wiper blade securely on the wiper arm.



■ Loading Your Vehicle

Two labels on your vehicle show how much weight it may properly carry. The Tire-Loading Information label found on the rear edge of the driver's door tells you the proper size, speed rating and recommended inflation pressures for the tires on your vehicle. It also gives you important information about the number of people that can be in your vehicle and the total weight that you can carry. This weight is called the Vehicle Capacity Weight and includes the weight of all occupants, cargo, and all nonfactory-installed options.

On vehicles equipped with electronic level control, the rear of the vehicle is automatically kept level as you load or unload your vehicle.

The other label is the Certification label, found on the rear edge of the driver's door. It tells you the gross weight capacity of your vehicle, called the GVWR (Gross Vehicle Weight Rating). The GVWR includes the weight of the vehicle, all occupants, fuel and cargo. Never exceed the GVWR for your vehicle, or the Gross Axle Weight Rating (GAWR) for either the front or rear axle.

And, if you do have a heavy load, you should spread it out. Don't carry more than 176 lbs. (80 kg) in your trunk.



CAUTION:

Do not load your vehicle any heavier than the GVWR or the maximum front and rear GAWRs. If you do, parts on your vehicle can break, or it can change the way your vehicle handles. These could cause you to lose control. Also, overloading can shorten the life of your vehicle.

NOTICE:

Your warranty does not cover parts or components that fail because of overloading.

If you put things inside your vehicle – like suitcases, tools, packages, or anything else – they will go as fast as the vehicle goes. If you have to stop or turn quickly, or if there is a crash, they'll keep going.



CAUTION:

Things you put inside your vehicle can strike and injure people in a sudden stop or turn, or in a crash.

- Put things in the trunk of your vehicle. In a trunk, put them as far forward as you can. Try to spread the weight evenly.
- Never stack heavier things, like suitcases, inside the vehicle so that some of them are above the tops of the seats.

CAUTION (Continued)

CAUTION (Continued)

- Don't leave an unsecured child restraint in your vehicle.
- When you carry something inside the vehicle, secure it whenever you can.
- Don't leave a seat folded down unless you need to.

■ Tires

We don't make tires. Your new vehicle comes with high quality tires made by a leading tire manufacturer. These tires are warranted by the tire manufacturers and their warranties are delivered with every new Oldsmobile. If your spare tire is a different brand than your road tires, you will have a tire warranty folder from each of these manufacturers.



CAUTION:

Poorly maintained and improperly used tires are dangerous.

- Overloading your tires can cause overheating as a result of too much friction. You could have an air-out and a serious accident. See *Loading Your Vehicle* in the *Index*.
- Underinflated tires pose the same danger as overloaded tires. The resulting accident could cause serious injury. Check all tires frequently to maintain the recommended pressure. Tire pressure should be checked when your tires are cold.
- Overinflated tires are more likely to be cut, punctured, or broken by a sudden impact, such as when you hit a pothole. Keep tires at the recommended pressure.
- Worn, old tires can cause accidents. If your tread is badly worn, or if your tires have been damaged, replace them.

Inflation - Tire Pressure

The Tire-Loading Information label which is on the rear edge of the driver's door shows the correct inflation pressures for your tires, when they're cold. "Cold" means your vehicle has been sitting for at least three hours or driven no more than a mile. Also see *Capacities & Specifications* in the *Index*.

NOTICE:

Don't let anyone tell you that underinflation or overinflation is all right. It's not. If your tires don't have enough air (underinflation) you can get:

- Too much flexing
- Too much heat
- Tire overloading
- Bad wear
- Bad handling
- Bad fuel economy.

NOTICE (Continued)

NOTICE (Continued)

If your tires have too much air (overinflation), you can get:

- Unusual wear
- Bad handling
- Rough ride
- Needless damage from road hazards.

When to Check

Check your tires once a month or more. Don't forget your compact spare tire. It should be at 60 psi (420 kPa).

How to Check

Use a good quality pocket-type gage to check tire pressure. Simply looking at the tires will not tell you the pressure, especially if you have radial tires — which may look properly inflated even if they're underinflated.

If your tires have valve caps, be sure to put them back on. They help prevent leaks by keeping out dirt and moisture.

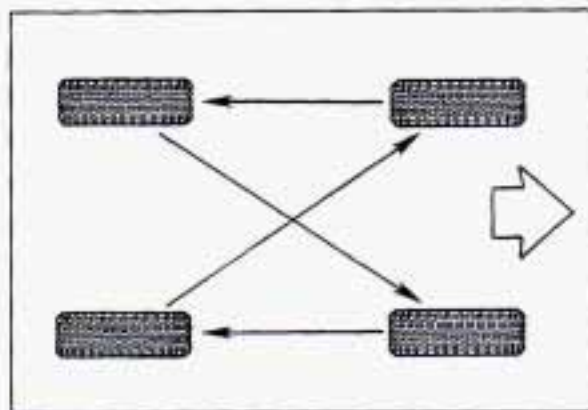

Tire Inspection and Rotation

To make your tires last longer, have them inspected and rotated at the mileages recommended in the Maintenance Schedule. See *Scheduled Maintenance Services* in the *Index*.

Use this rotation pattern.

After the tires have been rotated, adjust the front and rear inflation pressure as shown on the Tire-Loading Information label. Make certain that all wheel nuts are properly tightened. See *Wheel Nut Torque* in the *Index*.



CAUTION:

Rust or dirt on a wheel, or on the parts to which it is fastened, can make wheel nuts become loose after a time. The wheel could come off and cause an accident. When you change a wheel, remove any rust or dirt from places where the wheel attaches to the vehicle. In an emergency, you can use a cloth or a paper towel to do this; but be sure to use a scraper or wire brush later, if you need to, to get all the rust or dirt off. (See *Changing a Flat Tire* in the *Index*.)

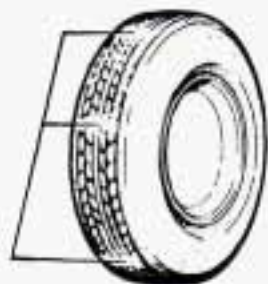

TREAD WEAR INDICATORS

When It's Time for New Tires

One way to tell when it's time for new tires is to check the treadwear indicators, which will appear when your tires have only $\frac{1}{32}$ inch (1.6 mm) or less of tread remaining.

You need a new tire if:

- You can see the indicators at three or more places around the tire.
- You can see cord or fabric showing through the tire's rubber.
- The tread or sidewall is cracked, cut or snagged deep enough to show cord or fabric.
- The tire has a bump, bulge or split.
- The tire has a puncture, cut, or other damage that can't be repaired well because of the size or location of the damage.

Buying New Tires

To find out what kind and size of tires you need, look at the Tire-Loading Information label.

The tires installed on your vehicle when it was new had a Tire Performance Criteria Specification (TPC Spec) number on each tire's sidewall. When you get new tires, get ones with that same TPC Spec number. That way, your vehicle will continue to have tires that are designed to give proper endurance, handling, speed rating, traction, ride and other things during normal service on your vehicle. If your tires have an all-season tread design, the TPC number will be followed by a "MS" (for mud and snow).

If you ever replace your tires with those not having a TPC Spec number, make sure they are the same size, load range, speed rating and construction type (bias, bias-belted or radial) as your original tires.



CAUTION:

Mixing tires could cause you to lose control while driving. If you mix tires of different sizes or types (radial and bias-belted tires), the vehicle may not handle properly, and you could have a crash. Be sure to use the same size and type tires on all four wheels. It's all right to drive with your compact spare, though. It was developed for use on your vehicle.

Uniform Tire Quality Grading

The following information relates to the system developed by the United States National Highway Traffic Safety Administration which grades tires by treadwear, traction and temperature performance. (This applies only to vehicles sold in the United States.)

Treadwear

The treadwear grade is a comparative rating based on the wear rate of the tire when tested under controlled conditions on a specified government

test course. For example, a tire graded 150 would wear one and a half (1 1/2) times as well on the government course as a tire graded 100. The relative performance of tires depends upon the actual conditions of their use, however, and may depart significantly from the norm due to variations in driving habits, service practices and differences in road characteristics and climate.

Traction - A, B, C

The traction grades, from highest to lowest are: A, B, and C. They represent the tire's ability to stop on wet pavement as measured under controlled conditions on specified government test surfaces of asphalt and concrete. A tire marked C may have poor traction performance.

Warning: The traction grade assigned to this tire is based on braking (straight-ahead) traction tests and does not include cornering (turning) traction.

Temperature - A, B, C

The temperature grades are A (the highest), B, and C, representing the tire's resistance to the generation of heat and its ability to dissipate heat

when tested under controlled conditions on a specified indoor laboratory test wheel. Sustained high temperature can cause the material of the tire to degenerate and reduce tire life, and excessive temperature can lead to sudden tire failure. The grade C corresponds to a level of performance which all passenger car tires must meet under the Federal Motor Vehicle Safety Standard No. 109. Grades B and A represent higher levels of performance on the laboratory test wheel than the minimum required by law.

Warning: The temperature grade for this tire is established for a tire that is properly inflated and not overloaded. Excessive speed, underinflation, or excessive loading, either separately or in combination, can cause heat buildup and possible tire failure.

These grades are molded on the sidewalls of passenger car tires.

While the tires available as standard or optional equipment on General Motors vehicles may vary with respect to these grades, all such tires meet General Motors performance standards and have been approved for use on General Motors

vehicles. All passenger type (P Metric) tires must conform to Federal safety requirements in addition to these grades.

Wheel Alignment and Tire Balance

The wheels on your vehicle were aligned and balanced carefully at the factory to give you the longest tire life and best overall performance.

In most cases, you will not need to have your wheels aligned again. However, if you notice unusual tire wear or your vehicle pulling one way or the other, the alignment may need to be reset. If you notice your vehicle vibrating when driving on a smooth road, your wheels may need to be rebalanced.

Wheel Replacement

Replace any wheel that is bent, cracked or badly rusted. If wheel nuts keep coming loose, the wheel, wheel bolts, and wheel nuts should be replaced. If the wheel leaks air, replace it (except some aluminum wheels, which can sometimes be repaired). See your Oldsmobile dealer if any of these conditions exist.

Your dealer will know the kind of wheel you need.

Each new wheel should have the same load carrying capacity, diameter, width, offset, and be mounted the same way as the one it replaces.

If you need to replace any of your wheels, wheel bolts, or wheel nuts, replace them only with new GM original equipment parts. This way, you will be sure to have the right wheel, wheel bolts, and wheel nuts for your Oldsmobile model.



CAUTION:

Using the wrong replacement wheels, wheel bolts, or wheel nuts on your vehicle can be dangerous. It could affect the braking and handling of your vehicle, make your tires lose air and make you lose control. You could have a collision in which you or others could be injured. Always use the correct wheel, wheel bolts, and wheel nuts for replacement.

NOTICE:

The wrong wheel can also cause problems with bearing life, brake cooling, speedometer/odometer calibration, headlight aim, bumper height, vehicle ground clearance, and tire or tire chain clearance to the body and chassis.

Used Replacement Wheels



CAUTION:

Putting a used wheel on your vehicle is dangerous. You can't know how it's been used or how many miles it's been driven. It could fail suddenly and cause an accident. If you have to replace a wheel use a **new** GM original equipment wheel.

Tire Chains

NOTICE:

Use tire chains only where legal and only when you must. Use only SAE Class "S" type chains that are the proper size for your tires. Install them on the front tires and tighten them as tightly as possible with the ends securely fastened. Drive slowly and follow the chain manufacturer's instructions. If you can hear the chains contacting your vehicle, stop and retighten them. If the contact continues, slow down until it stops. Driving too fast with chains on will damage your vehicle.

■ Appearance Care

Remember, cleaning products can be hazardous. Some are toxic. Others can burst into flame if you strike a match or get them on a hot part of the vehicle. Some are dangerous if you breathe their fumes in a closed space. When you use anything from a container to clean your Oldsmobile, be sure to follow the manufacturer's warnings and

instructions. And always open your doors or windows when you're cleaning the inside.

Never use these to clean your vehicle:

- Gasoline
- Benzene
- Naphtha
- Carbon Tetrachloride
- Acetone
- Paint Thinner
- Turpentine
- Lacquer Thinner
- Nail Polish Remover

They can all be hazardous — some more than others — and they can all damage your vehicle, too.

NOTICE:

Don't use any of these unless this manual says you can. In many uses, these will damage your vehicle:

- Laundry Soap
- Bleach
- Reducing Agents

■ *Cleaning the Inside of Your Oldsmobile*

Use a vacuum cleaner often to get rid of dust and loose dirt. Wipe vinyl or leather with a clean, damp cloth.

Your Oldsmobile dealer has two GM cleaners, a solvent-type spot lifter and a foam-type powdered cleaner. They will clean normal spots and stains very well. Do not use them on vinyl or leather.

Here are some cleaning tips:

- Always read the instructions on the cleaner label.
- Clean up stains as soon as you can — before they set.
- Use a clean cloth or sponge, and change to a clean area often. A soft brush may be used if stains are stubborn.
- Use solvent-type cleaners in a well-ventilated area only. If you use them, don't saturate the stained area.
- If a ring forms after spot cleaning, clean the entire area immediately or it will set.

Using Foam-Type Cleaner on Fabric

- Vacuum and brush the area to remove any loose dirt.
- Always clean a whole trim panel or section. Mask surrounding trim along stitch or welt lines.
- Mix Multi-Purpose Powdered Cleaner following the directions on the container label.
- Use suds only and apply with a clean sponge.
- Don't saturate the material.
- Don't rub it roughly.
- As soon as you've cleaned the section, use a sponge to remove the suds.
- Rinse the section with a clean, wet sponge.
- Wipe off what's left with a slightly damp paper towel or cloth.
- Then dry it immediately with a blow dryer or a heat lamp.

NOTICE:

Be careful with a hair dryer or heat lamp. You could scorch the fabric.

- Wipe with a clean cloth.

Using Solvent-Type Cleaner on Fabric

First, see if you have to use solvent-type cleaner at all. Some spots and stains will clean off better with just water and mild soap.

If you need to use a solvent:

- Gently scrape excess soil from the trim material with a clean, dull knife or scraper. Use very little cleaner, light pressure and clean cloths (preferably cheesecloth). Cleaning should start at the outside of the stain, "feathering" toward the center. Keep changing to a clean section of the cloth.
- When you clean a stain from fabric, immediately dry the area with an air hose, hair dryer, or heat lamp to help prevent a cleaning ring. (See the previous NOTICE.)

Service & Appearance Care

Special Cleaning Problems

Greasy or Oily Stains

Such as grease, oil, butter, margarine, shoe polish, coffee with cream, chewing gum, cosmetic creams, vegetable oils, wax crayon, tar and asphalt.

- Carefully scrape off excess stain.
- Follow the solvent-type instructions described earlier.
- Shoe polish, wax crayon, tar and asphalt will stain if left on a vehicle seat fabric. They should be removed as soon as possible. Be careful, because the cleaner will dissolve them and may cause them to spread.

Non-Greasy Stains

Such as catsup, coffee (black), egg, fruit, fruit juice, milk, soft drinks, wine, vomit, urine and blood.

- Carefully scrape off excess stain, then sponge the soiled area with cool water.
- If a stain remains, follow the foam-type instructions described earlier.
- If an odor lingers after cleaning vomit or urine, treat the area with a

water/baking soda solution: 1 teaspoon (5 ml) of baking soda to 1 cup (250 ml) of lukewarm water.

- If needed, clean lightly with solvent-type cleaner.

Combination Stains

Such as candy, ice cream, mayonnaise, chili sauce and unknown stains.

- Carefully scrape off excess stain, then clean with cool water and allow to dry.
- If a stain remains, clean it with solvent-type cleaner.

Cleaning Vinyl

Use warm water and a clean cloth.

- Rub with a clean, damp cloth to remove dirt. You may have to do it more than once.
- Things like tar, asphalt and shoe polish will stain if you don't get them off quickly. Use a clean cloth and a solvent-type vinyl cleaner.

Cleaning Leather

Use a soft cloth with lukewarm water and a mild soap or saddle soap.

- For stubborn stains, use a mild solution of 10% isopropyl alcohol (rubbing alcohol) and 90% water.
- **Never** use oils, varnishes, solvent-based or abrasive cleaners, furniture polish or shoe polish on leather.
- Soiled leather should be cleaned immediately. If dirt is allowed to work into finish, it can harm the leather.

Cleaning the Top of the Instrument Panel

Use only mild soap and water to clean the top surfaces of the instrument panel. Sprays containing silicones or waxes may cause annoying reflections in the windshield and even make it difficult to see through the windshield under certain conditions.

■ *Care of Safety Belts*

Keep belts clean and dry.



CAUTION:

Do not bleach or dye safety belts. If you do, it may severely weaken them. In a crash they might not be able to provide adequate protection. Clean safety belts only with mild soap and lukewarm water.

■ *Glass*

Glass should be cleaned often. GM Glass Cleaner (GM Part No. 1050427) or a liquid household glass cleaner will remove normal tobacco smoke and dust films.

Don't use abrasive cleaners on glass, because they may cause scratches. Avoid placing decals on the inside rear window, since they may have to be scraped off later. If abrasive cleaners are used on the inside of the rear window, an electric defogger element may be damaged. Any temporary license should not be attached across the defogger grid.

■ *Cleaning the Outside of the Windshield and Wiper Blades*

If the windshield is not clear after using the windshield washer, or if the wiper blade chatters when running, wax or other material may be on the blade or windshield.

Clean the outside of the windshield with GM Windshield Cleaner, Bon-Ami Powder® (GM Part No. 1050011). The windshield is clean if beads do not form when you rinse it with water.

Clean the blade by wiping vigorously with a cloth soaked in full strength windshield washer solvent. Then rinse the blade with water.

Wiper blades should be checked on a regular basis and replaced when worn.

■ *Cleaning the Outside of Your Oldsmobile*

The paint finish on your vehicle provides beauty, depth of color, gloss retention and durability.

Washing Your Vehicle

The best way to preserve your vehicle's finish is to keep it clean by washing it often with lukewarm or cold water.

Don't wash your vehicle in the direct rays of the sun. Don't use strong soaps or chemical detergents. Use liquid hand, dish or car washing (mild detergent) soaps. Don't use cleaning agents that contain acid or abrasives. All cleaning agents should be flushed promptly and not allowed to dry on the surface, or they could stain. Dry the finish with a soft, clean chamois or a 100% cotton towel to avoid surface scratches and water spotting.

High pressure vehicle washes may cause water to enter your vehicle.

Finish Care

Occasional waxing or mild polishing of your Oldsmobile may be necessary to remove residue from the paint finish. You can get GM approved cleaning products from your dealer.

Service & Appearance Care

Your Oldsmobile has a "basecoat/clearcoat" paint finish. The clearcoat gives more depth and gloss to the colored basecoat. Always use waxes and polishes that are non-abrasive and made for a basecoat/clearcoat paint finish.

NOTICE:

Machine compounding or aggressive polishing on a basecoat/clearcoat paint finish may dull the finish or leave swirl marks.

■ *Aluminum Wheels (If So Equipped)*

Your aluminum wheels have a protective coating similar to the painted surface of your vehicle. Don't use strong soaps, chemicals, chrome polish, abrasive cleaners or abrasive cleaning brushes on them because you could damage this coating. After rinsing thoroughly, a wax may be applied.

NOTICE:

If you have aluminum wheels, don't use an automatic vehicle wash that has hard silicon carbide cleaning brushes. These brushes can take off the protective coating.

■ *White Sidewall Tires*

Your Oldsmobile dealer has a GM White Sidewall Tire Cleaner. You can use a stiff brush with the cleaner.

■ *Weatherstrips*

Silicone grease on weatherstrips will make them last longer, seal better, and not stick or squeak. Apply silicone grease with a clean cloth at least every six months. During very cold, damp weather more frequent application may be required. (See *Recommended Fluids & Lubricants* in the *Index*.)

■ *Sheet Metal Damage*

If your vehicle is damaged and requires sheet metal repair or replacement, make sure the body repair shop applies anti-corrosion material to the parts repaired or replaced to restore corrosion protection.

■ *Foreign Material*

Calcium chloride and other salts, ice melting agents, road oil and tar, tree sap, bird droppings, chemicals from industrial chimneys, and other foreign matter can damage your vehicle's finish if they remain on painted surfaces. Use cleaners that are marked safe for painted surfaces to remove foreign matter.

■ *Finish Damage*

Any stone chips, fractures or deep scratches in the finish should be repaired right away. Bare metal will corrode quickly and may develop into a major repair expense.

Minor chips and scratches can be repaired with touch-up materials available from your dealer or other service outlets. Larger areas of finish damage can be corrected in your dealer's body and paint shop.

■ *Underbody Maintenance*

Chemicals used for ice and snow removal and dust control can collect on the underbody. If these are not removed, accelerated corrosion (rust) can occur on the underbody parts such as fuel lines, frame, floor pan, and exhaust system even though they have corrosion protection.

At least every spring, flush these materials from the underbody with plain water. Clean any areas where mud and other debris can collect. Dirt packed in closed areas of the frame should be loosened before being flushed. Your dealer or an underbody vehicle washing system can do this for you.

Service & Appearance Care

■ Chemical Paint Spotting

Some weather and atmospheric conditions can create a chemical fallout. Airborne pollutants can fall upon and attack painted surfaces on your vehicle. This damage can take two forms: blotchy, ringlet-shaped discolorations, and small irregular dark spots etched into the paint surface.

Although no defect in the paint job causes this, Oldsmobile will repair, at no charge to the owner, the surfaces of new vehicles damaged by this fallout condition within 12 months or 12,000 miles (20 000 km) of purchase, whichever comes first.

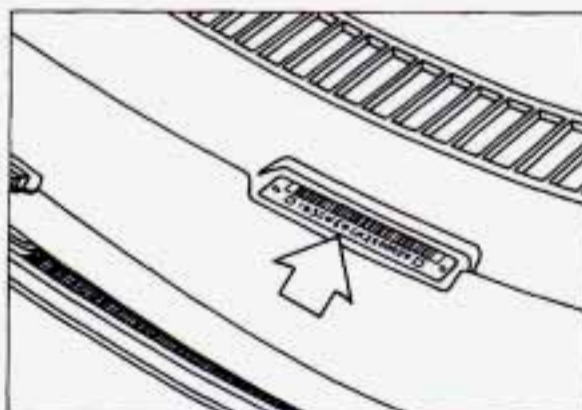

■ Vehicle Identification Number (VIN)

This is the legal identifier for your Oldsmobile. It appears on a plate in the front corner of the instrument panel, on the driver's side. You can see it if you look through the windshield from outside your vehicle. The VIN also appears on the Vehicle Certification and Service Parts labels and the certificates of title and registration.

Engine Identification

The eighth character in your VIN is the engine code. This code will help you identify your engine, specifications, and replacement parts.



■ Service Parts Identification Label

You'll find this label on your spare tire cover. It's very helpful if you ever need to order parts. On this label is:

- your VIN,
- the model designation,
- paint information, and
- a list of all production options and special equipment.

Be sure that this label is not removed from the vehicle.

■ *Add-On Electrical Equipment*

NOTICE:

Don't add anything electrical to your Oldsmobile unless you check with your dealer first. Some electrical equipment can damage your vehicle and the damage wouldn't be covered by your warranty. Some add-on electrical equipment can keep other components from working as they should.

Your vehicle has an air bag system. Before attempting to add anything electrical to your Oldsmobile, see *Servicing Your Air Bag-Equipped Oldsmobile* in the *Index*.

■ *Fuses & Circuit Breakers*

The wiring circuits in your vehicle are protected from short circuits by a combination of fuses and circuit breakers. This greatly reduces the chance of damage caused by electrical problems.

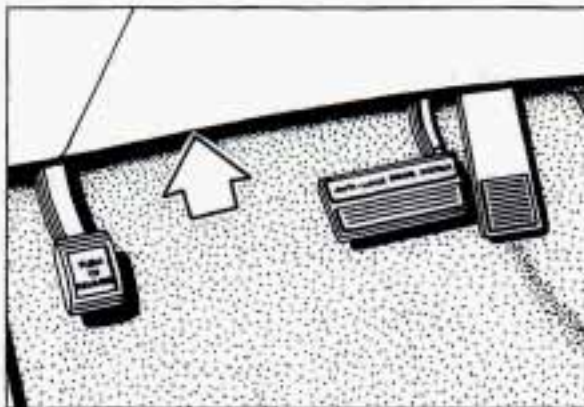

The left side fuse panel is located to the left of the steering wheel, under the instrument panel.

Snap off the cover to reveal the fuses. You'll find a fuse puller clipped to the inside of the cover. Place the wide end of the fuse puller over the plastic end of the fuse. Squeeze the ends over the fuse and pull it out.

Spare fuses are located in the slots labeled "Spare" on the following chart.

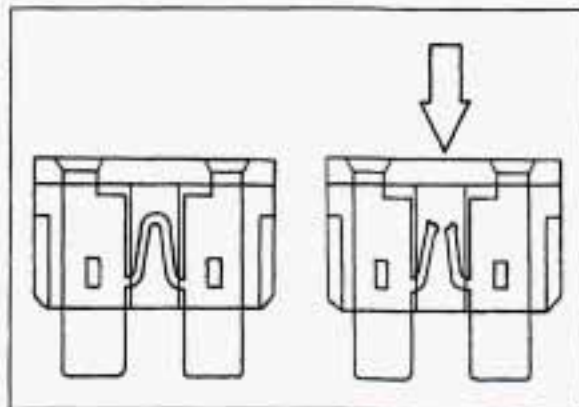

Look at the silver-colored band inside the fuse. If the band is broken or melted, replace the fuse. Be sure you replace a bad fuse with a new one of the correct amp rating.

When finished, replace the cover and pinch the release levers again to unlock the panel. Press it back up into place.

Service & Appearance Care

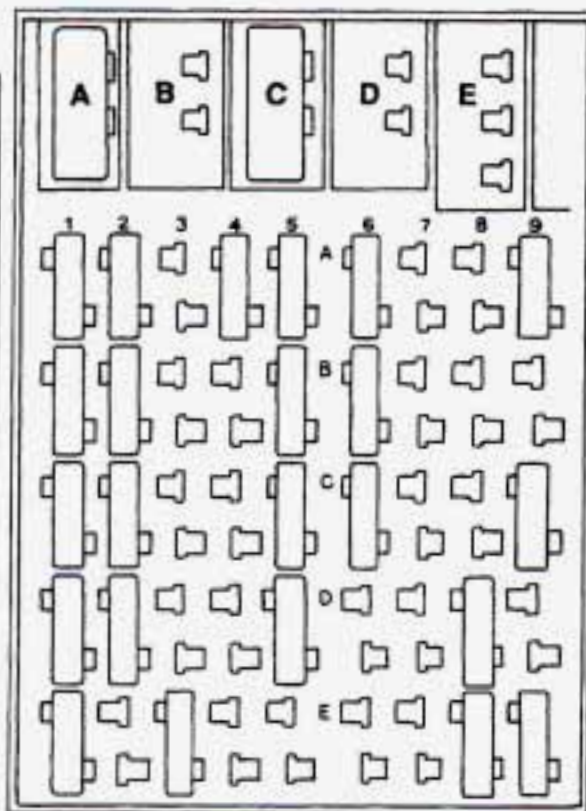

Left Side Fuse Panel

Position	Rating (AMP.)	Circuitry
A	30	Circuit Breaker-Power Windows
B		Not Used
C	25	Power Seats
D		Not Used
E		Not Used
1A	10	Start-Up Signal - Air Bag
2A	10	Spare
3A		Not Used
4A	10	Interior Lamps
5A	10	Ignition (Run), Automatic A/C Control
6A	15	Courtesy Lights, Power Mirrors
7A		Not Used
8A		Not Used
9A	15	Cigar Lighter
1B	20	Turn Signal, Back-up Lights, Cornering Lights, Brake-Transaxle Shift Interlock
2B	15	Spare
3B		Not Used
4B		Not Used
5B	10	Anti-Lock Brake System
6B	20	Brake and Hazard Lamps
7B		Not Used
8B		Not Used
9B		Not Used
1C	10	Air Bag
2C	20	Spare

Position	Rating (AMP.)	Circuitry
3C		Not Used
4C		Not Used
5C	10	Cooling Fans, Transaxle
6C	15	Parking Lamps
7C		Not Used
8C		Not Used
9C	10	(Battery) Chime, Radio, Cluster
1D	15	Ignition (Run/Crank), Chime, Cluster
2D	25	Spare
3D		Not Used
4D		Not Used
5D	25	Base A/C
6D		Not Used
7D		Not Used
8D	10	Radio
9D		Not Used
1E	20	Auxiliary Outlet(s)
2E		Not Used
3E	10	Ignition (Off/Unlock)
4E		Not Used
5E		Not Used
6E		Not Used
7E		Not Used
8E	25	Wipers, Washer
9E	30	Rear Defog

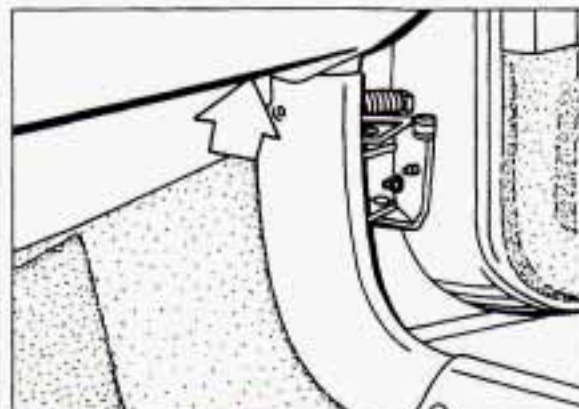

Right Side Fuse Panel

Additional fuses are located in the relay center, on the far right side, below the instrument panel. You must remove the sound insulator on the right side of the passenger foot well to replace these fuses.

Replacing these fuses is difficult. We recommend that you see your dealer if you need one replaced.

Service & Appearance Care

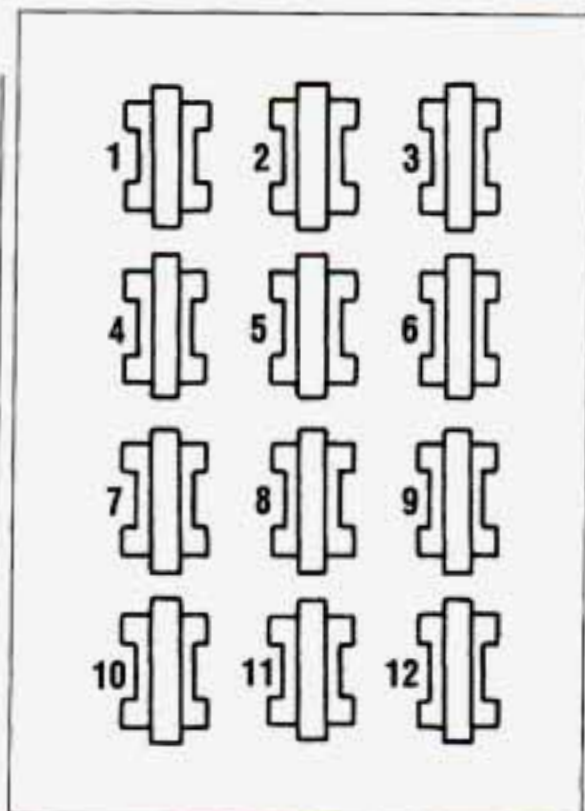

Right Side Fuse Panel (CONT.)

Position	Rating (AMP.)	Circuitry
1	20	Door Locks
2	15	Cruise Control, Misc. Engine Controls
3		Not Used
4	15	Power Antenna, Lock Switch
5	20	Fuel Pump
6		Not Used
7	15	Horns
8	10	Injectors
9	10	A/C Programmer
10		Not Used
11	10	Powertrain Control Module, PASS-Key® II
12		Not Used

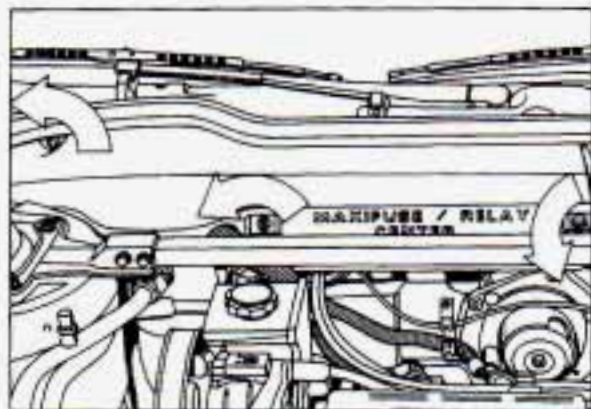

Maxifuse/Relay Center

To check the fuses in this underhood fuse center, turn the two knobs $\frac{1}{4}$ turn counterclockwise and loosen the metal wing nut on the passenger side of the cover. Then remove the cover. The inside of the cover has a chart that explains the features and controls governed by each fuse and relay.

Headlight Wiring

The headlight wiring is protected by a circuit breaker in the wiring harness. An electrical overload will cause the lights to go on and off, or in some cases to remain off. If this happens, have your headlight system checked right away.

Windshield Wipers

The windshield wiper motor is protected by an internal circuit breaker and a fuse in the left side fuse panel. If the motor overheats due to heavy snow, etc., the wiper will stop until the motor cools. If the overload is caused by some electrical problem, have it fixed.

Power Windows and Power Seats

Circuit breakers in the fuse panel protect the power windows and power seats. When the current load is too heavy, the circuit breaker opens and closes, protecting the circuit until the problem is fixed.

Service & Appearance Care

Capacities & Specifications

Automatic Transaxle AT (Overdrive)

When draining or replacing torque converter, more fluid may be needed.

Pan Removal and Replacement	6.5 quarts	6.1 L
After Complete Overhaul	11 quarts	10.4 L

Cooling System	13 quarts	12.3 L
-----------------------------	-----------	--------

Refrigerant (R-134A), Air Conditioning	2.42 pounds	1.1 kg
---	-------------	--------

Not all air conditioning refrigerants are the same. If the air conditioning system in your vehicle needs refrigerant, be sure the proper refrigerant is used. If you're not sure, ask your Oldsmobile dealer. For additional information, see your "Warranty and Owner Assistance Information" booklet.

Engine Crankcase	4 quarts	3.8 L
-------------------------------	----------	-------

When changing filter, up to 1 quart (1 liter) more oil may be needed.

Fuel Tank	18 gallons	68 L
------------------------	------------	------

Power Steering

Pump Only	1 pint	0.5 L
Complete System	1.5 pints	0.7 L

Tire Pressures

All Except Spare	30 psi	210 kPa
Spare	60 psi	415 kPa

Wheel Nut Torque	100 pound-feet	140 N•m
-------------------------------	----------------	---------

NOTE: All capacities are approximate. When adding, be sure to fill to the appropriate level, as recommended in this manual.

Engine Specifications

3800 Tuned Port Injection Engine

VIN Engine Code	L
Type	V6
Displacement	3.8 Liters
Compression Ratio	9.0:1
Firing Order	1-6-5-4-3-2
Thermostat Temperature Specification	195°F (91°C)

3800 Supercharged Engine

VIN Engine Code	1
Type	V6
Displacement	3.8 Liters
Compression Ratio	8.5:1
Firing Order	1-6-5-4-3-2
Thermostat Temperature Specification	195°F (91°C)

Normal Maintenance Replacement Parts

Air Cleaner Element	AC Type A-1096C
Engine Oil Filter	AC Type PF-47
Remote Lock Control Battery (2)	2016
Spark Plugs	AC Type•41-601 Gap: 0.060 inch (1.52 mm)

Service & Appearance Care

Fluids & Lubricants

ITEM	APPLICATION	GM PART NUMBER	SIZE
Antifreeze Coolant (Ethylene Glycol Base)	Year-round antifreeze for coolant mixtures	1052753	1 gal. (3.8 L)
Chassis Lubricant (Grease Gun Insert)	General chassis lube, etc.	1052497	14 oz. (397 g)
Delco Supreme 11® Brake Fluid	Brake System	1052535	16 oz. (0.5 L)
Automatic Transmission Fluid	Automatic Transaxle		
DEXRON®-III		12346143	32 oz. (1.0 L)
DEXRON®-IIE		12345881	32 oz. (1.0 L)
Engine Oil	Engine lubrication	See <i>Engine Oil</i> in this section.	
GM Engine Oil Supplement (E.O.S.) ...	See your dealer for advice	1052367	16 oz. (0.5 L)
Engine Oil	Hood, trunk and door hinges		
Windshield Washer Solvent	Windshield washer fluid		
Power Steering Fluid (Normal)	Power Steering System	1050017	32 oz. (1.0 L)
		1052884	16 oz. (0.5 L)
Power Steering Fluid (Cold Climate)	Power Steering System	12345867	32 oz. (1.0 L)
(System must be drained and refilled with it.)		12345866	16 oz. (0.5 L)
Dielectric Silicone Grease	Weatherstrips	12345579	1 oz. (28 g)
Spray-A-Squeak Silicone Lubricant	General purpose silicone	1052276 (aerosol)	4.5 oz. (128 g)
	lubricant	1052277	12 oz. (0.35 L)

Replacement Bulbs

OUTSIDE LIGHTS

BULB

Bulb Messages

If you have the Electronic Cluster, your information center provides these messages about burned-out bulbs.

Front

Cornering Lights (Optional)	2057	
Front Parking Lights	2057NA	FRONT PARK LAMP OUT
Front Turn Signal Lights	2057NA	FRONT TURN LAMP OUT
Halogen Headlights		
Low Beam	9006	LOW BEAM LAMP OUT
High Beam	9005	HIGH BEAM LAMP OUT
Front Sidemarkers	194	FRONT PARK LAMP OUT
Underhood Light	561	

Rear

Back-up Lights	2057	BACK-UP LAMP OUT
License Plate Light	194	TAIL LAMP OUT
Center High-Mounted Stoplight	1156	CENTER STOP LAMP OUT
Rear Sidemarkers	194	TAIL LAMP OUT
Stop/Taillights	2057	TAIL LAMP OUT
Rear Turn Signal	2057	REAR LAMP OUT
Trunk Light	93	

Service & Appearance Care

INSIDE LIGHTS	BULB
Overhead	
Front Overhead Lights	906
Rear Overhead Lights	906
Visor Vanity Lights	7065
Doors	
Front Courtesy Lights	74
Rear Courtesy/Warning Lights	194
Instrument Panel	
IP Sound Insulator Panel (Lower Floor Lighting)	168
Glove Compartment Light	194
Ashtray Light	194

IMPORTANT
KEEP ENGINE OIL
AT THE PROPER
LEVEL AND CHANGE AS
RECOMMENDED

This part covers the maintenance required for your Oldsmobile. Your vehicle needs these services to retain its safety, dependability and emission control performance.



Have you purchased the
GM Protection Plan?
The Plan supplements your
new vehicle warranties.
See your Oldsmobile dealer for details.

Part 7

Maintenance Schedule

Section

Introduction

A Word About Maintenance.....	234
Your Vehicle and the Environment.....	234
How This Part is Organized	234

A. Scheduled Maintenance Services

Using Your Maintenance Schedule	235
Selecting the Right Schedule.....	235
Schedule I.....	236
Schedule II	238
Explanation of Scheduled Maintenance Services.....	240

B. Owner Checks and Services

At Each Fuel Fill.....	242
At Least Once a Month	242
At Least Once a Year.....	243

C. Periodic Maintenance Inspections.....

D. Recommended Fluids and Lubricants.....

E. Maintenance Record.....

Maintenance Schedule

■ Introduction

A Word About Maintenance

We at General Motors want to help you keep your vehicle in good working condition. But we don't know exactly how you'll drive it. You may drive very short distances only a few times a week. Or you may drive long distances all the time in very hot, dusty weather. You may use your vehicle in making deliveries. Or you may drive it to work, to do errands or in many other ways.

Because of all the different ways people use their GM vehicles, maintenance needs vary. You may even need more frequent checks and replacements than you will find in the schedules in this part. So please read this part and note how you drive. If you have any questions on how to keep your vehicle in good condition, see your Oldsmobile dealer, the place many GM owners choose to have their maintenance work done. Your dealer can be relied upon to use proper parts and practices.

Your Vehicle and the Environment

Proper vehicle maintenance not only helps to keep your vehicle in good working condition, but also helps the environment. All recommended maintenance procedures are important. Improper vehicle maintenance or the removal of important components can significantly affect the quality of the air we breathe. Improper fluid levels or even the wrong tire inflation can increase the level of emissions from your vehicle. To help protect our environment, and to help keep your vehicle in good condition, please maintain your vehicle properly.

How This Part is Organized

The remainder of this part is divided into five sections:

"Section A: Scheduled Maintenance Services" shows what to have done and how often. Some of these services can be complex, so unless you are technically qualified and have the necessary equipment, you should let your dealer's service department or another qualified service center do these jobs.



CAUTION:

Performing maintenance work on a vehicle can be dangerous. In trying to do some jobs, you can be seriously injured. Do your own maintenance work only if you have the required know-how and the proper tools and equipment for the job. If you have any doubt, have a qualified technician do the work.

If you are skilled enough to do some work on your vehicle, you will probably want to get the service information GM publishes. You will find a list of publications and how to get them in this manual. See *Service Publications* in the *Index*.

"Section B: Owner Checks and Services" tells you what should be checked whenever you stop for fuel. It also explains what you can easily do to help keep your vehicle in good condition.

"Section C: Periodic Maintenance Inspections" explains important inspections that your Oldsmobile dealer's service department or another qualified service center should perform.

"Section D: Recommended Fluids and Lubricants" lists some products GM recommends to help keep your vehicle properly maintained. These products, or their equivalents, should be used whether you do the work yourself or have it done.

"Section E: Maintenance Record" provides a place for you to record the maintenance performed on your vehicle. Whenever any maintenance is performed, be sure to write it down in this section. This will help you determine when your next maintenance should be done. In addition, it is a good idea to keep your maintenance receipts. They may be needed to qualify your vehicle for warranty repairs.

■ *Section A: Scheduled Maintenance Services*

Using Your Maintenance Schedule

This section tells you the maintenance services you should have done and when you should schedule them. Your Oldsmobile dealer knows your vehicle best and wants you to be happy with it. If you go to your dealer for your service needs, you'll know that GM-trained and supported service people will perform the work using genuine GM parts.

These schedules are for vehicles that:

- carry passengers and cargo within recommended limits. You will find these limits on your vehicle's Tire-Loading Information label. See *Loading Your Vehicle* in the *Index*.
- are driven on reasonable road surfaces within legal driving limits.
- use the recommended unleaded fuel. See *Fuel* in the *Index*.

Selecting the Right Schedule

First you'll need to decide which of the two schedules is right for your vehicle. Here's how to decide which schedule to follow:

Schedule I

Is any one of these true for your vehicle?

- Most trips are less than 4 miles (6 km).
- Most trips are less than 10 miles (16 km) when outside temperatures are below freezing.
- The engine is at low speed most of the time (as in door-to-door delivery, or in stop-and-go traffic).
- You operate your vehicle in dusty areas.
- You tow a trailer.

If any one (or more) of these is true for your driving, follow Schedule I.

Schedule II

Follow Schedule II **only** if none of the above conditions is true.

Maintenance Schedule

Schedule I

Follow Schedule I if your vehicle is **MAINLY** driven under one or more of the following conditions:

- When most trips are less than 4 miles (6 km).
- When most trips are less than 10 miles (16 km) and outside temperatures remain below freezing.
- When most trips include extended idling and/or frequent low-speed operation, as in stop-and-go traffic.
- When towing a trailer.
- When operating in dusty areas.

Schedule I should also be followed if the vehicle is used for delivery service, police, taxi or other commercial applications.

ITEM NO.	TO BE SERVICED <i>See Explanation of Scheduled Maintenance Services following Schedules I and II.</i>	WHEN TO PERFORM <i>Miles (kilometers) or Months (whichever occurs first).</i>
1	Engine Oil Change & Filter Change*	Every 3,000 Miles (5 000 km) or 3 Months.
2	Chassis Lubrication	Every other oil change.
3	Tire and Wheel Inspection & Rotation	At 6,000 Miles (10 000 km) and then every 15,000 Miles (25 000 km) or as necessary.
4	Engine Accessory Drive Belt Inspection*	Every 30,000 Miles (50 000 km) or 24 Months.
5	Cooling System Service*	Every 30,000 Miles (50 000 km) or 24 Months.
6	Transaxle Service	<i>See Explanation of Scheduled Maintenance Services following Schedules I and II.</i>
7	Spark Plug Replacement*	Every 30,000 Miles (50 000 km).
8	Spark Plug Wire Inspection*†	Every 30,000 Miles (50 000 km).
9	Air Cleaner Filter Replacement*	<i>See Explanation of Scheduled Maintenance Services following Schedules I and II.</i>
10	Fuel Tank, Cap and Lines Inspection*†	Every 30,000 Miles (50 000 km).
11	Supercharger Oil Check	Every 30,000 Miles (50 000 km) or 36 Months.

Maintenance Schedule

Schedule II

Follow Schedule II ONLY if none of the driving conditions specified in Schedule I apply.

ITEM NO.	TO BE SERVICED <i>See Explanation of Scheduled Maintenance Services following Schedules I and II.</i>	WHEN TO PERFORM <i>Miles (kilometers) or Months (whichever occurs first).</i>
1	Engine Oil Change*	Every 7,500 Miles (12 500 km) or 12 Months.
	Oil Filter Change*	At first and every other oil change.
2	Chassis Lubrication	Every 7,500 Miles (12 500 km) or 12 Months.
3	Tire and Wheel Inspection & Rotation	At 7,500 Miles (12 500 km) and then every 15,000 Miles (25 000 km) or as necessary.
4	Engine Accessory Drive Belt Inspection*	Every 30,000 Miles (50 000 km) or 24 Months.
5	Cooling System Service*	Every 30,000 Miles (50 000 km) or 24 Months.
6	Transaxle Service	<i>See Explanation of Scheduled Maintenance Services following Schedules I and II.</i>
7	Spark Plug Replacement*	Every 30,000 Miles (50 000 km).
8	Spark Plug Wire Inspection*†	Every 30,000 Miles (50 000 km).
9	Air Cleaner Filter Replacement*	<i>See Explanation of Scheduled Maintenance Services following Schedules I and II.</i>
10	Fuel Tank, Cap & Lines Inspection*†	Every 30,000 Miles (50 000 km).
11	Supercharger Oil Check	Every 30,000 Miles (50 000 km) or 36 Months.

The services shown on this chart up to 60,000 miles (100 000 km) should be performed after 60,000 miles at the same intervals.

MILES (000)

5 7.5 10 15 20 22.5 25 30 35 37.5 40 45 50 52.5 55 60

KILOMETERS (000)

8 12.5 16 25 32 37.5 40 50 56 62.5 64 75 83.5 87.5 92 100

	•		•		•		•		•		•		•		•
	•				•				•				•		
	•		•		•		•		•		•		•		•
	•				•				•				•		
							•								•
							•								•
							•								•
							•								•

• = An Emission Control Service.

† = The U.S. Environmental Protection Agency or the California Air Resources Board has determined that the failure to perform this maintenance item will not nullify the emission warranty or limit recall liability prior to the completion of vehicle useful life. General Motors, however, urges that all recommended maintenance services be performed at the indicated intervals and the maintenance be recorded in "Section E: Maintenance Record."

Maintenance Schedule

Explanation of Scheduled Maintenance Services

Following are explanations of the services listed in Schedule I and Schedule II.

The proper fluids and lubricants to use are listed in Section D. Make sure whoever services your vehicle uses these. All parts should be replaced and all necessary repairs done before you or anyone else drives the vehicle.

ITEM NO.	SERVICE
----------	---------

- | | |
|----|--|
| 1. | Engine Oil and Filter Change* — Always use SH or SG Energy Conserving II oils of proper viscosity. The "SH" or "SG" designation may be shown alone or in combination with others, such as "SH/CD" "SH, SG, CD," "SG/CD," etc. To determine the preferred viscosity for your vehicle's engine (e.g., SAE 5W-30 or SAE 10W-30), see <i>Engine Oil</i> in the <i>Index</i> . If your vehicle has an Engine Oil-Change Indicator (EOCI), the indicator will show you when to change the oil, usually between 3,000 miles (5 000 km) and 7,500 miles |
|----|--|

(12 500 km) since your last oil change. Under severe conditions the indicator may come on before 3,000 miles (5 000 km). Never drive your vehicle more than 7,500 miles (12 500 km) or 12 months without an oil change.

The system won't detect dust in the oil. So if you drive in a dusty area be sure to change your oil every 3,000 miles (5 000 km) or sooner if the **CHANGE OIL NOW** message appears in the information center. Remember to reset the Oil Change Indicator when the oil has been changed. For more information, see *Driver Information System* in the *Index*.

- | | |
|----|---|
| 2. | Chassis Lubrication — Lubricate suspension and steering linkage. Lubricate the transaxle shift linkage, and parking brake cable guides, underbody contact points and linkage. |
| 3. | Tire and Wheel Rotation and Inspection — For proper wear and maximum tire life, rotate your tires following the instructions in this manual. See <i>Tires, Inspection & Rotation</i> in the <i>Index</i> . Check the |

tires for uneven wear or damage. If you see irregular or premature wear, check the wheel alignment. Check for damaged wheels also.

- | | |
|----|--|
| 4. | Engine Accessory Drive Belt Inspection* — Inspect the belt for cracks, fraying, wear and proper tension. Replace as needed. |
| 5. | Cooling System Service* — Drain, flush and refill the system with new or approved recycled coolant conforming to GM Specification 1825M. Keep coolant at the proper mixture as specified. See <i>Coolant</i> in the <i>Index</i> . This provides proper freeze and boil protection, corrosion inhibitor level and maintains proper engine operating temperature. Inspect hoses and replace if they are cracked, swollen or deteriorated. Tighten screw-type hose clamps. Clean the outside of the radiator and air conditioning condenser. Wash the pressure cap and neck. To help ensure proper operation, we recommend a pressure test of both the cooling system and the pressure cap. |

6. Transaxle Service— Change both the fluid and filter every 15,000 miles (25 000 km) if the vehicle is mainly driven under one or more of these conditions:

- In heavy city traffic where the outside temperature regularly reaches 90°F (32°C) or higher.
- In hilly or mountainous terrain.
- When doing frequent trailer towing.
- Uses such as found in taxi, police car or delivery service.

If you do not use your vehicle under any of these conditions, change both the fluid and filter every 100,000 miles (166 000 km).

7. Spark Plug Replacement* — Replace spark plugs with the proper type. See *Replacement Parts* in the *Index*.

8. Spark Plug Wire Inspection*† — Inspect for burns, cracks or other damage. Check the boot fit at the coils and at the spark plugs. Replace wires as needed.

9. Air Cleaner Filter Replacement* — Replace every 30,000 miles (50 000 km) or more often under dusty conditions. Ask your dealer for the proper replacement intervals for your driving conditions.

10. Fuel Tank, Cap and Lines Inspection*† — Inspect fuel tank, cap and lines (including fuel rails and injection assembly) for damage or leaks. Inspect fuel cap gasket for an even filler neck imprint or any damage. Replace parts as needed. Periodic replacement of the fuel filter is not required.

11. Supercharger Oil Check — Check oil every 30,000 miles (50 000 km) or 36 months. Add the proper synthetic oil. See *Recommended Fluids & Lubricants* and *Supercharger Oil* in the *Index*.

NOTE: To determine your engine's displacement and code, see Engine Identification in the Index.

* = An Emission Control Service.

† = The U.S. Environmental Protection Agency or the California Air Resources Board has determined that the failure to perform this maintenance item will not nullify the emission warranty or limit recall liability prior to the completion of vehicle useful life. General Motors, however, urges that all recommended maintenance services be performed at the indicated intervals and the maintenance be recorded in "Section E: Maintenance Record."

Maintenance Schedule

■ Section B: Owner Checks and Services

Listed below are owner checks and services which should be performed at the intervals specified to help ensure the safety, dependability and emission control performance of your vehicle.

Be sure any necessary repairs are completed at once. Whenever any fluids or lubricants are added to your vehicle, make sure they are the proper ones, as shown in Section D.

At Each Fuel Fill (It is important for you or a service station attendant to perform these underhood checks at each fuel fill.)

CHECK OR SERVICE	WHAT TO DO
Engine Oil Level	Check the engine oil level and add the proper oil if necessary. See <i>Engine Oil</i> in the <i>Index</i> for further details.
Engine Coolant Level	Check the engine coolant level and add the proper coolant mix if necessary. See <i>Coolant</i> in the <i>Index</i> for further details.
Windshield Washer Fluid Level	Check the windshield washer fluid level in the windshield washer tank and add the proper fluid if necessary. See <i>Windshield Washer Fluid</i> in the <i>Index</i> for further details.

At Least Once a Month

CHECK OR SERVICE	WHAT TO DO
Tire Inflation	Check tire inflation. Make sure they are inflated to the pressures specified on the Tire-Loading Information label located on the rear edge of the driver's door. See <i>Tires</i> in the <i>Index</i> for further details.
Cassette Deck	Clean cassette deck. Cleaning should be done every 15 hours of tape play. See <i>Audio Systems</i> in the <i>Index</i> for further details.

At Least Once a Year

CHECK OR SERVICE	WHAT TO DO
Key Lock Cylinders	Lubricate the key lock cylinders with the lubricant specified in Section D.
Body Lubrication	Lubricate all body door hinges. Also lubricate all hinges and latches, including those for the hood, rear compartment, glove box door, console door and any folding seat hardware. Section D tells you what to use.
Starter Switch	<p>CAUTION: When you are doing this check, the vehicle could move suddenly. If it does, you or others could be injured. Follow the steps below.</p> <ol style="list-style-type: none">1. Before you start, be sure you have enough room around the vehicle.2. Firmly apply both the parking brake (see <i>Parking Brake</i> in the <i>Index</i> if necessary) and the regular brake. <p>NOTE: Do not use the accelerator pedal, and be ready to turn off the engine immediately if it starts.</p> <ol style="list-style-type: none">3. Try to start the engine in each gear. The starter should work only in P (Park) or N (Neutral). If the starter works in any other position, your vehicle needs service.
Brake-Transaxle Shift Interlock — BTSI (Automatic Transaxle)	<p>CAUTION: When you are doing this check, the vehicle could move suddenly. If it does, you or others could be injured. Follow the steps below.</p> <ol style="list-style-type: none">1. Before you start, be sure you have enough room around the vehicle. It should be parked on a level surface.2. Firmly apply the parking brake (see <i>Parking Brake</i> in the <i>Index</i> if necessary). <p>NOTE: Be ready to apply the regular brake immediately if the vehicle begins to move.</p> <ol style="list-style-type: none">3. With the engine off, turn the key to the RUN position, but don't start the engine. Without applying the regular brake, try to move the shift lever out of P (Park) with normal effort. If the shift lever moves out of P (Park), your vehicle's BTSI needs service.

Maintenance Schedule

At Least Once a Year (Cont.)

CHECK OR SERVICE	WHAT TO DO
Steering Column Lock	<p>While parked, and with the parking brake set, try to turn the key to LOCK in each shift lever position.</p> <ul style="list-style-type: none">• The key should turn to LOCK only when the shift lever is in P (Park).• The key should come out only in LOCK.
Parking Brake and Automatic Transaxle P (Park) Mechanism Check	<p>CAUTION: When you are doing this check, your vehicle could begin to move. You or others could be injured and property could be damaged. Make sure there is room in front of your vehicle in case it begins to roll. Be ready to apply the regular brake at once should the vehicle begin to move.</p> <p>Park on a fairly steep hill, with the vehicle facing downhill. Keeping your foot on the regular brake, set the parking brake.</p> <ul style="list-style-type: none">• To check the parking brake: With the engine running and transaxle in N (Neutral), slowly remove foot pressure from the regular brake pedal. Do this until the vehicle is held by the parking brake only.• To check the P (Park) mechanism's holding ability: Shift to P (Park). Then release all brakes.
Underbody Flushing	<p>At least every spring, use plain water to flush any corrosive materials from the underbody. Take care to clean thoroughly any areas where mud and other debris can collect.</p>

■ *Section C: Periodic Maintenance Inspections*

Listed below are inspections and services which should be performed at least twice a year (for instance, each spring and fall). You should let your GM dealer's service department or other qualified service center do these jobs. Make sure any necessary repairs are completed at once.

INSPECTION OR SERVICE	WHAT SHOULD BE DONE
Restraint Systems	Now and then, make sure all your belts, buckles, latch plates, retractors, anchorages and reminder systems are working properly. Look for any loose parts or damage. If you see anything that might keep a restraint system from doing its job, have it repaired.
Steering, Suspension and Front-Wheel-Drive Axle Boot and Seal Inspection	Inspect the front and rear suspension and steering system for damaged, loose or missing parts, signs of wear, or lack of lubrication. Inspect the power steering lines and hoses for proper hookup, binding, leaks, cracks, chafing, etc. Clean and then inspect the drive axle boot seals for damage, tears or leakage. Replace seals if necessary.
Exhaust System Inspection	Inspect the complete exhaust system. Inspect the body near the exhaust system. Look for broken, damaged, missing or out-of-position parts as well as open seams, holes, loose connections, or other conditions which could cause a heat build-up in the floor pan or could let exhaust fumes into the vehicle. See <i>Engine Exhaust</i> in the <i>Index</i> .

Maintenance Schedule

INSPECTION OR SERVICE	WHAT SHOULD BE DONE
Throttle Linkage Inspection	Inspect the throttle linkage for interference or binding, and for damaged or missing parts. Replace parts as needed.
Brake System Inspection	<p>Inspect the complete system. Inspect brake lines and hoses for proper hookup, binding, leaks, cracks, chafing, etc. Inspect disc brake pads for wear and rotors for surface condition. Also inspect drum brake linings for wear and cracks. Inspect other brake parts, including drums, wheel cylinders, calipers, parking brake, etc. Check parking brake adjustment. You may need to have your brakes inspected more often if your driving habits or conditions result in frequent braking.</p> <p>NOTE: A low brake fluid level can indicate worn disc brake pads which may need to be serviced. Also, if the brake system warning light stays on or comes on, something may be wrong with the brake system. See <i>Brake System Warning Light</i> in the <i>Index</i>. If your anti-lock brake system warning light stays on, comes on or flashes, something may be wrong with the anti-lock brake system. See <i>Anti-Lock Brake System Warning Light</i> in the <i>Index</i>.</p>

■ Section D: Recommended Fluids and Lubricants

NOTE: Fluids and lubricants identified below by name, part number or specification may be obtained from your GM dealer.

USAGE	FLUID/LUBRICANT
Engine Oil	API service SH or SG Energy Conserving II oils of the proper viscosity. The "SH" or "SG" designation may be shown alone or in combination with others, such as "SH/CD," "SH,SG,CD," "SG/CD," etc. To determine the preferred viscosity for your vehicle's engine, see <i>Engine Oil</i> in the <i>Index</i> .
Engine Coolant	50/50 mixture of water (preferably distilled) and good quality ethylene glycol base antifreeze (GM Part No. 1052753 or equivalent) conforming to GM Specification 1825M or approved recycled coolant conforming to GM Specification 1825M.
Hydraulic Brake System	Delco Supreme 11 [®] Brake Fluid (GM Part No. 1052535 or equivalent DOT-3 brake fluid).
Parking Brake Guides	Chassis lubricant (GM Part No. 1052497 or equivalent) or lubricant meeting requirements of NLGI Grade 2, Category LB or GC-LB.
Power Steering System	GM Hydraulic Power Steering Fluid (GM Part No. 1052884 or equivalent).
Automatic Transaxle	DEXRON [®] -III or DEXRON [®] -IIE Automatic Transmission Fluid.
Supercharger	Supercharger oil (GM Part No. 12345982).
Key Lock Cylinders	Lubricate with Multi-Purpose Lubricant (GM Part No. 12345120) or synthetic SAE 5W-30 engine oil.
Automatic Transaxle Shift Linkage	Engine oil.

Maintenance Schedule

USAGE	FLUID/LUBRICANT
Floor Shift Linkage	Engine oil.
Chassis Lubrication	Chassis lubricant (GM Part No. 1052497 or equivalent) or lubricant meeting requirements of NLGI Grade 2, Category LB or GC-LB.
Windshield Washer Solvent	GM Optikleen® Washer Solvent (GM Part No. 1051515) or equivalent.
Hood Latch Assembly a. Pivots and Spring Anchor b. Release Pawl	a. Engine oil. b. Chassis lubricant meeting requirements of NLGI Grade 2, Category LB (GM Part No. 1052497 or equivalent) or GC-LB.
Hood and Door Hinges, Fuel Filler Door Hinge, Rear Compartment Lid Hinges	Engine oil or Lubriplate Lubricant (GM Part No. 1050109).
Weatherstrips	Dielectric Silicone Grease (GM Part No. 12345579 or equivalent).

See *Replacement Parts* in the *Index* for recommended replacement filters, valves and spark plugs.

■ *Section E: Maintenance Record*

After the scheduled services are performed, record the date, odometer reading and who performed the service in the columns indicated. When completing the Maintenance Performed column, insert the numbers from the Schedule I or Schedule II maintenance charts which correspond to the maintenance performed. Also, you should retain all maintenance receipts. Your owner information portfolio is a convenient place to store them.

<i>DATE</i>	<i>ODOMETER READING</i>	<i>SERVICED BY</i>	<i>MAINTENANCE PERFORMED</i>

Maintenance Schedule

DATE	ODOMETER READING	SERVICED BY	MAINTENANCE PERFORMED

<i>DATE</i>	<i>ODOMETER READING</i>	<i>SERVICED BY</i>	<i>MAINTENANCE PERFORMED</i>

Maintenance Schedule

DATE	ODOMETER READING	SERVICED BY	MAINTENANCE PERFORMED

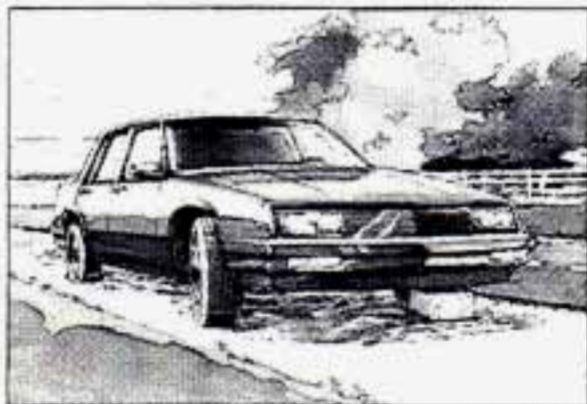

Here you will find out how to contact Oldsmobile if you need assistance. This part also tells you how to obtain service publications and how to report any safety defects.

Part 8

Customer Assistance Information

Customer Satisfaction Procedure.....	254
Customer Assistance for the Hearing or Speech Impaired	255
BBB Auto Line Program.....	255
Reporting Safety Defects	256
Oldsmobile Roadside Assistance Program.....	257
Service Publications.....	257

Customer Assistance Information



■ Customer Satisfaction Procedure

Your satisfaction and goodwill are important to your dealer and Oldsmobile. Normally, any concern with the sales transaction or the operation of your vehicle will be resolved by your dealer's Sales or Service Departments. Sometimes, however, despite the best intentions of all concerned, misunderstandings can occur. If your concern has not been resolved to your satisfaction, the following steps should be taken:

STEP ONE — Discuss your concern with a member of dealership management. Complaints can often be quickly resolved at that level. If the matter has already been reviewed with

the Sales, Service, or Parts Manager, contact the owner of the dealership or the General Manager.

STEP TWO — If after contacting a member of dealership management, it appears your concern cannot be resolved by the dealership without further help, contact the Oldsmobile Customer Assistance Network by calling 1-800-442-6537. In Canada, contact GM of Canada Customer Assistance Center in Oshawa by calling 1-800-263-3777 (English) or 1-800-263-7854 (French).

In Mexico, call (525) 254-3777. In Puerto Rico or U.S. Virgin Islands, call 1-809-763-1315. In all other overseas locations, contact GM North American Export Sales in Canada by calling 1-416-644-4112.

For prompt assistance, please have the following information available to give the Customer Assistance Representative:

- Your name, address, telephone number
- Vehicle Identification Number (This is available from the vehicle registration or title, or the plate at the left top of the instrument panel and visible through the windshield.)

- Dealership name and location
- Vehicle delivery date and present mileage
- Nature of concern

We encourage you to call the toll free number listed previously in order to give your inquiry prompt attention. However, if you wish to write Oldsmobile, write to

United States

Customer Assistance Representative
Oldsmobile Central Office
920 Townsend St.
P. O. Box 30095
Lansing, MI 48909

Canada

Customer Assistance Center
General Motors of Canada Limited
1908 Colonel Sam Drive
Oshawa, Ontario L1H 8P7

When contacting Oldsmobile, please remember that your concern will likely be resolved in the dealership, using the dealership's facilities, equipment and personnel. That is why we suggest you follow Step One first if you have a concern.

■ *Customer Assistance for the Hearing or Speech Impaired (TDD)*

To assist owners who have hearing difficulties, Oldsmobile has installed special TDD (Telecommunication Devices for the Deaf) equipment at its Customer Assistance Center. Any hearing or speech impaired customer who has access to a TDD or a conventional teletypewriter (TTY) can communicate with Oldsmobile by dialing: 1-800-TDD-OLDS. (TDD users in Canada can dial 1-800-263-3830.)

■ *GM Participation in BBB AUTO LINE- Alternative Resolution Program**

Both Oldsmobile and your Oldsmobile dealer are committed to making sure you are completely satisfied with your new vehicle. If a situation arises where you feel your concern has not been adequately addressed, our experience has shown that the Customer Satisfaction Procedure described earlier

in this section is very successful at resolving problems.

There may be instances where an impartial third-party can assist in arriving at a solution to a disagreement regarding vehicle repairs or interpretation of the New Vehicle Limited Warranty. To assist in resolving these disagreements Oldsmobile voluntarily participates in BBB AUTO LINE.

BBB AUTO LINE is an out-of-court program administered by the Better Business Bureau system to settle disputes between customers and automobile manufacturers. This program is available free of charge to customers who currently own or lease a GM vehicle.

If you are not satisfied after following the Customer Satisfaction Procedure, you may contact the BBB using the toll-free telephone number, or write them at the following address:

BBB AUTO LINE

Council of Better Business Bureaus
4200 Wilson Boulevard
Suite 800
Arlington, VA 22203
Telephone: 1-800-955-5100

To file a claim, you will be asked to provide your name and address, your vehicle identification number (VIN), and a statement of the nature of your complaint. Eligibility is limited by vehicle age and mileage, and other factors.

We prefer you utilize the Customer Satisfaction Procedure before you resort to AUTO LINE, but you may contact the BBB at any time. The BBB will attempt to resolve the complaint serving as an intermediary between you and Oldsmobile. If this mediation is unsuccessful, an informal hearing will be scheduled where eligible customers may present their case to an impartial third-party arbitrator.

The arbitrator will make a decision which you may accept or reject. If you accept the decision, GM will be bound by that decision. The entire dispute resolution procedure should ordinarily

Customer Assistance Information

take about forty days from the time you file a claim until a decision is made.

Some state laws may require you to use this program before filing a claim with a state-run arbitration program or in the courts. For further information, contact the BBB or the Oldsmobile Customer Assistance Center at 1-800-442-6537.

** This program may not be available in all states, depending on state law. Canadian owners refer to your Warranty and Owner Assistance information booklet. General Motors reserves the right to change eligibility limitations and/or to discontinue its participation in this program.*

■ REPORTING SAFETY DEFECTS TO THE UNITED STATES GOVERNMENT

If you believe that your vehicle has a defect which could cause a crash or could cause injury or death, you should immediately inform the National Highway Traffic Safety Administration (NHTSA), in addition to notifying General Motors.

If NHTSA receives similar complaints, it may open an investigation, and if it finds that a safety defect exists in a group of vehicles, it may order a recall

and remedy campaign. However, NHTSA cannot become involved in individual problems between you, your dealer, or General Motors.

To contact NHTSA, you may either call the Auto Safety Hotline toll-free at 1-800-424-9393 (or 366-0123 in the Washington, D.C. area) or write to:

NHTSA
U.S. Department of Transportation
Washington, D.C. 20590

You can also obtain other information about motor vehicle safety from the Hotline.

■ REPORTING SAFETY DEFECTS TO THE CANADIAN GOVERNMENT

If you live in Canada, and you believe that your vehicle has a safety defect, you should immediately notify Transport Canada, in addition to notifying General Motors of Canada Limited. You may write to:

Transport Canada
Box 8880
Ottawa, Ontario K1G 3J2.

■ REPORTING SAFETY DEFECTS TO GENERAL MOTORS

In addition to notifying NHTSA (or Transport Canada) in a situation like this, we certainly hope you'll notify us. Please call us at 1-800-442-6537, or write:

Oldsmobile Customer Assistance
Network
P. O. Box 30095
Lansing, Michigan 48909

In Canada, please call us at 1-800-263-3777 (English) or 1-800-263-7854 (French). Or, write:

General Motors of Canada Limited
Customer Assistance Center
1908 Colonel Sam Drive
Oshawa, Ontario L1H 8P7



■ *Oldsmobile Roadside Assistance Program Features & Benefits*

The Oldsmobile Roadside Assistance program means help is just a toll-free call away—24 hours a day, 365 days a year.

Courteous and capable Customer Assistance Advisors are on-call to provide you with prompt assistance.

24-Hour Oldsmobile Roadside Assistance Number

1-800-442-OLDS (6537) is the one number to call for assistance in the United States. Trained Customer Assistance Advisors, on-call to render assistance to Oldsmobile drivers, can dispatch roadside assistance and towing

service, locate the nearest Oldsmobile dealership, take your request for an Oldsmobile computerized trip routing or simply answer any questions the Oldsmobile driver may have about the coverage provided by your Oldsmobile Roadside Assistance Program. The Oldsmobile Roadside Assistance number is fully staffed and operational 24 hours a day, 365 days a year.

Who is Covered?

Oldsmobile Roadside Assistance covers all 1994 Oldsmobile vehicles.*

Coverage is for the Oldsmobile vehicle, *regardless of the driver*, and is concurrent with the Bumper-to-Bumper warranty period.

Oldsmobile reserves the right to limit services or reimbursement to an owner or driver when in Oldsmobile's judgement the claims become excessive in frequency or type of occurrence.

* Vehicles sold in Canada have a separate roadside assistance program, as described later in this section.

Canadian Roadside Assistance

Vehicles purchased in Canada have an extensive Roadside Assistance program accessible from anywhere in Canada or the U.S.A. Please refer to the separate brochure provided by the dealer or call 1-800-268-6800 for emergency services.

■ *Service Publications*

Information on how to obtain Product Service Publications, Subscriptions and Indexes and Service Manuals as described below is applicable only in the fifty U.S. states (and the District of Columbia) and only for cars and light trucks with GVWR less than 10,000 pounds (4 536 kg).

In Canada, information pertaining to Product Service Bulletins and Indexes can be obtained by writing to:

General Motors of Canada Limited
Service Publications Department
1908 Colonel Sam Dr.
Oshawa, Ontario L1H 8P7

Customer Assistance Information

Oldsmobile regularly sends its dealers useful service bulletins about Oldsmobile products. Oldsmobile monitors product performance in the field. We then prepare bulletins for servicing our products better. Now, you can get these bulletins too.

Bulletins cover various subjects. Some pertain to the proper use and care of your vehicle. Some describe costly repairs. Others describe inexpensive repairs which, if done on time with the latest parts, may avoid future costly repairs. Some bulletins tell a technician how to repair a new or unexpected condition. Others describe a quicker way to fix your vehicle. They can help a technician service your vehicle better.

Most bulletins apply to conditions affecting a small number of cars or trucks. Your Oldsmobile dealer or a qualified technician may have to determine if a specific bulletin applies to your vehicle.

You can subscribe to all Oldsmobile bulletins. This way you'll get them as they come out. You can wait a while and get an index to the bulletins. You can also get individual bulletins.

However, you'll need the index to identify them.

Subscriptions

You can subscribe to all Oldsmobile Product Service Publications (PSP's). This will include bulletins for all vehicles sold by Oldsmobile and will not be limited to PSP's applicable to any particular model.

For subscription costs and ordering information call the toll-free number shown in the following text.

What You'll Find in the Index

- A list of all PSP's published by Oldsmobile in a model year (1990 or later). PSP's covering all models of Oldsmobile vehicles are listed in the same index.
- Price information for the PSP's you may want to buy.

How You Can Get an Index

Indexes are published periodically. Most of the PSP's which could potentially apply to the most recent Oldsmobile models will be listed in the most recent publication for that model year. This means you may want to wait until the end of the model year before ordering an index, if you are interested in buying PSP's pertaining to a current model year car or truck.

Some PSP's pertaining to a particular model year vehicle may be published in later years, and these would be listed in the later year's index. When you order an index for a model year that is not over yet, we'll send you the most recently published issue.

Toll-Free Telephone Number

If you want an ordering form for an index or a subscription, just call toll-free and we'll be happy to send you one. Automated recording equipment will take your name and mailing address. The number to call is 1-800-551-4123.

Copies at Participating Dealers

Copies of Indexes and PSP's are at your participating Oldsmobile dealer. You can ask to see them.

A VERY IMPORTANT REMINDER:
These PSP's are meant for technicians. They are not meant for the "do-it-yourselfer." Technicians have the equipment, tools, safety instructions, and know-how to do a job quickly and safely.

Oldsmobile Service Manuals

For Service Manual costs and ordering information call 1-800-551-4123.

Product Service Publication Ordering Information

Oldsmobile Division service publications are intended for use by professional, qualified technicians. Attempting repairs or service without the appropriate training, tools, and equipment could cause injury to you or others and damage to your vehicle that may cause it not to operate properly.

Available publications include Service Manuals, Product Service Publication indexes, quarterly and model year PSP's and binders. For 1994 Product Service Publication pricing information and orders call 1-800-551-4123.

Notes

- A**BS Warning Light..... 95
 Accessory Power Outlets..... 81
 Adding
 Brake Fluid..... 204
 Electrical Equipment..... 121, 221
 Engine Coolant..... 169, 171
 Engine Oil..... 192, 198
 Power Steering Fluid..... 203
 Sound Equipment..... 121
 Transaxle Fluid..... 200
 Windshield Washer Fluid..... 203
 Air Bag (see *Supplemental Restraint System*)
 Air Bag Readiness Light..... 23
 Air Cleaner Filter..... 195, 227
 Air Conditioner..... 112, 117
 Alcohol, Driving Under the
 Influence of..... 136
 Alcohol in Gasoline..... 185
 Aluminum Wheels
 Cleaning..... 218
 Removing..... 176
 Antenna
 Fixed..... 134
 Power..... 134
 Antifreeze..... 200
 Anti-Lock Brake System (ABS)..... 139
 Anti-Lock Brake System
 Warning Light..... 95
 Anti-Theft Tips..... 48
 Appearance Care..... 214
 Armrest, Storage..... 79, 80
 Ashtrays & Lighter..... 80
 Audio Systems..... 121
 AM/FM Stereo Radio..... 122
 AM/FM Stereo Radio with ATC,
 Cassette Tape Player..... 124
 AM/FM Stereo with ATC,
 Cassette Tape and Compact
 Disc Player..... 128
 Care of Audio Systems..... 133
 Radio Reception, For the Best..... 132
 Setting the Clock..... 121
 Steering Wheel Touch Controls..... 132
 Automatic Electronic Climate
 Control..... 113
 Automatic Transaxle..... 55
 Adding Fluid..... 200
 Checking Fluid..... 198
 Shifting..... 56
Battery..... 206
 Jump Starting..... 161
 Warning..... 206
 Battery Warning Light
 Electronic..... 101
 Standard..... 100
 Blizzard..... 153
 Block Heater, Engine..... 54
 Blowout, Tire..... 173
 Brake
 Adjustment..... 205
 Fluid..... 204
 Master Cylinder..... 204
 Parking..... 60
 Pedal Travel..... 205
 Warning Light..... 94, 95
 Wear Indicators—Front Brakes..... 204
 Brake System Warning Light..... 94
 Brakes, Anti-Lock..... 139
 Warning Light..... 95
 Braking..... 138
 Braking in Emergencies..... 141
 Braking Technique..... 138
 Break-In, New Vehicle..... 52, 155
 Buckling Up (see *Safety Belts*)
 Bulb Replacement
 Headlight..... 206, 229
 Taillight..... 207, 229
 Bulbs, Replacement..... 229
Capacities & Specifications..... 226
 Carbon Monoxide in
 Exhaust..... 63, 64, 153
 Cassette Tape Player
 (see *Audio Systems*)
 Center Passenger Position..... 27
 Chains, Tire..... 180, 214
 Changing a Flat Tire..... 173

Index

- Change Oil Reminder..... 105
Change Oil Soon Message..... 105
Checking
 Brake Fluid..... 204
 Engine Coolant..... 169, 201
 Engine Oil Level..... 192, 198
 Power Steering Fluid..... 203
 Restraint Systems..... 40
 Transaxle Fluid..... 198
Check Oil Level Warning
 Light..... 100, 113
Chemical Spotting..... 220
Child Restraints..... 31
Child Security Locks..... 46
Children and Safety Belts..... 30, 38
Cigarette Lighter..... 80
Circuit Breakers & Fuses..... 221
City Driving..... 148
Cleaner, Air..... 195, 227
Cleaning
 Aluminum Wheels..... 218
 Cassette Player..... 132
 Compact Discs..... 132
 Fabric..... 215
 Glass..... 217
 Inside of Your Oldsmobile..... 215
 Leather and Vinyl..... 216
 Outside of Your Oldsmobile..... 217
 Power Antenna..... 134
 Safety Belts..... 217
 Special Problems..... 216
 Top of the Instrument Panel..... 216
 Underbody Maintenance..... 219
 Vinyl and Leather..... 216
 Warnings..... 214, 215, 219, 220
 Weatherstrips..... 218
 White Sidewall Tires..... 218
 Windshield and Wiper Blades..... 217
Clock, Setting the..... 121
Clusters, Instrument Panel..... 86, 87
Coin/Cup Holder..... 79
Comfort Controls..... 110
 Automatic Electronic Climate
 Control..... 113
 Four Season Climate Control..... 110
 Passenger Temperature Control... 118
 Rear Outlets..... 119
 Steering Wheel Touch Controls... 119
 Ventilation, Flow-Through..... 120
Compact Disc Player
 (see *Audio Systems*)
Compact Spare Tire..... 180
Compass..... 76
Convenience Net..... 51
Convex Mirror, Outside..... 77
Coolant..... 200
 Checking &
 Adding..... 169, 171, 201, 226, 228
 Proper Mixture to Use..... 200
Safety Warnings
 About..... 168, 169, 170, 200
 Temperature Gage..... 92, 93
 Temperature Warning Light..... 92, 93
Cornering Lights..... 73
Cruise Control..... 69
Curves, Driving on..... 142
Customer Assistance Information... 255
Daytime Running Lights..... 73
Dead Battery: What to Do..... 161
Defects, Reporting Safety..... 256
Defensive Driving..... 136
Defogger, Rear Window..... 112, 118
Door Locks..... 43
Downshifting..... 59, 151
Driver Information System..... 100
Driver Position..... 18
Driver's Side SRS ("Air Bag")..... 22
Driving..... 135
 At Night..... 145
 City..... 148
 Controlling a Skid..... 144
 Defensively..... 136
 Drunken..... 136
 Foreign Operation..... 186
 Freeway..... 149
 Hill and Mountain Roads..... 150

In a Foreign Country.....	186
In Rain.....	146
Long Distance.....	149
Loss of Control.....	144
On Curves.....	142
Passing.....	143
Through Deep Standing Water.....	54
Winter Driving.....	151
With a Trailer.....	157
Drunken Driving.....	136

Electrical Equipment,

Adding.....	121, 221
Electrochromic Day/Night Mirror.....	76
Electronic Cluster.....	87
Emergencies, Braking in.....	141
Emergencies on the Road.....	159
Emergencies, Steering in.....	142
Emergency Starting.....	161
Emergency Towing.....	164
Engine Block Heater.....	54
Engine Coolant.....	169, 171
Engine Coolant Heater.....	54
Engine Coolant Temperature Warning Light (see <i>Coolant</i>)	
Engine Exhaust.....	63
Engine Identification.....	220
Engine Oil.....	192
Additives.....	194
Capacities & Specifications.....	226

Change Oil Soon Message.....	105
Check Level Warning Light.....	99, 100
Checking & Adding.....	198
Disposing of Used Oil.....	195
Energy Conserving.....	193
Starburst.....	193
Supercharger.....	198
Warning Light.....	100, 105
When to Change.....	194
Engine Overheating.....	167
Engine Specifications.....	227
Engine, Starting.....	53
Ethanol in Gasoline.....	186
Exhaust	
Dangerous Gas in.....	63, 64, 153
Parking with the Engine Running.....	62, 64
Expectant Mothers, Use of Safety Belts.....	27
Expressway Driving.....	149
Extender, Safety Belt.....	40
Exterior Appearance (see <i>Appearance Care</i>)	
F abric Cleaning (see <i>Appearance Care</i>)	
Fan Warnings.....	169, 189
Filling the Fuel Tank.....	187
Filter	
Air Cleaner.....	195, 227

Oil.....	194, 227
Finish Care.....	217
Finish Damage.....	219
Flashers, Hazard Warning.....	160
Flat Tire.....	173
Flooded Engine.....	54
Fluid	
Brake.....	204, 228
Capacities.....	226
Power Steering.....	202, 226, 228
Transaxle.....	198, 226, 228
Windshield Washer.....	67, 203, 228
Fluids & Lubricants.....	228
Foreign Material.....	219
Foreign Operation.....	186
Four Season Climate Control.....	110
Freeway Driving.....	149
French Language Manual.....	2
Fuel.....	185
Alcohol in Fuel.....	185
Capacity.....	187
Exhaust Warnings.....	63, 64, 153
Filling Your Tank.....	187
Foreign Countries.....	186
Fuels with Alcohol.....	185
Gage.....	91, 92
Low, Warning Light.....	91, 92
Requirements.....	185
Fuse Panel.....	222, 223
Fuses & Circuit Breakers.....	221

- G**age Cluster 86, 87
- Gages
- Coolant Temperature 93
 - Fuel 91, 92
 - Speedometer 88, 89
 - Tachometer 91
- Gasoline 185
- Gasoline Tank, Filling Your 187
- Gear Positions
(see *Shifting the Transaxle*)
- Gearshift Lever
(see *Shifting the Transaxle*)
- Glove Box 52
- H**alogen Bulb Replacement 206
- Hazard Warning Flashers 160
- Headlight & Taillight, Removing
and Replacing 206, 207
- Headlights 72
- Aiming 207
 - High-Low Beam Changer 67
 - Instrument Panel Intensity Control ... 74
 - "On" Reminder 72
 - Operation 67
 - Replacement Bulb 229
 - Torx® Screws 207
 - Wiring 225
- Head Restraint 14
- Heater (see *Comfort Controls*)
- Heater, Engine Coolant 54
- High Beams 67, 146
- Highway Hypnosis 150
- Hill and Mountain Roads 150
- Hood Release 188
- Safety Warning 189
 - Warning, Overheated Engine... 167, 189
- Horn 64
- Hot Engine, Safety
Warnings 168, 169, 170, 200
- How the Anti-Lock Brake System
Works 139
- Hydroplaning 147
- I**dentification Number, Vehicle 220
- Idling Your Engine 62, 64, 119
- If You're Stuck: In Sand, Mud,
Ice or Snow 181
- Ignition
- Key 42
 - Switch Positions 52
- Illuminated Entry 50
- Indicator Lights (see *Warning Lights*)
- Infant Restraint (see *Child Restraints*)
- Inflatable Restraint 22
- Inflatable Restraint Warning Light ... 23
- Inflation, Tires 210
- Inside Rearview Mirror
- Electrochromic 76
 - Electrochromic with Compass 76
- Manual Day/Night 75
- Instrument Panel 83, 85
- Instrument Panel Clusters 86, 87
- Instrument Panel Intensity Control 74
- Instrument Panel Warning Lights 88
- Intensity Control 74
- J**ack, Tire 174
- Jump Starting 161
- K**eys 42
- L**ane Change Indicator 66
- Lap-Shoulder Safety Belt
- Front 18
 - Rear 29
 - Use by Children 30, 38
- Lighter 80
- Lights
- Bulb Messages 229
 - Cornering 73
 - Daytime Running Lights 73
 - Headlights 72
 - "On" Reminder 72
 - Operation 67
 - Reading 74
 - Removing & Replacing Bulbs ... 206, 207
 - Replacement Bulbs 229
 - Taillights 72
 - Turn Signal 66

Underhood.....	189
Warning Lights.....	101
Loading Your Vehicle.....	208
Locks.....	43
Locks, Programmable Automatic.....	44
Locks, Remote Control.....	45
Locks, Security.....	46
Long Distance Driving.....	149
Low Battery.....	100, 101
Low Fuel Warning.....	91, 92
Low Oil Level Warning.....	99, 100
Low Washer Fluid Warning.....	98
Lubricants and Fluids.....	228
M aintenance Record.....	249
Maintenance Schedule.....	233
Malfunction Indicator Lamp.....	98
Manual Front Seat.....	12
Maxifuse/Relay Center.....	225
Methanol in Gasoline.....	186
Mileage Indicator (see <i>Odometer & Speedometer</i>)	
Mirrors	
Inside Electrochromic Rearview with Compass.....	76
Inside Manual Rearview.....	75
Manual Remote Control.....	78
Outside Convex.....	77
Power Remote Control.....	78

Visor Vanity.....	79
Mountain Driving.....	150
N et, Convenience.....	51
New Vehicle Break-In.....	52, 155
Night Driving.....	145
O ctane Requirements (see <i>Fuel Requirements</i>)	
Odometer & Speedometer	
Electronic.....	89, 90
Standard.....	88, 89
Off-Road Recovery.....	143
Oil, Engine.....	192
Additives.....	194
Capacity.....	226
Change Oil Reminder.....	105
Check Oil Light.....	99, 100
Checking and Adding.....	192, 198
Disposing of Used Oil.....	195
Pressure Warning.....	99
Quality.....	193
Starburst.....	193
Supercharger.....	198
Thickness.....	193
Warning Light.....	99, 100
When to Change.....	194
Outside Rearview Mirrors.....	77, 78
Overdrive, Automatic.....	59

Overheated Engine.....	167
Warnings.....	168, 169
Overheated Engine Coolant Warning.....	168, 169, 200
Owner Checks & Services.....	242
P ark.....	56
Shifting Into.....	61
Shifting Out of.....	62
Parking	
On Hills.....	158
Over Things That Burn.....	63
With the Engine Running.....	64
Parking Brake.....	60
PASS-Key®II System.....	48
Passenger Belts (see <i>Safety Belts</i>)	
Passenger Temperature Controls.....	118
Passing.....	143
Polishing and Waxing (see <i>Appearance Care</i>)	
Power Antenna.....	134
Power Door Locks.....	44
Power Mirrors.....	78
Power Seat.....	12
Power Seat Controls.....	12
Power Steering.....	142, 202
Power Steering Fluid.....	202, 226, 228
Power Windows.....	65, 225

- Pregnancy, Use of Safety Belts
 - During 27
- Programmable Automatic Door
 - Locks 44
- Publications
 - (see *Service Publications*)
- R**adiator Overheating
 - (see *Overheated Engine*)
- Radiator Pressure Cap 202
- Radio (see *Audio Systems*)
- Reading Lights 74, 75
- Rear Door Security Locks 46
- Rear Window Defogger 112, 118
- Rearview Mirror
 - Electrochromic with Compass 76
 - Manual 75
- Reclining Seatback 13
- Recommended Fluids and Lubricants 247
- Remote Lock Control 45
- Remote Trunk Release 45, 51
- Replacement Bulbs 229
- Replacement Parts 227
- Replacement, Windshield Wiper 208
- Replacing Brakes 205
- Replacing Bulbs
 - Headlight 206
 - Taillight 207
- Replacing Safety Belts 40
- Replacing Tires 212
- Replacing Wheels 214
- Reporting Safety Defects 256
- Restraints, Child 31
- Restraints, Head 14
- Retained Accessory Power 53
- Roadside Assistance 257
- Roads, Hill and Mountain 150
- Rocking Your Vehicle 57, 181
- Rotation, Tire 211
- S**afety Belts 14
 - Adults 18
 - Babies 31
 - Center Passenger Position 27
 - Checking 40
 - Children 30, 38
 - Child Restraints 31
 - Child Restraints—How to Install Them 33
 - Child Restraints, Where to Put 32
 - Cleaning 217
 - Driver Position 18
 - Extender 40
 - How to Wear 18
 - Lap Belt 27
 - Lap-Shoulder Belt 18
 - Passenger Belts 27
- Replacing Safety Belts 40
- Replacing Tires 212
- Replacing Wheels 214
- Reporting Safety Defects 256
- Restraints, Child 31
- Restraints, Head 14
- Retained Accessory Power 53
- Roadside Assistance 257
- Roads, Hill and Mountain 150
- Rocking Your Vehicle 57, 181
- Rotation, Tire 211
- Pregnancy, Use During 27
- Questions & Answers 17, 20, 21, 39, 40
- Rear Seat Passengers 28
- Reminder Light 17
- Replacement 40
- Right Front, Adult Passenger 27
- Shoulder Belt Height Adjuster 19
- Supplemental Restraint System (SRS) 22
 - Torn 40
 - Twisted 21
 - Why You Should Wear Safety Belts ... 15
- Safety Defects, Reporting 256
- Scheduled Maintenance Services 235
- Seat and Seat Controls 12
 - Adjustment 12
 - Head Restraints 14
 - Manual Front Seat 12
 - Manual Reclining Seatback 13
 - Power Seat 12
 - Reclining Seatback 13
- Seat Belts (see *Safety Belts*)
- Security Light 49
- Security Locks, Rear Door 46
- Service Engine Soon Light (Malfunction Indicator Lamp) 98
- Service Information 184
- Service Parts Identification Label ... 220

Service Publications.....	257	Tips	142	Replacement Parts.....	227
Service Station Information	272	Steering Wheel, Tilt.....	64	Service Parts Identification Label ..	220
Servicing Your Air Bag-Equipped Oldsmobile.....	26	Steering Wheel Touch Controls Audio System	132	Vehicle Identification Number (VIN).....	220
Setting the Clock.....	121	Climate Control	119	Temperature Warning.....	92, 93
Setting the Trip Odometer.....	89, 90	Stereo Sound Systems (see <i>Audio Systems</i>)		Theft-Deterrent System	48
Sheet Metal Damage.....	219	Storing Your Vehicle.....	206	Thermostat	202
Shifting Into P (Park).....	61	Storage Armrest	79	Tilt Steering Wheel.....	65
Shifting out of P (Park)	62	Coin/Cup Holder.....	79	Time, Setting the.....	121
Shifting the Automatic Transaxle	56	Convenience Net	50	Tires.....	209
Signaling Turns	66, 157	Glove Box	52	Blowout.....	173
Skidding.....	144	Sun Visors	78	Buying New	212
Snowstorm, If You're Caught in a... 153		Sunglasses Storage.....	75	Chains.....	180, 214
Sound Equipment, Adding.....	121	Supercharger Oil.....	198	Flat, Changing	173
Sound Systems (see <i>Audio Systems</i>)		Supplemental Restraint System (SRS)	22	Inflation	210
Spare Tire, Compact	180	Light.....	23	Inspection & Rotation.....	211
Specifications & Capacities	226	Servicing Oldsmobiles with SRS 26		Loading.....	210
Speed Control (see <i>Cruise Control</i>)		T achometer.....	91	Pressure	210
Speedometer & Odometer.....	88, 89	Tape Player (see <i>Audio Systems</i>)		Quality Grading.....	212
SRS (Supplemental Restraint System)	22	Technical Facts & Specifications Bulbs	229	Spare, Compact	180
Servicing Oldsmobiles with SRS	26	Electrical Equipment, Add-On	121, 221	Wear Indicators	211, 212
Stains, Removing	215, 216	Engine Specifications	227	Wheel Alignment & Tire Balance ... 213	
Starting your Engine	53	Fluid Capacities & Types.....	226, 228	Wheel Replacement.....	213
Starting Your Vehicle if the Battery is "Dead" (see <i>Jump Starting</i>)		Fuses & Circuit Breakers.....	221	When to Replace Wheels.....	213
Steering In Emergencies	142			Winter Driving.....	152
Off-Road Recovery	143			Top Strap.....	32
				Torque Lock.....	62
				Towing a Trailer	154
				New Vehicle Break-In.....	155
				Parking on Hills.....	158

Towing Your Oldsmobile.....	164
Traction Control System.....	97, 140
Traction Control System Warning Light.....	96, 141
Trailer Towing.....	154
Transaxle, Automatic (see <i>Automatic Transaxle</i>)	
Transmission, Automatic (see <i>Automatic Transaxle</i>)	
Trip Odometer.....	89, 90
Trunk	
Convenience Net.....	51
Lock.....	50
Release, Remote.....	45, 51
Security Override.....	51
Turn Signal Indicator.....	66
Turn Signal/Multifunction Lever.....	66
Cruise Control.....	69
Headlight High-Low Beam Changer.....	67
Turn & Lane Change Signals.....	66
Turn Signal Indicator.....	66
Windshield Washer.....	68
Windshield Wipers.....	67
U nderbody Maintenance.....	219
Underhood Light.....	189
Unleaded Gasoline.....	185
Upholstery Care.....	215
Urban Driving.....	148

V ehicle Identification Number (VIN).....	220
Vehicle Loading.....	208
Vehicle Storage.....	206
Ventilation.....	120
VIN.....	220
Visor Vanity Mirror.....	79
W arning Flashers, Hazard.....	160
Warning Lights.....	88
Anti-Lock Brake System.....	95
Battery.....	100, 101
Brake System.....	94, 95
Check Oil.....	99, 100
Coolant Temperature.....	92, 93
Inflatable Restraint.....	23
Low Coolant.....	94
Low Washer Fluid.....	98
Oil.....	99, 100
Safety Belt.....	19
Service Engine Soon (see <i>Malfunction Indicator Lamp</i>)	
Traction Control.....	96
Washer, Windshield.....	68
Weatherstrips.....	218
Weight (GAWR).....	209
Weight (GVWR).....	209
Wheel Alignment & Tire Balance....	213

Wheel Covers, How to Remove.....	175, 176
Wheel Nuts.....	178
Wheel Nut Torque.....	179, 226
Wheel Replacement.....	213
Windows, Lock.....	65
Windows, Power.....	65, 225
Windshield Washer.....	68
Fluid.....	67, 203, 228
Windshield Wiper Replacement.....	208
Windshield Wipers.....	67, 217, 225
Winter Driving.....	151
If you're Stuck in Deep Snow.....	153, 181
If You're Caught in a Blizzard.....	153
Snow or Ice, Driving On.....	152
Wrecker Towing.....	164

[Faint, illegible handwritten notes]

Service Station Information



