

CUTLASS MOBILE



1994 CUTLASS SUPREME
OWNER'S MANUAL







Table of Contents

	<i>The Heritage of Oldsmobile</i>	<i>3</i>
	<i>How to Use this Manual</i>	<i>6</i>
Part 1	<i>Seats & Restraint Systems</i>	<i>11</i>
2	<i>Features & Controls</i>	<i>49</i>
3	<i>Comfort Controls & Audio Systems</i>	<i>103</i>
4	<i>Your Driving and the Road</i>	<i>125</i>
5	<i>Problems on the Road</i>	<i>149</i>
6	<i>Service & Appearance Care</i>	<i>175</i>
7	<i>Maintenance Schedule</i>	<i>235</i>
8	<i>Customer Assistance Information</i>	<i>251</i>
	<i>Includes "Reporting Safety Defects" on page 254</i>	
9	<i>Index</i>	<i>263</i>
	<i>Service Station Information</i>	<i>Last Page</i>

Important Notes About this Manual

Please keep this manual in your Oldsmobile, so it will be there if you ever need it when you're on the road. If you sell the vehicle, please leave this manual in it so the new owner can use it.

This manual includes the latest information at the time it was printed. We reserve the right to make changes in the product after that time without further notice.

Note to Canadian Owners

For vehicles first sold in Canada, substitute the name "General Motors of Canada Limited" for Oldsmobile Division whenever it appears in this manual.

For Canadian Owners Who Prefer a French Language Manual

Aux propriétaires canadiens: Vous pouvez vous procurer un exemplaire de ce guide en français chez votre concessionnaire ou au DGN Marketing Services Ltd., 1500 Bonhill Rd., Mississauga, Ontario L5T 1C7.

Published by
Oldsmobile Division
General Motors Corporation
920 Townsend Street
Lansing, Michigan 48921

The word *Oldsmobile* and the Oldsmobile rocket emblem are registered trademarks of General Motors Corporation.

The word *Delco* is a registered trademark of General Motors Corporation.

The Heritage of Oldsmobile

Engineering with a purpose. It's at the heart of every Oldsmobile. Your new Oldsmobile continues a 97-year tradition of engineering excellence.

That tradition was born in Lansing, Michigan, on August 21, 1897, when Ransom E. Olds began building a horseless carriage "in as nearly a perfect manner as possible." Soon, Oldsmobiles rolled off the nation's first assembly line.

Innovation and refinement have always set Oldsmobiles apart. In 1939, Oldsmobile introduced the celebrated Hydra-Matic transmission, a four-speed forerunner of today's advanced systems. In 1948, the high-spirited Rocket V8 engine set standards for performance.



A Step Ahead

In 1966, Toronado made front-wheel-drive news, including Motor Trend's "Car of the Year." Still breaking new ground, the 1974 "Toro" became the first car equipped with a production "air bag."

Recent Oldsmobile engineering has created exciting advancements like the responsive Quad 4 engine. Versions of the 4-cylinder, 16-valve Quad 4 propelled Oldsmobiles on roads and racetracks to new standards of economy and performance.

Today, the all-wheel-drive security of SmartTrak in the Oldsmobile Bravada continues that proud tradition of meaningful technology.



1965



1960



The Security of Owner Satisfaction

The quality we built into your new Oldsmobile gives us the confidence to back it with the Oldsmobile Edge—the most comprehensive owner satisfaction program in the industry. The Edge gives you 24-hour roadside assistance, Bumper-to-Bumper Warranty protection, even free transportation while your vehicle is in for warranty service. With the Oldsmobile Edge, we've pledged to make your ownership experience a great one.



J. D. Rock
General Manager

How to Use this Manual

MANY PEOPLE READ THEIR OWNER'S manual from beginning to end when they first receive their new vehicle. This will help you learn about the features and controls for your vehicle. In this manual, you'll find that pictures and words work together to explain things quickly.

There are nine parts with thumb-tabbed pages in this manual. Each part begins with a brief list of contents, so you can usually tell at a glance if that part contains the information you want.

You can bend the manual slightly to reveal the tabs that help you find a part.

Part 1: Seats & Restraint Systems

This part tells you how to use your seats and safety belts properly.

Part 2: Features & Controls

This part explains how to start and operate your Oldsmobile.

Part 3: Comfort Controls & Audio Systems

This part tells you how to adjust the ventilation and comfort controls and how to operate your audio system.

Part 4: Your Driving and the Road

Here you'll find helpful information and tips about the road and how to drive under different conditions.

Part 5: Problems on the Road

This part tells you what to do if you have a problem while driving, such as a flat tire or engine overheating.

Part 6: Service & Appearance Care

Here the manual tells you how to keep your Oldsmobile running properly and looking good.

Part 7: Maintenance Schedule

This part tells you when to perform vehicle maintenance and what fluids and lubricants to use.

Part 8: Customer Assistance Information

This part includes important information about reporting safety defects and gives you details about the "Roadside Assistance" program. You will also find customer satisfaction phone numbers (including customer satisfaction numbers for the hearing and speech impaired) as well as the mediation/arbitration procedure. We've also included ordering information for service publications in this part.

Part 9: Index

Here's an alphabetical listing of almost every subject in this manual. You can use it to quickly find something you want to read.

Service Station Information:

This is a quick reference of service information. You can find it on the last page of this manual.

How to Use this Manual

Safety Warnings and Symbols

You will find a number of safety cautions in this book. We use a box with gray background and the word **CAUTION** to tell you about things that could hurt you if you were to ignore the warning.

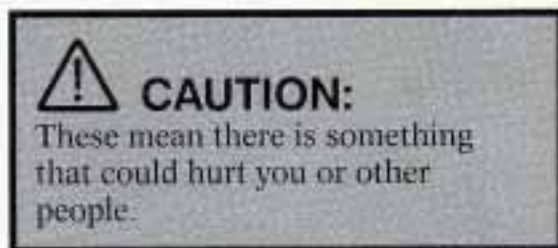

In the gray caution area, we tell you what the hazard is. Then we tell you what to do to help avoid or reduce the hazard. Please read these cautions. If you don't, you or others could be hurt.

You will also find a circle with a slash through it in this book. This safety symbol means:

Don't
Don't do this
Don't let this happen



Vehicle Damage Warnings

Also, in this book you will find these notices:

NOTICE:
These mean there is something that could damage your vehicle.

In the notice area, we tell you about something that can damage your vehicle. Many times, this damage would not be covered by your warranty, and it could be costly. But the notice will tell you what to do to help avoid the damage.

When you read other manuals, you might see **CAUTION** and **NOTICE** warnings in different colors or in different words.

You'll also see warning labels on your vehicle. They use yellow for cautions, blue for notices and the words **CAUTION** or **NOTICE**.

Vehicle Symbols

These are some of the symbols you will find on your vehicle. For example, these symbols are used on an original battery:

Caution Possible Injury



Protect Eyes by Shielding



Caustic Battery Acid Could Cause Burns



Avoid Sparks or Flames



Spark or Flame Could Explode Battery



These symbols are important for you and your passengers whenever your vehicle is driven:

Fasten Safety Belts



Door Lock/Unlock



These symbols have to do with your lights:

Master Lighting Switch



Turn Signal Direction

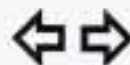

Hazard Warning Flashers



Headlight High Beam



Parking Lights

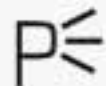

Fog Lights



How to Use this Manual

These symbols are on some of your controls:

Windshield Wipers



Windshield Washer



Windshield Defroster



Rear Window Defogger



Ventilating Fan



Power Window



These symbols are used on warning and indicator lights:

Engine Coolant Temperature



Battery Charging System



Fuel



Engine Oil Pressure



Brake



Anti-Lock Brakes



Here are some other symbols you may see:

Fuse



Trunk or Liftgate Release



Lighter



Horn



Speaker



Hood Release





Here you'll find information about the seats in your Oldsmobile and how to use your safety belts properly. You can also learn about some things you should not do with safety belts.

Part 1

Seats & Restraint Systems

Seats and Seat Controls.....	12
Safety Belts.....	15
How to Wear Safety Belts Properly.....	19
Driver Position.....	19
Supplemental Inflatable Restraint System (Air Bag).....	23
Safety Belt Use During Pregnancy.....	27
Right Front Passenger Position.....	27
Center Passenger Position.....	28
Rear Seat Passengers (2-Door).....	29
Rear Seat Passengers (4-Door).....	31
Children.....	35
Smaller Children and Babies.....	35
Child Restraints.....	36
Larger Children.....	45
Safety Belt Extender.....	46
Replacing Safety Belts After a Crash.....	47

Seats & Restraint Systems

■ Seats and Seat Controls

This section tells you about the seats—how to adjust them—and also about reclining seatbacks and head restraints.

Manual Front Seat



CAUTION:

You can lose control of the vehicle if you try to adjust a manual driver's seat while the vehicle is moving. The sudden movement could startle and confuse you, or make you push a pedal when you don't want to. Adjust the driver's seat only when the vehicle is not moving.

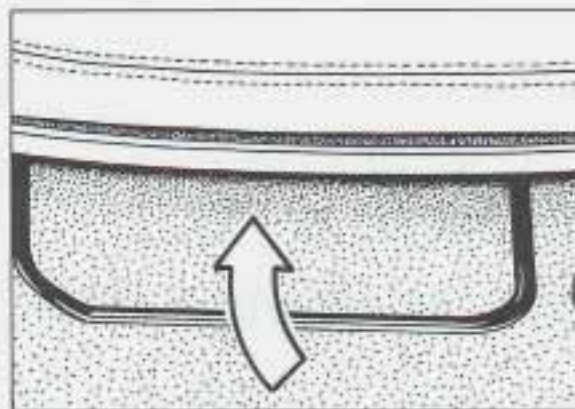

To adjust the seat forward or back, lift the handle. After it's adjusted, release the handle and try to move the seat to be certain it has locked into place.

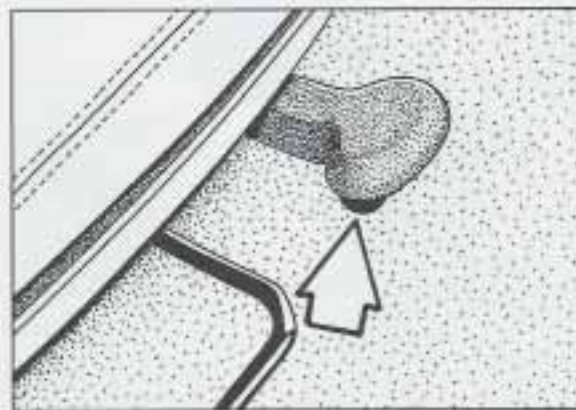

Manual Four-Way Seat Adjuster (OPTION)

To tilt the whole seat forward or backward, squeeze the lever. Position the seat where you would like it, then release the lever.

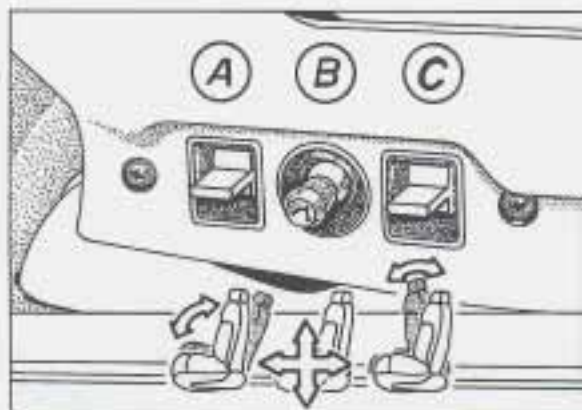

Six-Way Power Seat (OPTION)

To Adjust the Six-Way Power Seat:

Front Control (A): Raise the front of the seat by holding the switch up. Hold the switch down to lower the front of the seat.

Center Control (B): Move the seat forward or back by holding the control to the front or back. Raise or lower the seat by holding the control up or down.

Rear Control (C): Raise the rear of the seat by holding the switch up. Hold the switch down to lower the rear of the seat.

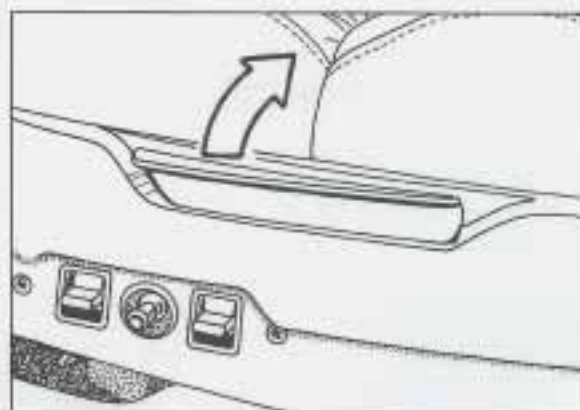

Reclining Front Seatbacks

Lift the lever to release the seatback, then tilt the seatback forward or backward, as desired. Release the lever to lock the seatback in place.

But don't have a seatback reclined if your vehicle is moving.



CAUTION:

Sitting in a reclined position when your vehicle is in motion can be dangerous. Even if you buckle up, your safety belts can't do their job when you're reclined like this. The shoulder belt can't do its job because it won't be against your body. Instead, it will be in front of you. In a crash you could go into it, receiving neck or other injuries.

CAUTION (Continued)

Seats & Restraint Systems

CAUTION (Continued)

The lap belt can't do its job either. In a crash the belt could go up over your abdomen. The belt forces would be there, not at your pelvic bones. This could cause serious internal injuries.

For proper protection when the vehicle is in motion, have the seatback upright. Then sit well back in the seat and wear your safety belt properly.



Head Restraints

Slide the head restraint up or down so that the top of the restraint is closest to the top of your ears.

This position reduces the chance of a neck injury in a crash.

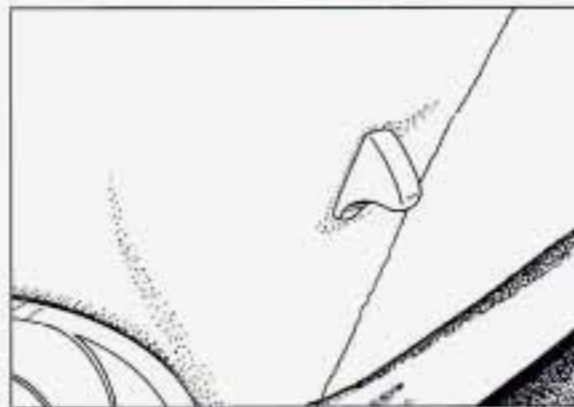

Seatback Latches

In 2-door Oldsmobiles, the front seat folds forward to let people get into the back seat.

Your seatback will move back and forth freely, unless you come to a sudden stop. Then it will lock in place.

There's one time the seatback may not fold without some help from you. That's if your vehicle is parked facing down a fairly steep hill.

To fold a seatback forward, push the seatback toward the rear as you lift this latch. Then the seatback will fold forward. The latch must be down for the seat to work properly.

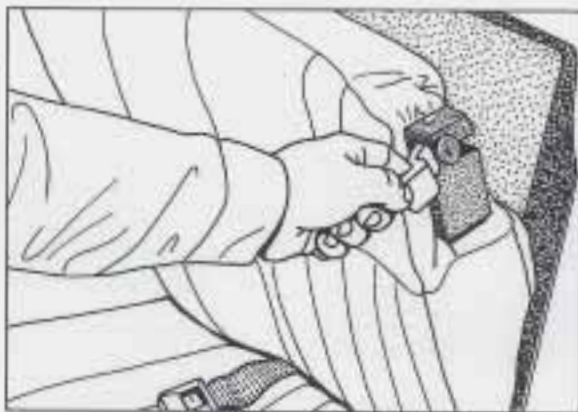

Split Fold-Down Rear Seat (OPTION)

To Open: Pull forward on the seat tab.

To Close: Push the seatback up to its original position.

Check latch resistance regularly by pulling on the seat tab. If the seatback does not latch securely, have it repaired right away. A loose seatback can cause an injury in a sudden stop.

■ **Safety Belts: They're For Everyone**

This part of the manual tells you how to use safety belts properly. It also tells you some things you should not do with safety belts.

And it explains the Supplemental Inflatable Restraint, or "air bag" system.



CAUTION:

Don't let anyone ride where they can't wear a safety belt properly. If you are in a crash and you're not wearing a safety belt, your injuries can be **much** worse. You can hit things inside the vehicle or be ejected from it. You can be seriously injured or killed. In the same crash, you might not be if you are buckled up. Always fasten your safety belt, and check that your passengers' belts are fastened properly too.



This figure lights up as a reminder to buckle up. (See *Safety Belt Warning Light* in the *Index*.)

In many states and Canadian provinces, the law says to wear safety belts. Here's why: **They work.**

Seats & Restraint Systems



You never know if you'll be in a crash. If you do have a crash, you don't know if it will be a bad one.

A few crashes are mild, and some crashes can be so serious that even buckled up a person wouldn't survive. But most crashes are in between. In many of them, people who buckle up can survive and sometimes walk away. Without belts they could have been badly hurt or killed.

After more than 25 years of safety belts in vehicles, the facts are clear. In most crashes buckling up does matter... a lot!

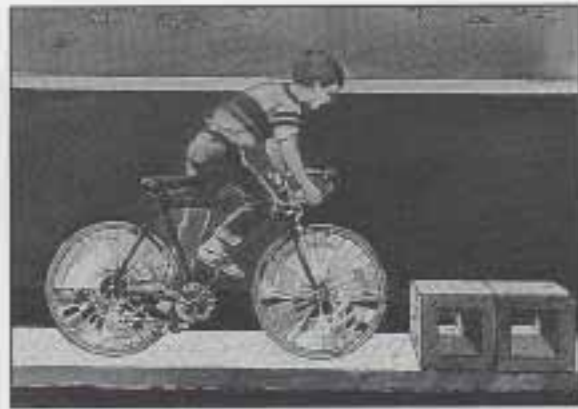

Why Safety Belts Work

When you ride in or on anything, you go as fast as it goes.

1. For example, if the bike is going 10 mph (16 km/h), so is the child.

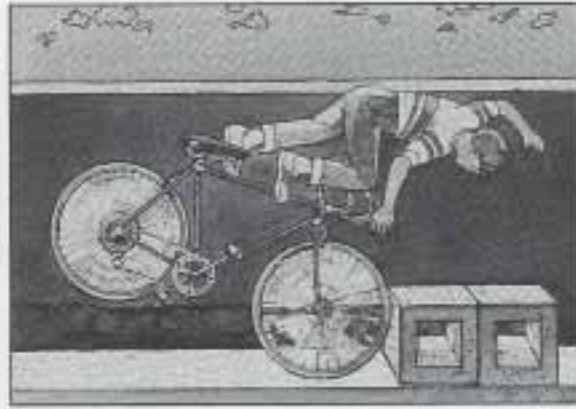

2. When the bike hits the block, it stops. But the child keeps going!

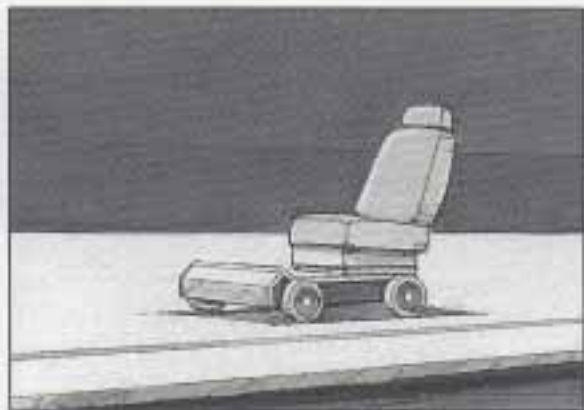

3. Take the simplest vehicle. Suppose it's just a seat on wheels.



4. Put someone on it.

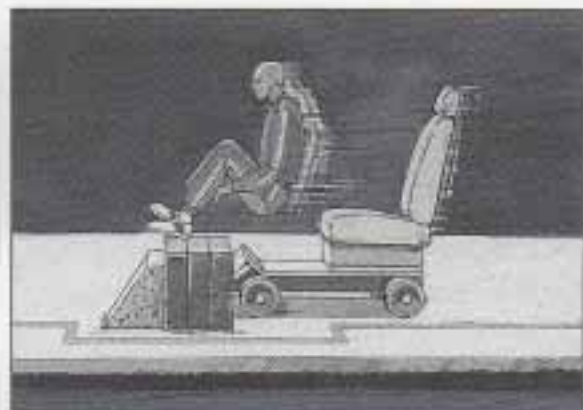

5. Get it up to speed. Then stop the vehicle. The rider doesn't stop.



6. The person keeps going until stopped by something.

In a real vehicle, it could be the windshield...



7. or the instrument panel...



8. or the safety belts!

With safety belts, you slow down as the vehicle does. You get more time to stop. You stop over more distance, and your strongest bones take the forces. That's why safety belts make such good sense.

Seats & Restraint Systems

■ *Here Are Questions Many People Ask About Safety Belts — and the Answers*

Q: Won't I be trapped in the vehicle after an accident if I'm wearing a safety belt?

A: You **could** be — whether you're wearing a safety belt or not. But you can easily unbuckle a safety belt, even if you're upside down. And your chance of being conscious during and after an accident, so you **can** unbuckle and get out, is **much** greater if you are belted.

Q: Why don't they just put in air bags so people won't have to wear safety belts?

A: Air bags, or Supplemental Inflatable Restraint systems, are in some vehicles today and will be in more of them in the future. But they are supplemental systems only — so they work **with** safety belts, not instead of them. Every air bag system ever offered for sale has required the use of safety belts. Even if you're in a vehicle that has air bags, you still

have to buckle up to get the most protection. That's true not only in frontal collisions, but especially in side and other collisions.

Q: If I'm a good driver, and I never drive far from home, why should I wear safety belts?

A: You may be an excellent driver, but if you're in an accident — even one that isn't your fault — you and your passengers can be hurt. Being a good driver doesn't protect you from things beyond your control, such as bad drivers. Most accidents occur within 25 miles (40 km) of home. And the greatest number of serious injuries and deaths occur at speeds of less than 40 mph (65 km/h).

Safety belts are for everyone.



Safety Belt Reminder Light

When the key is turned to **Run** or **Start**, a chime will come on for about eight seconds to remind people to fasten their safety belts, unless the driver's safety belt is already buckled. The safety belt light will also come on and stay on until the driver's belt is buckled.

■ *How To Wear Safety Belts Properly*

Adults

This section is only for people of adult size.

Be aware that there are special things to know about safety belts and children. And there are different rules for smaller children and babies. If a child will be riding in your Oldsmobile, see the section after this one, called *Children*. Follow those rules for everyone's protection.

First, you'll want to know which restraint systems your vehicle has. We'll start with the driver position.

■ *Vehicles First Sold In Canada*

Was your Oldsmobile first sold, when new, in Canada? (If it was, a sticker on the driver's door will say "conforms to all applicable Canada motor vehicle..." etc.) If so, then the rest of Part 1 does not apply to your vehicle.

To learn how to use your safety belts, please read the **Owner's Manual Safety Belt Supplement**. It comes with every new Oldsmobile first sold in Canada.

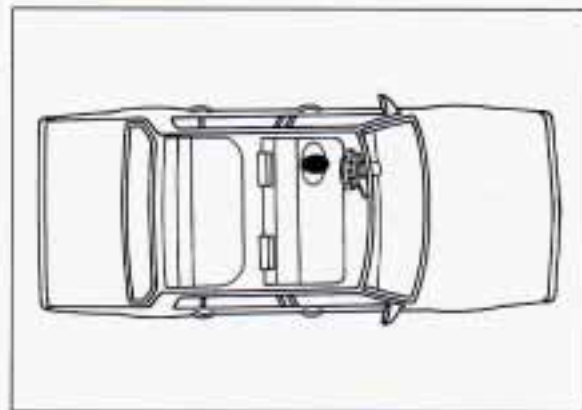

■ *Driver Position*

This section describes the driver's restraint system.

Seats & Restraint Systems



Automatic Lap-Shoulder Belt

This safety belt is called “automatic” because you don’t have to buckle up when you get into your vehicle.



And you don’t have to unbuckle when you get out.

Just get into your vehicle. Then close and lock the door. Adjust the seat (to see how, see *Seat Controls* in the *Index*) so you can sit up straight.

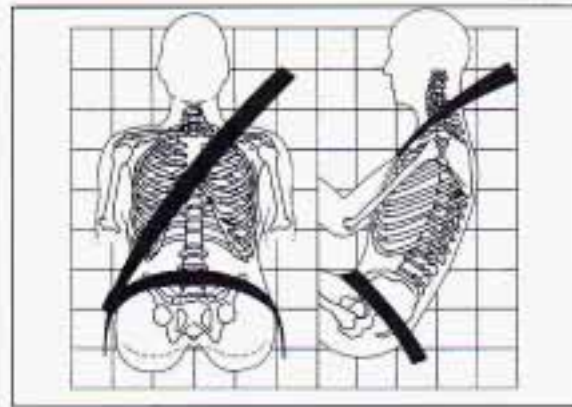

The lap belt should be worn as low on the hips as possible. In a crash, this applies force to the strong pelvic bones. And you’d be less likely to slide under the lap belt. If you slid under it, the belt would apply force at your abdomen. This could cause serious or even fatal injuries. The shoulder belt should go over the shoulder and across the chest. These parts of the body are best able to take belt restraining forces.

The safety belt locks if there’s a sudden stop or a crash.

It’s possible that an automatic belt could keep you from fully opening a door. That can happen if the door was slammed shut very hard. Just close the door all the way, then slowly open it. If

that doesn't fix it, then your Oldsmobile needs service.

We hope you'll always keep your automatic belt buckled. However, you may need to unbuckle it in an emergency. And you would need to unbuckle it to let someone get into the center front seat position, if your vehicle has one.



To unbuckle the automatic belt, just push the button on the buckle.



To reattach the automatic belt:

1. Close and lock the door.
2. Adjust the seat (to see how, see *Seat Controls* in the *Index*) so you can sit up straight.
3. Pick up the latch plate and pull the belt across you. Don't let it get twisted.
4. Push the latch plate into the buckle until it clicks. Pull up on the latch plate to make sure it is secure.

Seats & Restraint Systems

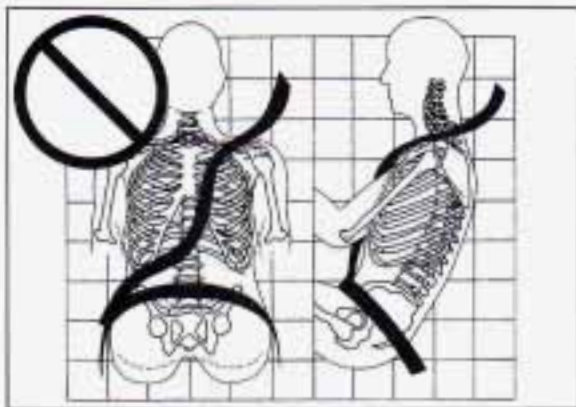

Q: What's wrong with this?

A: The shoulder belt is too loose. It won't give nearly as much protection this way.

 **CAUTION:**

You can be seriously hurt if your shoulder belt is too loose. In a crash you would move forward too much, which could significantly increase injury. The shoulder belt should fit against your body.

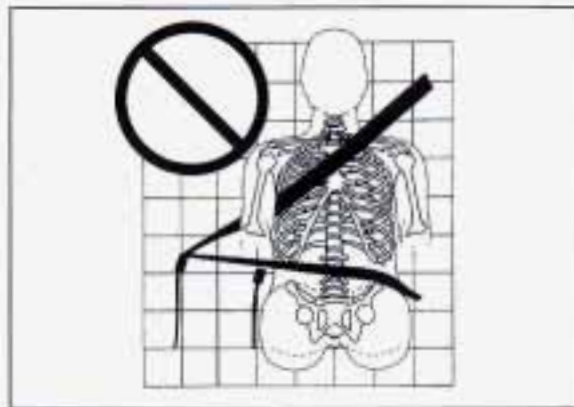

Q: What's wrong with this?

A: The belt is buckled in the wrong place.

 **CAUTION:**

You can be seriously injured if your belt is buckled in the wrong place like this. In a crash, the belt would go up over your abdomen. The belt forces would be there, not at the pelvic bones. This could cause serious internal injuries. Always buckle your belt into the buckle nearest you.

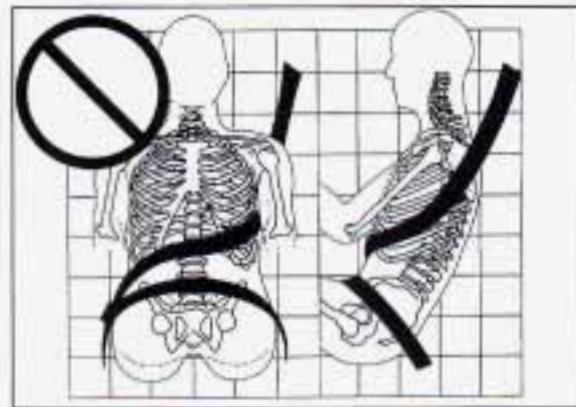

Q: What's wrong with this?

A: The shoulder belt is worn under the arm. It should be worn over the shoulder at all times.

 **CAUTION:**

You can be seriously injured if you wear the shoulder belt under your arm. In a crash, your body would move too far forward, which would increase the chance of head and neck injury. Also, the belt would apply too much force to the ribs, which aren't as strong as shoulder bones. You could also severely injure internal organs like your liver or spleen.

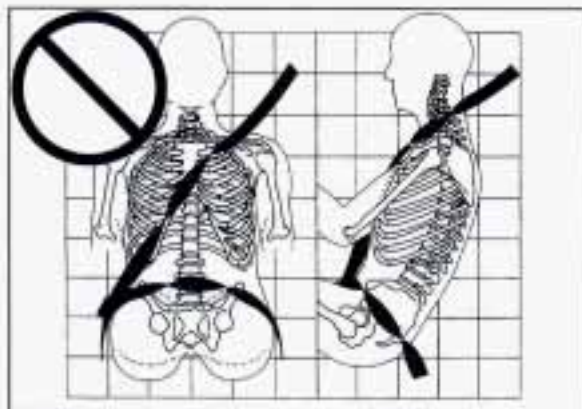

Q: What's wrong with this?

A: The belt is twisted across the body.



CAUTION:

You can be seriously injured by a twisted belt. In a crash, you wouldn't have the full width of the belt to take impact forces. If a belt is twisted, make it straight so it can work properly, or ask your dealer to fix it.

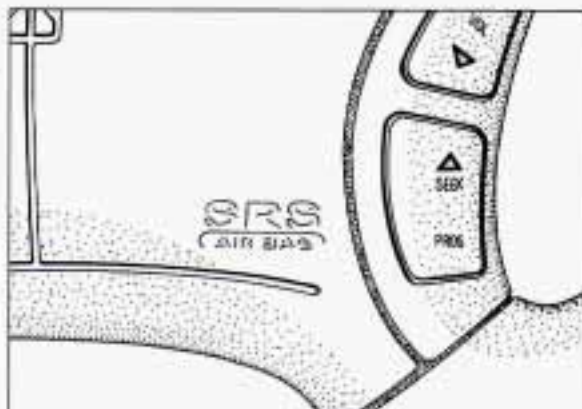

■ ***Supplemental Restraint System (Air Bag)***

This section explains the driver's Supplemental Restraint (SRS) system, commonly referred to as an air bag. Here are the most important things to know:



CAUTION:

Even with an air bag, if you're not wearing a safety belt and you're in a crash, your injuries may be much worse. Air bags are not designed to inflate in rollovers or in rear, side or low-speed frontal crashes. You need to wear your safety belt to reduce the chance of hitting things inside the vehicle or being ejected from it. Always wear your safety belt, even with an air bag.



CAUTION:

Air bags inflate with great force, faster than the blink of an eye. If you're too close to an inflating air bag, it could seriously injure you. Safety belts help keep you in position for an air bag inflation in a crash. Always wear your safety belt, even with an air bag, and sit as far back as you can while still maintaining control of your vehicle.

Seats & Restraint Systems



CAUTION:

When an air bag inflates, there is dust in the air. This dust could cause breathing problems for people with a history of asthma or other breathing trouble. To avoid this, everyone in the vehicle should get out as soon as it is safe to do so. If you have breathing problems but can't get out of the vehicle after an air bag inflates, then get fresh air by opening a window or door.



CAUTION:

Don't put anything on, or attach anything to, the driver air bag. Also, don't put anything (such as pets or objects) between the driver and the driver air bag. If something is between an occupant and an air bag, it could affect the performance of the air bag, or, worse, it could cause injury.

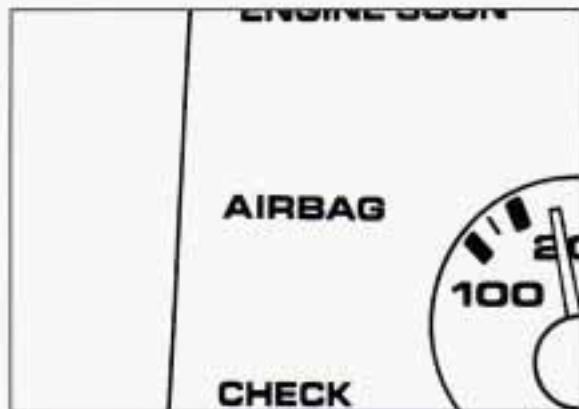

Air Bag Readiness Light

There is an air bag readiness light on the instrument panel, which shows **AIR BAG**. The system checks for electrical malfunctions, and the light tells you if there is a problem.

You will see this light flash for a few seconds when you turn your ignition to **Run** or **Start**. Then the light should go out, which means the system is ready.

Remember, if the air bag readiness light doesn't come on when you start your vehicle, or stays on, or comes on when you are driving, your air bag system may not work properly. Have your vehicle serviced right away.



How The Air Bag System Works

Where is the air bag?

The driver's air bag is in the middle of the steering wheel.

When is an air bag expected to inflate?

The air bag is designed to inflate in moderate to severe frontal or near-frontal crashes. The air bag will only inflate if the velocity of the impact is above the designed threshold level. When impacting straight into a wall that does not move or deform, the threshold level for most GM vehicles is between 9 and 15 mph (14 and 23 km/h). However, this velocity threshold depends on the vehicle design and may be several miles-per-hour faster or

slower. In addition, this threshold velocity will be considerably higher if the vehicle strikes an object such as a parked car which will move and deform on impact. The air bag is also not designed to inflate in rollovers, side impacts, or rear impacts where the inflation would provide no occupant protection benefit.

In any particular crash, the determination of whether the air bag should have inflated cannot be based solely on the level of damage on the vehicle(s). Inflation is determined by the angle of the impact and the vehicle's deceleration, of which vehicle damage is only one indication. Repair cost is not a good indicator of whether an air bag should have deployed.

What makes an air bag inflate?

In a frontal impact of sufficient severity, the air bag sensing system detects that the vehicle is suddenly stopping as a result of a crash. The sensing system triggers a chemical reaction of the sodium azide sealed in the inflator. The reaction produces nitrogen gas, which inflates the cloth bag. The inflator, cloth bag, and related hardware are all part of

the air bag inflator module packed inside the steering wheel.

How does an air bag restrain?

In moderate to severe frontal or near-frontal collisions, even belted occupants can contact the steering wheel. The air bag supplements the protection provided by safety belts. Air bags distribute the force of the impact more evenly over the occupant's upper body, stopping the occupant more gradually. But air bags would not provide protection in many types of collisions, including rollovers and rear and side impacts, primarily because an occupant's motion is not toward the air bag. Air bags should never be regarded as anything more than a supplement to safety belt protection in moderate to severe frontal and near-frontal collisions.

What will you see after an air bag inflation?

After the air bag has inflated, it will then quickly deflate. This occurs so quickly that some people may not even realize that the air bag inflated. Some components of the air bag module in the

steering wheel hub may be hot for a short time, but the portion of the bag that comes into contact with you will not be hot to the touch. There will be small amounts of smoke and dust coming from vents in the deflated air bag. The air bag will **not** impede the driver's vision or ability to steer the vehicle, nor will it hinder the occupants from exiting the vehicle.

- The air bag is designed to inflate only once. After it inflates, you'll need some new parts for your air bag system. If you don't get them, the air bag system won't be there to help protect you in another crash. A new system will include the air bag module and possibly other parts. The service manual has information about the need to replace other parts.
- Your vehicle is equipped with a diagnostic module, which records information about the air bag system if the air bag deploys during a crash. The module records information about the readiness of the system, which sensors activated the deployment, and whether the driver's safety belt was in use.

Seats & Restraint Systems

- Let only qualified technicians work on your air bag system. Improper service can mean that your air bag system won't work properly. See your dealer for service.

NOTICE:

If you damage the cover for the driver's air bag, it may not work properly. You may have to replace the air bag on the steering wheel. Do not open or break the air bag cover.

Is the smoke from an air bag inflation harmful?

The particles emitted during air bag inflation are not harmful to most people. Some people with respiratory ailments may experience difficulty breathing if they stay in the vehicle with the windows closed after air bag inflation. So, if your air bag inflates, you and any passengers should exit the vehicle if and when it is safe to do so. If you or your passengers can't get out of the vehicle, try to get fresh air by opening a window, turning on the fan, or opening a door.

Servicing Your Air Bag-Equipped Oldsmobile

The air bag affects how your Oldsmobile should be serviced. There are parts of the air bag system in several places around your vehicle. You don't want the system to inflate while someone is working on your vehicle. Your Oldsmobile dealer and the 1994 Cutlass Supreme Service Manual have information about servicing your vehicle and the air bag system. The air bag system does not need regular maintenance.



CAUTION:

For up to 2 minutes after the ignition key is turned off and the battery is disconnected, an air bag can still inflate during improper service. You can be injured if you are close to an air bag when it inflates. Avoid wires wrapped with yellow tape, or yellow connectors. They are probably part of the air bag system. Be sure to follow the proper service procedures, and make sure the person performing work for you is qualified to do so.



■ *Safety Belt Use During Pregnancy*

Safety belts work for everyone, including pregnant women. Like all occupants, they are more likely to be seriously injured if they don't wear safety belts.

A pregnant woman should wear a lap-shoulder belt, and the lap portion should be worn as low as possible throughout the pregnancy.

The best way to protect the fetus is to protect the mother. When a safety belt is worn properly, it's more likely that the fetus won't be hurt in a crash. For pregnant women, as for anyone, the key to making safety belts effective is wearing them properly.

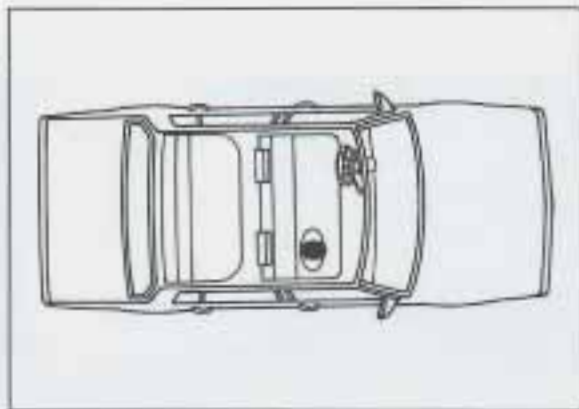

■ *Right Front Passenger Position*

The right front passenger's safety belt works the same way as the driver's safety belt. See *Driver Position*, earlier in this part.



Adjust the seat (to see how, see *Seat Controls* in the *Index*) so you can sit up straight. Move your seat far enough forward that your feet touch the part of the car that is called the "toeboard" (A). That way you'd be less likely to slide under the lap belt in a crash.

Seats & Restraint Systems

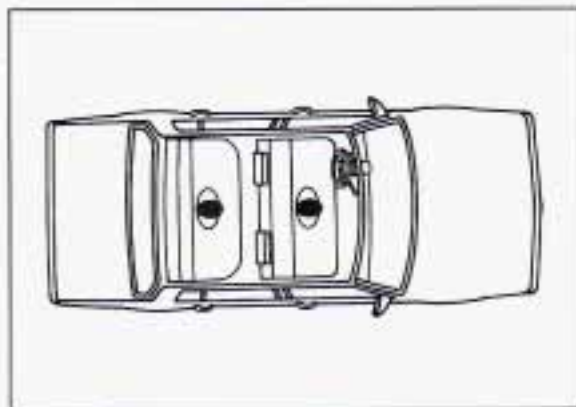

■ *Center Passenger Position* *Lap Belt*

If your vehicle has a bench seat, someone can sit in the center position.

When you sit in a center seating position, you have a lap safety belt, which has no retractor.



To make the belt longer, tilt the latch plate and pull it along the belt.



To make the belt shorter, pull its free end as shown until the belt is snug.

Buckle, position and release it the same way as the lap part of a lap-shoulder belt. If the belt isn't long enough, see *Safety Belt Extender* at the end of this section.

Make sure the release button on the buckle is positioned so you would be able to unbuckle the safety belt quickly if you ever had to.

■ *Rear Seat Passengers* (2-DOOR OLDSMOBILES)

It's very important for rear seat passengers to buckle up! Accident statistics show that unbelted people in the rear seat are hurt more often in crashes than those who are wearing safety belts.

Rear passengers who aren't safety belted can be thrown out of the vehicle in a crash. And they can strike others in the vehicle who are wearing safety belts.

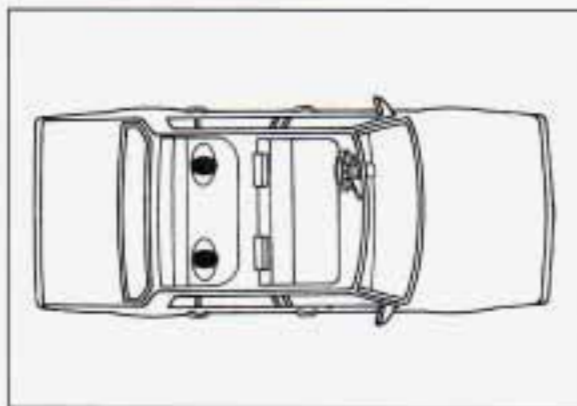

Rear Seat Outside Passenger Positions

Lap-Shoulder Belt

The positions next to the windows have lap-shoulder belts. Here's how to wear one properly.



1. Pick up the latch plate and pull the belt across you. Don't let it get twisted.
2. Push the latch plate into the buckle until it clicks.

Seats & Restraint Systems



If the belt stops before it reaches the buckle, tilt the latch plate and keep pulling until you can buckle it.

Pull up on the latch plate to make sure it is secure.

If the belt is not long enough, see *Safety Belt Extender* at the end of this section. Make sure the release button on the buckle is positioned so you would be able to unbuckle the safety belt quickly if you ever had to.



3. To make the lap part tight, pull down on the buckle end of the belt as you pull up on the shoulder part.

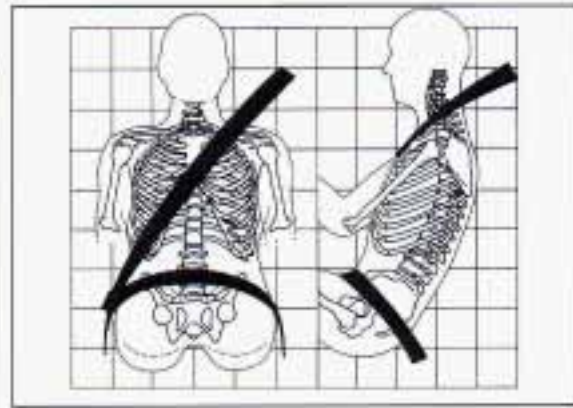

The lap part of the belt should be worn low and snug on the hips, just touching the thighs. In a crash, this applies force to the strong pelvic bones. And you'd be less likely to slide under the lap belt. If you slid under it, the belt would apply force at your abdomen. This could cause serious or even fatal injuries. The shoulder belt should go over the shoulder and across the chest. These parts of the body are best able to take belt restraining forces.

The safety belt locks if there's a sudden stop or a crash.



CAUTION:

You can be seriously hurt if your shoulder belt is too loose. In a crash you would move forward too much, which could increase injury. The shoulder belt should fit against your body.



To unfasten the belt, just push the button on the buckle.

■ ***Rear Seat Passengers*** **(4-DOOR OLDSMOBILES)**

It's very important for rear seat passengers to buckle up! Accident statistics show that unbelted people in the rear seat are hurt more often in crashes than those who are wearing safety belts.

Rear passengers who aren't safety belted can be thrown out of the vehicle in a crash. And they can strike others in the vehicle who are wearing safety belts.

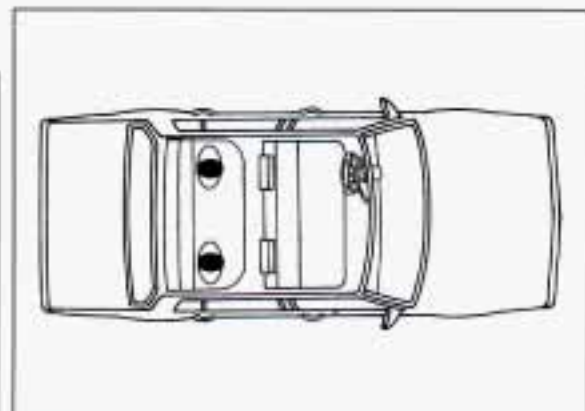

Rear Seat Outside Passenger Positions

Lap-Shoulder Belt

The positions next to the windows have lap-shoulder belts. Here's how to wear one properly.

Seats & Restraint Systems



1. Pick up the latch plate and pull the belt across you. Don't let it get twisted.
2. Push the latch plate into the buckle until it clicks. Pull up on the latch plate to make sure it is secure. When the shoulder belt is pulled out all the way, it will lock. If it does, let it go back all the way and start again.

If the belt is not long enough, see *Safety Belt Extender* at the end of this section.

Make sure the release button on the buckle is positioned so you would be able to unbuckle the safety belt quickly if you ever had to.



3. To make the lap part tight, pull down on the buckle end of the belt as you pull up on the shoulder part.

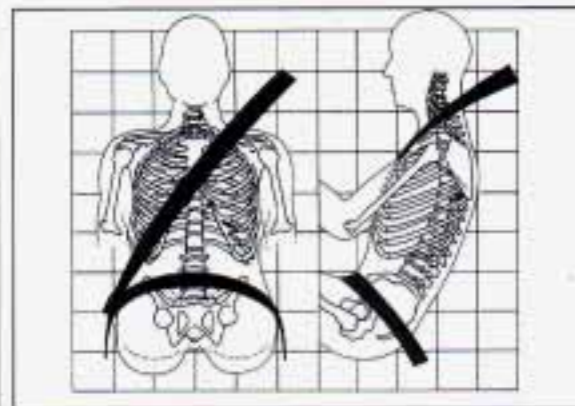

The lap part of the belt should be worn low and snug on the hips, just touching the thighs. In a crash, this applies force to the strong pelvic bones. And you'd be less likely to slide under the lap belt. If you slid under it, the belt would apply force at your abdomen. This could cause serious or even fatal injuries. The shoulder belt should go over the shoulder and across the chest. These parts of the body are best able to take belt restraining forces.

The safety belt locks if there's a sudden stop or a crash.



CAUTION:

You can be seriously hurt if your shoulder belt is too loose. In a crash you would move forward too much, which could increase injury. The shoulder belt should fit against your body.



To unlatch the belt, just push the button on the buckle.

Rear Safety Belt Comfort Guides for Children and Small Adults

Your vehicle may be equipped with rear shoulder belt comfort guides. This feature will provide added comfort for children who have outgrown child restraints and for small adults. The comfort guides pull the shoulder belts away from the neck and head.

Not available on vehicles with a convertible top.



There is one guide for each outside passenger position in the rear seat. You will find them tucked in between the seatback and the interior body, about half-way down the edge of the seatback. Here is how you should install the comfort guides on the shoulder belts:

1. Pull the elastic cord out from between the edge of the seatback and the interior body to remove the guide from its storage clip.

Seats & Restraint Systems



2. Slide the guide under and past the belt. The elastic cord must be under the belt. Then, place the guide over the belt, and insert the two edges of the belt into the slots of the guide.



3. Be sure that the belt is not twisted and it lies flat. The elastic cord must be under the belt and the guide on top.



4. Buckle the belt around the child, and make sure that both the lap belt and the shoulder belt are secured properly. Make sure that the shoulder belt crosses the shoulder. See *Safety Belts, Rear Seat Passengers* in the *Index*.

To remove and store the comfort guides, just perform these steps in reverse order. Squeeze the belt edges together so you can take them out from the guides. Pull the guide upward to expose its storage clip, and then slide the guide onto the clip. Rotate the guide and clip inward and in between the seatback and the interior body, leaving only the loop of elastic cord exposed.



■ Children

Everyone in a vehicle needs protection! That includes infants and all children smaller than adult size. In fact, the law in every state in the United States and in every Canadian province says children up to some age must be restrained while in a vehicle.

Smaller Children and Babies

CAUTION:

Smaller children and babies should always be restrained in a child or infant restraint. The instructions for the restraint will say whether it is the right type and size for your child. A very young child's hip bones are so small that a regular belt might not stay low on the hips, as it should. Instead, the belt will likely be over the child's abdomen. In a crash the belt would apply force right on the child's abdomen, which could cause serious or fatal injuries. So, be sure that any child small enough for one is always properly restrained in a child or infant restraint.



CAUTION:

Never hold a baby in your arms while riding in a vehicle. A baby doesn't weigh much — until a crash. During a crash a baby will become so heavy you can't hold it. For example, in a crash at only 25 mph (40 km/h), a 12-pound (5.5 kg) baby will suddenly become a 240-pound (110 kg) force on your arms. The baby would be almost impossible to hold.

CAUTION (Continued)

Seats & Restraint Systems



CAUTION (Continued)

Secure the baby in an infant restraint.

■ *Child Restraints*

Be sure to follow the instructions for the restraint. You may find these instructions on the restraint itself or in a booklet, or both. These restraints use the belt system in your vehicle, but the child also has to be secured within the restraint to help reduce the chance of personal injury. The instructions that come with the infant or child restraint will show you how to do that.

Where to Put the Restraint

Accident statistics show that children are safer if they are restrained in the rear rather than the front seat. We at General Motors therefore recommend that you put your child restraint in the rear seat unless the child is an infant and you're the only adult in the vehicle. In that case, you might want to secure the restraint in the front seat where you can keep an eye on the baby.

Wherever you install it, be sure to secure the child restraint properly.

Keep in mind that an unsecured child restraint can move around in a collision or sudden stop and injure people in the vehicle. Be sure to properly secure any child restraint in your vehicle — even when no child is in it.



Top Strap

If your child restraint has a top strap, it should be anchored.

If you need to have an anchor installed, you can ask your Oldsmobile dealer to put it in for you. If you want to install an anchor yourself, your dealer can tell you how to do it.

For cars first sold in Canada, child restraints with a top strap must be anchored according to Canadian Law.

Your dealer can obtain the hardware kit and install it for you, or you may install it yourself using the instructions provided in the kit.

Use the tether hardware kit available from the dealer. The hardware and installation instructions were specifically designed for this vehicle.

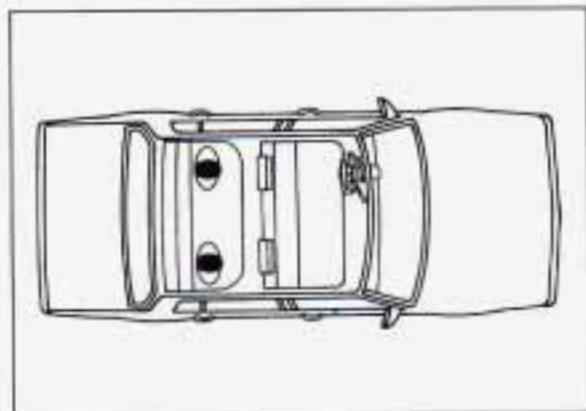

Securing a Child Restraint in a Rear Outside Position – 2-Door Oldsmobiles

You'll be using the lap-shoulder belt. See the earlier section about the top strap if the child restraint has one.

- 1.** Put the restraint on the seat. Follow the instructions for the child restraint.
- 2.** Secure the child in the child restraint as the instructions say.
- 3.** Pick up the latch plate, and run the lap and shoulder portions of the vehicle's safety belt through or

around the restraint. The child restraint will show you how. Tilt the latch plate to adjust the belt if needed. If the shoulder belt goes in front of the child's face or neck, put it behind the child restraint.



- 4.** Buckle the belt. Make sure the release button is positioned so you would be able to unbuckle the safety belt quickly if you ever had to.

Seats & Restraint Systems



5. To tighten the belt, pull up on the shoulder belt while you push down on the child restraint.



6. Push and pull the child restraint in different directions to be sure it is secure.

To remove the child restraint, just unbuckle the vehicle's safety belt and let it go back all the way. The safety belt will move freely again and be ready to work for an adult or larger child passenger.

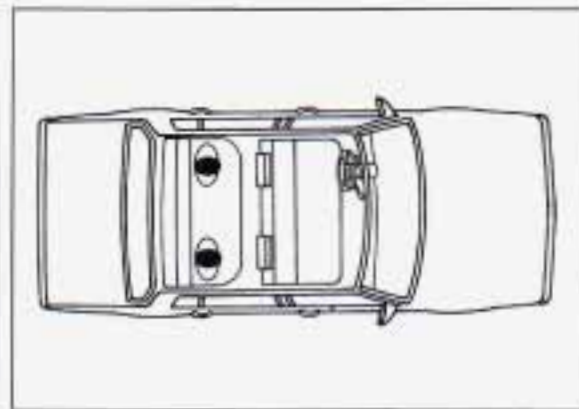

Securing a Child Restraint in a Rear Outside Position — 4-Door Oldsmobiles

You'll be using the lap-shoulder belt. See the earlier section about the top strap if the child restraint has one.

1. Put the restraint on the seat. Follow the instructions for the child restraint.
2. Secure the child in the child restraint as the instructions say.
3. Pick up the latch plate, and run the lap and shoulder portions of the vehicle's safety belt through or around the restraint. The child restraint will show you how.



- 4.** Buckle the belt. Make sure the release button is positioned so you would be able to unbuckle the safety belt quickly if you ever had to.



- 5.** Pull the rest of the shoulder belt all the way out of the retractor to set the lock.



- 6.** To tighten the belt, feed the shoulder belt into the retractor while you push down on the child restraint.

Seats & Restraint Systems



7. Push and pull the child restraint in different directions to be sure it is secure.

To remove the child restraint, just unbuckle the vehicle's safety belt and let it go back all the way. The safety belt will move freely again and be ready to work for an adult or larger child passenger.

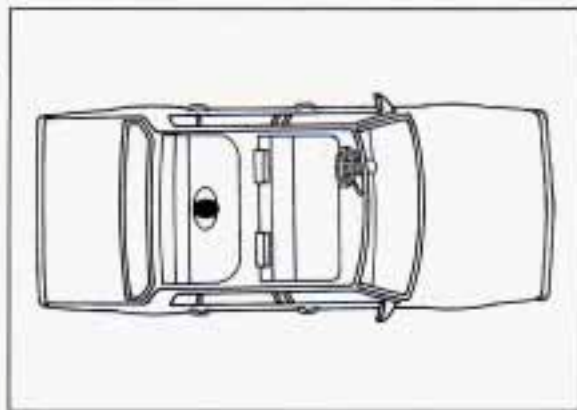

Securing a Child Restraint in the Center Rear Seat Position

When you secure a child restraint in a center seating position, you'll be using the lap belt.

See the earlier section about the top strap if the child restraint has one.



1. Make the belt as long as possible by tilting the latch plate and pulling it along the belt.
2. Put the restraint on the seat. Follow the instructions for the child restraint.
3. Secure the child in the child restraint as the instructions say.
4. Run the vehicle's safety belt through or around the restraint. The child restraint instructions will show you how.



5. Buckle the belt. Make sure the release button is positioned so you would be able to unbuckle the safety belt quickly if you ever had to.
6. To tighten the belt, pull its free end while you push down on the child restraint.

7. Push and pull the child restraint in different directions to be sure it is secure. If the child restraint isn't secure, turn the latch plate over and buckle it again. Then see if it is secure. If it isn't, secure the restraint in a different place in the vehicle and contact the child restraint maker for their advice about how to attach the child restraint properly.

To remove the child restraint, just unbuckle the vehicle's safety belt. It will be ready to work for an adult or larger child passenger.

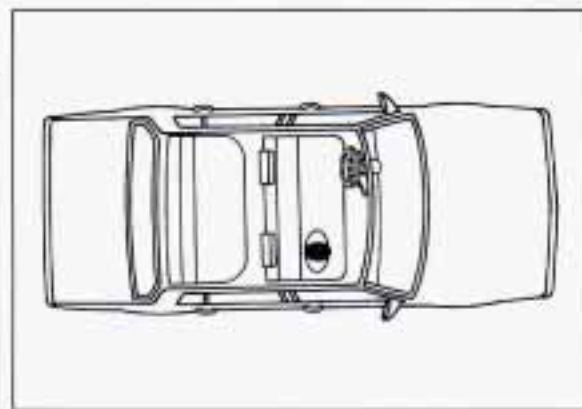

Securing a Child Restraint in the Right Front Seat

To use a child restraint here, you will need a special infant/child seat attaching belt and the hardware that goes with it. See the earlier section about the top strap if the child restraint has one.

Seats & Restraint Systems



Your dealer can get these and install the hardware for you. It's free. The special belt is GM Part Number 12340286. Your dealer can find the correct hardware in the accessory section of the GM Parts Catalog.



CAUTION:

Don't use the special infant/child seat attaching hardware in another vehicle. If you do, it may not work well and the child may not be protected properly in a crash. The special hardware is for your vehicle only. Also, don't use the special belt for anything but securing a child restraint in the right front seat. If an adult or older child uses it, the belt won't provide protection and may even increase injury in a crash.



Once the special hardware is installed, please follow the instructions with it and these steps:

1. Unbuckle the automatic lap-shoulder belt by pushing the button on the buckle.

It will stay on the door, ready to be rebuckled for use by adults or older children.



- 2.** Snap one hook of the infant/child seat attaching belt near the floor at the door side of the seat.



- 3.** Put the belt's special latch plate into the vehicle's safety belt buckle.

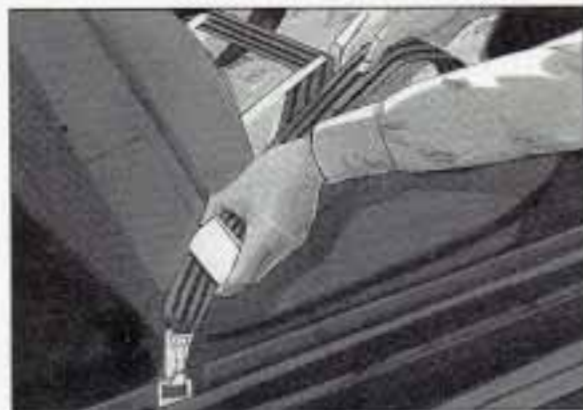

- 4.** You can make the belt longer by tilting the buckle and pulling it along the belt.
- 5.** Put the restraint on the seat. Follow the instructions for the child restraint.
- 6.** Secure the child in the child restraint as the instructions say.
- 7.** Run the belt through or around the child restraint. The child restraint instructions will show you how.

Seats & Restraint Systems



8. Put the hook on the free end through the slot in the latch plate.



9. To make it tight, pull the belt while you push down on the child restraint. If the belt won't stay tight, switch it end for end.

10. Push and pull the child restraint in different directions to be sure it is secure.

To Remove the Infant/Child Seat Restraint:

1. Push the button on the safety belt buckle and remove the special latch plate. Leave the latch plate on the special belt.



2. Push the spring on the hook near the door and remove the special belt.
3. Put the belt away in a safe place in your vehicle, so it won't fly around in a crash and injure someone.
4. Remember to reattach the automatic belt again, once the child restraint is removed. Be sure it isn't twisted.



Larger Children

Children who have outgrown child restraints should wear the vehicle's safety belts.

If you have the choice, a child should sit next to a window so the child can wear a lap-shoulder belt and get the additional restraint a shoulder belt can provide.

Accident statistics show that children are safer if they are restrained in the rear seat. But they need to use the safety belts properly.

- Children who aren't buckled up can be thrown out in a crash.

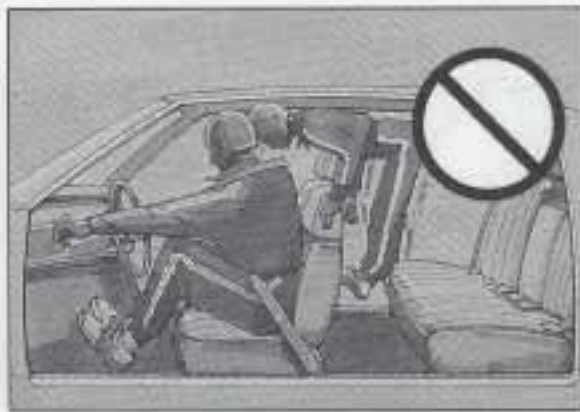

- Children who aren't buckled up can strike other people who are.



CAUTION:

Never do this. Here two children are wearing the same belt. The belt can't properly spread the impact forces. In a crash, the two children can be crushed together and seriously injured. A belt must be used by only one person at a time.

Q: What if a child is wearing a lap-shoulder belt, but the child is so small that the shoulder belt is very close to the child's face or neck?

A: Move the child toward the center of the vehicle, but be sure that the shoulder belt still is on the child's shoulder, so that in a crash the

Seats & Restraint Systems

child's upper body would have the restraint that belts provide. If the child is so small that the shoulder belt is still very close to the child's face or neck, you might want to place the child in the center seat position, the one that has only a lap belt.



CAUTION:

Never do this. Here a child is sitting in a seat that has a lap-shoulder belt, but the shoulder part is behind the child. If the child wears the belt in this way, in a crash the child might slide under the belt. The belt's force would then be applied right on the child's abdomen. That could cause serious or fatal injuries.

Wherever the child sits, the lap portion of the belt should be worn low and snug on the hips, just touching the child's thighs. This applies belt force to the child's pelvic bones in a crash. See *Rear Safety Belt Comfort Guides* in the *Index*.

■ *Safety Belt Extender*

If the vehicle's safety belt will fasten around you, you should use it. The automatic lap-shoulder belt has plenty of extra length built in, so it will fasten around almost all people.

But if a safety belt isn't long enough to fasten, your dealer will order you an extender. It's free. When you go in to order it, take the heaviest coat you will wear, so the extender will be long enough for you. The extender will be just for you, and just for the seat in your vehicle that you choose. Don't let someone else use it, and use it only for the seat it is made to fit. To wear it, just attach it to the regular safety belt.

■ *Checking Your Restraint Systems*

Now and then, make sure all your belts, buckles, latch plates, retractors, anchorages and reminder systems are working properly. Look for any loose parts or damage. If you see anything that might keep a restraint system from doing its job, have it repaired.



■ *Replacing Safety Belts After a Crash*

If you've had a crash, do you need new belts?

After a very minor collision, nothing may be necessary. But if the belts were stretched, as they would be if worn during a more severe crash, then you need new belts.

If you ever see a label on a right front safety belt in 4-door Oldsmobiles that says to replace the belt, be sure to do so. Then the new belt will be there to help protect you in an accident. You would see this label on the belt near the door opening.

If belts are cut or damaged, replace them. Collision damage also may mean

you will need to have safety belt or seat parts repaired or replaced. New parts and repairs may be necessary even if the belt wasn't being used at the time of the collision.

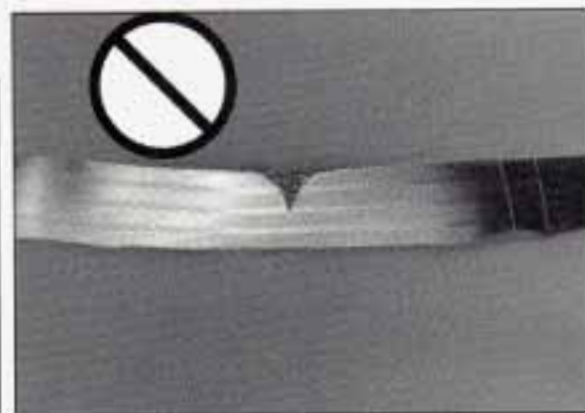

Q: What's wrong with this?

A: The belt is torn.

Torn or frayed belts may not protect you in a crash. They can rip apart under impact forces. If a belt is torn or frayed, get a new one right away.

Notes



Here you can learn about the many standard and optional features on your Oldsmobile, and information on starting, shifting and braking. Also explained are the instrument panel and the warning systems that tell you if everything is working properly — and what to do if you have a problem.

Part 2

Features & Controls

Keys	50
Locks.....	51
Remote Lock Control.....	52
Glove Box	58
Ignition	59
Starting Your Engine	59
Engine Coolant Heater.....	61
Shifting the Transaxle.....	62
Parking Brake.....	66
Shifting into Park.....	67
Windows	71
Turn Signal/Multifunction Lever	72
Cruise Control	74
Windshield Wipers	76
Windshield Washer	77
Headlights.....	77
Interior Lights	79
Mirrors	81
Storage Compartments	83
Ashtrays and Lighter.....	85
Sunroof	86
Luggage Carrier	87
Instrument Panel.....	88
Warning Lights, Gages and Indicators.....	91
Head-Up Display.....	98

Features & Controls

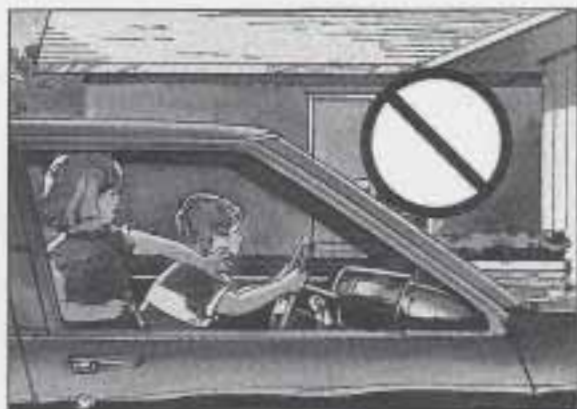

■ Keys



CAUTION:

Leaving young children in a vehicle with the ignition key is dangerous for many reasons. A child or others could be badly injured or even killed. They could operate power windows or other controls or even make the vehicle move. Don't leave the keys in a vehicle with young children.

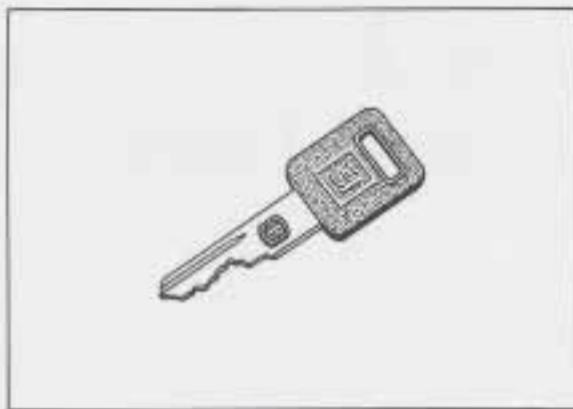

The ignition keys are for the ignition only.

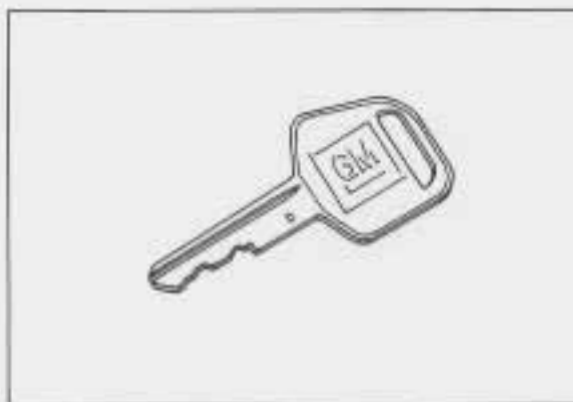

The door keys are for the doors and all other locks.

When a new Oldsmobile is delivered, the dealer removes the plugs from the door keys, and gives them to the first owner.

Each plug has a code on it that tells your dealer or a qualified locksmith how to make extra door keys. Keep the plugs in a safe place. If you lose your door keys, you'll be able to have new ones made easily using these plugs.

The ignition keys don't have plugs. Your Oldsmobile dealer or Roadside Assistance has the code for your keys. If you need a new ignition key, contact your Oldsmobile dealer. In an emergency, contact the Oldsmobile Roadside Assistance program at 1-800-442-OLDS (6537).

NOTICE:

Your Oldsmobile has a number of new features that can help prevent theft. But you can have a lot of trouble getting into your vehicle if you ever lock your keys inside. You may even have to damage your vehicle to get in. So be sure you have extra keys.

■ Door Locks



CAUTION:

Unlocked doors can be dangerous. Passengers — especially children — can easily open the doors and fall out. When a door is locked, the inside handle won't open it.

Outsiders can easily enter through an unlocked door when you slow down or stop your vehicle.

This may not be so obvious: You increase the chance of being thrown out of the vehicle in a crash if the doors aren't locked. Wear safety belts properly, lock your doors, and you will be far better off whenever you drive your vehicle.

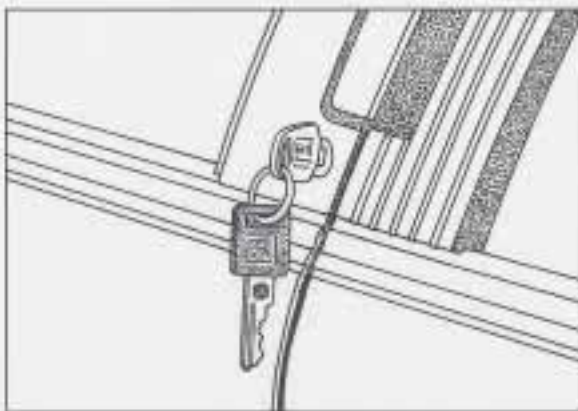

There are several ways to lock and unlock your vehicle.

From the Outside:

Use your door key or Remote Lock Control, if your vehicle has this option.

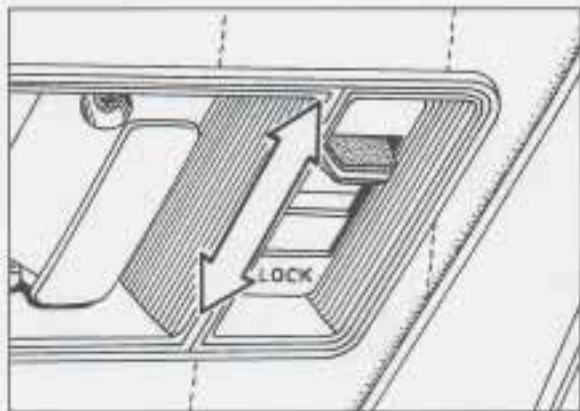

From the Inside:

To lock the door, push down the locking lever. To unlock, push the lever up.

Features & Controls

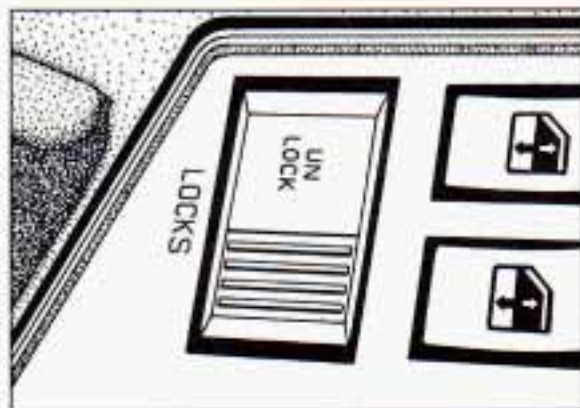

Power Door Locks

You can lock or unlock all doors of your vehicle from the driver or passenger door lock switch.

On 4-door models, the switch on each rear door works only that door's lock. It won't lock (or unlock) all of the doors—that's a safety feature.

Leaving Your Vehicle

If you are leaving the vehicle, open your door and set the locks from inside, then get out and close the door.

Automatic Door Locks

Just close your doors and turn on the ignition. All of the doors will lock when you move your shift lever out of **P**

(Park) or **N** (Neutral). Each time you close your doors and turn on the ignition, the doors will lock automatically. If someone needs to get out while the vehicle is running, have that person use the manual or power lock. When the door is closed again, it will lock automatically as long as the shift lever is out of **P** (Park) or **N** (Neutral). All doors will automatically unlock when the ignition is turned off.

If you don't want the doors to automatically unlock when you turn the ignition off, you can remove the Lock Control fuse in the Component Center. See the *Index* under *Fuses & Circuit Breakers*.



■ Remote Lock Control (OPTION)

If your Oldsmobile has this option, you can lock and unlock your doors or unlock your trunk from up to 30 feet (9 m) away using the key chain transmitter supplied with your vehicle.

Your Remote Lock Control operates on a radio frequency subject to Federal Communications Commission (FCC) Rules.

This device complies with Part 15 of the FCC Rules. Operation is subject to the following two conditions: (1) This device may not cause harmful interference, and (2) This device must accept any interference received, including interference that may cause undesired operation.

Should interference to this system occur, try this:

- Check to determine if battery replacement is necessary. See the instructions on battery replacement.
- Check the distance. You may be too far from your vehicle. This product has a maximum range.
- Check the location. Other vehicles or objects may be blocking the signal.
- See your Oldsmobile dealer or a qualified technician for service.

Changes or modifications to this system by other than an authorized service facility could void authorization to use this equipment.

Operation

When you press and release **UNLOCK**, the driver's door will unlock and the interior lights will come on. They'll stay on for 16 seconds, or until you turn the ignition to **ON**.

Press and release **UNLOCK** a second time within five seconds to unlock the passenger door or doors.

To lock all doors, press **DOOR**. If you first press **UNLOCK** and then press

DOOR within 16 seconds, the interior lights will go off.

Press  to unlock the trunk. Your interior lights will not come on.

Matching Transmitter(s) To Your Vehicle

Each key chain transmitter is coded to prevent another transmitter from unlocking your vehicle. If a transmitter is lost or stolen, a replacement can be purchased through your dealer. Remember to bring any remaining transmitters with you when you go to your dealer. When the dealer matches the replacement transmitter to your vehicle, the remaining transmitters must also be matched. Once the new transmitter is coded, the lost transmitter will not unlock your vehicle.

You can match a transmitter to as many different vehicles as you own, provided they are equipped with **exactly the same model system**. (General Motors offers several different models of these systems on their vehicles.) Each vehicle can have only two transmitters matched to it.

See your dealer to match transmitters to another vehicle.



Battery Replacement

Under normal use, the batteries in your key chain transmitter should last about two years.

You can tell the batteries are weak if the transmitter won't work at the normal range in any location. If you have to get close to your vehicle before the transmitter works, it's probably time to change the batteries.

To Replace Batteries in the Remote Lock Control:

1. If your transmitter has a screw, remove the screw from the back cover.

Features & Controls

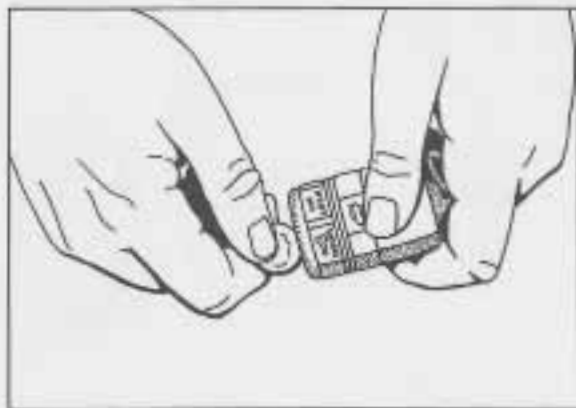

If it doesn't have a screw, pop the cover off by inserting a dime (or similar object) in the slot between the covers and twisting.

2. Lift the front cover off, bottom half first.
3. Remove and replace the two batteries (2016).
4. Reassemble the transmitter.
5. Check the transmitter operation.

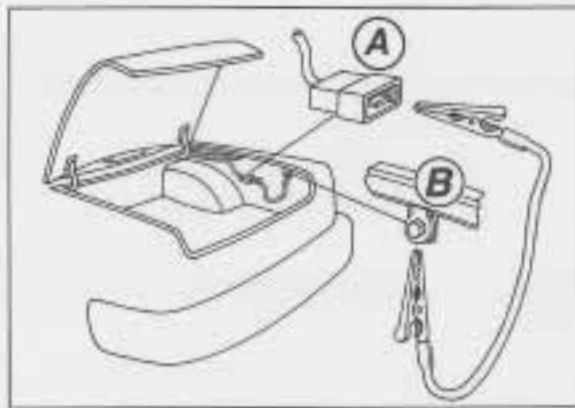

Programming the Module

You will need to program your Remote Lock Control module if any of the following things occur:

- You replace your Remote Lock Control transmitter;
- You add a second transmitter;
- Something grounds the data encoder connector in the trunk;
- You replace the Remote Lock Control module.

To program the module, you'll need the transmitter and a short length of wire, about 3 feet (1 m) long. Then follow these steps:

1. Open the trunk and locate the data encoder connector (A). It's on the right side, above the wheel well.

2. Attach one end of the grounding wire to the stud inside the data encoder connector terminal.
3. Attach the other end of the wire to a ground (B).
4. Press any button on the transmitter once. Wait for the locks to fully cycle. If you have a second portable transmitter, press any button on it, once, also. Wait for the locks to fully cycle. Your module is now programmed.
5. Disconnect the wire from the data encoder connector and the ground.

■ Theft

Vehicle theft is big business, especially in some cities. Although your Oldsmobile has a number of theft deterrent features, we know that nothing we put on it can make it impossible to steal. However, there are ways you can help.

Key in the Ignition

If you walk away from your vehicle with the keys inside, it's an easy target for

joy riders or professional thieves — so don't do it.

When you park your Oldsmobile and open the driver's door, you'll hear a tone reminding you to remove your key from the ignition and take it with you. Always do this. Your steering wheel will be locked, and so will your ignition and transaxle. And remember to lock the doors.

Parking at Night

Park in a lighted spot, close all windows and lock your vehicle. Remember to keep your valuables out of sight. Put them in a storage area, or take them with you.

Parking Lots

If you park in a lot where someone will be watching your vehicle, it's best to lock it up and take your keys. But what if you have to leave your ignition key? What if you have to leave something valuable in your vehicle?

- Put your valuables in a storage area, like your trunk or glove box.

- Lock all the doors except the driver's.
- Then take the door key with you.

■ *PASS-Key® II*

Your vehicle is equipped with the PASS-Key®II (Personalized Automotive Security System) theft deterrent system. PASS-Key®II is a passive theft deterrent system. This means you don't have to do anything different to arm or disarm the system. It works when you insert or remove the key from the ignition. PASS-Key®II uses a resistor pellet in the ignition key that matches a decoder in your vehicle.

When the PASS-Key®II system senses that someone is using the wrong key, it shuts down the vehicle's starter and fuel systems. For about three minutes, the starter won't work and fuel won't go to the engine. If someone tries to start your vehicle again or uses another key during this time, the vehicle will not start. This discourages someone from randomly trying different keys with different resistor pellets in an attempt to make a match.

The ignition key must be clean and dry before it's inserted in the ignition or the engine may not start. If the engine does not start and the **SECURITY** light is on, the key may be dirty or wet. Turn the ignition off.

Clean and dry the key. Wait about three minutes and try again. The security light may remain on during this time. If the starter still won't work, and the key appears to be clean and dry, wait about three minutes and try the other ignition key. At this time, you may also want to check the fuses (see *Fuses & Circuit Breakers* in the *Index*). If the starter won't work with the other key, your vehicle needs service. If your vehicle does start, the first ignition key may be faulty. See your Oldsmobile dealer or a locksmith who can service the PASS-Key®II.

If you accidentally use a key that has a damaged or missing resistor pellet, the starter won't work, and the **SECURITY** light will come on. But you don't have to wait three minutes before trying one of the other ignition keys.

Features & Controls

See your Oldsmobile dealer or a locksmith who can service the PASS-Key®II to have a new key made.

If you're ever driving and the **SECURITY** light comes on, you will be able to restart your engine if you turn it off. Your PASS-Key®II system, however, is not working properly and must be serviced by your Oldsmobile dealer. Your vehicle is not protected by the PASS-Key®II system.

If you lose or damage a PASS-Key®II ignition key, see your Oldsmobile dealer or a locksmith who can service PASS-Key®II to have a new key made.

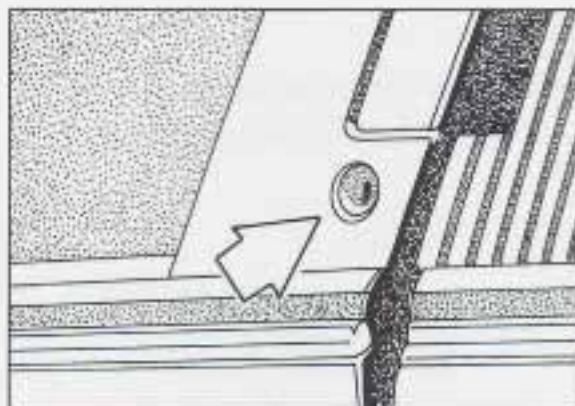

Lock Finder

On 2-door models only, pull the driver's door handle to light the door lock for a few seconds. This helps you find the lock when it's dark.

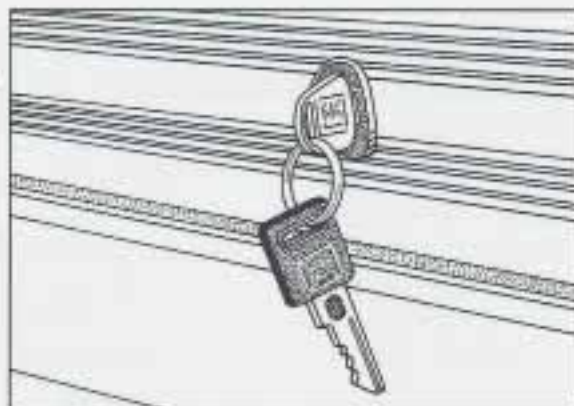

Trunk Lock

To unlock the trunk from the outside, insert the door key and turn it.

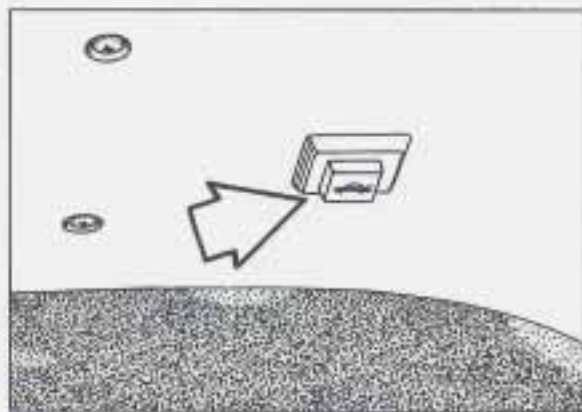

Remote Trunk Release (OPTION)

Press the yellow trunk release button located under the instrument panel on the driver's side.

Your automatic transaxle must be in **P** (Park).

Remember that your trunk can be opened at any time using the lock release. Be sure to lock your doors.

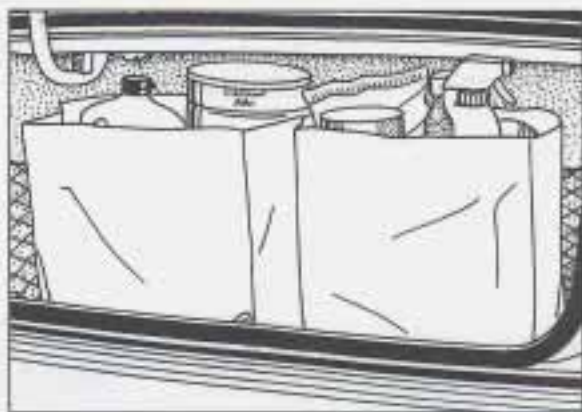

Convenience Net (OPTION)

Your vehicle may have a convenience net. You'll see it just inside the back wall of the trunk.

Put small loads, like grocery bags, behind the net. It can help keep them from falling over during sharp turns or quick starts and stops.

The net isn't for larger, heavier loads. Store them in the trunk as far forward as you can.

You can unhook the net so that it will lie flat when you're not using it.



CAUTION:

It can be dangerous to drive with the trunk lid open because carbon monoxide (CO) gas can come into your vehicle. You can't see or smell CO. It can cause unconsciousness and even death. If you must drive with the trunk lid open or if electrical wiring or other cable connections must pass through the seal between the body and the trunk lid:

- Make sure all windows are shut.
- Turn the fan on your heating or cooling system to its highest speed with the setting on **VENT** or **NORM** or **UPPER**. That will force outside air into your vehicle. See *Comfort Controls* in the *Index*.

See *Engine Exhaust* in the *Index*.

Features & Controls

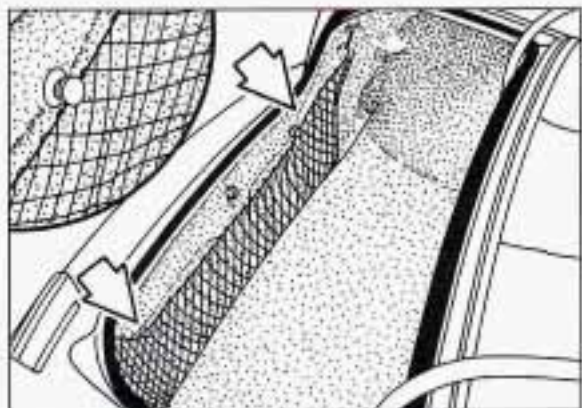

4-Door Models:

To allow easier access to the trunk area when the convenience net is not being used, push the net down and hook it under the retaining screws as shown.

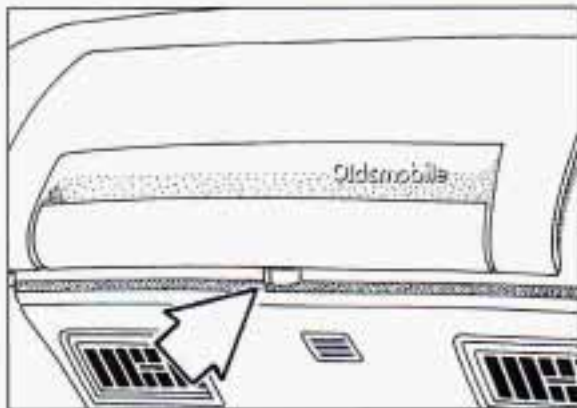

Glove Box

To open, turn the knob clockwise. Push the lid down to close.

■ New Vehicle "Break-In"

NOTICE:

Your modern Oldsmobile doesn't need an elaborate "break-in." But it will perform better in the long run if you follow these guidelines:

- Don't drive at any one speed — fast or slow — for the first 500 miles (804 km). Don't make full-throttle starts.
- Avoid making hard stops for the first 200 miles (322 km) or so. During this time your new brake linings aren't yet broken in. Hard stops with new linings can mean premature wear and earlier replacement. Follow this "breaking-in" guideline every time you get new brake linings.

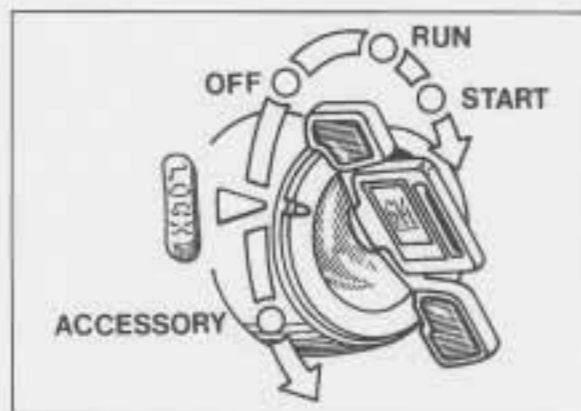

■ Ignition Switch

NOTICE:

If your key seems stuck in **Lock** and you can't turn it, be sure it is all the way in. If it is, then turn the steering wheel left and right while you turn the key hard. But turn the key only with your hand. Using a tool to force it could break the key or the ignition switch. If none of this works, then your vehicle needs service.

With the ignition key in the ignition switch, you can turn the switch to five positions:

Accessory: An "on" position in which you can operate your radio and

windshield wipers. Press in the ignition switch as you turn the top of it toward you.

Lock: The only position in which you can remove the key. This locks your steering wheel, ignition and transaxle.

Off: Unlocks the steering wheel, ignition, and transaxle, but does not send electrical power to any accessories. Use this position if your vehicle must be pushed or towed, but never try to push-start your vehicle.

Run: An "on" position to which the switch returns after you start your engine and release the switch. The switch stays in the **Run** position when the engine is running. But even when the engine is not running, you can use **Run** to operate your electrical power accessories, and to display some instrument panel warning lights.

Start: Starts the engine. When the engine starts, release the key. The ignition switch will return to **Run** for normal driving.

Note that even if the engine is not running, the positions **Accessory** and **Run** are "on" positions that allow you

to operate your electrical accessories, such as the radio.

■ Starting Your Engine

Engines start differently. The 8th digit of your Vehicle Identification Number (VIN) shows the code letter or number for your engine. You will find the VIN at the top left of your instrument panel. (See *Vehicle Identification Number in the Index*.) Follow the proper steps to start the engine.

Move your shift lever to **P** (Park) or **N** (Neutral). Your engine won't start in any other position — that's a safety feature. To restart when you're already moving, use **N** (Neutral) only.

NOTICE:

Don't try to shift to **P** (Park) if your Oldsmobile is moving. If you do, you could damage the transaxle. Shift to **P** (Park) only when your vehicle is stopped.

Features & Controls

To start your engine:

1. Without pushing the accelerator pedal, turn your ignition key to **Start**. When the engine starts, let go of the key. The idle speed will go down as your engine gets warm.

NOTICE:

Holding your key in **Start** for longer than 15 seconds at a time will cause your battery to be drained much sooner. And the excessive heat can damage your starter motor.

2. If your engine won't start (or starts but then stops), it could be flooded with too much gasoline. Try pushing your accelerator pedal all the way to the floor and holding it there as you hold the key in **Start** for about three seconds. If the vehicle starts briefly but then stops again, do the same thing, but this time keep the pedal down for five or six seconds. This clears the extra gasoline from the engine.

NOTICE:

Your engine is designed to work with the electronics in your vehicle. If you add electrical parts or accessories, you could change the way the fuel injection system operates. Before adding electrical equipment, check with your dealer. If you don't, your engine might not perform properly. If you ever have to have your vehicle towed, see the part of this manual that tells how to do it without damaging your vehicle. See *Towing Your Vehicle* in the *Index*.

■ *Driving Through Deep Standing Water*

NOTICE:

If you drive too quickly through deep puddles or standing water, water can come in through your engine's air intake and badly damage your engine. If you can't avoid deep puddles or standing water, drive through them very slowly.

■ *Engine Coolant Heater* *(Engine Block Heater)* (OPTION)

In very cold weather, 0°F (-18°C) or colder, the engine coolant heater can help. You'll get easier starting and better fuel economy during engine warm-up. Usually, the coolant heater should be plugged in a minimum of four hours prior to starting your vehicle.

To use the coolant heater:

1. Turn off the engine.
2. Open the hood and unwrap the electrical cord.
3. Plug it into a normal, grounded 110-volt outlet.



CAUTION:

Plugging the cord into an ungrounded outlet could cause an electrical shock. Also, the wrong kind of extension cord could overheat and cause a fire. You could be seriously injured. Plug the cord into a properly grounded three-prong 110-volt outlet. If the cord won't reach, use a heavy-duty three-prong extension cord rated for at least 15 amps.

NOTICE:

After you've used the coolant heater, be sure to store the cord as it was before to keep it away from moving engine parts. If you don't, it could be damaged.

How long should you keep the coolant heater plugged in? The answer depends on the weather, the kind of oil you have, and some other things. Instead of trying to list everything here, we ask that you contact an Oldsmobile dealer in the area where you'll be parking your vehicle. The dealer can give you the best advice for that particular area.

Features & Controls

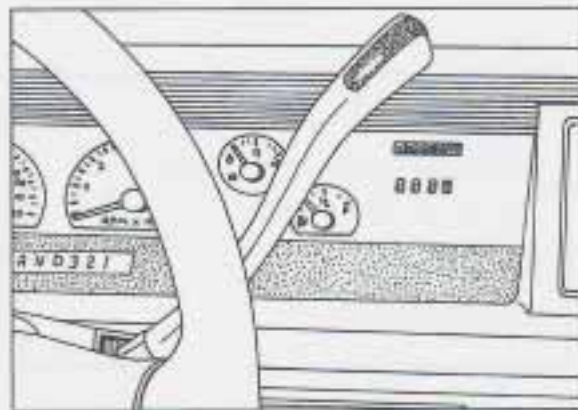

■ Automatic Transaxle

Your automatic transaxle may have a shift lever located on the steering column or on the console between the seats. Both are shown above.

Maximum engine speed is limited on automatic transaxle vehicles when you're in **D** (Overdrive) or **N** (Neutral), to protect driveline components from improper operation.

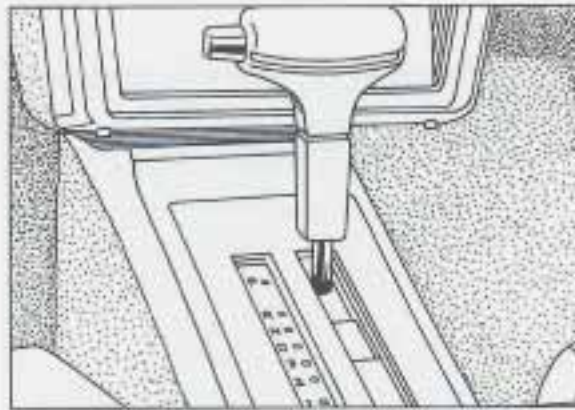

There are seven shift positions. In this manual, these are referred to by the commonly used symbols in the right column below:

Park	P
Reverse	R
Neutral	N
Overdrive	D
Third	3
Second	2
First	1

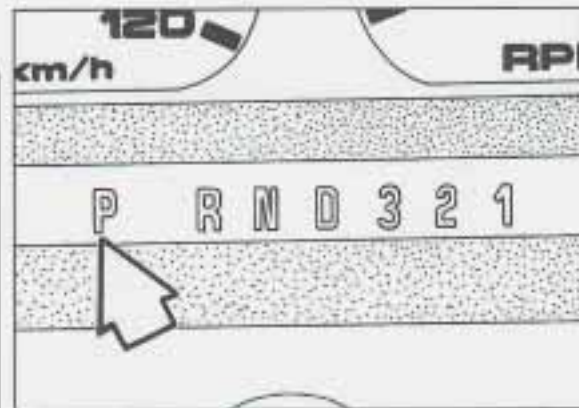

Park

P (Park): This locks your front wheels. It's the best position to use when you start your engine because your vehicle can't move easily.



CAUTION:

It is dangerous to get out of your vehicle if the shift lever is not fully in **P** (Park) with the parking brake firmly set. Your vehicle can roll. Don't leave your vehicle when the engine is running unless you have to. If you have left the engine running, the vehicle can move suddenly. You or others could be

CAUTION (Continued)

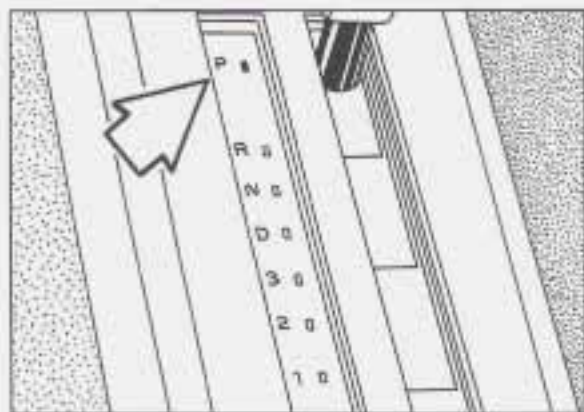

CAUTION (Continued)

injured. To be sure your vehicle won't move, even when you're on fairly level ground, always set your parking brake and move the shift lever to **P** (Park).

See *Shifting Into P (Park)* in the *Index*. If you're pulling a trailer, see *Towing a Trailer* in the *Index*.

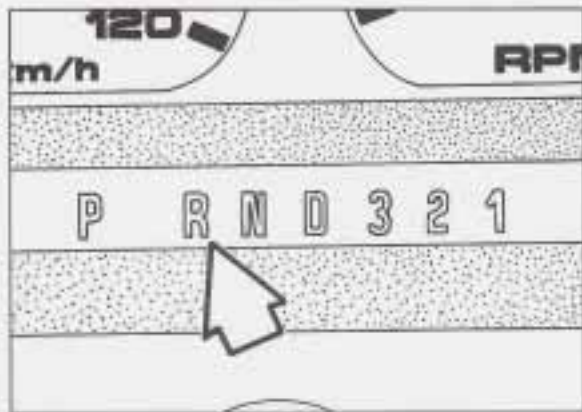

Reverse

R (Reverse): Use this gear to back up.

NOTICE:

Shifting to **R** (Reverse) while your vehicle is moving forward could damage your transaxle. Shift to **R** only after your vehicle is stopped.

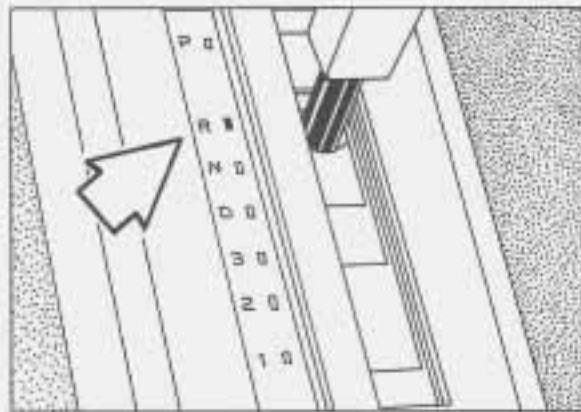

To rock your vehicle back and forth to get out of snow, ice or sand without damaging your transaxle, see the *Index* under *If You're Stuck: In Sand, Mud, Ice or Snow*.

Features & Controls

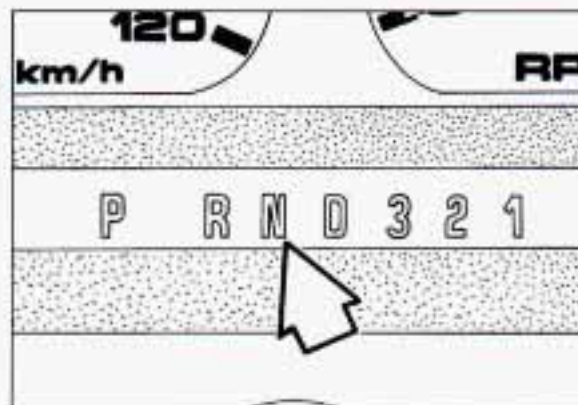

Neutral

N (Neutral): In this position, your engine doesn't connect with the wheels. To restart when you're already moving, use **N (Neutral)** only. Also, use **N (Neutral)** when your vehicle is being towed.

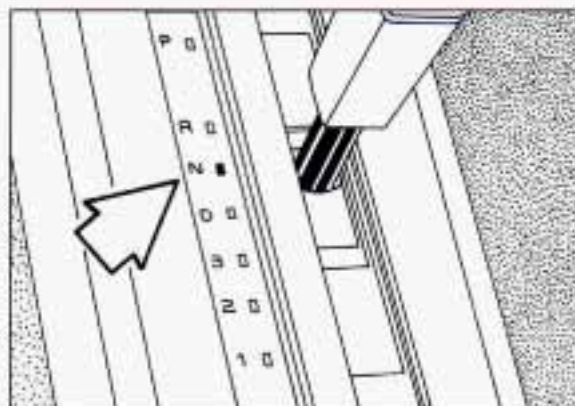

CAUTION:

Shifting out of **P (Park)** or **N (Neutral)** while your engine is "racing" (running at high speed) is dangerous. Unless your foot is firmly on the brake pedal, your vehicle could move very rapidly. You could lose control and hit people or objects. Don't shift out of **P (Park)** or **N (Neutral)** while your engine is racing.

NOTICE:

Damage to your transaxle caused by shifting out of **P (Park)** or **N (Neutral)** with the engine racing isn't covered by your warranty.

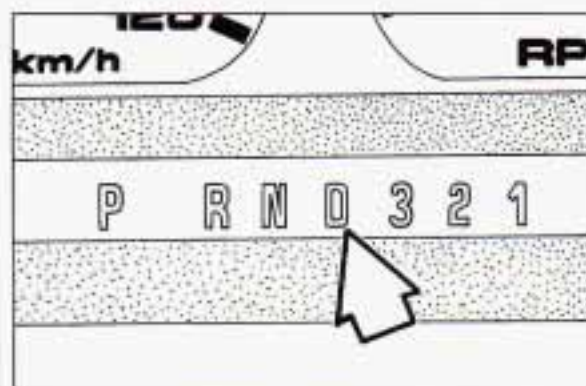

Forward Gears

D (Automatic Overdrive): This position is for normal driving. If you need more power for passing, and you're:

- Going less than 35 mph (56 km/h), push your accelerator pedal about halfway down.
- Going about 35 mph (56 km/h) or more, push the accelerator all the way down. You'll shift down to the next gear and have more power.

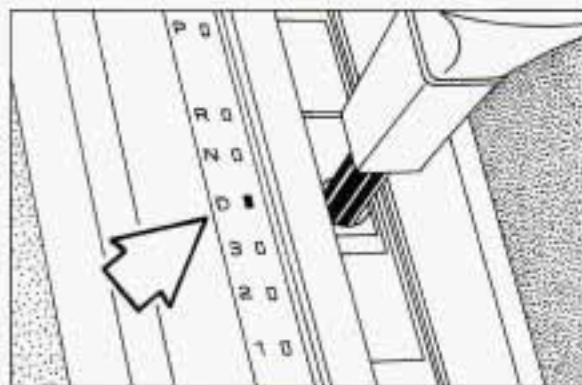

NOTICE:

If your vehicle seems to start up rather slowly, or if it seems not to shift gears as you go faster, something may be wrong with a transaxle system sensor. If you drive very far that way, your vehicle can be damaged. So, if this happens, have your vehicle serviced right away. Until then, you can use **2 (Second Gear)** when you are driving less than 35 mph (56 km/h) and **D (Overdrive)** for higher speeds.

3 (Third Gear): 3 is like **D**, but you never go into Overdrive.

Here are some times you might choose **3** instead of **D**:

- When driving on hilly, winding roads.
- When towing a trailer, so there is less shifting between gears.
- When going down a steep hill.

2 (Second Gear): This position gives you more power but lower fuel economy. You can use **2** on hills. It can help control your speed as you go down steep mountain roads, but then you would also want to use your brakes off and on.

Features & Controls

NOTICE:

Don't drive in 2 (Second Gear) for more than 5 miles (8 km), or at speeds over 55 mph (88 km/h), or you can damage your transaxle. Use **D** or **3** as much as possible.

Don't shift into 2 unless you are going slower than 65 mph (105 km/h), or you can damage your engine.

1 (First Gear): This position gives you even more power (but lower fuel economy) than 2. You can use it on very steep hills, or in deep snow or mud. If the shift lever is put in 1, the transaxle won't shift into first gear until the vehicle is going slowly enough.

NOTICE:

If your front wheels can't rotate, don't try to drive. This might happen if you were stuck in very deep sand or mud or were up against a solid object. You could damage your transaxle.

Also, if you stop when going uphill, don't hold your vehicle there with only the accelerator pedal. This could overheat and damage the transaxle. Use your brakes or shift into **P** (Park) to hold your vehicle in position on a hill.

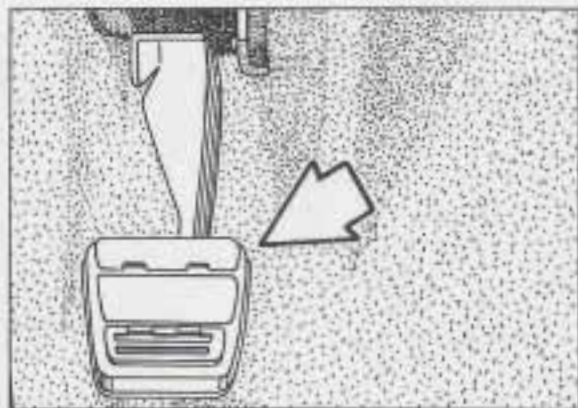

Parking Brake

The parking brake uses the brakes on the rear wheels.

To Set the Parking Brake:

Hold the regular brake pedal down with your right foot. Push down the parking brake pedal with your left foot. If the ignition is on, the brake system warning light will come on.

To Release the Parking Brake:

Push the parking brake pedal to release it.

NOTICE:

Driving with the parking brake on can cause your rear brakes to overheat. You may have to replace them, and you could also damage other parts of your vehicle.

If You are Towing a Trailer and are Parking on any Hill:

See the *Index* under *Towing a Trailer*. That section shows what to do first to keep the trailer from moving.

■ *Shifting Into P (Park)*



CAUTION:

It can be dangerous to get out of your vehicle if the shift lever is not fully in **P (Park)** with the parking brake firmly set. Your vehicle can roll. If you have left the engine running, the vehicle can move suddenly. You or others could be injured. To be sure your vehicle won't move, even when you're on fairly level ground, use the steps that follow. If you're pulling a trailer, see *Towing a Trailer* in the *Index*.

Column Shift

1. Hold the brake pedal down with your right foot and set the parking brake.

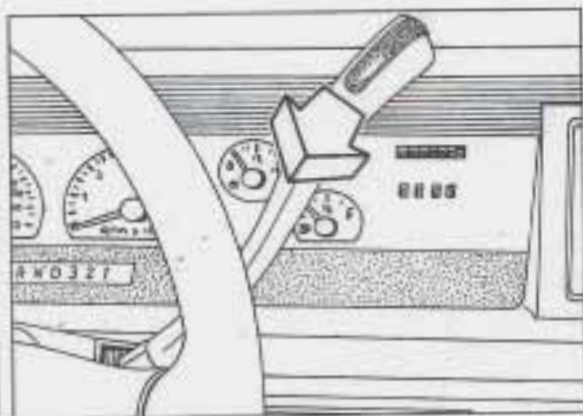

2. Move the shift lever into **P (Park)** position like this:

- Pull the lever towards you.

Features & Controls

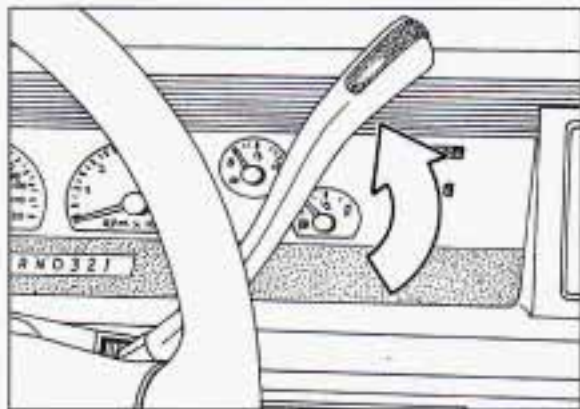

- Move the lever up as far as it will go.
3. Move the ignition key to **Lock**.
 4. Remove the key and take it with you. If you can walk away from your vehicle with the ignition key in your hand, your vehicle is in **P** (Park).

Console Shift

1. Hold the brake pedal down with your right foot and set the parking brake.

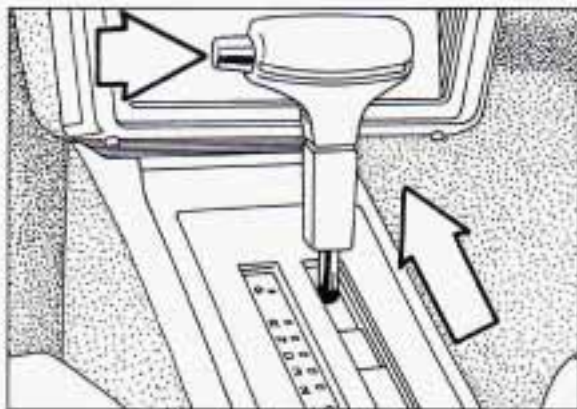

2. Move the shift lever into the **P** (Park) position like this:
 - Hold in the button on the lever.
 - Push the lever all the way toward the front of your vehicle.
3. Move the ignition key to **Lock**.
4. Remove the key and take it with you. If you can walk away from your vehicle with the ignition key in your hand, your vehicle is in **P** (Park).

Leaving Your Vehicle With the Engine Running

CAUTION:

It can be dangerous to leave your vehicle with the engine running. Your vehicle could move suddenly if the shift lever is not fully in **P** (Park) with the parking brake firmly set. And, if you leave the vehicle with the engine running, it could overheat and even catch fire. You or others could be injured. Don't leave your vehicle with the engine running unless you have to.

If you have to leave your vehicle with the engine running, be sure your vehicle is in **P** (Park) and your parking brake is firmly set before you leave it. After you've moved the shift lever into the **P** (Park) position, hold the regular brake pedal down. Then, see if you can move the shift lever away from **P** (Park) without first pulling it toward you (or, if you have the console shift lever, without first pushing the button). If you

can, it means that the shift lever wasn't fully locked into **P** (Park).

Torque Lock

If you are parking on a hill and you don't shift your transaxle into **P** (Park) properly, the weight of the vehicle may put too much force on the parking pawl in the transaxle. You may find it difficult to pull the shift lever out of **P** (Park). This is called "torque lock." To prevent torque lock, set the parking brake and then shift into **P** (Park) properly before you leave the driver's seat. To find out how, see *Shifting Into P (Park)* in the *Index*.

When you are ready to drive, move the shift lever out of **P** (Park) BEFORE you release the parking brake.

If "torque lock" does occur, you may need to have another vehicle push yours a little uphill to take some of the pressure from the transaxle, so you can pull the shift lever out of **P** (Park).



■ ***Parking Over Things That Burn***



CAUTION:

Things that can burn could touch hot exhaust parts under your vehicle and ignite. Don't park over papers, leaves, dry grass or other things that can burn.

■ ***Engine Exhaust***



CAUTION:

Engine exhaust can kill. It contains the gas carbon monoxide (CO), which you can't see or smell. It can cause unconsciousness and death. You might have exhaust coming in if:

- Your exhaust system sounds strange or different.
- Your vehicle gets rusty underneath.
- Your vehicle was damaged in a collision.
- Your vehicle was damaged when driving over high points on the road or over road debris.
- Repairs weren't done correctly.
- Your vehicle or exhaust system had been modified improperly.

CAUTION (Continued)

CAUTION (Continued)

If you ever suspect exhaust is coming into your vehicle:

- Drive it only with all the windows down to blow out any CO; and
- Have your vehicle fixed immediately.

■ Running Your Engine While You're Parked

It's better not to park with the engine running. But if you ever have to, here are some things to know.



CAUTION:

Idling the engine with the air system control off could allow dangerous exhaust into your vehicle. (See the earlier caution under *Engine Exhaust*.) Also, idling in a closed-in place can let deadly carbon monoxide (CO) into your vehicle even if the fan switch is at the highest setting. One place this can happen is a garage. Exhaust — with CO — can come in easily. NEVER park in a garage with the engine running.

Another closed-in place can be a blizzard. (See *Blizzard* in the *Index*.)



CAUTION:

It can be dangerous to get out of your vehicle if the shift lever is not fully in **P** (Park) with the parking brake firmly set. Your vehicle can roll. Don't leave your vehicle when the engine is running unless you have to. If you've left the engine running, the vehicle can move suddenly. You or others could be injured. To be sure your vehicle won't move, even when you're on fairly level ground, always set your parking brake and move the shift lever to **P** (Park).

Follow the proper steps to be sure your vehicle won't move. See *Shifting Into P (Park)* in the *Index*.

If you are parking on a hill and if you're pulling a trailer, also see *Towing a Trailer* in the *Index*.

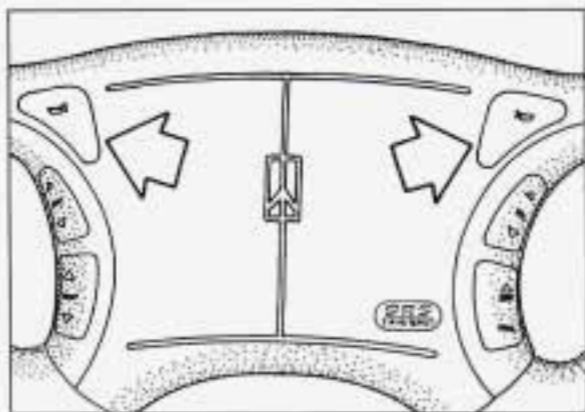

Horn

You can sound the horn by pressing the horn symbols on your steering wheel.

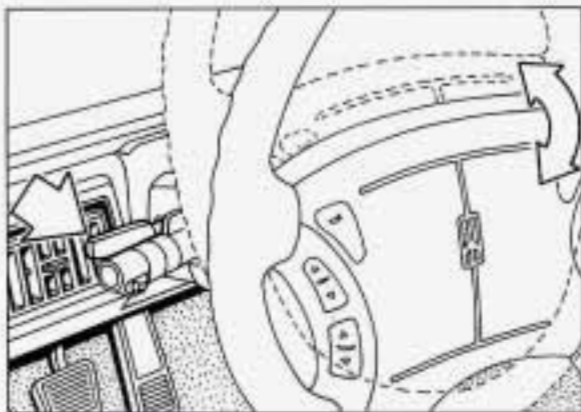

Tilt Steering Wheel

A tilt steering wheel allows you to adjust the steering wheel before you drive.

You can also raise it to the highest level to give your legs more room when you exit and enter the vehicle.

To tilt the wheel, hold the steering wheel and pull the lever. Move the steering wheel to a comfortable level, then release the lever to lock the wheel in place.

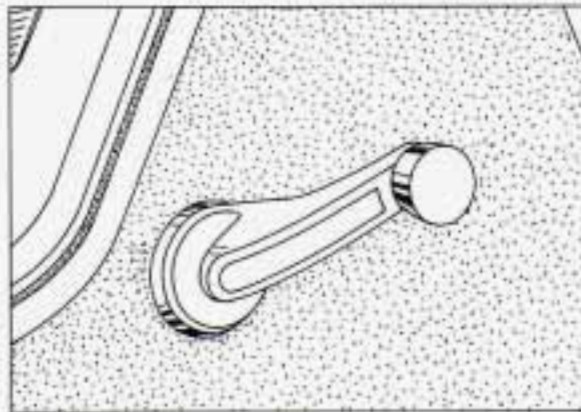

Windows

On a vehicle with manual windows, use the window crank to open and close each window.

Features & Controls

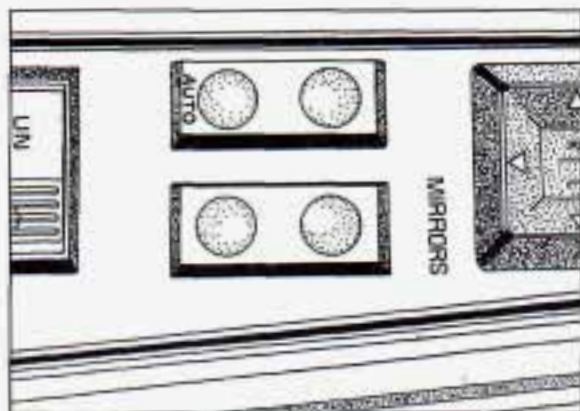

Power Windows (OPTION)

With power windows, switches on the driver's armrest control each of the windows when the ignition is on. In addition, each passenger door has a control switch for its own window.

The driver's window switch has a Power Auto Down feature. This switch is labeled **AUTO**. The driver's window can be opened a small amount by tapping the rear of the switch. If the rear of the switch is pressed down firmly, the window will go all the way down.

To stop the window while it is lowering, press the front of the **AUTO** switch, then release. To raise the window, press and hold the front of the **AUTO** switch.

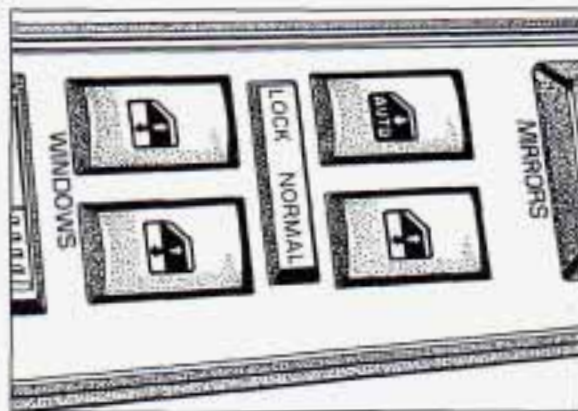

Passenger Lockout Switch

On 4-door models, this switch disables all passenger power windows. Push the switch to **LOCK** to disable the window switches on all doors except the driver's. Push the switch to **NORMAL** for normal power window operation.

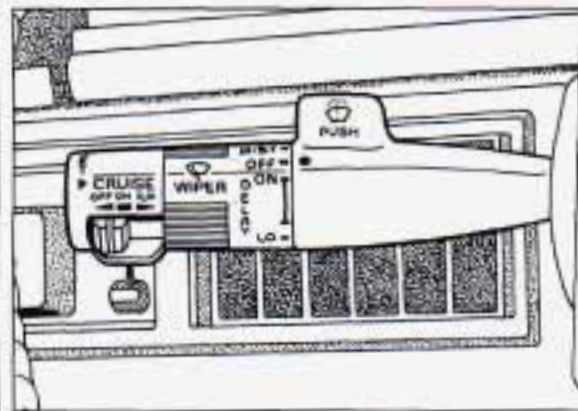

■ Turn Signal/Multifunction Lever

The lever on the left side of the steering column includes your:

- Turn Signal and Lane Change Indicator
- Cruise Control (Option)
- Windshield Wipers
- Windshield Washer
- Headlight High-Low Beam
- Flash-to-Pass

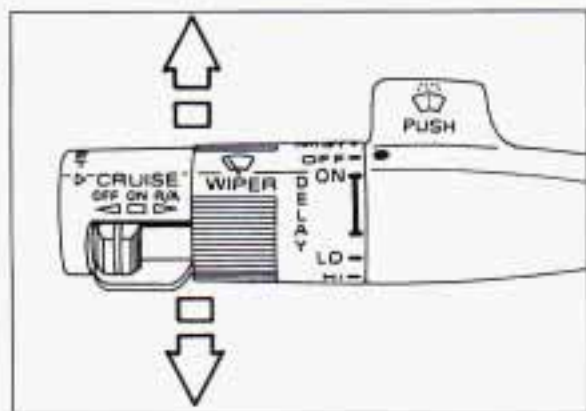

Turn Signal and Lane Change Indicator

The turn signal has two upward (for Right) and two downward (for Left) positions. These positions allow you to signal a turn or a lane change.

To Signal a Turn:

Move the lever all the way up or down. When the turn is finished, the lever will return automatically.

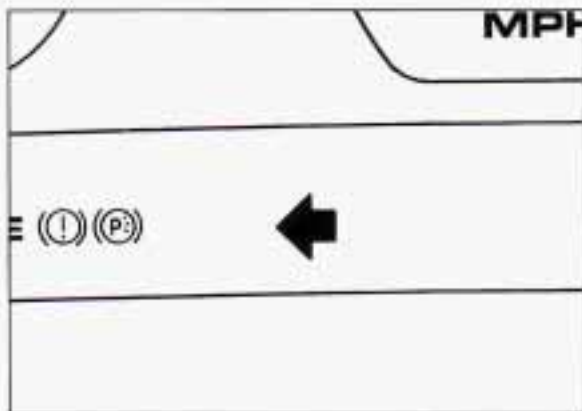

A green arrow on the instrument panel will flash in the direction of the turn or lane change.

To signal a lane change, just raise or lower the lever until the green arrow starts to flash. Hold it there until you complete your lane change. The lever will return by itself when you release it.

As you signal a turn or a lane change, if the arrows don't flash but just stay on, a signal bulb may be burned out and other drivers won't see your turn signal.

If a bulb is burned out, replace it to help avoid an accident. If the green arrows don't go on at all when you signal a turn, check the fuse (see the *Index* under *Fuses & Circuit Breakers*) and for burned-out bulbs.

A warning chime will remind you if you have left your turn signal on for more than $\frac{1}{2}$ mile (.8 km) of driving.

Features & Controls

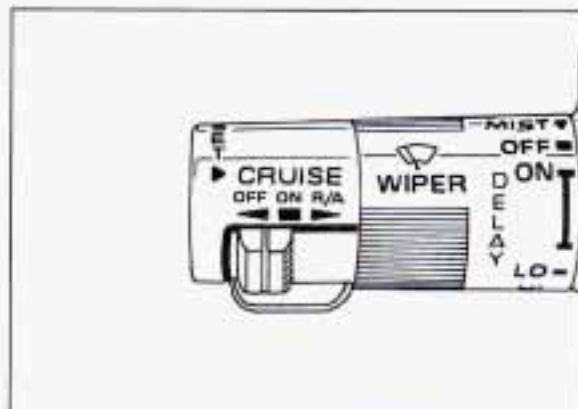

■ Cruise Control (OPTION)

With cruise control, you can maintain a speed of about 25 mph (40 km/h) or more without keeping your foot on the accelerator. This can really help on long trips.

Cruise control does not work at speeds below about 25 mph (40 km/h).

When you apply your brakes, the cruise control shuts off.

To Set Cruise Control

1. Move the cruise control switch to **ON**.



CAUTION:

- Cruise Control can be dangerous where you can't drive safely at a steady speed. So, don't use your Cruise Control on winding roads or in heavy traffic.
- Cruise Control can be dangerous on slippery roads. On such roads, fast changes in tire traction can cause needless wheel spinning, and you could lose control. Don't use Cruise Control on slippery roads.

2. Get up to the speed you want.

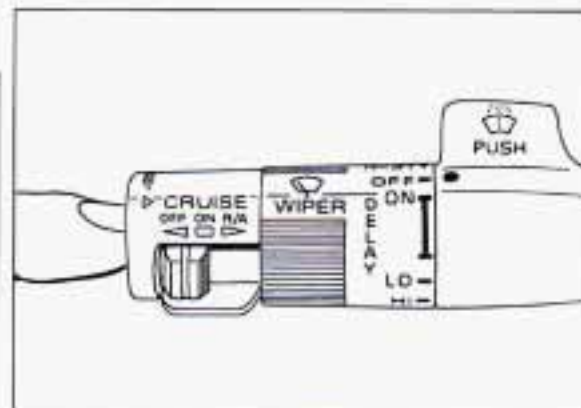

3. Push in the **SET** button at the end of the lever and release it.
4. Take your foot off the accelerator pedal.



CAUTION:

If you leave your Cruise Control switch on when you're not using Cruise, you might hit a button and go into Cruise when you don't want to. You could be startled and even lose control. Keep the Cruise Control switch **OFF** until you want to use it.

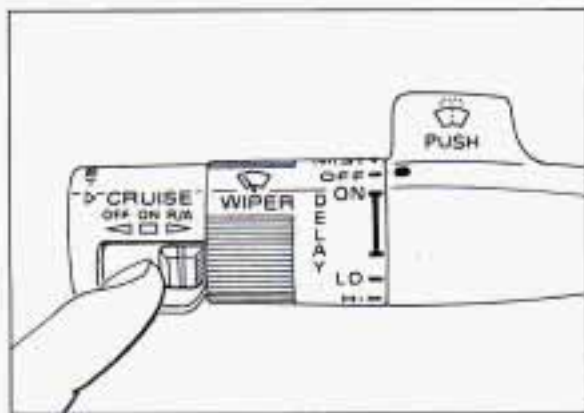

To Resume a Set Speed

Suppose you set your cruise control at a desired speed with the **SET** button and then you apply the brake. This, of course, shuts off the cruise control. But you don't need to reset it. Once you're going about 25 mph (40 km/h) or more, you can move the cruise control switch from **ON** to **R/A** (which stands for Resume/Accelerate) for about half a second.

You'll go right back up to your chosen speed and stay there.

If you shift into **P** (Park) after you set a cruise control speed, you'll erase the system's memory. Moving the switch to **R/A** won't restore the speed you set.

To Increase Speed While Using Cruise Control

There are two ways to go to a higher speed. Here's the first:

1. Use the accelerator pedal to get to the higher speed.
2. Push the button at the end of the lever, then release the button and the accelerator pedal.

You'll now cruise at the higher speed.

Here's the second way to go to a higher speed:

1. Move the cruise switch from **ON** to **R/A**.
Hold it there until you get up to the speed you want, and then release the switch.
2. To increase your speed in very small amounts, move the switch to **R/A** for less than half a second and then release it. Each time you do this, your vehicle will go about 1 mph (1.6 km/h) faster.

The accelerate feature will only work after you turn on the cruise control by pushing the **SET** button.

To Reduce Speed While Using Cruise Control

There are two ways to reduce your speed while using cruise control:

- Push in the button at the end of the lever until you reach the lower speed you want, then release it.
- To slow down in very small amounts, push the button for less than half a second. Each time you do this, you'll go 1 mph (1.6 km/h) slower.

Passing Another Vehicle While Using Cruise Control

Use the accelerator pedal to increase your speed. When you take your foot off the pedal, your vehicle will slow down to the cruise control speed you set earlier.

Using Cruise Control on Hills

How well your cruise control will work on hills depends upon your speed, load, and the steepness of the hills. When going up steep hills, you may have to step on the accelerator pedal to maintain your speed. When going downhill, you may have to brake or shift to a lower gear to keep your speed

Features & Controls

down. Of course, applying the brake takes you out of cruise control. Many drivers find this to be too much trouble and don't use cruise control on steep hills.

To Get Out of Cruise Control

There are two ways to turn off the cruise control:

- Step lightly on the brake pedal; OR
- Move the cruise switch to **OFF**.

To Erase Cruise Speed Memory

When you turn off the cruise control or the ignition, or shift into **P** (Park), your cruise control set speed memory is erased.

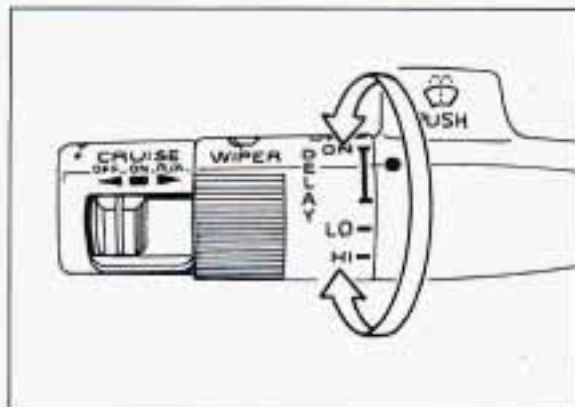

Pulse Windshield Wipers

You control the windshield wipers by turning the band marked **WIPER**.

For a single wiping cycle, turn the band to **MIST**. Hold it there until the wipers start, then let go. The wipers will stop after one cycle. If you want more cycles, hold the band on **MIST** longer.

For steady wiping at low speed, turn the band away from you to the **LO** position. For high speed wiping, turn the band further, to **HI**. To stop the wipers, move the band to **OFF**.

Remember that damaged wiper blades may prevent you from seeing well enough to drive safely. To avoid damage, be sure to clear ice and snow from the wiper blades before using

them. If they're frozen to the windshield, carefully loosen or thaw them. If your blades do become damaged, get new blades or blade inserts.

Heavy snow or ice can overload your wipers. A circuit breaker will stop them until the motor cools. Clear away snow or ice to prevent an overload.

You can set the wiper speed for a long or short delay between wipes. This can be very useful in light rain or snow. Turn the band to choose the delay time. The closer to **LO**, the shorter the delay.

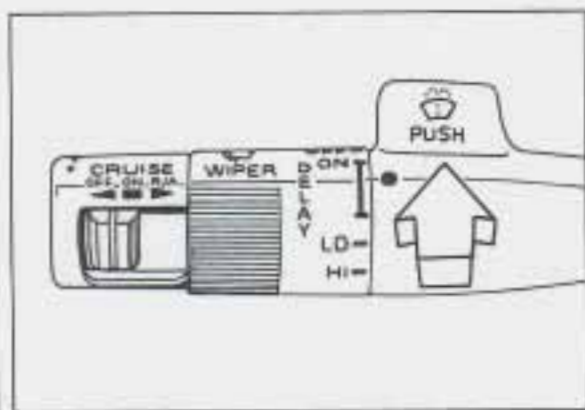

Windshield Washer

At the top of the turn signal/multifunction lever there's a paddle with the word **PUSH** on it. To spray washer fluid on the windshield, push the paddle.

If you have the standard wipers, the wipers will keep going in **LO** until you turn the wiper control to **OFF**.

If you have the Pulse option, the wipers will clear the window and then either stop or return to your preset speed.

Driving without washer fluid can be dangerous. A bad mud splash can block your vision. You could hit another vehicle or go off the road. Check your washer fluid level often.



CAUTION:

In freezing weather, don't use your washer until the windshield is warmed. Otherwise the washer fluid can form ice on the windshield, blocking your vision.

NOTICE:

- When using concentrated washer fluid, follow the manufacturer's instructions for adding water.
- Don't mix water with ready-to-use washer fluid. Water can cause the solution to freeze and damage your washer fluid tank and other parts of the washer system. Also, water doesn't clean as well as washer fluid.
- Fill your washer fluid tank only $3/4$ full when it's very cold. This allows for expansion, which could damage the tank if it is completely full.
- Don't use radiator antifreeze in your windshield washer. It can damage your washer system and paint.

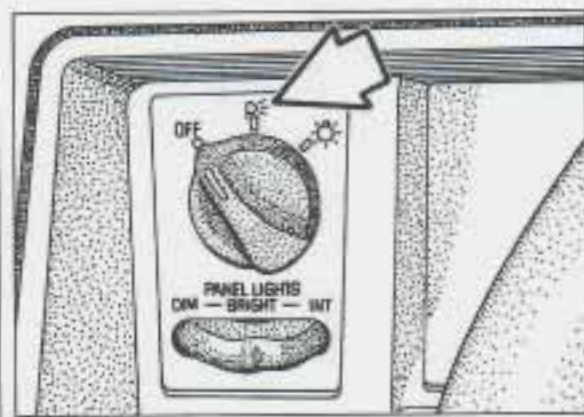

Headlights

The main light controls are on the left side of the instrument panel.

Rotate the knob to  to turn on your:

- Parking Lights
- Running Lights
- Taillights
- Instrument Panel Lights

Features & Controls

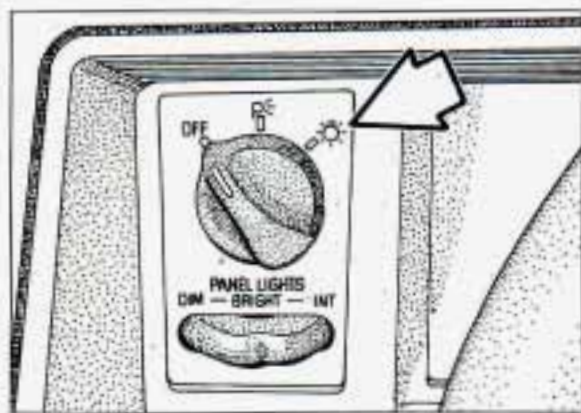

Rotate the knob to  to turn on the headlights, together with the:

- Parking Lights
- Running Lights
- Taillights
- Instrument Panel Lights

Rotate the knob to **OFF** to turn the lights off.

Operation of Lights

Although your vehicle's lighting system (headlights, parking lights, fog lamps, side marker lights and taillights) meets all applicable federal lighting requirements, certain states and provinces may apply their own lighting regulations that may require special

attention before you operate these lights.

For example, some jurisdictions may require that you operate your fog lamps only when your lower beam headlights are also on, or that headlights be turned on whenever you must use your windshield wipers. In addition, most jurisdictions prohibit driving solely with parking lights, especially at dawn or dusk. It is recommended that you check with your own state or provincial highway authority for applicable lighting regulations.

Lights On Reminder

If you open the door while leaving the lights on, you will hear a warning tone.

Daytime Running Lights (CANADA ONLY)

The Canadian Federal Government has decided that "Daytime Running Lights" (DRL) are a useful feature, in that DRL can make your vehicle more visible to pedestrians and other drivers during daylight hours. DRL are required on new vehicles sold in Canada.

Your DRL work with a light sensor on top of the instrument panel. Don't cover it up.

The low beam headlights will come on at reduced brightness in daylight when:

- The ignition is on
- The headlight switch is off, and
- The parking brake is released.

At dusk, the exterior lights will come on automatically and the low beams will change to full brightness. At dawn, the exterior lights will go out and the low beams will change to the reduced brightness of DRL (if the headlight switch is off).

Of course, you may still turn on the headlights any time you need to.

To idle your vehicle with the DRL off, set the parking brake while the ignition is in the **Off** or **Lock** position. Then start the vehicle. The DRL will stay off until you release the parking brake.



Headlight High-Low Beam Changer

To change the headlights from low beam to high or high to low, pull the turn signal/multifunction lever all the way toward you. Then release it.

When the high beams are on, a blue light on the instrument panel also will be on.

Flash-to-Pass

Flash-to-pass lets you use your high beam headlights to signal a driver in front of you that you want to pass.

To use it, pull the turn signal/multifunction lever toward you.

If Your Headlights are Off:

Your high beam headlights will turn on.

They'll stay on as long as you hold the lever there. Release the lever to turn them off.

If Your Headlights are On:

No flash-to-pass. Use the lever to change between high and low beams, as explained under *Headlight High-Low Beam Changer* earlier in this section.

If You Have Fog Lights:

They go off whenever the high beams are on. When the high beams go off, the fog lights will come on again, if the fog light switch is on.

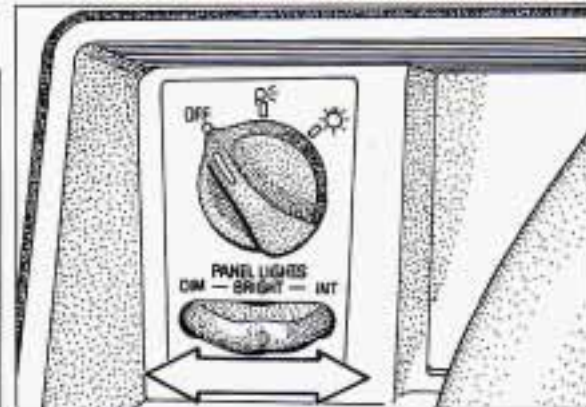

Instrument Panel Intensity Control

You can brighten or dim the instrument panel lights by rotating the control. If you rotate the control all the way to

INT your courtesy or interior lights will come on.

Features & Controls

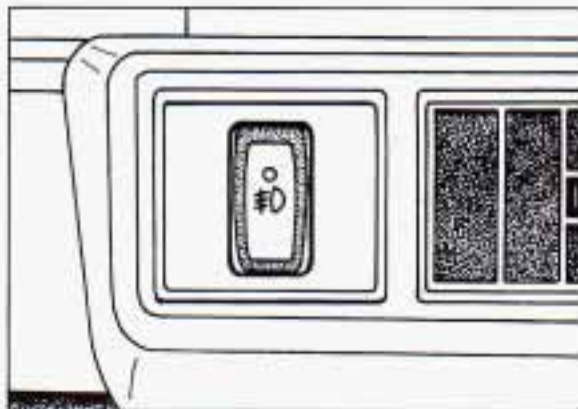

Fog Lights (OPTION)

Use your fog lights for better vision in foggy or misty conditions.

To turn fog lights on, push the switch. Push the switch again to turn the fog lights off.

When using fog lights, the parking lights or low beam headlights must be on.

The fog lights will go off whenever the high beam headlights come on. When the high beams go off, the fog lights will come on again.

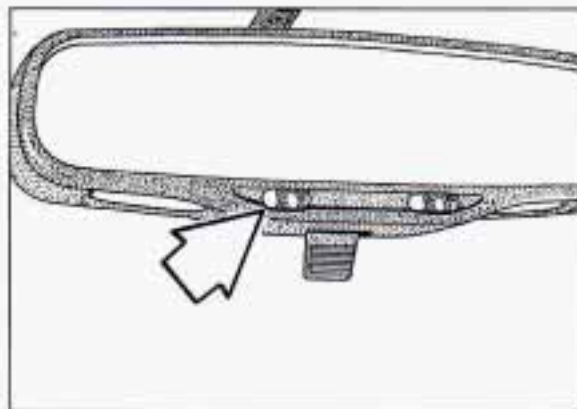

Front Reading/Map Lights

These lights are part of the rearview mirror. They go on when you open the doors. When the doors are closed, turn them on and off with the switch.

To avoid draining your vehicle battery's power, be sure to turn off all front and rear reading lights when leaving your vehicle.

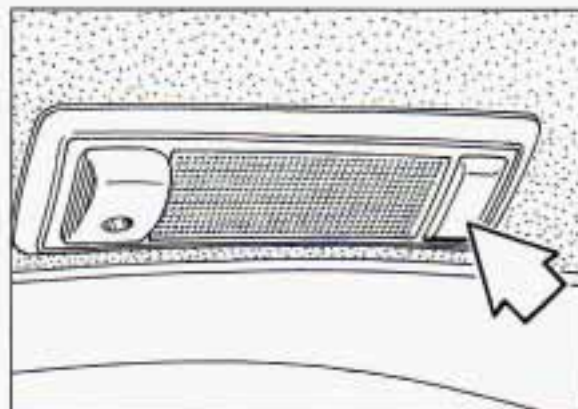

Rear Reading Lights

These lights go on when you open the doors. To turn on the reading lights when the doors are closed, push the button in. Push the button again to turn the light off.

Illuminated Entry

Your courtesy lights will come on and stay on for a predetermined time whenever you:

- Open a door.
- Press the **UNLOCK** button on the Remote Lock Control (if equipped).
- Press the power door **UNLOCK** switch.

If you open a door, the lights will stay on while it's open and then turn off

automatically about 16 seconds after you close it, or when you do any of these things:

- Turn the ignition key to **Run** or **Start**.
- Press the power door **LOCK** switch.
- Press the **DOOR** button on the Remote Lock Control (if equipped).

If you don't open a door, the lights will turn off automatically after about 16 seconds, or when you do any of the things just mentioned.

When the ignition is on, pressing the **UNLOCK** button on the Remote Lock Control or the power door **UNLOCK** switch won't activate the Illuminated Entry.

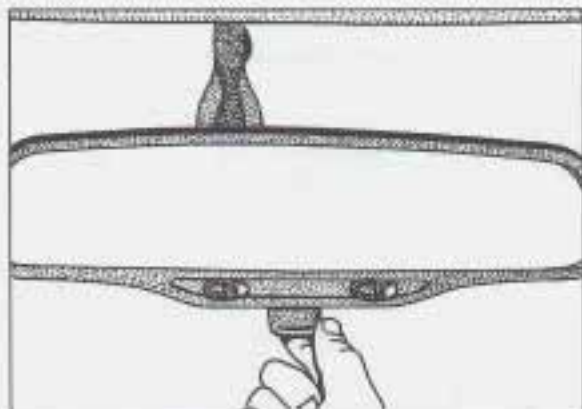

Inside Manual Day/Night Rearview Mirror

To reduce glare from lights behind you, pull the lever toward you to the night position.

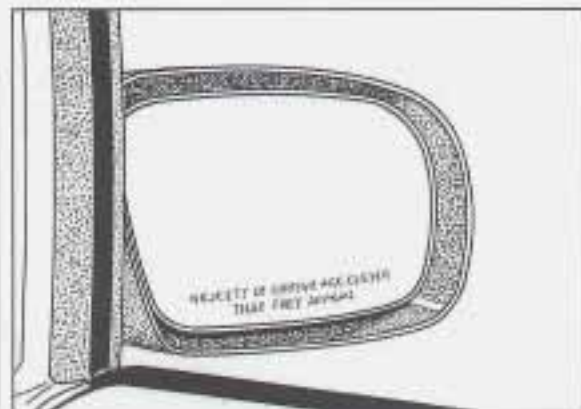

Convex Outside Mirror

Your right side mirror is convex. A convex mirror's surface is curved so you can see more from the driver's seat.



CAUTION:

If you aren't used to a convex mirror, you can hit another vehicle. A convex mirror can make things (like other vehicles) look farther away than they really are. If you cut too sharply into the right lane, you could hit a vehicle on your right. Check your inside mirror or glance over your shoulder before changing lanes.

Features & Controls

Manual Adjust Mirror

The passenger side outside mirror should be adjusted by hand so that you just see the side of your vehicle when you are sitting in a comfortable driving position.

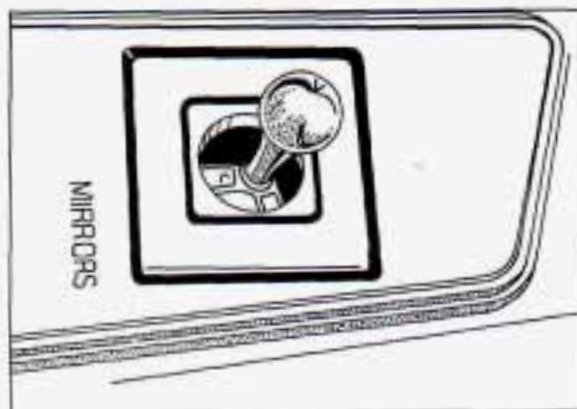

Manual Remote Control Mirror

The driver's side outside mirror can be adjusted with the control lever on the armrest so that you just see the side of your vehicle when you are sitting in a comfortable driving position.

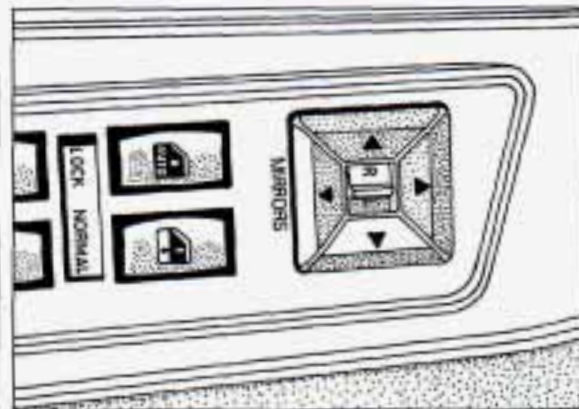

Power Remote Control Mirrors (OPTION)

A selector switch on the driver's door armrest controls both outside rearview mirrors. Move the switch to **L** to select the driver's side rearview mirror, or to **R** to select the passenger side rearview mirror. Then press the control pad to adjust each mirror so that you just see the side of your vehicle when you are sitting in a comfortable driving position. To lock the controls, leave the selector switch in the middle position.

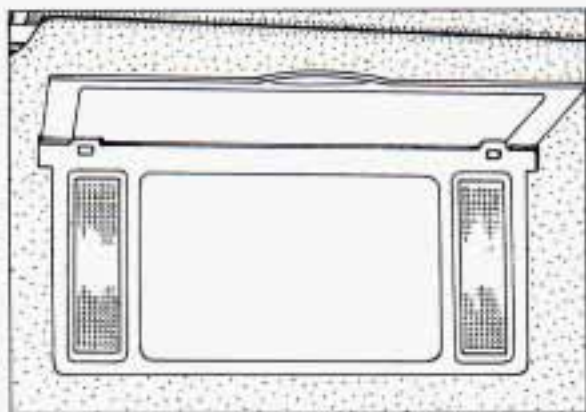

Sun Visors and Visor Vanity Mirrors

Standard Mirror: Open the cover to expose the vanity mirror.

Lighted Mirrors (Option): If your vehicle has the optional lighted vanity mirrors, the lights come on when you open the cover. These can even be used for reading.

To block out glare, you can swing down the visors. You can also remove them from the center mount and swing them to the side.

Fold-Down Storage Compartment (OPTION)

To open, fold down the armrest console, press the latch on the underside and pull up.

In addition to storage space, you will find:

- A fold-out cup holder.
- A coin holder.
- Cassette tape storage.

To close, push down on the lid.

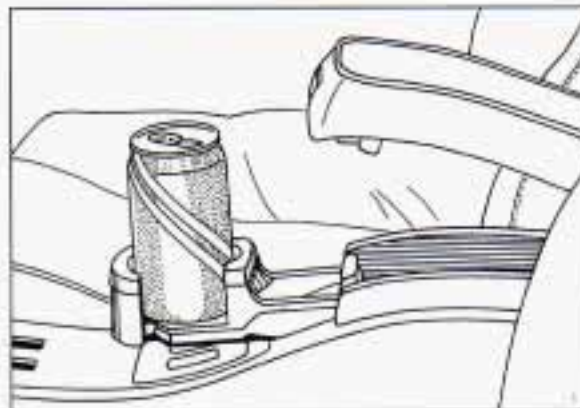

Cassette Tape Holder/Storage Compartment and Cup Holder (OPTION)

You may store cassette tapes in the slots at the bottom. To open, press the latch on the underside of the center armrest console and pull up.

To close, push down on the lid.

You also have a fold-out cup holder.

Features & Controls

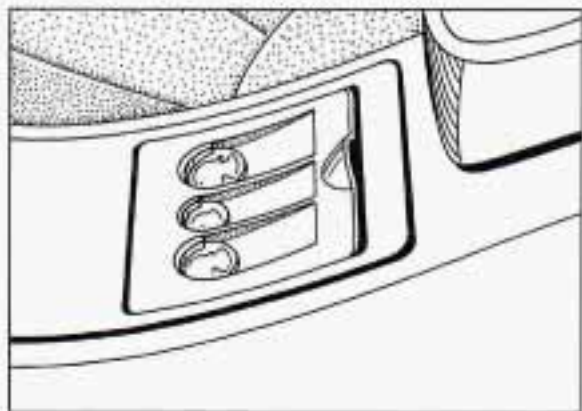

Coin Holder (OPTION)

Use your coin holder to store nickels, dimes and quarters. It lifts out for loading coins or cleaning.

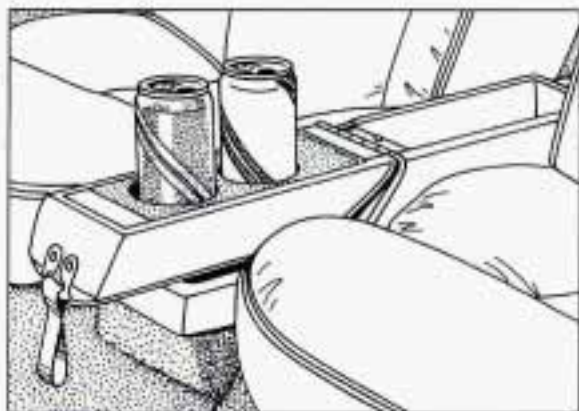

Rear Seat Console (OPTION)

To use the rear seat storage compartment and cup holders, pull the strap on the back of the console forward.

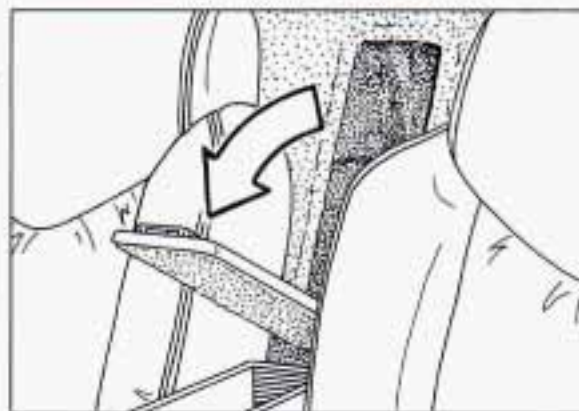

Trunk Access Panel

If you have split rear seats, you may have a trunk access panel for storing long objects like skis. Pull your rear armrest down using the strap. Then pull the latch on the trunk access panel towards you to open the panel.

To close the access panel lift the latch.

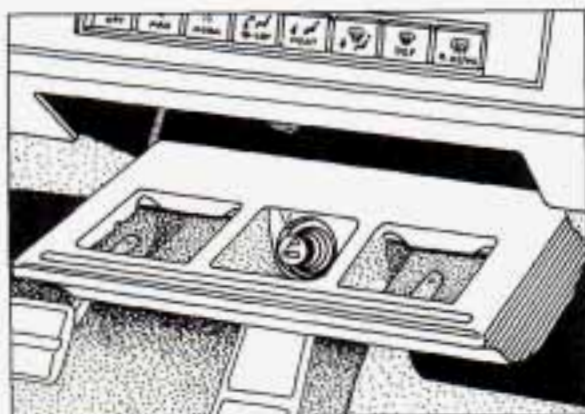

Ashtrays and Lighter

To clean the ashtrays, open them fully and lift out the ashtray by pulling on the snuffer.

To use the lighter, just push it in all the way and let go. When it's ready, it will pop back by itself.

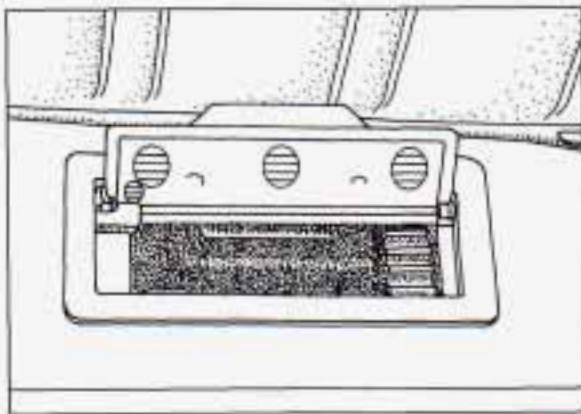

NOTICE:

Don't hold a cigarette lighter in with your hand while it is heating. If you do, it won't be able to back away from the heating element when it's ready. That can make it overheat, damaging the lighter and the heating element.

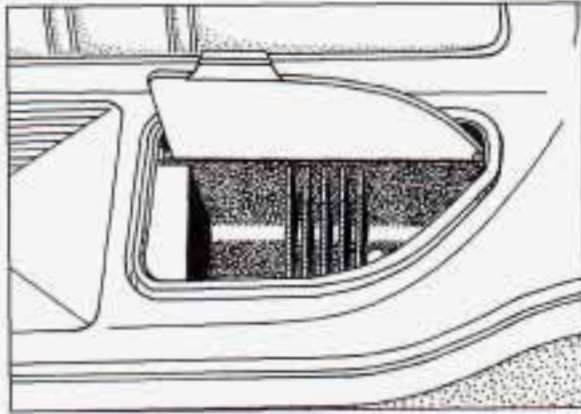

NOTICE:

Don't put papers and other things that burn into your ashtrays. If you do, cigarettes or other smoking materials could set them on fire, causing damage.

Features & Controls

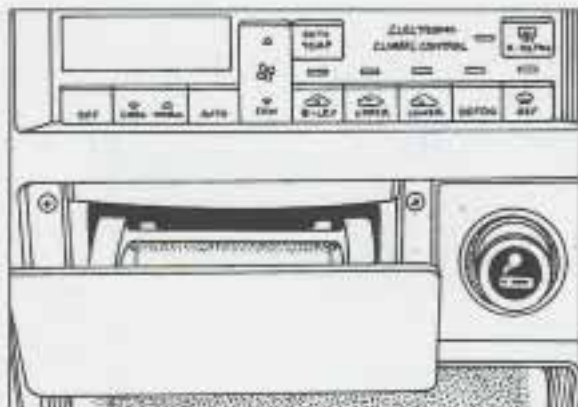

Easy-Open Ashtray

Push in on the front of the ashtray and release; it will slide open. To close, push it in again.

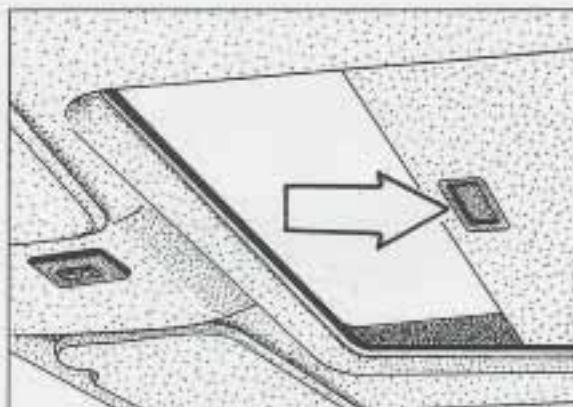

Sunroof (OPTION)

Your sunroof provides an airy, spacious feel to your vehicle's interior and can also increase ventilation. It includes a sliding glass panel and a sliding sunshade. The control switch will work only when the ignition is on.

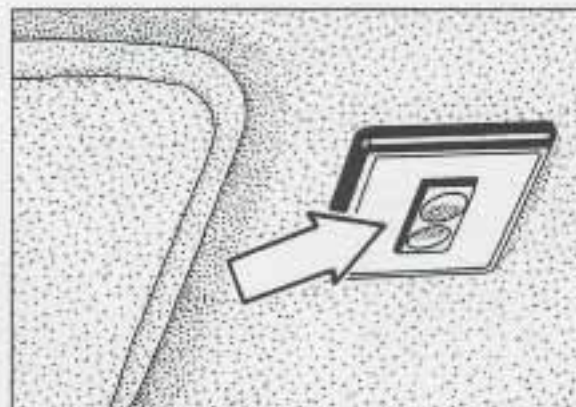

To Open the Sunroof:

Press the rear of the switch to open the glass panel and sunshade. Let go of the switch to stop the panel in any position.

To Close the Sunroof:

Press the front of the switch to close the glass panel. The sunshade can only be closed by hand.

The sunroof glass panel cannot be opened or closed if your Oldsmobile has an electrical failure.

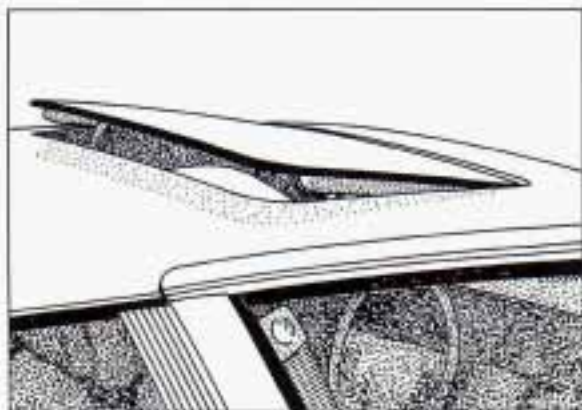

To Open the Sunroof Rear Vent:

Press the front of the switch when the sunroof is closed. Open the sunshade by hand.

To Close the Sunroof Rear Vent:

Press the rear of the switch.

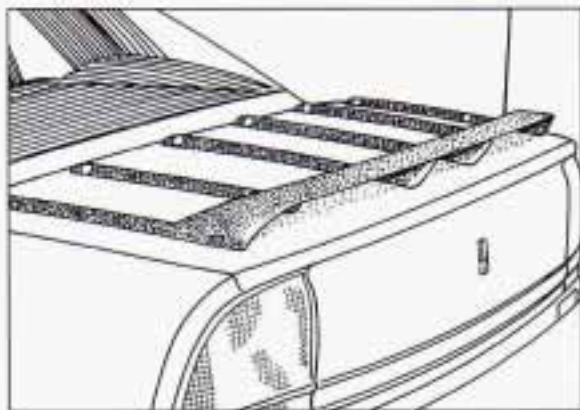

Luggage Carrier (OPTION)

If you have the optional luggage carrier, you can load things on the deck lid of your vehicle.

The luggage carrier has slats attached to the deck lid, a rear rail, and tiedowns.

NOTICE:

Loading cargo that weighs more than 50 pounds (23 kg) on the luggage carrier may damage your vehicle. When you carry large things, never let them hang over the rear or the sides of your vehicle. Load your cargo so that it rests on the slats and does not scratch or damage the vehicle. Put the cargo against the rear rail and fasten it securely to the luggage carrier.

Don't exceed the maximum vehicle capacity when loading your Oldsmobile. For more information on vehicle capacity and loading, see the *Index* under *Loading Your Vehicle*.

To prevent damage or loss of cargo as you're driving, check now and then to make sure the luggage carrier and cargo are still securely fastened.

Features & Controls

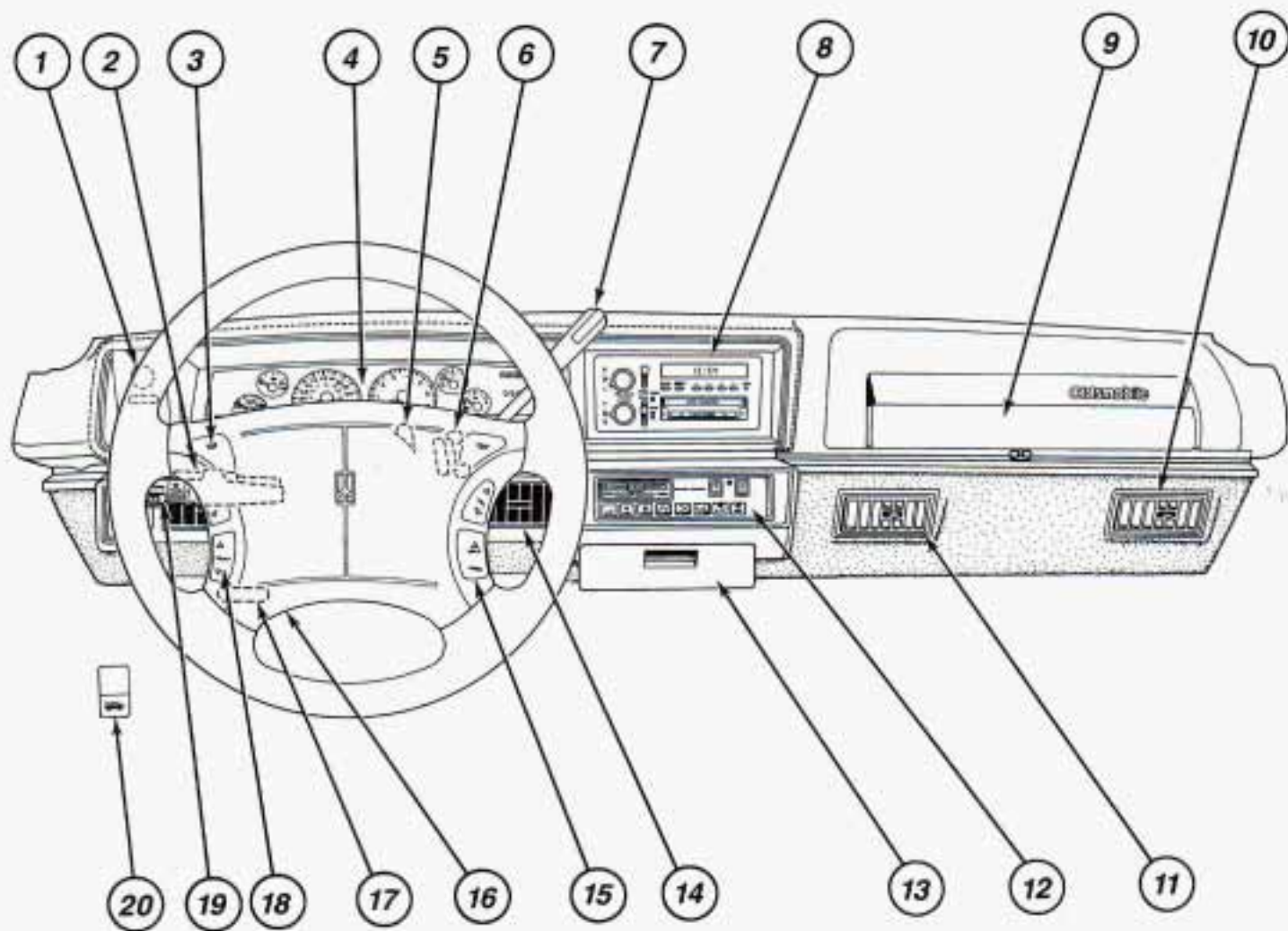

The Instrument Panel— Your Information System

Your instrument panel is designed to let you know at a glance how your vehicle is running. You'll know how fast you're going, how much fuel you're using, and many other things you'll need to drive safely and economically.

The main components of your instrument panel are:

1. Light Controls
2. Tilt Steering Wheel Lever
3. Horn
4. Instrument Cluster
5. Hazard Warning Flashers Switch
6. Ignition Switch
7. Gearshift Lever
8. Audio System
9. Glove Box/Fuse Panel
10. Vents
11. Vents
12. Climate Control/Rear Window Defogger
13. Ashtray and Lighter
14. Vents
15. Audio System Steering Wheel Touch Controls
16. Remote Trunk Release (Option)
17. Parking Brake
18. Climate Control Steering Wheel Touch Controls
19. Turn Signal/Multifunction Lever
20. Hood Release (on floor by driver's door)

Features & Controls

Instrument Panel Cluster

Your Oldsmobile is equipped with an instrument panel cluster that includes indicator warning lights and gages that are explained on the following pages. Be sure to read about these.

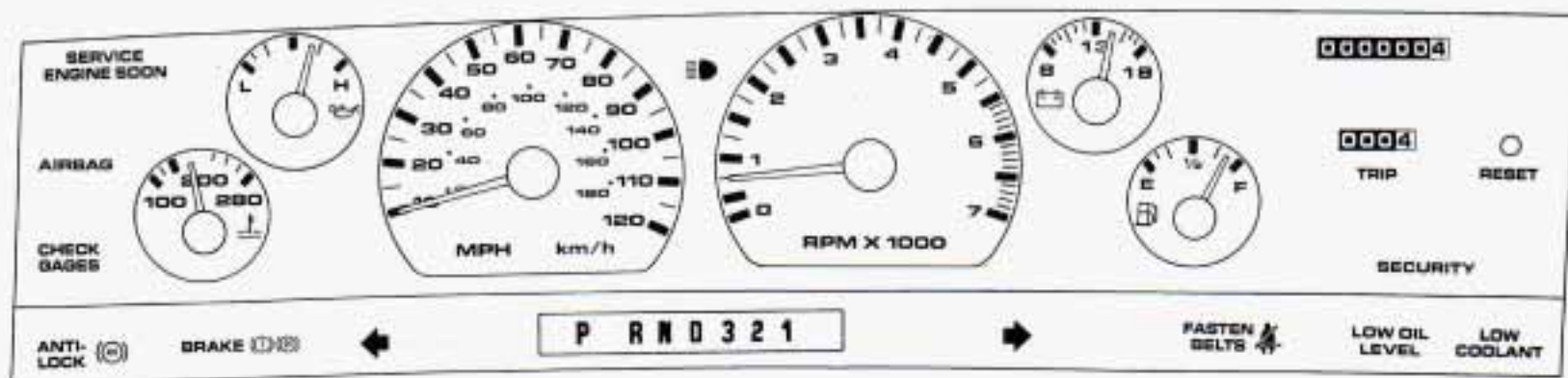

■ *Warning Lights, Gages and Indicators*

This section describes the warning lights and gages that may be on your vehicle. The pictures will help you locate them.

Warning lights and gages can signal that something is wrong before it becomes serious enough to cause an expensive repair or replacement. Paying attention to your warning lights and gages could also save you or others from injury.

Warning lights go on when there may be or is a problem with one of your vehicle's functions. As you will see in the details on the next few pages, some warning lights come on briefly when you turn the ignition key just to let you know they're working. If you are familiar with this section, you should not be alarmed when this happens.

Gages can indicate when there may be or is a problem with one of your vehicle's functions. Often gages and warning lights work together to let you know when there's a problem with your vehicle.

When one of the warning lights comes on and stays on when you are driving, or when one of the gages shows there may be a problem, check the section that tells you what to do about it. Please follow the manual's advice. Waiting to do repairs can be costly — and even dangerous. So please get to know your warning lights and gages. They're a big help.



Speedometer

Your speedometer lets you see your speed in both miles per hour (mph) and kilometers per hour (km/h).

Features & Controls

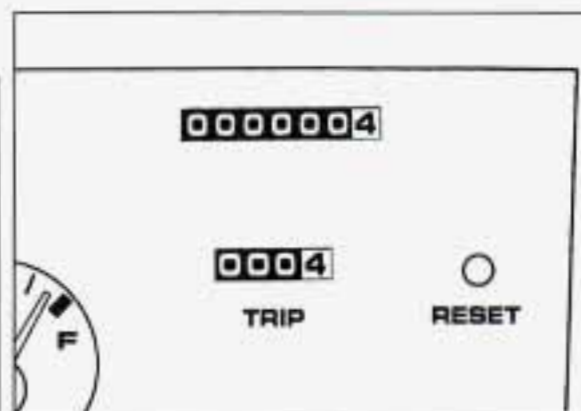

Odometer and Trip Odometer

Your odometer shows how far your vehicle has been driven, in either miles (used in the U.S.) or in kilometers (used in Canada). Your trip odometer tells how far you have driven since you last reset it. To set it to zero, press the **RESET** button located next to the trip odometer on the right side of the instrument panel.

Your Oldsmobile has a tamper resistant odometer. If you see silver lines between the numbers, you'll know someone has probably tampered with it and the numbers may not be true.

You may wonder what happens if your vehicle needs a new odometer installed. If the new one can be set to the mileage total of the old odometer, then it must

be. But if it can't, then it's set at zero and a label must be put on the driver's door to show the old mileage reading when the new odometer was installed.

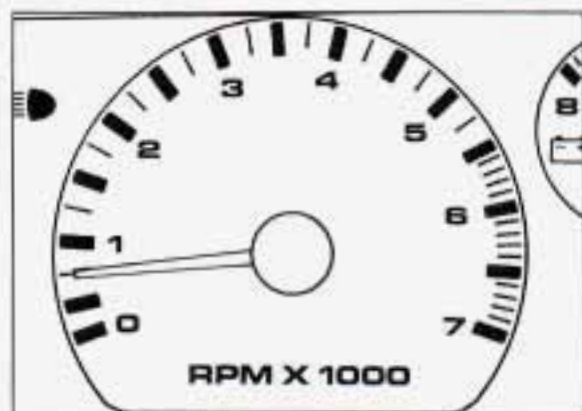

Tachometer

The tachometer displays the engine speed in revolutions per minute (rpm).

NOTICE:

Do not operate the engine with the tachometer in the red area, or engine damage may occur.

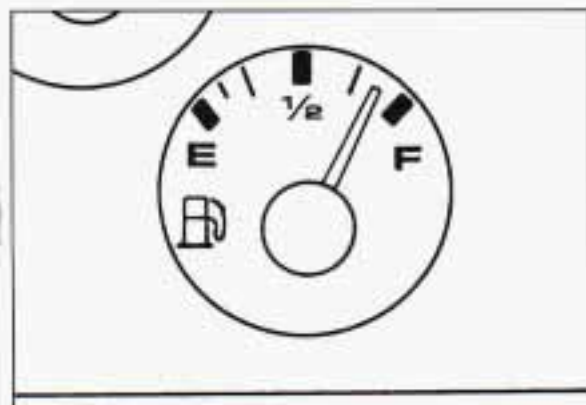

Fuel Gage

Your fuel gage tells you about how much fuel you have left, when the ignition is on. When the indicator nears **E** (Empty), you still have a little fuel left, but you should get more soon.

Here are three things that some owners ask about. None of these show a problem with your fuel gage:

- At the gas station, with your ignition on, the gas pump shuts off before the gage reads **F** (Full).

- It takes a little more or less fuel to fill up than the gage indicated. For example, the gage may have indicated the tank was half full, but it actually took a little more or less than half the tank's capacity to fill the tank.
- The gage moves a little when you turn a corner or speed up.

For your fuel tank capacity, see *Service Station Information* on the last page of this manual.

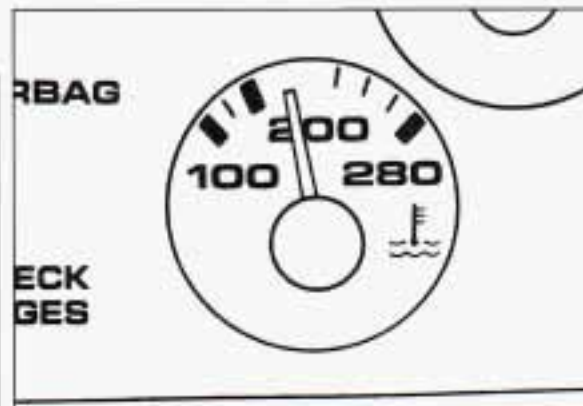

Engine Coolant Temperature Gage

You have a gage that shows the engine coolant temperature. If the gage pointer moves into the red area, your engine is too hot!

That reading means the same thing as the warning light. It means that your engine coolant has overheated. If you have been operating your vehicle under normal driving conditions, you should pull off the road, stop your vehicle and turn off the engine as soon as possible.

HOT COOLANT CAN BURN YOU BADLY!

In *Problems on the Road*, this manual shows what to do. See the *Index* under *Engine Overheating*.

Features & Controls

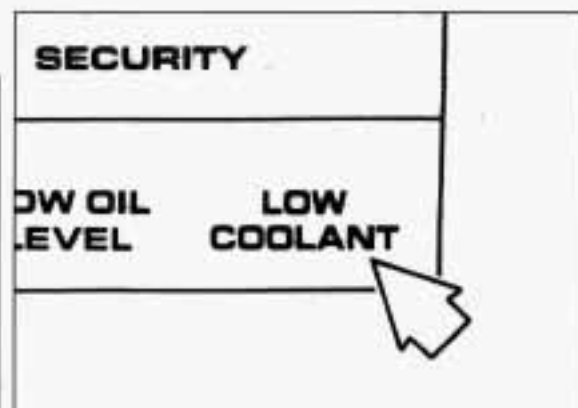

Low Coolant Warning Light

If this light comes on, your system is low on coolant and the engine may overheat.

See the *Index* under *Engine Coolant* and have your vehicle serviced as soon as you can.

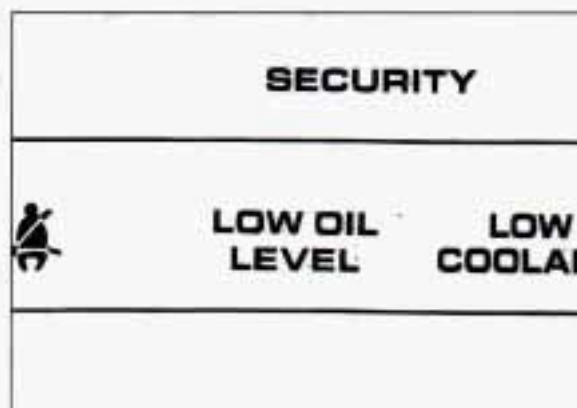

Low Engine Oil Level Warning Light (OPTION)

Your engine may be equipped with an oil level monitoring system. When the ignition key is turned on, the **LOW OIL LEVEL** light will briefly flash. If the light stays on, stop the vehicle on a level surface and turn the engine off. Check the oil level using the engine oil dipstick. (See the *Index* under *Engine Oil*.) If the light does not flash, have the low oil level sensor system repaired so it will be ready to warn you if there's a problem.

NOTICE:

The oil level monitoring system only checks oil level during the brief period between key on and engine crank. It does not monitor engine oil level when the engine is running. Additionally, an oil level check is only performed if the engine has been turned off for a considerable period of time allowing the oil normally in circulation to drain back into the oil pan.

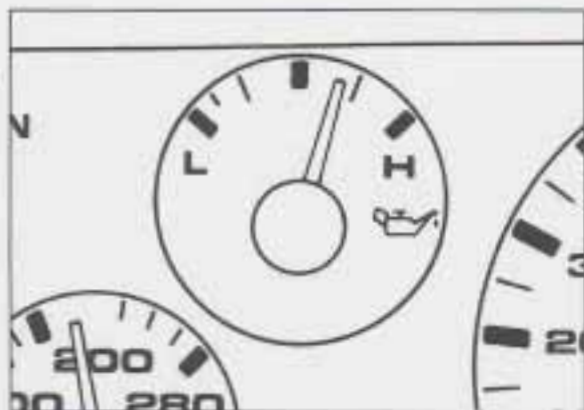

Oil Pressure Indicator

This indicator tells you if there could be a problem with your engine oil pressure.

The pointer should be above the red zone when the engine is running. Readings in the red area tell you that the engine is low on oil, or that you might have some other oil problem. See the *Index* under *Engine Oil*.



CAUTION:

Don't keep driving if the oil pressure is low. If you do, your engine can become so hot that it catches fire. You or others could be burned. Check your oil as soon as possible and have your vehicle serviced.

NOTICE:

Damage to your engine from neglected oil problems can be costly and is not covered by your warranty.



Voltmeter

When the engine is running, the gage shows the condition of the charging system. Readings between the red warning zones indicate the normal operating range.

Readings in either red warning zone indicate a possible problem in the electrical system. Have your vehicle serviced immediately.

When your engine is not running, but the ignition is on (in the **Run** position), the gage shows your battery's state of charge.

Features & Controls



Brake System Warning Light

Your Oldsmobile's hydraulic brake system is divided into two parts. If one part isn't working, the other part can still work and stop you. For good braking, though, you need both parts working well.

If the warning light comes on, there could be a brake problem. Have your brake system inspected right away.

This light should come on as you start the vehicle. If it doesn't come on then, have it fixed so it will be ready to warn you if there's a problem.

If the light comes on while you are driving, pull off the road and stop carefully. You may notice that the pedal is harder to push. Or, the pedal may go

closer to the floor. It may take longer to stop. If the light is still on, or if the anti-lock brake system warning light is flashing, have the vehicle towed for service. (See *Anti-Lock Brake System Warning Light* and *Towing Your Vehicle* in the *Index*.)



CAUTION:

Your brake system may not be working properly if the brake system warning light is on. Driving with the brake system warning light on can lead to an accident. If the light is still on or if the anti-lock brake system warning light is flashing after you've pulled off the road and stopped carefully, have the vehicle towed for service.

The brake system warning light will also come on when you set your parking brake, and it will stay on if your parking brake doesn't release fully. If it stays on after your parking brake is fully released, it means you have a brake problem.

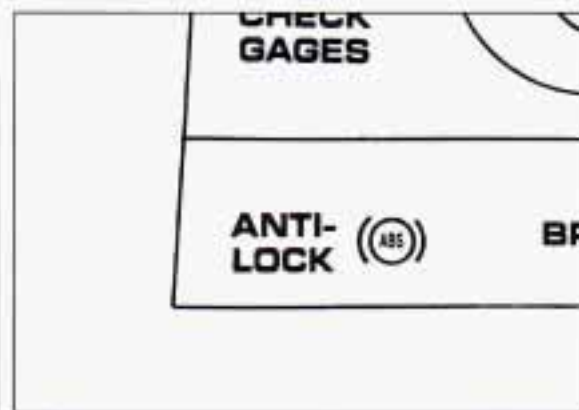

Anti-Lock Brake System Warning Light

This light will come on when you start your engine and it will stay on for three seconds. That's normal. If the light doesn't come on, have it fixed so it will be ready to warn you if there is a problem.

If the light flashes when you're driving, you don't have anti-lock brakes and there's a problem with your regular brakes. Pull off the road and stop carefully. You may notice that the pedal is harder to push. Or, the pedal may go closer to the floor. It may take longer to stop. Have the vehicle towed for service. (See *Towing Your Vehicle* in the *Index*.)



CAUTION:

Your regular brake system may not be working properly if the anti-lock brake system warning light is flashing. Driving with the anti-lock brake system warning light flashing can lead to an accident. After you've pulled off the road and stopped carefully, have the vehicle towed for service.

If the anti-lock brake system warning light stays on longer than normal after you've started your engine, turn the ignition off. Or, if the light comes on and stays on when you're driving, stop as soon as possible and turn the ignition off. Then start the engine again to reset the system. If the light still stays on, or comes on again while you're driving, your Oldsmobile needs service. If the light is on but not flashing and the regular brake system warning light isn't on, you still have brakes, but you don't have anti-lock brakes.



Malfunction Indicator Lamp (Service Engine Soon Light)

A computer monitors operation of your fuel, ignition and emission control systems. This light should come on when the ignition is on, but the engine is not running, as a check to show you it is working. If it does not come on at all, have it fixed right away. If it stays on, or it comes on while you are driving, the computer is indicating that you have a problem. You should take your vehicle in for service soon.

Features & Controls

NOTICE:

If you keep driving your vehicle with this light on, after a while the emission controls won't work as well, your fuel economy won't be as good and your engine may not run as smoothly. This could lead to costly repairs not covered by your warranty.

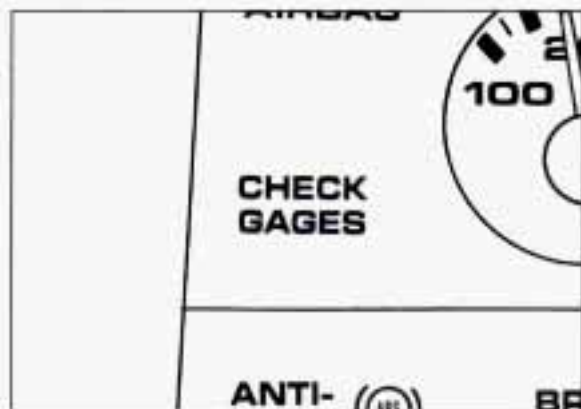

Check Gages Light

When this light comes on it means one of these four things:

- You have approximately 3 gallons (12 L) or less of fuel remaining in your tank. Check your fuel gage.
- Your oil pressure is low. Check your oil pressure indicator.
- Your engine is too hot. Check your coolant temperature gage.
- There is a problem with the charging system.

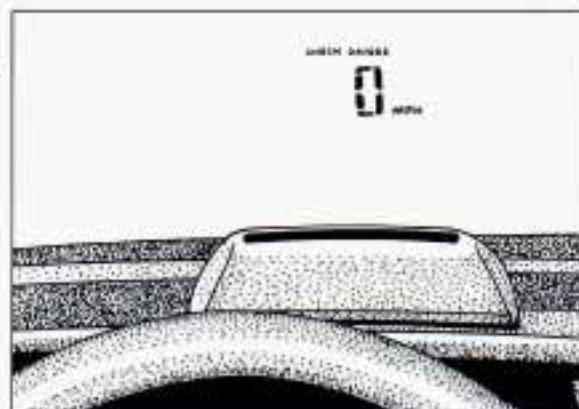

■ Head-Up Display (OPTION)

If you have the optional Head-Up Display (HUD), you can see the speedometer reading, in English or metric units, displayed "through" the windshield. The HUD also shows:

- Turn signal indicator lights.
- A high beam indicator symbol.
- A **CHECK GAUGES** message. (For low oil pressure, high coolant temperature, high or low battery voltage, and low fuel.)

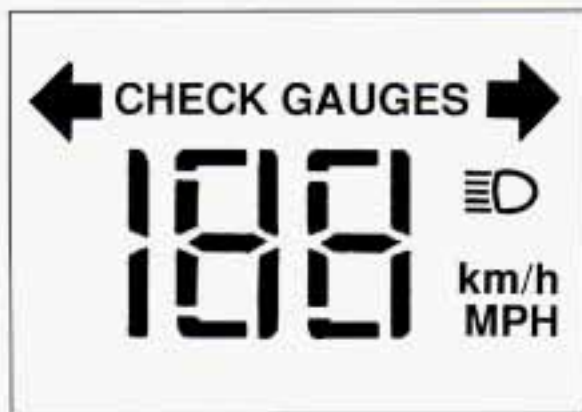

HUD shows these lights when they are lit on the instrument panel.

When you sit straight in your seat, the HUD image will appear slightly to the right.

When the ignition key is turned to **Run**, all possible HUD images will come on and look like this. Then the Head-Up Display will operate normally.

 **CAUTION:**
If you never look at your instrument panel, you may not see something important, such as a warning light. So be sure to scan your displays and controls and the driving environment just as you would in a vehicle without HUD.

NOTICE:
Although the HUD image appears to be near the front of the vehicle, do not use it as a parking aid. The HUD was not designed for that purpose. If you try to use it that way, such as in a parking lot, you may misjudge distance and run into something.

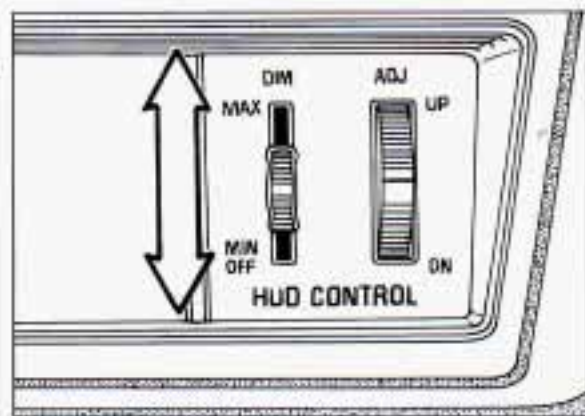

To adjust the HUD so you can see it properly:

1. Start your engine and slide the HUD dimmer control (located below the climate controls) all the way to **MAX**. The brightness of the HUD image is determined by whether the headlight switch is on or off, and where you have set the HUD dimmer control.

Features & Controls

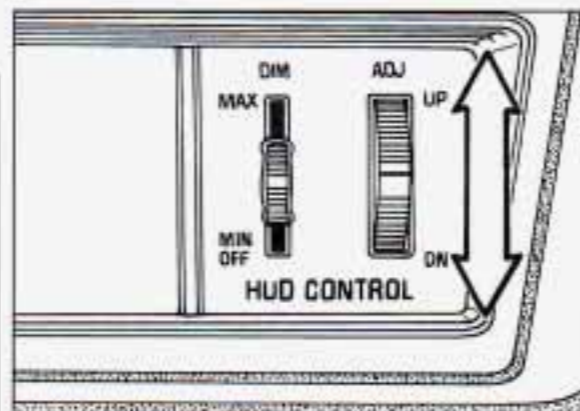

2. Adjust the seat, if necessary, before setting the height control.

Rotate the HUD image height control all the way up, raising the image as far as possible. Then rotate the HUD image height control downward so the image is as low as possible but in full view.

3. Slide the dimmer control toward **OFF** until the HUD image is no brighter than necessary. To turn the HUD off, slide the HUD dimmer control to **OFF**.

If the sun comes out, or it becomes cloudy, or if you turn on your headlights, you may need to adjust the

HUD's brightness using the HUD dimmer control. Polarizing sunglasses could make the HUD image harder to see.



CAUTION:

If the HUD image is too bright, or too high in your field of view, it may take you more time to see things you need to see when it's dark outside. Be sure to keep the HUD image dim and placed low in your field of view.

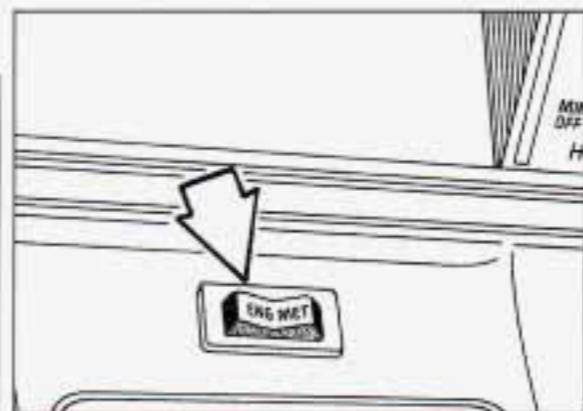

Pushing the **ENG/MET** rocker switch on the center console will switch the HUD speedometer from English (conventional) to metric units, or back again.

Some vehicles may not be equipped with the **ENG/MET** switch.

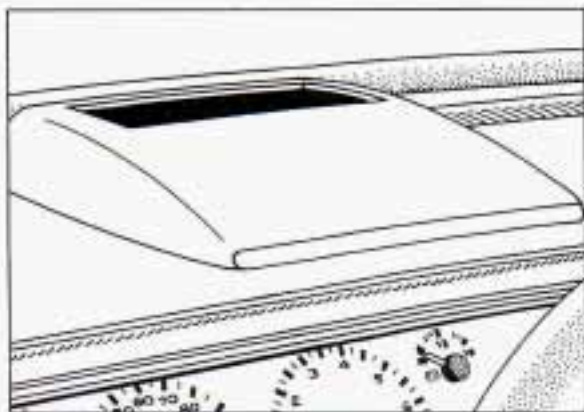

Care of the Head-Up Display

Clean the inside of the windshield as needed to remove any dirt or film that reduces the sharpness or clarity of the HUD image.

To Clean the HUD:

Spray household glass cleaner on a soft, clean cloth. Wipe the HUD lens gently, then dry it. Do not spray cleaner directly on the lens, because the cleaner fluid could leak inside the unit if you do.

If You Can't See the HUD Image When the Ignition is On:

- Is anything covering the HUD unit?
- Is the HUD dimmer control close enough to **MAX**?
- Is the HUD image adjusted to the proper height?

- Still no HUD image? Check the fuse in the **CLSTR** position in the glove box fuse panel. See the *Index* under *Fuses & Circuit Breakers*.

If the HUD Image is Not Clear:

- It could be too bright. Move the HUD dimmer control closer to **OFF**.
- You may need to clean the windshield and HUD lens.

Your windshield is part of the HUD system. If you ever have to have a new windshield, be sure to get one designed for HUD. If you don't, the HUD image may look blurred and out of focus.

Notes



In this part you'll find out how to operate the comfort control systems and audio systems offered with your Oldsmobile. Be sure to read about the particular system supplied with your vehicle.

Part 3

Comfort Controls & Audio Systems

Climate Control	104
Electronic Climate Control	107
Steering Wheel Touch Controls for Climate Control	109
Setting the Clock	111
AM/FM Stereo Radio	112
AM/FM Stereo Radio with Cassette Player	113
AM/FM Stereo with Cassette Player and Music Search	115
AM/FM Stereo with Cassette Player and Graphic Equalizer	117
AM/FM Stereo with Compact Disc Player	119
Compact Disc Player Anti-Theft Feature	120
Steering Wheel Touch Controls for Audio System	122
Understanding Radio Reception	122
Care of Your Cassette Tape Player	123
Care of Your Compact Discs	123
Fixed Mast Antenna	123
Power Antenna Mast Care	124

Comfort Controls & Audio Systems

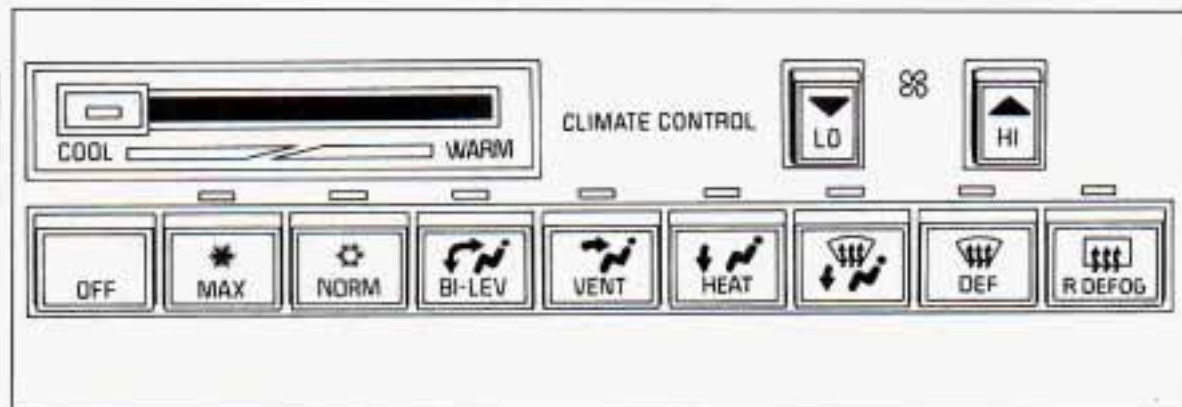

cools it and directs it through the instrument panel outlets.

BI-LEV (Bi-Level): Use on cool, but sunny days. This setting brings in outside air, but directs it in two ways. The cool air is directed to the upper portion of your body through the instrument panel outlets, but most warmed air is directed through the heater ducts and a little to the defrost and side window vents. At times this temperature difference may be more apparent than others.

Heating and Ventilation

When you don't need to cool the outside air, use these next settings. You can leave the air as it is or heat it.

The air conditioner compressor doesn't run in these settings. This reduces the engine load, resulting in improved fuel economy (gas mileage).

VENT: For mild outside temperatures, when little heating or cooling is needed, push **VENT**. Air flow is through the instrument panel outlets. Slide the temperature control lever to a comfortable level.

Climate Control

The air conditioner and heater work best if you keep your windows closed while using them. Your vehicle also has the flow-through ventilation system described later in this section.

OFF: Press to turn the blower off. Air will still come from the outlets at the floor. Press any function button to turn the system on.

Temperature Control Lever: This lever changes the temperature of the air coming through the system. The higher the lever setting, the warmer the air.

Fan Speed: Selects the force of air you want. Press **LO** to lower the fan speed, **HI** to raise it.

Air Conditioning

On very hot days, open the windows long enough to let hot inside air escape. This reduces the time it takes for your vehicle to cool down, which should help fuel economy.

There are three air conditioning settings:

MAX: Provides maximum cooling or quick cool-down on very hot days. This setting also helps prevent outside odors from entering your vehicle.

This setting recirculates much of the air inside your vehicle, and it should not be used for long periods because the air may become too cold and dry. This setting is not recommended if an occupant is smoking.

NORM: Use for normal cooling on hot days. This setting brings in outside air,

HEAT: When outside temperatures are cold, push **HEAT**. Slide the temperature control lever to a comfortable level. For maximum heating, slide it all the way to the right. This setting will send most of the heated air through the ducts near the floor. The rest will come out of the defroster vents and side window defogger vents.

Defogging and Defrosting

There are two settings for clearing your windows. For each setting, adjust the temperature control as desired. The air conditioner compressor will run in these settings to remove moisture from the air when the temperature is above freezing.



This setting allows half of the air to flow to the floor heater ducts, and half to go to the windshield and side window vents located in the windshield pillars. Use this setting to warm passengers while keeping the windshield clear.

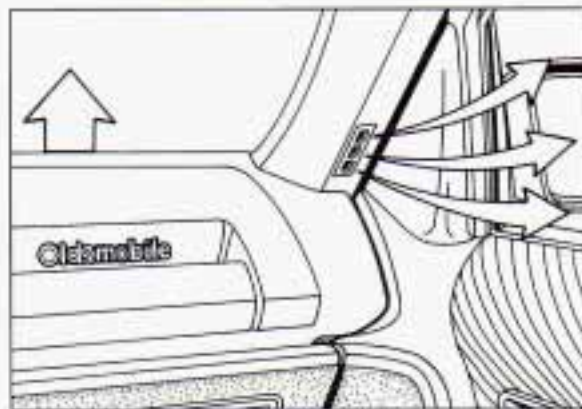

The **DEF** setting directs 90% of the air through the defroster vents and the side window vents, and 10% to the floor.

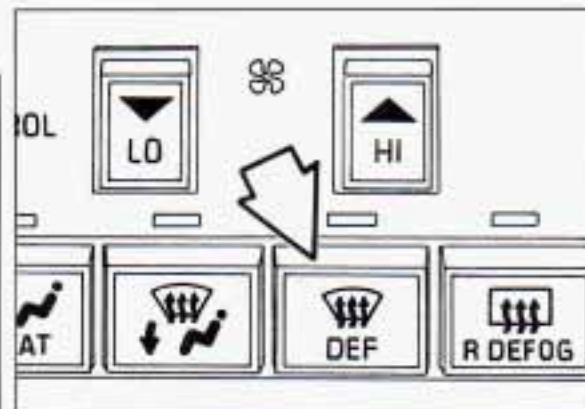

To rapidly defrost the windshield, slide the temperature control lever all the way to **WARM** and press the **DEF** button.

Adjust the fan to the highest speed.

Comfort Controls & Audio Systems

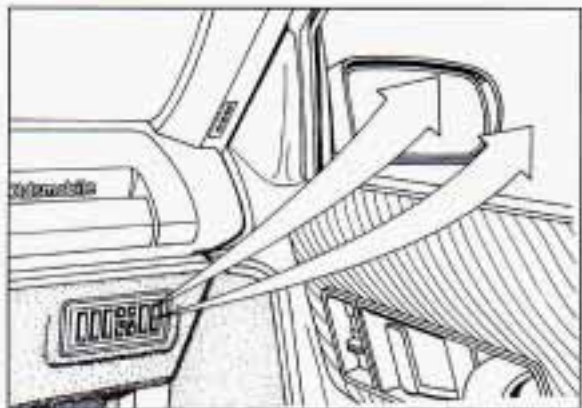

Your vehicle is equipped with side window defogger vents located on the window pillar. For additional side window defogging, push the **BI-LEV** button, set the fan control on high and aim the side vents on the instrument panel toward the side windows. For increased air flow to the side vents, close the center vents,

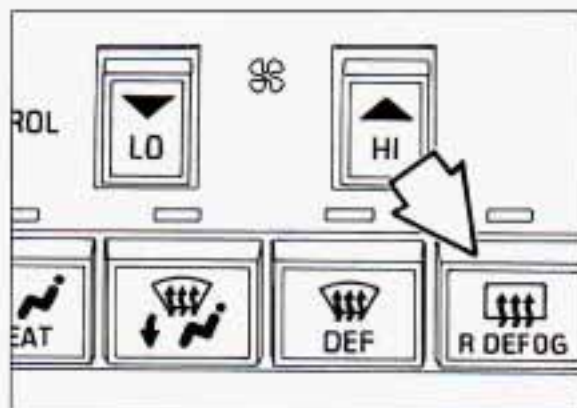

Rear Window Defogger

The rear window defogger uses a warming grid to remove fog from the rear window. Press **R DEFOG** to turn on. The defogger will turn off automatically after about 10 minutes of use. If you turn it on again, the defogger will operate for about five minutes only. You can also turn the defogger off by turning off the ignition or pressing the **R DEFOG** button again.

Do not attach a temporary vehicle license across the defogger grid on the rear window.

NOTICE:

Don't use a razor blade or something else sharp on the inside of the rear window. If you do, you could cut or damage the warming grid, and the repairs wouldn't be covered by your warranty.

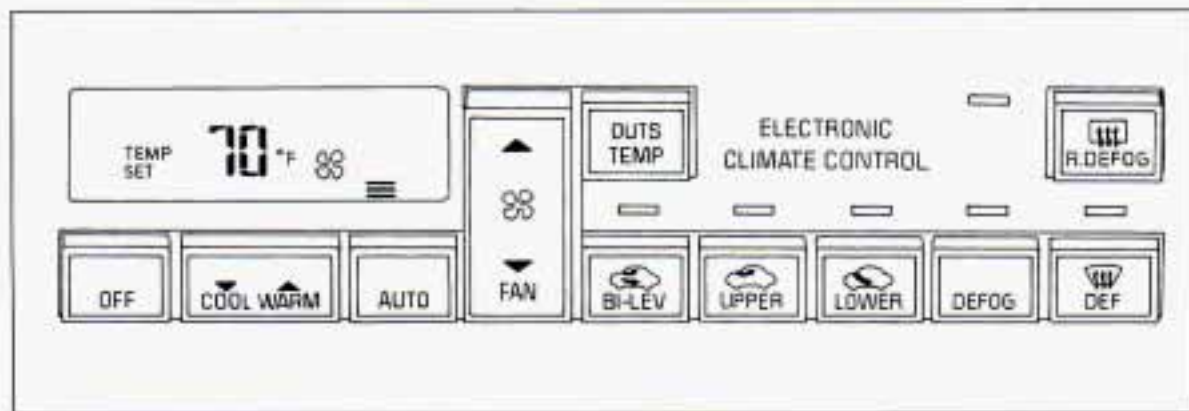

■ *Electronic Climate Control* (OPTION)

This system allows you to set the temperature you want. It also lets you choose automatic air flow and direction control, or air flow and direction settings you select. Your vehicle also has the flow-through ventilation system described later in this section.

The digital screen displays the outside temperature, the inside temperature setting and the fan speed.

When you select the **AUTO** mode, the air conditioner compressor will operate if the outside temperature is above freezing.

The air conditioner compressor also operates in **DEFOG**, **DEF** (Defrost)

and **BI-LEV** (Bi-Level) when the outside temperature is above freezing.

COOL/WARM: Sets the interior temperature you want. Press **COOL** to lower the inside temperature setting; press **WARM** to raise the setting. The temperature you set will be displayed on the digital screen.

Once you set the temperature, the system will try to maintain the set temperature, whether you are using the heating or cooling controls.

Your system has an interior temperature sensor that detects increased interior temperature caused by sunlight. To keep you comfortable, it reduces the interior temperature by as much as 5°F (3°C) below the setting on the digital screen.

AUTO: To allow the system to automatically control the temperature, air distribution and fan speed:

1. Set the temperature you want with the **COOL/WARM** switch.
2. Press the **AUTO** switch. The **AUTO** symbol will appear on the digital screen.

The system will approach the temperature you select as quickly as possible. For most efficient operation, just set the system temperature where you would like it and drive away.

You may notice a delay of three or four minutes before the blower comes on.

OUTS TEMP: Press to have the outside temperature displayed on the digital screen. Press again to return to the inside temperature setting.

If the system is left in the outside temperature mode, the outside temperature will be displayed except when changing the inside temperature setting using the **COOL/WARM** switch. The display will return to the outside temperature setting in about five seconds.

Comfort Controls & Audio Systems

Use the following controls when the system is not set on **AUTO**:

: Press the top of the switch to raise the fan speed, the bottom of the switch to lower the fan speed. The fan symbol and bar graph will be displayed on the digital screen.

When the **AUTO** switch is pressed, the fan symbol will go out and the fan will return to automatic operation.

If the Fahrenheit (F°) or Celsius (C°) symbol begins to flash, or flashes when you turn on the ignition, it indicates an electrical problem with your air conditioning system. The flashing will continue for about two minutes. It means you should have your system serviced.

Directional Controls

When the following buttons are pressed, an indicator light will glow above the button.

BI-LEV (Bi-Level): Use on cool, but sunny days. This setting brings in the outside air, but directs it in two ways. The cool air is directed to the upper portion of your body through the

instrument panel outlets, but most warmed air is directed through the heater ducts and a little to the defrost and side window vents. At times this temperature difference may be more apparent than others.

You may notice a delay of three or four minutes before the blower comes on.

UPPER: Press to direct air flow through the instrument panel outlets only.

LOWER: Press to direct 90% of the air flow through the heater ducts, and 10% of the air flow through the windshield defroster vents.

DEFOG: Press to direct half the air to the windshield, and the other half through the heater ducts.

DEF (Defrost): Press to direct 90% of the air to the windshield and side window vents, and 10% to the floor. The fan will automatically go to high. For a lower fan speed, press the fan switch.

OFF: Press to turn off the system. Some air will still come from the outlets at the floor.

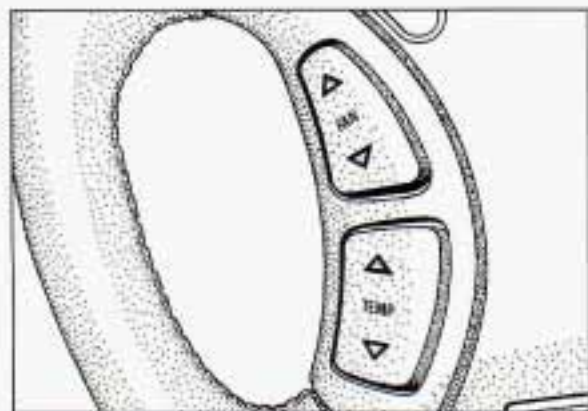

Steering Wheel Touch Controls for Climate Control (OPTION)

Some heating and cooling controls can be adjusted at the steering wheel. These touch controls also operate some audio controls. See the *Index* under *Steering Wheel Touch Controls for Audio System*.

FAN: Press the upper part of the control to increase the fan speed; press the lower part to reduce the fan speed.

TEMP: Press the upper part of the control to raise the inside temperature setting; press the lower part to lower the setting.

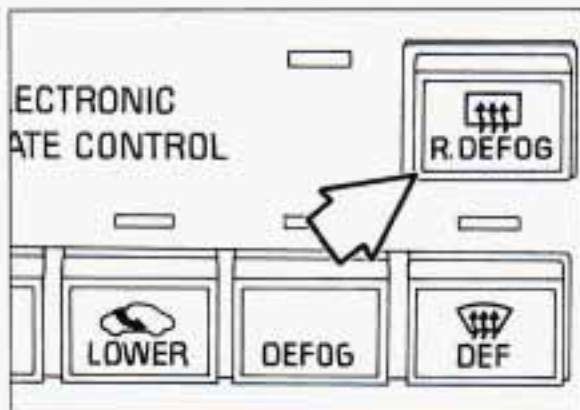

Rear Window Defogger

R. DEFOG: Press to warm the defogger grid on the rear window. The indicator light will glow while the rear window defogger is operating. The rear window defogger will turn off automatically after about 10 minutes of use. If you turn it on again, the defogger will operate for about five minutes only. You can also turn the defogger off by turning off the ignition or pressing the **R. DEFOG** switch again.

Do not attach a temporary vehicle license across the defogger grid on the rear window.

NOTICE:

Don't use a razor blade or something else sharp on the inside of the rear window. If you do, you could cut or damage the warming grid, and the repairs wouldn't be covered by your warranty.

Comfort Controls & Audio Systems

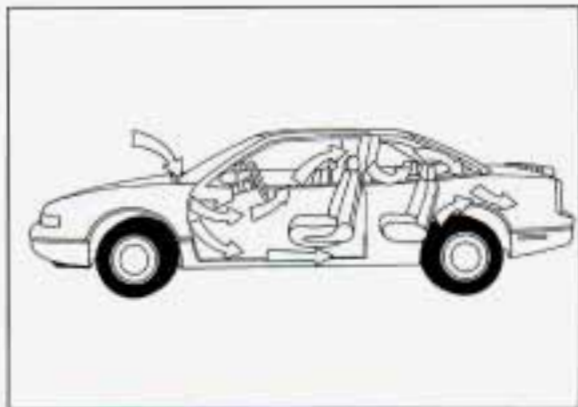

Flow-Through Ventilation System

Your Oldsmobile's flow-through ventilation system supplies outside air into the vehicle when it is moving. Outside air will also enter the vehicle when the heater or the air conditioning fan is running.



Ventilation Tips

- Keep the hood and front air inlet free of ice, snow, or any other obstruction (such as leaves). The heater and defroster will work far better, reducing the chance of fogging the inside of your windows.
- When you enter a vehicle in cold weather, set the blower fan to the highest setting for a few moments before driving off. This helps clear the intake ducts of snow and moisture, and reduces the chance of fogging the inside of your windows.
- Keep the air path under the front seats clear of objects. This helps air to circulate throughout your vehicle.

■ **Audio Systems**

The following pages describe the audio systems available for your Oldsmobile, and how to get the best performance from them. Please read about the system in your vehicle.

Hearing damage from loud noise is almost undetectable until it is too late. Your hearing can adapt to higher volumes of sound. Sound that seems normal can be loud and harmful to your hearing. Take precautions by adjusting the volume control on your radio to a safe sound level before your hearing adapts to it. To help avoid hearing loss or damage:

- Adjust the volume control to the lowest setting.
- Increase volume slowly until you hear comfortably and clearly.

NOTICE:

Before you add any sound equipment to your vehicle — like a tape player, CB radio, mobile telephone or two-way radio — be sure you can add what you want. If you can, it's very important to do it properly. Added sound equipment may interfere with the operation of your vehicle's engine, Delco® radio or other systems, and even damage them. And, your vehicle's systems may interfere with the operation of sound equipment that has been added improperly. So, before adding sound equipment, check with your dealer and be sure to check Federal rules covering mobile radio and telephone units.

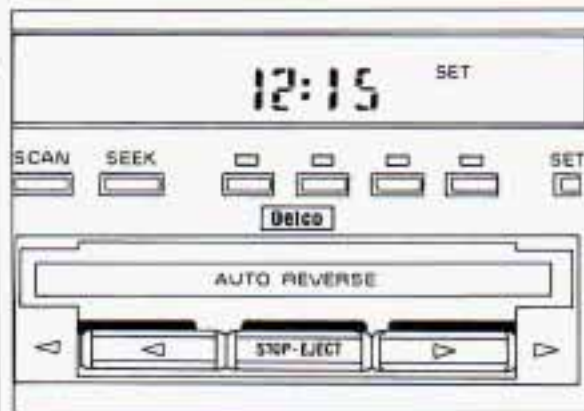

Setting the Clock

No matter which audio system you have in your vehicle, setting the clock is easy.

For Radios with SCAN and One SEEK Button:

1. With the radio off and the ignition on, press **SET**. The **SET** indicator will appear on the digital screen for five seconds.
2. During those five seconds, you can set the clock to the correct hour and minute by depressing the **SEEK** and **SCAN** buttons. For some radios **SEEK** will set the hour, for others it sets the minute. For some radios, **SCAN** will set the hour, for others it sets the minute.

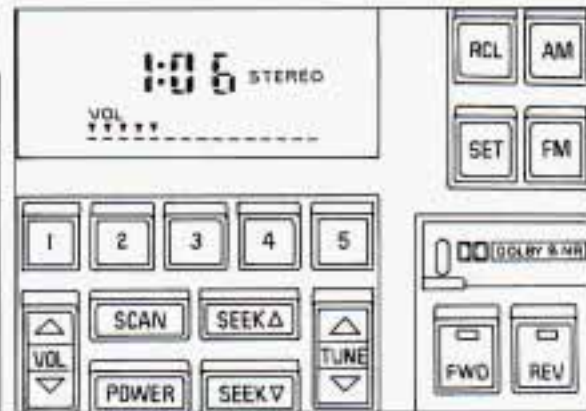

For Radios with SCAN and SEEK ▲ and SEEK ▼:

1. With the radio off and the ignition on, press **SET**. The **SET** indicator will appear on the digital screen for five seconds.
2. Press and hold **SCAN** until the correct hour appears on the display.
3. Press **SET** again.
4. Press and hold **SEEK ▲** or **SEEK ▼** until the correct minute appears on the display.

Comfort Controls & Audio Systems

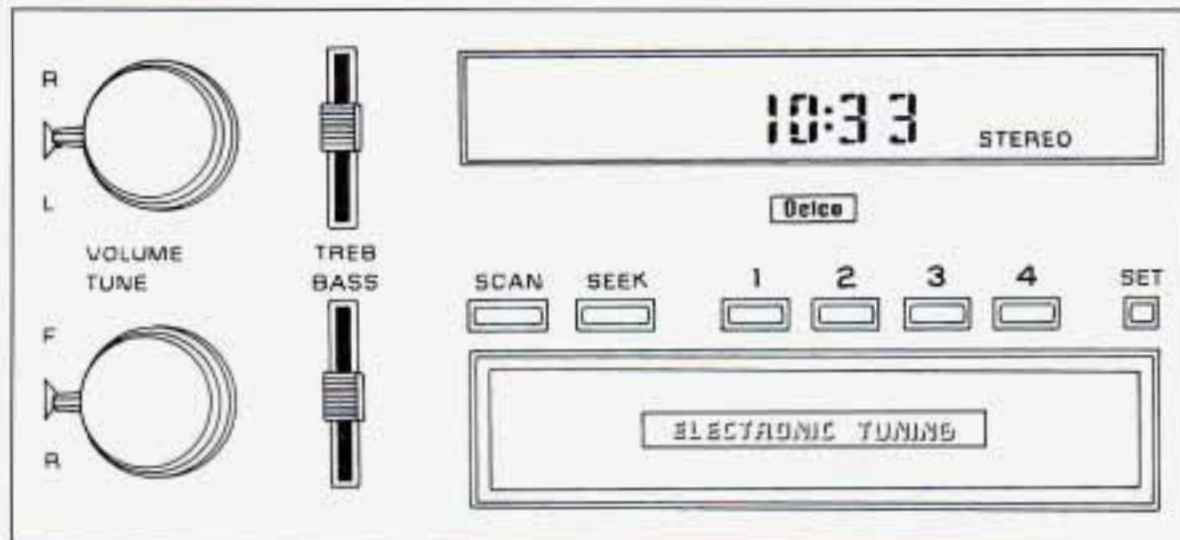

AM/FM Stereo Radio

The digital display indicates information on time or radio station frequency, the AM or FM radio band, whether the station is in stereo, and other radio functions.

VOLUME: Turn the upper knob to turn the radio on or off, or to adjust volume. Press it to change the display between the clock and the radio station frequency when the radio is on.

The control ring behind the **VOLUME** knob adjusts the left/right speaker balance.

TUNE: This knob has two functions. Turn it to the left or right to tune in radio stations (the radio station frequency will be displayed on the digital screen). Press this knob to change between the AM and FM bands.

The control ring behind the **TUNE** knob adjusts the front/rear speaker balance.

TREB (Treble): Slide this lever up to increase treble, or down to decrease it.

BASS: Slide this lever up to increase bass, or down to decrease it.

SCAN: Press to listen for a few seconds to the next station on the AM or FM band; the scan will continue every few seconds until you press **SCAN** again to stop on a particular station. You can also press the upper knob (**VOLUME**) to stop the scan.

SEEK: Each time you press **SEEK**, you will tune in the next station higher on the radio band.

To Preset Radio Stations:

Using the four pushbuttons numbered 1-4, you can set up to 14 radio stations (seven AM and seven FM).

1. Use the lower knob (**TUNE**) to tune in the station you want.
2. Press **SET**. The **SET** indicator will appear on the digital screen for five seconds.
3. While the **SET** indicator is displayed, press one of the four pushbuttons.
4. Repeat steps 1-3 for each of four AM and four FM stations.

Up to three additional stations on each band may be preset by "pairing" pushbuttons:

1. Tune in the desired station.
2. Press **SET**, and within five seconds press any two adjacent pushbuttons at the same time.
3. The station can be tuned in when the same two pushbuttons are pressed at the same time.

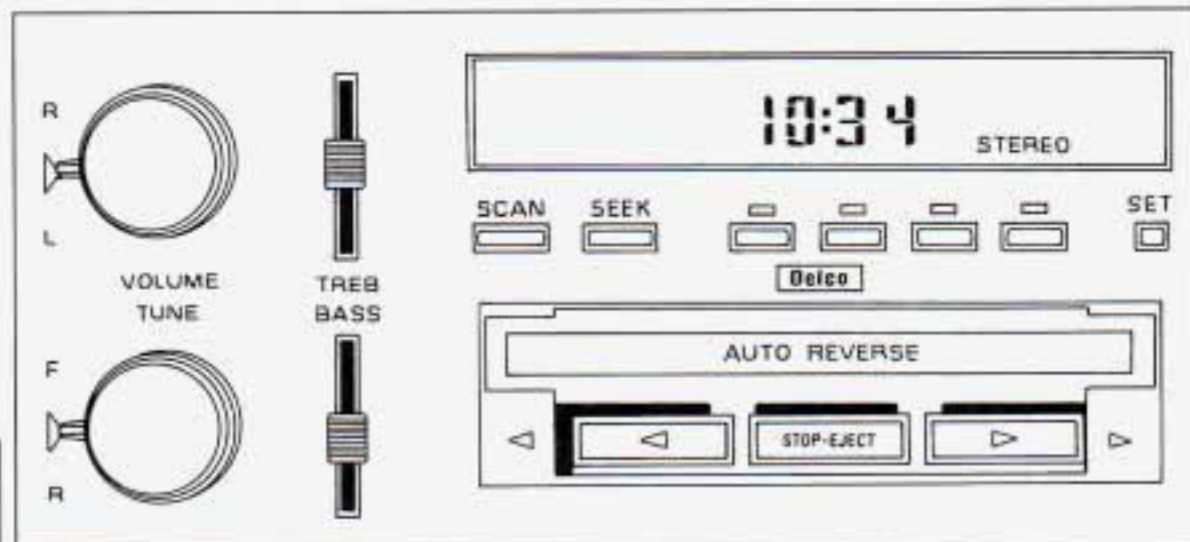

AM/FM Stereo Radio with Cassette Player

The digital display indicates information on time or radio station frequency, the AM or FM radio band, whether the station is in stereo, and other radio functions.

VOLUME: Turn the upper knob to turn the radio on or off, or to change volume. Press it to change the display between the clock and the radio station frequency when the radio is on.

The control ring behind the **VOLUME** knob adjusts the left/right speaker balance.

TUNE: This knob has two functions. Turn it to the left or right to tune in radio stations (the radio station frequency will be displayed on the digital screen). Press this knob to change between the AM and FM bands.

The control ring behind the **TUNE** knob adjusts the front/rear speaker balance.

TREB (Treble): Slide this lever up to increase treble, or down to decrease it.

BASS: Slide this lever up to increase bass, or down to decrease it.

SCAN: Press to listen for a few seconds to the next station on the AM or FM

Comfort Controls & Audio Systems

band; the scan will continue every few seconds until you press **SCAN** again to stop on a particular station. You can also press the upper knob (**VOLUME**) to stop the scan.

SEEK: Each time you press **SEEK**, you will tune in the next station higher on the radio band.

To Preset Radio Stations:

Using the four pushbuttons below the digital display, you can set up to 14 radio stations (seven AM and seven FM).

1. Use the lower knob (**TUNE**) to tune in the station you want.
2. Press **SET**. The **SET** indicator will appear on the digital screen for five seconds.
3. While the **SET** indicator is displayed, press one of the four pushbuttons.
4. Repeat steps 1-3 for each of four AM and four FM stations.

Up to three additional stations on each band may be preset by "pairing" pushbuttons:

1. Tune in the desired station.
2. Press **SET**, and within five seconds press any two adjacent pushbuttons at the same time.
3. The station can be tuned in when the same two pushbuttons are pressed at the same time.

To Play a Cassette Tape:

With the power on, insert a tape into the cassette door. Using tapes that are longer than 90 minutes (45 minutes on each side) is not recommended.

When the right indicator arrow is lit, selections listed on the bottom side of the cassette are playing. When the left arrow is lit, selections listed on the top side of the cassette are playing. To change sides of the tape, press the upper control knob (**VOLUME**) while the cassette is playing. The tape player automatically begins playing the other side when it reaches the end of the tape.

Fast Forward: Press the button with the arrow pointing in the same direction that the tape is playing. To stop fast forward, press the **STOP-EJECT** button.

Reverse: Press the button with the arrow pointing in the opposite direction that the tape is playing. To stop reverse, press the **STOP-EJECT** button.

STOP-EJECT: To stop playing a tape, fully press this button. The cassette will be partially ejected, and the radio will begin playing.

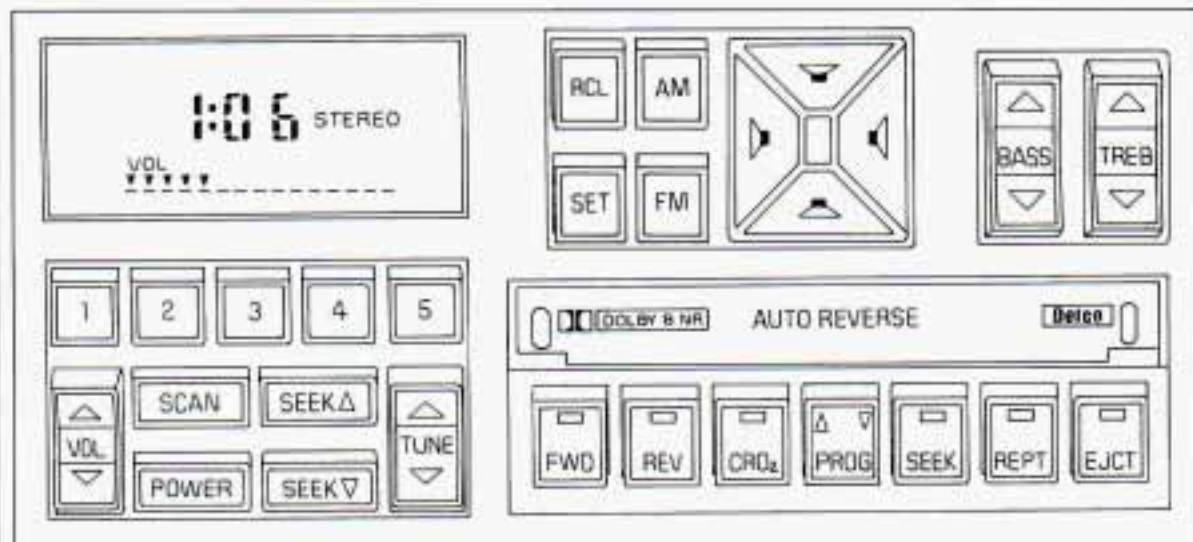

AM/FM Stereo with Cassette Player and Music Search

The digital display indicates information on time or radio station frequency, the AM or FM radio band, whether the station is in stereo, and other radio functions.

POWER: Turns the unit on and off when the ignition is on.

VOL (Volume): Press the top of the switch to increase the volume. Press the bottom of the switch to decrease the volume. The volume setting will be displayed. To quickly reduce the volume to a low level, press the center of the

VOL button.

BASS: Adjusts the bass level.

TREB (Treble): Adjusts the treble level.

Press the top of each switch to increase the level, or the bottom to decrease the level. Press the center of each switch for preset levels.

Balance Controls

Adjusts the left/right and front/rear speaker balance to your individual taste. When you change either adjustment, the bottom of the digital screen will display the point of balance you have selected. For the normal

setting preset at the factory, press the left and right or top and bottom buttons at the same time.

Radio Controls

The band you select will be displayed on the digital screen. The frequency of the station will also be displayed, and if the station is in stereo, the **STEREO** indicator will also be displayed.

RCL (Recall): Press to change between the clock and the radio station frequency display on the digital screen, when the radio is on.

AM: Press to select the AM band.

FM: Press to select the FM band.

SEEK▲: Press to tune in the next station higher on the band.

SEEK▼: Press to tune in the next station lower on the band.

SCAN: Press to listen for a few seconds to the next station on the AM or FM band; the scan will continue every few seconds until you press **SCAN** again to stop on a particular station.

TUNE: Press this control to tune in stations higher or lower on the AM or FM radio band.

Comfort Controls & Audio Systems

To Preset Radio Stations:

You can preselect up to 10 radio stations (five AM and five FM) and tune to any of them by pushing a single button. Here's how.

1. Tune to a desired station with the lower knob.
2. Press **SET**.
3. Within about five seconds, press one of the five numbered pushbuttons. The station you selected will be automatically tuned whenever you press this button again.
4. Repeat for up to four more stations on the same band, and up to five on the other band.

To Play a Cassette Tape:

Your cassette tape player is designed to work best with tapes that play for 30 to 45 minutes per side. Tapes that run longer than that are so thin they may not work well in this player.

With the unit on, press a cassette into the slot marked **AUTO REVERSE**,

tape side first. Adjust volume, balance, fade and tone as described earlier.

Here are your other tape player controls:

PROG (Program): Press to switch from one side of the tape to the other. The unit switches automatically at the end of a side.

CRO₂: Press to adjust the unit for high bias chrome or metal tapes. For standard bias tapes, press again to return to the factory-preset adjustment.

REV (Reverse): Press to rewind the tape rapidly. The tape will stop at the end, or when you press **REV** or **PROG** lightly. The radio will play while the tape is rewinding.

FWD (Forward): Press to advance the tape rapidly. The tape will stop at the end, or when you press **FWD** or **PROG** lightly. The radio will play while the tape is advancing.

SEEK: Press to advance to the next selection or passage. The tape will fast-forward and stop either at the first four-

second quiet spot or when you press **SEEK** again (or **PROG**).

REPT (Repeat): Press to repeat a selection. The tape will rewind to the first four-second quiet spot or until you press **REPT** (or **PROG**) again.

EJCT: Press to remove the tape.

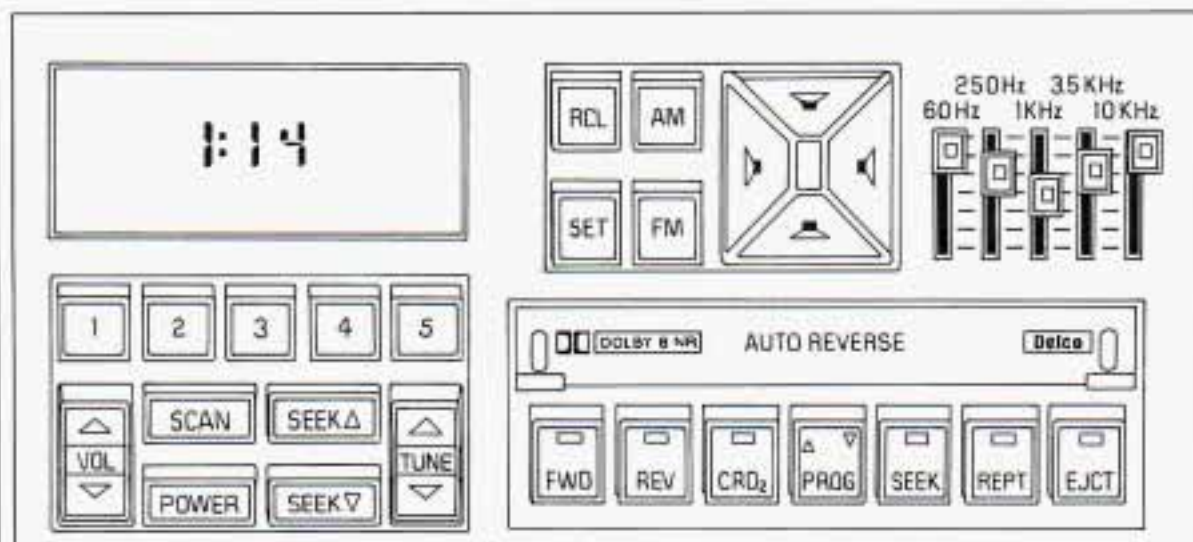

AM/FM Stereo with Cassette Player and Graphic Equalizer

The digital display indicates information on time or radio station frequency, the AM or FM radio band, whether the station is in stereo, and other radio functions.

POWER: Turns the unit on and off when the ignition is on.

VOL (Volume): Press the top of the switch to increase the volume. Press the bottom of the switch to decrease the volume. The volume setting will be displayed. To quickly reduce the volume

to a low level, press the center of the **VOL** button.

Equalizer Controls

Boost the bass, emphasize a voice in a song, brighten the treble —your equalizer gives you freedom to adjust five separate frequencies of sound to your individual taste. Move a lever up to emphasize a frequency, move it down to de-emphasize. It's best to begin with the levers in the middle position, then adjust individual levers as you like.

Balance Controls

 Adjusts the left/right and front/rear speaker balance to your individual

taste. When you change either adjustment, the bottom of the digital screen will display the point of balance you have selected. For the normal setting preset at the factory, press the center of the balance control.

Radio Controls

AM/FM: Press the **AM** or **FM** buttons to select either the AM or FM radio band. The band you select will be displayed on the digital screen. The frequency of the station will also be displayed, and if the station is in stereo, the **STEREO** indicator will also be displayed.

RCL (Recall): Press to change between the clock and the radio station frequency display on the digital screen, when the radio is on.

SEEK▲: Press to tune in the next station higher on the band.

SEEK▼: Press to tune in the next station lower on the band.

SCAN: Press to listen for a few seconds to the next station on the AM or FM band; the scan will continue every few seconds until you press **SCAN** again to stop on a particular station.

Comfort Controls & Audio Systems



TUNE: Press this control to tune in stations higher or lower on the AM or FM radio band.

To Preset Radio Stations:

The five pushbuttons (numbered 1-5) can be used to preset up to ten radio stations (five AM and five FM).

1. Tune the digital display to the station you want.
2. Press **SET**. The **SET** indicator will appear on the digital screen for five seconds.
3. While the **SET** indicator is displayed, press one of the five pushbuttons.
4. Repeat steps 1-3 for each of five AM and five FM stations.

Tape Player

This audio system has automatic  Dolby B NR[®] to reduce background noise on Dolby encoded tapes. Dolby[®] Noise Reduction is manufactured under license from Dolby Laboratories Licensing Corporation. Dolby[®] and the  symbol are trademarks of Dolby Laboratories Licensing Corporation. Press **POWER** to turn the radio on.

Then push a cassette into the cassette entry door (the tape side goes in first). Using tapes that are longer than 90 minutes (45 minutes on each side) is not recommended.

FWD (Fast Forward): Press to advance the tape rapidly; press again to play. (The radio plays while a tape is fast forwarding.)

REV (Reverse): Press to reverse the tape rapidly; press again to play tape. (The radio plays while a tape is rewinding.)

SEEK: Press to advance the tape to the beginning of the next selection.

REPT (Repeat): Press to rewind the tape to the beginning of a selection.

PROG (Program): Press to change the side of tape being played. When the arrow pointing up is lighted, the selections listed on the top side of the tape are played. When the arrow pointing down is lighted, selections listed on the bottom side of the tape are played. The tape player automatically begins playing the other side when it reaches the end of the tape.

CRO₂: This button sets tape bias. When playing high bias chrome or metal tapes, press the button to turn the button light on. When playing standard tapes, press again to turn the light off.

EJCT: Press to have the cassette tape ejected (the radio will then play).

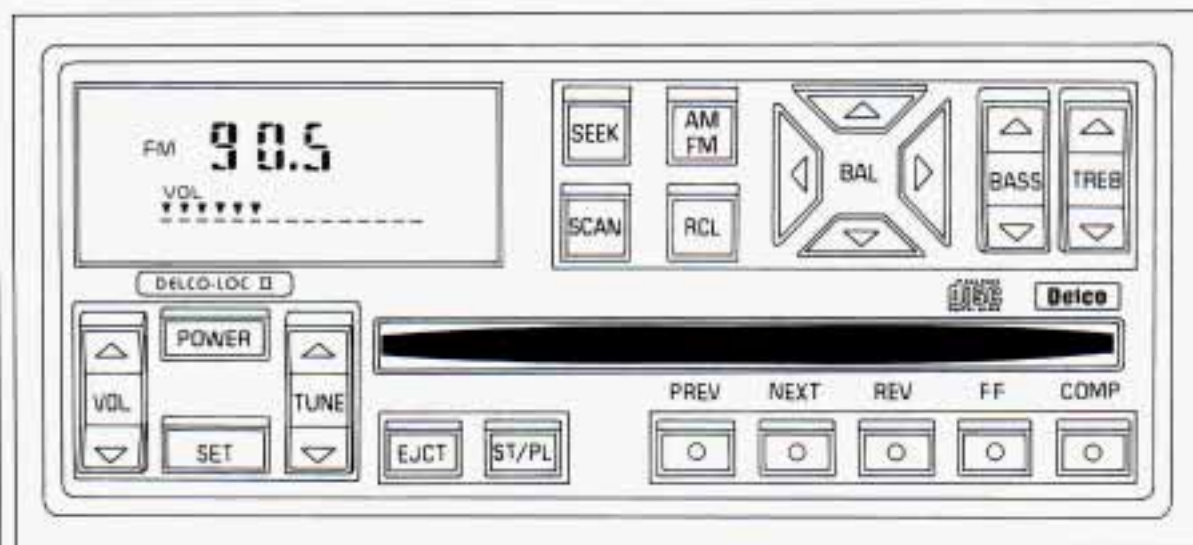

AM/FM Stereo with Compact Disc Player

The digital display indicates information on time or radio station frequency, the AM or FM radio band, whether the station is in stereo, and other radio functions.

POWER: Press to turn the unit on and off when the ignition is on.

VOL (Volume): Adjusts the volume up or down, and the bottom of the digital screen displays the setting. For a normal listening level preset at the factory, press the center of the switch.

TUNE: Press this switch to tune in higher frequencies and lower frequencies.

SEEK: Press to tune automatically to the next station higher on the band.

BAL (Balance): Adjusts the left/right and front/rear speaker balance to your individual taste. When you change either adjustment, the bottom of the digital screen will display the point of balance you have selected. For the normal setting preset at the factory, press the left and right or front and rear buttons at the same time.

SCAN: Press to listen for a few seconds to the next station on the AM or FM band; the scan will continue every few seconds until you press **SCAN** again to stop on a particular station.

RCL (Recall): Press to change between the clock and the radio station frequency displayed on the digital screen.

AM/FM: Press to switch between the AM and FM bands.

To Preset Radio Stations

The five pushbuttons in the lower right corner can be used to preset up to ten radio stations (five AM and five FM). The buttons have other uses when you are playing a compact disc.

1. Tune the digital display to the station you want.
2. Press **SET**. The **SET** indicator will appear on the digital screen for five seconds.
3. While the **SET** indicator is displayed, press one of the five pushbuttons.
4. Repeat steps 1-3 for each of five AM and five FM stations.

Comfort Controls & Audio Systems

To Play a Compact Disc:

Many of the controls for the radio also have functions for the compact disc player, as explained here.

Don't use mini-discs that are called singles. They won't eject. Use only full-size compact discs.

1. Press **POWER** to turn the unit on.
2. Insert a disc part-way into the slot, with the label side up. The player will pull it in. In a few seconds, the disc should play.

If the disc comes back out:

- The disc may be upside down.
- The disc may be dirty, scratched or wet.
- There may be too much moisture in the air (wait about one hour and try again).
- The player may be too hot, or the road may be too rough for the disc to play.

While a disc is playing, the CD indicator is displayed on the digital screen, as is the clock.

RCL (Recall): Press once to see which track is playing. Press again within five

seconds to see how long your selection has been playing. The track number also will be displayed when the volume is changed or a new track starts to play.

PREV (Previous): Press to play a track again. If you hold the **PREV** button, the disc will keep backing up to previous tracks.

NEXT: Press when you want to hear the next track. If you hold the **NEXT** button, the disc will keep advancing to other tracks.

REV (Reverse): Press and hold to rapidly back up to a favorite passage. Release to resume playing.

FF (Fast Forward): Press and hold to rapidly advance the disc. Release to resume playing.

COMP (Compression): Depressing this button makes soft and loud passages more equal in volume. Press again to resume normal play.

When Finished with the Compact Disc Player:

If you press **POWER** or turn off the ignition, the disc will stay in the player and start again when you turn on the

ignition or power switch. The disc will begin playing at the point where it had been stopped.

ST/PL (Stop/Play): Press to stop the disc player; the radio will play. Press again to play the disc (the player will start playing the disc where it was stopped earlier).

EJCT (Eject): Press to eject the disc; the radio will play.

CD Player Anti-Theft Feature

Delco Loc II[®] is a security feature that can be used or ignored. If you ignore it, your system will play normally. If you use it, your system cannot be turned on if it is stolen. These instructions will tell you how to enter a secret code into your system. Then, if battery power is lost for any reason, the secret code must be entered again before the system can be turned on.

To Set:

1. Write down any six-digit number and keep it in a safe place. This is your secret code.

2. Turn the ignition to **Accessory** or **Run**.
3. Press the **POWER** button to turn the radio off.
4. Press the **PREV** and **FF** buttons at the same time and hold until "—" shows on the display. You now have only 15 seconds between each of the following steps.
5. Press **SET** and **000** appears on the display.
6. Press and hold **SEEK** until the first digit of your code appears.
7. Press and hold **SCAN** until the second and third digits of your code appear.
8. Press **AM/FM** (**000** appears).
9. Press and hold **SEEK** until the fourth digit of your code appears.
10. Press and hold **SCAN** until the fifth and sixth digits of your code appear.
11. Press **AM/FM** (**rEP** will appear for five seconds, then **000**).
12. Repeat steps 6 through 10. Then press the **AM/FM** button again. **SEC** will appear, indicating that Delco-Loc II® is set, and your radio

is secure. If "—" appears, the steps were not successful and you must repeat the entire procedure.

To Disable the Anti-Theft System:

Enter your secret code by following these steps (you will have only 15 seconds between each step).

1. Turn the ignition to **Accessory** or **Run** and the radio off, then press the **PREV** and **FF** buttons of the station presets. **SEC** will appear, showing the radio is secure.
2. Press **SET** and **000** appears on the display.
3. Press and hold **SEEK** until the first digit of your secret code appears.
4. Press and hold **SCAN** until the second and third digits of your code appear.
5. Press **AM/FM** (**000** will appear on the display).
6. Press and hold **SEEK** until the fourth digit of your code appears.
7. Press and hold **SCAN** until the fifth and sixth digits of your code appear.
8. Press **AM/FM**. If the display shows "—" the radio is unsecured and will

play again. If the display shows **SEC**, the steps were not successful and the numbers did not match the secret code.

If you lose or forget your code, see your dealer.

If you lose battery power, when the battery is reconnected, the system will not turn on and **LOC** will appear. Follow steps 1-8 for disabling your system (the time will appear if you are successful). If **SEC** appears, the numbers did not match and your unit is still locked.

Comfort Controls & Audio Systems

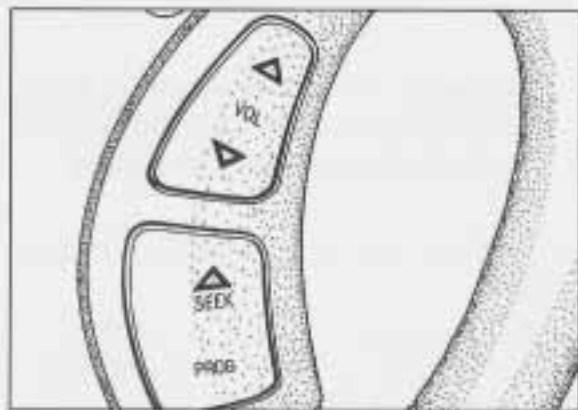

Steering Wheel Touch Controls for Audio System (OPTION)

Some audio system functions described in the previous pages can also be operated with the Steering Wheel Touch Controls option. These touch controls also operate some climate controls. See the *Index* under *Steering Wheel Touch Controls for Climate Control*.

PROG (Program): Press to hear stations which you have preset on your radio.

VOL (Volume): Press the top of the switch to increase volume or the bottom to decrease it. Press the middle of the

switch to mute the audio system. Press any switch to return to your original volume level.

SEEK: Each time you press the switch, you will tune in a radio station higher on the AM or FM band.

With a CD player, pressing **SEEK** will advance the tracks.

Understanding Radio Reception

FM Stereo

FM Stereo will give you the best sound, but FM signals will reach only about 10 to 40 miles (16 to 65 km). Tall buildings or hills can interfere with FM signals, causing the sound to come and go.

AM

The range for most AM stations is greater than for FM, especially at night. The longer range, however, can cause stations to interfere with each other. AM can also pick up noise from things like storms and power lines. To lower this noise, try reducing the treble level.

AM Stereo

Your Delco® system may be able to receive C-Quam® stereo broadcasts. Many AM stations around the country use C-Quam® to produce stereo, though some do not. C-Quam® is a registered trademark of Motorola, Inc. If your Delco® system can get C-Quam® signals, your stereo indicator light will come on when you are receiving it.



Care of Your Cassette Tape Player

A tape player that is not cleaned regularly is subject to reduced sound quality, ruining the cassette, or damaging the mechanism. Tape cassettes that are not properly stored in their plastic cases away from contaminants, direct sunlight, and extreme heat may not operate properly and could cause premature failure of the tape player.

Your tape player should be cleaned monthly or with every 15 hours of use, as regular maintenance. If you notice a reduction in sound quality, try a good cassette to see if the tape or the tape player is at fault. If the second cassette results in no improvement in sound

quality, try cleaning the tape player.

Proper tape player cleaning should be done with a **wiping action** nonabrasive cleaner cassette. To properly clean your tape player, you should follow the directions on the cleaning cassette.

Cassettes are subject to wear and the sound quality may degrade over time. Always verify that the cassette tape is in good condition before obtaining service on your tape player.



Care of Your Compact Discs

Handle discs carefully. Store them in their original cases or other protective cases and away from direct sunlight and dust. If the surface of a disc is soiled, dampen a clean, soft cloth in a mild, neutral detergent solution and clean it, wiping from the center to the edge.

Be sure never to touch the signal surface when handling discs. Pick up discs by grasping the outer edges or the edge of the hole and the outer edge.

Fixed Mast Antenna

The fixed mast antenna can withstand most car washes without being damaged. If the mast should ever become slightly bent, you can straighten

Comfort Controls & Audio Systems

it out by hand. If the mast is badly bent, as it might be by vandals, you should replace it.

Check every once in a while to be sure the mast is still tightened to the fender.

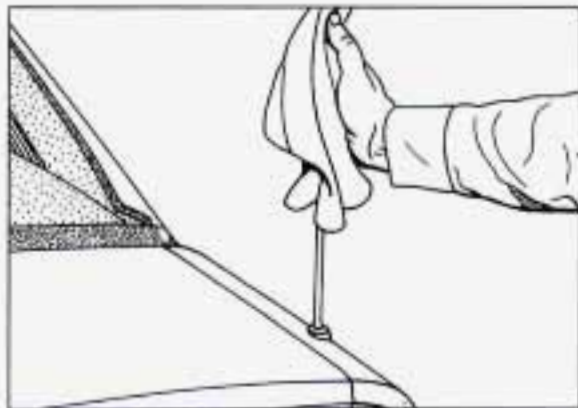

Power Antenna Mast Care

Your power antenna will look its best and work well if it's cleaned from time to time.

To Clean the Antenna Mast:

1. Turn on the ignition and radio to raise the antenna to full mast extension.
2. Dampen a clean cloth with mineral spirits or equivalent solvent.
3. Wipe cloth over the mast sections, removing any dirt.
4. Wipe dry with clean cloth before retracting.
5. Make the antenna go up and down by turning the radio or ignition on and off.

6. Then repeat if necessary.

NOTICE:

Don't lubricate the power antenna. Lubrication could damage it.

NOTICE:

Before entering an automatic car wash, turn off your radio to make the power antenna go down. This will prevent the mast from possibly getting damaged. If the antenna does not go down when you turn the radio off, it may be damaged or need to be cleaned. In either case, lower the antenna by hand by carefully pressing the antenna down.

If the mast portion of your antenna is damaged, you can easily replace it. See your dealer for a replacement kit and follow the instructions in the kit.

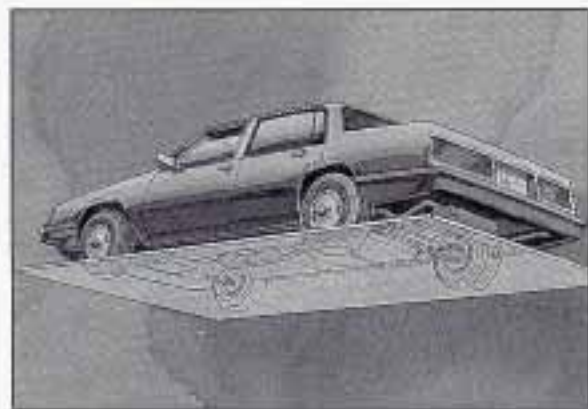

Here you'll find information about driving on different kinds of roads and in varying weather conditions. We've also included many other useful tips on driving.

Part 4

Your Driving and the Road

Defensive Driving	126
Drunken Driving	126
Control of a Vehicle	
Braking	128
Anti-Lock Brakes	129
Steering Tips	130
Steering in Emergencies	131
Passing	132
Driving at Night.....	134
Driving in the Rain	135
City Driving.....	137
Freeway Driving	137
Hill and Mountain Roads	139
Winter Driving	140
Towing a Trailer.....	143

Your Driving and the Road

■ *Defensive Driving*

The best advice anyone can give about driving is: Drive defensively.

Please start with a very important safety device in your Oldsmobile: Buckle up. (See *Safety Belts* in the *Index*.)

Defensive driving really means “be ready for anything.” On city streets, rural roads, or freeways, it means “always expect the unexpected.”

Assume that pedestrians or other drivers are going to be careless and make mistakes. Anticipate what they might do. Be ready for their mistakes.

Rear-end collisions are about the most preventable of accidents. Yet they are common. Allow enough following distance. It's the best defensive driving maneuver, in both city and rural driving. You never know when the vehicle in front of you is going to brake or turn suddenly.

■ *Drunken Driving*

Death and injury associated with drinking and driving is a national tragedy. It's the number one contributor to the highway death toll, claiming

thousands of victims every year. Alcohol takes away three things that anyone needs to drive a vehicle:

- Judgment
- Muscular Coordination
- Vision

Police records show that almost half of all motor vehicle-related deaths involve alcohol — a driver, a passenger or someone else, such as a pedestrian, had been drinking. In most cases, these deaths are the result of someone who was drinking and driving. About 20,000 motor vehicle-related deaths occur each year because of alcohol, and thousands of people are injured.

Just how much alcohol is too much if a person plans to drive? Ideally, no one should drink alcohol and then drive. But if one does, then what's “too much”? It can be a lot less than many might think. Although it depends on each person and situation, here is some general information on the problem.

The Blood Alcohol Content (BAC) of someone who is drinking depends upon four things:

- How much alcohol is in the drink.
- The drinker's body weight.
- The amount of food that is consumed before and during drinking.
- The length of time it has taken the drinker to consume the alcohol.



According to the American Medical Association, a 180-pound (82 kg) person who drinks three 12-ounce (355 ml) bottles of beer in an hour will end up with a BAC of about 0.06 percent. The person would reach the same BAC by drinking three 4-ounce (120 ml) glasses of wine or three mixed drinks if each had 1-1/2 ounces (45 ml) of a liquor like whiskey, gin or vodka.

It's the amount of alcohol that counts. For example, if the same person drank three double martinis (3 ounces or 90 ml of liquor each) within an hour, the person's BAC would be close to 0.12 percent. A person who consumes food just before or during drinking will have a slightly lower BAC level.

Drinking That Will Result in a BAC of .05% in the Time Shown

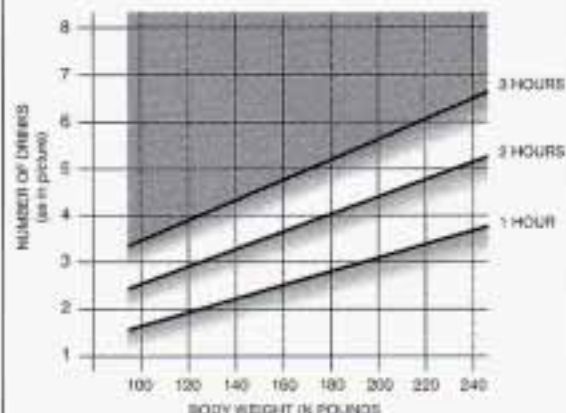

The law in most U.S. states sets the legal limit at a BAC of 0.10 percent. In Canada the limit is 0.08 percent, and in some other countries it's lower than that. The BAC will be over 0.10 percent after three to six drinks (in one hour). Of course, as we've seen, it depends on how much alcohol is in the drinks, and how quickly the person drinks them.

But it's very important to keep in mind that the ability to drive is affected well below a BAC of 0.10 percent. Research shows that the driving skills of many people are impaired at a BAC approaching 0.05 percent, and that the effects are worse at night. All drivers are

impaired at BAC levels above 0.05 percent. Statistics show that the chance of being in an accident increases sharply for drivers who have a BAC of 0.05 percent or above. A driver with a BAC level of 0.06 percent (three beers in one hour for a 180-pound or 82 kg person) has doubled his or her chance of having an accident. At a BAC level of 0.10 percent, the chance of that driver having an accident is six times greater; at a level of 0.15 percent, the chances are twenty-five times greater! And, the body takes about an hour to rid itself of the alcohol in one drink. No amount of coffee or number of cold showers will speed that up.

"I'll be careful" isn't the right answer. What if there's an emergency, a need to take sudden action, as when a child darts into the street? A person with a higher BAC might not be able to react quickly enough to avoid the collision.

There's something else about drinking and driving that many people don't know. Medical research shows that alcohol in a person's system can make crash injuries worse. That's especially true for brain, spinal cord and heart

Your Driving and the Road

injuries. That means that if anyone who has been drinking — driver or passenger — is in a crash, the chance of being killed or permanently disabled is higher than if that person had not been drinking. And we've already seen that the chance of a crash itself is higher for drinking drivers.



CAUTION:

Drinking and then driving is very dangerous. Your reflexes, perceptions, and judgment will be affected by even a small amount of alcohol. You could have a serious — or even fatal — accident if you drive after drinking. Please don't drink and drive or ride with a driver who has been drinking. Ride home in a cab; or if you're with a group, designate a driver who will not drink.

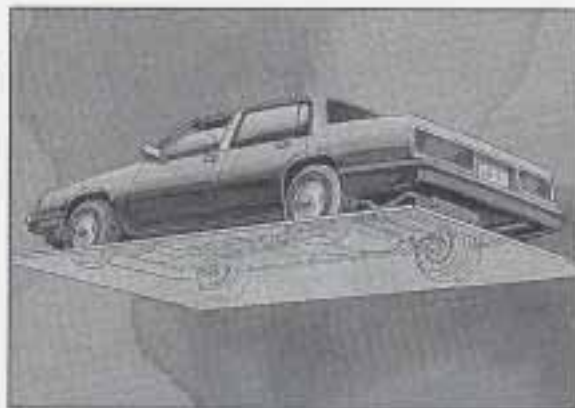

■ Control of a Vehicle

You have three systems that make your vehicle go where you want it to go. They are the brakes, the steering and the accelerator. All three systems have to do their work at the places where the tires meet the road.

Sometimes, as when you're driving on snow or ice, it's easy to ask more of those control systems than the tires and road can provide. That means you can lose control of your vehicle.

■ Braking

Braking action involves **perception time** and **reaction time**.

First, you have to decide to push on the

brake pedal. That's **perception time**. Then you have to bring up your foot and do it. That's **reaction time**.

Average **reaction time** is about $\frac{3}{4}$ of a second. But that's only an average. It might be less with one driver and as long as two or three seconds or more with another. Age, physical condition, alertness, coordination, and eyesight all play a part. So do alcohol, drugs and frustration. But even in $\frac{3}{4}$ of a second, a vehicle moving at 60 mph (100 km/h) travels 66 feet (20 m). That could be a lot of distance in an emergency, so keeping enough space between your vehicle and others is important.

And, of course, actual stopping distances vary greatly with the surface of the road (whether it's pavement or gravel); the condition of the road (wet, dry, icy); tire tread; and the condition of your brakes.

Avoid needless heavy braking. Some people drive in spurts — heavy acceleration followed by heavy braking — rather than keeping pace with traffic. This is a mistake. Your brakes may not have time to cool between hard stops. Your brakes will wear out much faster if

you do a lot of heavy braking. If you keep pace with the traffic and allow realistic following distances, you will eliminate a lot of unnecessary braking. That means better braking and longer brake life.

If your engine ever stops while you're driving, brake normally but don't pump your brakes. If you do, the pedal may get harder to push down. If your engine stops, you will still have some power brake assist. But you will use it when you brake. Once the power assist is used up, it may take longer to stop and the brake pedal will be harder to push.

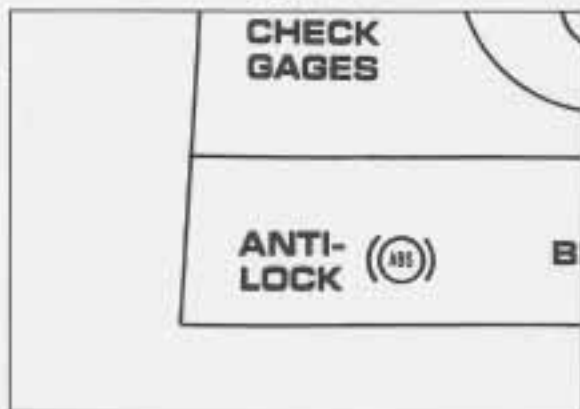

Anti-Lock Brakes (ABS)

Your Oldsmobile has an advanced electronic braking system that will help prevent skidding.

This light on the instrument panel will go on when you start your vehicle.

When you start your vehicle, or when you begin to drive away, you may hear a momentary motor or clicking noise. And you may even notice that your brake pedal moves a little while this is going on. This is the ABS system testing itself. If there's a problem with the anti-lock brake system, the anti-lock brake system warning light will stay on or flash.

See Anti-Lock Brake System Warning Light in the Index.



Here's how anti-lock works. Let's say the road is wet. You're driving safely. Suddenly an animal jumps out in front of you.

You slam on the brakes. Here's what happens with ABS.

A computer senses that wheels are slowing down. If one of the wheels is about to stop rolling, the computer will separately work the brakes at each front wheel and at the rear wheels.

The anti-lock system can change the brake pressure faster than any driver could. The computer is programmed to make the most of available tire and road conditions.

Your Driving and the Road



You can steer around the obstacle while braking hard.

As you brake, your computer keeps receiving updates on wheel speed and controls braking pressure accordingly.

Remember: Anti-lock doesn't change the time you need to get your foot up to the brake pedal. If you get too close to the vehicle in front of you, you won't have time to apply your brakes if that vehicle suddenly slows or stops. Always leave enough room up ahead to stop, even though you have anti-lock brakes.

To Use Anti-Lock

Don't pump the brakes. Just hold the brake pedal down and let anti-lock work for you. You may feel the system working, or you may notice some noise, but this is normal.

Braking in Emergencies

Use your anti-lock braking system when you need to. With anti-lock, you can steer and brake at the same time. In many emergencies, steering can help you more than even the very best braking.

Steering Power Steering

If you lose power steering assist because the engine stops or the system is not functioning, you can steer but it will take much more effort.

Steering Tips

Driving on Curves

It's important to take curves at a reasonable speed.

A lot of the "driver lost control" accidents mentioned on the news happen on curves. Here's why:

Experienced driver or beginner, each of us is subject to the same laws of physics when driving on curves. The traction of the tires against the road surface makes

it possible for the vehicle to change its path when you turn the front wheels. If there's no traction, inertia will keep the vehicle going in the same direction. If you've ever tried to steer a vehicle on wet ice, you'll understand this.

The traction you can get in a curve depends on the condition of your tires and the road surface, the angle at which the curve is banked, and your speed. While you're in a curve, speed is the one factor you can control.

Suppose you're steering through a sharp curve. Then you suddenly accelerate. Both control systems — steering and acceleration — have to do their work where the tires meet the road. Adding the sudden acceleration can demand too much of those places. You can lose control.

What should you do if this ever happens? Ease up on the accelerator pedal, steer the vehicle the way you want it to go, and slow down.

Speed limit signs near curves warn that you should adjust your speed. Of course, the posted speeds are based on good weather and road conditions.

Under less favorable conditions you'll want to go slower.

If you need to reduce your speed as you approach a curve, do it before you enter the curve, while your front wheels are straight ahead.

Try to adjust your speed so you can "drive" through the curve. Maintain a reasonable, steady speed. Wait to accelerate until you are out of the curve, and then accelerate gently into the straightaway.



Steering in Emergencies

There are times when steering can be more effective than braking. For example, you come over a hill and find a truck stopped in your lane, or a car suddenly pulls out from nowhere, or a child darts out from between parked cars and stops right in front of you. You can avoid these problems by braking — if you can stop in time. But sometimes you can't; there isn't room. That's the time for evasive action — steering around the problem.

Your Oldsmobile can perform very well in emergencies like these. First apply your brakes. It is better to remove as much speed as you can from a possible collision. Then steer around the

problem, to the left or right depending on the space available.

An emergency like this requires close attention and a quick decision. If you are holding the steering wheel at the recommended 9 and 3 o'clock positions, you can turn it a full 180 degrees very quickly without removing either hand. But you have to act fast, steer quickly, and just as quickly straighten the wheel once you have avoided the object.

The fact that such emergency situations are always possible is a good reason to practice defensive driving at all times and wear safety belts properly.

Your Driving and the Road



■ Off-Road Recovery

You may find sometime that your right wheels have dropped off the edge of a road onto the shoulder while you're driving.

If the level of the shoulder is only slightly below the pavement, recovery should be fairly easy. Ease off the accelerator and then, if there is nothing in the way, steer so that your vehicle straddles the edge of the pavement. You can turn the steering wheel up to 1/4 turn until the right front tire contacts the pavement edge. Then turn your steering wheel to go straight down the roadway.

■ Passing

The driver of a vehicle about to pass another on a two-lane highway waits for just the right moment, accelerates, moves around the vehicle ahead, then goes back into the right lane again. A simple maneuver?

Not necessarily! Passing another vehicle on a two-lane highway is a potentially dangerous move, since the passing vehicle occupies the same lane as oncoming traffic for several seconds. A miscalculation, an error in judgment, or a brief surrender to frustration or anger can suddenly put the passing driver face to face with the worst of all traffic accidents — the head-on collision.

So here are some tips for passing:

- "Drive ahead." Look down the road, to the sides, and to crossroads for situations that might affect your passing patterns. If you have any doubt whatsoever about making a successful pass, wait for a better time.
- Watch for traffic signs, pavement markings, and lines. If you can see a sign up ahead that might indicate a turn or an intersection, delay your

pass. A broken center line usually indicates it's all right to pass (providing the road ahead is clear). Never cross a solid line on your side of the lane or a double solid line, even if the road seems empty of approaching traffic.

- Do not get too close to the vehicle you want to pass while you're awaiting an opportunity. For one thing, following too closely reduces your area of vision, especially if you're following a larger vehicle. Also, you won't have adequate space if the vehicle ahead suddenly slows or stops. Keep back a reasonable distance.
- When it looks like a chance to pass is coming up, start to accelerate but stay in the right lane and don't get too close. Time your move so you will be increasing speed as the time comes to move into the other lane. If the way is clear to pass, you will have a "running start" that more than makes up for the distance you would lose by dropping back. And if something happens to cause you to cancel your pass, you need only slow down and

drop back again and wait for another opportunity.

- If other cars are lined up to pass a slow vehicle, wait your turn. But take care that someone isn't trying to pass you as you pull out to pass the slow vehicle. Remember to glance over your shoulder and check the blind spot.
- Check your mirrors, glance over your shoulder, and start your left lane change signal before moving out of the right lane to pass. When you are far enough ahead of the passed vehicle to see its front in your inside mirror, activate your right lane change signal and move back into the right lane. (Remember that your right outside mirror is convex. The vehicle you just passed may seem to be farther away from you than it really is.)
- Try not to pass more than one vehicle at a time on two-lane roads. Reconsider before passing the next vehicle.
- Don't overtake a slowly moving vehicle too rapidly. Even though the

brake lights are not flashing, it may be slowing down or starting to turn.

- If you're being passed, make it easy for the following driver to get ahead of you. Perhaps you can ease a little to the right.

■ *Loss of Control*

Let's review what driving experts say about what happens when the three control systems (brakes, steering and acceleration) don't have enough friction where the tires meet the road to do what the driver has asked.

In any emergency, don't give up. Keep trying to steer and constantly seek an escape route or area of less danger.

Skidding

In a skid, a driver can lose control of the vehicle. Defensive drivers avoid most skids by taking reasonable care suited to existing conditions, and by not "overdriving" those conditions. But skids are always possible.

The three types of skids correspond to your Oldsmobile's three control

systems. In the braking skid your wheels aren't rolling. In the steering or cornering skid, too much speed or steering in a curve causes tires to slip and lose cornering force. And in the acceleration skid too much throttle causes the driving wheels to spin.

A cornering skid and an acceleration skid are best handled by easing your foot off the accelerator pedal.

If your vehicle starts to slide, ease your foot off the accelerator pedal and quickly steer the way you want the vehicle to go. If you start steering quickly enough, your vehicle may straighten out. Always be ready for a second skid if it occurs.

Of course, traction is reduced when water, snow, ice, gravel, or other material is on the road. For safety, you'll want to slow down and adjust your driving to these conditions. It is important to slow down on slippery surfaces because stopping distance will be longer and vehicle control more limited.

While driving on a surface with reduced traction, try your best to avoid sudden

Your Driving and the Road

steering, acceleration, or braking (including engine braking by shifting to a lower gear). Any sudden changes could cause the tires to slide. You may not realize the surface is slippery until your vehicle is skidding. Learn to recognize warning clues — such as enough water, ice or packed snow on the road to make a “mirrored surface” — and slow down when you have any doubt.

Remember: Any anti-lock braking system (ABS) helps avoid only the braking skid.



■ *Driving at Night*

Night driving is more dangerous than day driving. One reason is that some drivers are likely to be impaired — by alcohol or drugs, with night vision problems, or by fatigue.

Here are some tips on night driving.

- Drive defensively.
- Don't drink and drive.
- Adjust your inside rearview mirror to reduce the glare from headlights behind you.
- Since you can't see as well, you may need to slow down and keep more space between you and other vehicles.
- Slow down, especially on higher speed roads. Your headlights can light

up only so much road ahead.

- In remote areas, watch for animals.
- If you're tired, pull off the road in a safe place and rest.

Night Vision

No one can see as well at night as in the daytime. But as we get older these differences increase. A 50-year-old driver may require at least twice as much light to see the same thing at night as a 20-year-old.

What you do in the daytime can also affect your night vision. For example, if you spend the day in bright sunshine you are wise to wear sunglasses. Your eyes will have less trouble adjusting to night. But if you're driving, don't wear sunglasses at night. They may cut down on glare from headlights, but they also make a lot of things invisible.

You can be temporarily blinded by approaching lights. It can take a second or two, or even several seconds, for your eyes to readjust to the dark. When you are faced with severe glare (as from a driver who doesn't lower the high beams, or a vehicle with misaimed

headlights), slow down a little. Avoid staring directly into the approaching lights.

Keep your windshield and all the glass on your vehicle clean — inside and out. Glare at night is made much worse by dirt on the glass. Even the inside of the glass can build up a film caused by dust. Dirty glass makes lights dazzle and flash more than clean glass would, making the pupils of your eyes contract repeatedly.

Remember that your headlights light up far less of a roadway when you are in a turn or curve. Keep your eyes moving; that way, it's easier to pick out dimly lighted objects. Just as your headlights should be checked regularly for proper aim, so should your eyes be examined regularly. Some drivers suffer from night blindness — the inability to see in dim light — and aren't even aware of it.



■ *Driving in the Rain*

Rain and wet roads can mean driving trouble. On a wet road you can't stop, accelerate or turn as well because your tire-to-road traction isn't as good as on dry roads. And, if your tires don't have much tread left, you'll get even less traction. It's always wise to go slower and be cautious if rain starts to fall while you are driving. The surface may get wet suddenly when your reflexes are tuned for driving on dry pavement.

The heavier the rain, the harder it is to see. Even if your windshield wiper blades are in good shape, a heavy rain can make it harder to see road signs and traffic signals, pavement markings, the edge of the road, and even people walking.

It's wise to keep your wiping equipment in good shape and keep your windshield washer tank filled. Replace your windshield wiper inserts when they show signs of streaking or missing areas on the windshield, or when strips of rubber start to separate from the inserts.

Your Driving and the Road



Driving too fast through large water puddles or even going through some car washes can cause problems, too. The water may affect your brakes. Try to avoid puddles. But if you can't, try to slow down before you hit them.



CAUTION:

Wet brakes can cause accidents. They won't work well in a quick stop and may cause pulling to one side. You could lose control of the vehicle. After driving through a large puddle of water or a car wash, apply your brake pedal lightly until your brakes work normally.

Hydroplaning

Hydroplaning is dangerous. So much water can build up under your tires that they can actually ride on the water. This can happen if the road is wet enough and you're going fast enough. When your vehicle is hydroplaning, it has little or no contact with the road.

Hydroplaning doesn't happen often. But it can if your tires haven't much tread or if the pressure in one or more is low. It can happen if a lot of water is standing on the road. If you can see reflections from trees, telephone poles, or other vehicles, and raindrops "dimple" the water's surface, there could be hydroplaning.

Hydroplaning usually happens at higher speeds. There just isn't a hard and fast rule about hydroplaning. The best advice is to slow down when it is raining.

Some Other Rainy Weather Tips

- Turn on your low-beam headlights — not just your parking lights — to help make you more visible to others.

- Besides slowing down, allow some extra following distance. And be especially careful when you pass another vehicle. Allow yourself more clear room ahead, and be prepared to have your view restricted by road spray.
- Have good tires with proper tread depth. (See *Tires* in the *Index*.)



■ *City Driving*

One of the biggest problems with city streets is the amount of traffic on them. You'll want to watch out for what the other drivers are doing and pay attention to traffic signals.

Here are ways to increase your safety in city driving:

- Know the best way to get to where you are going. Get a city map and plan your trip into an unknown part of the city just as you would for a cross-country trip.
- Try to use the freeways that rim and crisscross most large cities. You'll save time and energy. (See the next section, *Freeway Driving*.)

- Treat a green light as a warning signal. A traffic light is there because the corner is busy enough to need it. When a light turns green, and just before you start to move, check both ways for vehicles that have not cleared the intersection or may be running the red light.



■ *Freeway Driving*

Mile for mile, freeways (also called thruways, parkways, expressways, turnpikes, or superhighways) are the safest of all roads. But they have their own special rules.

The most important advice on freeway driving is: Keep up with traffic and keep to the right. Drive at the same speed most of the other drivers are driving. Too-fast or too-slow driving breaks a smooth traffic flow. Treat the left lane on a freeway as a passing lane.

At the entrance there is usually a ramp that leads to the freeway. If you have a clear view of the freeway as you drive along the entrance ramp, you should begin to check traffic. Try to determine where you expect to blend with the

Your Driving and the Road

flow. Try to merge into the gap at close to the prevailing speed. Switch on your turn signal, check your mirrors and glance over your shoulder as often as necessary. Try to blend smoothly with the traffic flow.

Once you are on the freeway, adjust your speed to the posted limit or to the prevailing rate if it's slower. Stay in the right lane unless you want to pass.

Before changing lanes, check your mirrors. Then use your turn signal.

Just before you leave the lane, glance quickly over your shoulder to make sure there isn't another vehicle in your "blind" spot.

Once you are moving on the freeway, make certain you allow a reasonable following distance. Expect to move slightly slower at night.

When you want to leave the freeway, move to the proper lane well in advance. If you miss your exit do not, under any circumstances, stop and back up. Drive on to the next exit.

The exit ramp can be curved, sometimes quite sharply.

The exit speed is usually posted.

Reduce your speed according to your speedometer, not to your sense of motion. After driving for any distance at higher speeds, you may tend to think you are going slower than you actually are.

■ *Before Leaving on a Long Trip*

Make sure you're ready. Try to be well rested. If you must start when you're not fresh — such as after a day's work — don't plan to make too many miles that first part of the journey. Wear comfortable clothing and shoes you can easily drive in.

Is your vehicle ready for a long trip? If you keep it serviced and maintained, it's ready to go. If it needs service, have it done before starting out. Of course, you'll find experienced and able service experts in Oldsmobile dealerships all across North America. They'll be ready and willing to help if you need it.

Here are some things you can check before a trip:

- **Windshield Washer Fluid:** Is the reservoir full? Are all windows clean inside and outside?
- **Wiper Blades:** Are they in good shape?
- **Fuel, Engine Oil, Other Fluids:** Have you checked all levels?
- **Lights:** Are they all working? Are the lenses clean?
- **Tires:** They are vitally important to a safe, trouble-free trip. Is the tread good enough for long-distance driving? Are the tires all inflated to the recommended pressure?
- **Weather Forecasts:** What's the weather outlook along your route? Should you delay your trip a short time to avoid a major storm system?
- **Maps:** Do you have up-to-date maps?

■ *Highway Hypnosis*

Is there actually such a condition as "highway hypnosis"? Or is it just plain falling asleep at the wheel? Call it highway hypnosis, lack of awareness, or whatever.

There is something about an easy stretch of road with the same scenery, along with the hum of the tires on the road, the drone of the engine, and the rush of the wind against the vehicle that can make you sleepy. Don't let it happen to you! If it does, your vehicle can leave the road in **less than a second**, and you could crash and be injured.

What can you do about highway hypnosis? First, be aware that it can happen.

Then here are some tips:

- Make sure your vehicle is well ventilated, with a comfortably cool interior.
- Keep your eyes moving. Scan the road ahead and to the sides. Check your rearview mirrors and your instruments frequently.
- If you get sleepy, pull off the road into a rest, service, or parking area and take a nap, get some exercise, or both. For safety, treat drowsiness on the highway as an emergency.



■ *Hill and Mountain Roads*

Driving on steep hills or mountains is different from driving in flat or rolling terrain.

If you drive regularly in steep country, or if you're planning to visit there, here are some tips that can make your trips safer and more enjoyable.

- Keep your vehicle in good shape. Check all fluid levels and also the brakes, tires, cooling system and transaxle. These parts can work hard on mountain roads.
- Know how to go down hills. The most important thing to know is this: let your engine do some of the slowing down. Shift to a lower gear when you go down a steep or long hill.



CAUTION:

If you don't shift down, your brakes could get so hot that they wouldn't work well. You would then have poor braking or even none going down a hill. You could crash. Shift down to let your engine assist your brakes on a steep downhill slope.



CAUTION:

Coasting downhill in **N** (Neutral) or with the ignition off is dangerous. Your brakes will have to do all the work of slowing down. They could get so hot that they wouldn't work well. You could crash. Always have your engine running and your vehicle in gear when you go downhill.

- Know how to go uphill. You may want to shift down to a lower gear. The lower gears help cool your engine.

Your Driving and the Road

and transaxle, and you can climb the hill better.

- Stay in your own lane when driving on two-lane roads in hills or mountains. Don't swing wide or cut across the center of the road. Drive at speeds that let you stay in your own lane.
- As you go over the top of a hill, be alert. There could be something in your lane, like a stalled car or an accident.
- You may see highway signs on mountains that warn of special problems. Examples are long grades, passing or no-passing zones, a falling rocks area, or winding roads. Be alert to these and take appropriate action.



■ Winter Driving

Here are some tips for winter driving:

- Have your Oldsmobile in good shape for winter. Be sure your engine coolant mix is correct.

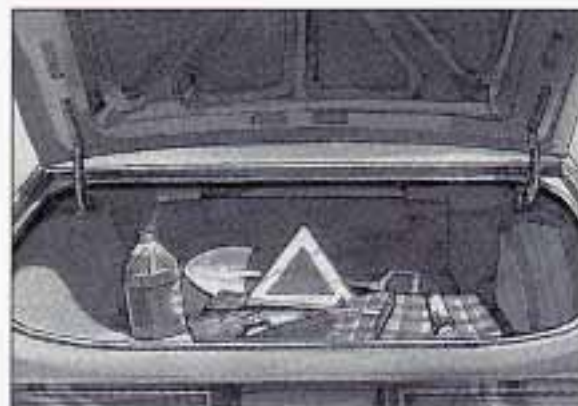

- You may want to put winter emergency supplies in your trunk. Include an ice scraper, a small brush or broom, a supply of windshield washer fluid, a rag, some winter outer clothing, a small shovel, a flashlight, a red cloth, and a couple of reflective warning triangles. And, if you will be driving under severe conditions, include a small bag of sand, a piece of old carpet or a couple of burlap bags to help provide traction. Be sure you properly secure these items in your vehicle.



Driving on Snow or Ice

Most of the time, those places where your tires meet the road probably have good traction.

However, if there is snow or ice between your tires and the road, you can have a very slippery situation. You'll have a lot less traction or "grip" and will need to be very careful.

What's the worst time for this? "Wet ice." Very cold snow or ice can be slick and hard to drive on. But wet ice can be even more trouble because it may offer the least traction of all. You can get "wet ice" when it's about freezing (32°F; 0°C) and freezing rain begins to

fall. Try to avoid driving on wet ice until salt and sand crews can get there.

Whatever the condition — smooth ice, packed, blowing or loose snow — drive with caution. Accelerate gently. Try not to break the fragile traction. If you accelerate too fast, the drive wheels will spin and polish the surface under the tires even more.

Your anti-lock brakes improve your ability to make a hard stop on a slippery road. Even though you have the anti-lock braking system, you'll want to begin stopping sooner than you would on dry pavement. See *Anti-Lock Brakes* in the *Index*.

- Allow greater following distance on any slippery road.
- Watch for slippery spots. The road might be fine until you hit a spot that's covered with ice. On an otherwise clear road, ice patches may appear in shaded areas where the sun can't reach: around clumps of trees, behind buildings, or under bridges. Sometimes the surface of a curve or

an overpass may remain icy when the surrounding roads are clear. If you see a patch of ice ahead of you, brake before you are on it. Try not to brake while you're actually on the ice, and avoid sudden steering maneuvers.

Your Driving and the Road



If You're Caught in a Blizzard

If you are stopped by heavy snow, you could be in a serious situation. You should probably stay with your vehicle unless you know for sure that you are near help and you can hike through the snow. Here are some things to do to summon help and keep yourself and your passengers safe: Turn on your hazard flashers. Tie a red cloth to your vehicle to alert police that you've been stopped by the snow. Put on extra clothing or wrap a blanket around you. If you have no blankets or extra clothing, make body insulators from newspapers, burlap bags, rags, floor

mats — anything you can wrap around yourself or tuck under your clothing to keep warm.

You can run the engine to keep warm, but be careful.



CAUTION:

Snow can trap exhaust gases under your vehicle. This can cause deadly CO (carbon monoxide) gas to get inside. CO could overcome you and kill you. You can't see it or smell it, so you might not know it is in your vehicle. Clear away snow from around the base of your vehicle, especially any that is blocking your exhaust pipe. And check around again from time to time to be sure snow doesn't collect there. Open a window just a little on the side of the vehicle that's away from the wind. This will help keep CO out.

Run your engine only as long as you must. This saves fuel. When you run the engine, make it go a little faster than just idle. That is, push the accelerator slightly. This uses less fuel for the heat that you get and it keeps the battery charged. You will need a well-charged battery to restart the vehicle, and possibly for signaling later on with your headlights. Let the heater run for awhile.

Then, shut the engine off and close the window almost all the way to preserve the heat. Start the engine again and repeat this only when you feel really uncomfortable from the cold. But do it as little as possible. Preserve the fuel as long as you can. To help keep warm, you can get out of the vehicle and do some fairly vigorous exercises every half hour or so until help comes.

■ *Towing a Trailer*



CAUTION:

If you don't use the correct equipment and drive properly, you can lose control when you pull a trailer. For example, if the trailer is too heavy, the brakes may not work well — or even at all. You and your passengers could be seriously injured. Pull a trailer only if you have followed all the steps in this section. Ask your Oldsmobile dealer for advice and information about towing a trailer with your vehicle.

NOTICE:

Pulling a trailer improperly can damage your vehicle and result in costly repairs not covered by your warranty. To pull a trailer correctly, follow the advice in this section, and see your Oldsmobile dealer for important information about towing a trailer with your vehicle.

Do not tow a trailer if your vehicle is equipped with a 3.4L VIN Code X engine and a convertible top.

Your vehicle can tow a trailer if it is equipped with a 3100 VIN Code M engine or a 3.4L VIN Code X engine (except for convertibles) and proper trailer towing equipment. To identify what the vehicle trailering capacity is for your vehicle, you should read the information in *Weight of the Trailer* that appears later in this section. But trailering is different than just driving your vehicle by itself. Trailering means changes in handling, durability, and fuel economy. Successful, safe trailering takes correct equipment, and it has to be used properly.

Your Driving and the Road

That's the reason for this section. In it are many time-tested, important trailering tips and safety rules. Many of these are important for your safety and that of your passengers. So please read this section carefully before you pull a trailer.

Load-pulling components such as the engine, transaxle, wheel assemblies, and tires are forced to work harder against the drag of the added weight. The engine is required to operate at relatively higher speeds and under greater loads, generating extra heat. What's more, the trailer adds considerably to wind resistance, increasing the pulling requirements.

If You Do Decide To Pull A Trailer

If you do, here are some important points.

- There are many different laws having to do with trailering. Make sure your rig will be legal, not only where you live but also where you'll be driving. A good source for this information can be state or provincial police.

- Consider using a sway control.

You can ask a hitch dealer about sway controls.

- Don't tow a trailer at all during the first 500 miles (800 km) your new vehicle is driven. Your engine, axle or other parts could be damaged.
- Then, during the first 500 miles (800 km) that you tow a trailer, don't drive over 50 mph (80 km/h) and don't make starts at full throttle. This helps your engine and other parts of your vehicle wear in at the heavier loads.

Three important considerations have to do with weight:

Weight of the Trailer

How heavy can a trailer safely be?

It should never weigh more than 1,000 pounds (450 kg). But even that can be too heavy.

It depends on how you plan to use your rig. For example, speed, altitude, road grades, outside temperature and how much your vehicle is used to pull a

trailer are all important. And, it can also depend on any special equipment that you have on your vehicle.

You can ask your dealer for our trailering information or advice, or you can write us at:

Oldsmobile Customer Assistance
Network
P.O. Box 30095
Lansing, MI 48909

In Canada, write to:

General Motors of Canada Limited
Customer Assistance Center
1908 Colonel Sam Drive
Oshawa, Ontario L1H 8P7.

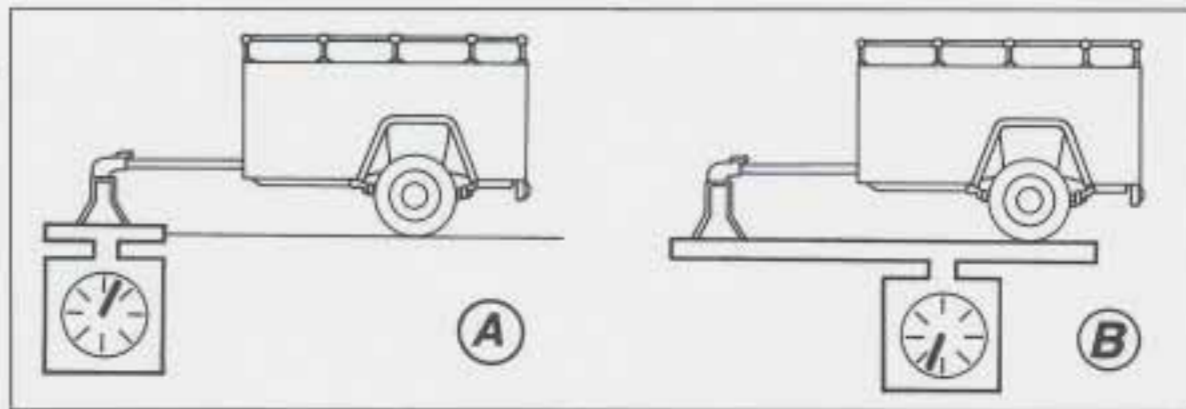

Weight of the Trailer Tongue

The tongue load (A) of any trailer is an important weight to measure because it affects the total capacity weight of your vehicle. The capacity weight includes the curb weight of the vehicle, any cargo you may carry in it, and the people who will be riding in the vehicle. And if you will tow a trailer, you must subtract the tongue load from your vehicle's capacity weight because your vehicle will be carrying that weight, too. See *Loading Your Vehicle* in the *Index* for more information about your vehicle's maximum load capacity.

If you're using a "dead-weight" hitch, the trailer tongue (A) should weigh 10% of the total loaded trailer weight (B). If you have a "weight-distributing"

hitch, the trailer tongue (A) should weigh 12% of the total loaded trailer weight (B).

After you've loaded your trailer, weigh the trailer and then the tongue, separately, to see if the weights are proper. If they aren't, you may be able to get them right simply by moving some items around in the trailer.

Total Weight on Your Vehicle's Tires

Be sure your vehicle's tires are inflated to the limit for cold tires. You'll find these numbers on the Tire-Loading Information label at the rear edge of the driver's door or on the inside of the trunk lid; or see *Loading Your Vehicle*

in the *Index*. Then be sure you don't go over the GVW limit for your vehicle.

Hitches

It's important to have the correct hitch equipment. Crosswinds, large trucks going by, and rough roads are a few reasons why you'll need the right hitch. Here are some rules to follow:

- Will you have to make any holes in the body of your vehicle when you install a trailer hitch? If you do, then be sure to seal the holes later when you remove the hitch. If you don't seal them, deadly carbon monoxide (CO) from your exhaust can get into your vehicle (see *Carbon Monoxide* in the *Index*). Dirt and water can, too.
- The bumpers on your vehicle are not intended for hitches. Do not attach rental hitches or other bumper-type hitches to them. Use only a frame-mounted hitch that does not attach to the bumper.

Your Driving and the Road

Safety Chains

You should always attach chains between your vehicle and your trailer. Cross the safety chains under the tongue of the trailer so that the tongue will not drop to the road if it becomes separated from the hitch. Instructions about safety chains may be provided by the hitch manufacturer or by the trailer manufacturer. Follow the manufacturer's recommendation for attaching safety chains. Always leave just enough slack so you can turn with your rig. And, never allow safety chains to drag on the ground.

Trailer Brakes

Because you have anti-lock brakes, don't try to tap into your vehicle's brake system at all. If you do, both brake systems won't work well or at all.

Driving with a Trailer

Towing a trailer requires a certain amount of experience. Before setting out for the open road, you'll want to get to know your rig. Acquaint yourself

with the feel of handling and braking with the added weight of the trailer. And always keep in mind that the vehicle you are driving is now a good deal longer and not nearly so responsive as your vehicle is by itself.

Before you start, check the trailer hitch and platform, safety chains, electrical connector, lights, tires and mirror adjustment. If the trailer has electric brakes, start your vehicle and trailer moving and then apply the trailer brake controller by hand to be sure the brakes are working. This lets you check your electrical connection at the same time.

During your trip, check occasionally to be sure that the load is secure, and that the lights and any trailer brakes are still working.

Following Distance

Stay at least twice as far behind the vehicle ahead as you would when driving your vehicle without a trailer. This can help you avoid situations that require heavy braking and sudden turns.

Passing

You'll need more passing distance up ahead when you're towing a trailer. And, because you're a good deal longer, you'll need to go much farther beyond the passed vehicle before you can return to your lane.

Backing Up

Hold the bottom of the steering wheel with one hand. Then, to move the trailer to the left, just move that hand to the left. To move the trailer to the right, move your hand to the right. Always back up slowly and, if possible, have someone guide you.

Making Turns

When you're turning with a trailer, make wider turns than normal. Do this so your trailer won't strike soft shoulders, curbs, road signs, trees, or other objects. Avoid jerky or sudden maneuvers. Signal well in advance.

Turn Signals When Towing a Trailer

When you tow a trailer, your vehicle has to have a different turn signal flasher and extra wiring. The green arrows on your instrument panel will flash whenever you signal a turn or lane change. Properly hooked up, the trailer lights will also flash, telling other drivers you're about to turn, change lanes or stop.

When towing a trailer, the green arrows on your instrument panel will flash for turns even if the bulbs on the trailer are burned out. Thus, you may think drivers behind you are seeing your signal when they are not. It's important to check occasionally to be sure the trailer bulbs are still working.

Driving On Grades

Reduce speed and shift to a lower gear **before** you start down a long or steep downgrade. If you don't shift down, you might have to use your brakes so much that they would get hot and no longer work well.

On a long uphill grade, shift down and reduce your speed to around 45 mph (70 km/h) to reduce the possibility of engine and transaxle overheating.

If you are towing a trailer and you have an automatic transaxle with Overdrive, you may want to drive in **3** instead of **D** (or, as you need to, a lower gear).

Parking on Hills

You really should not park your vehicle, with a trailer attached, on a hill. If something goes wrong, your rig could start to move. People can be injured, and both your vehicle and the trailer can be damaged.

But if you ever have to park your rig on a hill, here's how to do it:

1. Apply your regular brakes, but don't shift into **P** (Park) yet.
2. Have someone place chocks under the trailer wheels.
3. When the wheel chocks are in place, release the regular brakes until the chocks absorb the load.

4. Reapply the regular brakes. Then apply your parking brake, and then shift to **P** (Park).

5. Release the regular brakes.

When You Are Ready to Leave After Parking on a Hill

1. Apply your regular brakes and hold the pedal down while you:
 - Start your engine;
 - Shift into a gear; and
 - Release the parking brake.
2. Let up on the brake pedal.
3. Drive slowly until the trailer is clear of the chocks.
4. Stop and have someone pick up and store the chocks.

Your Driving and the Road

Maintenance When Trailer Towing

Your vehicle will need service more often when you're pulling a trailer. See the *Maintenance Schedule* for more on this. Things that are especially important in trailer operation are automatic transaxle fluid (don't overfill), engine oil, belts, cooling system, and brake adjustment. Each of these is covered in this manual, and the *Index* will help you find them quickly. If you're trailering, it's a good idea to review these sections before you start your trip.

Check periodically to see that all hitch nuts and bolts are tight.



Here you'll find what to do about some problems that can occur on the road.

Part 5

Problems on the Road

Hazard Warning Flashers	150
Jump Starting	150
Towing Your Oldsmobile	154
Engine Overheating	158
If a Tire Goes Flat	165
Changing a Flat Tire	166
Compact Spare Tire	172
If You're Stuck: In Sand, Mud, Ice or Snow	173

Problems on the Road



■ Hazard Warning Flashers

Your hazard warning flashers let you warn others. They also let police know you have a problem. Your front and rear turn signal lights will flash on and off.

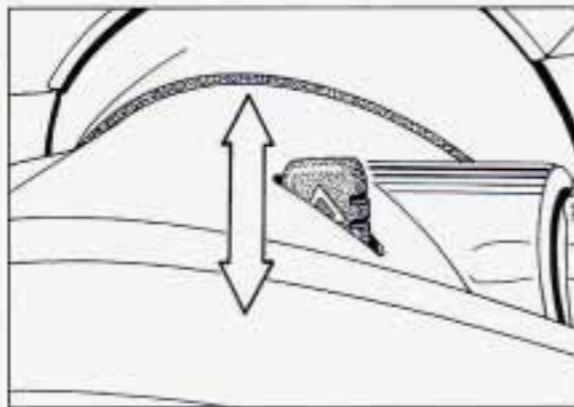

Slide the switch up to make your front and rear turn signal lights flash on and off.

Your hazard warning flashers work no matter what position your key is in, and even if the key isn't in.

To turn off the flashers, slide the switch down.

When the hazard warning flashers are on, your turn signals won't work.

■ Other Warning Devices

If you carry reflective triangles, you can set one up at the side of the road about 300 feet (100 m) behind your vehicle.

■ Jump Starting

If your battery has run down, you may want to use another vehicle and some jumper cables to start your Oldsmobile. But please follow the steps below to do it safely.



CAUTION:

Batteries can hurt you. They can be dangerous because:

- They contain **acid** that can burn you.
- They contain **gas** that can explode or ignite.
- They contain enough **electricity** to burn you.

If you don't follow these steps exactly, some or all of these things can hurt you.

NOTICE:

Ignoring these steps could result in costly damage to your vehicle that wouldn't be covered by your warranty. Trying to start your Oldsmobile by pushing or pulling it won't work, and it could damage your vehicle.

To Jump Start Your Oldsmobile:

1. Check the other vehicle. It must have a 12-volt battery with a negative ground system.

NOTICE:

If the other system isn't a 12-volt system with a negative ground, both vehicles can be damaged.

2. Get the vehicles close enough so the jumper cables can reach, but be sure the vehicles aren't touching each other. If they are, it could cause a ground connection you don't want. You wouldn't be able to start your Oldsmobile, and the bad grounding could damage the electrical systems. You could be injured if the vehicles roll. Set the parking brake firmly on each vehicle. Put an automatic transaxle in **P** (Park) or a manual transaxle in **N** (Neutral).
3. Turn off the ignition on both vehicles. Turn off all lights that aren't

needed, and radios. This will avoid sparks and help save both batteries. And it could save your radio!

NOTICE:

If you leave your radio on, it could be badly damaged. The repairs wouldn't be covered by your warranty.

4. Open the hoods and locate the batteries.

Problems on the Road



CAUTION:

An electric fan can start up even when the engine is not running and can injure you. Keep hands, clothing and tools away from any underhood electric fan.

Find the positive (+) and negative (-) terminals on each battery. Your Oldsmobile has a remote positive (+) jump starting terminal. The terminal is on the same side of the engine compartment as your battery.

You should always use the remote positive (+) terminal instead of the positive (+) terminal on your battery.

To uncover the remote positive (+) terminal, lift the red plastic cap.



CAUTION:

Using a match near a battery can cause battery gas to explode. People have been hurt doing this, and some have been blinded. Use a flashlight if you need more light. Be sure the battery has enough water. You don't need to add water to the Delco Freedom[®] battery installed in every new GM vehicle. But if a battery has filler caps, be sure the right amount of fluid is there. If it is low, add water to take care of that first. If you don't, explosive gas could be present.

Battery fluid contains acid that can burn you. Don't get it on you. If you accidentally get it in your eyes or on your skin, flush the place with water and get medical help immediately.

5. Check that the jumper cables don't have loose or missing insulation. If they do, you could get a shock. The vehicles could be damaged, too.

Before you connect the cables, here are some basic things you should know. Positive (+) will go to positive (+) and negative (-) will go to negative (-) or a metal engine part. Don't connect (+) to (-) or you'll get a short that would damage the battery and maybe other parts, too.



CAUTION:

Fans or other moving engine parts can injure you badly. Keep your hands away from moving parts once the engines are running.

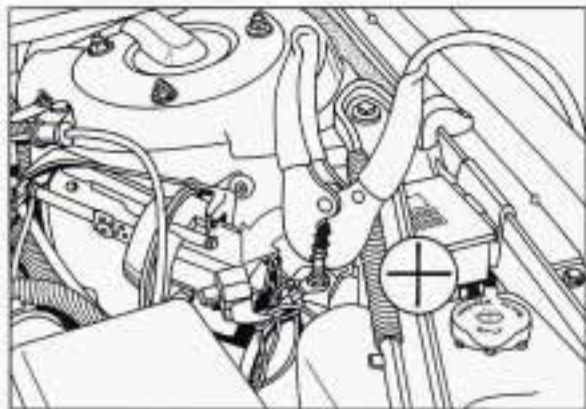

6. Connect the red positive (+) cable to the positive (+) terminal of the vehicle with the dead battery. Use a remote positive (+) terminal if the vehicle has one.

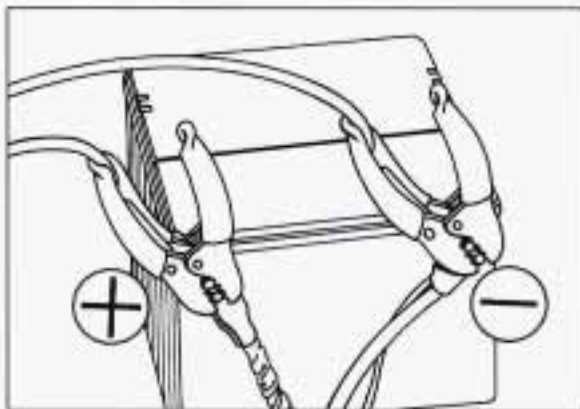

7. Don't let the other end touch metal. Connect it to the positive (+) terminal of the good battery. Use a remote positive (+) terminal if the vehicle has one.

8. Now connect the black negative (-) cable to the good battery's negative (-) terminal. Don't let the other end touch anything until the next step. The other end of the negative cable **doesn't** go to the dead battery. It goes to a heavy unpainted metal part on the engine of the vehicle with the dead battery.

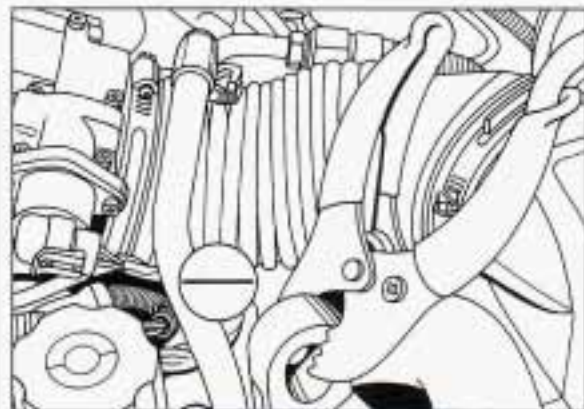

9. Attach the cable at least 18 inches (45 cm) away from the dead battery, but not near engine parts that move. The electrical connection is just as good there, but the chance of sparks getting back to the battery is much less.

10. Now start the vehicle with the good battery and run the engine for a while.

11. Try to start the vehicle with the dead battery. If it won't start after a few tries, it probably needs service.

Problems on the Road

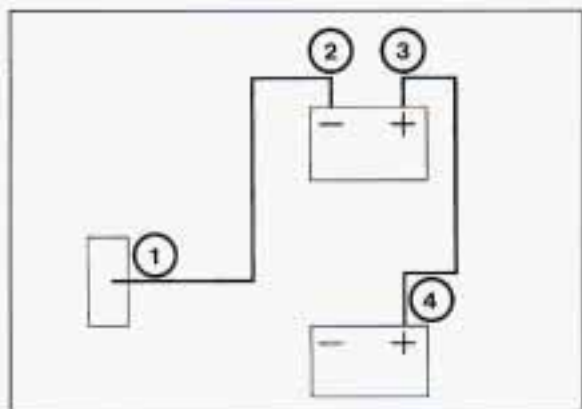

12. Remove the cables in reverse order to prevent electrical shorting. Take care that they don't touch each other or any other metal.

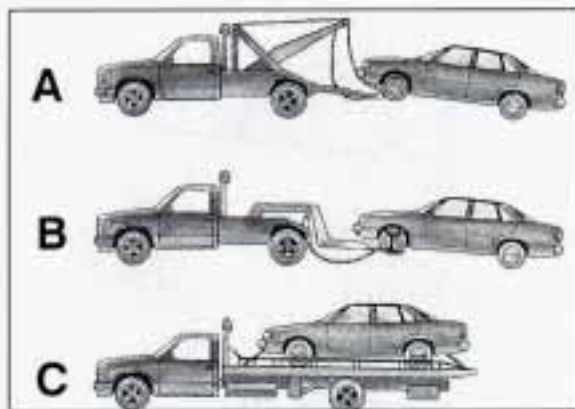

■ Towing Your Oldsmobile

Try to have a GM dealer or a professional towing service tow your Oldsmobile. The usual towing equipment is:

- (A) Sling-type tow truck
- (B) Wheel-lift tow truck
- (C) Car carrier

If your vehicle has been changed or modified since it was factory-new by adding aftermarket items like fog lamps, aero skirting, or special tires and wheels, these instructions and illustrations may not be correct.

Before you do anything, turn on the hazard warning flashers.

When you call, tell the towing service:

- That, if you have a 2-door

Oldsmobile, your vehicle cannot be towed from the front with sling-type equipment.

- That your vehicle has front-wheel drive.
- The make, model, and year of your vehicle.
- Whether you can still move the shift lever.
- If there was an accident, what was damaged.

When the towing service arrives, let the tow operator know that this manual contains detailed towing instructions and illustrations. The operator may want to see them.



CAUTION:

To help avoid injury to you or others:

- Never let passengers ride in a vehicle that is being towed.
- Never tow faster than safe or posted speeds.
- Never tow with damaged parts not fully secured.
- Never get under your vehicle after it has been lifted by the tow truck.
- Always secure the vehicle on each side with separate safety chains when towing it.
- Never use "J" hooks. Use T-hooks instead.

When your vehicle is being towed, have the ignition key off. The steering wheel should be clamped in a straight-ahead position, with a clamping device designed for towing service. Do not use the vehicle's steering column lock for this. The transaxle should be in N (Neutral) and the parking brake released.

Don't have your vehicle towed on the front wheels, unless you must. If the vehicle must be towed on the front wheels, don't go more than 35 mph (56 km/h) or farther than 50 miles (80 km) or your transaxle will be damaged. If these limits must be exceeded, then the front wheels have to be supported on a dolly.



CAUTION:

A vehicle can fall from a car carrier if it isn't adequately secured. This can cause a collision, serious personal injury and vehicle damage. The vehicle should be tightly secured with chains or steel cables before it is transported. Don't use substitutes (ropes, leather straps, canvas webbing, etc.) that can be cut by sharp edges underneath the towed vehicle. Always use T-hooks inserted in the T-hook slots. Never use J-hooks. They will damage drivetrain and suspension components.

Problems on the Road

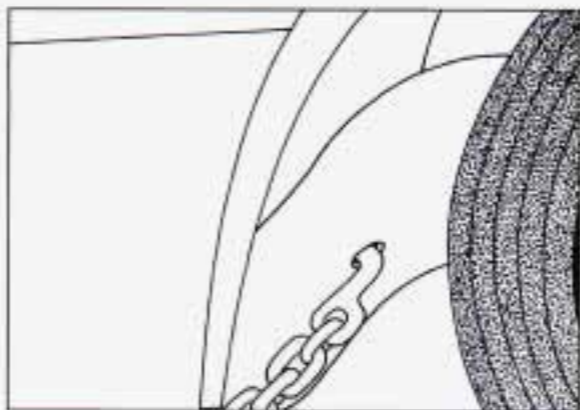

Towing from the Front—Vehicle Hook-up

Before hooking up to a tow truck, be sure to read all the information on *Towing Your Oldsmobile* earlier in this section.

All Models

1. Attach T-hook chains into the side slots in the cradle in front of the wheels, on both sides.

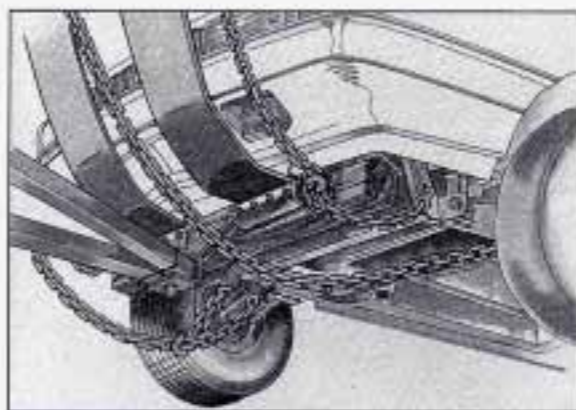

4-Door Models

2. Position a 4x4 wood beam across sling chains against the bottom of the cradle horns.

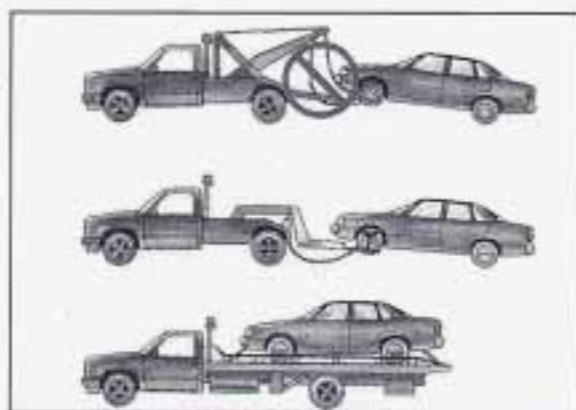

2-Door Models

NOTICE:

Do not tow with sling-type equipment or fascia/fog light damage will occur. Use wheel-lift or car carrier equipment. Additional ramping may be required for car carrier equipment.

Use safety chains and wheel straps.

NOTICE:

Towing a vehicle over rough surfaces could damage a vehicle. Damage can occur from vehicle to ground or vehicle to wheel-lift equipment. To help avoid damage, install a towing dolly and raise vehicle until adequate clearance is obtained between the ground and/or wheel-lift equipment.

Do not attach winch cables or J-hooks to suspension components when using car carrier equipment. Always use T-hooks inserted in the T-hook slots.

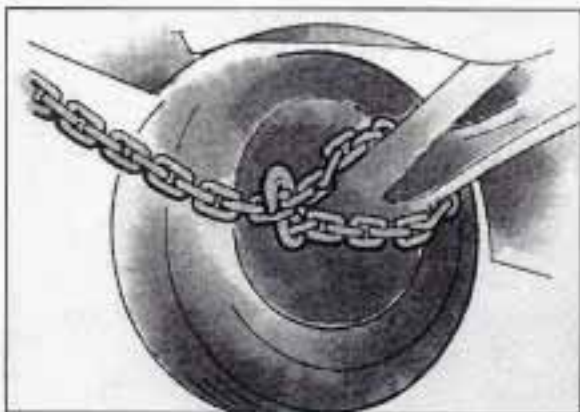

All Models

3. Attach a separate safety chain around the outboard end of each lower control arm.



Towing from the Rear—Vehicle Hook-Up

Before hooking up to a tow truck, be sure to read all the information on *Towing Your Oldsmobile* earlier in this section.

1. Attach T-hook chains on both sides in the slotted holes in the bottom of the floor pan support rails just ahead of the rear wheels.

Problems on the Road

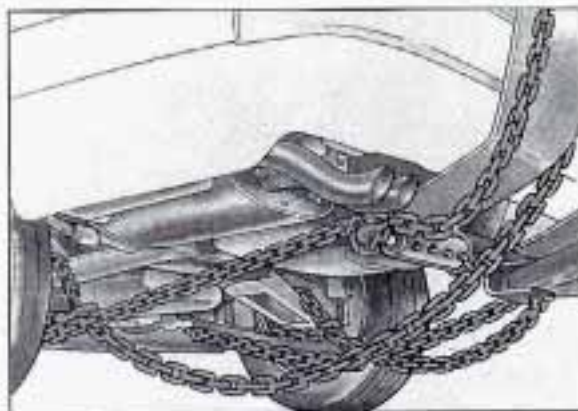

2. Position the lower sling crossbar just ahead of the rear bumper.

Dual Exhausts

If your vehicle is equipped with dual exhausts, center the sling between exhaust pipes.

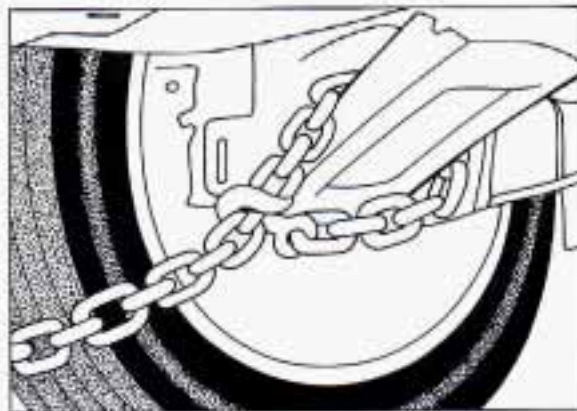

3. Attach a separate safety chain around the outboard end of each lower control arm.

■ Engine Overheating

You will find a coolant temperature gage on your Oldsmobile's instrument panel. You also have a low coolant warning light on your instrument panel. See the *Index* under *Coolant Temperature Gage*.

NOTICE:

If your engine catches fire because you keep driving with no coolant, your vehicle can be badly damaged. The costly repairs would not be covered by your warranty.



If Steam Is Coming From Your Engine



CAUTION:

Steam from an overheated engine can burn you badly, even if you just open the hood. Stay away from the engine if you see or hear steam coming from it. Just turn it off and get everyone away from the vehicle until it cools down. Wait until there is no sign of steam or coolant before opening the hood. If you keep driving when your engine is overheated, the liquids in it can

CAUTION (Continued)

CAUTION (Continued)

catch fire. You or others could be badly burned. Stop your engine if it overheats, and get out of the vehicle until the engine is cool.

NOTICE:

If your engine catches fire because you keep driving with no coolant, your vehicle can be badly damaged. The costly repairs would not be covered by your warranty.

If No Steam Is Coming From Your Engine

If you get the overheat warning but see or hear no steam, the problem may not be too serious. Sometimes the engine can get a little too hot when you:

- Climb a long hill on a hot day.
- Stop after high speed driving.
- Idle for long periods in traffic.
- Tow a trailer.

If you get the overheat warning with no sign of steam, try this for a minute or so:

1. Turn off your air conditioner.
2. Turn on your heater to full hot at the highest fan speed and open the window as necessary.
3. Try to keep your engine under load (in a drive gear where the engine runs slower).

If you no longer have the overheat warning, you can drive. Just to be safe, drive slower for about ten minutes. If the warning doesn't come back on, you can drive normally.

If the warning continues, pull over, stop, and park your vehicle right away.

If there's still no sign of steam, you can idle the engine for two or three minutes while you're parked, to see if the warning stops. But then, if you still have the warning, **TURN OFF THE ENGINE AND GET EVERYONE OUT OF THE VEHICLE** until it cools down.

You may decide not to lift the hood but to get service help right away.

Problems on the Road

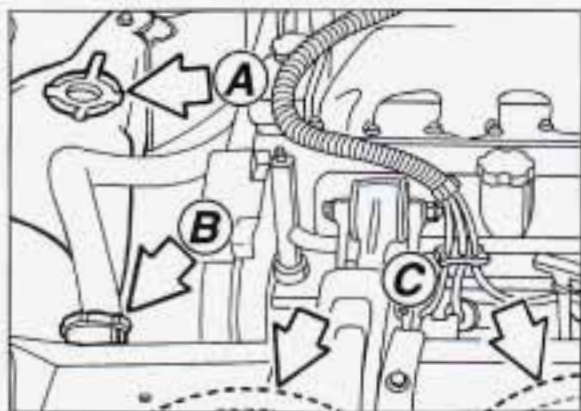

■ Cooling System

When you decide it's safe to lift the hood, here's what you'll see:

- (A) Coolant recovery tank
- (B) Radiator pressure cap
- (C) Electric engine fans



CAUTION:

An electric fan under the hood can start up even when the engine is not running and can injure you. Keep hands, clothing and tools away from any underhood electric fan.

If the coolant inside the coolant recovery tank is boiling, don't do anything else until it cools down.

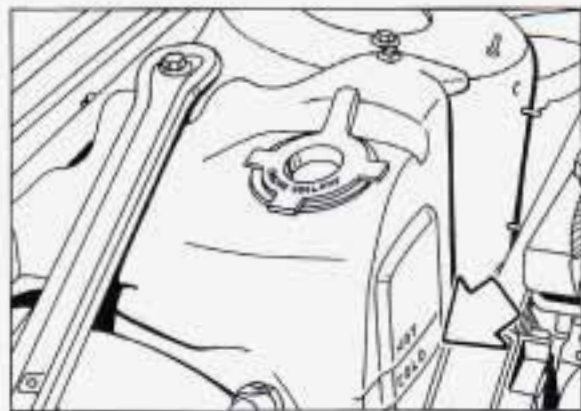

The coolant level should be at or above the **COLD** mark. If it isn't, you may have a leak in the radiator hoses, heater hoses, radiator, water pump or somewhere else in the cooling system.



CAUTION:

Heater and radiator hoses, and other engine parts, can be very hot. Don't touch them. If you do, you can be burned. Don't run the engine if there is a leak. If you run the engine, it could lose all coolant. That could cause an engine fire, and you could be burned. Get any leak fixed before you drive the vehicle.

NOTICE:

Engine damage from running your engine without coolant isn't covered by your warranty.

If there seems to be no leak, check to see if the electric engine fans are running. If the engine is overheating, both fans should be running. If they aren't, your vehicle needs service.

How to Add Coolant to the Coolant Recovery Tank

If you haven't found a problem yet, but the coolant level isn't at or above the **COLD** mark, add a 50/50 mixture of **clean water** (preferably distilled) and a proper antifreeze at the coolant recovery tank. See *Engine Coolant* in the *Index* for more information about the proper coolant mix.)



CAUTION:

Adding only plain water to your cooling system can be dangerous. Plain water, or some other liquid like alcohol, can boil before the proper coolant mix will. Your vehicle's coolant warning system is set for the proper coolant mix. With plain water or the wrong mix, your engine could get too hot but you wouldn't get the overheat warning. Your engine could catch fire and you or others could be burned. Use a 50/50 mix of **clean water** and a proper antifreeze.

NOTICE:

In cold weather, water can freeze and crack the engine, radiator, heater core and other parts. Use the recommended coolant.



CAUTION:

You can be burned if you spill coolant on hot engine parts. Coolant contains ethylene glycol and it will burn if the engine parts are hot enough. Don't spill coolant on a hot engine.

When the coolant in the coolant recovery tank is at or above the **COLD** mark, start your vehicle.

If the overheat warning continues, there's one more thing you can try. You can add the proper coolant mix directly to the radiator, but be sure the cooling system is cool before you do it.

Problems on the Road

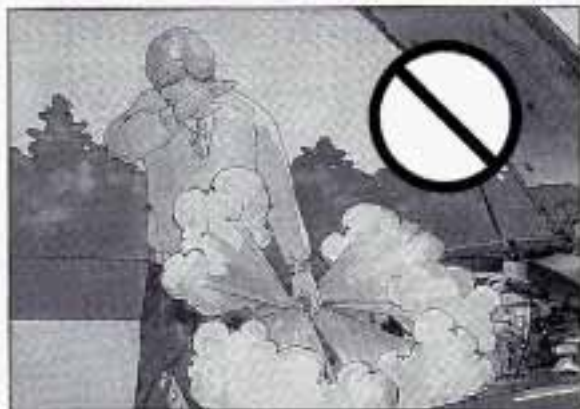

CAUTION:

Steam and scalding liquids from a hot cooling system can blow out and burn you badly. They are under pressure, and if you turn the radiator pressure cap — even a little — they can come out at high speed. Never turn the cap when the cooling system, including the radiator pressure cap, is hot. Wait for the cooling system and radiator pressure cap to cool if you ever have to turn the pressure cap.

How to Add Coolant to the Radiator

NOTICE:

Your engine has a specific radiator fill procedure. Failure to follow this procedure could cause your engine to overheat and be severely damaged.

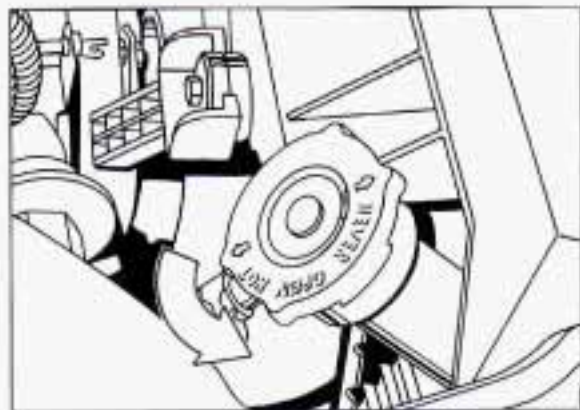

1. You can remove the radiator pressure cap when the cooling system, including the radiator pressure cap and upper radiator hose, is no longer hot. Turn the pressure cap slowly to the left until it first stops. (Don't press down while turning the pressure cap.) If you hear a hiss, wait for that to stop. A hiss means there is still some pressure left.

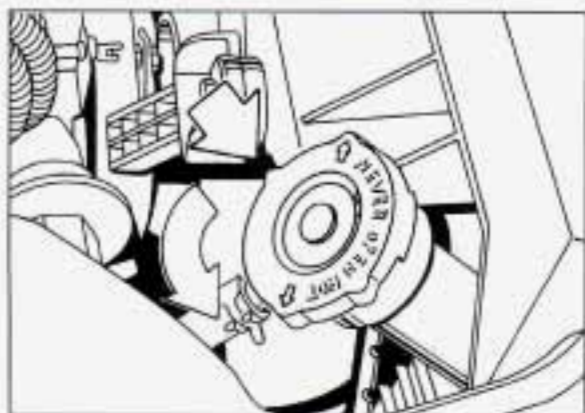

2. Then keep turning the pressure cap, but now push down as you turn it. Remove the pressure cap.



CAUTION:

You can be burned if you spill coolant on hot engine parts. Coolant contains ethylene glycol and it will burn if the engine parts are hot enough. Don't spill coolant on a hot engine.

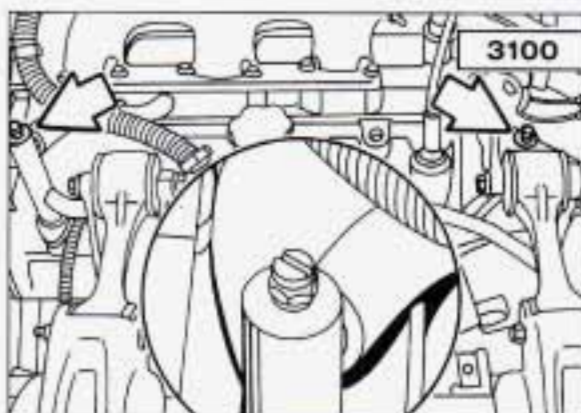

3. After the engine cools, open the coolant air bleed valve or valves.
3100 V6 (VIN Code M): There are two bleed valves. One is located on the thermostat housing. The other is located on the thermostat bypass tube.



- 3.4L V6 (VIN Code X):** There are two bleed valves. They are located on the thermostat housing and heater inlet pipe.

Problems on the Road



4. Fill the radiator with the proper mix, up to the base of the filler neck. If you see a stream of coolant coming from an air bleed valve, close the valve. Otherwise, close the valves after the radiator is filled.
5. Rinse or wipe any spilled coolant from the engine and compartment.



6. Then fill the coolant recovery tank to the **COLD** mark.

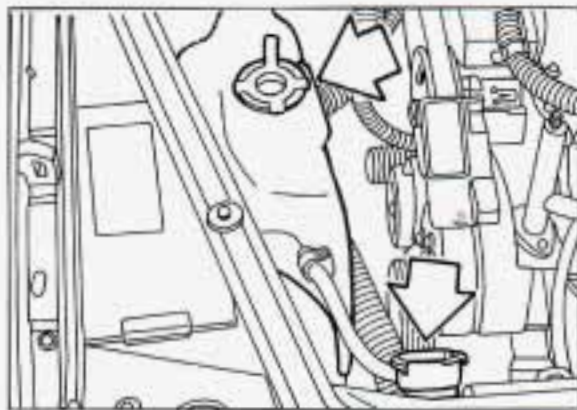

7. Put the cap back on the coolant recovery tank, but leave the radiator pressure cap off.



8. Start the engine and let it run until you can feel the upper radiator hose getting hot. Watch out for the engine fans.
9. By this time the coolant level inside the radiator filler neck may be lower. If the level is lower, add more of the proper mix through the filler neck until the level reaches the base of the filler neck.

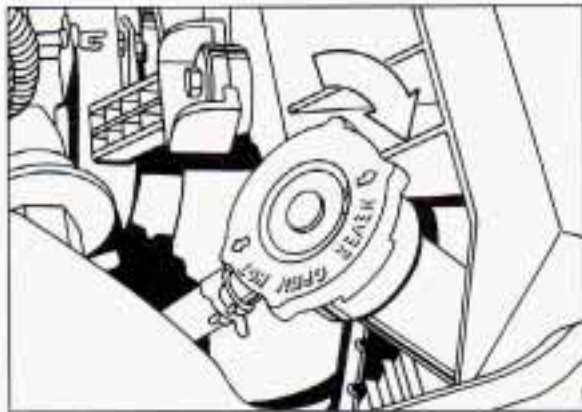

10. Then replace the pressure cap. At any time during this procedure if coolant begins to flow out of the filler neck, reinstall the pressure cap. Be sure the arrows on the pressure cap line up like this.
11. Check the coolant in the recovery tank. The level in the coolant recovery tank should be at the **HOT** mark when the engine is hot or at the **COLD** mark when the engine is cold.

■ *If a Tire Goes Flat*

It's unusual for a tire to "blow out" while you're driving, especially if you maintain your tires properly. If air goes out of a tire, it's much more likely to

leak out slowly. But if you should ever have a "blowout," here are a few tips about what to expect and what to do:

If a front tire fails, the flat tire will create a drag that pulls the vehicle toward that side. Take your foot off the accelerator pedal and grip the steering wheel firmly. Steer to maintain lane position, then gently brake to a stop well out of the traffic lane.

A rear blowout, particularly on a curve, acts much like a skid and may require the same correction you'd use in a skid. In any rear blowout, remove your foot from the accelerator pedal. Get the vehicle under control by steering the way you want the vehicle to go. It may be very bumpy and noisy, but you can still steer. Gently brake to a stop, well off the road if possible.

If a tire goes flat, the next section shows how to use your jacking equipment to change a flat tire safely.

Problems on the Road



■ *Changing a Flat Tire*

If a tire goes flat, avoid further tire and wheel damage by driving slowly to a level place. Turn on your hazard warning flashers.



CAUTION:

Changing a tire can cause an injury. The vehicle can slip off the jack and roll over you or other people. You and they could be badly injured. Find a level place to change your tire. To help prevent the vehicle from moving:

1. Set the parking brake firmly.
2. Put the shift lever in **P** (Park).
3. Turn off the engine.

To be even more certain the vehicle won't move, you can put chocks at the front and rear of the tire farthest away from the one being changed. That would be the tire on the other side of the vehicle, at the opposite end.

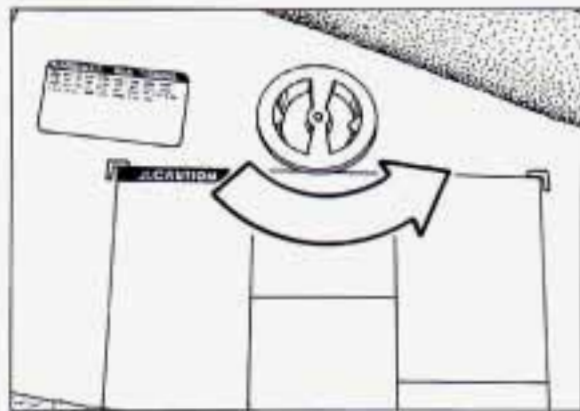

The following steps will tell you how to use the jack and change a tire.

The equipment you'll need is in the trunk.

1. Pull the carpeting from the floor of the trunk.
2. Turn the center retainer bolt on the compact spare tire housing counterclockwise to remove it, then lift the tire cover.

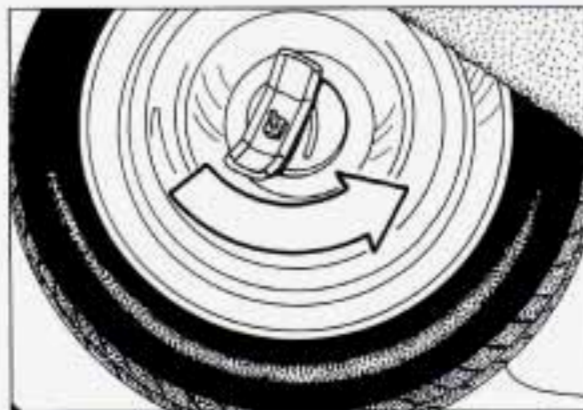

3. Remove the wing nut securing the compact spare tire and spacer by turning it counterclockwise. Then lift off the spacer and remove the spare tire.

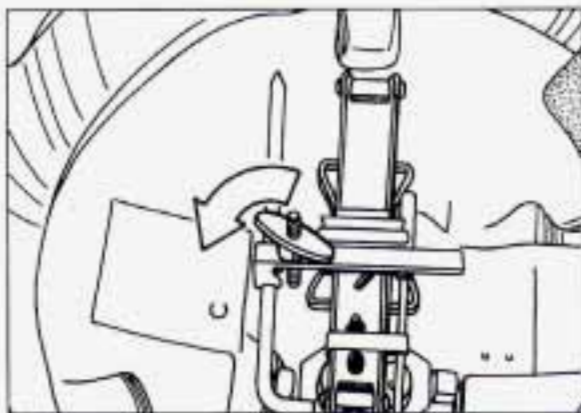

4. Remove the bolt securing the jack and wrench by turning it counterclockwise. Then remove the jack and wrench.

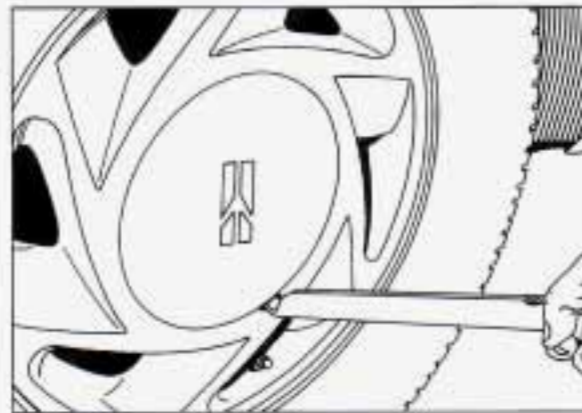

5. If there is a wheel cover, remove it by using the wedge end of the wrench to pry gently in a notch at the edge of the center cap. Do not use a tool that is narrower, such as a screwdriver, to pry in this notch. You may damage the wheel cover or the center cap. You may also have plastic nut caps. Loosen the plastic nut caps with the wheel wrench. They won't come off. Then pry along the edge of the wheel cover until it comes off.

Problems on the Road

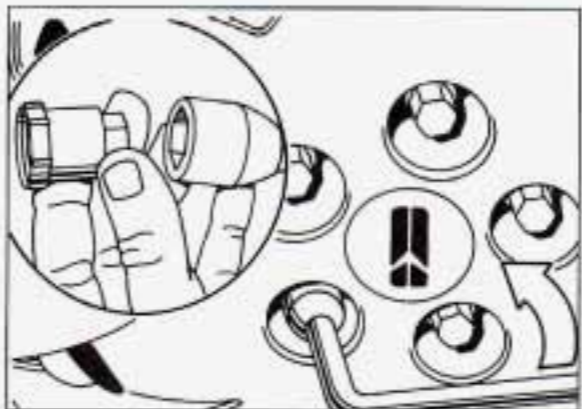

6. If your vehicle has exposed wheel nut caps, remove them using the wheel nut wrench.

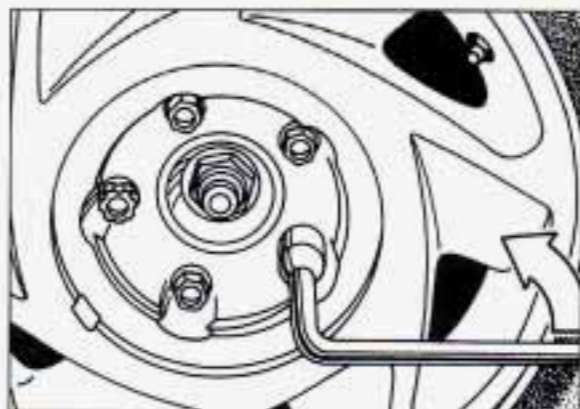

7. Using the wheel wrench, loosen all the wheel nuts. Don't remove them yet.

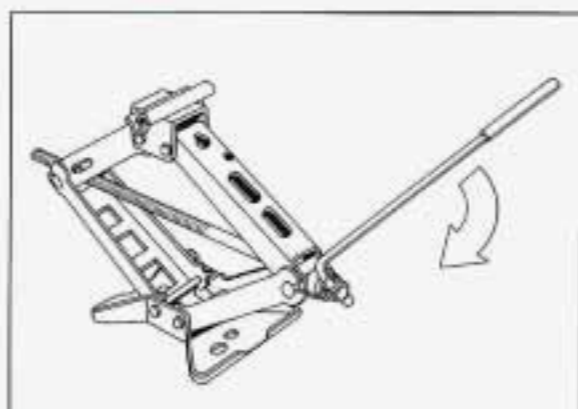

8. Remove the band around the jack. Turn the jack handle clockwise to raise the jack head a few inches.

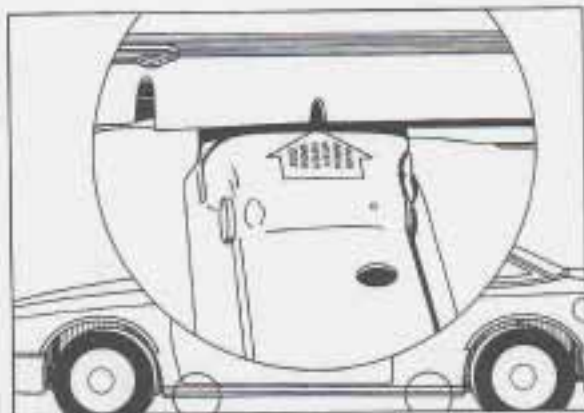

9. Position the jack and raise the jack head until it fits firmly into the notch in the vehicle's frame nearest the flat tire. Do not raise the vehicle yet. Put the compact spare tire near you.



CAUTION:

Getting under a vehicle when it is jacked up is dangerous. If the vehicle slips off the jack, you could be badly injured or killed. Never get under a vehicle when it is supported only by a jack.

NOTICE:

Raising your vehicle with the jack improperly positioned will damage the vehicle or may allow the vehicle to fall off the jack. Be sure to fit the jack lift head into the proper location before raising your vehicle.

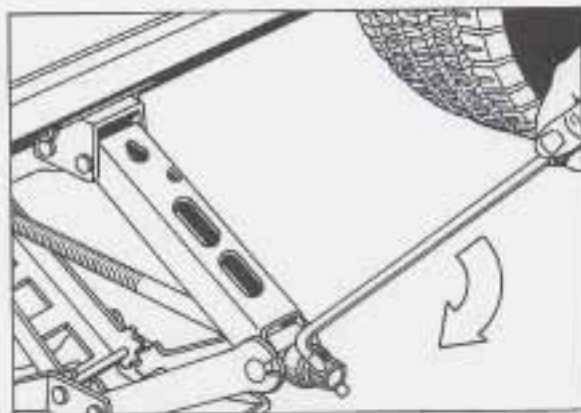

10. Raise the vehicle by rotating the jack handle clockwise. Raise the jack far enough so there's enough room for the spare tire to fit.
11. Remove all wheel nuts and take off the flat tire.

Problems on the Road



CAUTION:

Rust or dirt on the wheel, or on the parts to which it is fastened, can make the wheel nuts become loose after a time. The wheel could come off and cause an accident. When you change a wheel, remove any rust or dirt from the places where the wheel attaches to the vehicle. In an emergency, you can use a cloth or a paper towel to do this; but be sure to use a scraper or wire brush later, if you need to, to get all the rust or dirt off.



12. Remove any rust or dirt from the wheel bolts, mounting surfaces and spare wheel. Place the spare on the wheel mounting surface.



CAUTION:

Never use oil or grease on studs or nuts. If you do, the nuts might come loose. Your wheel could fall off, causing a serious accident.

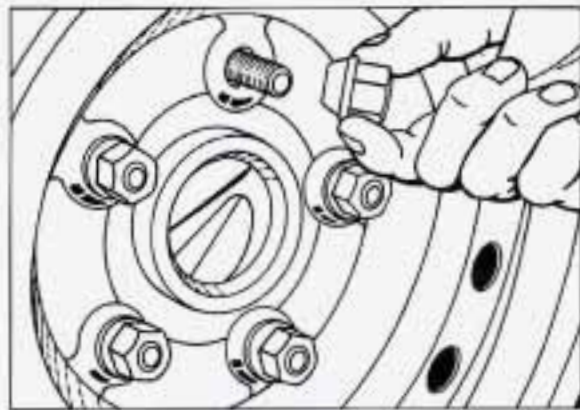

13. Replace the wheel nuts with the rounded end of the nuts toward the wheel. Tighten each nut by hand until the wheel is held against the hub.

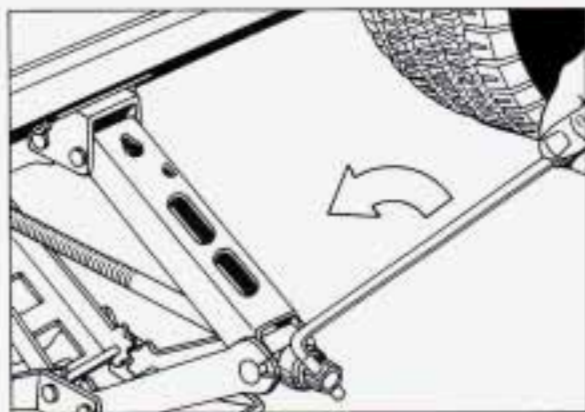

14. Lower the vehicle by rotating the jack handle counterclockwise. Lower the jack completely.

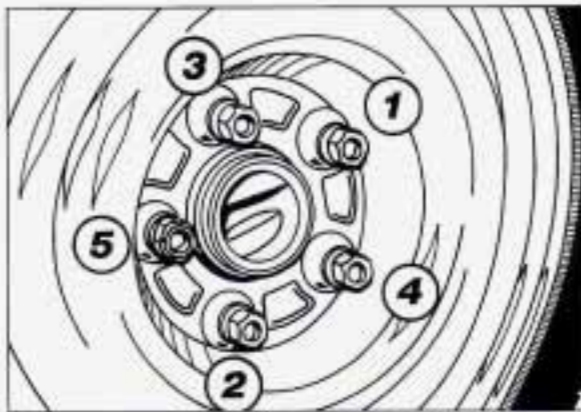

15. Tighten the wheel nuts firmly in a crisscross sequence as shown. Don't try to put the wheel cover on your compact spare tire. It won't fit. Store the wheel cover in the trunk until you have the flat tire repaired or replaced.

NOTICE:

Wheel covers won't fit on your compact spare. If you try to put a wheel cover on your compact spare, you could damage the cover or the spare.



CAUTION:

Incorrect wheel nuts or improperly tightened wheel nuts can cause the wheel to become loose and even come off. This could lead to an accident. Be sure to use the correct wheel nuts. If you have to replace them, be sure to get the right kind. Stop somewhere as soon as you can and have the nuts tightened with a torque wrench to 100 lb ft. (140 N•m).

16. Store the flat tire as far forward in the trunk as possible. Store the jack and the wheel wrench in their compartment in the trunk.



CAUTION:

Storing a jack, a tire or other equipment in the passenger compartment of the vehicle could cause injury. In a sudden stop or collision, loose equipment could strike someone. Store all these in the proper place.

The compact spare is for temporary use only. Replace the compact spare tire with a full-size tire as soon as you can. See *Compact Spare Tire* later in this section.

■ *Compact Spare Tire*

Although the compact spare was fully inflated when your vehicle was new, it can lose air after a time. Check the inflation pressure regularly. It should be 60 psi (420 kPa). After installing the compact spare on your vehicle, you should stop as soon as possible and make sure your spare tire is correctly inflated. The compact spare is made to perform well at posted speed limits for distances up to 3,000 miles (5 000 km). The compact spare is made to go up to 3,000 miles (5 000 km), so you can finish your trip and have your full-size tire repaired or replaced where you want. Of course, it's best to replace your spare with a full-size tire as soon as you can. Your spare will last longer and be in good shape in case you need it again.

NOTICE:

Don't take your compact spare through an automatic car wash with guide rails. The compact spare can get caught on the rails. That can damage the tire and wheel, and maybe other parts of your vehicle.

Don't use your compact spare on some other vehicle.

And don't mix your compact spare or wheel with other wheels or tires. They won't fit. Keep your spare and its wheel together.

NOTICE:

Tire chains won't fit your compact spare. Using them will damage your vehicle and destroy the chains too. Don't use tire chains on your compact spare.

■ *If You're Stuck: In Sand, Mud, Ice or Snow*

What you don't want to do when your vehicle is stuck is to spin your wheels. The method known as "rocking" can help you get out when you're stuck, but you must use caution.



CAUTION:

If you let your tires spin at high speed, they can explode and you or others could be injured. And, the transaxle or other parts of the vehicle can overheat. That could cause an engine compartment fire or other damage. When you're stuck, spin the wheels as little as possible. Don't spin the wheels above 35 mph (55 km/h) as shown on the speedometer.

NOTICE:

Spinning your wheels can destroy parts of your vehicle as well as the tires. If you spin the wheels too fast while shifting your transaxle back and forth, you can destroy your transaxle.

Rocking Your Vehicle to Get it Out:

First, turn your steering wheel left and right. That will clear the area around

your front wheels. Then shift back and forth between **R** (Reverse) and a forward gear, spinning the wheels as little as possible. Release the accelerator pedal while you shift, and press lightly on the accelerator pedal when the transaxle is in gear. If that doesn't get you out after a few tries, you may need to be towed out. If you do need to be towed out, see *Towing Your Oldsmobile* in the *Index*.



Here you will find information about the care of your Oldsmobile. This part begins with service and fuel information, and then it shows how to check important fluid and lubricant levels. There is also technical information about your vehicle, and a section devoted to its appearance care.

Part 6

Service & Appearance Care

Service	176
Fuel	177
Hood Release.....	180
Engine Oil.....	184
Air Cleaner	187
Transaxle Fluid.....	188
Engine Coolant.....	190
Power Steering Fluid.....	192
Windshield Washer Fluid.....	193
Brakes	194
Battery	196
Bulb Replacement	196
Windshield Wiper Blade Replacement	205
Loading Your Vehicle	205
Tires	206
Appearance Care.....	212
Vehicle Identification Number (VIN)	219
Add-On Electrical Equipment	220
Fuses & Circuit Breakers.....	220
Capacities & Specifications.....	227
Fluids & Lubricants	229
Replacement Bulbs.....	230
Normal Maintenance Replacement Parts.....	233

Service & Appearance Care



■ Service

Your Oldsmobile dealer knows your vehicle best and wants you to be happy with it. We hope you'll go to your dealer for all your service needs. You'll get genuine GM parts and GM-trained and supported service people.

We hope you'll want to keep your GM vehicle all GM. Genuine GM parts have one of the above marks.

Doing Your Own Service Work

If you want to do some of your own service work, you'll want to get the proper Oldsmobile Service Manual. It tells you much more about how to service your Oldsmobile than this manual can. To order the proper service

manual, see *Service Publications* in the *Index*.

Your vehicle has an air bag system. Before attempting to do your own service work, see *Servicing Your Air Bag-Equipped Oldsmobile* in the *Index*.

You should keep a record with all parts receipts and list the mileage and the date of any service work you perform. See *Maintenance Record* in the *Index*.



CAUTION:

You can be injured if you try to do service work on a vehicle without knowing enough about it.

- Be sure you have sufficient knowledge, experience, and the proper replacement parts and tools before you attempt any vehicle maintenance task.
- Be sure to use the proper nuts, bolts and other fasteners. "English" and "metric" fasteners can be easily confused. If you use the wrong fasteners, parts can later break or fall off. You could be hurt.

NOTICE:

If you try to do your own service work without knowing enough about it, your vehicle could be damaged.



■ Fuel

Use regular unleaded gasoline rated at 87 octane or higher. It should meet specifications ASTM D4814 in the U.S. and CGSB 3.5-92 in Canada. These fuels should have the proper additives, so you should not have to add anything to the fuel.

In the U.S. and Canada, it's easy to be sure you get the right kind of gasoline (unleaded). You'll see "UNLEADED" right on the pump. And only unleaded nozzles will fit into your vehicle's filler neck.

Be sure the posted octane is at least 87. If the octane is less than 87, you may get a heavy knocking noise when you drive. If it's bad enough, it can damage your engine.

If you're using fuel rated at 87 octane or higher and you still hear heavy knocking, your engine needs service. But don't worry if you hear a little pinging noise when you're accelerating or driving up a hill. That's normal, and you don't have to buy a higher octane fuel to get rid of pinging. It's the heavy, constant knock that means you have a problem.

What about gasoline with blending materials that contain oxygen (oxygenates), such as MTBE or alcohol?

MTBE is "methyl tertiary-butyl ether." Fuel that is no more than 15% MTBE is fine for your vehicle.

Ethanol is ethyl or grain alcohol. Properly-blended fuel that is no more than 10% **ethanol** is fine for your vehicle.

Methanol is methyl or wood alcohol.

NOTICE:

Fuel that is more than 5% **methanol** is bad for your vehicle. Don't use it. It can corrode metal parts in your fuel system and also damage plastic and rubber parts. That damage wouldn't be covered under your warranty. And even at 5% or less, there must be "cosolvents" and corrosion preventers in this fuel to help avoid these problems.

Service & Appearance Care

Gasolines for Cleaner Air

Your use of gasoline with deposit control additives will help prevent deposits from forming in your engine and fuel system. That helps keep your engine in tune and your emission control system working properly. It's good for your vehicle, and you'll be doing your part for cleaner air.

Many gasolines are now blended with oxygenates. General Motors recommends that you use gasolines with these blending materials, such as MTBE and ethanol. By doing so, you can help clean the air, especially in those parts of the country that have high carbon monoxide levels.

In addition, some gasoline suppliers are now producing reformulated gasolines. These gasolines are specially designed to reduce vehicle emissions. General Motors recommends that you use reformulated gasoline. By doing so, you can help clean the air, especially in those parts of the country that have high ozone levels.

You should ask your service station operators if their gasolines contain

deposit control additives and oxygenates, and if they have been reformulated to reduce vehicle emissions.

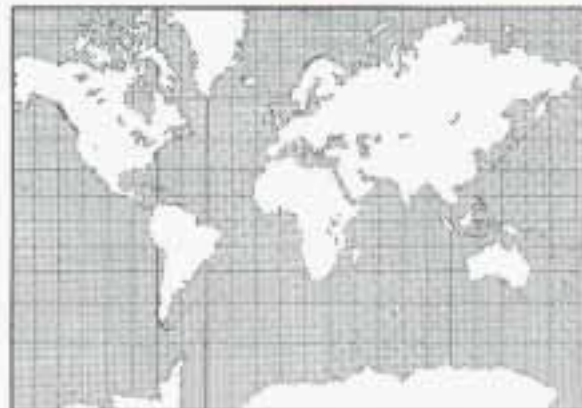

■ Fuels in Foreign Countries

If you plan on driving in another country outside the U.S. or Canada, unleaded fuel may be hard to find. Do not use leaded gasoline. If you use even one tankful, your emission controls won't work well or at all. With continuous use, spark plugs can get fouled, the exhaust system can corrode, and your engine oil can deteriorate quickly. Your vehicle's oxygen sensor will be damaged. All of that means costly repairs that wouldn't be covered by your warranty.

To check on fuel availability, ask an auto club, or contact a major oil company that does business in the country where you'll be driving.

You can also write us at the following address for advice. Just tell us where you're going and give your Vehicle Identification Number (VIN).

General Motors Overseas Distribution Corporation
North American Export Sales (NAES)
1908 Colonel Sam Drive
Oshawa, Ontario L1H 8P7

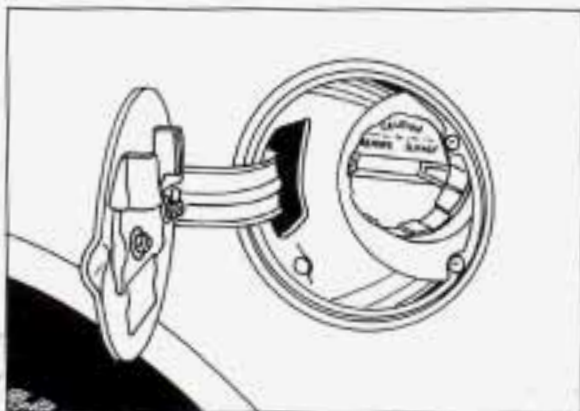

■ *Filling Your Tank*

Fuel Capacity:

16.5 U.S. Gallons (62 L). Use unleaded fuel only.

The cap is behind a hinged door on the left side of your vehicle.



CAUTION:

Gasoline vapor is highly flammable. It burns violently, and that can cause very bad injuries. Don't smoke if you're near gasoline or refueling your vehicle. Keep sparks, flames, and smoking materials away from gasoline.

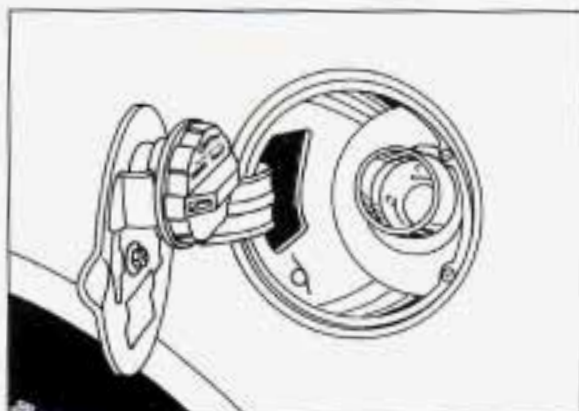

While refueling, hang the cap inside the fuel door.

To take off the cap, turn it slowly to the left (counterclockwise).



CAUTION:

If you get gasoline on you and then something ignites it, you could be badly burned. Gasoline can spray out on you if you open the fuel filler cap too quickly. This spray can happen if your tank is nearly full, and is more likely in hot weather. Open the fuel filler cap slowly and wait for any "hiss" noise to stop. Then unscrew the cap all the way.

Service & Appearance Care

Be careful not to spill gasoline. Clean gasoline from painted surfaces as soon as possible. See *Cleaning the Outside of Your Oldsmobile* in the *Index*.

When you put the cap back on, turn it to the right until you hear at least three clicks.

NOTICE:

If you need a new cap, be sure to get the right type. Your dealer can get one for you. If you get the wrong type, it may not fit or have proper venting, and your fuel tank and emissions system might be damaged.

■ *Checking Things Under the Hood*

The following sections tell you how to check fluids, lubricants and important parts underhood.

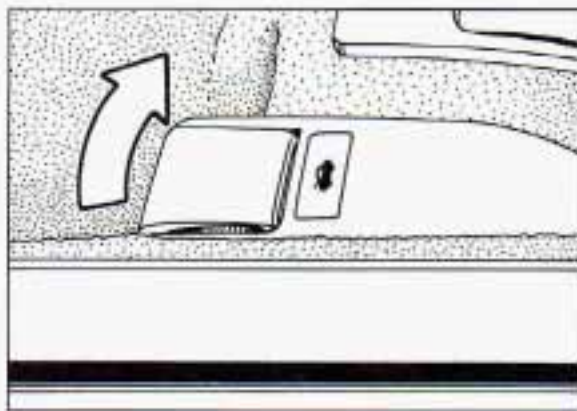

Hood Release

To open the hood, first pull the handle inside the vehicle.

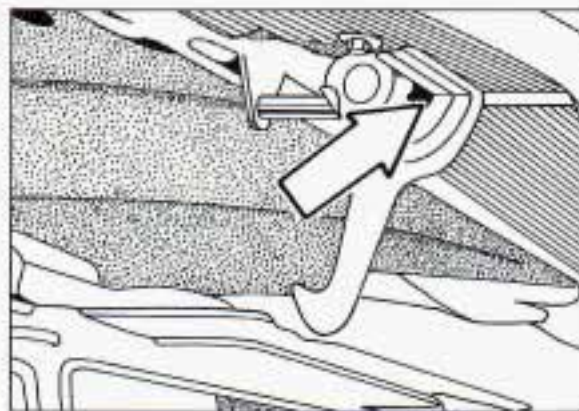

Then go to the front of the vehicle and release the secondary hood release. Lift the hood.

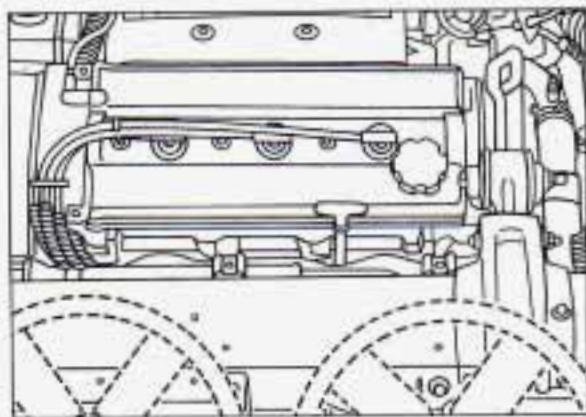

CAUTION:

An electric fan under the hood can start up and injure you even when the engine is not running. Keep hands, clothing and tools away from any underhood electric fan.



CAUTION:

Things that burn can get on hot engine parts and start a fire. These include liquids like gasoline, oil, coolant, brake fluid, windshield washer and other fluids, and plastic or rubber. You or others could be burned. Be careful not to drop or spill things that will burn onto a hot engine.

Before closing the hood, be sure all the filler caps are on properly. Then just pull the hood down and close it firmly.

Service & Appearance Care

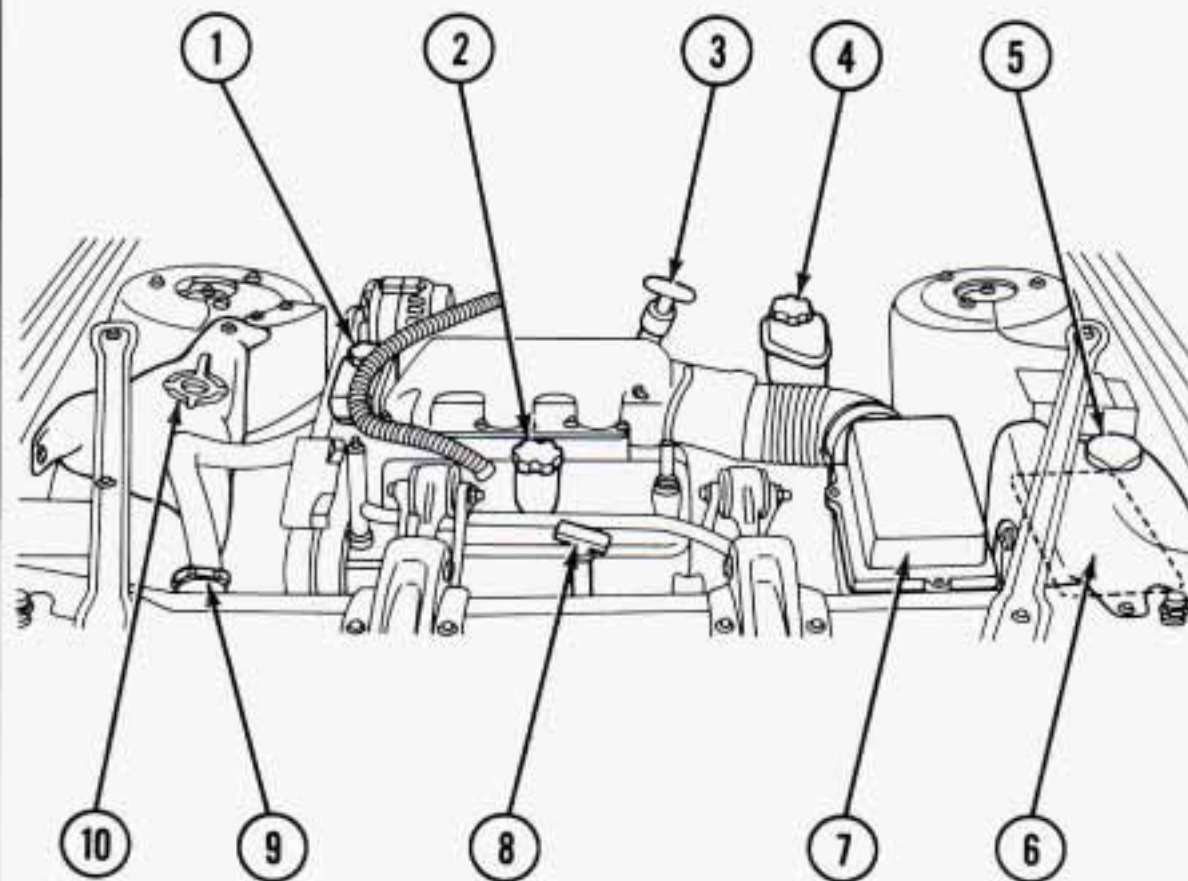

3100 V6 Engine (CODE M)

When you open the hood, you'll see:

1. Power Steering Fluid Reservoir
2. Engine Oil Fill Cap
3. Automatic Transaxle Fluid Dipstick
4. Brake Fluid Reservoir
5. Windshield Washer Fluid Reservoir
6. Battery
7. Air Cleaner
8. Engine Oil Dipstick
9. Radiator Pressure Cap
10. Engine Coolant Reservoir

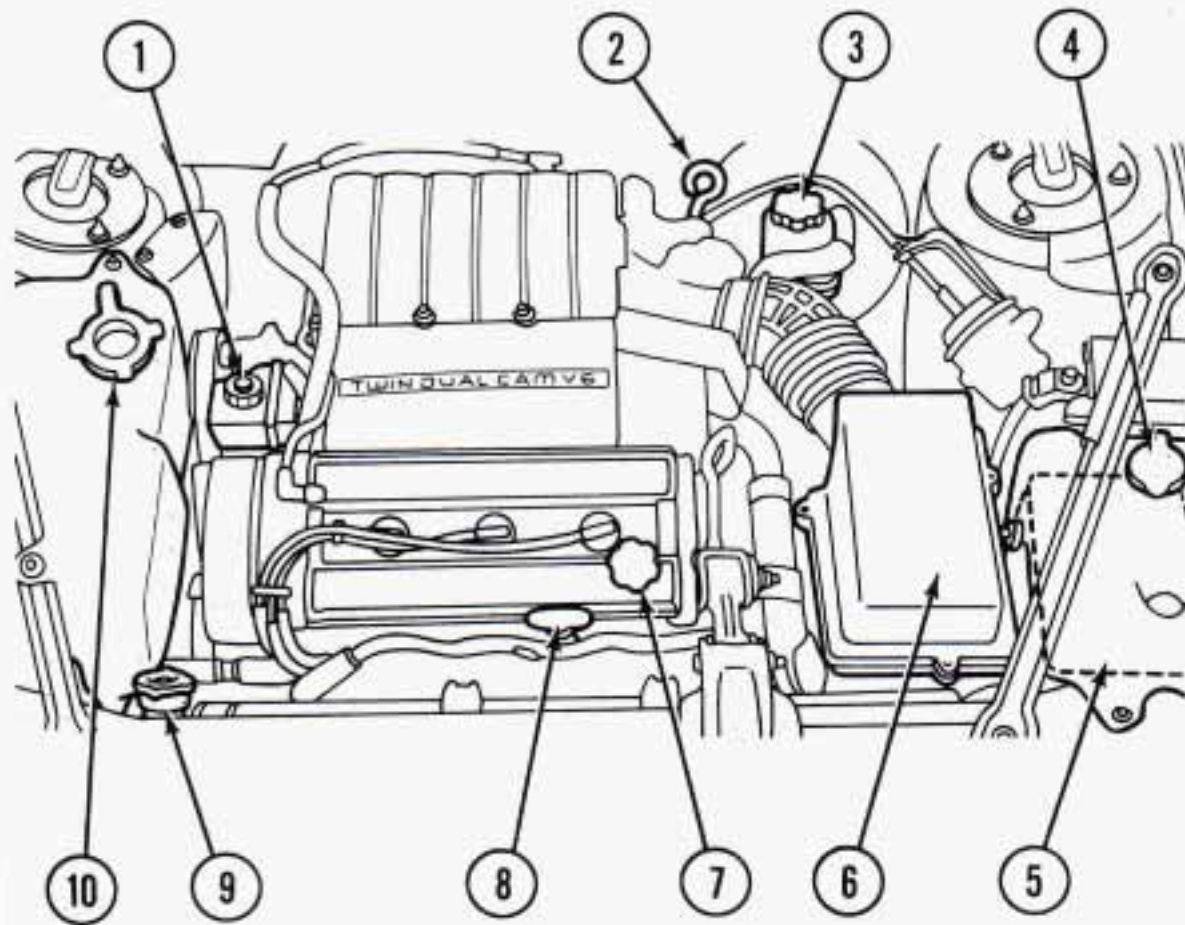

Twin Dual Cam (DOHC) 3.4L V6 Engine (CODE X)

When you open the hood, you'll see:

1. Power Steering Fluid Reservoir
2. Automatic Transaxle Fluid Dipstick
3. Brake Fluid Reservoir
4. Windshield Washer Fluid Reservoir
5. Battery
6. Air Cleaner
7. Engine Oil Fill Cap
8. Engine Oil Dipstick
9. Radiator Pressure Cap
10. Engine Coolant Reservoir

Service & Appearance Care

■ Engine Oil

If the **LOW OIL LEVEL** light on the instrument panel comes on, it means you need to check your engine oil level right away. For more information, see *Low Oil Level Light* in the *Index*. You should check your engine oil level regularly; this is an added reminder.

It's a good idea to check your engine oil every time you get fuel. In order to get an accurate reading, the oil must be warm and the vehicle must be on level ground.

Turn off the engine and give the oil a few minutes to drain back into the oil pan. If you don't, the oil dipstick might not show the actual level.

To Check Engine Oil

Pull out the dipstick and clean it with a paper towel or cloth, then push it back in all the way. Remove it again, keeping the tip lower, and check the level.

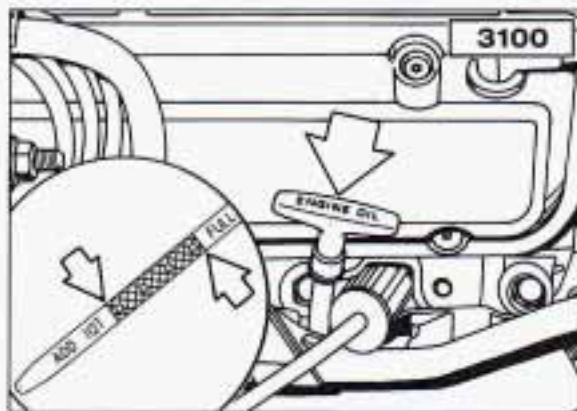

3100 V6: Checking Engine Oil

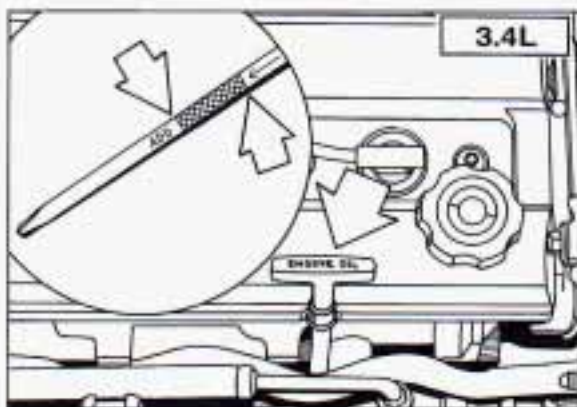

Twin Dual Cam 3.4L V6: Checking Engine Oil

When to Add Oil

If the oil is at or below the **ADD** line, then you'll need to add some oil. But you must use the right kind. This section explains what kind of oil to use. For crankcase capacity, see *Capacities and Specifications* in the *Index*.

NOTICE:

Don't add too much oil. If your engine has so much oil that the oil level gets above the cross-hatched area that shows the proper operating range, your engine could be damaged.

Just fill it enough to put the level somewhere in the proper operating range. Push the dipstick all the way back in when you're through.

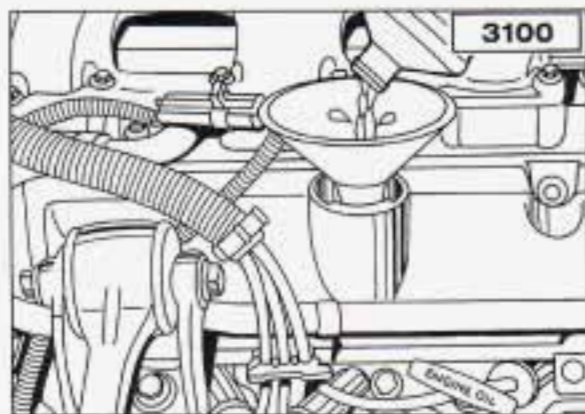

3100 V6: Adding Engine Oil

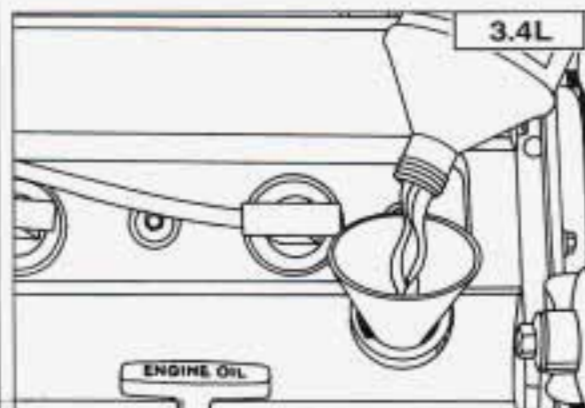

Twin Dual Cam 3.4L V6: Adding Engine Oil



What Kind of Oil to Use

Beginning midyear 1993, oils of the proper quality for your vehicle will be identified with this new "starburst" symbol. The "starburst" symbol indicates that the oil has been certified by the American Petroleum Institute (API), and is preferred for use in your gasoline engine.

You should look for this on the front of the oil container, and use only oils that display this new symbol.

You should also use the proper viscosity oil for your vehicle, as shown in the following chart.

RECOMMENDED SAE VISCOSITY GRADE ENGINE OILS

FOR BEST FUEL ECONOMY AND COLD STARTING, SELECT THE LOWEST SAE VISCOSITY GRADE OIL FOR THE EXPECTED TEMPERATURE RANGE.

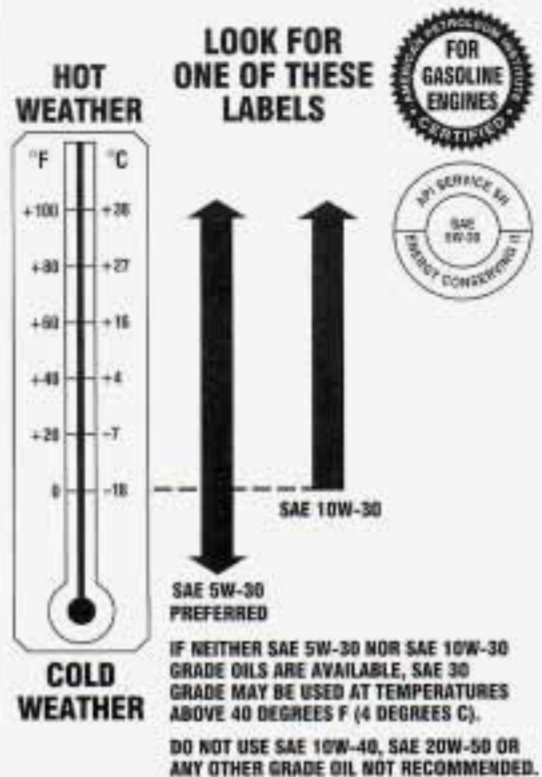

As shown in the chart, SAE 5W-30 is best for your vehicle. However, you can use SAE 10W-30 if it's going to be 0°F

Service & Appearance Care

(-18°C) or above. These numbers on an oil container show its viscosity, or thickness. Do not use other viscosity oils, such as SAE 10W-40 or SAE 20W-50.

If you cannot find oils with the new “starburst” symbol on the front of the container, you should look for and use oils containing the following three things:

- **SH or SG**

“SH” or “SG” must be on the oil container, either by itself or combined with other quality designations, such as “SH/CD,” “SH,SG,CD,” “SG/CD,” etc. These letters show American Petroleum Institute (API) levels of quality.

- **SAE 5W-30**

- **Energy Conserving II**

Oils with these words on the container will help you save fuel.

These three things are usually included in a doughnut shaped logo (symbol) on most containers. If you cannot find oils with the “starburst” symbol, you should look for oils with the doughnut shaped symbol, containing the three things noted above.



NOTICE:

If you use oils that do not have either the “starburst” symbol or an API SH or SG designation, you can cause engine damage not covered by your warranty.

GM Goodwrench® oil (in Canada, GM Engine Oil) meets all the requirements for your vehicle.

Engine Oil Additives

Don't add anything to your oil. Your Oldsmobile dealer is ready to advise if you think something should be added.

When to Change Engine Oil

See if any one of these is true for you:

- Most trips are less than 4 miles (6 km).
- It's below freezing outside and most trips are less than 10 miles (16 km).
- The engine is at low speed most of the time (as in door-to-door delivery, or in stop-and-go traffic).
- You tow a trailer often.
- Most trips are through dusty places.

If any one of these is true for your vehicle, then you need to change your **oil and filter** every 3,000 miles (5 000 km) or 3 months — whichever comes first.

If none of them is true, change the oil every 7,500 miles (12 500 km) or 12 months — whichever comes first. Change the filter at the first oil change and at every other oil change after that.

Engine Coolant Heater (Engine Block Heater) (OPTION)

An engine coolant heater can be a big help if you have to park outside in very

cold weather, 0°F (-18°C) or colder. If your vehicle has this option, see *Engine Coolant Heater* in the *Index*.

What to Do with Used Oil

Did you know that used engine oil contains certain elements that may be unhealthy for your skin and could even cause cancer? Don't let used oil stay on your skin for very long. Clean your skin and nails with soap and water, or a good hand cleaner. Wash or properly throw away clothing or rags containing used engine oil. (See the manufacturer's warnings about the use and disposal of oil products.)

Used oil can be a real threat to the environment. If you change your own oil, be sure to drain all free-flowing oil from the filter before disposal. Don't ever dispose of oil by putting it in the trash, pouring it on the ground, into sewers, or into streams or bodies of water. Instead, recycle it by taking it to a place that collects used oil. If you have a problem properly disposing of your used oil, ask your dealer, a service station or a local recycling center for help.

■ **Air Cleaner**

Refer to the Maintenance Schedule to determine when to replace the air filter and the crankcase ventilation filter.

See *Scheduled Maintenance Services* in the *Index*.



CAUTION:

Operating the engine with the air cleaner off can cause you or others to be burned. The air cleaner not only cleans the air, it stops flame if the engine backfires. If it isn't there, and the engine backfires, you could be burned. Don't drive with it off, and be careful working on the engine with the air cleaner off.

NOTICE:

If the air cleaner is off, a backfire can cause a damaging engine fire. And, dirt can easily get into your engine, which will damage it. Always have the air cleaner in place when you're driving.

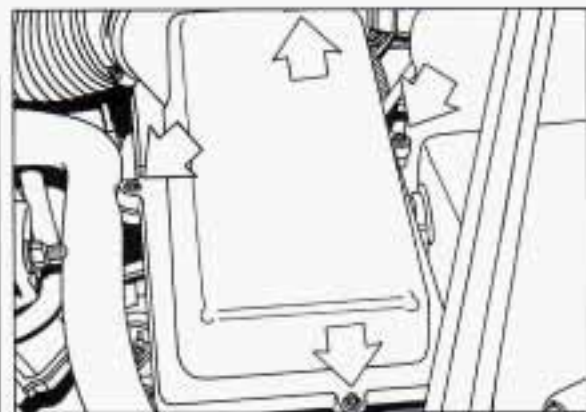

To Check or Replace the Air Filter:

1. Remove the four screws and pull off the cover.

Service & Appearance Care



2. Remove the air cleaner filter.
3. Be sure to install the air cleaner filter and replace the cover tightly.

■ Automatic Transaxle Fluid When to Check and Change

A good time to check your automatic transaxle fluid level is when the engine oil is changed. Refer to the Maintenance Schedule to determine when to change your fluid. See *Scheduled Maintenance Services* in the *Index*.

How to Check

Because this operation can be a little difficult, you may choose to have this done at an Oldsmobile dealership Service Department.

If you do it yourself, be sure to follow all the instructions here, or you could get a false reading on the dipstick.

NOTICE:

Too much or too little fluid can damage your transaxle. Too much can mean that some of the fluid could come out and fall on hot engine parts or exhaust system, starting a fire. Be sure to get an accurate reading if you check your transaxle fluid.

Wait at least 30 minutes before checking the transaxle fluid level if you have been driving:

- When outside temperatures are above 90°F (32°C).
- At high speed for quite a while.
- In heavy traffic — especially in hot weather.
- While pulling a trailer.

To get the right reading, the fluid should be at normal operating temperature, which is 180°F to 200°F (82°C to 93°C).

Get the vehicle warmed up by driving about 15 miles (24 km) when outside temperatures are above 50°F (10°C). If

it's colder than 50°F (10°C), you may have to drive longer.

To Check the Fluid Level:

- Park your vehicle on a level place.
- With the parking brake applied, place the shift lever in **P** (Park).
- With your foot on the brake pedal, move the shift lever through each gear range, pausing for about three seconds in each range. Then, position the shift lever in **P** (Park).
- Let the engine run at idle for three to five minutes.

Then, Without Shutting off the Engine, Follow These Steps:

1. Pull out the dipstick and wipe it with a clean rag or paper towel.
2. Push it back in all the way, wait three seconds and then pull it back out again.
3. Check both sides of the dipstick, and read the lower level. The fluid level must be in the cross-hatched area.
4. If the fluid level is in the acceptable range, push the dipstick back in all the way.

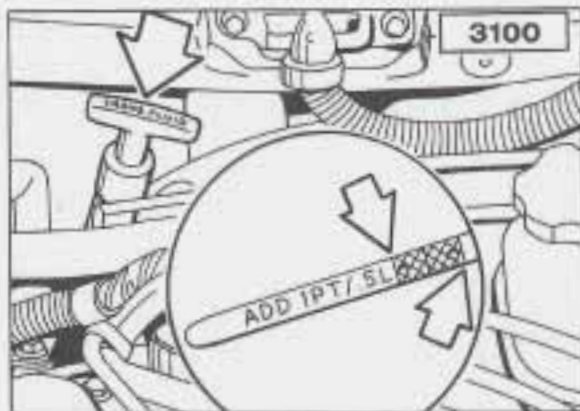

3100 V6: Checking Automatic Transaxle Fluid

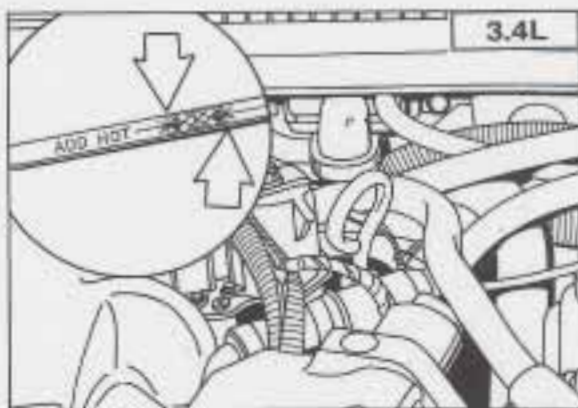

Twin Dual Cam 3.4L V6: Checking Automatic Transaxle Fluid

How to Add Fluid

Refer to the Maintenance Schedule to determine what kind of transaxle fluid to use. See *Recommended Fluids & Lubricants* in the *Index*.

If the fluid level is low, add only enough of the proper fluid to bring the level into the cross-hatched area on the dipstick.

1. Pull out the dipstick.
2. Using a long-neck funnel, add enough fluid at the dipstick hole to bring it to the proper level.

It doesn't take much fluid, generally less than a pint (0.5L). **Don't overfill.** We recommend you use only fluid labeled DEXRON®-III or DEXRON®-IIE, because fluids with that label are made especially for your automatic transaxle. Damage caused by fluid other than DEXRON®-III or DEXRON®-IIE is not covered by your new vehicle warranty.

- After adding fluid, recheck the fluid level as described under *How to Check*.
- When the correct fluid level is obtained, push the dipstick back in all the way.

Service & Appearance Care

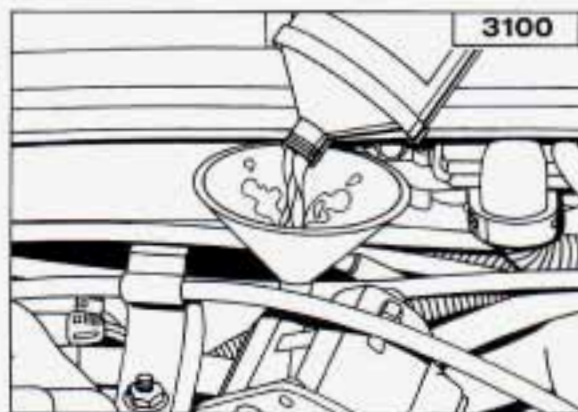

3100 V6: Adding Automatic Transaxle Fluid

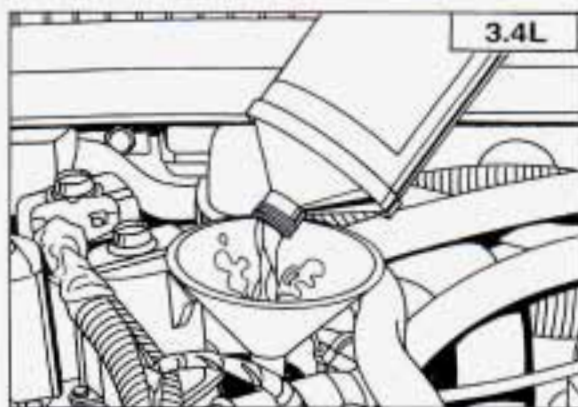

Twin Dual Cam 3.4L V6: Adding Automatic Transaxle Fluid

■ Engine Coolant

The following explains your cooling system and how to add coolant when it is low. If you have a problem with engine overheating or if you need to add coolant to your radiator, see *Engine Overheating* in the *Index*.

The proper coolant for your Oldsmobile will:

- Give freezing protection down to -34°F (-37°C).
- Give boiling protection up to 262°F (128°C).
- Protect against rust and corrosion.
- Help keep the proper engine temperature.
- Let the warning lights work as they should.

What to Use

Use a mixture of one-half **clean water** (preferably distilled) and one-half antifreeze that meets "GM Specification 1825-M," which won't damage aluminum parts. You can also use a recycled coolant conforming to GM Specification 1825-M with a complete

coolant flush and refill. If you use this mixture, you don't need to add anything else.



CAUTION:

Adding only plain water to your cooling system can be dangerous. Plain water, or some other liquid like alcohol, can boil before the proper coolant mix will. Your vehicle's coolant warning system is set for the proper coolant mix. With plain water or the wrong mix, your engine could get too hot but you wouldn't get the overheat warning. Your engine could catch fire and you or others could be burned. Use a 50/50 mix of clean water and a proper antifreeze.

NOTICE:

If you use an improper coolant mix, your engine could overheat and be badly damaged. The repair cost wouldn't be covered by your warranty. Too much water in the mix can freeze and crack the engine, radiator, heater core and other parts.

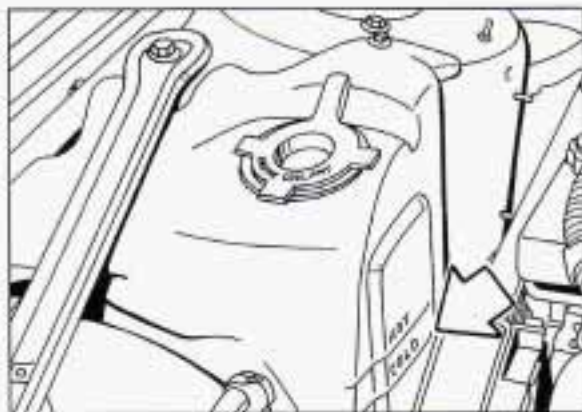

Adding Coolant

To Check Coolant

When your engine is cold, the coolant level should be at the **COLD** mark or a little higher. When your engine is warm, the level should be up to the **HOT** mark or a little higher.

SECURITY

LOW OIL
LEVEL

LOW
COOLANT



If this light comes on, it means you're low on engine coolant.

To Add Coolant

If you need more coolant, add the proper mix **at the coolant recovery tank**.

If the coolant recovery tank is completely empty, add coolant to the radiator. (See *Engine Overheating* in the *Index*.)



CAUTION:

Turning the radiator pressure cap when the engine and radiator are hot can allow steam and scalding liquids to blow out and burn you badly. With the coolant recovery tank, you will almost never have to add coolant at the radiator. Never turn the radiator pressure cap — even a little — when the engine and radiator are hot.

Add coolant mix at the recovery tank, but be careful not to spill it.



CAUTION:

You can be burned if you spill coolant on hot engine parts. Coolant contains ethylene glycol, and it will burn if the engine parts are hot enough. Don't spill coolant on a hot engine.

Radiator Pressure Cap

NOTICE:

Your radiator cap is a 15 psi (105kPa) pressure-type cap and must be tightly installed to prevent coolant loss and possible engine damage from overheating. Be sure the arrows on the cap line up with the overflow tube on the radiator filler neck.

When you replace your radiator pressure cap, an AC® cap is recommended.

Thermostat

Engine coolant temperature is controlled by a thermostat in the engine coolant system. The thermostat stops the flow of coolant through the radiator until the coolant reaches a preset temperature.

When you replace your thermostat, an AC® thermostat is recommended.

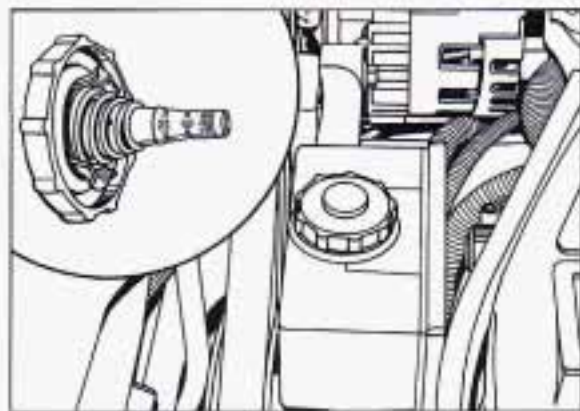

■ Power Steering Fluid How To Check Power Steering Fluid

Unscrew the cap and wipe the dipstick with a clean rag. Replace the cap and completely tighten it. Then remove the cap again and look at the fluid level on the dipstick.

- When the engine compartment is hot, the level should be at the **H** mark.
- When the engine compartment is cool, the level should be at the **C** mark.

What to Add

Refer to the Maintenance Schedule to determine what kind of fluid to use. See

Recommended Fluids and Lubricants in the Index.

NOTICE:

When adding power steering fluid or making a complete fluid change, always use the proper fluid. Failure to use the proper fluid can cause leaks and damage hoses and seals.

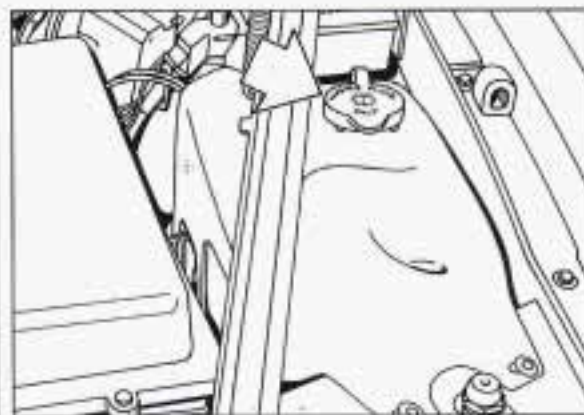

■ *Windshield Washer Fluid To Add*

Open the cap labeled **WASHER FLUID ONLY**. Add washer fluid until the bottle is full.

NOTICE:

- When using concentrated washer fluid, follow the manufacturer's instructions for adding water.
- Don't mix water with ready-to-use washer fluid. Water can cause the solution to freeze and damage your washer fluid tank and other parts of the washer system. Also, water doesn't clean as well as washer fluid.
- Fill your washer fluid tank only $\frac{3}{4}$ full when it's very cold. This allows for expansion, which could damage the tank if it is completely full.
- Don't use radiator antifreeze in your windshield washer. It can damage your washer system and paint.

Service & Appearance Care

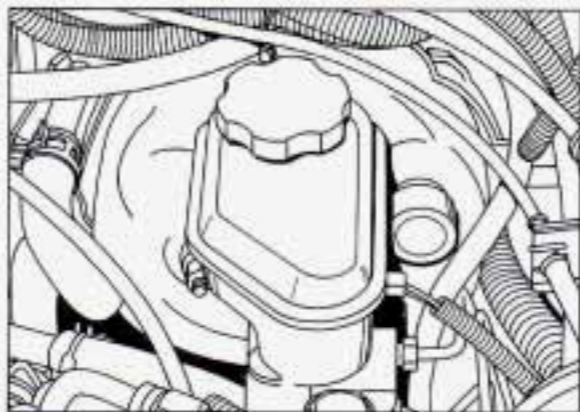

■ Brakes

Brake Master Cylinder

Your brake master cylinder is here. It is filled with DOT-3 brake fluid.

There are only two reasons why the brake fluid level in your master cylinder might go down. The first is that the brake fluid goes down to an acceptable level during normal brake lining wear. When new linings are put in, the fluid level goes back up. The other reason is that fluid is leaking out of the brake system. If it is, you should have your brake system fixed, since a leak means that sooner or later your brakes won't work well, or won't work at all. So, it isn't a good idea to "top off" your brake fluid. Adding brake fluid won't correct a leak. If you add fluid when your linings

are worn, then you'll have too much fluid when you get new brake linings. You should add (or remove) brake fluid, as necessary, only when work is done on the brake hydraulic system.



CAUTION:

If you have too much brake fluid, it can spill on the engine. The fluid will burn if the engine is hot enough. You or others could be burned, and your vehicle could be damaged. Add brake fluid only when work is done on the brake hydraulic system.

When your brake fluid falls to a low level, your brake warning light will come on. See *Brake System Warning Light* in the *Index*.

What to Add

When you do need brake fluid, use only DOT-3 brake fluid — such as Delco Supreme 11® (GM Part No.1052535). Use new brake fluid from a sealed container only, and always clean the

brake fluid reservoir cap before removing it.

NOTICE:

- DOT-5 silicone brake fluid can damage your vehicle. Don't use it.
- Don't let someone put in the wrong kind of fluid. For example, just a few drops of mineral-based oil, such as engine oil, in your brake system can damage brake system parts so badly that they'll have to be replaced.
- Brake fluid can damage paint, so be careful not to spill brake fluid on your vehicle. If you do, wash it off immediately. See *Appearance Care* in the *Index*.

Brake Wear

Your Oldsmobile has four-wheel disc brakes.

Disc brake pads have built-in wear indicators that make a high-pitched warning sound when the brake pads are worn and new pads are needed. The

sound may come and go or be heard all the time your vehicle is moving (except when you are pushing on the brake pedal firmly).



CAUTION:

The brake wear warning sound means that sooner or later your brakes won't work well. That could lead to an accident. When you hear the brake wear warning sound, have your vehicle serviced.

NOTICE:

Continuing to drive with worn-out brake pads could result in costly brake repair.

Some driving conditions or climates may cause a brake squeal when the brakes are first applied or lightly applied. This does not mean something is wrong with your brakes.

Brake linings should always be replaced as complete axle sets.

Brake Pedal Travel

See your dealer if the brake pedal does not return to normal height, or if there is a rapid increase in pedal travel. This could be a sign of brake trouble.

Brake Adjustment

Every time you make a moderate brake stop, your disc brakes adjust for wear. If you rarely make a moderate or heavier stop, then your brakes might not adjust correctly. If you drive in that way, then — very carefully — make a few moderate brake stops about every 1,000 miles (1 600 km), so your brakes will adjust properly.

Replacing Brake System Parts

The braking system on a modern vehicle is complex. Its many parts have to be of top quality and work well together if the vehicle is to have really good braking. Vehicles we design and test have top-quality GM brake parts in them, as your Oldsmobile does when it is new. When you replace parts of your braking system — for example, when your brake linings wear down and you

have to have new ones put in — be sure you get new genuine GM replacement parts. If you don't, your brakes may no longer work properly. For example, if someone puts in brake linings that are wrong for your vehicle, the balance between your front and rear brakes can change, for the worse. The braking performance you've come to expect can change in many other ways if someone puts in the wrong replacement brake parts.

Service & Appearance Care

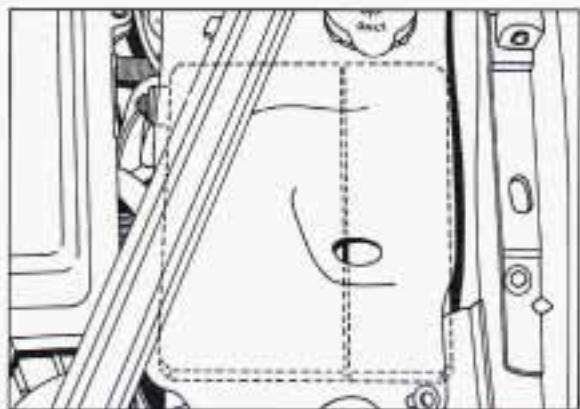

■ Battery

Every new Oldsmobile has a Delco Freedom[®] battery. You never have to add water to one of these. When it's time for a new battery, we recommend a Delco Freedom[®] battery. Get one that has the catalog number shown on the original battery's label.

Vehicle Storage

If you're not going to drive your vehicle for 25 days or more, take off the black, negative (-) cable from the battery. This will help keep your battery from running down.



CAUTION:

Batteries have acid that can burn you and gas that can explode. You can be badly hurt if you aren't careful. See *Jump Starting* in the *Index* for tips on working around a battery without getting hurt.

Contact your dealer to learn how to prepare your vehicle for longer storage periods.

■ Bulb Replacement

In this section you'll find directions for changing the light bulbs in some of the lights on your Oldsmobile. You'll also find directions for adjusting the alignment of the mini-quad headlights, if you have this type.

Be sure to read the directions before you begin to replace or adjust any lights.

See the *Index* under *Replacement Bulbs* to find the type of bulb you need to use.

■ Halogen Bulbs



CAUTION:

Halogen bulbs have pressurized gas inside and can burst if you drop or scratch the bulb. You or others could be injured. Take special care when handling and disposing of halogen bulbs.

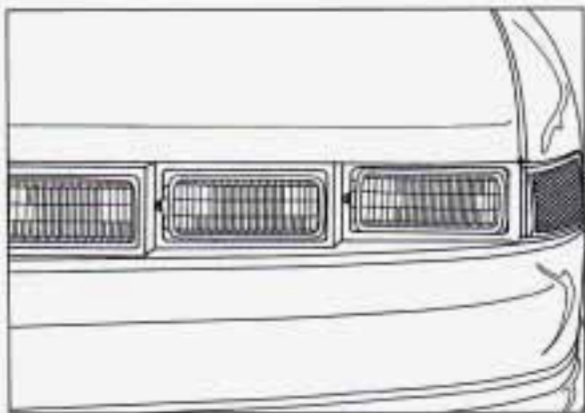

■ *Headlight Aiming*

This section is for owners of 2-door Oldsmobiles only. The headlights on 2-door Oldsmobiles can be checked and aimed by the owner. If you have a 4-door Oldsmobile, please see your dealer when your headlight aim needs to be checked or adjusted. To replace a headlight on a 4-door Oldsmobile, see the *Index* under *Headlight Replacement*.

Checking Headlight Aim

(2-DOOR MODELS)

Your vehicle has the 55 x 135 mini-quad headlight system. These headlights have horizontal and vertical aim indicators. The aim has been pre-

set at the factory and should need no further adjustment.

If your vehicle is damaged in an accident and the headlight aim seems to be affected, see your Oldsmobile dealer. Headlights on damaged vehicles may require recalibration of the horizontal aim by your Oldsmobile dealer.

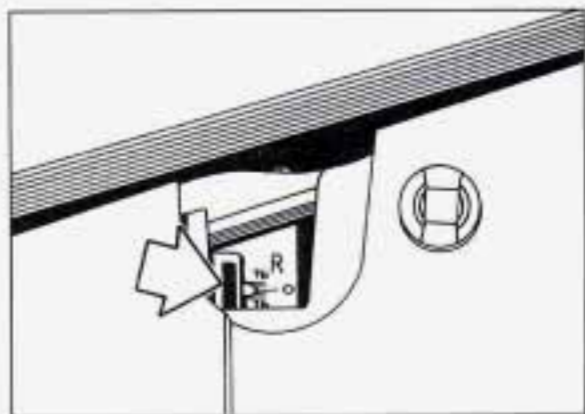

To check the aim, the vehicle should be properly prepared as follows:

- The vehicle must have all four tires on a perfectly level surface.
- The vehicle should not have any snow, ice, or mud attached to it.
- There should not be any cargo or loading of vehicle, except it should have a full tank of gas and one person or 160 pounds (75 kg) on the driver's seat.
- Tires should be properly inflated.
- The horizontal indicator should read **0** (zero).

Service & Appearance Care

NOTICE:

To make sure your headlights are aimed properly, read all the instructions before beginning. Failure to follow these instructions could cause damage to headlight parts.

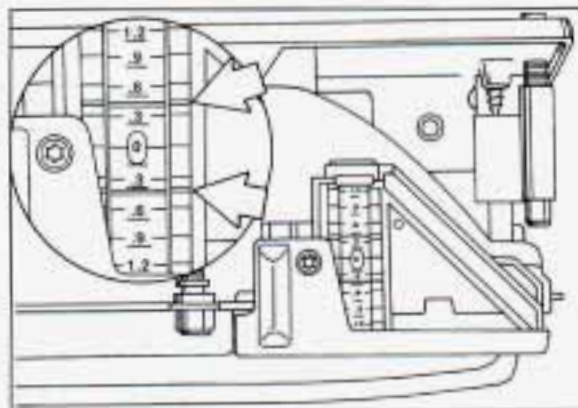

State inspection stations will allow a vertical reading of up plus .76 degrees or down minus .76 degrees for the center of the bubble.

It is recommended that the upper limit not exceed up plus .4 degrees for the center of the bubble. There may be an increased chance of being flashed if adjustment is much above up plus .4 degrees.

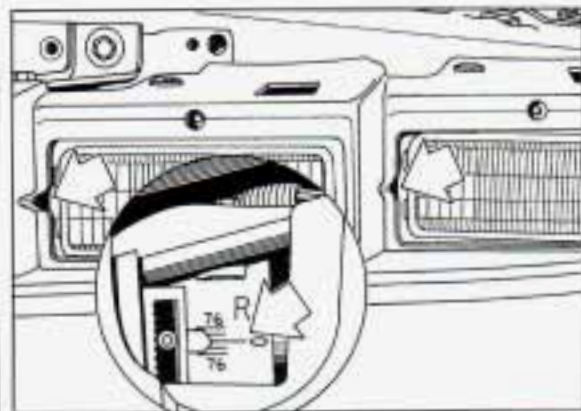

Aiming Headlights (2-DOOR MODELS)

1. Start with the horizontal (left and right) headlight aim. Don't try to adjust the vertical (up and down) aim first.
2. Check the horizontal aim for each headlight and adjust it as necessary.
3. Turn the horizontal aiming screw until the pointer is lined up with the 0 (zero).

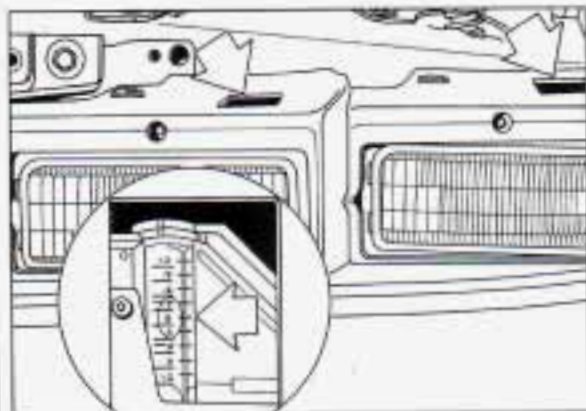

4. Now adjust the vertical aim. Check the vertical aim for each headlight and adjust it as necessary.
5. Turn the vertical aiming screw until the bubble in the level is centered at 0 (zero).

To Replace a Headlight

(2-DOOR MODELS)

Before replacing a headlight that does not light, check to make sure that the wiring connector is securely fastened to it.

See the *Index* under *Replacement Bulbs* to check the size and type of headlight you need to use before you begin to replace the headlight. You must replace a headlight with one that is exactly the same.

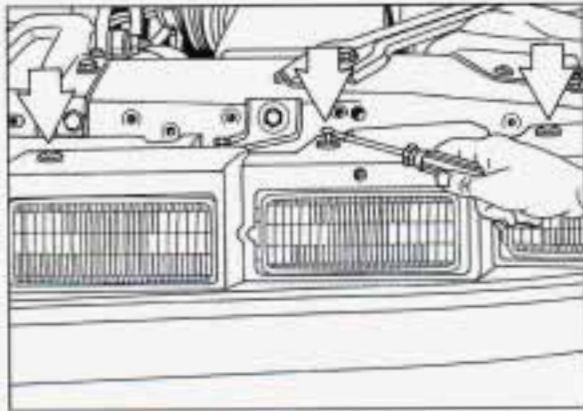

1. Pry up the plastic pins and remove the headlight cover.

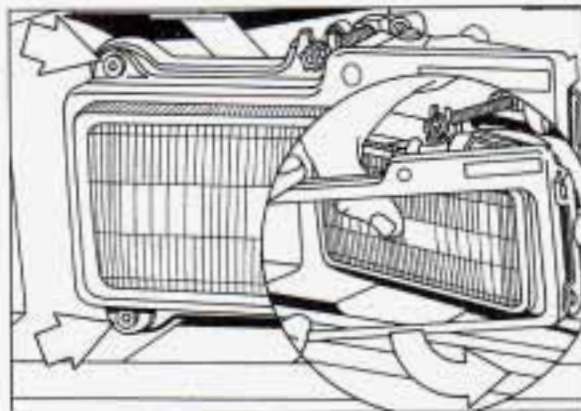

2. Remove the Torx® head screws at the end of the aiming ring. The aiming ring will swing open like a gate.
3. Remove the aiming ring from the assembly.

Service & Appearance Care

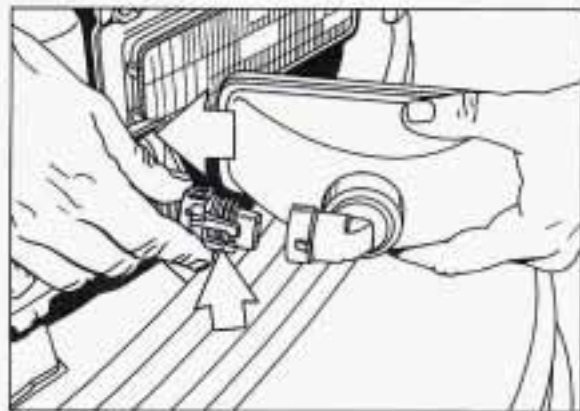

4. Remove the wiring connector from the headlight socket by lifting the plastic locking tabs on the connector and pulling it from the socket.

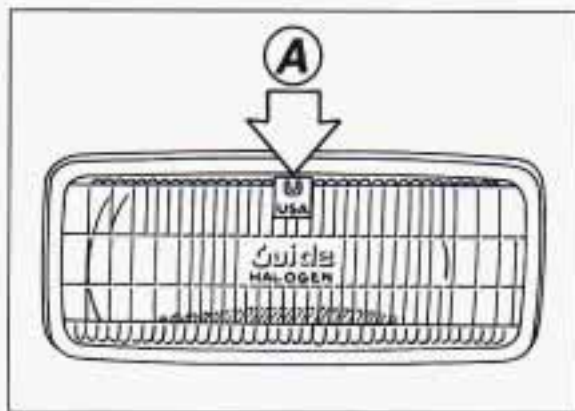

5. Check the new headlight again. The number on the top of the light (A) must match the number on the headlight being replaced. The letter, U or L, must also match.

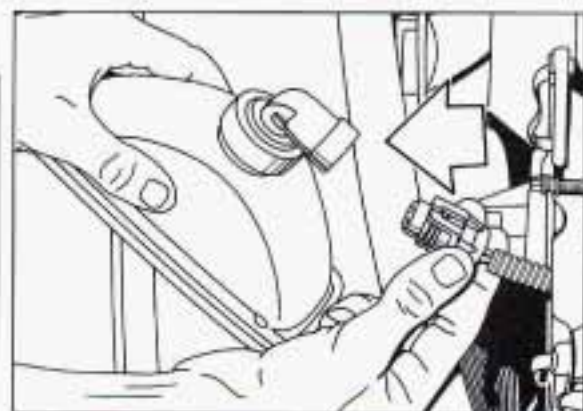

6. Plug the wiring connector into the headlight socket. Snap the locking tabs onto the socket.
7. Place the new headlight in the headlight assembly. The socket must be pointing in the same direction the socket on the burned-out bulb was.

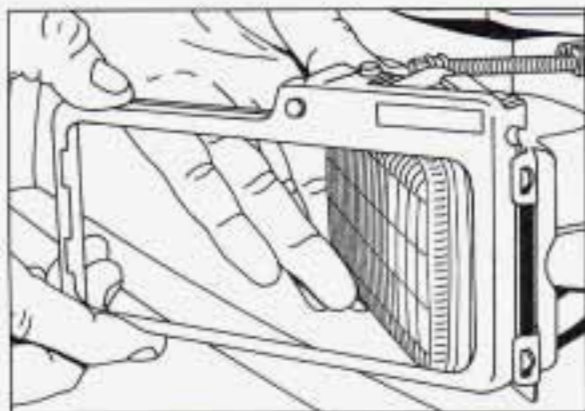

8. Insert the tabs on the aiming ring into the slots in the headlight assembly.

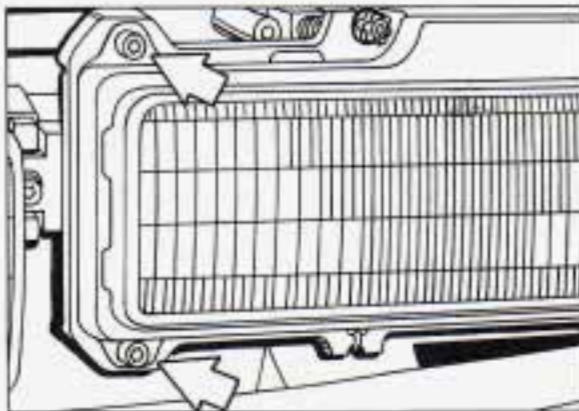

9. Holding the aiming ring closed, insert the screws at the end of the ring. Tighten the screws until the aiming ring touches the plastic nuts on both the top and bottom. Do not overtighten. Do not damage the vertical aiming bubble.

To check the aim, the vehicle should be properly prepared as follows:

- The vehicle must have all four tires on a perfectly level surface.
- The vehicle should not have any snow, ice or mud attached to it.
- There should not be any cargo or loading of vehicle, except it should have a full tank of gas and one person or 160 pounds (75 kg) on the driver's seat.

- Tires should be properly inflated.
- The horizontal indicator should read **0** (zero).

If your vehicle is damaged in an accident and the headlight aim seems to be affected, see your Oldsmobile dealer. Headlights on damaged vehicles may require recalibration of the horizontal aim by your Oldsmobile dealer.

Service & Appearance Care

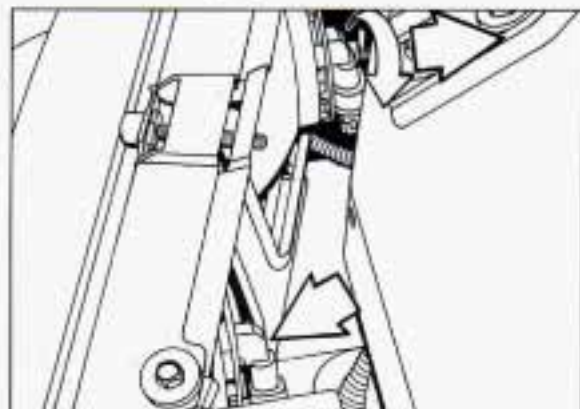

Headlight Replacement

(4-DOOR MODELS)

See the *Index* under *Replacement Bulbs* to check the type of bulb to use.

To Replace a Bulb:

1. Turn the L-shaped bulb assembly counterclockwise $\frac{1}{4}$ turn until the flanges align with the slots in the retainer ring. You may need to twist it back and forth slightly to loosen it.

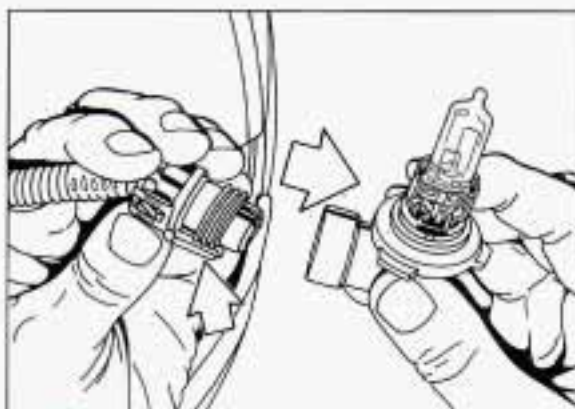

2. Pull out the bulb assembly.
3. Disconnect the bulb wiring harness from the socket bulb assembly by lifting the plastic locking tab.
4. Snap a new bulb assembly into the wiring harness.
5. Replace the bulb assembly by reversing step one.

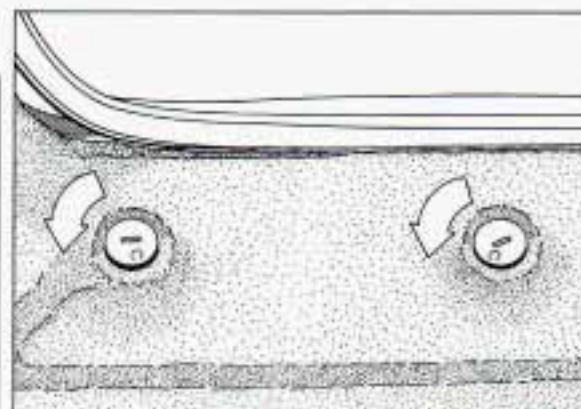

Taillight Bulb Replacement

(2-DOOR MODELS)

For the type of bulb, see the *Index* under *Replacement Bulbs*.

1. Remove the two large plastic screws and pull the carpet away from the rear corner of the trunk.

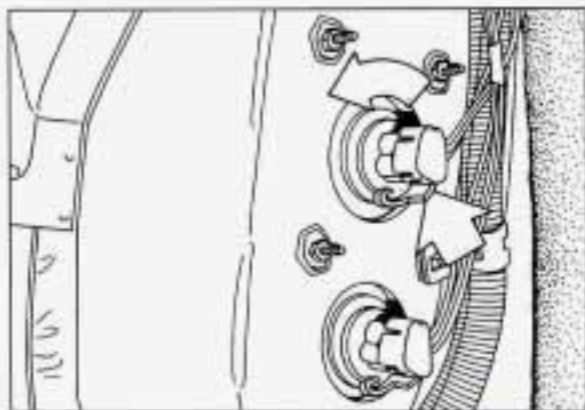

2. Press the bulb housing release lever and turn the housing $\frac{1}{4}$ turn counterclockwise to remove it.

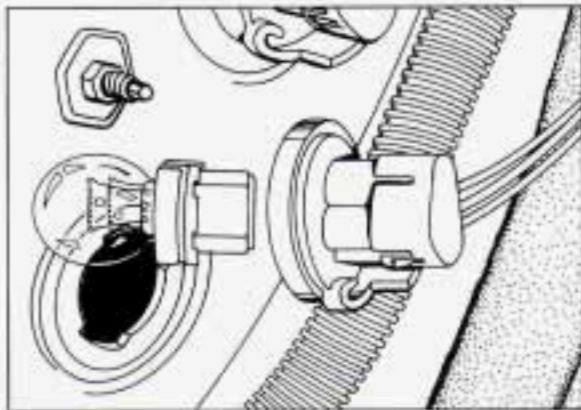

3. To remove the bulb, pull it from the assembly.
4. Push in a new bulb.
5. Reverse all steps to reassemble the taillight housing.

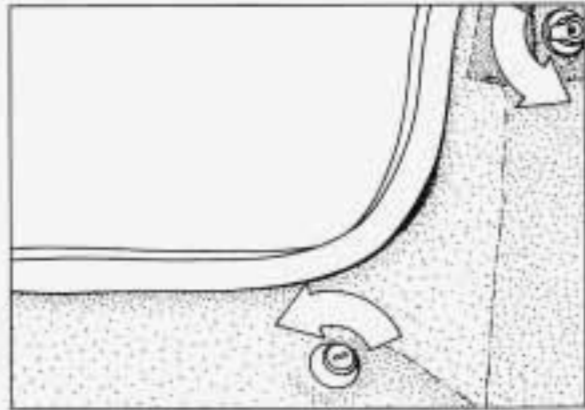

Taillight Bulb Replacement

(4-DOOR MODELS)

For the type of bulb, see the *Index* under *Replacement Bulbs*.

1. Remove the two large plastic screws and pull the carpet away from the rear corner of the trunk.

Service & Appearance Care

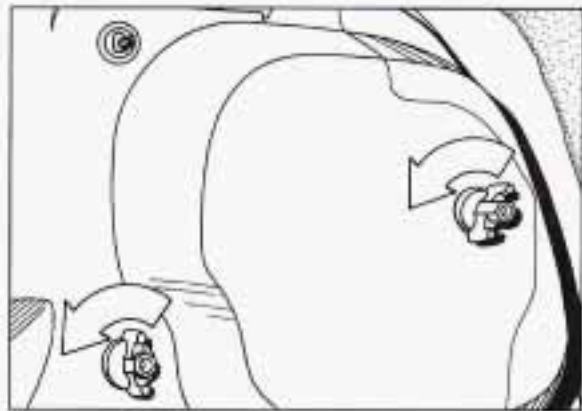

2. Remove the two wing nuts.

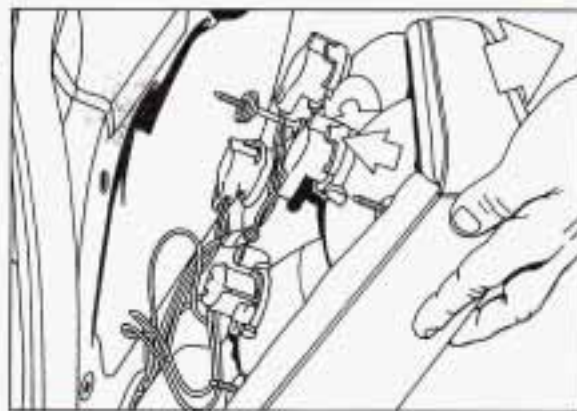

3. Pull the taillight housing away from the body of the vehicle.

4. Press the bulb housing release lever and turn the housing $\frac{1}{8}$ turn counterclockwise to remove it.

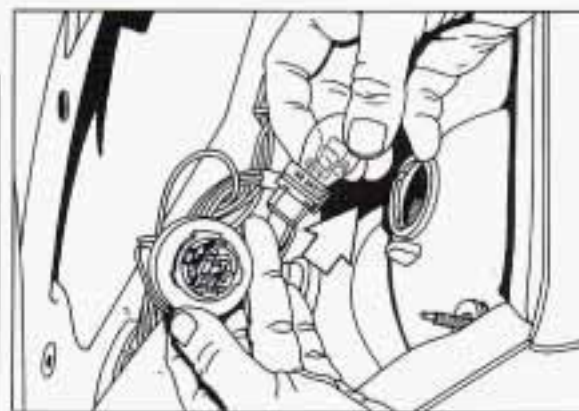

5. To remove the bulb, pull it from the assembly.

6. Push in a new bulb.

7. Reverse all steps to reassemble the taillight.

Fog Light Bulb Replacement

Oldsmobile recommends that you not change your fog light bulb unless you have the proper aiming equipment. See your Oldsmobile dealer for help with this.

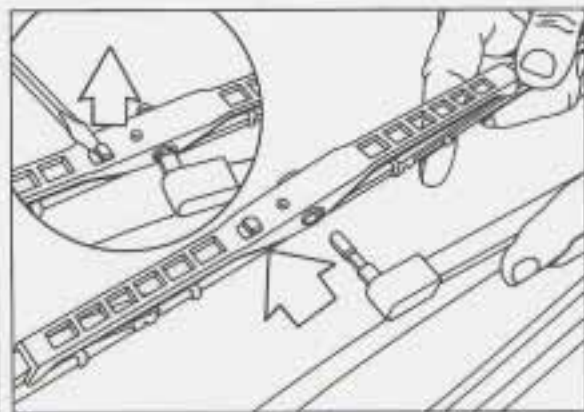

Windshield Wiper Blade Replacement

Replacement blades come in different types and are removed in different ways. Here's how to remove the type with a release clip:

1. Pull the windshield wiper arm away from the windshield.
2. Lift the release clip with a screwdriver and pull the blade assembly off the wiper arm.
3. Push the new wiper blade securely on the wiper arm.

TIRE-LOADING INFORMATION	
VEHICLE USE ONLY	
NO. OF OCCUPANTS	WEIGHT
1	2
MAX. LOADS & SPEED RATING BY TIRE SIZE	MAX. LOAD
VEHICLE WEIGHT	MAX. GAWR
MAX. TIRE SIZE	MAX. GVWR
MAX. TIRE SPEED	MAX. GVWR
MAX. TIRE LOAD	MAX. GVWR
MAX. TIRE LOAD	MAX. GVWR

CERTIFICATION LABEL	
VEHICLE USE ONLY	
NO. OF OCCUPANTS	WEIGHT
1	2
MAX. LOADS & SPEED RATING BY TIRE SIZE	MAX. LOAD
VEHICLE WEIGHT	MAX. GAWR
MAX. TIRE SIZE	MAX. GVWR
MAX. TIRE SPEED	MAX. GVWR
MAX. TIRE LOAD	MAX. GVWR
MAX. TIRE LOAD	MAX. GVWR

■ Loading Your Vehicle

Two labels on your vehicle show how much weight it may properly carry. The Tire-Loading Information label found on the inside of the trunk lid tells you the proper size, speed rating and recommended inflation pressures for the tires on your vehicle. It also gives you important information about the number of people that can be in your vehicle and the total weight that you can carry. This weight is called the Vehicle Capacity Weight and includes the weight of all occupants, cargo, and all nonfactory-installed options.

The other label is the Certification label, on the rear edge of the driver's door. It tells you the gross weight capacity of your vehicle, called the GVWR (Gross

Vehicle Weight Rating). The GVWR includes the weight of the vehicle, all occupants, fuel and cargo. Never exceed the GVWR for your vehicle, or the Gross Axle Weight Rating (GAWR) for either the front or rear axle.

And, if you do have a heavy load, you should spread it out. Don't carry more than 167 lbs. (75 kg) in your trunk.



CAUTION:

Do not load your vehicle any heavier than the GVWR or the maximum front and rear GAWRs. If you do, parts on your vehicle can break, or it can change the way your vehicle handles. These could cause you to lose control. Also, overloading can shorten the life of your vehicle.

NOTICE:

Your warranty does not cover parts or components that fail because of overloading.

Service & Appearance Care

If you put things inside your vehicle—like suitcases, tools, packages, or anything else—they will go as fast as the vehicle goes. If you have to stop or turn quickly, or if there is a crash, they'll keep going.



CAUTION:

Things you put inside your vehicle can strike and injure people in a sudden stop or turn, or in a crash.

- Put things in the trunk of your vehicle. In a trunk, put them as far forward as you can. Try to spread the weight evenly.
- Never stack heavier things, like suitcases, inside the vehicle so that some of them are above the tops of the seats.
- Don't leave an unsecured child restraint in your vehicle.
- When you carry something inside the vehicle, secure it whenever you can.
- Don't leave a seat folded down unless you need to.

■ Tires

We don't make tires. Your new vehicle comes with high quality tires made by a leading tire manufacturer. These tires are warranted by the tire manufacturers and their warranties are delivered with every new Oldsmobile. If your spare tire is a different brand than your road tires, you will have a tire warranty folder from each of these manufacturers.



CAUTION:

Poorly maintained and improperly used tires are dangerous.

- Overloading your tires can cause overheating as a result of too much friction. You could have an air-out and a serious accident. See *Loading Your Vehicle* in the *Index*.
- Underinflated tires pose the same danger as overloaded tires. The resulting accident could cause serious injury. Check all tires frequently to maintain the recommended pressure. Tire pressure should be checked when your tires are cold.
- Overinflated tires are more likely to be cut, punctured, or broken by a sudden impact, such as when you hit a pothole. Keep tires at the recommended pressure.

CAUTION (Continued)

CAUTION (Continued)

- Worn, old tires can cause accidents. If your tread is badly worn, or if your tires have been damaged, replace them.

Inflation – Tire Pressure

The Tire-Loading Information label which is on the inside of the trunk lid shows the correct inflation pressures for your tires, when they're cold. **Cold** means your vehicle has been sitting for at least three hours or driven no more than a mile.

NOTICE:

Don't let anyone tell you that underinflation **or** overinflation is all right. It's not. If your tires don't have enough air (underinflation) you can get:

- Too much flexing
- Too much heat
- Tire overloading
- Bad wear
- Bad handling
- Bad fuel economy.

If your tires have too much air (overinflation), you can get:

- Unusual wear
- Bad handling
- Rough ride
- Needless damage from road hazards.

When to Check

Check your tires once a month or more. Don't forget your compact spare tire. It should be at 60 psi (420 kPa).

Service & Appearance Care

How to Check

Use a good quality pocket-type gage to check tire pressure. Simply looking at the tires will not tell you the pressure, especially if you have radial tires — which may look properly inflated even if they're underinflated.

If your tires have valve caps, be sure to put them back on. They help prevent leaks by keeping out dirt and moisture.

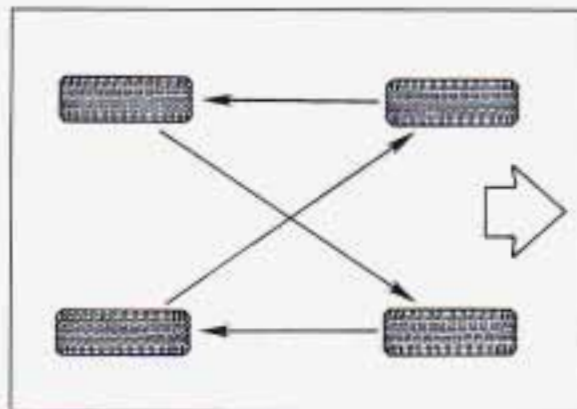

Tire Inspection and Rotation

To make your tires last longer, have them inspected and rotated at the mileages recommended in the Maintenance Schedule. See *Scheduled Maintenance Services* in the *Index*.

Use this rotation pattern.

After the tires have been rotated, adjust the front and rear inflation pressure as shown on the Tire-Loading Information label. Make certain that all wheel nuts are properly tightened. See *Wheel Nut Torque* in the *Index*.



CAUTION:

Rust or dirt on a wheel, or on the parts to which it is fastened, can make wheel nuts become loose after a time. The wheel could come off and cause an accident. When you change a wheel, remove any rust or dirt from places where the wheel attaches to the vehicle. In an emergency, you can use a cloth or a paper towel to do this; but be sure to use a scraper or wire brush later, if you need to, to get all the rust or dirt off. (See *Changing a Flat Tire* in the *Index*.)

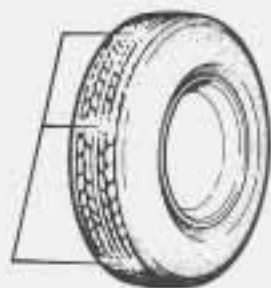

TREAD WEAR INDICATORS

When It's Time for New Tires

One way to tell when it's time for new tires is to check the treadwear indicators, which will appear when your tires have only 2/32 inch (1.6 mm) or less of tread remaining.

You need a new tire if:

- You can see the indicators at three or more places around the tire.
- You can see cord or fabric showing through the tire's rubber.
- The tread or sidewall is cracked, cut or snagged deep enough to show cord or fabric.
- The tire has a bump, bulge or split.
- The tire has a puncture, cut, or other damage that can't be repaired well because of the size or location of the damage.

Buying New Tires

To find out what kind and size of tires you need, look at the Tire-Loading Information label.

The tires installed on your vehicle when it was new had a Tire Performance Criteria Specification (TPC Spec) number on each tire's sidewall. When you get new tires, get ones with that same TPC Spec number. That way, your vehicle will continue to have tires that are designed to give proper endurance, handling, speed rating, traction, ride and other things during normal service on your vehicle. If your tires have an all-season tread design, the TPC number will be followed by a "MS" (for mud and snow).

If you ever replace your tires with those not having a TPC Spec number, make sure they are the same size, load range, speed rating and construction type (bias, bias-belted or radial) as your original tires.



CAUTION:

Mixing tires could cause you to lose control while driving. If you mix tires of different sizes or types (radial and bias-belted tires), the vehicle may not handle properly, and you could have a crash. Be sure to use the same size and type tires on all four wheels. It's all right to drive with your compact spare, though. It was developed for use on your vehicle.

Uniform Tire Quality Grading

The following information relates to the system developed by the United States National Highway Traffic Safety Administration which grades tires by treadwear, traction and temperature performance. (This applies only to vehicles sold in the United States.)

Treadwear

The treadwear grade is a comparative rating based on the wear rate of the tire when tested under controlled conditions on a specified government

Service & Appearance Care

test course. For example, a tire graded 150 would wear one and a half (1 1/2) times as well on the government course as a tire graded 100. The relative performance of tires depends upon the actual conditions of their use, however, and may depart significantly from the norm due to variations in driving habits, service practices and differences in road characteristics and climate.

Traction – A, B, C

The traction grades, from highest to lowest are: A, B, and C. They represent the tire's ability to stop on wet pavement as measured under controlled conditions on specified government test surfaces of asphalt and concrete. A tire marked C may have poor traction performance.

Warning: The traction grade assigned to this tire is based on braking (straight-ahead) traction tests and does not include cornering (turning) traction.

Temperature – A, B, C

The temperature grades are A (the highest), B, and C, representing the tire's resistance to the generation of heat and its ability to dissipate heat

when tested under controlled conditions on a specified indoor laboratory test wheel. Sustained high temperature can cause the material of the tire to degenerate and reduce tire life, and excessive temperature can lead to sudden tire failure. The grade C corresponds to a level of performance which all passenger car tires must meet under the Federal Motor Vehicle Safety Standard No. 109. Grades B and A represent higher levels of performance on the laboratory test wheel than the minimum required by law.

Warning: The temperature grade for this tire is established for a tire that is properly inflated and not overloaded. Excessive speed, underinflation, or excessive loading, either separately or in combination, can cause heat buildup and possible tire failure.

These grades are molded on the sidewalls of passenger car tires.

While the tires available as standard or optional equipment on General Motors vehicles may vary with respect to these grades, all such tires meet General Motors performance standards and

have been approved for use on General Motors vehicles. All passenger type (P Metric) tires must conform to Federal safety requirements in addition to these grades.

Wheel Alignment and Tire Balance

The wheels on your vehicle were aligned and balanced carefully at the factory to give you the longest tire life and best overall performance.

In most cases, you will not need to have your wheels aligned again. However, if you notice unusual tire wear or your vehicle pulling one way or the other, the alignment may need to be reset. If you notice your vehicle vibrating when driving on a smooth road, your wheels may need to be rebalanced.

Wheel Replacement

Replace any wheel that is bent, cracked or badly rusted. If wheel nuts keep coming loose, the wheel, wheel bolts, and wheel nuts should be replaced. If the wheel leaks air, replace it (except

some aluminum wheels, which can sometimes be repaired). See your Oldsmobile dealer if any of these conditions exist.

Your dealer will know the kind of wheel you need.

Each new wheel should have the same load carrying capacity, diameter, width, offset, and be mounted the same way as the one it replaces.

If you need to replace any of your wheels, wheel bolts, or wheel nuts, replace them only with new GM

original equipment parts. This way, you will be sure to have the right wheel, wheel bolts, and wheel nuts for your Oldsmobile model.



CAUTION:

Using the wrong replacement wheels, wheel bolts, or wheel nuts on your vehicle can be dangerous. It could affect the braking and handling of your vehicle, make your tires lose air and make you lose control. You could have a collision in which you or others could be injured. Always use the correct wheel, wheel bolts, and wheel nuts for replacement.

NOTICE:

The wrong wheel can also cause problems with bearing life, brake cooling, speedometer/odometer calibration, headlight aim, bumper height, vehicle ground clearance, and tire or tire chain clearance to the body and chassis.

Used Replacement Wheels



CAUTION:

Putting a used wheel on your vehicle is dangerous. You can't know how it's been used or how many miles it's been driven. It could fail suddenly and cause an accident. If you have to replace a wheel use a **new GM** original equipment wheel.

Service & Appearance Care

Tire Chains

NOTICE:

If your Oldsmobile has P215/60R16, P225/60R16 or P245/50ZR16 size tires, don't use tire chains; they can damage your vehicle. If you have other tires, use tire chains only where legal and only when you must. Use only SAE Class "S" type chains that are the proper size for your tires. Install them on the front tires and tighten them as tightly as possible with the ends securely fastened. Drive slowly and follow the chain manufacturer's instructions. If you can hear the chains contacting your vehicle, stop and retighten them. If the contact continues, slow down until it stops. Driving too fast with chains on will damage your vehicle.

■ Appearance Care

Remember, cleaning products can be hazardous. Some are toxic. Others can burst into flame if you strike a match or get them on a hot part of the vehicle.

Some are dangerous if you breathe their fumes in a closed space. When you use anything from a container to clean your Oldsmobile, be sure to follow the manufacturer's warnings and instructions. And always open your doors or windows when you're cleaning the inside.

Never use these to clean your vehicle:

- Gasoline
- Benzene
- Naphtha
- Carbon Tetrachloride
- Acetone
- Paint Thinner
- Turpentine
- Lacquer Thinner
- Nail Polish Remover

They can all be hazardous — some more than others — and they can all damage your vehicle, too.

NOTICE:

Don't use any of these unless this manual says you can. In many uses, these will damage your vehicle:

- Laundry Soap
- Bleach
- Reducing Agents

■ Cleaning the Inside of Your Oldsmobile

Use a vacuum cleaner often to get rid of dust and loose dirt. Wipe vinyl or leather with a clean, damp cloth.

Your Oldsmobile dealer has two GM cleaners, a solvent-type spot lifter and a foam-type powdered cleaner. They will clean normal spots and stains very well. Do not use them on vinyl or leather.

Here are some cleaning tips:

- Always read the instructions on the cleaner label.
- Clean up stains as soon as you can — before they set.
- Use a clean cloth or sponge, and

change to a clean area often. A soft brush may be used if stains are stubborn.

- Use solvent-type cleaners in a well-ventilated area only. If you use them, don't saturate the stained area.
- If a ring forms after spot cleaning, clean the entire area immediately or it will set.

Using Foam-Type Cleaner on Fabric

- Vacuum and brush the area to remove any loose dirt.
- Always clean a whole trim panel or section. Mask surrounding trim along stitch or welt lines.
- Mix Multi-Purpose Powdered Cleaner following the directions on the container label.
- Use suds only and apply with a clean sponge.
- Don't saturate the material.
- Don't rub it roughly.
- As soon as you've cleaned the section, use a sponge to remove the suds.

- Rinse the section with a clean, wet sponge.
- Wipe off what's left with a slightly damp paper towel or cloth.
- Then dry it immediately with a blow dryer or a heat lamp.

NOTICE:

Be careful with a hair dryer or heat lamp. You could scorch the fabric.

- Wipe with a clean cloth.

Using Solvent-Type Cleaner on Fabric

First, see if you have to use solvent-type cleaner at all. Some spots and stains will clean off better with just water and mild soap.

If you need to use a solvent:

- Gently scrape excess soil from the trim material with a clean, dull knife or scraper. Use very little cleaner, light pressure and clean cloths (preferably cheesecloth). Cleaning should start at the outside of the

stain, "feathering" toward the center. Keep changing to a clean section of the cloth.

- When you clean a stain from fabric, immediately dry the area with an air hose, hair dryer, or heat lamp to help prevent a cleaning ring. (See the previous NOTICE.)

Special Cleaning Problems

Greasy or Oily Stains

Such as grease, oil, butter, margarine, shoe polish, coffee with cream, chewing gum, cosmetic creams, vegetable oils, wax crayon, tar and asphalt.

- Carefully scrape off excess stain.
- Follow the solvent-type instructions described earlier.
- Shoe polish, wax crayon, tar and asphalt will stain if left on a vehicle seat fabric. They should be removed as soon as possible. Be careful, because the cleaner will dissolve them and may cause them to spread.

Non-Greasy Stains

Such as catsup, coffee (black), egg,

Service & Appearance Care

fruit, fruit juice, milk, soft drinks, wine, vomit, urine and blood.

- Carefully scrape off excess stain, then sponge the soiled area with cool water.
- If a stain remains, follow the foam-type instructions described earlier.
- If an odor lingers after cleaning vomit or urine, treat the area with a water/baking soda solution: 1 teaspoon (5 ml) of baking soda to 1 cup (250 ml) of lukewarm water.
- If needed, clean lightly with solvent-type cleaner.

Combination Stains

Such as candy, ice cream, mayonnaise, chili sauce and unknown stains.

- Carefully scrape off excess stain, then clean with cool water and allow to dry.
- If a stain remains, clean it with solvent-type cleaner.

Cleaning Vinyl

Use warm water and a clean cloth.

- Rub with a clean, damp cloth to

remove dirt. You may have to do it more than once.

- Things like tar, asphalt and shoe polish will stain if you don't get them off quickly. Use a clean cloth and a solvent-type vinyl cleaner.

Cleaning Leather

Use a soft cloth with lukewarm water and a mild soap or saddle soap.

- For stubborn stains, use a mild solution of 10% isopropyl alcohol (rubbing alcohol) and 90% water.
- **Never** use oils, varnishes, solvent-based or abrasive cleaners, furniture polish or shoe polish on leather.
- Soiled leather should be cleaned immediately. If dirt is allowed to work into finish, it can harm the leather.

Cleaning the Top of the Instrument Panel

Use only mild soap and water to clean the top surfaces of the instrument panel. Sprays containing silicones or waxes may cause annoying reflections in the windshield and even make it difficult to see through the windshield under certain conditions.

■ Care of Safety Belts

Keep belts clean and dry.



CAUTION:

Do not bleach or dye safety belts. If you do, it may severely weaken them. In a crash they might not be able to provide adequate protection. Clean safety belts only with mild soap and lukewarm water.

■ Glass

Glass should be cleaned often. GM Glass Cleaner (GM Part No. 1050427) or a liquid household glass cleaner will remove normal tobacco smoke and dust films.

Don't use abrasive cleaners on glass, because they may cause scratches. Avoid placing decals on the inside rear window, since they may have to be scraped off later. If abrasive cleaners are used on the inside of the rear window, an electric defogger element may be damaged. Any temporary license should not be attached across the defogger grid.

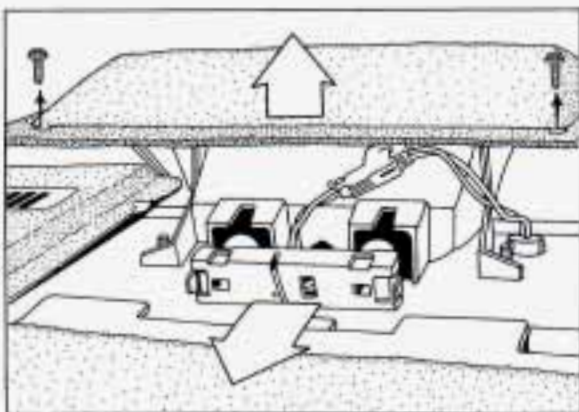

■ Inside Center High-Mounted Stoplight (2-DOOR MODELS)

For the type of bulb, see the *Index* under *Replacement Bulbs*.

If you would like to clean the inside surface of the rear window or need to replace a bulb, you can remove the stoplight housing by following these steps:

1. Remove the two Phillips-head screws from the cover.
2. Remove the cover.
3. Unclip the bulb carrier.

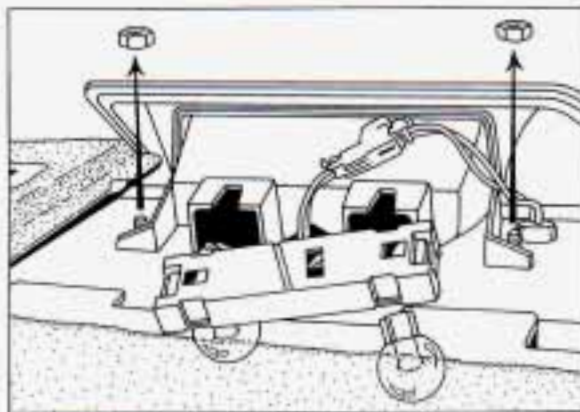

4. Pull the bulb out to replace. Push in a new bulb.
5. Clip the bulb carrier back into place.
6. To remove the stoplight lens to clean the window, remove the two nuts on either side of the housing.
7. Replace the cover.

Service & Appearance Care

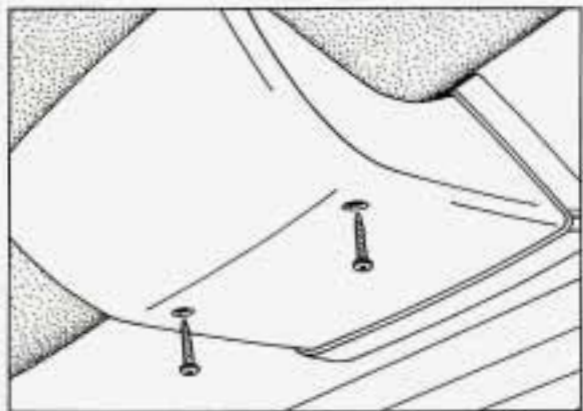

■ *Inside Center High-Mounted Stoplight (4-DOOR MODELS)*

For the type of bulb, see the *Index* under *Replacement Bulbs*.

If you would like to clean the inside surface of the rear window or need to replace a bulb, you can remove the stoplight housing by following these steps:

1. Remove the two Phillips-head screws from the cover.
2. Pull down the cover.

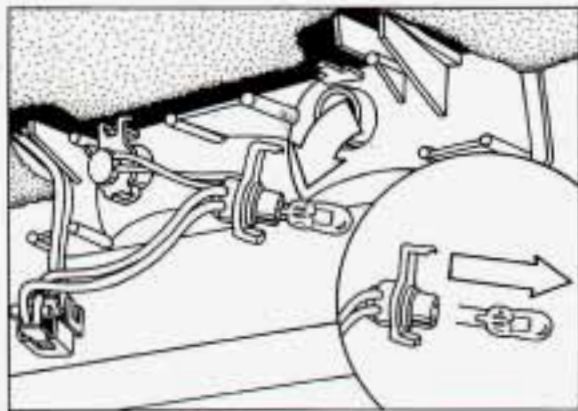

3. Unclip the bulb socket from the housing.
4. Pull the bulb out to replace. Push in a new bulb.
5. Press the bulb socket back into the housing.
6. Remove the lens to clean the window by pressing in on the ends of the lens.
7. Replace the cover.

■ *Cleaning the Outside of the Windshield and Wiper Blades*

If the windshield is not clear after using the windshield washer, or if the wiper blade chatters when running, wax or other material may be on the blade or windshield.

Clean the outside of the windshield with GM Windshield Cleaner, Bon-Ami Powder® (GM Part No. 1050011). The windshield is clean if beads do not form when you rinse it with water.

Clean the blade by wiping vigorously with a cloth soaked in full strength windshield washer solvent. Then rinse the blade with water.

Wiper blades should be checked on a regular basis and replaced when worn.

■ *Cleaning the Outside of Your Oldsmobile*

The paint finish on your vehicle provides beauty, depth of color, gloss retention and durability.

Washing Your Vehicle

The best way to preserve your vehicle's finish is to keep it clean by washing it often with lukewarm or cold water.

Don't wash your vehicle in the direct rays of the sun. Don't use strong soaps or chemical detergents. Use liquid hand, dish or car washing (mild detergent) soaps. Don't use cleaning agents that contain acid or abrasives. All cleaning

agents should be flushed promptly and not allowed to dry on the surface, or they could stain. Dry the finish with a soft, clean chamois or a 100% cotton towel to avoid surface scratches and water spotting.

High pressure vehicle washes may cause water to enter your vehicle.

Finish Care

Occasional waxing or mild polishing of your Oldsmobile may be necessary to remove residue from the paint finish. You can get GM approved cleaning products from your dealer.

Your Oldsmobile has a "basecoat/clearcoat" paint finish. The clearcoat gives more depth and gloss to the colored basecoat. Always use waxes and polishes that are non-abrasive and made for a basecoat/clearcoat paint finish.

NOTICE:

Machine compounding or aggressive polishing on a basecoat/clearcoat paint finish may dull the finish or leave swirl marks.

Aluminum Wheels

(IF SO EQUIPPED)

Your aluminum wheels have a protective coating similar to the painted surface of your Oldsmobile. Don't use strong soaps, chemicals, chrome polish, abrasive cleaners or abrasive cleaning brushes on them because you could damage this coating. After rinsing thoroughly, a wax may be applied.

NOTICE:

If you have aluminum wheels, don't use an automatic vehicle wash that has hard silicon carbide cleaning brushes. These brushes can take off the protective coating.

Weatherstrips

Silicone grease on weatherstrips will make them last longer, seal better, and not stick or squeak. Apply silicone grease with a clean cloth at least every six months. During very cold, damp weather more frequent application may be required. (See *Recommended Fluids & Lubricants* in the *Index*.)

Sheet Metal Damage

If your vehicle is damaged and requires sheet metal repair or replacement, make sure the body repair shop applies anti-corrosion material to the parts repaired or replaced to restore corrosion protection.

Foreign Material

Calcium chloride and other salts, ice melting agents, road oil and tar, tree sap, bird droppings, chemicals from industrial chimneys, and other foreign matter can damage your vehicle's finish if they remain on painted surfaces. Use cleaners that are marked safe for painted surfaces to remove foreign matter.

Finish Damage

Any stone chips, fractures or deep scratches in the finish should be repaired right away. Bare metal will corrode quickly and may develop into a major repair expense.

Minor chips and scratches can be repaired with touch-up materials available from your dealer or other

Service & Appearance Care

service outlets. Larger areas of finish damage can be corrected in your dealer's body and paint shop.

■ *Underbody Maintenance*

Chemicals used for ice and snow removal and dust control can collect on the underbody. If these are not removed, accelerated corrosion (rust) can occur on the underbody parts such as fuel lines, frame, floor pan, and exhaust system even though they have corrosion protection.

At least every spring, flush these materials from the underbody with plain water. Clean any areas where mud and other debris can collect. Dirt packed in closed areas of the frame should be loosened before being flushed. Your dealer or an underbody vehicle washing system can do this for you.

■ *Fiberglass Springs*

NOTICE:

Don't use corrosive or acidic cleaning agents, engine degreasers, aluminum cleaning agents or other harsh solvents to clean fiberglass springs; they'll damage the springs.

■ *Chemical Paint Spotting*

Some weather and atmospheric conditions can create a chemical fallout. Airborne pollutants can fall upon and attack painted surfaces on your vehicle. This damage can take two forms: blotchy, ringlet-shaped discolorations, and small irregular dark spots etched into the paint surface.

Although no defect in the paint job causes this, Oldsmobile will repair, at no charge to the owner, the surfaces of new vehicles damaged by this fallout condition within 12 months or 12,000 miles (20 000 km) of purchase, whichever comes first.

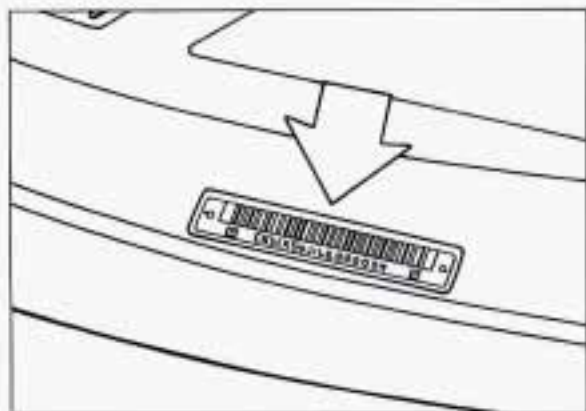

■ *Vehicle Identification Number (VIN)*

This is the legal identifier for your Oldsmobile. It appears on a plate in the front corner of the instrument panel, on the driver's side. You can see it if you look through the windshield from outside your vehicle. The VIN also appears on the Vehicle Certification and Service Parts labels and the certificates of title and registration.

Engine Identification

The eighth character in your VIN is the engine code. This code will help you identify your engine, specifications, and replacement parts.



■ *Service Parts Identification Label*

You'll find this label on your spare tire cover. It's very helpful if you ever need to order parts. On this label is:

- Your VIN,
- The model designation,
- Paint information, and
- A list of all production options and special equipment.

Be sure that this label is not removed from the vehicle.

Service & Appearance Care

■ Add-On Electrical Equipment

NOTICE:

Don't add anything electrical to your Oldsmobile unless you check with your dealer first. Some electrical equipment can damage your vehicle and the damage wouldn't be covered by your warranty. Some add-on electrical equipment can keep other components from working as they should.

Your vehicle has an air bag system. Before attempting to add anything electrical to your Oldsmobile, see *Servicing Your Air Bag-Equipped Oldsmobile* in the *Index*.

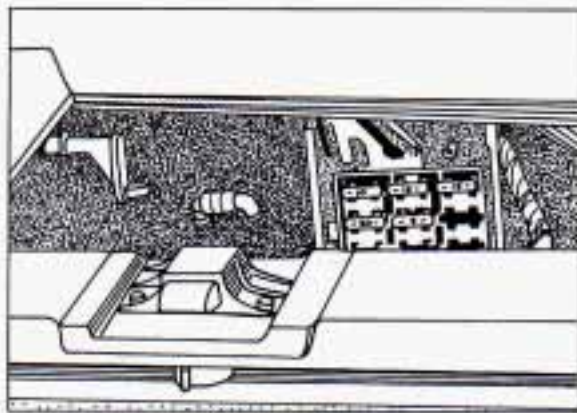

■ Fuses & Circuit Breakers

The wiring circuits in your vehicle are protected from short circuits by a combination of fuses, circuit breakers, and fusible thermal links in the wiring itself. This greatly reduces the chance of damage caused by electrical problems.

Some fuses are located in a fuse block in the glove box as shown above. To locate the fuse block, lift out the storage bin inside the glove box. See the diagram later in this section.

Another set of fuses is located in the component center, under the instrument panel.

Additional fuses are located in the underhood electrical centers on the right and left sides of the engine compartment.

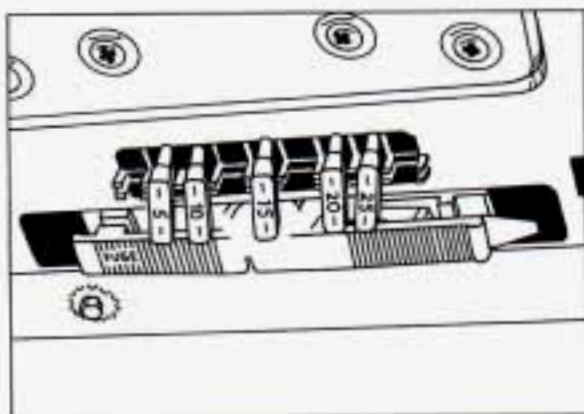

Spare fuses and a fuse puller are located in the glove box lid. To remove the cover, press in on both ends of the cover, press in on both ends of the cover and pull it off.

Place the wide end of the fuse puller over the plastic end of the fuse. Squeeze the ends over the fuse and pull it out.

To identify and check fuses, refer to the charts on the following pages.

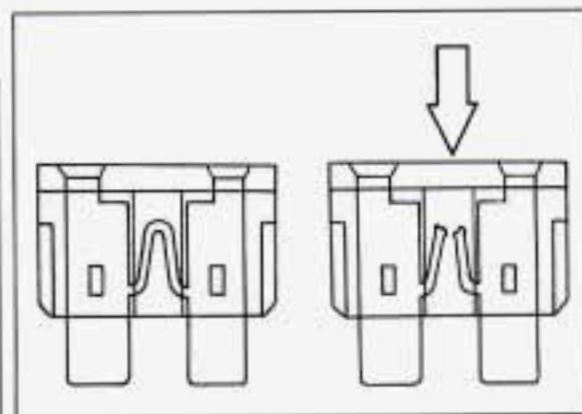

Look at the silver-colored band inside the fuse. If the band is broken or melted, replace the fuse. Be sure you replace a bad fuse with a new one of the identical size and rating.

Service & Appearance Care

Glove Box Fuse Block

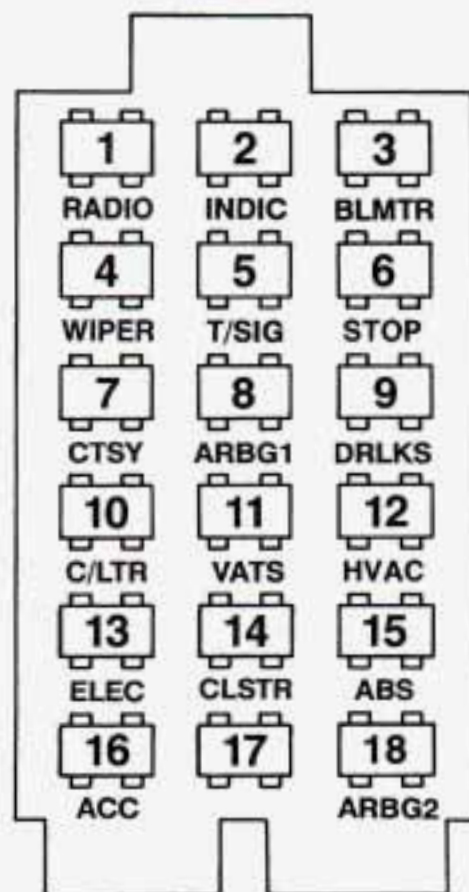

Fuse	Rating (AMP)	Circuitry
1	10	Radio & Clock
2	10	Rear Defogger Timer Relay; Instrument Cluster; Chime Module; Cruise Control; DRL Module (Canada); ABS Lamp Driver Module; SIR
3	20	Blower Motor
4	25	Windshield Wiper & Washer
5	10	Turn Signals/Flasher
6	15	Brake Lights
7	10	Courtesy, Glove Box, Underhood, Trunk, Header Lights; Lighted Inside Rearview Mirror
8	15	SIR
9	20	Door Locks
10	15	Cigarette Lighter
11	5	Vehicle Anti-Theft System (Pass-Key® II)
12	15	Blower Control Switch; Solenoid
13	15	Radio & Clock; Passive Restraint Lockout, Passive Restraint Timer; Chime Module; ABS; VATS
14	15	Cluster; HVAC Controls; HUD; DRL
15	5	ABS Control Module
16	10	Power Door Lock Switch; Seat Belts; Power Outside Mirrors; Power Antenna
17		Not Used
18	5	SIR (crank)

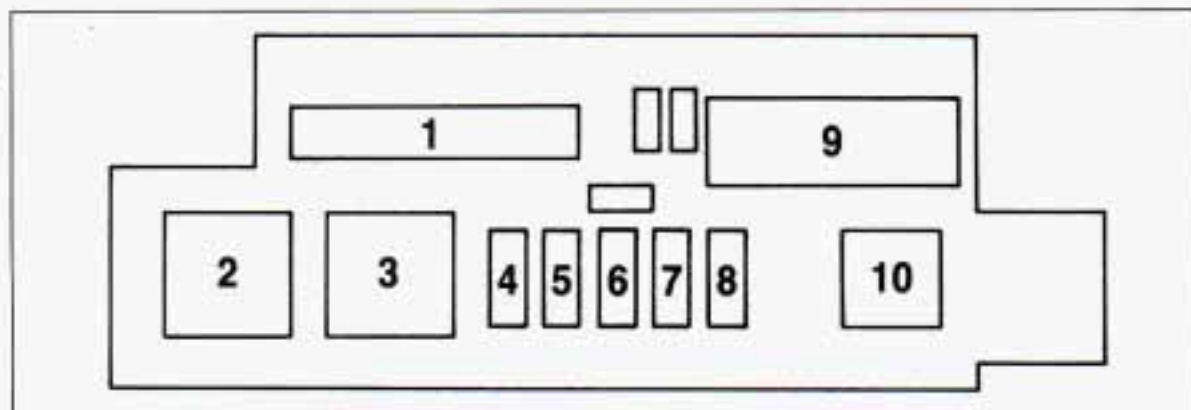

Component Center

Fuse	Rating (AMP)	Circuitry
1		Defogger Timer Relay
2		Air Conditioner Blower Relay (HI) (Electronic AC only)
3		Air Conditioner Blower Relay (LO) (Electronic AC only)
4	30	Rear Defogger Circuit Breaker
5	30	Power Accessories Circuit Breaker
6	30	Power Windows and Sunroof Circuit Breaker
7		Not Used
8	20	Lock Control
9		Chime Module
10		Hazard Flasher

Service & Appearance Care

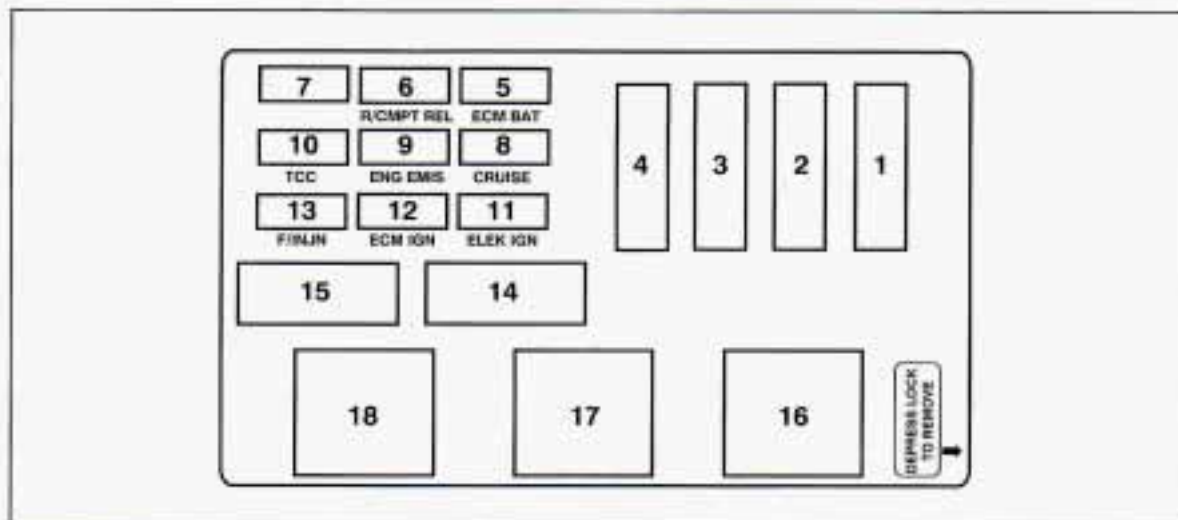

Passenger Side Underhood Electrical Center

Fuse	Rating (AMP)	Circuitry
1	60	Instrument Panel
2	60	Instrument Panel
3	60	Cooling Fan
4	60	Instrument Panel
5	20	ECM; Fuel Pump
6	15	Trunk Release
7		Not Used
8	15	Cruise Control; Air Conditioner (3.4L Only)
9	15	Engine Emission Controls
10	15	Transmission Torque Converter Clutch
11	15	Electronic Ignition System
12	15	ECM
13	15	Fuel Injectors

Relay	Circuitry
14	Air Conditioner Compressor
15	Fuel Pump
16	Not Used
17	Driver Side Engine Cooling Fan Control
18	Passenger Side Engine Cooling Fan Control

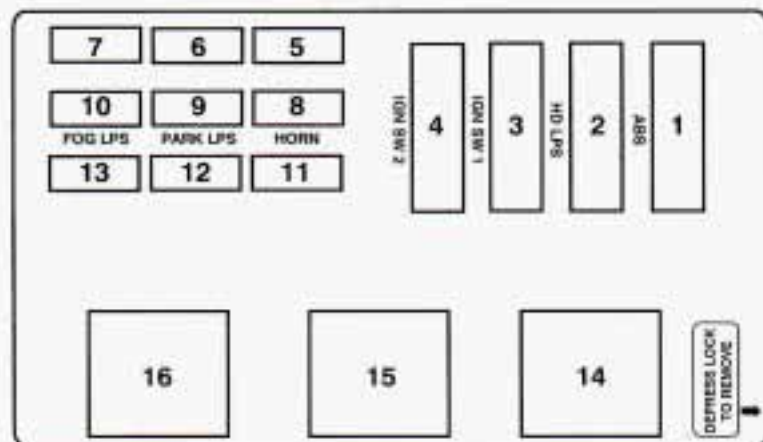

Driver Side Underhood Electrical Center

Fuse	Rating (AMP)	Circuitry
1	60	ABS
2	30	Headlamp Circuit Breaker
3	40	Ignition Switch
4	40	Ignition Switch
5		Not Used
6		Not Used
7		Not Used
8	15	Horn
9	25	Park Lamps
10	10	Fog Lamps
11		Not Used
12		Not Used
13		Not Used

Relay	Circuitry
14	Horn
15	Fog Lamps
16	ABS

Service & Appearance Care

Headlight Wiring

The headlight wiring is protected by a circuit breaker in the component center. An electrical overload will cause the lights to go on and off, or in some cases to remain off. If this happens, have your headlight system checked right away.

Windshield Wipers

The windshield wiper motor is protected by a circuit breaker and a fuse. If the motor overheats due to heavy snow, etc., the wiper will stop until the motor cools. If the overload is caused by some electrical problem, have it fixed.

Power Windows and Other Power Options

Circuit breakers in the fuse panel protect the power windows and other power accessories. When the current load is too heavy, the circuit breaker opens and closes, protecting the circuit until the problem is fixed.

Capacities & Specifications

Engine Crankcase

3100 V6	4 quarts	3.8 L
Twin Dual Cam (DOHC) 3.4L V6	5 quarts	4.8 L

When changing filter, up to 0.50 quarts (0.50L) more oil may be needed.

Automatic Transaxle

When draining/replacing converter, more fluid may be needed.

Pan Removal and Replacement	4 quarts	3.8 L
After Complete Overhaul	7 quarts	6.6 L

Automatic Transaxle with Overdrive

When draining/replacing converter, more fluid may be needed.

Pan Removal and Replacement	6 quarts	5.8 L
After Complete Overhaul	8 quarts	7.5 L

Cooling System

3100 V6		
With 4-Speed Automatic Transaxle	12.5 quarts	11.8 L
Twin Dual Cam (DOHC) 3.4L V6		
With 4-Speed Automatic Transaxle	12.7 quarts	12.0 L

Service & Appearance Care

Refrigerant (R-134A), Air Conditioning 2.0 pounds 0.91 kg

Not all air conditioning refrigerants are the same. If the air conditioning system in your vehicle needs refrigerant, be sure the proper refrigerant is used. If you're not sure, ask your Oldsmobile dealer. For additional information, see your "Warranty and Owner Assistance Information" booklet.

Fuel Tank 16.5 gallons 62.0 L

Power Steering

Pump Only 2 pints 0.925 L

Wheel Nut Torque 100 lb. ft. (140 N•m)

Battery Size

3100 V6 525 CCA

Twin Dual Cam (DOHC) 3.4L V6 690 CCA

Fluids & Lubricants

ITEM	APPLICATION	GM PART NUMBER	SIZE
Antifreeze Coolant..... (Ethylene Glycol Base)	Year-round antifreeze for..... coolant mixtures	1052753	1 gal. (3.8 L)
Chassis Lubricant (Grease Gun Insert) ..	General chassis lube, etc.....	1052497	14 oz. (397 g)
Delco Supreme 11® Brake Fluid	Brake System	1052535	16 oz. (0.5L)
Automatic Transmission Fluid.....	Automatic Transaxle		
DEXRON®-III	12346143	32 oz. (1.0L)
DEXRON®-IIE.....	12345881	32 oz. (1.0L)
Engine Oil	Engine lubrication	See the <i>Index</i> under <i>Engine Oil</i> .	
GM Engine Oil Supplement (E.O.S.)	See your dealer for advice	1052367	16 oz. (0.5 L)
Engine Oil	Hood, trunk and door hinges		
Windshield Washer Solvent	Windshield washer fluid		
Power Steering Fluid	Power Steering System	1050017 1052884	32 oz. (1.0 L) 16 oz. (0.5 L)
Silicone Grease	Weatherstrips	12345579	1 oz. (28 g)
Spray-A-Squeak Silicone Lubricant	General purpose silicone lubricant	1052276 (aerosol) 1052277	4.5 oz. (127 g) 12 oz. (0.35 L)

Service & Appearance Care

Replacement Bulbs

OUTSIDE LIGHTS	BULB
Back-up Lights	3057
Front Parking/Turn Signal Lights	2358NA
License Plate Light	194
Center High-Mounted Stoplight	
Inside Vehicle, 2-Door Models	2355
Inside Vehicle, 4-Door Models	891
Luggage Carrier Mount	891
Halogen Headlights	
2-Door Models	
Low Beam	H4351 (L)
High Beam	H4352 (U)
4-Door Models	
Low Beam	9006
High Beam	9005
Fog Lights	885
Side Marker Lights	
Front	
2-Door Models	24
4-Door Models	24NA
Stop/Tail/Turn Signal Lights	3057
Luggage Compartment	920

INSIDE LIGHTS	BULB
Ashtray	194
Center Instrument Cluster	168, 194
Courtesy Lights	
Door	12864
Rear	212-2
Reading Lights	
Front	561
Inside Rearview Mirror	192
Rear	212-2
Glove Box Light	194
Heater & A/C Control	37
High Beam Indicator	74
Indicator Lights	PC161
Turn Signal Indicators	PC161
Visor Vanity Light	124

Service & Appearance Care

Engine Specifications

	3100 V6	Twin Dual Cam (DOHC) 3.4L V6
VIN Engine Code	M	X
Type	V6	V6
Displacement	3.1L (191 CID)	3.4L (207 CID)
Compression Ratio	9.6:1	9.25:1
Firing Order	1-2-3-4-5-6	1-2-3-4-5-6
Thermostat Temperature	195°F (91°C)	195°F (91°C)
Valve Arrangement	In-Head	In-Head

Normal Maintenance Replacement Parts

Air Cleaner Element

3100 V6	AC Type A-905
Twin Dual Cam (DOHC) 3.4L V6.....	AC Type A-1129 C

Engine Oil Filter

3100 V6	AC Type PF-47
Twin Dual Cam (DOHC) 3.4L V6.....	AC Type PF-51

PCV Valve

3100 V6	AC Type CV-899C
Twin Dual Cam (DOHC) 3.4L V6	AC Type CV-881C

Spark Plugs

3100 V6	AC Type •R44LTSM6 Gap: 0.060 inch (1.52 mm)
Twin Dual Cam (DOHC) 3.4L V6	AC Type •R42LTSM Gap: 0.045 inch (1.14 mm)

Batteries

Remote Lock Control Transmitter	2016 (2)
---------------------------------------	----------

Notes

IMPORTANT
KEEP ENGINE OIL
AT THE PROPER
LEVEL AND CHANGE AS
RECOMMENDED

This part covers the maintenance required for your Oldsmobile. Your vehicle needs these services to retain its safety, dependability and emission control performance.



**Protection
Plan**

Have you purchased the
GM Protection Plan?
The Plan supplements your new
vehicle warranties. See your
Oldsmobile dealer for details.

Part 7

Maintenance Schedule

Section

Introduction

A Word About Maintenance	236
Your Vehicle and the Environment	236
How This Part is Organized	236

A. Scheduled Maintenance Services

Using Your Maintenance Schedules	237
Selecting the Right Schedule	237
Schedule I	238
Schedule II	240
Explanation of Scheduled Maintenance Services	242

B. Owner Checks and Services

At Each Fuel Fill	244
At Least Once a Month	244
At Least Once a Year	245

C. Periodic Maintenance Inspections

D. Recommended Fluids & Lubricants

E. Maintenance Record

Maintenance Schedule

■ Introduction

A Word About Maintenance

We at General Motors want to help you keep your vehicle in good working condition. But we don't know exactly how you'll drive it. You may drive very short distances only a few times a week. Or you may drive long distances all the time in very hot, dusty weather. You may use your vehicle in making deliveries. Or you may drive it to work, to do errands or in many other ways.

Because of all the different ways people use their GM vehicles, maintenance needs vary. You may even need more frequent checks and replacements than you will find in the schedules in this part. So please read this part and note how you drive. If you have any questions on how to keep your vehicle in good condition, see your Oldsmobile dealer, the place many GM owners choose to have their maintenance work done. Your dealer can be relied upon to use proper parts and practices.

Your Vehicle and the Environment

Proper vehicle maintenance not only helps to keep your vehicle in good working condition, but also helps the environment. All recommended maintenance procedures are important. Improper vehicle maintenance or the removal of important components can significantly affect the quality of the air we breathe. Improper fluid levels or even the wrong tire inflation can increase the level of emissions from your vehicle. To help protect our environment, and to help keep your vehicle in good condition, please maintain your vehicle properly.

How This Part is Organized

The remainder of this part is divided into five sections:

"Section A: Scheduled Maintenance Services" shows what to have done and how often. Some of these services can be complex, so unless you are technically qualified and have the necessary equipment, you should let your dealer's service department or another qualified service center do these jobs.



CAUTION:

Performing maintenance work on a vehicle can be dangerous. In trying to do some jobs, you can be seriously injured. Do your own maintenance work only if you have the required know-how and the proper tools and equipment for the job. If you have any doubt, have a qualified technician do the work.

If you are skilled enough to do some work on your vehicle, you will probably want to get the service information GM publishes. You will find a list of publications and how to get them in this manual. See *Service Publications* in the *Index*.

"Section B: Owner Checks and Services" tells you what should be checked whenever you stop for fuel. It also explains what you can easily do to help keep your vehicle in good condition.

"Section C: Periodic Maintenance Inspections" explains important

inspections that your Oldsmobile dealer's service department or another qualified service center should perform.

"Section D: Recommended Fluids & Lubricants" lists some products GM recommends to help keep your vehicle properly maintained. These products, or their equivalents, should be used whether you do the work yourself or have it done.

"Section E: Maintenance Record" provides a place for you to record the maintenance performed on your vehicle. Whenever any maintenance is performed, be sure to write it down in this section. This will help you determine when your next maintenance should be done. In addition, it is a good idea to keep your maintenance receipts. They may be needed to qualify your vehicle for warranty repairs.

■ *Section A: Scheduled Maintenance Services*

Using Your Maintenance Schedule

This section tells you the maintenance services you should have done and

when you should schedule them. Your Oldsmobile dealer knows your vehicle best and wants you to be happy with it. If you go to your dealer for your service needs, you'll know that GM-trained and supported service people will perform the work using genuine GM parts.

These schedules are for vehicles that:

- carry passengers and cargo within recommended limits. You will find these limits on your vehicle's Tire-Loading Information label. See *Loading Your Vehicle* in the *Index*.
- are driven on reasonable road surfaces within legal driving limits.
- use the recommended unleaded fuel. See *Fuel* in the *Index*.

Selecting the Right Schedule

First you'll need to decide which of the two schedules is right for your vehicle. Here's how to decide which schedule to follow:

Schedule I

Is any one of these true for your vehicle?

- Most trips are less than 4 miles (6 km).

- Most trips are less than 10 miles (16 km) when outside temperatures are below freezing.
- The engine is at low speed most of the time (as in door-to-door delivery, or in stop-and-go traffic).
- You operate your vehicle in dusty areas.
- You tow a trailer. (With some models, you should never tow a trailer. See *Towing a Trailer* in the *Index*.)

If any one (or more) of these is true for your driving, follow Schedule I.

Schedule II

Follow Schedule II **only** if none of the above conditions is true.

Maintenance Schedule

Schedule I

Follow Schedule I if your vehicle is **MAINLY** driven under one or more of the following conditions:

- When most trips are less than 4 miles (6 km).
- When most trips are less than 10 miles (16 km) and outside temperatures remain below freezing.
- When most trips include extended idling and/or frequent low-speed operation, as in stop-and-go traffic.
- When towing a trailer. (With some models, you should never tow a trailer. See *Towing a Trailer* in the *Index*.)
- When operating in dusty areas.

Schedule I should also be followed if the vehicle is used for delivery service, police, taxi or other commercial applications.

ITEM NO.	TO BE SERVICED <i>See Explanation of Scheduled Maintenance Services following Schedules I and II.</i>	WHEN TO PERFORM <i>Miles (kilometers) or Months (whichever occurs first).</i>
1	Engine Oil Change & Filter Change*	Every 3,000 Miles (5 000 km) or 3 Months.
2	Chassis Lubrication	Every other oil change.
3	Tire and Wheel Inspection & Rotation	At 6,000 Miles (10 000 km) and then every 15,000 Miles (25 000 km) or as necessary.
4	Engine Accessory Drive Belt Inspection*	Every 30,000 Miles (50 000 km) or 24 Months.
5	Camshaft Timing Belt Inspection (3.4L Code X engine only)*	At 6,000 Miles (10 000 km) and then every 15,000 Miles (25 000 km).
6	Cooling System Service*	Every 30,000 Miles (50 000 km) or 24 Months.
7	Transaxle Service	<i>See Explanation of Scheduled Maintenance Services following Schedules I and II.</i>
8	Spark Plug Replacement*	Every 30,000 Miles (50 000 km).
9	Spark Plug Wire Inspection*†	Every 30,000 Miles (50 000 km).
10	Exhaust Gas Recirculation (EGR) System Inspection (3.4L Code X engine only)*†	Every 30,000 Miles (50 000 km).
11	Air Cleaner Filter Replacement*	<i>See Explanation of Scheduled Maintenance Services following Schedules I and II.</i>
12	Fuel Tank, Cap and Lines Inspection*†	Every 30,000 Miles (50 000 km).

MILES (000)																			
3	6	9	12	15	18	21	24	27	30	33	36	39	42	45	48	51	54	57	60
KILOMETERS (000)																			
5	10	15	20	25	30	35	40	45	50	55	60	65	70	75	80	85	90	95	100
•	•	•	•	•	•	•	•	•	•	•	•	•	•	•	•	•	•	•	•
•		•		•		•		•		•		•		•		•		•	
	•					•					•					•			
									•										•
	•					•					•					•			
									•										•
									•										•
									•										•
									•										•
									•										•

The services shown on this chart up to 60,000 miles (100 000 km) should be performed after 60,000 miles at the same intervals.

• = An Emission Control Service.

† = The U.S. Environmental Protection Agency or the California Air Resources Board has determined that the failure to perform this maintenance item will not nullify the emission warranty or limit recall liability prior to the completion of vehicle useful life. General Motors, however, urges that all recommended maintenance services be performed at the indicated intervals and the maintenance be recorded in Section E: Maintenance Record.

Maintenance Schedule

Schedule II

Follow Schedule II ONLY if none of the driving conditions specified in Schedule I apply.

ITEM NO.	TO BE SERVICED <i>See Explanation of Scheduled Maintenance Services following Schedules I and II.</i>	WHEN TO PERFORM <i>Miles (kilometers) or Months (whichever occurs first).</i>
1	Engine Oil Change*	Every 7,500 Miles (12 500 km) or 12 Months.
	Oil Filter Change*	At first and every other oil change.
2	Chassis Lubrication	Every 7,500 Miles (12 500 km) or 12 Months.
3	Tire and Wheel Inspection & Rotation	At 7,500 Miles (12 500 km) and then every 15,000 Miles (25 000 km) or as necessary.
4	Engine Accessory Drive Belt Inspection*	Every 30,000 Miles (50 000 km) or 24 Months.
5	Camshaft Timing Belt Inspection (3.4L Code X engine only)*	At 60,000 miles (100 000 km) and then every 15,000 miles (25 000 km).
6	Cooling System Service*	Every 30,000 Miles (50 000 km) or 24 Months.
7	Transaxle Service	<i>See Explanation of Scheduled Maintenance Services following Schedules I and II.</i>
8	Spark Plug Replacement*	Every 30,000 Miles (50 000 km).
9	Spark Plug Wire Inspection*†	Every 30,000 Miles (50 000 km).
10	Exhaust Gas Recirculation (EGR) System Inspection (3.4L Code X engine only)*†	Every 30,000 Miles (50 000 km).
11	Air Cleaner Filter Replacement*	<i>See Explanation of Scheduled Maintenance Services following Schedules I and II.</i>
12	Fuel Tank, Cap & Lines Inspection*†	Every 30,000 Miles (50 000 km).

MILES (000)															
5	7.5	10	15	20	22.5	25	30	35	37.5	40	45	50	52.5	55	60
KILOMETERS (000)															
8	12.5	16	25	32	37.5	40	50	56	62.5	64	75	83.5	87.5	92	100
*			*		*		*		*		*		*		*
*					*				*				*		
*			*		*		*		*		*		*		*
*					*				*				*		
							*								*
															*
							*								*
															*
							*								*
															*
							*								*
															*
							*								*

The services shown on this chart up to 60,000 miles (100 000 km) should be performed after 60,000 miles at the same intervals.

* = An Emission Control Service.

† = The U.S. Environmental Protection Agency or the California Air Resources Board has determined that the failure to perform this maintenance item will not nullify the emission warranty or limit recall liability prior to the completion of vehicle useful life. General Motors, however, urges that all recommended maintenance services be performed at the indicated intervals and the maintenance be recorded in Section E: Maintenance Record.

Maintenance Schedule

Explanation of Scheduled Maintenance Services

Following are explanations of the services listed in Schedule I and Schedule II.

The proper fluids and lubricants to use are listed in Section D. Make sure whoever services your vehicle uses these. All parts should be replaced and all necessary repairs done before you or anyone else drives the vehicle.

ITEM SERVICE NO.

1. Engine Oil and Filter Change* — Always use SH or SG Energy Conserving II oils of proper viscosity. The "SH" or "SG" designation may be shown alone or in combination with others, such as "SH/CD," "SH, SG, CD," "SG/CD," etc. To determine the preferred viscosity for your vehicle's engine (e.g., SAE 5W-30 or SAE 10W-30), see *Engine Oil* in the *Index*.

2. Chassis Lubrication — Lubricate suspension and steering linkage. Lubricate the transaxle shift linkage, and parking brake cable guides, underbody contact points and linkage.

3. Tire and Wheel Rotation and Inspection — For proper wear and maximum tire life, rotate your tires following the instructions in this manual. See *Tires, Inspection & Rotation* in the *Index*. Check the tires for uneven wear or damage. If you see irregular or premature wear, check the wheel alignment. Check for damaged wheels also.

4. Engine Accessory Drive Belt Inspection* — Inspect the belt for cracks, fraying, wear and proper tension. Replace as needed.

5. Camshaft Timing Belt Inspection (3.4L Code X engine only)* — Inspect for cracks, wear or oiliness. Check tensioner for proper operation. See the service manual. (To purchase

a service manual, see *Service Publications* in the *Index*.) Replace parts as needed.

6. Cooling System Service* — Drain, flush and refill the system with new or approved recycled coolant conforming to GM Specification 1825M. Keep coolant at the proper mixture as specified. See *Coolant* in the *Index*. This provides proper freeze and boil protection, corrosion inhibitor level and maintains proper engine operating temperature. Inspect hoses and replace if they are cracked, swollen or deteriorated. Clean the outside of the radiator and air conditioning condenser. Wash the pressure cap and neck.

To help ensure proper operation, we recommend a pressure test of both the cooling system and the pressure cap.

7. Transaxle Service — Change both the fluid and filter every 15,000 miles (25 000 km) if the vehicle is mainly

driven under one or more of these conditions:

- In heavy city traffic where the outside temperature regularly reaches 90°F (32°C) or higher.
- In hilly or mountainous terrain.
- When doing frequent trailer towing. (With some models, you shouldn't ever tow a trailer. See *Towing a Trailer* in the *Index*.)
- Uses such as found in taxi, police car or delivery service.

If you do not use your vehicle under any of these conditions, change both the fluid and filter every 100,000 miles (166 000 km).

- 8. Spark Plug Replacement*** — Replace spark plugs with the proper type. See *Replacement Parts* in the *Index*.
- 9. Spark Plug Wire Inspection*†** — Inspect for burns, cracks or other damage. Check the boot fit at the coils and at the spark plugs. Replace wires as needed.

10. Exhaust Gas Recirculation (EGR) System Inspection (3.4L Code X engine only)*† — Conduct the EGR system service as described in the service manual. To purchase a service manual, see *Service Publications* in the *Index*.

11. Air Cleaner Filter Replacement* — Replace every 30,000 miles (50 000 km) or more often under dusty conditions. Ask your dealer for the proper replacement intervals for your driving conditions.

12. Fuel Tank, Cap and Lines Inspection*† — Inspect fuel tank, cap and lines (including fuel rails and injection assembly) for damage or leaks. Inspect fuel cap gasket for an even filler neck imprint or any damage. Replace parts as needed. Periodic replacement of the fuel filter is not required.

NOTE: To determine your engine's displacement and code, see Engine Identification in the Index.

** = An Emission Control Service.*

† = The U.S. Environmental Protection Agency or the California Air Resources Board has determined that the failure to perform this maintenance item will not nullify the emission warranty or limit recall liability prior to the completion of vehicle useful life. General Motors, however, urges that all recommended maintenance services be performed at the indicated intervals and the maintenance be recorded in "Section E: Maintenance Record."

Maintenance Schedule

■ Section B: Owner Checks and Services

Listed below are owner checks and services which should be performed at the intervals specified to help ensure the safety, dependability and emission control performance of your vehicle.

Be sure any necessary repairs are completed at once. Whenever any fluids or lubricants are added to your vehicle, make sure they are the proper ones, as shown in Section D.

At Each Fuel Fill (It is important for you or a service station attendant to perform these underhood checks at each fuel fill.)

CHECK OR SERVICE	WHAT TO DO
Engine Oil Level	Check the engine oil level and add the proper oil if necessary. See <i>Engine Oil</i> in the <i>Index</i> for further details.
Engine Coolant Level	Check the engine coolant level and add the proper coolant mix if necessary. See <i>Coolant</i> in the <i>Index</i> for further details.
Windshield Washer Fluid Level	Check the windshield washer fluid level in the windshield washer tank and add the proper fluid if necessary. See <i>Windshield Washer Fluid</i> in the <i>Index</i> for further details.

At Least Once Month

CHECK OR SERVICE	WHAT TO DO
Tire Inflation	Check tire inflation. Make sure they are inflated to the pressures specified on the Tire-Loading Information label located on the rear edge of the driver's door. See <i>Tires</i> in the <i>Index</i> for further details.
Cassette Deck	Clean cassette deck. Cleaning should be done every 15 hours of tape play. See <i>Audio Systems</i> in the <i>Index</i> for further details.

At Least Once a Year

CHECK OR SERVICE	WHAT TO DO
Key Lock Cylinders	Lubricate the key lock cylinders with the lubricant specified in Section D.
Body Lubrication	Lubricate all body door hinges. Also lubricate all hinges and latches, including those for the hood, rear compartment, glove box door, console door and any folding seat hardware. Section D tells you what to use.
Starter Switch	<p>CAUTION: When you are doing this check, the vehicle could move suddenly. If it does, you or others could be injured. Follow the steps below.</p> <ol style="list-style-type: none">1. Before you start, be sure you have enough room around the vehicle.2. Firmly apply both the parking brake (<i>see Parking Brake in the Index if necessary</i>) and the regular brake. <p>NOTE: Do not use the accelerator pedal, and be ready to turn off the engine immediately if it starts.</p> <ol style="list-style-type: none">3. Try to start the engine in each gear. The starter should work only in P (Park) or N (Neutral). If the starter works in any other position, your vehicle needs service.
Steering Column Lock	<p>While parked, and with the parking brake set, try to turn the key to Lock in each shift lever position.</p> <ul style="list-style-type: none">• The key should turn to Lock only when the shift lever is in P (Park).• The key should come out only in Lock.

Maintenance Schedule

At Least Once a Year (Cont.)

CHECK OR SERVICE	WHAT TO DO
Parking Brake and Automatic Transaxle P (Park) Mechanism Check	<p>CAUTION: When you are doing this check, your vehicle could begin to move. You or others could be injured and property could be damaged. Make sure there is room in front of your vehicle in case it begins to roll. Be ready to apply the regular brake at once should the vehicle begin to move.</p> <p>Park on a fairly steep hill, with the vehicle facing downhill. Keeping your foot on the regular brake, set the parking brake.</p> <ul style="list-style-type: none">• To check the parking brake: With the engine running and transaxle in N (Neutral), slowly remove foot pressure from the regular brake pedal. Do this until the vehicle is held by the parking brake only.• To check the P (Park) mechanism's holding ability: Shift to P (Park). Then release all brakes.
Underbody Flushing	At least every spring, use plain water to flush any corrosive materials from the underbody. Take care to clean thoroughly any areas where mud and other debris can collect.

■ Section C: Periodic Maintenance Inspections

Listed below are inspections and services which should be performed at least twice a year (for instance, each spring and fall). You should let your GM dealer's service department or other qualified service center do these jobs. Make sure any necessary repairs are completed at once.

INSPECTION OR SERVICE	WHAT SHOULD BE DONE
Restraint Systems	Now and then, make sure all your belts, buckles, latch plates, retractors, anchorages and reminder systems are working properly. Look for any loose parts or damage. If you see anything that might keep a restraint system from doing its job, have it repaired.
Steering, Suspension and Front-Wheel-Drive Axle Boot and Seal Inspection	Inspect the front and rear suspension and steering system for damaged, loose or missing parts, signs of wear, or lack of lubrication. Inspect the power steering lines and hoses for proper hookup, binding, leaks, cracks, chafing, etc. Clean and then inspect the drive axle boot seals for damage, tears or leakage. Replace seals if necessary.
Exhaust System Inspection	Inspect the complete exhaust system. Inspect the body near the exhaust system. Look for broken, damaged, missing or out-of-position parts as well as open seams, holes, loose connections, or other conditions which could cause a heat build-up in the floor pan or could let exhaust fumes into the vehicle. See <i>Engine Exhaust</i> in the <i>Index</i> .
Throttle Linkage Inspection	Inspect the throttle linkage for interference or binding, and for damaged or missing parts. Replace parts as needed.
Brake System Inspection	Inspect the complete system. Inspect brake lines and hoses for proper hookup, binding, leaks, cracks, chafing, etc. Inspect disc brake pads for wear and rotors for surface condition. Inspect other brake parts, including calipers, parking brake, etc. Check parking brake adjustment. You may need to have your brakes inspected more often if your driving habits or conditions result in frequent braking. NOTE: A low brake fluid level can indicate worn disc brake pads which may need to be serviced. Also, if the brake system warning light stays on or comes on, something may be wrong with the brake system. See <i>Brake System Warning Light</i> in the <i>Index</i> . If your vehicle is equipped with anti-lock brakes and the anti-lock brake system warning light stays on, comes on or flashes, something may be wrong with the anti-lock brake system. See <i>Anti-Lock Brake System Warning Light</i> in the <i>Index</i> .

Maintenance Schedule

■ Section D: Recommended Fluids and Lubricants

NOTE: Fluids and lubricants identified below by name, part number or specification may be obtained from your GM dealer.

USAGE	FLUID/LUBRICANT
Engine Oil	API service SH or SG Energy Conserving II oils of the proper viscosity. The "SH" or "SG" designation may be shown alone or in combination with others, such as "SH/CD," "SH,SG,CD," "SG/CD," etc. To determine the preferred viscosity for your vehicle's engine, see <i>Engine Oil</i> in the <i>Index</i> .
Engine Coolant	50/50 mixture of water (preferably distilled) and good quality ethylene glycol base antifreeze (GM Part No. 1052753 or equivalent) conforming to GM Specification 1825M or approved recycled coolant conforming to GM Specification 1825M.
Hydraulic Brake System	Delco Supreme 11 [®] Brake Fluid (GM Part No. 1052535 or equivalent DOT-3 brake fluid).
Parking Brake Guides	Chassis lubricant (GM Part No. 1052497 or equivalent) or lubricant meeting requirements of NLGI Grade 2, Category LB or GC-LB.
Power Steering System	GM Hydraulic Power Steering Fluid (GM Part No. 1052884 or equivalent).
Automatic Transaxle	DEXRON [®] -III or DEXRON [®] -III-E Automatic Transmission Fluid.
Key Lock Cylinders	Lubricate with Multi-Purpose Lubricant (GM Part No. 12345120), synthetic SAE 5W-30 engine oil or silicone lubricant (GM Part No. 1052276 or 1052277).
Automatic Transaxle Shift Linkage	Engine oil.

USAGE	FLUID/LUBRICANT
Chassis Lubrication	Chassis lubricant (GM Part No. 1052497 or equivalent) or lubricant meeting requirements of NLGI Grade 2, Category LB or GC-LB.
Windshield Washer Solvent	GM Optikleen® Washer Solvent (GM Part No. 1051515) or equivalent.
Hood Latch Assembly a. Pivots and Spring Anchor b. Release Pawl	a. Engine oil. b. Chassis lubricant meeting requirements of NLGI Grade 2, Category LB (GM Part No. 1052497 or equivalent) or GC-LB.
Hood and Door Hinges, Fuel Door Hinge	Engine oil or Lubriplate Lubricant (GM Part No. 1050109).
Weatherstrips	Dielectric Silicone Grease (GM Part No. 12345579 or equivalent).

See *Replacement Parts* in the *Index* for recommended replacement filters, valves and spark plugs.

Maintenance Schedule

■ Section E: Maintenance Record

After the scheduled services are performed, record the date, odometer reading and who performed the service in the columns indicated. When completing the Maintenance Performed column, insert the numbers from the Schedule I

or Schedule II maintenance charts which correspond to the maintenance performed. Also, you should retain all maintenance receipts. Your owner information portfolio is a convenient place to store them.

DATE	ODOMETER READING	SERVICED BY	MAINTENANCE PERFORMED



Here you will find out how to contact Oldsmobile if you need assistance. This part also tells you how to obtain service publications and how to report any safety defects.

Part 8

Customer Assistance Information

Customer Satisfaction Procedure	252
Customer Assistance for the Hearing or Speech Impaired	253
BBB Auto Line Program.....	253
Reporting Safety Defects	254
Oldsmobile Roadside Assistance Program.....	255
Service Publications	256

Customer Assistance Information



■ Customer Satisfaction Procedure

Your satisfaction and goodwill are important to your dealer and Oldsmobile. Normally, any concern with the sales transaction or the operation of your vehicle will be resolved by your dealer's Sales or Service Departments. Sometimes, however, despite the best intentions of all concerned, misunderstandings can occur. If your concern has not been resolved to your satisfaction, the following steps should be taken:

STEP ONE — Discuss your concern with a member of dealership management. Complaints can often be quickly resolved at that level. If the

matter has already been reviewed with the Sales, Service, or Parts Manager, contact the owner of the dealership or the General Manager.

STEP TWO — If after contacting a member of dealership management, it appears your concern cannot be resolved by the dealership without further help, contact the Oldsmobile Customer Assistance Network by calling 1-800-442-6537. In Canada, contact GM of Canada Customer Assistance Center in Oshawa by calling 1-800-263-3777 (English) or 1-800-263-7854 (French).

In Mexico, call (525) 254-3777. In Puerto Rico or U.S. Virgin Islands, call 1-809-763-1315. In all other overseas locations, contact GM North American Export Sales in Canada by calling 1-416-644-4112.

For prompt assistance, please have the following information available to give the Customer Assistance Representative:

- Your name, address, telephone number
- Vehicle Identification Number (This

is available from the vehicle registration or title, or the plate at the left top of the instrument panel and visible through the windshield.)

- Dealership name and location
- Vehicle delivery date and present mileage
- Nature of concern

We encourage you to call the toll free number listed previously in order to give your inquiry prompt attention. However, if you wish to write Oldsmobile, write to

United States

Customer Assistance Representative
Oldsmobile Central Office
920 Townsend St.
P.O. Box 30095
Lansing, MI 48909

Canada

Customer Assistance Center
General Motors of Canada Limited
1908 Colonel Sam Drive
Oshawa, Ontario L1H 8P7

When contacting Oldsmobile, please remember that your concern will likely be resolved in the dealership, using the

dealership's facilities, equipment and personnel. That is why we suggest you follow Step One first if you have a concern.

■ *Customer Assistance for the Hearing or Speech Impaired (TDD)*

To assist owners who have hearing difficulties, Oldsmobile has installed special TDD (Telecommunication Devices for the Deaf) equipment at its Customer Assistance Center. Any hearing or speech impaired customer who has access to a TDD or a conventional teletypewriter (TTY) can communicate with Oldsmobile by dialing: 1-800-TDD-OLDS. (TDD users in Canada can dial 1-800-263-3830.)

■ *GM Participation in BBB AUTO LINE- Alternative Resolution Program**

Both Oldsmobile and your Oldsmobile dealer are committed to making sure you are completely satisfied with your new vehicle. If a situation arises where you feel your concern has not been adequately addressed, our experience has shown that the Customer Satisfaction Procedure described earlier in this section is very successful at resolving problems.

There may be instances where an impartial third-party can assist in arriving at a solution to a disagreement regarding vehicle repairs or interpretation of the New Vehicle Limited Warranty. To assist in resolving these disagreements Oldsmobile voluntarily participates in BBB AUTO LINE.

BBB AUTO LINE is an out-of-court program administered by the Better Business Bureau system to settle disputes between customers and

automobile manufacturers. This program is available free of charge to customers who currently own or lease a GM vehicle.

If you are not satisfied after following the Customer Satisfaction Procedure, you may contact the BBB using the toll-free telephone number, or write them at the following address:

BBB AUTO LINE
Council of Better Business Bureaus
4200 Wilson Boulevard
Suite 800
Arlington, VA 22203
Telephone: 1-800-955-5100

To file a claim, you will be asked to provide your name and address, your vehicle identification number (VIN), and a statement of the nature of your complaint. Eligibility is limited by vehicle age and mileage, and other factors.

We prefer you utilize the Customer Satisfaction Procedure before you resort to AUTO LINE, but you may contact the BBB at any time. The BBB will attempt to resolve the complaint serving as an intermediary between you and

Customer Assistance Information

Oldsmobile. If this mediation is unsuccessful, an informal hearing will be scheduled where eligible customers may present their case to an impartial third-party arbitrator.

The arbitrator will make a decision which you may accept or reject. If you accept the decision, GM will be bound by that decision. The entire dispute resolution procedure should ordinarily take about forty days from the time you file a claim until a decision is made.

Some state laws may require you to use this program before filing a claim with a state-run arbitration program or in the courts. For further information, contact the BBB or the Oldsmobile Customer Assistance Center at 1-800-442-6537.

**This program may not be available in all states, depending on state law. Canadian owners refer to your Warranty and Owner Assistance information booklet. General Motors reserves the right to change eligibility limitations and/or to discontinue its participation in this program.*

■ **REPORTING SAFETY DEFECTS TO THE UNITED STATES GOVERNMENT**

If you believe that your vehicle has a defect which could cause a crash or could cause injury or death, you should immediately inform the National Highway Traffic Safety Administration (NHTSA), in addition to notifying General Motors.

If NHTSA receives similar complaints, it may open an investigation, and if it finds that a safety defect exists in a group of vehicles, it may order a recall and remedy campaign. However, NHTSA cannot become involved in individual problems between you, your dealer, or General Motors.

To contact NHTSA, you may either call the Auto Safety Hotline toll-free at 1-800-424-9393 (or 366-0123 in the Washington, D.C. area) or write to:

NHTSA
U.S. Department of Transportation
Washington, D.C. 20590

You can also obtain other information about motor vehicle safety from the Hotline.

■ **REPORTING SAFETY DEFECTS TO THE CANADIAN GOVERNMENT**

If you live in Canada, and you believe that your vehicle has a safety defect, you should immediately notify Transport Canada, in addition to notifying General Motors of Canada Limited. You may write to:

Transport Canada
Box 8880
Ottawa, Ontario K1G 3J2.

■ **REPORTING SAFETY DEFECTS TO GENERAL MOTORS**

In addition to notifying NHTSA (or Transport Canada) in a situation like this, we certainly hope you'll notify us. Please call us at **1-800-442-6537**, or write:

Oldsmobile Customer Assistance
Network
P.O. Box 30095
Lansing, MI 48909

In Canada, please call us at
1-800-263-3777 (English) or
1-800-263-7854 (French). Or, write:

General Motors of Canada Limited
Customer Assistance Center
1908 Colonel Sam Drive
Oshawa, Ontario L1H 8P7



■ *Oldsmobile Roadside Assistance Program Features & Benefits*

The Oldsmobile Roadside Assistance program means help is just a toll-free call away—24 hours a day, 365 days a year.

Courteous and capable Customer Assistance Advisors are on-call to provide you with prompt assistance.

24-Hour Oldsmobile Roadside Assistance Number

1-800-442-OLDS (6537) is the one number to call for assistance in the United States. Trained Customer Assistance Advisors, on-call to render

assistance to Oldsmobile drivers, can dispatch roadside assistance and towing service, locate the nearest Oldsmobile dealership, take your request for an Oldsmobile computerized trip routing or simply answer any questions the Oldsmobile driver may have about the coverage provided by your Oldsmobile Roadside Assistance Program. The Oldsmobile Roadside Assistance number is fully staffed and operational 24 hours a day, 365 days a year.

Who is Covered?

Oldsmobile Roadside Assistance covers all 1994 Oldsmobile vehicles.*

Coverage is for the Oldsmobile vehicle, *regardless of the driver*, and is concurrent with the Bumper-to-Bumper warranty period.

Oldsmobile reserves the right to limit services or reimbursement to an owner or driver when in Oldsmobile's judgement the claims become excessive in frequency or type of occurrence.

**Vehicles sold in Canada have a separate roadside assistance program, as described later in this section.*

Customer Assistance Information

Canadian Roadside Assistance

Vehicles purchased in Canada have an extensive Roadside Assistance program accessible from anywhere in Canada or the U.S.A. Please refer to the separate brochure provided by the dealer or call 1-800-268-6800 for emergency services.

■ **Service Publications**

Information on how to obtain Product Service Publications, Subscriptions and Indexes and Service Manuals as described below is applicable only in the fifty U.S. states (and the District of Columbia) and only for cars and light trucks with GVWR less than 10,000 pounds (4 536 kg).

In Canada, information pertaining to Product Service Bulletins and Indexes can be obtained by writing to:

General Motors of Canada Limited
Service Publications Department
1908 Colonel Sam Drive
Oshawa, Ontario L1H 8P7

Oldsmobile regularly sends its dealers useful service bulletins about Oldsmobile products. Oldsmobile

monitors product performance in the field. We then prepare bulletins for servicing our products better. Now, you can get these bulletins too.

Bulletins cover various subjects. Some pertain to the proper use and care of your vehicle. Some describe costly repairs. Others describe inexpensive repairs which, if done on time with the latest parts, may avoid future costly repairs. Some bulletins tell a technician how to repair a new or unexpected condition. Others describe a quicker way to fix your vehicle. They can help a technician service your vehicle better.

Most bulletins apply to conditions affecting a small number of cars or trucks. Your Oldsmobile dealer or a qualified technician may have to determine if a specific bulletin applies to your vehicle.

You can subscribe to all Oldsmobile bulletins. This way you'll get them as they come out. You can wait a while and get an index to the bulletins. You can also get individual bulletins. However, you'll need the index to identify them.

Subscriptions

You can subscribe to all Oldsmobile Product Service Publications (PSP's). This will include bulletins for all vehicles sold by Oldsmobile and will not be limited to PSP's applicable to any particular model.

For subscription costs and ordering information call the toll-free number shown in the following text.

What You'll Find in the Index

- A list of all PSP's published by Oldsmobile in a model year (1990 or later). PSP's covering all models of Oldsmobile vehicles are listed in the same index.
- Price information for the PSP's you may want to buy.

How You Can Get an Index

Indexes are published periodically. Most of the PSP's which could potentially apply to the most recent Oldsmobile models will be listed in the most recent publication for that model

year. This means you may want to wait until the end of the model year before ordering an index, if you are interested in buying PSP's pertaining to a current model year car or truck.

Some PSP's pertaining to a particular model year vehicle may be published in later years, and these would be listed in the later year's index. When you order an index for a model year that is not over yet, we'll send you the most recently published issue.

Toll-Free Telephone Number

If you want an ordering form for an index or a subscription, just call toll-free and we'll be happy to send you one. Automated recording equipment will take your name and mailing address. The number to call is 1-800-551-4123.

Copies at Participating Dealers

Copies of Indexes and PSP's are at your participating Oldsmobile dealer. You can ask to see them.

A VERY IMPORTANT REMINDER:
These PSP's are meant for technicians. They are not meant for the "do-it-yourselfer." Technicians have the equipment, tools, safety instructions, and know-how to do a job quickly and safely.

Oldsmobile Service Manuals

For Service Manual costs and ordering information call 1-800-551-4123.

Product Service Publication Ordering Information

Oldsmobile Division service publications are intended for use by professional, qualified technicians. Attempting repairs or service without the appropriate training, tools, and equipment could cause injury to you or others and damage to your vehicle that may cause it not to operate properly.

Available publications include Service Manuals, Product Service Publication Indexes, quarterly and model year PSP's and binders. For 1994 Product Service Publication pricing information and orders call 1-800-551-4123.

Notes

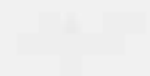

[The main body of the page is blank, with two vertical lines defining a central area for notes.]

Notes

Notes

Index

- A**BS Warning Light..... 96
- Adding
- Automatic Transaxle Fluid..... 189
 - Brake Fluid..... 194
 - Electrical Equipment..... 60, 111, 220
 - Engine Coolant..... 191
 - Engine Oil..... 184
 - Power Steering Fluid..... 192
 - Sound Equipment..... 111
 - Windshield Washer Fluid..... 193
- Air Bag..... 23
- Air Bag Readiness Light..... 24
- Air Cleaner Filter..... 187
- Air Conditioner..... 104
- Alcohol, Driving Under the
- Influence of..... 126
- Alcohol in Gasoline..... 177
- Aluminum Wheels
- Cleaning..... 217
 - Removing..... 167
- Antenna
- Fixed Mast..... 123
 - Power..... 124
- Antifreeze..... 190
- Anti-Lock Brake System (ABS)..... 129
- Anti-Lock Brake System
- Warning Light..... 96
- Appearance Care..... 212
- Ashtrays and Lighters..... 85, 86
- Audio Systems..... 110
- AM/FM Stereo Radio..... 112
 - AM/FM Stereo Radio with
Cassette Player..... 113
 - AM/FM Stereo with Cassette
Player and Graphic Equalizer.... 117
 - AM/FM Stereo with Cassette
Player and Music Search..... 115
 - AM/FM Stereo with Compact
Disc Player..... 119
 - Audio Bass Control..... 115
 - Care of Audio Systems..... 123
 - Delco-Loc Anti-Theft Feature..... 120
 - Radio Reception, Understanding.... 122
 - Setting the Clock..... 111
 - Steering Wheel Touch Controls.... 122
- Automatic Lap-Shoulder Belt (see
Safety Belts)
- Automatic Transaxle
- Adding Fluid..... 189
 - Checking Fluid..... 188
 - Shifting..... 62
 - Starting the Engine..... 59
- B**atteries, Remote Lock Control..... 53
- Battery..... 196
- Jump Starting..... 150
 - Warning Light..... 98
 - Warnings..... 152, 196
- Blizzard..... 142
- Block Heater, Engine..... 61, 186
- Blowout, Tire..... 165
- Brake
- Adjustment..... 195
 - Fluid..... 194
 - Master Cylinder..... 194
 - Parking..... 66
 - Replacing Parts..... 195
 - Warning Light..... 96
 - Wear Indicators..... 194
- Brake System Warning Light
- Anti-Lock Brake System..... 96
 - Standard Brakes..... 96
- Brakes, Anti-Lock..... 129
- Warning Light..... 96
- Braking..... 128
- Braking in Emergencies..... 130
- Braking Technique..... 129
- Break-In, New Vehicle
- Normal Driving..... 58
 - When Towing a Trailer..... 144
- Buckling Up (see *Safety Belts*)
- Bulb Replacement
- Center High-Mounted
Stoplight..... 215, 216
 - Fog Lights..... 204
 - Headlight..... 199, 202
 - Taillight..... 202, 203

Index

- C**
Capacities & Specifications 227
Carbon Monoxide in Exhaust... 57, 69, 142
Cassette Tape Holder..... 83
Cassette Tape Player (see *Audio Systems*)
Center Lap Belts (see *Safety Belts*)
Chains, Tire..... 173, 212
Changing a Flat Tire 166
Check Gages Light..... 98
Checking
 Aim of the Headlights 197
 Automatic Transaxle Fluid 188
 Brake Fluid 194
 Engine Coolant..... 160
 Engine Oil..... 184
 Power Steering Fluid..... 192
 Safety Belt Systems 46
 Things Under the Hood 180
Chemical Paint Spotting..... 218
Child Restraints 36
Children and Safety Belts..... 35, 45
Cigarette Lighter..... 85
Circuit Breakers & Fuses 220
City Driving..... 137
Cleaner, Air..... 187
Cleaning
 Aluminum Wheels..... 217
 Antenna..... 123, 124
 Cassette Player and Tapes 123
 Compact Discs 123
 Fabric..... 213
 Fiberglass Springs 218
 Glass 215
 HUD (Head-Up Display)..... 101
 Inside of Your Oldsmobile..... 212
 Leather and Vinyl..... 214
 Outside of Your Oldsmobile..... 216
 Safety Belts..... 214
 Special Problems..... 213
 Underbody Maintenance..... 218
 Warnings..... 212
 Weatherstrips 217
 Windshield..... 216
Clock, Setting the 111
Cluster, Instrument Panel 90
Coin Holder..... 84
Comfort Controls
 Climate Control..... 104
 Electronic Climate Control 107
 Steering Wheel Touch Controls.... 109
 Ventilation..... 104, 110
Compact Disc Player (see *Audio Systems*)
Compact Spare Tire 172
Compartments, Storage..... 83
Console, Rear Seat..... 84
Control of a Vehicle..... 128
Convenience Net..... 57
Convex Outside Mirror..... 81
Coolant (see *Engine Coolant*)
Cooling System 160
Cruise Control..... 74
Cup Holder..... 83
Curves, Driving on..... 130
Customer Assistance Information... 251
D
Daytime Running Lights 78
Dead Battery: What to Do..... 151
Defects, Reporting Safety 254
Defensive Driving 126
Defogger, Rear Window 106, 109
Defogging Your Windows..... 105
Defrosting Windows 105
Disc Brake Wear Indicators 194
Door Locks..... 51
Downshifting 66, 139, 147
Driver Position..... 19
Driving..... 125
 At Night..... 134
 City..... 137
 Controlling a Skid 133
 Defensively 126
 Drunken 126
 Freeway..... 137
 Hill and Mountain..... 139
 In a Foreign Country..... 178
 In Rain 135
 Long Distance 138
 Loss of Control..... 133
 Off-Road Recovery 132
 On Curves..... 130

Passing.....	132	Checking & Adding.....	184	Finish Care.....	217
Through Deep Standing Water.....	60	Disposing of Used Oil.....	187	Finish Damage.....	217
Winter Driving.....	140	Energy Conserving.....	186	Flash-to-Pass.....	79
With a Trailer.....	146	Filter.....	186	Flashers, Hazard Warning.....	150
Drunken Driving.....	126	Pressure Gage.....	95	Flat Tire.....	165
E lectric Outside Mirror Control.....	82	Starburst.....	185	Flooded Engine.....	60
Electrical Center, Underhood.....	220	Warning Light.....	94	Fluid	
Electrical Equipment,		When to Change.....	186	Automatic Transaxle.....	188
Adding.....	60, 111, 220	Engine Overheating.....	158	Brake.....	194
Electronic Climate Control.....	107	Engine Specifications.....	232	Capacities.....	227
Emergencies, Braking in.....	130	Engine Starting.....	59	Power Steering.....	192
Emergencies on the Road.....	149	Ethanol in Gasoline.....	177	Windshield Washer.....	193
Emergencies, Steering in.....	131	Exhaust		Fluids & Lubricants.....	229, 248
Emergency Starting.....	150	Dangerous Gas in.....	57, 69, 142	Fog Lights.....	80, 204
Emergency Towing.....	154	Parking with the Engine		Fold-Down Storage Compartment....	83
Engine Block Heater.....	61	Running.....	68, 70	Foreign Material.....	217
Engine Coolant.....	190	Expectant Mothers, Use of Safety		Freeway Driving.....	137
Checking & Adding.....	160, 161	Belts.....	27	French Language Manual.....	2
Heater.....	61, 186	Expressway Driving.....	137	Fuel.....	177
Low Coolant Warning Light.....	94	Extender, Safety Belt.....	46	Alcohol in Fuel.....	177
Proper Mixture to Use.....	161	Exterior Appearance (see <i>Appearance</i>		Capacity.....	179, 272
Safety Warnings		<i>Care</i>)		Exhaust Warnings.....	57, 142
About.....	159, 160, 181, 190	F abric Cleaning (see <i>Appearance Care</i>)		Filling Your Tank.....	179
Temperature Gage.....	93	Fan Warnings.....	152, 181	Fuels with Alcohol.....	177
Engine Exhaust.....	69	Filling the Fuel Tank.....	179	Gage.....	93
Engine Identification.....	219	Filter		In Foreign Countries.....	178
Engine Oil.....	184	Air.....	187	Low Fuel Warning Light.....	98
Additives.....	186	Fuel.....	233	Requirements.....	177
Capacity.....	227	Oil.....	186, 233	Fuses & Circuit Breakers.....	220

- G**ages
- Coolant Temperature 93
 - Fuel 93
 - Oil Pressure 95
 - Voltmeter 95
- Gasoline 177
- Gasoline Tank, Filling Your 179
- Gear Positions (see *Shifting the Transaxle*)
- Gearshift Lever (see *Shifting the Transaxle*)
- Glove Box 58
- Graphic Equalizer (see *Audio Systems*)
- H**alogen Bulbs 196
- Hazard Warning Flashers 150
- Headlight & Taillight, Removing and Replacing 199, 202
- Headlights 77
- Aim of the, Checking 197
 - Aiming 197, 198
 - Flash-to-Pass 79
 - High-Low Beam 79
 - "On" Reminder 78
 - Replacing 199, 202
 - Replacement Bulbs 230
 - Wiring 226
- Head Restraint 14
- Head-Up Display (HUD) 98
- Heater 104
- Heater, Engine Block 61, 186
- High Beams 79
- Highway Hypnosis 138
- Hill and Mountain Roads 139
- Hills, Parking on 147
- Hood Release 180
- Safety Warning 192
 - Warning, Overheated Engine 159
- Horn 71
- Hot Engine, Safety Warnings 159
- How the Anti-Lock Brake System Works 129
- HUD (Head-Up Display) 98
- Hydroplaning 136
- I**dentification
- Engine 219
 - Label, Service Parts 219
 - Number, Vehicle (VIN Code) 219
- Idling Your Engine 68, 70
- If You're Stuck in Sand, Mud, Ice, or Snow 173
- Ignition
- Key 50
 - Positions 59
- Illuminated Entry 80
- Indicator Lights (see *Warning Lights*)
- Infant Restraint (see *Child Restraints*)
- Inflation, Tires 207
- Inside Rearview Mirror 81
- Instrument Panel 89
- Instrument Panel Cluster 90
- Instrument Panel Intensity Control 79
- Instrument Panel Warning Lights 91
- J**ack, Tire 166
- Jump Starting 150
- K**eyless Entry System 52
- Keys 50
- L**ane Change Indicator 73
- Lap-Shoulder Safety Belt 20
- Front, Automatic 20
 - Rear 29
 - Use by Children 45
- Latches, Seatback 14
- Lighter 85
- Lights
- Daytime Running 78
 - Entry, Illuminated 80
 - Fog Lights 80, 204
 - Headlights 77, 199, 202
 - On Reminder 78
 - Operation of 78
 - Reading 80
 - Removing & Replacing
 - Bulbs 199, 202
 - Replacement Bulbs 230

Stoplight, Inside	215, 216
Taillights	77, 202, 203
Turn Signal	146
Warning Lights	91, 98
Loading Your Vehicle	205
Lock Finder	56
Locks, Door	51
Locks, Remote Control	52
Lockout Control Switch, Power Window	72
Long Distance Driving	138
Low Battery	98
Low Coolant Warning Light	94
Low Fuel Warning Light	98
Low Oil Level Light	94
Luggage Carrier	87
M aintenance	
Replacement Parts	233
Schedule	235
Services, Scheduled	237
When Trailer Towing	148
Malfunction Indicator Lamp	97
Manual Front Seat	12
Master Cylinder, Brake	194
Methanol in Gasoline	177
Mileage Indicator (see <i>Odometer & Speedometer</i>)	

Mirrors	
Convex Outside	81
Inside Manual Day/Night	81
Manual Adjust	82
Manual Remote Control	82
Power Remote Control	82
Visor Vanity	83
Mountain Driving	139
N et, Convenience	57
New Vehicle Break-In	58, 144
Night Driving	134
O ctane Requirements (see <i>Fuel</i>)	
Odometer	92
Oil, Engine	184
Capacity	227
Pressure Gage	95
Quality	185
Thickness	186
Used Oil	187
When to Change	186
Oil Warning Light	94, 98
Outside Rearview Mirrors	82
Overdrive, Automatic	65
Overheated Engine	158
Overheated Engine Coolant Warning Light	94
Owner Checks & Services	244

P aint	
Chemical Spotting	218
Finish Care	217
Finish Damage	217
Park, Shifting Into	
Column Shift	67
Console Shift	68
Parking	
Over Things That Burn	69
With the Engine Running	68, 70
Parking Brake	66
PASS-Key®II	55
Passenger Belts (see <i>Safety Belts</i>)	
Passing	132
Polishing and Waxing (see <i>Appearance Care</i>)	
Power Antenna	124
Power Door Locks	52
Power Mirrors	82
Power Seat Controls	13
Power Steering	192, 226
Power Steering Fluid	192
Power Windows	226
Power Window Lockout Control Switch	72
Pregnancy, Use of Safety Belts During ...	27
Problems on the Road	149
Publications (see <i>Service Publications</i>)	
Pulse Windshield Wipers	76

- R**
 Radiator Overheating (see *Overheated Engine*)
 Radiator Pressure Cap..... 162, 192
 Radio (see *Audio Systems*)
 Rain, Driving in the 135
 Reading Lights 80
 Rear Safety Belt Comfort Guides..... 33
 Rear Seat Console..... 84
 Rear Window Defogger..... 109
 Rearview Mirror..... 81
 Reclining Seatbacks 13
 Recommended Fluids & Lubricants ... 248
 Remote Control Mirrors 82
 Remote Lock Control 52
 Remote Positive Battery Terminal..... 152
 Remote Trunk Release..... 57
 Replacement Bulbs 230
 Replacement Parts 233
 Replacing Safety Belts 47
 Replacing Tires..... 209
 Replacing Wheels..... 210
 Replacing Windshield Wipers..... 205
 Reporting Safety Defects 254
 Restraint, Child..... 36
 Restraint, Head..... 14
 Roads, Hill and Mountain..... 139
 Roadside Assistance 255
 Rocking Your Vehicle..... 173
 Stuck, If You Are 173
 Rotation, Tire..... 208
 Running Lights, Daytime 78
S
 Safety Belts..... 15
 Adults 19
 Automatic Lap-Shoulder Belt..... 20
 Center Passenger Position 28
 Checking..... 46
 Children..... 35, 45
 Child Restraints..... 36
 Child Restraints,
 How to Install..... 37, 38, 40, 41
 Child Restraints, Where to Put..... 36
 Cleaning..... 214
 Comfort Guides..... 33
 Driver Position 19
 Extender 46
 How to Wear 19
 Passenger Belts..... 27
 Pregnancy, Use During 27
 Questions & Answers... 18, 22, 45, 47
 Rear Safety Belts 29, 31
 Reminder Light..... 18
 Replacement 47
 Right Front, Adult Passenger 27
 Top Strap..... 36
 Torn 47
 Twisted 23
 Vehicles First Sold in Canada..... 19
 Why You Should Wear Safety Belts.... 16
 Safety Defects, Reporting..... 254
 Scheduled Maintenance Services.... 237
 Seat Belts (see *Safety Belts*)
 Seat Controls..... 12
 Adjustable Supports..... 12
 Head Restraint 14
 Manual Front Seat 12
 Manual Reclining Seatback 13
 Power Seat, Six-Way..... 13
 Reclining Seatback..... 13
 Seatback Latches..... 14
 Seat, Rear Split Fold-Down..... 15
 Service Engine Soon Light 97
 Service Information 176
 Service Parts Identification Label... 219
 Service Publications..... 256
 Service Station Information 272
 Servicing Your Air Bag-Equipped
 Oldsmobile..... 26
 Setting the Clock 111
 Setting the Trip Odometer 92
 Sheet Metal Damage..... 217
 Shifting Into Park
 Column Shift 67
 Console Shift 68
 Shifting the Automatic Transaxle 62
 Signaling Turns..... 73
 Six-Way Power Seat 13
 Skidding 133
 Snowstorm, If You're Caught in a ... 142

Sound Equipment, Adding.....	111	Sunroof.....	86	Quality Grading.....	209
Sound Systems (see <i>Audio Systems</i>)		Sun Visors.....	83	Spare, Compact.....	172
Spare Tire, Compact.....	172	T achometer.....	92	Wear Indicators.....	209
Spark Plugs.....	220, 233	Tape Player (see <i>Audio Systems</i>)		Wheel Alignment & Tire Balance...	210
Specifications & Capacities.....	227	Technical Facts & Specifications		Wheel Replacement.....	210
Speed Control (see <i>Cruise Control</i>)		Bulbs.....	230	When to Replace Wheels.....	210
Speedometer.....	91	Electrical Equipment,		Winter Driving, and	
SRS (Supplemental Restraint		Add-On.....	60, 111	Tires.....	140, 141, 212
System).....	23	Engine Specifications.....	232	Top Strap.....	36
Stains, Removing.....	212	Fluid Capacities & Types.....	227, 229	Torque Lock.....	69
Starting Your Engine.....	59	Fuses & Circuit Breakers.....	220	Towing a Trailer.....	143
Starting, Jump.....	150	Replacement Parts.....	233	Towing Your Oldsmobile.....	154
Steering		Service Parts Identification		Trailer Towing.....	143
In Emergencies.....	131	Label.....	219	Driving with a Trailer.....	146
Off-Road Recovery.....	132	Vehicle Identification Number		Maintenance.....	148
Tips.....	130	(VIN).....	219	Parking on Hills.....	147
Steering Wheel, Tilt.....	71	Temperature Warning Light.....	98	Trailer Brakes.....	146
Steering Wheel Touch Controls		Theft.....	54	Turn Signals.....	146
Audio System.....	122	Thermostat.....	192	Transaxle, Automatic (see <i>Automatic</i>	
Climate Control.....	109	Tilt Steering Wheel.....	71	<i>Transaxle</i>)	
Stereo Systems (see <i>Audio Systems</i>)		Time, Setting the.....	111	Transmission, Automatic (see	
Stoplight, Inside Center		Tires.....	206	<i>Automatic Transaxle</i>)	
High Mounted.....	215, 216	Buying New.....	209	Trip Odometer.....	92
Storage		Chains.....	173, 212	Trunk	
Cassette Tape Holders.....	83	Flat, Changing.....	166	Access Panel.....	84
Convenience Net.....	57	Inflation.....	207	Lock.....	56
Fold-Down Storage Compartment...	83	Inspection & Rotation.....	208	Remote Release.....	57
Rear Seat Console.....	84	Loading.....	207	Turn Signal Indicator.....	73
Storing Your Vehicle.....	196	Pressure.....	207	Turn Signal/Multifunction Lever.....	72
Stuck, If You Are.....	173			Cruise Control.....	74

Index

- Flash-to-Pass 79
- High/Low Beam Changer 79
- Pulse Windshield Wipers 76
- Turn & Lane Change Indicator 73
- Turn Signal Indicator 73
- Windshield Washer 77
- Windshield Wipers 76
- U**nderhood Electrical
 - Center 220, 224, 225
- Unleaded Gasoline 177
- Upholstery Care 212
- V**ehicle Identification Number (VIN) 219
- Vehicle Loading 205
- Vehicle Storage 196
- Ventilation 104, 110
- VIN 219
- Visor Vanity Mirrors 83
- Voltmeter 95
- W**arning Flashers, Hazard 150
- Warning Lights
 - Anti-Lock Brake System 96
 - Battery 98
 - Brake 96
 - Coolant Temperature 94
 - Fasten Belts 18
 - Low Coolant 94
 - Oil 94
 - Safety Belt 15
 - Service Engine Soon 97
- Washer, Windshield 77
- Weight
 - Gross Axle Rating (GAWR) 205
 - Gross Vehicle Rating (GVWR) 205
- Wheel Alignment & Tire Balance ... 210
- Wheel Covers, How to Remove 167
- Wheel Nut Torque 171, 228
- Wheel Nuts 167
- Wheel Replacement 210
- Windows
 - Passenger Lockout Switch 72
 - Power 72
 - Standard 71
- Windshield Washer 77
- Fluid 191
- Windshield Wipers 76, 216, 226
- Windshield Wiper Replacement 205
- Winter Driving 140
 - If Your Vehicle is Stuck in Deep Snow 173
 - If You're Caught in a Blizzard 142
- Wrecker Towing 154

Notes

Service Station Information

