



1994  
TRACKER  
OWNER'S MANUAL



## Geo Tracker

Introduction	<b>How to Use This Manual</b> .....	<b>4</b>
Part 1	<b>Seats &amp; Restraint Systems</b> .....	<b>9</b>
Part 2	<b>Features &amp; Controls</b> .....	<b>35</b>
Part 3	<b>Comfort Controls &amp; Audio Systems</b> .....	<b>83</b>
Part 4	<b>Your Driving and the Road</b> .....	<b>99</b>
Part 5	<b>Problems on the Road</b> .....	<b>131</b>
Part 6	<b>Service &amp; Appearance Care</b> .....	<b>155</b>
Part 7	<b>Maintenance Schedule</b> .....	<b>203</b>
Part 8	<b>Customer Assistance Information</b> .....	<b>233</b>
	Including "Reporting Safety Defects" on page 236.	
Part 9	<b>Index</b> .....	<b>243</b>
	<b>Service Station Information</b> .....	<b>Last Page</b>

# How to Use This Manual

## *Important Notes about This Manual*

Please keep this manual in your Geo, so it will be there if you ever need it when you're on the road. If you sell the vehicle, please leave this manual in it so the new owner can use it.

This manual includes the latest information at the time it was printed. We reserve the right to make changes in the product after that time without further notice. For vehicles first sold in Canada, substitute the name "General Motors of Canada Limited" for Chevrolet Motor Division wherever it appears in this manual.

## **For Canadian Owners Who Prefer a French Language Manual**

Aux propriétaires canadiens: Vous pouvez vous procurer un exemplaire de ce guide en français chez votre concessionnaire ou au DGN Marketing Services Ltd., 1500 Bonhill Rd., Mississauga, Ontario L5T 1C7.

Published by:

**Chevrolet Motor Division  
General Motors Corporation**

**General Motors, GM** and the GM emblem, **Chevrolet** and the Chevrolet emblem, and **Geo** and the Geo emblem are registered trademarks of General Motors Corporation.

©Copyright 1993 General Motors Corporation, Chevrolet/Geo Division. All Rights Reserved.

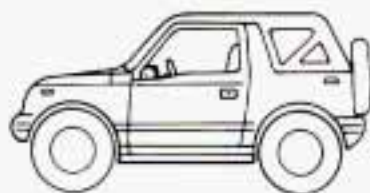

**CONVERTIBLE  
UTILITY**

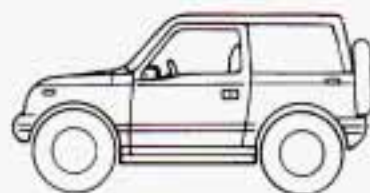

**HARDTOP  
UTILITY**

### ***About Driving Your Tracker***

As with other vehicles of this type, failure to operate this vehicle correctly may result in loss of control or an accident. Be sure to read the "on-pavement" and "off-road" driving guidelines in this manual. (See "Driving Guidelines" and "Off-Road Driving with Your Four-Wheel-Drive Vehicle" in the Index.)

# How to Use This Manual



## ■ *How to Use This Manual*

Many people read their owner's manual from beginning to end when they first receive their new vehicle. This will help you learn about the features and controls for your vehicle. In this manual, you'll find that pictures and words work together to explain things quickly.

**Index:** A good place to look for what you need is the Index in back of the manual. It's an alphabetical list of all

that's in the manual, and the page number where you'll find it.

**Parts 1-8:** Each part of this manual begins with a brief list of its contents, so you can often find at a glance if a part contains the information you want.

**How to Use This Manual:** This part tells you how to use your manual and includes safety and vehicle damage warnings and symbols.

### **Part 1 – Seats & Restraint Systems:**

This part tells you how to use your seats and safety belts properly.

**Part 2 – Features & Controls:** This part explains how to start and operate your Geo.

**Part 3 – Comfort Controls & Audio Systems:** This part tells you how to adjust the comfort controls and how to operate your sound system.

**Part 4 – Your Driving and the Road:** Here you'll find helpful information and tips about the road and how to drive under different conditions.

**Part 5 – Problems on the Road:** This part tells you what to do if you have a problem while driving, such as a flat tire or engine overheating, etc.

**Part 6 – Service & Appearance Care:** Here the manual tells you how to keep your Geo running properly and looking good.

**Part 7 – Maintenance Schedule:** This part tells when to perform vehicle maintenance and what fluids and lubricants to use.

## Part 8 – Customer Assistance

**Information:** This part includes important information about reporting safety defects and gives you details about the “Roadside Assistance” program. You will also find customer satisfaction phone numbers (including customer satisfaction numbers for the hearing and speech impaired), as well as the mediation/arbitration procedure. We’ve also included ordering information for service publications in this part.

**Service Station Information:** This is a quick reference of service information. You can find it on the last page of this manual.



### **CAUTION:**

These mean there is something that could hurt you or other people.

### ***Safety Warnings and Symbols***

You will find a number of safety cautions in this book. We use a box with a gray background and the word CAUTION to tell you about things that could hurt you if you were to ignore the warning.

In the gray caution area, we tell you what the hazard is. Then we tell you what to do to help avoid or reduce the hazard. Please read these cautions. If you don’t, you or others could be hurt.



You will also find a circle with a slash through it in this book. This safety symbol means “Don’t,” “Don’t do this,” or “Don’t let this happen.”

# How to Use This Manual

## NOTICE:

These mean there is something that could damage your vehicle.

### Vehicle Damage Warnings

Also, in this book you will find these notices.

In the notice area, we tell you about something that can damage your vehicle. Many times, this damage would not be covered by your warranty, and it could be costly. But the notice will tell you what to do to help avoid the damage.

When you read other manuals, you might see CAUTION and NOTICE warnings in different colors or in different words.

You'll also see warning labels on your vehicle. They use yellow for cautions, blue for notices and the words CAUTION or NOTICE.

### Vehicle Symbols

These are some of the symbols you will find on your vehicle. For example, these symbols are used on an original battery:

*Caution Possible Injury*



*Protect Eyes by Shielding*



*Caustic Battery Acid  
Could Cause Burns*



*Avoid Sparks or Flames*



*Sparks or Flame Could  
Explode Battery*



These symbols are important for you and your passengers whenever your vehicle is driven:

*Fasten Safety Belts*



These symbols have to do with your lights:

*Master Lighting Switch*



*Turn Signal Direction*



*Hazard Warning Flashers*



*Headlight High Beam*



*Headlight Low Beam*



*Parking Lights*



*Brightness Control*



These symbols are on some of your controls:

Windshield Wiper



Windshield Washer



Windshield Defroster



Rear Window Wiper and Washer



Rear Window Wiper



Rear Window Defogger



Ventilating Fan



*Recirculate  
Inside Air*

*Circulate  
Outside Air*

*Bi-Level*

*Vent*

*Heater*



These symbols are used on warning and indicator lights:

*Engine Coolant  
Temperature*



*Battery Charging System*



*Fuel*



*Engine Oil Pressure*



*Brake (Canada)*



*Daytime Running Lights  
(Canada)*





## How to Use This Manual

Here are some other symbols you may see:

*Hood Release*



*Lighter*



*Horn*





**H**ere you'll find information about the seats in your Geo and how to use your safety belts properly. You can also learn about some things you should not do with safety belts.

## Part 1 Seats & Restraint Systems

Seats and Seat Controls .....	10
Safety Belts: They're for Everyone .....	15
Why Safety Belts Work .....	16
Here Are Questions Many People Ask about Safety Belts — and the Answers ..	18
Safety Belt Reminder Light .....	19
How to Wear Safety Belts Properly .....	19
Children .....	26
Child Restraints .....	27
Larger Children .....	32
Safety Belt Extender .....	33
Checking Your Restraint Systems .....	33
Replacing Safety Belts after a Crash .....	34

# Seats and Restraint Systems

## ■ *Seats and Seat Controls*

This section tells you about the seats — how to adjust them, and also about reclining front seatbacks, head restraints, seatback latches, easy entry seats and the folding rear seatback.



### *Front Seat*



#### **CAUTION:**

You can lose control of the vehicle if you try to adjust a manual driver's seat while the vehicle is moving. The sudden movement could startle and confuse you, or make you push a pedal when you don't want to. Adjust the driver's seat only when the vehicle is not moving.

Move the lever under the front seat to unlock it. Slide the seat to where you want it. Then release the lever and try to move the seat with your body, to make sure the seat is locked into place.

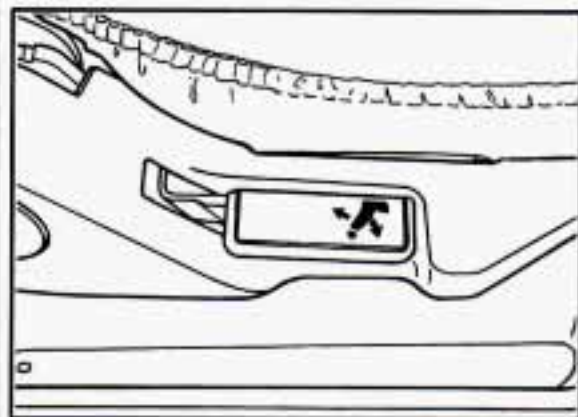

### *Reclining Front Seatbacks*

To adjust the seatback, lift the lever on the outer side of the seat. Release the lever to lock the seatback where you want it. Pull up on the lever, and the seat will go to its original upright position. But don't have the seatback reclined if your vehicle is moving.



## CAUTION:

Sitting in a reclined position when your vehicle is in motion can be dangerous. Even if you buckle up, your safety belts can't do their job when you're reclined like this.

The shoulder belt can't do its job because it won't be against your body. Instead, it will be in front of you. In a crash you could go into it, receiving neck or other injuries.

The lap belt can't do its job either. In a crash the belt could go up over your abdomen. The belt forces would be there, not at your pelvic bones. This could cause serious internal injuries.

For proper protection when the vehicle is in motion, have the seatback upright. Then sit well back in the seat and wear your safety belt properly.



## *Head Restraints*

Head restraints are fixed on some vehicles and adjustable on others. Slide an adjustable head restraint up or down so that the top of the restraint is closest to the top of your ears. This position reduces the chance of a neck injury in a crash.

# Seats and Restraint Systems

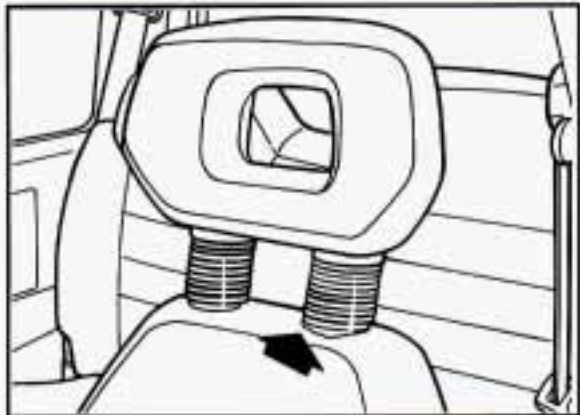

To raise or lower the restraint, push in the release while you pull up or push down on the restraint.

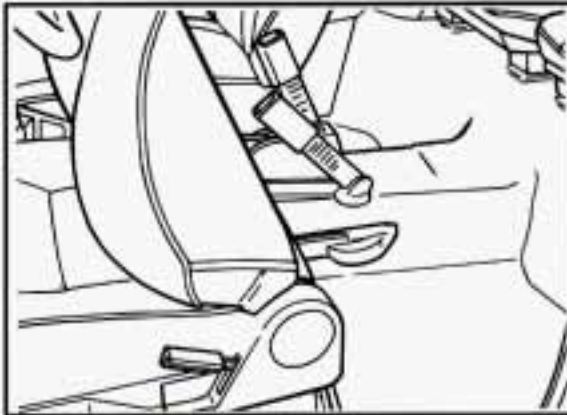

## *Easy Entry Seats*

The front seats of your vehicle make it easy to get in and out of the rear seat.

- When you pull up on the recliner release lever, the seatback will tilt forward and the whole seat will slide forward.
- After someone gets into the rear seat area, move the seatback to its original position. Then move the seat rearward until it locks.

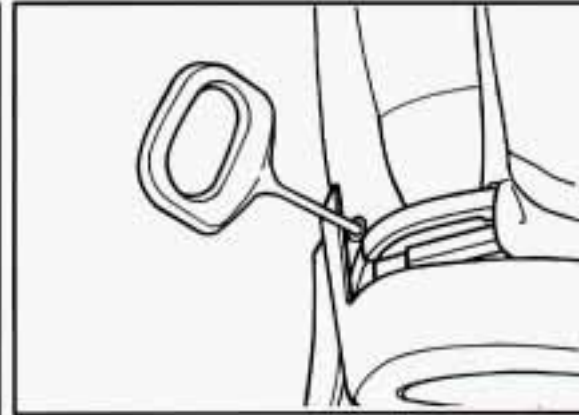

## **CAUTION:**

If an easy entry front seat isn't locked, it can move. In a sudden stop or crash, the person sitting there could be injured. And, even if there is no crash or sudden stop, a driver sitting in an unlocked easy entry seat could be startled by the sudden movement and hit the wrong control or pedal, causing an accident. After you've used it, be sure to press rearward on an easy entry seat to be sure it is locked.

- To get out, pull the release handle on the rear of the right front seat.

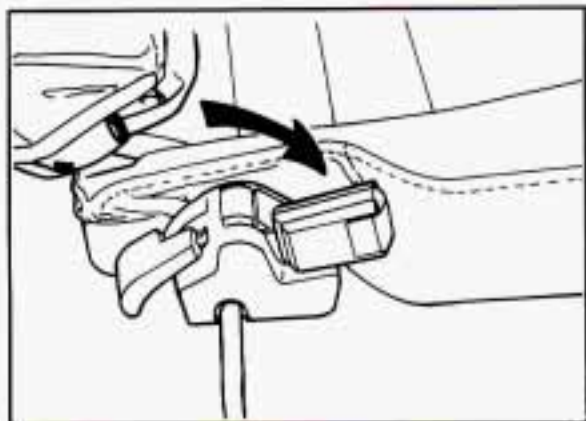

### ***Folding Rear Seat***

The rear seat in your Geo folds to provide more cargo space.

To fold the seat, lower the rear seatback and then flip the whole rear seat up against the front seats.

- 1.** Swing the safety belt buckles forward and down.

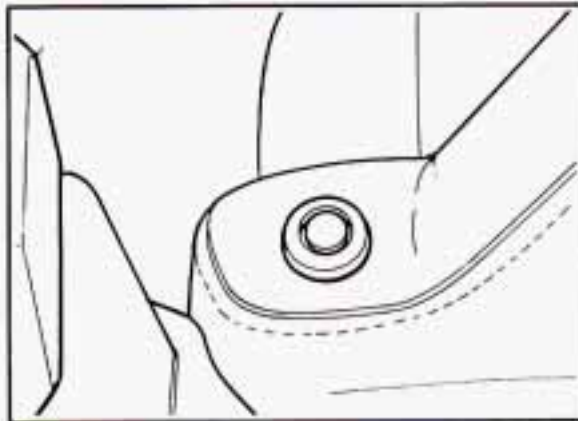

- 2.** Pull the knobs on both sides of the seatback. If you have a split rear seat, you can fold half of the seat by pulling only the knob on the side you want to fold.

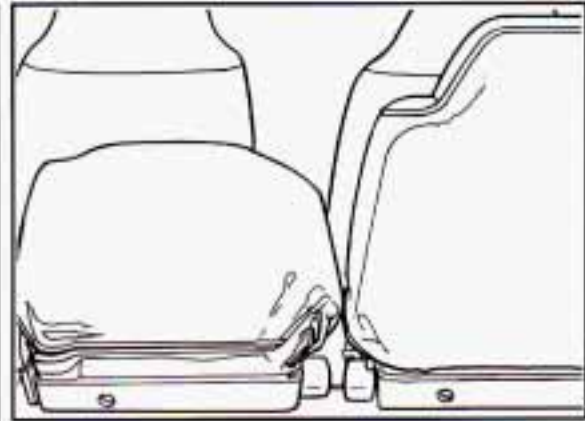

- 3.** Fold the seatback down.

# Seats and Restraint Systems



4. Unlock the bottom part of the seat.
  - On the one-piece rear seat, pull out the release ring.
  - On the split rear seat, lift the release lever on either seat.
5. Lift the bottom of the seat up and push it toward the front of the vehicle.

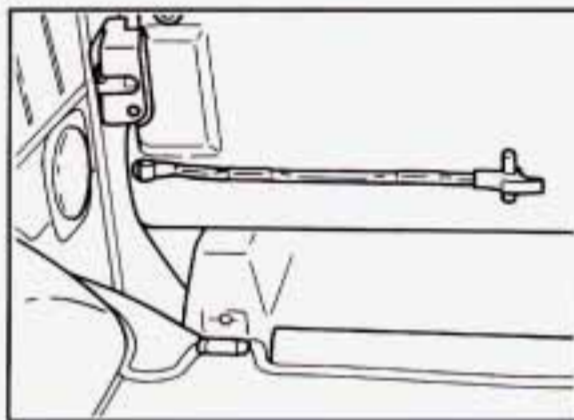

6. Find the support bar on the bottom of the seat. This bar keeps the rear seat from unfolding.
7. Pull the inner end of the support off of the seat bracket and swing it down.

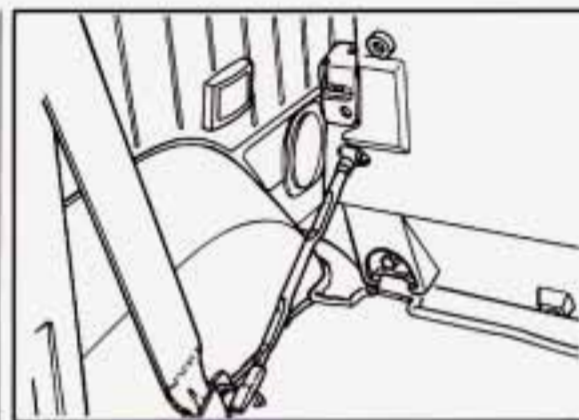

8. Push the support bar into the floor bracket. Be sure the support bar is secured.
- To unfold the seat:  
Keep your hands, safety belts and other objects away from where the seat will rest.
1. Pull the support bar out of the floor bracket and swing it up and toward the bottom of the seat.
  2. Push the support bar into the bracket on the bottom of the seat.
  3. Slowly pull the seat down to the floor. The seat should latch into place. Pull up on the bottom of the seat to be sure it is locked in position.
  4. Pull the seatback up and push it back. Push and pull the top of the seatback to be sure it is locked in place.

## ■ *Safety Belts: They're for Everyone*

This part of the manual tells you how to use safety belts properly. It also tells you some things you should not do with safety belts.



### **CAUTION:**

Don't let anyone ride where they can't wear a safety belt properly. If you are in a crash and you're not wearing a safety belt, your injuries can be much worse. You can hit things inside the vehicle or be ejected from it. You can be seriously injured or killed. In the same crash, you might not be if you are buckled up. Always fasten your safety belt, and check that your passengers' belts are fastened properly too.



This figure lights up as a reminder to buckle up. (See "Safety Belt Reminder Light" in the Index.)

In many states and Canadian provinces, the law says to wear safety belts. Here's why: They work.



You never know if you'll be in a crash. If you do have a crash, you don't know if it will be a bad one.

A few crashes are mild, and some crashes can be so serious that even buckled up a person wouldn't survive. But most crashes are in between. In many of them, people who buckle up can survive and sometimes walk away. Without belts they could have been badly hurt or killed.

After more than 25 years of safety belts in vehicles, the facts are clear. In most crashes buckling up does matter . . . a lot!



# Seats and Restraint Systems



## ■ *Why Safety Belts Work*

When you ride in or on anything, you go as fast as it goes.

For example, if the bike is going 10 mph (16 km/h), so is the child.

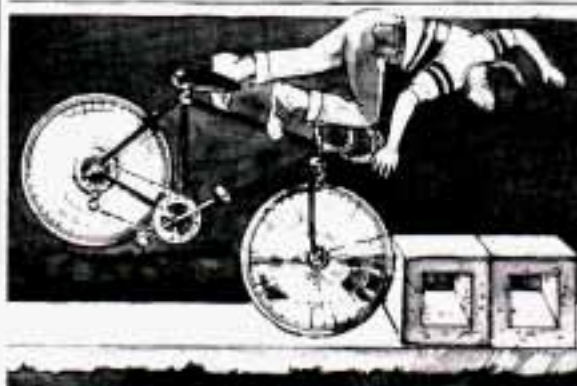

When the bike hits the block, it stops. But the child keeps going!

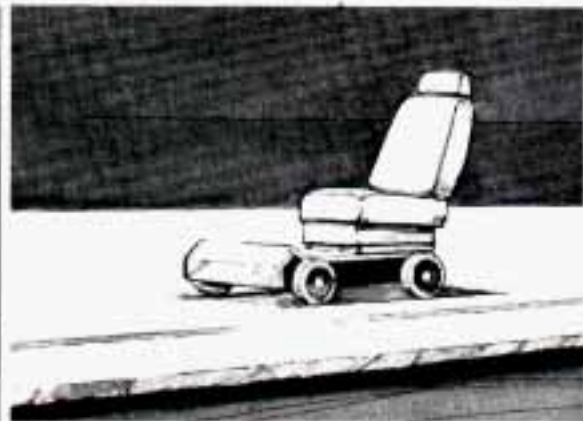

Take the simplest vehicle. Suppose it's just a seat on wheels.



Put someone on it.

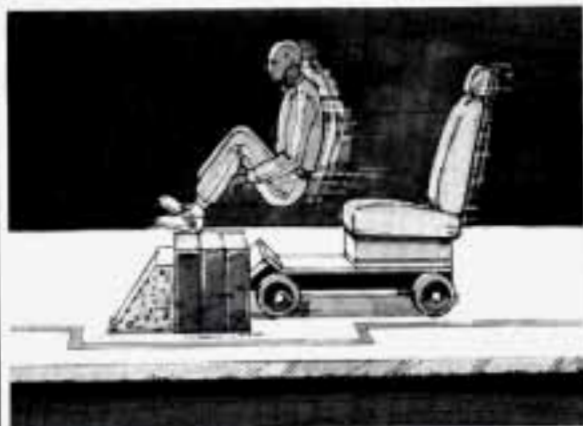

Get it up to speed. Then stop the vehicle.  
The rider doesn't stop.



The person keeps going until stopped by  
something.

In a real vehicle, it could be the  
windshield ...

# Seats and Restraint Systems



or the instrument panel ...



or the safety belts!

With safety belts, you slow down as the vehicle does. You get more time to stop. You stop over more distance, and your strongest bones take the forces. That's why safety belts make such good sense.

## ■ *Here Are Questions Many People Ask about Safety Belts – and the Answers*

**Q:** Won't I be trapped in the vehicle after an accident if I'm wearing a safety belt?

**A:** You could be – whether you're wearing a safety belt or not. But you can easily unbuckle a safety belt, even if you're upside down. And your chance of being conscious during and after an accident, so you can unbuckle and get out, is much greater if you are belted.

**Q:** Why don't they just put in air bags so people won't have to wear safety belts?

**A:** Air bags are in some vehicles today and will be in more of them in the future. But they are supplemental systems only – so they work with safety belts, not instead of them. Every air bag system ever offered for sale has required the use of safety belts. Even if you're in a vehicle that

has air bags, you still have to buckle up to get the most protection. That's true not only in frontal collisions, but especially in side and other collisions.

**Q:** If I'm a good driver, and I never drive far from home, why should I wear safety belts?

**A:** You may be an excellent driver, but if you're in an accident – even one that isn't your fault – you and your passengers can be hurt. Being a good driver doesn't protect you from things beyond your control, such as bad drivers.

Most accidents occur within 25 miles (40 km) of home. And the greatest number of serious injuries and deaths occur at speeds of less than 40 mph (65 km/h).

Safety belts are for everyone.



### ■ *Safety Belt Reminder Light*

When the key is turned to "ON" or "START," a light will come on for about eight seconds to remind people to fasten their safety belts. Unless the driver's safety belt is already buckled, a chime will also sound.

## ■ *How to Wear Safety Belts Properly*

### **Adults**

This section is only for people of adult size.

Be aware that there are special things to know about safety belts and children. And there are different rules for smaller children and babies. If a child will be riding in your Geo, see the section after this one, called "Children." Follow those rules for everyone's protection.

# Seats and Restraint Systems

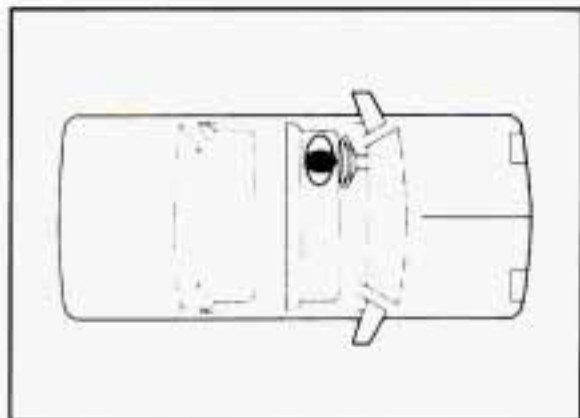

First, you'll want to know which restraint systems your vehicle has.

We'll start with the driver position.

## ***Driver Position***

This section describes the driver's restraint system.



## **Lap-Shoulder Belt**

The driver has a lap-shoulder belt. Here's how to wear it properly.

1. Close and lock the door.
2. Adjust the seat (to see how, see "Seats" in the Index) so you can sit up straight.



3. Pick up the latch plate and pull the belt across you. Don't let it get twisted.
4. Push the latch plate into the buckle until it clicks.

Pull up on the latch plate to make sure it is secure. If the belt isn't long enough, see "Safety Belt Extender" at the end of this section.

Make sure the release button on the buckle is positioned so you would be able to unbuckle the safety belt quickly if you ever had to.



5. To make the lap part tight, pull down on the buckle end of the belt as you pull up on the shoulder belt.

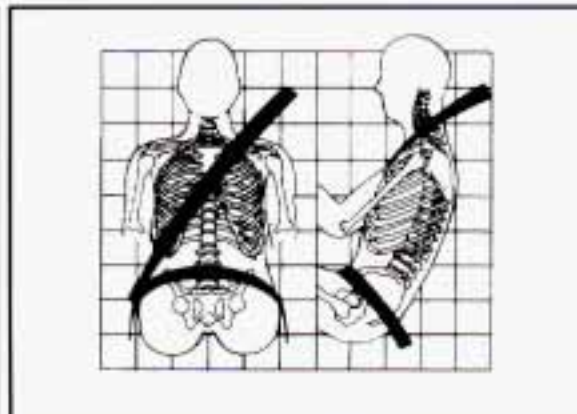

The lap part of the belt should be worn low and snug on the hips, just touching the thighs. In a crash, this applies force to the strong pelvic bones. And you'd be less likely to slide under the lap belt. If you slid under it, the belt would apply force at your abdomen. This could cause serious or even fatal injuries. The shoulder belt should go over the shoulder and across the chest. These parts of the body are best able to take belt restraining forces.

The safety belt locks if there's a sudden stop or crash, or if you pull the belt very quickly out of the retractor.

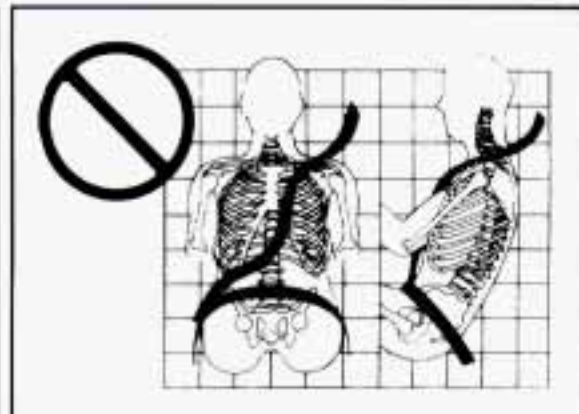

**Q:** What's wrong with this?

**A:** The shoulder belt is too loose. It won't give nearly as much protection this way.



### **CAUTION:**

You can be seriously hurt if your shoulder belt is too loose. In a crash you would move forward too much, which could increase injury. The shoulder belt should fit against your body.

# Seats and Restraint Systems

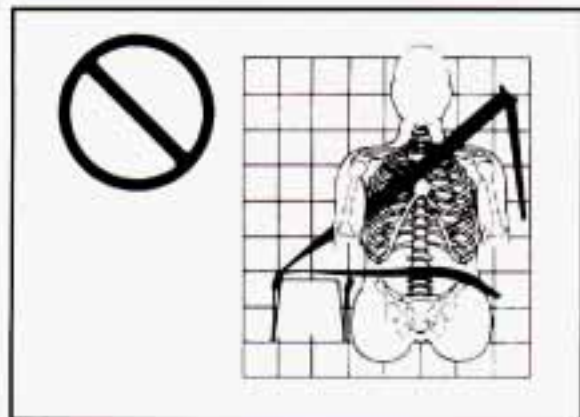

**Q:** What's wrong with this?

**A:** The belt is buckled in the wrong place.

## CAUTION:

You can be seriously injured if your belt is buckled in the wrong place like this. In a crash, the belt would go up over your abdomen. The belt forces would be there, not at the pelvic bones. This could cause serious internal injuries. Always buckle your belt into the buckle nearest you.

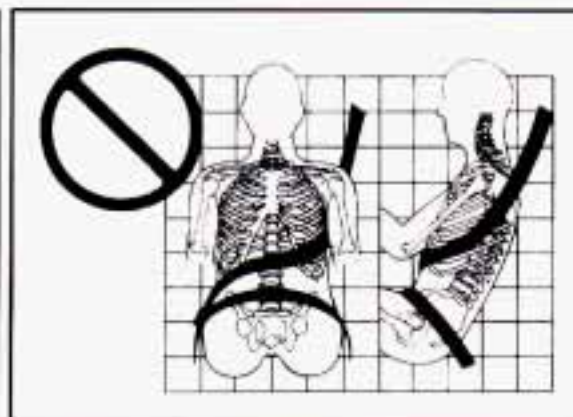

**Q:** What's wrong with this?

**A:** The shoulder belt is worn under the arm. It should be worn over the shoulder at all times.

## CAUTION:

You can be seriously injured if you wear the shoulder belt under your arm. In a crash, your body would move too far forward, which would increase the chance of head and neck injury. Also, the belt would apply too much force to the ribs, which aren't as strong as shoulder bones. You could also severely injure internal organs like your liver or spleen.

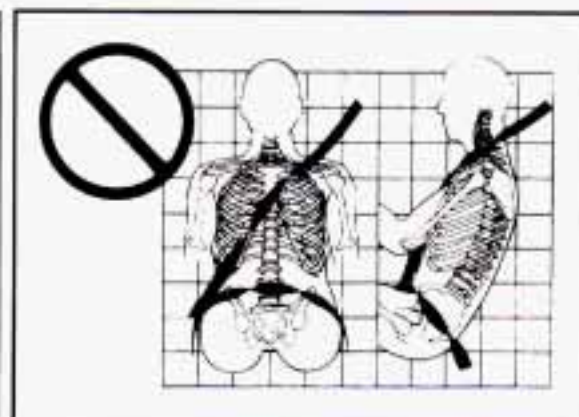

**Q:** What's wrong with this?

**A:** The belt is twisted across the body.

## CAUTION:

You can be seriously injured by a twisted belt. In a crash, you wouldn't have the full width of the belt to spread impact forces. If a belt is twisted, make it straight so it can work properly, or ask your dealer to fix it.



To unlatch the belt, just push the button on the buckle. The belt should go back out of the way.

Before you close the door, be sure the belt is out of the way. If you slam the door on it, you can damage both the belt and your vehicle.



### ***Safety Belt Use during Pregnancy***

Safety belts work for everyone, including pregnant women. Like all occupants, they are more likely to be seriously injured if they don't wear safety belts.

A pregnant woman should wear a lap-shoulder belt, and the lap portion should be worn as low as possible throughout the pregnancy.

The best way to protect the fetus is to protect the mother. When a safety belt is worn properly, it's more likely that the fetus won't be hurt in a crash. For pregnant women, as for anyone, the key to making safety belts effective is wearing them properly.

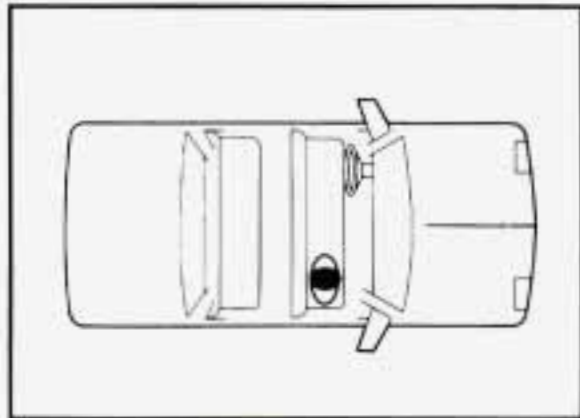

### ***Passenger Positions***

#### **Right Front Passenger Position**

The right front passenger's safety belt works the same way as the driver's safety belt. See "Driver Position," earlier in this part.

When the shoulder belt is pulled out all the way, it will lock. If it does, let it go back all the way and start again.



# Seats and Restraint Systems

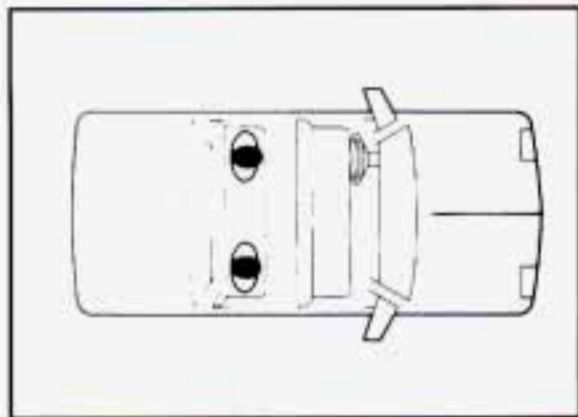

## Rear Seat Passengers

It's very important for rear seat passengers to buckle up! Accident statistics show that unbelted people in the rear seat are hurt more often in crashes than those who are wearing safety belts.

Rear passengers who aren't safety belted can be thrown out of the vehicle in a crash. And they can strike others in the vehicle who are wearing safety belts.

## Lap-Shoulder Belt

The rear seats have lap-shoulder belts. Here's how to wear one properly.



1. Pick up the latch plate and pull the belt across you. Don't let it get twisted.
2. Push the latch plate into the buckle until it clicks.

Pull up on the latch plate to make sure it is secure.

When the shoulder belt is pulled out all the way, it will lock. If it does, let it go back all the way and start again.

If the belt is not long enough, see "Safety Belt Extender" at the end of this section.

Make sure the release button on the buckle is positioned so you would be able to unbuckle the safety belt quickly if you ever had to.



3. To make the lap part tight, pull down on the buckle end of the belt as you pull up on the shoulder part.

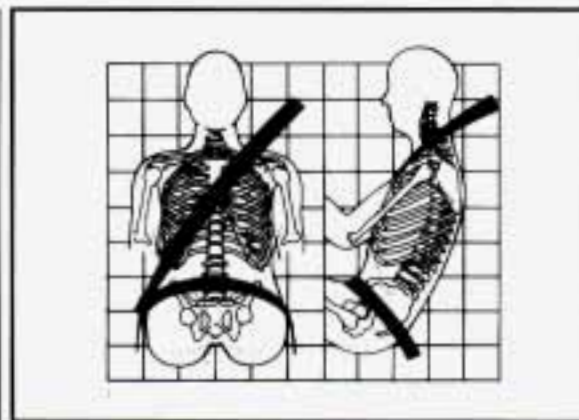

The lap part of the belt should be worn low and snug on the hips, just touching the thighs. In a crash, this applies force to the strong pelvic bones. And you'd be less likely to slide under the lap belt. If you slid under it, the belt would apply force at your abdomen. This could cause serious or even fatal injuries. The shoulder belt should go over the shoulder and across the chest. These parts of the body are best able to take belt restraining forces.

The safety belt locks if there's a sudden stop or a crash, or if you pull the belt very quickly out of the retractor.



## CAUTION:

You can be seriously hurt if your shoulder belt is too loose. In a crash you would move forward too much, which could increase injury. The shoulder belt should fit against your body.

# Seats and Restraint Systems



- To unlatch the belt, just push the button on the buckle.



## ■ *Children*

Everyone in a vehicle needs protection! That includes infants and all children smaller than adult size. In fact, the law in every state in the United States and in every Canadian province says children up to some age must be restrained while in a vehicle.

## Smaller Children and Babies

### CAUTION:

Smaller children and babies should always be restrained in a child or infant restraint. The instructions for the restraint will say whether it is the right type and size for your child. A very young child's hip bones are so small that a regular belt might not stay low on the hips, as it should. Instead, the belt will likely be over the child's abdomen. In a crash the belt would apply force right on the child's abdomen, which could cause serious or fatal injuries. So, be sure that any child small enough for one is always properly restrained in a child or infant restraint.

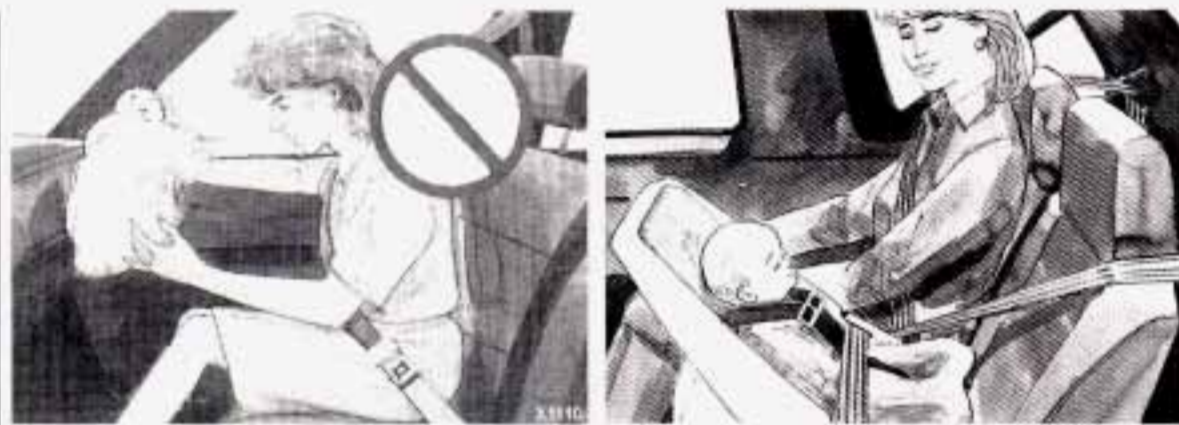

**⚠ CAUTION:**

Never hold a baby in your arms while riding in a vehicle. A baby doesn't weigh much – until a crash. During a crash a baby will become so heavy you can't hold it. For example, in a crash at only 25 mph (40 km/h), a 12-pound (5.5 kg) baby will suddenly become a 240-pound (110 kg) force on your arms. The baby would be almost impossible to hold.

Secure the baby in an infant restraint.

## ■ *Child Restraints*

Be sure to follow the instructions for the restraint. You may find these instructions on the restraint itself or in a booklet, or both. These restraints use the belt system in your vehicle, but the child also has to be secured within the restraint to help reduce the chance of personal injury. The instructions that come with the infant or child restraint will show you how to do that.

### **Where to Put the Restraint**

Accident statistics show that children are safer if they are restrained in the rear rather than the front seat. We at General Motors therefore recommend that you put your child restraint in the rear seat unless the child is an infant and you're the only adult in the vehicle. In that case, you might want to secure the restraint in the front seat where you can keep an eye on the baby.

Wherever you install it, be sure to secure the child restraint properly.

Keep in mind that an unsecured child restraint can move around in a collision or sudden stop and injure people in the vehicle. Be sure to properly secure any child restraint in your vehicle – even when no child is in it.

# Seats and Restraint Systems



## Top Strap

If your child restraint has a top strap, it should be anchored.

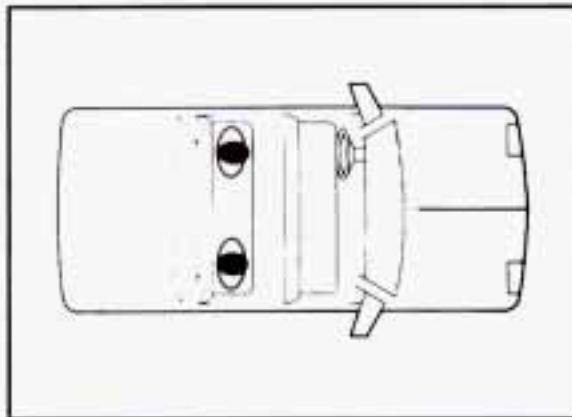

## Securing a Child Restraint in the Rear Seat

You'll be using the lap-shoulder belt. See the earlier section about the top strap if the child restraint has one.

1. Put the restraint on the seat. Follow the instructions for the child restraint.
2. Secure the child in the child restraint as the instructions say.
3. Pick up the latch plate, and run the lap and shoulder portions of the vehicle's safety belt through or around the restraint. The child restraint instructions will show you how.

If the shoulder belt goes in front of the child's face or neck, put it behind the child restraint.



4. Buckle the belt. Make sure the release button is positioned so you would be able to unbuckle the safety belt quickly if you ever had to.



- 5.** Pull the rest of the shoulder belt all the way out of the retractor to set the lock.

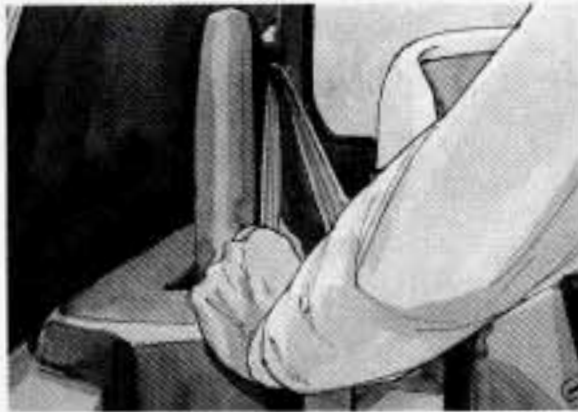

- 6.** To tighten the belt, feed the shoulder belt into the retractor while you push down on the child restraint.



- 7.** Push and pull the child restraint in different directions to be sure it is secure.

To remove the child restraint, just unbuckle the vehicle's safety belt and let it go back all the way. The safety belt will move freely again and be ready to work for an adult or larger child passenger.

# Seats and Restraint Systems

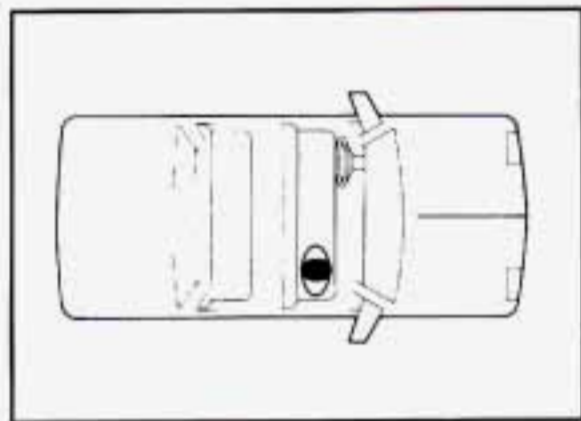

## Securing a Child Restraint in the Right Front Seat

You'll be using the lap-shoulder belt. See the earlier section about the top strap if the child restraint has one.

1. This is the only place in your vehicle where you can use a child restraint with a top strap.
2. Put the restraint on the seat. Follow the instructions for the child restraint.
3. Secure the child in the child restraint as the instructions say.
4. Pick up the latch plate, and run the lap and shoulder portions of the vehicle's safety belt through or around the restraint.

The child restraint instructions will show you how.

If the shoulder belt goes in front of the child's face or neck, put it behind the child restraint.



## 5. Buckle the belt.

Make sure the release button is positioned so you would be able to unbuckle the safety belt quickly if you ever had to.

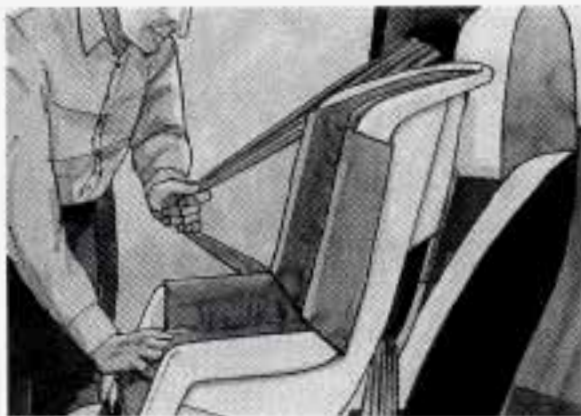

- 6.** Pull the rest of the shoulder belt all the way out of the retractor to set the lock.



- 7.** To tighten the belt, feed the shoulder belt back into the retractor while you push down on the child restraint.



- 8.** Push and pull the child restraint in different directions to be sure it is secure.

To remove the child restraint, just unbuckle the vehicle's safety belt and let it go back all the way.

The safety belt will move freely again and be ready to work for an adult or larger child passenger.



# Seats and Restraint Systems



## ■ *Larger Children*

Children who have outgrown child restraints should wear the vehicle's safety belts.

Accident statistics show that children are safer if they are restrained in the rear seat. But they need to use the safety belts properly.

- Children who aren't buckled up can be thrown out in a crash.



- Children who aren't buckled up can strike other people who are.



## **CAUTION:**

Never do this.

Here two children are wearing the same belt. The belt can't properly spread the impact forces. In a crash, the two children can be crushed together and seriously injured. A belt must be used by only one person at a time.

**Q.** What if a child is wearing a lap-shoulder belt, but the child is so small that the shoulder belt is very close to the child's face or neck?

**A:** Move the child toward the center of the vehicle, but be sure that the shoulder belt still is on the child's shoulder, so that in a crash the child's upper body would have the restraint that belts provide.



### **CAUTION:**

Never do this.

Here a child is sitting in a seat that has a lap-shoulder belt, but the shoulder part is behind the child. If the child wears the belt in this way, in a crash the child might slide under the belt. The belt's force would then be applied right on the child's abdomen. That could cause serious or fatal injuries.

Wherever the child sits, the lap portion of the belt should be worn low and snug on the hips, just touching the child's thighs.

This applies belt force to the child's pelvic bones in a crash.

### ■ *Safety Belt Extender*

If the vehicle's safety belt will fasten around you, you should use it.

But if a safety belt isn't long enough to fasten, your dealer will order you an extender. It's free. When you go in to order it, take the heaviest coat you will wear, so the extender will be long enough for you. The extender will be just for you, and just for the seat in your vehicle that you choose. Don't let someone else use it, and use it only for the seat it is made to fit. To wear it, just attach it to the regular safety belt.

### ■ *Checking Your Restraint Systems*

Now and then, make sure all your belts, buckles, latch plates, retractors, anchorages and reminder systems are working properly. Look for any loose parts or damage. If you see anything that might keep a restraint system from doing its job, have it repaired.

# Seats and Restraint Systems

## ■ *Replacing Safety Belts after a Crash*

If you've had a crash, do you need new belts?

After a very minor collision, nothing may be necessary. But if the belts were stretched, as they would be if worn during a more severe crash, then you need new belts.

If belts are cut or damaged, replace them. Collision damage also may mean you will need to have safety belt or seat parts repaired or replaced. New parts and repairs may be necessary even if the belt wasn't being used at the time of the collision.

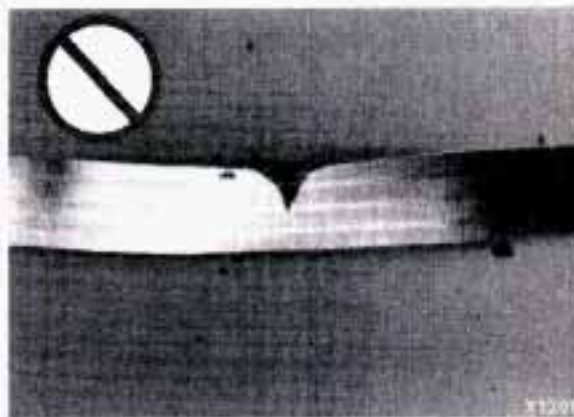

**Q: What's wrong with this?**

**A:** The belt is torn.

Torn or frayed belts may not protect you in a crash. They can rip apart under impact forces. If a belt is torn or frayed, get a new one right away.

Before replacing any safety belt, see your dealer for the correct part number. You'll need the model year and model number for your vehicle. The model year is on your title and registration. And you can find the model number on the Certification/Tire label of your vehicle. See "Certification/Tire Label" in the Index.

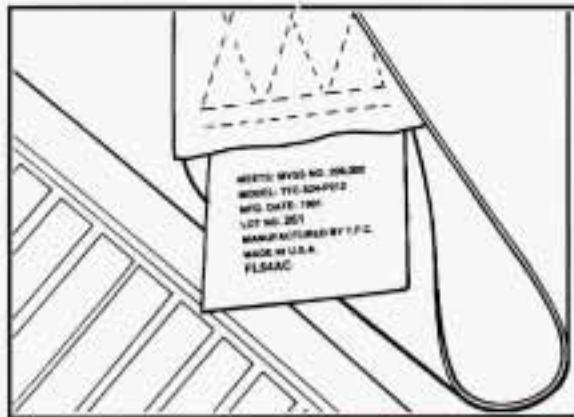

The model number on the replacement belt must be listed on the safety belt you want to replace. Pull the shoulder belt all the way out to see this label.

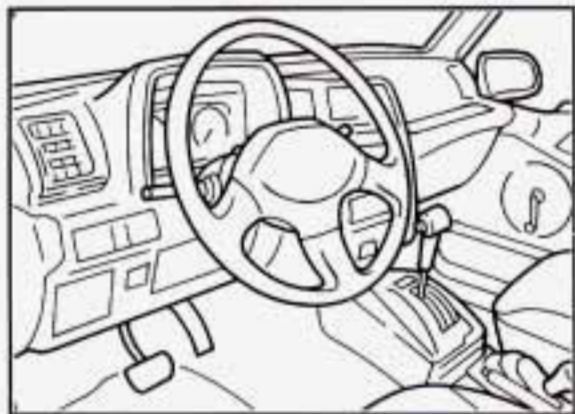

**H**ere you can learn about the many standard and optional features on your Geo, and information on starting, shifting and braking. Also explained are the instrument panel and the warning systems that tell you if everything is working properly — and what to do if you have a problem.

## Part 2 Features & Controls

Keys .....	36
Door Locks .....	37
Theft .....	39
New Vehicle "Break-In" .....	39
Ignition Switch .....	39
Starting Your Engine .....	40
Automatic Transmission .....	42
Manual Transmission .....	44
Four-Wheel Drive .....	46
Parking .....	48
Engine Exhaust .....	51
Windows .....	52
Horn .....	53
Adjustable Steering Column .....	53
The Turn Signal/Lights Control/Headlight Beam Lever .....	54
Interior Lights .....	57
Windshield Wiper/Washer Lever .....	57
Rear Window Wiper/Washer .....	59
Mirrors .....	59
Storage and Compartments .....	60
Sun Visors .....	61
Passenger Assist Grips .....	62
Ashtray and Lighter .....	62
Instrument Panel and Cluster .....	66
Convertible Top .....	72

# Features and Controls

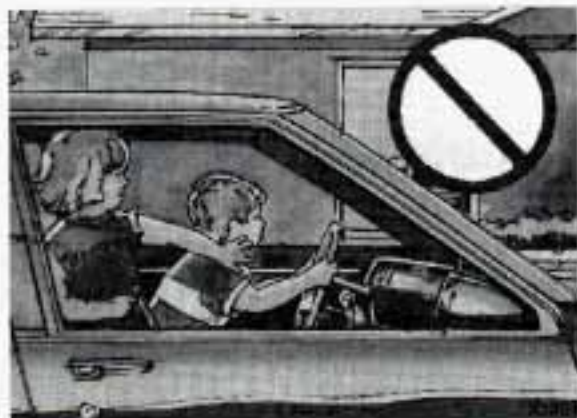

## ■ Keys



### **CAUTION:**

Leaving young children in a vehicle with the ignition key is dangerous for many reasons. A child or others could be badly injured or even killed.

They could operate controls or even make the vehicle move. Don't leave the keys in a vehicle with young children.

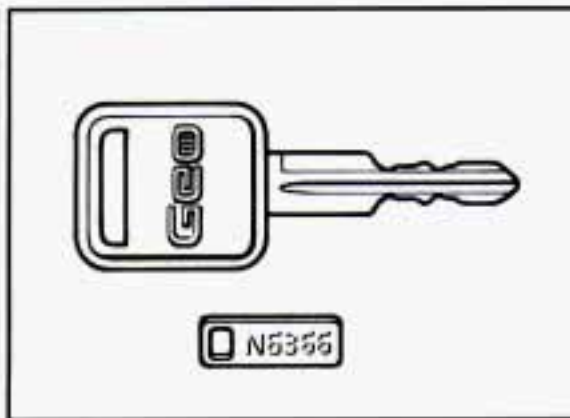

One key is used for the ignition, the doors, and all other locks.

When a new Tracker is delivered, the dealer removes the metal plate from the key ring and gives it to the first owner.

The metal plate has a code on it that tells your dealer or a qualified locksmith how to make extra keys. Keep the code in a safe place. If you lose your keys, you'll be able to have new ones made easily using this code.

## **NOTICE:**

Your Geo has a number of features that can help prevent theft. But you can have a lot of trouble getting into your vehicle if you ever lock your keys inside. You may even have to damage your vehicle to get in. So be sure you have an extra key.

## ■ *Door Locks*

### **CAUTION:**

Unlocked doors can be dangerous. Passengers — especially children — can easily open the doors and fall out. When a door is locked, the inside handle won't open it.

Outsiders can easily enter through an unlocked door when you slow down or stop your vehicle.

This may not be so obvious: You increase the chance of being thrown out of the vehicle in a crash if the doors aren't locked. Wear safety belts properly, lock your doors, and you will be far better off whenever you drive your vehicle.

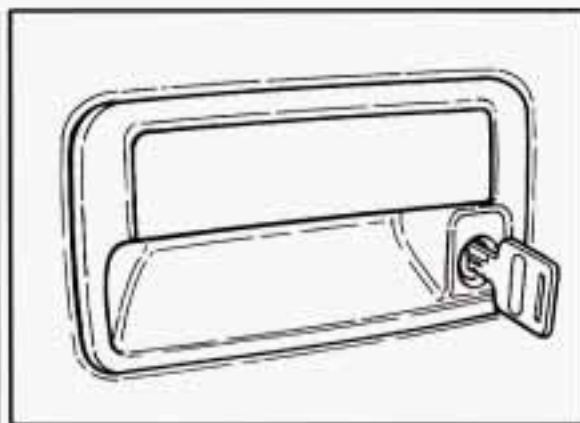

There are several ways to lock and unlock your vehicle:

From the outside, use your key. To lock the door, turn the key toward the front of the vehicle. To unlock the door, turn the key toward the rear.

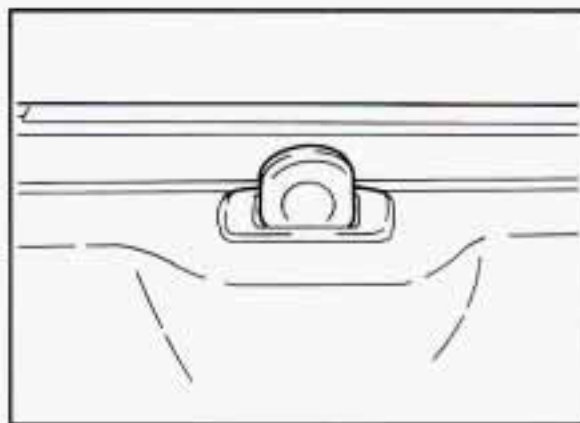

To lock the door from the inside, push down the button on the door. To unlock it, pull up on the button.

### **Leaving Your Vehicle**

If you are leaving the vehicle, take your key, open your door and set the locks from inside. Then get out and close the door.

## Features and Controls

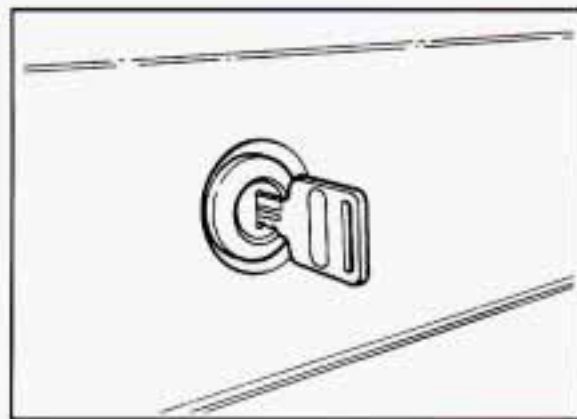

### Tailgate

Use your key to lock or unlock your tailgate.

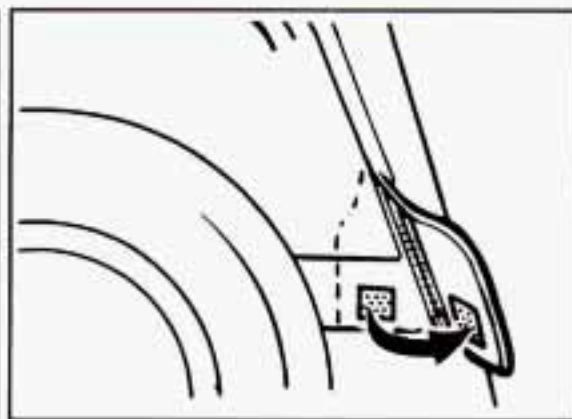

If you have a convertible, be sure to unzip the rear plastic window completely before opening the tailgate. See "Opening and Closing Your Rear Window" in the Index. Open the tailgate with the bottom of the window still attached to the tailgate.

When closing the tailgate be sure:

- Both lower canvas top flaps are facing outward so they do not get caught in the tailgate.
- The zipper connector is engaged correctly or you could damage your zipper.

### CAUTION:

It can be dangerous to drive with the tailgate window open because carbon monoxide (CO) gas can come into your vehicle. You can't see or smell CO. It can cause unconsciousness and even death.

If you must drive with the tailgate window open or if electrical wiring or other cable connections must pass through the seal between the body and the tailgate window:

- Make sure all windows are shut.
- Turn the fan on your heating or cooling system to its highest speed with the setting on . That will force outside air into your vehicle. See "Comfort Controls" in the Index.
- If you have air vents on or under the instrument panel, open them all the way.

See "Engine Exhaust" in the Index.

## ■ *Theft*

Vehicle theft is big business, especially in some cities. Although your Geo has a number of theft deterrent features, we know that nothing we put on it can make it impossible to steal. However, there are ways you can help.

### **Key in the Ignition**

If you walk away from your vehicle with the keys inside, it's an easy target for joy riders or professional thieves — so don't do it.

When you park your Geo and open the driver's door, you'll hear a chime reminding you to remove your key from the ignition and take it with you. Always do this. Your steering wheel will be locked, and so will your ignition. If you have an automatic transmission, taking your key out also locks your transmission. And remember to lock the doors.

### **Parking at Night**

Park in a lighted spot, close all windows and lock your vehicle. Remember to keep your valuables out of sight. Put them in a storage area, or take them with you.

## ■ *New Vehicle "Break-In"*

### **NOTICE:**

Your modern Geo doesn't need an elaborate "break-in." But it will perform better in the long run if you follow these guidelines:

- Keep your speed at 55 mph (88 km/h) or less for the first 500 miles (804 km).
- Don't drive at any one speed — fast or slow — for the first 500 miles (804 km). Don't make full-throttle starts.
- Avoid making hard stops for the first 200 miles (322 km) or so. During this time your new brake linings aren't yet broken in. Hard stops with new linings can mean premature wear and earlier replacement. Follow this "breaking-in" guideline every time you get new brake linings.

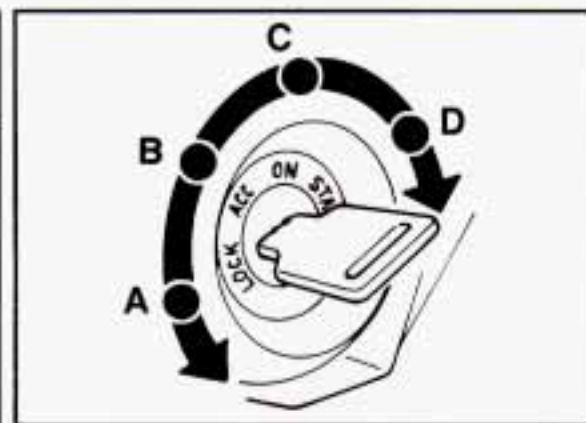

### ■ *Ignition Switch*

With the key in the ignition switch, you can turn the switch to four positions:

**LOCK (A):** The only position in which you can remove the key. This locks your steering wheel, ignition and automatic transmission. Press in the ignition switch as you turn the top of it toward you.

If you have an automatic transmission, the ignition switch can't be turned to "LOCK" unless the shift lever is in the "P" (Park) position.

**ACC (B):** Position in which you can operate your electrical power accessories. It unlocks the steering wheel and ignition. Use this position if your vehicle must be pushed or towed.



# Features and Controls

**ON (C):** Position to which the switch returns after you start your engine and release the switch. The switch stays in the "ON" position when the engine is running. But even when the engine is not running, you can use "ON" to operate your electrical power accessories and to display some instrument panel warning and indicator lights.

**START (D):** Starts the engine. When the engine starts, release the key. The ignition switch will return to "ON" for normal driving.

When the engine is not running, "ACC" and "ON" allow you to operate your electrical accessories, such as the radio and ventilation fan.

A warning chime will sound if you open the driver's door when the ignition is in "ACC" or "LOCK" and the key is in the ignition.



## CAUTION:

On manual transmission vehicles, turning the key to "LOCK" will lock the steering column and result in a loss of ability to steer the vehicle. This could cause a collision. If you need to turn the engine off while the vehicle is moving, turn the key only to "ACC." Don't push the key in while the vehicle is moving.

## NOTICE:

If your key seems stuck in "LOCK" and you can't turn it, be sure it is all the way in. If it is, then turn the steering wheel left and right while you turn the key hard. But turn the key only with your hand. Using a tool to force it could break the key or the ignition switch. If none of this works, then your vehicle needs service.

## ■ Starting Your Engine

**Automatic transmission:** Move your shift lever to "P" (Park) or "N" (Neutral). Your engine won't start in any other position — that's a safety feature. To restart when you're already moving, use "N" (Neutral) only.

## NOTICE:

Don't try to shift to "P" (Park) if your Geo is moving. If you do, you could damage the transmission. Shift to "P" (Park) only when your vehicle is stopped.

**Manual transmission:** The gear selector should be in neutral. Hold the clutch pedal to the floor and start the engine. Your vehicle won't start if the clutch pedal is not all the way down — that's a safety feature.

### To start your engine:

1. Without pushing the accelerator pedal, turn your ignition key to "START." When the engine starts, let go of the key.

## NOTICE:

Holding your key in "START" for longer than 15 seconds at a time will cause your battery to be drained much sooner. And the excessive heat can damage your starter motor.

2. If it doesn't start right away, hold your key in "START" for about three seconds at a time until your engine starts. Wait about 15 seconds between each try to help avoid draining your battery.

If your engine still won't start, call your dealer for help.

## NOTICE:

Your engine is designed to work with the electronics in your vehicle. If you add electrical parts or accessories, you could change the way the fuel injection system operates. Before adding electrical equipment, check with your dealer. If you don't, your engine might not perform properly.

If you ever have to have your vehicle towed, see the part of this manual that tells how to do it without damaging your vehicle. See "Towing Your Vehicle" in the Index.

### *Driving through Deep Standing Water*

## NOTICE:

If you drive too quickly through deep puddles or standing water, water can come in through your engine's air intake and badly damage your engine. If you can't avoid deep puddles or standing water, drive through them very slowly.

### *Engine Coolant Heater (Engine Block Heater) (CANADA)*

In very cold weather, 0°F (-18°C) or colder, the engine coolant heater can help. You'll get easier starting and better fuel economy during engine warm-up. Usually, the coolant heater should be plugged in a minimum of four hours prior to starting your vehicle.

#### **To use the coolant heater:**

1. Turn off the engine.
2. Open the hood and unwrap the electrical cord.
3. Plug it into a normal, grounded 110-volt outlet.



## CAUTION:

Plugging the cord into an ungrounded outlet could cause an electrical shock. Also, the wrong kind of extension cord could overheat and cause a fire. You could be seriously injured. Plug the cord into a properly grounded three-prong 110-volt outlet. If the cord won't reach, use a heavy-duty three-prong extension cord rated for at least 15 amps.

# Features and Controls

## NOTICE:

After you've used the coolant heater, be sure to store the cord as it was before to keep it away from moving engine parts. If you don't, it could be damaged.

How long should you keep the coolant heater plugged in? The answer depends on the weather, the kind of oil you have, and some other things. Instead of trying to list everything here, we ask that you contact a Geo dealer in the area where you'll be parking your vehicle. The dealer can give you the best advice for that particular area.

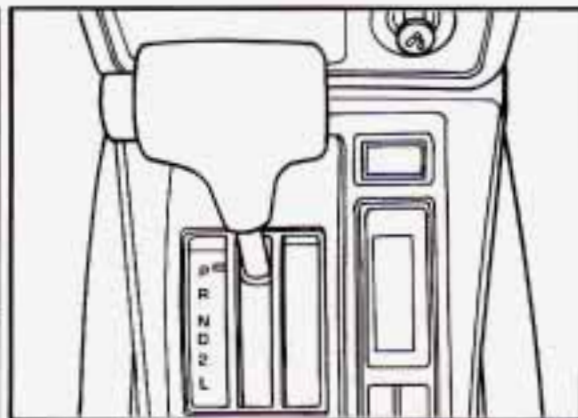

## ■ Automatic Transmission

There are several different positions for your shift lever.

### ● P (Park)

This locks your rear wheels. It's the best position to use when you start your engine because your vehicle can't move easily.

## ⚠ CAUTION:

It is dangerous to get out of your vehicle if the shift lever is not fully in "P" (Park) with the parking brake firmly set. Your vehicle can roll.

Don't leave your vehicle when the engine is running unless you have to. If you have left the engine running, the vehicle can move suddenly. You or others could be injured. To be sure your vehicle won't move, even when you're on fairly level ground, always set your parking brake and move the shift lever to "P" (Park).

If you have four-wheel drive, your vehicle will be free to roll – even if your shift lever is in "P" (Park) – if your transfer case is in "N" (Neutral). So, be sure the transfer case is in a drive gear, two-wheel high (2H) or four-wheel high (4H) or four-wheel low (4L) – not in "N" (Neutral).

See "Shifting into 'P' (Park)" in the Index. If you're pulling a trailer, see "Towing a Trailer" in the Index.

Ensure the shift lever is fully in "P" (Park) range before starting the engine. Your Geo has a brake-transmission shift interlock. You have to fully apply your regular brakes before you can shift from "P" (Park) when the ignition key is in the "ON" position. If you cannot shift out of "P" (Park), ease pressure on the shift lever — push the shift lever all the way into "P" (Park) and release the shift lever button as you maintain brake application. Then press the shift lever button and move the shift lever into the gear you wish. See "Shifting out of 'P' (Park)" in the Index.

- **R (Reverse)**

Use this gear to back up.

**NOTICE:**

Shifting to "R" (Reverse) while your vehicle is moving forward could damage your transmission. Shift to "R" only after your vehicle is stopped.

To rock your vehicle back and forth to get out of snow, ice or sand without damaging your transmission, see "Stuck: In Sand, Mud, Ice or Snow" in the Index.

- **N (Neutral)**

In this position, your engine doesn't connect with the wheels. To restart when you're already moving, use "N" (Neutral) only. Also, use "N" when your vehicle is being towed.



**CAUTION:**

Shifting out of "P" (Park) or "N" (Neutral) while your engine is "racing" (running at high speed) is dangerous. Unless your foot is firmly on the brake pedal, your vehicle could move very rapidly. You could lose control and hit people or objects. Don't shift out of "P" (Park) or "N" (Neutral) while your engine is racing.

**NOTICE:**

Damage to your transmission caused by shifting out of "P" (Park) or "N" (Neutral) with the engine racing isn't covered by your warranty.

- **D (Drive)**

This position is for normal driving. If you need more power for passing, and you're:

- Going less than about 15 mph (25 km/h), push your accelerator pedal about halfway down.
- Going about 15 mph (25 km/h) or more, push your accelerator pedal all the way down.

You'll shift down to the next gear and have more power.

- **2 (Second Gear)**

This position gives you more power but lower fuel economy. You can use "2" on hills. It can help control your speed as you go down steep mountain roads, but then you would also want to use your brakes off and on.

**NOTICE:**

Don't shift into "2" unless you are going slower than 65 mph (105 km/h) with the transfer case in "4H" or 35 mph (55 km/h) with the transfer case in "4L," or you can damage your transmission.

# Features and Controls

- **L (Low Gear)**

This position gives you even more power (but lower fuel economy) than “2.” You can use it on very steep hills, or in deep snow or mud. If the selector lever is put in “L,” the transmission won’t shift into low gear until the vehicle is going slowly enough.

## NOTICE:

Don’t shift into “L” (Low) at speeds above 40 mph (65 km/h) with the transfer case in “4L,” or you can damage your transmission.

## NOTICE:

If your rear wheels can’t rotate, don’t try to drive. This might happen if you were stuck in very deep sand or mud or were up against a solid object. You could damage your transmission.

Also, if you stop when going uphill, don’t hold your vehicle there with only the accelerator pedal. This could overheat and damage the transmission. Use your brakes to hold your vehicle in position on a hill.

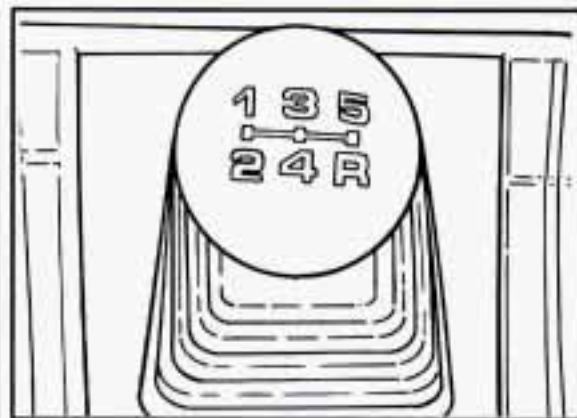

## ■ Manual Transmission Five-Speed

This is your shift pattern. Here’s how to operate your transmission:

- **1 (First Gear)** — Press the clutch pedal and shift into “1.” Then, slowly let up on the clutch pedal as you press the accelerator pedal.

You can shift into “1” when you’re going less than 20 mph (32 km/h). If you’ve come to a complete stop and it’s hard to shift into “1,” put the shift lever in “Neutral” and let up on the clutch. Press the clutch pedal back down. Then shift into “1.”

- **2 (Second Gear)** — Press the clutch pedal as you let up on the accelerator pedal and shift into “2.” Then, slowly let up on the clutch pedal as you press the accelerator pedal.
- **3, 4 and 5 (Third, Fourth and Fifth Gears)** — Shift into “3,” “4” and “5” the same way you do for “2.” Slowly let up on the clutch pedal as you press the accelerator pedal.
- **To Stop** — Let up on the accelerator pedal and press the brake pedal. Just before the vehicle stops, press the clutch pedal and the brake pedal, and shift to “Neutral.”
- **Neutral** — Use this position when you start or idle your engine.
- **R (Reverse)** — To back up, press down the clutch pedal and shift into “R.” Let up on the clutch pedal slowly while pressing the accelerator pedal.

You cannot go from “5” (Fifth Gear) into “R” (Reverse). If you try, you will be locked out. You must first shift into “Neutral,” move the lever to the left, back to the right, and then shift into “R” (Reverse). This is a safety feature.

## NOTICE:

Shift to "R" (Reverse) only after your vehicle is stopped. Shifting to "R" (Reverse) while your vehicle is moving could damage your transmission.

Also, use "R" (Reverse) along with the parking brake for parking your vehicle.

## Shift Speeds (MANUAL TRANSMISSION)

This chart shows when to shift to the next higher gear for best fuel economy.

MANUAL TRANSMISSION RECOMMENDED SHIFT SPEEDS, IN MPH (km/h)

Engine	Acceleration Shift Speed				Cruise Shift Speed		
	1 to 2	2 to 3	3 to 4	4 to 5	2 to 3	3 to 4	4 to 5
1.6L L4 8-valve	15 (24)	26 (42)	35 (56)	45 (72)	20 to 26	30 to 35	39 to 45
1.6L L4 16-valve	15 (24)	25 (40)	40 (64)	45 (72)	(32 to 42)	(48 to 56)	(63 to 72)

If your speed drops below 20 mph (30 km/h), or if the engine is not running smoothly, you should downshift to the next lower gear. You may have to downshift two or more gears to keep the engine running smoothly or for good performance.



## CAUTION:

If you skip more than one gear when you downshift, you could lose control of your vehicle. And you could injure yourself or others. Don't shift from "5" to "2" or "4" to "1."

## NOTICE:

If you skip more than one gear when you downshift, or if you race the engine when you downshift, you can damage the clutch or transmission.

# Features and Controls

## ■ *Four-Wheel Drive*

If your vehicle has four-wheel drive, you can send your engine's driving power to all four wheels for extra traction. To shift out of two-wheel drive and into four-wheel drive, lock the freewheeling hubs and move the transfer case shift lever to "4H" or "4L" (see the following). You should use "2H" for most normal driving.

Rear wheel anti-lock brakes do not work when you shift into four-wheel drive. Your regular brakes will still work. When you shift back into two-wheel drive, your rear wheel anti-lock brakes will take over again.

### **NOTICE:**

Driving in "4H" or "4L" positions for a long time on dry or wet pavement could shorten the life of your vehicle's drivetrain.

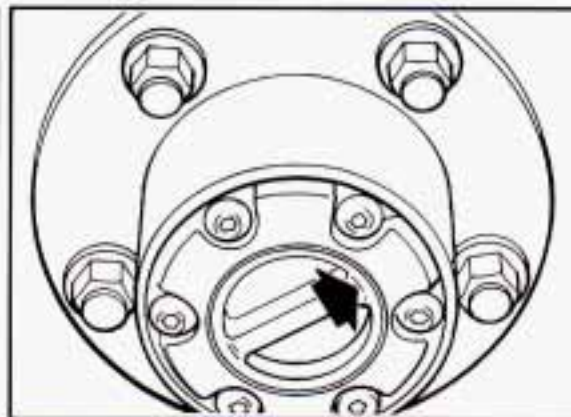

### **Freewheeling Hubs**

Your vehicle may have either manual or automatic freewheeling hubs. You must lock the hubs before you use "4H" or "4L."

#### **Manual**

To lock or unlock the hubs, you must park your vehicle (see "Shifting into 'P' (Park)" or "Parking Your Vehicle" in the Index) and get out. To lock the hubs, turn the hub dials to "LOCK."

### **NOTICE:**

Don't drive in "2H" with the manual locking hubs in "LOCK." If you do, you could damage your front drive-shaft parts.

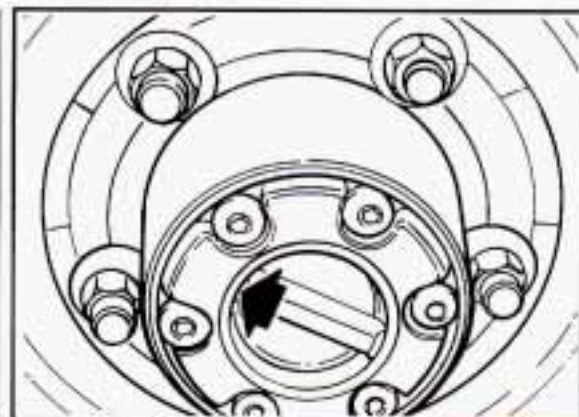

To unlock the hubs, turn the hub dials to "FREE."

## Automatic

With automatic freewheeling hubs, you don't have to get out of the vehicle to lock or unlock the hubs.

### To lock the hubs:

1. Stop your vehicle.
2. Shift the transfer case to "4H" or "4L."
3. Drive slowly forward and the hubs will lock.

### To unlock the hubs:

1. Stop your vehicle.
2. Drive seven feet (two meters) in the direction opposite to the direction you were driving before you stopped.
3. Then, press the clutch if you have a manual transmission, and shift the transfer case to "2H." The hubs will unlock.

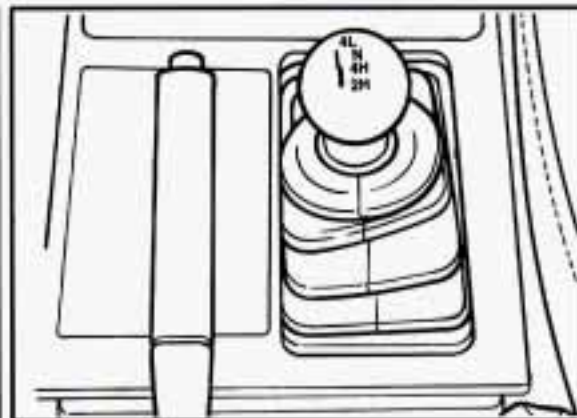

## Transfer Case

The transfer case shift lever is on the floor to the right of the driver. Use this lever to shift into and out of four-wheel drive. An indicator light comes on when the transfer case is in "4H" or "4L."

**2H:** This setting is for driving in most street and highway situations. Your front axle is not engaged in two-wheel drive.

**4H:** This setting engages your front axle to help drive your vehicle. Use "4H" when you need extra traction, such as on wet or icy roads, or in most off-road situations.

**N:** Shift to this setting only when your vehicle needs to be towed.

**4L:** This setting also engages your front axle to give you extra traction, but should be used only for driving downhill or on slippery surfaces when you're driving slower than 35 mph (55 km/h).

Remember that driving in "4H" or "4L" may reduce fuel economy. Also, driving in four-wheel drive on dry pavement could cause your tires to wear faster and make your transfer case harder to shift.

You can shift from "2H" to "4H" or from "4H" to "2H" at any speed if your hubs are locked and your wheels are straight ahead. Your front axle will engage faster if you take your foot off the accelerator pedal for a few seconds as you shift.

### To shift into or out of 4L:

1. Stop your vehicle and shift your transmission to "N" (Neutral).
2. Shift the transfer case in one continuous motion.

Don't pause in "N" as you shift into "4H," or your gears could clash.



## Features and Controls

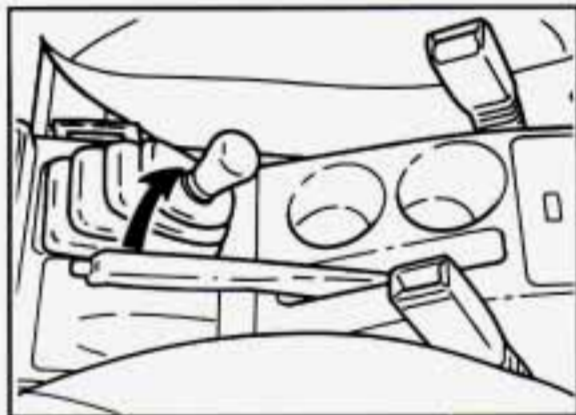

### ■ *Parking*

#### *Parking Brake*

**To set the parking brake:** Hold the brake pedal down and pull up on the parking brake lever. If the ignition is on, the brake system warning light will come on.

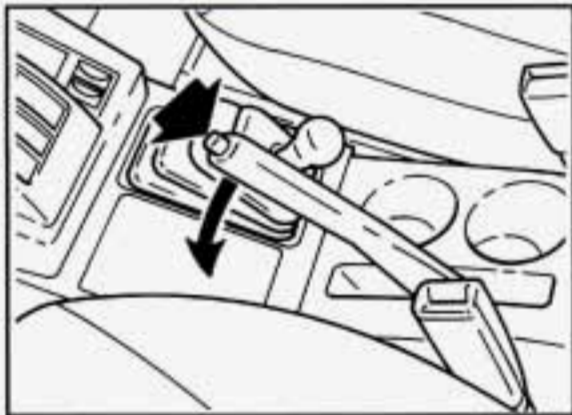

**To release the parking brake:** Hold the brake pedal down. Pull the parking brake lever up until you can push in the release button. Hold the release button in as you move the lever all the way down.

#### **NOTICE:**

Driving with the parking brake on can cause your rear brakes to overheat. You may have to replace them, and you could also damage other parts of your vehicle.

If you are towing a trailer, see "Towing a Trailer" in the Index.

#### *Shifting into "P" (Park)* *(AUTOMATIC TRANSMISSION)*

#### **CAUTION:**

It can be dangerous to get out of your vehicle if the shift lever is not fully in "P" (Park) with the parking brake firmly set. Your vehicle can roll.

If you have left the engine running, the vehicle can move suddenly. You or others could be injured. To be sure your vehicle won't move, even when you're on fairly level ground, use the steps that follow.

If you have four-wheel drive and your transfer case is in "N" (Neutral), your vehicle will be free to roll even if your shift lever is in "P" (Park). So, be sure the transfer case is in a drive gear – not in "N" (Neutral).

If you're pulling a trailer, see "Towing a Trailer" in the Index.

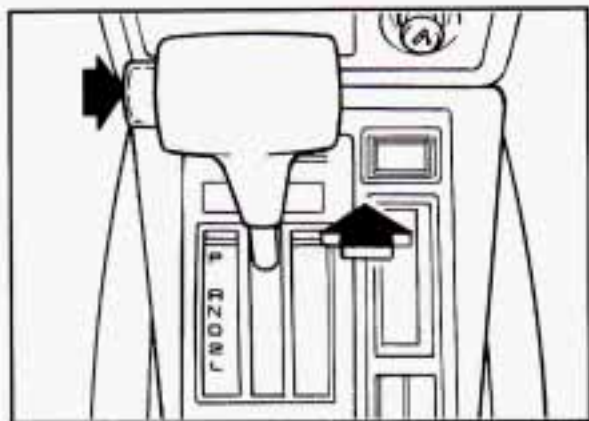

1. Hold the brake pedal down with your right foot and set the parking brake.
2. Move the shift lever into "P" (Park) position like this:
  - Hold in the button on the lever, and push the lever all the way toward the front of your vehicle.
3. If you have four-wheel drive, be sure the transfer case is in a drive gear – not in "N" (Neutral).
4. Move the key to "LOCK."
5. Remove the key and take it with you. If you can walk away from your vehicle with the key in your hand, your vehicle is in "P" (Park).

## ***Leaving Your Vehicle with the Engine Running*** ***(AUTOMATIC TRANSMISSION)***



### **CAUTION:**

It can be dangerous to leave your vehicle with the engine running. Your vehicle could move suddenly if the shift lever is not fully in "P" (Park) with the parking brake firmly set.

If you have four-wheel drive and your transfer case is in "N" (Neutral), your vehicle will be free to roll, even if your shift lever is in "P" (Park). So be sure the transfer case is in a drive gear – not in "N" (Neutral).

And, if you leave the vehicle with the engine running, it could overheat and even catch fire. You or others could be injured. Don't leave your vehicle with the engine running unless you have to.

## ***Torque Lock***

### ***(AUTOMATIC TRANSMISSION)***

If you are parking on a hill and you don't shift your transmission into "P" (Park) properly, the weight of the vehicle may put too much force on the parking pawl in the transmission. You may find it difficult to pull the shift lever out of "P" (Park). This is called "torque lock." To prevent torque lock, set the parking brake and then shift into "P" (Park) properly before you leave the driver's seat. To find out how, see "Shifting into 'P' (Park)" in the Index.

When you are ready to drive, move the shift lever out of "P" (Park) BEFORE you release the parking brake.

If "torque lock" does occur, you may need to have another vehicle push yours a little uphill to take some of the pressure from the transmission, so you can pull the shift lever out of "P" (Park).

## ***Shifting out of P (Park)***

### ***(AUTOMATIC TRANSMISSION)***

Your Geo has a brake-transmission shift interlock. You have to fully apply your regular brake before you can shift from "P" (Park) when the ignition is in the

# Features and Controls

"ON" position. See "Automatic Transmission" in the Index.

If you cannot shift out of "P" (Park), ease pressure on the shift lever — push the shift lever all the way into "P" (Park) and release the shift lever button as you maintain brake application. Then press the shift lever button and move the shift lever into the gear you wish.

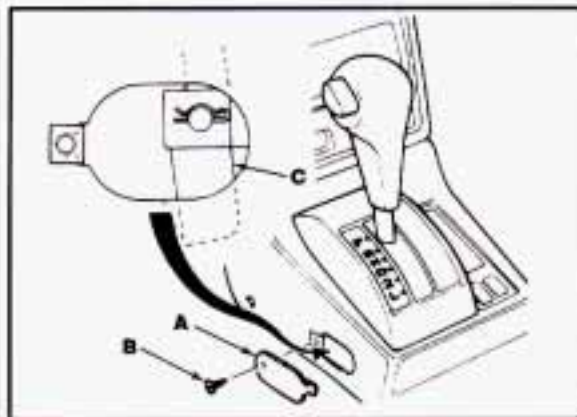

If you ever hold the brake pedal down but still can't shift out of "P" (Park), try this:

1. Apply and hold the brake until the end of step 6.
2. If the engine is running, shut it off. Turn the key to "ON" or "ACC."
3. Find the access hole cover (A) on the driver's side of the console, near the shift lever.
4. Remove the screw (B) and cover (A).
5. Inside you'll see the return plate (C). Using your finger, move the return plate toward the rear of the vehicle until it stops.
6. Move the shift lever into the gear you want.
7. Have the vehicle fixed as soon as you can.

## ***Parking Your Vehicle (MANUAL TRANSMISSION)***

Before you get out of your vehicle, put your manual transmission in "R" (Reverse) and firmly apply the parking brake.

If you have four-wheel drive, be sure your transfer case is in a drive gear. Your vehicle could roll if it isn't.

If your vehicle is equipped to tow a trailer, see "Towing a Trailer" in the Index.



### ***Parking over Things That Burn***

#### **CAUTION:**

Things that can burn could touch hot exhaust parts under your vehicle and ignite. Don't park over papers, leaves, dry grass or other things that can burn.

### ■ ***Engine Exhaust***

#### **CAUTION:**

Engine exhaust can kill. It contains the gas carbon monoxide (CO), which you can't see or smell. It can cause unconsciousness and death.

You might have exhaust coming in if:

- Your exhaust system sounds strange or different.
- Your vehicle gets rusty underneath.
- Your vehicle was damaged in a collision.
- Your vehicle was damaged when driving over high points on the road or over road debris.
- Repairs weren't done correctly.
- Your vehicle or exhaust system had been modified improperly.

If you ever suspect exhaust is coming into your vehicle:

- Drive it only with all the windows down to blow out any CO; and
- Have your vehicle fixed **immediately**.

### ***Running Your Engine While You're Parked***

#### ***(AUTOMATIC TRANSMISSION)***

It's better not to park with the engine running. But if you ever have to, here are some things to know.

#### **CAUTION:**

Idling the engine with the air system control off could allow dangerous exhaust into your vehicle (see the earlier Caution under "Engine Exhaust").

Also, idling in a closed-in place can let deadly carbon monoxide (CO) into your vehicle even if the fan switch is at the highest setting. One place this can happen is a garage. Exhaust — with CO — can come in easily. **NEVER** park in a garage with the engine running.

Another closed-in place can be a blizzard. (See "Blizzard" in the Index.)

# Features and Controls

## CAUTION:

It can be dangerous to get out of your vehicle if the shift lever is not fully in "P" (Park) with the parking brake firmly set. Your vehicle can roll. Don't leave your vehicle when the engine is running unless you have to. If you've left the engine running, the vehicle can move suddenly. You or others could be injured. To be sure your vehicle won't move, even when you're on fairly level ground, always set your parking brake and move the shift lever to "P" (Park).

If you have four-wheel drive and your transfer case is in "N" (Neutral), your vehicle will be free to roll, even if your shift lever is in "P" (Park). So, be sure the transfer case is in a drive gear — not in "N" (Neutral).

Follow the proper steps to be sure your vehicle won't move. See "Shifting into 'P' (Park)" in the Index.

If you're parking on a hill and if you're pulling a trailer, also see "Towing a Trailer" in the Index.

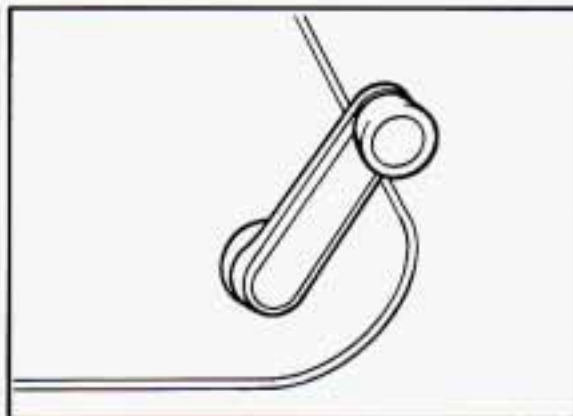

## ■ *Windows*

### Manual Windows

Use the window crank to open and close each door window.

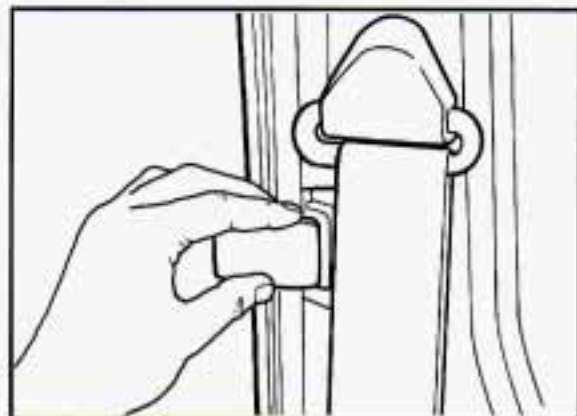

### Rear Swing-Out Side Windows

To open this window, pull the latch out and forward.

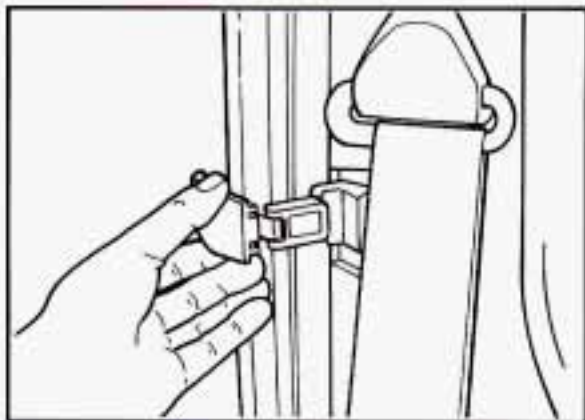

To close the window, pull the latch in and back.

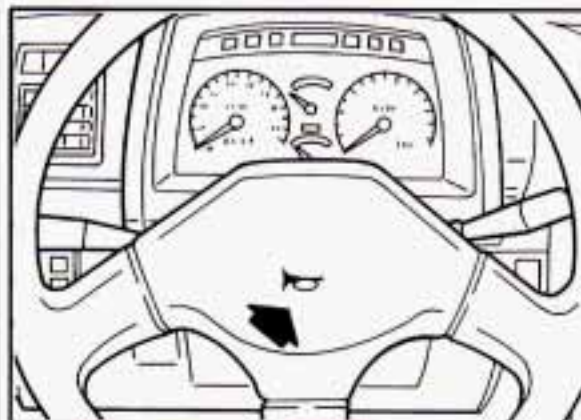

### ■ **Horn**

To sound the horn, press the horn symbol on your steering wheel.

### ■ **Adjustable Steering Column (OPTION)**

#### **CAUTION:**

Adjusting the steering column while driving can be dangerous. The movement of the column could startle or confuse you, causing you to lose control of the vehicle. Adjust the steering column only when the vehicle is not being driven.

An adjustable steering column allows you to adjust the steering column before you drive.

You can also raise it to the highest level to give your legs more room when you exit and enter the vehicle.

## Features and Controls

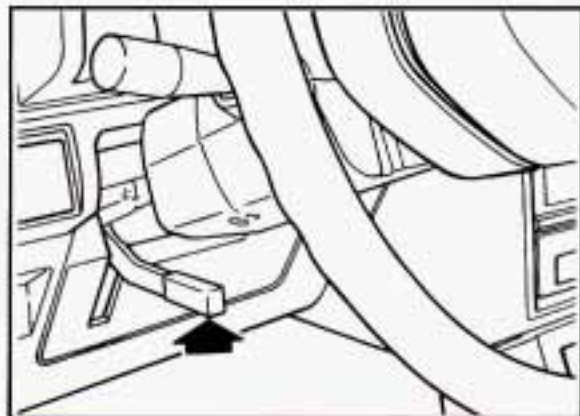

To adjust the column, hold the steering wheel and lower the lever. Move the column to a comfortable level, then raise the lever to its highest position to lock the column in place.

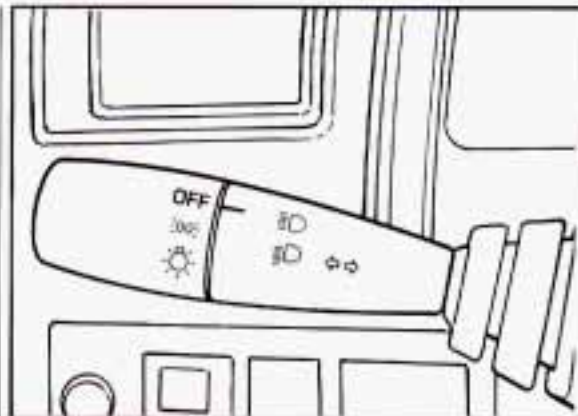

### ■ *The Turn Signal/Lights Control/Headlight Beam Lever*

The lever on the left side of the steering column includes your:

- Turn Signal and Lane Change Indicator
- Headlight High/Low Beam and Passing Signal
- Lighting Operation

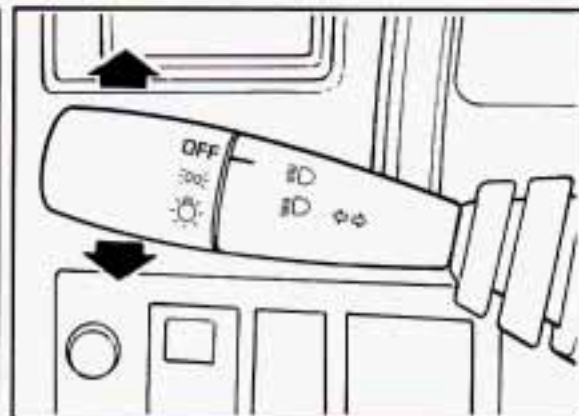

### *Turn Signal and Lane Change Indicator*

The turn signal has two upward (for Right) and two downward (for Left) positions. These positions allow you to signal a turn or a lane change.

To signal a turn, move the lever all the way up or down. When the turn is finished, the lever will return automatically.

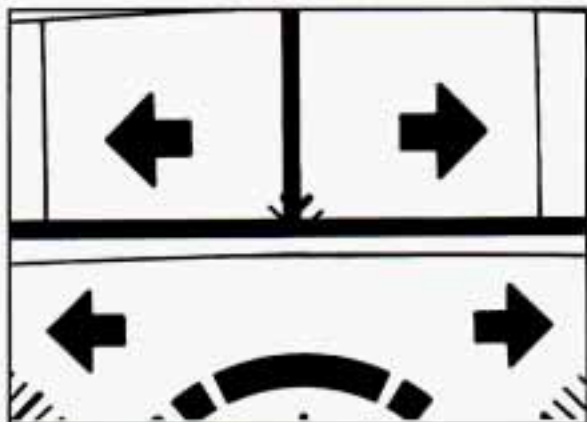

A green arrow on the instrument panel will flash in the direction of the turn or lane change.

To signal a lane change, just raise or lower the lever until the green arrow starts to flash. Hold it there until you complete your lane change. The lever will return by itself when you release it.

As you signal a turn or a lane change, if the arrows don't flash but just stay on, a signal bulb may be burned out and other drivers won't see your turn signal.

If a bulb is burned out, replace it to help avoid an accident. If the green arrows don't go on at all when you signal a turn, check the fuse (see "Fuses and Circuit Breakers" in the Index) and for burned-out bulbs.



## Operation of Lights

Although your vehicle's lighting system (headlights, parking lights, fog lamps, sidemarker lights and taillights) meets all applicable federal lighting requirements, certain states and provinces may apply their own lighting regulations that may require special attention before you operate these lights.

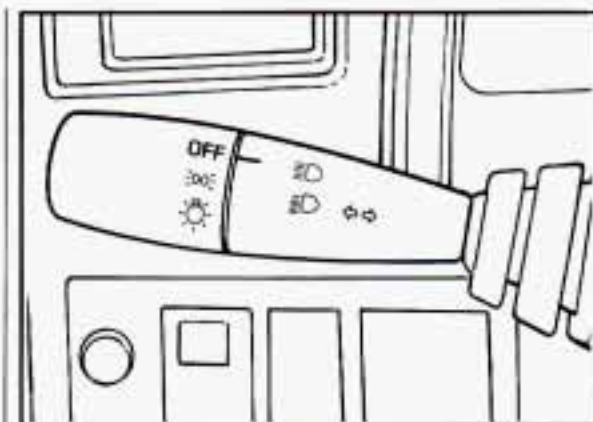
For example, some jurisdictions may require that you operate your fog lamps only when your lower beam headlights are also on, or that headlights be turned on whenever you must use your windshield wipers. In addition, most jurisdictions prohibit driving solely with parking lights, especially at dawn or dusk. It is recommended that you check with your own state or provincial highway authority for applicable lighting regulations.



Turn the outside part of the lever to control the lights. There are three positions for the light switch.

- **OFF**: All lights are off.
- : The parking lights, taillights, license plate light and the instrument panel lighting come on. The headlights are off.
- : The headlights and all other operating lights come on.

## Lights On Reminder

If you turn the ignition off, remove the key, open the door and leave the lights on, a chime will remind you to turn off your lights.



# Features and Controls

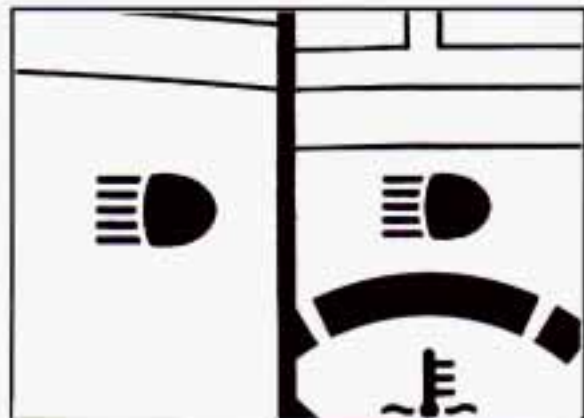

## Headlight High/Low Beam

First, you must have the headlights on. For high beams, push the turn signal lever away from you. When the high beams are on, a blue light on the instrument panel also will be on. It will go off when you switch to low beam. To switch back to low beams, pull the lever toward you.

## Passing Signal

With the lever in the low beam position, pull the lever toward you to momentarily switch to high beam (to signal that you are going to pass). When you release the lever, the headlights will return to low beam operation.

## Daytime Running Lights (Canada)

The Canadian Federal Government has decided that "Daytime Running Lights" (DRL) are a useful feature, in that DRL can make your vehicle more visible to pedestrians and other drivers during daylight hours. DRL are required on new vehicles sold in Canada.

The low beam headlights will come on at reduced brightness in daylight when:

- The ignition is on
- The headlight switch is off, and
- The parking brake is released.

When you turn on your headlights, the DRL will switch off and the exterior lights will come on. When you turn off the headlights, the exterior lights will go out and the low beams will change to the reduced brightness of DRL again.

The DRL indicator light on the instrument panel will go on whenever the DRL are on. This light means that only the DRL are on. When you turn on your exterior lights, this light will go out.

Of course, you may still turn on the headlights or passing signal any time you need to.

To idle your vehicle with the DRL off, set the parking brake. The DRL will stay off until you release the parking brake.

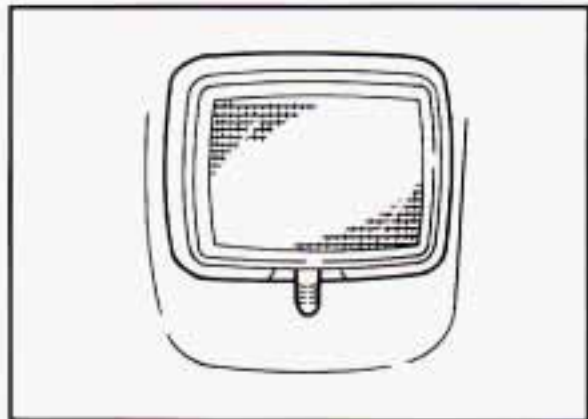

## ■ Interior Lights

### Dome Light

The dome light has a three position switch.

- **1:** The light turns on and stays on whether or not a door is open.
- **2:** The light comes on when a door is opened.
- **3:** The light stays off even when a door is open.

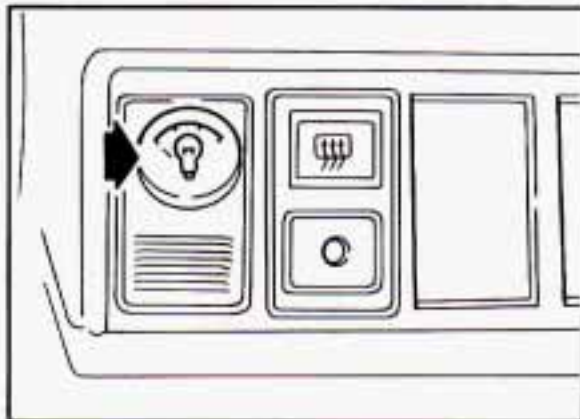

### Brightness Control

This knob controls the brightness of your instrument panel lights. Turn the knob to the right to brighten the lights or to the left to dim them.

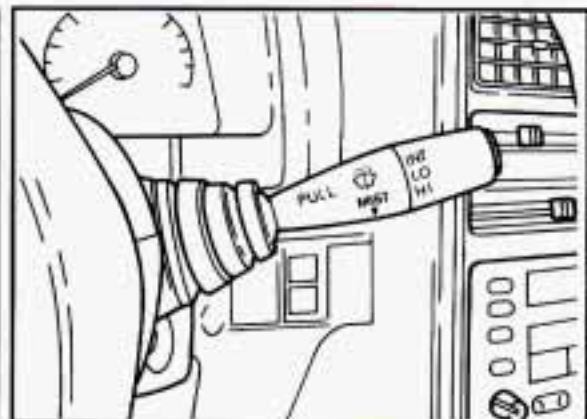

## ■ Windshield Wiper/Washer Lever

The lever on the right side of the steering column controls the windshield wipers and washers.

Move the wiper switch to the position you want:

- **OFF:** The wipers are off.
- **INT:** Intermittent wiper operation. In light rain or snow, you might want to use this position rather than continuous wiping.
- **LO:** The wipers will run continuously at low speed.
- **HI:** The wipers will run continuously at high speed.

# Features and Controls

For a single wiping cycle, push the lever to "MIST." Hold it there until the wipers start, then let go. The wipers will stop after one cycle. If you want more cycles, hold the lever on "MIST" longer.

## Washers

Pull the wiper/washer lever toward you to spray washer fluid on the windshield. The spray will continue until you release the lever. This will also turn on the low speed wipers.

Heavy snow or ice can overload your wipers. A circuit breaker will stop them until the motor cools. Clear away snow or ice to prevent an overload.



## CAUTION:



In freezing weather, don't use your washer until the windshield is warmed. Otherwise the washer fluid can form ice on the windshield, blocking your vision.

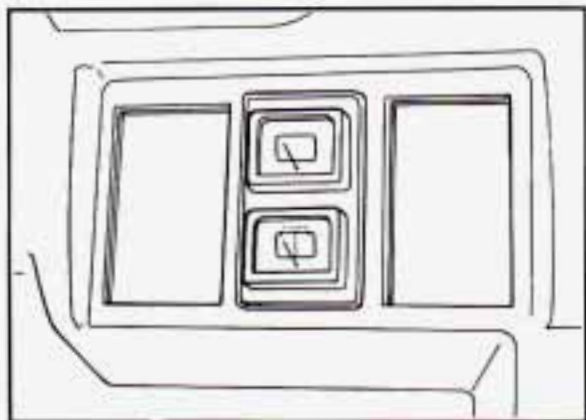

## NOTICE:

- When using concentrated washer fluid, follow the manufacturer's instructions for adding water.
- Don't mix water with ready-to-use washer fluid. Water can cause the solution to freeze and damage your washer fluid tank and other parts of the washer system. Also, water doesn't clean as well as washer fluid.
- Fill your washer fluid tank only 3/4 full when it's very cold. This allows for expansion, which could damage the tank if it is completely full.
- Don't use radiator antifreeze in your windshield washer. It can damage your paint.



### ■ **Rear Window Wiper/Washer (OPTION)**

To turn on your rear wiper, push . Push  again to turn it off.

To spray washer fluid on the rear window, push  about halfway down. Washer fluid will spray as long as you hold .

To wash and wipe at the same time, push  all the way in.

The washer and wiper will run as long as you hold . To add washer fluid, see "Windshield Washer Fluid" in the Index.

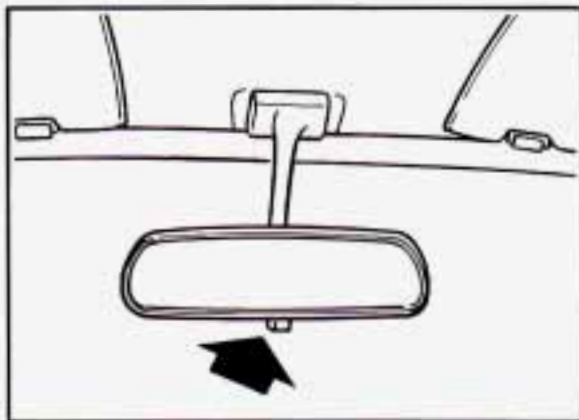

### ■ **Mirrors**

#### ■ **Inside Rearview Mirror**

An inside rearview mirror is attached above your windshield. The mirror has pivots so that you can adjust it up and down or side to side.

#### ■ **Inside Day/Night Rearview Mirror**

You can adjust the mirror for day or night driving. Pull the tab for night driving to reduce glare. Push the tab for daytime driving.

### Convex Outside Mirror

Your right side mirror is convex.

A convex mirror's surface is curved so you can see more from the driver's seat.

### **CAUTION:**

If you aren't used to a convex mirror, you can hit another vehicle. A convex mirror can make things (like other vehicles) look farther away than they really are. If you cut too sharply into the right lane, you could hit a vehicle on your right. Check your inside mirror or glance over your shoulder before changing lanes.

## Features and Controls

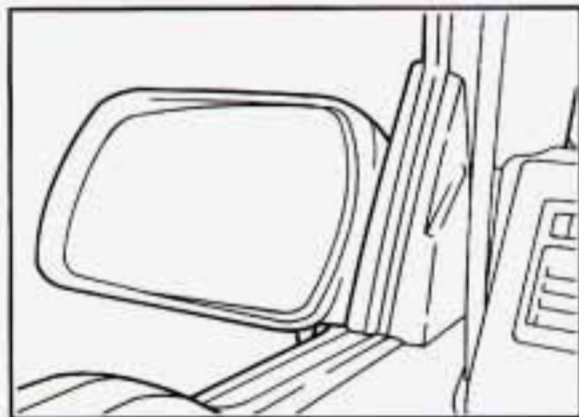

### Outside Manual Adjust Mirrors

The mirrors should be adjusted by hand so that you can just see the side of your vehicle, when you are sitting in a comfortable position.

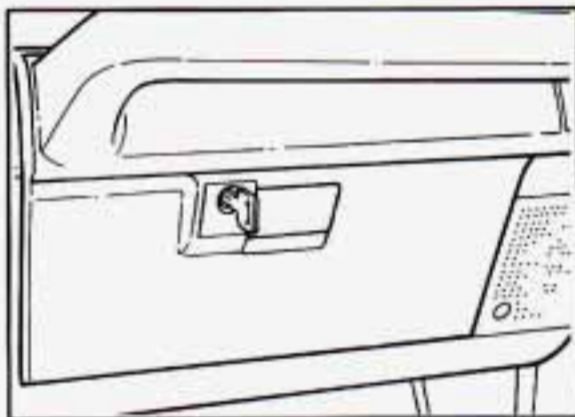

### ■ *Storage and Compartments*

#### Glove Box

To open the glove box, pull the latch toward you. Use your key to lock and unlock the glove box.

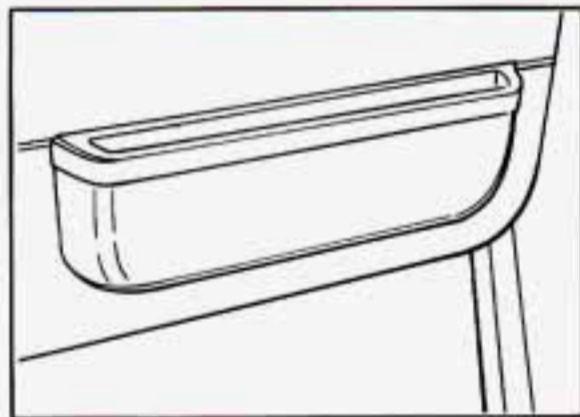

### Door Storage Compartments

Each door has a storage compartment.

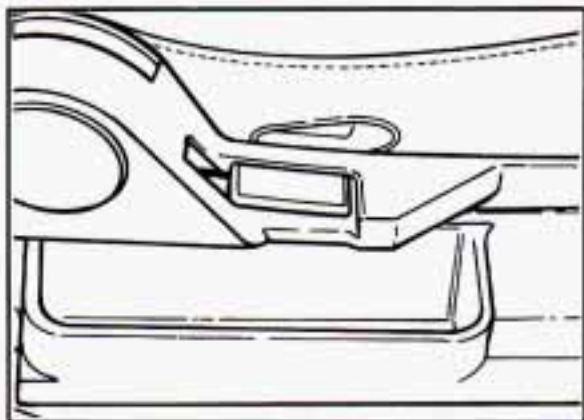

#### **Front Seat Side Pockets**

On the outside of each front seat is a storage pocket.

#### **Instrument Panel Bins**

On the top center of the instrument panel is a storage bin.

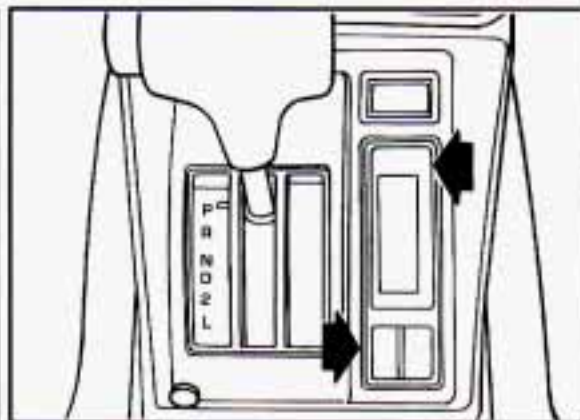

#### **Coinholder and Bin**

Your console has a coinholder and a small storage bin.

#### **Cupholder**

Two cupholders are on the center console next to the parking brake lever.

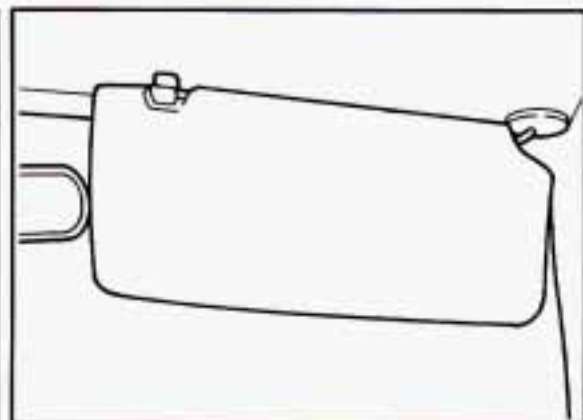

#### **■ Sun Visors**

To block out glare, you can swing down the visors.

You can also swing them to the side. If the visors swing too easily, tighten the screw on the roof rail.

## Features and Controls

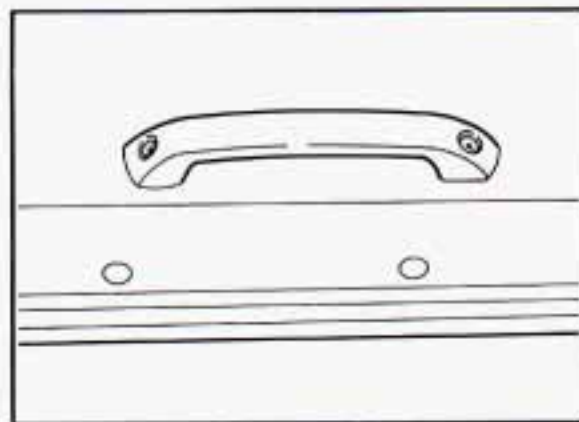

### ■ *Passenger Assist Grips*

Your Geo may have assist grips. Passengers can use the grips to help keep their balance over rough roads or during sharp turns.

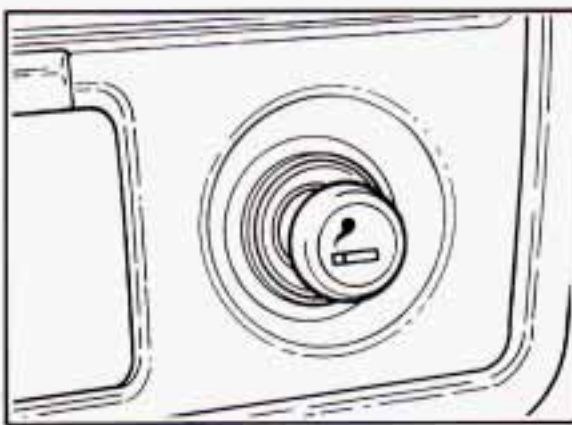

### ■ *Ashtrays and Lighter*

#### **Cigarette Lighter**

To use the lighter, push the lighter in all the way and let go. When it's ready, it will pop back by itself.

### **NOTICE:**

Don't hold a cigarette lighter in with your hand while it is heating. If you do, it won't be able to back away from the heating element when it's ready. That can make it overheat, damaging the lighter and the heating element.



#### **Front Ashtray**

Pull the door to open it. To remove the ashtray, press down on the tab and pull out the ashtray.



#### **Rear Ashtray**

The rear ashtray is on the back of the center console. Pull the door to open it. To remove the ashtray, press down on the tab and pull the ashtray out.

### **NOTICE:**

Don't put papers and other things that burn into your ashtray. If you do, cigarettes or other smoking materials could set them on fire, causing damage.



# Features and Controls

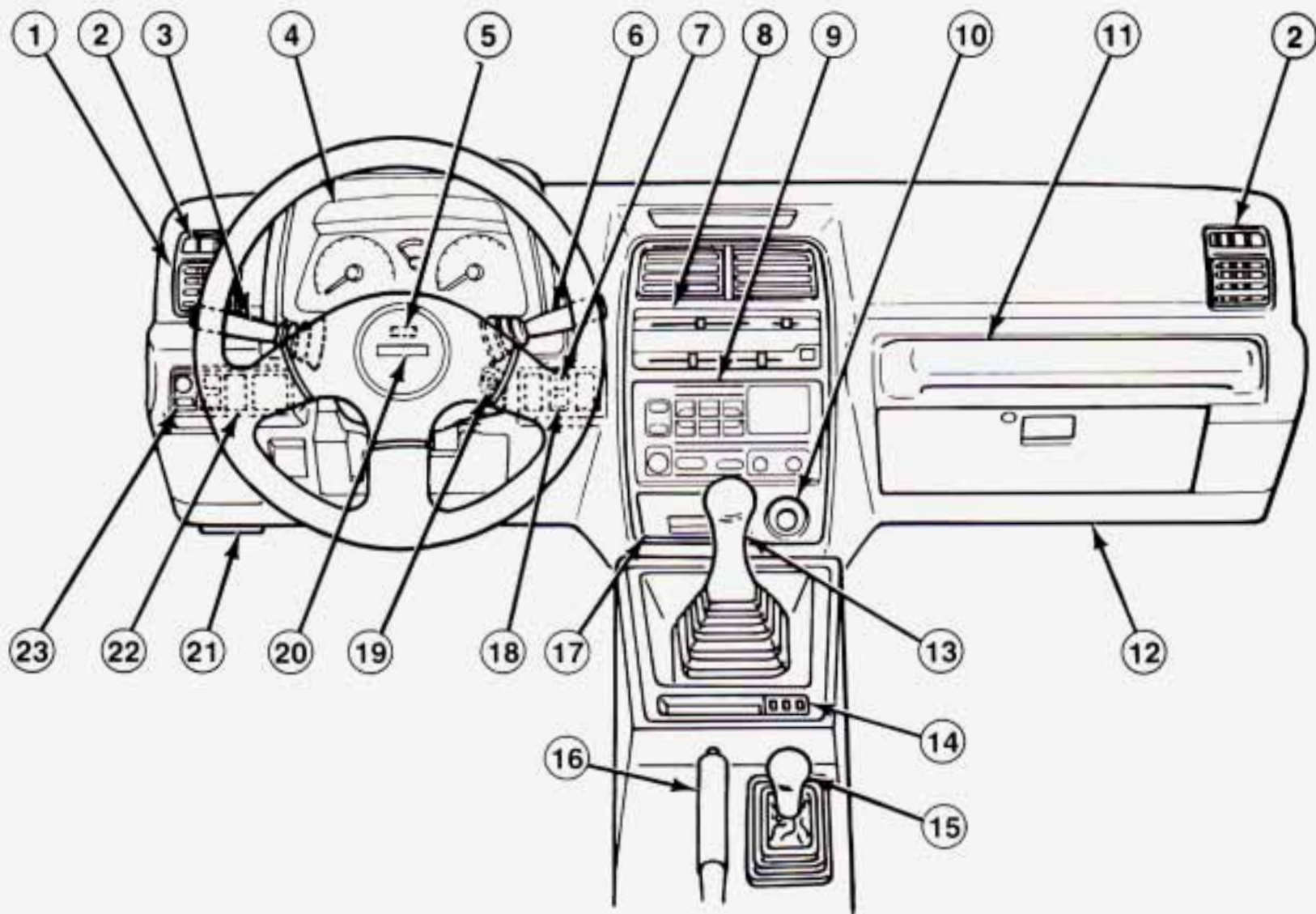

## ***Instrument Panel***

- 1.** Air Vent
- 2.** Side Defroster Vent
- 3.** Turn Signal/Lights Control/Headlight Beam Lever
- 4.** Instrument Cluster
- 5.** Hazard Warning Flasher
- 6.** Windshield Wiper/Washer Lever
- 7.** Rear Window Wiper Switch
- 8.** Comfort Controls
- 9.** Audio System
- 10.** Lighter
- 11.** Assist Grip
- 12.** Glove Box
- 13.** Transmission Shift Lever
- 14.** Coinholder and Bin
- 15.** Transfer Case Shift Lever
- 16.** Parking Brake Lever
- 17.** Ashtray
- 18.** Rear Window Washer Switch
- 19.** Ignition Switch
- 20.** Horn
- 21.** Fuse Block
- 22.** Rear Window Defogger Switch
- 23.** Brightness Control

# Features and Controls



## ■ *Instrument Panel and Clusters*

Your instrument cluster is designed to let you know at a glance how your vehicle is running. You'll know how fast you're going, about how much fuel you have left

and many other things you'll need to know to drive safely and economically.

### **Optional Cluster**

If you have the optional cluster, your instrument panel gives you additional information. The cluster includes a tachometer.

### **Speedometer and Odometer**

Your speedometer lets you see your speed in both miles per hour (mph) and kilometers per hour (km/h). Your odometer shows how far your vehicle has been driven, in either miles (used in the U.S.) or kilometers (used in Canada).

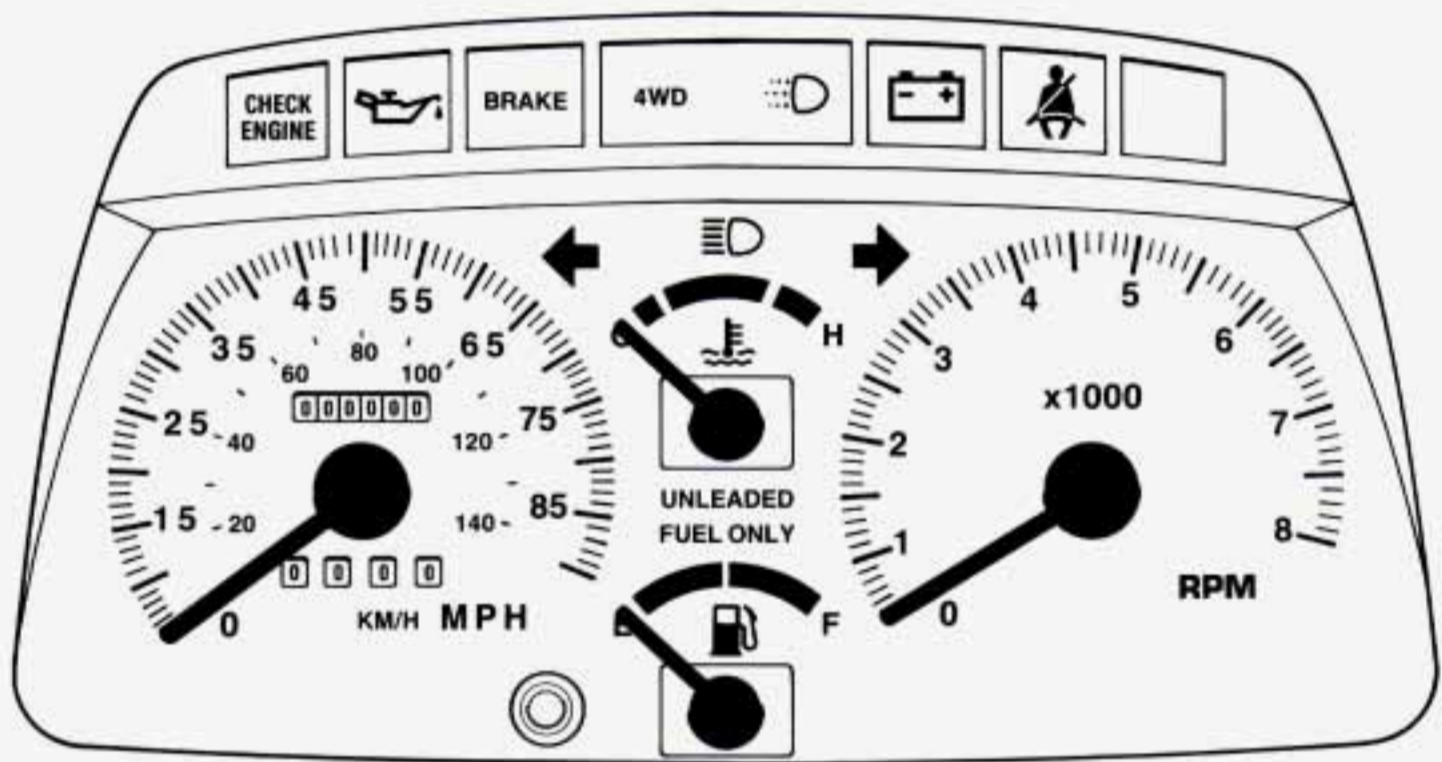

Your Geo's odometer is tamper-resistant. If you can see silver lines between the numbers, probably someone has tried to turn it back. The numbers may not be true.

You may wonder what happens if your vehicle needs a new odometer installed. If possible, the new one has to be set to the

same reading the old one had. If it can't be, then it's set at zero, but a label on the driver's door must show the old reading and when the new one was installed.

### **Trip Odometer**

The trip odometer can tell you how far your vehicle has been driven since you last set the trip odometer to zero.

To set the trip odometer to zero, press the knob.

# Features and Controls

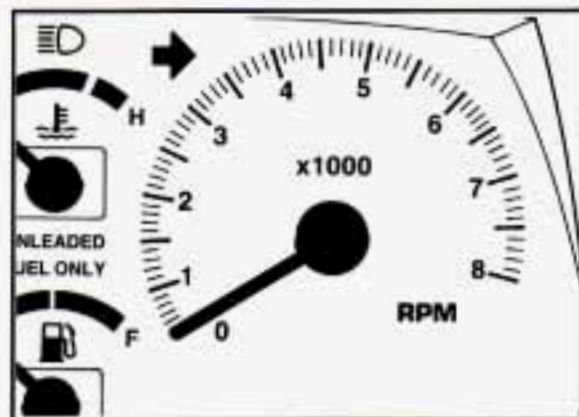

## Tachometer

The tachometer shows engine speed in thousands of revolutions per minute (rpm). You can use it while driving to select correct shift points. The tachometer may not return to zero when the engine is not running.

### **NOTICE:**

Do not operate the engine with the tachometer in the red area, or engine damage may occur.

## ■ *Warning Lights, Gages and Indicators*

This section describes the warning lights and gages that may be on your vehicle. The pictures will help you locate them.

Warning lights and gages can signal that something is wrong before it becomes serious enough to cause an expensive repair or replacement. Paying attention to your warning lights and gages could also save you or others from injury.

Warning lights go on when there may be or is a problem with one of your vehicle's functions. As you will see in the details on the next few pages, some warning lights come on briefly when you turn the ignition key just to let you know they're working. If you are familiar with this section, you should not be alarmed when this happens.

Gages can indicate when there may be or is a problem with one of your vehicle's functions. Often gages and warning lights work together to let you know when there's a problem with your vehicle.

When one of the warning lights comes on and stays on when you are driving, or when one of the gages shows there may

be a problem, check the section that tells you what to do about it. Please follow the manual's advice. Waiting to do repairs can be costly — and even dangerous. So please get to know your warning lights and gages. They're a big help.

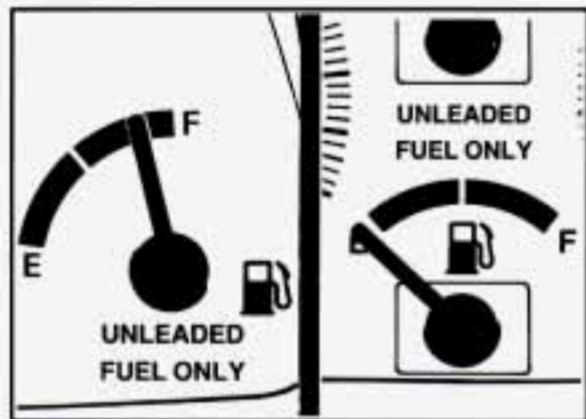

### Fuel Gage

Your fuel gage shows about how much fuel is in your tank. When the gage first indicates "E," you still have a little fuel left (about one or two gallons), but you need to get more right away.

Here are four concerns some owners have had about the fuel gage. All these situations are normal and do not indicate that anything is wrong with the fuel gage.

- At the gas station, the fuel pump shuts off before the gage reads "F."
- It takes more (or less) fuel to fill up than the gage reads. For example, the gage reads half full, but it took more (or less) than half of the tank's capacity to fill it.

- The gage moves a little when you turn, stop or speed up.
- When you turn the engine off, the gage doesn't go back to "E."

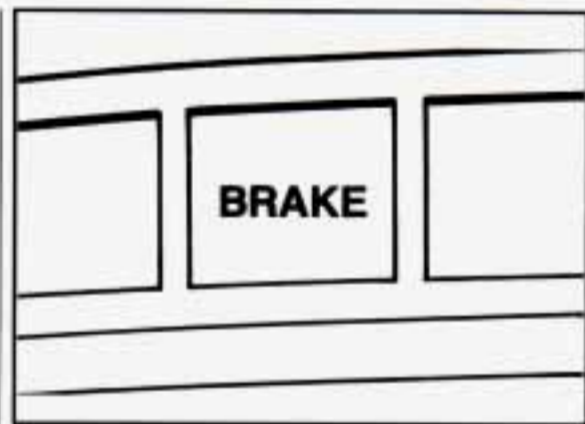

### Brake System Warning Light

Your Geo's hydraulic brake system is divided into two parts. If one part isn't working, the other part can still work and stop you. For good braking, though, you need both parts working well.

Your vehicle also has rear-wheel anti-lock brakes. If the warning light comes on, there could be a brake problem with either your regular or rear-wheel anti-lock brakes, or both. Have your brake system inspected right away.

This light should come on as you start the vehicle. If it doesn't come on then, have it fixed so it will be ready to warn you if there's a problem.

# Features and Controls

If the light comes on while you are driving, pull off the road and stop carefully. You may notice that the pedal is harder to push. Or, the pedal may go closer to the floor. It may take longer to stop. If the light is still on, have the vehicle towed for service. (See "Towing Your Vehicle" in the Index.)



## CAUTION:

Your brake system may not be working properly if the brake system warning light is on. Driving with the brake system warning light on can lead to an accident. If the light is still on after you've pulled off the road and stopped carefully, have the vehicle towed for service.

The brake system warning light will also come on when you set your parking brake, and it will stay on if your parking brake doesn't release fully. If it stays on after your parking brake is fully released, it means you have a brake problem.

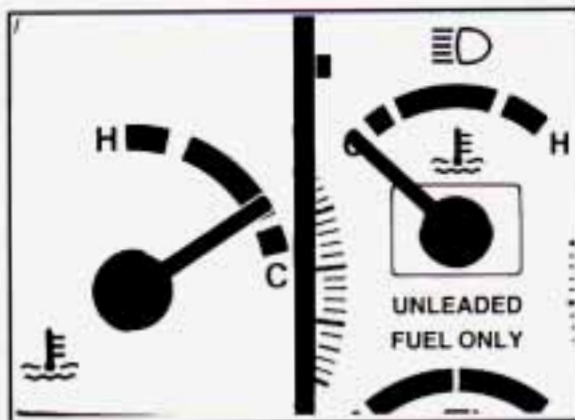

## Engine Coolant Temperature Gage

This gage shows the engine coolant temperature. If the gage pointer moves to the "H" (red) side, your engine is too hot! It means that your engine coolant has overheated and you should stop your vehicle and turn off the engine as soon as possible.

## HOT COOLANT CAN BURN YOU BADLY!

In "Problems on the Road," this manual shows what to do. See "Engine Overheating" in the Index.

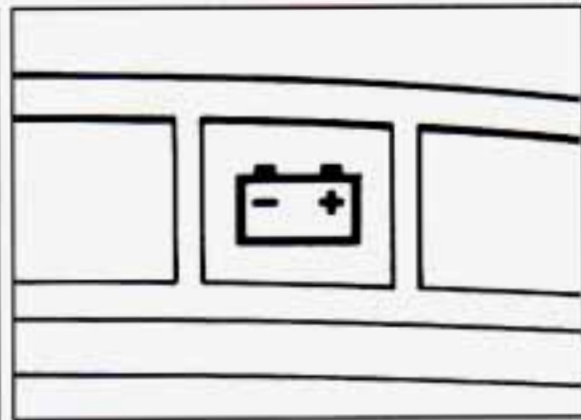

## Charging System Light

This light will come on briefly when you turn on the ignition, but the engine is not running, as a check to show you it is working. Then it should go out when the engine starts. If it stays on or comes on while you are driving, you may have a problem with the electrical charging system. It could indicate that you have a loose generator drive belt or another electrical problem. Have it checked right away. Driving while this light is on could drain your battery.

If you must drive a short distance with this light on, be certain to turn off all your accessories, such as the radio and air conditioner.

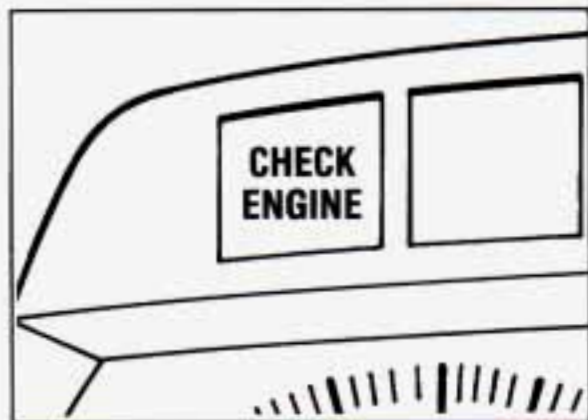

### Malfunction Indicator Lamp (Check Engine Light)

A computer monitors operation of your fuel, ignition and emission control systems. This light should come on when the ignition is on, but the engine is not running, as a check to show you it is working. If it does not come on at all, have it fixed right away. If it stays on, or comes on while you are driving, the computer is indicating that you have a problem. You should take your vehicle in for service soon.

### NOTICE:

If you keep driving your vehicle with this light on, after a while the emission controls won't work as well, your fuel economy won't be as good and your engine may not run as smoothly. This could lead to costly repairs not covered by your warranty.

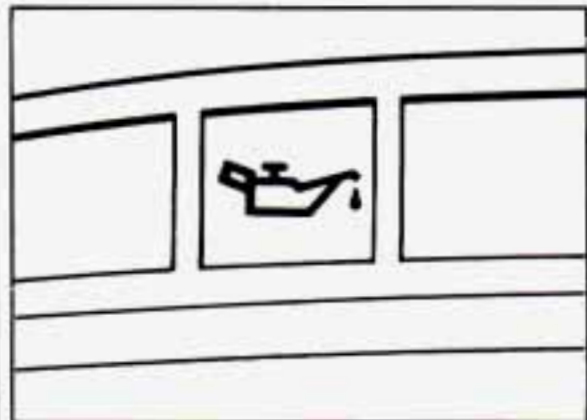

### Engine Oil Pressure Light

If you have a problem with your oil, this light may stay on after you start your engine, or come on when you are driving. This indicates that there is not enough pressure to keep your engine properly lubricated and cool. The engine could be low on oil, or have some other oil related problem. Have it fixed right away.

The oil light could also come on in three other situations.

- When the ignition is on but the engine is not running, the light will come on as a test to show you it is working, but the light will go out when you turn the engine to "START." If it doesn't come on with the ignition on, you may have



## Features and Controls

a problem with the fuse or bulb. Have it fixed right away.

- Sometimes when the engine is idling at a stop, the light may blink on and off. This is normal.
- If you make a hard stop, the light may come on for a moment. This is normal.



### CAUTION:

Don't keep driving if the oil pressure is low. If you do, your engine can become so hot that it catches fire. You or others could be burned. Check your oil as soon as possible and have your vehicle serviced.

### NOTICE:

Damage to your engine from neglected oil problems can be costly and is not covered by your warranty.



### Daytime Running Lights (DRL) Indicator Light (Canada)

If your vehicle was first sold, when new, in Canada, you will have this light on the instrument panel. It goes on whenever the Daytime Running Lights are on.

### ■ *Convertible Top (OPTION)*

Your convertible top features a sunroof, a removable rear window and a removable canvas top.



### CAUTION:

Don't change the center pillars or horizontal roof support. These parts are designed to help protect you and passengers in a crash. Don't add anything, like light bars or roll bars, to these parts, either. If the center pillars or horizontal roof support are ever damaged, be sure to have them repaired as soon as possible so they'll be able to protect you in a crash.

## NOTICE:

- Never raise or lower the top while the vehicle is moving, or drive with any part of the top unfastened or partially removed. The wind could get under it and cause damage.
- Do not take your vehicle through an automatic car wash. It could damage your convertible top.
- Don't try to lower or raise the convertible top or tap or beat on the plastic windows if your vehicle is out in cold weather, 41°F (5°C) or below. The cold can cause cracks and other damage to the windows and to the top as it is being lowered or raised.
- Don't lower the top if it is damp or wet. After the top is down, the trapped water can cause stains, mildew and damage to the inside of your car. Be sure to dry off the top before you lower it.
- Don't lower the convertible top if the rear flap or side windows are dirty. Dirt could scratch the side windows.
- The convertible top isn't designed to carry weight. Never let anyone sit on the top, and don't put anything on top of it when it is up, or it could be damaged.



The parts of your convertible top are:

1. Top Bow Latch
2. Front Top Bow
3. Horizontal Roof Support
4. Rear Top Bow
5. Strap
6. Strut
7. Clamp
8. Center Pillar
9. Roof Rail

## Features and Controls

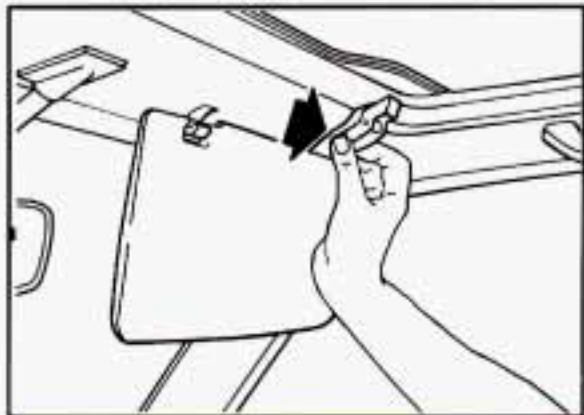

### Opening and Closing Your Sunroof

1. Lower your antenna and swing your sun visors down.
2. Squeeze the front top bow latch buttons and pull the latch back.

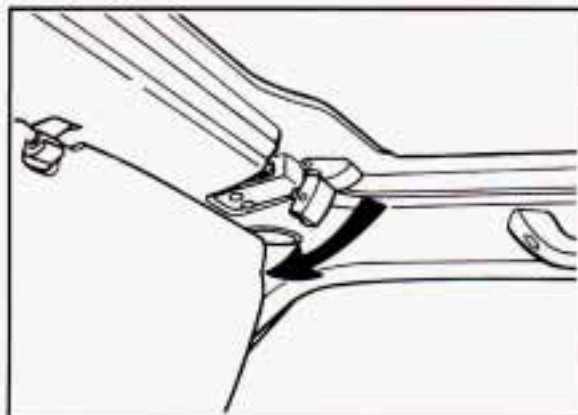

3. Unhook the latch from the front top bow.

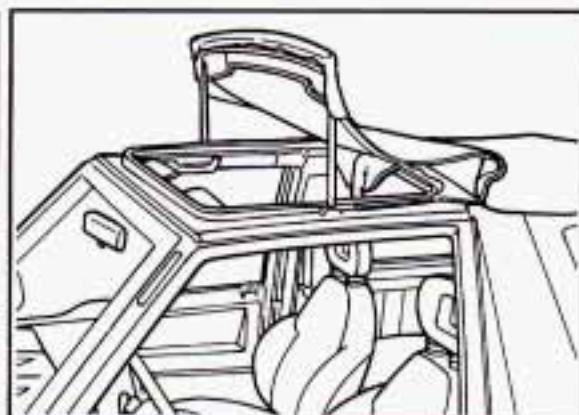

4. Swing the front top bow up and back while folding the canvas top out from between the top bow and the roof support. Be sure that you don't pinch the canvas top between the front top bow arms and the roof rails.



5. Unfasten the holding strap near the dome light and pull it through the slot in the front top bow.
6. Fasten the holding strap to itself.
7. Push the front top bow latches down until they "click."
8. Swing your sun visors up and raise your antenna.

Reverse the steps to close your sunroof. Be sure your front top bow is latched securely.

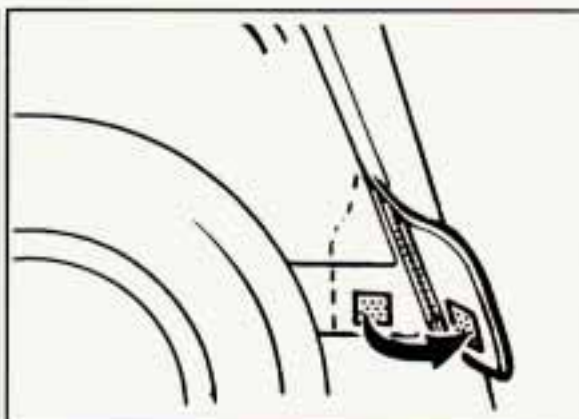

### Opening and Closing Your Rear Window

Make sure your rear window is clean before you try to remove it. See "Special Care of Canvas Top" in the Index.

1. Unfasten the lower right corner flap to uncover the zipper pull.

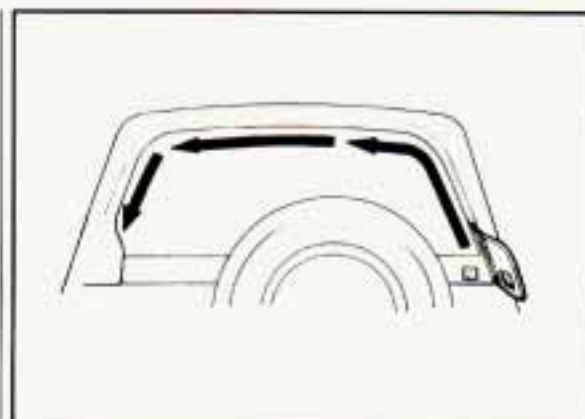

2. Unzip the rear window. If the zipper is hard to move, you can lubricate it with beeswax, bar soap or silicone spray. Remove the window.

# Features and Controls

## CAUTION:

It can be dangerous to drive with the rear window removed or open because carbon monoxide (CO) gas can come into your vehicle. You can't see or smell CO. It can cause unconsciousness and even death.

If you must drive with the rear window open or if electrical wiring or other cable connections must pass through the seal between the body and the rear window:

- Make sure all windows are shut.
- Turn the fan on your heating or cooling system to its highest speed with the setting on . That will force outside air into your vehicle. See "Comfort Controls" in the Index.
- If you have air vents on or under the instrument panel, open them all the way.

See "Engine Exhaust" in the Index.

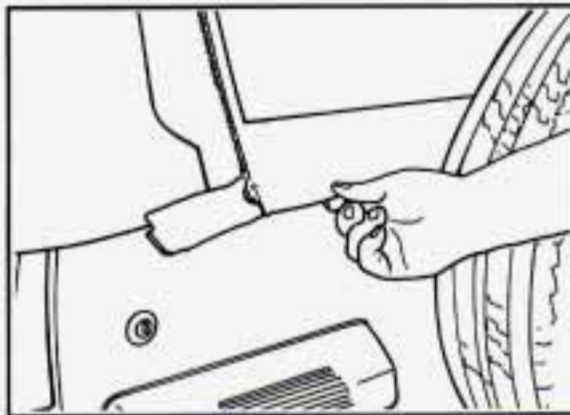

### Removing and Installing Your Rear Window

1. Unfasten the lower corner flaps on both sides.
2. There are two places on the canvas on the tailgate marked "PULL." Pull at each place to unhook the rear window frame from the tailgate. Also, pull the canvas at the center of the tailgate.
3. Unzip and remove the rear window.

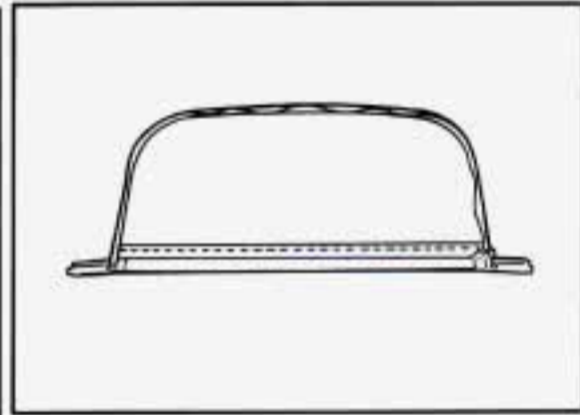

4. Lay the rear window inside-up on a clean, dry, flat surface and roll the rear window from the bottom to the top.

Reverse the steps to install the rear window. Be sure the rear window is completely closed before driving.

### Removing and Installing Your Canvas Top

1. Lower your antenna and swing your sun visors down.
2. Remove your rear window. See "Removing and Installing Your Rear Window" in this section.

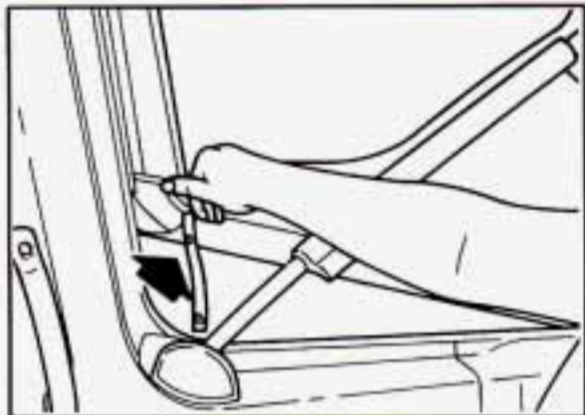

3. Unsnap the upper and lower straps that connect the rear top bow to the side window frames.
4. From inside your vehicle, push out on the lower front corner metal support of the rear side window frames.

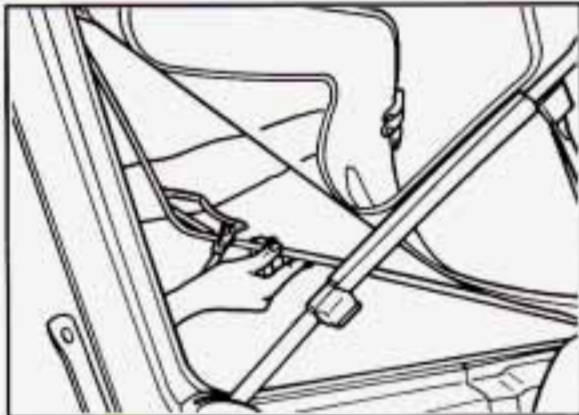

5. Unfasten the rear side windows from the frames.
6. Hook the frames back to the body of your vehicle.  
Be sure the strap is above the frame so you don't pinch the strap between the frame and the body of the vehicle.
  - Snap the strap on the frame to itself.

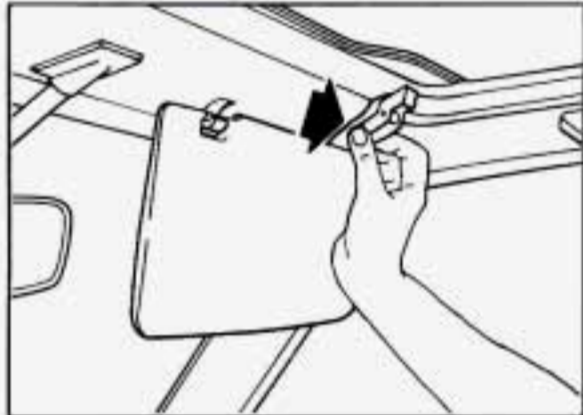

7. Squeeze the front top bow latch buttons and pull the latch back.

## Features and Controls

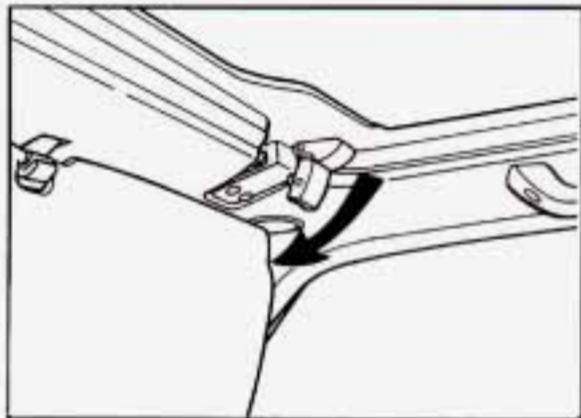

- 8.** Unhook the latch from the front top bow.

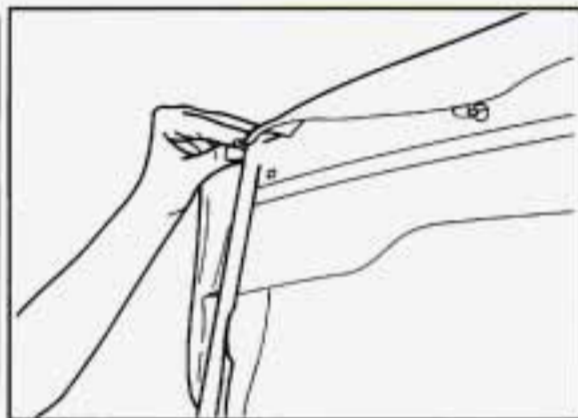

- 9.** Swing the front top bow back so you'll have some slack in the canvas top.
- 10.** Unhook the canvas top from the front top bow.

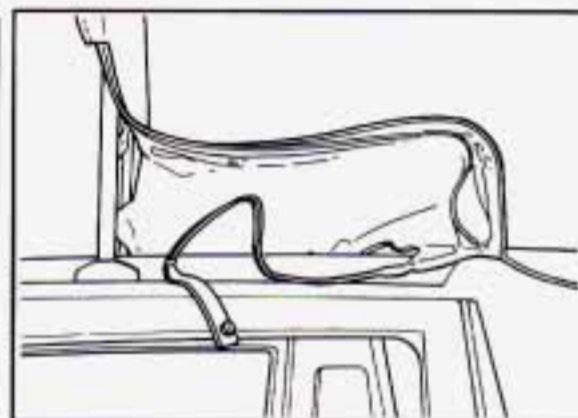

- 11.** Unsnap the tension straps at the roof rails and pull the straps out of the plastic loops.

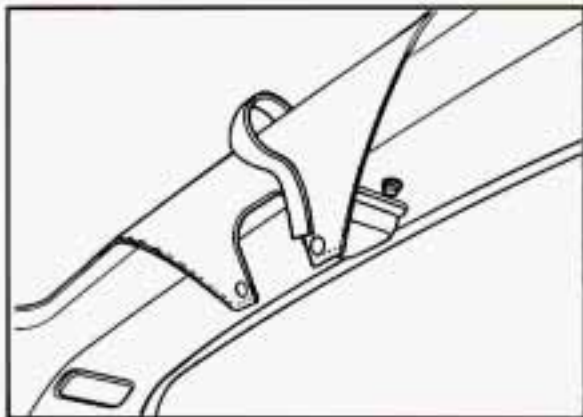

- 12.** Unsnap the flaps (near the dome light) that hold the canvas top to the roof support.

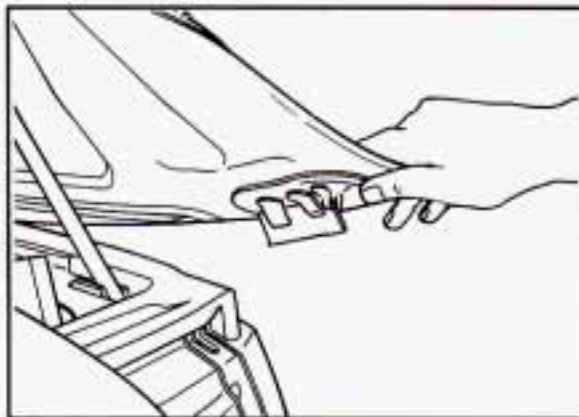

- 13.** Slide out the rear corner pieces.

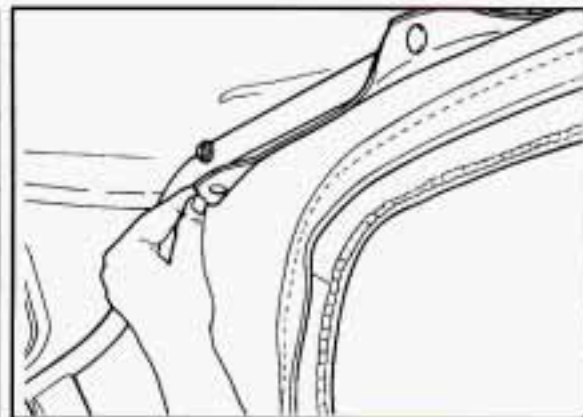

- 14.** Unsnap the canvas from the rear top bow.
- 15.** Remove the canvas top from the vehicle and lay inside-up on a clean, dry, flat surface.



## Features and Controls

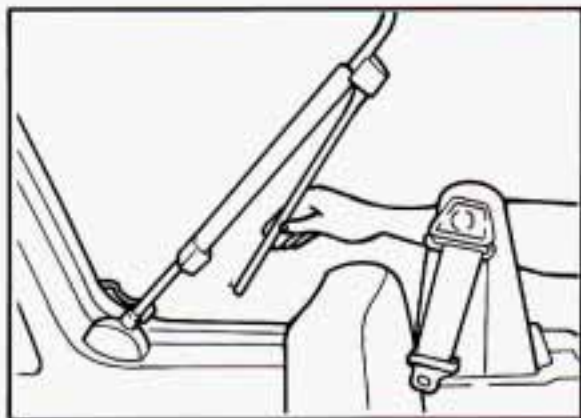

**16.** Pull up and back on the rear top bow struts and swing each strut forward.

**17.** Clamp the struts to the rear top bow.

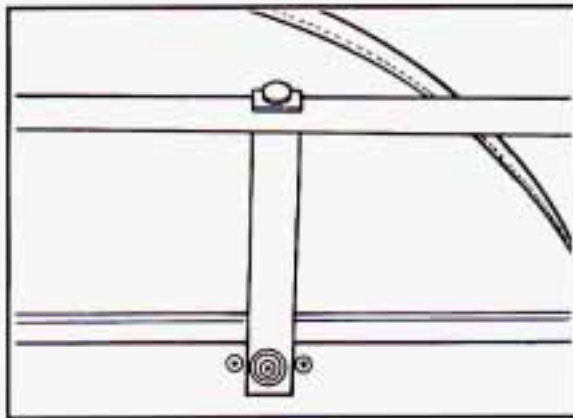

**18.** Swing down the rear top bow and secure it with the strap at the inside center of your tailgate.

**19.** Pull the front top bow forward and lock it in place.

Reverse the steps to install your canvas top. Be sure:

- The front top bow is securely latched.
- The rear side window frames are installed all the way into the corners of the canvas.
- The rear side window frames are clamped to the body.
- The rear straps on the side window frames are snapped.
- The rear top bow struts are secure in their proper place.

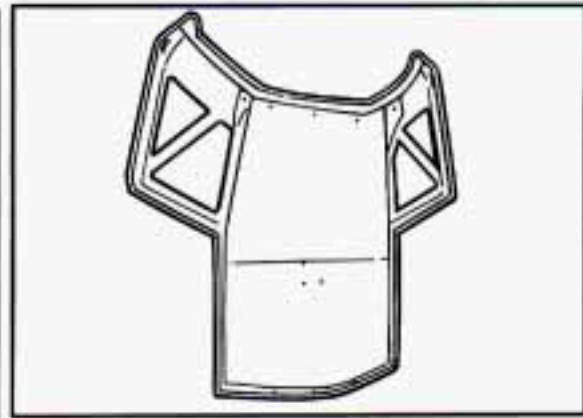

### Preparing Your Canvas Top for Storage

- 1.** Lay the canvas top inside-up on a clean, dry, flat surface.

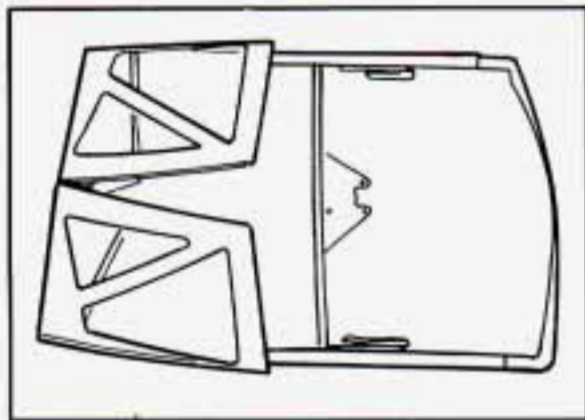

**2.** Fold the side windows onto the top.

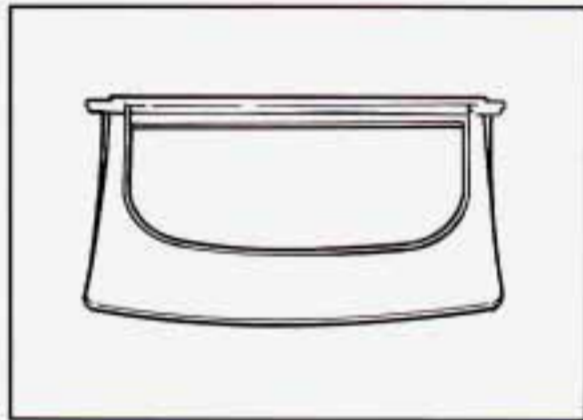

**3.** Fold the front part of the canvas top over the windows.

**4.** Lay the rear window on top of the folded canvas top.

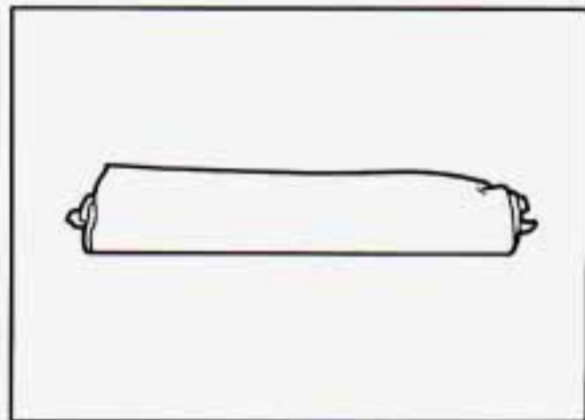

**5.** Roll the canvas top around the rear window.

**6.** Store in a clean, dry location.

# Notes

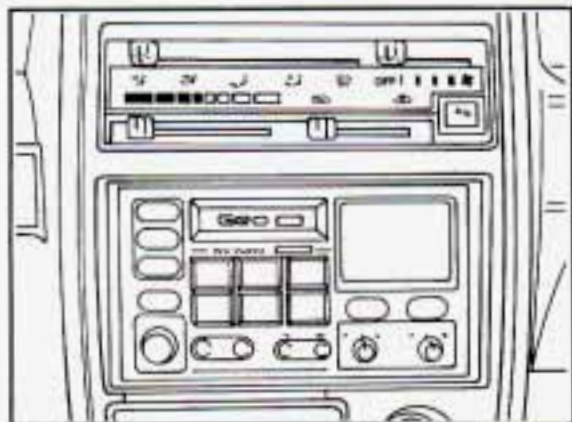

In this part you'll find out how to operate the comfort control systems and audio systems offered with your Geo. Be sure to read about the particular system supplied with your vehicle.

## Part 3 Comfort Controls & Audio Systems

Comfort Controls .....	84
Heater Controls .....	85
Air Conditioner Controls .....	85
Rear Window Defogger .....	86
Flow-Through Ventilation System .....	86
Audio Systems .....	87
Setting the Clock .....	88
AM/FM Stereo .....	88
AM/FM Stereo with Cassette Tape Player .....	89
AM/FM Stereo with Cassette Tape and Compact Disc Player .....	93
Understanding Radio Reception .....	97
Care of Your Cassette Tape Player .....	97
Care of Your Compact Discs .....	98
Antenna .....	98

# Comfort Controls and Audio Systems

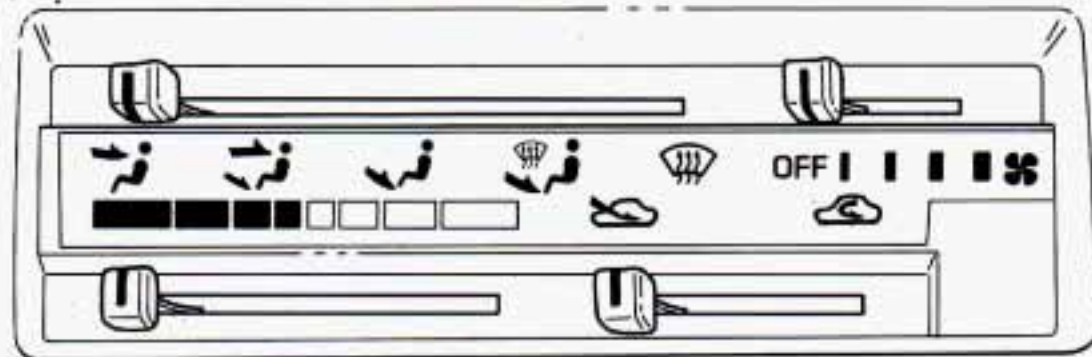

## ■ Comfort Controls

With this system, you can control the heating and ventilation in your Geo. If you have the air conditioning option, you can also control cooling.

Your vehicle also has the flow-through ventilation system described later in this section.

### Heater Controls

#### Airflow Lever

 : This position directs the airflow through the instrument panel vents.

 : This position directs air through the instrument panel vents and toward the floor.

 : This position directs air toward the floor.

 : This position directs air toward the floor, the windshield and side windows.

 : This position directs air to the windshield.

#### Fan Control Lever

Slide the lever away from "OFF" to turn the heating system on. Move the lever toward  to increase the fan's speed.

#### Temperature Control Lever





Slide the lever to change the temperature of the air flowing from the system. Move it to the right for warmer air and to the left for cooler air. The air temperature can't be less than the outside air temperature.

#### Air Intake Lever

 : Choose this position to recirculate the inside air through the comfort control system.



 : Choose this position to circulate outside air through the comfort control system.

### Heating

1. For the quickest results, move the air intake lever to .
2. Move the airflow lever to .
3. Move the temperature lever toward the right for warmer air.
4. Move the fan lever toward .
5. You should switch to  once in a while to avoid stale air and cloudy windows.



### Bi-Level

You may want to use bi-level on cool, but sunny days. This setting directs outside air toward your body and warmer air toward your feet.



1. Move the air intake lever to .
2. Move the airflow lever to .
3. Move the temperature lever to the center.
4. Move the fan lever toward .

## Ventilation

For mild outside temperatures, when little heating or cooling is needed, you can still direct outside air through your vehicle.

1. Move the air intake lever to .
2. Move the airflow lever to .
3. Adjust the temperature lever to a comfortable setting.
4. Move the fan control lever to .

## Defogging and Defrosting Windows

1. Slide the air intake lever to .
2. Slide the airflow lever to  to direct air to the windshield vents.
3. Slide the temperature lever toward the right.
4. Slide the fan lever to .

When the windshield is clear, turn down the fan speed.

To defog the side windows, slide the airflow lever to . For increased airflow to the side vents, close the center vents.

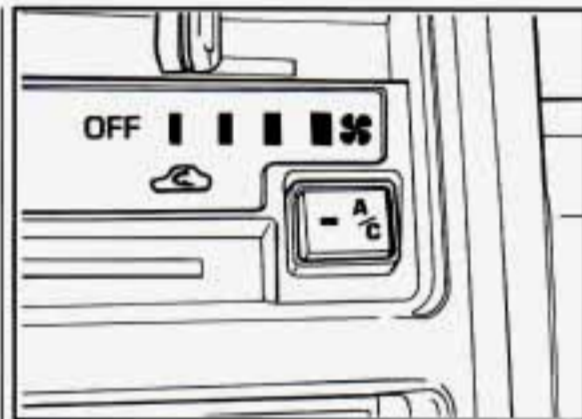





## Air Conditioner Controls

The air conditioning system uses the same controls as the heating system. The function of each lever is explained under "Heater Controls" in this part. The incoming air is cooled and dehumidified instead of being heated.

**A/C:** Push this button to change your comfort control system from heating to air conditioning. A light will come on when the air conditioning is on. The "A/C" button can also control the humidity in your vehicle.



## Cooling

The air conditioner works best if you keep your windows closed. On very hot days, open the windows just long enough for the hot air to escape.

1. Push the "A/C" button.
2. Move the air intake lever to  for normal cooling. For faster cooling move the lever to .
3. Move the airflow lever to .
4. Move the temperature control lever toward the left.
5. Move the fan control lever to .

## Dehumidifying

On days when it is raining or the humidity is high, follow these dehumidifying steps instead of the cooling directions. It will help clean windows that are cloudy with moisture.

1. Push the "A/C" button.
2. Move the air intake lever to .
3. Move the airflow lever to .
4. Move the fan control lever toward .
5. Adjust the temperature control lever to a comfortable setting.

# Comfort Controls and Audio Systems

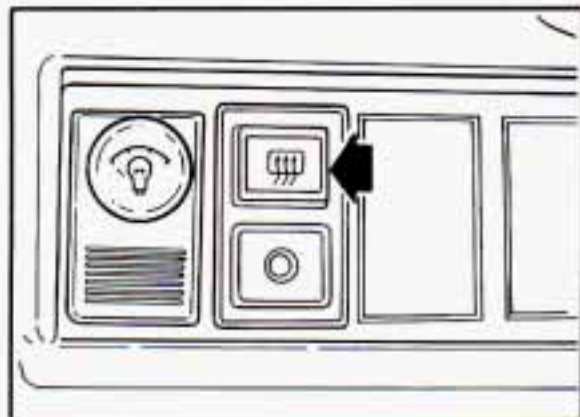

## ***Rear Window Defogger***

The rear window defogger uses a warming grid to remove fog from the rear window.

Press the switch to turn on the defogger. An indicator light will come on below the switch to remind you that the defogger is on. Press the switch again to turn the defogger off. The rear window defogger will also turn off if you turn the ignition switch to "ACC" or "LOCK."

Do not attach anything like a temporary vehicle license or a decal across the defogger grid on the rear window.

## **NOTICE:**

Don't use a razor blade or something else sharp on the inside of the rear window. If you do, you could cut or damage the warming grid, and the repairs wouldn't be covered by your warranty.

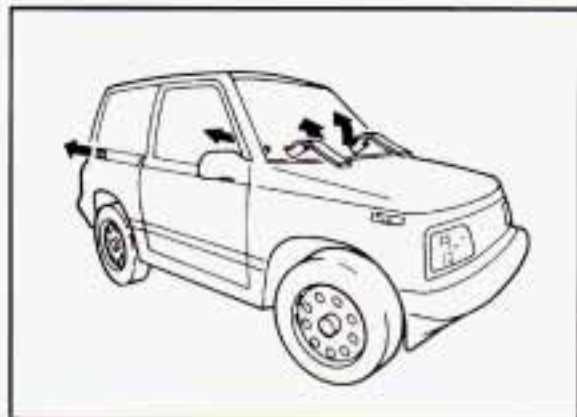

## ***Flow-Through Ventilation System***

Your Geo's flow-through ventilation system supplies outside air into the vehicle when it is moving. Outside air will also enter the vehicle when the heater or the air conditioning fan is running.

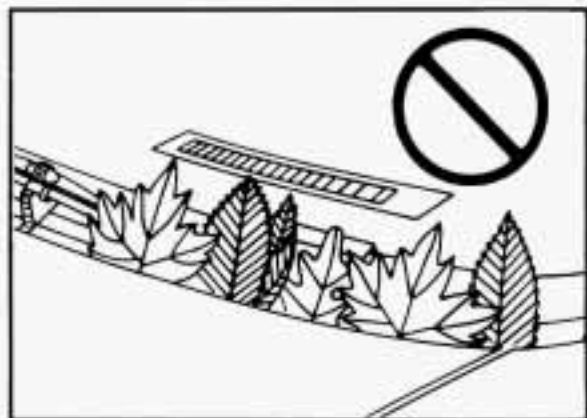

### Ventilation Tips

- Keep the hood and front air inlet free of ice, snow, or any other obstruction (such as leaves). The heater and defroster will work far better, reducing the chance of fogging the inside of your windows.
- When you enter a vehicle in cold weather, move the fan lever toward  for a few moments before driving off. This helps clear the intake ducts of snow and moisture, and reduces the chance of fogging the inside of your windows.
- Keep the air path under the front seats clear of objects. This helps air to circulate throughout your vehicle.

## ■ Audio Systems

Your Delco® audio system has been designed to operate easily and give years of listening pleasure. But you will get the most enjoyment out of it if you acquaint yourself with it first. Find out what your Delco® system can do and how to operate all its controls, to be sure you're getting the most out of the advanced engineering that went into it.

## NOTICE:

Before you add any sound equipment to your vehicle — like a tape player, CB radio, mobile telephone or two-way radio — be sure you can add what you want. If you can, it's very important to do it properly. Added sound equipment may interfere with the operation of your vehicle's engine, Delco® radio or other systems, and even damage them. And, your vehicle's systems may interfere with the operation of sound equipment that has been added improperly. So, before adding sound equipment, check with your dealer and be sure to check Federal rules covering mobile radio and telephone units.



# Comfort Controls and Audio Systems

## Setting the Clock

### AM/FM Stereo

1. Press and hold "RCL" (TIME SET). At the same time, press and hold "TUNE ◀" (HR) until the correct hour appears.
2. Press and hold "RCL" (TIME SET). At the same time press and hold "TUNE ▶" (MIN) until the correct minute appears.

### AM/FM Stereo with Cassette Tape Player

1. Press and hold "RCL/PROG" (TIME SET). At the same time, press and hold "TUNE ◀" (HR) until the correct hour appears.
2. Press and hold "RCL/PROG" (TIME SET). At the same time press and hold "TUNE ▶" (MIN) until the correct minute appears.

### AM/FM Stereo with Cassette Tape and Compact Disc Player

1. Press and hold "RCL ▼▲" (TIME SET). At the same time, press and hold "TUNE ◀" (HR) until the correct hour appears.
2. Press and hold "RCL ▼▲" (TIME SET). At the same time press and hold "TUNE ▶" (MIN) until the correct minute appears.

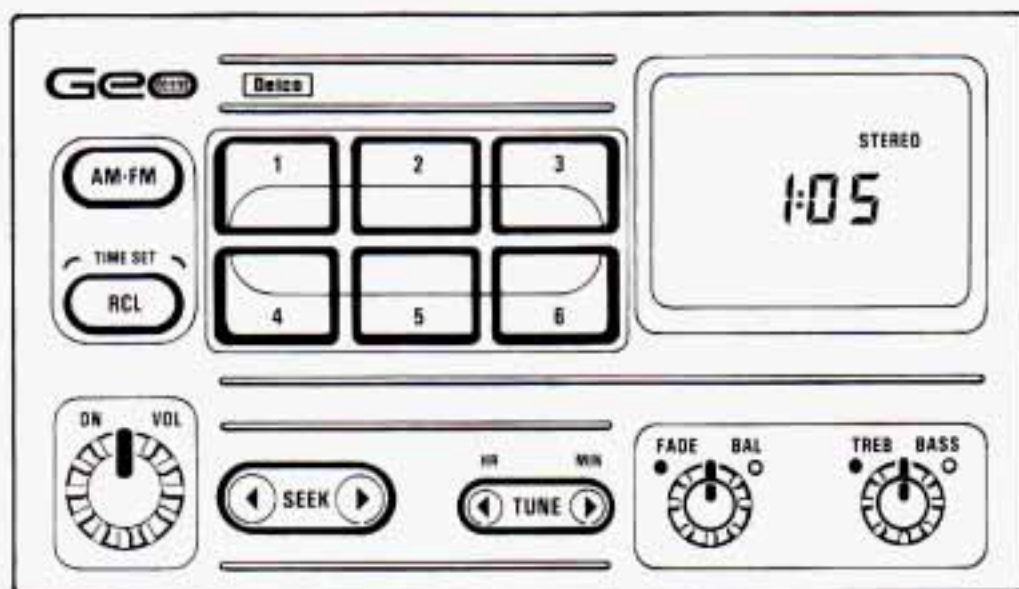

## AM/FM Stereo

### To Play the Radio

Turn the "ON/VOL" knob to turn the system on or off.

**Volume:** Turn the "ON/VOL" knob to adjust the volume.

### Finding a Station

**Band:** Press "AM-FM" to get AM or FM. The lighted display shows your selection.

**Tune:** Press "TUNE ▶" or "TUNE ◀" to go to a higher or lower station. Press and hold to continue tuning and release when you find your station. The display will show the frequency of each station tuned.

**Seek:** Press "SEEK ▶" or "SEEK ◀" and the radio will tune to the next higher or lower station and stay there.

**Pushbuttons:** The six pushbuttons let you return to your favorite stations. To set the pushbuttons for up to 12 stations (6 AM and 6 FM), just:

1. Tune in the station.
2. Press and hold one of the pushbuttons for at least two seconds. The sound will go away for a second and will return when the station is stored.

Repeat these steps for each pushbutton.

#### Setting the Tone

**Treble:** Turn the "TREB" knob to the right to hear more treble.

**Bass:** Turn the "BASS" control behind the "TREB" knob to the right to hear more bass.

#### Adjusting the Speakers

**Fade:** Turn the "FADE" knob to move the sound between the front and rear speakers.

**Balance:** Turn the "BAL" control behind the "FADE" knob to move the sound between the left and right speakers.

#### Recall

Press "RCL" to see the station being played for a moment. Or, press it if you want to see the time when the ignition is off.

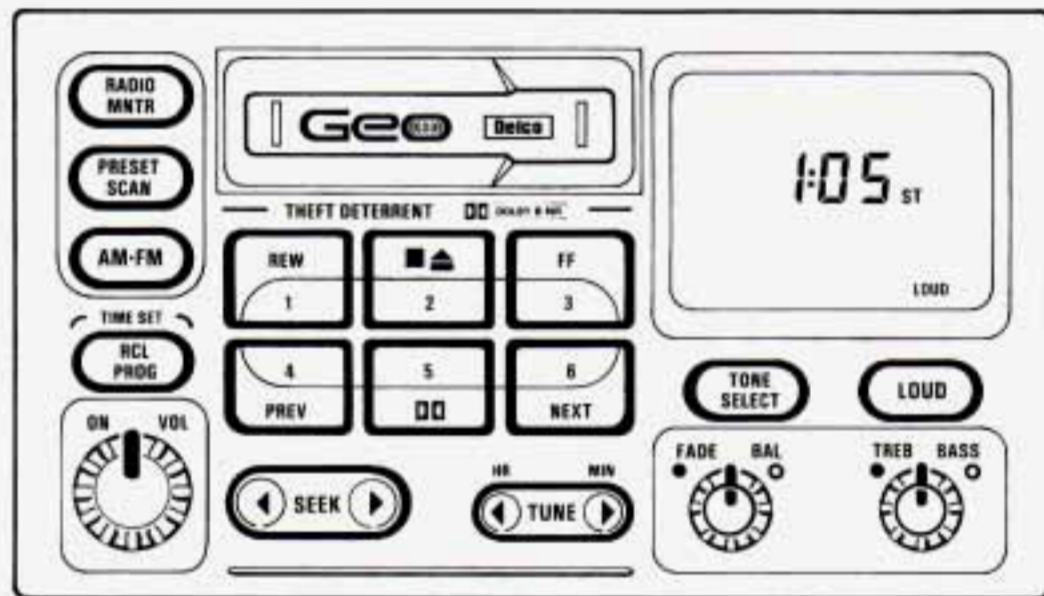

### *AM/FM Stereo with Cassette Tape Player*

#### To Play the Radio

Turn the "ON/VOL" knob to turn the system on or off.

**Volume:** Turn the "ON/VOL" knob to adjust the volume.

#### Finding a Station

**Band:** Press "AM-FM" to get AM, FM1 or FM2. The lighted display shows your selection.

**Tune:** Press and hold "TUNE ►" or "TUNE ◀" to go to higher or lower stations. Release when you find your station. The display will show the frequency of each station tuned.

**Seek:** Press "SEEK ►" or "SEEK ◀" and the radio will tune to the next higher or lower station and stay there.

# Comfort Controls and Audio Systems

**Pushbuttons:** The six pushbuttons let you return to your favorite stations. To set the pushbuttons for up to 18 stations (6 AM, 6 FM1 and 6 FM2), just:

1. Tune in the station.
2. Press and hold one of the pushbuttons for more than two seconds. The sound will go away for a second and will return when the station is stored.

Repeat these steps for each pushbutton.

**Preset Scan:** Press the "PRESET SCAN" button to hear each of your preset stations for a few seconds. When you want to stop at a chosen station, press "PRESET SCAN" again.

## Setting the Tone

**Treble:** Turn the "TREB" knob to the right to hear more treble.

**Bass:** Turn the "BASS" control behind the "TREB" knob to the right to hear more bass.

Treble and bass cannot be adjusted manually when "TONE SELECT" is on.

**Loud:** To increase the bass tone at low volumes, press the "LOUD" button.

**Tone Select:** Press "TONE SELECT" to choose preset treble and bass equalization

settings designed for "ROCK," "NEWS," "POP," "JAZZ" and "CLASSICAL."

"ROCK" will appear when you first press "TONE SELECT." Each time you press it, another setting will appear on the display. Press it after "CLASSICAL" and tone control will be back to the treble and bass knobs.

## Adjusting the Speakers

**Fade:** Turn the "FADE" knob to move the sound between the front and rear speakers.

**Balance:** Turn the "BAL" control behind the "FADE" knob to move the sound between the right and left speakers.

## Recall

Press "RCL" to see the station being played for a moment. Or, press it if you want to see the time when the ignition is off.

## To Play a Cassette Tape

Your tape player is built to work best with tapes that are 30 to 45 minutes long on each side. Tapes longer than that are so thin they may not work well in this player.

The longer side with the tape visible should face to the right. If you hear nothing or hear just a garbled sound, it may not be in squarely. Press "■▲" to remove the tape and start over.

Once the tape is playing, use the knobs for volume, fade and balance, just as you do for radio. The lighted arrows show which side of the tape is playing.

**Metal Tapes:** Your bias is set automatically. When a metal or chrome tape is inserted, "MTL" will appear on the display.

**Fast Forward:** Press "FF" to advance rapidly to another part of the tape. Press "FF," "RCL/PROG" or "■▲" to return to playing speed.

**Rewind:** Press "REW" to reverse the tape rapidly. Press "REW," "RCL/PROG" or "■▲" to return to playing speed.

**Next Selection:** Press "NEXT" to go forward to the beginning of the next selection. Press "NEXT" again or press "RCL/PROG" or "■▲" to cancel this function.

For "NEXT" to work properly, your tape must have at least three or four seconds of silence between each selection.

**Previous Selection:** Press "PREV" to go back to the beginning of the last selection. Press "PREV" again or press "RCL/PROG" or "■▲" to cancel this function.

**Program:** Press "RCL/PROG" to switch from one side of the tape to the other. Your cassette tape player can play continuously because the player has an auto-reverse feature.

**Noise Reduction:** Press **DD**® to remove noise from Dolby® B NR-encoded tapes. Dolby® B Noise Reduction manufactured under license from Dolby Laboratories Licensing Corporation.

"Dolby®" and the **DD**® symbol are trademarks of Dolby Laboratories Licensing Corporation.

**Eject:** Press "■▲" to remove the tape and switch to radio.

**Radio Monitor:** Press the "RADIO MNTR" button to hear the radio when you are fast forwarding or reversing a cassette tape. You can use the "TUNE," "SEEK" and "PRESET-SCAN" buttons while in the radio monitor mode.

### Theft Deterrent Feature

The theft deterrent feature for the AM/FM stereo with cassette tape player can be used or ignored. If ignored, the system plays normally. If it is used, your system won't be usable if it's ever stolen.

### Setting Your Security Code

The instructions below tell you how to enter a security code into the system. If your vehicle loses battery power for any reason, you must enter the security code again before the system will turn on.

1. Write down any four-digit number and keep it in a safe place.
2. Turn on the ignition switch to the "ACC" or "ON" position.
3. Turn the audio system off.
4. Press the "1" and "4" buttons together. Hold them down until "----" shows on the display.

You are now ready to enter your security code. Don't wait more than 15 seconds between steps.

5. Press "◀ SEEK ▶" and/or "◀ TUNE ▶" and "0000" will appear on the display.
6. Press "SEEK ◀" and hold it until the first digit of your code appears. Release the button.
7. Press "SEEK ▶" and hold it until the second digit of your code appears. Release the button.
8. Press "TUNE ◀" and hold it until the third digit of your code appears. Release the button.
9. Press "TUNE ▶" and hold it until the fourth digit of your code appears. Release the button.
10. Press "AM-FM" after you have checked that the code you entered is the one you wrote down. "rEP" will appear in the display, which means you need to repeat steps 5 through 9.
11. Press "AM-FM" again and the display will now show "SEC."

# Comfort Controls and Audio Systems

## How to Shut Off the Theft-Deterrent Feature

If your radio is secured ("SEC" shows on the display) and you wish to disable it, enter your security code as follows, pausing no more than 15 seconds between steps:

1. Press the "1" and "4" buttons together. Hold them down until "SEC" shows on the display. You are now ready to enter your security code.
2. Press the "SEEK◀" button and hold it until the first digit of your code appears.
3. Press the "SEEK▶" button and hold it until the second digit of your code appears.
4. Press the "TUNE◀" button and hold it until the third digit of your code appears.

5. Press the "TUNE▶" button and hold it until the fourth digit of your code appears.

6. Press "AM-FM" after you have checked that the code you entered matches the one you wrote down. "----" should now appear in the display.

If the code is correct, the radio will now operate. If the code is wrong, "Err" will appear in the display.

## To Unlock the System After a Power Loss

If power is disrupted to the radio while in the "SEC" mode, the unit will not work and "LOC" will show on the display whenever the ignition is on. To unlock the unit:

1. Press "◀SEEK▶" and/or "◀TUNE▶" and "0000" will appear on the display.
2. Press the "SEEK◀" button and hold it until the first digit of your code appears.
3. Press the "SEEK▶" button and hold it until the second digit of your code appears.
4. Press the "TUNE◀" button and hold it until the third digit of your code appears.
5. Press the "TUNE▶" button and hold it until the fourth digit of your code appears.
6. Press "AM-FM" after you have checked that the code matches the one you wrote down. Now "SEC" will appear on the display.

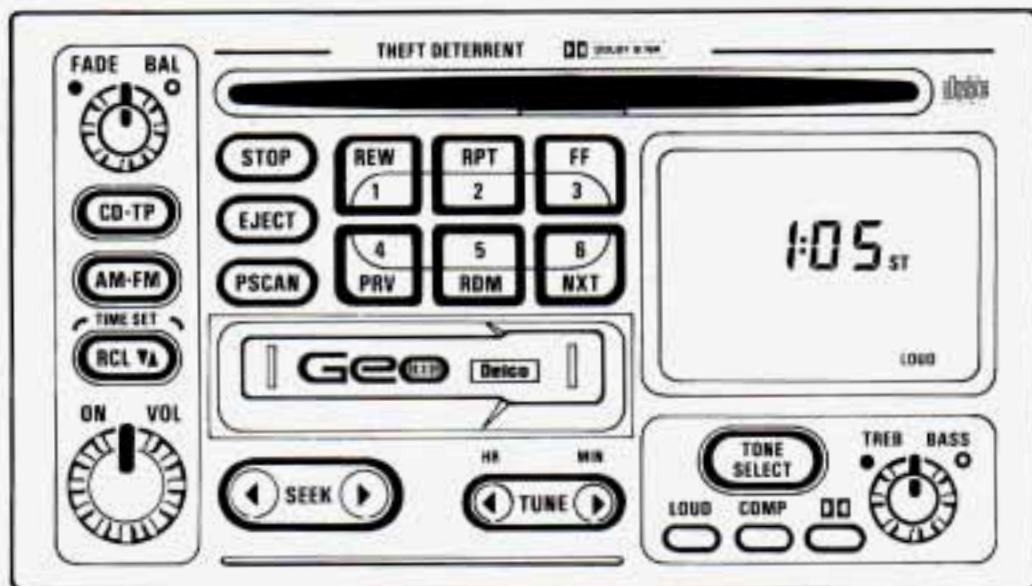

## ***AM/FM Stereo with Cassette Tape and Compact Disc Player***

### **To Play the Radio**

Turn the "ON/VOL" knob to turn the system on or off.

**Volume:** Turn the "ON/VOL" knob to adjust the volume.

### **Finding a Station**

**Band:** Press "AM-FM" to get AM, FM1 or FM2. The lighted display shows your selection.

**Tune:** Press and hold "TUNE ►" or "TUNE ◀" to go to higher or lower stations. Release when you find your station. The display will indicate the frequency of each station tuned.

**Seek:** Press "SEEK ►" or "SEEK ◀" and the radio will tune to the next higher or lower station and stay there.

**Pushbuttons:** The six pushbuttons let you return to your favorite stations. To set the pushbuttons for up to 18 stations (6 AM, 6 FM1 and 6 FM2), just:

1. Tune in the station.
2. Press and hold one of the pushbuttons for more than two seconds. The sound will go away for a second and will return when the station is stored.

Repeat these steps for each pushbutton.

**Preset Scan:** Press the "PSCAN" button to hear each of your FM preset stations for a few seconds. When you want to stop at a chosen station, press "PSCAN" again.

### **Setting the Tone**

**Treble:** Turn the "TREB" knob to the right to hear more treble.

**Bass:** Turn the "BASS" control behind the "TREB" knob to the right to hear more bass.

Treble and bass cannot be adjusted manually when "TONE SELECT" is on.

**Loud:** To increase the bass tone at low volumes, press the "LOUD" button.

# Comfort Controls and Audio Systems

**Tone Select:** Press "TONE SELECT" to choose preset treble and bass equalization settings designed for "ROCK," "NEWS," "POP," "JAZZ" and "CLASSICAL."

"ROCK" will appear when you first press "TONE SELECT." Each time you press it, another setting will appear on the display. Press it after "CLASSICAL" and tone control will be back to the treble and bass knobs.

## Adjusting the Speakers

**Fade:** Turn the "FADE" knob to move the sound between the front and rear speakers.

**Balance:** Turn the "BAL" control behind the "FADE" knob to move the sound between the right and left speakers.

## Recall

Press "RCL▼▲" to see the station being played for a moment. Or, press it if you want to see the time when the ignition is off.

## To Play a Cassette Tape

Your tape player is built to work best with tapes that are 30 to 45 minutes long on

each side. Tapes longer than that are so thin they may not work well in this player.

The longer side with the tape visible should face to the right. If you hear nothing or hear just a garbled sound, it may not be in squarely. Press "STOP" or "EJECT" to remove the tape and start over.

Once the tape is playing, use the knobs for volume, fade and balance, just as you do for radio. The lighted arrows show which side of the tape is playing.

**Metal Tapes:** Your bias is set automatically. When a metal or chrome tape is inserted, "MTL" will appear on the display.

**Fast Forward:** Press "FF" to advance rapidly to another part of the tape. Press "FF," "RCL▼▲" or "STOP" to return to playing speed.

**Rewind:** Press "REW" to reverse the tape rapidly. Press "REW," "RCL▼▲" or "STOP" to return to playing speed.

**Next Selection:** Press "NXT" to go forward to the beginning of the next selection. Press "NXT" again or press "RCL▼▲" or "STOP" to cancel this function.

**Previous Selection:** Press "PRV" to go back to the beginning of the selection. Press "PRV" again or press "RCL▼▲" or "STOP" to cancel this function.

For "NXT" and "PRV" to work properly, your tape must have at least three or four seconds of silence between each selection.

**Repeat:** Press "RPT" to go to the beginning of the selection and play it again. Press "RPT" again to cancel this function.

**Noise Reduction:** Press  to remove noise from Dolby<sup>®</sup> B NR-encoded tapes. Dolby<sup>®</sup> B Noise Reduction manufactured under license from Dolby Laboratories Licensing Corporation.

"Dolby<sup>®</sup>" and the  symbol are trademarks of Dolby Laboratories Licensing Corporation.

**Radio Monitor:** When playing a tape, press "RDM" during "FF" or "REW" to hear the radio. Press "RDM" again to turn the radio off. During "RDM" operation, only "TUNE," "SEEK" and "PSCAN" will work.

**Tape Sides:** Press "RCL▼▲" to switch from one side of the tape to the other.

**Stop:** Press "STOP" to stop the tape and switch to radio.

**Eject:** Press "EJECT" to remove the tape and switch to radio.

### To Play a Compact Disc

Don't use the mini-discs (3" singles). They won't eject. Use full-size compact discs.

Insert your disc into the CD slot on your audio system.

If the disc comes back out, it could be that:

- The disc is upside down.
- It is dirty, scratched, or wet.
- There is too much moisture in the air. (If there is, wait about one hour and try again.)

If you see "Err" on the display, the disc player is too hot to play the disc. Press "RCL ▼▲" to take "Err" off the display.

**Track Number and Playing Time:** Press "RCL ▼▲" to see which track is playing. Press it again within five seconds to see how long it has been playing.

The track number also appears when the disc is inserted or you change the volume.

**Previous Track:** Press "PRV" to hear a track again. If you hold this button, or press it more than once, the disc will return to previous tracks.

**Next Track:** Press "NXT" to hear the next track now (instead of waiting until the present track is finished).

If you hold this button, or press it more than once, the disc will advance further.

**Rewind:** Press and hold "REW" to return rapidly to a favorite passage. Release it to play the passage.

**Fast Forward:** Press and hold "FF" to advance quickly within a track. Release it to resume playing.

**Compression:** Press "COMP" to make soft and loud passages more nearly equal in volume.

**Repeat:** Press "RPT" once to hear a selection over again.

**Random:** Pressing "RDM" will cause the CD player to play the tracks back in random order. To cancel the random feature, press "RDM," "STOP" or "RPT."

**Stop:** Press "STOP" to stop playing the disc and switch to radio. Press "STOP" again to restart the disc at the point where it stopped. Press "AM-FM" to cancel CD operation and listen to the radio.

**CD-Tape:** Press "CD-TP" to switch between playing a tape and a CD when both are inserted.

**Eject:** Press "EJECT" to eject the disc and the radio will play. The disc will start playing at track 1 when you reinsert it.

### Special Eject

If you choose, you can eject only the tape or CD when you have both a CD and a tape in your audio system.

- **CD Only:** To eject only the CD, press "EJECT" and then press "REW."
- **Tape Only:** To eject only the tape, press "EJECT" and then press "PRV."



# Comfort Controls and Audio Systems

## Theft Deterrent Feature

The theft deterrent feature for the AM/FM stereo with cassette tape and compact disc player can be used or ignored. If ignored, the system plays normally. If it is used, your system won't be usable if it's ever stolen.

## Setting Your Security Code

The instructions below tell you how to enter a security code into the system. If your vehicle loses battery power for any reason, you must enter the security code again before the system will turn on.

1. Write down any four-digit number and keep it in a safe place.
2. Turn on the ignition switch to the "ACC" or "ON" position.
3. Turn the audio system off.
4. Press the "1" and "4" buttons together. Hold them down until "----" shows on the display.

You are now ready to enter your security code. Don't wait more than 15 seconds between steps.

5. Press "◀ SEEK ▶" and/or "◀ TUNE ▶" and "0000" will appear on the display.
6. Press "SEEK ◀" and hold it until the first digit of your code appears. Release the button.
7. Press "SEEK ▶" and hold it until the second digit of your code appears. Release the button.
8. Press "TUNE ◀" and hold it until the third digit of your code appears. Release the button.
9. Press "TUNE ▶" and hold it until the fourth digit of your code appears. Release the button.
10. Press "AM-FM" after you have checked that the code you entered is the one you wrote down. "rEP" will appear in the display, which means you need to repeat steps 5 through 9.
11. Press "AM-FM" again and the display will now show "SEC."

## How to Shut Off the Theft-Deterrent Feature

If your radio is secured ("SEC" shows on the display) and you wish to disable it, enter your security code as follows, pausing no more than 15 seconds between steps:

1. Press the "1" and "4" buttons together. Hold them down until "SEC" shows on the display. You are now ready to enter your security code.
2. Press the "SEEK ◀" button and hold it until the first digit of your code appears.
3. Press the "SEEK ▶" button and hold it until the second digit of your code appears.
4. Press the "TUNE ◀" button and hold it until the third digit of your code appears.
5. Press the "TUNE ▶" button and hold it until the fourth digit of your code appears.
6. Press "AM-FM" after you have checked that the code you entered matches the one you wrote down. "----" should now appear in the display.

If the code is correct, the radio will operate. If the code is wrong, "Err" will appear in the display.

### **To Unlock the System After a Power Loss**

If power is disrupted to the radio while in the "SEC" mode, the unit will not work and "LOC" will show on the display whenever the ignition is on. To unlock the unit:

1. Press "◀ SEEK ▶" and/or "◀ TUNE ▶" and "0000" will appear on the display.
2. Press the "SEEK ◀" button and hold it until the first digit of your code appears.
3. Press the "SEEK ▶" button and hold it until the second digit of your code appears.
4. Press the "TUNE ◀" button and hold it until the third digit of your code appears.
5. Press the "TUNE ▶" button and hold it until the fourth digit of your code appears.
6. Press "AM-FM" after you have checked that the code matches the one

you wrote down. Now "SEC" will appear on the display.

## ***Understanding Radio Reception***

### **FM Stereo**

FM stereo will give you the best sound. But FM signals will reach only about 10 to 40 miles (16 to 65 km). And, tall buildings or hills can interfere with FM signals, causing the sound to come and go.

### **AM**

The range for most AM stations is greater than for FM, especially at night. The longer range, however, can cause stations to interfere with each other. AM can pick up noise from things like storms and power lines. Try reducing the treble to reduce this noise if you ever get it.



## ***Care of Your Cassette Tape Player***

A tape player that is not cleaned regularly can cause reduced sound quality, ruined cassettes, or a damaged mechanism. Cassette tapes should be stored in their cases away from contaminants, direct sunlight, and extreme heat. If they aren't, they may not operate properly or cause failure of the tape player.

Your tape player should be cleaned regularly each month or after every 15 hours of use. If you notice a reduction in sound quality, try a known good cassette to see if the tape or the tape player is at fault. If this other cassette has no improvement in sound quality, clean the tape player.

# Comfort Controls and Audio Systems

Clean your tape player with a wiping-action, non-abrasive cleaning cassette, and follow the directions provided with it.

Cassettes are subject to wear and the sound quality may degrade over time. Always make sure that the cassette tape is in good condition before you have your tape player serviced.

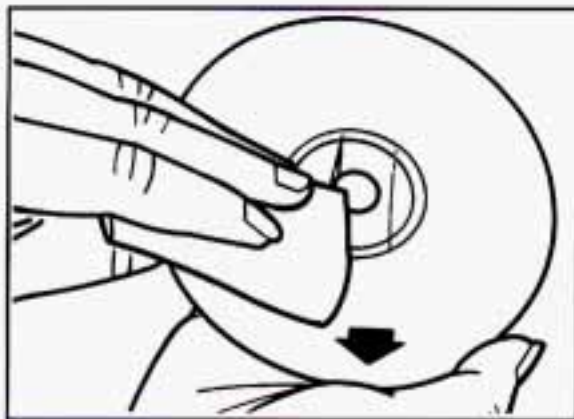

## ***Care of Your Compact Discs***

Handle discs carefully. Store them in their original cases or other protective cases and away from direct sunlight and dust. If the surface of a disc is soiled, dampen a clean, soft cloth in a mild, neutral detergent solution and clean it, wiping from the center to the edge.

Be sure never to touch the signal surface when handling discs. Pick up discs by grasping the outer edges or the edge of the hole and the outer edge.

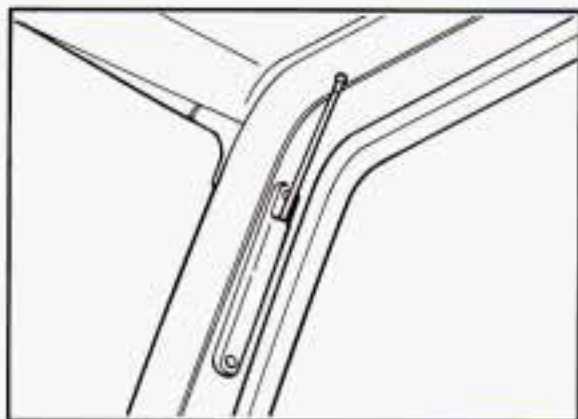

## ***Antenna***

Use the knob on the end of the antenna to raise the antenna or to push it back down. Keep the antenna mast clean for good performance.

Always lower the antenna before entering a car wash. If you have the convertible top, also lower the antenna before removing or installing the top.

## Part 4

# Your Driving and the Road



**H**ere you'll find information about driving on different kinds of roads and in varying weather conditions. We've also included many other useful tips on driving.

Defensive Driving .....	100
Drunken Driving .....	100
Control of a Vehicle .....	102
Driving Guidelines .....	107
Off-Road Driving with Your Geo Four-Wheel Drive Vehicle .....	108
Driving at Night .....	116
Driving in the Rain .....	117
City Driving .....	119
Freeway Driving .....	120
Hill and Mountain Roads .....	121
Winter Driving .....	122
Towing a Trailer .....	125
Recreational Vehicle Towing .....	129

# Your Driving and the Road

## ■ *Defensive Driving*

The best advice anyone can give about driving is: Drive defensively.

Please start with a very important safety device in your Geo: Buckle up. (See "Safety Belts" in the Index.)

Defensive driving really means "be ready for anything." On city streets, rural roads, or freeways, it means "always expect the unexpected."

Assume that pedestrians or other drivers are going to be careless and make mistakes. Anticipate what they might do. Be ready for their mistakes.

Rear-end collisions are about the most preventable of accidents. Yet they are common. Allow enough following distance. It's the best defensive driving maneuver, in both city and rural driving. You never know when the vehicle in front of you is going to brake or turn suddenly.

## ■ *Drunken Driving*

Death and injury associated with drinking and driving is a national tragedy. It's the number one contributor to the highway death toll, claiming thousands of victims every year. Alcohol takes away three things that anyone needs to drive a vehicle:

- Judgment
- Muscular Coordination
- Vision

Police records show that almost half of all motor vehicle-related deaths involve alcohol — a driver, a passenger or someone else, such as a pedestrian, had been drinking. In most cases, these deaths are the result of someone who was drinking and driving. About 20,000 motor vehicle-related deaths occur each year because of alcohol, and thousands of people are injured.

Just how much alcohol is too much if a person plans to drive? Ideally, no one should drink alcohol and then drive. But if one does, then what's "too much"? It can be a lot less than many might think. Although it depends on each person and situation, here is some general information on the problem.

The Blood Alcohol Content (BAC) of someone who is drinking depends upon four things:

- How much alcohol is in the drink.
- The drinker's body weight.
- The amount of food that is consumed before and during drinking.
- The length of time it has taken the drinker to consume the alcohol.



According to the American Medical Association, a 180-pound (82 kg) person who drinks three 12-ounce (355 ml) bottles of beer in an hour will end up with a BAC of about 0.06 percent. The person would reach the same BAC by drinking three 4-ounce (120 ml) glasses of wine or three mixed drinks if each had 1-1/2 ounces (45 ml) of a liquor like whiskey, gin or vodka.

It's the amount of alcohol that counts. For example, if the same person drank three double martinis (3 ounces or 90 ml of liquor each) within an hour, the person's BAC would be close to 0.12 percent. A person who consumes food just before or during drinking will have a slightly lower BAC level.

### DRINKING THAT WILL RESULT IN A BAC OF .05% IN THE TIME SHOWN

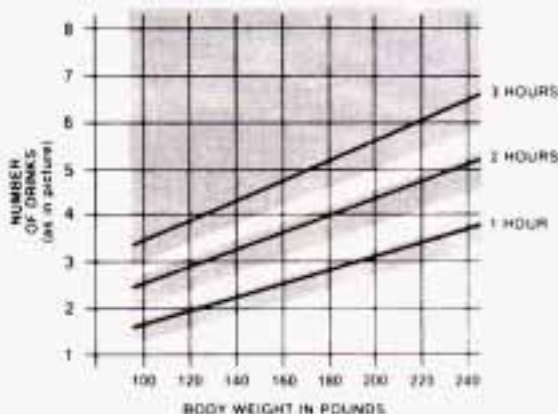

The law in most U.S. states sets the legal limit at a BAC of 0.10 percent. In Canada the limit is 0.08 percent, and in some other countries it's lower than that. The BAC will be over 0.10 percent after three to six drinks (in one hour). Of course, as we've seen, it depends on how much alcohol is in the drinks, and how quickly the person drinks them.

But it's very important to keep in mind that the ability to drive is affected well below a BAC of 0.10 percent. Research shows that the driving skills of many people are impaired at a BAC approaching 0.05 percent, and that the effects are worse at night. All drivers are impaired at BAC levels above 0.05 percent. Statistics show that the chance of being in an accident increases sharply for drivers who have a BAC of 0.05 percent or above. A driver with a BAC level of 0.06 percent (three beers in one hour for a 180-pound or 82 kg person) has doubled his or her chance of having an accident. At a BAC level of 0.10 percent, the chance of that driver having an accident is six times greater; at a level of 0.15 percent, the chances are twenty-five times greater! And, the body takes about an hour to rid itself of the alcohol in one drink. No amount of coffee or number of cold showers will speed that up. "I'll be careful" isn't the right answer. What if there's an emergency, a need to take sudden action, as when a child darts into the street? A person with a higher BAC might not be able to react quickly enough to avoid the collision.

# Your Driving and the Road

There's something else about drinking and driving that many people don't know. Medical research shows that alcohol in a person's system can make crash injuries worse. That's especially true for brain, spinal cord and heart injuries. That means that if anyone who has been drinking — driver or passenger — is in a crash, the chance of being killed or permanently disabled is higher than if that person had not been drinking. And we've already seen that the chance of a crash itself is higher for drinking drivers.



## CAUTION:

Drinking and then driving is very dangerous. Your reflexes, perceptions, and judgment will be affected by even a small amount of alcohol. You could have a serious — or even fatal — accident if you drive after drinking. Please don't drink and drive or ride with a driver who has been drinking. Ride home in a cab; or if you're with a group, designate a driver who will not drink.

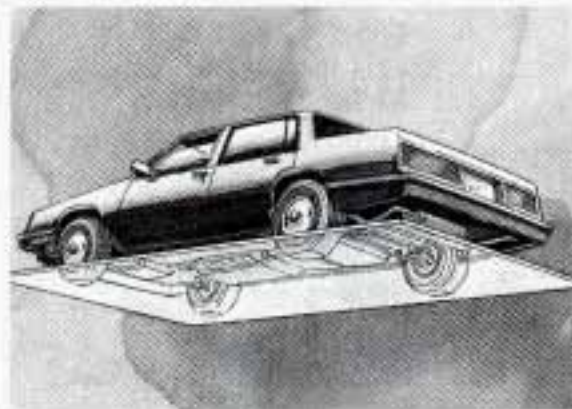

## ■ *Control of a Vehicle*

You have three systems that make your vehicle go where you want it to go. They are the brakes, the steering and the accelerator. All three systems have to do their work at the places where the tires meet the road.

Sometimes, as when you're driving on snow or ice, it's easy to ask more of those control systems than the tires and road can provide. That means you can lose control of your vehicle.

## *Braking*

Braking action involves perception time and reaction time.

First, you have to decide to push on the brake pedal. That's perception time. Then you have to bring up your foot and do it. That's reaction time.

Average reaction time is about 3/4 of a second. But that's only an average. It might be less with one driver and as long as two or three seconds or more with another. Age, physical condition, alertness, coordination, and eyesight all play a part. So do alcohol, drugs and frustration. But even in 3/4 of a second, a vehicle moving at 60 mph (100 km/h) travels 66 feet (20 m). That could be a lot of distance in an emergency, so keeping enough space between your vehicle and others is important.

And, of course, actual stopping distances vary greatly with the surface of the road (whether it's pavement or gravel); the condition of the road (wet, dry, icy); tire tread; and the condition of your brakes.

Avoid needless heavy braking. Some people drive in spurts — heavy acceleration followed by heavy braking — rather than keeping pace with traffic.

This is a mistake. Your brakes may not have time to cool between hard stops. Your brakes will wear out much faster if you do a lot of heavy braking. If you keep pace with the traffic and allow realistic following distances, you will eliminate a lot of unnecessary braking. That means better braking and longer brake life.

If your engine ever stops while you're driving, brake normally but don't pump your brakes. If you do, the pedal may get harder to push down. If your engine stops, you will still have some power brake assist. But you will use it when you brake. Once the power assist is used up, it may take longer to stop and the brake pedal will be harder to push.



#### **Anti-Lock Brakes (ABS)**

Your vehicle has an advanced electronic braking system that can help you keep it under control.

Here's how anti-lock works. Let's say the road is wet. You're driving safely. Suddenly an animal jumps out in front of you.

You slam on the brakes. Here's what happens with ABS.

A computer senses that the rear wheels are slowing down. If one of the rear wheels is about to stop rolling, the computer will work the brakes at the rear wheels. It is programmed to make the most of available tire and road conditions.



As you brake, your computer keeps receiving updates on rear wheel speed and controls braking pressure accordingly.

Remember: Anti-lock doesn't change the time you need to get your foot up to the brake pedal. If you get too close to the vehicle in front of you, you won't have time to apply your brakes if that vehicle suddenly slows or stops. Always leave enough room up ahead to stop, even though you have anti-lock brakes.

#### **To Use Anti-Lock:**

Use rear-wheel anti-lock like regular brakes. You may feel the brakes vibrate, or you may notice some noise outside your vehicle, but this is normal. Let anti-lock work for you, but remember: Your front wheels can still stop rolling. If



# Your Driving and the Road

that happens, release enough pressure on the brakes to get the wheels rolling again so that you can steer.

With the four-wheel drive option, you won't have anti-lock braking when you shift into four-wheel drive. But you will have regular braking. When you shift back into two-wheel drive, you will have anti-lock again.

## **Braking in Emergencies**

At some time, nearly every driver gets into a situation that requires hard braking.

You have the rear-wheel anti-lock braking system. Your front wheels can stop rolling when you brake very hard. Once they do, the vehicle can't respond to your steering. Momentum will carry it in whatever direction it was headed when the front wheels stopped rolling. That could be off the road, into the very thing you were trying to avoid, or into traffic.

So, use a "squeeze" braking technique. This will give you maximum braking while maintaining steering control. You do this by pushing on the brake pedal with steadily increasing pressure. When you do, it will help maintain steering control. In many emergencies, steering can help you more than even the very best braking.

## **Steering**

### **Power Steering**

If you lose power steering assist because the engine stops or the system is not functioning, you can steer but it will take much more effort.

### **Steering Tips**

#### **Driving on Curves**

It's important to take curves at a reasonable speed.

A lot of the "driver lost control" accidents mentioned on the news happen on curves. Here's why:

Experienced driver or beginner, each of us is subject to the same laws of physics when driving on curves. The traction of the tires against the road surface makes it possible for the vehicle to change its path when you turn the front wheels. If there's no traction, inertia will keep the vehicle going in the same direction. If you've ever tried to steer a vehicle on wet ice, you'll understand this.

The traction you can get in a curve depends on the condition of your tires and the road surface, the angle at which the curve is banked, and your speed. While

you're in a curve, speed is the one factor you can control.

Suppose you're steering through a sharp curve. Then you suddenly apply the brakes. Both control systems — steering and braking — have to do their work where the tires meet the road. Adding the hard braking can demand too much at those places. You can lose control.

The same thing can happen if you're steering through a sharp curve and you suddenly accelerate. Those two control systems — steering and acceleration — can overwhelm those places where the tires meet the road and make you lose control.

What should you do if this ever happens? Ease up on the brake or accelerator pedal, steer the vehicle the way you want it to go, and slow down.

Speed limit signs near curves warn that you should adjust your speed. Of course, the posted speeds are based on good weather and road conditions. Under less favorable conditions you'll want to go slower.

If you need to reduce your speed as you approach a curve, do it before you enter

the curve, while your front wheels are straight ahead.

Try to adjust your speed so you can "drive" through the curve. Maintain a reasonable, steady speed. Wait to accelerate until you are out of the curve, and then accelerate gently into the straightaway.

### Steering in Emergencies

There are times when steering can be more effective than braking. For example, you come over a hill and find a truck stopped in your lane, or a car suddenly pulls out from nowhere, or a child darts out from between parked cars and stops right in front of you. You can avoid these problems by braking — if you can stop in time. But sometimes you can't; there isn't room. That's the time for evasive action — steering around the problem.

Your Geo can perform very well in emergencies like these. First apply your brakes, but not enough to lock your front wheels. It is better to remove as much speed as you can from a possible collision. Then steer around the problem, to the left or right depending on the space available.



An emergency like this requires close attention and a quick decision. If you are holding the steering wheel at the recommended 9 and 3 o'clock positions, you can turn it a full 180 degrees very quickly without removing either hand. But you have to act fast, steer quickly, and just as quickly straighten the wheel once you have avoided the object.

The fact that such emergency situations are always possible is a good reason to practice defensive driving at all times and wear safety belts properly.

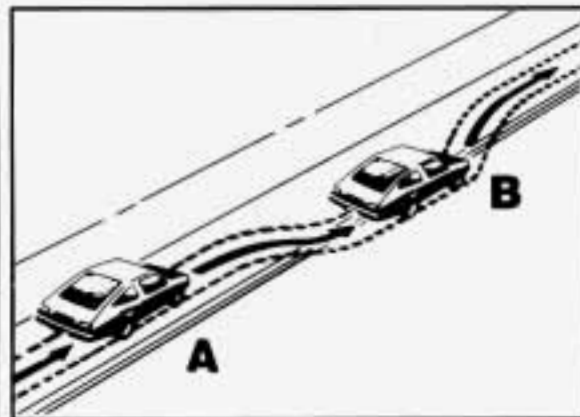

### Off-Road Recovery

You may find sometime that your right wheels have dropped off the edge of a road onto the shoulder (A) while you're driving.

If the level of the shoulder is only slightly below the pavement, recovery should be fairly easy. Ease off the accelerator and then, if there is nothing in the way, steer so that your vehicle straddles the edge of the pavement. You can turn the steering wheel up to 1/4 turn (B) until the right front tire contacts the pavement edge. Then turn your steering wheel to go straight down the roadway.

# Your Driving and the Road

## *Passing*

The driver of a vehicle about to pass another on a two-lane highway waits for just the right moment, accelerates, moves around the vehicle ahead, then goes back into the right lane again. A simple maneuver?

Not necessarily! Passing another vehicle on a two-lane highway is a potentially dangerous move, since the passing vehicle occupies the same lane as oncoming traffic for several seconds. A miscalculation, an error in judgment, or a brief surrender to frustration or anger can suddenly put the passing driver face to face with the worst of all traffic accidents — the head-on collision.

So here are some tips for passing:

- “Drive ahead.” Look down the road, to the sides, and to crossroads for situations that might affect your passing patterns. If you have any doubt whatsoever about making a successful pass, wait for a better time.
- Watch for traffic signs, pavement markings, and lines. If you can see a sign up ahead that might indicate a turn or an intersection, delay your pass. A broken center line usually

indicates it’s all right to pass (providing the road ahead is clear). Never cross a solid line on your side of the lane or a double solid line, even if the road seems empty of approaching traffic.

- Do not get too close to the vehicle you want to pass while you’re awaiting an opportunity. For one thing, following too closely reduces your area of vision, especially if you’re following a larger vehicle. Also, you won’t have adequate space if the vehicle ahead suddenly slows or stops. Keep back a reasonable distance.
- When it looks like a chance to pass is coming up, start to accelerate but stay in the right lane and don’t get too close. Time your move so you will be increasing speed as the time comes to move into the other lane. If the way is clear to pass, you will have a “running start” that more than makes up for the distance you would lose by dropping back. And if something happens to cause you to cancel your pass, you need only slow down and drop back again and wait for another opportunity.

- If other cars are lined up to pass a slow vehicle, wait your turn. But take care that someone isn’t trying to pass you as you pull out to pass the slow vehicle. Remember to glance over your shoulder and check the blind spot.
- Check your mirrors, glance over your shoulder, and start your left lane change signal before moving out of the right lane to pass. When you are far enough ahead of the passed vehicle to see its front in your inside mirror, activate your right lane change signal and move back into the right lane. (Remember that your right outside mirror is convex. The vehicle you just passed may seem to be farther away from you than it really is.)
- Try not to pass more than one vehicle at a time on two-lane roads. Reconsider before passing the next vehicle.
- Don’t overtake a slowly moving vehicle too rapidly. Even though the brake lights are not flashing, it may be slowing down or starting to turn.
- If you’re being passed, make it easy for the following driver to get ahead of you. Perhaps you can ease a little to the right.

## ***Loss of Control***

Let's review what driving experts say about what happens when the three control systems (brakes, steering and acceleration) don't have enough friction where the tires meet the road to do what the driver has asked.

In any emergency, don't give up. Keep trying to steer and constantly seek an escape route or area of less danger.

### **Skidding**

In a skid, a driver can lose control of the vehicle. Defensive drivers avoid most skids by taking reasonable care suited to existing conditions, and by not "overdriving" those conditions. But skids are always possible.

The three types of skids correspond to your Geo's three control systems. In the braking skid your wheels aren't rolling. In the steering or cornering skid, too much speed or steering in a curve causes tires to slip and lose cornering force. And in the acceleration skid too much throttle causes the driving wheels to spin.

A cornering skid and an acceleration skid are best handled by easing your foot off the accelerator pedal.

If your vehicle starts to slide, ease your foot off the accelerator pedal and quickly steer the way you want the vehicle to go. If you start steering quickly enough, your vehicle may straighten out. Always be ready for a second skid if it occurs.

Of course, traction is reduced when water, snow, ice, gravel, or other material is on the road. For safety, you'll want to slow down and adjust your driving to these conditions. It is important to slow down on slippery surfaces because stopping distance will be longer and vehicle control more limited.

While driving on a surface with reduced traction, try your best to avoid sudden steering, acceleration, or braking (including engine braking by shifting to a lower gear). Any sudden changes could cause the tires to slide. You may not realize the surface is slippery until your vehicle is skidding. Learn to recognize warning clues — such as enough water, ice or packed snow on the road to make a "mirrored surface" — and slow down when you have any doubt.

Remember: The rear-wheel anti-lock braking system (RWAL) helps avoid only a rear braking skid. In a braking skid (where the front wheels are no longer

rolling), release enough pressure on the brakes to get the front wheels rolling again. This restores steering control. Push the brake pedal down steadily when you have to stop suddenly. As long as the front wheels are rolling, you will have steering control.

## **■ *Driving Guidelines***

This multipurpose passenger vehicle is defined as a utility vehicle in Consumer Information Regulations issued by the National Highway Traffic Safety Administration (NHTSA) of the United States Department of Transportation. Utility vehicles have higher ground clearance and a narrower track to make them capable of performing in a wide variety of off-road applications. Specific design characteristics give them a higher center of gravity than ordinary cars. An advantage of the higher ground clearance is a better view of the road allowing you to anticipate problems. They are not designed for cornering at the same speeds as conventional 2-wheel drive vehicles any more than low-slung sports cars are designed to perform satisfactorily under off-road conditions. If at all possible, avoid sharp turns or abrupt maneuvers.

# Your Driving and the Road

As with other vehicles of this type, failure to operate this vehicle correctly may result in loss of control or vehicle rollover.

## ■ *Off-Road Driving with Your Geo Four-Wheel Drive Vehicle*

This off-road guide is for vehicles that have four-wheel drive.

Also, see "Anti-lock Brakes" in the Index.

If your vehicle doesn't have four-wheel drive, you shouldn't drive off-road unless you're on a level, solid surface.

Off-road driving can be great fun. But it does have some definite hazards. The greatest of these is the terrain itself.

"Off-roading" means you've left the great North American road system behind.

Traffic lanes aren't marked. Curves aren't banked. There are no road signs. Surfaces can be slippery, rough, uphill or downhill. In short, you've gone right back to nature.

Off-road driving involves some new skills. And that's why it's very important that you read this guide. You'll find many driving tips and suggestions. These will help make your off-road driving safer and more enjoyable.

## **Before You Go Off-Road**

There are some things to do before you go out. For example, be sure to have all necessary maintenance and service work done. Be sure you read all the information about your four-wheel drive vehicle in this manual. Is there enough fuel? Is the spare tire fully inflated? Are the fluid levels up where they should be? What are the local laws that apply to off-roading where you'll be driving? If you don't know, you should check with law enforcement people in the area. Will you be on someone's private land? If so, be sure to get the necessary permission.

## **Loading Your Vehicle for Off-Road Driving**

There are some important things to remember about how to load your vehicle.

- The heaviest things should be on the load floor and forward of your rear axle. Put heavier items as far forward as you can.
- Be sure the load is secured properly, so driving on the off-road terrain doesn't toss things around.



## **CAUTION:**

- Cargo on the load floor piled higher than the seatbacks can be thrown forward during a sudden stop. You or your passengers could be injured. Keep cargo below the top of the seatbacks.
- Unsecured cargo on the load floor can be tossed about when driving over rough terrain. You or your passengers can be struck by flying objects. Secure the cargo properly.
- Heavy loads on the roof raise the vehicle's center of gravity, making it more likely to roll over. You can be seriously or fatally injured if the vehicle rolls over. Put heavy loads inside the cargo area, not on the roof. Keep cargo in the cargo area as far forward and as low as possible.

You'll find other important information in this manual. See "Vehicle Loading" and "Tires" in the Index.

## Traveling to Remote Areas

It makes sense to plan your trip, especially when going to a remote area. Know the terrain and plan your route. You are much less likely to get bad surprises. Get accurate maps of trails and terrain. Try to learn of any blocked or closed roads.

It's also a good idea to travel with at least one other vehicle. If something happens to one of them, the other can help quickly.

Does your vehicle have a winch? If so, be sure to read the winch instructions. In a remote area, a winch can be handy if you get stuck. But you'll want to know how to use it properly.

## Getting Familiar with Off-Road Driving

It's a good idea to practice in an area that's safe and close to home before you go into the wilderness. Off-road driving does require some new and different driving skills. Here's what we mean.

Tune your senses to different kinds of signals. Your eyes, for example, need to constantly sweep the terrain for unexpected obstacles. Your ears need to listen for unusual tire or engine sounds.

With your arms, hands, feet, and body you'll need to respond to vibrations and vehicle bounce.

Controlling your vehicle is the key to successful off-road driving. One of the best ways to control your vehicle is to control your speed. Here are some things to keep in mind. At higher speeds:

- you approach things faster and you have less time to scan the terrain for obstacles.
- you have less time to react.
- you have more vehicle bounce when you drive over obstacles.
- you'll need more distance for braking, especially since you're on an unpaved surface.



### CAUTION:

When you're driving off road, bouncing and quick changes in direction can easily throw you out of position. This could cause you to lose control and crash. So, whether you're driving on or off the road, you and your passengers should wear safety belts.

## Scanning the Terrain

Off-road driving can take you over many different kinds of terrain. You need to be familiar with the terrain and its many different features. Here are some things to consider.

**Surface Conditions.** Off-roading can take you over hard-packed dirt, gravel, rocks, grass, sand, mud, snow or ice. Each of these surfaces affects the steering, acceleration, and braking of your vehicle in different ways. Depending upon the kind of surface you are on, you may experience slipping, sliding, wheel spinning, delayed acceleration, poor traction, and longer braking distances.

**Surface Obstacles.** Unseen or hidden obstacles can be hazardous. A rock, log, hole, rut, or bump can startle you if you're not prepared for them. Often these obstacles are hidden by grass, bushes, snow or even the rise and fall of the terrain itself. Here are some things to consider:

- Is the path ahead clear?
- Will the surface texture change abruptly up ahead?

# Your Driving and the Road

- Does the travel take you uphill or downhill? (There's more discussion of these subjects later.)
- Will you have to stop suddenly or change direction quickly?

When you drive over obstacles or rough terrain, keep a firm grip on the steering wheel. Ruts, troughs, or other surface features can jerk the wheel out of your hands if you're not prepared.

When you drive over bumps, rocks, or other obstacles, your wheels can leave the ground. If this happens, even with one or two wheels, you can't control the vehicle as well or at all.

Because you will be on an unpaved surface, it's especially important to avoid sudden acceleration, sudden turns, or sudden braking.

In a way, off-road driving requires a different kind of alertness from driving on paved roads and highways. There are no road signs, posted speed limits or signal lights. You have to use your own good judgment about what is safe and what isn't.

Drinking and driving can be very dangerous on any road. And this is certainly true for off-road driving. At the

very time you need special alertness and driving skills, your reflexes, perceptions and judgment can be affected by even a small amount of alcohol. You could have a serious — or even fatal — accident if you drink and drive or ride with a driver who has been drinking. (See "Drunken Driving" in the Index.)

## Driving On Off-Road Hills

Off-road driving often takes you up, down, or across a hill. Driving safely on hills requires good judgment and an understanding of what your vehicle can and can't do. There are some hills that simply can't be driven, no matter how well built the vehicle.



### CAUTION:

Many hills are simply too steep for any vehicle. If you drive up them, you will stall. If you drive down them, you can't control your speed. If you drive across them, you will roll over. You could be seriously injured or killed. If you have any doubt about the steepness, don't drive the hill.

## Approaching a Hill

When you approach a hill, you need to decide if it's one of those hills that's just too steep to climb, descend, or cross. Steepness can be hard to judge. On a very small hill, for example, there may be a smooth, constant incline with only a small change in elevation where you can easily see all the way to the top. On a large hill, the incline may get steeper as you near the top, but you may not see this because the crest of the hill is hidden by bushes, grass, or shrubs.

Here are some other things to consider as you approach a hill.

- Is there a constant incline, or does the hill get sharply steeper in places?
- Is there good traction on the hillside, or will the surface cause tire slipping?
- Is there a straight path up or down the hill so you won't have to make turning maneuvers?
- Are there obstructions on the hill that can block your path (boulders, trees, logs or ruts)?
- What's beyond the hill? Is there a cliff, an embankment, a drop-off, a fence? Get out and walk the hill if you don't know. It's the smart way to find out.

- Is the hill simply too rough? Steep hills often have ruts, gullies, troughs and exposed rocks because they are more susceptible to the effects of erosion.

### Driving Uphill

Once you decide you can safely drive up the hill, you need to take some special steps.

- Use a low gear and get a firm grip on the steering wheel.
- Get a smooth start up the hill and try to maintain your speed. Don't use more power than you need, because you don't want your wheels to start spinning or sliding.
- Try to drive straight up the hill if at all possible. If the path twists and turns, you might want to find another route.



### CAUTION:

Turning or driving across steep hills can be dangerous. You could lose traction, slide sideways, and possibly roll over. You could be seriously injured or killed. When driving up hills, always try to go straight up.

- Ease up on your speed as you approach the top of the hill.
- Attach a flag to the vehicle to make you more visible to approaching traffic on trails or hills.
- Sound the horn as you approach the top of the hill to let opposing traffic know you're there.
- Use your headlights even during the day. They make you more visible to oncoming traffic.



### CAUTION:

Driving to the top (crest) of a hill at full speed can cause an accident. There could be a drop-off, embankment, cliff, or even another vehicle. You could be seriously injured or killed. As you near the top of a hill, slow down and stay alert.

**Q: What should I do if my vehicle stalls, or is about to stall, and I can't make it up the hill?**

**A:** If this happens, there are some things you should do, and there are some things you must not do. First, here's what you should do:

- Push the brake pedal to stop the vehicle and keep it from rolling backwards. Also, apply the parking brake.
- If your engine is still running, shift the transmission into reverse, release the parking brake, and slowly back down the hill in reverse.
- If your engine has stopped running, you'll need to restart it. With the brake pedal depressed and the parking brake still applied, shift the transmission to "P" (Park) (or, shift to "N" (Neutral) if your vehicle has a manual transmission) and restart the engine. Then, shift to reverse, release the parking brake, and slowly back down the hill as straight as possible in reverse.
- As you are backing down the hill, put your left hand on the steering wheel at the 12 o'clock position. This way,



# Your Driving and the Road

you'll be able to tell if your wheels are straight and maneuver as you back down. It's best that you back down the hill with your wheels straight rather than in the left or right direction. Turning the wheel too far to the left or right will increase the possibility of a rollover.

Here are some things you must not do if you stall, or are about to stall, when going up a hill.

- Never attempt to prevent a stall by shifting into "N" (Neutral) (or depressing the clutch, if you have a manual transmission) to "rev-up" the engine and regain forward momentum. This won't work. Your vehicle will roll backwards very quickly and you could go out of control. Instead, apply the regular brake to stop the vehicle. Then apply the parking brake. Shift into reverse, release the parking brake, and slowly back straight down.
- Never attempt to turn around if you are about to stall when going up a hill. If the hill is steep enough to stall your vehicle, it's steep enough to cause you to roll over if you turn around. If you can't make it up the hill, you must back straight down the hill.

**Q:** Suppose, after stalling, I try to back down the hill and decide I just can't do it. What should I do?

**A:** Set the parking brake, put your transmission in "P" (Park) (or the manual transmission in first gear), and turn off the engine. Leave the vehicle and go get some help. Exit on the uphill side and stay clear of the path the vehicle would take if it rolled downhill. Do not shift the transfer case to "N" (Neutral) when you leave the vehicle. Leave it in some gear.



## CAUTION:

Shifting the transfer case to "N" (Neutral) can cause your vehicle to roll even if the transmission is in "P" (Park) (or, if you have the manual transmission, even if you're in gear). This is because the "N" (Neutral) position on the transfer case overrides the transmission. If you are going to leave your vehicle, set the parking brake and shift the transmission to "P" (Park) (or, put your manual transmission in first gear). But do not shift the transfer case to the "N" (Neutral) position. Leave the transfer case in the "2H," "4H" or "4L" position.

### Driving Downhill

When off-roading takes you downhill, you'll want to consider a number of things:

- How steep is the downhill? Will I be able to maintain vehicle control?
- What's the surface like? Smooth? Rough? Slippery? Hard-packed dirt? Gravel?

- Are there hidden surface obstacles? Ruts? Logs? Boulders?
- What's at the bottom of the hill? Is there a hidden creek bank or even a river bottom with large rocks?

If you decide you can go down a hill safely, then try to keep your vehicle headed straight down, and use a low gear. This way, engine drag can help your brakes and they won't have to do all the work. Descend slowly, keeping your vehicle under control at all times.



## CAUTION:

Heavy braking when going down a hill can cause your brakes to overheat and fade. This could cause loss of control and a serious accident. Apply the brakes lightly when descending a hill and use a low gear to keep vehicle speed under control.

### Q: Are there some things I should not do when driving down a hill?

A: Yes! These are important because if you ignore them you could lose control and have a serious accident.

- When driving downhill, avoid turns that take you across the incline of the hill. A hill that's not too steep to drive down may be too steep to drive across. You could roll over if you don't drive straight down.
- Never go downhill with the transmission in "N" (Neutral), or with the clutch pedal depressed in a manual shift. This is called "free-wheeling." Your brakes will have to do all the work and could overheat and fade.
- Avoid braking so hard that you lock the front wheels when going downhill. If your front wheels are locked, you can't steer your vehicle. If your wheels lock up during downhill braking, you may feel the vehicle starting to slide sideways. To regain your direction, just ease off the brakes and steer to keep the front of the vehicle pointing straight downhill.

### Q: Am I likely to stall when going downhill?

A: It's much more likely to happen going uphill. But if it happens going downhill, here's what to do.

- Stop your vehicle by applying the regular brakes. Apply the parking brake.
- Shift to "P" (Park) (or to Neutral with the manual transmission) and, while still braking, restart the engine.
- Shift back to a low gear, release the parking brake, and drive straight down.
- If the engine won't start, get out and get help.

### Driving Across an Incline

Sooner or later, an off-road trail will probably go across the incline of a hill. If this happens, you have to decide whether to try to drive across the incline. Here are some things to consider:

- A hill that can be driven straight up or down may be too steep to drive across. When you go straight up or down a hill, the length of the wheel base (the distance from the front wheels to the rear wheels) reduces the

# Your Driving and the Road

likelihood the vehicle will tumble end over end. But when you drive across an incline, the much more narrow track width (the distance between the left and right wheels) may not prevent the vehicle from tilting and rolling over. Also, driving across an incline puts more weight on the downhill wheels. This could cause a downhill slide or a rollover.

- Surface conditions can be a problem when you drive across a hill. Loose gravel, muddy spots, or even wet grass can cause your tires to slip sideways, downhill. If the vehicle slips sideways, it can hit something that will trip it (a rock, a rut, etc.) and roll over.
- Hidden obstacles can make the steepness of the incline even worse. If you drive across a rock with the uphill wheels, or if the downhill wheels drop into a rut or depression, your vehicle can tilt even more.

For reasons like these, you need to decide carefully whether to try to drive across an incline. Just because the trail goes across the incline doesn't mean you have to drive it. The last vehicle to try it might have rolled over.



## CAUTION:

Driving across an incline that's too steep will make your vehicle roll over. You could be seriously injured or killed. If you have any doubt about the steepness of the incline, don't drive across it. Find another route instead.

**Q: What if I'm driving across an incline that's not too steep, but I hit some loose gravel and start to slide downhill. What should I do?**

**A:** If you feel your vehicle starting to slide sideways, turn downhill. This should help straighten out the vehicle and prevent the side slipping. However, a much better way to prevent this is to get out and "walk the course" so you know what the surface is like before you drive it.

## Stalling on an Incline

If your vehicle stalls when you're crossing an incline, be sure you (and your passengers) get out on the uphill side, even if the door there is harder to open. If you get out on the downhill side and the vehicle starts to roll over, you'll be right in its path.

If you have to walk down the slope, stay out of the path the vehicle will take if it does roll over.



### CAUTION:

Getting out on the downhill (low) side of a vehicle stopped across an incline is dangerous. If the vehicle rolls over, you could be crushed or killed. Always get out on the uphill (high) side of the vehicle and stay well clear of the rollover path.

#### **Driving in Mud, Sand, Snow or Ice**

When you drive in mud, snow or sand, your wheels won't get good traction. You can't accelerate as quickly, turning is more difficult, and you'll need longer braking distances.

It's best to use a low gear when you're in mud — the deeper the mud, the lower the gear. In really deep mud, the idea is to keep your vehicle moving so you don't get stuck.

When you drive on sand, you'll sense a change in wheel traction. But it will depend upon how loosely packed the sand is. On loosely packed sand (as on beaches or sand dunes) your tires will tend to sink into the sand. This has an effect on steering, accelerating, and braking. You may want to reduce the air pressure in your tires slightly when driving on sand. This will improve traction.

Hard packed snow and ice offer the worst tire traction. On these surfaces, it's very easy to lose control. On wet ice, for example, the traction is so poor that you will have difficulty accelerating. And if you do get moving, poor steering and difficult braking can cause you to slide out of control.

### CAUTION:

Driving on frozen lakes, ponds or rivers can be dangerous. Underwater springs, currents under the ice, or sudden thaws can weaken the ice. Your vehicle could fall through the ice and you and your passengers could drown. Drive your vehicle on safe surfaces only.

#### **Driving in Water**

Light rain causes no special off-road driving problems. But heavy rain can mean flash flooding, and flood waters demand extreme caution.

Find out how deep the water is before you drive through it. If it's deep enough to cover your wheel hubs, axles, or exhaust pipe, don't try it — you probably won't get through. Also, water that deep can damage your axle and other vehicle parts.

If the water isn't too deep, then drive through it slowly. At fast speeds, water splashes on your ignition system and your vehicle can stall. Stalling can also occur if you get your tailpipe under water. And, as

# Your Driving and the Road

long as your tailpipe is under water, you'll never be able to start your engine. When you go through water, remember that when your brakes get wet, it may take you longer to stop.



## CAUTION:

Driving through rushing water can be dangerous. Deep water can sweep your vehicle downstream and you and your passengers could drown. If it's only inches deep, it can still wash away the ground from under your tires, and you could lose traction and roll the vehicle over. Don't drive through rushing water.

### After Off-Road Driving

Remove any brush or debris that has collected on the underbody, chassis or under the hood. These accumulations can be a fire hazard.

After operation in mud or sand, have the brake linings cleaned and checked. These substances can cause glazing and uneven braking. Check the body structure, steering, suspension, wheels, tires, and

exhaust system for damage. Also, check the fuel lines and cooling system for any leakage.

Your vehicle will require more frequent service due to off-road use. Refer to the Maintenance Schedule for additional information.

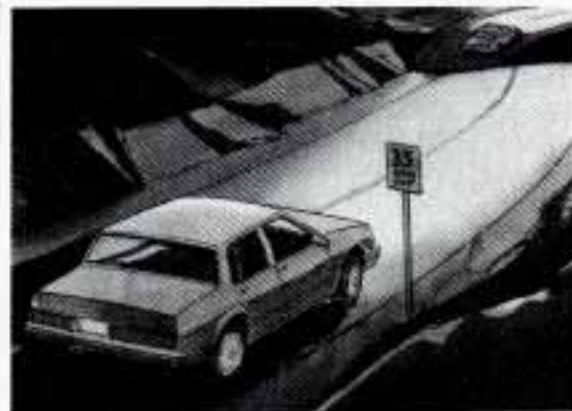

### ■ *Driving at Night*

Night driving is more dangerous than day driving. One reason is that some drivers are likely to be impaired — by alcohol or drugs, with night vision problems, or by fatigue.

Here are some tips on night driving.

- Drive defensively.
- Don't drink and drive.
- Adjust your inside rearview mirror to reduce the glare from headlights behind you.
- Since you can't see as well, you may need to slow down and keep more space between you and other vehicles.

- Slow down, especially on higher speed roads. Your headlights can light up only so much road ahead.
- In remote areas, watch for animals.
- If you're tired, pull off the road in a safe place and rest.

### Night Vision

No one can see as well at night as in the daytime. But as we get older these differences increase. A 50-year-old driver may require at least twice as much light to see the same thing at night as a 20-year-old.

What you do in the daytime can also affect your night vision. For example, if you spend the day in bright sunshine you are wise to wear sunglasses. Your eyes will have less trouble adjusting to night. But if you're driving, don't wear sunglasses at night. They may cut down on glare from headlights, but they also make a lot of things invisible.

You can be temporarily blinded by approaching lights. It can take a second or two, or even several seconds, for your eyes to readjust to the dark. When you are faced with severe glare (as from a driver who doesn't lower the high beams, or a

vehicle with misaimed headlights), slow down a little. Avoid staring directly into the approaching lights.

Keep your windshield and all the glass on your vehicle clean — inside and out. Glare at night is made much worse by dirt on the glass. Even the inside of the glass can build up a film caused by dust. Dirty glass makes lights dazzle and flash more than clean glass would, making the pupils of your eyes contract repeatedly.

Remember that your headlights light up far less of a roadway when you are in a turn or curve.

Keep your eyes moving; that way, it's easier to pick out dimly lighted objects. Just as your headlights should be checked regularly for proper aim, so should your eyes be examined regularly. Some drivers suffer from night blindness — the inability to see in dim light — and aren't even aware of it.



### ■ *Driving in the Rain*

Rain and wet roads can mean driving trouble. On a wet road you can't stop, accelerate or turn as well because your tire-to-road traction isn't as good as on dry roads. And, if your tires don't have much tread left, you'll get even less traction. It's always wise to go slower and be cautious if rain starts to fall while you are driving. The surface may get wet suddenly when your reflexes are tuned for driving on dry pavement.

The heavier the rain, the harder it is to see. Even if your windshield wiper blades are in good shape, a heavy rain can make it harder to see road signs and traffic signals, pavement markings, the edge of the road, and even people walking.

# Your Driving and the Road

It's wise to keep your wiping equipment in good shape and keep your windshield washer tank filled. Replace your windshield wiper inserts when they show signs of streaking or missing areas on the windshield, or when strips of rubber start to separate from the inserts.



Driving too fast through large water puddles or even going through some car washes can cause problems, too. The water may affect your brakes. Try to avoid puddles. But if you can't, try to slow down before you hit them.

## CAUTION:

Wet brakes can cause accidents. They won't work well in a quick stop and may cause pulling to one side. You could lose control of the vehicle.

After driving through a large puddle of water or a car wash, apply your brake pedal lightly until your brakes work normally.

## Hydroplaning

Hydroplaning is dangerous. So much water can build up under your tires that they can actually ride on the water. This can happen if the road is wet enough and you're going fast enough. When your vehicle is hydroplaning, it has little or no contact with the road.

Hydroplaning doesn't happen often. But it can if your tires haven't much tread or if the pressure in one or more is low. It can happen if a lot of water is standing on the road. If you can see reflections from trees, telephone poles, or other vehicles, and raindrops "dimple" the water's surface, there could be hydroplaning.

Hydroplaning usually happens at higher speeds. There just isn't a hard and fast rule about hydroplaning. The best advice is to slow down when it is raining.

## Some Other Rainy Weather Tips

- Turn on your low-beam headlights — not just your parking lights — to help make you more visible to others.
- Besides slowing down, allow some extra following distance. And be especially careful when you pass another vehicle. Allow yourself more

clear room ahead, and be prepared to have your view restricted by road spray.

- Have good tires with proper tread depth. (See "Tires" in the Index.)



### ■ *City Driving*

One of the biggest problems with city streets is the amount of traffic on them. You'll want to watch out for what the other drivers are doing and pay attention to traffic signals.

Here are ways to increase your safety in city driving:

- Know the best way to get to where you are going. Get a city map and plan your trip into an unknown part of the city just as you would for a cross-country trip.
- Try to use the freeways that rim and crisscross most large cities. You'll save time and energy. (See the next section, "Freeway Driving.")

- Treat a green light as a warning signal. A traffic light is there because the corner is busy enough to need it. When a light turns green, and just before you start to move, check both ways for vehicles that have not cleared the intersection or may be running the red light.



# Your Driving and the Road

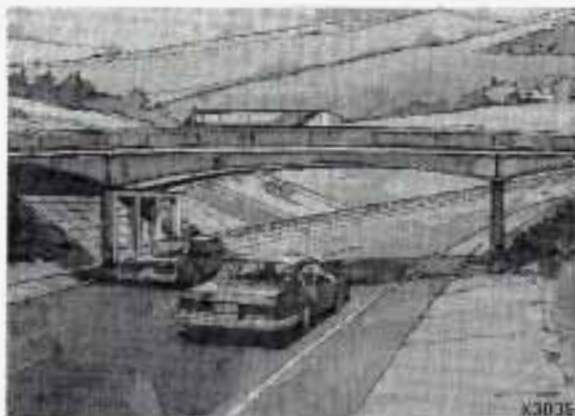

## ■ *Freeway Driving*

Mile for mile, freeways (also called thruways, parkways, expressways, turnpikes, or superhighways) are the safest of all roads. But they have their own special rules.

The most important advice on freeway driving is: Keep up with traffic and keep to the right. Drive at the same speed most of the other drivers are driving. Too-fast or too-slow driving breaks a smooth traffic flow. Treat the left lane on a freeway as a passing lane.

At the entrance there is usually a ramp that leads to the freeway. If you have a clear view of the freeway as you drive along the entrance ramp, you should

begin to check traffic. Try to determine where you expect to blend with the flow. Try to merge into the gap at close to the prevailing speed. Switch on your turn signal, check your mirrors and glance over your shoulder as often as necessary. Try to blend smoothly with the traffic flow.

Once you are on the freeway, adjust your speed to the posted limit or to the prevailing rate if it's slower. Stay in the right lane unless you want to pass.

Before changing lanes, check your mirrors. Then use your turn signal.

Just before you leave the lane, glance quickly over your shoulder to make sure there isn't another vehicle in your "blind" spot.

Once you are moving on the freeway, make certain you allow a reasonable following distance. Expect to move slightly slower at night.

When you want to leave the freeway, move to the proper lane well in advance. If you miss your exit do not, under any circumstances, stop and back up. Drive on to the next exit.

The exit ramp can be curved, sometimes quite sharply. The exit speed is usually posted. Reduce your speed according to your speedometer, not to your sense of motion. After driving for any distance at higher speeds, you may tend to think you are going slower than you actually are.

## *Before Leaving on a Long Trip*

Make sure you're ready. Try to be well rested. If you must start when you're not fresh — such as after a day's work — don't plan to make too many miles that first part of the journey. Wear comfortable clothing and shoes you can easily drive in.

Is your vehicle ready for a long trip? If you keep it serviced and maintained, it's ready to go. If it needs service, have it done before starting out. Of course, you'll find experienced and able service experts in Geo dealerships all across North America. They'll be ready and willing to help if you need it.

Here are some things you can check before a trip:

- **Windshield Washer Fluid:** Is the reservoir full? Are all windows clean inside and outside?

- **Wiper Blades:** Are they in good shape?
- **Fuel, Engine Oil, Other Fluids:** Have you checked all levels?
- **Lights:** Are they all working? Are the lenses clean?
- **Tires:** They are vitally important to a safe, trouble-free trip. Is the tread good enough for long-distance driving? Are the tires all inflated to the recommended pressure?
- **Weather Forecasts:** What's the weather outlook along your route? Should you delay your trip a short time to avoid a major storm system?
- **Maps:** Do you have up-to-date maps?

### Highway Hypnosis

Is there actually such a condition as "highway hypnosis"? Or is it just plain falling asleep at the wheel? Call it highway hypnosis, lack of awareness, or whatever.

There is something about an easy stretch of road with the same scenery, along with the hum of the tires on the road, the drone of the engine, and the rush of the wind against the vehicle that can make you

sleepy. Don't let it happen to you! If it does, your vehicle can leave the road in less than a second, and you could crash and be injured.

What can you do about highway hypnosis? First, be aware that it can happen.

Then here are some tips:

- Make sure your vehicle is well ventilated, with a comfortably cool interior.
- Keep your eyes moving. Scan the road ahead and to the sides. Check your mirrors and your instruments frequently.
- If you get sleepy, pull off the road into a rest, service, or parking area and take a nap, get some exercise, or both. For safety, treat drowsiness on the highway as an emergency.



### ■ *Hill and Mountain Roads*

Driving on steep hills or mountains is different from driving in flat or rolling terrain. If you drive regularly in steep country, or if you're planning to visit there, here are some tips that can make your trips safer and more enjoyable. (See "Off-Road Driving" in the Index for information about driving off-road.)

- Keep your vehicle in good shape. Check all fluid levels and also the brakes, tires, cooling system and transmission. These parts can work hard on mountain roads.

# Your Driving and the Road

- Know how to go down hills. The most important thing to know is this: let your engine do some of the slowing down. Shift to a lower gear when you go down a steep or long hill.



## CAUTION:

If you don't shift down, your brakes could get so hot that they wouldn't work well. You would then have poor braking or even none going down a hill. You could crash. Shift down to let your engine assist your brakes on a steep downhill slope.



## CAUTION:

Coasting downhill in "N" (Neutral) or with the ignition off is dangerous. Your brakes will have to do all the work of slowing down. They could get so hot that they wouldn't work well. You could crash. Always have your engine running and your vehicle in gear when you go downhill.

- Know how to go uphill. You may want to shift down to a lower gear. The lower gears help cool your engine and transmission, and you can climb the hill better.
- Stay in your own lane when driving on two-lane roads in hills or mountains. Don't swing wide or cut across the center of the road. Drive at speeds that let you stay in your own lane.
- As you go over the top of a hill, be alert. There could be something in your lane, like a stalled car or an accident.
- You may see highway signs on mountains that warn of special problems. Examples are long grades, passing or no-passing zones, a falling rocks area, or winding roads. Be alert to these and take appropriate action.

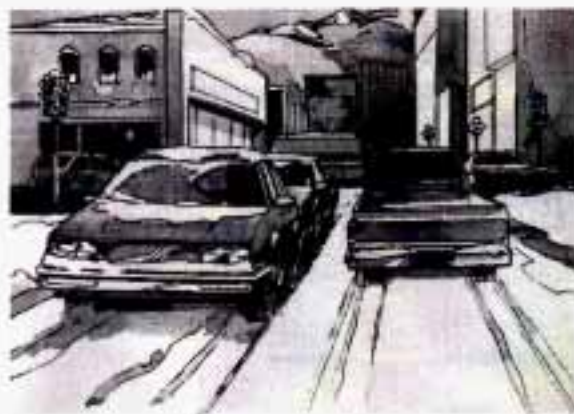

## ■ *Winter Driving*

Here are some tips for winter driving:

- Have your Geo in good shape for winter. Be sure your engine coolant mix is correct.
- You may want to put winter emergency supplies in your vehicle.

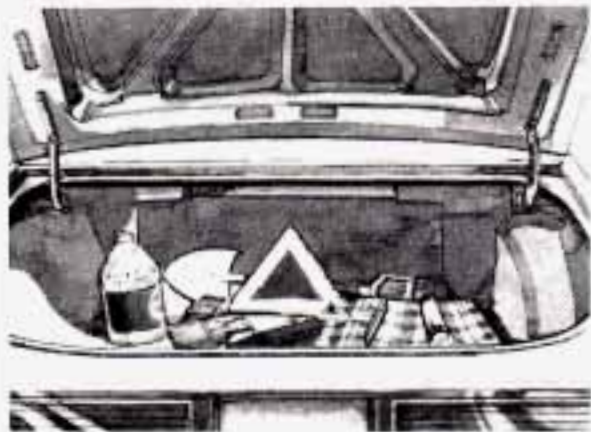

Include an ice scraper, a small brush or broom, a supply of windshield washer fluid, a rag, some winter outer clothing, a small shovel, a flashlight, a red cloth, and a couple of reflective warning triangles. And, if you will be driving under severe conditions, include a small bag of sand, a piece of old carpet or a couple of burlap bags to help provide traction. Be sure you properly secure these items in your vehicle.



### Driving on Snow or Ice

Most of the time, those places where your tires meet the road probably have good traction.

However, if there is snow or ice between your tires and the road, you can have a very slippery situation. You'll have a lot less traction or "grip" and will need to be very careful.

What's the worst time for this? "Wet ice." Very cold snow or ice can be slick and hard to drive on. But wet ice can be even more trouble because it may offer the least traction of all. You can get "wet ice" when it's about freezing (32°F; 0°C) and freezing rain begins to fall. Try to avoid driving on wet ice until salt and sand crews can get there.

Whatever the condition — smooth ice, packed, blowing or loose snow — drive with caution.

Accelerate gently. Try not to break the fragile traction. If you accelerate too fast, the drive wheels will spin and polish the surface under the tires even more.

Your anti-lock brakes improve your ability to make a hard stop on a slippery road. Even though you have an anti-lock braking system, you'll want to begin stopping sooner than you would on dry pavement. See "Anti-lock" in the Index.

- Allow greater following distance on any slippery road.
- Watch for slippery spots. The road might be fine until you hit a spot that's covered with ice. On an otherwise clear road, ice patches may appear in shaded areas where the sun can't reach: around clumps of trees, behind buildings, or under bridges. Sometimes the surface of a curve or an overpass may remain icy when the surrounding roads are clear. If you see a patch of ice ahead of you, brake before you are on it. Try not to brake while you're actually on the ice, and avoid sudden steering maneuvers.

## Your Driving and the Road



### If You're Caught in a Blizzard

If you are stopped by heavy snow, you could be in a serious situation. You should probably stay with your vehicle unless you know for sure that you are near help and you can hike through the snow. Here are some things to do to summon help and keep yourself and your passengers safe: Turn on your hazard flashers. Tie a red cloth to your vehicle to alert police that you've been stopped by the snow. Put on extra clothing or wrap a blanket around you. If you have no blankets or extra clothing, make body insulators from newspapers, burlap bags, rags, floor mats — anything you can wrap around yourself or tuck under your clothing to keep warm. You can run the engine to keep warm, but be careful.



### CAUTION:

Snow can trap exhaust gases under your vehicle. This can cause deadly CO (carbon monoxide) gas to get inside. CO could overcome you and kill you. You can't see it or smell it, so you might not know it is in your vehicle. Clear away snow from around the base of your vehicle, especially any that is blocking your exhaust pipe. And check around again from time to time to be sure snow doesn't collect there.

Open a window just a little on the side of the vehicle that's away from the wind. This will help keep CO out.

Run your engine only as long as you must. This saves fuel. When you run the engine, make it go a little faster than just idle. That is, push the accelerator slightly. This uses less fuel for the heat that you get and it keeps the battery charged. You will need a well-charged battery to restart the vehicle, and possibly for signaling later on with your headlights. Let the heater run for awhile.

Then, shut the engine off and close the window almost all the way to preserve the heat. Start the engine again and repeat this only when you feel really uncomfortable from the cold. But do it as little as possible. Preserve the fuel as long as you can. To help keep warm, you can get out of the vehicle and do some fairly vigorous exercises every half hour or so until help comes.

## ■ *Towing a Trailer*

### **CAUTION:**

If you don't use the correct equipment and drive properly, you can lose control when you pull a trailer. For example, if the trailer is too heavy, the brakes may not work well — or even at all. You and your passengers could be seriously injured. Pull a trailer only if you have followed all the steps in this section. Ask your Geo dealer for advice and information about towing a trailer with your vehicle.

### **NOTICE:**

Pulling a trailer improperly can damage your vehicle and result in costly repairs not covered by your warranty. To pull a trailer correctly, follow the advice in this section, and see your Geo dealer for important information about towing a trailer with your vehicle.

Your vehicle can tow a trailer. To identify what the vehicle trailering capacity is for your vehicle, you should read the information in "Weight of the Trailer" that appears later in this section. But trailering is different than just driving your vehicle by itself. Trailering means changes in handling, durability, and fuel economy. Successful, safe trailering takes correct equipment, and it has to be used properly. That's the reason for this section. In it are many time-tested, important trailering tips and safety rules. Many of these are important for your safety and that of your passengers. So please read this section carefully before you pull a trailer.

Load-pulling components such as the engine, transmission, wheel assemblies, and tires are forced to work harder against the drag of the added weight. The engine is required to operate at relatively higher speeds and under greater loads, generating extra heat. What's more, the trailer adds considerably to wind resistance, increasing the pulling requirements.

## **If You Do Decide to Pull a Trailer**

If you do, here are some important points.

- There are many different laws having to do with trailering. Make sure your rig will be legal, not only where you live but also where you'll be driving. A good source for this information can be state or provincial police.
- Consider using a sway control. You can ask a hitch dealer about sway controls.
- Don't tow a trailer at all during the first 500 miles (800 km) your new vehicle is driven. Your engine, axle or other parts could be damaged.
- Then, during the first 500 miles (800 km) that you tow a trailer, don't drive over 50 mph (80 km/h) and don't make starts at full throttle. This helps your engine and other parts of your vehicle wear in at the heavier loads.

# Your Driving and the Road

Three important considerations have to do with weight:

## Weight of the Trailer

How heavy can a trailer safely be?

It should never weigh more than 1,000 pounds (450 kg). But even that can be too heavy.

It depends on how you plan to use your rig. For example, speed, altitude, road grades, outside temperature and how much your vehicle is used to pull a trailer are all important. And, it can also depend on any special equipment that you have on your vehicle.

You can ask your dealer for our trailering information or advice, or you can write us at:

Customer Assistance Department  
Chevrolet/Geo  
P.O. Box 7047  
Troy, MI 48007-7047

In Canada, write to:

General Motors of Canada Limited  
Customer Assistance Center  
1908 Colonel Sam Drive  
Oshawa, Ontario L1H 8P7

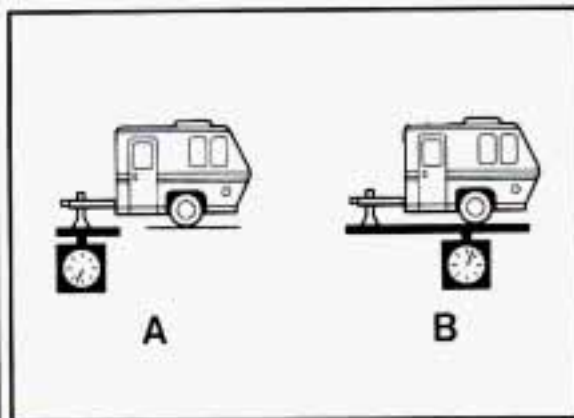

## Weight of the Trailer Tongue

The tongue load (A) of any trailer is an important weight to measure because it affects the total or gross weight of your vehicle. The gross vehicle weight (GVW) includes the curb weight of the vehicle, any cargo you may carry in it, and the people who will be riding in the vehicle. And if you will tow a trailer, you must add the tongue load to the GVW because your vehicle will be carrying that weight, too. See "Loading Your Vehicle" in the Index for more information about your vehicle's maximum load capacity.

If you're using a "dead-weight" hitch, the trailer tongue (A) should weigh 10% of the total loaded trailer weight (B). If you have a "weight-distributing" hitch, the

trailer tongue (A) should weigh 12% of the total loaded trailer weight (B).

After you've loaded your trailer, weigh the trailer and then the tongue, separately, to see if the weights are proper. If they aren't, you may be able to get them right simply by moving some items around in the trailer.

## Total Weight on Your Vehicle's Tires

Be sure your vehicle's tires are inflated to the limit for cold tires. You'll find these numbers on the Certification label at the rear edge of the driver's door or see "Tire Loading" in the Index. Then be sure you don't go over the GVW limit for your vehicle.

## Hitches

It's important to have the correct hitch equipment. Crosswinds, large trucks going by, and rough roads are a few reasons why you'll need the right hitch. Here are some rules to follow:

- If you use a step bumper hitch, and your trailer tongue has a V-shaped foot, your bumper could be damaged in sharp turns. Check the distance from the front edge of the foot to the middle of the hitch ball socket. If the

distance is less than 12 inches, take the foot off the trailer tongue.

- Will you have to make any holes in the body of your vehicle when you install a trailer hitch? If you do, then be sure to seal the holes later when you remove the hitch. If you don't seal them, deadly carbon monoxide (CO) from your exhaust can get into your vehicle (see "Carbon Monoxide" in the Index). Dirt and water can, too.

### Safety Chains

You should always attach chains between your vehicle and your trailer. Cross the safety chains under the tongue of the trailer so that the tongue will not drop to the road if it becomes separated from the hitch. Instructions about safety chains may be provided by the hitch manufacturer or by the trailer manufacturer. Follow the manufacturer's recommendation for attaching safety chains. Always leave just enough slack so you can turn with your rig. And, never allow safety chains to drag on the ground.

### Trailer Brakes

If your trailer weighs more than 1,000 pounds (450 kg) loaded, then it needs its

own brakes — and they must be adequate. Be sure to read and follow the instructions for the trailer brakes so you'll be able to install, adjust and maintain them properly.

- Don't tap into your vehicle's brake system if the trailer's brake system will use more than 0.02 cubic inch (0.3 cc) of fluid from your vehicle's master cylinder. If it does, both systems won't work well. You could even lose your brakes.
- Will the trailer brake parts take 3,000 psi (20 650 kPa) of pressure? If not, the trailer brake system must not be used with your vehicle.
- If everything checks out this far, then make the brake fluid tap at the port on the master cylinder that sends fluid to the rear brakes. But don't use copper tubing for this. If you do, it will bend and finally break off. Use steel brake tubing.

### Driving with a Trailer

Towing a trailer requires a certain amount of experience. Before setting out for the open road, you'll want to get to know your rig. Acquaint yourself with the feel of handling and braking with the added weight of the trailer. And always keep in

mind that the vehicle you are driving is now a good deal longer and not nearly so responsive as your vehicle is by itself.

Before you start, check the trailer hitch and platform, safety chains, electrical connector, lights, tires and mirror adjustment. If the trailer has electric brakes, start your vehicle and trailer moving and then apply the trailer brake controller by hand to be sure the brakes are working. This lets you check your electrical connection at the same time.

During your trip, check occasionally to be sure that the load is secure, and that the lights and any trailer brakes are still working.

### Following Distance

Stay at least twice as far behind the vehicle ahead as you would when driving your vehicle without a trailer. This can help you avoid situations that require heavy braking and sudden turns.

### Passing

You'll need more passing distance up ahead when you're towing a trailer. And, because you're a good deal longer, you'll need to go much farther beyond the



# Your Driving and the Road

passed vehicle before you can return to your lane.

## Backing Up

Hold the bottom of the steering wheel with one hand. Then, to move the trailer to the left, just move that hand to the left. To move the trailer to the right, move your hand to the right. Always back up slowly and, if possible, have someone guide you.

## Making Turns

When you're turning with a trailer, make wider turns than normal. Do this so your trailer won't strike soft shoulders, curbs, road signs, trees, or other objects. Avoid jerky or sudden maneuvers. Signal well in advance.

## Turn Signals When Towing a Trailer

When you tow a trailer, your vehicle has to have a different turn signal flasher and extra wiring. The green arrows on your instrument panel will flash whenever you signal a turn or lane change. Properly hooked up, the trailer lights will also flash, telling other drivers you're about to turn, change lanes or stop.

When towing a trailer, the green arrows on your instrument panel will flash for turns even if the bulbs on the trailer are burned out. Thus, you may think drivers behind you are seeing your signal when they are not. It's important to check occasionally to be sure the trailer bulbs are still working.

## Driving on Grades

Reduce speed and shift to a lower gear before you start down a long or steep downgrade. If you don't shift down, you might have to use your brakes so much that they would get hot and no longer work well.

On a long uphill grade, shift down and reduce your speed to around 45 mph (70 km/h) to reduce the possibility of engine and transmission overheating.

If you are towing a trailer and you have a manual transmission with fifth gear, you may prefer not to use fifth gear. Just drive in fourth gear (or, as you need to, a lower gear).

## Parking on Hills

You really should not park your vehicle, with a trailer attached, on a hill. If something goes wrong, your rig could

start to move. People can be injured, and both your vehicle and the trailer can be damaged.

But if you ever have to park your rig on a hill, here's how to do it:

1. Apply your regular brakes, but don't shift into "P" (Park) yet, or into gear for a manual transmission.
2. Have someone place chocks under the trailer wheels.
3. When the wheel chocks are in place, release the regular brakes until the chocks absorb the load.
4. Reapply the regular brakes. Then apply your parking brake, and then shift to "P" (Park), or "R" (Reverse) for a manual transmission.
5. If you have a four-wheel-drive vehicle, be sure the transfer case is in a drive gear — not in "N" (Neutral).
6. Release the regular brakes.

## CAUTION:

It can be dangerous to get out of your vehicle if the shift lever is not fully in "P" (Park) with the parking brake firmly set. Your vehicle can roll.

If you have left the engine running, the vehicle can move suddenly. You or others could be injured. To be sure your vehicle won't move, even when you're on fairly level ground, use the steps that follow.

If you have four-wheel drive and your transfer case is in "N" (Neutral), your vehicle will be free to roll, even if your shift lever is in "P" (Park). So, be sure the transfer case is in a drive gear — not in "N" (Neutral).

### When You Are Ready to Leave after Parking on a Hill

1. Apply your regular brakes and hold the pedal down while you:
  - Start your engine;
  - Shift into a gear; and
  - Release the parking brake.

2. Let up on the brake pedal.
3. Drive slowly until the trailer is clear of the chocks.
4. Stop and have someone pick up and store the chocks.

### Maintenance When Trailer Towing

Your vehicle will need service more often when you're pulling a trailer. See the Maintenance Schedule for more on this. Things that are especially important in trailer operation are automatic transmission fluid (don't overfill), engine oil, axle lubricant, belts, cooling system, and brake adjustment. Each of these is covered in this manual, and the Index will help you find them quickly. If you're trailering, it's a good idea to review these sections before you start your trip.

Check periodically to see that all hitch nuts and bolts are tight.

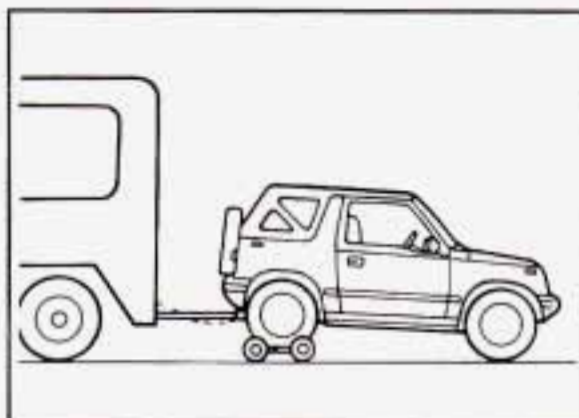

## ■ *Recreational Vehicle Towing*

There may be times when you want to tow your Geo behind another vehicle for use at your destination. Be sure to use the proper towing equipment designed for recreational towing. Follow the instructions for the towing equipment. **Towing Your Geo from the Rear**

The best way to tow your Geo is from the rear. Follow these steps:

1. Put the rear wheels on a dolly,

## NOTICE:

Do not tow your Geo with the rear wheels in contact with the ground, or the transmission could be damaged.

## Your Driving and the Road

2. Set the parking brake.
3. If your Geo is a four-wheel-drive vehicle, set your manual freewheeling hubs to "FREE" or unlock your automatic freewheeling hubs. See "Four-Wheel Drive" in the Index.
4. Turn the ignition key to "ACC" to unlock the steering wheel.
5. Clamp the steering wheel in a straight-ahead position, with a clamping device designed for towing.
6. Release the parking brake.

### NOTICE:

Make sure that the towing speed does not exceed 55 mph (90 km/h), or your Geo could be badly damaged.

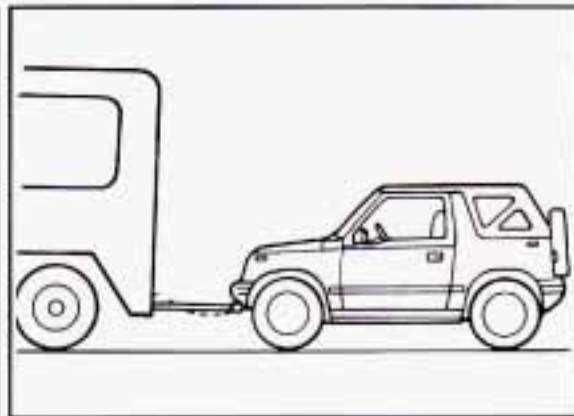

### Towing Your Geo from the Front

### NOTICE:

If your vehicle has automatic freewheeling hubs or two-wheel drive, do not tow it on all four wheels. If you do, your transmission could be damaged.

If you have a four-wheel-drive vehicle with manual freewheeling hubs, it can be towed from the front with all four wheels on the ground. Follow these steps:

1. Set the parking brake.
2. Turn the ignition key to "ACC" to unlock the steering wheel.

3. Shift your automatic transmission into "P" (Park), or your manual transmission into "2" (Second).
4. Shift the transfer case to "N" (Neutral).
5. Set the hubs to "FREE." See "Four-Wheel Drive" in the Index.
6. Release the parking brake.

Stop towing every 200 miles (300 km) and start the engine. Leave the transfer case shift lever in "N" (Neutral). Shift your automatic transmission to "D" (Drive); leave a manual transmission in "2" (Second) and release the clutch. Run the engine at medium speed for one minute to circulate the oil in the transfer case. Turn the ignition key to "ACC." Now, you can continue towing your Geo.

### NOTICE:

Make sure the towing speed does not exceed 50 mph (80 km/h), or your Geo could be badly damaged.

## Part 5 Problems on the Road



**H**ere you'll find what to do about some problems that can occur on the road.

Hazard Warning Flashers .....	132
Jump Starting .....	133
Towing Your Vehicle .....	136
Engine Overheating .....	140
If a Tire Goes Flat .....	146
If You're Stuck: In Sand, Mud, Ice or Snow .....	153

## Problems on the Road

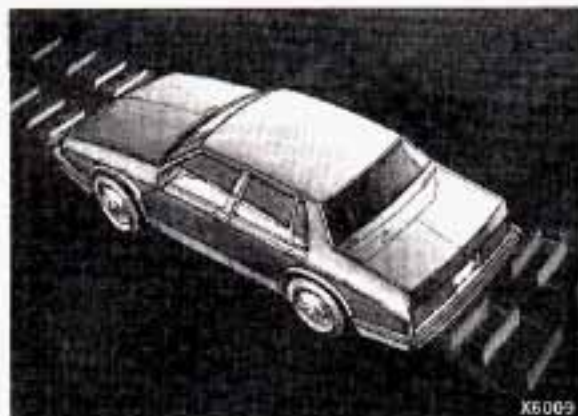

### ■ *Hazard Warning Flashers*

Your hazard warning flashers let you warn others. They also let police know you have a problem. Your front and rear turn signal lights will flash on and off.

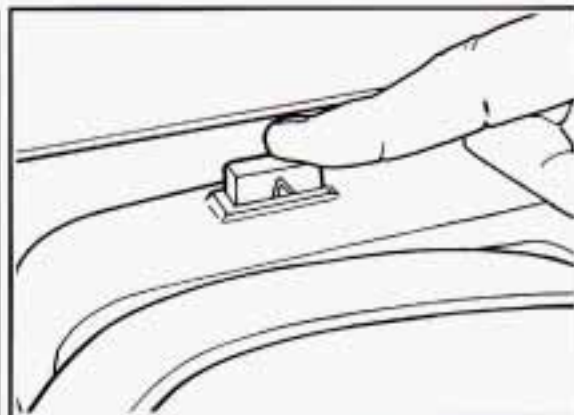

Press the button in to make your front and rear turn signal lights flash on and off.

Your hazard warning flashers work no matter what position your key is in, and even if the key isn't in.

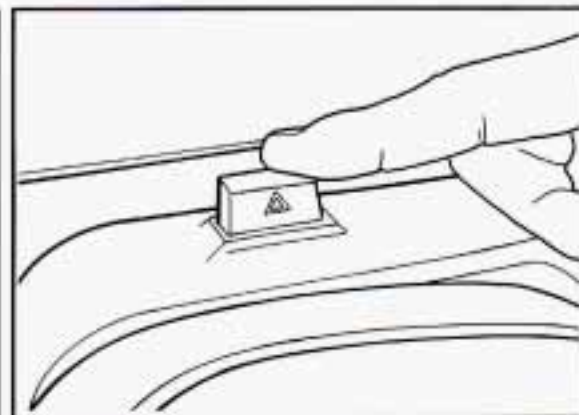

To turn off the flashers, push the switch again.

When the hazard warning flashers are on, your turn signals won't work.

### **Other Warning Devices**

If you carry reflective triangles, you can set one up at the side of the road about 300 feet (100 m) behind your vehicle.

## ■ *Jump Starting*

If your battery has run down, you may want to use another vehicle and some jumper cables to start your Geo. But please follow the steps below to do it safely.



### **CAUTION:**

Batteries can hurt you. They can be dangerous because:

- They contain acid that can burn you.
- They contain gas that can explode or ignite.
- They contain enough electricity to burn you.

If you don't follow these steps exactly, some or all of these things can hurt you.

### **NOTICE:**

Ignoring these steps could result in costly damage to your vehicle that wouldn't be covered by your warranty.

Trying to start your Geo by pushing or pulling it could damage your vehicle, even if you have a manual transmission. And if you have an automatic transmission, it won't start that way.

#### **To Jump Start Your Geo:**

1. Check the other vehicle. It must have a 12-volt battery with a negative ground system.

### **NOTICE:**

If the other system isn't a 12-volt system with a negative ground, both vehicles can be damaged.

2. Get the vehicles close enough so the jumper cables can reach, but be sure the vehicles aren't touching each other. If they are, it could cause a ground connection you don't want. You wouldn't be able to start your Geo, and the bad grounding could damage the electrical systems.
3. Turn off the ignition on both vehicles. Turn off all lights that aren't needed, and radios. This will avoid sparks and help save both batteries. And it could save your radio!

### **NOTICE:**

If you leave your radio on, it could be badly damaged. The repairs wouldn't be covered by your warranty.

## Problems on the Road

4. Open the hoods and locate the batteries. Find the positive (+) and negative (-) terminals on each.

### CAUTION:

An electric fan can start up even when the engine is not running and can injure you. Keep hands, clothing and tools away from any underhood electric fan.

### CAUTION:

Using a match near a battery can cause battery gas to explode. People have been hurt doing this, and some have been blinded. Use a flashlight if you need more light.

Be sure the battery has enough water. You don't need to add water to the Delco Freedom<sup>®</sup> battery installed in every new GM vehicle. But if a battery has filler caps, be sure the right amount of fluid is there. If it is low, add water to take care of that first. If you don't, explosive gas could be present.

Battery fluid contains acid that can burn you. Don't get it on you. If you accidentally get it in your eyes or on your skin, flush the place with water and get medical help immediately.

5. Check that the jumper cables don't have loose or missing insulation. If they do, you could get a shock. The vehicles could be damaged, too.

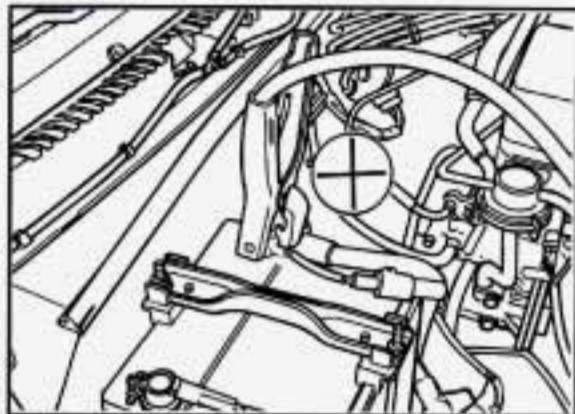

### CAUTION:

Fans or other moving engine parts can injure you badly. Keep your hands away from moving parts once the engines are running.

6. Positive (+) goes to positive (+) and negative (-) goes to negative (-) or a metal engine part. Connect the red positive (+) cable to the positive (+) terminal of the vehicle with the dead battery. Use a remote positive (+) terminal if the vehicle has one.

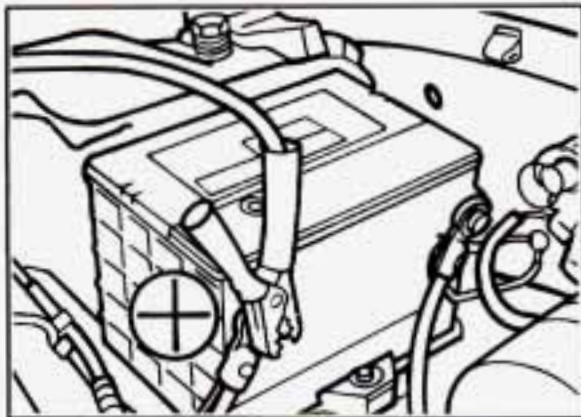

- 7.** Don't let the other end touch metal. Connect it to the positive (+) terminal of the good battery. Use a remote positive (+) terminal if the vehicle has one.

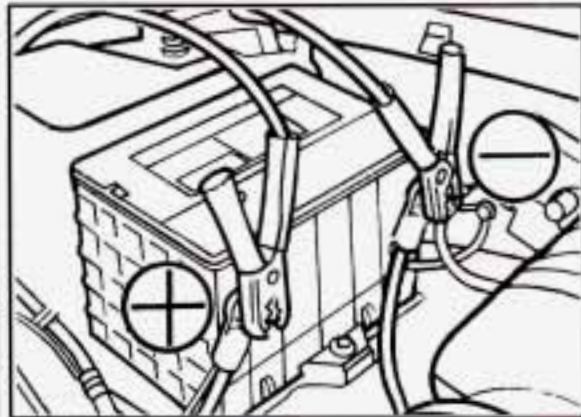

- 8.** Now connect the black negative (-) cable to the good battery's negative (-) terminal. Don't let the other end touch anything until the next step.

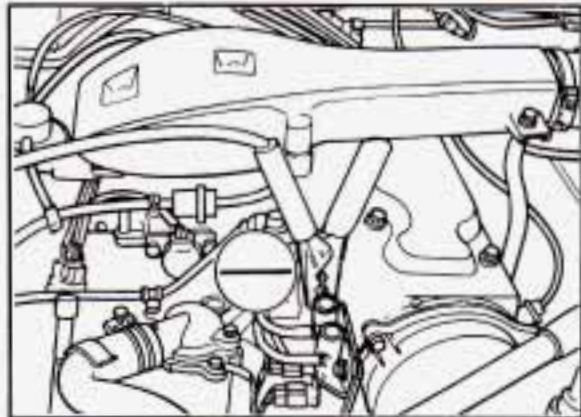

- 9.** The other end of the negative cable doesn't go to the dead battery. It goes to a heavy, unpainted metal part on the engine of the vehicle with the dead battery. Attach the cable at least 18 inches (45 cm) away from the dead battery, but not near engine parts that move. The electrical connection is just as good there, but the chance of sparks getting back to the battery is much less.
- 10.** Now start the vehicle with the good battery and run the engine for a while.
- 11.** Try to start the vehicle with the dead battery. If it won't start after a few tries, it probably needs service.



## Problems on the Road

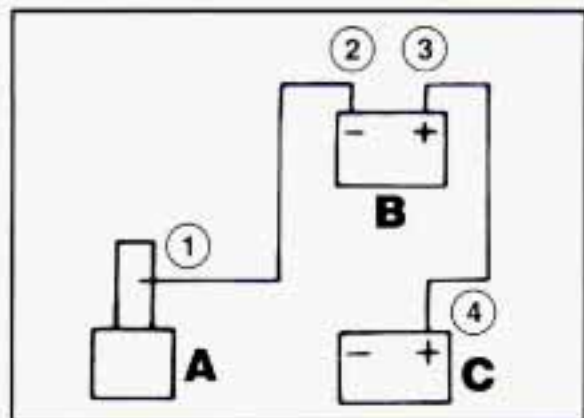

12. Remove the cables in reverse order to prevent electrical shorting. Take care that they don't touch each other or any other metal.

- A. Heavy Metal Engine Part
- B. Good Battery
- C. Dead Battery



### ■ *Towing Your Vehicle*

Try to have a GM dealer or a professional towing service tow your Geo. The usual towing equipment is a sling-type (A) or a wheel-lift (B) or car carrier (C) tow truck.

If your vehicle has been changed or modified since it was factory-new by adding aftermarket items like fog lamps, aero skirting, or special tires and wheels, these instructions and illustrations may not be correct.

Before you do anything, turn on the hazard warning flashers.

When you call, tell the towing service:

- A dolly must be used when towing from the front.

- That your vehicle has rear-wheel drive, or that it has the four-wheel-drive option.
- The make, model, and year of your vehicle.
- Whether you can still move the shift levers for the transmission and transfer case, if you have one.
- If there was an accident, what was damaged.

When the towing service arrives, let the tow operator know that this manual contains detailed towing instructions and illustrations. The operator may want to see them.



 **CAUTION:**

To help avoid injury to you or others:

- Never let passengers ride in a vehicle that is being towed.
- Never tow faster than safe or posted speeds.
- Never tow with damaged parts not fully secured.
- Never get under your vehicle after it has been lifted by the tow truck.
- Always use separate safety chains on each side when towing a vehicle.
- Never use T-hooks. Use "J" hooks instead.

When your vehicle is being towed, have the ignition key off. The steering wheel should be clamped in a straight-ahead position, with a clamping device designed for towing service. Do not use the vehicle's steering column lock for this. The transmission and transfer case, if you have one, should be in "Neutral" and the parking brake released.

Don't have your vehicle towed with the rear wheels in contact with the ground. If a vehicle must be towed from the front with sling-type or wheel lift equipment, the rear wheels must be supported on a dolly.

If your vehicle has four-wheel drive, don't have it towed on the front wheels unless you must. If a vehicle with four-wheel drive must be towed on the front wheels, set your manual, freewheeling hubs to "FREE" or unlock your automatic freewheeling hubs, and set your transfer case to two-wheel drive. If your vehicle must be towed on the front wheels, don't go more than 55 mph (90 km/h).

 **CAUTION:**

A vehicle can fall from a car carrier if it isn't adequately secured. This can cause a collision, serious personal injury and vehicle damage. The vehicle should be tightly secured with chains or steel cables before it is transported.

Don't use substitutes (ropes, leather straps, canvas webbing, etc.) that can be cut by sharp edges underneath the towed vehicle.

## Problems on the Road

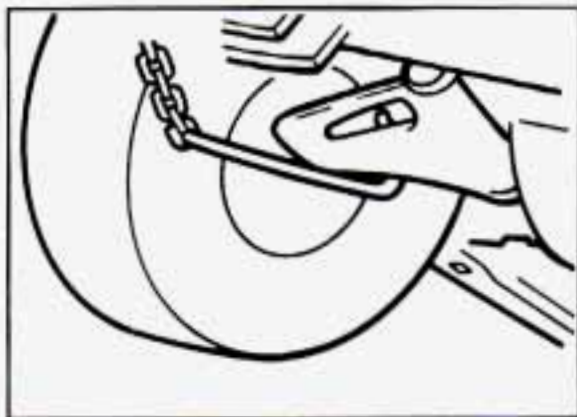

### Front Towing Hook-Ups

Attach "J" hooks to the rear of lower control arms inboard of springs.



Position 4x4 wood beam across sling chains and against lower control arm front attachment brackets. Position the lower sling crossbar in front and against 4x4 wood beam.

### NOTICE:

Dollies are required under the rear wheels or damage will occur.

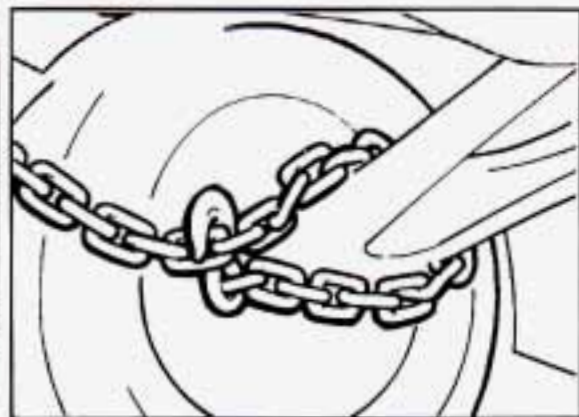

Attach a separate safety chain around outboard end of each lower control arm.

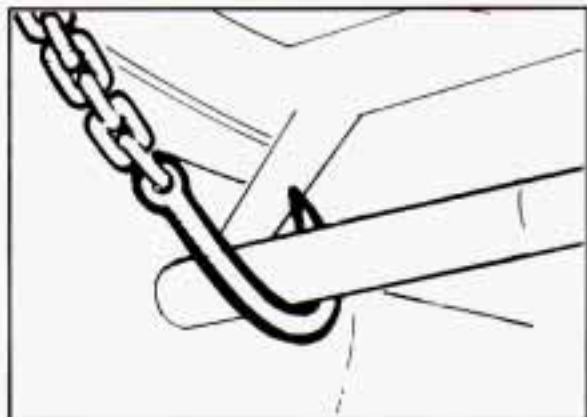

### Rear Towing Hook-Ups

Attach "J" hooks around axle tube.

#### **NOTICE:**

Take care not to damage the brake pipes on the axle tubes.



Position the sling crossbar under and forward of the rear bumper.



Attach a separate safety chain around the outboard end of each side of the rear axle.

# Problems on the Road

## ■ *Engine Overheating*

You will find a coolant temperature gage on your Geo instrument panel.



### If Steam Is Coming from Your Engine:



### CAUTION:

Steam from an overheated engine can burn you badly, even if you just open the hood. Stay away from the engine if you see or hear steam coming from it. Just turn it off and get everyone away from the vehicle until it cools down. Wait until there is no sign of steam or coolant before opening the hood.

If you keep driving when your engine is overheated, the liquids in it can catch fire. You or others could be badly burned. Stop your engine if it overheats, and get out of the vehicle until the engine is cool.

### NOTICE:

If your engine catches fire because you keep driving with no coolant, your vehicle can be badly damaged. The costly repairs would not be covered by your warranty.

### If No Steam Is Coming from Your Engine:

If you get the overheat warning but see or hear no steam, the problem may not be too serious. Sometimes the engine can get a little too hot when you:

- Climb a long hill on a hot day.
- Stop after high speed driving.
- Idle for long periods in traffic.
- Tow a trailer.

If you get the overheat warning with no sign of steam, try this for a minute or so:

1. If you have an air conditioner, turn it off.
2. Turn on your heater to full hot at the highest fan speed and open the window as necessary.
3. If you're in a traffic jam, shift to "N" (Neutral).

If you no longer have the overheat warning, you can drive. Just to be safe, drive slower for about ten minutes. If the warning doesn't come back on, you can drive normally.

If the warning continues, pull over, stop, and park your vehicle right away.

If there's still no sign of steam, you can idle the engine for two or three minutes while you're parked, to see if the warning stops. But then, if you still have the warning, **TURN OFF THE ENGINE AND GET EVERYONE OUT OF THE VEHICLE** until it cools down.

You may decide not to lift the hood but to get service help right away.

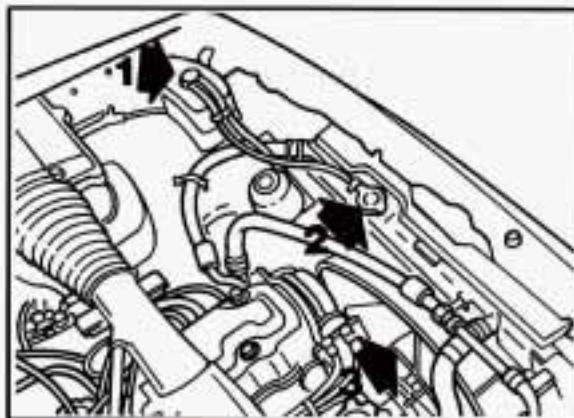

### Cooling System

When you decide it's safe to lift the hood, here's what you'll see on the 8-valve engine:

1. Coolant Recovery Tank
2. Radiator Pressure Cap
3. Electric Engine Fan



### CAUTION:

An electric fan under the hood can start up even when the engine is not running and can injure you. Keep hands, clothing and tools away from any underhood electric fan.

Don't reach through the grille to release the underhood lever.

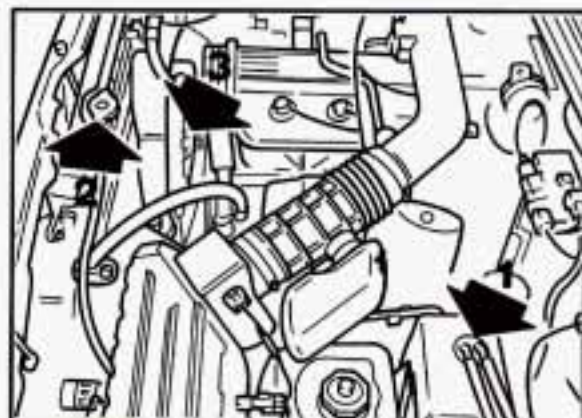

Here's what you'll see on the 16-valve engine:

1. Coolant Recovery Tank
2. Radiator Pressure Cap
3. Electric Engine Fan



### CAUTION:

An electric fan under the hood can start up even when the engine is not running and can injure you. Keep hands, clothing and tools away from any underhood electric fan.

Don't reach through the grille to release the underhood lever.

## Problems on the Road

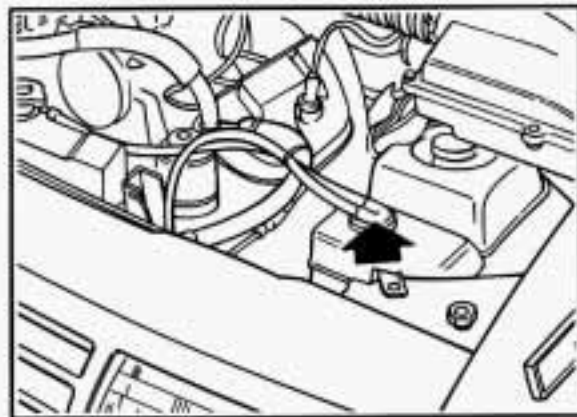

If the coolant inside the coolant recovery tank is boiling, don't do anything else until it cools down.

The coolant level should be at or above "FULL." If it isn't, you may have a leak in the radiator hoses, heater hoses, radiator, water pump or somewhere else in the cooling system.



### CAUTION:

Heater and radiator hoses, and other engine parts, can be very hot. Don't touch them. If you do, you can be burned.

Don't run the engine if there is a leak. If you run the engine, it could lose all coolant. That could cause an engine fire, and you could be burned. Get any leak fixed before you drive the vehicle.

### NOTICE:

Engine damage from running your engine without coolant isn't covered by your warranty.

If there seems to be no leak, check to see if the electric engine fan is running. If the engine is overheating, the fan should be running. If it isn't, your vehicle needs service.

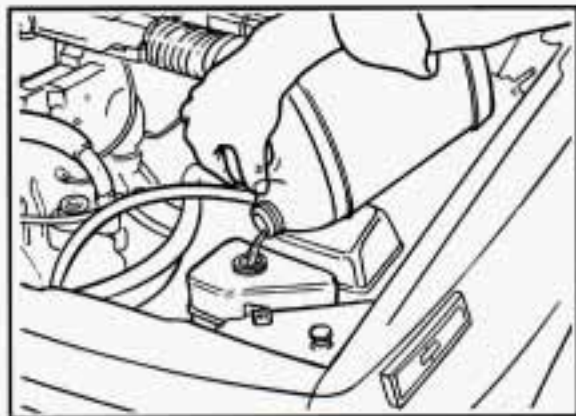

### How to Add Coolant to the Coolant Recovery Tank

If you haven't found a problem yet, but the coolant level isn't at or above the "FULL" mark, add a 50/50 mixture of clean water (preferably distilled) and a proper antifreeze at the coolant recovery tank. (See "Engine Coolant" in the Index for more information about the proper coolant mix.)

**⚠ CAUTION:**

Adding only plain water to your cooling system can be dangerous. Plain water, or some other liquid like alcohol, can boil before the proper coolant mix will. Your vehicle's coolant warning system is set for the proper coolant mix. With plain water or the wrong mix, your engine could get too hot but you wouldn't get the overheat warning. Your engine could catch fire and you or others could be burned. Use a 50/50 mix of clean water and a proper antifreeze.

**NOTICE:**

In cold weather, water can freeze and crack the engine, radiator, heater core and other parts. Use the recommended coolant.

**⚠ CAUTION:**

You can be burned if you spill coolant on hot engine parts. Coolant contains ethylene glycol and it will burn if the engine parts are hot enough. Don't spill coolant on a hot engine.

When the coolant in the coolant recovery tank is at or above the "FULL" mark, start your vehicle.

If the overheat warning continues, there's one more thing you can try. You can add the proper coolant mix directly to the radiator, but be sure the cooling system is cool before you do it.



**⚠ CAUTION:**

Steam and scalding liquids from a hot cooling system can blow out and burn you badly. They are under pressure, and if you turn the radiator pressure cap – even a little – they can come out at high speed. Never turn the cap when the cooling system, including the radiator pressure cap, is hot. Wait for the cooling system and radiator pressure cap to cool if you ever have to turn the pressure cap.



## Problems on the Road

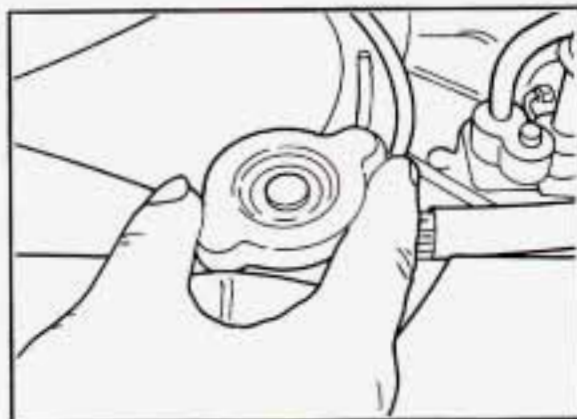

### How to Add Coolant to the Radiator

1. You can remove the radiator pressure cap when the cooling system, including the radiator pressure cap and upper radiator hose, is no longer hot. Turn the pressure cap slowly to the left until it first stops. (Don't press down while turning the pressure cap.)  
If you hear a hiss, wait for that to stop. A hiss means there is still some pressure left.

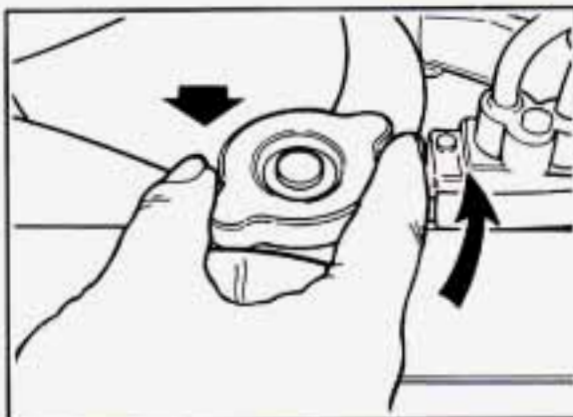

2. Then keep turning the pressure cap, but now push down as you turn it. Remove the pressure cap.

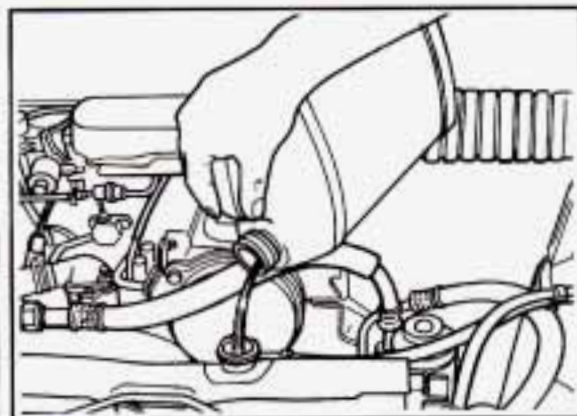

3. Fill the radiator with the proper mix, up to the base of the filler neck.

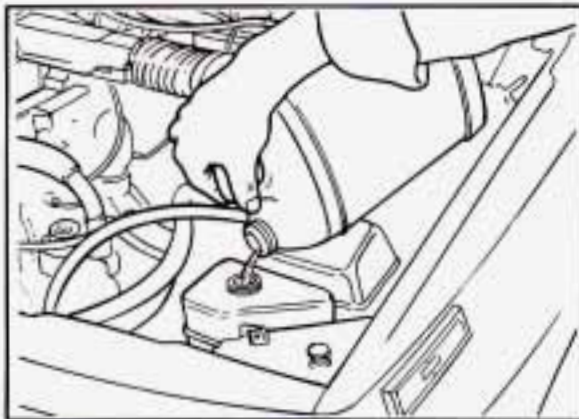

4. Then fill the coolant recovery tank to the "FULL" mark.

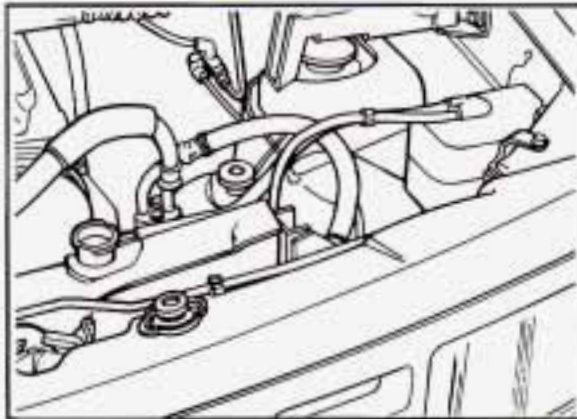

5. Put the cap back on the coolant recovery tank, but leave the radiator pressure cap off.

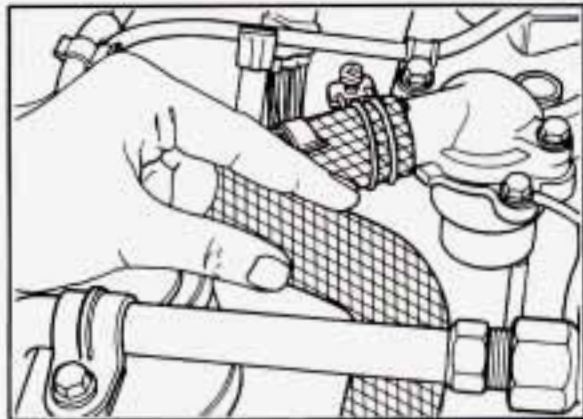

6. Start the engine and let it run until you can feel the upper radiator hose getting hot. Watch out for the engine fan.
- By this time, the coolant level inside the radiator filler neck may be lower. If the level is lower, add more of the proper mix through the filler neck until the level reaches the base of the filler neck.

## Problems on the Road

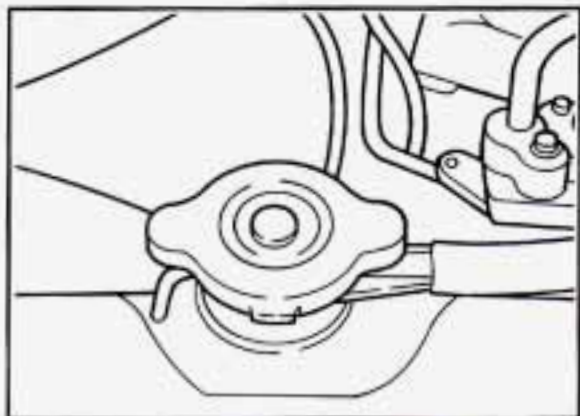

7. Then replace the pressure cap. At any time during this procedure, if coolant begins to flow out of the filler neck, reinstall the pressure cap. Be sure the arrows on the pressure cap line up like this.

### ■ *If a Tire Goes Flat*

It's unusual for a tire to "blow out" while you're driving, especially if you maintain your tires properly. If air goes out of a tire, it's much more likely to leak out slowly. But if you should ever have a "blowout," here are a few tips about what to expect and what to do:

If a front tire fails, the flat tire will create a drag that pulls the vehicle toward that side. Take your foot off the accelerator pedal and grip the steering wheel firmly. Steer to maintain lane position, then gently brake to a stop well out of the traffic lane.

A rear blowout, particularly on a curve, acts much like a skid and may require the same correction you'd use in a skid. In any rear blowout, remove your foot from the accelerator pedal. Get the vehicle under control by steering the way you want the vehicle to go. It may be very bumpy and noisy, but you can still steer. Gently brake to a stop, well off the road if possible.

If a tire goes flat, the next section shows how to use your jacking equipment to change a flat tire safely.

### *Changing a Flat Tire*

If a tire goes flat, avoid further tire and wheel damage by driving slowly to a level place. Turn on your hazard warning flashers.



**⚠ CAUTION:**

Changing a tire can cause an injury. The vehicle can slip off the jack and roll over you or other people. You and they could be badly injured. Find a level place to change your tire. To help prevent the vehicle from moving:

1. Set the parking brake firmly.
2. Put an automatic transmission shift lever in "P" (Park), or shift a manual transmission to "1" (First) or "R" (Reverse).
3. If you have a four-wheel-drive vehicle, be sure the transfer case is in a drive gear — not in "N" (Neutral).
4. Turn off the engine.

To be even more certain the vehicle won't move, you can put chocks at the front and rear of the tire farthest away from the one being changed. That would be the tire on the other side of the vehicle, at the opposite end.

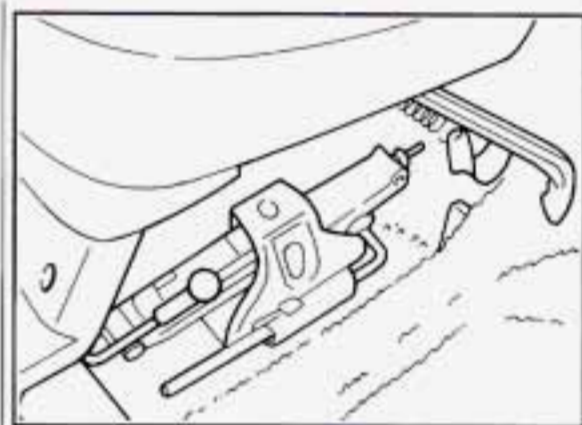

The following steps will tell you how to use the jack and change a tire.

The equipment you'll need is under the front seats.

The jack and wheel wrench are under the passenger's seat.

## Problems on the Road

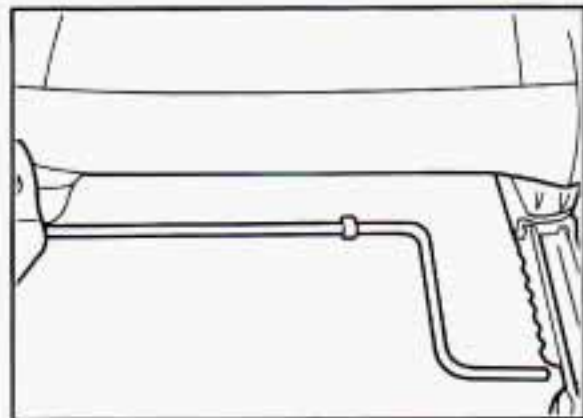

The jack handle is under the driver's seat.

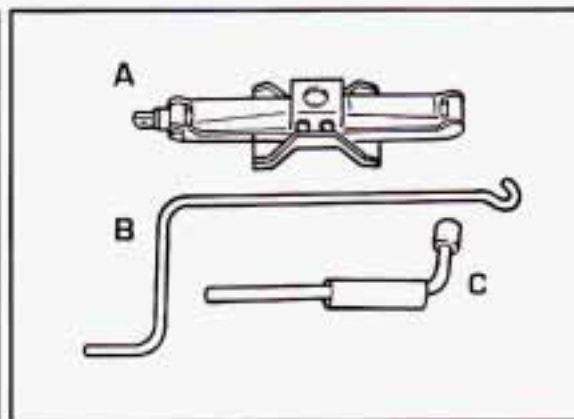

Start with the jack (A), jack handle (B) and wheel wrench (C).

Attach the jack handle to the jack. Turn the jack handle to the right to raise the lift head.

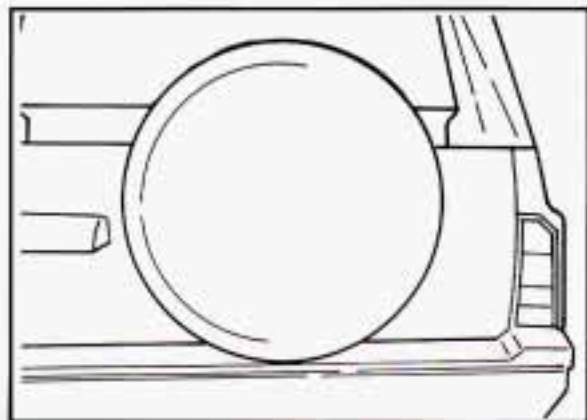

The spare tire is mounted on your tailgate. Pull the cover off of the spare tire.

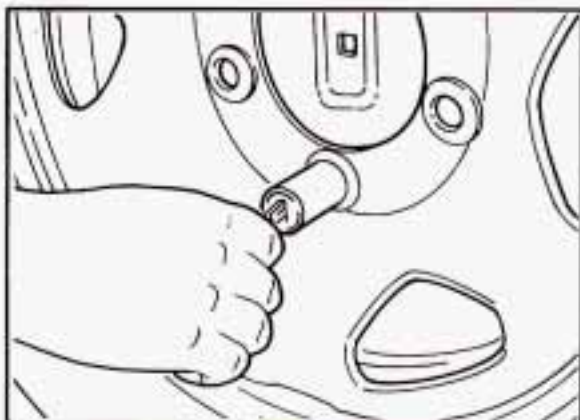

Insert your key into the wheel lock on the spare tire and pull the wheel lock off.

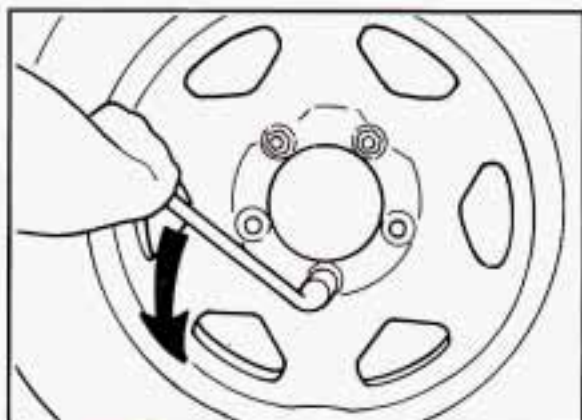

Remove wheel nuts with the wheel wrench.

Remove the spare tire from the mounting bracket and place it near your flat tire.

Attach the jack handle to the jack bolt. Turn the jack handle clockwise (to the right). That will raise the lift head a little.

## Problems on the Road

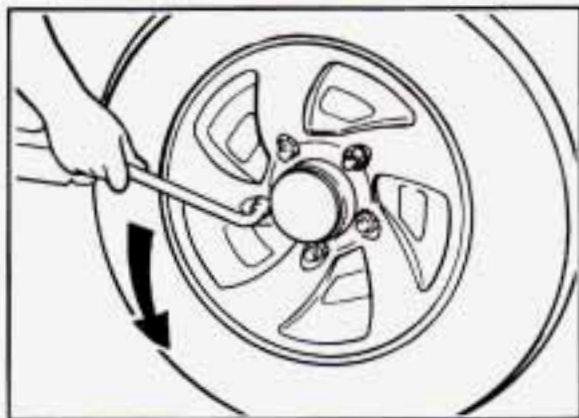

Using the wheel wrench, loosen all the wheel nuts. Don't remove them yet.

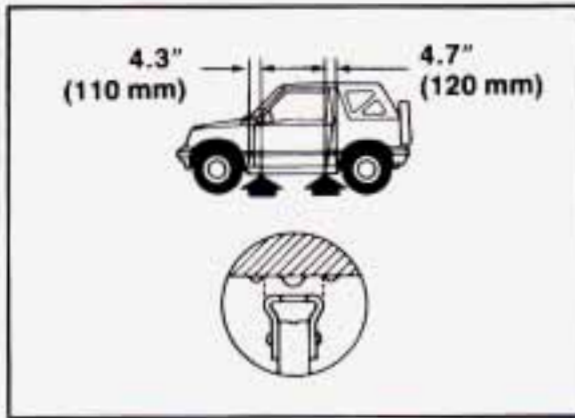

Under the vehicle near each wheel, there are bosses in the vehicle's rocker flange. Position the jack and raise the jack lift head until it fits firmly onto the bosses nearest the flat tire.



### CAUTION:

Getting under a vehicle when it is jacked up is dangerous. If the vehicle slips off the jack, you could be badly injured or killed. Never get under a vehicle when it is supported only by a jack.

### NOTICE:

Raising your vehicle with the jack improperly positioned will damage the vehicle or may allow the vehicle to fall off the jack. Be sure to fit the jack lift head into the proper location before raising your vehicle.

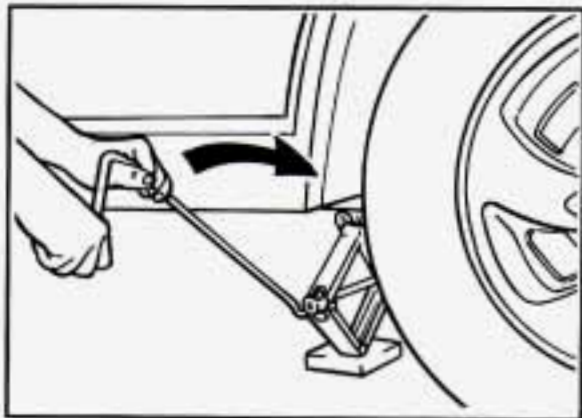

Raise the vehicle by turning the jack handle clockwise. Raise the vehicle far enough off the ground so there is enough room for the spare tire to fit.

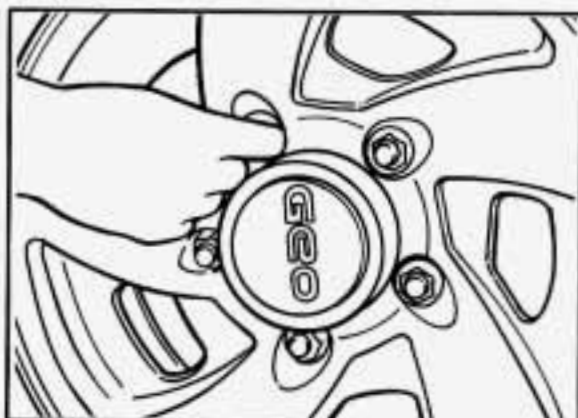

Remove all the wheel nuts and take off the flat tire.

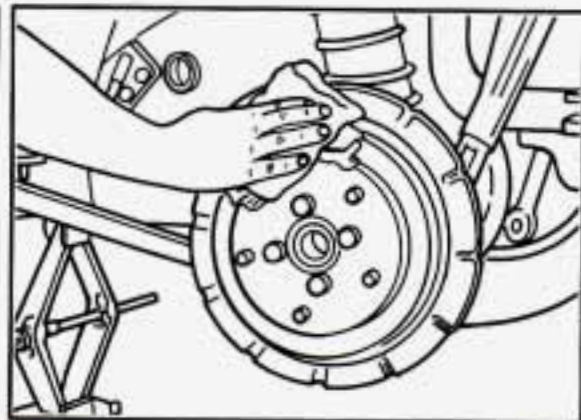

**⚠ CAUTION:**

Rust or dirt on the wheel, or on the parts to which it is fastened, can make the wheel nuts become loose after a time. The wheel could come off and cause an accident. When you change a wheel, remove any rust or dirt from the places where the wheel attaches to the vehicle. In an emergency, you can use a cloth or a paper towel to do this; but be sure to use a scraper or wire brush later, if you need to, to get all the rust or dirt off.

Remove any rust or dirt from the wheel bolts, mounting surfaces and spare wheel. Place the spare on the wheel mounting surface.



## Problems on the Road

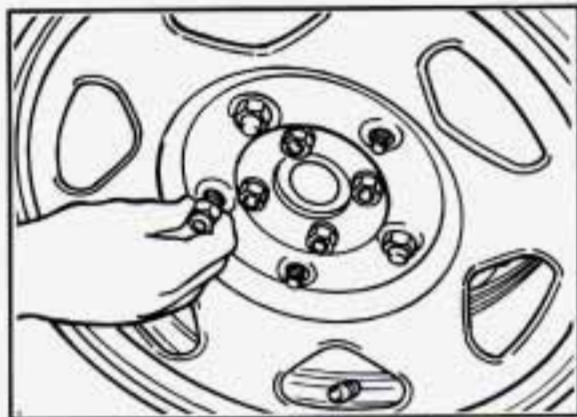

### CAUTION:

Never use oil or grease on studs or nuts. If you do, the nuts might come loose. Your wheel could fall off, causing a serious accident.

Replace the wheel nuts with the rounded end of the nuts toward the wheel. Tighten each nut by hand until the wheel is held against the hub.

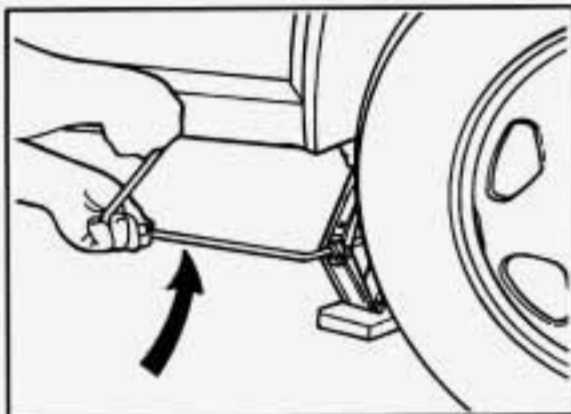

Lower the vehicle by turning the jack handle counterclockwise. Lower the jack completely.

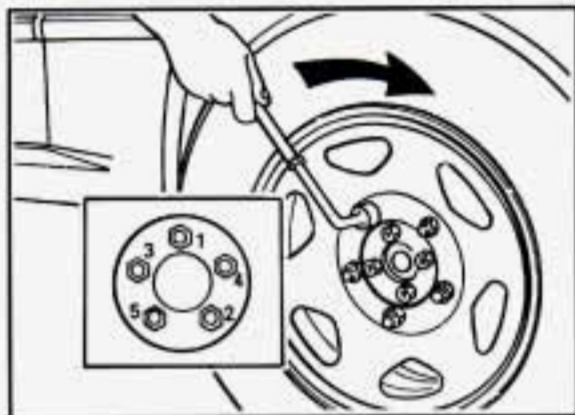

Tighten the wheel nuts firmly in a criss-cross sequence as shown.



### CAUTION:

Incorrect wheel nuts or improperly tightened wheel nuts can cause the wheel to become loose and even come off. This could lead to an accident. Be sure to use the correct wheel nuts. If you have to replace them, be sure to get the right kind.

Stop somewhere as soon as you can and have the nuts tightened with a torque wrench to 60 pound-feet (80 N•m).

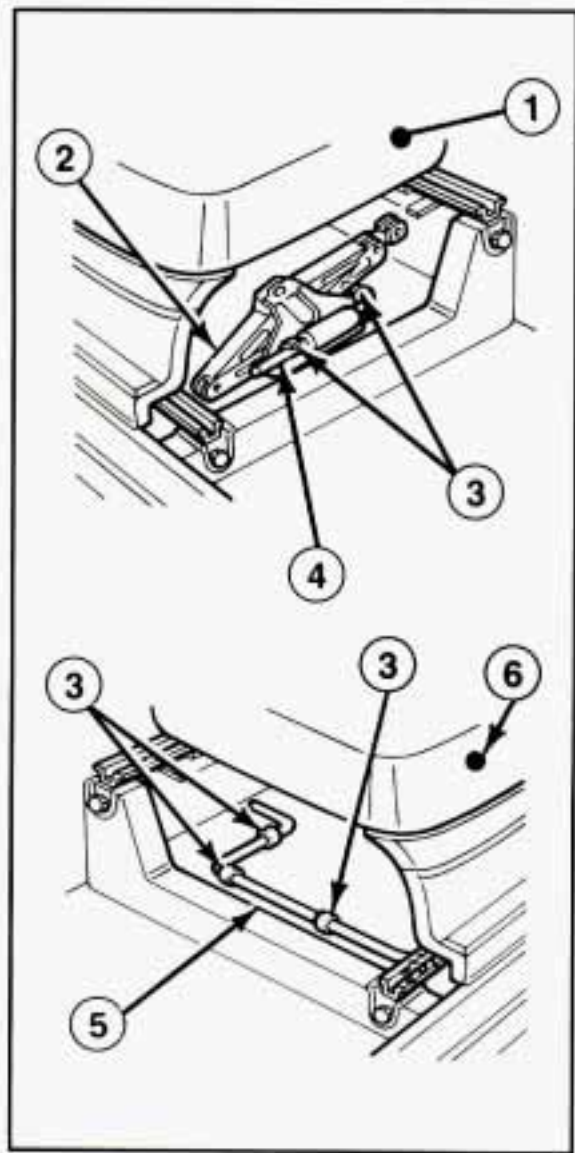

1. Front Passenger Seat
2. Jack
3. Clamp
4. Wrench
5. Jack Handle
6. Driver Seat

Replace the jack, jack handle, flat tire, and wheel wrench.



### CAUTION:

Storing a jack, a tire or other equipment in the passenger compartment of the vehicle could cause injury. In a sudden stop or collision, loose equipment could strike someone. Store all these in the proper place.

## ■ *If You're Stuck: In Sand, Mud, Ice or Snow*

What you don't want to do when your vehicle is stuck is to spin your wheels. The method known as "rocking" can help you get out when you're stuck, but you must use caution.



### CAUTION:

If you let your tires spin at high speed, they can explode and you or others could be injured. And, the transmission or other parts of the vehicle can overheat. That could cause an engine compartment fire or other damage. When you're stuck, spin the wheels as little as possible. Don't spin the wheels above 35 mph (55 km/h) as shown on the speedometer.

# Problems on the Road

## NOTICE:

Spinning your wheels can destroy parts of your vehicle as well as the tires. If you spin the wheels too fast while shifting your transmission back and forth, you can destroy your transmission.

### Rocking your vehicle to get it out:

First, turn your steering wheel left and right. That will clear the area around your front wheels. Then shift back and forth between "R" (Reverse) and a forward gear (or with a manual transmission, between First or Second gear and Reverse), spinning the wheels as little as possible. Release the accelerator pedal while you shift, and press lightly on the accelerator pedal when the transmission is in gear. If that doesn't get you out after a few tries, you may need to be towed out. Or, you can use your recovery hooks, if your vehicle has them. If you do need to be towed out, see "Towing Your Vehicle" in the Index.

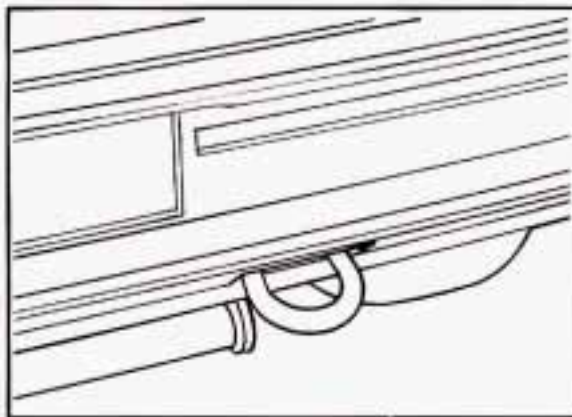

### Using the Recovery Hooks

If you ever get stuck in sand, mud, ice or snow, your Tracker is equipped with recovery hooks. The recovery hooks are provided at the front and rear of your vehicle. You may need to use them if you're stuck off-road and need to be pulled to some place where you can continue driving.

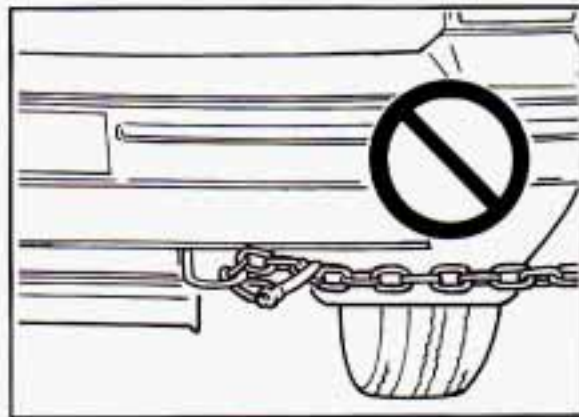

## CAUTION:

The recovery hooks, when used, are under a lot of force. Always pull the vehicle straight out. Never pull on the hooks at a sideways angle. The hooks could break off and you or others could be injured from the chain or cable snapping back.

## NOTICE:

Never use the recovery hooks to tow the vehicle. Your Tracker could be damaged and it would not be covered by warranty.

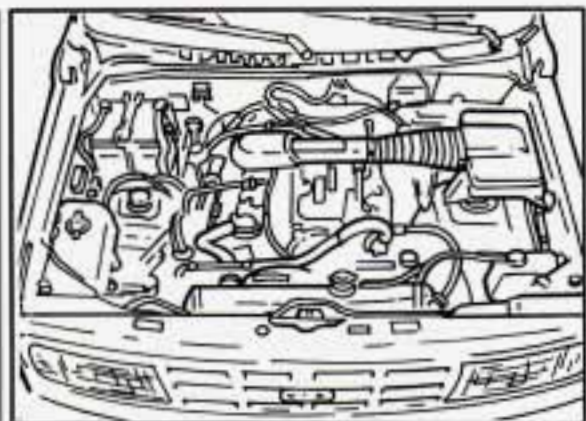
**Service & Appearance Care**

**H**ere you will find information about the care of your Geo. This part begins with service and fuel information, and then it shows how to check important fluid and lubricant levels. There is also technical information about your vehicle, and a section devoted to its appearance care.

Service .....	156
Fuel .....	156
Checking Things under the Hood .....	159
Hood Release .....	159
Engine Oil .....	162
Air Cleaner .....	165
Automatic Transmission Fluid .....	167
Manual Transmission Fluid .....	168
Clutch Adjustment .....	169
Rear Axle .....	169
Four-Wheel Drive .....	170
Engine Coolant .....	170
Power Steering Fluid .....	173
Windshield Washer Fluid .....	174
Brake Master Cylinder .....	174
Battery .....	176
Bulb Replacement .....	177
Loading Your Vehicle .....	181
Tires .....	183
Appearance Care .....	189
Appearance Care Materials Chart .....	195
Vehicle Identification Number (VIN) .....	196
Service Parts Identification Label .....	196
Add-On Electrical Equipment .....	196
Fuses and Circuit Breakers .....	196
Replacement Bulbs .....	199
Capacities and Specifications .....	200

## Service and Appearance Care



### ■ *Service*

Your Geo dealer knows your vehicle best and wants you to be happy with it. We hope you'll go to your dealer for all your service needs. You'll get genuine GM parts and GM-trained and supported service people.

We hope you'll want to keep your GM vehicle all GM. Genuine GM parts have one of these marks.

#### **Doing Your Own Service Work**

If you want to do some of your own service work, you'll want to get the proper Geo Service Manual. It tells you much more about how to service your Geo than this manual can. To order the

proper service manual, see "Service Publications" in the Index.

You should keep a record with all parts receipts and list the mileage and the date of any service work you perform. See "Maintenance Record" in the Index.



### **CAUTION:**

You can be injured if you try to do service work on a vehicle without knowing enough about it.

- Be sure you have sufficient knowledge, experience, and the proper replacement parts and tools before you attempt any vehicle maintenance task.
- Be sure to use the proper nuts, bolts and other fasteners. "English" and "metric" fasteners can be easily confused. If you use the wrong fasteners, parts can later break or fall off. You could be hurt.

### **NOTICE:**

If you try to do your own service work without knowing enough about it, your vehicle could be damaged.

### ■ *Fuel*

Use regular unleaded gasoline rated at 87 octane or higher. It should meet specifications ASTM D4814 in the U.S. and CGSB 3.5-92 in Canada. These fuels should have the proper additives, so you should not have to add anything to the fuel.

In the U.S. and Canada, it's easy to be sure you get the right kind of gasoline (unleaded). You'll see "UNLEADED" right on the pump. And only unleaded nozzles will fit into your vehicle's filler neck.

Be sure the posted octane is at least 87. If the octane is less than 87, you may get a heavy knocking noise when you drive. If it's bad enough, it can damage your engine.

If you're using fuel rated at 87 octane or higher and you still hear heavy knocking, your engine needs service. But don't

worry if you hear a little pinging noise when you're accelerating or driving up a hill. That's normal and you don't have to buy a higher octane fuel to get rid of pinging. It's the heavy, constant knock that means you have a problem.

What about gasoline with blending materials that contain oxygen (oxygenates), such as MTBE or alcohol?

MTBE is "methyl tertiary-butyl ether." Fuel that is no more than 15% MTBE is fine for your vehicle.

Ethanol is ethyl or grain alcohol. Properly-blended fuel that is no more than 10% ethanol is fine for your vehicle.

Methanol is methyl or wood alcohol.

## **NOTICE:**

Fuel that is more than 5% methanol is bad for your vehicle. Don't use it. It can corrode metal parts in your fuel system and also damage plastic and rubber parts. That damage wouldn't be covered under your warranty. And even at 5% or less, there must be "cosolvents" and corrosion preventers in this fuel to help avoid these problems.

## **Gasolines for Cleaner Air**

Your use of gasoline with deposit control additives will help prevent deposits from forming in your engine and fuel system. That helps keep your engine in tune and your emission control system working properly. It's good for your vehicle, and you'll be doing your part for cleaner air.

Many gasolines are now blended with oxygenates. General Motors recommends that you use gasolines with these blending materials, such as MTBE and ethanol. By doing so, you can help clean the air, especially in those parts of the country that have high carbon monoxide levels.

In addition, some gasoline suppliers are now producing reformulated gasolines. These gasolines are specially designed to reduce vehicle emissions. General Motors recommends that you use reformulated gasoline. By doing so, you can help clean the air, especially in those parts of the country that have high ozone levels.

You should ask your service station operators if their gasolines contain deposit control additives and oxygenates, and if they have been reformulated to reduce vehicle emissions.

## **Fuels in Foreign Countries**

If you plan on driving in another country outside the U.S. or Canada, unleaded fuel may be hard to find. Do not use leaded gasoline. If you use even one tankful, your emission controls won't work well or at all. With continuous use, spark plugs can get fouled, the exhaust system can corrode, and your engine oil can deteriorate quickly. Your vehicle's oxygen sensor will be damaged. All of that means costly repairs that wouldn't be covered by your warranty.

To check on fuel availability, ask an auto club, or contact a major oil company that does business in the country where you'll be driving.

You can also write us at the following address for advice. Just tell us where you're going and give your Vehicle Identification Number (VIN).

General Motors Overseas Distribution Corporation  
North American Export Sales (NAES)  
1908 Colonel Sam Drive  
Oshawa, Ontario L1H 8P7

## Service and Appearance Care

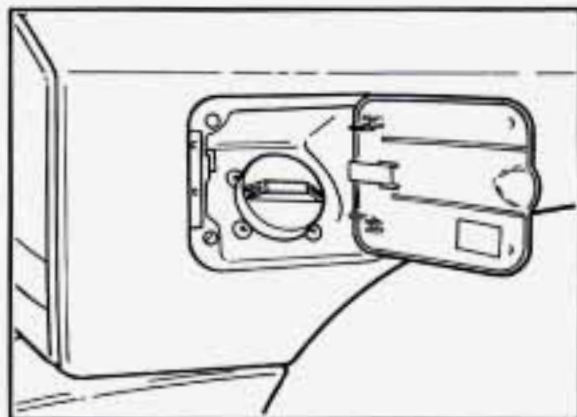

### Filling Your Tank

#### CAUTION:

Gasoline vapor is highly flammable. It burns violently, and that can cause very bad injuries. Don't smoke if you're near gasoline or refueling your vehicle. Keep sparks, flames, and smoking materials away from gasoline.

The cap is behind a hinged door on the right side of your vehicle.

To take off the cap, turn it slowly to the left (counterclockwise).

#### CAUTION:

If you get gasoline on you and then something ignites it, you could be badly burned. Gasoline can spray out on you if you open the fuel filler cap too quickly. This spray can happen if your tank is nearly full, and is more likely in hot weather. Open the fuel filler cap slowly and wait for any "hiss" noise to stop. Then unscrew the cap all the way.

Be careful not to spill gasoline. Clean gasoline from painted surfaces as soon as possible. See "Cleaning the Outside of Your Geo" in the Index.

When you put the cap back on, turn it to the right until you hear at least three clicks.

#### **NOTICE:**

If you need a new cap, be sure to get the right type. Your dealer can get one for you. If you get the wrong type, it may not fit or have proper venting, and your fuel tank and emissions system might be damaged.

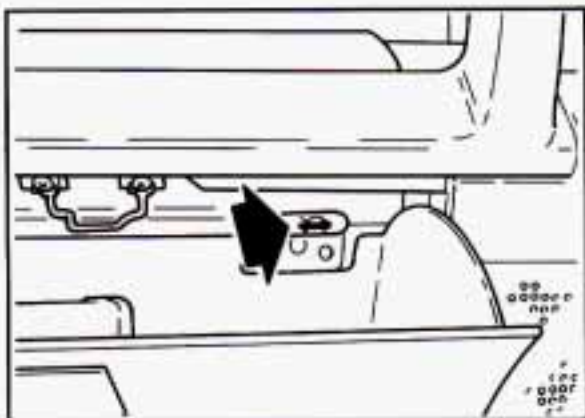

## ■ *Checking Things under the Hood*

### *Hood Release*

To open the hood, first pull the release handle inside the glove box.

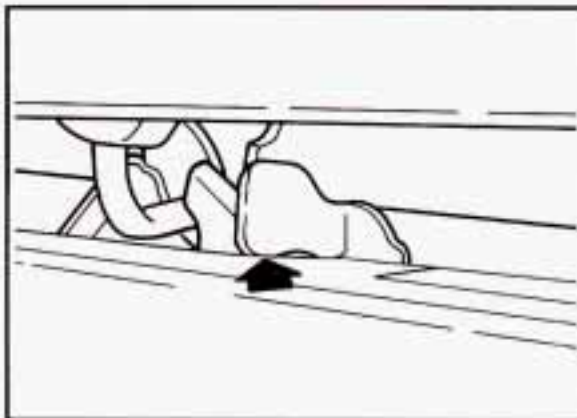

Then go to the front of the vehicle, push down lightly on the hood, and push the hood release lever to your left.

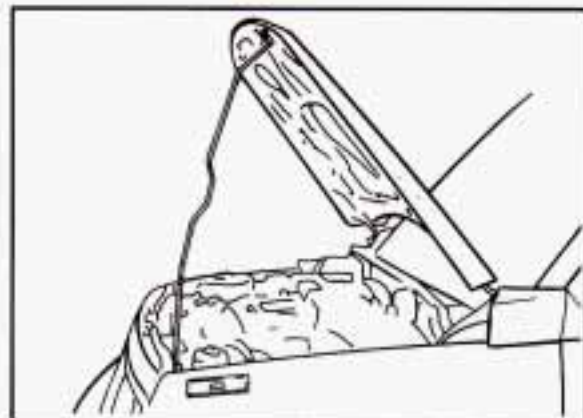

Lift the hood, release the hood prop from its retainer and put the hood prop into the slot in the hood.



### **CAUTION:**

An electric fan under the hood can start up and injure you even when the engine is not running. Keep hands, clothing and tools away from any underhood electric fan. Don't reach through the grille to release the underhood lever.



## Service and Appearance Care

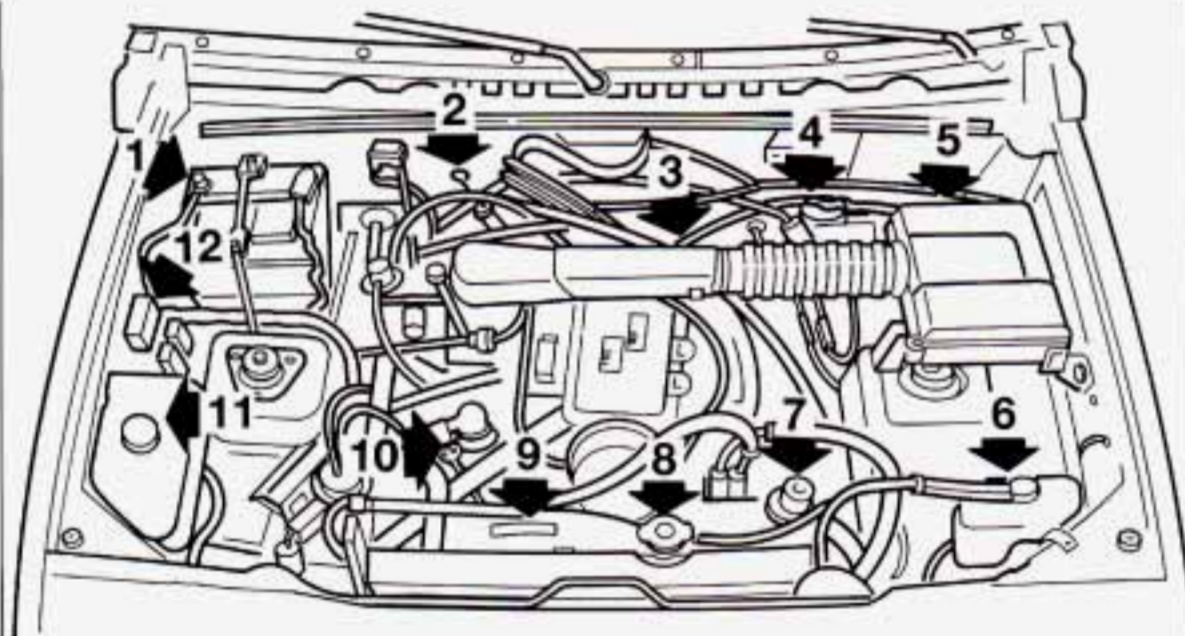

When you open the hood, you'll see on the 8-valve engine:

1. Battery
2. Automatic Transmission Dipstick (if equipped)
3. Oil Fill Cap
4. Brake Fluid Reservoir
5. Air Cleaner
6. Engine Coolant Reservoir
7. Power Steering Reservoir
8. Radiator Pressure Cap
9. Electric Engine Fan
10. Engine Oil Dipstick
11. Windshield Washer Reservoir
12. Main Fuse Box

### CAUTION:

Things that burn can get on hot engine parts and start a fire. These include liquids like gasoline, oil, coolant, brake fluid, windshield washer and other fluids, and plastic or rubber. You or others could be burned. Be careful not to drop or spill things that will burn onto a hot engine.

Before closing the hood, be sure all the filler caps are on.

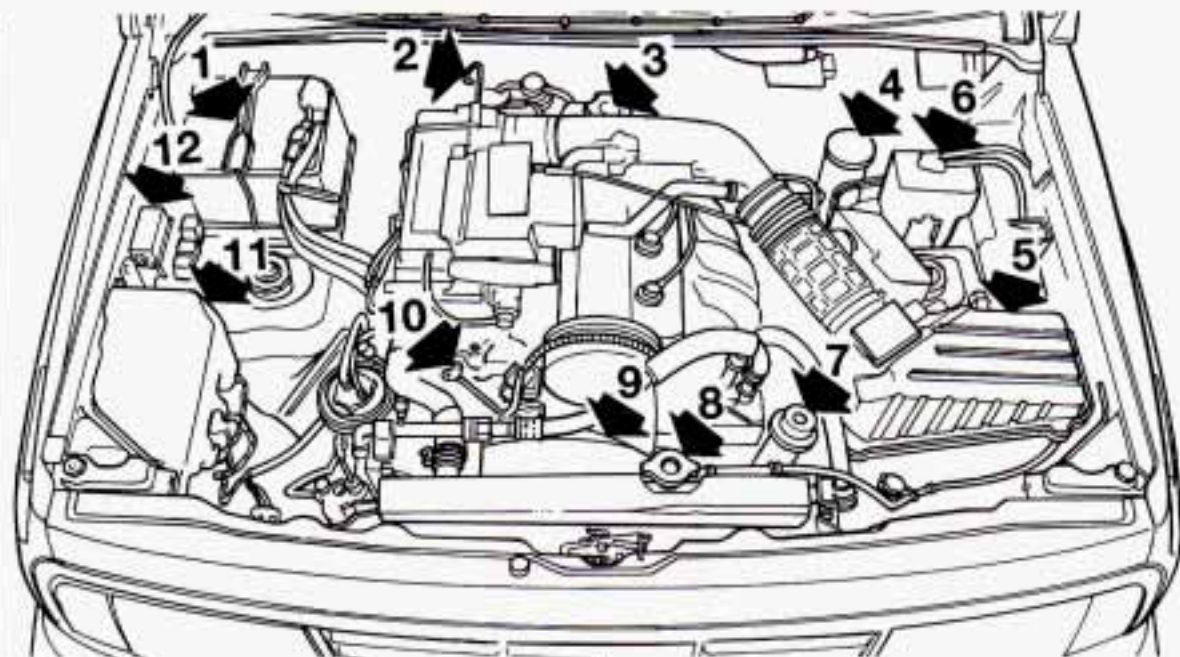

When you open the hood, you'll see on the 16-valve engine:

- |   |                                 |
|---|---------------------------------|
| 1. Battery  | 7. Power Steering Reservoir     |
| 2. Automatic Transmission Dipstick<br>(if equipped) | 8. Radiator Pressure Cap        |
| 3. Oil Fill Cap                                     | 9. Electric Engine Fan          |
| 4. Brake Fluid Reservoir                            | 10. Engine Oil Dipstick         |
| 5. Air Cleaner                                      | 11. Windshield Washer Reservoir |
| 6. Engine Coolant Reservoir                         | 12. Main Fuse Box               |

**⚠ CAUTION:**

Things that burn can get on hot engine parts and start a fire. These include liquids like gasoline, oil, coolant, brake fluid, windshield washer and other fluids, and plastic or rubber. You or others could be burned. Be careful not to drop or spill things that will burn onto a hot engine.

Before closing the hood, be sure all the filler caps are on.

## Service and Appearance Care



Then lift the hood to relieve pressure on the hood prop. Remove the hood prop from the slot in the hood and return the prop to its retainer. Then just let the hood down and close it firmly.

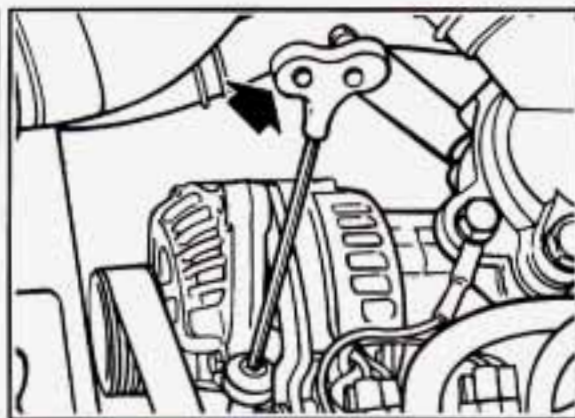

### ***Engine Oil***

It's a good idea to check your engine oil level every time you get fuel. In order to get an accurate reading, the oil must be warm and the vehicle must be on level ground.

Turn off the engine and give the oil a few minutes to drain back into the oil pan. If you don't, the oil dipstick might not show the actual level.



### **To Check Engine Oil**

Pull out the dipstick and clean it with a paper towel or cloth, then push it back in all the way. Remove it again, keeping the tip lower.

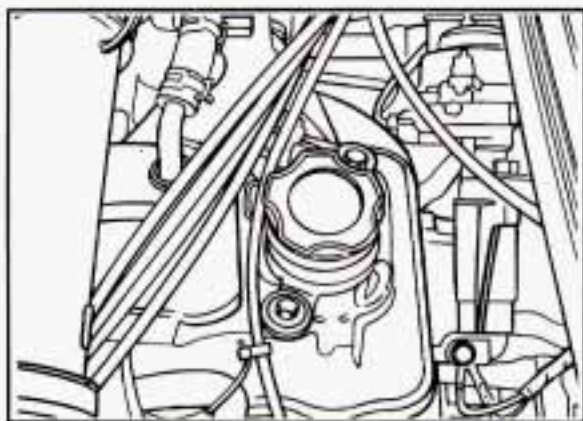

8-Valve Engine

### When to Add Oil:

If the oil is at or below the ADD mark, you'll need to add some oil. But you must use the right kind. This section explains what kind of oil to use. For crankcase capacity, see "Capacities and Specifications" in the Index.

### NOTICE:

Don't add too much oil. If your engine has so much oil that the oil level gets above the upper mark that shows the proper operating range, your engine could be damaged.

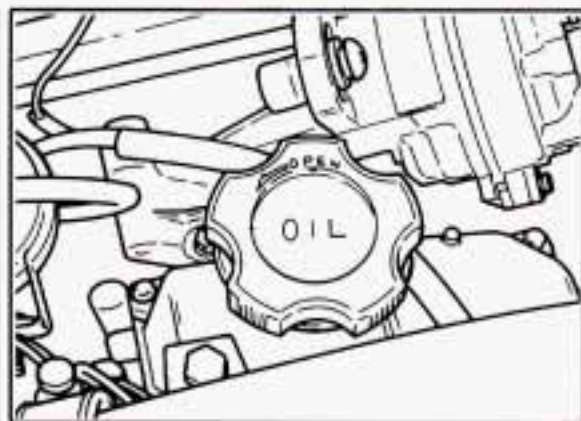

16-Valve Engine

Just fill it enough to put the level somewhere in the proper operating range. Push the dipstick all the way back in when you're through.



### What Kind of Oil to Use

Beginning midyear 1993, oils of the proper quality for your vehicle will be identified with this new "starburst" symbol. The "starburst" symbol indicates that the oil has been certified by the American Petroleum Institute (API), and is preferred for use in your gasoline engine.

You should look for this on the front of the oil container, and use only oils that display this new symbol.

You should also use the proper viscosity oil for your vehicle, as shown in the following chart:

# Service and Appearance Care

## Recommended SAE Viscosity Grade Engine Oils

For best fuel economy and cold starting, select the lowest SAE viscosity grade oil for the expected temperature range.

**HOT WEATHER**

**LOOK FOR ONE OF THESE LABELS**

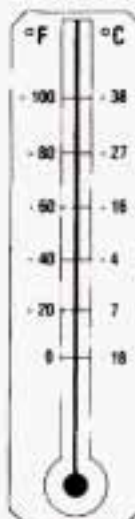

**COLD WEATHER**

IF NEITHER SAE 5W-30 NOR SAE 10W-30 GRADE OILS ARE AVAILABLE, SAE 30 GRADE MAY BE USED AT TEMPERATURES ABOVE 40 DEGREES F (4 DEGREES C).

DO NOT USE SAE 10W-40, SAE 20W-50 OR ANY OTHER GRADE OIL NOT RECOMMENDED.

As shown in the chart, SAE 5W-30 is best for your vehicle. However, you can use SAE 10W-30 if it's going to be 0°F (-18°C) or above. These numbers on an oil container show its viscosity, or thickness. Do not use other viscosity oils, such as SAE 10W-40 or SAE 20W-50.

If you cannot find oils with the new "starburst" symbol on the front of the container, you should look for and use oils containing the following three things:

- SH or SG  
"SH" or "SG" must be on the oil container, either by itself or combined with other quality designations, such as "SH/CD," "SH,SG,CD," "SG/CD," etc. These letters show American Petroleum Institute (API) levels of quality.
- SAE 5W-30
- Energy Conserving II  
Oils with these words on the container will help you save fuel.



These three things are usually included in a doughnut shaped logo (symbol) on most containers. If you cannot find oils with the "starburst" symbol, you should look for oils with the doughnut shaped symbol, containing the three things noted above.

## NOTICE:

If you use oils that do not have either the "starburst" symbol or an API SH or SG designation, you can cause engine damage not covered by your warranty.

GM Goodwrench<sup>®</sup> oil (in Canada, GM Engine Oil) meets all the requirements for your vehicle.

## Engine Oil Additives

Don't add anything to your oil. Your Geo dealer is ready to advise if you think something should be added.

## When to Change Engine Oil

See if any one of these is true for you:

- Most trips are less than 4 miles (6 km).
- It's below freezing outside and most trips are less than 10 miles (16 km).
- The engine is at low speed most of the time (as in door-to-door delivery, or stop-and-go traffic).
- You tow a trailer often.
- Most trips are through dusty places.
- The vehicle is frequently operated off-road.

If any one of these is true for your vehicle, then you need to change your oil and filter every 3,000 miles (5 000 km) or 3 months — whichever comes first.

If none of them is true, change oil and filter every 7,500 miles (12 500 km) or 7.5 months — whichever comes first.

## Engine Coolant Heater (Engine Block Heater)

An engine coolant heater can be a big help if you have to park outside in very cold weather, 0°F (-18°C) or colder. If your vehicle has this option, see "Engine Coolant Heater" in the Index.

## What to Do with Used Oil

Did you know that used engine oil contains elements that may be unhealthy for your skin and could even cause cancer? Don't let used oil stay on your skin for very long. Clean your skin and nails with soap and water, or a good hand cleaner. Wash or properly throw away clothing or rags containing used engine oil. (See the manufacturer's warnings about the use and disposal of oil products.)

Used oil can be a real threat to the environment. If you change your own oil, be sure to drain all free-flowing oil from the filter before disposal. Don't ever dispose of oil by putting it in the trash, pouring it on the ground, into sewers, or into streams or bodies of water. Instead, recycle it by taking it to a place that collects used oil. If you have a problem properly disposing of your used oil, ask your dealer, a service station or a local recycling center for help.

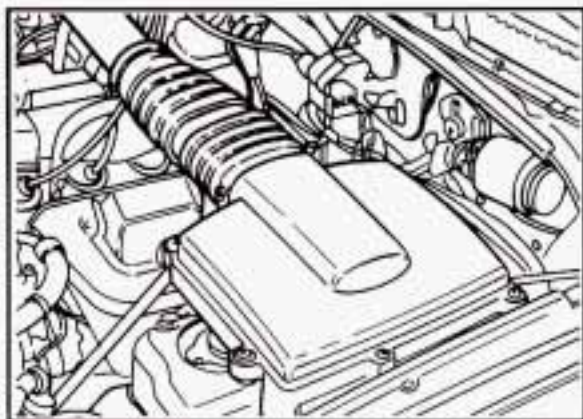

8-Valve Engine

## Air Cleaner

Refer to the Maintenance Schedule to determine when to replace the air filter. See "Scheduled Maintenance Services" in the Index.



## CAUTION:

Operating the engine with the air cleaner off can cause you or others to be burned. The air cleaner not only cleans the air, it stops flame if the engine backfires. If it isn't there, and the engine backfires, you could be burned. Don't drive with it off, and be careful working on the engine with the air cleaner off.

## Service and Appearance Care

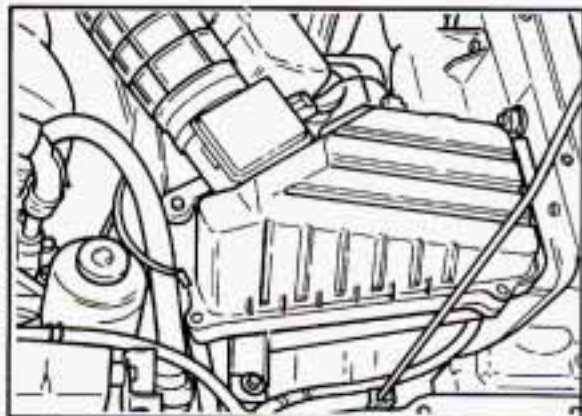

16-Valve Engine

### **NOTICE:**

If the air cleaner is off, a backfire can cause a damaging engine fire. And, dirt can easily get into your engine, which will damage it. Always have the air cleaner in place when you're driving.

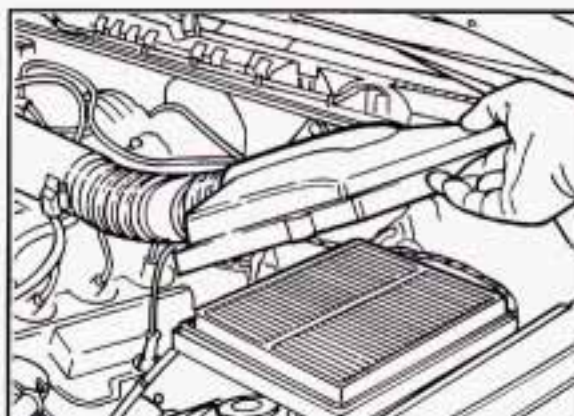

### **Air Filter Replacement (8-Valve Engine)**

To check or replace the filter:

1. Remove the screws.
2. Lift up the cover.
3. Pull out the filter.

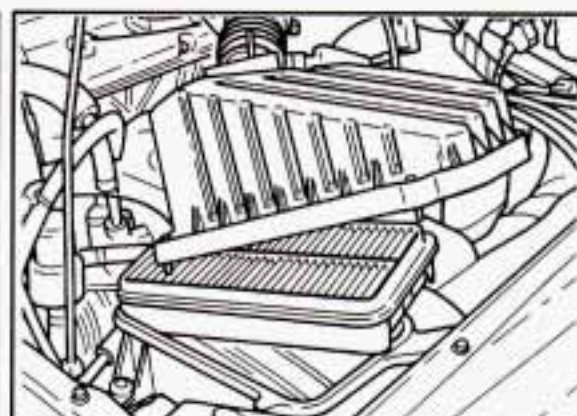

### **Air Filter Replacement (16-Valve Engine)**

To check or replace the filter:

1. Remove the screws on the cover.
2. Lift it up.
3. Pull out the filter.

## Automatic Transmission Fluid

### When to Check and Change

A good time to check your automatic transmission fluid level is when the engine oil is changed. Refer to the Maintenance Schedule to determine when to change your fluid. See "Scheduled Maintenance Services" in the Index.

### How to Check

Because this operation can be a little difficult, you may choose to have this done at your Geo dealership Service Department.

If you do it yourself, be sure to follow all the instructions here, or you could get a false reading on the dipstick.

### NOTICE:

Too much or too little fluid can damage your transmission. Too much can mean that some of the fluid could come out and fall on hot engine parts or exhaust system parts, starting a fire. Be sure to get an accurate reading if you check your transmission fluid.

Wait at least 30 minutes before checking the transmission fluid level if you have been driving:

- When outside temperatures are above 90°F (32°C).
- At high speed for quite a while.
- In heavy traffic — especially in hot weather.
- While pulling a trailer.

To get the right reading, the fluid should be at normal operating temperature, which is 180°F to 200°F (82°C to 93°C).

**To check transmission fluid hot:** Get the vehicle warmed up by driving about 15 miles (24 km) when outside temperatures are above 50°F (10°C). If it's colder than 50°F (10°C), drive the vehicle in "D" (Third Gear) until the engine temperature gage moves and then remains steady for ten minutes. Then follow the hot check procedures.

**To check transmission fluid cold:** A cold check is made after the vehicle has been sitting for eight hours or more with the engine off and is used only as a reference. Let the engine run at idle for five minutes if outside temperatures are 50°F (10°C) or more. If it's colder than 50°F (10°C), you may have to idle the engine longer.

Should the fluid level be low during a cold check, you must perform a hot check before adding fluid. This will give you a more accurate reading of the fluid level.

### To check the fluid hot or cold

- Park your vehicle on a level place. Keep the engine running.
- With the parking brake applied, place the shift lever in "P" (Park).
- With your foot on the brake pedal, move the shift lever through each gear range, pausing for about three seconds in each range. Then, position the shift lever in "P" (Park).
- Let the engine run at idle for three minutes or more.



## Service and Appearance Care

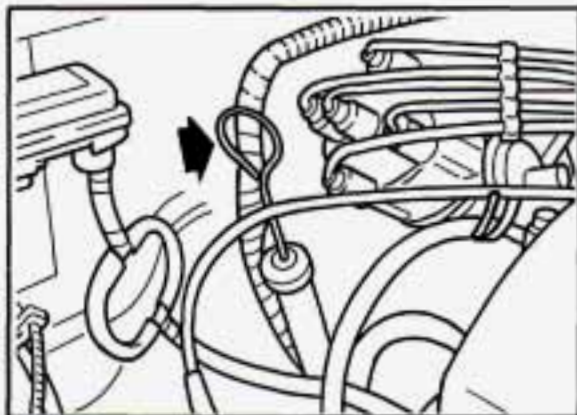

**Then, without shutting off the engine, follow these steps:**

1. Pull out the dipstick and wipe it with a clean rag or paper towel.
2. Push it back in all the way, wait three seconds and then pull it back out again.

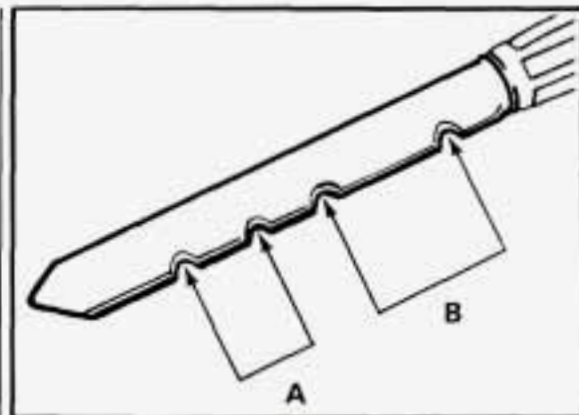

3. Check both sides of the dipstick, and read the lower level. The fluid level must be in the "COLD" area for a cold check or in the "HOT" area or cross-hatched area for a hot check.
4. If the fluid level is in the acceptable range, push the dipstick back in all the way.

### How to Add Fluid

Refer to the Maintenance Schedule to determine what kind of transmission fluid to use. See "Recommended Fluids and Lubricants" in the Index.

If the fluid level is low, add only enough of the proper fluid to bring the level up to the "COLD" area for a cold check or the "HOT" area for a hot check. It doesn't

take much fluid, generally less than a pint. Don't overfill. We recommend you use only fluid labeled DEXRON<sup>®</sup>-III or DEXRON<sup>®</sup>-IIE, because fluids with that label are made especially for your automatic transmission. Damage caused by fluid other than DEXRON<sup>®</sup>-III or DEXRON<sup>®</sup>-IIE is not covered by your new vehicle warranty.

- After adding fluid, recheck the fluid level as described under "How to Check."
- When the correct fluid level is obtained, push the dipstick back in all the way.

### Manual Transmission Fluid

#### When to Check and Change

A good time to have it checked is when the engine oil is changed. Refer to the Maintenance Schedule to determine when to change your transmission fluid. See "Scheduled Maintenance Services" in the Index.

#### How to Check:

Because this operation can be a little difficult, you may choose to have this done at your Geo dealership Service Department.

If you do it yourself, be sure to follow all the instructions here, or you could get a false reading.

## **NOTICE:**

Too much or too little fluid can damage your transmission. Too much can mean that some of the fluid could come out and fall on hot engine parts or exhaust system parts, starting a fire. Be sure to get an accurate reading if you check your transmission fluid.

Check the fluid level only when your engine is off, the vehicle is parked on a level place and the transmission is cool enough for you to rest your fingers on the transmission case.

### **Then, follow these steps:**

1. Remove the filler plug.
2. Check that the lubricant level is up to the bottom of the filler plug hole.
3. If the fluid level is good, install the plug and be sure it is fully seated. If the fluid level is low, add more fluid as described in the next steps.

### **How to Add Fluid:**

Here's how to add fluid. Refer to the Maintenance Schedule to determine what kind of fluid to use. See "Recommended Fluids and Lubricants" in the Index.

1. Remove the filler plug.
2. Add fluid at the filler plug hole. Add only enough fluid to bring the fluid level up to the bottom of the filler plug hole.
3. Install the filler plug. Be sure the plug is fully seated.

### **Clutch Adjustment**

The clutch linkage in your vehicle should be checked as recommended in your Maintenance Schedule. To check, push the clutch pedal down with your hand until you feel some resistance to movement of the pedal. If the pedal moves freely up to an inch (25 mm) or so before you feel resistance to the travel, adjustment isn't needed.

If there is no free travel or very little (less than 5/8 of an inch), see your dealer for adjustment.

## **Rear Axle**

### **When to Check and Change Lubricant**

Refer to the Maintenance Schedule to determine how often to check the lubricant and when to change it. See "Periodic Maintenance Inspections" and "Scheduled Maintenance Services" in the Index.

### **How to Check Lubricant**

If the level is below the bottom of the filler plug hole, you'll need to add some lubricant. Add enough lubricant to raise the level to the bottom of the filler plug hole.

### **What to Use:**

Refer to the Maintenance Schedule to determine what kind of lubricant to use. See "Recommended Fluids and Lubricants" in the Index.

# Service and Appearance Care

## **Four-Wheel Drive**

Most lubricant checks in this section also apply to four-wheel-drive vehicles. However, they have two additional systems that need lubrication.

### **Transfer Case**

#### **When to Check and Change Lubricant**

Refer to the Maintenance Schedule to determine how often to check the lubricant and when to change it. See "Scheduled Maintenance Services" in the Index.

#### **How to Check Lubricant**

If the level is below the bottom of the filler plug hole, you'll need to add some lubricant. Add enough lubricant to raise the level to the bottom of the filler plug hole.

#### **What to Use**

Refer to the Maintenance Schedule to determine what kind of lubricant to use. See "Recommended Fluids and Lubricants" in the Index.

## **Front Axle**

### **When to Check and Change Lubricant**

Refer to the Maintenance Schedule to determine how often to check the lubricant and when to change it. See "Periodic Maintenance Inspections" and "Scheduled Maintenance Services" in the Index.

### **How to Check Lubricant**

If the level is below the bottom of the filler plug hole, you'll need to add some lubricant.

If the differential is at operating temperature (warm), add enough lubricant to raise the level to the bottom of the filler plug hole.

If the differential is cold, add enough lubricant to raise the level to 1/2 inch (12 mm) below the filler plug hole.

### **What to Use**

Refer to the Maintenance Schedule to determine what kind of lubricant to use. See "Recommended Fluids and Lubricants" in the Index.

## **Engine Coolant**

The following explains your cooling system and how to add coolant when it is low. If you have a problem with engine overheating, see "Engine Overheating" in the Index.

The proper coolant for your Geo will:

- Give freezing protection down to  $-20^{\circ}\text{F}$  ( $-29^{\circ}\text{C}$ ), or  $-34^{\circ}\text{F}$  ( $-37^{\circ}\text{C}$ ) in Canada and for vehicles with the cold climate option.
- Give boiling protection up to  $258^{\circ}\text{F}$  ( $125^{\circ}\text{C}$ ).
- Protect against rust and corrosion.
- Help keep the proper engine temperature.
- Let the warning lights work as they should.

### **What to Use:**

Use a mixture of one-half clean water (preferably distilled) and one-half antifreeze that meets "GM Specification 6038-M," which won't damage aluminum parts. You can also use a recycled coolant conforming to "GM Specification 6038-M" with a complete coolant flush

and refill. If you use this mixture, you don't need to add anything else.

**⚠ CAUTION:**

Adding only plain water to your cooling system can be dangerous. Plain water, or some other liquid like alcohol, can boil before the proper coolant mix will. Your vehicle's coolant warning system is set for the proper coolant mix. With plain water or the wrong mix, your engine could get too hot but you wouldn't get the overheat warning. Your engine could catch fire and you or others could be burned. Use a 50/50 mix of clean water and a proper antifreeze.

**NOTICE:**

If you use an improper coolant mix, your engine could overheat and be badly damaged. The repair cost wouldn't be covered by your warranty. Too much water in the mix can freeze and crack the engine, radiator, heater core and other parts.

Some conditions, such as air trapped in the cooling system, can affect the coolant level in the radiator. Check the coolant level when the engine is cold and follow the steps under "Adding Coolant" for the proper way to add coolant.

If you have to add coolant more than four times a year, have your dealer check your cooling system.

**NOTICE:**

If you use the proper coolant, you don't have to add extra inhibitors or additives which claim to improve the system. These can be harmful.

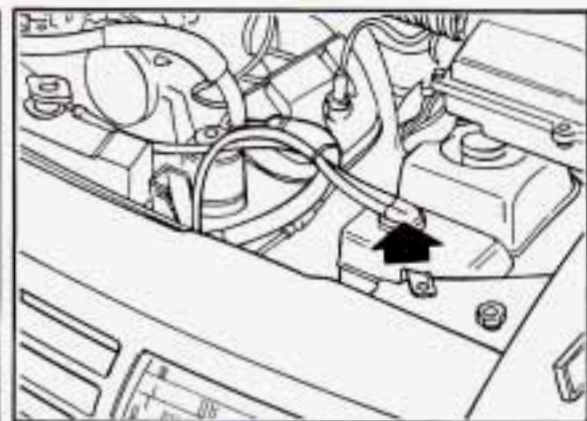

8-Valve Engine

**Adding Coolant**

**To Check Coolant:** When your engine is cold, the coolant level should be at "LOW," or a little higher. When your engine is warm, the level should be up to "FULL," or a little higher.

# Service and Appearance Care

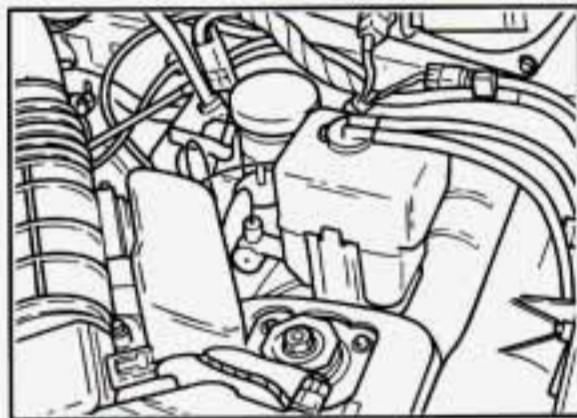

16-Valve Engine

**To Add Coolant:** If you need to add more coolant, add the proper mix at the coolant recovery tank.



## CAUTION:

Turning the radiator pressure cap when the engine and cooling system are hot can allow steam and scalding liquids to blow out and burn you badly. With the coolant recovery tank, you will almost never have to add coolant at the radiator. Never turn the radiator pressure cap – even a little – when the engine and radiator are hot.

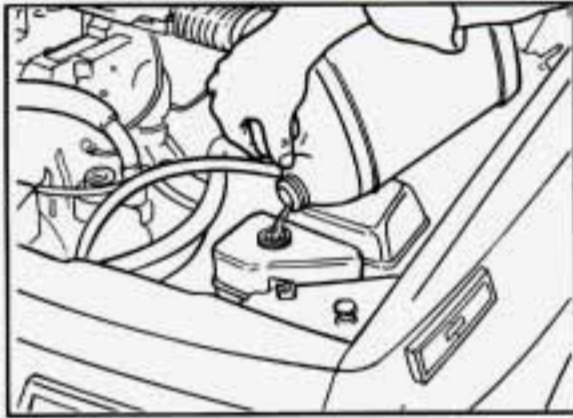

Add coolant mix at the recovery tank, but be careful not to spill it.



## CAUTION:

You can be burned if you spill coolant on hot engine parts. Coolant contains ethylene glycol, and it will burn if the engine parts are hot enough. Don't spill coolant on a hot engine.

## Radiator Pressure Cap

### NOTICE:

Your radiator cap is a 13 psi (90 kPa) pressure-type cap and must be tightly installed to prevent coolant loss and possible engine damage from overheating. Be sure the arrows on the cap line up with the overflow tube on the radiator filler neck.

When you replace your radiator pressure cap, an AC<sup>®</sup> cap is recommended.

### Thermostat

Engine coolant temperature is controlled by a thermostat in the engine coolant system. The thermostat stops the flow of coolant through the radiator until the coolant reaches a preset temperature. When you replace your thermostat, an AC<sup>®</sup> thermostat is recommended.

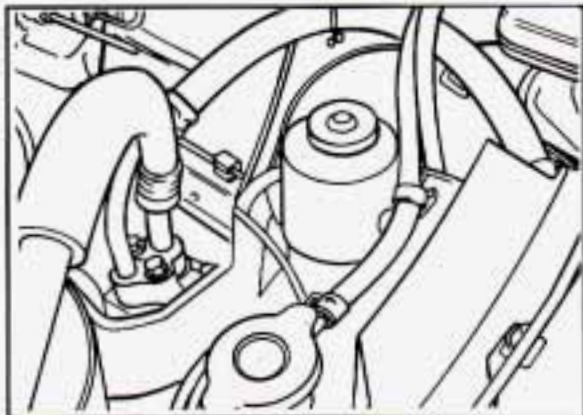

## ***Power Steering Fluid***

### **How to Check Power Steering Fluid:**

Unscrew the cap and wipe the dipstick with a clean rag. Replace the cap and completely tighten it. Then remove the cap again and look at the fluid level on the dipstick.

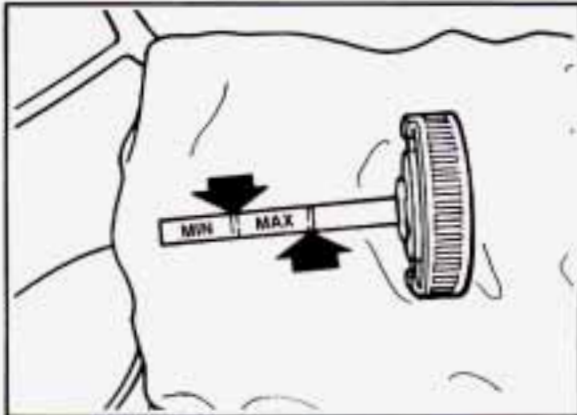

- When the engine compartment is hot, the level should be at the "MAX" mark.
- When the engine compartment is cool, the level should be at the "MIN" mark.

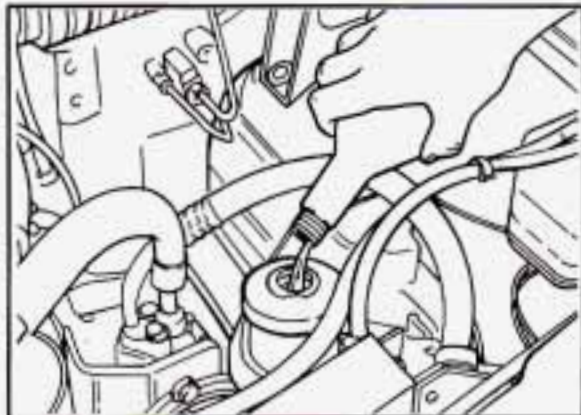

### **What to Add:**

Refer to the Maintenance Schedule to determine what kind of fluid to use. See "Recommended Fluids and Lubricants" in the Index.

### **NOTICE:**

When adding power steering fluid or making a complete fluid change, always use the proper fluid. Failure to use the proper fluid can cause leaks and damage hoses and seals.

# Service and Appearance Care

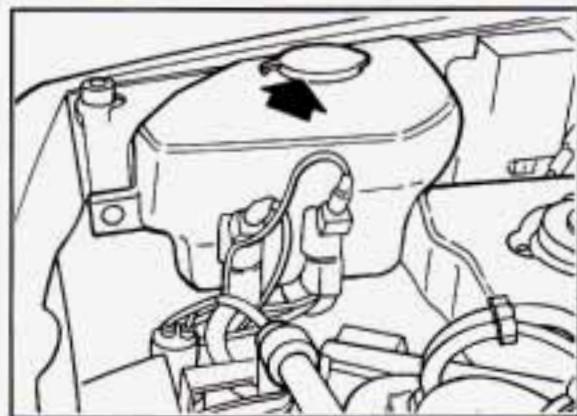

## ***Windshield Washer Fluid***

### **To Add:**

Open the cap with the washer symbol on it. Add washer fluid until the bottle is full.

## **NOTICE:**

- When using concentrated washer fluid, follow the manufacturer's instructions for adding water.
- Don't mix water with ready-to-use washer fluid. Water can cause the solution to freeze and damage your washer fluid tank and other parts of the washer system. Also, water doesn't clean as well as washer fluid.
- Fill your washer fluid tank only 3/4 full when it's very cold. This allows for expansion, which could damage the tank if it is completely full.
- Don't use radiator antifreeze in your windshield washer. It can damage your washer system and paint.

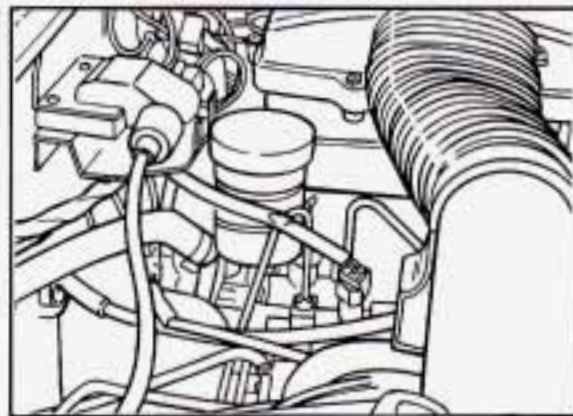

## ***Brake Master Cylinder***

Your brake master cylinder is here. It is filled with DOT-3 brake fluid.

There are only two reasons why the brake fluid level in your master cylinder might go down. The first is that the brake fluid goes down to an acceptable level during normal brake lining wear. When new linings are put in, the fluid level goes back up. The other reason is that fluid is leaking out of the brake system. If it is, you should have your brake system fixed, since a leak means that sooner or later your brakes won't work well, or won't work at all.

So, it isn't a good idea to "top off" your brake fluid. Adding brake fluid won't

correct a leak. If you add fluid when your linings are worn, then you'll have too much fluid when you get new brake linings. You should add (or remove) brake fluid, as necessary, only when work is done on the brake hydraulic system.



## CAUTION:

If you have too much brake fluid, it can spill on the engine. The fluid will burn if the engine is hot enough. You or others could be burned, and your vehicle could be damaged. Add brake fluid only when work is done on the brake hydraulic system.

Refer to the Maintenance Schedule to determine when to check your brake fluid. See "Periodic Maintenance Inspections" in the Index.

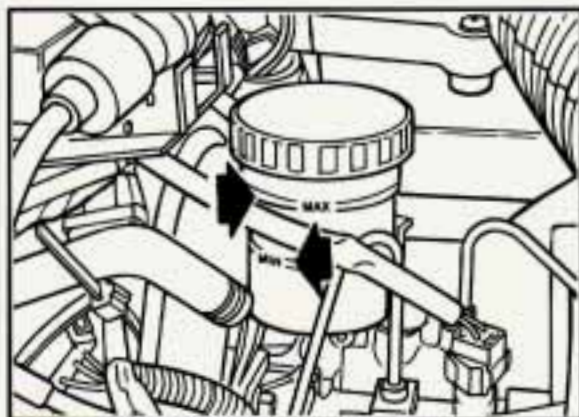

### To Check Brake Fluid:

You can check the brake fluid without taking off the cap. Just look at the windows on the brake fluid reservoir. The fluid levels should be above "MIN." If they aren't, have your brake system checked to see if there is a leak.

After work is done on the brake hydraulic system, make sure the levels are above "MIN" and below the top of each window.

### What to Add:

When you do need brake fluid, use only DOT-3 brake fluid — such as Delco-Supreme 11® (GM Part No. 1052535). Use new brake fluid from a sealed

container only, and always clean the brake fluid reservoir cap before removing it.

## NOTICE:

- Don't let someone put in the wrong kind of fluid. For example, just a few drops of mineral-based oil, such as engine oil, in your brake system can damage brake system parts so badly that they'll have to be replaced.
- Brake fluid can damage paint, so be careful not to spill brake fluid on your vehicle. If you do, wash it off immediately. See "Appearance Care" in the Index.

### Brake Wear

Your Geo has front disc brakes and rear drum brakes.

Disc brake pads have built-in wear indicators that make a high-pitched warning sound when the brake pads are worn and new pads are needed. The sound may come and go or be heard all the time your vehicle is moving (except when you are pushing on the brake pedal firmly).



# Service and Appearance Care



## CAUTION:

The brake wear warning sound means that sooner or later your brakes won't work well. That could lead to an accident. When you hear the brake wear warning sound, have your vehicle serviced.

## NOTICE:

Continuing to drive with worn-out brake pads could result in costly brake repair.

Some driving conditions or climates may cause a brake squeal when the brakes are first applied or lightly applied. This does not mean something is wrong with your brakes.

Your rear drum brakes don't have wear indicators, but if you ever hear a rear brake rubbing noise, have the rear brake linings inspected. Also, the rear brake drums should be removed and inspected each time the tires are removed for rotation or changing. When you have the

front brakes replaced, have the rear brakes inspected, too.

Brake linings should always be replaced as complete axle sets.

### Brake Pedal Travel

See your dealer if the brake pedal does not return to normal height, or if there is a rapid increase in pedal travel. This could be a sign of brake trouble.

### Brake Adjustment

Every time you make a brake stop, your disc brakes adjust for wear.

If your brake pedal goes down farther than normal, your rear drum brakes may need adjustment. Adjust them by backing up and firmly applying the brakes a few times.

### Replacing Brake System Parts

The braking system on a modern vehicle is complex. Its many parts have to be of top quality and work well together if the vehicle is to have really good braking. Vehicles we design and test have top-quality GM brake parts in them, as your Geo does when it is new. When you

replace parts of your braking system — for example, when your brake linings wear down and you have to have new ones put in — be sure you get new genuine GM replacement parts. If you don't, your brakes may no longer work properly. For example, if someone puts in brake linings that are wrong for your vehicle, the balance between your front and rear brakes can change, for the worse. The braking performance you've come to expect can change in many other ways if someone puts in the wrong replacement brake parts.

### Battery

Every new Geo has a Delco Freedom® battery. You never have to add water to one of these. When it's time for a new battery, we recommend a Delco Freedom® battery. Get one that has the catalog number shown on the original battery's label.

### Vehicle Storage

If you're not going to drive your vehicle for 25 days or more, take off the black, negative (-) cable from the battery. This

will help keep your battery from running down.

**⚠ CAUTION:**

Batteries have acid that can burn you and gas that can explode. You can be badly hurt if you aren't careful. See "Jump Starting" in the Index for tips on working around a battery without getting hurt.

Contact your dealer to learn how to prepare your vehicle for longer storage periods.

## ■ *Bulb Replacement*

See "Replacement Bulbs" in the Index to check the size and type of bulb you need to use.

### Halogen Bulbs

**⚠ CAUTION:**

Halogen bulbs have pressurized gas inside and can burst if you drop or scratch the bulb. You or others could be injured. Take special care when handling and disposing of halogen bulbs.

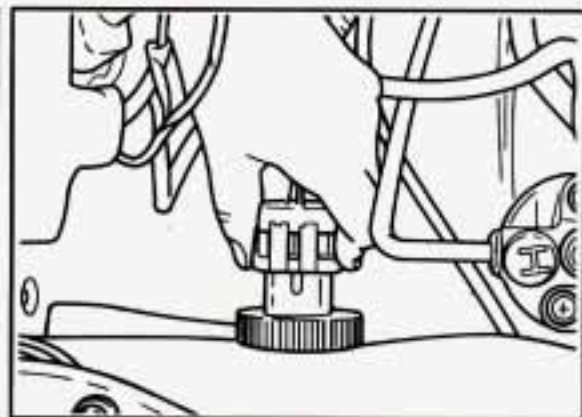

### Headlights

To replace the headlight bulb:

1. Open the hood.
2. Push in on both sides and pull rearward, while holding the headlight wiring harness, to disconnect it from the bulb.

## Service and Appearance Care

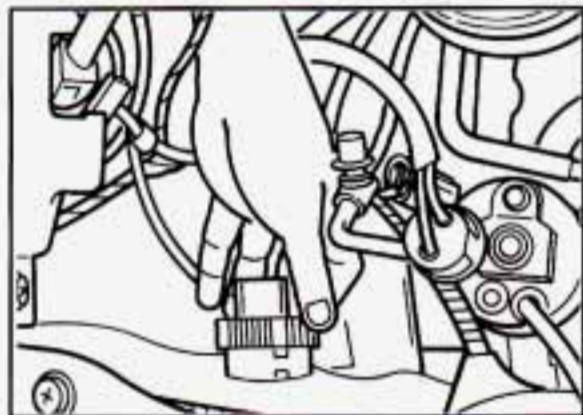

3. Turn the lock ring to the left to release the bulb.

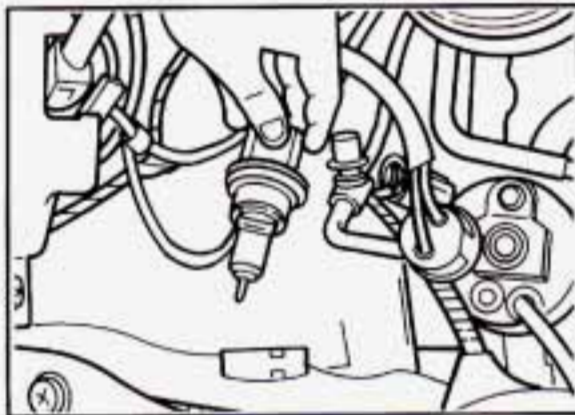

4. Pull the lock ring and the headlight bulb straight out. Save the lock ring and use with the new bulb.
5. Reverse the steps with a new bulb.

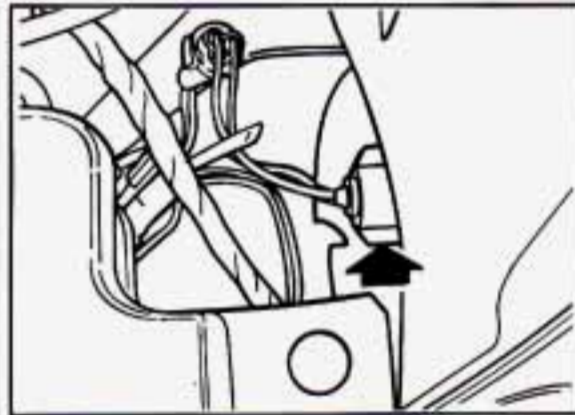

### Front Parking and Turn Signal Lights

To replace the parking and turn signal bulb:

1. Open the hood.
2. Turn the bulb socket to the left and pull it out of light housing.

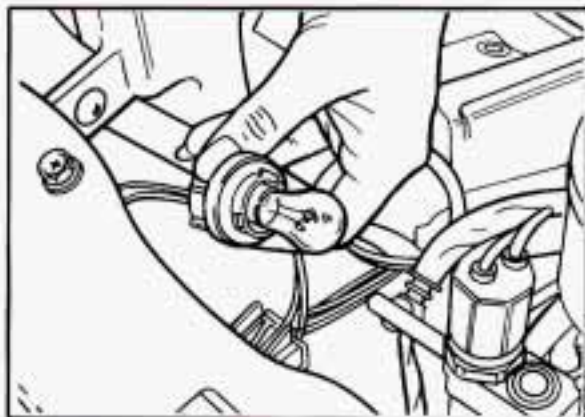

3. Push the bulb in, turn it to the left and pull it out.
4. Reverse the steps with a new bulb.

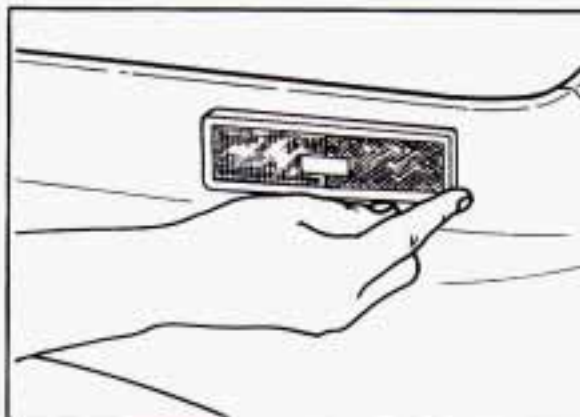

### Sidemarker Lights

To replace the sidemarker bulb:

1. Push the sidemarker housing toward the back of the vehicle and pull out the front edge. The housing should pull away from the vehicle.

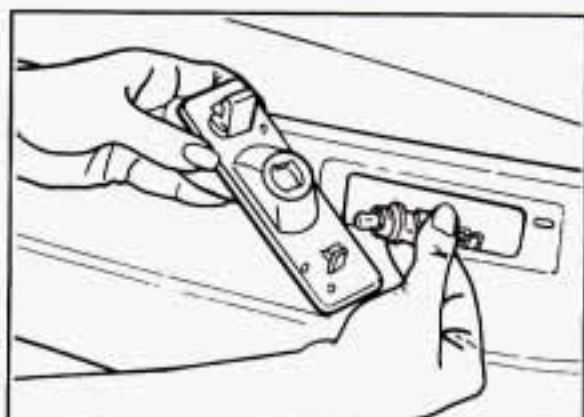

2. Turn the socket toward the rear of the vehicle and pull it out of the housing.
3. Pull the bulb out of the socket.
4. Reverse the steps with a new bulb.

### Rear Sidemarker Lights

To replace the rear sidemarker bulb:

1. Remove the screw (hardtop only).
2. Pull the sidemarker light housing out at the back edge.
3. Turn the socket toward the rear of the vehicle and pull it out.
4. Pull the bulb out of the socket.
5. Reverse the steps with a new bulb.

## Service and Appearance Care

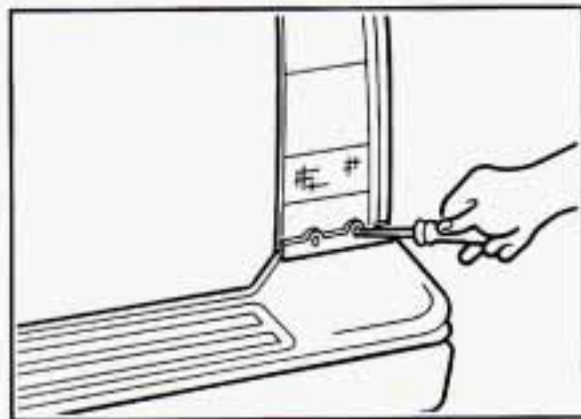

### Rear Combination Lights

To remove the rear combination bulbs:

1. Remove the two screws from the combination lights.

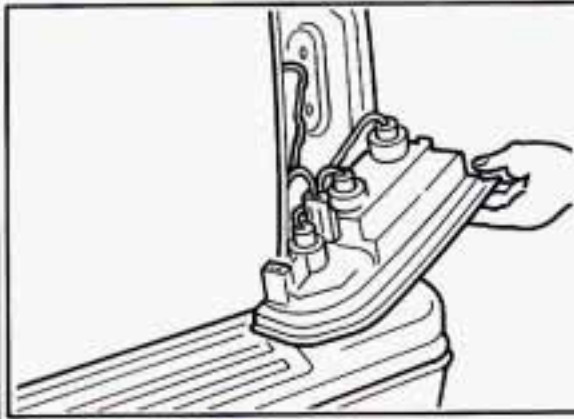

2. Pull the combination light out far enough to reach the bulb socket.

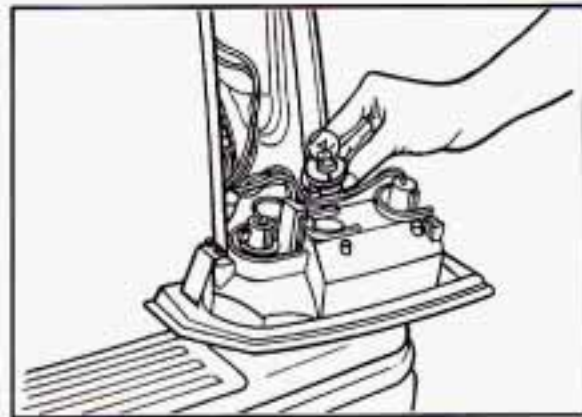

3. Turn the socket to the right and pull it out.
4. Pull the bulb out of the socket.
5. Reverse the steps with a new bulb.

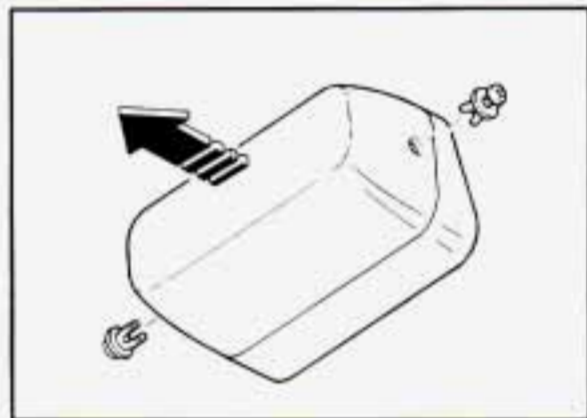

### Center High-Mounted Stoplight (Hardtop)

To remove the bulb:

1. Remove the side pins.
2. Pull the housing forward.
3. Turn the socket counterclockwise and pull it out.
4. Pull the bulb out of the socket.
5. Reverse the steps with a new bulb.

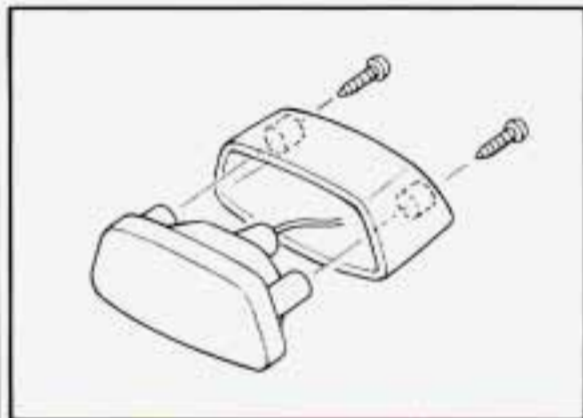

### Center High-Mounted Stoplight (Convertible)

To remove the bulb:

1. Remove the two screws and the lens housing.
2. Turn the socket counterclockwise and pull it out.
3. Pull the bulb out of the socket.
4. Reverse the steps with a new bulb.

TIRE PLACARD			
	GVWR	GAWR FRT	GAWR RR
LB/Kg			
TIRES			
RIMS			
INFLATION PRESSURE COLD PSI/kPa			

### ■ *Loading Your Vehicle*

Two labels on your vehicle show how much weight it may properly carry. The Tire-Loading Information label found on the driver's door lock pillar tells you the proper size, speed rating and recommended inflation pressures for the tires on your vehicle. It also gives you important information about the number of people that can be in your vehicle and the total weight that you can carry. This weight is called the Vehicle Capacity Weight and includes the weight of all occupants, cargo, and all nonfactory-installed options.

## Service and Appearance Care

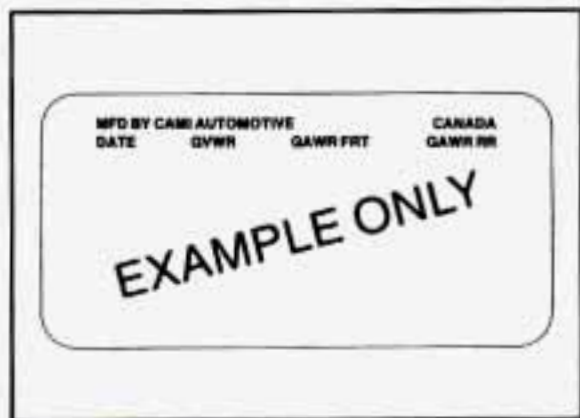

The other label is the Certification label, also found on the driver's door lock pillar. It tells you the gross weight capacity of your vehicle, called the GVWR (Gross Vehicle Weight Rating). The GVWR includes the weight of the vehicle, all occupants, fuel and cargo. Never exceed the GVWR for your vehicle, or the Gross Axle Weight Rating (GAWR) for either the front or rear axle.

And, if you do have a heavy load, you should spread it out. Don't carry more than 400 pounds (181 kilograms) in your rear area when four people are in your two-wheel drive vehicle. If you have a four-wheel drive vehicle, don't carry more than 200 pounds (91 kilograms) in your rear area when four people are in your vehicle.



### CAUTION:

Do not load your vehicle any heavier than the GVWR or the maximum front and rear GAWRs. If you do, parts on your vehicle can break, or it can change the way your vehicle handles. These could cause you to lose control. Also, overloading can shorten the life of your vehicle.

### NOTICE:

Your warranty does not cover parts or components that fail because of overloading.

If you put things inside your vehicle — like suitcases, tools, packages, or anything else — they will go as fast as the vehicle goes. If you have to stop or turn quickly, or if there is a crash, they'll keep going.

 **CAUTION:**

Things you put inside your vehicle can strike and injure people in a sudden stop or turn, or in a crash.

- Put things in the cargo area of your vehicle. Try to spread the weight evenly.
- Never stack heavier things, like suitcases, inside the vehicle so that some of them are above the tops of the seats.
- Don't leave an unsecured child restraint in your vehicle.
- When you carry something inside the vehicle, secure it whenever you can.
- Don't leave a seat folded down unless you need to.

■ *Tires*

We don't make tires. Your new vehicle comes with high quality tires made by a leading tire manufacturer. These tires are warranted by the tire manufacturers and their warranties are delivered with every new Geo. If your spare tire is a different brand than your road tires, you will have a tire warranty folder from each of these manufacturers.

 **CAUTION:**

Poorly maintained and improperly used tires are dangerous.

- Overloading your tires can cause overheating as a result of too much friction. You could have an air-out and a serious accident. See "Loading Your Vehicle" in the Index.
- Underinflated tires pose the same danger as overloaded tires. The resulting accident could cause serious injury. Check all tires frequently to maintain the recommended pressure. Tire pressure should be checked when your tires are cold.
- Overinflated tires are more likely to be cut, punctured, or broken by a sudden impact, such as when you hit a pothole. Keep tires at the recommended pressure.
- Worn, old tires can cause accidents. If your tread is badly worn, or if your tires have been damaged, replace them.



# Service and Appearance Care

## Inflation — Tire Pressure

The Certification/Tire label which is on the driver's door shows the correct inflation pressures for your tires, when they're cold. "Cold" means your vehicle has been sitting for at least three hours or driven no more than a mile.

### **NOTICE:**

Don't let anyone tell you that underinflation or overinflation is all right. It's not. If your tires don't have enough air (underinflation) you can get:

- Too much flexing
- Too much heat
- Tire overloading
- Bad wear
- Bad handling
- Bad fuel economy.

If your tires have too much air (overinflation), you can get:

- Unusual wear
- Bad handling
- Rough ride
- Needless damage from road hazards.

**When to Check:** Check your tires once a month or more. Also, check the tire pressure of the spare tire.

**How to Check:** Use a good quality pocket-type gage to check tire pressure. Simply looking at the tires will not tell you the pressure, especially if you have radial tires — which may look properly inflated even if they're underinflated.

If your tires have valve caps, be sure to put them back on. They help prevent leaks by keeping out dirt and moisture.

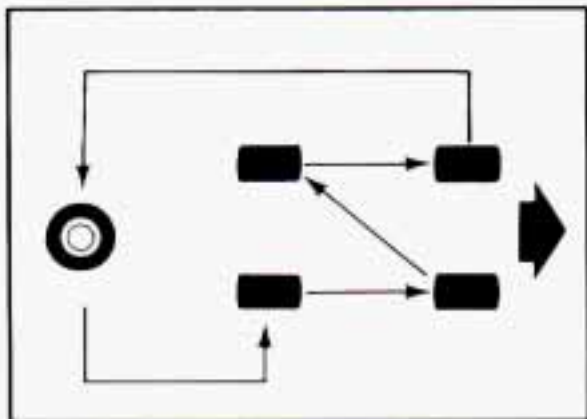

### Tire Inspection and Rotation

To make your tires last longer, have them inspected and rotated at the mileages recommended in the Maintenance Schedule. See “Scheduled Maintenance Services” in the Index.

Use this rotation pattern.

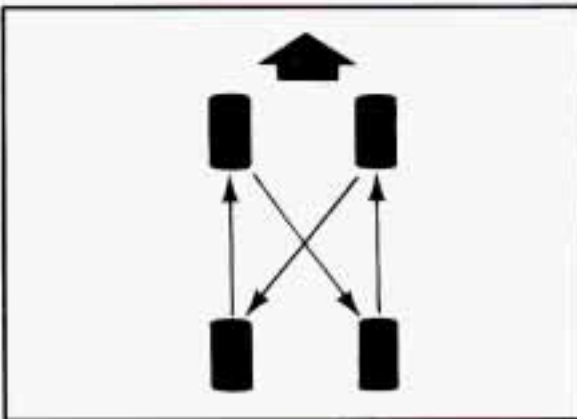

If your spare wheel does not match your other wheels, you may want to use this pattern.

If your vehicle has front tires with different load ratings or tread designs (such as all season vs. on/off road) than the rear tires, don't rotate your tires front to rear.

After the tires have been rotated, adjust the front and rear inflation pressure as shown on the Certification/Tire label. Make certain that all wheel nuts are properly tightened. See “Wheel Nut Torque” in the Index.



### CAUTION:

Rust or dirt on a wheel, or on the parts to which it is fastened, can make wheel nuts become loose after a time. The wheel could come off and cause an accident. When you change a wheel, remove any rust or dirt from places where the wheel attaches to the vehicle. In an emergency, you can use a cloth or a paper towel to do this; but be sure to use a scraper or wire brush later, if you need to, to get all the rust or dirt off. (See “Changing a Flat Tire” in the Index.)

## Service and Appearance Care

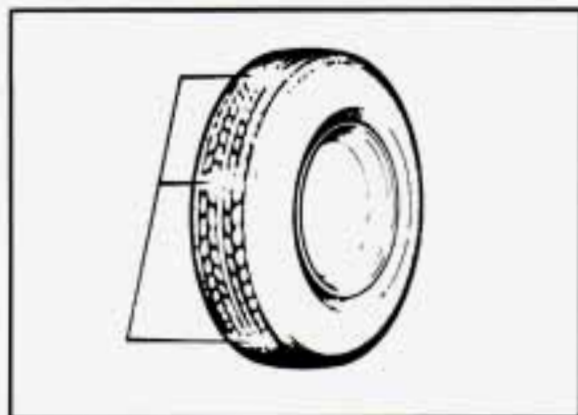

### When It's Time for New Tires

One way to tell when it's time for new tires is to check the treadwear indicators, which will appear when your tires have only 2/32 inch (1.6 mm) or less of tread remaining.

You need a new tire if:

- You can see the indicators at three or more places around the tire.
- You can see cord or fabric showing through the tire's rubber.
- The tread or sidewall is cracked, cut or snagged deep enough to show cord or fabric.
- The tire has a bump, bulge or split.

- The tire has a puncture, cut, or other damage that can't be repaired well because of the size or location of the damage.

### Buying New Tires

To find out what kind and size of tires you need, look at the Certification/Tire label.

The tires installed on your vehicle when it was new had a Tire Performance Criteria Specification (TPC Spec) number on each tire's sidewall. When you get new tires, get ones with that same TPC Spec number. That way, your vehicle will continue to have tires that are designed to give proper endurance, handling, speed rating, traction, ride and other things during normal service on your vehicle. If your tires have an all-season tread design, the TPC number will be followed by a "MS" (for mud and snow).

If you ever replace your tires with those not having a TPC Spec number, make sure they are the same size, load range, speed rating and construction type (bias, bias-belted or radial) as your original tires.



### CAUTION:

Mixing tires could cause you to lose control while driving. If you mix tires of different sizes or types (radial and bias-belted tires), the vehicle may not handle properly, and you could have a crash. Be sure to use the same size and type tires on all four wheels.

### Uniform Tire Quality Grading

The following information relates to the system developed by the United States National Highway Traffic Safety Administration which grades tires by treadwear, traction and temperature performance. (This applies only to vehicles sold in the United States.)

#### Treadwear

The treadwear grade is a comparative rating based on the wear rate of the tire when tested under controlled conditions on a specified government test course. For example, a tire graded 150 would wear one and a half (1 1/2) times as well on the government course as a tire graded 100. The relative performance of tires depends

upon the actual conditions of their use, however, and may depart significantly from the norm due to variations in driving habits, service practices and differences in road characteristics and climate.

### **Traction — A, B, C**

The traction grades, from highest to lowest are: A, B, and C. They represent the tire's ability to stop on wet pavement as measured under controlled conditions on specified government test surfaces of asphalt and concrete. A tire marked C may have poor traction performance.

**Warning:** The traction grade assigned to this tire is based on braking (straight-ahead) traction tests and does not include cornering (turning) traction.

### **Temperature — A, B, C**

The temperature grades are A (the highest), B, and C, representing the tire's resistance to the generation of heat and its ability to dissipate heat when tested under controlled conditions on a specified indoor laboratory test wheel. Sustained high temperature can cause the material of the tire to degenerate and reduce tire life, and excessive temperature can lead to sudden tire failure. The grade C

corresponds to a level of performance which all passenger car tires must meet under the Federal Motor Vehicle Safety Standard No. 109. Grades B and A represent higher levels of performance on the laboratory test wheel than the minimum required by law.

**Warning:** The temperature grade for this tire is established for a tire that is properly inflated and not overloaded. Excessive speed, underinflation, or excessive loading, either separately or in combination, can cause heat buildup and possible tire failure.

These grades are molded on the sidewalls of passenger car tires.

While the tires available as standard or optional equipment on General Motors vehicles may vary with respect to these grades, all such tires meet General Motors performance standards and have been approved for use on General Motors vehicles. All passenger type (P Metric) tires must conform to Federal safety requirements in addition to these grades.

### **Wheel Alignment and Tire Balance**

The wheels on your vehicle were aligned and balanced carefully at the factory to

give you the longest tire life and best overall performance.

In most cases, you will not need to have your wheels aligned again. However, if you notice unusual tire wear or your vehicle pulling one way or the other, the alignment may need to be reset. If you notice your vehicle vibrating when driving on a smooth road, your wheels may need to be rebalanced.

### **Wheel Replacement**

Replace any wheel that is bent, cracked or badly rusted. If wheel nuts keep coming loose, the wheel, wheel bolts, and wheel nuts should be replaced. If the wheel leaks air, replace it (except some aluminum wheels, which can sometimes be repaired). See your Geo dealer if any of these conditions exist.

Your dealer will know the kind of wheel you need.

Each new wheel should have the same load carrying capacity, diameter, width, offset, and be mounted the same way as the one it replaces.

## Service and Appearance Care

If you need to replace any of your wheels, wheel bolts, or wheel nuts, replace them only with new GM original equipment parts. This way, you will be sure to have the right wheel, wheel bolts, and wheel nuts for your Geo model.



### CAUTION:

Using the wrong replacement wheels, wheel bolts, or wheel nuts on your vehicle can be dangerous. It could affect the braking and handling of your vehicle, make your tires lose air and make you lose control. You could have a collision in which you or others could be injured. Always use the correct wheel, wheel bolts, and wheel nuts for replacement.

### NOTICE:

The wrong wheel can also cause problems with bearing life, brake cooling, speedometer/odometer calibration, headlight aim, bumper height, vehicle ground clearance, and tire or tire chain clearance to the body and chassis.

#### Used Replacement Wheels



### CAUTION:

Putting a used wheel on your vehicle is dangerous. You can't know how it's been used or how many miles it's been driven. It could fail suddenly and cause an accident. If you have to replace a wheel use a new GM original equipment wheel.

#### Tire Chains

### NOTICE:

Use tire chains only where legal and only when you must. Use only SAE Class "S" type chains that are the proper size for your tires. Install them on the tires of the drive axle (four-wheel drive vehicles can use chains on both axles). Tighten them as tightly as possible with the ends securely fastened. Drive slowly and follow the chain manufacturer's instructions. If you can hear the chains contacting your vehicle, stop and retighten them. If the contact continues, slow down until it stops. Driving too fast with chains on will damage your vehicle.



## ■ Appearance Care

Remember, cleaning products can be hazardous. Some are toxic. Others can burst into flame if you strike a match or get them on a hot part of the vehicle. Some are dangerous if you breathe their fumes in a closed space. When you use anything from a container to clean your Geo, be sure to follow the manufacturer's warnings and instructions. And always open your doors or windows when you're cleaning the inside.

Never use these to clean your vehicle:

- Gasoline
- Benzene
- Naphtha
- Carbon Tetrachloride
- Acetone
- Paint Thinner
- Turpentine
- Lacquer Thinner
- Nail Polish Remover

They can all be hazardous – some more than others – and they can all damage your vehicle, too.

Don't use any of these unless this manual says you can. In many uses, these will damage your vehicle:

- Alcohol
- Laundry Soap
- Bleach
- Reducing Agents

## *Cleaning the Inside of Your Geo*

Use a vacuum cleaner often to get rid of dust and loose dirt. Wipe vinyl or leather with a clean, damp cloth.

Your Geo dealer has two GM cleaners, a solvent-type spot lifter and a foam-type powdered cleaner. They will clean normal spots and stains very well. Do not use them on vinyl or leather.

Here are some cleaning tips:

- Always read the instructions on the cleaner label.
- Clean up stains as soon as you can — before they set.

## Service and Appearance Care

- Use a clean cloth or sponge, and change to a clean area often. A soft brush may be used if stains are stubborn.
- Use solvent-type cleaners in a well-ventilated area only. If you use them, don't saturate the stained area.
- If a ring forms after spot cleaning, clean the entire area immediately or it will set.

### Using Foam-Type Cleaner on Fabric

- Vacuum and brush the area to remove any loose dirt.
- Always clean a whole trim panel or section. Mask surrounding trim along stitch or welt lines.
- Mix Multi-Purpose Powdered Cleaner following the directions on the container label.
- Use suds only and apply with a clean sponge.
- Don't saturate the material.
- Don't rub it roughly.
- As soon as you've cleaned the section, use a sponge to remove the suds.
- Rinse the section with a clean, wet sponge.

- Wipe off what's left with a slightly damp paper towel or cloth.
- Then dry it immediately with a blow dryer or a heat lamp.

### NOTICE:

Be careful with a hair dryer or heat lamp. You could scorch the fabric.

- Wipe with a clean cloth.

### Using Solvent-Type Cleaner on Fabric

First, see if you have to use solvent-type cleaner at all. Some spots and stains will clean off better with just water and mild soap.

If you need to use a solvent:

- Gently scrape excess soil from the trim material with a clean, dull knife or scraper. Use very little cleaner, light pressure and clean cloths (preferably cheesecloth). Cleaning should start at the outside of the stain, "feathering" toward the center. Keep changing to a clean section of the cloth.

- When you clean a stain from fabric, immediately dry the area with an air hose, hair dryer, or heat lamp to help prevent a cleaning ring. (See the previous NOTICE.)

### Fabric Protection

Your Geo has upholstery that has been treated with Scotchgard™ Fabric Protector, a 3M product. Scotchgard™ protects fabrics by repelling oil and water, which are the carriers of most stains. Even with this protection, you still need to clean your upholstery often to keep it looking new.

Further information on cleaning is available by calling 1-800-433-3296 (in Minnesota, 1-800-642-6167).

### Special Cleaning Problems

**Greasy or oily stains:** Such as grease, oil, butter, margarine, shoe polish, coffee with cream, chewing gum, cosmetic creams, vegetable oils, wax crayon, tar and asphalt.

- Carefully scrape off excess stain.
- Follow the solvent-type instructions described earlier.

- Shoe polish, wax crayon, tar and asphalt will stain if left on a vehicle seat fabric. They should be removed as soon as possible. Be careful, because the cleaner will dissolve them and may cause them to spread.

**Non-greasy stains:** Such as catsup, coffee (black), egg, fruit, fruit juice, milk, soft drinks, wine, vomit, urine and blood.

- Carefully scrape off excess stain, then sponge the soiled area with cool water.
- If a stain remains, follow the foam-type instructions described earlier.
- If an odor lingers after cleaning vomit or urine, treat the area with a water/baking soda solution: 1 teaspoon (5 ml) of baking soda to 1 cup (250 ml) of lukewarm water.
- If needed, clean lightly with solvent-type cleaner.

**Combination stains:** Such as candy, ice cream, mayonnaise, chili sauce and unknown stains.

- Carefully scrape off excess stain, then clean with cool water and allow to dry.
- If a stain remains, clean it with solvent-type cleaner.

### Cleaning Vinyl

Use warm water and a clean cloth.

- Rub with a clean, damp cloth to remove dirt. You may have to do it more than once.
- Things like tar, asphalt and shoe polish will stain if you don't get them off quickly. Use a clean cloth and solvent-type vinyl cleaner.

### Cleaning Leather

Use a soft cloth with lukewarm water and a mild soap or saddle soap.

- For stubborn stains, use a mild solution of 10% isopropyl alcohol (rubbing alcohol) and 90% water.
- Never use oils, varnishes, solvent-based or abrasive cleaners, furniture polish or shoe polish on leather.
- Soiled leather should be cleaned immediately. If dirt is allowed to work into finish, it can harm the leather.

### Cleaning the Top of the Instrument Panel

Use only mild soap and water to clean the top surfaces of the instrument panel. Sprays containing silicones or waxes may cause annoying reflections in the windshield and even make it difficult to see through the windshield under certain conditions.

### Care of Safety Belts

Keep belts clean and dry.



### CAUTION:

Do not bleach or dye safety belts. If you do, it may severely weaken them. In a crash they might not be able to provide adequate protection. Clean safety belts only with mild soap and lukewarm water.

### Glass

Glass should be cleaned often. GM Glass Cleaner (GM Part No. 1050427) or a liquid household glass cleaner will remove normal tobacco smoke and dust films.



# Service and Appearance Care

Don't use abrasive cleaners on glass, because they may cause scratches. Avoid placing decals on the inside rear window, since they may have to be scraped off later. If abrasive cleaners are used on the inside of the rear window, an electric defogger element may be damaged. Any temporary license should not be attached across the defogger grid.

## **Cleaning the Outside of the Windshield and Wiper Blades**

If the windshield is not clear after using the windshield washer, or if the wiper blade chatters when running, wax or other material may be on the blade or windshield.

Clean the outside of the windshield with GM Windshield Cleaner, Bon-Ami Powder<sup>®</sup> (GM Part No. 1050011). The windshield is clean if beads do not form when you rinse it with water.

Clean the blade by wiping vigorously with a cloth soaked in full strength windshield washer solvent. Then rinse the blade with water.

Wiper blades should be checked on a regular basis and replaced when worn.

## ***Cleaning the Outside of Your Geo***

The paint finish on your vehicle provides beauty, depth of color, gloss retention and durability.

### **Washing Your Vehicle**

The best way to preserve your vehicle's finish is to keep it clean by washing it often with lukewarm or cold water.

Don't wash your vehicle in the direct rays of the sun. Don't use strong soaps or chemical detergents. Use liquid hand, dish or car washing (mild detergent) soaps. Don't use cleaning agents that are petroleum based, or contain acid or abrasives. All cleaning agents should be flushed promptly and not allowed to dry on the surface, or they could stain. Dry the finish with a soft, clean chamois or a 100% cotton towel to avoid surface scratches and water spotting.

High pressure car washes may cause water to enter your vehicle.

### **Finish Care**

Occasional waxing or mild polishing of your Geo may be necessary to remove residue from the paint finish. You can get GM approved cleaning products from

your dealer. (See "Appearance Care and Materials" in the Index.)

Your Geo has a "basecoat/clearcoat" paint finish. The clearcoat gives more depth and gloss to the colored basecoat. Always use waxes and polishes that are non-abrasive and made for a basecoat/clearcoat paint finish.

## **NOTICE:**

Machine compounding or aggressive polishing on a basecoat/clearcoat paint finish may dull the finish or leave swirl marks.

### **Protecting Exterior Bright Metal Parts**

Bright metal parts should be cleaned regularly to keep their luster. Washing with water is all that is usually needed. However, you may use GM Chrome Polish on chrome or stainless steel trim, if necessary.

Use special care with aluminum trim. To avoid damaging protective trim, never use auto or chrome polish, steam or caustic soap to clean aluminum. A coating of wax, rubbed to high polish, is recommended for all bright metal parts.

### Special Care for Canvas Top

To protect the canvas top:

- After you wash the vehicle, make sure the top is completely dry before you open or remove it.
- Don't get any vinyl cleaner on the vehicle's painted finish; it could leave streaks.
- Don't go through automatic car washes; the canvas top could be damaged.

The plastic windows are pliable and can be scratched if you don't take these precautions when you clean them:

- Wipe off dust with a soft cotton cloth moistened with clean, cool or lukewarm water. Don't use a "dry" cloth. Wipe in one direction only, not back and forth.
- To remove frost, snow or ice, use lukewarm water. Don't use a scraper or any de-icing fluids.
- Wash the windows with a soft cloth and clean, cool or lukewarm water. Never use a dry cloth, hot water, strong soap or detergent, solvents or harsh cleaning agents. Rinse thoroughly and wipe with a slightly moist soft, clean cloth.

- Don't put any labels, stickers or tape on windows. It's hard to remove adhesives left on the window when such items are removed. If a sticker or label must be removed, remove any adhesive left on the window while the adhesive is still soft and sticky. Press on a new sticker or piece of tape and then lift it off again; keep doing this until all the adhesive lifts off with the sticker or tape.

### Aluminum Wheels (If So Equipped)

Your aluminum wheels have a protective coating similar to the painted surface of your vehicle. Don't use strong soaps, chemicals, chrome polish, abrasive cleaners or abrasive cleaning brushes on them because you could damage this coating. After rinsing thoroughly, a wax may be applied.

#### **NOTICE:**

If you have aluminum wheels, don't use an automatic car wash that has hard silicon carbide cleaning brushes. These brushes can take off the protective coating.

### Tires

Your Geo dealer has a GM White Sidewall Tire Cleaner. You can use a stiff brush with the cleaner.

When applying a tire dressing, always take care to wipe off any overspray or splash from painted surfaces. Petroleum-based products may damage the paint finish.

### Weatherstrips

Silicone grease on weatherstrips will make them last longer, seal better, and not stick or squeak. Apply silicone grease with a clean cloth at least every six months. During very cold, damp weather more frequent application may be required. (See "Recommended Fluids and Lubricants" in the Index.)

### Sheet Metal Damage

If your vehicle is damaged and requires sheet metal repair or replacement, make sure the body repair shop applies anti-corrosion material to the parts repaired or replaced to restore corrosion protection.

# Service and Appearance Care

## Foreign Material

Calcium chloride and other salts, ice melting agents, road oil and tar, tree sap, bird droppings, chemicals from industrial chimneys, and other foreign matter can damage your vehicle's finish if they remain on painted surfaces. Use cleaners that are marked safe for painted surfaces to remove foreign matter.

## Finish Damage

Any stone chips, fractures or deep scratches in the finish should be repaired right away. Bare metal will corrode quickly and may develop into a major repair expense.

Minor chips and scratches can be repaired with touch-up materials available from your dealer or other service outlets. Larger areas of finish damage can be corrected in your dealer's body and paint shop.

## Underbody Maintenance

Chemicals used for ice and snow removal and dust control can collect on the underbody. If these are not removed, accelerated corrosion (rust) can occur on the underbody parts such as fuel lines, frame, floor pan, and exhaust system even though they have corrosion protection.

At least every spring, flush these materials from the underbody with plain water. Clean any areas where mud and other debris can collect. Dirt packed in closed areas of the frame should be loosened before being flushed. Your dealer or an underbody vehicle washing system can do this for you.

## Chemical Paint Spotting

Some weather and atmospheric conditions can create a chemical fallout. Airborne pollutants can fall upon and attack painted surfaces on your vehicle. This damage can take two forms: blotchy, ringlet-shaped discolorations, and small irregular dark spots etched into the paint surface.

Although no defect in the paint job causes this, Geo will repair, at no charge to the owner, the surfaces of new vehicles damaged by this fallout condition within 12 months or 12,000 miles (20 000 km) of purchase, whichever comes first.

## ■ Appearance Care Materials Chart

PART NUMBER	SIZE	DESCRIPTION	USAGE
1051516	32 oz. (0.946 L)	Washer Solvent and Gas Liner De-Icer	Windshield washing system and gas line
1050172	16 oz. (0.473 L)	Tar and Road Oil Remover	Also old waxes, polishes
1050173	16 oz. (0.473 L)	Cleaner and Polish	Removes rust and corrosion on chrome and steel
1050174	16 oz. (0.473 L)	White Sidewall Tire Cleaner	Cleans white and black tires
1050214	32 oz. (0.946 L)	Vinyl/Leather Cleaner*	Spot and stain removal on leather and vinyl
1050244	16 oz. (0.473 L)	Fabric Cleaner*	Spot and stain removal on cloth and fabric
1050427	24 oz. (0.680 L)	Glass Cleaner	Glass cleaning and spot cleaning on vinyls
1050429	6 lb. (2.72 kg)	Multi-Purpose Powdered Cleaner	Vinyl, cloth, door trims, seats, carpet, tires, mats
1052870	16 oz. (0.473 L)	Wash-Wax (Concentrated)	Exterior wash
1051398	8 oz. (0.237 L)	Spot Lifter*	Spot and stain removal on cloth and fabric
1050201	16 oz. (0.473 L)	Magic Mirror Cleaner-Polish	Exterior cleaner and polish
1050011	12 oz. (0.340 kg)	Bon-Ami Powder*	Windshield cleaner

\*Not recommended for pigskin suede leather.

See your General Motors Dealer for these products. See the Index under "Recommended Fluids and Lubricants" for other products.

# Service and Appearance Care

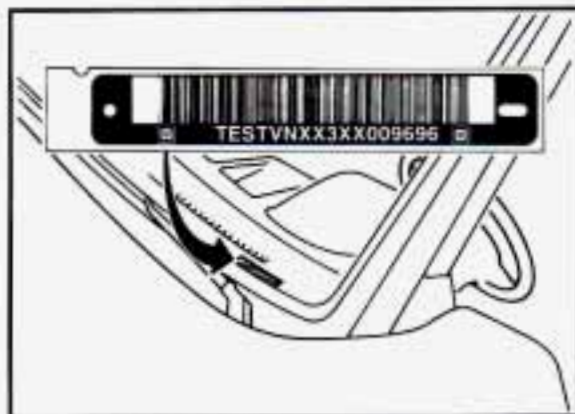

## ■ *Vehicle Identification Number (VIN)*

This is the legal identifier for your Geo. It appears on a plate in the front corner of the instrument panel, on the driver's side. You can see it if you look through the windshield from outside your vehicle. The VIN also appears on the Vehicle Certification and Service Parts labels and the certificates of title and registration.

### **Engine Identification**

The eighth character in your VIN is the engine code. This code will help you identify your engine, specifications, and replacement parts.

## ■ *Service Parts Identification Label*

You'll find this label inside the glove box on the door. It's very helpful if you ever need to order parts. On this label is:

- your VIN,
- the model designation,
- paint information, and
- a list of all production options and special equipment.

Be sure that this label is not removed from the vehicle.

## ■ *Add-On Electrical Equipment*

### **NOTICE:**

Don't add anything electrical to your Geo unless you check with your dealer first. Some electrical equipment can damage your vehicle and the damage wouldn't be covered by your warranty. Some add-on electrical equipment can keep other components from working as they should.

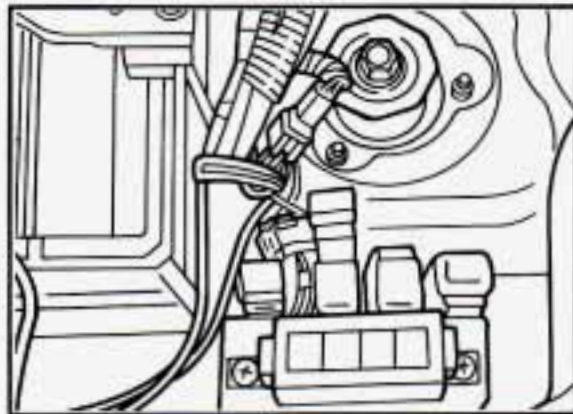

## ■ *Fuses and Circuit Breakers*

The wiring circuits in your vehicle are protected from short circuits by fuses, circuit breakers and thermal links in the wiring itself. This greatly reduces the chance of fires caused by electrical problems.

The main fuse box is in your engine compartment on the right side. It protects all electrical loads.

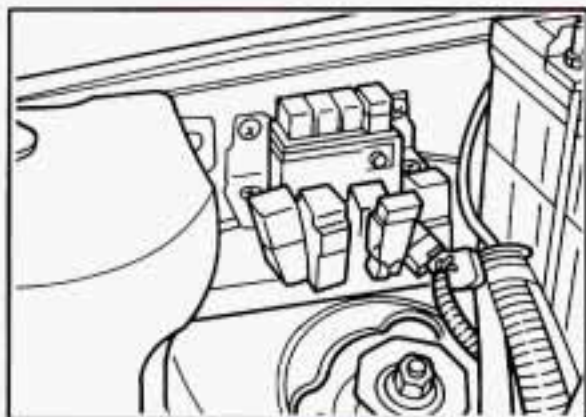

For access to the main fuses, pull off the cover. A spare fuse is also inside the fuse box.

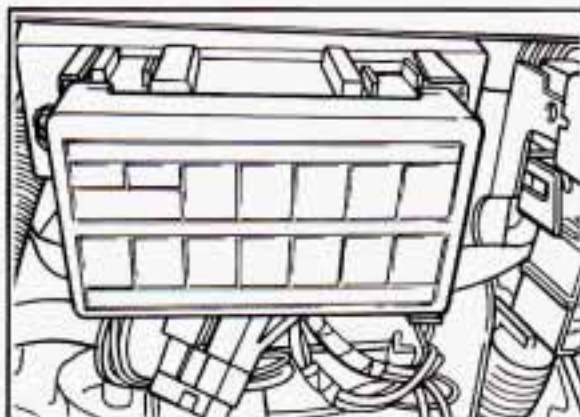

Another fuse box is under the left side of the instrument panel. The fuses here protect each separate circuit including headlights. If you have electrical failure, check here first.

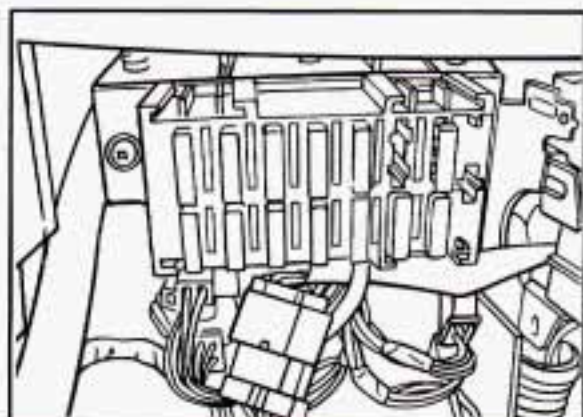

Look at the silver-colored band inside the fuse. If the band is broken or melted, replace the fuse. Be sure you replace a bad fuse with a new one of the correct size.

If you ever have a problem on the road and don't have a spare fuse, you can borrow one. Just pick some feature of your vehicle that you can get along without — like the radio or cigarette lighter — and use its fuse, if it is the size you need. Replace it as soon as you can.

Before replacing a fuse, turn every vehicle electrical switch off.

## Service and Appearance Care

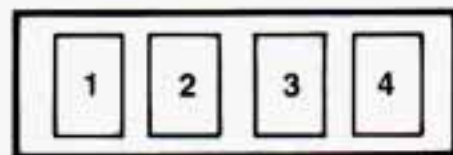

### Main Fuse Block

- 1 — Generator to Battery Circuit (60A)
- 2 — Circuits Only Active When Ignition Switch is in "ACC," "ON" or "START" (50A)
- 3 — Circuits Always Active (40A)
- 4 — Circuits Always Active (30A)



### Instrument Panel Fuse Block

- 1 — Right Headlight (15A)
- 2 — Left Headlight; High Beam Indicator Light (15A)
- 3 — Taillights; Interior Light; Sidemarker Lights; Instrument Cluster Lights (15A)
- 4 — Stop Lights; Horn (15A)
- 5 — Hazard Lights (15A)
- 6 — Door Lock (Option) (20A)
- 7 — Lighter; Radio (20A)
- 8 — Ignition System; Warning and Indicator Lights (15A)
- 9 — Turn Signal Lights; Back-up Lights (15A)

- 10 — Wiper/Washer (15A)
- 11 — Rear Defogger (15A)
- 12 — Heater (25A)
- 13 — Rear Wheel Anti-Lock Main Relay (20A)
- 14 — Electronic Fuel Injection Main Relay (15A)

## ■ *Replacement Bulbs*

Back-up .....	1156
Center High-Mounted Stop .....	921
Dome .....	96051559
Front Parking and Turn Signal .....	1157 NA
Headlight (Halogen) .....	9004
Heater or Air Conditioning Control .....	96052599
Indicator and Warning	
Brake .....	9433184
Charging System .....	9433184
Check Engine .....	9433184
Engine Oil Pressure .....	9433184
4WD .....	9433184
Headlight High Beam .....	9433184
Safety Belt .....	9433184
Turn Signal .....	9433184
Instrument Cluster .....	9605156
License Plate .....	194
Lighter .....	9433184
Rear Defogger Switch .....	96061736
Rear Hazard and Turn Signal .....	1156
Rear Parking and Stop .....	1157
Rear Wiper/Washer Switch .....	96061736
Sidemarkers .....	194



# Service and Appearance Care

## ■ Capacities and Specifications

### Engine

Type .....	L4
Compression Ratio	
8-Valve Engine .....	8.9:1
16-Valve Engine .....	9.5:1
Firing Order .....	1-3-4-2
Fuel Delivery .....	Fuel Injection
Piston Displacement .....	97 CID (1.6L)
Valve Arrangement .....	In-Head "V" Type
AC Belt Tension ... Deflect Belt 0.24-0.35 in. (6-9 mm) @ 22 lbs. (10 kg.) Pressure	
Fan Belt Tension	
Inspection .....	Deflect Belt 0.24-0.32 in. (6-8 mm) @ 22 lbs. (10 kg.) Pressure
Replacement ....	Deflect Belt 0.20-0.28 in. (5-7 mm) @ 22 lbs. (10 kg.) Pressure
Thermostat Temperature Specification .....	180°F (82°C)

### Replacement Parts

Air Cleaner Filter	
8-Valve Engine .....	13780-61AA0
16-Valve Engine .....	13780-58B20
Battery .....	26-60S
Engine Oil Filter .....	96062415
Fuel Filter .....	AC Type GF571
PCV Valve .....	96058079
Radiator Pressure Cap .....	13 psi
Spark Plug .....	R43XLS (0.028" - 0.032" Gap)

### Capacities (Approximate)

The following approximate capacities are given in U.S. and metric conversions.

Air Conditioning† . . . . . See the refrigerant information label under hood.

#### Automatic Transmission

Drain and Refill . . . . . 3.0 qt. (2.8 L)\*\*

Overhaul . . . . . 5.4 qt. (5.1 L)

#### Cooling System

Automatic Transmission . . . . . 5.5 qt. (5.2 L)

Manual Transmission . . . . . 5.6 qt. (5.3 L)

#### Crankcase

With Filter Change . . . . . 4.5 qt. (4.2 L)\*

Without Filter Change . . . . . 4.2 qt. (4.0 L)

Front Differential . . . . . 1.1 qt. (1.0 L)

Fuel Tank . . . . . 11.1 gal. (42 L)

#### Manual Transmission

Four-Wheel Drive . . . . . 1.6 qt. (1.5 L) \*\*

Two-Wheel Drive . . . . . 1.8 qt. (1.7 L) \*\*

Rear Differential . . . . . 2.3 qt. (2.2 L)

Transfer Case . . . . . 1.8 qt. (1.7 L)

† Not all air conditioning refrigerants are the same. If the air conditioning system in your vehicle needs refrigerant, be sure the proper refrigerant is used. If you're not sure, ask your Geo dealer.

\* When changing the oil filter, additional oil may be needed. Recheck the oil level after filling. See "Engine Oil" in the Index.

\*\* Recheck fluid level after filling. See "Automatic Transmission Fluid" or "Manual Transmission Fluid" in the Index.

# Service and Appearance Care

## Wheel Nuts

Wheel Nut Torque ..... 60 lb. ft. (80 N•m)

## Vehicle Dimensions

Wheelbase ..... 86.6" (2 200 mm)

### Tread

Front ..... 54.9" (1 395 mm)

Rear ..... 55.1" (1 400 mm)

Length ..... 142.5" (3 620 mm)

Width ..... 64.2" (1 630 mm)

Height ..... 65.0" (1 651 mm)

**IMPORTANT:  
KEEP THE ENGINE OIL  
AT THE PROPER  
LEVEL AND CHANGE AS  
RECOMMENDED**

**T**his part covers the maintenance required for your Geo. Your vehicle needs these services to retain its safety, dependability and emission control performance.

## Part 7

# Maintenance Schedule

### Section

<b>Introduction: A Word about Maintenance</b> .....	204
Your Vehicle and the Environment .....	204
How This Part Is Organized .....	204
<b>A. Scheduled Maintenance Services</b> .....	205
Using Your Maintenance Schedule .....	205
Selecting the Right Schedule .....	205
Schedule I .....	206
Schedule II .....	210
Explanation of Scheduled Maintenance Services .....	214
<b>B. Owner Checks and Services</b> .....	218
At Each Fuel Fill .....	218
At Least Once a Month .....	219
At Least Twice a Year .....	219
At Least Once a Year .....	220
<b>C. Periodic Maintenance Inspections</b> .....	223
<b>D. Recommended Fluids and Lubricants</b> .....	225
<b>E. Maintenance Record</b> .....	228



**Protection  
Plan**

*Have you purchased the GM Protection Plan? The Plan  
supplements your new car warranties.  
See your GM dealer for details.*

# Maintenance Schedule

## Introduction: A Word about Maintenance

We at General Motors want to help you keep your vehicle in good working condition. But we don't know exactly how you'll drive it. You may drive very short distances only a few times a week. Or you may drive long distances all the time in very hot, dusty weather. You may use your vehicle in making deliveries. Or you may drive it to work, to do errands or in many other ways.

Because of all the different ways people use their GM vehicles, maintenance needs vary. You may even need more frequent checks and replacements than you will find in the schedules in this part. So please read this part and note how you drive. If you have any questions on how to keep your vehicle in good condition, see your Geo dealer, the place many GM owners choose to have their maintenance work done. Your dealer can be relied upon to use proper parts and practices.

### ***Your Vehicle and the Environment***

Proper vehicle maintenance not only helps to keep your vehicle in good working condition, but also helps the environment. All recommended maintenance procedures are important. Improper vehicle maintenance or the removal of important components can significantly affect the quality of the air we breathe. Improper fluid levels or even the wrong tire inflation can increase the level of emissions from your vehicle. To help protect our environment, and to help keep your vehicle in good condition, please maintain your vehicle properly.

### ***How This Part is Organized***

The remainder of this part is divided into five sections:

"Section A: Scheduled Maintenance Services" shows what to have done and how often. Some of these services can be complex, so unless you are technically qualified and have the necessary

equipment, you should let your dealer's service department or another qualified service center do these jobs.



### **CAUTION**

Performing maintenance work on a vehicle can be dangerous. In trying to do some jobs, you can be seriously injured. Do your own maintenance work only if you have the required know-how and the proper tools and equipment for the job. If you have any doubt, have a qualified technician do the work.

If you are skilled enough to do some work on your vehicle, you will probably want to get the service information GM publishes. You will find a list of publications and how to get them in this manual. See "Service Publications" in the Index.

"Section B: Owner Checks and Services" tells you what should be checked whenever you stop for fuel. It also explains what you can easily do to help keep your vehicle in good condition.

“Section C: Periodic Maintenance Inspections” explains important inspections that your Geo dealer’s service department or another qualified service center should perform.

“Section D: Recommended Fluids and Lubricants” lists some products GM recommends to help keep your vehicle properly maintained. These products, or their equivalents, should be used whether you do the work yourself or have it done.

“Section E: Maintenance Record” provides a place for you to record the maintenance performed on your vehicle. Whenever any maintenance is performed, be sure to write it down in this section. This will help you determine when your next maintenance should be done. In addition, it is a good idea to keep your maintenance receipts. They may be needed to qualify your vehicle for warranty repairs.

## ■ **Section A: Scheduled Maintenance Services**

### **Using Your Maintenance Schedules**

This section tells you the maintenance services you should have done and when you should schedule them. Your Geo dealer knows your vehicle best and wants you to be happy with it. If you go to your dealer for your service needs, you’ll know that GM-trained and supported service people will perform the work using genuine GM parts.

These schedules are for vehicles that:

- carry passengers and cargo within recommended limits. You will find these limits on your vehicle’s Tire-Loading Information label. See “Loading Your Vehicle” in the Index.
- are driven on reasonable road surfaces within legal driving limits.
- use the recommended unleaded fuel. See “Fuel” in the Index.

## **Selecting the Right Schedule**

First you’ll need to decide which of the two schedules is right for your vehicle. Here’s how to decide which schedule to follow:

### Schedule I

Is any one of these true for your vehicle?

- Most trips are less than 4 miles (6 km).
- Most trips are less than 10 miles (16 km) when outside temperatures are below freezing.
- The engine is at low speed most of the time (as in door-to-door delivery, or in stop-and-go traffic).
- You operate your vehicle in dusty areas or off-road frequently.
- You tow a trailer.

If any one (or more) of these is true for your driving, follow Schedule I.

### Schedule II

Follow Schedule II only if none of the above conditions is true.

# Maintenance Schedule

## Section A: Scheduled Maintenance Services (Cont.)

### **Schedule I**

Follow Schedule I if your vehicle is MAINLY driven under one or more of the following conditions:

- When most trips are less than 4 miles (6 km).
- When most trips are less than 10 miles (16 km) and outside temperatures remain below freezing.
- When most trips include extended idling and/or frequent low-speed operation, as in stop-and-go traffic.
- When towing a trailer.
- When operating in dusty areas or off-road frequently.

Schedule I should also be followed if the vehicle is used for delivery service, police, taxi or other commercial applications.

\* An Emission Control Service.

† The U.S. Environmental Protection Agency or the California Air Resources Board has determined that the failure to perform this maintenance item will not nullify the emission warranty or limit recall liability prior to the completion of vehicle useful life. General Motors, however, urges that all recommended maintenance services be performed at the indicated intervals and the maintenance be recorded in "Section E: Maintenance Record."

ITEM NO.	WHAT TO SERVICE <i>See "Explanation of Scheduled Maintenance Services" following Schedules I and II.</i>	WHEN TO PERFORM <i>Miles (kilometers) or Months (whichever occurs first).</i>
1	Engine Oil and Filter Change*	Every 3,000 miles (5 000 km) or 3 months.
2	Tire and Wheel Rotation and Inspection	Every 6,000 miles (10 000 km).
3	Fan (Water Pump) Drive Belt Service	See "Explanation of Scheduled Maintenance Services" following Schedules I and II.
4	Camshaft Timing Belt Replacement*	At 60,000 miles (100 000 km). See "Explanation of Scheduled Maintenance Services" following Schedules I and II.
5	Cooling System Service*	Every 30,000 miles (50 000 km) or 30 months.
6	Wheel Bearing Inspection	Every 15,000 miles (25 000 km) or 15 months.
7	Transmission (All) and Transfer Case Differential (Four-Wheel Drive) Service	See "Explanation of Scheduled Maintenance Services" following Schedules I and II.
8	Propeller Shafts and U-Joints Inspection	See "Explanation of Scheduled Maintenance Services" following Schedules I and II.
9	Freewheeling Hubs Inspection (if equipped)	Every 3,000 miles (5 000 km) or 3 months.
10	Spark Plug Replacement*	Every 30,000 miles (50 000 km).
11	Spark Plug Wire Replacement*	Every 60,000 miles (100 000 km) or 60 months.
12	Positive Crankcase Ventilation (PCV) Valve Replacement*	Every 50,000 miles (83 000 km).
13	Exhaust Gas Recirculation (EGR) System Inspection*	Every 50,000 miles (83 000 km).

The services shown on this chart up to 60,000 miles (100 000 km) should be performed after 60,000 miles (100 000 km) at the same intervals.

**MILES (000)**

3 6 7.5 9 12 15 18 21 22.5 24 27 30 33 36 37.5 39 42 45 48 50 51 52.5 54 57 60

**KILOMETERS (000)**

5 10 12.5 15 20 25 30 35 37.5 40 45 50 55 60 62.5 65 70 75 80 83 85 87.5 90 95 100

•	•		•	•	•	•	•		•	•	•	•	•		•	•	•	•		•		•	•	•	
	•			•		•			•		•		•			•		•					•		•
																									•
											•														•
					•						•						•								•
•	•		•	•	•	•	•		•	•	•	•	•		•	•	•	•		•		•	•	•	
											•													•	
																								•	
																				•					
																				•					



# Maintenance Schedule

## Section A: Scheduled Maintenance Services (Cont.)

### *Schedule I (Cont.)*

\* An Emission Control Service.

† The U.S. Environmental Protection Agency or the California Air Resources Board has determined that the failure to perform this maintenance item will not nullify the emission warranty or limit recall liability prior to the completion of vehicle useful life. General Motors, however, urges that all recommended maintenance services be performed at the indicated intervals and the maintenance be recorded in "Section E: Maintenance Record."

<b>ITEM NO.</b>	<b>WHAT TO SERVICE</b> <i>See "Explanation of Scheduled Maintenance Services" following Schedules I and II.</i>	<b>WHEN TO PERFORM</b> <i>Miles (kilometers) or Months (whichever occurs first).</i>
14	Air Cleaner Filter Replacement*	See "Explanation of Scheduled Maintenance Services" following Schedules I and II.
15	Fuel Tank, Cap and Lines Inspection*†	See "Explanation of Scheduled Maintenance Services" following Schedules I and II.
16	Fuel Filter Replacement*	Every 30,000 miles (50 000 km) or 30 months.
17	Fuel Injector Inspection*	Every 100,000 miles (166 000 km).
18	Heated Oxygen Sensor Replacement*	Every 80,000 miles (133 000 km).
19	Evaporative Emissions Canister Replacement*	Every 100,000 miles (166 000 km).
20	Engine Control Module (ECM) and Associated Sensors Inspection*	Every 100,000 miles (166 000 km).
21	Emission System Hoses Inspection*	Every 60,000 miles (100 000 km).
22	Three Way Catalytic Converter Inspection*	Every 100,000 miles (166 000 km).
23	Engine Timing and Distributor Check*	Every 60,000 miles (100 000 km).
24	Engine Idle Speed Check*†	Every 15,000 miles (25 000 km).
25	Valve Lash (Clearance) Inspection*	Every 15,000 miles (25 000 km).
26	Power Steering System Inspection	Every 7,500 miles (12 500 km) or 7.5 months.
27	Wiring Harness and Connectors Inspection*	Every 60,000 miles (100 000 km) or 60 months.
28	Brake Fluid Service	Every 60,000 miles (100 000 km).



# Maintenance Schedule

## Section A: Scheduled Maintenance Services (Cont.)

### **Schedule II**

Follow Schedule II **ONLY** if none of the driving conditions specified in Schedule I apply.

\* An Emission Control Service.

† The U.S. Environmental Protection Agency or the California Air Resources Board has determined that the failure to perform this maintenance item will not nullify the emission warranty or limit recall liability prior to the completion of vehicle useful life. General Motors, however, urges that all recommended maintenance services be performed at the indicated intervals and the maintenance be recorded in "Section E: Maintenance Record."

ITEM NO.	WHAT TO SERVICE <i>See "Explanation of Scheduled Maintenance Services" following Schedules I and II.</i>	WHEN TO PERFORM <i>Miles (kilometers) or Months (whichever occurs first).</i>
1	Engine Oil and Filter Change*	Every 7,500 miles (12 500 km) or 7.5 months.
2	Tire and Wheel Rotation and Inspection	Every 7,500 miles (12 500 km).
3	Fan (Water Pump) Drive Belt Service	See "Explanation of Scheduled Maintenance Services" following Schedules I and II.
4	Camshaft Timing Belt Replacement*	At 60,000 miles (100 000 km). See "Explanation of Scheduled Maintenance Services" following Schedules I and II.
5	Cooling System Service*	Every 30,000 miles (50 000 km) or 30 months.
6	Wheel Bearing Inspection	Every 15,000 miles (25 000 km) or 15 months.
7	Transmission (All) and Transfer Case Differential (Four-Wheel Drive) Service	See "Explanation of Scheduled Maintenance Services" following Schedules I and II.
8	Propeller Shafts and U-Joints Inspection	See "Explanation of Scheduled Maintenance Services" following Schedules I and II.
9	Freewheeling Hubs Inspection (if equipped)	Every 3,000 miles (5 000 km) or 3 months.
10	Spark Plug Replacement*	Every 30,000 miles (50 000 km).
11	Spark Plug Wire Replacement*	Every 60,000 miles (100 000 km) or 60 months.
12	Positive Crankcase Ventilation (PCV) Valve Replacement*	Every 50,000 miles (83 000 km).
13	Exhaust Gas Recirculation (EGR) System Inspection*	Every 50,000 miles (83 000 km).

The services shown on this chart up to 60,000 miles (100 000 km) should be performed after 60,000 miles (100 000 km) at the same intervals.

**MILES (000)**

3	6	7.5	9	12	15	18	21	22.5	24	27	30	33	36	37.5	39	42	45	48	50	51	52.5	54	57	60
---	---	-----	---	----	----	----	----	------	----	----	----	----	----	------	----	----	----	----	----	----	------	----	----	----

**KILOMETERS (000)**

5	10	12.5	15	20	25	30	35	37.5	40	45	50	55	60	62.5	65	70	75	80	83	85	87.5	90	95	100
---	----	------	----	----	----	----	----	------	----	----	----	----	----	------	----	----	----	----	----	----	------	----	----	-----

		•			•			•			•			•			•				•			•
		•			•			•			•			•			•				•			•
											•													•
											•													•
					•						•													•
											•													•
•	•			•	•	•	•	•		•	•	•	•		•	•	•	•		•		•	•	•
											•													•
																								•

# Maintenance Schedule

## Section A: Scheduled Maintenance Services (Cont.)

### ***Schedule II (Cont.)***

\* An Emission Control Service.

† The U.S. Environmental Protection Agency or the California Air Resources Board has determined that the failure to perform this maintenance item will not nullify the emission warranty or limit recall liability prior to the completion of vehicle useful life. General Motors, however, urges that all recommended maintenance services be performed at the indicated intervals and the maintenance be recorded in "Section E: Maintenance Record."

<b>ITEM NO.</b>	<b>WHAT TO SERVICE</b> <i>See "Explanation of Scheduled Maintenance Services" following Schedules I and II.</i>	<b>WHEN TO PERFORM</b> <i>Miles (kilometers) or Months (whichever occurs first).</i>
14	Air Cleaner Filter Replacement*	See "Explanation of Scheduled Maintenance Services" following Schedules I and II.
15	Fuel Tank, Cap and Lines Inspection*†	See "Explanation of Scheduled Maintenance Services" following Schedules I and II.
16	Fuel Filter Replacement*	Every 30,000 miles (50 000 km) or 30 months.
17	Fuel Injector Inspection*	Every 100,000 miles (166 000 km).
18	Heated Oxygen Sensor Replacement*	Every 80,000 miles (133 000 km).
19	Evaporative Emissions Canister Replacement*	Every 100,000 miles (166 000 km).
20	Engine Control Module (ECM) and Associated Sensors Inspection*	Every 100,000 miles (166 000 km).
21	Emission System Hoses Inspection*	Every 60,000 miles (100 000 km).
22	Three Way Catalytic Converter Inspection*	Every 100,000 miles (166 000 km).
23	Engine Timing and Distributor Check*	Every 60,000 miles (100 000 km).
24	Engine Idle Speed Check*†	Every 15,000 miles (25 000 km).
25	Valve Lash (Clearance) Inspection*	Every 15,000 miles (25 000 km).
26	Power Steering System Inspection	Every 7,500 miles (12 500 km) or 7.5 months.
27	Wiring Harness and Connectors Inspection*	Every 60,000 miles (100 000 km) or 60 months.
28	Brake Fluid Service	Every 60,000 miles (100 000 km).

The services shown on this chart up to 60,000 miles (100 000 km) should be performed after 60,000 miles (100 000 km) at the same intervals.

**MILES (000)**

3	6	7.5	9	12	15	18	21	22.5	24	27	30	33	36	37.5	39	42	45	48	50	51	52.5	54	57	60
---	---	-----	---	----	----	----	----	------	----	----	----	----	----	------	----	----	----	----	----	----	------	----	----	----

**KILOMETERS (000)**

5	10	12.5	15	20	25	30	35	37.5	40	45	50	55	60	62.5	65	70	75	80	83	85	87.5	90	95	100
---	----	------	----	----	----	----	----	------	----	----	----	----	----	------	----	----	----	----	----	----	------	----	----	-----

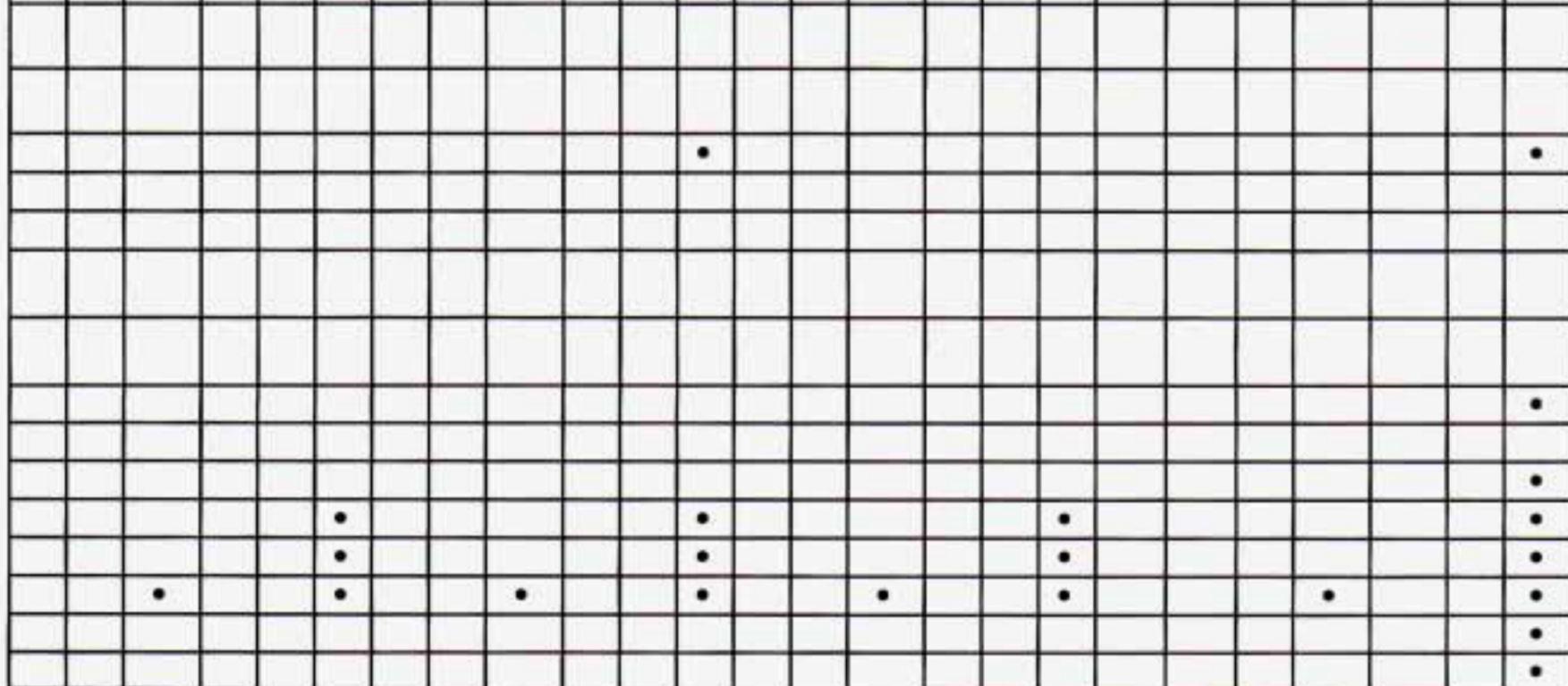

# Maintenance Schedule

## Section A: Scheduled Maintenance Services (Cont.)

### ***Explanation of Scheduled Maintenance Services***

Following are explanations of the services listed in Schedule I and Schedule II.

The proper fluids and lubricants to use are listed in Section D. Make sure whoever services your vehicle uses these. All parts should be replaced and all necessary repairs done before you or anyone else drives the vehicle.

NOTE: To determine your engine's displacement and code, see "Engine Identification" in the Index.

### **ITEM NO. SERVICE**

- 1** Engine Oil and Filter Change\* – Always use SH or SG Energy Conserving II oils of proper viscosity. The "SH" or "SG" designation may be shown alone, or in combination with others, such as "SH/CD," "SH, SG, CD," "SG/CD," etc.

\* An Emission Control Service.

### **ITEM NO. SERVICE**

- To determine the preferred viscosity for your vehicle's engine (e.g., SAE 5W-30 or SAE 10W-30), see "Engine Oil" in the Index.
- 2** Tire and Wheel Rotation and Inspection – For proper wear and maximum tire life, rotate your tires following the instructions in this manual. See "Tires, Inspection and Rotation" in the Index. Check the tires for uneven wear or damage. If you see irregular or premature wear, check the wheel alignment. Check for damaged wheels also.
- 3** Fan (Water Pump) Drive Belt Service – Inspect and adjust if necessary at 30,000 mile (50 000 km), or 30 month intervals. Replace the belt at 60,000 miles (100 000 km) and 120,000 miles (200 000 km).
- 4** Camshaft Timing Belt Replacement\* – Replace every 60,000 miles (100 000 km) and

### **ITEM**

### **NO. SERVICE**

- then inspect after 30,000 miles (50 000 km).
- 5** Cooling System Service\* – Drain, flush and refill the system with new or approved recycled coolant conforming to GM Specification 1825M. Keep coolant at the proper mixture as specified. See "Coolant" in the Index. This provides proper freeze and boil protection, corrosion inhibitor level and maintains proper engine operating temperature.
- Inspect hoses and replace if they are cracked, swollen or deteriorated. Tighten screw-type hose clamps. Clean the outside of the radiator and air conditioning condenser. Wash the pressure cap and neck.
- To help ensure proper operation, we recommend a pressure test of both the cooling system and the pressure cap.

**ITEM  
NO. SERVICE**

- 6** Wheel Bearing Inspection – Inspect for wear and proper adjustment. Relubricate the bearings if grease is contaminated.
- 7** Transmission (All) and Transfer Case Differential (Four-Wheel Drive) Service – For the manual transmission and transfer case differential, check the fluid level every time the oil is changed. See “Manual Transmission Fluid” and “Transfer Case” in the Index. Inspect for damage and leaks and change the fluid every 15,000 miles (25 000 km) or 15 months for Schedule I conditions and every 30,000 miles (50 000 km) or 30 months for Schedule II conditions.
- For the automatic transmission, check the fluid level every time the oil is changed. See “Automatic Transmission Fluid” in the Index. Inspect for damage and leaks and change

**ITEM  
NO. SERVICE**

- the fluid every 15,000 miles (25 000 km) or 15 months for Schedule I conditions and 100,000 miles (166 000 km) for Schedule II conditions. Replace the automatic transmission cooler hoses every 45,000 miles (75 000 km).
- 8** Propeller Shafts and U-Joints Inspection – Inspect for looseness and damage. Do this every 15 months, or at 15,000 mile (25 000 km) intervals, more frequently if used off-road or for pulling a trailer. Tighten U-joint flange bolts if necessary.
- 9** Freewheeling Hubs Inspection (If Equipped) – Inspect the locking front hubs for correct operation. Repair or replace if necessary. (Both hubs must operate correctly for the front axle to power the front wheels.)

**ITEM  
NO. SERVICE**

- 10** Spark Plug Replacement\* – Replace spark plugs with the proper type. See “Replacement Parts” in the Index.
- 11** Spark Plug Wire Replacement\* – Replace wires. Check the boot fit at the distributor and at the spark plugs. Operation in extreme cold and/or on salted roads may require more frequent replacement.

\* An Emission Control Service.

† The U.S. Environmental Protection Agency or the California Air Resources Board has determined that the failure to perform this maintenance item will not nullify the emission warranty or limit recall liability prior to the completion of vehicle useful life. General Motors, however, urges that all recommended maintenance services be performed at the indicated intervals and the maintenance be recorded in “Section E: Maintenance Record.”



# Maintenance Schedule

## Section A: Scheduled Maintenance Services (Cont.)

### ITEM

#### NO. SERVICE

- 12** Positive Crankcase Ventilation (PCV) Valve Replacement\* – Inspect valve for proper function. Replace the valve every 50,000 miles (83 000 km) as well as any worn, plugged or collapsed hoses.
- 13** Exhaust Gas Recirculation (EGR) System Inspection\* – Inspect at 50,000 mile (83 000 km) intervals.
- 14** Air Cleaner Filter Replacement\* – Replace every 30,000 miles (50 000 km) or more often under dusty conditions. Ask your dealer for the proper replacement intervals for your driving conditions.
- 15** Fuel Tank, Cap and Lines Inspection\*† – Inspect fuel tank, cap, lines and hoses for damage or leaks. Inspect fuel cap gasket for an even filler neck imprint or any damage at 30,000 miles (50 000 km). Replace parts as

### ITEM

#### NO. SERVICE

- needed. Replace the cap and gasket at 60,000 mile (100 000 km) intervals.
- 16** Fuel Filter Replacement\* – Replace the fuel filter every 30,000 miles (50 000 km), or sooner if clogged.
- 17** Fuel Injector Inspection\* – Inspect at 100,000 mile (166 000 km) intervals.
- 18** Heated Oxygen Sensor Replacement\* – Replace at 80,000 miles (133 000 km).
- 19** Evaporative Emissions Canister Replacement\* – Replace at 100,000 mile (166 000 km) intervals.
- 20** Engine Control Module (ECM) and Associated Sensors Inspection\* – Inspect at 100,000 mile (166 000 km) intervals.
- 21** Emission System Hoses Inspection\* – Inspect at 60,000 mile (100 000 km) intervals.

### ITEM

#### NO. SERVICE

- 22** Three-Way Catalytic Converter Inspection\* – Inspect at 100,000 mile (166 000 km) intervals. At each oil change, inspect the entire exhaust system for leaks and loose fittings, especially if the vehicle is used off-road.
- 23** Engine Timing and Distributor Check\* – Adjust the timing to the underhood label specifications. Inspect the inside and outside of the distributor cap and rotor for cracks, carbon tracking and corrosion. Clean or replace as needed.

\* An Emission Control Service.

† The U.S. Environmental Protection Agency or the California Air Resources Board has determined that the failure to perform this maintenance item will not nullify the emission warranty or limit recall liability prior to the completion of vehicle useful life. General Motors, however, urges that all recommended maintenance services be performed at the indicated intervals and the maintenance be recorded in "Section E: Maintenance Record."

**ITEM****NO. SERVICE**

- 24** Engine Idle Speed Check\*† – Check the idle speed and adjust it to underhood label specifications.
- 25** Valve Lash (Clearance) Inspection\* – Inspect the valve lash and adjust if necessary.
- 26** Power Steering System Inspection – Check the power steering gear box, pump and hose connections for leaks or damage. Check the fluid level on the dipstick. See "Power Steering Fluid" in the Index. Check the drive belt for cracks, fraying and wear. Check belt tension. There should be 0.24-0.35" (6-9 mm) deflection when you press your thumb midway between the pulleys. Adjust or replace belt as needed.

**ITEM****NO. SERVICE**

- 27** Wiring Harness and Connectors Inspection\* – Inspect the underhood wiring harness for loose connections, chafed wires and damage.
- 28** Brake Fluid Service – Drain, refill and bleed the brake system every 60,000 miles (100 000 km). Use only new DOT-3 fluid from a sealed container.

\* *An Emission Control Service.*

† *The U.S. Environmental Protection Agency or the California Air Resources Board has determined that the failure to perform this maintenance item will not nullify the emission warranty or limit recall liability prior to the completion of vehicle useful life. General Motors, however, urges that all recommended maintenance services be performed at the indicated intervals and the maintenance be recorded in "Section E: Maintenance Record."*

# Maintenance Schedule

## Section B: Owner Checks and Services

Listed below are owner checks and services which should be performed at the intervals specified to help ensure the safety, dependability and emission control performance of your vehicle. Be sure any necessary repairs are completed at once. Whenever any fluids or lubricants are added to your vehicle, make sure they are the proper ones, as shown in Section D.

**At Each Fuel Fill** *(It is important for you or a service station attendant to perform these underhood checks at each fuel fill.)*

<b>CHECK OR SERVICE</b>	<b>WHAT TO DO</b>
Engine Oil Level	Check the engine oil level and add the proper oil if necessary. See "Engine Oil" in the Index for further details.
Engine Coolant Level	Check the engine coolant level and add the proper coolant mix if necessary. See "Coolant" in the Index for further details.
Windshield Washer Fluid Level	Check the windshield washer fluid level in the windshield washer tank and add the proper fluid if necessary. See "Windshield Washer Fluid" in the Index for further details.
Hood Latch Operation	Pull the primary hood latch release handle inside the vehicle. The secondary latch should keep the hood from opening all the way when the primary latch is released. Make sure the hood closes firmly. See "Hood Release" in the Index for further details.

### ***At Least Once a Month***

<b>CHECK OR SERVICE</b>	<b>WHAT TO DO</b>
Tire Inflation	Check tire inflation. Make sure they are inflated to the pressures specified on the Tire-Loading Information label located on the driver's door lock pillar. See "Tires" in the Index for further details.
Cassette Deck	Clean cassette deck. Cleaning should be done every 15 hours of tape play. See "Audio Systems" in the Index for further details.

### ***At Least Twice a Year***

<b>CHECK OR SERVICE</b>	<b>WHAT TO DO</b>
Fluid Level Check	Check the transfer case, axle differential(s) and automatic or manual transmission fluid levels and add as needed. See "Transfer Case," "Axle, Rear" "Axle, Front" and "Automatic Transmission" or "Manual Transmission" in the Index. A fluid loss in these systems could indicate a problem. Have the system inspected and repaired at once.

# Maintenance Schedule

## Section B: Owner Checks and Services (Cont.)

### *At Least Once a Year*

CHECK OR SERVICE	WHAT TO DO
Key Lock Cylinders	Lubricate the key lock cylinders with the lubricant specified in Section D.
Body Lubrication	Lubricate all body door hinges. Also lubricate all hinges and latches, including those for the hood, rear compartment, glove box door, console door and any folding seat hardware. Section D tells you what to use.
Starter Switch	<p> <b>CAUTION:</b> When you are doing this check, the vehicle could move suddenly. If it does, you or others could be injured. Follow the steps below.</p> <ol style="list-style-type: none"><li>1. Before you start, be sure you have enough room around the vehicle.</li><li>2. Firmly apply both the parking brake (see "Parking Brake" in the Index if necessary) and the regular brake.</li></ol> <p><b>NOTE:</b> Do not use the accelerator pedal, and be ready to turn off the engine immediately if it starts.</p> <ol style="list-style-type: none"><li>3. On automatic transmission vehicles, try to start the engine in each gear. The starter should work only in "P" (Park) or "N" (Neutral). If the starter works in any other position, your vehicle needs service. On manual transmission vehicles, put the shift lever in "N" (Neutral), push the clutch down halfway and try to start the engine. The starter should work only when the clutch is pushed down all the way to the floor. If the starter works when the clutch isn't pushed all the way down, your vehicle needs service.</li></ol>

## At Least Once a Year (CONT.)

CHECK OR SERVICE	WHAT TO DO
Brake Transmission Shift Interlock – BTSI (Automatic Transmission)	<p> <b>CAUTION:</b> When you are doing this check, the vehicle could move suddenly. If it does, you or others could be injured. Follow the steps below.</p> <ol style="list-style-type: none"><li>1. Before you start, be sure you have enough room around the vehicle. It should be parked on a level surface.</li><li>2. Firmly apply the parking brake. (See “Parking Brake” in the Index if necessary).</li></ol> <p><u>NOTE:</u> Be ready to apply the regular brake immediately if the vehicle begins to move.</p> <ol style="list-style-type: none"><li>3. With the engine off, turn the key to the “ON” position, but don’t start the engine. Without applying the regular brake, try to move the shift lever out of “P” (Park) with normal effort. If the shift lever moves out of “P” (Park), your vehicle’s BTSI needs service.</li></ol>
Steering Column Lock	<p>While parked, and with the parking brake set, try to turn the key to “LOCK” in each shift lever position.</p> <ul style="list-style-type: none"><li>● With an automatic transmission, the key should turn to “LOCK” only when the shift lever is in “P” (Park).</li><li>● With a manual transmission, the key will turn to “LOCK” only if you push the key in farther, while turning it towards “LOCK.”</li></ul> <p>On vehicles with the key release lever, try to turn the key to “LOCK” without pressing the lever. The key should turn to “LOCK” only with the key lever depressed. On all vehicles, the key should come out only in “LOCK”.</p>

# Maintenance Schedule

## Section B: Owner Checks and Services (Cont.)

### *At Least Once a Year (CONT.)*

CHECK OR SERVICE	WHAT TO DO
Parking Brake and Automatic Transmission "P" (Park) Mechanism Check	<p> <b>CAUTION:</b> When you are doing this check, your vehicle could begin to move. You or others could be injured and property could be damaged. Make sure there is room in front of your vehicle in case it begins to roll. Be ready to apply the regular brake at once should the vehicle begin to move.</p> <p>Park on a fairly steep hill, with the vehicle facing downhill. Keeping your foot on the regular brake, set the parking brake.</p> <ul style="list-style-type: none"><li>● To check the parking brake: With the engine running and transmission in "N" (Neutral), slowly remove foot pressure from the regular brake pedal. Do this until the vehicle is held by the parking brake only.</li><li>● To check the "P" (Park) mechanism's holding ability: Shift to "P" (Park). Then release all brakes. If your vehicle is four-wheel drive, be sure the transfer case is not in "N" (Neutral).</li></ul>
Underbody Flushing	At least every spring, use plain water to flush any corrosive materials from the underbody. Take care to clean thoroughly any areas where mud and other debris can collect.

# Maintenance Schedule

## Section C: Periodic Maintenance Inspections

Listed below are inspections and services which should be performed at least twice a year (for instance, each spring and fall). You should let your GM dealer's service department or other qualified service center do these jobs. Make sure any necessary repairs are completed at once.

<b>INSPECTION OR SERVICE</b>	<b>WHAT SHOULD BE DONE</b>
Restraint Systems	Now and then, make sure all your belts, buckles, latch plates, retractors, anchorages and reminder systems are working properly. Look for any loose parts or damage. If you see anything that might keep a restraint system from doing its job, have it repaired.
Steering, Suspension and Front-Wheel-Drive Axle Boot and Seal Inspection	Inspect the front and rear suspension and steering system for damaged, loose or missing parts, signs of wear, or lack of lubrication. Inspect the power steering lines and hoses for proper hookup, binding, leaks, cracks, chafing, etc. Clean and then inspect the drive axle boot seals for damage, tears or leakage. Replace seals if necessary.
Exhaust System Inspection	Inspect the complete exhaust system. Inspect the body near the exhaust system. Look for broken, damaged, missing or out-of-position parts as well as open seams, holes, loose connections, or other conditions which could cause a heat build-up in the floor pan or could let exhaust fumes into the vehicle. See "Engine Exhaust" in the Index.
Throttle Linkage Inspection	Inspect the throttle linkage for interference or binding, and for damaged or missing parts. Replace parts as needed.



# Maintenance Schedule

## Section C: Periodic Maintenance Inspections (Cont.)

INSPECTION OR SERVICE	WHAT SHOULD BE DONE
Rear Axle (All) and Front Axle (Four-Wheel Drive) Service	Check the gear lubricant level and add if needed. See "Rear Axle" and "Four-Wheel Drive" in the Index. A fluid loss may indicate a problem. Check the system(s), and repair the system(s) if needed. Refer to "Scheduled Maintenance Services," earlier in this part, to determine when to change the lubricant.
Brake System Inspection	<p>Inspect the complete system. Inspect brake lines and hoses for proper hookup, binding, leaks, cracks, chafing, etc. Inspect disc brake pads for wear and rotors for surface condition. Also inspect drum brake linings for wear and cracks. Inspect other brake parts, including drums, wheel cylinders, calipers, parking brake, etc. Check parking brake adjustment. You may need to have your brakes inspected more often if your driving habits or conditions result in frequent braking.</p> <p><b>NOTE:</b> A low brake fluid level can indicate worn disc brake pads which may need to be serviced. Also, if the brake system warning light stays on or comes on, something may be wrong with either the regular or rear wheel anti-lock brake system, or both systems. See "Brake System Warning Light" in the Index.</p>
Clutch System Service	Check clutch pedal free travel and adjust as necessary. See "Clutch Adjustment" in the Index.

# Maintenance Schedule

## Section D: Recommended Fluids & Lubricants

**NOTE:** Fluids and lubricants identified below by name, part number or specification may be obtained from your GM Dealer.

USAGE	FLUID/LUBRICANT
Engine Oil	API service SH or SG Energy Conserving II oils of the proper viscosity. The "SH" or "SG" designation may be shown alone or in combination with others, such as "SH/CD," or "SH, SG, CD," "SG/CD," etc. To determine the preferred viscosity for your vehicle's engine, see "Engine Oil" in the Index.
Engine Coolant	50/50 mixture of water (preferably distilled) and good quality ethylene glycol base antifreeze (GM Part No. 1052753 or equivalent) conforming to GM Specification 1825M or approved recycled coolant conforming to GM Specification 1825M.
Hydraulic Brake System	Delco-Supreme 11 <sup>®</sup> Brake Fluid (GM Part No. 1052535 or equivalent DOT-3 brake fluid).
Parking Brake Guides	Chassis lubricant (GM Part No. 1052497 or equivalent) or lubricant meeting requirements of NLGI Grade 2, Category LB or GC-LB.
Power Steering System	DEXRON <sup>®</sup> -IIE Automatic Transmission Fluid.
Manual Transmission	SAE 75W-90 GL-4 (GM Part No. 12346074 Castrol <sup>®</sup> Syntorq GL-4 or equivalent) or SAE 75W-90 GL-5 Gear Lubricant.
Automatic Transmission	DEXRON <sup>®</sup> -III or DEXRON <sup>®</sup> -IIE Automatic Transmission Fluid.

# Maintenance Schedule

## Section D: Recommended Fluids & Lubricants (Cont.)

USAGE	FLUID/LUBRICANT
Key Lock Cylinders	Lubricate with Multi-Purpose Lubricant (GM Part No. 12345120) or synthetic SAE 5W-30 engine oil.
Manual Transmission Shift Linkage	Chassis lubricant (GM Part No. 1052497 or equivalent) or lubricant meeting requirements of NLGI Grade 2, Category LB or GC-LB.
Automatic Transmission Shift Linkage	Engine oil.
Clutch Linkage Pivot Points	Lithium base grease.
Floor Shift Linkage	Engine oil.
Chassis Lubrication	Chassis lubricant (GM Part No. 1052497 or equivalent) or lubricant meeting requirements of NLGI Grade 2, Category LB or GC-LB.

USAGE	FLUID/LUBRICANT
Rear Axle (All) and Front Axle (Four-Wheel Drive)	SAE 75W-90 GL-5 Hypoid Gear Lubricant.
Windshield Washer Solvent	GM Optikleen <sup>®</sup> Washer Solvent (GM Part No. 1051515) or equivalent.
Transfer Case (Four-Wheel Drive)	SAE 75W-90 GL-4 Gear Lubricant.
Hood Latch Assembly a. Pivots and Spring Anchor b. Release Pawl	a. Engine oil. b. Chassis lubricant (GM Part No. 1052497 or equivalent) or lubricant meeting requirements of NLGI Grade 2, Category LB or GC-LB.
Hood, Door and Lift-gate Hinges, Rear Folding Seat, Fuel Door Hinge, Rear Compartment Lid Hinges	Engine oil or Lubriplate Lubricant (GM Part No. 1050109).
Weatherstrips	Dielectric Silicone Grease (GM Part No. 12345579 or equivalent).

See "Replacement Parts" in the Index for recommended replacement filters, valves and spark plugs.

# Maintenance Schedule

## Section E: Maintenance Record

After the scheduled services are performed, record the date, odometer reading and who performed the service in the columns indicated. When completing the Maintenance Performed column, insert the numbers from the Schedule I or Schedule II maintenance charts which correspond to the maintenance performed. Also, you should retain all maintenance receipts. Your owner information portfolio is a convenient place to store them.

DATE	ODOMETER READING	SERVICED BY	MAINTENANCE PERFORMED

DATE	ODOMETER READING	SERVICED BY	MAINTENANCE PERFORMED

# Maintenance Schedule

## Section E: Maintenance Record (Cont.)

DATE	ODOMETER READING	SERVICED BY	MAINTENANCE PERFORMED

DATE	ODOMETER READING	SERVICED BY	MAINTENANCE PERFORMED



# Maintenance Schedule

## Section E: Maintenance Record (Cont.)

DATE	ODOMETER READING	SERVICED BY	MAINTENANCE PERFORMED

## Customer Assistance Information



**H**ere you will find out how to contact Chevrolet/Geo if you need assistance. This part also tells you how to obtain service publications and how to report any safety defects.

Customer Satisfaction Procedure .....	234
Customer Assistance for the Hearing or Speech Impaired .....	234
GM Participation in BBB AUTO LINE – Alternative Dispute Resolution Program .....	235
Reporting Safety Defects .....	236
Chevrolet/Geo Roadside Assistance Program .....	237
Canadian Roadside Assistance .....	237
Courtesy Transportation .....	237
Service Publications .....	238

# Customer Assistance Information

## ■ *Customer Satisfaction Procedure*

Your satisfaction and goodwill are important to your dealer and Chevrolet/Geo. Normally, any concern with the sales transaction or the operation of your vehicle will be resolved by your dealer's Sales or Service Departments. Sometimes, however, despite the best intentions of all concerned, misunderstandings can occur. If your concern has not been resolved to your satisfaction, the following steps should be taken:

**STEP ONE:** Discuss your concern with a member of dealership management. Normally, concerns can be quickly resolved at that level. If the matter has already been reviewed with the Sales, Service, or Parts Manager, contact the owner of the dealership or the General Manager.

**STEP TWO:** If after contacting a member of dealership management, it appears your concern cannot be resolved by the dealership without further help, contact the Chevrolet/Geo Customer Assistance Center by calling 1-800-222-1020. In Canada, contact GM

of Canada Customer Assistance Center in Oshawa by calling 1-800-263-3777 (English) or 1-800-263-7854 (French). In Mexico, call (525) 254-3777. In Puerto Rico or U.S. Virgin Islands, call 1-809-763-1315. In all other overseas locations, contact GM North American Export Sales in Canada by calling 1-905-644-4112.

For prompt assistance, please have the following information available to give the Customer Assistance Representative:

- Your name, address, home and business telephone numbers
- Vehicle Identification Number (This is available from the vehicle registration or title, or the plate at the left top of the instrument panel and visible through the windshield.)
- Dealership name and location
- Vehicle delivery date and present mileage
- Nature of concern

We encourage you to call the toll-free number listed previously in order to give your inquiry prompt attention. However, if you wish to write Chevrolet/Geo, write to:

Chevrolet/Geo  
Customer Assistance Center  
P.O. Box 7047  
Troy, MI 48007-7047

Refer to your Warranty and Owner Assistance Information booklet for addresses of Canadian and GM Overseas offices.

When contacting Chevrolet/Geo, please remember that your concern will likely be resolved in the dealership, using the dealership's facilities, equipment and personnel. That is why we suggest you follow Step One first if you have a concern.

### **Customer Assistance for the Hearing or Speech Impaired (TDD)**

To assist customers who have hearing difficulties, Chevrolet/Geo has installed special TDD (Telecommunication Devices for the Deaf) equipment at its Customer Assistance Center. Any hearing or speech impaired customer who has access to a TDD or a conventional teletypewriter (TTY) can communicate with Chevrolet by dialing: 1-800-TDD-CHEV (1-800-833-2438). (TDD users in Canada can dial 1-800-263-3830.)

## ■ *GM Participation in BBB AUTO LINE - Alternative Dispute Resolution Program* \*

Both Chevrolet/Geo and your Chevrolet/Geo dealer are committed to making sure you are completely satisfied with your new vehicle. Our experience has shown that, if a situation arises where you feel your concern has not been adequately addressed, the Customer Satisfaction Procedure described earlier in this section is very successful.

There may be instances where an impartial third-party can assist in arriving at a solution to a disagreement regarding vehicle repairs or interpretation of the New Vehicle Limited Warranty. To assist in resolving these disagreements Chevrolet/Geo voluntarily participates in BBB AUTO LINE.

BBB AUTO LINE is an out-of-court program administered by the Better Business Bureau system to settle disputes between customers and automobile manufacturers. This program is available free of charge to customers who currently own or lease a GM vehicle.

If you are not satisfied after following the Customer Satisfaction Procedure, you may contact the BBB using the toll-free telephone number, or write them at the following address:

BBB AUTO LINE  
Council of Better Business Bureaus  
4200 Wilson Boulevard  
Suite 800  
Arlington, VA 22203

Telephone: 1-800-955-5100

To file a claim, you will be asked to provide your name and address, your vehicle identification number (VIN), and a statement of the nature of your complaint. Eligibility is limited by vehicle age and mileage, and other factors.

We prefer you utilize the Customer Satisfaction Procedure before you resort to AUTO LINE, but you may contact the BBB at any time. The BBB will attempt to resolve the complaint serving as an intermediary between you and Chevrolet/Geo. If this mediation is unsuccessful, an informal hearing will be scheduled where eligible customers may present their case to an impartial third-party arbitrator.

The arbitrator will make a decision which you may accept or reject. If you accept the decision, GM will be bound by that decision. The entire dispute resolution procedure should ordinarily take about forty days from the time you file a claim until a decision is made.

Some state laws may require you to use this program before filing a claim with a state-run arbitration program or in the courts. For further information, contact the BBB at 1-800-955-5100 or the Chevrolet/Geo Customer Assistance Center at 1-800-222-1020.

\*This program may not be available in all states, depending on state law. Canadian owners refer to your Warranty and Owner Assistance information booklet. General Motors reserves the right to change eligibility limitations and/or to discontinue its participation in this program.

## Customer Assistance Information

### ■ *Reporting Safety Defects to the United States Government*

If you believe that your vehicle has a defect which could cause a crash or could cause injury or death, you should immediately inform the National Highway Traffic Safety Administration (NHTSA), in addition to notifying General Motors.

If NHTSA receives similar complaints, it may open an investigation, and if it finds that a safety defect exists in a group of vehicles, it may order a recall and remedy campaign. However, NHTSA cannot become involved in individual problems between you, your dealer, or General Motors.

To contact NHTSA, you may either call the Auto Safety Hotline toll-free at 1-800-424-9393 (or 366-0123 in the Washington, D.C. area) or write to:

NHTSA  
U.S. Department of Transportation  
Washington, D.C. 20590

You can also obtain other information about motor vehicle safety from the Hotline.

### ■ *Reporting Safety Defects to the Canadian Government*

If you live in Canada, and you believe that your vehicle has a safety defect, you should immediately notify Transport Canada, in addition to notifying General Motors of Canada Limited. You may write to:

Transport Canada  
Box 8880  
Ottawa, Ontario K1G 3J2

### ■ *Reporting Safety Defects to General Motors*

In addition to notifying NHTSA (or Transport Canada) in a situation like this, we certainly hope you'll notify us. Please call us at 1-800-222-1020, or write:

Chevrolet/Geo  
Customer Assistance Center  
P.O. Box 7047  
Troy, MI 48007-7047

In Canada, please call us at 1-800-263-3777 (English) or 1-800-263-7854 (French).

Or, write:

General Motors of Canada Limited  
Customer Assistance Center  
1908 Colonel Sam Drive  
Oshawa, Ontario L1H 8P7



### ■ ***Chevrolet/Geo Roadside Assistance Program***

To enhance Chevrolet/Geo's strong commitment to customer satisfaction, Chevrolet/Geo is excited to provide the services of the Chevrolet/Geo Roadside Assistance Center.

Roadside Assistance is available 24 hours a day, 365 days a year, by calling 1-800-CHEV USA (1-800-243-8872). This toll-free number will provide you over-the-phone roadside assistance with minor mechanical problems. If your problem cannot be resolved over the phone, our advisors have access to a nationwide network of dealer

recommended service providers. The following services are available:

- Towing
- Locksmith
- Tire Repair
- Rental car or taxi
- Additional services as necessary

The Roadside Assistance Center uses companies that will provide you with quality and priority service. When roadside services are required, our advisors will explain any payment obligations that may be incurred for utilizing outside services.

For prompt assistance when calling, please have the following available to give to the advisor:

- Vehicle Identification Number
- License plate number
- Vehicle color
- Vehicle location
- Telephone number where you can be reached
- Vehicle mileage
- Description of problem

### ■ ***Canadian Roadside Assistance***

Vehicles purchased in CANADA have an extensive ROADSIDE ASSISTANCE Program accessible from anywhere in Canada or the U.S.A. Please refer to the separate brochure provided by the dealer or call 1-800-268-6800 for emergency services.

### ■ ***Courtesy Transportation***

Chevrolet/Geo offers Courtesy Transportation for customers needing warranty service. Courtesy Transportation will be offered in conjunction with the coverage provided by the BUMPER TO BUMPER New Vehicle Limited Warranty to retail and retail lease purchasers of 1994 Chevrolet/Geo passenger cars and light-duty trucks.

Courtesy Transportation includes:

- One-way SHUTTLE RIDE for any warranty repair completed during the same day.
- Up to \$30 maximum daily VEHICLE RENTAL allowance for any overnight warranty repair up to 5 days.

**OR**

# Customer Assistance Information

- Up to \$30 maximum daily CAB, BUS, or OTHER public transportation allowance in lieu of rental for any overnight warranty repair up to 5 days.

**OR**

- Up to \$10 daily FUEL allowance for rides provided by another person (i.e., friend, neighbor, etc.) in lieu of rental or other public transportation for any overnight warranty repair up to 5 days.

**Note: All Courtesy Transportation arrangements will be administered by your Chevrolet/Geo dealership service management. Claim amounts should reflect all actual costs.**

- Chevrolet/Geo Courtesy Transportation is not part of the BUMPER TO BUMPER New Vehicle Limited Warranty. Chevrolet/Geo reserves the right to make any changes or discontinue Courtesy Transportation at any time without notification.
- For additional program details, contact your Chevrolet/Geo dealer.

**In Canada**, please consult your GM Dealer for information on courtesy transportation.

## ■ *Service Publications*

Information on how to obtain Product Service Publications (PSP's) and Indexes as described below is applicable only in the fifty U.S. states (and the District of Columbia) and only for cars and light trucks with GVWR less than 10,000 pounds (4 536 kg).

In Canada, information pertaining to Product Service Bulletins and Indexes can be obtained by writing to:

General Motors of Canada Limited  
Service Publications Department  
1908 Colonel Sam Dr.  
Oshawa, Ontario L1H 8P7

Chevrolet/Geo regularly sends its dealers useful service bulletins about Chevrolet/Geo products. Chevrolet/Geo monitors product performance in the field. We then prepare bulletins for servicing our products better. Now, you can get these bulletins too.

Bulletins cover various subjects. Some pertain to the proper use and care of your vehicle. Some describe costly repairs. Others describe inexpensive repairs which, if done on time with the latest parts, may avoid future costly repairs. Some bulletins tell a technician how to

repair a new or unexpected condition. Others describe a quicker way to fix your vehicle. They can help a technician service your vehicle better.

Most bulletins apply to conditions affecting a small number of cars or trucks. Your Chevrolet/Geo dealer or a qualified technician may have to determine if a specific bulletin applies to your vehicle.

### **Individual PSP's**

If you don't want to buy all the PSP's issued by Chevrolet/Geo for all car or truck models in the model year, you can buy individual PSP's, such as those which may pertain to a particular model. To do this, you will first need to see our index of PSP's. It provides a variety of information. Here's what you'll find in the index and how you can get one:

### **What You'll Find in the Index:**

- A list of all PSP's published by Chevrolet/Geo in a model year (1990 or later). PSP's covering all models of Chevrolet/Geo cars or light trucks (less than 10,000 pounds (4 536 kg) GVWR) are listed in the same index.

- Ordering information so you can buy the specific PSP's you may want.
- Price information for the PSP's you may want to buy.

### **How You Can Get an Index:**

Indexes are published periodically. Most of the PSP's which could potentially apply to the most recent Chevrolet/Geo models will be listed in the most recent publication for that model year. This means you may want to wait until the end of the model year before ordering an index, if you are interested in buying PSP's pertaining to a current model year car or truck.

Some PSP's pertaining to a particular model year vehicle may be published in later years, and these would be listed in the later year's index. When you order an index for a model year that is not over yet, we'll send you the most recently published issue. Check the ordering form for indexes for earlier model years.

Cut out the ordering form, fill it out, and mail it in. We will then see to it that an index is mailed to you. There is no charge for indexes for the 1990-1994 model years.

### **Toll-Free Telephone Number**

If you want an additional ordering form for an index, just call toll-free and we'll be happy to send you one. Automated recording equipment will take your name and mailing address. The number to call is 1-800-551-4123.

### **A VERY IMPORTANT REMINDER:**

These PSP's are meant for technicians. They are not meant for the "do-it-yourselfer." Technicians have the equipment, tools, safety instructions, and know-how to do a job quickly and safely.

### **Chevrolet/Geo Service Publications**

You can get these by using the order form.



# Customer Assistance Information

## 1994 CHEVROLET/GEO SERVICE PUBLICATIONS ORDERING INFORMATION

The following publications covering the operation and servicing of your vehicle can be purchased by filling out the Service Publications Order Form in this book and mailing it with your check, money order or credit card information to Helm, Incorporated (address listed below).

### CURRENT PUBLICATIONS FOR 1994 GEO TRACKER

#### PRODUCT SERVICE PUBLICATIONS

Product Service Publications (PSP's), are bulletins, letters and articles published for trained dealer service personnel. See Service Publications listed previously in this section.

A cumulative index is published quarterly during the current model year. The indexes list all PSP's published by Chevrolet in the model year.

#### PSP Index

Year	Form Number	Price
1994	PSPI-94 .....	Free
1993	PSPI-93 .....	Free
1990-92	PSPI-90-92 .....	Free

#### PSP Bound Bulletin Book (Complete Year Bulletins)

Year	Description	Form Number	Price
1991	All PSP's .....	PSP-91-4	40.00
1990	All PSP's .....	PSP-90-4	40.00

For subscription information call Helm, Incorporated.

#### SERVICE MANUALS

Service Manuals have the diagnosis, repair and overhaul information on engines, transmission, axle, suspension, brakes, electrical, steering, body, etc.

Model	Form Number	Price
1994 Geo Tracker .....	ST-377-94	\$60.00

**NOTE:** Please specify special body or engine types on order form. Write information in the Form Number column. For example: Turbo, Convertible.

#### OWNER'S INFORMATION

Owner publications are written directly for owners and intended to provide basic operational information about the vehicle. The Owner's Manual includes the Maintenance Schedule for all models.

#### 1994 Geo Tracker Owner's Manual

**In Portfolio:** Includes Portfolio, Owner's Manual and Warranty Booklet.

1994 Geo Tracker In-Portfolio .....	10260660	\$15.00
-------------------------------------	----------	---------

**Without Portfolio:** Includes Owner's Manual.

1994 Geo Tracker Without Portfolio .....	10260663	\$10.00
--	----------	---------

#### CURRENT & PAST MODEL ORDER FORMS

Service Publications are available for current and past model Chevrolet/Geo vehicles. To request an order form, please specify year and model name of vehicle.

Address all inquiries to: HELM, INCORPORATED  
P.O. Box 07130  
Detroit, MI 48207

For information and inquiries call: 1-800-782-4356

# CHEVROLET/GEO SERVICE PUBLICATIONS ORDER FORM

NOTE: Please complete form below (Print or Type) and MAIL TO:

## HELM

Post Office Box 07130, Detroit, Michigan 48207

**ORDER TOLL FREE**  
**1-800-782-4356**  
 (Monday-Friday 8:00 A.M.-6:00 P.M. EST)

PUBLICATION FORM NUMBER	ITEM DESCRIPTION	VEHICLE MODEL		QTY.	PRICE EACH*	TOTAL PRICE
		NAME	YEAR			
ST-377-94	Service Manual	Geo Tracker	1994		\$60.00	
10260660	Owner's Manual In-Portfolio	Geo Tracker	1994		\$15.00	
10260663	Owner's Manual Without-Portfolio	Geo Tracker	1994		\$10.00	

**S  
H  
I  
P  
T  
O**

**NOTE:** Dealers and Companies please provide dealer or company name, and also the name of the person to whose attention the shipment should be sent. For purchases outside U.S.A. please write to the above address for quotation.

\_\_\_\_\_  
 (CUSTOMER NAME) (ATTENTION)

\_\_\_\_\_  
 (STREET ADDRESS—NO P.O. BOX NUMBERS) (APT. NO.)

\_\_\_\_\_  
 (CITY) (STATE) (ZIP CODE)

DAYTIME TELEPHONE NO. AREA CODE ( )

**P  
A  
Y  
M  
E  
N  
T**

Check or Money  
 Order payable to  
 Helm, Inc. (USA  
 funds only — do not  
 send cash.)

MasterCard  
 VISA  Discover  
 Card

Account Number:

Expiration Date mo/yr:      Check here if your billing address is different from your shipping address shown.

\_\_\_\_\_  
 (CUSTOMER SIGNATURE)

TOTAL MATERIAL	
Michigan Purchasers add 4% sales tax	
Handling Charge	\$4.00
Canadian Postage (See Note Below)	
<b>GRAND TOTAL</b>	

\*Prices are subject to change without notice and without incurring obligation. Orders cannot be returned without prior authorization. A restocking fee may apply.

NOTE TO CANADIAN CUSTOMERS: All listed prices are quoted in U.S. funds. Canadian residents are to make checks payable in U.S. funds. To cover Canadian postage, add \$11.50 plus the U.S. Handling Charge. Requests for manuals printed in French should be directed to Canadian General Motors dealerships. Please allow adequate time for postal service.

# Notes

<b>A</b> bout Driving Your Tracker . . . . .	3	Audio Systems . . . . .	87	Brakes	
ABS . . . . .	103	Audio Systems, Comfort		Pedal Travel . . . . .	176
Add-On Electrical Equipment . . . . .	196	Controls and . . . . .	83	System Parts, Replacing . . . . .	176
Adding Coolant . . . . .	171	Automatic		System Warning Light . . . . .	69
Additives, Engine Oil . . . . .	165	Freewheeling Hubs . . . . .	47	Trailer . . . . .	127
Adjustment, Clutch . . . . .	169	Transmission . . . . .	42	Wear . . . . .	175
Adjustable Steering Column . . . . .	53	Transmission Fluid . . . . .	167	Braking (Control of a Vehicle) . . . . .	102
Air Cleaner . . . . .	165	Axle, Front . . . . .	170	Braking in Emergencies . . . . .	104
Air Conditioner Controls . . . . .	85	Axle, Rear . . . . .	169	“Break-In,” New Vehicle . . . . .	39
Air Filter Replacement . . . . .	166	<b>B</b> abies, Smaller Children		Bright Metal Parts, Protecting	
Air Intake Lever . . . . .	84	and (Safety Belts) . . . . .	26	Exterior . . . . .	192
Airflow Lever . . . . .	84	Balance, Wheel Alignment		Brightness Control . . . . .	57
Alignment and Tire Balance,		and Tire . . . . .	187	Bulb Replacement . . . . .	177
Wheel . . . . .	187	Battery . . . . .	176	Center High-Mounted	
Aluminum Wheels . . . . .	193	BBB Auto Line – Alternative Dispute		Stoplight . . . . .	181
AM/FM Stereo . . . . .	88	Resolution Program, GM		Front Parking and Turn Signal . . . . .	178
With Cassette Tape and Compact		Participation in . . . . .	235	Headlights . . . . .	177
Disc Player . . . . .	93	Before Leaving on a Long Trip . . . . .	120	Rear Combination . . . . .	180
With Cassette Tape Player . . . . .	89	Belt, Lap-Shoulder . . . . .	20	Rear Sidemarker . . . . .	179
Antenna . . . . .	98	Bi-Level . . . . .	84	Sidemarker . . . . .	179
Anti-Lock Brakes . . . . .	103	Bin, Coinholder and . . . . .	61	Bulbs, Halogen . . . . .	177
To Use . . . . .	103	Bins, Instrument Panel . . . . .	61	Bulbs, Replacement . . . . .	199
Appearance Care . . . . .	189	Blizzard, If You’re Caught in a . . . . .	124	<b>C</b> anadian Roadside Assistance . . . . .	237
Appearance Care and Materials . . . . .	195	Box, Glove . . . . .	60	Canvas Top	
Appearance Care, Service and . . . . .	155	Brakes		Preparing for Storage . . . . .	80
Approaching a Hill . . . . .	110	Adjustment . . . . .	176	Removing and Installing Your . . . . .	76
Ashtrays and Lighter . . . . .	62	Anti-Lock (ABS) . . . . .	103	Special Care for . . . . .	193
Ashtray, Front . . . . .	63	Fluid . . . . .	174	Capacities and Specifications . . . . .	200
Ashtray, Rear . . . . .	63	Master Cylinder . . . . .	174	Carbon Monoxide . . . . .	51
Assist Grips, Passenger . . . . .	62	Parking . . . . .	48		

# Index

Care		Chevrolet/Geo Service Publications		Compact Disc, To Play a	95
Appearance	189	(Ordering Information)	240	Compact Disc Player, AM/FM Stereo	
Canvas Top	193	Child Restraints	27	with Cassette Tape and	93
Cassette Tape Player	97	Rear Seat	28	Compact Discs, Care of Your	98
Compact Discs	98	Right Front Seat	30	Compartments, Door Storage	60
Safety Belts	191	Top Strap	28	Compartments, Storage and	60
Case, Transfer	47	Where to Put the	27	Control of a Vehicle	102
Case, Transfer (Service)	170	Children (Safety Belts)	26	Control, Loss of	107
Cassette Tape, To Play a		Children, Larger (Safety Belts)	32	Controls	
AM/FM Stereo with Cassette Tape		Cigarette Lighter	62	Air Conditioner	85
and Compact Disc Player	94	Circuit Breakers, Fuses and	196	Brightness	57
AM/FM Stereo with Cassette Tape		City Driving	119	Comfort	84
Player	90	Cleaner, Air	165	Features and	35
Cassette Tape and Compact Disc Player,		Cleaning		Heater	84
AM/FM Stereo with	93	Aluminum Wheels	193	Seat	10
Cassette Tape Player, AM/FM		Canvas Top	193	Convertible Top	72
Stereo with	89	Fabric	190	Convex Outside Mirror	59
Cassette Tape Player, Care		Glass	191	Coolant	
of Your	97	Inside of Your Geo	189	Adding	171
Certification/Tire Label	181	Instrument Panel, Top of	191	Engine	170
Chains, Tire	188	Leather	191	Heater, Engine	41
Changing a Flat Tire	146	Outside of Your Geo	192	How to Add to the Coolant	
Charging System Light	70	Problems, Special	190	Recovery Tank	142
Check Engine Light	71	Vinyl	191	How to Add to the Radiator	144
Checking Things under the		Windshield and Wiper Blades	192	Temperature Gage, Engine	70
Hood	159	Clock, Setting the	88	Cooling	85
Checking Your Restraint Systems	33	Clutch Adjustment	169	Cooling System	141
Chemical Paint Spotting	194	Coinholder and Bin	61	Courtesy Transportation	237
Chevrolet/Geo Roadside Assistance		Comfort Controls	84	Cupholder	61
Program	237	Comfort Controls and Audio		Curves, Driving on	104
		Systems	83		

Customer Assistance for the Hearing or Speech Impaired (TDD) . . . . .	234	Driver Position (Safety Belts) . . . . .	20	Engine	
Customer Assistance Information . . . . .	233	Driving		Coolant . . . . .	170
Customer Satisfaction Procedure . . . . .	234	Across an Incline . . . . .	113	Coolant (Block) Heater . . . . .	41
<b>D</b> amage, Finish . . . . .	194	At Night . . . . .	116	Coolant Temperature Gage . . . . .	70
Damage, Sheet Metal . . . . .	193	City . . . . .	119	Exhaust . . . . .	51
Daytime Running Lights . . . . .	56	Defensive . . . . .	100	Identification . . . . .	196
Daytime Running Lights Indicator		Downhill . . . . .	112	Oil . . . . .	162
Light . . . . .	72	Drunken . . . . .	100	Oil Pressure Light . . . . .	71
Deep Standing Water,		Freeway . . . . .	120	Overheating . . . . .	140
Driving through . . . . .	41	Guidelines . . . . .	107	Specifications . . . . .	200
Defects, Safety		In Mud, Sand, Ice or Snow . . . . .	115	Starting Your . . . . .	40
Reporting to General Motors . . . . .	236	In the Rain . . . . .	117	Environment, Your Vehicle	
Reporting to the Canadian		In Water . . . . .	115	and the . . . . .	204
Government . . . . .	236	Off-Road, With Your Geo Four-		Exhaust, Engine . . . . .	51
Reporting to the United States		Wheel-Drive Vehicle . . . . .	108	Extender, Safety Belt . . . . .	33
Government . . . . .	236	On Curves . . . . .	104	Exterior Bright Metal Parts,	
Defensive Driving . . . . .	100	On Off-Road Hills . . . . .	110	Protecting . . . . .	192
Defogger, Rear Window . . . . .	86	On Snow or Ice . . . . .	123	<b>F</b> abric Protection . . . . .	190
Defogging and Defrosting		Through Deep Standing Water . . . . .	41	Fan Control Lever . . . . .	84
Windows . . . . .	85	Uphill . . . . .	111	Features and Controls . . . . .	35
Dehumidifying . . . . .	85	Winter . . . . .	122	Filling Your Tank . . . . .	158
Dimensions, Vehicle . . . . .	202	With a Trailer . . . . .	127	Filter, Air, Replacement . . . . .	166
Doing Your Own Service Work . . . . .	156	Your Tracker, About . . . . .	3	Finish Care (Paint) . . . . .	192
Dome Light . . . . .	57	Drunken Driving . . . . .	100	Finish Damage (Paint) . . . . .	194
Door Locks . . . . .	37	<b>E</b> asy Entry Seats . . . . .	12	Flashers, Hazard Warning . . . . .	132
Door Storage Compartments . . . . .	60	Electrical Equipment, Add-On . . . . .	196	Flat Tire, Changing a . . . . .	146
Downhill, Driving . . . . .	112	Emergencies, Braking in . . . . .	104	Flat, If a Tire Goes . . . . .	146
Drive, Four-Wheel . . . . .	46	Emergencies, Steering in . . . . .	105	Flow-Through Ventilation System . . . . .	86
Drive, Four-Wheel (Service) . . . . .	170				

# Index

## Fluid

Automatic Transmission	167
Brake	174
Manual Transmission	168
Power Steering	173
Recommended	225
Windshield Washer	174
Folding Rear Seat	13
Foreign Countries, Fuels in	157
Foreign Material Paint Damage	194
Four-Wheel Drive	46
Four-Wheel Drive (Service)	170
Four-Wheel-Drive Vehicle, Off-Road Driving With Your Geo	108
Freeway Driving	120
Freewheeling Hubs	
Automatic	47
Manual	46
Front	
Ashtray	63
Axle	170
Seat	10
Seat Side Pockets	61
Seatbacks, Reclining	10
Towing Hook-ups	138
Fuel	156
Fuel Gage	69
Fuels in Foreign Countries	157
Fuse Block, Instrument Panel	198
Fuse Block, Main	198
Fuses and Circuit Breakers	196

## Gages

Engine Coolant Temperature	70
Fuel	69
Warning Lights and Indicators	68
Gasolines for Cleaner Air	157
Glass	191
Glove Box	60
GM Participation in BBB Auto Line – Alternative Dispute Resolution Program	235
Grips, Passenger Assist	62
Guidelines, Driving	107

## H

Halogen Bulbs	177
Hazard Warning Flashers	132
Head Restraints	11
Headlight High/Low Beam	56
Headlights	177
Heater Controls	84
Heater, Engine Coolant (Block)	41
Heating	84
Highway Hypnosis	121
Hill and Mountain Roads	121
Hill, Approaching a	110
Hitches	126
Hood Release	159
Hood, Checking Things under the	159
Hook-Ups, Front Towing	138
Hook-Ups, Rear Towing	139
Horn	53

How to Add Coolant to the Coolant Recovery Tank	142
How to Add Coolant to the Radiator	144
Hubs, Freewheeling	
Automatic	47
Manual	46
Hydroplaning	118
Hypnosis, Highway	121

## I

Identification Number, Vehicle	196
Identification, Engine	196
If a Tire Goes Flat	146
If You're Stuck: In Sand, Mud, Ice or Snow	153
Ignition Switch	39
Incline, Driving Across an	113
Incline, Stalling on an	114
Inflation – Tire Pressure	184
Inside Day/Night Rearview Mirror	59
Inside Rearview Mirror	59
Instrument Cluster	66
Instrument Panel	64
Instrument Panel Bins	61
Instrument Panel Fuse Block	198
Instrument Panel, Cleaning the Top of	191
Interior Lights	57
Jump Starting	133

<b>K</b> ey	36	Locks, Door	37	<b>N</b> ew Vehicle "Break-In"	39
<b>L</b> abel, Certification/Tire	181	Loss of Control	107	Night Driving	116
Label, Service Parts Identification	196	Lubricant		Night Vision	117
Lamp, Malfunction Indicator	71	Front Axle	170	Nuts, Wheel	202
Lane Change Indicator,		Rear Axle	169	<b>O</b> dometer, Speedometer and	66
Turn Signal and	54	Recommended	225	Odometer, Trip	67
Lap-Shoulder Belt (Safety Belts)	20	Transfer Case	170	Off-Road Driving	
Larger Children (Safety Belts)	32	<b>M</b> ain Fuse Block	198	After	116
Leaving Your Vehicle	37	Maintenance		Before You Go	108
Leaving Your Vehicle with the		Inspections, Periodic	223	Getting Familiar With	109
Engine Running	49	Record	228	Loading Your Vehicle for	108
Lighter, Ashtrays and	62	Schedule	203	On Hills	110
Lights		Services, Scheduled	206	With Your Geo Four-Wheel-Drive	108
Brake System Warning	69	Underbody	194	Vehicle	108
Bulb Replacement	177	When Trailer Towing	129	Off-Road Recovery	105
Charging System	70	Malfunction Indicator Lamp	71	Oil, Engine	162
Check Engine	71	Manual		Opening and Closing Your Rear	
Daytime Running	56	Adjust Mirrors, Outside	60	Window	75
Daytime Running Lights		Freewheeling Hubs	46	Opening and Closing Your	
Indicator	72	Transmission Fluid	168	Sunroof	74
Dome	57	Transmission, Five-Speed	44	Operation of Lights	55
Engine Oil Pressure	71	Windows	52	Outside Manual Adjust Mirrors	60
Gages and Indicators, Warning	68	Master Cylinder, Brake	174	Overheating, Engine	140
Interior	57	Mirrors		Owner Checks and Services	218
Malfunction Indicator Lamp	71	Convex Outside	59	<b>P</b> (Park) Shifting into	48
Operation of	55	Inside Day/Night Rearview	59	P (Park), Shifting out of	49
Safety Belt Reminder	19	Inside Rearview	59		
Lights On Reminder	55	Outside Manual Adjust	60		
Loading Your Vehicle	181	Mountain Roads, Hill and	121		



# Index

Paint	
Chemical Spotting	194
Finish Care	192
Finish Damage	194
Foreign Material	194
Parking	
Brake	48
On Hills (Trailer Towing)	128
Over Things That Burn	51
Your Vehicle	50
Parts, Replacement	200
Passenger Assist Grips	62
Passenger Positions (Safety Belts)	23
Rear Seat	24
Right Front	23
Passengers, Rear Seat (Safety Belts)	24
Passing	106
Passing Signal	56
Pedal Travel, Brake	176
Periodic Maintenance Inspections	223
Pockets, Front Seat Side	61
Power Steering	104
Power Steering Fluid	173
Pregnancy, Safety Belt Use during	23
Preparing Your Canvas Top for Storage	80
Pressure Cap, Radiator	172
Problems on the Road	131

Protecting Exterior Bright Metal Parts	192
Publications, Service	238
<b>Q</b> uestions Many People Ask about Safety Belts – and the Answers, Here are	18
<b>R</b> adiator Pressure Cap	172
Radiator, How to Add Coolant to the	144
Radio Reception, Understanding	97
Radio, To Play the	
AM/FM Stereo	88
AM/FM Stereo with Cassette Tape and Compact Disc Player	93
AM/FM Stereo with Cassette Tape Player	89
Rain, Driving in the	117
Rainy Weather Tips, Some Other	118
Rear	
Ashtray	63
Axle	169
Seat Passengers (Safety Belts)	33
Seat, Folding	13
Seat, Securing a Child Restraint in the	28
Swing-Out Side Windows	52
Towing Hook-Ups	139

Rear	
Window Defogger	86
Window Wiper/Washer	59
Window, Opening and Closing Your	75
Window, Removing and Installing Your	76
Rearview Mirror	
Inside	59
Inside Day/Night	59
Reclining Front Seatbacks	10
Recommended Fluids and Lubricants	225
Recovery Hooks, Using the	154
Recovery, Off-Road	105
Recreational Vehicle Towing	129
Release, Hood	159
Reminder Light, Safety Belt	19
Reminder, Lights On	55
Remote Areas, Traveling to	109
Removing and Installing Your Canvas Top	76
Removing and Installing Your Rear Window	76
Replacement	
Air Filter	166
Bulbs (Part Numbers)	199
Bulbs (Service)	177
Parts	200
Wheel	187
Wheels, Used	188

Replacing Brake System Parts . . . . .	176	Safety Belts		Securing a Child Restraint	
Replacing Safety Belts after		Extender . . . . .	33	Rear Seat . . . . .	28
a Crash . . . . .	34	How to Wear Properly . . . . .	19	Right Front Seat . . . . .	30
Reporting Safety Defects . . . . .	236	Lap-Shoulder . . . . .	20	Service . . . . .	156
Restraint Systems, Seats and . . . . .	9	Larger Children . . . . .	32	And Appearance Care . . . . .	155
Restraints		Questions People Ask . . . . .	18	Parts Identification Label . . . . .	196
Checking Your System . . . . .	33	Reminder Light . . . . .	19	Publications . . . . .	238
Child . . . . .	27	Replacing after a Crash . . . . .	34	Publications Ordering Information,	
Head . . . . .	11	Smaller Children and Babies . . . . .	26	Chevrolet/Geo . . . . .	240
Where to Put the . . . . .	27	They're for Everyone . . . . .	15	Work, Doing Your Own . . . . .	156
Right Front Passenger Position		Use during Pregnancy . . . . .	23	Setting the Clock . . . . .	88
(Safety Belts) . . . . .	23	Why They Work . . . . .	16	Sheet Metal Damage . . . . .	193
Right Front Seat, Securing a Child		Safety Chains . . . . .	127	Shift Speeds . . . . .	45
Restraint in the . . . . .	30	Safety Defects		Shifting into P (Park) . . . . .	48
Road, Problems on the . . . . .	131	Reporting to General Motors . . . . .	236	Shifting out of P (Park) . . . . .	49
Road, Your Driving and the . . . . .	99	Reporting to the Canadian		Skidding . . . . .	107
Roads, Hill and Mountain . . . . .	121	Government . . . . .	236	Smaller Children and Babies	
Roadside Assistance Program,		Reporting to the United States		(Safety Belts) . . . . .	26
Chevrolet/Geo . . . . .	237	Government . . . . .	236	Snow or Ice, Driving on . . . . .	123
Roadside Assistance, Canadian . . . . .	237	Safety Warnings and Symbols . . . . .	5	Speakers, Adjusting the	
Rocking Your Vehicle to Get		Scanning the Terrain . . . . .	109	AM/FM Stereo . . . . .	89
It Out . . . . .	154	Schedule, Maintenance . . . . .	203	AM/FM Stereo with Cassette Tape	
Rotation, Tire . . . . .	185	Scheduled Maintenance Services . . . . .	206	and Compact Disc Player . . . . .	94
Running Lights, Daytime . . . . .	56	Scheduled Maintenance Services,		AM/FM Stereo with Cassette Tape	
Running Your Engine while		Explanation of . . . . .	214	Player . . . . .	90
You're Parked . . . . .	51	Seats		Special Care for Canvas Top . . . . .	193
<b>S</b> afety Belts		And Restraint Systems . . . . .	9	Specifications, Capacities and . . . . .	200
Adults . . . . .	19	And Seat Controls . . . . .	10	Speedometer and Odometer . . . . .	66
Care of . . . . .	191	Easy Entry . . . . .	12	Stalling on an Incline . . . . .	114
Children . . . . .	26	Folding Rear . . . . .	13	Starting Your Engine . . . . .	40
		Seatback, Reclining Front . . . . .	10	Starting, Jump . . . . .	133

# Index

- Steam Coming from Your Engine . . . 140
- Steering . . . . . 104
- Column, Adjustable . . . . . 53
  - Fluid, Power . . . . . 173
  - In Emergencies . . . . . 105
  - Power . . . . . 104
  - Tips . . . . . 104
- Storage
- Compartments, Door . . . . . 60
  - Preparing Your Canvas Top for . . . 80
  - Vehicle . . . . . 176
- Stuck: In Sand, Mud, Ice or Snow . . 153
- Sun Visors . . . . . 61
- Sunroof, Opening and Closing
- Your . . . . . 74
- Switch, Ignition . . . . . 39
- Symbols, Safety Warnings and . . . . 5
- Symbols, Vehicle . . . . . 7
- T**achometer . . . . . 68
- Tailgate . . . . . 38
- Tank, Filling Your . . . . . 158
- Temperature Control Lever . . . . . 84
- Terrain, Scanning the . . . . . 109
- Theft . . . . . 39
- Theft Deterrent Feature
- AM/FM Stereo with Cassette Tape and Compact Disc Player . . . . . 96
  - AM/FM Stereo with Cassette Tape Player . . . . . 91
- Thermostat . . . . . 172
- Tips, Steering . . . . . 104
- Tips, Ventilation . . . . . 87
- Tires . . . . . 183
- Balance, Wheel Alignment and . . 187
  - Buying New . . . . . 186
  - Chains . . . . . 188
  - Changing a Flat . . . . . 146
  - Inflation Pressure . . . . . 184
  - Inspection and Rotation . . . . . 185
  - Loading . . . . . 181
  - Temperature Grades . . . . . 187
  - Traction Grades . . . . . 187
  - Treadwear . . . . . 186
  - Uniform Quality Grading . . . . . 186
  - When It's Time for New . . . . . 186
- Tone, Setting the
- AM/FM Stereo . . . . . 89
  - AM/FM Stereo with Cassette Tape and Compact Disc Player . . . . . 93
  - AM/FM Stereo with Cassette Tape Player . . . . . 90
- Top Strap (Child Restraints) . . . . . 28
- Top, Convertible . . . . . 72
- Torque Lock . . . . . 49
- Towing
- A Trailer . . . . . 125
  - Front Hook-Ups . . . . . 138
  - Rear Hook-Ups . . . . . 139
  - Recreational Vehicle . . . . . 129
  - Your Vehicle . . . . . 136
- Trailer Brakes . . . . . 127
- Trailer, Towing a . . . . . 125
- Transfer Case . . . . . 47
- Transfer Case (Service) . . . . . 170
- Transmission
- Automatic . . . . . 42
  - Fluid, Automatic . . . . . 167
  - Fluid, Manual . . . . . 168
  - Manual . . . . . 44
- Transportation, Courtesy . . . . . 237
- Traveling to Remote Areas . . . . . 109
- Trip Odometer . . . . . 67
- Trip, Before Leaving on a Long . . . . 120
- Turn Signal and Lane Change
- Indicator . . . . . 54
- Turn Signal/Lights Control/Headlight
- Beam Lever . . . . . 54
- U**nderbody Maintenance . . . . . 194
- Understanding Radio Reception . . . . 97
- Uniform Tire Quality Grading . . . . . 186
- Uphill, Driving . . . . . 111
- Used Oil, What to Do With . . . . . 165
- Used Replacement Wheels . . . . . 189
- Using the Recovery Hooks . . . . . 154
- V**ehicle
- Control of a . . . . . 102
  - Damage Warnings . . . . . 6
  - Dimensions . . . . . 202
  - Environment and Your . . . . . 204
  - Identification Number (VIN) . . . . 196

Vehicle		Weatherstrips	193
Leaving Your	37	Weight of the Trailer	126
Loading Your	181	Wheel Nut Torque	202
Off-Road-Driving With Your Geo		Wheels	
Four-Wheel-Drive	108	Alignment and Tire Balance	187
Parking Your	50	Aluminum	193
Rocking	154	Replacement	187
Storage	176	Used Replacement	188
Symbols	7	Where to Put the Restraint	
Towing Your	136	(Child Restraints)	27
Towing, Recreational	129	Why Safety Belts Work	16
Washing Your	192	Windows	52
Ventilation	85	Defogging and Defrosting	85
Ventilation System,		Manual	52
Flow-Through	86	Rear Swing-Out Side	52
Ventilation Tips	87	Rear Defogger	86
Vision, Night	117	Windshield	
Visors, Sun	61	Cleaning	192
<b>W</b> arning		Washers	58
Devices, Other	132	Washer Fluid	174
Hazard Flashers	132	Wiper/Washer Lever	57
Lights, Gages and Indicators	68	Winter Driving	122
Safety	5	Wiper/Washer, Rear Window	59
Vehicle Damage	6	Wiper/Washer Lever, Windshield	57
Washer Fluid, Windshield	174	Wipers, Windshield	57
Washers, Windshield	58	<b>Y</b> our Driving and the Road	99
Washing Your Vehicle	192		
Water, Driving in	115		
Water, Driving Through			
Deep Standing	41		

# Notes



# Notes





# Service Station Information

## **Cooling System Reservoir**

Check and add coolant only at the coolant recovery tank. The fluid should be at the "FULL" mark when the engine is warm. If the engine is cool, the level should be at the "LOW" mark or a little higher.  
See Page 170

## **Engine Oil Dipstick**

See Page 162

## **Engine Oil Fill Cap**

See Page 163

## **Cold Tire Pressure**

See Tire-Loading Information label on the inside of the rear edge of the driver's door.  
See Page 181

## **Spare Tire Pressure**

See Tire-Loading Information label on the inside of the rear edge of the driver's door.  
See Page 181

## **Hood Release**

See Page 159

## **Windshield Washer Fluid Reservoir**

See Page 174

## **Battery**

The Delco Freedom<sup>®</sup> battery needs no water. See Page 176

## **Fuel Cap**

Capacity 11 U.S. Gal. (42 L).  
Use unleaded gas only, 87 octane or higher.  
See Page 156

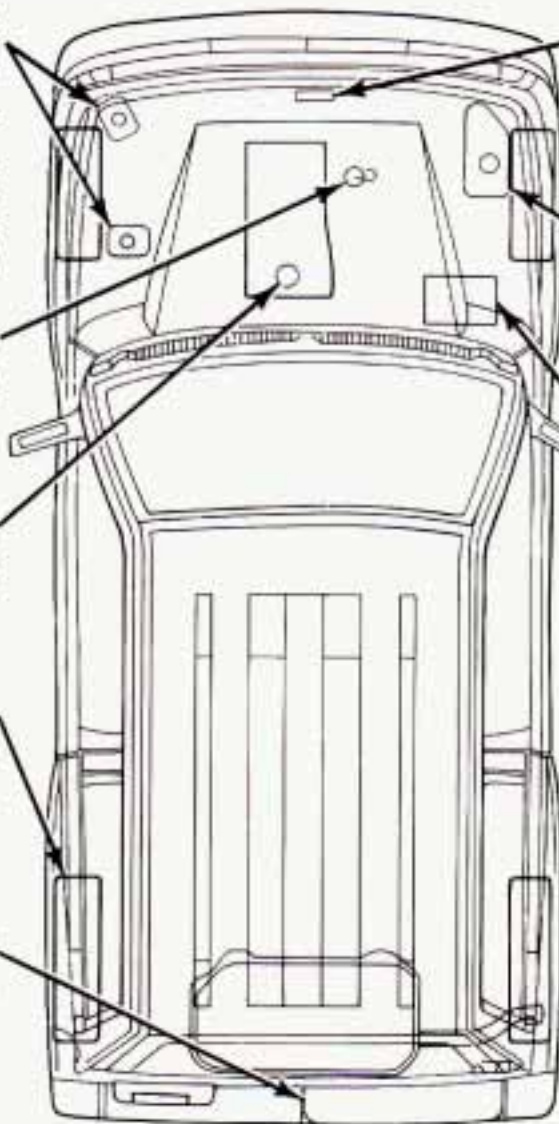



WE SUPPORT  
VOLUNTARY TECHNICIAN  
CERTIFICATION THROUGH  
National Institute for  
**AUTOMOTIVE  
SERVICE  
EXCELLENCE**

