

19

Owner's Manual

94

GMC

SONOMA

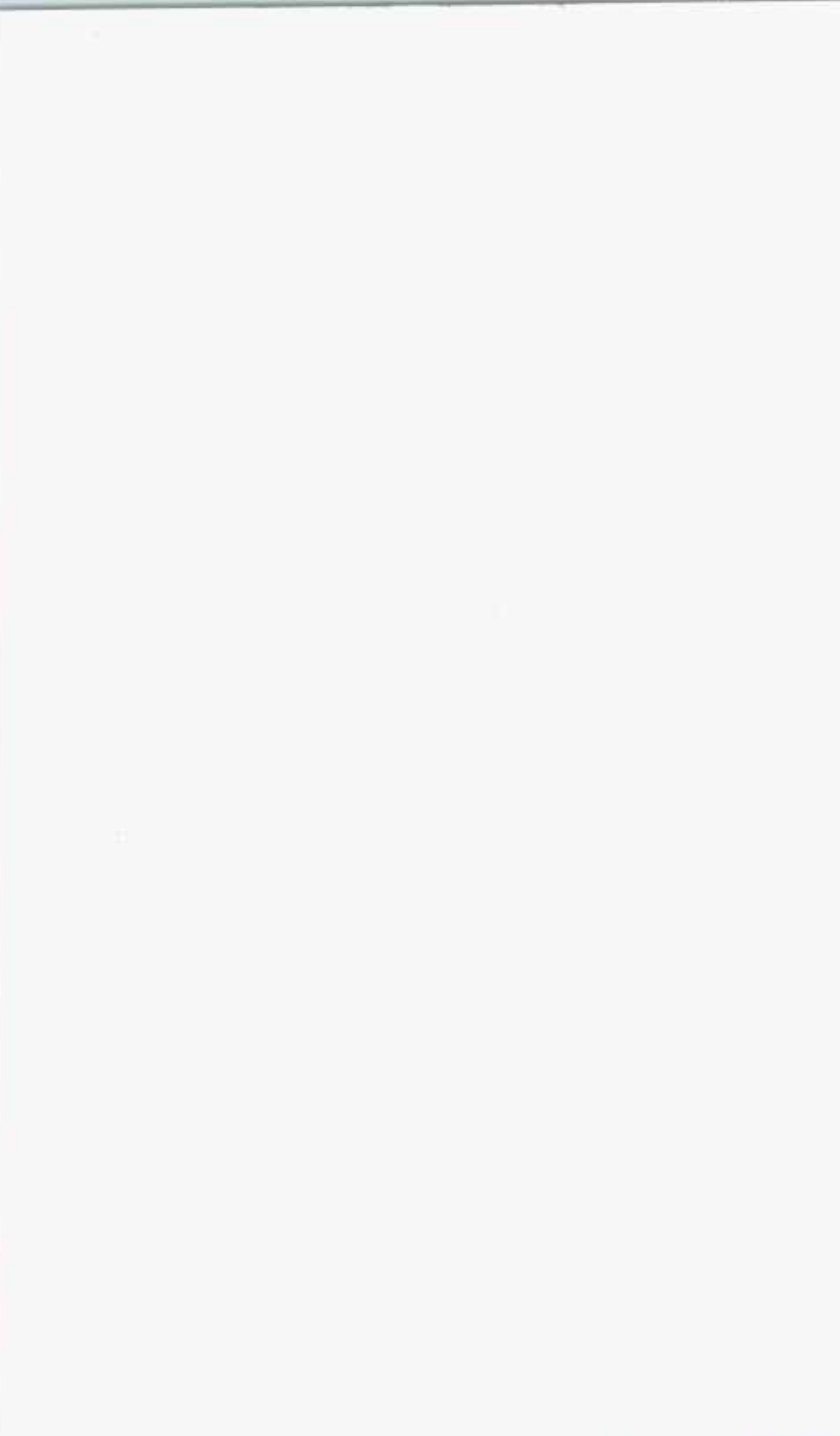

INTRODUCTION

1994 GMC Sonoma Owner's Manual

Welcome

This manual was prepared to acquaint you with the operation and maintenance of your 1994 GMC Sonoma and to provide important safety information. There is also a GMC Truck Warranty and Owner Assistance Information booklet. In some vehicles, there can be information manuals from other manufacturers like body builders or special equipment companies. We urge you to review all these publications carefully. This will help you enjoy safe and trouble-free operation of your vehicle.

When it comes to service, keep in mind that your GMC Truck dealer knows your vehicle best and is interested in your complete satisfaction. Your dealer invites you to return for all of your service needs both during and after the warranty period.

Remember, if you have a concern and need help handling it to your satisfaction, see the procedure in the GMC Truck Warranty and Owner Assistance Information booklet.

Thanks for choosing a GMC Truck product. We value you as a member of the GMC Truck family. We want to assure you of our continuing interest in your pleasure and satisfaction with your vehicle.

GMC Truck Division
General Motors Corporation
Pontiac, Michigan

© Copyright 1993 General Motors Corporation, GMC Truck Division.
All Rights Reserved

Second Edition

Printed in U.S.A.

Important Notes to Owners and Drivers

. . . .About This Manual:

Please keep this manual in your vehicle so it will be there if you ever need it when you're on the road. If you sell the vehicle, please leave this manual in it so the new owner can use it.

This manual includes the latest information at the time it was printed. We reserve the right to make changes in the product after that time without further notice. For vehicles first sold in Canada, substitute the name "General Motors of Canada Limited" for GMC Truck Division whenever it appears in this manual.

For Canadian Owners Who Prefer a French Language Manual:

Aux propriétaires canadiens: Vous pouvez vous procurer un exemplaire de ce guide en français chez votre concessionnaire ou au DGN Marketing Services Ltd., 1500 Bonhill Rd., Mississauga, Ontario L5T 1C7.



General Motors, GM and the GM Emblem, GMC and the GMC Emblem, and SONOMA are registered trademarks of General Motors Corporation.

Model Reference

This manual covers these models:

REGULAR CAB

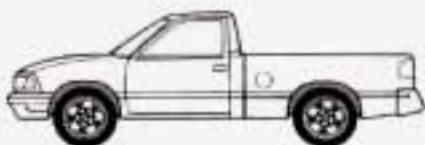

CLUB COUPE / EXTENDED CAB

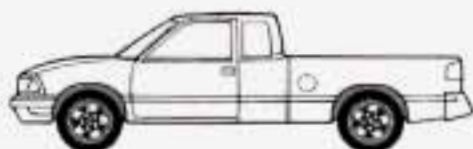

Table of Contents

Introduction — How to Use this Manual

This section tells you how to use your manual and includes safety and vehicle damage warnings and symbols.

Section 1 — Seats and Safety Restraints

This section tells you how to use your seats and safety restraints properly.

Section 2 — Features & Controls

This section explains how to start and operate your vehicle.

Section 3 — Comfort Controls & Audio Systems

This section tells you how to adjust the ventilation and comfort controls and how to operate your audio system.

Section 4 — Your Driving and the Road

Here you'll find helpful information and tips about the road and how to drive under different conditions.

Section 5 — Problems on the Road

This section tells you what to do if you have a problem while driving, such as a flat tire or engine overheating.

Section 6 — Service & Appearance Care

Here the manual tells you how to keep your vehicle running properly and looking good.

Section 7— Scheduled Maintenance Services

This section tells you when to perform vehicle maintenance and what fluids and lubricants to use.

Section 8 — Customer Assistance Information

This section tells you how to contact your GM division for assistance and how to get service publications. It also gives you information on "Reporting Safety Defects" on page 8-4.

Index

Here's an alphabetical listing of almost every subject in this manual. You can use it to quickly find something you want to read.

How to Use This Manual

Many people read their owner's manual from beginning to end when they first receive their new vehicle. This will help you learn about the features and controls for your vehicle. In this manual, you'll find that pictures and words work together to explain things quickly.

INDEX: A good place to look for what you need is the Index in back of the manual. It's an alphabetical list of all that's in the manual, and the page number where you'll find it.

SECTIONS 1–6: Each section of this manual begins with a brief list of its contents, so you can often find at a glance if a section contains the information you want.

SECTION 7: This section of the manual covers the maintenance required for your vehicle.

SECTION 8 CUSTOMER ASSISTANCE: This section includes important information about reporting safety defects and gives you details about the "Roadside Assistance" program. You will also find customer satisfaction phone numbers (including customer satisfaction numbers for the hearing and speech impaired) as well as the mediation/arbitration procedure. We've also included ordering information for service publications in this section.

Safety Warnings and Symbols

You will find a number of safety cautions in this book. We use a box with gray background and the word CAUTION to tell you about things that could hurt you if you were to ignore the warning.



CAUTION:

These mean there is something that could hurt you or other people.

In the gray caution area, we tell you what the hazard is. Then we tell you what to do to help avoid or reduce the hazard. Please read these cautions. If you don't, you or others could be hurt.

You will also find a circle with a slash through it in this book. This safety symbol means "Don't," "Don't do this," or "Don't let this happen."



Vehicle Damage Warnings

Also, in this book you will find these notices:

NOTICE:

These mean there is something that could damage your vehicle.

In the notice area, we tell you about something that can damage your vehicle. Many times, this damage would not be covered by your warranty, and it could be costly. But the notice will tell you what to do to help avoid the damage.

When you read other manuals, you might see CAUTION and NOTICE warnings in different colors or in different words.

You'll also see warning labels on your vehicle. They use yellow for cautions, blue for notices and the words CAUTION or NOTICE.

Vehicle Symbols

These are some of the symbols you will find on your vehicle. For example, these symbols are used on an original battery:



*Caution
Possible Injury*



*Protect Eyes
by Shielding*



*Caustic Battery Acid
Could Cause Burns*



*Spark or Flame Could
Explode Battery*



*Avoid Sparks
or Flames*

These symbols are important for you and your passengers whenever your vehicle is driven:



Fasten Safety Belts



Door Lock/Unlock

These symbols have to do with your lights:



Master Lighting Switch

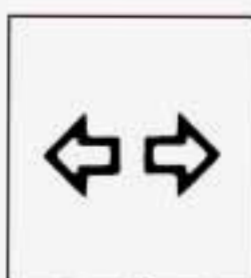

Turn Signal Direction



Hazard Warning Flasher



Headlight High Beam



Parking Lights

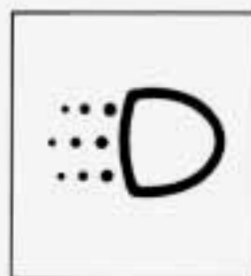

Daytime Running Lights



Fog Lights

These symbols are on some of your controls:



*Windshield
Washer*



*Windshield
Defroster*



*Windshield
Wiper*



Off

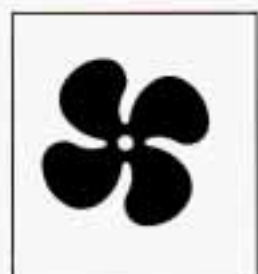

Ventilating Fan

These symbols are used on warning and indicator lights:



*Engine Coolant
Temperature*

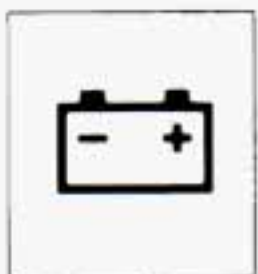

*Battery Charging
System*



Fuel



*Engine Oil
Pressure*



Brake



Shift Light

Here are some other symbols you may see:



Fuse



Hood Release



Lighter



Horn

Seats & Restraint Systems



Section

1

Here you'll find information about the seats in your vehicle and how to use your safety belts properly. You can also learn about some things you should **not** do with safety belts.

Seats and Seat Controls	1-2
Head Restraints	1-6
Safety Belts: They're for Everyone	1-7
Why Safety Belts Work	1-8
Questions Many People Ask About Safety Belts	1-11
How to Wear Safety Belts Properly	1-12
Adults	1-12
Driver Position	1-13
Lap-Shoulder Belt	1-13
Safety Belt Use During Pregnancy	1-19
Right Front Passenger Position	1-19
Center Passenger Position	1-20
Lap Belt	1-20
Rear Seat Passenger Positions	1-21
Children	1-23
Smaller Children and Babies	1-23
Child Restraints	1-25
Larger Children	1-30
Safety Belt Extender	1-33
Checking Your Restraint Systems	1-33
Replacing Safety Belts After a Crash	1-33

Seats and Seat Controls

This section tells you about the seats—how to adjust them, and fold them up and down.

Front Seat (Except Easy Entry)



CAUTION:

You can lose control of the vehicle if you try to adjust a manual driver's seat while the vehicle is moving. The sudden movement could startle and confuse you, or make you push a pedal when you don't want to. Adjust the driver's seat only when the vehicle is not moving.

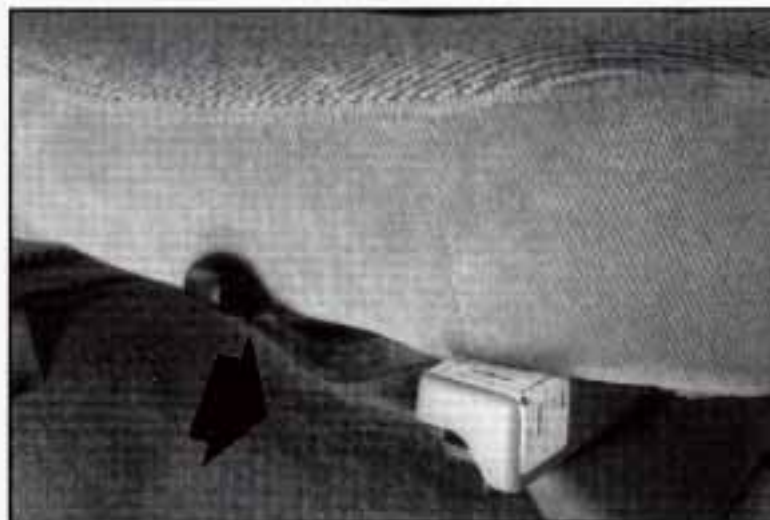

Move the lever under the front of the seat to your left to unlock it. Slide the seat to where you want it. Then release the lever and try to move the seat with your body to make sure the seat is locked into place.

Front Seat (Easy Entry Only)

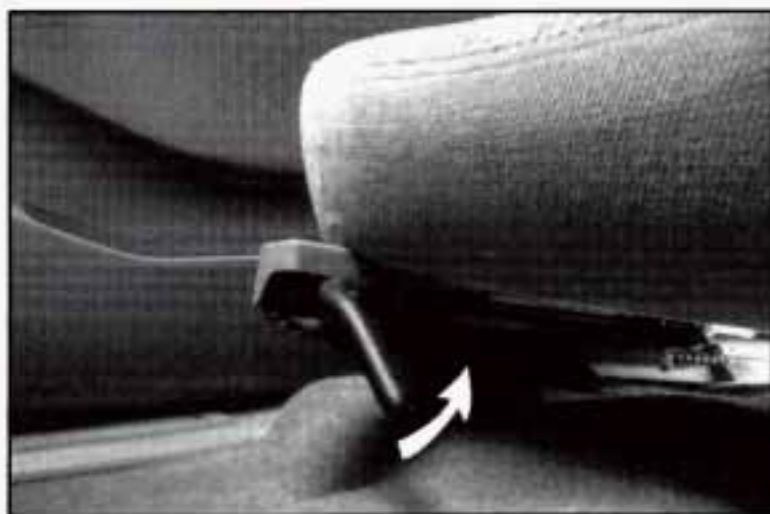

Move the lever under the front of the seat up to unlock it. Slide the seat to where you want it. Then release the lever and try to move the seat with your body to make sure the seat is locked into place.

Reclining Front Seatbacks (Bucket Seats or 60/40 Bench)

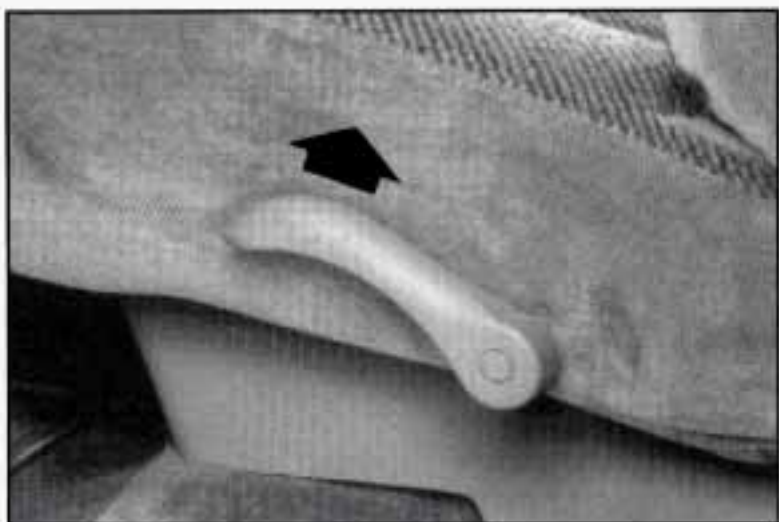

To adjust the seatback, lift the lever on the outer side of the seat. Release the lever to lock the seatback where you want it. Pull up on the lever and the seat will go to an upright position.

But don't have a seatback reclined if your vehicle is moving.

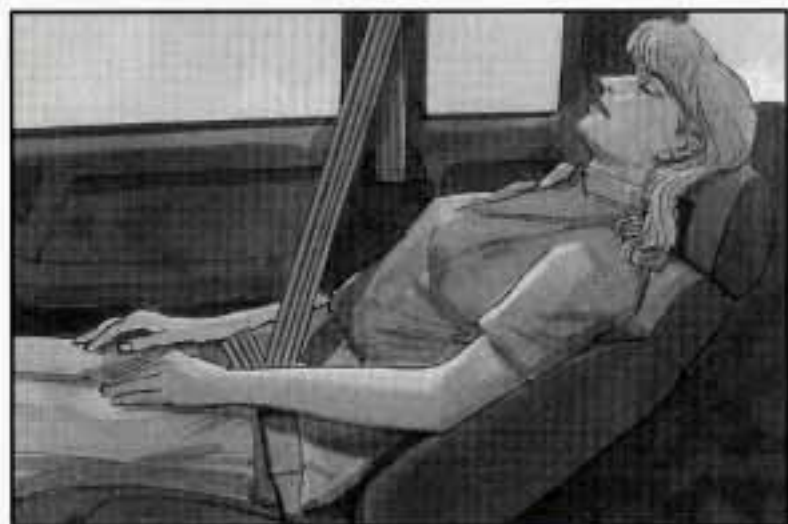

CAUTION:

Sitting in a reclined position when your vehicle is in motion can be dangerous. Even if you buckle up, your safety belts can't do their job when you're reclined like this.

The shoulder belt can't do its job because it won't be against your body. Instead, it will be in front of you. In a crash you could go into it, receiving neck or other injuries.

CAUTION: (Continued)

CAUTION: (Continued)

The lap belt can't do its job either. In a crash the belt could go up over your abdomen. The belt forces would be there, not at your pelvic bones. This could cause serious internal injuries.

For proper protection when the vehicle is in motion, have the seatback upright. Then sit well back in the seat and wear your safety belt properly.

Front Seatback Latches

The front seatback folds forward to let people get into the back seat or reach the storage area behind the seat. Your seatback will move back and forth freely, unless you come to a sudden stop. Then it will lock in place.

There's one time the seatback may not fold without some help from you. That's if your vehicle is parked going down a fairly steep hill.



To fold a front seatback forward, push the seatback toward the rear as you lift this latch. Then the seatback will fold forward. The latch must be down for the seat to work properly.

Easy Entry Seat (Extended Cab)



The right front bucket or split-bench seat of your vehicle makes it easy to get in and out of the rear vehicle area.

- When you tilt the right front seatback fully forward, the whole seat will slide forward.
- After someone gets into the rear seat area, move the right front seatback to its original position. Then move the seat rearward until it locks.



CAUTION:

If an easy entry right front seat isn't locked, it can move. In a sudden stop or crash, the person sitting there could be injured. After you've used it, be sure to push rearward on an easy entry seat to be sure it is locked.

- To get out, again tilt the seatback fully forward.

Jump Seat (Extended Cab Models)

STORED POSITION



FOLDED-DOWN POSITION



Your extended cab pickup has jump seats in the rear area. To fold the jump seat down, pull down on the handle on the bottom of the seat until the seat is in place, then move the seatback to a vertical position. To store the seat, fold the seatback down on the cushion, then push the entire seat up until it is flush with the trim panels.

Don't let the safety belts be damaged by the hinges or the latches. Safety belts should be folded and stored between the seat cushion and seatback.

Head Restraints



The head restraints in this vehicle are not adjustable.

Safety Belts: They're For Everyone

This part of the manual tells you how to use safety belts properly. It also tells you some things you should not do with safety belts.



CAUTION:

Don't let anyone ride where they can't wear a safety belt properly. If you are in a crash and you're not wearing a safety belt, your injuries can be *much* worse. You can hit things inside the vehicle or be ejected from it. You can be seriously injured or killed. In the same crash, you might not be if you are buckled up. Always fasten your safety belt, and check that your passengers' belts are fastened properly too.



This figure lights up as a reminder to buckle up. (See "Safety Belt Reminder Light" in the Index.)

In many states and Canadian provinces, the law says to wear safety belts. Here's why: *They work.*

You never know if you'll be in a crash. If you do have a crash, you don't know if it will be a bad one.

A few crashes are mild, and some crashes can be so serious that even buckled up a person wouldn't survive. But most crashes are in between. In many of them, people who buckle up can survive and sometimes walk away. Without belts they could have been badly hurt or killed.

After more than 25 years of safety belts in vehicles, the facts are clear. In most crashes buckling up does matter ... a lot!



Why Safety Belts Work

When you ride in or on anything, you go as fast as it goes.

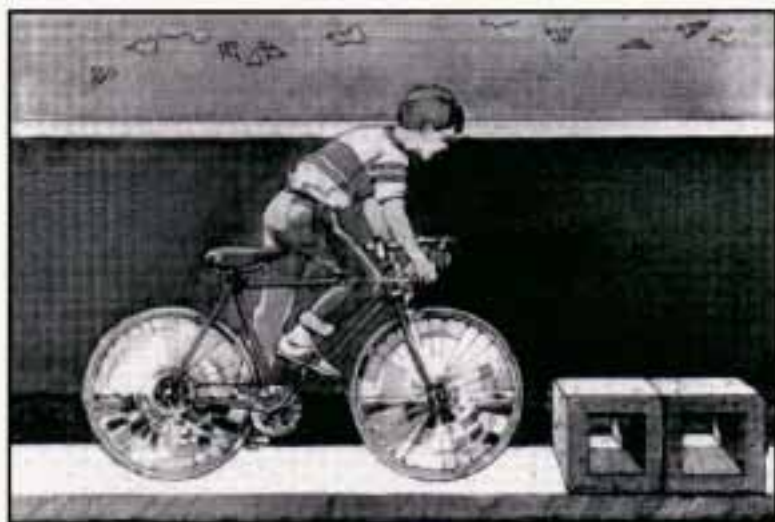

For example, if the bike is going 10 mph (16 km/h), so is the child.

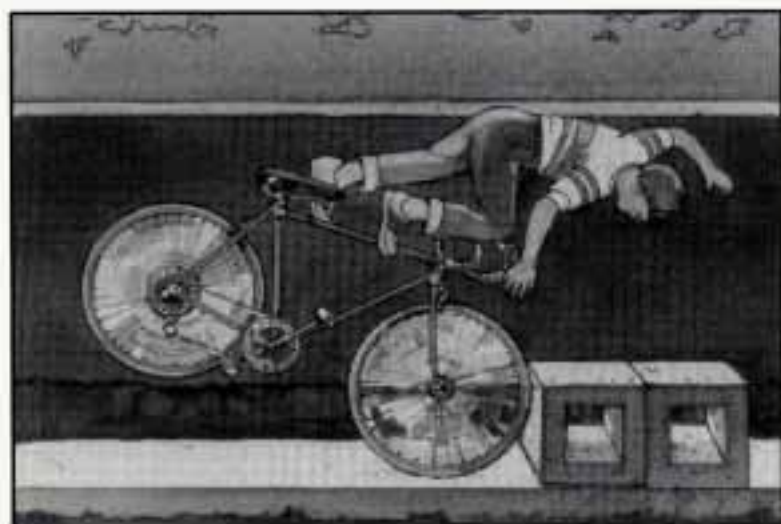

When the bike hits the block, it stops. But the child keeps going!

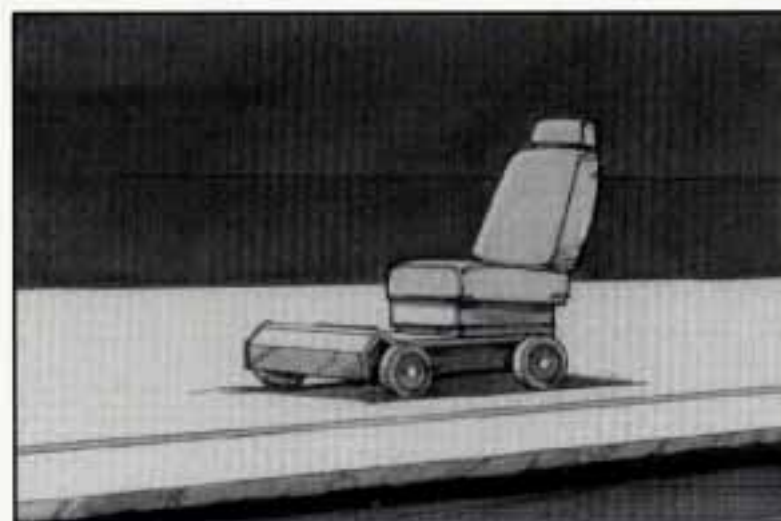

Take the simplest "vehicle." Suppose it's just a seat on wheels.

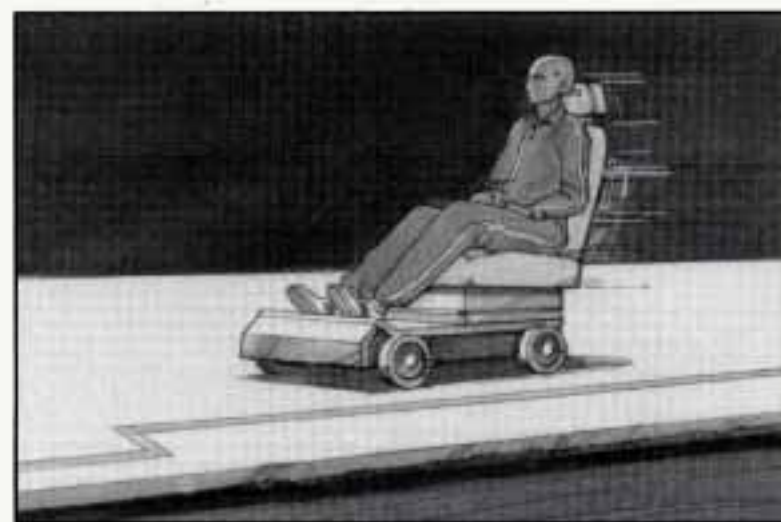

Put someone on it.

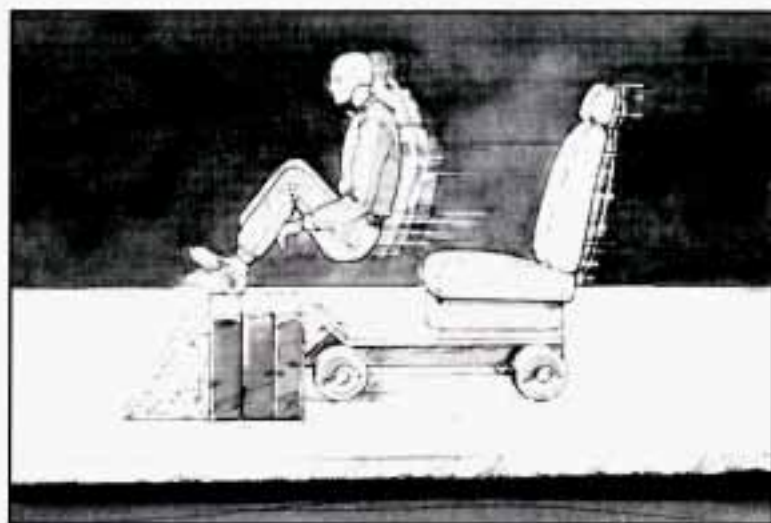

Get it up to speed.
Then stop the
“vehicle.” The rider
doesn’t stop.



The person keeps
going until stopped by
something.

In a real vehicle, it
could be the
windshield ...

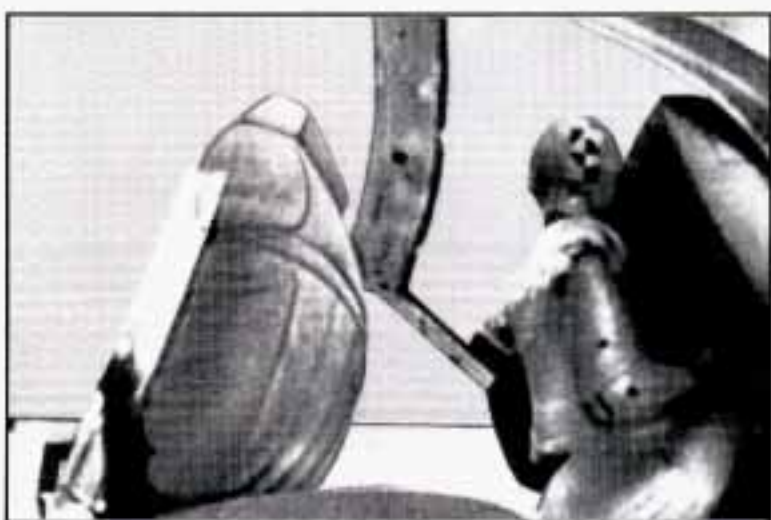

or the instrument
panel ...



or the safety belts!

With safety belts, you slow down as the vehicle does. You get more time to stop. You stop over more distance, and your strongest bones take the forces. That's why safety belts make such good sense.

Here Are Questions Many People Ask About Safety Belts — and the Answers

Q: *Won't I be trapped in the vehicle after an accident if I'm wearing a safety belt?*

A: You *could* be — whether you're wearing a safety belt or not. But you can easily unbuckle a safety belt, even if you're upside down. And your chance of being conscious during and after an accident, so you *can* unbuckle and get out, is *much* greater if you are belted.

Q: *Why don't they just put in air bags so people won't have to wear safety belts?*

A: Air bags are in some vehicles today and will be in more of them in the future. But they are supplemental systems only — so they work *with* safety belts, not instead of them. Every air bag system ever offered for sale has required the use of safety belts. Even if you're in a vehicle that has air bags, you still have to buckle up to get the most protection. That's true not only in frontal collisions, but especially in side and other collisions.

Q: *If I'm a good driver, and I never drive far from home, why should I wear safety belts?*

A: You may be an excellent driver, but if you're in an accident — even one that isn't your fault — you and your passengers can be hurt. Being a good driver doesn't protect you from things beyond your control, such as bad drivers.

Most accidents occur within 25 miles (40 km) of home. And the greatest number of serious injuries and deaths occur at speeds of less than 40 mph (65 km/h).

Safety belts are for everyone.

Safety Belt Reminder Light



When the key is turned to "Run" or "Start," a light will come on for about eight seconds to remind people to fasten their safety belts. Unless the driver's safety belt is already buckled, a tone will also sound.

How To Wear Safety Belts Properly

Adults

This section is only for people of adult size.

Be aware that there are special things to know about safety belts and children. And there are different rules for smaller children and babies. If a child will be riding in your vehicle, see the section after this one, called "Children." Follow those rules for everyone's protection.

First, you'll want to know which restraint systems your vehicle has.

We'll start with the driver position.

Driver Position

This section describes the driver's restraint system.

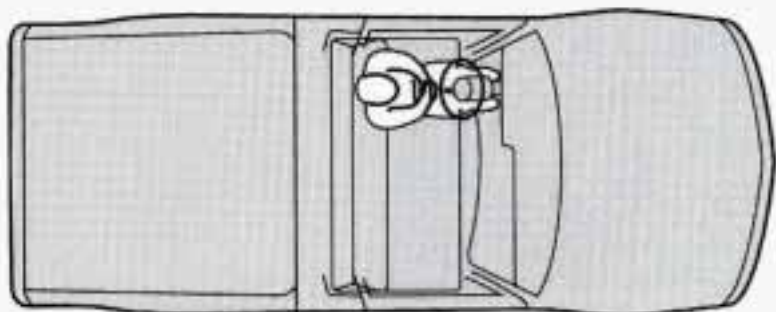

Lap–Shoulder Belt



The driver has a lap–shoulder belt. Here's how to wear it properly.

1. Close and lock the door.
2. Adjust the seat (to see how, see “Seats” in the Index) so you can sit up straight.



3. Pick up the latch plate and pull the belt across you. Don't let it get twisted.

4. Push the latch plate into the buckle until it clicks.

Pull up on the latch plate to make sure it is secure.

If the belt isn't long enough, see "Safety Belt Extender" at the end of this section.

Make sure the release button on the buckle is positioned so you would be able to unbuckle the safety belt quickly if you ever had to.



5. To make the lap part tight, pull down on the buckle end of the belt as you pull up on the shoulder belt.

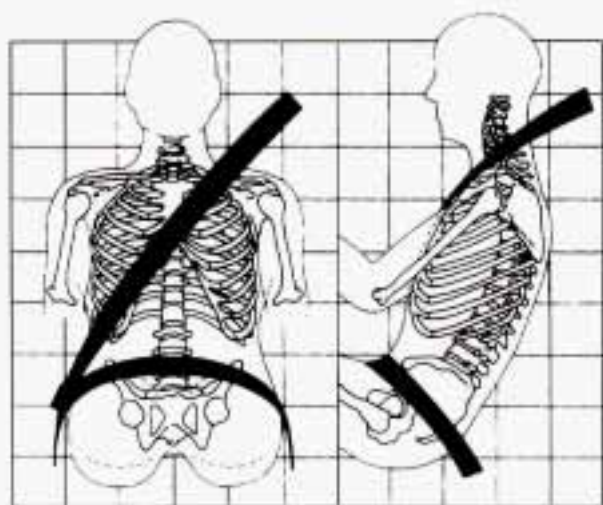

The lap part of the belt should be worn low and snug on the hips, just touching the thighs. In a crash, this applies force to the strong pelvic bones. And you'd be less likely to slide under the lap belt. If you slid under it, the belt would apply force at your abdomen. This could cause serious or even fatal injuries. The shoulder belt should go over the shoulder and across the chest. These parts of the body are best able to take belt restraining forces.

The safety belt locks if there's a sudden stop or a crash.

Q: What's wrong with this?

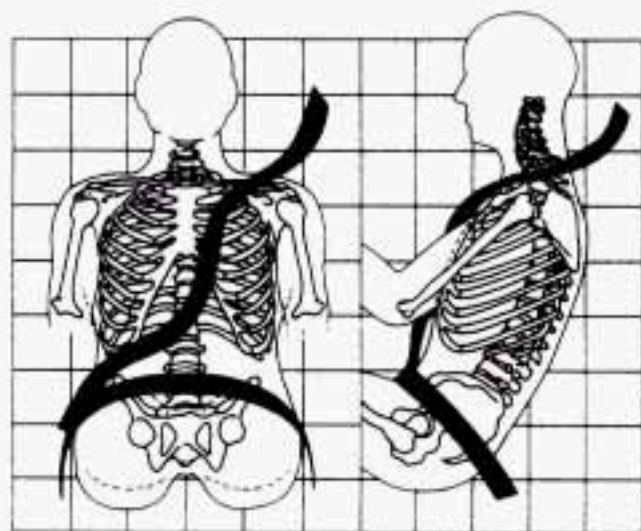

A: The shoulder belt is too loose. It won't give nearly as much protection this way.



CAUTION:

You can be seriously hurt if your shoulder belt is too loose. In a crash you would move forward too much, which could increase injury. The shoulder belt should fit against your body.

Q: What's wrong with this?

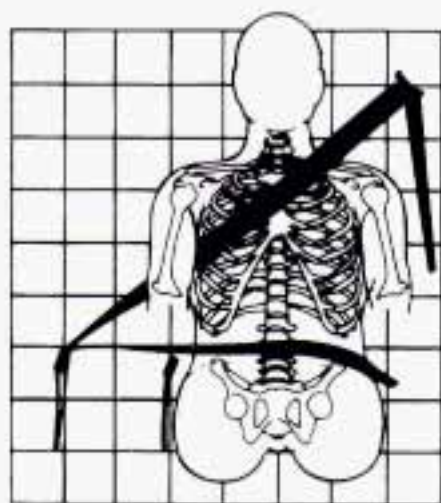

A: The belt is buckled in the wrong place.



CAUTION:

You can be seriously injured if your belt is buckled in the wrong place like this. In a crash, the belt would go up over your abdomen. The belt forces would be there, not at the pelvic bones. This could cause serious internal injuries. Always buckle your belt into the buckle nearest you.

Q: What's wrong with this?

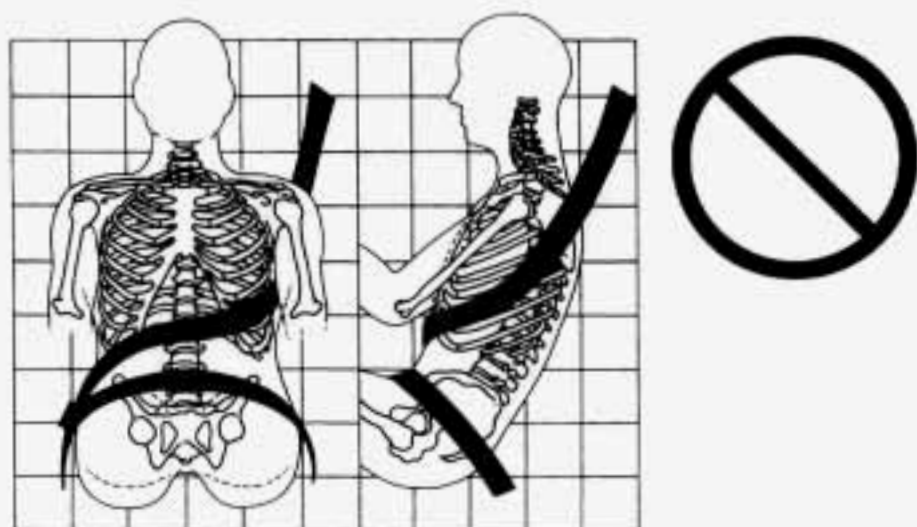

A: The shoulder belt is worn under the arm. It should be worn over the shoulder at all times.



CAUTION:

You can be seriously injured if you wear the shoulder belt under your arm. In a crash, your body would move too far forward, which would increase the chance of head and neck injury. Also, the belt would apply too much force to the ribs, which aren't as strong as shoulder bones. You could also severely injure internal organs like your liver or spleen.

Q: What's wrong with this?

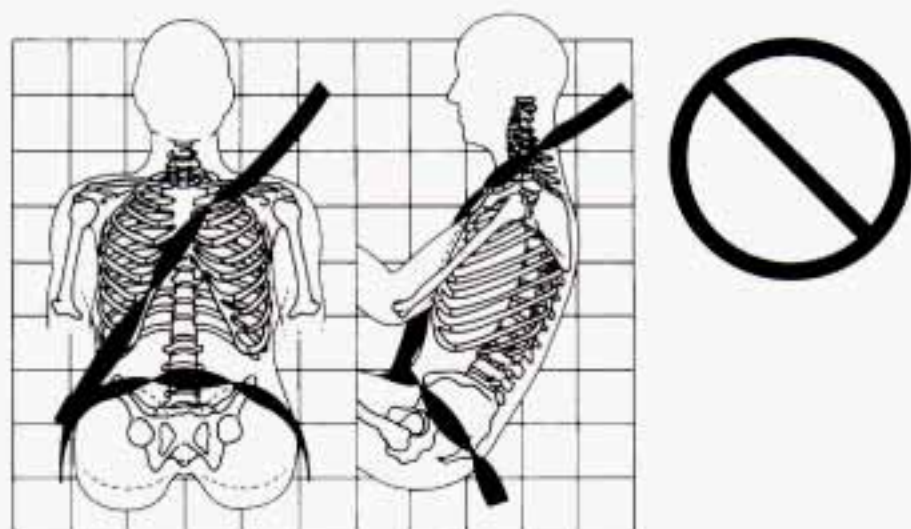

A: The belt is twisted across the body.

 **CAUTION:**

You can be seriously injured by a twisted belt. In a crash, you wouldn't have the full width of the belt to spread impact forces. If a belt is twisted, make it straight so it can work properly, or ask your dealer to fix it.



To unlatch the belt, just push the button on the buckle. The belt should go back out of the way.

Before you close the door, be sure the belt is out of the way. If you slam the door on it, you can damage both the belt and your vehicle.

Safety Belt Use During Pregnancy

Safety belts work for everyone, including pregnant women. Like all occupants, they are more likely to be seriously injured if they don't wear safety belts.

A pregnant woman should wear a lap-shoulder belt, and the lap portion should be worn as low as possible throughout the pregnancy.

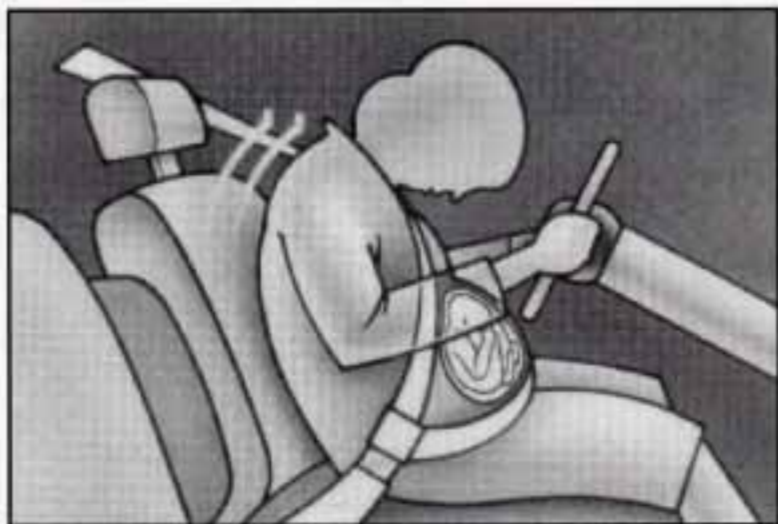

The best way to protect the fetus is to protect the mother. When a safety belt is worn properly, it's more likely that the fetus won't be hurt in a crash. For pregnant women, as for anyone, the key to making safety belts effective is wearing them properly.

Right Front Passenger Position

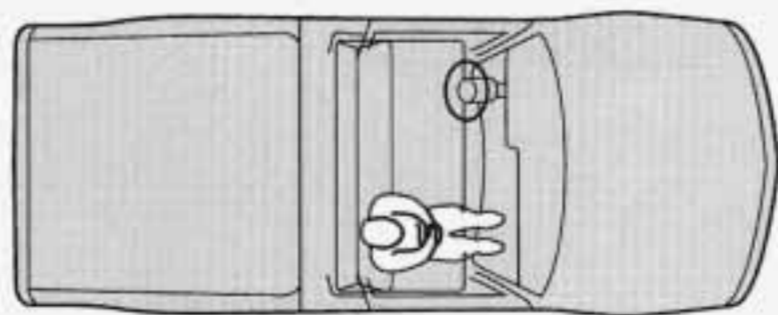

The right front passenger's safety belt works the same way as the driver's safety belt. See "Driver Position," earlier in this part.

When the shoulder belt is pulled out all the way, it will lock. If it does, let it go back all the way and start again.

Center Passenger Position (Bench Seat)

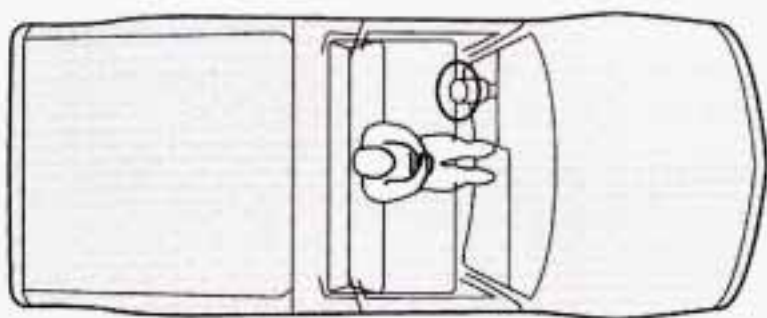

Lap Belt

If your vehicle has a bench seat, someone can sit in the center position.



When you sit in a center seating position, you have a lap safety belt, which has no retractor. To make the belt longer, tilt the latch plate and pull it along the belt.



To make the belt shorter, pull its free end as shown until the belt is snug.

Buckle, position and release it the same way as the lap part of a lap-shoulder belt. If the belt isn't long enough, see "Safety Belt Extender" at the end of this section.

Make sure the release button on the buckle is positioned so you would be able to unbuckle the safety belt quickly if you ever had to.

Rear Seat Passengers (Extended Cab Jump Seats)

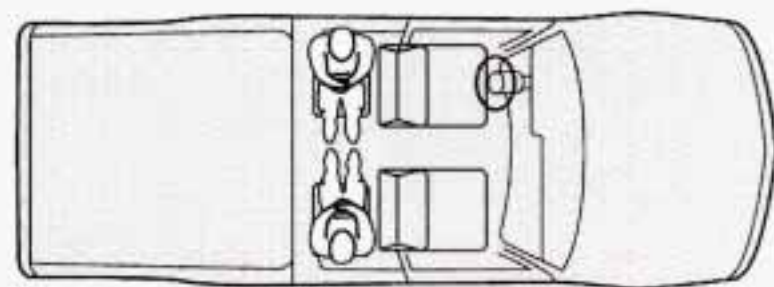

Lap Belt

These are reserve seating positions equipped with lap belts only.

It's very important for rear seat passengers to buckle up! Accident statistics show that unbelted people in the rear seat are hurt more often in crashes than those who are wearing safety belts.

Rear passengers who aren't safety belted can be thrown out of the vehicle in a crash. And they can strike others in the vehicle who are wearing safety belts.



Each jump seat has a lap belt with no retractor. To make the belt longer, tilt the latch plate a little and pull the belt.



To make it shorter, pull the belt as shown until it is snug.

Buckle, position and release it the same way as the lap part of the driver's safety belt (see "Driver Position" in the Index). Make sure the release button on the buckle is positioned so you would be able to unbuckle the safety belt quickly if you ever had to.

Don't use child restraints on these seats. They won't work properly.

Children



Everyone in a vehicle needs protection! That includes infants and all children smaller than adult size. In fact, the law in every state in the United States and in every Canadian province says children up to some age must be restrained while in a vehicle.

Smaller Children and Babies

CAUTION:

Smaller children and babies should always be restrained in a child or infant restraint. The instructions for the restraint will say whether it is the right type and size for your child. A very young child's hip bones are so small that a regular belt might not stay low on the hips, as it should. Instead, the belt will likely be over the child's abdomen. In a crash the belt would apply force right on the child's abdomen, which could cause serious or fatal injuries. So, be sure that any child small enough for one is always properly restrained in a child or infant restraint.



CAUTION:

Never hold a baby in your arms while riding in a vehicle. A baby doesn't weigh much — until a crash. During a crash a baby will become so heavy you can't hold it. For example, in a crash at only 25 mph (40 km/h), a 12-pound (5.5 kg) baby will suddenly become a 240-pound (110 kg) force on your arms. The baby would be almost impossible to hold.

Secure the baby in an infant restraint.

Child Restraints

Be sure to follow the instructions for the restraint. You may find these instructions on the restraint itself or in a booklet, or both. These restraints use the belt system in your vehicle, but the child also has to be secured within the restraint to help reduce the chance of personal injury. The instructions that come with the infant or child restraint will show you how to do that.

The child restraint must be secured properly in the center (except 60/40 bench seat) or right front passenger seat. If you have a 60/40 split bench seat, you must use the right front passenger seat.

Keep in mind that an unsecured child restraint can move around in a collision or sudden stop and injure people in the vehicle. Be sure to properly secure any child restraint in your vehicle — even when no child is in it.

Top Strap

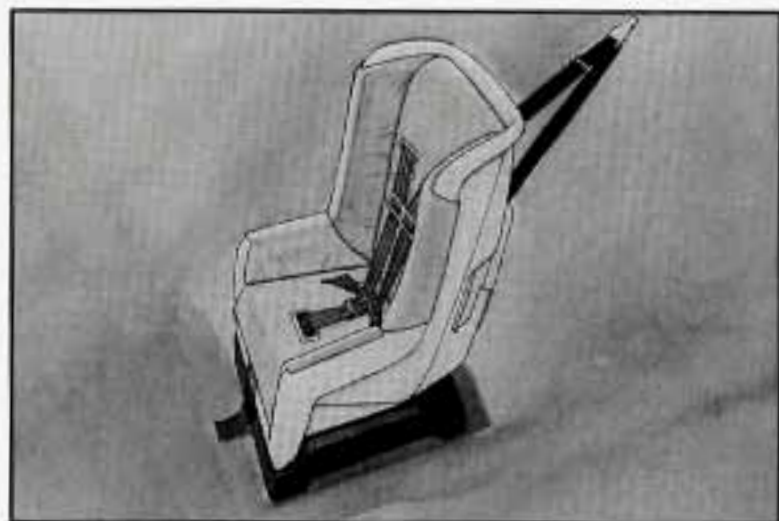

If your child restraint has a top strap, it should be anchored.

If you need to have an anchor installed, you can ask your vehicle dealer to put it in for you. If you want to install an anchor yourself, your dealer can tell you how to do it.

Securing a Child Restraint in the Center Front Seat Position (Bench Seat – Except 60/40 Bench Seat)

Don't use child restraints in the center position of a 60/40 bench seat.

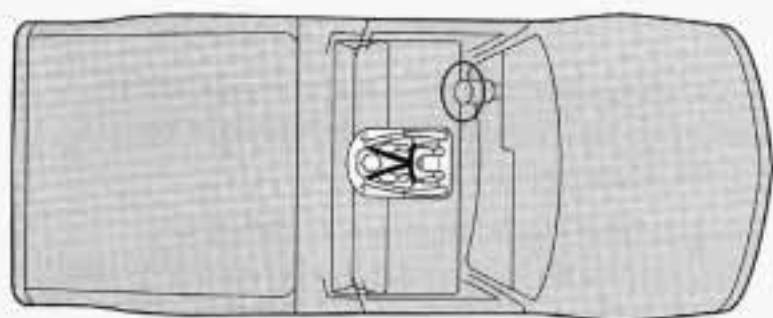

When you secure a child restraint in a center seating position, you'll be using the lap belt.

See the earlier section about the top strap if the child restraint has one.



1. Make the belt as long as possible by tilting the latch plate and pulling it along the belt.
2. Put the restraint on the seat. Follow the instructions for the child restraint.
3. Secure the child in the child restraint as the instructions say.
4. Run the vehicle's safety belt through or around the restraint. The child restraint instructions will show you how.



5. Buckle the belt. Make sure the release button is positioned so you would be able to unbuckle the safety belt quickly if you ever had to.

6. To tighten the belt, pull its free end while you push down on the child restraint.
7. Push and pull the child restraint in different directions to be sure it is secure. If the child restraint isn't secure, turn the latch plate over and buckle it again. Then see if it is secure. If it isn't, secure the restraint in a different place in the vehicle and contact the child restraint maker for their advice about how to attach the child restraint properly.

To remove the child restraint, just unbuckle the vehicle's safety belt. It will be ready to work for an adult or larger child passenger.

Jump Seats (Extended Cab)

Don't use child restraints in these positions. The restraints won't work properly.

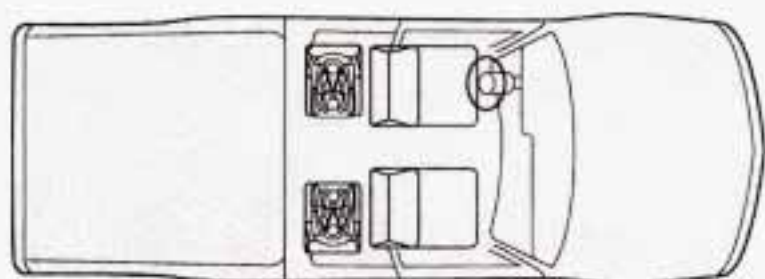

60/40 Split Bench Seats

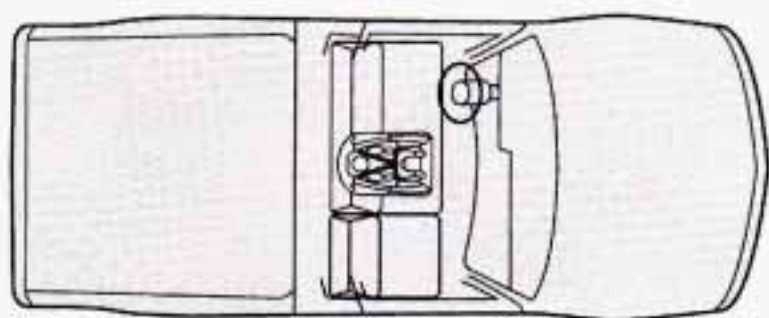

Don't use a child restraint in this position. The restraint won't work properly.

Securing a Child Restraint in the Right Front Seat Position

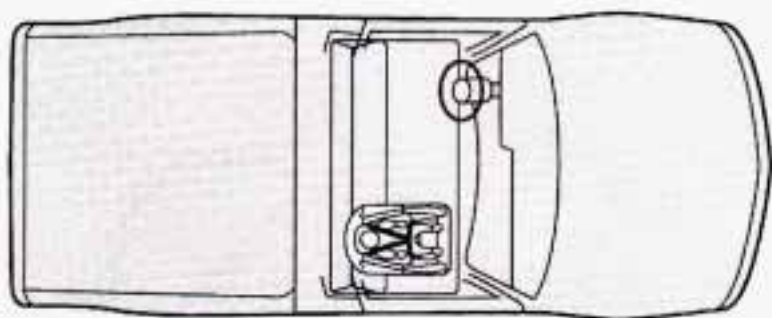

You'll be using the lap-shoulder belt. See the earlier section about the top strap if the child restraint has one.

1. Put the restraint on the seat. Follow the instructions for the child restraint.
2. Secure the child in the child restraint as the instructions say.
3. Pick up the latch plate, and run the lap and shoulder portions of the vehicle's safety belt through or around the restraint. The child restraint instructions will show you how.

If the shoulder belt goes in front of the child's face or neck, put it behind the child restraint.



4. Buckle the belt.

Make sure the release button is positioned so you would be able to unbuckle the safety belt quickly if you ever had to.



5. Pull the rest of the shoulder belt all the way out of the retractor to set the lock.

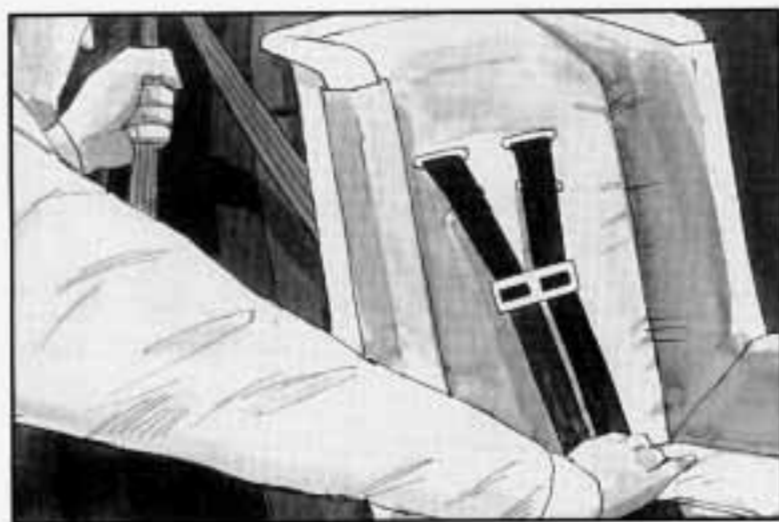

6. To tighten the belt, feed the shoulder belt back into the retractor while you push down on the child restraint.



7. Push and pull the child restraint in different directions to be sure it is secure.

To remove the child restraint, just unbuckle the vehicle's safety belt and let it go back all the way.

The safety belt will move freely again and be ready to work for an adult or larger child passenger.

Larger Children



Children who have outgrown child restraints should wear the vehicle's safety belts.

If you have the choice, a child should sit next to a window so the child can wear a lap-shoulder belt and get the additional restraint a shoulder belt can provide.

- Children who aren't buckled up can be thrown out in a crash.



- Children who aren't buckled up can strike other people who are.



 **CAUTION:**

Never do this.

Here two children are wearing the same belt. The belt can't properly spread the impact forces. In a crash, the two children can be crushed together and seriously injured. A belt must be used by only one person at a time.

Q: What if a child is wearing a lap–shoulder belt, but the child is so small that the shoulder belt is very close to the child’s face or neck?

A: Move the child toward the center of the vehicle, but be sure that the shoulder belt still is on the child’s shoulder, so that in a crash the child’s upper body would have the restraint that belts provide. If the child is so small that the shoulder belt is still very close to the child’s face or neck, you might want to place the child in a seat that has a lap belt, if your vehicle has one.



 **CAUTION:**

Never do this.

Here a child is sitting in a seat that has a lap–shoulder belt, but the shoulder part is behind the child. If the child wears the belt in this way, in a crash the child might slide under the belt. The belt’s force would then be applied right on the child’s abdomen. That could cause serious or fatal injuries.

Wherever the child sits, the lap portion of the belt should be worn low and snug on the hips, just touching the child’s thighs. This applies belt force to the child’s pelvic bones in a crash.

Safety Belt Extender

If the vehicle's safety belt will fasten around you, you should use it.

But if a safety belt isn't long enough to fasten, your dealer will order you an extender. It's free. When you go in to order it, take the heaviest coat you will wear, so the extender will be long enough for you. The extender will be just for you, and just for the seat in your vehicle that you choose. Don't let someone else use it, and use it only for the seat it is made to fit. To wear it, just attach it to the regular safety belt.

Checking Your Restraint Systems

Now and then, make sure all your belts, buckles, latch plates, retractors, anchorages and reminder systems are working properly. Look for any loose parts or damage. If you see anything that might keep a restraint system from doing its job, have it repaired.

Replacing Safety Belts After a Crash

If you've had a crash, do you need new belts?

After a very minor collision, nothing may be necessary. But if the belts were stretched, as they would be if worn during a more severe crash, then you need new belts.

If you ever see a label on the driver's safety belt that says to replace the belt, be sure to do so. Then the new belt will be there to help protect you in an accident. You would see this label on the belt near the door opening.



If belts are cut or damaged, replace them. Collision damage also may mean you will need to have safety belt or seat parts repaired or replaced. New parts and repairs may be necessary even if the belt wasn't being used at the time of the collision.

Q: What's wrong with this?

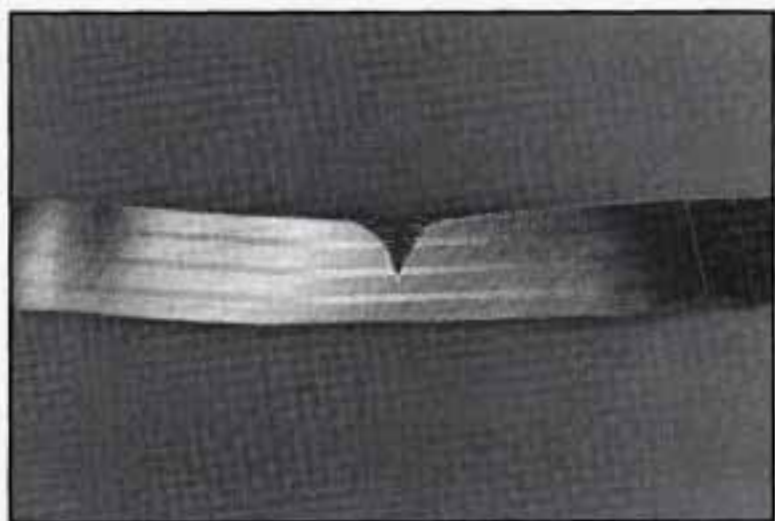

A: The belt is torn.

Torn or frayed belts may not protect you in a crash. They can rip apart under impact forces. If a belt is torn or frayed, get a new one right away.

Before replacing any safety belt, see your dealer for the correct part number. You'll need the model year and model number for your vehicle. The model year is on your title and registration. And you can find the model number on the Certification/Tire label of your vehicle. See "Certification/Tire Label" in the Index.



The model number on the replacement belt must be listed on the safety belt you want to replace.

Pull shoulder belt all the way out to see this label.

Features & Controls



Section

2

Here you can learn about the many standard and optional features on your vehicle, and information on starting, shifting, and braking. Also explained are the instrument panel and the warning systems that tell you if everything is working properly—and what to do if you have a problem.

For explanation of vehicle symbols, refer to “Vehicle Symbols” in the Introduction.

Keys	2-3
Your Doors and How They Work	2-5
Side Doors	2-5
Door Locks	2-6
Tailgate	2-7
Theft	2-8
New Vehicle Break-In	2-9
Ignition Switch	2-10
Starting Your Engine	2-12
Driving Through Deep Standing Water	2-14
Automatic Transmission	2-16
Five-Speed Manual Transmission	2-19
Locking Rear Axle	2-21
Parking Brake	2-21
Parking Over Things That Burn	2-24
Engine Exhaust	2-25
Running Your Engine While You're Parked	2-26

Four-Wheel Drive	2-27
Manual Transfer Case	2-27
Electronic Transfer Case	2-29
Windows	2-31
Horn	2-33
Tilt Wheel	2-33
Turn Signal/Multifunction Lever	2-34
Turn Signal and Lane Change Indicator	2-34
Headlight High-Low Beam	2-36
Windshield Wipers	2-36
Windshield Washer	2-37
Cruise Control	2-39
Lights	2-45
Mirrors	2-48
Accessory Power Outlets	2-51
Cigarette Lighter/Ashtray	2-52
Storage Compartments	2-53
Instrument Cluster	2-55
Warning Lights, Gages and Indicators	2-58
Center High Mounted Stop Lamp (CHMSL) Feed Wire	2-67
Trailer Wiring Harness	2-68

Keys

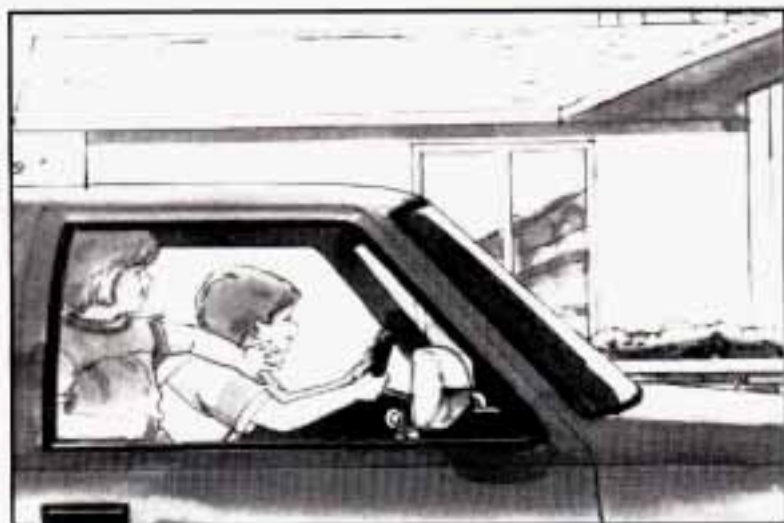

CAUTION:

Leaving young children in a vehicle with the ignition key is dangerous for many reasons. A child or others could be badly injured or even killed.

They could operate power windows or other controls or even make the vehicle move. Don't leave the keys in a vehicle with young children.

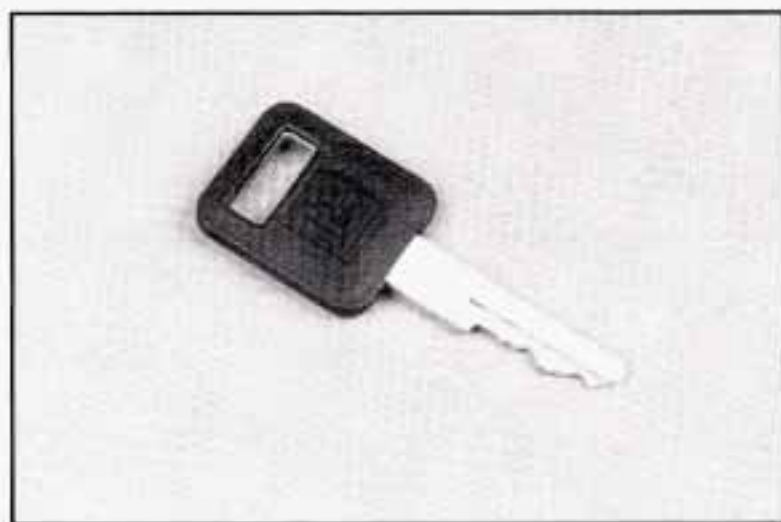

The square-shaped key is for the ignition only.



The oval-shaped key is for the doors and all other locks.

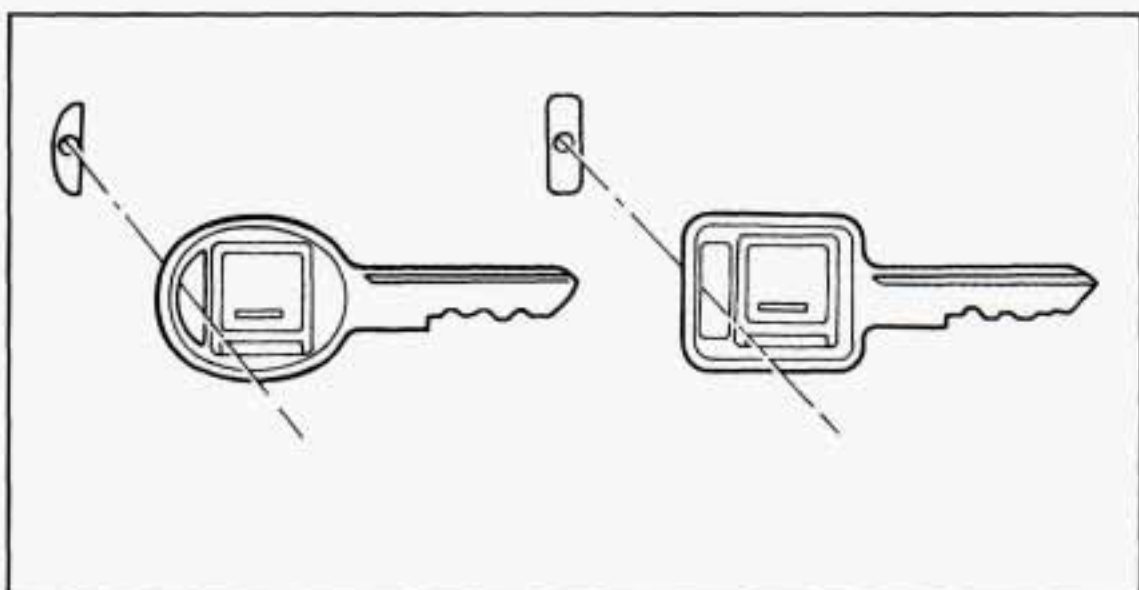

When a new vehicle is delivered, the dealer removes the plugs from the keys, and gives them to the first owner.

Each plug has a code on it that tells your dealer or a qualified locksmith how to make extra keys. Keep the plugs in a safe place. If you lose your keys, you'll be able to have new ones made easily using these plugs.

NOTICE:

Your vehicle has a number of new features that can help prevent theft. But you can have a lot of trouble getting into your vehicle if you ever lock your keys inside. You may even have to damage your vehicle to get in. So be sure you have extra keys.

Your Doors And How They Work

Side Doors



To open the door from the outside, lift the handle and pull the door open.



To open the door from the inside, pull the lever toward you and push the door open.

Door Locks

CAUTION:

Unlocked doors can be dangerous.

Passengers — especially children — can easily open the doors and fall out. When a door is locked, the inside handle won't open it.

Outsiders can easily enter through an unlocked door when you slow down or stop your vehicle.

This may not be so obvious: You increase the chance of being thrown out of the vehicle in a crash if the doors aren't locked. Wear safety belts properly, lock your doors, and you will be far better off whenever you drive your vehicle.

There are several ways to lock and unlock your vehicle:



From the outside: Use your door key.



From the inside: To lock the door, slide the lever on your inside door to **LOCK**.

To unlock the door, slide the lever on your inside door toward you. You will see a red area on the lever.

Power Door Locks



If your vehicle has power door locks, push **LOCK** on the power door lock switch on either front door. This switch will lock all the doors at once.

To unlock the doors, push on the raised area next to the key symbol.

Leaving Your Vehicle

If you are leaving the vehicle, take your keys, open your door and set the locks from inside. Then get out and close the door.

Tailgate



You can open the tailgate by pulling up on the handle while pulling the tailgate down.

When you put the tailgate back up, be sure it latches securely.

Tailgate Removal



1. Raise the tailgate slightly and remove both retaining cables.



2. Lift the tailgate at the right side and pull it out at the left side.

Reverse the procedure to reinstall. Make sure the tailgate is secure.

Theft

Vehicle theft is big business, especially in some cities. Although your vehicle has a number of theft deterrent features, we know that nothing we put on it can make it impossible to steal. However, there are ways you can help.

Key in the Ignition

If you walk away from your vehicle with the keys inside, it's an easy target for joy riders or professional thieves — so don't do it.

When you park your vehicle and open the driver's door, you'll hear a chime reminding you to remove your key from the ignition and take it with you. Always do this. Your steering wheel will be locked, and so will your ignition. If you have an automatic transmission, taking your key out also locks your transmission. And remember to lock the doors.

Parking at Night

Park in a lighted spot, close all windows and lock your vehicle. Remember to keep your valuables out of sight. Put them in a storage area, or take them with you.

Parking Lots

If you park in a lot where someone will be watching your vehicle, it's best to lock it up and take your keys. But what if you have to leave your ignition key? What if you have to leave something valuable in your vehicle?

- Put your valuables in a storage area, like your glove box.
- Lock all the doors except the driver's.
- Then take the door key with you.

New Vehicle "Break-In"

NOTICE:

Your modern vehicle doesn't need an elaborate "break-in." But it will perform better in the long run if you follow these guidelines:

- Keep your speed at 55 mph (88 km/h) or less for the first 500 miles (804 km).
- Don't drive at any one speed — fast or slow — for the first 500 miles (804 km). Don't make full-throttle starts.
- Avoid making hard stops for the first 200 miles (322 km) or so. During this time your new brake linings aren't yet broken in. Hard stops with new linings can mean premature wear and earlier replacement. Follow this "breaking-in" guideline every time you get new brake linings.

Ignition Switch

Use your ignition key to start your vehicle. The ignition key lets you turn the ignition switch to five different positions.

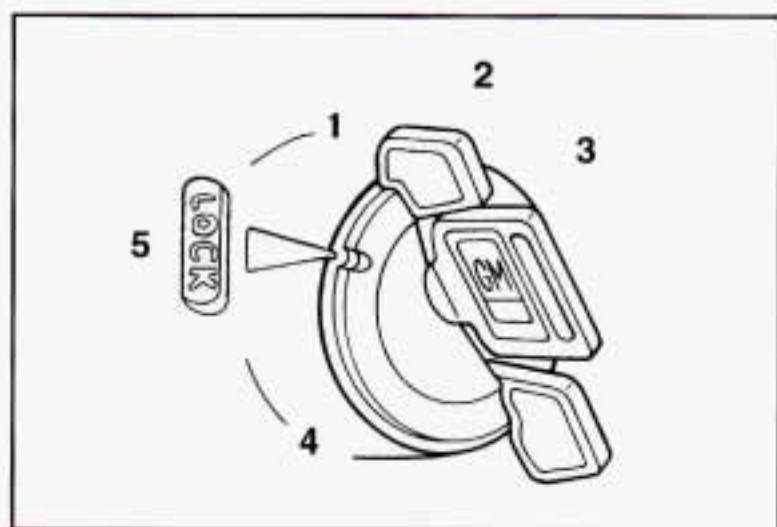

1. OFF
2. RUN
3. START
4. ACC
5. LOCK

ACC (Accessory): ACC lets you use things like the radio and the windshield wipers when the engine is off. To get into ACC, push in the key and turn it toward you. Your steering wheel will remain locked, just as it was before you inserted the key.

NOTICE:

Prolonged operation of accessories in the ACC position could drain your battery and prevent you from starting your vehicle.

LOCK: This position locks your ignition, steering wheel and transmission. It's a theft deterrent feature. You will only be able to remove your key when the ignition is turned to **LOCK**.

OFF: This position lets you turn off the engine but still turn the steering wheel. Use **OFF** if you must have your vehicle in motion while the engine is off (for example, if your vehicle is being pushed).

RUN: This is the position for driving.

START: This starts your engine.



CAUTION:

On manual transmission vehicles, turning the key to “Lock” will lock the steering column and result in a loss of ability to steer the vehicle. This could cause a collision. If you need to turn the engine off while the vehicle is moving, turn the key only to “Off.” Don’t move the key release lever while the vehicle is moving.

NOTICE:

If your key seems stuck in “Lock” and you can’t turn it, be sure it is all the way in. If it is, then turn the steering wheel left and right while you turn the key hard. But turn the key only with your hand. Using a tool to force it could break the key or the ignition switch. If none of this works, then your vehicle needs service.

Key Release Lever

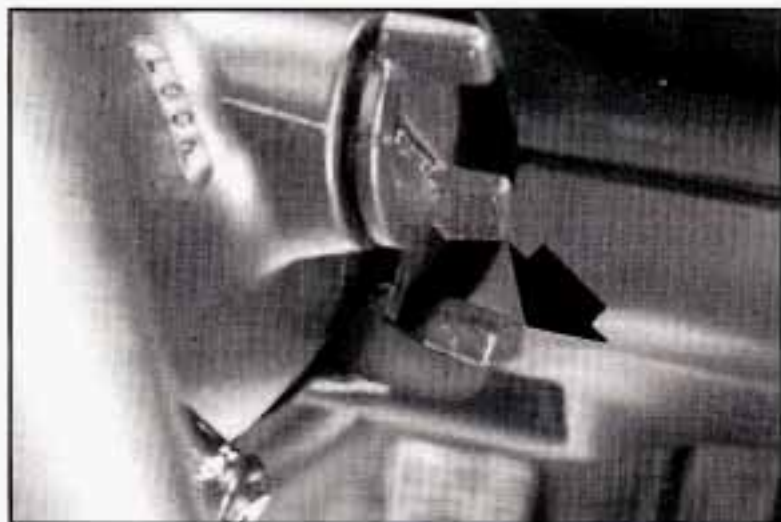

The ignition key cannot be removed from the ignition of manual transmission vehicles unless the key release lever is used.

To Remove the Key

Turn the key to the **LOCK** position while pressing the key release lever down at the same time. Keeping your finger on the lever, pull the key straight out.

On automatic transmission vehicles, turn the key to **LOCK** and pull it straight out.

Starting Your Engine

Engines start differently. The 8th digit of your Vehicle Identification Number (VIN) shows the code letter or number for your engine. You will find the VIN at the top left of your instrument panel. (See “Vehicle Identification Number” in the Index.) Follow the proper steps to start the engine.

Automatic transmission:

Move your shift lever to “P” (Park) or “N” (Neutral). Your engine won’t start in any other position — that’s a safety feature. To restart when you’re already moving, use “N” (Neutral) only.

NOTICE:

Don’t try to shift to “P” (Park) if your vehicle is moving. If you do, you could damage the transmission. Shift to “P” (Park) only when your vehicle is stopped.

Manual transmission:

Hold the clutch pedal to the floor, then shift your gear selector to neutral while starting the engine. Your vehicle won’t start if the clutch pedal is not all the way down — that’s a safety feature.

To start your 2.2 Liter engine:

1. Without pushing the accelerator pedal, turn your ignition key to “Start.” When the engine starts, let go of the key. The idle speed will go down as your engine gets warm.

NOTICE:

Holding your key in “Start” for longer than 15 seconds at a time will cause your battery to be drained much sooner. And the excessive heat can damage your starter motor.

2. If your engine still won’t start (or starts but then stops), it could be flooded with too much gasoline. Try pushing your accelerator pedal all the way to the floor and holding it there as you hold the key in “Start” for about three seconds. If the vehicle starts briefly but then stops again, do the same thing, but this time keep the pedal down for five or six seconds. This clears the extra gasoline from the engine.

NOTICE:

Your engine is designed to work with the electronics in your vehicle. If you add electrical parts or accessories, you could change the way the fuel injection system operates. Before adding electrical equipment, check with your dealer. If you don't, your engine might not perform properly.

If you ever have to have your vehicle towed, see the part of this manual that tells how to do it without damaging your vehicle. See "Towing Your Vehicle" in the Index.

To start your 4.3 Liter engine:

1. Without pushing the accelerator pedal, turn your ignition key to "Start." When the engine starts, let go of the key. The idle speed will go down as your engine gets warm.

NOTICE:

Holding your key in "Start" for longer than 15 seconds at a time will cause your battery to be drained much sooner. And the excessive heat can damage your starter motor.

2. If it doesn't start right away, hold your key in "Start." If it doesn't start in three seconds, push the accelerator pedal about one-quarter of the way down for 12 more seconds, or until it starts.
3. If your engine still won't start (or starts but then stops), it could be flooded with too much gasoline. Try this:

Wait 15 seconds to let the starter motor cool down. Then push your accelerator pedal all the way to the floor. Hold it there. Then, hold the key in "Start" for no more than ten seconds. This clears the extra gasoline from the engine.

If the engine still doesn't start, wait another 15 seconds and do it all again.

When the engine starts, let go of the key and the accelerator pedal.

NOTICE:

Your engine is designed to work with the electronics in your vehicle. If you add electrical parts or accessories, you could change the way the fuel injection system operates. Before adding electrical equipment, check with your dealer. If you don't, your engine might not perform properly.

If you ever have to have your vehicle towed, see the part of this manual that tells how to do it without damaging your vehicle. See "Towing Your Vehicle" in the Index.

Driving Through Deep Standing Water

NOTICE:

If you drive too quickly through deep puddles or standing water, water can come in through your engine's air intake and badly damage your engine. If you can't avoid deep puddles or standing water, drive through them very slowly.

Engine Coolant Heater (Engine Block Heater) (Option)

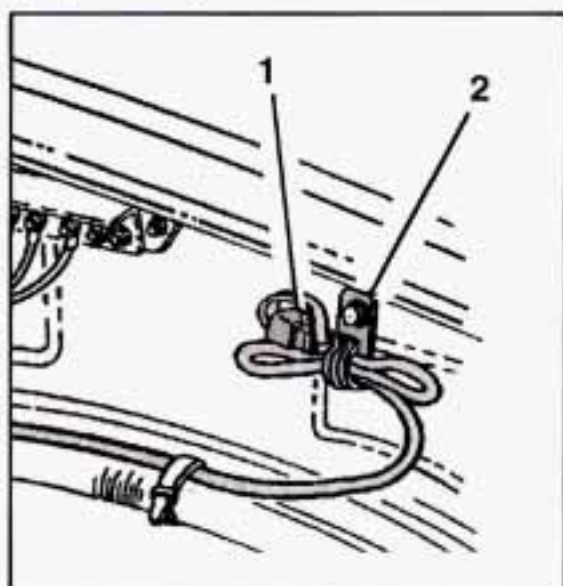

2.2 Liter

1. Engine coolant heater cord cap
2. Engine coolant heater cord clip

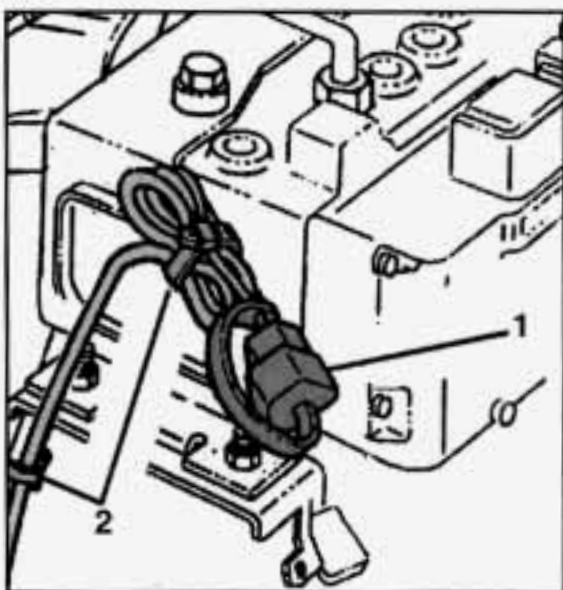

4.3 Liter

1. Engine coolant heater cord cap
2. Engine coolant heater cord strap

In very cold weather, 0°F (-18°C) or colder, the engine coolant heater can help. You'll get easier starting and better fuel economy during engine warm-up. Usually, the coolant heater should be plugged in a minimum of four hours prior to starting your vehicle.

To use the coolant heater:

1. Turn off the engine.
2. Open the hood and unwrap the electrical cord.
3. Plug it into a normal, grounded 110-volt outlet.



CAUTION:

Plugging the cord into an ungrounded outlet could cause an electrical shock. Also, the wrong kind of extension cord could overheat and cause a fire. You could be seriously injured. Plug the cord into a properly grounded three-prong 110-volt outlet. If the cord won't reach, use a heavy-duty three-prong extension cord rated for at least 15 amps.

NOTICE:

After you've used the coolant heater, be sure to store the cord as it was before to keep it away from moving engine parts. If you don't, it could be damaged.

How long should you keep the coolant heater plugged in? The answer depends on the weather, the kind of oil you have, and some other things. Instead of trying to list everything here, we ask that you contact a GM dealer in the area where you'll be parking your vehicle. The dealer can give you the best advice for that particular area.

Automatic Transmission



There are several different positions for your shift lever.

- **P (Park)**

This locks your rear wheels. It's the best position to use when you start your engine because your vehicle can't move easily.



CAUTION:

It is dangerous to get out of your vehicle if the shift lever is not fully in "P" (Park) with the parking brake firmly set. Your vehicle can roll.

Don't leave your vehicle when the engine is running unless you have to. If you have left the engine running, the vehicle can move suddenly. You or others could be injured. To be sure your vehicle won't move, even when you're on fairly level ground, always set your parking brake and move the shift lever to "P" (Park).

CAUTION: (Continued)

CAUTION: (Continued)

If you have four-wheel drive, your vehicle will be free to roll — even if your shift lever is in “P” (Park) — if your transfer case is in “N” (Neutral). So, be sure the transfer case is in a drive gear, two-wheel high (2HI), four-wheel high (4HI) or four-wheel low (4LO)— not in “N” (Neutral). See “Shifting Into “P” (Park)” in the Index. If you’re pulling a trailer, see “Towing a Trailer” in the Index.

- **R (Reverse)**

Use this gear to back up.

NOTICE:

Shifting to “R” (Reverse) while your vehicle is moving forward could damage your transmission. Shift to “R” (Reverse) only after your vehicle is stopped.

To rock your vehicle back and forth to get out of snow, ice or sand without damaging your transmission, see “If You’re Stuck: In Sand, Mud, Ice or Snow” in the Index.

- **N (Neutral)**

In this position, your engine doesn’t connect with the wheels. To restart when you’re already moving, use “N” (Neutral) only. Also, use “N” (Neutral) when your vehicle is being towed.



CAUTION:

Shifting out of “P” (Park) or “N” (Neutral) while your engine is “racing” (running at high speed) is dangerous. Unless your foot is firmly on the brake pedal, your vehicle could move very rapidly. You could lose control and hit people or objects. Don’t shift out of “P” (Park) or “N” (Neutral) while your engine is racing.

NOTICE:

Damage to your transmission caused by shifting out of “P” (Park) or “N” (Neutral) with the engine racing isn’t covered by your warranty.

- **ⓓ (Overdrive)**

This position is for normal driving. If you need more power for passing, and you’re:

- Going less than about 35 mph (56 km/h), push your accelerator pedal about halfway down.
- Going about 35 mph (56 km/h) or more, push the accelerator all the way down.

You’ll shift down to the next gear and have more power.

ⓓ should **not** be used when towing a trailer, carrying a heavy load, driving on steep hills, or for off-road driving. Select “D” (Third Gear) when operating the vehicle under any of these conditions.

- **D (Third Gear)**

This is like ⓓ, but you never go into Overdrive. You should use “D” (Third Gear) when towing a trailer, carrying a heavy load, driving on steep hills, or for off-road driving.

- **2 (Second Gear)**

This position gives you more power but lower fuel economy. You can use “2” (Second Gear) on hills. It can help control your speed as you go down steep mountain roads, but then you would also want to use your brakes off and on.

If you manually select “2” (Second Gear), the transmission will drive in second gear. You may use this feature for reducing torque to the rear wheels when you are trying to start your vehicle from a stop on slippery road surfaces.

- **1 (First Gear)**

This position gives you even more power (but lower fuel economy) than “2” (Second Gear). You can use it on very steep hills, or in deep snow or mud. If the selector lever is put in “1” (First Gear), the transmission won’t shift into “1” (First Gear) until the vehicle is going slowly enough.

NOTICE:

If your rear wheels can't rotate, don't try to drive. This might happen if you were stuck in very deep sand or mud or were up against a solid object. You could damage your transmission.

Also, if you stop when going uphill, don't hold your vehicle there with only the accelerator pedal. This could overheat and damage the transmission. Use your brakes or shift into "P" Park to hold your vehicle in position on a hill.

Five-Speed Manual Transmission

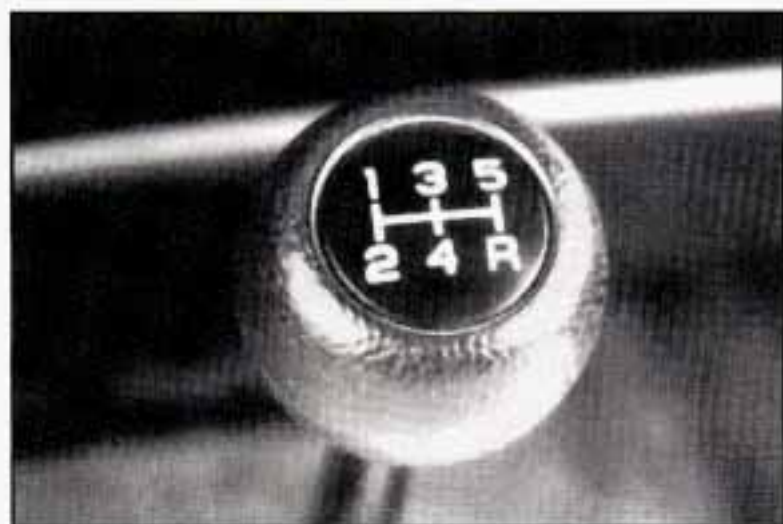

This is your shift pattern. Here's how to operate your transmission:

- **1 (First Gear)**

Press the clutch pedal and shift into "1" (First Gear). Then, slowly let up on the clutch pedal as you press the accelerator pedal.

You can shift into "1" (First Gear) when you're going less than 20 mph (32 km/h). If you've come to a complete stop and it's hard to shift into "1" (First Gear), put the shift lever in "N" (Neutral) and let up on the clutch. Press the clutch pedal back down. Then shift into "1" (First Gear).

- **2 (Second Gear)**

Press the clutch pedal as you let up on the accelerator pedal and shift into "2" (Second Gear). Then, slowly let up on the clutch pedal as you press the accelerator pedal.

- **3, 4 and 5 (Third, Fourth and Fifth Gears)**

Shift into "3" (Third Gear), "4" (Fourth Gear), and "5" (Fifth Gear) the same way you do for "2" (Second Gear). Slowly let up on the clutch pedal as you press the accelerator pedal.

- **To Stop**

Let up on the accelerator pedal and press the brake pedal. Just before the vehicle stops, press the clutch pedal and the brake pedal, and shift to “N” (Neutral).

- **N (Neutral)**

Use this position when you start or idle your engine.

- **R (Reverse)**

To back up, press down the clutch pedal, wait about 6 seconds, then shift into “R” (Reverse). Then let up on the clutch pedal slowly while pressing the accelerator pedal.

NOTICE:

Shift to “R” (Reverse) only after your vehicle is stopped. Shifting to “R” (Reverse) while your vehicle is moving could damage your transmission.

Also, use “R” (Reverse), along with the parking brake, for parking your vehicle.

Shift Light



If you have a manual transmission, you have a **SHIFT** light. This light will show you when to shift to the next higher gear for best fuel economy.

When this light comes on, you can shift to the next higher gear if weather, road and traffic conditions let you. For the best fuel economy, accelerate slowly and shift when the light comes on.

While you accelerate, it is normal for the light to go on and off if you quickly change the position of the accelerator. Ignore the **SHIFT** light when you downshift.

Four-Wheel Drive Vehicles Only: If your vehicle has four-wheel drive and is equipped with a manual transmission, disregard the shift light when the transfer case is in **4LO**.

Locking Rear Axle

If you have this feature, your rear axle can give you additional traction on snow, mud, ice, sand or gravel. It works like a standard axle most of the time, but when one of the rear wheels has no traction and the other does, the locking feature will allow the wheel with traction to move the vehicle.

Parking Brake

To Set the Parking Brake:

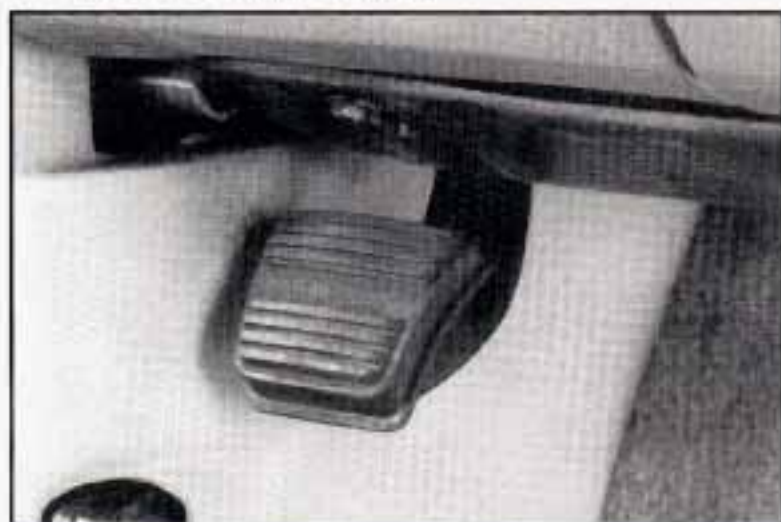

Hold the regular brake pedal down with your right foot. Push down the parking brake pedal with your left foot. If the ignition is on, the brake system warning light will come on.

To Release the Parking Brake:



Hold the regular brake pedal down. Pull the brake release lever.

NOTICE:

Driving with the parking brake on can cause your rear brakes to overheat. You may have to replace them, and you could also damage other parts of your vehicle.

If you are on a hill: See “Parking on Hills” in the Index. That section shows how to turn your front wheels.

If you are towing a trailer and are parking on any hill: See “Towing a Trailer” in the Index. That section shows what to do first to keep the trailer from moving.

Shifting Into “P” (Park) (Automatic Transmission Models Only)



CAUTION:

It can be dangerous to get out of your vehicle if the shift lever is not fully in “P” (Park) with the parking brake firmly set. Your vehicle can roll.

If you have left the engine running, the vehicle can move suddenly. You or others could be injured. To be sure your vehicle won’t move, even when you’re on fairly level ground, use the steps that follow. If you have four-wheel drive with a manual transfer case shift lever and your transfer case is in “N” (Neutral), your vehicle will be free to roll, even if your shift lever is in “P” (Park). So, be sure the transfer case is in a drive gear — not in “N” (Neutral). If you’re pulling a trailer, see “Towing a Trailer” in the Index.

1. Hold the brake pedal down with your right foot and set the parking brake.

2. Move the shift lever into “P” (Park) position like this:



- Pull the lever toward you.
 - Move the lever up as far as it will go.
3. If you have four-wheel drive with a manual transfer case shift lever, be sure the transfer case is in a drive gear — not in “N” (Neutral).
 4. Move the ignition key to **LOCK**.
 5. Remove the key and take it with you. If you can walk away from your vehicle with the ignition key in your hand, your vehicle is in “P” (Park).

Leaving Your Vehicle With the Engine Running (Automatic Transmission Models Only)



CAUTION:

It can be dangerous to leave your vehicle with the engine running. Your vehicle could move suddenly if the shift lever is not fully in “P” (Park) with the parking brake firmly set. If you have four-wheel drive with a manual transfer case shift lever and your transfer case is in “N” (Neutral), your vehicle will be free to roll, even if your shift lever is in “P” (Park). So be sure the transfer case is in a drive gear – not in “N” (Neutral). And, if you leave the vehicle with the engine running, it could overheat and even catch fire. You or others could be injured. Don't leave your vehicle with the engine running unless you have to.

Torque Lock (Automatic Transmission)

If you are parking on a hill and you don't shift your transmission into "P" (Park) properly, the weight of the vehicle may put too much force on the parking pawl in the transmission. You may find it difficult to pull the shift lever out of "P" (Park). This is called "torque lock." To prevent torque lock, set the parking brake and then shift into "P" (Park) properly before you leave the driver's seat. To find out how, see "Shifting Into 'P' (Park)" in the Index.

When you are ready to drive, move the shift lever out of "P" (Park) BEFORE you release the parking brake.

If "torque lock" does occur, you may need to have another vehicle push yours a little uphill to take some of the pressure from the transmission, so you can pull the shift lever out of "P" (Park).

Parking Your Vehicle (Manual Transmission Models Only)

Before you get out of your vehicle, turn off your engine, put your manual transmission in "R" (Reverse) and firmly apply the parking brake.

If you have four-wheel drive with a manual transfer case shift lever, be sure your transfer case is in a drive gear. Your vehicle could roll if it isn't.

If you are parking on a hill, or if your vehicle is equipped to tow a trailer, see "Parking on Hills" or "Towing a Trailer" in the Index.

Parking Over Things That Burn





CAUTION:

Things that can burn could touch hot exhaust parts under your vehicle and ignite. Don't park over papers, leaves, dry grass or other things that can burn.

Engine Exhaust



CAUTION:

Engine exhaust can kill. It contains the gas carbon monoxide (CO), which you can't see or smell. It can cause unconsciousness and death.

You might have exhaust coming in if:

- Your exhaust system sounds strange or different.
- Your vehicle gets rusty underneath.
- Your vehicle was damaged in a collision.
- Your vehicle was damaged when driving over high points on the road or over road debris.
- Repairs weren't done correctly.
- Your vehicle or exhaust system had been modified improperly.

If you *ever* suspect exhaust is coming into your vehicle:

- Drive it only with all the windows down to blow out any CO; and
- Have your vehicle fixed *immediately*.

Running Your Engine While You're Parked (Automatic Transmission)

It's better not to park with the engine running. But if you ever have to, here are some things to know.



CAUTION:

Idling the engine with the air system control off could allow dangerous exhaust into your vehicle (see the earlier Caution under "Engine Exhaust").

Also, idling in a closed-in place can let deadly carbon monoxide (CO) into your vehicle even if the fan switch is at the highest setting. One place this can happen is a garage. Exhaust — with CO — can come in easily. **NEVER** park in a garage with the engine running.

Another closed-in place can be a blizzard. (See "Blizzard" in the Index.)



CAUTION:

It can be dangerous to get out of your vehicle if the shift lever is not fully in "P" (Park) with the parking brake firmly set. Your vehicle can roll. Don't leave your vehicle when the engine is running unless you have to. If you've left the engine running, the vehicle can move suddenly. You or others could be injured. To be sure your vehicle won't move, even when you're on fairly level ground, always set your parking brake and move the shift lever to "P" (Park).

If you have four-wheel drive with a manual transfer case shift lever and your transfer case is in "N" (Neutral), your vehicle will be free to roll, even if your shift lever is in "P" (Park). So, be sure the transfer case is in a drive gear — not in "N" (Neutral). Follow the proper steps to be sure your vehicle won't move. See "Shifting Into 'P' (Park)" in the Index.

If you're pulling a trailer, see "Towing a Trailer" in the Index.

Four-Wheel Drive

If your vehicle has four-wheel drive, you can send your engine's driving power to all four wheels for extra traction. To shift out of two-wheel drive and into four-wheel drive, move the transfer case shift lever to **4HI** or **4LO**. You should use **2HI** for most normal driving conditions, however.

NOTICE:

Driving in the **4HI** or **4LO** positions for a long time on dry or wet pavement could shorten the life of your vehicle's drivetrain.

Manual Transfer Case



If your four-wheel drive vehicle has the manual transfer case, the transfer case shift lever is on the floor to the right of the driver. Use this lever to shift into and out of four-wheel drive.

An indicator light near the lever shows you the transfer case settings:



- **2HI**
- **4HI**
- **N SET PARK BRAKE**
- **4LO**

The front axle portion of the diagram on the indicator will light up when you shift into four-wheel drive. A slight delay between shifting and the pattern's lighting is normal. If the pattern does not light up, or if the front axle does not go out after you shift out of four-wheel drive, have your dealer check your system. Turn the **INT LIGHTS** switch located to the right of your headlight switch to dim your transfer case indicator light when your headlights or parking lights are on. This will also cause your instrument panel lights to dim.

2HI: This setting is for driving in most street and highway situations. Your front axle is not engaged in two-wheel drive.

4HI: This setting engages your front axle to help drive your vehicle. Use **4HI** when you need extra traction, such as on snowy or icy roads, or in most off-road situations.

N SET PARK BRAKE: Shift to this neutral setting only when your vehicle needs to be towed.

4LO: This setting also engages your front axle to give you extra traction. You may never need **4LO**. It sends the maximum power to all four wheels. You might choose **4LO** if you were driving off-road in sand, mud, or deep snow and climbing or descending steep hills.

You can shift from **2HI** to **4HI** or from **4HI** to **2HI** while the vehicle is moving. It is not necessary for you to press the transfer case shift lever button. Your front axle will engage faster if you take your foot off of the accelerator for a few seconds after you shift.

To shift your transfer case into **N SET PARK BRAKE:**

1. Stop the vehicle and shift your transmission into "N" (Neutral).
2. Set the parking brake. Your vehicle can roll unless the brakes are applied.

To shift into or out of **4LO** :

1. The vehicle must be stopped or moving less than 3 mph (4.8 km/h) with the transmission in "N" (Neutral) or the clutch pedal depressed.
2. Press the transfer case shift button and shift in one continuous motion.

Don't pause in **N SET PARK BRAKE** as you shift into or out of **4LO**, or your gears could clash.

Remember that driving in **4HI** or **4LO** may reduce fuel economy. Also, driving in four-wheel drive on dry pavement could cause your tires to wear faster and make your transfer case harder to shift.

Electronic Transfer Case



If your four-wheel drive vehicle has the electronic transfer case, the transfer case switches are on the right side of your instrument panel above the radio controls. Use these switches to shift into and out of four-wheel drive. You can choose among three driving settings:

1. **2HI:** This setting is for driving in most street and highway situations. Your front axle is not engaged in two-wheel drive.
2. **4HI:** This setting engages your front axle to help drive your vehicle. Use **4HI** when you need extra traction, such as on snowy or icy roads, or in most off-road situations.
3. **4LO:** This setting also engages your front axle to give you extra traction. You may never need **4LO**. It sends the maximum power to all four wheels. You might choose **4LO** if you were driving off-road in sand, mud, deep snow and climbing or descending steep hills.

Amber indicator lights in the switches show you which setting you are in. The indicator lights will come on briefly when you turn on the ignition and one will stay on. If the lights do not come on, you should take your vehicle in for service. When shifting, an indicator light will flash until the shift is completed then remain solidly lit.

To shift from 2HI to 4HI: Press and release the **4HI** switch. This can be done at any speed, and the front axle will lock automatically.

To shift from 4HI to 2HI: Press and release the **2HI** switch. This can be done at any speed, and the front axle will unlock automatically.

To shift from 2HI, or 4HI to 4LO : The vehicle must be stopped or moving less than 3 mph (4.8 km/h) with the transmission in "N" (Neutral) or the clutch pedal depressed. The preferred method for shifting into **4LO** is to have your vehicle slowly moving 1 to 2 mph (1.6 to 3.2 km/h). Press and release the **4LO** switch. You must wait for the amber **4LO** indicator light to stop flashing and go solid amber before shifting your transmission into gear or releasing the clutch pedal.

If the **4LO** switch is pressed when your vehicle is in gear and/or moving, the amber **4LO** indicator light will flash for 30 seconds and not complete the shift unless your vehicle is below 3 mph (4.8 km/h) and the transmission is in "N" (Neutral) or the clutch pedal depressed.

On automatic transmission equipped vehicles: If your transfer case does not shift into **4LO**, your transmission indicator switch may require adjustment. With your transmission in "N" (Neutral), press and release the **4LO** switch. While the amber **4LO** indicator light is flashing, shift your transmission into **P** (Park).

Wait until the **4LO** indicator light goes solid amber before shifting your transmission into gear. This will get you into **4LO**, but you should take your vehicle in for service so normal operation can be restored.

To shift from 4LO to 4HI: Your vehicle must be stopped or moving less than 3 mph (4.8 km/h) with the transmission in "N" (Neutral) and the clutch pedal depressed. The preferred method for shifting out of **4LO** is to have your vehicle slowly moving 1 to 2 mph (1.6 to 3.2 km/h). Press and release the **4HI** switch. You must wait for the **4HI** indicator light to stop flashing and go solid amber before shifting your transmission into gear or releasing the clutch pedal.

If the **4HI** switch is pressed when your vehicle is in gear and/or moving, the **4HI** indicator light will flash for 30 seconds but not complete the shift unless the vehicle is below 3 mph (4.8 km/h) and the transmission is in "N" (Neutral) or the clutch pedal depressed.

On automatic transmission equipped vehicles: If your transfer case does not shift into **4HI**, your transmission indicator switch may require adjustment. With your transmission in "N" (Neutral), press and release the **4HI** switch. While the **4HI** indicator light is flashing, shift your transmission into **P** (Park). Wait until the **4HI** indicator light goes solid amber before shifting your transmission into gear. This will get you into **4HI**, but you should take your vehicle in for service so normal operation can be restored.

Windows



To open your manual windows, turn the hand crank on each door to raise or lower your side door windows.



If you have the optional power windows, the controls are on each of the side doors. Your power windows will only work when the ignition has been turned to **RUN**.

The driver's window switch has an "express" feature that allows it to lower faster than the passenger's window. The driver's door also has a switch for the passenger windows.

Push the down arrow on the switch to lower the window.

Push the up arrow on the switch to raise the window.

Sliding Rear Window

Your vehicle may have a sliding rear window.



Push the latch in the center of the window and slide the glass to open it.

When you close the window, be sure the latch catches.

Swing-Out Windows (Extended Cab)



If your vehicle has rear swing-out windows, just unlatch them at their clasps and push out on the glass to open them.

Horn



Press the pad in the center of the steering wheel to sound the horn.

Tilt Wheel (Option)



A tilt steering wheel allows you to adjust the steering wheel before you drive.

You can also raise it to the highest level to give your legs more room when you enter and exit the vehicle.

To tilt the wheel, hold the steering wheel and pull the lever. Move the steering wheel to a comfortable level, then release the lever to lock the wheel in place.

Do not adjust the steering wheel while driving.

Turn Signal/Multifunction Lever



The lever on the left side of the steering column includes your:

- Turn Signal and Lane Change Indicator
- Headlight High–Low Beam
- Windshield Wipers
- Windshield Washer
- Cruise Control (Option)

Turn Signal and Lane Change Indicator

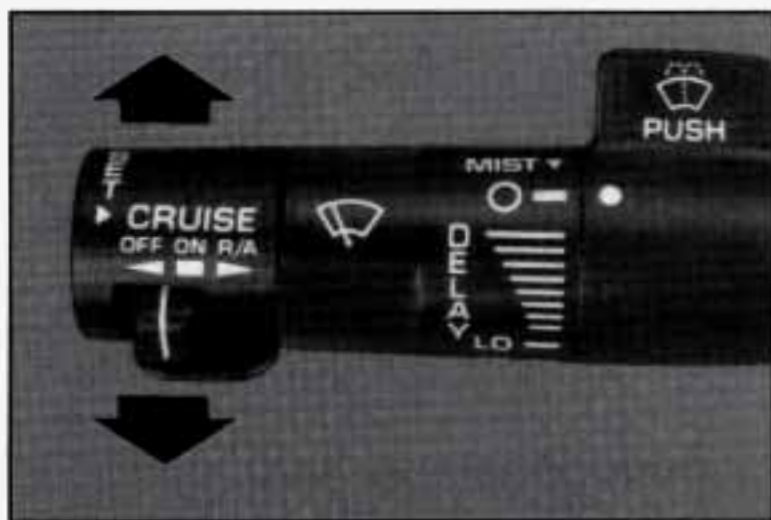

The turn signal has two upward (for Right) and two downward (for Left) positions. These positions allow you to signal a turn or a lane change.

To signal a turn, move the lever all the way up or down. When the turn is finished, the lever will return automatically.

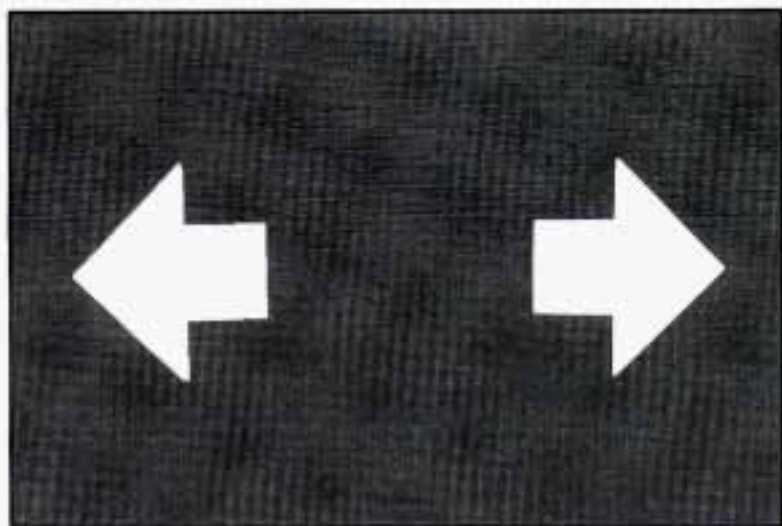

A green arrow on the instrument panel will flash in the direction of the turn or lane change.

To signal a lane change, just raise or lower the lever until the green arrow starts to flash. Hold it there until you complete your lane change. The lever will return by itself when you release it.

As you signal a turn or a lane change, if the arrows don't flash but just stay on, a signal bulb may be burned out and other drivers won't see your turn signal.

If a bulb is burned out, replace it to help avoid an accident. If the green arrows don't go on at all when you signal a turn, check the fuse (see "Fuses" in the Index) and for burned-out bulbs.

If you have a trailer towing option with added wiring for the trailer lights, a different turn signal flasher is used. With this flasher installed, the signal indicator will flash even if a turn signal bulb is burned out. Check the front and rear turn signal lights regularly to make sure they are working.

Operation of Lights

Although your vehicle's lighting system (headlights, parking lights, fog lamps, side marker lights and taillights) meets all applicable federal lighting requirements, certain states and provinces may apply their own lighting regulations that may require special attention before you operate these lights.

For example, some jurisdictions may require that you operate your fog lamps only when your lower beam headlights are also on, or that headlights be turned on whenever you must use your windshield wipers. In addition, most jurisdictions prohibit driving solely with parking lights, especially at dawn or dusk. It is recommended that you check with your own state or provincial highway authority for applicable lighting regulations.

Headlight High–Low Beam



To change the headlights from low beam to high or high to low, pull the turn signal lever all the way toward you. Then release it.

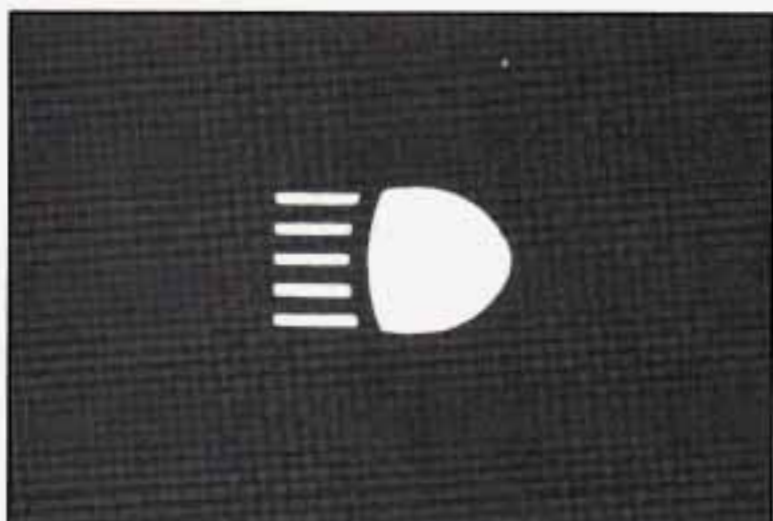

When the high beams are on, this blue indicator light on the instrument panel also will be on.

Windshield Wipers



You control the windshield wipers by turning the band with the wiper symbol on it.

For a single wiping cycle, turn the band to **MIST**. Hold it there until the wipers start, then let go. The wipers will stop after one cycle. If you want more cycles, hold the band on **MIST** longer.

You can set the wiper speed for a long or short delay between wipes. This can be very useful in light rain or snow. Turn the band to choose the delay time. The closer to **LO**, the shorter the delay.

For steady wiping at low speed, turn the band away from you to the **LO** position. For high speed wiping, turn the band further, to **HI**. To stop the wipers, move the band to the off symbol.

Remember that damaged wiper blades may prevent you from seeing well enough to drive safely. To avoid damage, be sure to clear ice and snow from the wiper blades before using them. If they're frozen to the windshield, carefully loosen or thaw them. If your blades do become damaged, get new blades or blade inserts.

Heavy snow or ice can overload your wipers. A circuit breaker will stop them until the motor cools. Clear away snow or ice to prevent an overload.

Windshield Washer



At the top of the multifunction lever there's a paddle marked with the windshield washer symbol and **PUSH**. To spray washer fluid on the windshield, push the paddle.

The wipers will clear the window and then either stop or return to your preset speed.

Driving without washer fluid can be dangerous. A bad mud splash can block your vision. You could hit another vehicle or go off the road. Check your washer fluid level often.



CAUTION:

In freezing weather, don't use your washer until the windshield is warmed. Otherwise the washer fluid can form ice on the windshield, blocking your vision.

NOTICE:

- **When using concentrated washer fluid, follow the manufacturer's instructions for adding water.**
- **Don't mix water with ready-to-use washer fluid. Water can cause the solution to freeze and damage your washer fluid tank and other parts of the washer system. Also, water doesn't clean as well as washer fluid.**
- **Fill your washer fluid tank only 3/4 full when it's very cold. This allows for expansion, which could damage the tank if it is completely full.**
- **Don't use radiator antifreeze in your windshield washer. It can damage your washer system and paint.**

Cruise Control (Option)



With Cruise Control, you can maintain a speed of about 25 mph (40 km/h) or more without keeping your foot on the accelerator. This can really help on long trips. Cruise Control does not work at speeds below about 25 mph (40 km/h).

If you have a manual transmission and you apply your brakes or push the clutch pedal, the Cruise Control will shut off.



CAUTION:

- **Cruise Control can be dangerous where you can't drive safely at a steady speed. So, don't use your Cruise Control on winding roads or in heavy traffic.**
- **Cruise Control can be dangerous on slippery roads. On such roads, fast changes in tire traction can cause needless wheel spinning, and you could lose control. Don't use Cruise Control on slippery roads.**

To Set Cruise Control



- Move the Cruise Control switch to **ON**.



CAUTION:

If you leave your Cruise Control switch on when you're not using Cruise, you might hit a button and go into Cruise when you don't want to. You could be startled and even lose control. Keep the Cruise Control switch "OFF" until you want to use it.

- Get up to the speed you want.
- Push in the set button at the end of the lever and release it.
- Take your foot off the accelerator pedal.

To Resume a Set Speed



Suppose you set your Cruise Control at a desired speed and then you apply the brake. This, of course, shuts off the Cruise Control. But you don't need to reset it. Once you're going about 25 mph (40 km/h) or more, you can move the Cruise Control switch from **ON** to **R/A** (Resume/Accelerate) for about half a second.

You'll go right back up to your chosen speed and stay there.

Remember, if you hold the switch at **R/A** (Resume/Accelerate) longer than half a second, the vehicle will keep going faster until you release the switch or apply the brake. You could be startled and even lose control. So unless you want to go faster, don't hold the switch at **R/A** (Resume/Accelerate).

To Increase Speed While Using Cruise Control

There are two ways to go to a higher speed. Here's the first:



- Use the accelerator pedal to get to the higher speed. Push the button at the end of the lever, then release the button and the accelerator pedal. You'll now cruise at the higher speed.

Here's the second :



- Move the Cruise switch from **ON** to **R/A** (Resume/Accelerate). Hold it there until you get up to the speed you want, and then release the switch.
- To increase your speed in very small amounts, move the switch to **R/A** (Resume/Accelerate). Each time you do this, your vehicle will go about 1 mph (1.6 km/h) faster.

To Reduce Speed While Using Cruise Control



- Push in the button at the end of the lever until you reach the lower speed you want, then release it.

- To slow down in very small amounts, push the button for less than half a second. Each time you do this, you'll go 1 mph (1.6 km/h) slower.

Passing Another Vehicle While Using Cruise Control

Use the accelerator pedal to increase your speed. When you take your foot off the pedal, your vehicle will slow down to the Cruise Control speed you set earlier.

Using Cruise Control on Hills

How well your Cruise Control will work on hills depends upon your speed, load, and the steepness of the hills. When going up steep hills, you may have to step on the accelerator pedal to maintain your speed. When going downhill, you may have to brake or shift to a lower gear to keep your speed down. Of course, applying the brake takes you out of Cruise Control. Many drivers find this to be too much trouble and don't use Cruise Control on steep hills.

To Get Out of Cruise Control

There are two ways to turn off the Cruise Control:



- Step lightly on the brake pedal or push the clutch pedal, if you have a manual transmission



- Move the Cruise switch to **OFF**.

To Erase Speed Memory

When you turn off the Cruise Control or the ignition, your Cruise Control set speed memory is erased.

Lights



Your light switches are on the left side of your instrument panel.

Push the top switch to turn on:

- Parking Lights
- Sidemarkers Lights
- Taillights
- License Plate Lights
- Instrument Panel Lights
- Transfer Case Shift Indicator Panel

Push the bottom switch to turn on the headlights, together with:

- Parking Lights
- Sidemarkers Lights
- Taillights
- License Plate Lights
- Instrument Panel Lights
- Transfer Case Shift Indicator Panel

Push the switch marked **OFF** to turn off your lights.

Turn the switch to the right of the headlight switch up to make your instrument panel and transfer case lights brighter. Turn the switch all the way up until it clicks to turn on the interior lights.

Turn the switch down to dim your instrument panel and transfer case indicator lights.

You can switch your headlights from high to low beam by pulling on the multifunction lever.

A circuit breaker protects your headlights. If you have an electrical overload, your headlights will flicker on and off. Have your headlight wiring checked right away if this happens.

Fog Lamps (Option)



Use your fog lamps for better vision in foggy or misty conditions. Your parking lights and/or low beam headlights must be on or your fog lamps won't work.



The fog lamp switch is on the instrument panel under the headlight switch.

Press the left side of the switch to turn the fog lamps on, and the right side of the switch to turn them off. A light will glow in the right side of the switch when they are on.

Remember, fog lamps alone will not give off as much light as your headlights.

Never use your fog lamps in the dark without turning on your headlights.

Fog lamps will go off whenever your high beam headlights come on. When the high beams go off, the fog lamps will come on again.

Daytime Running Lights (DRL) Indicator Light (Canada Only)

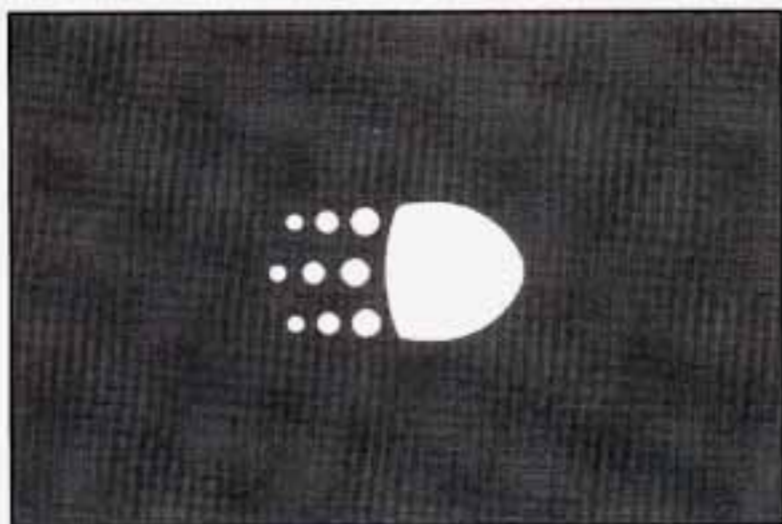

If your vehicle was first sold, when new, in Canada, you will have this light on the instrument panel. It goes on whenever the Daytime Running Lights are on, the ignition is on, the headlamp switch is off, and the parking brake is released.

Daytime Running Lights (Canada Only)

The Canadian Federal Government has decided that “Daytime Running Lights” (DRL) is a useful feature, in that DRL can make your vehicle more visible to pedestrians and other drivers during daylight hours. DRL is required on new vehicles sold in Canada.

The high beam headlights will come on at reduced brightness in daylight when:

- The ignition is on,
- The headlight switch is off, and
- The parking brake is released.

When you turn on your headlights, the DRL will switch off and the exterior lights will come on. When you turn off the headlights, the exterior lights will go out and the high beams will change to the reduced brightness of DRL again.

The DRL indicator light on the instrument panel will go on whenever the DRL is on. This light means that only the DRL is on. When you turn on your exterior lights, this light will go out.

If the DRL indicator light is on at dawn or dusk, it is a reminder to turn on your headlights.

Of course, you may still turn on the headlights any time you need to.

To idle your vehicle with the DRL off, set the parking brake. The DRL will stay off until you release the parking brake.

Headlights—On Reminder

A reminder tone will sound when your headlights or parking lights are turned on and your ignition is in **OFF**, **LOCK** or **ACC**. To turn the tone off, turn the dimmer switch all the way down.

Dome Light



The dome light will come on when you open the side doors. You can also turn the dome light on by turning the dimmer switch up until it clicks.

Mirrors

Inside Mirror

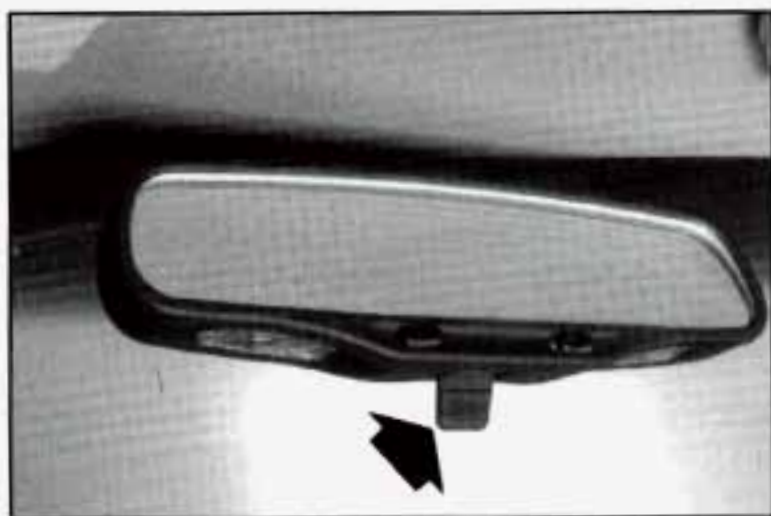

Press the tab under the mirror to reduce glare from headlights behind you.

If your vehicle has optional map lights, they will automatically come on for approximately 15 seconds when either front door is opened, or until the ignition is turned to **RUN** or **ACC**.

They will also stay on for 15 seconds when the interior light switch on the dash is turned on then off, while the ignition is off.



You can also turn the map lights on and off by pressing the switch near each light. However, the ignition must be turned to **RUN** or **ACC** for the map lights to come on.

Outside Mirrors



Adjust your outside mirrors so you can just see the side of your vehicle.

Manual mirrors should be adjusted by pressing the glass as needed.



Some vehicles come with a remote control switch for adjusting the outside mirrors. Find the switch on the driver's side door. Move the switch to the right or left to choose the mirror, then move the switch from side to side or up and down as needed.

Your outside mirrors must be folded in before entering a carwash. To fold, pull the mirrors in towards the vehicle. Push the mirrors back out when finished.

Convex Outside Mirror

Your right side mirror is convex.

A convex mirror's surface is curved so you can see more from the driver's seat.



CAUTION:

If you aren't used to a convex mirror, you can hit another vehicle. A convex mirror can make things (like other vehicles) look farther away than they really are. If you cut too sharply into the right lane, you could hit a vehicle on your right. Check your inside mirror or glance over your shoulder before changing lanes.

Sun Visors/Vanity Mirrors

To block out glare, you can swing down the visors. You can also swing them from side to side. Your visors have an extension that can be pulled out for additional glare protection.

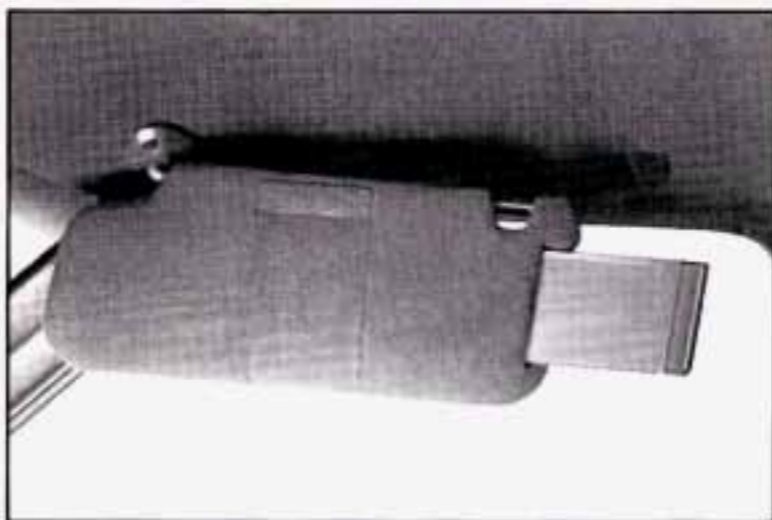

Your visor will have a strap for holding small items, such as maps.



Some visors have a lighted mirror. Just lift the cover up to turn on the mirror lights.

Accessory Power Outlets (Option)



If you have accessory power outlets, you can plug in auxiliary electrical equipment. Just pull down from the top of the door and follow the proper installation instructions that are included with any electrical equipment you install.

These circuits are protected by a fuse and have maximum current levels.

NOTICE:

When using the accessory power outlets, maximum electrical load must not exceed 25 amps. Always turn off any electrical equipment when not in use. Leaving electrical equipment on for extended periods will drain your battery.

Cigarette Lighter/Ashtray



To use the lighter, press it in all the way, and let go. When it's ready, it will pop back by itself.

Don't hold a cigarette lighter in with your hand while it is heating. If you do, it won't be able to back away from the heating element when it's ready. That can make it overload, damaging the lighter and the heating element.



The ashtray must be completely pulled out to open position before the ashtray cover opens and smoking material can be deposited.

Don't put papers and other things that burn into your ashtray. If you do, cigarettes or other smoking materials could set them on fire causing damage.

To remove the ashtray, lift the release tab as high as possible, then remove the tray.

Storage Compartments



Your vehicle may have a console compartment between the bucket seats. To open it, just squeeze the lever in the front of the console while lifting the top of the console. Your console also includes a handy place to hold cups.



To open your glove box, squeeze the lever at the top of the glovebox and lower the door.



Two cup depressions are provided for your convenience, but the glovebox should not be open while driving.



A storage compartment under your radio may be used to hold small items.



You will find a storage pocket on each of the front doors.

You also have a storage pocket on the back of your bucket or 60/40 bench seats.

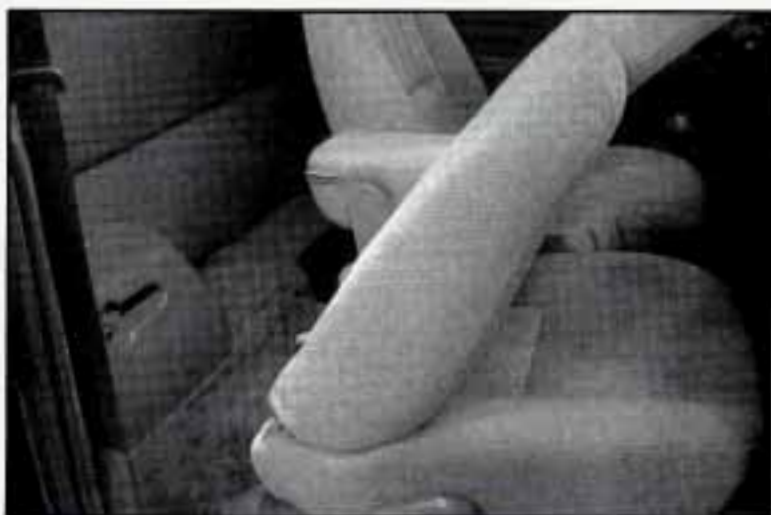

Some vehicles have a storage area behind the seat

Instrument Panel

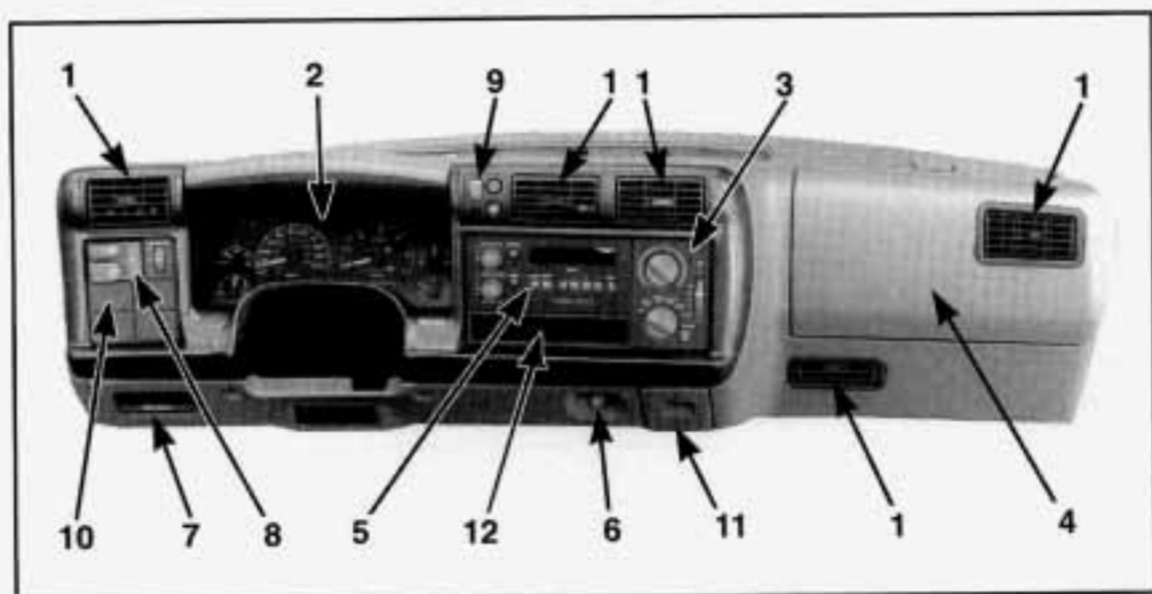

- | | |
|---------------------------|-----------------------------|
| 1. Vents | 7. Brake Release Handle |
| 2. Instrument Cluster | 8. Light Switches |
| 3. Air Conditioner/Heater | 9. Electronic Transfer Case |
| 4. Glove Box | 10. Fog Lamp Switch |
| 5. Sound System | 11. Ashtray |
| 6. Cigarette Lighter | 12. Storage Compartment |

Instrument Cluster

Your instrument cluster is designed to let you know at a glance how your vehicle is running. You'll know how fast you're going, about how much fuel you've used, and many other things you'll need to know to drive safely and economically.

Speedometer and Odometer



Your speedometer lets you see your speed in both miles per hour (mph) and kilometers per hour (km/h).

All speedometers will show speeds up to 85 mph (140 km/h), but if you have a 4.3L (VIN W) engine with a tachometer, the speedometer will show speeds up to 100 mph (160 km/h).

Your odometer shows how far your vehicle has been driven, in either miles (used in the U.S.) or kilometers (used in Canada).

Tamper Resistant Odometer

Standard Cluster



Tachometer Cluster



Your odometer is tamper resistant. It will show silver lines between the numbers if someone tries to turn it back.

You may wonder what happens if your vehicle needs a new odometer installed. If the new one can be set to the mileage total of the old odometer, then it must be. But if it can't, then it's set at zero, and a label must be put on the driver's door to show the old mileage reading when the new odometer was installed.

Trip Odometer

Standard Cluster



Tachometer Cluster



The trip odometer can tell you how far your vehicle has been driven since you last set the trip odometer to zero. Make sure the button is completely depressed.

To set the trip odometer to zero, completely push the button near the readout.

Tachometer



The tachometer displays the engine speed in revolutions per minute (rpm).

Each tachometer has a different limit depending on the powertrain in your vehicle. The tachometer has three areas: normal operating range, yellow warning range, and red danger range.

Normal operating range shows your engine speed during normal driving conditions. For example, when the needle points to 2, it means the engine is

running at 2,000 revolutions per minute (rpm). The tachometer needle will vary all the time that the engine is running.

The yellow warning range tells you that your engine speed is reaching its upper limits. Don't drive very long with the tachometer in the yellow range. If you have a manual transmission, shift to a higher gear as soon as possible. If you have an automatic transmission, lift your foot off of the accelerator pedal so that the transmission can select a higher gear.

The Red danger range tells you that your engine speed is at its upper limits. You should immediately shift to a higher gear, or lift your foot off of the accelerator pedal. If you drive for very long with the tachometer in the red danger range, engine damage will result.

NOTICE:

Do not operate the engine with the tachometer in the red area, or engine damage will occur.

Warning Lights, Gages and Indicators

This section describes the warning lights and gages that may be on your vehicle. The pictures will help you locate them.

Warning lights and gages can signal that something is wrong before it becomes serious enough to cause an expensive repair or replacement. Paying attention to your warning lights and gages could also save you or others from injury.

Warning lights go on when there may be or is a problem with one of your vehicle's functions. As you will see in the details on the next few pages, some warning lights come on briefly when you turn the ignition key just to let you know they're working. If you are familiar with this section, you should not be alarmed when this happens.

Gages can indicate when there may be or is a problem with one of your vehicle's functions. Often gages and warning lights work together to let you know when there's a problem with your vehicle.

When one of the warning lights comes on and stays on when you are driving, or when one of the gages shows there may be a problem, check the section that tells you what to do about it. Please follow the manual's advice. Waiting to do repairs can be costly — and even dangerous. So please get to know your warning lights and gages. They're a big help.

Brake System Warning Light



Your vehicle hydraulic brake system is divided into two parts. If one part isn't working, the other part can still work and stop you. For good braking, though, you need both parts working well.

Your vehicle also has rear-wheel or four-wheel anti-lock brakes. See "Anti-Lock Brakes" in the Index. If the warning light comes on, there could be a brake problem with either your regular or rear-wheel anti-lock brakes, or both. Have your brake system inspected right away.

This light should come on as you start the vehicle. If it doesn't come on then, have it fixed so it will be ready to warn you if there's a problem.

If the light comes on while you are driving, pull off the road and stop carefully. You may notice that the pedal is harder to push. Or, the pedal may go closer to the floor. It may take longer to stop. If the light is still on, have the vehicle towed for service. (See "Towing Your Vehicle" in the Index.)



CAUTION:

Your brake system may not be working properly if the brake system warning light is on. Driving with the brake system warning light on can lead to an accident. If the light is still on after you've pulled off the road and stopped carefully, have the vehicle towed for service.

The brake system warning light will also come on when you set your parking brake, and it will stay on if your parking brake doesn't release fully. If it stays on after your parking brake is fully released, it means you have a brake problem.

Anti-Lock Brake System Warning Light (Option)



If your vehicle has four-wheel anti-lock brakes, it will have this yellow light.

With anti-lock, this light will go on when you start your engine and may stay on for several seconds. That's normal. If the light doesn't come on, have it fixed so it will be ready to warn you if there is a problem.

If the light stays on, or comes on when you're driving, your vehicle needs service. If the regular brake system warning light isn't on, you still have brakes, but you don't have anti-lock brakes. If the regular brake system warning light is also on, you don't have anti-lock brakes and there's a problem with your regular brakes. See "Brake System Warning Light" earlier in this part.

Engine Coolant Temperature Gage



This gage shows the engine coolant temperature. If the gage pointer moves into the red area, your engine is too hot!

It means that your engine coolant has overheated. If you have been operating your vehicle under normal driving conditions, you should pull off the road, stop your vehicle and turn off the engine as soon as possible.

Hot Coolant Can Burn you Badly! In *Problems On The Road*, this manual explains what to do. See "Engine Overheating" in the Index.

Malfunction Indicator (Service Engine Soon) Lamp

**SERVICE
ENGINE
SOON**

A computer monitors operation of your fuel, ignition and emission control systems. This light should come on when the ignition is on, but the engine is not running, as a check to show you it is working. If it does not come on at all, have it fixed right away. If it stays on, or it comes on while you are driving, the computer is indicating that you have a problem. You should take your vehicle in for service soon.

NOTICE:

If you keep driving your vehicle with this light on, after a while the emission controls won't work as well, your fuel economy won't be as good and your engine may not run as smoothly. This could lead to costly repairs not covered by your warranty.

Oil Pressure Gage



The oil pressure gage shows the engine oil pressure in psi (pounds per square inch) when the engine is running. Canadian vehicles indicate pressure in kPa (kilopascals). Oil pressure may vary with engine speed, outside temperature and oil viscosity, but readings above the low pressure zone indicate the normal operating range.

A reading in the low pressure zone may be caused by a dangerously low oil level or other problems causing low oil pressure.



CAUTION:

Don't keep driving if the oil pressure is low. If you do, your engine can become so hot that it catches fire. You or others could be burned. Check your oil as soon as possible and have your vehicle serviced.

NOTICE:

Damage to your engine from neglected oil problems can be costly and is not covered by your warranty.

Indicator Lights

Indicator lights go on when you use your turn signals, change from low beam headlights to high beams, or when you use your hazard flashers. The next few pages will also tell you about the indicator lights on your vehicle and help you locate them.

Charging System Light

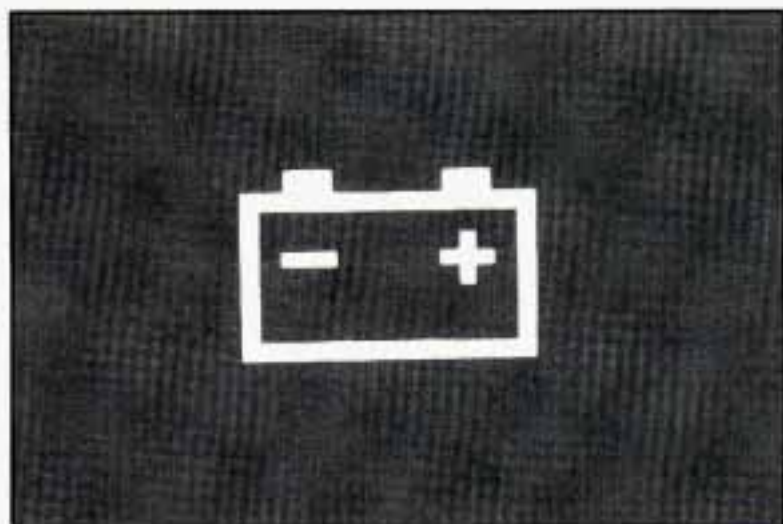

The charging system light is on your instrument cluster and will come on briefly when you turn on the ignition, but the engine is not running, as a check to show you it is working.

It should go out once the engine is running. If it stays on, or comes on while you are driving, you may have a problem with the charging system. It could indicate that you have problems with a generator drive belt, or another electrical problem. Have it checked right away. Driving while this light is on could drain your battery.

If you must drive a short distance with the light on, be certain to turn off all your accessories, such as the radio and air conditioner.

Check Gages Light

A black rectangular box contains the words "CHECK GAGES" in large, white, bold, sans-serif capital letters. The text is centered within the box.

This Check Gages light is on the instrument cluster and will come on briefly when you are starting the engine. If the light comes on and stays on while you are driving, check your various gages to see if they are in the warning zones.

Daytime Running Lights (DRL) Indicator Light (Canada Only)

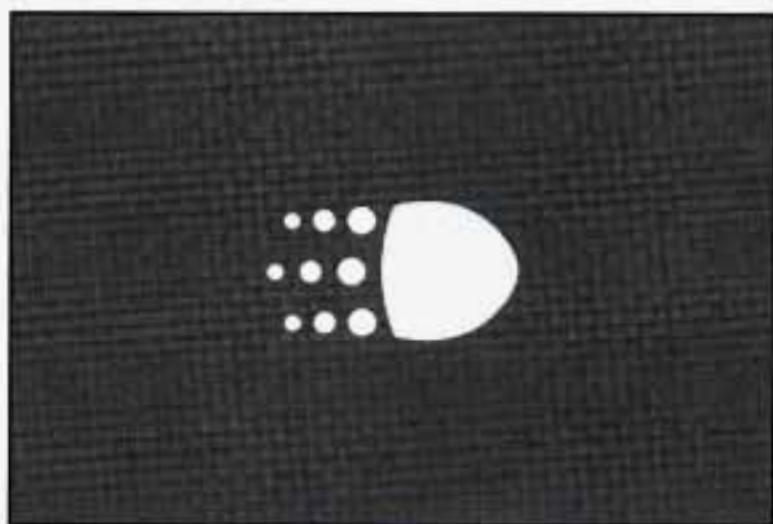

This green DRL indicator light is on the instrument cluster. The DRL indicator light is on whenever the ignition is on and the headlight switch and parking brake are off. For more details about DRL, see “Lights” in this section.

SHIFT Indicator Light



This amber **SHIFT** indicator light is on the instrument cluster of vehicles with manual transmissions. The **SHIFT** indicator light will help you get the best fuel economy. See “Shift Indicator Light” in this section.

Headlight High Beam Indicator Light

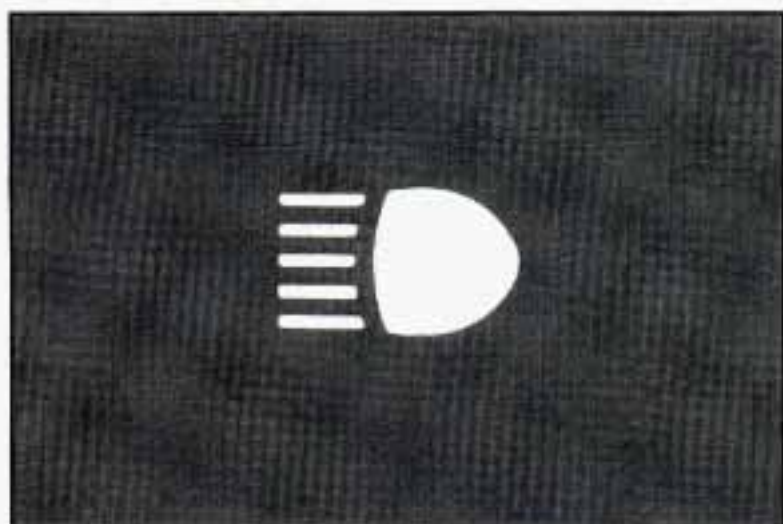

This blue high beam indicator light is on the instrument cluster and is on whenever you use your high beam headlights. For more details about high beams, see “Headlight High–Low Beam Changer” in this section.

Turn Signal and Lane Change Indicator

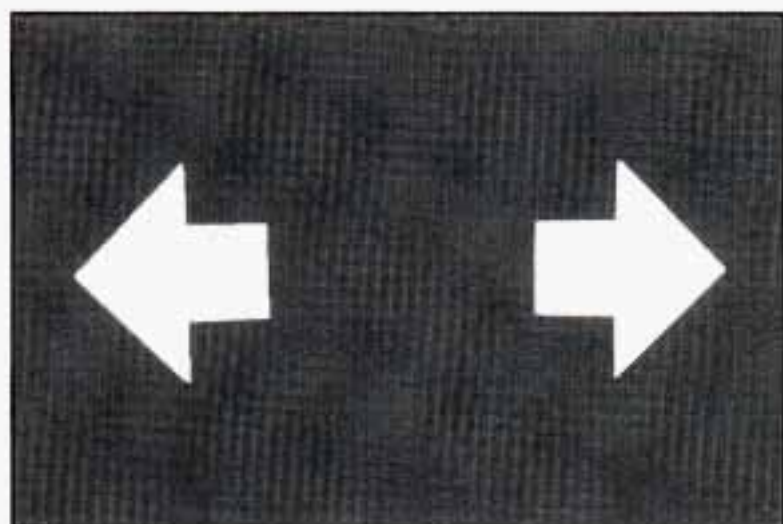

This light with the green arrows is on the instrument cluster. The turn signal indicator will come on whenever you signal a turn or lane change. See “Turn and Lane Change Signal” in this section.

Gages

Fuel Gage



The fuel gage tells you about how much fuel you have remaining, when the ignition is on. When the gage first indicates empty, you still have a little fuel left, but you should get more fuel soon.

Here are four things that some owners ask about. None of these show a problem with your fuel gage:

- At the gas station, the gas pump shuts off before the gage reads full.
- It takes a little more or less fuel to fill up than the gage indicated. For example, the gage may have indicated the tank was half full, but it actually took a little more or less than half the tank's capacity to fill the tank.
- The gage moves a little when you turn a corner or speed up.
- The gage doesn't go back to empty when you turn off the ignition.

For your fuel tank capacity, see the Index under "Fluid Capacities."

Voltmeter



When your engine is not running, but the ignition is on (in the **RUN** position), this gage shows your battery's state of charge in DC volts. When the engine is running, the gage shows the condition of the charging system. Readings between the low and high warning zones indicate the normal operating range.

You can only drive for a short time with the reading in either warning zone. If you must drive, turn off all unnecessary accessories.

Readings in either warning zone indicate a possible problem in the electrical system. Have the vehicle serviced as soon as possible.

Center High Mounted Stop Lamp (CHMSL) Feed Wire

Your vehicle includes a Center High Mounted Stop Lamp (CHMSL) located above the rear window.

If equipment such as a cap or camper is installed, a wire labeled "Center High Mounted Stop Lamp (CHMSL)" feed is provided along the left rear frame. This wire should be used to install a CHMSL in the cap or camper.

Trailer Wiring Harness

Your vehicle may have either a 5-wire or 7-wire harness.

The 5-wire harness is stored under your vehicle, along the left rear frame crossmember. The harness has no connector, and you should have a qualified service person wire your harness for you. Be sure you leave it loose enough so the wiring doesn't bend or break, but not so loose that it drags on the ground.



Store the harness in its original place. Wrap the harness together and tie it neatly so it won't be damaged.

The 7-wire is stored under your vehicle along the rear frame crossmember. This harness has a 30 Amp. in-line fused battery feed wire and no connector, and should be wired by a qualified service person. Attach the harness to the trailer, then tape or strap it to your vehicle's frame rail. Be sure you leave it loose enough so the wiring doesn't bend or break, but not so loose that it drags on the ground.

Store the harness in its original place. Wrap the harness together and tie it neatly so it won't be damaged.

The fuse for trailer wiring is in-line and located in left front side panel electrical block.

Comfort Controls & Audio Systems



Section

3

In this part you'll find out how to operate the comfort control systems and audio systems offered with your vehicle. Be sure to read about the particular system supplied with your vehicle.

For explanation of vehicle symbols, refer to "Vehicle Symbols" in the Introduction.

Comfort Controls

Flow-Through Ventilation System	3-2
Heater Controls	3-3
Heater/Air Conditioning Controls	3-4
Engine Coolant Heater (Engine Block Heater)	3-5
Audio Systems	3-5
FM Stereo	3-6
AM	3-6
AM Stereo	3-6
How to Operate Your ETR [®] AM Radio	3-7
How to Operate Your ETR [®] AM-FM Stereo Audio System	3-8
How to Operate Your ETR [®] AM-FM Stereo Audio Cassette System	3-10
How to Operate Your ETR [®] AM-FM Stereo Audio Cassette System With Equalizer	3-13
Care of Your Cassette Tape Player	3-16
How to Operate Your ETR [®] AM-FM Stereo Audio Compact Disc (CD) System	3-17
Care of Compact Disc	3-22
Fixed Mast Antenna	3-22

Comfort Controls

Flow-Through Ventilation System

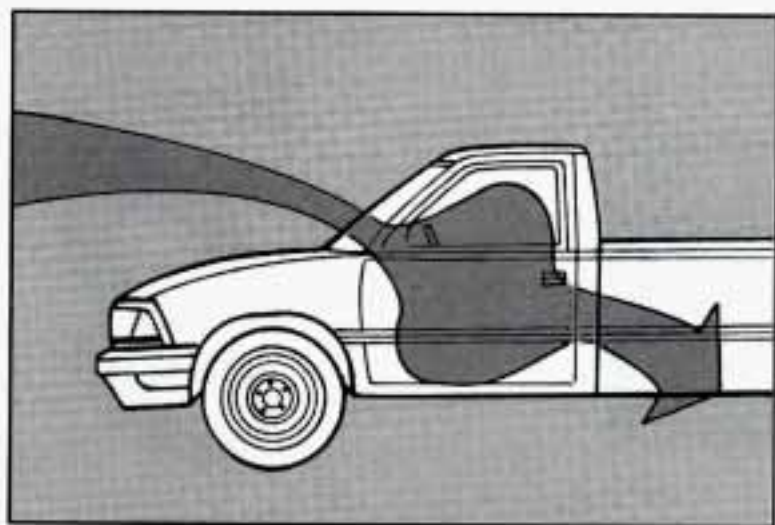

Your vehicle's flow-through ventilation system supplies outside air to the inside of your vehicle when it is moving. With the side windows closed, air will flow into the front air inlet grilles, through the vehicle, and out the rear air exhaust valve. Outside air will also enter the vehicle when the heater or the air conditioning fan is running.

Ventilation Tips

- Keep the hood and front air inlet free of ice, snow, or any other obstruction (such as leaves). The heater and defroster will work far better, reducing the chance of fogging the inside of your windows.
- When you enter a vehicle in cold weather, turn the blower fan to **HI** for a few moments before driving off. This helps clear the intake ducts of snow and moisture, and reduces the chance of fogging the inside of your windows.
- Keep the air path under the front seats clear of objects. This helps air to circulate throughout your vehicle.

Air Vents



You will find air vents in the center and on the sides of your instrument panel. You can move the vents to direct the flow of air, or close the vents altogether. When you close a vent, it will increase the flow of air coming out of any vents that are open.

Heater Controls



If your vehicle does not have air conditioning, your heater controls will look like this.

The switch on the righthand side changes the fan speed. To increase the fan speed, push the switch upward toward **HI**. To decrease the fan speed, push the switch downward toward **LO**.

The upper knob changes the air temperature. Turn the knob right (clockwise) for warmer air. Turn the knob left (counterclockwise) for cooler air.

The lower knob changes the heater function and determines which outlets the air will flow through (instrument panel, defroster, heater, etc.).

OFF: This setting turns off all heating functions. Some outside air will still come out of the heater outlet whenever the vehicle is moving forward.

VENT: Airflow is through the instrument panel vents. Set the upper knob to the temperature desired. This setting is useful for mild outside temperatures, when little heating or cooling is desired.

BI-LEV: Outside air comes in through the heater floor vents and the instrument panel vents. This setting is useful in cool weather with bright sunlight.

HEAT: Heated air comes out through the heater floor vents and windshield defroster vents. This setting is useful for cold weather.

BLEND: Airflow is divided equally between the heater floor vent and the windshield defroster vents. This setting is useful in cool weather when you have fog or ice on the windshield or side windows.

DEF: This setting directs most air through the windshield defroster vents and some through the heater vents. This setting is useful when you have fog or ice on the windshield.

Heater/Air Conditioning Controls



If your vehicle has air conditioning, your heater/air conditioning controls will look like this.

Before using your vehicle's air conditioning, open the windows to clear the vehicle of hot air.

The switch on the righthand side changes the fan speed. To increase the fan speed, push the switch upward toward **HI**. To decrease the fan speed, push the switch downward toward **LO**.

The upper knob changes the air temperature. Turn the knob right (clockwise) for warmer air. Turn the knob left (counterclockwise) for cooler air.

The lower knob changes the heater function and determines which outlets the air will flow through (instrument panel, defroster, heater, etc.).

OFF: This setting turns off all heating functions. Some outside air will still come out of the heater outlet whenever the vehicle is moving forward.

MAX A/C: Air inside your vehicle is recirculated to maximize your air conditioner's performance and your vehicle's fuel economy. This setting cools the air the fastest and should be used to keep "unwanted odors" from entering vehicle..

NORM A/C: This setting cools outside air and directs it through the instrument panel vents. This setting is useful for normal cooling on hot days.

BI-LEV A/C: Outside air is delivered through the heater floor vents and the instrument panel vents. This setting is useful in cool weather with bright sunlight.

VENT: Airflow is through the instrument panel vents. Set the upper knob to the temperature desired. This setting is useful for mild outside temperatures, when little heating or cooling is desired.

HEAT: Heated air comes out through the heater floor vents and windshield defroster vents. This setting is useful for cold weather.

BLEND: Airflow is divided equally between the heater floor vent and the windshield defroster vents. This setting is useful in cool weather when you have fog or ice on the windshield or side windows.

DEF: This setting directs most air through the windshield defroster vents and some through the heater vents. This setting is useful when you have fog or ice on the windshield.

Engine Coolant Heater (Engine Block Heater)

If you use the optional engine coolant heater before starting your engine, your heating system will produce warmer air faster, to heat the passenger compartment in cold weather. See "Engine Coolant Heater" in the Index.

Audio Systems

Your Delco[®] audio system has been designed to operate easily and give years of listening pleasure. But you will get the most enjoyment out of it if you acquaint yourself with it first. Find out what your Delco[®] system can do and how to operate all its controls, to be sure you're getting the most out of the advanced engineering that went into it.

Be aware that hearing damage from loud noise is almost undetectable until it is too late. Your hearing can adapt to higher volumes of sound. Sound that seems normal can be loud and harmful to your hearing. Take precautions by adjusting the volume control on your radio to a safe sound level before your hearing adapts to it.

To help avoid hearing loss or damage:

- Adjust the volume control to the lowest setting.
- Increase volume slowly until you hear comfortably and clearly.

FM Stereo

FM stereo will give you the best sound. But FM signals will reach only about 10 to 40 miles (16 to 65 km). And, tall buildings or hills can interfere with FM signals, causing the sound to come and go.

AM

The range for most AM stations is greater than for FM, especially at night. The longer range, however, can cause stations to interfere with each other. AM can pick up noise from things like storms and power lines. Try reducing the treble to reduce this noise if you ever get it.

AM Stereo

This means the Delco[®] system can receive C-QUAM[®] stereo broadcasts. Many AM stations around the country use C-QUAM[®] to produce stereo, though some do not. (C-QUAM[®] is a registered trademark of Motorola, Inc.) If your Delco[®] system can get C-QUAM[®], your "STEREO" light will come on when you're receiving it.

NOTICE:

Before you add any sound equipment to your vehicle — like a tape player, CB radio, mobile telephone or two-way radio — be sure you can add what you want. If you can, it's very important to do it properly. Added sound equipment may interfere with the operation of your vehicle's engine, Delco[®] radio or other systems, and even damage them. And, your vehicle's systems may interfere with the operation of sound equipment that has been added improperly.

So, before adding sound equipment, check with your dealer and be sure to check Federal rules covering mobile radio and telephone units.

How To Operate Your ETR[®] AM Radio



This part tells you how your ETR[®] AM radio works.

Upper Knob (PWR–VOL–RECALL)

The upper knob has four functions:

- Rotate it to turn the system on and off.
- Rotate it to control the volume.
- Press it to display the time when the ignition is off.
- Press it to change between the clock and the radio station frequency displayed when the radio is on.

BAL (Balance)

The control ring behind the upper knob adjusts the left/right speaker balance.

Lower Knob

Rotate the lower knob to tune in radio stations.

The control ring behind the lower knob is non-functional.

Pushbuttons

The four pushbuttons let you return to favorite stations. You can set the pushbuttons for up to six favorite AM stations. Just:

- Tune in the station you want.
- Press the **SET** pushbutton. (**SET** appears in the VF display for a few seconds.)
- Within 5 seconds, push one of the four pushbuttons to store the station. Whenever you press that button, the preset station will return.

NOTE:

Up to two additional stations may be preset by pressing two adjoining buttons at the same time.

- Tune in the desired station.
- Press the **SET** pushbutton.
- Within 5 seconds, press any two adjoining pushbuttons at the same time. (The station will return when the same two buttons are pressed again.)

Clock

To set the clock, just:

- Press the **SET** pushbutton.
- Within 5 seconds, press and hold **MINS** until the correct minute appears on the display.
- Press and hold **HRS** until the correct hour appears on the display.

TREBLE

Slide the **TREBLE** lever up to increase the treble response. If the station is weak or noisy, slide the **TREBLE** lever down to reduce the noise.

BASS

Slide the **BASS** lever up to increase the bass response. Adjust the **BASS** lever to give a pleasing sound to your ear.

How to Operate Your ETR[®] AM-FM Stereo Audio System



This part tells you how your ETR[®] AM–FM stereo audio system works:

Upper Knob (PWR–VOL–RECALL)

The upper knob has these four functions:

- Rotate it to turn the system on and off.
- Rotate it to control the volume.
- Press it to display the time when the ignition is off.
- Press it to change between the clock and the radio station frequency displayed when the radio is on.

BAL (Balance)

The control ring behind the upper knob adjusts the left/right speaker balance.

Lower Knob

The lower knob has two functions:

- Rotate it to tune in radio stations.
- Press it to change between the AM and FM bands.

FADE

The control ring behind the lower knob adjusts the front/rear speaker balance.

SEEK

Press the **SEEK** button to cause the receiver to **SEEK** the next higher station and stop.

SCAN

When you press **SCAN**, the radio will go to the next station and pause and will keep scanning until you press **SCAN** again. **SCAN** appears in the VF display.

Pushbuttons

The four pushbuttons let you return to favorite stations.

You can set the pushbuttons for up to eight favorite stations (4 AM and 4 FM). Just:

- Tune in the desired station.
- Press the **SET** pushbutton. (**SET** appears in the VF display for a few seconds.)
- Within 5 seconds, push one of the four pushbuttons to store the station. Whenever you press that button, the preset station will return.

NOTE:

Up to two additional stations may be preset on each band by pressing two adjoining buttons at the same time. (The station will return when the same two buttons are pressed again.)

Clock

To set the clock, just:

- Press the **SET** pushbutton.
- Within 5 seconds, press and hold **SEEK** until the correct minute appears on the display.
- Press and hold **SCAN** until the correct hour appears on the display.

TREBLE

Slide the **TREBLE** lever up to increase the treble response. If a station is weak or noisy, slide the **TREBLE** lever down to reduce the noise.

BASS

Slide the **BASS** lever up to increase the bass response. Adjust the **BASS** lever to give a pleasing sound to your ear.

How to Operate Your ETR[®] AM-FM Stereo Audio Cassette System



This part tells you how your ETR[®] AM-FM stereo audio cassette system works:

Upper Knob (PWR-VOL-PROG-RCL)

The upper knob has these five functions:

- Rotate it to turn the system on and off.
- Rotate it to control the volume.
- Press it to display the time when the ignition is off (**RCL**).
- Press it to change between the clock and the radio station frequency displayed when the radio is on (**RCL**).
- Press it to change sides of a tape when a cassette is playing (**PROG**).

BAL (Balance)

The control ring behind the upper knob adjusts the left/right speaker balance.

Lower Knob

The lower knob has two functions:

- Rotate it to tune in radio stations.
- Press it to change between the AM and FM bands.

FADE

The control ring behind the lower knob adjusts the front/rear speaker balance.

SEEK

Press the **SEEK** button to cause the receiver to **SEEK** the next higher station and stop.

SCAN

When you press **SCAN**, the radio will go to the next station and pause, and will keep scanning until you press **SCAN** again. **SCAN** appears in the VF display.

Pushbuttons

The four pushbuttons let you return to favorite stations. You can set the pushbuttons for up to eight favorite stations (4 AM and 4 FM). Just:

- Tune in the desired station.
- Press the **SET** pushbutton. (**SET** appears in the VF display for 5 seconds.)
- Within 5 seconds, push one of the four pushbuttons to store the station. Whenever you press that button, the preset station will return.

NOTE:

In addition to the four stations set as above, up to two additional stations may be preset on each band by pressing two adjoining pushbuttons at the same time.

- Tune in the desired station.
- Push the **SET** pushbutton. (**SET** appears in the VF display for 5 seconds.)
- Within 5 seconds, press any two adjoining pushbuttons at the same time. (The station will return when the same two buttons are pressed again.)

Clock

To set the clock, just:

- Press the **SET** pushbutton.
- Within 5 seconds, press and hold **SEEK** until the correct minute appears on the display.
- Press and hold **SCAN** until the correct hour appears on the display.

TREBLE

Slide the **TREBLE** lever up to increase the treble response. If the station is weak or noisy, slide the **TREBLE** lever down to reduce the noise.

BASS

Slide the **BASS** lever up to increase the bass response. Adjust the **BASS** lever to give a pleasing sound to your ear.

AUTO DNR[®]

This unit is equipped with an automatic Dynamic Noise Reduction system. DNR[®] reduces background hiss on AM and FM radio broadcasts, as well as on cassette tapes.

DNR[®] is a registered trademark of National Semiconductor Corporation.

To Play A Cassette

Your tape player is built to work best with tapes that are 30 to 45 minutes long on each side. Tapes longer than that are so thin they may not work well in this player.

Once the tape is playing, use the upper and lower knobs for volume, balance, and fade just as you do for the radio. The arrows indicate which side of the tape is being played.

Fast Forward

Press the button with the arrow pointing in the same direction that the tape is playing. The arrow light next to the arrow button will be lit. To stop fast forward, press the **STOP-EJECT** button.

Reverse

Press the button with the arrow pointing in the opposite direction that the tape is playing. The arrow light next to the arrow button will be lit. To stop reverse, press the **STOP-EJECT** button.

PROGRAM

To change sides of the tape, press the **PWR-VOL-PROG-RCL** knob.

STOP-EJECT

To stop playing a tape, fully press this button (the cassette will be partially ejected, and the radio will begin playing).

How to Operate Your ETR[®] AM-FM Stereo Audio Cassette System with Equalizer



This part tells you how your ETR[®] AM-FM stereo audio cassette system with equalizer works:

Upper Knob (PWR-VOL-PROG-RCL)

The upper knob has these five functions:

- Rotate it to turn the system on and off.
- Rotate it to control the volume.
- Press it to display the time when the ignition is off (**RCL**).
- Press it to change between the clock and the radio station frequency displayed when the radio is on (**RCL**).
- Press it to change sides of a tape when a cassette is playing (**PROG**).

BAL (Balance)

The control ring behind the upper knob adjusts the left/right speaker balance.

Lower Knob

The lower knob has two functions:

- Rotate it to tune in radio stations.
- Press it to change between the AM and FM bands.

FADE

The control ring behind the lower knob adjusts the front/rear speaker balance.

SEEK

Press the **SEEK** button to cause the receiver to **SEEK** the next higher station and stop.

SCAN

When you press **SCAN**, the radio will go to the next station and pause and will keep scanning until you press **SCAN** again. **SCAN** appears in the graphic display.

Pushbuttons

The four pushbuttons let you return to favorite stations. You can set the pushbuttons for up to eight favorite stations (4 AM and 4 FM). Just:

- Tune in the desired station.
- Push the **SET** pushbutton (**SET** appears in the VF display for 5 seconds.)
- Within the 5 seconds, push one of the four pushbuttons. Whenever you press that button, the preset station will return.

NOTE:

In addition to the four stations set as above, up to two additional stations may be preset on each band by pressing two adjoining pushbuttons at the same time. Just:

- Tune in the desired station.
- Press the **SET** pushbutton (**SET** appears in the VF display for 5 seconds.)
- Within 5 seconds, press any two adjoining pushbuttons at the same time. (The station will return when the same two buttons are pressed again.)

Clock

To set the clock, just:

- Press the **SET** pushbutton.
- Within 5 seconds, press and hold **SEEK** until the correct minute appears on the display.
- Press and hold **SCAN** until the correct hour appears on the display.

Adjust the Tone

Use the levers in the upper left corner to set the bass, midrange, and treble until you get the sound you want. The 60 and 250 levers adjust the bass; 1K is midrange; and 3.5K and 10K control the treble.

We suggest you start with the center lever (1K) in the midpoint position, then move the others up until you get the amount of bass and treble you like.

Am–St Button

The **Am–St** is just below the **SEARCH** button. Push this when you tune to an AM station that broadcasts in stereo. Your **STEREO** light will come on when you're receiving AM stereo. If you push **Am–St** and there is no more noise, it means the station is weak. You'll hear the station better if you don't use **Am–St**. Just push the **Am–St** button again to delete stereo.

AUTO DNR[®]

This unit is equipped with an automatic Dynamic Noise Reduction system. DNR[®] reduces background hiss on AM and FM radio broadcasts, as well as on cassette tapes.

DNR[®] is a registered trademark of National Semiconductor Corporation.

To Play A Cassette

Your tape player is built to work best with tapes that are 30 to 45 minutes long on each side. Tapes longer than that are so thin they may not work well in this player.

Once the tape is playing, use the upper and lower knobs for volume, balance and fade, just as you do for the radio. The arrows indicate which side of the tape is being played.

Fast Forward

Press the button with the arrow pointing in the same direction that the tape is playing. The arrow light next to the arrow button will be lit. To stop fast forward, press the **STOP-EJECT** button.

Reverse

Press the button with the arrow pointing in the opposite direction that the tape is playing. The arrow light next to the arrow button will be lit. To stop reverse, press the **STOP-EJECT** button.

SEARCH

Press the **SEARCH** button.

Press **FWR** to go to the beginning of the next selection.

Press **REV** and the tape will reverse to the beginning of the current selection.

Cr02

The **Cr02** button lets you set the system for the type of cassette being used. If you are using chrome or metal tapes, push the **Cr02** button in.

PROGRAM

To change sides of the tape, press the **PWR-VOL-PROG-RCL** knob.

STOP-EJECT

To stop playing a tape, fully press this button (the cassette will be partially ejected, and the radio will begin playing).

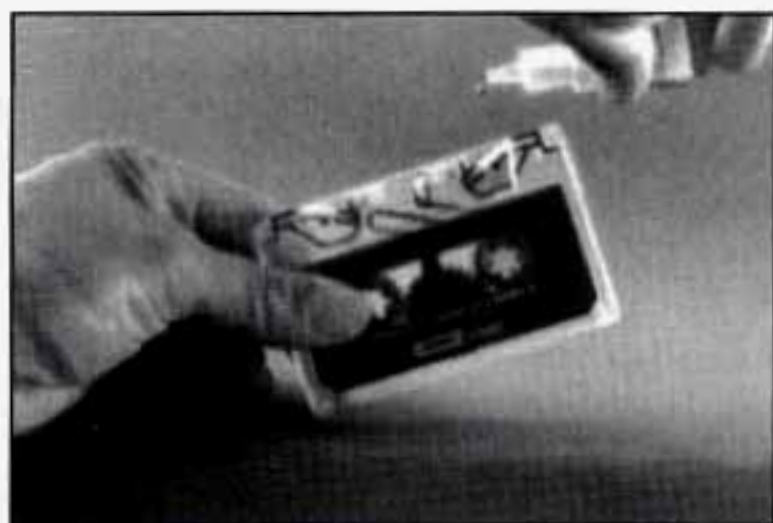

Care of Your Cassette Tape Player

A tape player that is not cleaned regularly is subject to reduced sound quality, ruining the cassette, or a damaging the mechanism. Tape cassettes that are not properly stored in their plastic cases away from contaminants, direct sunlight, and extreme heat may not operate properly and could cause premature failure of the tape player.

Your tape player should be cleaned monthly or with every 15 hours of use, as regular maintenance. If you notice a reduction in sound quality, try a good cassette to see if the tape or the tape player is at fault. If the second cassette results in no improvement in sound quality, try cleaning the tape player.

Proper tape player cleaning should be done with a *wiping-action* non-abrasive cleaner cassette. To properly clean your tape player, you should follow the directions on the cleaning cassette.

Cassettes are subject to wear and the sound quality may degrade over time. Always verify that the cassette tape is in good condition before obtaining service on your tape player.

How to Operate Your ETR[®] AM-FM Stereo Audio Compact Disc (CD) System



This part tells you how your ETR[®] AM-FM stereo system works:

Upper Knob (PWR-VOL)

The upper knob has three functions:

- It switches the radio on and off when the ignition is on.
- It controls the volume. Volume will increase when the **RCL** knob is turned to the right and decrease when turned to the left. Volume will be displayed briefly unless **Left/Right** speaker control, **Rear/Front** speaker control, **BASS** or **TREB** are adjusted.
- It controls the mute feature. By pressing the **MUTE** knob, all sound from the radio or CD player stops. By pressing the knob again, or by turning the **VOL** knob to the right, sound will begin again.

Left/Right Speaker Control

The control ring behind the upper knob allows you to balance the sound between the left and right speakers. Balance will be displayed briefly when using this control.

Lower Knob

The lower knob has two functions:

- It enables you to tune in different radio stations by turning the knob to the right or to the left.
- It enables you to alternate between AM and FM stations by pressing the **BAND** knob. Your selection will be briefly displayed.

Rear/Front Speaker Control

The control ring behind the lower knob fades the sound between your rear and front speakers. Fade levels will be briefly displayed.

SEEK

Pressing the **SEEK ▶** button will cause the receiver to seek the next higher station and stop.

Pressing the **◀ SEEK** button will cause the receiver to seek the next lower station and stop.

SCAN

When you press **SCAN**, the radio will go to the next station and pause, and will keep scanning until you press **SCAN** again. **SC** will be displayed when using this control.

Pushbuttons

The five pushbuttons let you return to favorite stations. They are also used when you play a disc. (See "To Play A Compact Disc".)

To set the pushbuttons for up to ten favorite stations (5 AM and 5 FM):

- Tune in the desired station.
- Push the **SET** button. (**SET** is displayed briefly.)
- Within 5 seconds, push one of the five pushbuttons to store the station. Whenever you press that button, the preset station will return.

Clock

To set the clock, just:

- Press the **SET** button. The radio may be on or off.
- Within 5 seconds, press and hold either **SEEK ▶** to increase the minutes or **◀ SEEK** to decrease the minutes until the correct minute appears on the display.
- Press and hold **SCAN** until the correct hour appears on the display.

RCL

Press the **RCL** button to alternate between time and radio station on the display. **RCL** may be pressed when the ignition is off to see the time.

BASS

Press the **BASS▲** to increase the bass tones and **▼ BASS** to decrease bass tones. Press the center of the control for a preset **BASS** position. The bass level will be displayed briefly when using this control.

TREBLE

Press the **TREB▲** to increase the treble tones and **▼ TREB** to decrease the treble tones. Press the center of the control for a preset **TREB** position. The treble level will be displayed briefly when using this control.

To Play A Compact Disc (CD)

NOTICE:

Before you begin, please note: **DO NOT** use mini-discs that are called singles. They won't eject. **USE FULL-SIZE COMPACT DISCS.**

If the disc player is very hot, or if you're driving on a very rough road, a disc may come out or just not play. If you see the word **HOT** on the display, the disc player is too hot to play the disc. Press **RCL** to make the word **HOT** go off the display. When things get back to normal, the disc should play again. Press **PWR** to turn the system on.

Insert a disc partway into the slot, label side up. The player will pull it in. Wait a few seconds and the disc should play.

If the disc comes back out, check whether:

- The disc is upside down.
- It is dirty, scratched, or wet.
- Too much moisture is in the air. (If there is, wait about one hour and try again.)

RCL

Press **RCL** to see what track is playing. Press it again within 5 seconds to see how long it has been playing. The track number also appears when you change the volume or when a new track starts to play.

COMP

Press the **COMP** button to make soft and loud passages more nearly equal in volume. **COMP** appears in the display while using this command.

RDM

The **RDM** button means random and when it is pressed, it causes the CD mechanism to play the tracks in a random order rather than in the sequential 1, 2, 3 order.

REV

Press and hold the **REV** button to quickly return to a favorite passage. The counter reading will be displayed when using this control.

FWD

Press and hold the **FWD** button to advance quickly within a track. Release it to resume playing. Watch the display to stop at a specific passage.

SCAN

Press **SCAN** to sample each track for approximately 10 seconds. Scanning will continue until the **RDM**, **SCAN** or any other motion button is pressed again.

PREV

If you hold the **PREV** (◀ **SEEK**) button, or press it more than once, the disc will return to previous tracks.

NEXT

Press **NEXT** (**SEEK** ▶) to hear the next track now instead of waiting until the present track is finished. If you hold this button or press it more than once, the disc will advance further.

ST-PL

Press **ST-PL** (Stop-Play) to make the disc stop and the radio play. Press **ST-PL** again to restart the disc at the point where it stopped.

Press **PWR** or turn the ignition key off to stop the disc player. The disc stays in the player and will resume playing at the point where it stopped.

Press **EJCT** to eject the disc and make the radio play. The disc will start at track 1 when you reinsert it.

Anti-Theft Feature

Delco LOC II[®] is an Anti-Theft feature for the compact disc player. It can be used or ignored. If ignored, the system plays normally. If it is used, your player won't be usable if it is ever stolen, because it won't turn on.

The instructions below tell you how to enter a secret code into the system. If your car loses battery power for any reason, you must unlock the system with the secret code before the radio will turn on.

To Lock The System:

1. Write down any 6 digit number and keep it in a safe place.
2. Turn the ignition to the *ACC* (Accessory) or *RUN* position.
3. Press the **PWR** button to turn the radio off.
4. Press the **1** and **4** buttons together. Hold them down until “- - -” shows on the display.

You are now ready to enter your secret code. **Don't wait more than 15 seconds between steps.**

5. Press **SET** and **000** will appear on the display.
6. Press the **SEEK** ▶ or ◀ button to make the first number appear.
7. Press **SCAN** to make the last two numbers agree with your code.

8. Press **BAND** and **000** will appear again. Now you are ready to enter the last three digits of your code.
9. Repeat steps 6 and 7 for the last three digits of your code.
10. Press **BAND** and **rEP** will appear for 5 seconds and then **000** will appear.
11. Repeat steps 6 through 10. This time **SEC** will appear—indicating that the radio is secure.

To Unlock The System After A Power Loss

When battery power is reapplied to a secured radio, the radio won't turn on and **LOC** will appear on the display.

Enter your secret code as follows; pause no more than 15 seconds between steps.

1. Turn the ignition on. (Radio off.)
2. Depress the **SET** button. The display will show **000**.
3. Enter the six digits of the code following steps 6–9 above. The display will show the numbers as entered.
4. Depress the **BAND** knob and the **time** appears — indicating that the disabling sequence was successful. If the display indicates **SEC**, the numbers did not match and the unit is still secured.

Disabling The Theft System

1. Depress presets **1** and **4** for 5 seconds with ignition on and radio power off. The display will show **SEC**, indicating the unit is in the secure mode.
2. Depress the **SET** button. The display will show **000**.
3. Enter the first three digits of the code following steps 6 and 7 of the preceding paragraphs. The display will show the numbers as entered.
4. Depress the **BAND** knob. The radio will display **000**.
5. Enter the second three digits of the code. The display will show the numbers as entered.
6. Depress the **BAND** knob. If the display shows “— — —”, the disabling sequence was successful. The numbers matched the user-selected code or the factory back-up code, and the unit is in the *UNSECURED* mode. If the display shows **SEC**, the disabling sequence was unsuccessful and the numbers did not match either of the codes and the unit will remain in the *SECURED* mode.

Care of Your Compact Discs

Handle discs carefully. Store them in their original cases or other protective cases and away from direct sunlight and dust. If the surface of a disc is soiled, dampen a clean, soft cloth in a mild, neutral detergent solution and clean it, wiping from the center to the edge.



Be sure never to touch the signal surface when handling discs. Pick up discs by grasping the outer edges or the edge of the hole and the outer edge.

Fixed Mast Antenna

The fixed mast antenna can withstand most car washes without being damaged. If the mast should ever become slightly bent, you can straighten it out by hand. If the mast is badly bent, as it might be by vandals, you should replace it.

Check every once in a while to be sure the mast is still tightened to the fender.

Your Driving and the Road



Section

4

Here you'll find information about driving on different kinds of roads and in varying weather conditions. We've also included many other useful tips on driving.

Defensive Driving	4-2
Drunken Driving	4-2
Control of a Vehicle	
Braking	4-5
Steering	4-8
Steering Tips	4-8
Passing	4-11
Loss of Control	4-12
Driving Guidelines	4-13
Off-Road Driving With Your Four-Wheel Drive Vehicle	4-13
Driving at Night	4-25
Driving in the Rain	4-26
City Driving	4-28
Freeway Driving	4-29
Hill and Mountain Roads	4-31
Winter Driving	4-33
Recreational Vehicle Towing (Four-Wheel Drive Only)	4-36
Towing a Trailer	4-38

Defensive Driving

The best advice anyone can give about driving is: Drive defensively.

Please start with a very important safety device in your vehicle: Buckle up. (See “Safety Belts” in the Index.)

Defensive driving really means “be ready for anything.” On city streets, rural roads, or freeways, it means “always expect the unexpected.”

Assume that pedestrians or other drivers are going to be careless and make mistakes. Anticipate what they might do. Be ready for their mistakes.

Rear-end collisions are about the most preventable of accidents. Yet they are common. Allow enough following distance. It’s the best defensive driving maneuver, in both city and rural driving. You never know when the vehicle in front of you is going to brake or turn suddenly.

Drunken Driving

Death and injury associated with drinking and driving is a national tragedy. It’s the number one contributor to the highway death toll, claiming thousands of victims every year. Alcohol takes away three things that anyone needs to drive a vehicle:

- Judgment
- Muscular Coordination
- Vision

Police records show that almost half of all motor vehicle-related deaths involve alcohol — a driver, a passenger or someone else, such as a pedestrian, had been drinking. In most cases, these deaths are the result of someone who was drinking and driving. About 20,000 motor vehicle-related deaths occur each year because of alcohol, and thousands of people are injured.

Just how much alcohol is too much if a person plans to drive? Ideally, no one should drink alcohol and then drive. But if one does, then what’s “too much”? It can be a lot less than many might think. Although it depends on each person and situation, here is some general information on the problem.

The Blood Alcohol Content (BAC) of someone who is drinking depends upon four things:

- How much alcohol is in the drink.
- The drinker’s body weight.
- The amount of food that is consumed before and during drinking.
- The length of time it has taken the drinker to consume the alcohol.



According to the American Medical Association, a 180-pound (82 kg) person who drinks three 12-ounce (355 ml) bottles of beer in an hour will end up with a BAC of about 0.06 percent. The person would reach the same BAC by drinking three 4-ounce (120 ml) glasses of wine or three mixed drinks if each had 1-1/2 ounces (45 ml) of a liquor like whiskey, gin or vodka.

It's the amount of alcohol that counts. For example, if the same person drank three double martinis (3 ounces or 90 ml of liquor each) within an hour, the person's BAC would be close to 0.12 percent. A person who consumes food just before or during drinking will have a slightly lower BAC level.

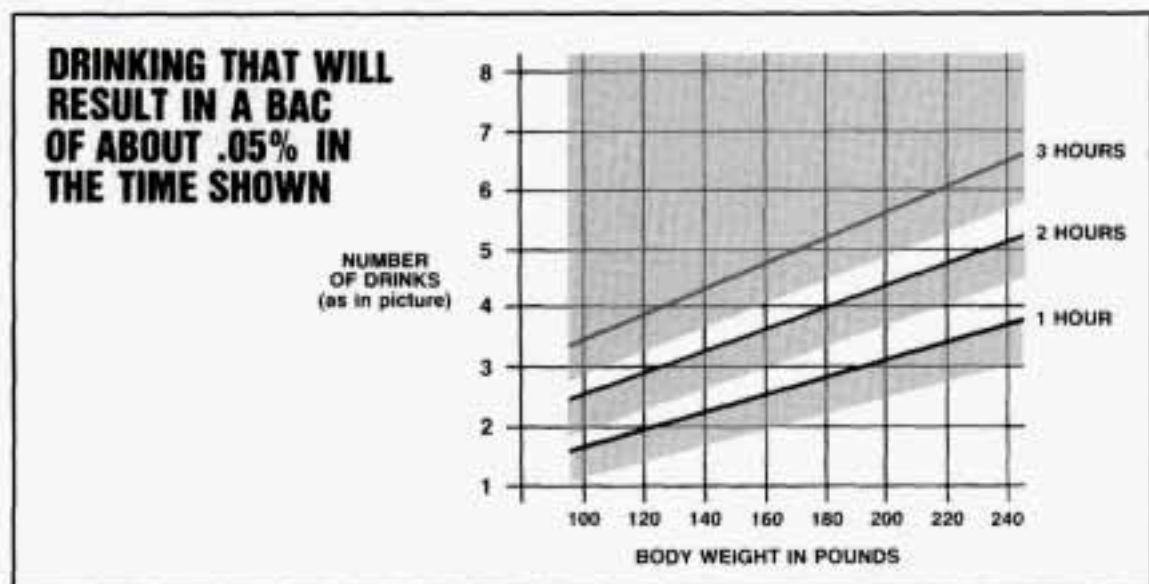

The law in most U.S. states sets the legal limit at a BAC of 0.10 percent. In Canada the limit is 0.08 percent, and in some other countries it's lower than that. The BAC will be over 0.10 percent after three to six drinks (in one hour). Of course, as we've seen, it depends on how much alcohol is in the drinks, and how quickly the person drinks them.

But it's very important to keep in mind that the ability to drive is affected well below a BAC of 0.10 percent. Research shows that the driving skills of many people are impaired at a BAC approaching 0.05 percent, and that the effects are worse at night. All drivers are impaired at BAC levels above 0.05 percent. Statistics show that the chance of being in an accident increases sharply for drivers who have a BAC of 0.05 percent or above. A driver with a BAC level of 0.06 percent (three beers in one hour for a 180-pound or 82 kg person) has doubled his or her chance of having an accident. At a BAC level of 0.10 percent, the chance of that driver having an accident is six times greater; at a level of 0.15 percent, the chances are twenty-five times greater! And, the body takes about an hour to rid itself of the alcohol in one drink. No amount of coffee or number of cold showers will speed that up.

"I'll be careful" isn't the right answer. What if there's an emergency, a need to take sudden action, as when a child darts into the street? A person with a higher BAC might not be able to react quickly enough to avoid the collision.

There's something else about drinking and driving that many people don't know. Medical research shows that alcohol in a person's system can make crash injuries worse. That's especially true for brain, spinal cord and heart injuries. That means that if anyone who has been drinking — driver or passenger — is in a crash, the chance of being killed or permanently disabled is higher than if that person had not been drinking. And we've already seen that the chance of a crash itself is higher for drinking drivers.



CAUTION:

Drinking and then driving is very dangerous. Your reflexes, perceptions, and judgment will be affected by even a small amount of alcohol. You could have a serious — or even fatal — accident if you drive after drinking. Please don't drink and drive or ride with a driver who has been drinking. Ride home in a cab; or if you're with a group, designate a driver who will not drink.

Control of a Vehicle

You have three systems that make your vehicle go where you want it to go. They are the brakes, the steering and the accelerator. All three systems have to do their work at the places where the tires meet the road.

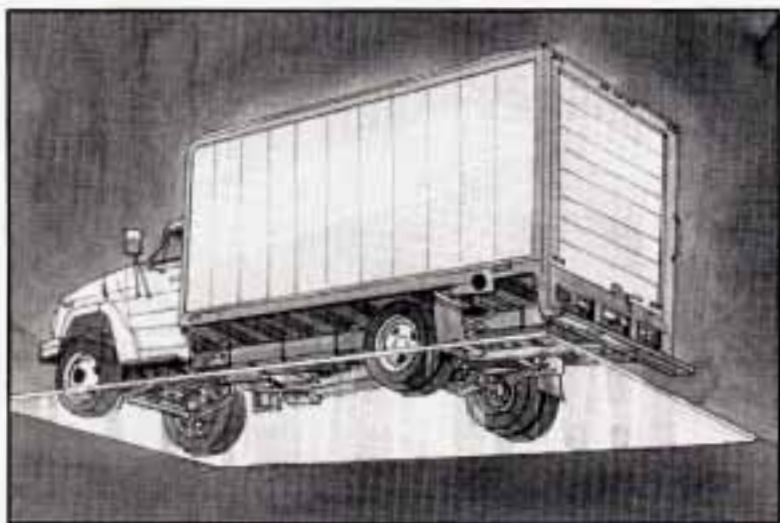

Sometimes, as when you're driving on snow or ice, it's easy to ask more of those control systems than the tires and road can provide. That means you can lose control of your vehicle.

Braking

Braking action involves *perception time* and *reaction time*.

First, you have to decide to push on the brake pedal. That's *perception time*. Then you have to bring up your foot and do it. That's *reaction time*.

Average *reaction time* is about $3/4$ of a second. But that's only an average. It might be less with one driver and as long as two or three seconds or more with another. Age, physical condition, alertness, coordination, and eyesight all play a part. So do alcohol, drugs and frustration. But even in $3/4$ of a second, a vehicle moving at 60 mph (100 km/h) travels 66 feet (20 m). That could be a lot of distance in an emergency, so keeping enough space between your vehicle and others is important.

And, of course, actual stopping distances vary greatly with the surface of the road (whether it's pavement or gravel); the condition of the road (wet, dry, icy); tire tread; and the condition of your brakes.

Avoid needless heavy braking. Some people drive in spurts — heavy acceleration followed by heavy braking — rather than keeping pace with traffic. This is a mistake. Your brakes may not have time to cool between hard stops. Your brakes will wear out much faster if you do a lot of heavy braking. If you keep pace with the traffic and allow realistic following distances, you will eliminate a lot of unnecessary braking. That means better braking and longer brake life.

If your engine ever stops while you're driving, brake normally but don't pump your brakes. If you do, the pedal may get harder to push down. If your engine stops, you will still have some power brake assist. But you will use it when you brake. Once the power assist is used up, it may take longer to stop and the brake pedal will be harder to push.

Anti-Lock Brakes (ABS)

Your vehicle has an advanced electronic braking system that can help you keep it under control.

If your vehicle has an anti-lock brake system warning light on the instrument panel, it has four-wheel anti-lock brakes. Otherwise, it has rear-wheel anti-lock brakes. When you start a vehicle that has four-wheel anti-lock brakes and begin to drive away, you may hear a momentary motor or clicking noise. This is the ABS system testing itself.



Here's how anti-lock works. Let's say the road is wet. You're driving safely. Suddenly an animal jumps out in front of you.

You slam on the brakes. Here's what happens with ABS.

A computer senses that wheels are slowing down. With four-wheel anti-lock: If one of the wheels is about to stop rolling, the computer will separately work the brakes at each front wheel and at the rear wheels. The four-wheel anti-lock system can change the brake pressure faster than any

driver could. With rear-wheel anti-lock: If one of the rear wheels is about to stop rolling, the computer will work the brakes at the rear wheels. The computer is programmed to make the most of available tire and road conditions.



As you brake, your computer keeps receiving updates on wheel speed and controls braking pressure accordingly.

Remember: Anti-lock doesn't change the time you need to get your foot up to the brake pedal. If you get too close to the vehicle in front of you, you won't have time to apply your brakes if that vehicle suddenly slows or stops. Always leave enough room up ahead to stop, even though you have anti-lock brakes.

To Use Four-Wheel Anti-Lock

Don't pump the brakes. Just hold the brake pedal down and let anti-lock work for you. You may feel the brakes vibrate, or you may notice some noise, but this is normal.

To Use Rear-Wheel Anti-Lock

Use rear-wheel anti-lock like regular brakes. You may feel the brakes vibrate, or you may notice some noise outside your vehicle, but this is normal. Let anti-lock work for you, but remember: Your front wheels can still stop rolling. If that happens, release enough pressure on the brakes to get the wheels rolling again so that you can steer.

With the four-wheel drive option, you won't have rear-wheel anti-lock braking when you shift into four-wheel drive. But you will have regular braking. When you shift back into two-wheel drive, you will have rear-wheel anti-lock again.

Braking in Emergencies

At some time, nearly every driver gets into a situation that requires hard braking.

The four-wheel anti-lock system lets you steer and brake at the same time. If you have the rear-wheel anti-lock braking system, your front wheels can stop rolling when you brake very hard. Once they do, the vehicle can't respond to your steering. Momentum will carry it in whatever direction it was headed when the front wheels stopped rolling. That could be off the road, into the very thing you were trying to avoid, or into traffic.

So, unless you have four-wheel anti-lock, use a "squeeze" braking technique. This will give you maximum braking while maintaining steering control. You do this by pushing on the brake pedal with steadily increasing pressure. When you do, it will help maintain steering control. In many emergencies, steering can help you more than even the very best braking.

Steering

Power Steering

If you lose power steering assist because the engine stops or the system is not functioning, you can steer but it will take much more effort.

Steering Tips

Driving on Curves

It's important to take curves at a reasonable speed.

A lot of the "driver lost control" accidents mentioned on the news happen on curves. Here's why:

Experienced driver or beginner, each of us is subject to the same laws of physics when driving on curves. The traction of the tires against the road surface makes it possible for the vehicle to change its path when you turn the front wheels. If there's no traction, inertia will keep the vehicle going in the same direction. If you've ever tried to steer a vehicle on wet ice, you'll understand this.

The traction you can get in a curve depends on the condition of your tires and the road surface, the angle at which the curve is banked, and your speed. While you're in a curve, speed is the one factor you can control.

Suppose you're steering through a sharp curve. Then you suddenly apply the brakes. Both control systems — steering and braking — have to do their work where the tires meet the road. Unless you have four-wheel anti-lock brakes, adding the hard braking can demand too much of those places. You can lose control.

The same thing can happen if you're steering through a sharp curve and you suddenly accelerate. Those two control systems — steering and acceleration — can overwhelm those places where the tires meet the road and make you lose control.

What should you do if this ever happens? Ease up on the brake or accelerator pedal, steer the vehicle the way you want it to go, and slow down.

Speed limit signs near curves warn that you should adjust your speed. Of course, the posted speeds are based on good weather and road conditions. Under less favorable conditions you'll want to go slower.

If you need to reduce your speed as you approach a curve, do it before you enter the curve, while your front wheels are straight ahead.

Try to adjust your speed so you can "drive" through the curve. Maintain a reasonable, steady speed. Wait to accelerate until you are out of the curve, and then accelerate gently into the straightaway.

Steering in Emergencies

There are times when steering can be more effective than braking. For example, you come over a hill and find a truck stopped in your lane, or a car suddenly pulls out from nowhere, or a child darts out from between parked cars and stops right in front of you. You can avoid these problems by braking — if you can stop in time. But sometimes you can't; there isn't room. That's the time for evasive action — steering around the problem.

Your Vehicle can perform very well in emergencies like these. First apply your brakes — but, unless you have four-wheel anti-lock, not enough to lock your front wheels. It is better to remove as much speed as you can from a possible collision. Then steer around the problem, to the left or right depending on the space available.

An emergency like this requires close attention and a quick decision. If you are holding the steering wheel at the recommended 9 and 3 o'clock positions, you can turn it a full 180 degrees very quickly without removing either hand. But you have to act fast, steer quickly, and just as quickly straighten the wheel once you have avoided the object.



The fact that such emergency situations are always possible is a good reason to practice defensive driving at all times and wear safety belts properly.

Off-Road Recovery

You may find sometime that your right wheels have dropped off the edge of a road onto the shoulder while you're driving.

If the level of the shoulder is only slightly below the pavement, recovery should be fairly easy. Ease off the accelerator and then, if there is nothing in the way, steer so that your vehicle straddles the edge of the pavement. You can turn the steering wheel up to 1/4 turn until the right front tire contacts the pavement edge. Then turn your steering wheel to go straight down the roadway.

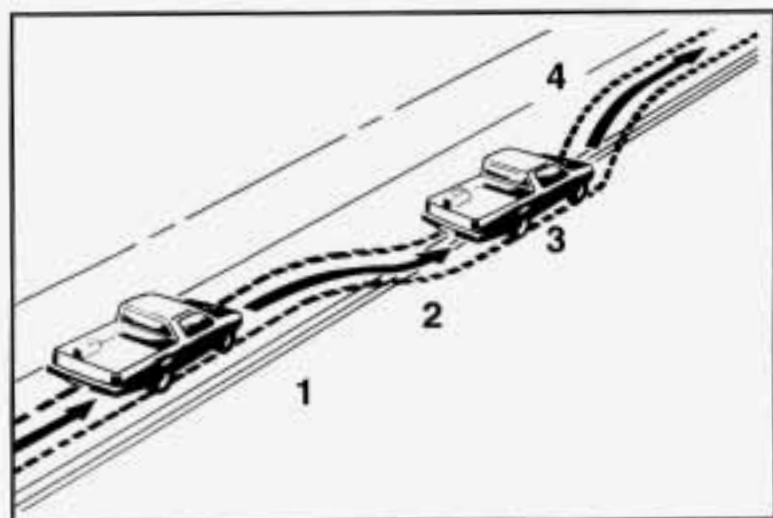

1. Edge of Road Surface
2. Slow Down
3. Left Approx. Quarter Turn
4. Recover

Passing

The driver of a vehicle about to pass another on a two-lane highway waits for just the right moment, accelerates, moves around the vehicle ahead, then goes back into the right lane again. A simple maneuver?

Not necessarily! Passing another vehicle on a two-lane highway is a potentially dangerous move, since the passing vehicle occupies the same lane as oncoming traffic for several seconds. A miscalculation, an error in judgment, or a brief surrender to frustration or anger can suddenly put the passing driver face to face with the worst of all traffic accidents — the head-on collision.

So here are some tips for passing:

- “Drive ahead.” Look down the road, to the sides, and to crossroads for situations that might affect your passing patterns. If you have any doubt whatsoever about making a successful pass, wait for a better time.
- Watch for traffic signs, pavement markings, and lines. If you can see a sign up ahead that might indicate a turn or an intersection, delay your pass. A broken center line usually indicates it’s all right to pass (providing the road ahead is clear). Never cross a solid line on your side of the lane or a double solid line, even if the road seems empty of approaching traffic.
- Do not get too close to the vehicle you want to pass while you’re awaiting an opportunity. For one thing, following too closely reduces your area of vision, especially if you’re following a larger vehicle. Also, you won’t have adequate space if the vehicle ahead suddenly slows or stops. Keep back a reasonable distance.
- When it looks like a chance to pass is coming up, start to accelerate but stay in the right lane and don’t get too close. Time your move so you will be increasing speed as the time comes to move into the other lane. If the way is clear to pass, you will have a “running start” that more than makes up for the distance you would lose by dropping back. And if something happens to cause you to cancel your pass, you need only slow down and drop back again and wait for another opportunity.
- If other cars are lined up to pass a slow vehicle, wait your turn. But take care that someone isn’t trying to pass you as you pull out to pass the slow vehicle. Remember to glance over your shoulder and check the blind spot.

- Check your mirrors , glance over your shoulder, and start your left lane change signal before moving out of the right lane to pass. When you are far enough ahead of the passed vehicle to see its front in your inside mirror, activate your right lane change signal and move back into the right lane. (Remember that your right outside mirror is convex. The vehicle you just passed may seem to be farther away from you than it really is.)
- Try not to pass more than one vehicle at a time on two-lane roads. Reconsider before passing the next vehicle.
- Don't overtake a slowly moving vehicle too rapidly. Even though the brake lights are not flashing, it may be slowing down or starting to turn.
- If you're being passed, make it easy for the following driver to get ahead of you. Perhaps you can ease a little to the right.

Loss of Control

Let's review what driving experts say about what happens when the three control systems (brakes, steering and acceleration) don't have enough friction where the tires meet the road to do what the driver has asked.

In any emergency, don't give up. Keep trying to steer and constantly seek an escape route or area of less danger.

Skidding

In a skid, a driver can lose control of the vehicle. Defensive drivers avoid most skids by taking reasonable care suited to existing conditions, and by not "overdriving" those conditions. But skids are always possible.

The three types of skids correspond to your Vehicle's three control systems. In the braking skid your wheels aren't rolling. In the steering or cornering skid, too much speed or steering in a curve causes tires to slip and lose cornering force. And in the acceleration skid too much throttle causes the driving wheels to spin.

A cornering skid and an acceleration skid are best handled by easing your foot off the accelerator pedal.

If your vehicle starts to slide, ease your foot off the accelerator pedal and quickly steer the way you want the vehicle to go. If you start steering quickly enough, your vehicle may straighten out. Always be ready for a second skid if it occurs.

Of course, traction is reduced when water, snow, ice, gravel, or other material is on the road. For safety, you'll want to slow down and adjust your driving to these conditions. It is important to slow down on slippery surfaces because stopping distance will be longer and vehicle control more limited.

While driving on a surface with reduced traction, try your best to avoid sudden steering, acceleration, or braking (including engine braking by shifting to a lower gear). Any sudden changes could cause the tires to slide. You may not realize the surface is slippery until your vehicle is skidding. Learn to recognize warning clues — such as enough water, ice or packed snow on the road to make a “mirrored surface” — and slow down when you have any doubt.

Remember: If you have the four-wheel anti-lock braking system, it helps avoid only the braking skid. The rear-wheel anti-lock braking system helps avoid only a rear braking skid. In a braking skid (where the front wheels are no longer rolling), release enough pressure on the brakes to get the front wheels rolling again. This restores steering control. Push the brake pedal down steadily when you have to stop suddenly. As long as the front wheels are rolling, you will have steering control.

Driving Guidelines

Off-Road Driving with Your Four-Wheel Drive Vehicle

This off-road guide is for vehicles that have four-wheel drive.

Also, see “Anti-lock Brakes” in the Index.

If your vehicle doesn't have four-wheel drive, you shouldn't drive off-road unless you're on a level, solid surface.

Off-road driving can be great fun. But it does have some definite hazards. The greatest of these is the terrain itself.

“Off-roading” means you've left the great North American road system behind. Traffic lanes aren't marked. Curves aren't banked. There are no road signs. Surfaces can be slippery, rough, uphill or downhill. In short, you've gone right back to nature.

Off-road driving involves some new skills. And that's why it's very important that you read this guide. You'll find many driving tips and suggestions. These will help make your off-road driving safer and more enjoyable.

Before You Go Off-Roading

There are some things to do before you go out. For example, be sure to have all necessary maintenance and service work done. Be sure you read all the information about your four-wheel drive vehicle in this manual. Is there enough fuel? Is the spare tire fully inflated? Are the fluid levels up where they should be? What are the local laws that apply to off-roading where you'll be driving? If you don't know, you should check with law enforcement people in the area. Will you be on someone's private land? If so, be sure to get the necessary permission.

Loading Your Vehicle for Off-Road Driving

There are some important things to remember about how to load your vehicle.

- The heaviest things should be on the load floor and forward of your rear axle. Put heavier items as far forward as you can.
- Be sure the load is secured properly, so driving on the off-road terrain doesn't toss things around.



CAUTION:

- **Cargo on the load floor piled higher than the seatbacks can be thrown forward during a sudden stop. You or your passengers could be injured. Keep cargo below the top of the seatbacks.**
- **Unsecured cargo on the load floor can be tossed about when driving over rough terrain. You or your passengers can be struck by flying objects. Secure the cargo properly.**
- **Heavy loads on the roof raise the vehicle's center of gravity, making it more likely to roll over. You can be seriously or fatally injured if the vehicle rolls over. Put heavy loads inside the cargo area, not on the roof. Keep cargo in the cargo area as far forward and low as possible.**

You'll find other important information in this manual. See "Vehicle Loading," and "Tires" in the Index.

Traveling to Remote Areas

It makes sense to plan your trip, especially when going to a remote area. Know the terrain and plan your route. You are much less likely to get bad surprises. Get accurate maps of trails and terrain. Try to learn of any blocked or closed roads.

It's also a good idea to travel with at least one other vehicle. If something happens to one of them, the other can help quickly.

Does your vehicle have a winch? If so, be sure to read the winch instructions. In a remote area, a winch can be handy if you get stuck. But you'll want to know how to use it properly.

Getting Familiar with Off-Road Driving

It's a good idea to practice in an area that's safe and close to home before you go into the wilderness. Off-road driving does require some new and different driving skills. Here's what we mean.

Tune your senses to different kinds of signals. Your eyes, for example, need to constantly sweep the terrain for unexpected obstacles. Your ears need to listen for unusual tire or engine sounds. With your arms, hands, feet, and body you'll need to respond to vibrations and vehicle bounce.

Controlling your vehicle is the key to successful off-road driving. One of the best ways to control your vehicle is to control your speed. Here are some things to keep in mind. At higher speeds:

- you approach things faster and you have less time to scan the terrain for obstacles.
- you have less time to react.
- you have more vehicle bounce when you drive over obstacles.
- you'll need more distance for braking, especially since you're on an unpaved surface.



CAUTION:

When you're driving off road, bouncing and quick changes in direction can easily throw you out of position. This could cause you to lose control and crash. So, whether you're driving on or off the road, you and your passengers should wear safety belts.

Scanning the Terrain

Off-road driving can take you over many different kinds of terrain. You need to be familiar with the terrain and its many different features. Here are some things to consider.

Surface Conditions. Off-roading can take you over hard-packed dirt, gravel, rocks, grass, sand, mud, snow or ice. Each of these surfaces affects the steering, acceleration, and braking of your vehicle in different ways. Depending upon the kind of surface you are on, you may experience slipping, sliding, wheel spinning, delayed acceleration, poor traction, and longer braking distances.

Surface Obstacles. Unseen or hidden obstacles can be hazardous. A rock, log, hole, rut, or bump can startle you if you're not prepared for them. Often these obstacles are hidden by grass, bushes, snow or even the rise and fall of the terrain itself. Here are some things to consider:

- Is the path ahead clear?
- Will the surface texture change abruptly up ahead?
- Does the travel take you uphill or downhill? (There's more discussion of these subjects later.)
- Will you have to stop suddenly or change direction quickly?

When you drive over obstacles or rough terrain, keep a firm grip on the steering wheel. Ruts, troughs, or other surface features can jerk the wheel out of your hands if you're not prepared.

When you drive over bumps, rocks, or other obstacles, your wheels can leave the ground. If this happens, even with one or two wheels, you can't control the vehicle as well or at all.

Because you will be on an unpaved surface, it's especially important to avoid sudden acceleration, sudden turns, or sudden braking.

In a way, off-road driving requires a different kind of alertness from driving on paved roads and highways. There are no road signs, posted speed limits or signal lights. You have to use your own good judgment about what is safe and what isn't.

Drinking and driving can be very dangerous on any road. And this is certainly true for off-road driving. At the very time you need special alertness and driving skills, your reflexes, perceptions and judgment can be affected by even a small amount of alcohol. You could have a serious — or even fatal — accident if you drink and drive or ride with a driver who has been drinking. (See "Drunken Driving" in the Index.)

Driving On Off-Road Hills

Off-road driving often takes you up, down, or across a hill. Driving safely on hills requires good judgment and an understanding of what your vehicle can and can't do. There are some hills that simply can't be driven, no matter how well built the vehicle.



CAUTION:

Many hills are simply too steep for any vehicle. If you drive up them, you will stall. If you drive down them, you can't control your speed. If you drive across them, you will roll over. You could be seriously injured or killed. If you have any doubt about the steepness, don't drive the hill.

Approaching a Hill

When you approach a hill, you need to decide if it's one of those hills that's just too steep to climb, descend, or cross. Steepness can be hard to judge. On a very small hill, for example, there may be a smooth, constant incline with only a small change in elevation where you can easily see all the way to the top. On a large hill, the incline may get steeper as you near the top, but you may not see this because the crest of the hill is hidden by bushes, grass, or shrubs.

Here are some other things to consider as you approach a hill.

- Is there a constant incline, or does the hill get sharply steeper in places?
- Is there good traction on the hillside, or will the surface cause tire slipping?
- Is there a straight path up or down the hill so you won't have to make turning maneuvers?
- Are there obstructions on the hill that can block your path (boulders, trees, logs or ruts)?
- What's beyond the hill? Is there a cliff, an embankment, a drop-off, a fence? Get out and walk the hill if you don't know. It's the smart way to find out.
- Is the hill simply too rough? Steep hills often have ruts, gullies, troughs and exposed rocks because they are more susceptible to the effects of erosion.

Driving Uphill

Once you decide you can safely drive up the hill, you need to take some special steps.

- Use a low gear and get a firm grip on the steering wheel.
- Get a smooth start up the hill and try to maintain your speed. Don't use more power than you need, because you don't want your wheels to start spinning or sliding.
- Try to drive straight up the hill if at all possible. If the path twists and turns, you might want to find another route.



CAUTION:

Turning or driving across steep hills can be dangerous. You could lose traction, slide sideways, and possibly roll over. You could be seriously injured or killed. When driving up hills, always try to go straight up.

- Ease up on your speed as you approach the top of the hill.
- Attach a flag to the vehicle to make you more visible to approaching traffic on trails or hills.
- Sound the horn as you approach the top of the hill to let opposing traffic know you're there.
- Use your headlights even during the day. They make you more visible to oncoming traffic.



CAUTION:

Driving to the top (crest) of a hill at full speed can cause an accident. There could be a drop-off, embankment, cliff, or even another vehicle. You could be seriously injured or killed. As you near the top of a hill, slow down and stay alert.

Q: What should I do if my vehicle stalls, or is about to stall, and I can't make it up the hill?

A: If this happens, there are some things you should do, and there are some things you must not do. First, here's what you *should* do:

- Push the brake pedal to stop the vehicle and keep it from rolling backwards. Also, apply the parking brake.
- If your engine is still running, shift the transmission into reverse, release the parking brake, and slowly back down the hill in reverse.
- If your engine has stopped running, you'll need to restart it. With the brake pedal depressed and the parking brake still applied, shift the transmission to "P" (Park) (or, shift to "N" (Neutral) if your vehicle has a manual transmission) and restart the engine. Then, shift to reverse, release the parking brake, and slowly back down the hill as straight as possible in reverse.
- As you are backing down the hill, put your left hand on the steering wheel at the 12 o'clock position. This way, you'll be able to tell if your wheels are straight and maneuver as you back down. It's best that you back down the hill with your wheels straight rather than in the left or right direction. Turning the wheel too far to the left or right will increase the possibility of a rollover.

Here are some things you *must not* do if you stall, or are about to stall, when going up a hill.

- Never attempt to prevent a stall by shifting into "N" (Neutral) (or depressing the clutch, if you have a manual transmission) to "rev-up" the engine and regain forward momentum. This won't work. Your vehicle will roll backwards very quickly and you could go out of control.

Instead, apply the regular brake to stop the vehicle. Then apply the parking brake. Shift into reverse, release the parking brake, and slowly back straight down.

- Never attempt to turn around if you are about to stall when going up a hill. If the hill is steep enough to stall your vehicle, it's steep enough to cause you to roll over if you turn around. If you can't make it up the hill, you must back straight down the hill.

Q: Suppose, after stalling, I try to back down the hill and decide I just can't do it. What should I do?

A: Set the parking brake, put your transmission in "P" (Park) (or the manual transmission in first gear) , and turn off the engine. Leave the vehicle and go get some help. Exit on the uphill side and stay clear of the path the vehicle would take if it rolled downhill. Do not shift the transfer case to "N" (Neutral) when you leave the vehicle. Leave it in some gear.



CAUTION:

If you have a manual transfer case shift lever, shifting the transfer case to "N" (Neutral) can cause your vehicle to roll even if the transmission is in "P" (Park) (or, if you have the manual transmission, even if you're in gear). This is because the "N" (Neutral) position on the transfer case overrides the transmission. If you are going to leave your vehicle, set the parking brake and shift the transmission to "P" (Park) (or, put your manual transmission in first gear). But do not shift the transfer case to the "N" (Neutral) position. Leave the transfer case in the 2HI, 4HI or 4LO position.

Driving Downhill

When off-roading takes you downhill, you'll want to consider a number of things:

- How steep is the downhill? Will I be able to maintain vehicle control?
- What's the surface like? Smooth? Rough? Slippery? Hard-packed dirt? Gravel?
- Are there hidden surface obstacles? Ruts? Logs? Boulders?
- What's at the bottom of the hill? Is there a hidden creek bank or even a river bottom with large rocks?

If you decide you can go down a hill safely, then try to keep your vehicle headed straight down, and use a low gear. This way, engine drag can help your brakes and they won't have to do all the work. Descend slowly, keeping your vehicle under control at all times.



CAUTION:

Heavy braking when going down a hill can cause your brakes to overheat and fade. This could cause loss of control and a serious accident. Apply the brakes lightly when descending a hill and use a low gear to keep vehicle speed under control.

Q: Are there some things I should not do when driving down a hill?

A: Yes! These are important because if you ignore them you could lose control and have a serious accident.

- When driving downhill, avoid turns that take you across the incline of the hill. A hill that's not too steep to drive down may be too steep to drive across. You could roll over if you don't drive straight down.
- Never go downhill with the transmission in "N" (Neutral) , or with the clutch pedal depressed in a manual shift . This is called "free-wheeling." Your brakes will have to do all the work and could overheat and fade.
- Unless you have four-wheel anti-lock: Avoid braking so hard that you lock the front wheels when going downhill. If your front wheels are locked, you can't steer your vehicle. If your wheels lock up during downhill braking, you may feel the vehicle starting to slide sideways. To regain your direction, just ease off the brakes and steer to keep the front of the vehicle pointing straight downhill.

Q: Am I likely to stall when going downhill?

A: It's much more likely to happen going uphill. But if it happens going downhill, here's what to do.

- Stop your vehicle by applying the regular brakes. Apply the parking brake.
- Shift to "P" (Park) (or to Neutral with the manual transmission) and, while still braking, restart the engine.
- Shift back to a low gear, release the parking brake, and drive straight down.
- If the engine won't start, get out and get help.

Driving Across an Incline

Sooner or later, an off-road trail will probably go across the incline of a hill. If this happens, you have to decide whether to try to drive across the incline. Here are some things to consider:

- A hill that can be driven straight up or down may be too steep to drive across. When you go straight up or down a hill, the length of the wheel base (the distance from the front wheels to the rear wheels) reduces the likelihood the vehicle will tumble end over end. But when you drive across an incline, the much more narrow track width (the distance between the left and right wheels) may not prevent the vehicle from tilting and rolling over. Also, driving across an incline puts more weight on the downhill wheels. This could cause a downhill slide or a rollover.
- Surface conditions can be a problem when you drive across a hill. Loose gravel, muddy spots, or even wet grass can cause your tires to slip sideways, downhill. If the vehicle slips sideways, it can hit something that will trip it (a rock, a rut, etc.) and roll over.
- Hidden obstacles can make the steepness of the incline even worse. If you drive across a rock with the uphill wheels, or if the downhill wheels drop into a rut or depression, your vehicle can tilt even more.

For reasons like these, you need to decide carefully whether to try to drive across an incline. Just because the trail goes across the incline doesn't mean you have to drive it. The last vehicle to try it might have rolled over.



CAUTION:

Driving across an incline that's too steep will make your vehicle roll over. You could be seriously injured or killed. If you have any doubt about the steepness of the incline, don't drive across it. Find another route instead.

Q: What if I'm driving across an incline that's not too steep, but I hit some loose gravel and start to slide downhill. What should I do?

A: If you feel your vehicle starting to slide sideways, turn downhill. This should help straighten out the vehicle and prevent the side slipping. However, a much better way to prevent this is to get out and "walk the course" so you know what the surface is like before you drive it.

Stalling on an Incline

If your vehicle stalls when you're crossing an incline, be sure you (and your passengers) get out on the uphill side, even if the door there is harder to open. If you get out on the downhill side and the vehicle starts to roll over, you'll be right in its path.

If you have to walk down the slope, stay out of the path the vehicle will take if it does roll over.



CAUTION:

Getting out on the downhill (low) side of a vehicle stopped across an incline is dangerous. If the vehicle rolls over, you could be crushed or killed. Always get out on the uphill (high) side of the vehicle and stay well clear of the rollover path.

Driving In Mud, Sand, Snow, Or Ice

When you drive in mud, snow or sand, your wheels won't get good traction. You can't accelerate as quickly, turning is more difficult, and you'll need longer braking distances.

It's best to use a low gear when you're in mud — the deeper the mud, the lower the gear. In really deep mud, the idea is to keep your vehicle moving so you don't get stuck.

When you drive on sand, you'll sense a change in wheel traction. But it will depend upon how loosely packed the sand is. On loosely packed sand (as on beaches or sand dunes) your tires will tend to sink into the sand. This has an effect on steering, accelerating, and braking. You may want to reduce the air pressure in your tires slightly when driving on sand. This will improve traction.

Hard packed snow and ice offer the worst tire traction. On these surfaces, it's very easy to lose control. On wet ice, for example, the traction is so poor that you will have difficulty accelerating. And if you do get moving, poor steering and difficult braking can cause you to slide out of control.



CAUTION:

Driving on frozen lakes, ponds or rivers can be dangerous. Underwater springs, currents under the ice, or sudden thaws can weaken the ice. Your vehicle could fall through the ice and you and your passengers could drown. Drive your vehicle on safe surfaces only.

Driving In Water

Light rain causes no special off-road driving problems. But heavy rain can mean flash flooding, and flood waters demand extreme caution.

Find out how deep the water is before you drive through it. If it's deep enough to cover your wheel hubs, axles, or exhaust pipe, don't try it — you probably won't get through. Also, water that deep can damage your axle and other vehicle parts.

If the water isn't too deep, then drive through it slowly. At fast speeds, water splashes on your ignition system and your vehicle can stall. Stalling can also occur if you get your tailpipe under water. And, as long as your tailpipe is under water, you'll never be able to start your engine. When you go through water, remember that when your brakes get wet, it may take you longer to stop.



CAUTION:

Driving through rushing water can be dangerous. Deep water can sweep your vehicle downstream and you and your passengers could drown. If it's only inches deep, it can still wash away the ground from under your tires, and you could lose traction and roll the vehicle over. Don't drive through rushing water.

After Off-Road Driving

Remove any brush or debris that has collected on the underbody, chassis or under the hood. These accumulations can be a fire hazard.

After operation in mud or sand, have the brake linings cleaned and checked. These substances can cause glazing and uneven braking. Check the body structure, steering, suspension, wheels, tires, and exhaust system for damage. Also, check the fuel lines and cooling system for any leakage.

Your vehicle will require more frequent service due to off-road use. Refer to the Maintenance Schedule booklet for additional information.

Driving at Night

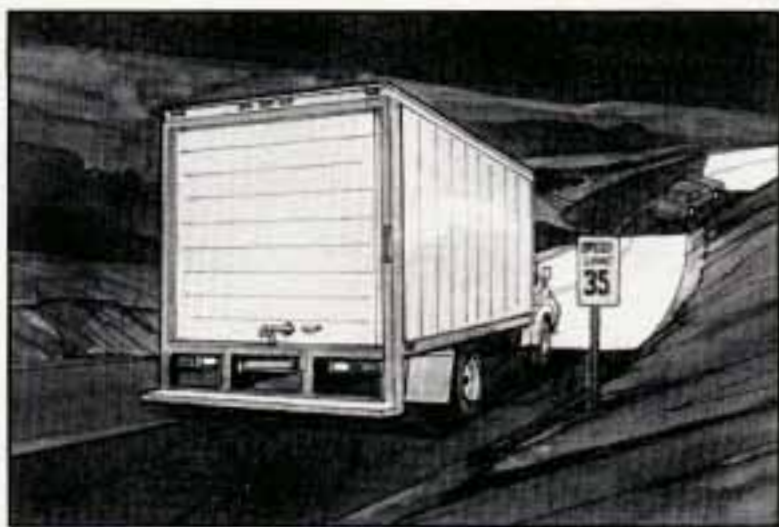

Night driving is more dangerous than day driving. One reason is that some drivers are likely to be impaired — by alcohol or drugs, with night vision problems, or by fatigue.

Here are some tips on night driving.

- Drive defensively.
- Don't drink and drive.
- Adjust your inside rearview mirror to reduce the glare from headlights behind you.
- Since you can't see as well, you may need to slow down and keep more space between you and other vehicles.
- Slow down, especially on higher speed roads. Your headlights can light up only so much road ahead.
- In remote areas, watch for animals.
- If you're tired, pull off the road in a safe place and rest.

Night Vision

No one can see as well at night as in the daytime. But as we get older these differences increase. A 50-year-old driver may require at least twice as much light to see the same thing at night as a 20-year-old.

What you do in the daytime can also affect your night vision. For example, if you spend the day in bright sunshine you are wise to wear sunglasses. Your eyes will have less trouble adjusting to night. But if you're driving, don't wear sunglasses at night. They may cut down on glare from headlights, but they also make a lot of things invisible.

You can be temporarily blinded by approaching lights. It can take a second or two, or even several seconds, for your eyes to readjust to the dark. When you are faced with severe glare (as from a driver who doesn't lower the high beams, or a vehicle with misaimed headlights), slow down a little. Avoid staring directly into the approaching lights.

Keep your windshield and all the glass on your vehicle clean — inside and out. Glare at night is made much worse by dirt on the glass. Even the inside of the glass can build up a film caused by dust. Dirty glass makes lights dazzle and flash more than clean glass would, making the pupils of your eyes contract repeatedly.

Remember that your headlights light up far less of a roadway when you are in a turn or curve. Keep your eyes moving; that way, it's easier to pick out dimly lighted objects. Just as your headlights should be checked regularly for proper aim, so should your eyes be examined regularly. Some drivers suffer from night blindness — the inability to see in dim light — and aren't even aware of it.

Driving in the Rain



Rain and wet roads can mean driving trouble. On a wet road you can't stop, accelerate or turn as well because your tire-to-road traction isn't as good as on dry roads. And, if your tires don't have much tread left, you'll get even

less traction. It's always wise to go slower and be cautious if rain starts to fall while you are driving. The surface may get wet suddenly when your reflexes are tuned for driving on dry pavement.

The heavier the rain, the harder it is to see. Even if your windshield wiper blades are in good shape, a heavy rain can make it harder to see road signs and traffic signals, pavement markings, the edge of the road, and even people walking.

It's wise to keep your wiping equipment in good shape and keep your windshield washer tank filled. Replace your windshield wiper inserts when they show signs of streaking or missing areas on the windshield, or when strips of rubber start to separate from the inserts.



Driving too fast through large water puddles or even going through some car washes can cause problems, too. The water may affect your brakes. Try to avoid puddles. But if you can't, try to slow down before you hit them.



CAUTION:

Wet brakes can cause accidents. They won't work well in a quick stop and may cause pulling to one side. You could lose control of the vehicle.

After driving through a large puddle of water or a car wash, apply your brake pedal lightly until your brakes work normally.

Hydroplaning

Hydroplaning is dangerous. So much water can build up under your tires that they can actually ride on the water. This can happen if the road is wet enough and you're going fast enough. When your vehicle is hydroplaning, it has little or no contact with the road.

Hydroplaning doesn't happen often. But it can if your tires haven't much tread or if the pressure in one or more is low. It can happen if a lot of water is standing on the road. If you can see reflections from trees, telephone poles, or other vehicles, and raindrops "dimple" the water's surface, there could be hydroplaning.

Hydroplaning usually happens at higher speeds. There just isn't a hard and fast rule about hydroplaning. The best advice is to slow down when it is raining.

Some Other Rainy Weather Tips

- Turn on your low-beam headlights — not just your parking lights — to help make you more visible to others.
- Besides slowing down, allow some extra following distance. And be especially careful when you pass another vehicle. Allow yourself more clear room ahead, and be prepared to have your view restricted by road spray.
- Have good tires with proper tread depth. (See "Tires" in the Index.)

City Driving

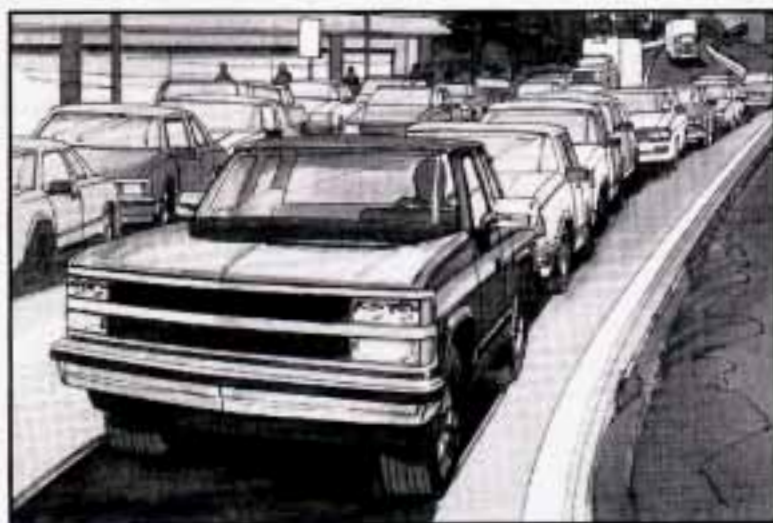

One of the biggest problems with city streets is the amount of traffic on them. You'll want to watch out for what the other drivers are doing and pay attention to traffic signals.

Here are ways to increase your safety in city driving:

- Know the best way to get to where you are going. Get a city map and plan your trip into an unknown part of the city just as you would for a cross-country trip.

- Try to use the freeways that rim and crisscross most large cities. You'll save time and energy. (See the next part, "Freeway Driving.")
- Treat a green light as a warning signal. A traffic light is there because the corner is busy enough to need it. When a light turns green, and just before you start to move, check both ways for vehicles that have not cleared the intersection or may be running the red light.

Freeway Driving

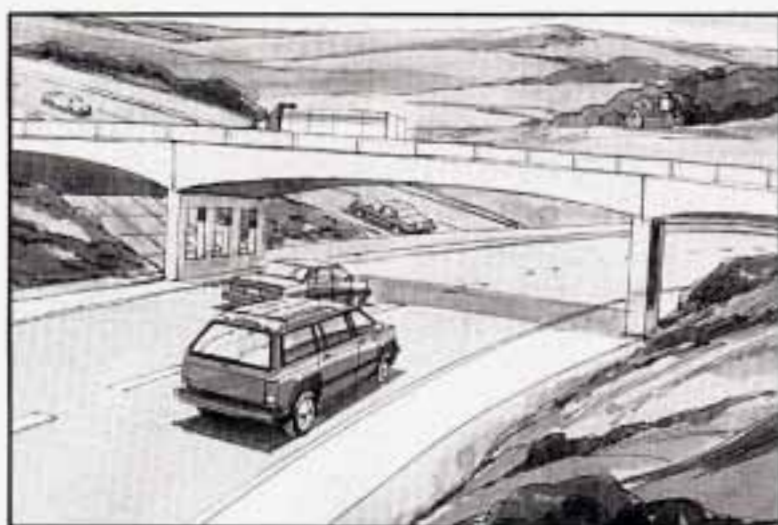

Mile for mile, freeways (also called thruways, parkways, expressways, turnpikes, or superhighways) are the safest of all roads. But they have their own special rules.

The most important advice on freeway driving is: Keep up with traffic and keep to the right. Drive at the same speed most of the other drivers are driving. Too-fast or too-slow driving breaks a smooth traffic flow. Treat the left lane on a freeway as a passing lane.

At the entrance there is usually a ramp that leads to the freeway. If you have a clear view of the freeway as you drive along the entrance ramp, you should begin to check traffic. Try to determine where you expect to blend with the flow. Try to merge into the gap at close to the prevailing speed. Switch on your turn signal, check your mirrors and glance over your shoulder as often as necessary. Try to blend smoothly with the traffic flow.

Once you are on the freeway, adjust your speed to the posted limit or to the prevailing rate if it's slower. Stay in the right lane unless you want to pass.

Before changing lanes, check your mirrors. Then use your turn signal.

Just before you leave the lane, glance quickly over your shoulder to make sure there isn't another vehicle in your "blind" spot.

Once you are moving on the freeway, make certain you allow a reasonable following distance. Expect to move slightly slower at night.

When you want to leave the freeway, move to the proper lane well in advance. If you miss your exit do not, under any circumstances, stop and back up. Drive on to the next exit.

The exit ramp can be curved, sometimes quite sharply.

The exit speed is usually posted.

Reduce your speed according to your speedometer, not to your sense of motion. After driving for any distance at higher speeds, you may tend to think you are going slower than you actually are.

Before Leaving on a Long Trip

Make sure you're ready. Try to be well rested. If you must start when you're not fresh — such as after a day's work — don't plan to make too many miles that first part of the journey. Wear comfortable clothing and shoes you can easily drive in.

Is your vehicle ready for a long trip? If you keep it serviced and maintained, it's ready to go. If it needs service, have it done before starting out. Of course, you'll find experienced and able service experts in Vehicle dealerships all across North America. They'll be ready and willing to help if you need it.

Here are some things you can check before a trip:

- *Windshield Washer Fluid:* Is the reservoir full? Are all windows clean inside and outside?
- *Wiper Blades:* Are they in good shape?
- *Fuel, Engine Oil, Other Fluids:* Have you checked all levels?
- *Lights:* Are they all working? Are the lenses clean?
- *Tires:* They are vitally important to a safe, trouble-free trip. Is the tread good enough for long-distance driving? Are the tires all inflated to the recommended pressure?
- *Weather Forecasts:* What's the weather outlook along your route? Should you delay your trip a short time to avoid a major storm system?
- *Maps:* Do you have up-to-date maps?

Highway Hypnosis

Is there actually such a condition as “highway hypnosis”? Or is it just plain falling asleep at the wheel? Call it highway hypnosis, lack of awareness, or whatever.

There is something about an easy stretch of road with the same scenery, along with the hum of the tires on the road, the drone of the engine, and the rush of the wind against the vehicle that can make you sleepy. Don't let it happen to you! If it does, your vehicle can leave the road in *less than a second*, and you could crash and be injured.

What can you do about highway hypnosis? First, be aware that it can happen.

Then here are some tips:

- Make sure your vehicle is well ventilated, with a comfortably cool interior.
- Keep your eyes moving. Scan the road ahead and to the sides. Check your mirrors and your instruments frequently.
- If you get sleepy, pull off the road into a rest, service, or parking area and take a nap, get some exercise, or both. For safety, treat drowsiness on the highway as an emergency.

Hill and Mountain Roads



Driving on steep hills or mountains is different from driving in flat or rolling terrain.

If you drive regularly in steep country, or if you're planning to visit there, here are some tips that can make your trips safer and more enjoyable. (See “Off-Road Driving” in the Index for information about driving off-road.)

- Keep your vehicle in good shape. Check all fluid levels and also the brakes, tires, cooling system and transmission. These parts can work hard on mountain roads.
- Know how to go down hills. The most important thing to know is this: let your engine do some of the slowing down. Shift to a lower gear when you go down a steep or long hill.



CAUTION:

If you don't shift down, your brakes could get so hot that they wouldn't work well. You would then have poor braking or even none going down a hill. You could crash. Shift down to let your engine assist your brakes on a steep downhill slope.



CAUTION:

Coasting downhill in "N" (Neutral) or with the ignition off is dangerous. Your brakes will have to do all the work of slowing down. They could get so hot that they wouldn't work well. You could crash. Always have your engine running and your vehicle in gear when you go downhill.

- Know how to go uphill. You may want to shift down to a lower gear. The lower gears help cool your engine and transmission, and you can climb the hill better.
- Stay in your own lane when driving on two-lane roads in hills or mountains. Don't swing wide or cut across the center of the road. Drive at speeds that let you stay in your own lane.
- As you go over the top of a hill, be alert. There could be something in your lane, like a stalled car or an accident.
- You may see highway signs on mountains that warn of special problems. Examples are long grades, passing or no-passing zones, a falling rocks area, or winding roads. Be alert to these and take appropriate action.

Winter Driving



Here are some tips for winter driving:

- Have your vehicle in good shape for winter. Be sure your engine coolant mix is correct.
- You may want to put winter emergency supplies in your vehicle.

Include an ice scraper, a small brush or broom, a supply of windshield washer fluid, a rag, some winter outer clothing, a small shovel, a flashlight, a red cloth, and a couple of reflective warning triangles. And, if you will be driving under severe conditions, include a small bag of sand, a piece of old carpet or a couple of burlap bags to help provide traction. Be sure you properly secure these items in your vehicle.

Driving on Snow or Ice

Most of the time, those places where your tires meet the road probably have good traction.

However, if there is snow or ice between your tires and the road, you can have a very slippery situation. You'll have a lot less traction or "grip" and will need to be very careful.



What's the worst time for this? "Wet ice." Very cold snow or ice can be slick and hard to drive on. But wet ice can be even more trouble because it may offer the least traction of all. You can get "wet ice" when it's about freezing (32°F ; 0°C) and freezing rain begins to fall. Try to avoid driving on wet ice until salt and sand crews can get there.

Whatever the condition — smooth ice, packed, blowing or loose snow — drive with caution.

Accelerate gently. Try not to break the fragile traction. If you accelerate too fast, the drive wheels will spin and polish the surface under the tires even more.

Your anti-lock brakes improve your ability to make a hard stop on a slippery road. Even though you have an anti-lock braking system, you'll want to begin stopping sooner than you would on dry pavement. See "Anti-lock" in the Index.

- Allow greater following distance on any slippery road.
- Watch for slippery spots. The road might be fine until you hit a spot that's covered with ice. On an otherwise clear road, ice patches may appear in shaded areas where the sun can't reach: around clumps of trees, behind buildings, or under bridges. Sometimes the surface of a curve or an overpass may remain icy when the surrounding roads are clear. If you see a patch of ice ahead of you, brake before you are on it. Try not to brake while you're actually on the ice, and avoid sudden steering maneuvers.

If You're Caught in a Blizzard



If you are stopped by heavy snow, you could be in a serious situation. You should probably stay with your vehicle unless you know for sure that you are near help and you can hike through the snow. Here are some things to do to summon help and keep yourself and your passengers safe: Turn on your hazard flashers. Tie a red cloth to your vehicle to alert police that you've been stopped by the snow. Put on extra clothing or wrap a blanket around you. If you have no blankets or extra clothing, make body insulators from newspapers, burlap bags, rags, floor mats — anything you can wrap around yourself or tuck under your clothing to keep warm.

You can run the engine to keep warm, but be careful.



CAUTION:

Snow can trap exhaust gases under your vehicle. This can cause deadly CO (carbon monoxide) gas to get inside. CO could overcome you and kill you. You can't see it or smell it, so you might not know it is in your vehicle. Clear away snow from around the base of your vehicle, especially any that is blocking your exhaust pipe. And check around again from time to time to be sure snow doesn't collect there.

Open a window just a little on the side of the vehicle that's away from the wind. This will help keep CO out.



Run your engine only as long as you must. This saves fuel. When you run the engine, make it go a little faster than just idle. That is, push the accelerator slightly. This uses less fuel for the heat that you get and it keeps the battery charged. You will need a well-charged battery to restart the vehicle, and possibly for signaling later on with your headlights. Let the heater run for awhile.

Then, shut the engine off and close the window almost all the way to preserve the heat. Start the engine again and repeat this only when you feel really uncomfortable from the cold. But do it as little as possible. Preserve the fuel as long as you can. To help keep warm, you can get out of the vehicle and do some fairly vigorous exercises every half hour or so until help comes.

Recreational Vehicle Towing (Four-Wheel Drive Only)

If your vehicle has 4-wheel drive, you may tow it behind another vehicle providing it does not have the optional electronic shift transfer case.

NOTICE:

Recreational vehicle towing is not recommended for vehicles with the optional electronic shift transfer case because the electronic shift has no neutral position.

Before towing, you should:

1. Set the parking brake firmly.
2. Place the automatic transmission in “P” (Park) or the manual transmission in the lowest gear (1st gear).
3. Firmly attach the vehicle being towed to the tow vehicle. Refer to the hitch manufacturer’s instructions.
4. Place the transfer case shift lever in “N” (Neutral).



CAUTION:

Shifting the transfer case into “N” (Neutral) can cause your vehicle to roll even if the transmission is in “P” (Park), for an automatic transmission, or if your vehicle is in gear, for a manual transmission. This is because the transfer case overrides the transmission.

NOTICE:

Removal of either propeller shaft is unnecessary.

5. Release the parking brake only after the vehicle being towed is firmly attached to the tow vehicle.
6. Insert the ignition key into the ignition switch and turn it one notch forward of the **LOCK** position. This places the key into the **OFF** position, which unlocks the steering column while preventing battery drain. Unlocking the steering column will allow for proper movement of the front wheels/tires during towing.

NOTICE:

You should exercise extra care whenever towing another vehicle.

Towing a Trailer



CAUTION:

If you don't use the correct equipment and drive properly, you can lose control when you pull a trailer. For example, if the trailer is too heavy, the brakes may not work well — or even at all. You and your passengers could be seriously injured. Pull a trailer only if you have followed all the steps in this section. Ask your dealer for advice and information about towing a trailer with your vehicle.

NOTICE:

Pulling a trailer improperly can damage your vehicle and result in costly repairs not covered by your warranty. To pull a trailer correctly, follow the advice in this section, and see your dealer for important information about towing a trailer with your vehicle.

Every vehicle is ready for some trailer towing. If it was built with trailering options, as many are, it's ready for heavier trailers. But trailering is different than just driving your vehicle by itself. Trailering means changes in handling, durability, and fuel economy. Successful, safe trailering takes correct equipment, and it has to be used properly.

That's the reason for this section. In it are many time-tested, important trailering tips and safety rules. Many of these are important for your safety and that of your passengers. So please read this section carefully before you pull a trailer.

If You Do Decide To Pull A Trailer

If you do, here are some important points.

- There are many different laws having to do with trailering. Make sure your rig will be legal, not only where you live but also where you'll be driving. A good source for this information can be state or provincial police.
- Consider using a sway control if your trailer will weigh 2,000 pounds (900 kg) or less. You should always use a sway control if your trailer will weigh more than 2,000 pounds (900 kg).

You can ask a hitch dealer about sway controls.

- Don't tow a trailer at all during the first 500 miles (800 km) your new vehicle is driven. Your engine, axle or other parts could be damaged.
- Then, during the first 500 miles (800 km) that you tow a trailer, don't drive over 50 mph (80 km/h) and don't make starts at full throttle. This helps your engine and other parts of your vehicle wear in at the heavier loads.

Three important considerations have to do with weight:

Weight of the Trailer

How heavy can a trailer safely be?

It depends on how you plan to use your rig. For example, speed, altitude, road grades, outside temperature and how much your vehicle is used to pull a trailer are all important. And, it can also depend on any special equipment that you have on your vehicle.

You can ask your dealer for our trailering information or advice, or you can write us at the address listed in your Warranty and Owner Assistance Information Booklet.

In Canada, write to General Motors of Canada Limited, Customer Assistance Center, 1908 Colonel Sam Drive, Oshawa, Ontario L1H 8P7.

Weight of the Trailer Tongue

The tongue load (A) of any trailer is an important weight to measure because it affects the total or gross weight of your vehicle. The gross vehicle weight (GVW) includes the curb weight of the vehicle, any cargo you may carry in it, and the people who will be riding in the vehicle. And if you will tow a trailer, you must add the tongue load to the GVW because your vehicle will be carrying that weight, too. See "Loading Your Vehicle" in the Index for more information about your vehicle's maximum load capacity.

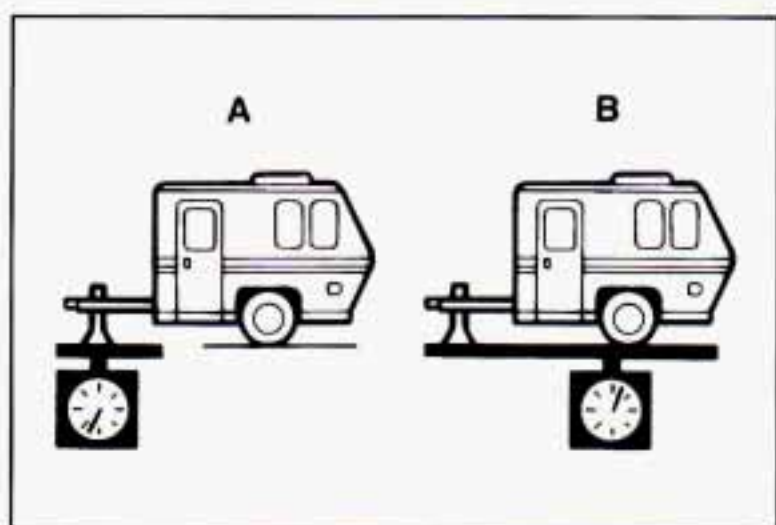

If you're using a "dead-weight" hitch, the trailer tongue (A) should weigh 10% of the total loaded trailer weight (B). If you have a "weight-distributing" hitch, the trailer tongue (A) should weigh 12% of the total loaded trailer weight (B).

After you've loaded your trailer, weigh the trailer and then the tongue, separately, to see if the weights are proper. If they aren't, you may be able to get them right simply by moving some items around in the trailer.

Total Weight on Your Vehicle's Tires

Be sure your vehicle's tires are inflated to the limit for cold tires. You'll find these numbers on the Certification label on the driver's door lock pillar or see "Tire Loading" in the Index. Then be sure you don't go over the GVW limit for your vehicle.

Hitches

It's important to have the correct hitch equipment. Crosswinds, large trucks going by, and rough roads are a few reasons why you'll need the right hitch. Here are some rules to follow:

- If you'll be pulling a trailer that, when loaded, will weigh more than 2,000 pounds (900 kg), be sure to use a properly mounted, weight-distributing hitch and sway control of the proper size. This equipment is very important for proper vehicle loading and good handling when you're driving.

NOTICE:

If your vehicle has the bumper delete option, do not bolt any type of hitch to the close-out panel. The close-out panel will not support a hitch.

You can tow trailers to 2,000 pounds (900 kg) with a step bumper hitch, but if your trailer tongue has a V-shaped foot, your bumper could be damaged in sharp turns. Check the distance from the front edge of the foot to the middle of the hitch ball socket. If the distance is less than 12 inches, take the foot off the trailer tongue.

Safety Chains

You should always attach chains between your vehicle and your trailer. Cross the safety chains under the tongue of the trailer so that the tongue will not drop to the road if it becomes separated from the hitch. Instructions about safety chains may be provided by the hitch manufacturer or by the trailer manufacturer. Follow the manufacturer's recommendation for attaching safety chains. Always leave just enough slack so you can turn with your rig. And, never allow safety chains to drag on the ground.

Trailer Brakes

If your trailer weighs more than 1,000 pounds (450 kg) loaded, then it needs its own brakes — and they must be adequate. Be sure to read and follow the instructions for the trailer brakes so you'll be able to install, adjust and maintain them properly.

Your trailer brakes system can tap into vehicle's hydraulic brake system except:

Don't tap into your vehicle's brake system if the trailer's brake system will use more than 0.02 cubic inch (0.3cc) of fluid from your vehicle's master cylinder. If it does, both braking systems won't work well. You could even lose your brakes.

Will the trailer parts take 3,000 psi (20 650 kPa) of pressure? If not, the trailer brake system must not be used with your vehicle.

If everything checks out this far, then make the brake fluid tap at the port on the master cylinder that sends fluid to the rear brakes. But don't use copper tubing for this. If you do, it will bend and finally break off. Use steel brake tubing.

Driving with a Trailer

Towing a trailer requires a certain amount of experience. Before setting out for the open road, you'll want to get to know your rig. Acquaint yourself with the feel of handling and braking with the added weight of the trailer. And always keep in mind that the vehicle you are driving is now a good deal longer and not nearly so responsive as your vehicle is by itself.

Before you start, check the trailer hitch and platform, safety chains, electrical connector, lights, tires and mirror adjustment. If the trailer has electric brakes, start your vehicle and trailer moving and then apply the

trailer brake controller by hand to be sure the brakes are working. This lets you check your electrical connection at the same time.

During your trip, check occasionally to be sure that the load is secure, and that the lights and any trailer brakes are still working.

Following Distance

Stay at least twice as far behind the vehicle ahead as you would when driving your vehicle without a trailer. This can help you avoid situations that require heavy braking and sudden turns.

Passing

You'll need more passing distance up ahead when you're towing a trailer. And, because you're a good deal longer, you'll need to go much farther beyond the passed vehicle before you can return to your lane.

Backing Up

Hold the bottom of the steering wheel with one hand. Then, to move the trailer to the left, just move that hand to the left. To move the trailer to the right, move your hand to the right. Always back up slowly and, if possible, have someone guide you.

Making Turns

When you're turning with a trailer, make wider turns than normal. Do this so your trailer won't strike soft shoulders, curbs, road signs, trees, or other objects. Avoid jerky or sudden maneuvers. Signal well in advance.

Turn Signals When Towing a Trailer

When you tow a trailer, your vehicle has to have a different turn signal flasher and extra wiring. The green arrows on your instrument panel will flash whenever you signal a turn or lane change. Properly hooked up, the trailer lights will also flash, telling other drivers you're about to turn, change lanes or stop.

When towing a trailer, the green arrows on your instrument panel will flash for turns even if the bulbs on the trailer are burned out. Thus, you may think drivers behind you are seeing your signal when they are not. It's important to check occasionally to be sure the trailer bulbs are still working.

Driving On Grades

Reduce speed and shift to a lower gear **before** you start down a long or steep downgrade. If you don't shift down, you might have to use your brakes so much that they would get hot and no longer work well.

On a long uphill grade, shift down and reduce your speed to around 45 mph (70 km/h) to reduce the possibility of engine and transmission overheating.

If you have an automatic transmission, you should use "D" when towing a trailer. Operating your vehicle in "D" when towing a trailer will minimize heat buildup and extend the life of your transmission. Or, if you have a manual transmission with fifth gear, it's better not to use fifth gear, just drive in fourth gear (or, as you need to, a lower gear).

Parking on Hills

You really should not park your vehicle, with a trailer attached, on a hill. If something goes wrong, your rig could start to move. People can be injured, and both your vehicle and the trailer can be damaged.

But if you ever have to park your rig on a hill, here's how to do it:

1. Apply your regular brakes, but don't shift into "P" (Park) yet, or into gear for a manual transmission.
2. Have someone place chocks under the trailer wheels.
3. When the wheel chocks are in place, release the regular brakes until the chocks absorb the load.
4. Reapply the regular brakes. Then apply your parking brake, and then shift into "P" (Park), or "R" (Reverse) for a manual transmission.
5. If you have a four-wheel drive vehicle with a manual transfer case shift lever, be sure the transfer case is in a drive gear—not in "N" (Neutral).
6. Release the parking brakes.



CAUTION:

It can be dangerous to get out of your vehicle if the shift lever is not fully in "P" (Park) with the parking brake firmly set. Your vehicle can roll.

If you have left the engine running, the vehicle can move suddenly. You or others could be injured. To be sure your vehicle won't move, even when you're on fairly level ground, use the steps that follow.

CAUTION: (Continued)

CAUTION: (Continued)

If you have four-wheel drive with a manual transfer case shift lever and your transfer case is in “N” (Neutral), your vehicle will be free to roll, even if your shift lever is in “P” (Park). So, be sure the transfer case is in a drive gear — not in “N” (Neutral).

If you are parking on a hill, or if you're pulling a trailer, also see “Parking On Hills” in the Index.

When You Are Ready to Leave After Parking on a Hill

1. Apply your regular brakes and hold the pedal down while you:
 - Start your engine;
 - Shift into a gear; and
 - Release the parking brake.
2. Let up on the brake pedal.
3. Drive slowly until the trailer is clear of the chocks.
4. Stop and have someone pick up and store the chocks.

Maintenance When Trailer Towing

Your vehicle will need service more often when you're pulling a trailer. See the Maintenance Schedule for more on this. Things that are especially important in trailer operation are automatic transmission fluid (don't overfill), engine oil, axle lubricant, belt, cooling system, and brake adjustment. Each of these is covered in this manual, and the Index will help you find them quickly. If you're trailering, it's a good idea to review these sections before you start your trip.

Check periodically to see that all hitch nuts and bolts are tight.

Trailer Light Wiring

See “Trailer Wiring Harness” in the Index.

Power Winches

If you wish to use a power winch on your vehicle, only use it when your vehicle is stationary or anchored.

NOTICE:

When operating a power winch on your vehicle always leave the transmission in the neutral position. Do not leave an automatic transmission in P (Park) or a manual transmission in gear or the transmission may be damaged.

Use the regular brakes, set the parking brake or block the wheels to keep your vehicle from rolling.

Notes

Problems on the Road



Section

5

Here you'll find what to do about some problems that can occur on the road.

Hazard Warning Flashers	5-2
Other Warning Devices	5-3
Jump Starting	5-3
Towing Your Vehicle	5-8
Engine Overheating	5-12
If a Tire Goes Flat	5-20
Changing a Flat Tire	5-20
If You're Stuck: In Sand, Mud, Ice or Snow	5-34

Hazard Warning Flashers



Your hazard warning flashers let you warn others. They also let police know you have a problem. Your front and rear turn signal lights will flash on and off.



Press the button in to make your front and rear turn signal lights flash on and off. Your hazard warning flashers work no matter what position your key is in, and even if the key isn't in.



To turn off the flashers, pull out on the collar.

When the hazard warning flashers are on, your turn signals won't work.

Other Warning Devices

If you carry reflective triangles, you can set one up at the side of the road about 300 feet (100 m) behind your vehicle.

Jump Starting

If your battery has run down, you may want to use another vehicle and some jumper cables to start your vehicle. But please follow the steps below to do it safely.



CAUTION:

Batteries can hurt you. They can be dangerous because:

- They contain *acid* that can burn you.
- They contain *gas* that can explode or ignite.
- They contain enough *electricity* to burn you.

If you don't follow these steps exactly, some or all of these things can hurt you.

NOTICE:

Ignoring these steps could result in costly damage to your vehicle that wouldn't be covered by your warranty.

Trying to start your vehicle by pushing or pulling it could damage your vehicle, even if you have a manual transmission. And if you have an automatic transmission, it won't start that way.

To Jump Start Your Vehicle:

1. Check the other vehicle. It must have a 12-volt battery with a negative ground system.

NOTICE:

If the other system isn't a 12-volt system with a negative ground, both vehicles can be damaged.

2. Get the vehicles close enough so the jumper cables can reach, but be sure the vehicles aren't touching each other. If they are, it could cause a ground connection you don't want. You wouldn't be able to start your vehicle, and the bad grounding could damage the electrical systems.

You could be injured if the vehicles roll. Set the parking brake firmly on each vehicle. Put an automatic transmission in "P" (Park) or a manual transmission in "N" (Neutral). If you have a four-wheel drive vehicle with a manual transfer case shift lever, be sure the transfer case is not in "N" (Neutral).

3. Turn off the ignition on both vehicles. Turn off all lights that aren't needed, and radios. This will avoid sparks and help save both batteries. And it could save your radio!

NOTICE:

If you leave your radio on, it could be badly damaged. The repairs wouldn't be covered by your warranty.

4. Open the hoods and locate the batteries. Find the positive (+) and negative (-) terminals on each battery.



CAUTION:

Using a match near a battery can cause battery gas to explode. People have been hurt doing this, and some have been blinded. Use a flashlight if you need more light.

Be sure the battery has enough water. You don't need to add water to the Delco Freedom[®] battery installed in every new GM vehicle. But if a battery has filler caps, be sure the right amount of fluid is there. If it is low, add water to take care of that first. If you don't, explosive gas could be present.

Battery fluid contains acid that can burn you. Don't get it on you. If you accidentally get it in your eyes or on your skin, flush the place with water and get medical help immediately.

5. Check that the jumper cables don't have loose or missing insulation. If they do, you could get a shock. The vehicles could also be damaged.

Before you connect the cables, here are some basic things you should know. Positive (+) will go to positive (+) and negative (-) will go to negative (-) or a metal engine part. Don't connect (+) to (-) or you'll get a short that would damage the battery and maybe other parts too.



CAUTION:

Fans or other moving engine parts can injure you badly. Keep your hands away from moving parts once the engines are running.

6. Connect the red positive (+) cable to the positive (+) terminal of the vehicle with the dead battery.

Dead Battery (+)



Good Battery (+)



7. Don't let the other end touch metal. Connect it to the positive (+) terminal of the good battery.
8. Now connect the black negative (-) cable to the good battery's negative (-) terminal.

Don't let the other end touch anything until the next step. The other end of the negative cable *doesn't* go to the dead battery. It goes to a heavy unpainted metal part on the engine of the vehicle with the dead battery.

Good Battery (-)



Heavy Metal Engine Part



9. Attach the cable at least 18 inches (45 cm) away from the dead battery, but not near engine parts that move. The electrical connection is just as good there, but the chance of sparks getting back to the battery is much less.

10. Now start the vehicle with the good battery and run the engine for a while.
11. Try to start the vehicle with the dead battery. If it won't start after a few tries, it probably needs service.
12. Remove the cables in reverse order to prevent electrical shorting. Take care that they don't touch each other or any other metal.

Remove Cables In This Order:

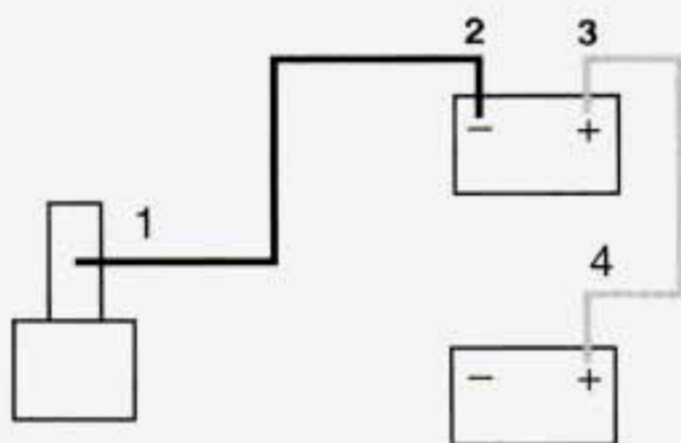

1. Heavy Metal Engine Part
2. Good Battery (-)
3. Good Battery (+)
4. Dead Battery (+)

Towing Your Vehicle

Try to have a GM dealer or a professional towing service tow your vehicle. They can provide the right equipment and know how to tow it without damage.

If your vehicle has been changed since it was factory–new by adding things like fog lamps, aero skirting, or special tires and wheels, these things could be damaged during towing.

Before you do anything, turn on the hazard warning flashers.

When you call, tell the towing service:

- That your vehicle has rear–wheel drive, or that it has the four–wheel drive option.
- The make, model, and year of your vehicle.
- Whether you can move the shift lever for the transmission and shift the transfer case, if you have one.
- If there was an accident, what was damaged.



CAUTION:

To help avoid injury to you or others:

- **Never let passengers ride in a vehicle that is being towed.**
- **Never tow faster than safe or posted speeds.**
- **Never tow with damaged parts not fully secured.**
- **Never get under your vehicle after it has been lifted by the tow truck.**
- **Always use separate safety chains on each side when towing a vehicle.**
- **Never use “J” hooks. Use T–hooks instead.**



When your vehicle is being towed, have the ignition key off. The steering wheel should be clamped in a straight-ahead position with a clamping device designed for towing service. Do not use the vehicle's steering column lock for this. The transmission (either automatic or manual) should be in "N" (Neutral) and the transfer case (either manual shift or electronic shift), if you have one, should be in **2 HI**. The parking brake should be released.



CAUTION:

A vehicle can fall from a car carrier if it isn't adequately secured. This can cause a collision, serious personal injury and vehicle damage. The vehicle should be tightly secured with chains or steel cables before it is transported.

Don't use substitutes (ropes, leather straps, canvas webbing, etc.) that can be cut by sharp edges underneath the towed vehicle. Always use T-hooks inserted in the T-hook slots. Never use J-hooks. They will damage drivetrain and suspension components.

Towing From the Front

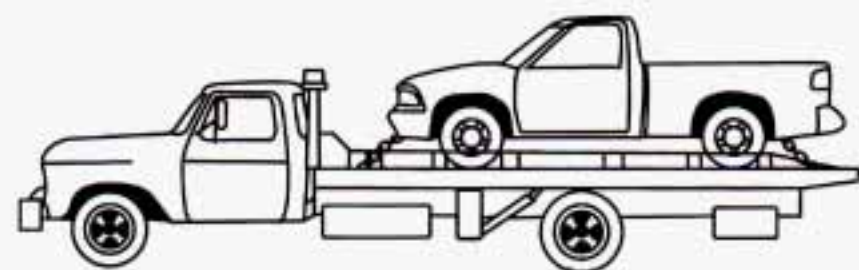

NOTICE:

Do not tow with sling-type equipment or front bumper system will be damaged.

Use wheel lift or car-carrier equipment.

Additional ramping may be required for car-carrier equipment.

Use safety chains and wheel straps.

If your vehicle has the four-wheel drive option, a dolly *MUST* be used under the rear wheels when towing from the front.

Towing From the Rear

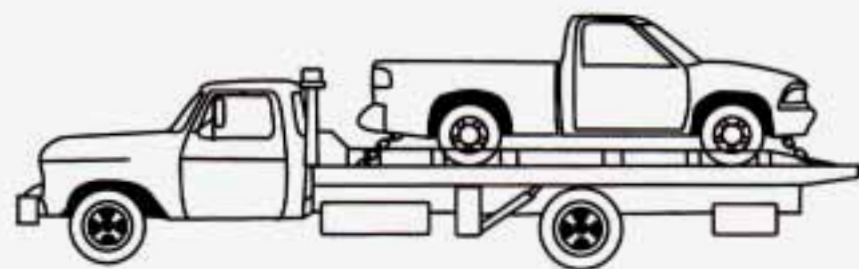

NOTICE:

Do not tow with sling-type equipment or rear bumper system will be damaged.

Use wheel lift or car-carrier equipment.

Additional ramping may be required for car-carrier equipment.

Use safety chains and wheel straps.

If your vehicle has the four-wheel drive option, a dolly *MUST* be used under the front wheels when towing from the rear.

Don't have your vehicle towed on the rear wheels, unless you have to. If the vehicle must be towed on the rear wheels, don't go more than 35 mph (56 km/h) or farther than 50 miles (80 km) or your transmission will be damaged. If these limits must be exceeded, then the rear drive wheels have to be supported on a dolly.

Engine Overheating

You will find a coolant temperature gage on your vehicle's instrument panel.

If Steam Is Coming From Your Engine



CAUTION:

Steam from an overheated engine can burn you badly, even if you just open the hood. Stay away from the engine if you see or hear steam coming from it. Just turn it off and get everyone away from the vehicle until it cools down. Wait until there is no sign of steam or coolant before opening the hood.

If you keep driving when your engine is overheated, the liquids in it can catch fire. You or others could be badly burned. Stop your engine if it overheats, and get out of the vehicle until the engine is cool.

NOTICE:

If your engine catches fire because you keep driving with no coolant, your vehicle can be badly damaged. The costly repairs would not be covered by your warranty.

If No Steam Is Coming From Your Engine

If you get the overheat warning but see or hear no steam, the problem may not be too serious. Sometimes the engine can get a little too hot when you:

- Climb a long hill on a hot day.
- Stop after high speed driving.
- Idle for long periods in traffic.
- Tow a trailer.

If you get the overheat warning with no sign of steam, try this for a minute or so:

1. If you have an air conditioner, turn it off.
2. Turn on your heater to full hot at the highest fan speed and open the window as necessary.
3. If you're in a traffic jam, shift to "N" (Neutral).

If you no longer have the overheat warning, you can drive. Just to be safe, drive slower for about ten minutes. If the warning doesn't come back on, you can drive normally.

If the warning continues, pull over, stop, and park your vehicle right away.

If there's still no sign of steam, push the accelerator until the engine speed is about twice as fast as normal idle speed. Bring the engine speed back to normal idle speed after two or three minutes. Now see if the warning stops. But then, if you still have the warning, **TURN OFF THE ENGINE AND GET EVERYONE OUT OF THE VEHICLE** until it cools down.

You may decide not to lift the hood but to get service help right away.

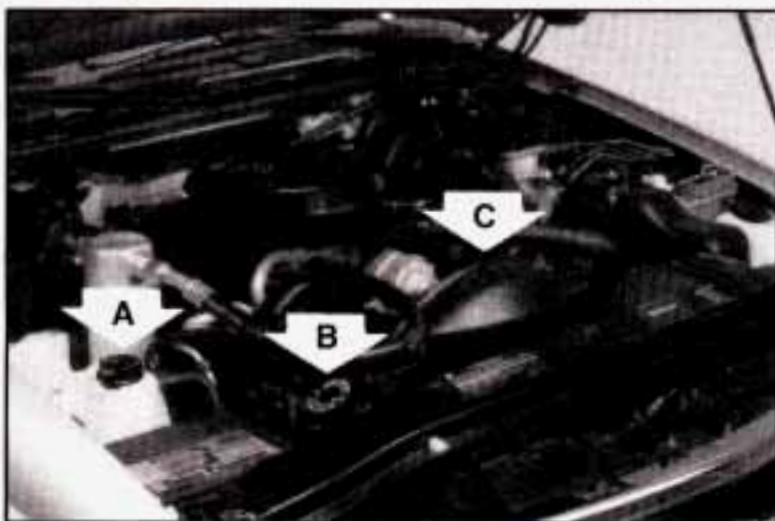

When you decide it's safe to lift the hood, here's what you'll see:

- A. Coolant recovery tank
- B. Radiator pressure cap
- C. Engine fan

If the coolant inside the coolant recovery tank is boiling, don't do anything else until it cools down.



The coolant level should be at or above the **ADD** mark. If it isn't, you may have a leak in the radiator hoses, heater hoses, radiator, water pump or somewhere else in the cooling system.



CAUTION:

Heater and radiator hoses, and other engine parts, can be very hot. Don't touch them. If you do, you can be burned.

Don't run the engine if there is a leak. If you run the engine, it could lose all coolant. That could cause an engine fire, and you could be burned. Get any leak fixed before you drive the vehicle.

NOTICE:

Engine damage from running your engine without coolant isn't covered by your warranty.

If there seems to be no leak, start the engine again. See if the fan speed increases when idle speed is doubled by pushing the accelerator pedal down. If it doesn't, your vehicle needs service. Turn off the engine.

How to Add Coolant to the Coolant Recovery Tank

If you haven't found a problem yet, but the coolant level isn't at or above the *ADD* mark, add a 50/50 mixture of *clean water* (preferably distilled) and a proper antifreeze at the coolant recovery tank. (See "Engine Coolant" in the Index for more information about the proper coolant mix.)



CAUTION:

Adding only plain water to your cooling system can be dangerous. Plain water, or some other liquid like alcohol, can boil before the proper coolant mix will. Your vehicle's coolant warning system is set for the proper coolant mix. With plain water or the wrong mix, your engine could get too hot but you wouldn't get the overheat warning. Your engine could catch fire and you or others could be burned. Use a 50/50 mix of *clean water* and a proper antifreeze.

NOTICE:

In cold weather, water can freeze and crack the engine, radiator, heater core and other parts. Use the recommended coolant.



CAUTION:

You can be burned if you spill coolant on hot engine parts. Coolant contains ethylene glycol and it will burn if the engine parts are hot enough. Don't spill coolant on a hot engine.

When the coolant in the coolant recovery tank is at or above the *ADD* mark, start your vehicle.

If the overheat warning continues, there's one more thing you can try. You can add the proper coolant mix directly to the radiator, but be sure the cooling system is cool before you do it.



CAUTION:

Steam and scalding liquids from a hot cooling system can blow out and burn you badly. They are under pressure, and if you turn the radiator pressure cap — even a little — they can come out at high speed. Never turn the cap when the cooling system, including the radiator pressure cap, is hot. Wait for the cooling system and pressure cap to cool if you ever have to turn the pressure cap.



How to Add Coolant to the Radiator

1. You can remove the radiator pressure cap when the cooling system, including the radiator pressure cap and upper radiator hose, is no longer hot.



Turn the pressure cap slowly to the left until it first stops. (Don't press down while turning the pressure cap.)

If you hear a hiss, wait for that to stop. A hiss means there is still some pressure left.



2. Then keep turning the pressure cap, but now push down as you turn it. Remove the pressure cap.



3. Fill the radiator with the proper mix, up to the base of the filler neck.



4. Then fill the coolant recovery tank to the **ADD** mark.



5. Put the cap back on the coolant recovery tank, but leave the radiator pressure cap off.



6. Start the engine and let it run until you can feel the upper radiator hose getting hot. Watch out for the engine fan.

7. By this time the coolant level inside the filler neck may be lower. If the level is lower, add more of the proper mix through the filler neck until the level reaches the base of the filler neck.



8. Then replace the pressure cap.
At any time during this procedure if coolant begins to flow out of the filler neck, reinstall the pressure cap. Be sure the arrows on pressure cap line up like this.

Engine Fan Noise

This vehicle has a clutched engine cooling fan. When the clutch is engaged, the fan spins faster to provide more air to cool the engine. In most every day driving conditions the clutch is not engaged. This improves fuel economy and reduces fan noise. Under heavy vehicle loading, trailer towing and/or high outside temperatures, the fan speed increases when the clutch engages. So you may hear an increase in fan noise. This is normal and should not be mistaken as the transmission slipping or making extra shifts. It is merely the cooling system functioning properly. The fan will slow down when additional cooling is not required and the clutch disengages.

You may also hear this fan noise when you start the engine. It will go away as the fan clutch disengages.

If a Tire Goes Flat

It's unusual for a tire to "blow out" while you're driving, especially if you maintain your tires properly. If air goes out of a tire, it's much more likely to leak out slowly. But if you should ever have a "blowout," here are a few tips about what to expect and what to do:

If a front tire fails, the flat tire will create a drag that pulls the vehicle toward that side. Take your foot off the accelerator pedal and grip the steering wheel firmly. Steer to maintain lane position, then gently brake to a stop well out of the traffic lane.

A rear blowout, particularly on a curve, acts much like a skid and may require the same correction you'd use in a skid. In any rear blowout, remove your foot from the accelerator pedal. Get the vehicle under control by steering the way you want the vehicle to go. It may be very bumpy and noisy, but you can still steer. Gently brake to a stop, well off the road if possible.

If a tire goes flat, the next part shows how to use your jacking equipment to change a flat tire safely.

Changing a Flat Tire

If a tire goes flat, avoid further tire and wheel damage by driving slowly to a level place. Turn on your hazard warning flashers.



CAUTION:

Changing a tire can cause an injury. The vehicle can slip off the jack and roll over you or other people. You and they could be badly injured. Find a level place to change your tire. To help prevent the vehicle from moving:

- 1. Set the parking brake firmly.**
- 2. Put an automatic transmission shift lever in "P" (Park) or shift a manual transmission to "1" (First) or "R" (Reverse).**
- 3. If you have a four-wheel drive vehicle with a manual transfer case shift lever, be sure the transfer case is in a drive gear – not in "N" (Neutral).**
- 4. Turn off the engine.**

To be even more certain the vehicle won't move, you can put chocks at the front and rear of the tire farthest away from the one being changed. That would be the tire on the other side of the vehicle, at the opposite end.

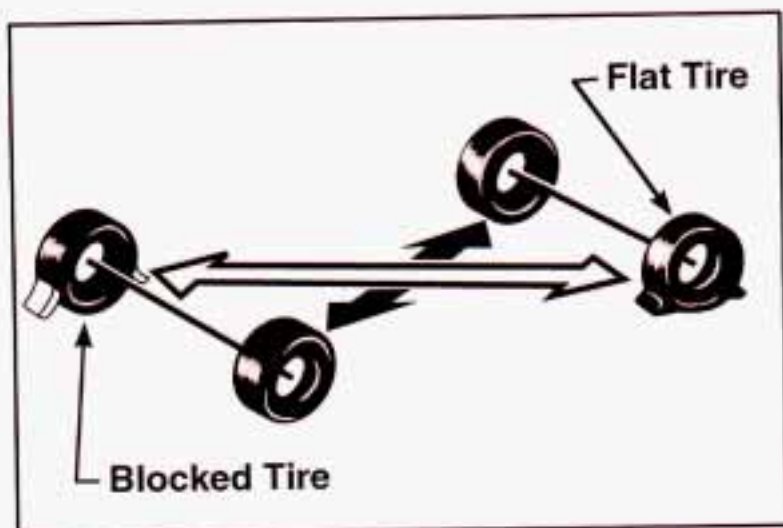

The following steps will tell you how to use the jack and change a tire.

Jack Storage

Your jack, wheel wrench and wheel blocks are stored behind the front seats, either on the center wall (extended cab) or along the right wall (regular cab).

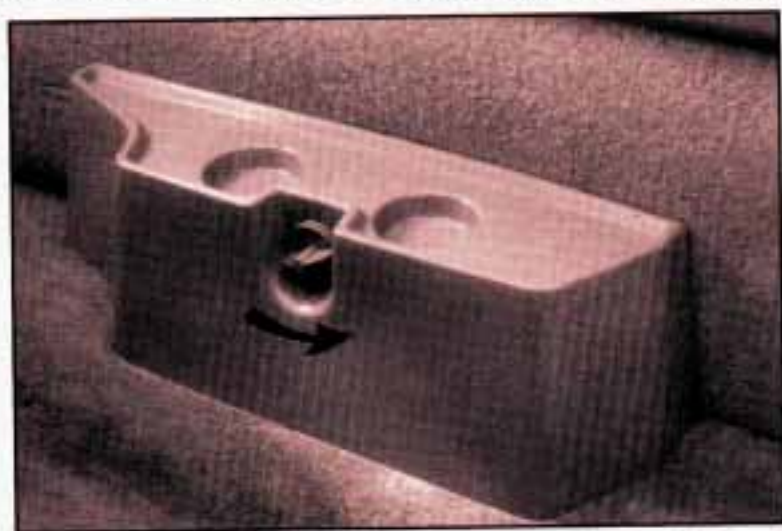

To remove your jack cover, if you have one, turn the plastic wing nut to the left until you can pull it out. Remove the jack cover.

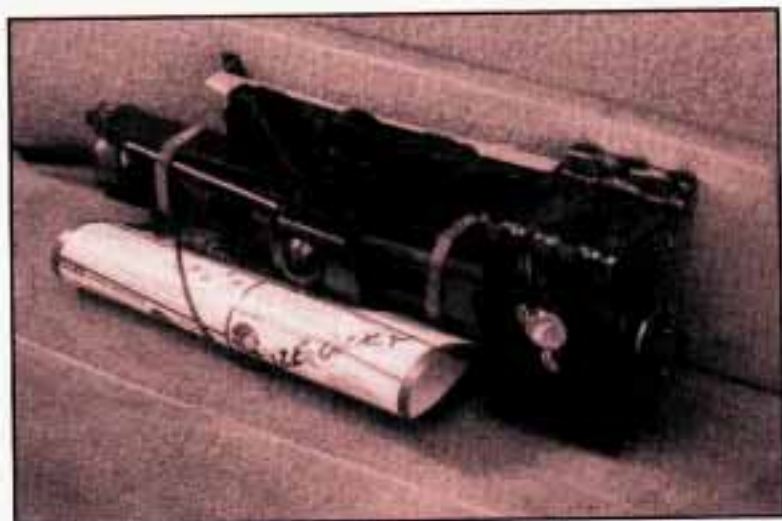

To remove the wheel blocks, jack and wheel wrench, turn the wing nut to the left. Pull the wheel blocks, jack and wheel wrench off.

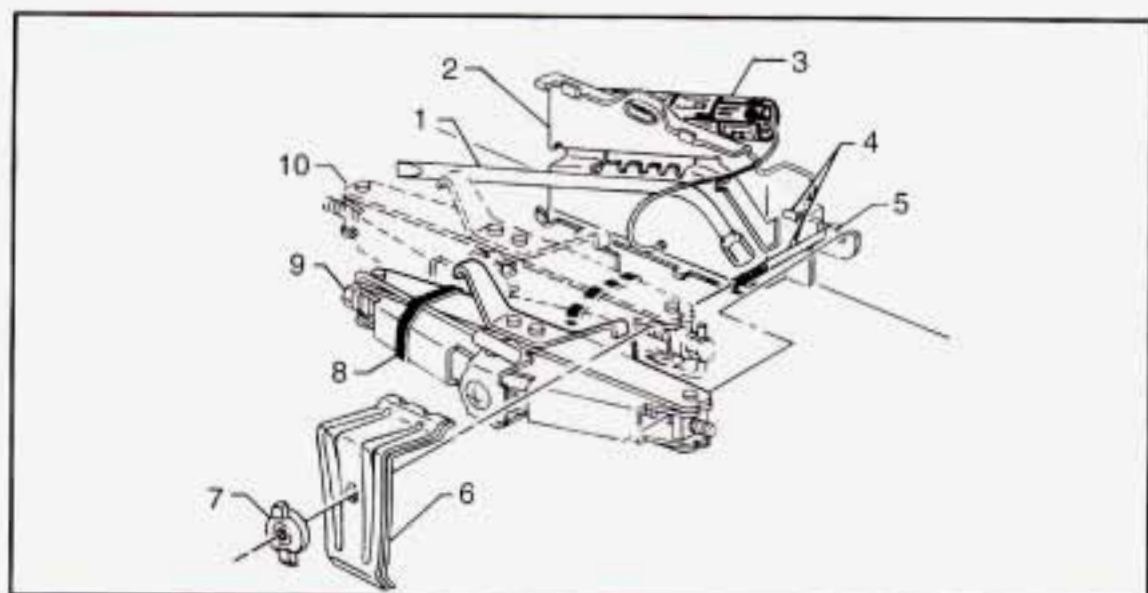

Jacking Equipment Storage

1. Wheel Wrench
2. Bracket
3. Jacking Instructions Tag (Roll and place tag behind the bracket after the tools are installed)
4. Bolt Location (Standard)
5. Bolt Location (ZR2)
6. Wheel Blocks
7. Nut
8. Rubber Band
9. Jack Position (ZR2)
10. Jack Position (Standard)

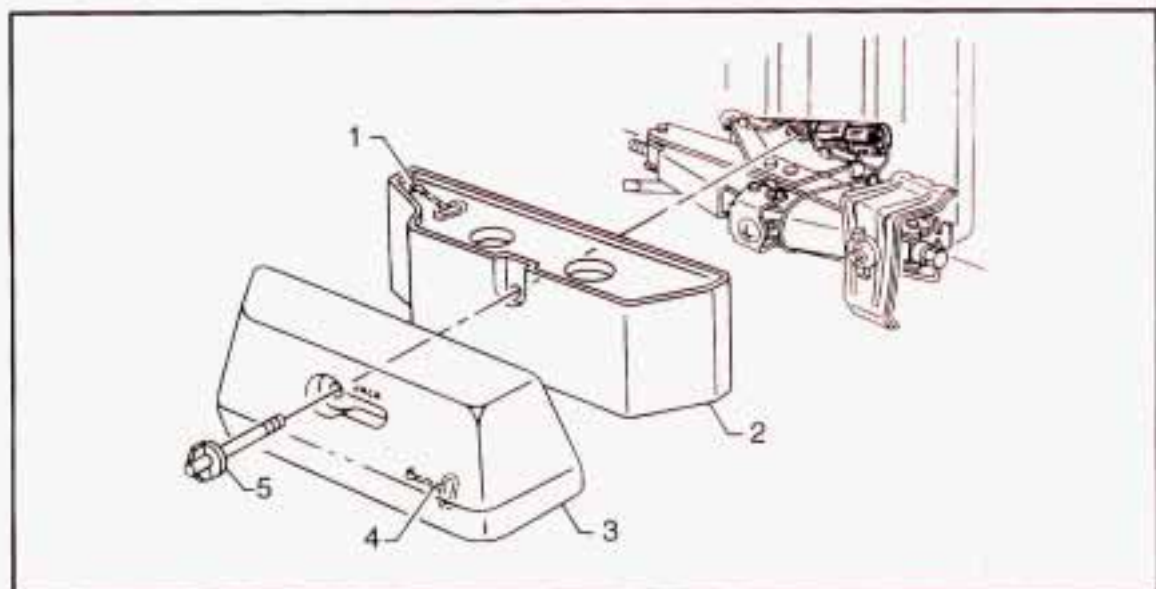

Jacking Storage Cover

1. Hub Cap Removal Tool
2. Cover (Extended Cab)
3. Cover (Standard Cab)
4. Hub Cap Removal Tool
5. Bolt

NOTE: Restore cover and hub cap removal tool if provided.

Spare Tire

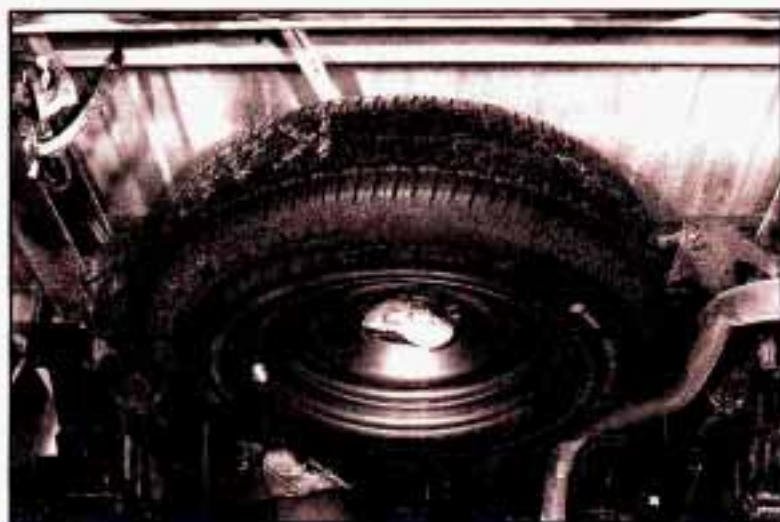

Your spare tire is stored underneath the rear of your vehicle.

Underbody Carrier

NOTICE:

Never remove or restow a tire from/to a stowage position under the vehicle while the vehicle is supported by a jack. Always tighten the tire fully against the underside of the vehicle when restowing.

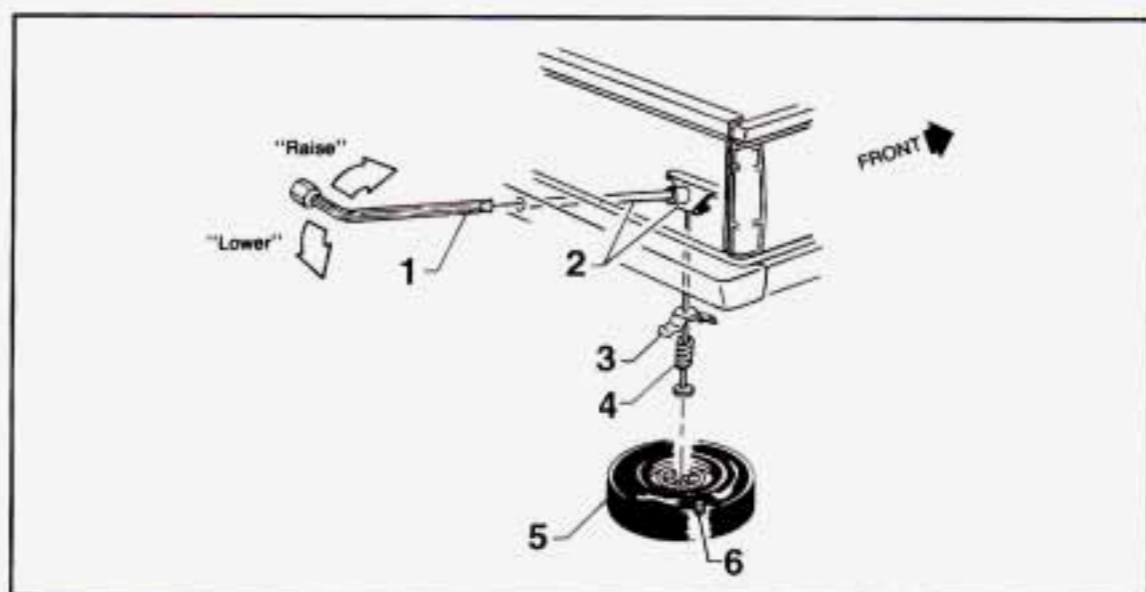

Underbody Spare Tire Mounting

1. Wheel Wrench
2. Hoist Assembly
3. Retainer
4. Spring
5. Tire
6. Valve Stem (Pointed Down)

NOTICE:

To help avoid vehicle damage, do not drive vehicle before cable is restored.

To Remove the Spare Tire



Insert the chisel end of the wheel wrench, on an angle, into the hole in the rear bumper. Be sure the chisel end of the wheel wrench connects into the hoist shaft.



Turn the wheel wrench to the left to lower the spare tire. Keep turning the wheel wrench until the spare tire can be pulled out from under the vehicle.



When the tire has been completely lowered, tilt the retainer at the end of the cable and pull it through the wheel opening. Pull the tire out from under the vehicle.

Changing the Tire

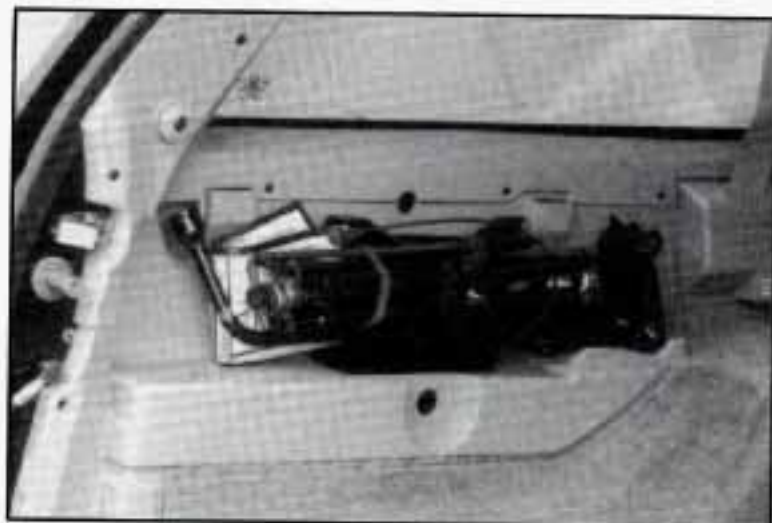

Start with the jack, wheel wrench and wheel blocks.

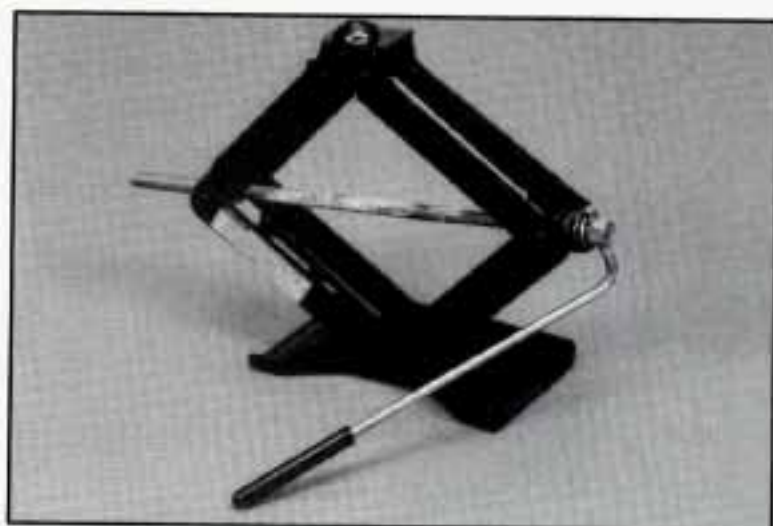

Rotate the jackhandle to the right. That will raise the jack lift head a little.



Before you start, block the front and rear of the tire farthest away from the one being changed. Then put your spare tire near the flat tire.

Hub Caps And Wheel Nut Caps

You will have to take off hub caps or wheel nut caps to reach your wheel nuts.

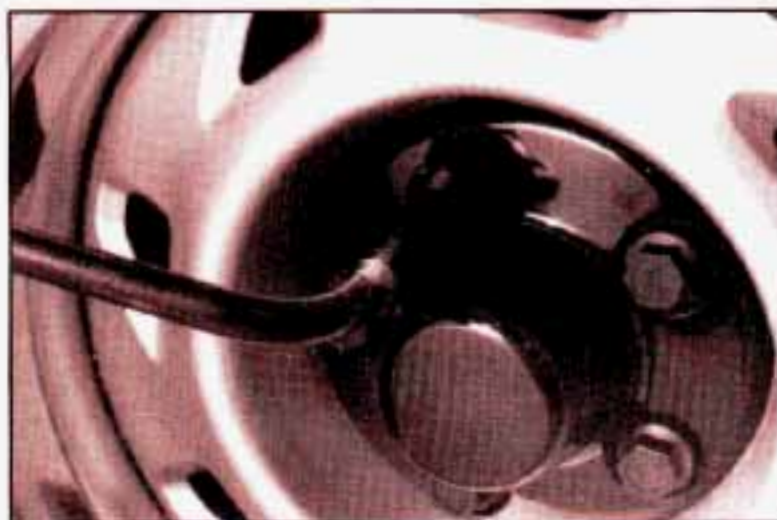

If you have individual wheel nut caps that cover each nut, they must be removed in order to get the wheel nuts. Use the socket end of the wheel wrench to remove the wheel nut caps.

Your wheel nut caps may attach your hub cap to the wheel. Remove these wheel nut caps and retaining ring (if so equipped) before you take off the hub cap.

If you have just an aluminum or plastic molded hub cap, pry it off with the chisel end of your wheel wrench.



Some of the molded plastic hub caps have imitation wheel nuts molded into them. The wheel wrench won't fit these imitation nuts, so don't try to remove them with the socket end of the wheel wrench.

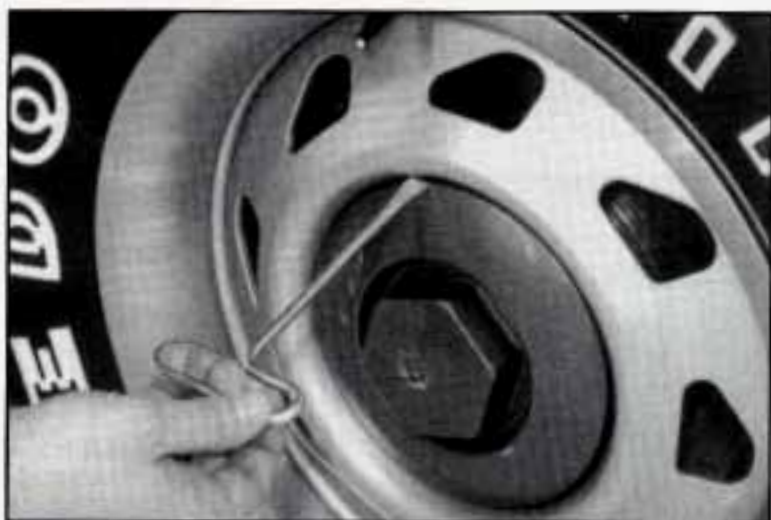

Some jack storage covers are equipped with a hub cap removal tool. Position hub cap removal tool in notch.

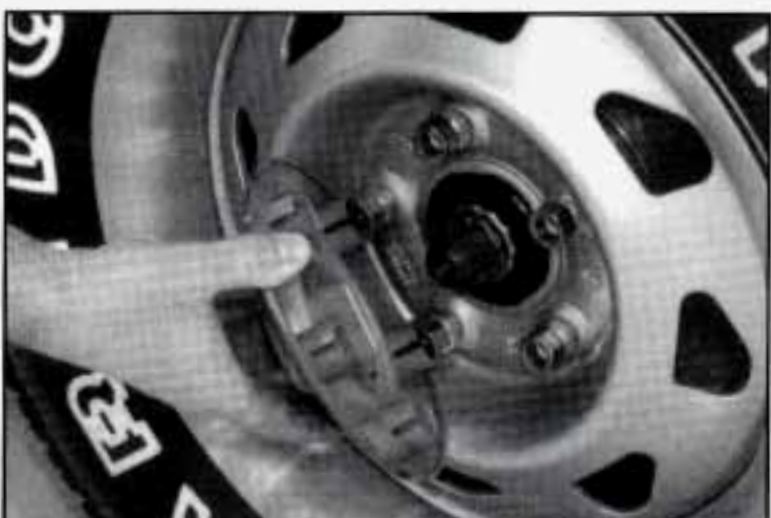

Remove the hub cap.

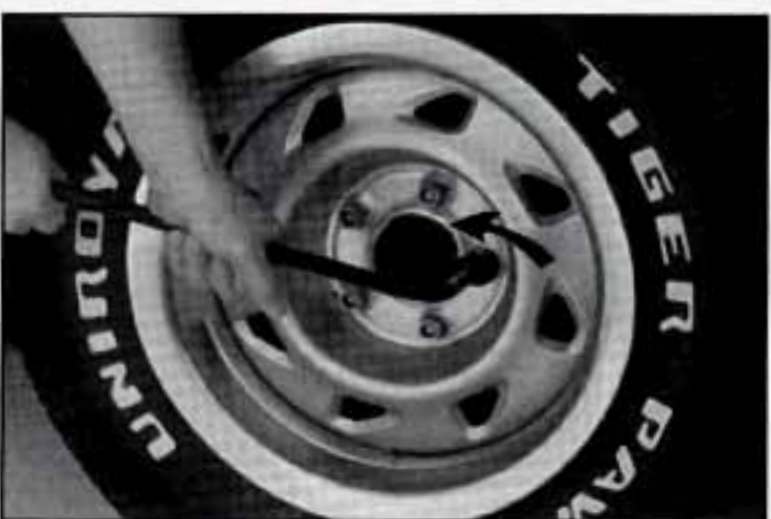

Using the wheel wrench, loosen all the wheel nuts. Don't remove them yet.

Jack Locations

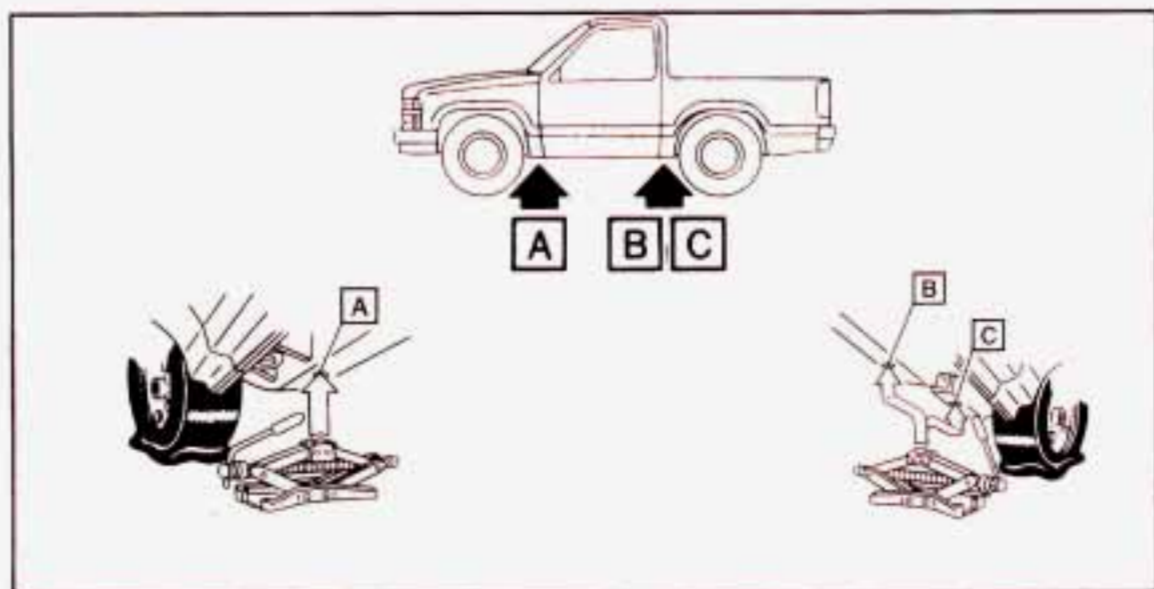

Position the jack under the vehicle.

- A. Front Frame Hole
- B. Rear Frame Hole (ZR2)
- C. Spring Hanger Hole (Standard Pick-ups)

Your vehicle has a hole in the frame near each front wheel, and a hole in the spring hanger near each rear wheel for the jack. Fit the jack into the hole nearest the flat tire.

CAUTION:

Getting under a vehicle when it is jacked up is dangerous. If the vehicle slips off the jack, you could be badly injured or killed. Never get under a vehicle when it is supported only by a jack.

NOTICE:

Raising your vehicle with the jack improperly positioned will damage the vehicle or may allow the vehicle to fall off the jack. Be sure to fit the jack lift head into the proper location before raising your vehicle.



Raise the vehicle by rotating the jackhandle to the right. Raise the vehicle far enough off the ground so there is enough room for the spare tire to fit.



Remove all the wheel nuts.



Take off the flat tire.

⚠ CAUTION:

Rust or dirt on the wheel, or on the parts to which it is fastened, can make the wheel nuts become loose after a time. The wheel could come off and cause an accident. When you change a wheel, remove any rust or dirt from the places where the wheel attaches to the vehicle. In an emergency, you can use a cloth or a paper towel to do this; but be sure to use a scraper or wire brush later, if you need to, to get all the rust or dirt off.



Remove any rust or dirt from the wheel bolts, mounting surfaces and spare wheel. Place the spare on the wheel mounting surface.

⚠ CAUTION:

Never use oil or grease on studs or nuts. If you do, the nuts might come loose. Your wheel could fall off, causing a serious accident.

Put on the spare tire.



Put the nuts on by hand. Make sure the cone-shaped end is toward the wheel.

Tighten each nut by hand until the wheel is held against the hub. If a nut can't be turned by hand, use the wheel wrench and see your dealer as soon as possible.

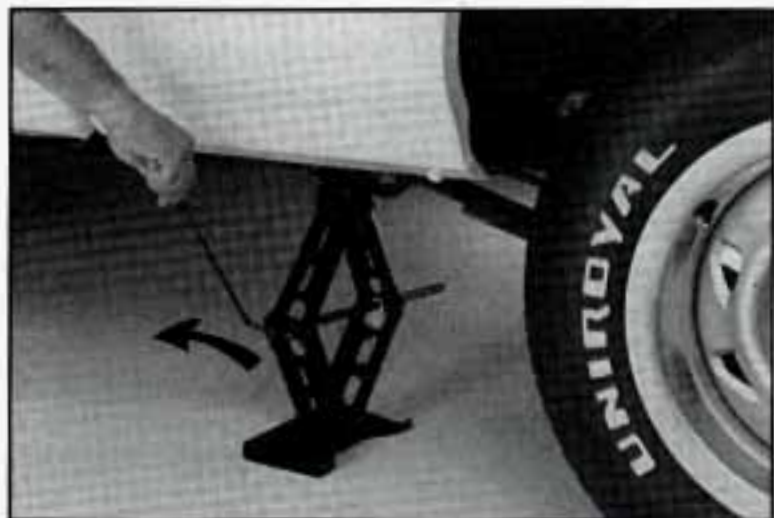

Lower the vehicle by rotating the jackhandle to the left. Lower the jack completely.

Tightening Wheel Nut



Tightening Sequence

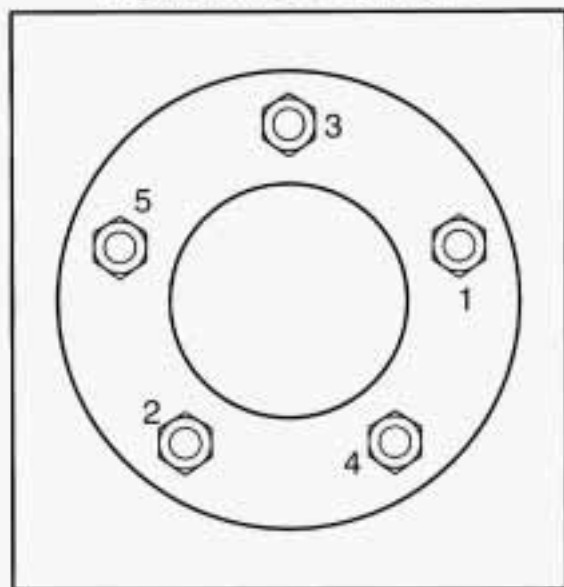

Use the wrench to tighten the wheel nuts firmly in a criss-cross sequence as shown. Remove the wheel blocks.



CAUTION:

Incorrect wheel nuts or improperly tightened wheel nuts can cause the wheel to become loose and even come off. This could lead to an accident. Be sure to use the correct wheel nuts. If you have to replace them, be sure to get the right kind.

Stop somewhere as soon as you can and have the nuts tightened with a torque wrench to 95 ft. lbs. (130 N.m).

Storing The Tire in The Underbody Carrier

Put the tire on the ground at the rear of the vehicle, with the valve stem pointed down and to the rear.

Pull the retaining bar through the wheel.

NOTE: With ZR2 option, spring and retainer must be separated to insert through wheel opening.

Put the chisel end of the wheel wrench, on an angle, through the hole in the rear bumper and into the hoist shaft. Turn the wheel wrench right until the tire is raised against the underside of the vehicle.

You will hear two "clicks" when the tire is secure, but pull on the tire to make sure.

Storing The Jacking Equipment

Return the jack, wheel wrench and wheel blocks to the proper location behind the seat. Secure the items and replace the jack cover.



CAUTION:

Storing a jack, a tire or other equipment in the passenger compartment of the vehicle could cause injury. In a sudden stop or collision, loose equipment could strike someone. Store all these in the proper place.

NOTICE:

Don't use the existing hoist to store a tire with an aluminum wheel or it could damage the wheel. Secure the tire in the pickup bed.

If You're Stuck: In Sand, Mud, Ice or Snow

What you *don't* want to do when your vehicle is stuck is to spin your wheels. The method known as "rocking" can help you get out when you're stuck, but you must use caution.



CAUTION:

If you let your tires spin at high speed, they can explode and you or others could be injured. And, the transmission or other parts of the vehicle can overheat. That could cause an engine compartment fire or other damage. When you're stuck, spin the wheels as little as possible. Don't spin the wheels above 35 mph (55 km/h) as shown on the speedometer.

NOTICE:

Spinning your wheels can destroy parts of your vehicle as well as the tires. If you spin the wheels too fast while shifting your transmission back and forth, you can destroy your transmission.

Rocking your vehicle to get it out:

First, turn your steering wheel left and right. That will clear the area around your front wheels. Then shift back and forth between "R" (Reverse) and a forward gear (or with a manual transmission, between First or Second gear and Reverse), spinning the wheels as little as possible. Release the accelerator pedal while you shift, and press lightly on the accelerator pedal when the transmission is in gear. If that doesn't get you out after a few tries, you may need to be towed out. Or, you can use your recovery hooks, if your vehicle has them. If you do need to be towed out, see "Towing Your Vehicle" in the Index.

Using the Recovery Hooks



If you ever get stuck in sand, mud, ice or snow, your vehicle may be equipped with recovery hooks. The recovery hooks are provided at the front of your vehicle. You may need to use them if you're stuck off-road and need to be pulled to some place where you can continue driving.



CAUTION:

The recovery hooks, when used, are under a lot of force. Always pull the vehicle straight out. Never pull on the hooks at a sideways angle. The hooks could break off and you or others could be injured from the chain or cable snapping back.



NOTICE:

Never use the recovery hooks to tow the vehicle. Your vehicle could be damaged and it would not be covered by warranty.

Service & Appearance Care



Section

6

Here you will find information about the care of your vehicle. This part begins with service and fuel information, and then it shows how to check important fluid and lubricant levels. There is also technical information about your vehicle, and a section devoted to its appearance care.

Service	6-2
Fuel	6-3
Checking Things Under the Hood	6-6
Engine Oil	6-9
Air Cleaner	6-14
Automatic Transmission Fluid	6-15
Manual Transmission Fluid	6-18
Hydraulic Clutch	6-20
Rear Axle	6-20
Transfer Case	6-21
Front Axle	6-22
Engine Coolant	6-23
Power Steering Fluid	6-26
Windshield Washer Fluid	6-28
Brake Master Cylinder	6-29
Replacing Brake System Parts	6-32
Battery	6-32
Vehicle Storage	6-32
Bulb Replacement	6-33
Other Maintenance Items	6-39
Loading Your Vehicle	6-45
Tires	6-51
Appearance Care	6-59
Vehicle Identification Number (VIN)	6-68
Service Parts Identification Label	6-70
Fuses and Circuit Breakers	6-70
Capacities and Specifications Charts	6-73

Service

Your GM dealer knows your vehicle best and wants you to be happy with it. We hope you'll go to your dealer for all your service needs. You'll get genuine GM parts and GM-trained and supported service people.

We hope you'll want to keep your GM vehicle all GM. Genuine GM parts have one of these marks:



Doing Your Own Service Work

If you want to do some of your own service work, you'll want to get the proper GM Service Manual. It tells you much more about how to service your vehicle than this manual can. To order the proper service manual, see "Service Publications" in the Index.

You should keep a record with all parts receipts and list the mileage and the date of any service work you perform. See "Maintenance Record" in the Index.



CAUTION:

You can be injured if you try to do service work on a vehicle without knowing enough about it.

- **Be sure you have sufficient knowledge, experience, and the proper replacement parts and tools before you attempt any vehicle maintenance task.**
- **Be sure to use the proper nuts, bolts and other fasteners. "English" and "metric" fasteners can be easily confused. If you use the wrong fasteners, parts can later break or fall off. You could be hurt.**

NOTICE:

If you try to do your own service work without knowing enough about it, your vehicle could be damaged.

Fuel

The 8th digit of your Vehicle Identification Number (VIN) shows the code letter for your engine. You will find the VIN at the top left of your instrument panel. (See “Vehicle Identification Number” in the Index.)

Use regular unleaded gasoline rated at 87 octane or higher. With the 4.3L (Code W) engine, use premium unleaded gasoline rated at 91 octane or higher for high power performance, when towing a trailer or with a high payload requirement. But when operating with a light load as a normal condition, you may use middle grade or regular unleaded gasolines.

The gasoline you use should meet specifications ASTM D4814 in the U.S. and CGSB 3.5-92 in Canada. These fuels should have the proper additives, so you should not have to add anything to the fuel.

In the U.S. and Canada, it's easy to be sure you get the right kind of gasoline (unleaded). You'll see “UNLEADED” right on the pump. And only unleaded nozzles will fit into your vehicle's filler neck.

Be sure the posted octane is at least 91 for premium, 89 for middle grade and 87 for regular. If the octane is less than 87, you may get a heavy knocking noise when you drive. If it's bad enough, it can damage your engine.

If you're using fuel rated at 91 octane or higher and you still hear heavy knocking, your engine needs service. But don't worry if you hear a little pinging noise when you're accelerating or driving up a hill. That's normal, and you don't have to buy a higher octane fuel to get rid of it. It's the heavy, constant knock that means you have a problem.

What about gasoline with blending materials that contain oxygen (oxygenates), such as MTBE or alcohol?

MTBE is “methyl tertiary-butyl ether.” Fuel that is no more than 15% MTBE is fine for your vehicle.

Ethanol is ethyl or grain alcohol. Properly-blended fuel that is no more than 10% *ethanol* is fine for your vehicle.

Methanol is methyl or wood alcohol.

NOTICE:

Fuel that is more than 5% *methanol* is bad for your vehicle. Don't use it. It can corrode metal parts in your fuel system and also damage plastic and rubber parts. That damage wouldn't be covered under your warranty. And even at 5% or less, there must be “cosolvents” and corrosion preventers in this fuel to help avoid these problems.

Gasolines for Cleaner Air

Your use of gasoline with deposit control additives will help prevent deposits from forming in your engine and fuel system. That helps keep your engine in tune and your emission control system working properly. It's good for your vehicle, and you'll be doing your part for cleaner air.

Many gasolines are now blended with oxygenates. General Motors recommends that you use gasolines with these blending materials, such as MTBE and ethanol. By doing so, you can help clean the air, especially in those parts of the country that have high carbon monoxide levels.

In addition, some gasoline suppliers are now producing reformulated gasolines. These gasolines are specially designed to reduce vehicle emissions. General Motors recommends that you use reformulated gasoline. By doing so, you can help clean the air, especially in those parts of the country that have high ozone levels.

You should ask your service station operators if their gasolines contain deposit control additives and oxygenates, and if they have been reformulated to reduce vehicle emissions.

Fuels in Foreign Countries

If you plan on driving in another country outside the U.S. or Canada, unleaded fuel may be hard to find. Do not use leaded gasoline. If you use even one tankful, your emission controls won't work well or at all. With continuous use, spark plugs can get fouled, the exhaust system can corrode, and your engine oil can deteriorate quickly. Your vehicle's oxygen sensor will be damaged. All of that means costly repairs that wouldn't be covered by your warranty.

To check on fuel availability, ask an auto club, or contact a major oil company that does business in the country where you'll be driving.

You can also write us at the following address for advice. Just tell us where you're going and give your Vehicle Identification Number (VIN).

General Motors Overseas Distribution Corporation
North American Export Sales (NAES)
1908 Colonel Sam Drive
Oshawa, Ontario
L1H 8P7

Filling Your Tank



The fuel cap is behind a hinged door on the left side of your vehicle.



CAUTION:

Gasoline vapor is highly flammable. It burns violently, and that can cause very bad injuries. Don't smoke if you're near gasoline or refueling your vehicle. Keep sparks, flames, and smoking materials away from gasoline.

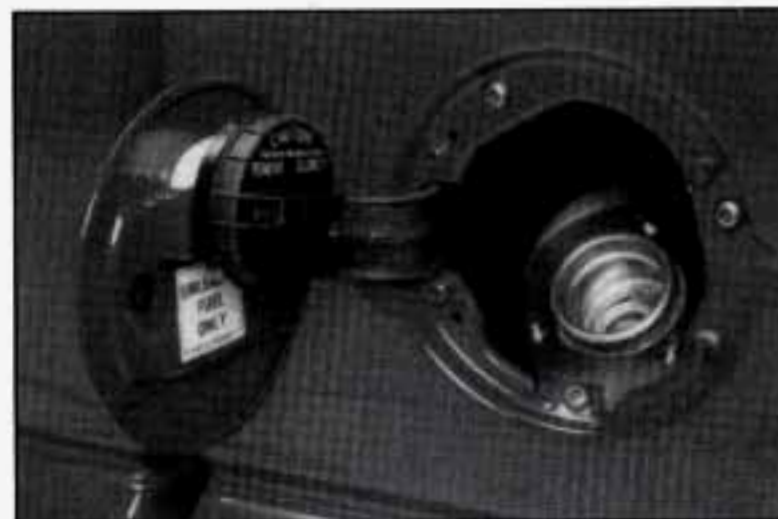

While refueling, hang the cap inside the fuel door.

To take off the cap, turn it slowly to the left.



CAUTION:

If you get gasoline on you and then something ignites it, you could be badly burned. Gasoline can spray out on you if you open the fuel filler cap too quickly. This spray can happen if your tank is nearly full, and is more likely in hot weather. Open the fuel filler cap slowly and wait for any “hiss” noise to stop. Then unscrew the cap all the way.

Be careful not to spill gasoline. Clean gasoline from painted surfaces as soon as possible. See “Cleaning the Outside of Your Vehicle” in the Index.

When you put the cap back on, turn it to the right until you hear a clicking noise.

NOTICE:

If you need a new cap, be sure to get the right type. Your dealer can get one for you. If you get the wrong type, it may not fit or have proper venting, and your fuel tank and emissions system might be damaged.

Checking Things Under the Hood

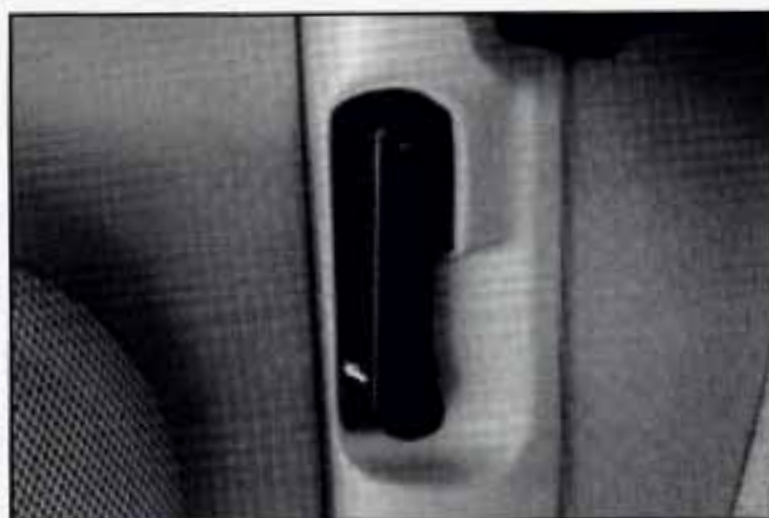

Hood Release

To open the hood, first pull the handle inside the vehicle on the lower left side of the instrument panel.

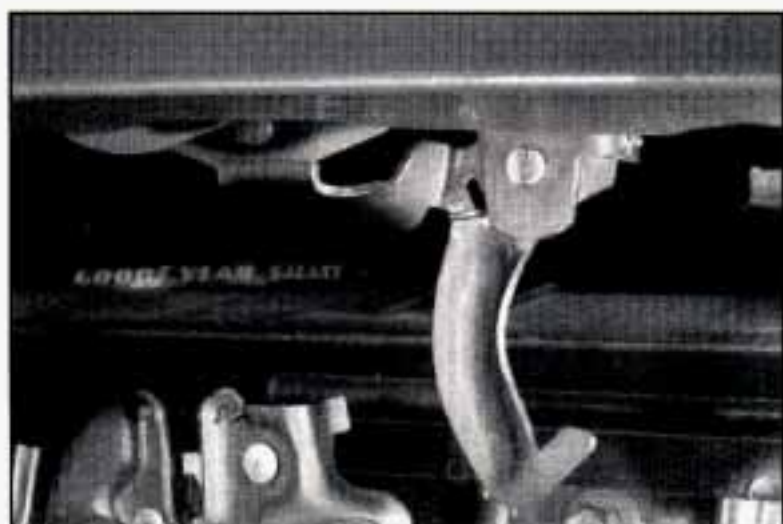

Then go to the front of the vehicle and release the secondary hood release.



Lift the hood, release the hood prop from its retainer and put the hood prop into the slot in the hood. You will have an underhood light that comes on when you lift the hood.



Before closing the hood, be sure all the filler caps are on properly. Then lift the hood to relieve pressure on the hood prop.

 **CAUTION:**

Things that burn can get on hot engine parts and start a fire. These include liquids like gasoline, oil, coolant, brake fluid, windshield washer and other fluids, and plastic or rubber. You or others could be burned. Be careful not to drop or spill things that will burn onto a hot engine.



Remove the hood prop from the slot in the hood and return the prop to its retainer.



Then just pull the hood down and close it firmly.

Engine Oil

It's a good idea to check your engine oil every time you get fuel. In order to get an accurate reading, the oil must be warm and the vehicle must be on level ground.



Turn off the engine and give the oil a few minutes to drain back into the oil pan. If you don't, the oil dipstick might not show the actual level.

To Check Engine Oil

Pull out the dipstick and clean it with a paper towel or cloth, then push it back in all the way. Remove it again, keeping the tip lower.

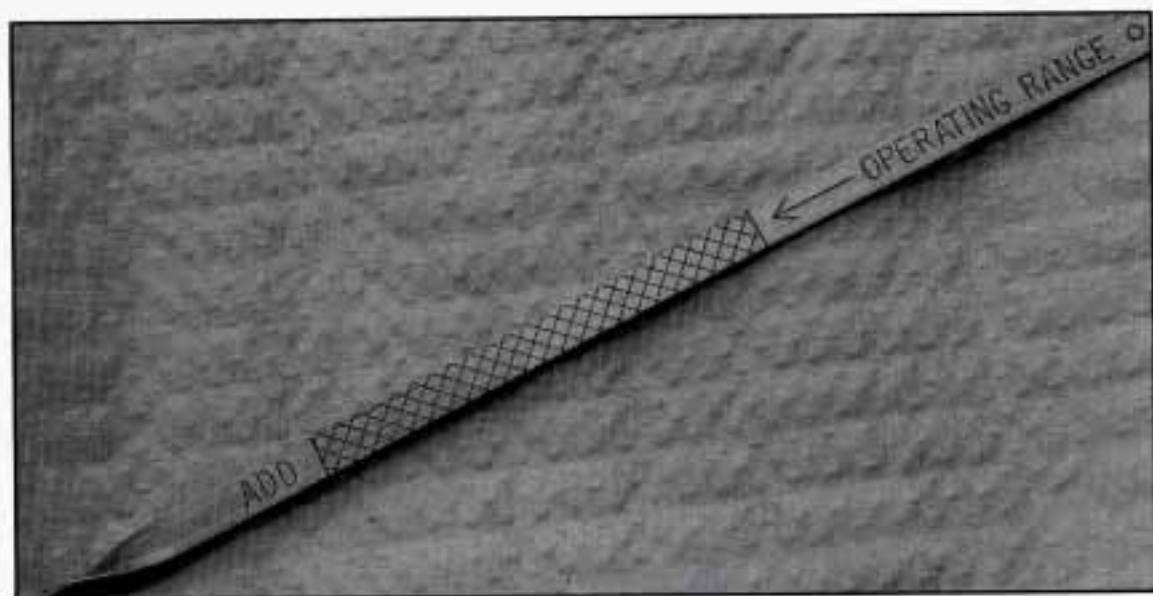

When to Add Oil

If the oil is at or below the ADD line, then you'll need to add some oil. But you must use the right kind. This section explains what kind of oil to use. For crankcase capacity, see "Capacities and Specifications" in the Index.

NOTICE:

Don't add too much oil. If your engine has so much oil that the oil level gets above the cross-hatched area that shows the proper operating range, your engine could be damaged.



Just fill it enough to put the level somewhere in the proper operating range. Push the dipstick all the way back in when you're through.

What Kind of Oil to Use

Beginning midyear 1993, oils of the proper quality for your vehicle will be identified with this new "starburst" symbol. The "starburst" symbol indicates that the oil has been certified by the American Petroleum Institute (API), and is preferred for use in your gasoline engine.



You should look for this on the front of the oil container, and use only oils that display this new symbol.

You should also use the proper viscosity oil for your vehicle, as shown in the following chart:

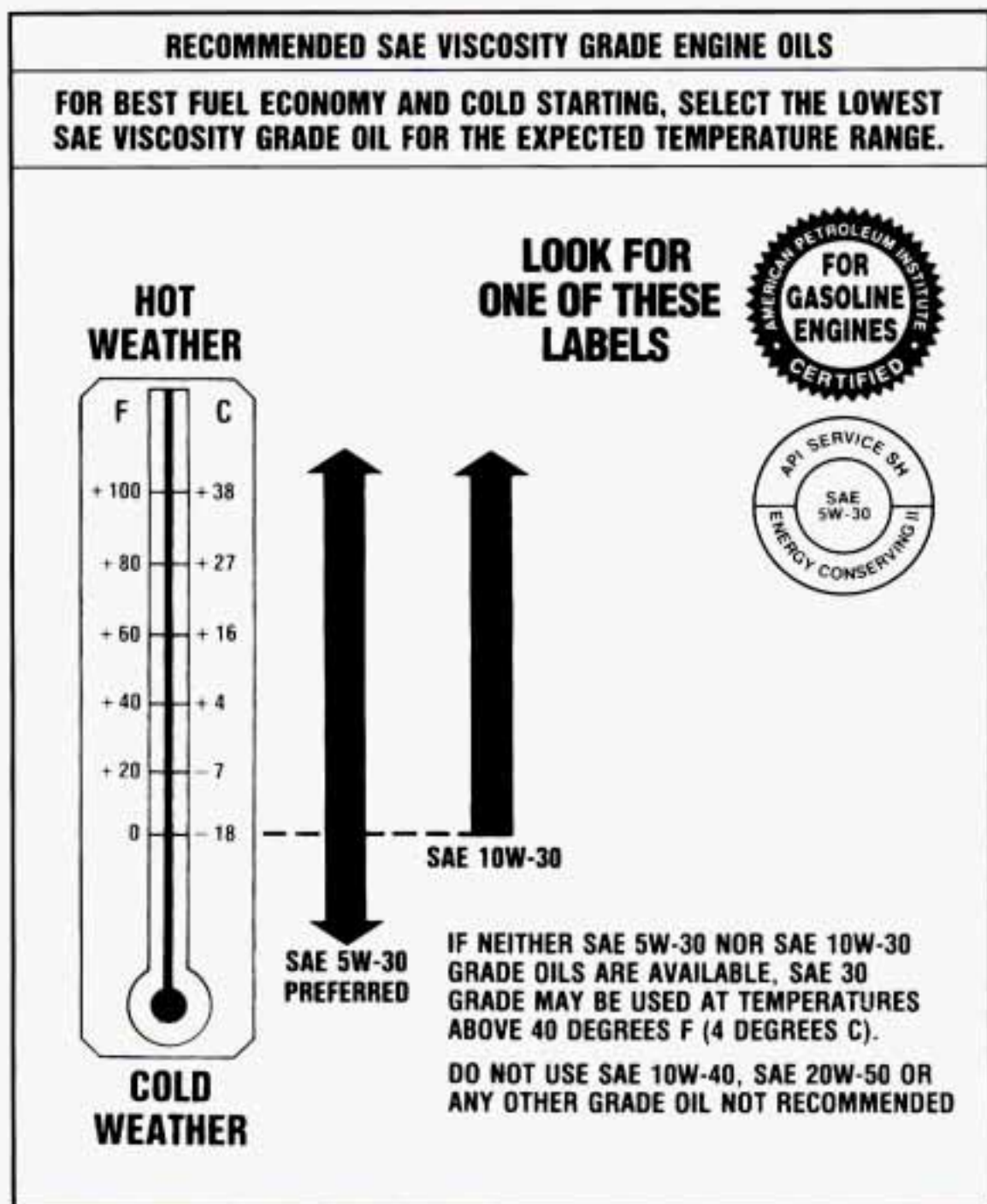

As shown in the chart, SAE 5W-30 is best for your vehicle. However, you can use SAE 10W-30 if it's going to be 0°F (-18°C) or above. These numbers on an oil container show its viscosity, or thickness. Do not use other viscosity oils, such as SAE 10W-40 or SAE 20W-50.

If you cannot find oils with the new “starburst” symbol on the front of the container, you should look for and use oils containing the following three things:

- SH or SG

“SH or SG” must be on the oil container, either by itself or combined with other quality designations, such as “SH/CD,” “SH, SG, CD,” “SG/CD,” etc. These letters show American Petroleum Institute (API) levels of quality.

- SAE 5W-30
- Energy Conserving II

Oils with these words on the container will help you save fuel.

These three things are usually included in a doughnut shaped logo (symbol) on most containers. If you cannot find oils with the “starburst” symbol, you should look for oils with the doughnut shaped symbol, containing the three things noted above.



NOTICE:

If you use oils that do not have either the “starburst” symbol or an API SH or SG designation, you can cause engine damage not covered by your warranty.

GM Goodwrench[®] oil (in Canada, GM Engine Oil) meets all the requirements for your vehicle.

Engine Oil Additives

Don't add anything to your oil. Your GM dealer is ready to advise if you think something should be added.

When to Change Engine Oil

See if any one of these is true for you:

- Most trips are less than 4 miles (6 km).
- It's below freezing outside and most trips are less than 10 miles (16 km).
- The engine is at low speed most of the time (as in door-to-door delivery, or in stop-and-go traffic).
- You tow a trailer often.
- Most trips are through dusty places.
- The vehicle is frequently operated off-road.

If any one of these is true for your vehicle, then you need to change your *oil and filter* every 3,000 miles (5 000 km) or 3 months — whichever comes first.

If none of them is true, change the oil every 7,500 miles (12 500 km) or 12 months — whichever comes first. Change the filter at the first oil change and at every other oil change after that.

Four-Wheel Drive Remote Oil Filter

If your vehicle has four-wheel drive, you will have a remote oil filter located under the radiator support. There is a special access door in the vehicle body skirt shield.

Engine Coolant Heater (Engine Block Heater)

An engine coolant heater can be a big help if you have to park outside in very cold weather, 0°F (-18°C) or colder. If your vehicle has this option, see "Engine Coolant Heater" in the Index.

What to Do with Used Oil

Did you know that used engine oil contains certain elements that may be unhealthy for your skin and could even cause cancer? Don't let used oil stay on your skin for very long. Clean your skin and nails with soap and water, or a good hand cleaner. Wash or properly throw away clothing or rags containing used engine oil. (See the manufacturer's warnings about the use and disposal of oil products.)

Used oil can be a real threat to the environment. If you change your own oil, be sure to drain all free-flowing oil from the filter before disposal. Don't ever dispose of oil by putting it in the trash, pouring it on the ground, into sewers, or into streams or bodies of water. Instead, recycle it by taking it to a place that collects used oil. If you have a problem properly disposing of your used oil, ask your dealer, a service station or a local recycling center for help.

Air Cleaner



To remove the round air cleaner filter for the 4.3L (VIN Z) engine, turn the wing nuts to the left. Remove the cover and change the filter. Care should be taken during reassembly to ensure that the cover is on straight and the wingnuts properly tightened.

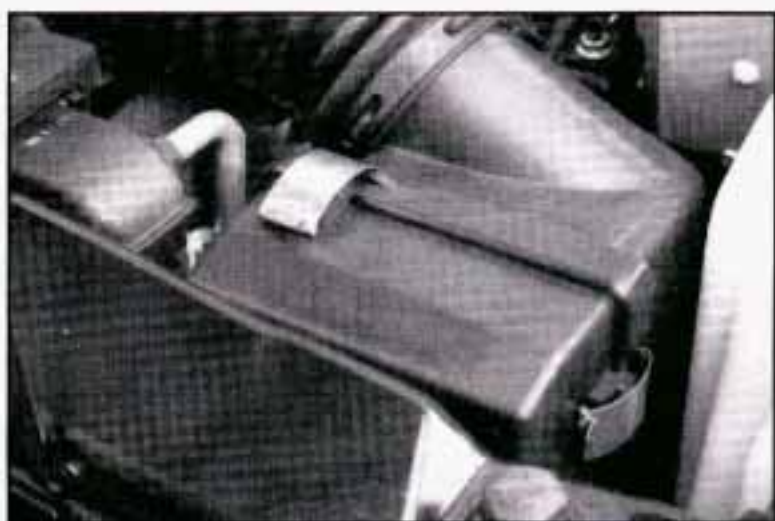

To remove the square air cleaner filter for the 2.2L (VIN 4) and the 4.3L (VIN W) engines, open both clamps and push the rear of the air cleaner back toward the rear of the engine compartment to change the filter.

While reassembling the air cleaner assembly, ensure that the air cleaner cover tabs are fully inserted into the slots in the air cleaner housing and the PCV air tube is properly seated in the left hand valve cover.

Refer to the Maintenance Schedule to determine when to replace the air filter.

See “Scheduled Maintenance Services” in the Index.



CAUTION:

Operating the engine with the air cleaner off can cause you or others to be burned. The air cleaner not only cleans the air, it stops flame if the engine backfires. If it isn't there, and the engine backfires, you could be burned. Don't drive with it off, and be careful working on the engine with the air cleaner off.

NOTICE:

If the air cleaner is off, a backfire can cause a damaging engine fire. And, dirt can easily get into your engine, which will damage it. Always have the air cleaner in place when you're driving.

Automatic Transmission Fluid

When to Check and Change

A good time to check your automatic transmission fluid level is when the engine oil is changed. Refer to the Maintenance Schedule to determine when to change your fluid. See “Scheduled Maintenance Services” in the Index.

How to Check

Because this operation can be a little difficult, you may choose to have this done at a GM dealership Service Department.

If you do it yourself, be sure to follow all the instructions here, or you could get a false reading on the dipstick.

NOTICE:

Too much or too little fluid can damage your transmission. Too much can mean that some of the fluid could come out and fall on hot engine parts or exhaust system, starting a fire. Be sure to get an accurate reading if you check your transmission fluid.

Wait at least 30 minutes before checking the transmission fluid level if you have been driving:

- When outside temperatures are above 90°F (32°C).
- At high speed for quite a while.
- In heavy traffic — especially in hot weather.
- While pulling a trailer.

To get the right reading, the fluid should be at normal operating temperature, which is 180°F to 200°F (82°C to 93°C).

To check transmission fluid hot: Get the vehicle warmed up by driving about 15 miles (24 km) when outside temperatures are above 50°F (10°C). If it's colder than 50°F (10°C), drive the vehicle in "D" (3rd Gear) until the engine temperature gage moves and then remains steady for ten minutes. Then follow the hot check procedures.

To check transmission fluid cold: A cold check is made after the vehicle has been sitting for eight hours or more with the engine off and is used only as a reference. Let the engine run at idle for five minutes if outside temperatures are 50°F (10°C) or more. If it's colder than 50°F (10°C), you may have to idle the engine longer. Should the fluid level be low during a cold check, you *must* perform a hot check before adding fluid. This will give you a more accurate reading of the fluid level.

To check the fluid hot or cold

- Park your vehicle on a level place.
- With the parking brake applied, place the shift lever in "P" (Park).
- With your foot on the brake pedal, move the shift lever through each gear range, pausing for about three seconds in each range. Then, position the shift lever in "P" (Park).
- Let the engine run at idle for three minutes or more.

Then, without shutting off the engine, follow these steps:



1. Flip the handle up and then pull out the dipstick and wipe it with a clean rag or paper towel.
2. Push it back in all the way, wait three seconds and then pull it back out again.

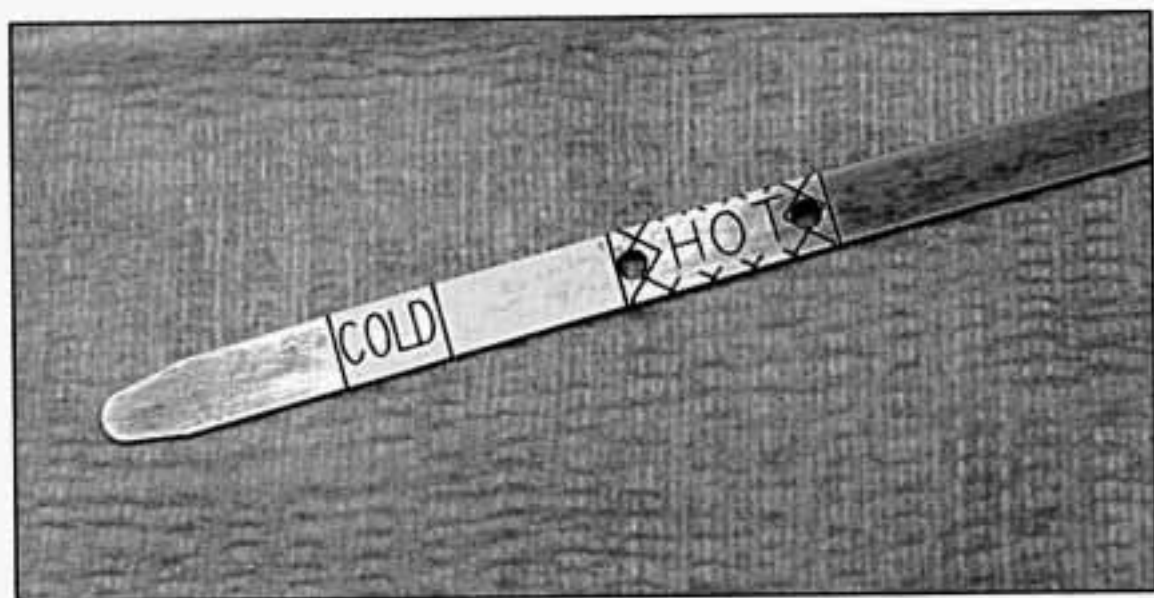

3. Check both sides of the dipstick, and read the lower level. The fluid level must be in the COLD area for a cold check or in the HOT area or cross-hatched area for a hot check.



4. If the fluid level is in the acceptable range, push the dipstick back in all the way; then flip the handle down to lock the dipstick in place.

How to Add Fluid

Refer to the Maintenance Schedule to determine what kind of transmission fluid to use. See "Recommended Fluids and Lubricants" in the Index.

If the fluid level is low, add only enough of the proper fluid to bring the level up to the COLD area for a cold check or the HOT area for a hot check. It doesn't take much fluid, generally less than a pint. **Don't overfill.** We recommend you use only fluid labeled DEXRON[®]-III or DEXRON[®]-IIE, because fluids with that label are made especially for your automatic transmission. Damage caused by fluid other than DEXRON[®]-III or DEXRON[®]-IIE is not covered by your new vehicle warranty.

- After adding fluid, recheck the fluid level as described under "How to Check."
- When the correct fluid level is obtained, push the dipstick back in all the way; then flip the handle down to lock the dipstick in place.

Manual Transmission Fluid

When to Check

A good time to have it checked is when the engine oil is changed. However, the fluid in your manual transmission doesn't require changing.

How to Check

Because this operation can be a little difficult, you may choose to have this done at a GM dealership Service Department.

If you do it yourself, be sure to follow all the instructions here, or you could get a false reading.

NOTICE:

Too much or too little fluid can damage your transmission. Too much can mean that some of the fluid could come out and fall on hot engine parts or exhaust system, starting a fire. Be sure to get an accurate reading if you check your transmission fluid.

Check the fluid level only when your engine is off, the vehicle is parked on a level place and the transmission is cool enough for you to rest your fingers on the transmission case.

Then, follow these steps:

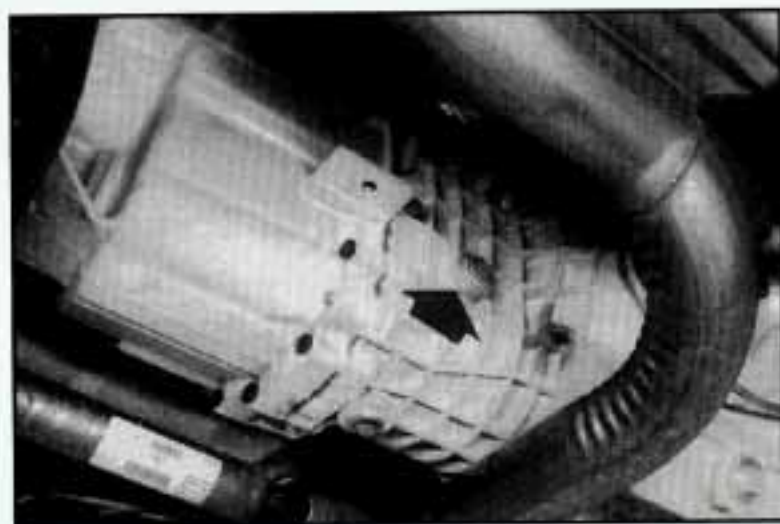

1. Remove the filler plug.
2. Check that the lubricant level is up to the bottom of the filler plug hole.
3. If the fluid level is good, install the plug and be sure it is fully seated. If the fluid level is low, add more fluid as described in the next steps.

How to Add Fluid

Here's how to add fluid. Refer to the Maintenance Schedule to determine what kind of fluid to use. See "Recommended Fluids and Lubricants" in the Index.

1. Remove the filler plug.
2. Add fluid at the filler plug hole. Add only enough fluid to bring the fluid level up to the bottom of the filler plug hole.
3. Install the filler plug. Be sure the plug is fully seated.

Hydraulic Clutch

The hydraulic clutch in your vehicle is self-adjusting. A slight amount of play (1/4 inch to 1/2 inch) in the pedal is normal.

When to Check and What to Use



Refer to the Maintenance Schedule to determine how often you should check the fluid level in your clutch master cylinder reservoir and what to add. See “Owner Checks and Services” and “Recommended Fluids and Lubricants” in the Index.

How to check

The proper fluid should be added if the level does not reach the bottom of the diaphragm when it's in place in the reservoir. See the instructions on the reservoir cap.

Rear Axle

When to Check and Change Lubricant

Refer to the Maintenance Schedule to determine how often to check the lubricant and when to change it. See “Scheduled Maintenance Services” in the Index.

How to Check Lubricant



If the level is below the bottom of the filler plug hole, you'll need to add some lubricant. Add enough lubricant to raise the level to the bottom of the filler plug hole.

What to Use

Refer to the Maintenance Schedule to determine what kind of lubricant to use. See "Recommended Fluids and Lubricants" in the Index.

Four-Wheel Drive

Most lubricant checks in this section also apply to four-wheel-drive vehicles. However, they have two additional systems that need lubrication.

Transfer Case

When to Check Lubricant

Refer to the Maintenance Schedule to determine how often to check the lubricant. See "Periodic Maintenance Inspections" in the Index.

How to Check Lubricant



If the level is below the bottom of the filler plug hole, you'll need to add some lubricant. Add enough lubricant to raise the level to the bottom of the filler plug hole.

The arrow on the left shows the drain plug location. The arrow on the right shows the filler plug location.

What to Use

Refer to the Maintenance Schedule to determine what kind of lubricant to use. See "Recommended Fluids and Lubricants" in the Index.

Front Axle

When to Check and Change Lubricant

Refer to the Maintenance Schedule to determine how often to check the lubricant and when to change it. See "Scheduled Maintenance Services" in the Index.

How to Check Lubricant



If the level is below the bottom of the filler plug hole, you'll need to add some lubricant.

If the differential is at operating temperature (warm), add enough lubricant to raise the level to the bottom of the filler plug hole.

If the differential is cold, add enough lubricant to raise the level to 1/2 inch (12 mm) below the filler plug hole.

What to use

Refer to the Maintenance Schedule to determine what kind of lubricant to use. See “Recommended Fluids and Lubricants” in the Index.

Engine Coolant

The following explains your cooling system and how to add coolant when it is low. If you have a problem with engine overheating, see “Engine Overheating” in the Index.

The proper coolant for your vehicle will:

- Give freezing protection down to -20°F (-29°C), or -34°F (-37°C) in Canada and for vehicles with the cold climate option.
- Give boiling protection up to 258°F (125°C).
- Protect against rust and corrosion.
- Help keep the proper engine temperature.
- Let the warning lights and gages work as they should.

What to Use

Use a mixture of one-half *clean water* (preferably distilled) and one-half antifreeze that meets “GM Specification 6038-M” or “GM Specification 6043-M” for the 2.2L (LN2) Code 4 engine, which won’t damage aluminum parts. You can also use a recycled coolant conforming to “GM Specification 6038-M” or “GM Specification 6043-M” for the 2.2L (LN2) Code 4 engine with a complete coolant flush and refill. If you use this mixture, you don’t need to add anything else.



CAUTION:

Adding only plain water to your cooling system can be dangerous. Plain water, or some other liquid like alcohol, can boil before the proper coolant mix will. Your vehicle’s coolant warning system is set for the proper coolant mix. With plain water or the wrong mix, your engine could get too hot but you wouldn’t get the overheat warning. Your engine could catch fire and you or others could be burned. Use a 50/50 mix of clean water and a proper antifreeze.

NOTICE:

If you use an improper coolant mix, your engine could overheat and be badly damaged. The repair cost wouldn't be covered by your warranty. Too much water in the mix can freeze and crack the engine, radiator, heater core and other parts.

Some conditions, such as air trapped in the cooling system, can affect the coolant level in the radiator. Check the coolant level when the engine is cold and follow the steps under "Adding Coolant" for the proper way to add coolant.

If you have to add coolant more than four times a year, have your dealer check your cooling system.

NOTICE:

If you use the proper coolant, you don't have to add extra inhibitors or additives which claim to improve the system. These can be harmful.

Adding Coolant

To Check Coolant

When your engine is cold, the coolant level should be at "ADD," or a little higher. When your engine is warm, the level should be up to "FULL HOT," or a little higher.

To Add Coolant



If you need more coolant, add the proper mix *at the coolant recovery tank.*



CAUTION:

Turning the radiator pressure cap when the engine and radiator are hot can allow steam and scalding liquids to blow out and burn you badly. With the coolant recovery tank, you will almost never have to add coolant at the radiator. Never turn the radiator pressure cap — even a little — when the engine and radiator are hot.

Add coolant mix at the recovery tank, but be careful not to spill it.



CAUTION:

You can be burned if you spill coolant on hot engine parts. Coolant contains ethylene glycol, and it will burn if the engine parts are hot enough. Don't spill coolant on a hot engine.

Radiator Pressure Cap

NOTICE:

Your radiator cap is a 15 psi (105 kPa) pressure-type cap and must be tightly installed to prevent coolant loss and possible engine damage from overheating. Be sure the arrows on the cap line up with the overflow tube on the radiator filler neck.



When you replace your radiator pressure cap, a GM cap is recommended. See “Service Replacement Part and Filter Recommendations” in the Index.

Thermostat

Engine coolant temperature is controlled by a thermostat in the engine coolant system. The thermostat stops the flow of coolant through the radiator until the coolant reaches a preset temperature.

When you replace your thermostat, an AC[®] thermostat is recommended.

Power Steering Fluid

NOTICE:

Always turn the engine off before checking or adding power steering fluid. The power steering cap is close to the fan and other moving parts.

How To Check Power Steering Fluid



Unscrew the cap and wipe the dipstick with a clean rag. Replace the cap and completely tighten it.



Then remove the cap again and look at the fluid level on the dipstick.

- When the engine compartment is hot, the level should be at the “HOT” mark.
- When the engine compartment is cool, the level should be at the “FULL COLD” mark.

What to Add

Refer to the Maintenance Schedule to determine what kind of fluid to use. See “Recommended Fluids and Lubricants” in the Index.

NOTICE:

When adding power steering fluid or making a complete fluid change, always use the proper fluid. Failure to use the proper fluid can cause leaks and damage hoses and seals.

Windshield Washer Fluid

To Add



Open the cap labeled "WASHER FLUID ONLY." Add washer fluid until the bottle is full.

NOTICE:

- When using concentrated washer fluid, follow the manufacturer's instructions for adding water.
- Don't mix water with ready-to-use washer fluid. Water can cause the solution to freeze and damage your washer fluid tank and other parts of the washer system. Also, water doesn't clean as well as washer fluid.
- Fill your washer fluid tank only 3/4 full when it's very cold. This allows for expansion, which could damage the tank if it is completely full.
- Don't use radiator antifreeze in your windshield washer. It can damage your washer system and paint.

Fluid Leak Check

After the vehicle has been parked for a while, inspect the surface under the vehicle for water, oil, fuel or other fluids. Water dripping from the air conditioning system after it has been used is normal. If you notice fuel leaks or fumes, the causes should be found and corrected at once.

Brakes

Brake Master Cylinder

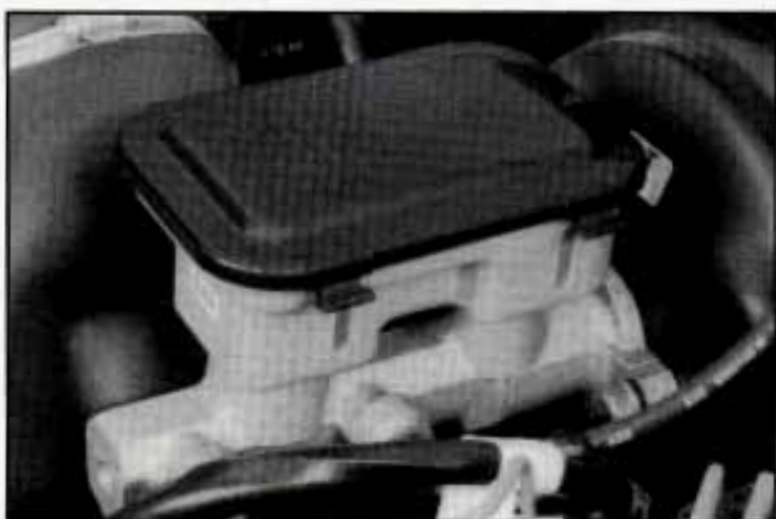

Your brake master cylinder is here. It is filled with DOT-3 brake fluid.

There are only two reasons why the brake fluid level in your master cylinder might go down. The first is that the brake fluid goes down to an acceptable level during normal brake lining wear. When new linings are put in, the fluid level goes back up. The other reason is that fluid is leaking out of the brake system. If it is, you should have your brake system fixed, since a leak means that sooner or later your brakes won't work well, or won't work at all. So, it isn't a good idea to "top off" your brake fluid. Adding brake fluid won't correct a leak. If you add fluid when your linings are worn, then you'll have too much fluid when you get new brake linings. You should add (or remove) brake fluid, as necessary, only when work is done on the brake hydraulic system.



CAUTION:

If you have too much brake fluid, it can spill on the engine. The fluid will burn if the engine is hot enough. You or others could be burned, and your vehicle could be damaged. Add brake fluid only when work is done on the brake hydraulic system.

Refer to the Maintenance Schedule to determine when to check your brake fluid. See "Periodic Maintenance Inspections" in the Index.

To Check Brake Fluid



You can check the brake fluid without taking off the cap. Just look at the windows on the brake fluid reservoir.

The fluid levels should be above “MIN.” If they aren’t, have your brake system checked to see if there is a leak.

After work is done on the brake hydraulic system, make sure the levels are above “MIN” and below the top of each window.

What to Add

When you do need brake fluid, use only DOT-3 brake fluid — such as Delco Supreme II[®] (GM Part No.1052535). Use new brake fluid from a sealed container only, and always clean the brake fluid reservoir cap before removing it.

NOTICE:

- Don’t let someone put in the wrong kind of fluid. For example, just a few drops of mineral-based oil, such as engine oil, in your brake system can damage brake system parts so badly that they’ll have to be replaced.
- Brake fluid can damage paint, so be careful not to spill brake fluid on your vehicle. If you do, wash it off immediately. See “Appearance Care” in the Index.

Brake Wear

Your vehicle has front disc brakes and rear drum brakes.

Disc brake pads have built-in wear indicators that make a high-pitched warning sound when the brake pads are worn and new pads are needed. The sound may come and go or be heard all the time your vehicle is moving (except when you are pushing on the brake pedal firmly).



CAUTION:

The brake wear warning sound means that sooner or later your brakes won't work well. That could lead to an accident. When you hear the brake wear warning sound, have your vehicle serviced.

NOTICE:

Continuing to drive with worn-out brake pads could result in costly brake repair.

Some driving conditions or climates may cause a brake squeal when the brakes are first applied or lightly applied. This does not mean something is wrong with your brakes.

Your rear drum brakes don't have wear indicators, but if you ever hear a rear brake rubbing noise, have the rear brake linings inspected. Also, the rear brake drums should be removed and inspected each time the tires are removed for rotation or changing. When you have the front brakes replaced, have the rear brakes inspected, too.

Brake linings should always be replaced as complete axle sets.

Brake Pedal Travel

See your dealer if the brake pedal does not return to normal height, or if there is a rapid increase in pedal travel. This could be a sign of brake trouble.

Brake Adjustment

Every time you make a brake stop, your disc brakes adjust for wear.

If your brake pedal goes down farther than normal, your rear drum brakes may need adjustment. Adjust them by backing up and firmly applying the brakes a few times.

Replacing Brake System Parts

The braking system on a modern vehicle is complex. Its many parts have to be of top quality and work well together if the vehicle is to have really good braking. Vehicles we design and test have top-quality GM brake parts in them, as your vehicle does when it is new. When you replace parts of your braking system — for example, when your brake linings wear down and you have to have new ones put in — be sure you get new genuine GM replacement parts. If you don't, your brakes may no longer work properly. For example, if someone puts in brake linings that are wrong for your vehicle, the balance between your front and rear brakes can change, for the worse. The braking performance you've come to expect can change in many other ways if someone puts in the wrong replacement brake parts.

Battery

Every new vehicle has a Delco Freedom[®] battery. You never have to add water to one of these. When it's time for a new battery, we recommend a Delco Freedom[®] battery. Get one that has the catalog number shown on the original battery's label.

Vehicle Storage

If you're not going to drive your vehicle for 25 days or more, take off the black, negative (-) cable from the battery. This will help keep your battery from running down.



CAUTION:

Batteries have acid that can burn you and gas that can explode. You can be badly hurt if you aren't careful. See "Jump Starting" in the Index for tips on working around a battery without getting hurt.

Contact your dealer to learn how to prepare your vehicle for longer storage periods.

For more information, contact your dealer's service department, or write:

Adistra Corporation
171 Hamilton Street
Plymouth, MI 48170

In Canada, write:

General Motors of Canada Limited
Customer Services Department
Oshawa, Ontario L1J 5Z6 Canada

Fluid Leak Check

After the vehicle has been parked for awhile, inspect the surface under the vehicle for water, oil, fuel or other fluids. Water dripping from the air conditioning system after it has been used is normal. If you notice fuel leaks or fumes, the causes should be found and corrected at once.

Bulb Replacement

Before you replace any bulbs, be sure that all the lights are off and the engine isn't running.

Halogen Bulbs



CAUTION:

Halogen bulbs have pressurized gas inside and can burst if you drop or scratch the bulb. You or others could be injured. Take special care when handling and disposing of halogen bulbs.

NOTICE:

Avoid touching the bulb or letting it come in contact with anything damp. Oil from your skin or moisture on the bulb can cause the bulb to explode when it is turned on. If either comes in contact with the bulb, clean it with alcohol or a suitable degreaser and wipe the bulb dry.

Composite Headlights

1. Open the hood.



2. Remove the screws at the top of the radiator support.



3. Pull the headlight lens assembly out.
4. Unplug the electrical connector.



5. Turn the bulb to the left to remove it.

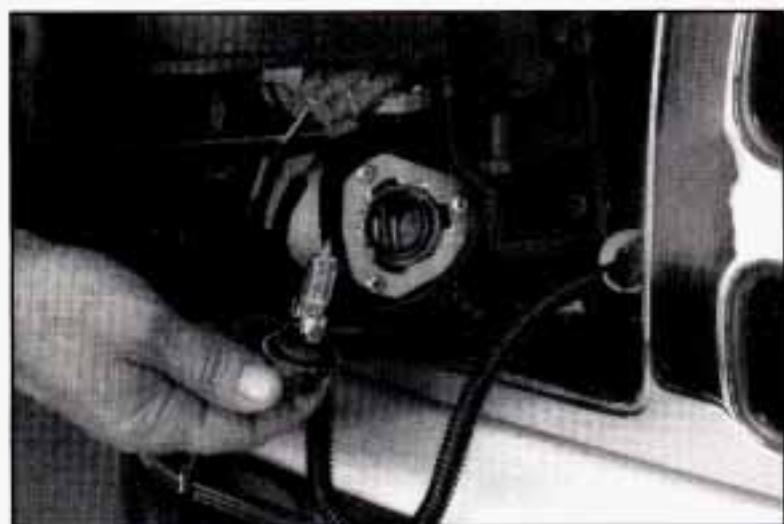

6. Put the new bulb into the headlight lens assembly and turn it to the right until it is tight.
7. Plug in the electrical connector.

8. Put the headlight lens assembly back into the vehicle. Install and tighten the screws.

Sealed Beam Headlights



1. Remove the screws from the headlight retainer.



2. Pull the headlight out and remove the retainer.
3. Unplug and remove the headlight.

4. Plug in the new headlight and put it in place.
5. Put the retainer on the headlight and install and tighten the screws.

Front Park/Turn Signal Lights (Composite and Sealed Beam)

If you have fog lamps, the fog lamp bracket must be removed before you can replace the front park/turn signal lights.

1. Reach under the bumper and behind the parking/turn signal light assembly.

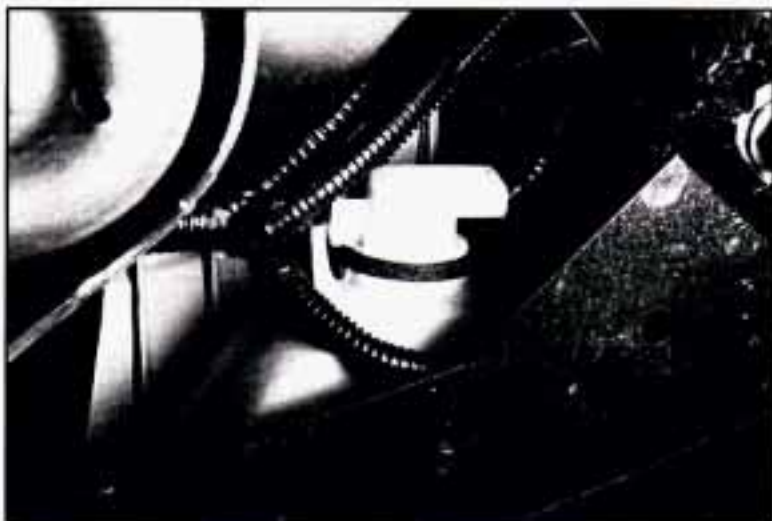

2. Turn the socket to the left and pull it out.



3. Pull the bulb out of the socket.

4. Push the new bulb into the socket.
5. Put the socket back into the parking/turn signal light assembly and turn it to the right until it locks in place.

Rear Lights

1. Open the tailgate.

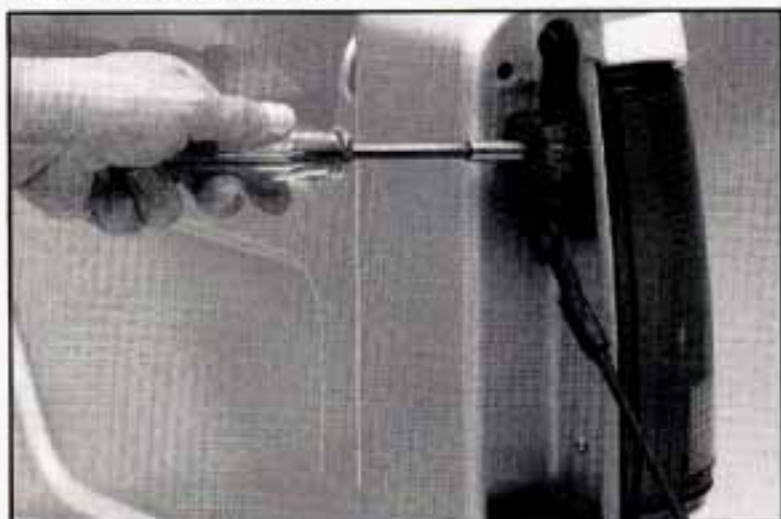

2. Remove the light assembly screws near the tailgate latch and pull out the light assembly.

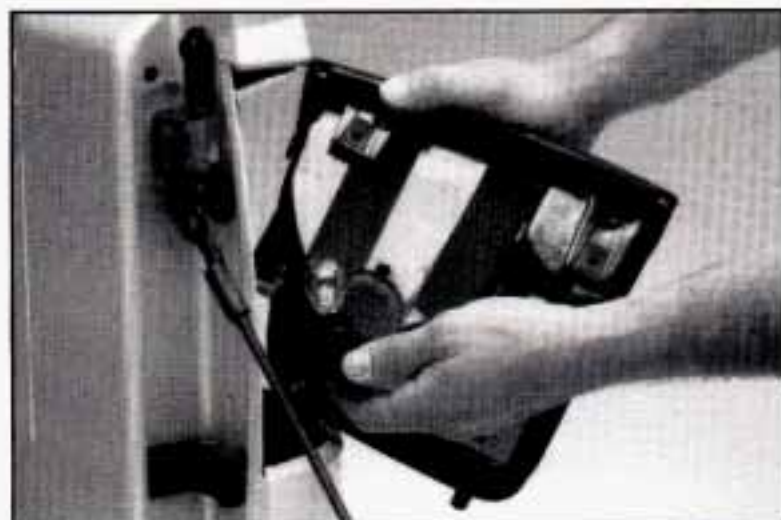

3. Pull the light assembly away from the pickup side panel.
4. Turn the socket to the left to remove it. Push the tab in while you turn the socket.

5. Pull the bulb out.
6. Push the new bulb into the socket.
7. Put the socket into the light assembly and turn the socket to the right until it locks in place.
8. Replace the light assembly. Install and tighten the screws.
9. Close the tailgate.

Center High Mounted Stop Lamp (CHMSL)



1. Remove the CHMSL lens retaining screws.
2. Remove the CHMSL lens.



3. Remove the CHMSL bulb.
4. Install the new CHMSL bulb.
5. Replace the CHMSL lens. Install and tighten the screws.

Other Maintenance Items

Front Suspension and Steering Linkage

Refer to the Maintenance Schedule to determine how often to lubricate the fittings and what type of lubricant to use.

Front Wheel Bearings (Two-Wheel Drive)

If your vehicle is two-wheel drive, it has wheel bearings that must be cleaned and repacked.

Refer to the Maintenance Schedule to determine how often this must be done.

Single Belt Accessory Drive

Your new vehicle uses a serpentine belt that is lighter, and more durable than systems with several belts.

The belt runs over or around the pulleys on the engine. A tensioner is used to keep the belt tight at all times. The tensioner also makes replacing the belt easier if you need to replace the belt, be sure to get the correct replacement belt. Your dealership or parts supplier can help you with this. The Accessory Drive Belt Routing label on your vehicle will show you how to route the belt your vehicle uses.

Windshield Wiper Blade Replacement

NOTICE:

Use care when removing or installing a blade assembly. Accidental bumping can cause the arm to fall back and strike the windshield.

To Remove the Old Wiper Blade:

- Lift the wiper arm until it locks into a vertical position.

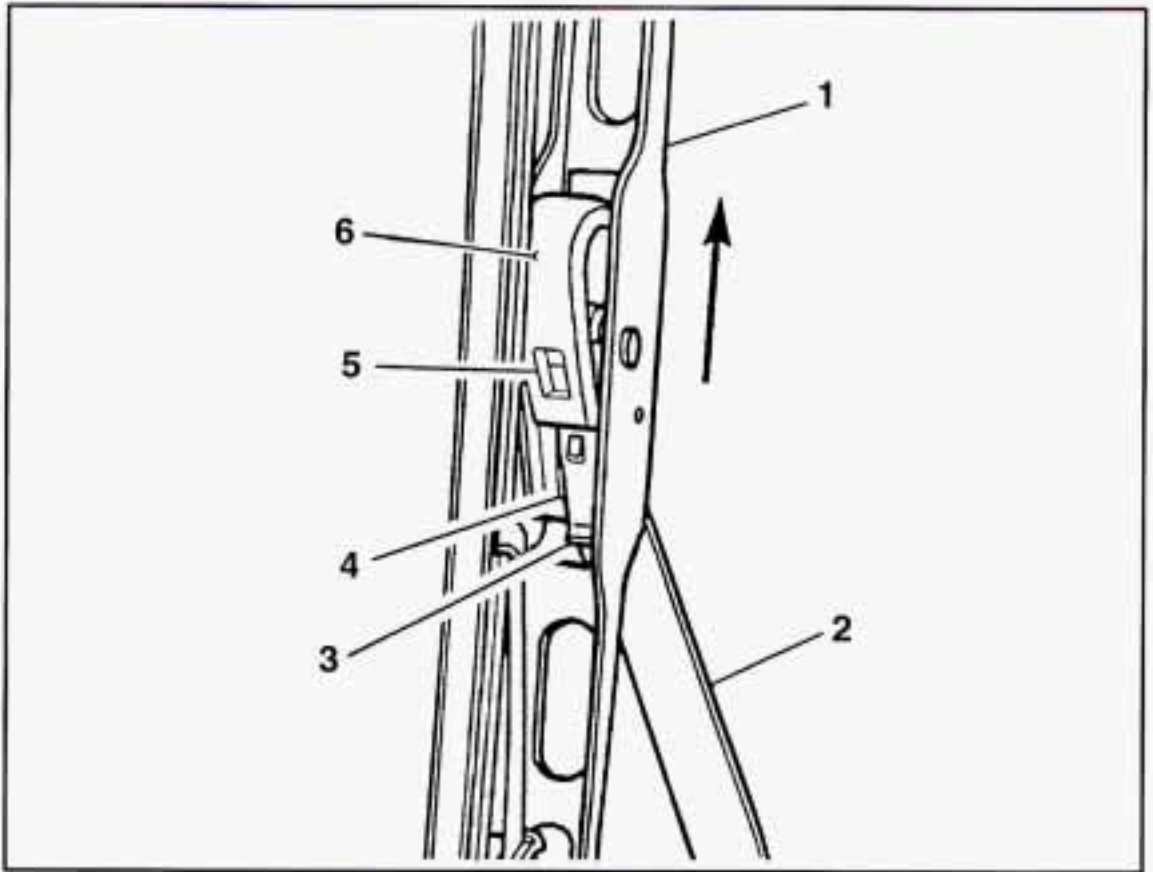

1. Blade Assembly
2. Arm Assembly
3. Locking Tab
4. Blade Pivot
5. Hook Slot
6. Arm Hook

- Press down on the blade assembly pivot locking tab. Pull down on the blade assembly to release it from the wiper arm hook .
- Remove the insert from the blade assembly. The insert has two notches at one end that are locked by bottom claws of the blade assembly. At the notched end, pull the insert from the blade assembly.

To Install the New Wiper Blade:

- Slide the insert (notched end last) into the blade claws at end "A". Plastic caps will be forced off as the insert is fully inserted.

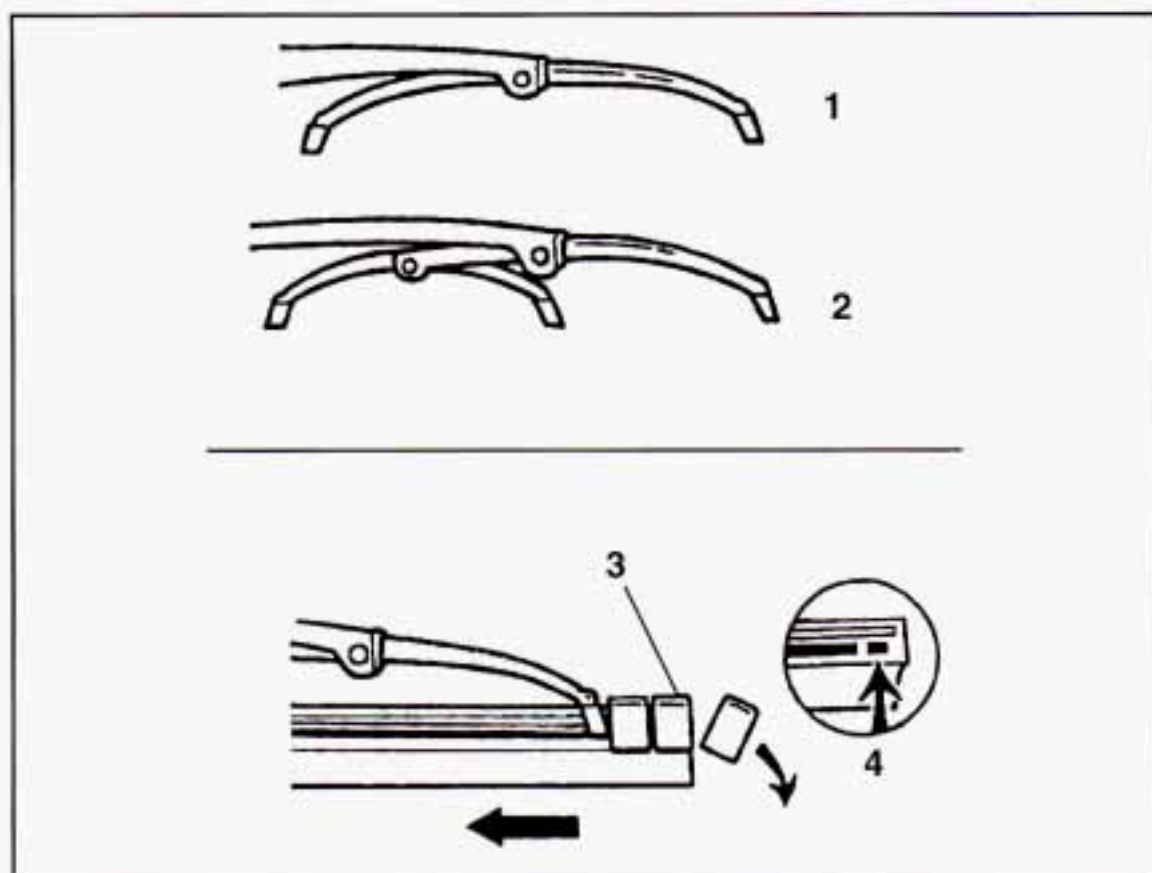

1. End "A"
2. End "B"
3. Retaining Caps
4. Notch

- Be sure that the notches are locked by the bottom claws. Make sure that all other claws are properly locked on both sides of the insert slots.

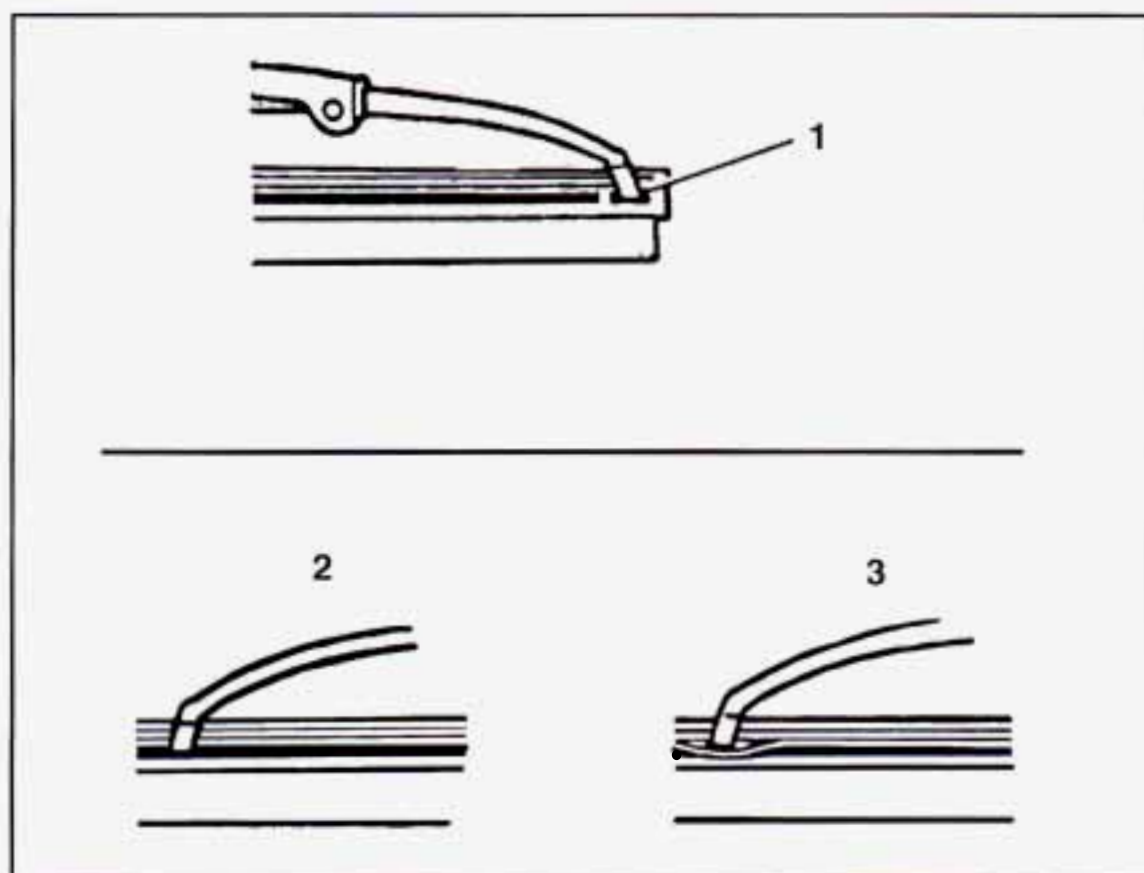

1. Claw in Notch
2. Correct Installation
3. Incorrect Installation

- Put the blade assembly pivot in the wiper arm hook. Pull up until the pivot locking tab locks in the hook slot.
- Carefully lower the wiper arm and blade assembly onto the windshield.

Air Conditioning

Every now and then have your dealership check your air conditioning system to be sure it has not lost any cooling ability. If you think the system is not working properly, have your dealership check it out as soon as possible.

The air conditioning will not work when the temperature is below 40°F (4°C).

Lubrication

Accelerator Control System

Refer to the Maintenance Schedule to determine how often the accelerator linkage pivot points must be lubricated and what type of lubricant to use.

Accelerator cables and cruise control cables should not be lubricated. Any cables that are worn or are hard to pull should be replaced.

When cleaning the engine compartment with water or steam, avoid directing the flow onto the throttle linkage in a manner that would cause moisture to enter the cables.

Hood Latches and Hood Hinge

Refer to the Maintenance Schedule to determine how to lubricate the hood latch and hood hinge assembly.

Propeller Shaft Slip Splines/Universal Joints

Refer to the Maintenance Schedule to determine how often the slip and universal joints must be lubricated and what type of lubricant to use.

Body

Normal use of your vehicle will cause metal to metal wear at some points on the cab and body if they are not lubricated.

For exposed surfaces, such as door checks, door lock bolts, lock striker plates, dovetail bumper wedges, etc., a thin film of engine oil should be applied.

Where oil holes are provided in the body or cab, a dripless oil can be used.

The seat adjusters and seat track should be lubricated with chassis grease.

Door weatherstrips and rubber hood bumpers should be wiped clean with a wet cloth and lightly coated with a rubber lubricant.

Never use too much of any lubricant and be sure to wipe up any extra lubricant when you are finished.

Window regulators and controls are inside the doors. They are lubricated with a long lasting grease. If lubrication is required your dealer should perform this service.

Refer to the Maintenance Schedule to determine how often to lubricate these items and what type of lubricant to use.

Lock Cylinders

To be sure your locks operate properly, they must be lubricated.

Refer to the Maintenance Schedule to determine how often to lubricate them and what type of lubricant to use.

You should not use penetrating oils because they could wash out the factory installed lubricant and cause the lock to bind. De-icers which contain alcohol could also wash away the lubricant, so be sure to lubricate the lock after using a de-icer of this type.

Tailgate Handle

The tailgate handle pivot points on your vehicle should be lubricated to keep the handle working smoothly.

Refer to the Maintenance Schedule to determine how often to lubricate them and what type of lubricant to use.

Exhaust System

To help prevent damage to your exhaust system, do not continue to drive your vehicle if you notice:

- Engine misfiring
- Loss of performance
- Other unusual operating conditions

Have your engine and exhaust system serviced regularly.

Three-Way Catalytic Converter

Your vehicle's three-way catalytic converter is designed to reduce the pollutants in your vehicle's exhaust. Use only unleaded fuel in your vehicle. If you use leaded fuel, you could damage your three-way catalytic converter and other engine components.

Malfunction Indicator Lamp (SERVICE ENGINE SOON)

This light on your instrument panel lets you know when your emission system needs service. The light will come on briefly when you start your engine to let you know that the system is working. If it does not come on when you start your engine, or if it comes on and stays on while you're driving, your system may need service. Your vehicle should still be driveable, but you should have your system serviced right away.

Engine Control Module System

This system has an oxygen (O₂) sensor that helps keep your engine's air-fuel mixture at a proper level. Use only unleaded fuel in your vehicle. If you use leaded fuel, you could damage your oxygen (O₂) sensor and affect your vehicle's emissions.

Loading Your Vehicle

MFD BY GENERAL MOTORS CORP []

GVWR [] GAWR FRT [] GAWR RR [] LB/KG

THIS VEHICLE CONFORMS TO ALL APPLICABLE FEDERAL MOTOR VEHICLE SAFETY STANDARDS IN EFFECT ON THE DATE OF MANUFACTURE SHOWN ABOVE.

[] MODEL [] SPEED [] PAYLOAD []

[] TIRE SIZE [] RTG [] RIM [] PSI/KPA (COLD)

FRT []
RR []
SPA []

SEE OWNERS MANUAL FOR ADDITIONAL INFORMATION

The Certification/Tire label is found on the driver's door lock pillar. The label shows the size of your original tires and the inflation pressures needed to obtain the gross weight capacity of your vehicle. This is called the GVWR (Gross Vehicle Weight Rating). The GVWR includes the weight of the vehicle, all occupants, fuel and cargo.

The Certification/Tire label also tells you the maximum weights for the front and rear axles, called Gross Axle Weight Rating (GAWR). To find out the actual loads on your front and rear axles, you need to go to a weigh station and weigh your vehicle. Your dealer can help you with this. Be sure to spread out your load equally on both sides of the centerline.

Never exceed the GVWR for your vehicle, or the Gross Axle Weight Rating (GAWR) for either the front or rear axle.

And, if you do have a heavy load, you should spread it out.



CAUTION:

In the case of a sudden stop or collision, things carried in the bed of your truck could shift forward and come into the passenger area, injuring you and others. If you put things in the bed of your truck, you should make sure they are properly secured.



CAUTION:

Do not load your vehicle any heavier than the GVWR or the maximum front and rear GAWRs. If you do, parts on your vehicle can break, or it can change the way your vehicle handles. These could cause you to lose control. Also, overloading can shorten the life of your vehicle.

Using heavier suspension components to get added durability might not change your weight ratings. Ask your dealer to help you load your vehicle the right way.

NOTICE:

Your warranty does not cover parts or components that fail because of overloading.

If you put things inside your vehicle — like suitcases, tools, packages, or anything else — they will go as fast as the vehicle goes. If you have to stop or turn quickly, or if there is a crash, they'll keep going.



CAUTION:

Things you put inside your vehicle can strike and injure people in a sudden stop or turn, or in a crash.

- **Put things in the cargo area of your vehicle. Try to spread the weight evenly.**
- **Never stack heavier things, like suitcases, inside the vehicle so that some of them are above the tops of the seats.**
- **Don't leave an unsecured child restraint in your vehicle.**
- **When you carry something inside the vehicle, secure it whenever you can.**
- **Don't leave a seat folded down unless you need to.**

Payload

The Payload Capacity is shown on the Certification/Tire label. This is the maximum load capacity that your vehicle can carry. Be sure to include the weight of the people inside as part of your load. If you added any accessories or equipment after your vehicle left the factory, remember to subtract the weight of these things from the payload. Your dealer can help you with this.

Trailer Package

If your vehicle comes with the Trailer Package, there is also a load rating which includes the weight of the vehicle *and* the trailer it tows. This rating is called the Gross Combination Weight Rating (GCWR).

When you weigh your trailer, be sure to include the weight of everything you put in it. And, remember to figure the weight of the people inside as part of your load.

Your dealer can help you determine your GCWR.

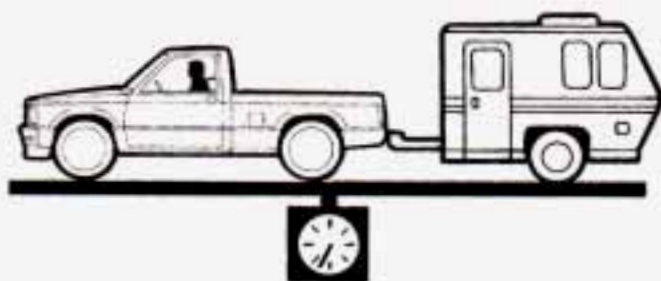

Add-On Equipment

When you carry removable items, you may need to put a limit on how many people you carry inside your vehicle. Be sure to weigh your vehicle before you buy and install the new equipment.

NOTICE:

Your warranty doesn't cover parts or components that fail because of overloading.

Truck-Camper Loading Information

Open your glove box and look for this label:



TRUCK CAMPER LOADING INFORMATION

This information is furnished to indicate the manufacturer's recommendation regarding the use of a slide-in camper with the truck as manufactured.

1GCCS14Z8N8166054
CARGO WEIGHT RATING 12000LB/522KB
DIMENSIONS: "A" = 60IN/152CM "B" = 60IN/152CM
SEE OWNER'S MANUAL FOR MORE TRUCK
CAMPER LOADING INFORMATION.

Printed in U.S.A.  Pt. No. 15696350

This label will tell you if your vehicle can carry a slide-in camper, how much of a load your vehicle can carry, and how to spread out your load the right way. Also, it will help you match the right slide-in camper to your vehicle.

When you carry a slide-in camper, the total cargo load of your vehicle is the weight of the camper, *plus*

- everything else added to the camper after it left the factory;
- everything in the camper; and
- all the people inside.

The Cargo Weight Rating (CWR) is the maximum weight of the load your vehicle can carry. It doesn't include the weight of the people inside. But, you can figure about 150 pounds for each seat.

The total cargo load must not be more than your vehicle's CWR.

Truck Loading Information

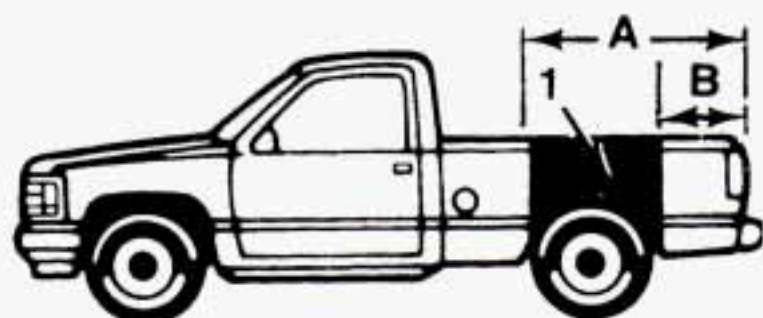

1. Recommended location for cargo center of gravity for cargo weight rating.
 - Refer to Truck Camper Loading Information label in the glove box for "A" and "B" dimensions.
 - Use rear edge of load floor for measurement purposes.

Example of Proper Truck and Camper Match

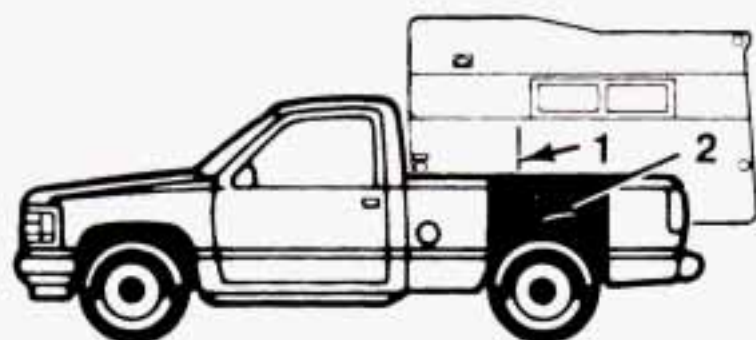

1. Camper center of gravity
2. Recommended center of gravity location zone

The camper's center of gravity should fall within the center of gravity zone for your vehicle's cargo load.

You must weigh any accessories, trailer hitches or other equipment you add to your vehicle. Then, subtract this extra weight from the CWR. This extra weight may shorten the center of gravity zone for your vehicle. Your dealer can help you with this.

If your slide-in camper and its load weigh less than the CWR, the center of gravity zone for your vehicle may be larger.

Your dealer can help you make a good vehicle-camper match. He'll also help you determine your CWR.

After you've loaded your vehicle and camper, drive to a weigh station and weigh on the front and rear wheels separately. This will tell you the loads on your axles. The loads on the front and rear axles shouldn't be more than either of the GAWRs. The total of the axle loads should not be more than the GVWR.

Open your driver's door and look at the door lock pillar for the Certification/Tire label to find out your GAWR and GVWR.

If you've gone over your weight ratings, move or take out some things until all the weights fall below the ratings. Of course, you should always tie down any loose items when you load your vehicle or camper.

When you install and load your slide-in camper, check the manufacturer's instructions.

If you want more information on curb weights, cargo weights, cargo weight rating and the correct center of gravity zone for your vehicle, your dealer can help you. Just ask for a copy of "Consumer Information, Truck - Camper Loading."

Trailer Recommendations

You must subtract your hitch loads from the CWR for your vehicle. Weigh your vehicle with your trailer attached, so that you won't go over the GVWR or the GAWR.

You'll get the best performance if you spread out the weight of your load the right way, and if you choose the correct hitch and trailer brakes.

For more information, see "Trailer Towing" in the Index.

Pickup Conversion To Chassis Cab

General Motors is aware that some vehicle owners may consider having the pickup box removed and a commercial or recreational body installed. However, we recommend that conversions of this type not be done to this pickup. Owners should be aware that, as manufactured, there are differences between a chassis cab and a pickup with the box removed which may affect vehicle safety. For further information, contact the GM Zone Office for your area. (See the "Warranty and Owner Assistance" booklet for Zone Office.)

Tires

We don't make tires. Your new vehicle comes with high quality tires made by a leading tire manufacturer. These tires are warranted by the tire manufacturers and their warranties are delivered with every new vehicle. If your spare tire is a different brand than your road tires, you will have a tire warranty folder from each of these manufacturers.



CAUTION:

Poorly maintained and improperly used tires are dangerous.

- **Overloading your tires can cause overheating as a result of too much friction. You could have an air-out and a serious accident. See “Loading Your Vehicle” in the Index.**
- **Underinflated tires pose the same danger as overloaded tires. The resulting accident could cause serious injury. Check all tires frequently to maintain the recommended pressure. Tire pressure should be checked when your tires are cold.**
- **Overinflated tires are more likely to be cut, punctured, or broken by a sudden impact, such as when you hit a pothole. Keep tires at the recommended pressure.**
- **Worn, old tires can cause accidents. If your tread is badly worn, or if your tires have been damaged, replace them.**
- **Even if it's legal, don't drive over 85 mph (135 km/h) if you have 31x10.50R15LT/C tires.**

See “Special Tire Inflation” in this section for more information on loading and inflation pressures at speeds above 65 mph (105 km/h).

Inflation – Tire Pressure

The Certification/Tire label which is on the driver's door lock pillar, shows the correct inflation pressures for your tires, when they're cold. "Cold" means your vehicle has been sitting for at least three hours or driven no more than a mile.

NOTICE:

Don't let anyone tell you that underinflation *or* overinflation is all right. It's not. If your tires don't have enough air (underinflation) you can get:

- Too much flexing
- Too much heat
- Tire overloading
- Bad wear
- Bad handling
- Bad fuel economy.

If your tires have too much air (overinflation), you can get:

- Unusual wear
- Bad handling
- Rough ride
- Needless damage from road hazards.

When to Check

Check your tires once a month or more. Also, check the tire pressure of the spare tire.

How to Check

Use a good quality pocket-type gage to check tire pressure. Simply looking at the tires will not tell you the pressure, especially if you have radial tires — which may look properly inflated even if they're underinflated.

If your tires have valve caps, be sure to put them back on. They help prevent leaks by keeping out dirt and moisture.

Special Tire Inflation

If you have **31x10.50R15LT/C tires** on your vehicle, and:

- You'll be driving for very long at speeds of 66 mph (105 km/h) to 75 mph (120 km/h) where legal, inflate tires to 10 psi (70 kPa) more than the recommended cold inflation pressures.
- You'll be driving for very long at speeds of 76 mph (120 km/h) to 85 mph (135 km/h) where legal, cold inflation pressures should be increased by 10 psi (70 kPa) and you must also reduce axle load capacity by 10%. **Do not drive over 85 mph (135 km/h) even when it's legal.**

Inflation pressures should never exceed 10 psi (70 kPa) above the inflation specified for the maximum load of the tire.

Tire Inspection and Rotation

To make your tires last longer, have them inspected and rotated at the mileages recommended in the Maintenance Schedule. See "Scheduled Maintenance Services" in the Index.

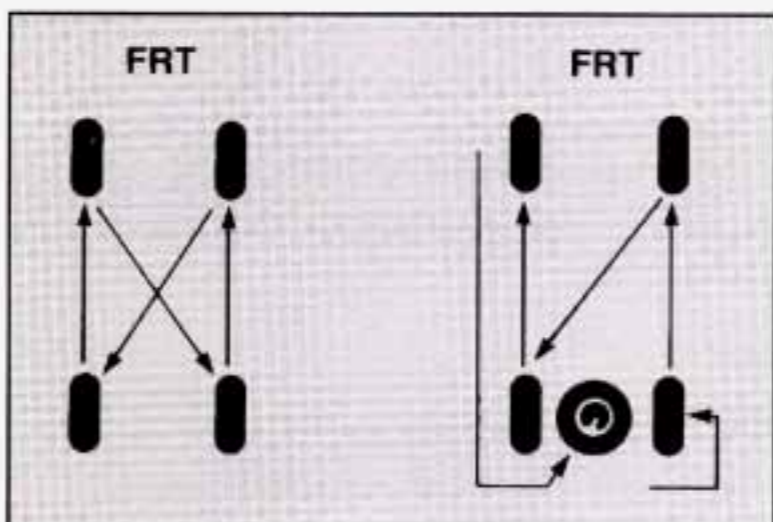

Use this rotation pattern.

The four wheel rotation is for aluminum wheels only. The five wheel rotation is for steel wheels only.

If your vehicle has front tires with different load ratings or tread designs (such as all season vs. on/off road) than the rear tires, don't rotate your tires front to rear.

After the tires have been rotated, adjust the front and rear inflation pressure as shown on the Certification/Tire label. Make certain that all wheel nuts are properly tightened. See "Wheel Nut Torque" in the Index.



CAUTION:

Rust or dirt on a wheel, or on the parts to which it is fastened, can make wheel nuts become loose after a time. The wheel could come off and cause an accident. When you change a wheel, remove any rust or dirt from places where the wheel attaches to the vehicle. In an emergency, you can use a cloth or a paper towel to do this; but be sure to use a scraper or wire brush later, if you need to, to get all the rust or dirt off. (See "Changing a Flat Tire" in the Index.)

When It's Time for New Tires

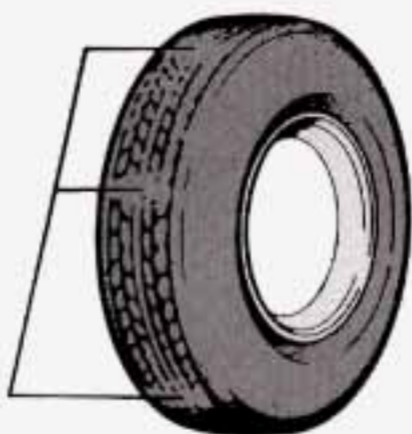

One way to tell when it's time for new tires is to check the treadwear indicators, which will appear when your tires have only 2/32 inch (1.6 mm) or less of tread remaining.

You need a new tire if:

- You can see the indicators at three or more places around the tire.
- You can see cord or fabric showing through the tire's rubber.
- The tread or sidewall is cracked, cut or snagged deep enough to show cord or fabric.
- The tire has a bump, bulge or split.
- The tire has a puncture, cut, or other damage that can't be repaired well because of the size or location of the damage.

Buying New Tires

To find out what kind and size of tires you need, look at the Certification/Tire label.

The tires installed on your vehicle when it was new had a Tire Performance Criteria Specification (TPC Spec) number on each tire's sidewall. When you get new tires, get ones with that same TPC Spec number. That way, your vehicle will continue to have tires that are designed to give proper endurance, handling, speed rating, traction, ride and other things during normal service on your vehicle. If your tires have an all-season tread design, the TPC number will be followed by a "MS" (for mud and snow).

If you ever replace your tires with those not having a TPC Spec number, make sure they are the same size, load range, speed rating and construction type (bias, bias-belted or radial) as your original tires.



CAUTION:

Mixing tires could cause you to lose control while driving. If you mix tires of different sizes or types (radial and bias-belted tires), the vehicle may not handle properly, and you could have a crash. Be sure to use the same size and type tires on all four wheels.

Uniform Tire Quality Grading

The following information relates to the system developed by the United States National Highway Traffic Safety Administration which grades tires by treadwear, traction and temperature performance. (This applies only to vehicles sold in the United States.)

Treadwear

The treadwear grade is a comparative rating based on the wear rate of the tire when tested under controlled conditions on a specified government test course. For example, a tire graded 150 would wear one and a half (1-1/2) times as well on the government course as a tire graded 100. The relative performance of tires depends upon the actual conditions of their use, however, and may depart significantly from the norm due to variations in driving habits, service practices and differences in road characteristics and climate.

Traction – A, B, C

The traction grades, from highest to lowest are: A, B, and C. They represent the tire's ability to stop on wet pavement as measured under controlled conditions on specified government test surfaces of asphalt and concrete. A tire marked C may have poor traction performance.

Warning: The traction grade assigned to this tire is based on braking (straight-ahead) traction tests and does not include cornering (turning) traction.

Temperature – A, B, C

The temperature grades are A (the highest), B, and C, representing the tire's resistance to the generation of heat and its ability to dissipate heat when tested under controlled conditions on a specified indoor laboratory test wheel.

Sustained high temperature can cause the material of the tire to degenerate and reduce tire life, and excessive temperature can lead to sudden tire failure. The grade C corresponds to a level of performance which all passenger car tires must meet under the Federal Motor Vehicle Safety Standard No. 109. Grades B and A represent higher levels of performance on the laboratory test wheel than the minimum required by law.

Warning: The temperature grade for this tire is established for a tire that is properly inflated and not overloaded. Excessive speed, underinflation, or excessive loading, either separately or in combination, can cause heat buildup and possible tire failure.

These grades are molded on the sidewalls of passenger car tires.

While the tires available as standard or optional equipment on General Motors vehicles may vary with respect to these grades, all such tires meet General Motors performance standards and have been approved for use on General Motors vehicles. All passenger type (P Metric) tires must conform to Federal safety requirements in addition to these grades.

Wheel Alignment and Tire Balance

The wheels on your vehicle were aligned and balanced carefully at the factory to give you the longest tire life and best overall performance.

In most cases, you will not need to have your wheels aligned again. However, if you notice unusual tire wear or your vehicle pulling one way or the other, the alignment may need to be reset. If you notice your vehicle vibrating when driving on a smooth road, your wheels may need to be rebalanced.

Wheel Replacement

Replace any wheel that is bent, cracked or badly rusted. If wheel nuts keep coming loose, the wheel, wheel bolts, and wheel nuts should be replaced. If the wheel leaks air, replace it (except some aluminum wheels, which can sometimes be repaired). See your GM dealer if any of these conditions exist.

Your dealer will know the kind of wheel you need.

Each new wheel should have the same load carrying capacity, diameter, width, offset, and be mounted the same way as the one it replaces.

If you need to replace any of your wheels, wheel bolts, or wheel nuts, replace them only with new GM original equipment parts. This way, you will be sure to have the right wheel, wheel bolts, and wheel nuts for your GM model.



CAUTION:

Using the wrong replacement wheels, wheel bolts, or wheel nuts on your vehicle can be dangerous. It could affect the braking and handling of your vehicle, make your tires lose air and make you lose control. You could have a collision in which you or others could be injured. Always use the correct wheel, wheel bolts, and wheel nuts for replacement.

NOTICE:

The wrong wheel can also cause problems with bearing life, brake cooling, speedometer/odometer calibration, headlight aim, bumper height, vehicle ground clearance, and tire or tire chain clearance to the body and chassis.

Used Replacement Wheels



CAUTION:

Putting a used wheel on your vehicle is dangerous. You can't know how it's been used or how many miles it's been driven. It could fail suddenly and cause an accident. If you have to replace a wheel use a *new* GM original equipment wheel.

Tire Chains

NOTICE:

If your vehicle has P235/75R15 or 31x10.50R15LT/C size tires, don't use tire chains; they can damage your vehicle.

If you have other size tires, use tire chains only where legal and only when you must. Use only SAE Class "S" type chains that are the proper size for your tires. Install them on the drive axle tires (four-wheel-drive vehicles can use chains on both axles) and tighten them as tightly as possible with the ends securely fastened. Drive slowly and follow the chain manufacturer's instructions. If you can hear the chains contacting your vehicle, stop and retighten them. If the contact continues, slow down until it stops. Driving too fast with chains on will damage your vehicle.

Appearance Care



Remember, cleaning products can be hazardous. Some are toxic. Others can burst into flame if you strike a match or get them on a hot part of the vehicle. Some are dangerous if you breathe their fumes in a closed space. When you use anything from a container to clean your vehicle, be sure to follow the manufacturer's warnings and instructions. And always open your doors or windows when you're cleaning the inside.

Never use these to clean your vehicle:

- Gasoline
- Benzene
- Naphtha
- Carbon Tetrachloride
- Acetone
- Paint Thinner
- Turpentine
- Lacquer Thinner
- Nail Polish Remover

They can all be hazardous — some more than others — and they can all damage your vehicle, too.

Don't use any of these unless this manual says you can. In many uses, these will damage your vehicle:

- Alcohol
- Laundry Soap
- Bleach
- Reducing Agents

Cleaning the Inside of Your Vehicle

Use a vacuum cleaner often to get rid of dust and loose dirt. Wipe vinyl or leather with a clean, damp cloth.

Your vehicle dealer has two GM cleaners, a solvent-type spot lifter and a foam-type powdered cleaner. They will clean normal spots and stains very well. Do not use them on vinyl or leather.

Here are some cleaning tips:

- Always read the instructions on the cleaner label.
- Clean up stains as soon as you can — before they set.
- Use a clean cloth or sponge, and change to a clean area often. A soft brush may be used if stains are stubborn.
- Use solvent-type cleaners in a well-ventilated area only. If you use them, don't saturate the stained area.
- If a ring forms after spot cleaning, clean the entire area immediately or it will set.

Using Foam-Type Cleaner on Fabric

- Vacuum and brush the area to remove any loose dirt.
- Always clean a whole trim panel or section. Mask surrounding trim along stitch or welt lines.
- Mix Multi-Purpose Powdered Cleaner following the directions on the container label.
- Use suds only and apply with a clean sponge.
- Don't saturate the material.
- Don't rub it roughly.
- As soon as you've cleaned the section, use a sponge to remove the suds.
- Rinse the section with a clean, wet sponge.
- Wipe off what's left with a slightly damp paper towel or cloth.
- Then dry it immediately with a blow dryer or a heat lamp.

NOTICE:

Be careful with a hair dryer or heat lamp. You could scorch the fabric.

- Wipe with a clean cloth.

Using Solvent-Type Cleaner on Fabric

First, see if you have to use solvent-type cleaner at all. Some spots and stains will clean off better with just water and mild soap.

If you need to use a solvent:

- Gently scrape excess soil from the trim material with a clean, dull knife or scraper. Use very little cleaner, light pressure and clean cloths (preferably cheesecloth). Cleaning should start at the outside of the stain, "feathering" toward the center. Keep changing to a clean section of the cloth.
- When you clean a stain from fabric, immediately dry the area with an air hose, hair dryer, or heat lamp to help prevent a cleaning ring. (See the previous NOTICE.)

Fabric Protection

Your vehicle has upholstery and carpet that has been treated with Scotchgard™ Fabric Protector, a 3M product. Scotchgard™ protects fabrics by repelling oil and water, which are the carriers of most stains. Even with this protection, you still need to clean your upholstery and carpet often to keep it looking new.

Further information on cleaning is available by calling 1-800-433-3296 (in Minnesota, 1-800-642-6167).

Special Cleaning Problems

Greasy or Oily Stains

Such as grease, oil, butter, margarine, shoe polish, coffee with cream, chewing gum, cosmetic creams, vegetable oils, wax crayon, tar and asphalt.

- Carefully scrape off excess stain.
- Follow the solvent-type instructions described earlier.
- Shoe polish, wax crayon, tar and asphalt will stain if left on a vehicle seat fabric. They should be removed as soon as possible. Be careful, because the cleaner will dissolve them and may cause them to spread.

Non-Greasy Stains

Such as catsup, coffee (black), egg, fruit, fruit juice, milk, soft drinks, wine, vomit, urine and blood.

- Carefully scrape off excess stain, then sponge the soiled area with cool water.
- If a stain remains, follow the foam-type instructions described earlier.
- If an odor lingers after cleaning vomit or urine, treat the area with a water/baking soda solution: 1 teaspoon (5 ml) of baking soda to 1 cup (250 ml) of lukewarm water.
- If needed, clean lightly with solvent-type cleaner.

Combination Stains

Such as candy, ice cream, mayonnaise, chili sauce and unknown stains.

- Carefully scrape off excess stain, then clean with cool water and allow to dry.
- If a stain remains, clean it with solvent-type cleaner.

Cleaning Vinyl

Use warm water and a clean cloth.

- Rub with a clean, damp cloth to remove dirt. You may have to do it more than once.
- Things like tar, asphalt and shoe polish will stain if you don't get them off quickly. Use a clean cloth and a solvent-type vinyl cleaner.

Cleaning Leather

Use a soft cloth with lukewarm water and a mild soap or saddle soap.

- For stubborn stains, use a mild solution of 10% isopropyl alcohol (rubbing alcohol) and 90% water.
- *Never* use oils, varnishes, solvent-based or abrasive cleaners, furniture polish or shoe polish on leather.
- Soiled leather should be cleaned immediately. If dirt is allowed to work into finish, it can harm the leather.

Cleaning the Top of the Instrument Panel

Use only mild soap and water to clean the top surfaces of the instrument panel. Sprays containing silicones or waxes may cause annoying reflections in the windshield and even make it difficult to see through the windshield under certain conditions.

Care of Safety Belts

Keep belts clean and dry.



CAUTION:

Do not bleach or dye safety belts. If you do, it may severely weaken them. In a crash they might not be able to provide adequate protection. Clean safety belts only with mild soap and lukewarm water.

Glass

Glass should be cleaned often. GM Glass Cleaner (GM Part No. 1050427) or a liquid household glass cleaner will remove normal tobacco smoke and dust films.

Don't use abrasive cleaners on glass, because they may cause scratches. Avoid placing decals on the inside rear window, since they may have to be scraped off later.

Cleaning the Outside of the Windshield and Wiper Blades

If the windshield is not clear after using the windshield washer, or if the wiper blade chatters when running, wax or other material may be on the blade or windshield.

Clean the outside of the windshield with GM Windshield Cleaner, Bon-Ami Powder[®] (GM Part No. 1050011). The windshield is clean if beads do not form when you rinse it with water.

Clean the blade by wiping vigorously with a cloth soaked in full strength windshield washer solvent. Then rinse the blade with water.

Wiper blades should be checked on a regular basis and replaced when worn.

Cleaning the Outside of Your Vehicle

The paint finish on your vehicle provides beauty, depth of color, gloss retention and durability.

Washing Your Vehicle

The best way to preserve your vehicle's finish is to keep it clean by washing it often with lukewarm or cold water.

Don't wash your vehicle in the direct rays of the sun. Don't use strong soaps or chemical detergents. Use liquid hand, dish or car washing (mild detergent) soaps. Don't use cleaning agents that contain acid or abrasives. All cleaning agents should be flushed promptly and not allowed to dry on the surface, or they could stain. Dry the finish with a soft, clean chamois or a 100% cotton towel to avoid surface scratches and water spotting.

High pressure vehicle washes may cause water to enter your vehicle.

Finish Care

Occasional waxing or mild polishing of your vehicle may be necessary to remove residue from the paint finish. You can get GM approved cleaning products from your dealer. (See “Appearance Care and Materials” in the Index.)

Your vehicle has a “basecoat/clearcoat” paint finish. The clearcoat gives more depth and gloss to the colored basecoat. Always use waxes and polishes that are non-abrasive and made for a basecoat/clearcoat paint finish.

NOTICE:

Machine compounding or aggressive polishing on a basecoat/clearcoat paint finish may dull the finish or leave swirl marks.

Protecting Exterior Bright Metal Parts

Bright metal parts should be cleaned regularly to keep their luster. Washing with water is all that is usually needed. However, you may use GM Chrome Polish on chrome or stainless steel trim, if necessary.

Use special care with aluminum trim. To avoid damaging protective trim, never use auto or chrome polish, steam or caustic soap to clean aluminum. A coating of wax, rubbed to high polish, is recommended for all bright metal parts.

Aluminum Wheels (If So Equipped)

Your aluminum wheels have a protective coating similar to the painted surface of your vehicle. Don't use strong soaps, chemicals, chrome polish, abrasive cleaners or abrasive cleaning brushes on them because you could damage this coating. After rinsing thoroughly, a wax may be applied.

NOTICE:

If you have aluminum wheels, don't use an automatic vehicle wash that has hard silicon carbide cleaning brushes. These brushes can take off the protective coating.

White Sidewall Tires

Your GM dealer has a GM White Sidewall Tire Cleaner. You can use a stiff brush with the cleaner.

Weatherstrips

Silicone grease on weatherstrips will make them last longer, seal better, and not stick or squeak. Apply silicone grease with a clean cloth at least every six months. During very cold, damp weather more frequent application may be required. (See "Recommended Fluids & Lubricants" in the Index.)

Sheet Metal Damage

If your vehicle is damaged and requires sheet metal repair or replacement, make sure the body repair shop applies anti-corrosion material to the parts repaired or replaced to restore corrosion protection.

Foreign Material

Calcium chloride and other salts, ice melting agents, road oil and tar, tree sap, bird droppings, chemicals from industrial chimneys, and other foreign matter can damage your vehicle's finish if they remain on painted surfaces. Use cleaners that are marked safe for painted surfaces to remove foreign matter.

Finish Damage

Any stone chips, fractures or deep scratches in the finish should be repaired right away. Bare metal will corrode quickly and may develop into a major repair expense.

Minor chips and scratches can be repaired with touch-up materials available from your dealer or other service outlets. Larger areas of finish damage can be corrected in your dealer's body and paint shop.

Underbody Maintenance

Chemicals used for ice and snow removal and dust control can collect on the underbody. If these are not removed, accelerated corrosion (rust) can occur on the underbody parts such as fuel lines, frame, floor pan, and exhaust system even though they have corrosion protection.

At least every spring, flush these materials from the underbody with plain water. Clean any areas where mud and other debris can collect. Dirt packed in closed areas of the frame should be loosened before being flushed. Your dealer or an underbody vehicle washing system can do this for you.

Chemical Paint Spotting

Some weather and atmospheric conditions can create a chemical fallout. Airborne pollutants can fall upon and attack painted surfaces on your vehicle. This damage can take two forms: blotchy, ringlet-shaped discolorations, and small irregular dark spots etched into the paint surface.

Although no defect in the paint job causes this, GM will repair, at no charge to the owner, the surfaces of new vehicles damaged by this fallout condition within 12 months or 12,000 miles (20 000 km) of purchase, whichever comes first.

This applies only to materials manufactured and sold by General Motors. Bodies, body conversions or equipment not made or sold by General Motors are not covered.

Appearance Care Materials Chart

PART NUMBER	SIZE	DESCRIPTION	USAGE
1050172	16 oz. (0.473L)	Tar and Road Oil Remover	Removes old waxes, polishes, tar and road oil
1050173	16 oz. (0.473L)	Chrome Cleaner and Polish	Removes rust and corrosion on chrome and stainless steel
1050174	16 oz. (0.473L)	White Sidewall Tire Cleaner	Cleans white and black tires
1050214	32 oz. (0.946L)	Vinyl Leather Cleaner	Spot and stain removal on leather or vinyl
1050244	16 oz. (0.473L)	Fabric Cleaner	Spot and stain removal on cloth and fabric

PART NUMBER	SIZE	DESCRIPTION	USAGE
1050427	23 oz. (0.680L)	Glass Cleaner	Glass cleaning and spot cleaning on vinyls
1050429	6 lbs. (2.72 kg)	Multi-Purpose Powder Cleaner	Cleans vinyl and cloth on door trim, seats, and carpet—also tires and mats
1050729	8 oz. (0.237L)	Vinyl Top Cleaner	Cleaning of vinyl tops
1051055	16 oz. (0.473L)	Preservatone	Vinyl top dressing
1051398	8 oz. (0.237L)	Spot Lifter	Spot and stain removal on cloth and fabric
1052870	16 oz. (0.473L)	Wash-Wax (conc.)	Exterior wash
1050201	16 oz. (0.473L)	Magic Mirror Cleaner-Polish	Exterior cleaner and polish

Vehicle Identification Number (VIN)

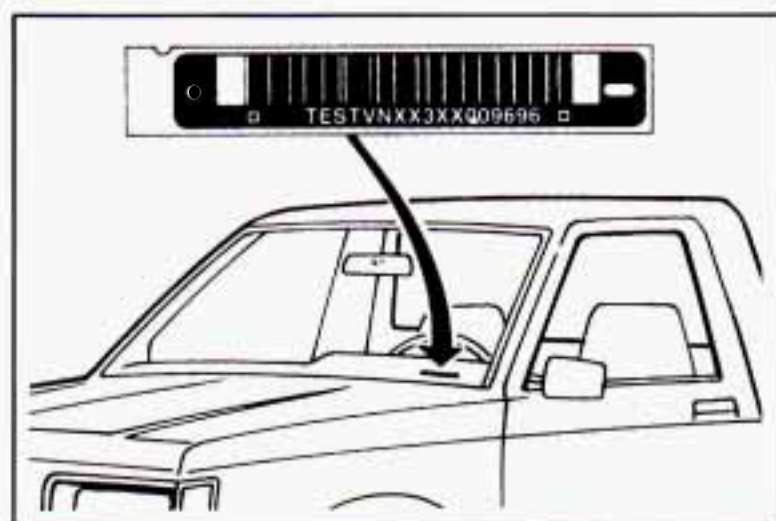

This is the legal identifier for your vehicle. It appears on a plate in the front corner of the instrument panel, on the driver's side. You can see it if you look through the windshield from outside your vehicle. The VIN also appears on the Vehicle Certification and Service Parts labels and the certificates of title and registration.

Engine Identification

The eighth character in your VIN is the engine code. This code will help you identify your engine, specifications, and replacement parts.

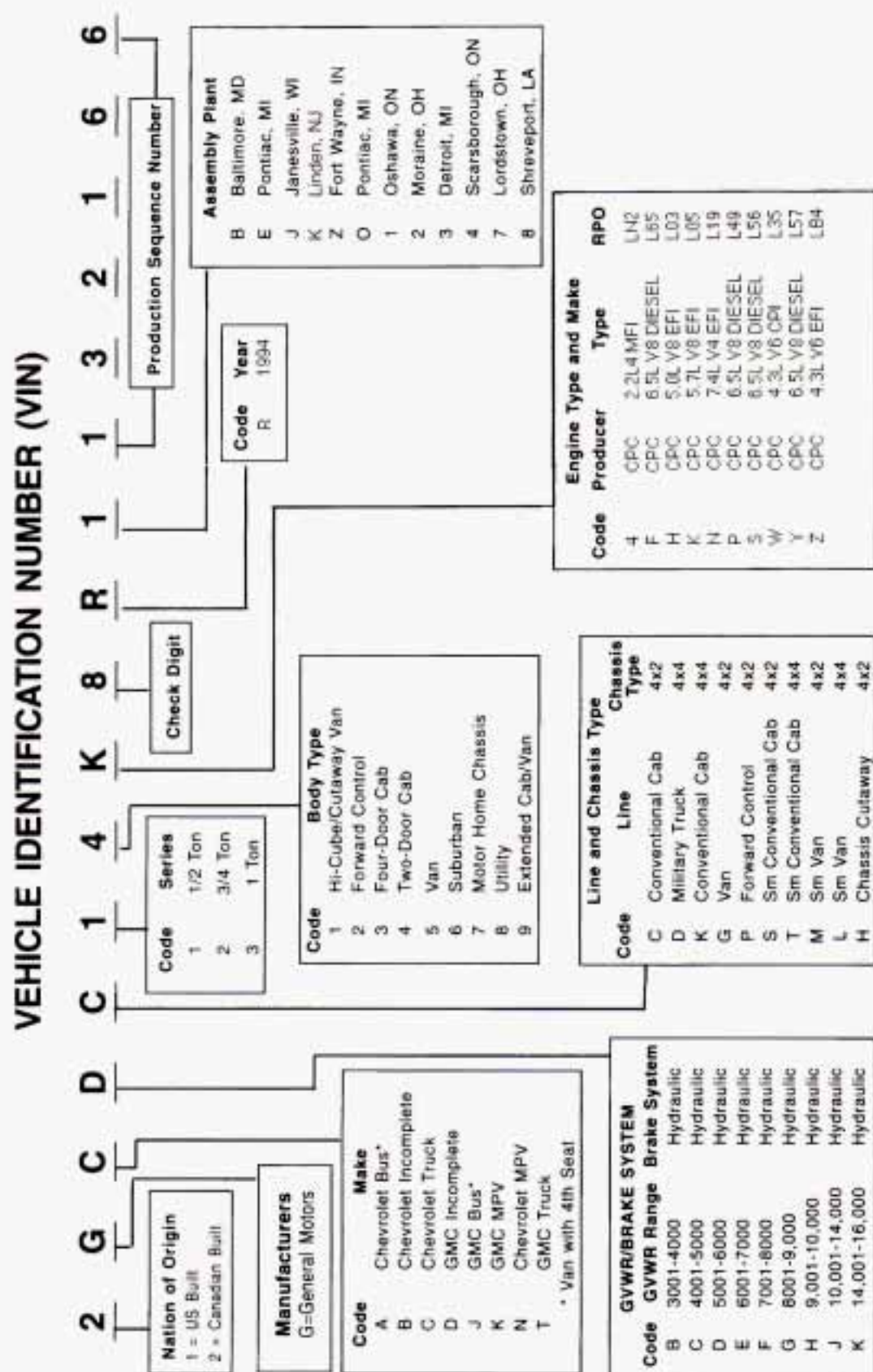

Service Parts Identification Label

You'll find this label on the inside of the glove box.

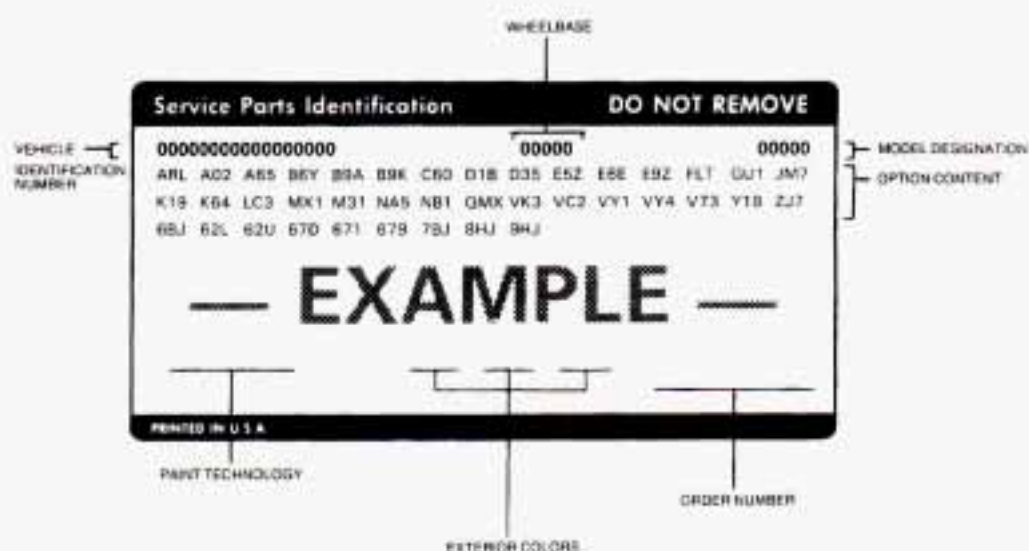

It's very helpful if you ever need to order parts. On this label is:

- your VIN,
- the model designation,
- paint information, and
- a list of all production options and special equipment.

Be sure that this label is not removed from the vehicle.

Add-On Electrical Equipment

NOTICE:

Don't add anything electrical to your vehicle unless you check with your dealer first. Some electrical equipment can damage your vehicle and the damage wouldn't be covered by your warranty. Some add-on electrical equipment can keep other components from working as they should.

Fuses and Circuit Breakers

The wiring circuits in your vehicle are protected from short circuits by a combination of fuses, circuit breakers, and fusible thermal links in the wiring itself. This greatly reduces the chance of fires caused by electrical problems.

Headlights

The headlight wiring is protected by a circuit breaker in the light switch. An electrical overload will cause the lights to go on and off, or in some cases to remain off. If this happens, have your headlight wiring checked right away.

Windshield Wipers

The windshield wiper motor is protected by a circuit breaker and a fuse. If the motor overheats due to heavy snow, etc., the wiper will stop until the motor cools. If the overload is caused by some electrical problem and not snow, etc., be sure to get it fixed.

Power Windows and Other Power Options

Circuit breakers in the fuse panel protect the power windows and other power accessories. When the current load is too heavy, the circuit breaker opens and closes, protecting the circuit until the problem is fixed.

Trailer Wiring Harness

The optional seven-wire trailer wiring harness is protected by an in-line fuse in the battery feed wire. This fuse is near the junction block. See "Trailer Wiring Harness" in the *Features & Controls* section.

Fuse Block



The fuse block is in the instrument panel on the driver's side. Remove the cover by turning the fastener to the left. Then you can remove fuses with a fuse extractor.



Be sure to use the correct fuse.

Spare fuses are provided, however if you ever have a problem on the road and don't have a spare fuse, you can "borrow" one of the correct value. Just pick some feature of your vehicle that you can get along without—like the radio or cigarette lighter—and use its fuse, if it is of the value you need. Replace it as soon as you can. See "Fuses and Circuit Breakers" in this section.

To reinstall the fuse panel cover, push in and turn the fastener to the right.

Capacities and Specification Charts

Replacement Parts

Replacement part numbers listed in this section are based on the latest information available at the time of printing, and are subject to change. If a part listed in this manual is not the same as the part used in your vehicle when it was built, or if you have any questions, please contact your GM truck dealer.

Engine Identification

Engine	2.2L	4.3L	4.3L
Type	L4	V6	V6
VIN Code	4	Z	W
Fuel Systems	MPI*	TBI**	CPI***
Emissions	LD	LD	LD

*Multi-Port Fuel Injection

**Throttle-Body Fuel Injection

***Central-Port Fuel Injection

Wheel Nut Torque

DESCRIPTION	TORQUE
Base or Optional Wheel	95 ft. lbs. (130 N•m)

Cooling System Capacity

ENGINE	VIN	QUANTITY*
2.2L	4	11.5 Quarts (11 Liters)
4.3L	Z	12.1 Quarts (11.5 Liters)
4.3L	W	12.1 Quarts (11.5 Liters)

*All quantities are approximate. After refill, the level MUST be rechecked.

Crankcase Capacity

ENGINE	VIN	QUANTITY WITHOUT FILTER*	QUANTITY WITH FILTER*
2.2L	4	4 Quarts (3.8 Liters)	4.5 Quarts (4.3 Liters)
4.3L	Z	4 Quarts (3.8 Liters)	4.5 Quarts (4.3 Liters)
4.3L	W	4 Quarts (3.8 Liters)	4.5 Quarts (4.3 Liters)

*All quantities are approximate. After refill, the level **MUST** be rechecked.

Fuel Tank Capacity

TYPE	QUANTITY*
Standard Tank	20 Gallons (76 Liters)

*All quantities are approximate.

Lamp and Bulb Data

LAMPS	QUANTITY	TRADE NO.
EXTERIOR		
Headlamps (Sealed Beam)	2	2E1H
Headlamps (Composite)	2	H9005 (HI) H9006 (LO)
Backup Lamp	2	3057
License Lamp (w/o Bumper)	2	194
License Lamp (Step Bumper)	2	194
Tail and Stop Lamps	2	3057
Marker Lamp—Front	2	194
Marker Lamp—Rear	2	194
Parking and Signal Lamp	2	3157NA
Underhood Lamp	1	93
CHMSL†\$	2	577

†Standard Cluster

\$Tach Cluster

INTERIOR

Ash Tray Lamp	1	161
Courtesy Lamp	2	906
Dome Lamp	1	211-2
Four-Wheel Drive Indicator	6	161
Heater & A/C Control	3	37
Instrument Panel Compartment Lamp	1	1003
Rearview Mirror Lamps	2	212-2
Sunshade Vanity Mirror Lamps	4	74

INSTRUMENT CLUSTER LAMPS

NOTE: A PC part number indicates that the bulb and base are one assembly and must be replaced as such.

LAMPS	QUANTITY	TRADE NO.
Anti-lock Brake Warning Indicator †\$	1	PC74
Brake System Warning Indicator †\$	1	PC74
Check Gages Indicator †\$	1	PC74
Daytime Running Lamps Indicator †\$	1	PC74
Charging System Indicator †\$	1	PC74
High Beam Indicator †\$	1	PC74
Standard Cluster Illumination †	4	PC194 and
	1	PC119
Tach Cluster Illumination \$	4	PC194 and
	1	GE194
Malfunction Indicator Lamp (Service Engine Soon) †\$	1	PC74
Seat Belt Indicator †\$	1	PC74
Turn Signal Indicator †	2	PC74
Upshift Indicator †\$	1	PC74

†Standard Cluster

\$Tach Cluster

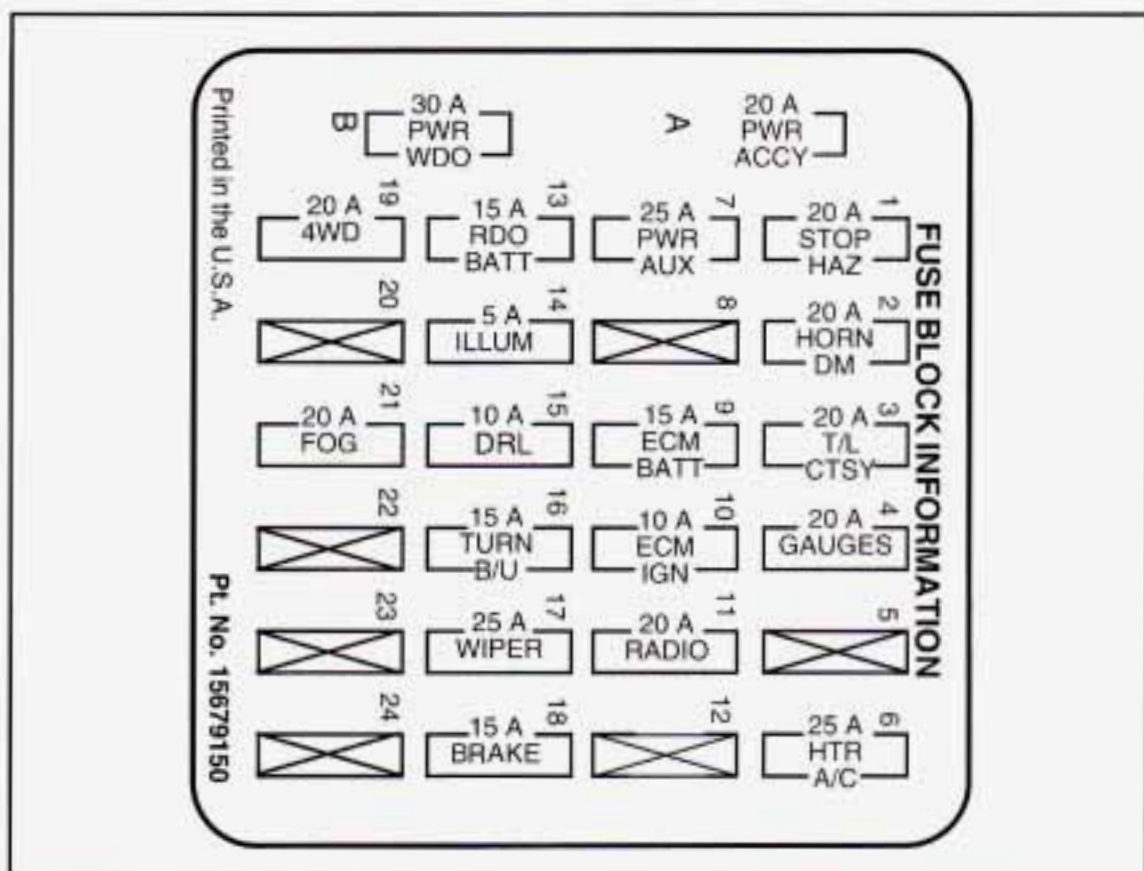

Fuses and Circuit Breakers

FUSE/CIRCUIT BREAKER	NAME	CIRCUITS PROTECTED
A	PWR ACCY	Power Door Locks
B	PWR WDO	Power Windows
1	STOP/HAZ	Stop Lamps, Hazard Lamps, Chime Module
2	HORN/DM	Dome Lamp, Lighted Visor Mirror, Glove Box Lamp, Horn, I/P Courtesy Lamps, Power Mirrors
3	T/L CTSY	Electric Shift Transfer Case Module, Park Lamps, License Plate Lamps
4	GAUGES	Auto Transmission, Alternator Field, Variable Throttle Control, A/C Compressor, Cluster, Chime Module, Four-Wheel Drive Indicator Lamp, Heated Oxygen Sensor, Daytime Running Lamps Module
5	(NOT USED)	

FUSE/CIRCUIT BREAKER	NAME	CIRCUITS PROTECTED
6	HTR A/C	Blower Motor, Temperature Door Motor
7	PWR AUX	Pwr Auxiliary Outlets
8	(NOT USED)	
9	ECM BATT	Engine Computer (Battery), ABS Battery, Fuel Pump
10	ECM IGN	Engine Computer (Ignition), Injectors, Engine Sensors
11	RADIO	Radio, Inside Rearview Mirror Map Lamps
12	(NOT USED)	
13	RDO/BATT	Clock, Radio Battery, CD Player
14	ILLUM	Cluster Illumination, Ash Tray Lamp, Radio Illumination, Heater Lamp, Four-Wheel Drive Illumination, Chime Module, Fog Lamp Switch Illumination, Daytime Running Lamps
15	DRL	Daytime Running Lamps (Canada Only)
16	TURN B/U	Turn Signals, Backup Lamps
17	WIPER	Windshield Washer, Windshield Wiper Motor
18	BRAKE	Speedometer, Anti-lock Braking System, Cruise Control
19	4 WD	Four-Wheel Drive
20	(NOT USED)	
21	FOG	Fog Lamps
22	(NOT USED)	
23	(NOT USED)	
24	(NOT USED)	

Service Replacement Part and Filter Recommendations

Engine (VIN)	2.2L (4)	4.3L (Z)	4.3L (W)
Oil Filter	PF47	PF52	PF52
Air Cleaner Filter	A1163C	A773C	A1163C
PCV Valve	CV900C	CV789C	CV774C
Spark Plugs*	AC908	.CR43TSM	.CR43TSM
Fuel Filter	GF481	GF481	GF481
Radiator Cap	RC36	RC36	RC36

*Use copper-cored resistor type spark plugs.

Air Conditioning Refrigerants

Not all air conditioning refrigerants are the same. If the air conditioning system in your vehicle needs refrigerant, be sure the proper refrigerant is used. If you're not sure, ask your GM dealer. For additional information, see your "Warranty and Owner Assistance Information" booklet.

Air Conditioning Refrigerant Capacity

TYPE	SYSTEM	QUANTITY*
R-134a	C-60	30 oz. (.85 kg)

*All quantities are approximate.

NOTICE:

R-134a refrigerant is not compatible with R-12 refrigerant in an air conditioning system. R-12 in an R-134a system will cause compressor failure, refrigerant oil sludge, or poor air conditioning system performance.

Scheduled Maintenance Services



Section

7

This section covers the maintenance required for your vehicle. Your vehicle needs these services to retain its safety, dependability, and emission control performance.

A Word About Maintenance	7-2
Your Vehicle and the Environment	7-2
Scheduled Maintenance Services	7-3
Selecting The Proper Maintenance Schedule	7-3
Maintenance Schedule I	7-4
Maintenance Schedule II	7-6
Explanation of Scheduled Maintenance Services	7-7
Owner Checks and Services	7-10
At Least Once a Month	7-10
At Least Four Times a Year	7-10
At Least Once a Year	7-10
Periodic Maintenance Inspections	7-12
Recommended Fluids & Lubricants	7-13
Maintenance Record	7-15
Service Station Checks	7-16



***Protection
Plan***

Have you purchased the GM Protection Plan? The Plan supplements your new vehicle warranties. See your GM dealer for details.

A Word About Maintenance

We at General Motors want to help you keep your vehicle in good working condition. But we don't know exactly how you'll drive it. You may drive very short distances only a few times a week. Or you may drive long distances all the time in very hot, dusty weather. You may use your vehicle in making deliveries. Or you may drive it to work, to do errands, or in many other ways.

Because of all the different ways people use their GM vehicles, maintenance needs vary. You may even need more frequent checks and replacements than you will find in the schedules in this section. So please read this section and note how you drive. If you have any questions on how to keep your vehicle in good condition, see your GM dealer, the place many GM owners choose to have their maintenance work done. Your dealer can be relied upon to use proper parts and practices.

Your Vehicle And The Environment

Proper vehicle maintenance not only helps keep your vehicle in good working condition, but it also helps the environment. All recommended maintenance procedures are important. Improper vehicle maintenance or the removal of important components can significantly affect the quality of the air we breathe. Improper fluid levels or even the wrong tire inflation can increase the level of emissions from your vehicle. To help protect our environment, and to help keep your vehicle in good condition, please maintain your vehicle properly.



CAUTION:

Performing maintenance work on a vehicle can be dangerous. In trying to do some jobs, you can be seriously injured. Do your own maintenance work only if you have the required know-how and the proper tools and equipment for the job. If you have any doubt, have a qualified technician do the work.

If you are skilled enough to do some work on your vehicle, you will probably want to get the service information GM publishes. You will find a list of publications and how to get them in Section 8, *Customer Assistance Information*. See "Service Publications" in the Index.

The Maintenance Record provides a place for you to record the maintenance performed on your vehicle. Whenever any maintenance is performed, be sure to write it down in this section. This will help you determine when your next maintenance should be done. In addition, it is a good idea to keep your

maintenance receipts. They may be needed to qualify your vehicle for warranty repairs.

Scheduled Maintenance Services

This part tells you the maintenance services you should have done and when you should schedule them. Your GM dealer knows your vehicle best and wants you to be happy with it. If you go to your dealer for all your service needs, you'll know that GM-trained and supported service people will perform the work using genuine GM parts.

These schedules are for vehicles that:

- carry passengers and cargo within the recommended limits. You will find these limits on your vehicle's Certification Label. See "Loading Your Vehicle" in the Index.
- are driven on regular road surfaces, and within legal driving limits, as described in Section 4, *Your Driving and the Road*.
- are driven off-road in the recommended manner. See "Off Road Driving With Your Four-Wheel Drive Vehicle" in the Index.
- use the proper fuel. See "Fuel" in the Index.

Selecting The Proper Maintenance Schedule

Your driving conditions and how you use your vehicle will help you determine which schedule to use. The schedules are found later in this section.

MAINTENANCE SCHEDULE I

Is any one of these true for your vehicle?

- Most trips are less than 4 miles (6 kilometers).
- Most trips are less than 10 miles (16 kilometers) and the outside temperatures are below freezing.
- The engine is at low speed most of the time (as in stop-and-go traffic, door-to-door delivery, or other commercial uses).
- You operate in dusty areas or off-road frequently.
- You tow a trailer.

If any one (or more) of these is true for your driving, follow Schedule I. The chart for Schedule I has plus signs (+).

MAINTENANCE SCHEDULE II

Follow Schedule II ONLY if none of the above conditions are true. The chart for Schedule II has dots (•).

MAINTENANCE SCHEDULE I

Item No.	Service	Miles (000)	3	6	9	12	15	18
		Kilometers (000)	5	10	15	20	25	30
1	Engine Oil Change*—Every 3 Months, or		+	+	+	+	+	+
	Oil Filter Change*—Every 3 Months, or		+	+	+	+	+	+
2	Chassis Lubrication—Every 12 Months, or		+	+	+	+	+	+
3	Cooling System Service *—Every 24 Months or							
4	Air Cleaner Filter Replacement*							
5	Front Wheel Bearing Repack (2WD Only)						+	
6	Transmission Service **							
7	Fuel Filter Replacement*\$							
8	Spark Plug Replacement*—4.3L Engine Only**							
	Spark Plug Replacement*—2.2L Engine Only**							
9	Spark Plug Wire Inspection*							
10	Engine Timing Check*\$ (Some Models)							
11	Fuel Tank, Cap and Lines Inspection *\$							
12	Engine Accessory Drive Belt Inspection*							
13	Tire and Wheel Rotation			+				
14	Drive Axle Service		+	+	+	+	+	+
15	Brake Systems Inspection**							

* An Emission Control Service

** See "Explanation of Scheduled Maintenance Services" in the Index

\$ The California Air Resources Board has determined that the failure to perform this maintenance item will not nullify the emission warranty or limit recall liability prior to the completion of vehicle useful life. General Motors, however, urges that all recommended maintenance services be performed at the indicated intervals and the maintenance be recorded.

T0801

MAINTENANCE SCHEDULE I (continued)

21	24	27	30	33	36	39	42	45	48	51	54	57	60
35	40	45	50	55	60	65	70	75	80	85	90	95	100
+	+	+	+	+	+	+	+	+	+	+	+	+	+
+	+	+	+	+	+	+	+	+	+	+	+	+	+
+	+	+	+	+	+	+	+	+	+	+	+	+	+
			+										+
			+										+
			+					+					+
			+										+
			+										+
													+
													+
													+
													+
+					+					+			
+	+	+	+	+	+	+	+	+	+	+	+	+	+

THE SERVICES SHOWN ON THIS CHART UP TO 60,000 MILES (100 000 km) ARE TO BE DONE AFTER 60,000 MILES AT THE SAME INTERVALS.

T0802

MAINTENANCE SCHEDULE II

Item No.	Service	Miles (000)	7.5	15	22.5	30	37.5	45	52.5	60
		Kilometers (000)	12.5	25	37.5	50	62.5	75	87.5	100
1	Engine Oil Change*—Every 12 Months, or		•	•	•	•	•	•	•	•
	Oil Filter Change*—Every 12 Months, or		•		•		•		•	
2	Chassis Lubrication—Every 12 Months, or		•	•	•	•	•	•	•	•
3	Cooling System Service*—Every 24 Months or					•				•
4	Air Cleaner Filter Replacement*					•				•
5	Front Wheel Bearing Repack (2WD Only)					•				•
6	Transmission Service **									
7	Fuel Filter Replacement*\$					•				•
8	Spark Plug Replacement*—4.3L Engine Only**					•				•
	Spark Plug Replacement*—2.2L Engine Only**									
9	Spark Plug Wire Inspection*									•
10	Engine Timing Check*\$ (Some Models)									•
11	Fuel Tank, Cap and Lines Inspection*\$									•
12	Engine Accessory Drive Belt Inspection*									•
13	Tire and Wheel Rotation		•		•		•		•	
14	Drive Axle Service		•	•	•	•	•	•	•	•
15	Brake Systems Inspection**									

* An Emission Control Service

** See "Explanation of Scheduled Maintenance Services" in the Index

§ The California Air Resources Board has determined that the failure to perform this maintenance item will not nullify the emission warranty or limit recall liability prior to the completion of vehicle useful life. General Motors, however, urges that all recommended maintenance services be performed at the indicated intervals and the maintenance be recorded.

THE SERVICES SHOWN ON THIS CHART UP TO 60,000 MILES (100 000 km) ARE TO BE DONE AFTER 60,000 MILES AT THE SAME INTERVALS.

T0803

Explanation Of Scheduled Maintenance Services

Below are explanations of the services listed in the maintenance charts.

The proper fluids and lubricants to use are listed in this section. Make sure whoever services your vehicle uses these. All parts should be replaced and all necessary repairs done before you or anyone else drives the vehicle.

1. **ENGINE OIL AND OIL FILTER CHANGE*** — ALWAYS USE API SERVICE SH OR SG ENERGY CONSERVING II OILS OF THE PROPER VISCOSITY. The "SH" or "SG" designation may be shown alone or in combination with others, such as "SH/CD", or "SH, SG, CD," or "SG/CD", etc. To determine the preferred viscosity oil for your vehicle's engine (e.g. SAE 5W-30), see "Engine Oil" in the Index.
2. **CHASSIS LUBRICATION** — Lubricate the front suspension, ball joint, steering linkage, and transfer case shift linkage, parking brake cable guides, propshaft splines, universal joints, brake pedal springs, and clutch pedal springs at the intervals specified on the proper maintenance schedule, or at every engine oil change, whichever comes first.

Ball joints should not be lubricated unless their temperature is 10°F (-12°C) or higher. When the weather is cold, let them warm up before lubricating them or they could be damaged.

Also, be sure to check all the vehicle fluid levels at this time.

3. **COOLING SYSTEM SERVICE*** — Drain, flush and refill the system with new or approved recycled coolant conforming to "GM Specification 6038-M" (4.3L engine) or "GM Specification 6043-M" (2.2L engine). See "Engine Coolant" in the Index for the proper coolant and mixture to use in your vehicle.

Also inspect the hoses and replace them if they are cracked, swollen, or deteriorated. Clean the outside of the radiator and air conditioning condenser. Wash the radiator neck. To ensure proper operation, pressure test the radiator and cap.
4. **AIR CLEANER FILTER REPLACEMENT*** — Replace at specified intervals. Ask your dealer for the proper replacement intervals for your driving conditions.
5. **FRONT WHEEL BEARING REPACK (2-WHEEL DRIVE ONLY)** — Clean and repack the front wheel bearings at each brake relining, or at the specified interval, whichever comes first.

*An Emission Control Service

6. TRANSMISSION SERVICE:

Automatic Transmission — Change the transmission fluid and filter every 15,000 miles (25 000 km) if the vehicle is mainly driven under one or more of these conditions:

- In heavy city traffic.
- Where the outside temperature regularly reaches 90°F (32°C) or higher.
- In hilly or mountainous terrain.
- Frequent trailer pulling.
- Uses such as taxi, police, delivery or other commercial service.

If the vehicle is not used mainly under any of these conditions, change the fluid and filter every 30,000 miles (50 000 km). See “Automatic Transmission Fluid” in the Index for more information.

Manual Transmission — Transmission fluid does not require periodic changing.

7. **FUEL FILTER REPLACEMENT*** — Replace the fuel filter at the specified interval or sooner if clogged.
8. **SPARK PLUG REPLACEMENT*§** — Replace spark plugs with the type listed in Section 6. Spark plugs (AC908) for the 2.2L Engine (VIN Code 4) should be replaced every 100,000 miles (166 000 kilometers). Spark plugs (.CR43TSM) for the 4.3L engines (VIN Codes W and Z) should be replaced every 30,000 miles (50 000 kilometers). See “Specification Charts” in the Index.
9. **SPARK PLUG WIRE INSPECTION*** — Clean wires and inspect for burns, cracks or other damage. Check the wire boot fit at the distributor and at the spark plugs. Replace wires as needed.
10. **ENGINE TIMING CHECK AND DISTRIBUTOR CHECK*§** — Adjust timing to underhood label specifications. Inspect the inside and outside of the distributor cap and rotor for cracks, carbon tracking and corrosion. Clean or replace as needed.

*An Emission Control Service

§=The California Air Resources Board has determined that the failure to perform this maintenance item will not nullify the emission warranty or limit recall liability prior to the completion of vehicle useful life. General Motors, however, urges that all recommended maintenance services be performed at the indicated intervals and the maintenance be recorded.

11. **FUEL TANK, CAP AND LINES INSPECTION*§ (4.3L only)** — Inspect the fuel tank, cap and lines for damage or leaks. Remove fuel cap, inspect gasket for an even filler neck imprint, and any damage. Replace parts as needed.
12. **ENGINE ACCESSORY DRIVE BELT INSPECTION*§** — Inspect belt. Look for cracks, fraying, wear, and proper tension. Adjust or replace as needed.
13. **TIRE AND WHEEL ROTATION AND INSPECTION** — For proper wear and maximum tire life, rotate tires at the first 6,000 miles (10 000 kilometers) for Schedule I or 7,500 miles (12 500 kilometers) for Schedule II and then every 15,000 miles (25 000 kilometers) thereafter. Follow the instructions and patterns shown in Section 6. Check tires for uneven wear or damage. If irregular or premature wear is apparent, check wheel alignment. Also, check for damaged wheels. See “Tires” in the Index for more information.
14. **DRIVE AXLE SERVICE** — Check rear/front axle fluid level and add as needed. Check constant velocity joints and axle seals for leaking.
 - **Locking Differential** — Drain fluid at first oil change and refill. Check fluid level and add as needed at subsequent oil changes. In dusty areas or trailer towing applications, drain fluid at every 15,000 miles (24 135 kilometers) and refill.†
 - **Standard Differential** — Check fluid level and add as needed at every oil change. In dusty areas or trailer towing applications, drain fluid every 15,000 miles (24 135 kilometers) and refill.†
 - More frequent lubrication may be required for off-road use.
15. **BRAKE SYSTEM INSPECTION** — When the engine oil is changed, inspect the lines and hoses for proper hookup, binding, leaks, cracks, chafing, etc. Check the parking brake adjustment, and the fluid level in the master cylinder. A low fluid level can indicate worn disc brake pads which may need to be serviced.†

When the wheels are removed for rotation, inspect disc brake pads for wear and rotors for surface condition. Also inspect drum brake linings for wear and cracks. Inspect other brake parts, including drums, wheel cylinders, parking brake, etc. at the same time.

Inspect brakes more often if driving habits or conditions result in frequent braking.

†A fluid loss in these systems may indicate a problem. Have them inspected and repaired at once.

Owner Checks and Services

Listed below are owner checks and services which would be made at the time period specified to help ensure proper safety, emission performance, and dependability of your vehicle.

Be sure any necessary repairs are completed at once. Whenever any fluids or lubricants are added to your vehicle, make sure they are the proper ones, as shown in this section.

At Least Once a Month

Tire Inflation Pressure Check — Check the tires for proper inflation. If they are low, inflate them to the level specified on the Certification label. See “Inflation–Tire Pressure” in the Index.

At Least Four Times a Year

Tailgate Lubrication — Lubricate tailgate latch bolt, handle assembly pivot points, and hinges with lubricant recommended in this section. Lubricate every 3,000 miles (5 000 kilometers) if following Maintenance Schedule I, or every 7,500 miles (12 500 kilometers) if following Maintenance Schedule II.

At Least Once a Year

Key Lock Cylinder Lubrication — Lubricate key lock cylinders with one of the lubricants recommended in this section.

Transmission Neutral or Clutch Start Switch Operation —



CAUTION:

When you are doing this check, the vehicle could move suddenly. If it does, you or others could be injured. Follow the steps below.

1. Before you start, be sure you have enough room around the vehicle.
2. Firmly apply both the manual parking brake, and the regular brake. See “Brakes” and “Parking Brake” in the Index. Do not use the accelerator pedal.
3. Be ready to turn off the engine immediately if it starts.
4. On automatic transmission vehicles, try to start the engine in each gear. The starter should work only in “P” (Park) or “N” (Neutral).

On manual transmission vehicles, put the shift lever in “N” (Neutral), push the clutch down halfway, and try to start the engine. The starter should work only when the clutch is pushed down all the way to the floor.

Steering Column Lock Operation — While parked, try to turn the key to **LOCK** in each gear shift position.

- With an automatic transmission, the key should turn to **LOCK** only when the gear shift is in “P” (Park).
- With manual shift, the key should turn to **LOCK** only when you’re in “R” (Reverse).

On vehicles with a key release lever, try to turn the key to **LOCK** without pressing the lever. The key should turn to **LOCK** only with the key lever depressed.

On all vehicles, the key should come out only in **LOCK**.

Parking Brake and Transmission “P” (Park) Mechanism Operation —



CAUTION:

When you are doing this check, your vehicle could begin to move. You or others could be injured and property could be damaged. Make sure there is room in front of your vehicle in case you begin to roll. Be ready to apply the regular brake at once should the vehicle begin to move.

Park on a fairly steep hill, with the vehicle facing downhill. Keeping your foot on the regular brake, set the manual parking brake.

- To check the parking brake: With the engine running and the transmission in “N” (Neutral), slowly remove foot pressure from the regular brake pedal. Do this until the vehicle is held by the parking brake only.
- To check the “P” (Park) mechanism’s holding ability: Apply the regular brake and shift to “P” (Park). Release the manual parking brake, then slowly release the regular brake.

Lap and Shoulder Belts Condition and Operation — Inspect belt system, including: webbing, buckles, latch plates, retractors, guide loops and anchors. Have a belt assembly replaced if the webbing has been cut or otherwise damaged.

Body Lubrication Service — Lubricate all body door hinges including the tailgate and tailgate handle pivot points. Lubricate the body hood, fuel door and rear compartment hinges, latches and locks including interior glove box and console doors, and any moving seat hardware. Lubricate the hood safety lever pivot and prop rod pivot. More frequent lubrication may be required when exposed to a corrosive environment.

Periodic Maintenance Inspections

Listed below are inspections and services which should be performed at least twice a year (for instance, each spring and fall). You should let your GM dealer's service department or other qualified service center do these jobs. Make sure any necessary repairs are completed at once.

Steering and Suspension Inspection[†] — Inspect front and rear suspension and steering system for damaged, loose or missing parts, signs of wear or lack of lubrication. Inspect power steering lines and hoses for proper hook-up, binding, leaks, cracks, chafing, etc. Lubricate the steering linkage.

Accelerator Control System — Lubricate all pivot points with engine oil, except the TBI throttle shaft. Do not lubricate the cam pulley. Remove all external deposits from pulley. Do not oil any accelerator or cruise control cables. Replace any cables that have high effort or excessive wear.

Exhaust System Inspection — Inspect the complete system. Inspect the body near the exhaust system. Look for broken, damaged, missing or out-of-position parts, as well as open seams, holes, loose connections or other conditions which could cause a heat buildup in the floor pan or could let exhaust fumes seep into the passenger compartments. See "Engine Exhaust" in the Index.

Drive Axle Service — Check rear/front axle fluid level and add as needed. Check constant velocity joints and axle seals for leaking.

Transfer Case (four-wheel drive) Inspection[†] — Every 12 months or at oil change intervals, check front axle and transfer case and add lubricant when necessary. Check vent hose at transfer case for kinks and proper installation. More frequent lubrication may be required on off-road use.

[†]A fluid loss in these systems may indicate a problem. Have them inspected and repaired at once.

Recommended Fluids & Lubricants

NOTE: Fluids and lubricants identified below by name, part number or specification may be obtained from your GM Dealer.

USAGE	FLUID/LUBRICANT
Engine Oil	API service SH or SG Energy Conserving II oils of the proper viscosity. The "SH" or "SG" designation may be shown alone or in combination with others, such as "SH/CD", or "SH, SG, CD," or "SG/CD", etc. To determine the preferred viscosity oil for your vehicle's engine (e.g. SAE 5W-30). See "Engine Oil" in the Index.
Engine Coolant	Mixture of water and a good quality ethylene glycol base antifreeze conforming to GM-6038-M (4.3L) or GM-6043-M (2.2L)
Hydraulic Clutch System	Hydraulic Clutch Fluid (GM Part No. 12345347 or equivalent).
Hydraulic Brake Systems	Delco Supreme II brake fluid (GM Part No. 1052535 or DOT-3).
Power Steering System	GM Power Steering Fluid (GM Part No. 1050017) or equivalent conforming to GM spec 9985010.
Manual Steering Gear	GM Lubricant (GM Part No. 1052182) or equivalent.
Automatic Transmission	DEXRON [®] -III (perferred) or DEXRON [®] -IIE Automatic Transmission Fluid.
Manual Transmission:	
a. 5-Speed (2.2L Engine)	a. DEXRON [®] -IIE Automatic Transmission Fluid (GM Part No. 1051855).
b. 5-Speed (4.3L Engine)	b. Synchromesh Transmission Fluid (GM Part No. 12345349).
Differential:	
a. Standard — Front and Rear Axle	a. SAE-80W-90 GL-5 gear lubricant (GM Part No. 1052271).
b. Locking	b. SAE-80W-90 gear lubricant (GM Part No. 1052271).
Transfer Case	DEXRON [®] -IIE Automatic Transmission Fluid (GM Part No. 1051855).

USAGE

Column Shift, Transfer Case Shift Lever, Propeller Shaft Slip Splines and Universal Joints.

Clutch Linkage. Pushrod to clutch fork joint.

Hood Latch Assembly:

- a. Pivots and spring anchor
- b. Release Pawl

Front Wheel Bearings

Constant Velocity Universal Joint

Automatic Transmission Shift Linkage, Floor Shift Linkage, Hood and Door Hinges, Body Door Hinge Pins, Folding Seat, Fuel Door Hinge

Key Lock Cylinders

Chassis Lubrication

Windshield Washer Solvent

Weatherstrip

Tailgate Handle Pivot Points, Hinges, Latch Bolt, and Linkage

Gas Line

Weather Strips

FLUID/LUBRICANT

Chassis lubricant meeting requirements of NLGI Grade 2, Category LB or GC-LB (GM Part No. 1052497).

Chassis lubricant meeting requirements of NLGI Grade 2, Category LB or GC-LB (GM Part No. 1052497).

- a. Engine oil (GM Part No. 1050109).
- b. Chassis lubricant meeting requirements of GM-6031-M (GM Part No. 1052497).

Wheel bearing lubricant meeting requirements of NLG Grade 2, Category GC or GC-LB (GM Part No. 1051344).

Chassis lubricant meeting requirements of NLG Grade 2, Category LB or GC-LB (GM Part No. 1052497).

Engine oil (GM Part No. 1050109).

GM Multi-Purpose Lubricant (GM Part No. 12345120) or a synthetic light weight engine oil (SAE 5W-30).

Chassis lubricant meeting requirements of NLG Grade 2, Category LB or GC-LB (GM Part No. 1052497).

GM Optikleen™ washer solvent (GM Part No. 1051515) or equivalent.

Silicone grease (GM Part No. 1052863) or equivalent.

Multi-purpose lubricant meeting requirements of GM Part No. 9985164.

Gas Line De-Icer (GM Part No. 1051516).

Spray-A-Squeek (GM Part No. 1052277).

Service Station Checks

It is important for you or a service station attendant to perform these under-hood checks at each fuel fill.

- Check the engine oil level and add if necessary.
- Check the engine coolant level and add if necessary.
- Check the windshield washer fluid level and add if necessary.

See the Index under these items for information on how to check them.

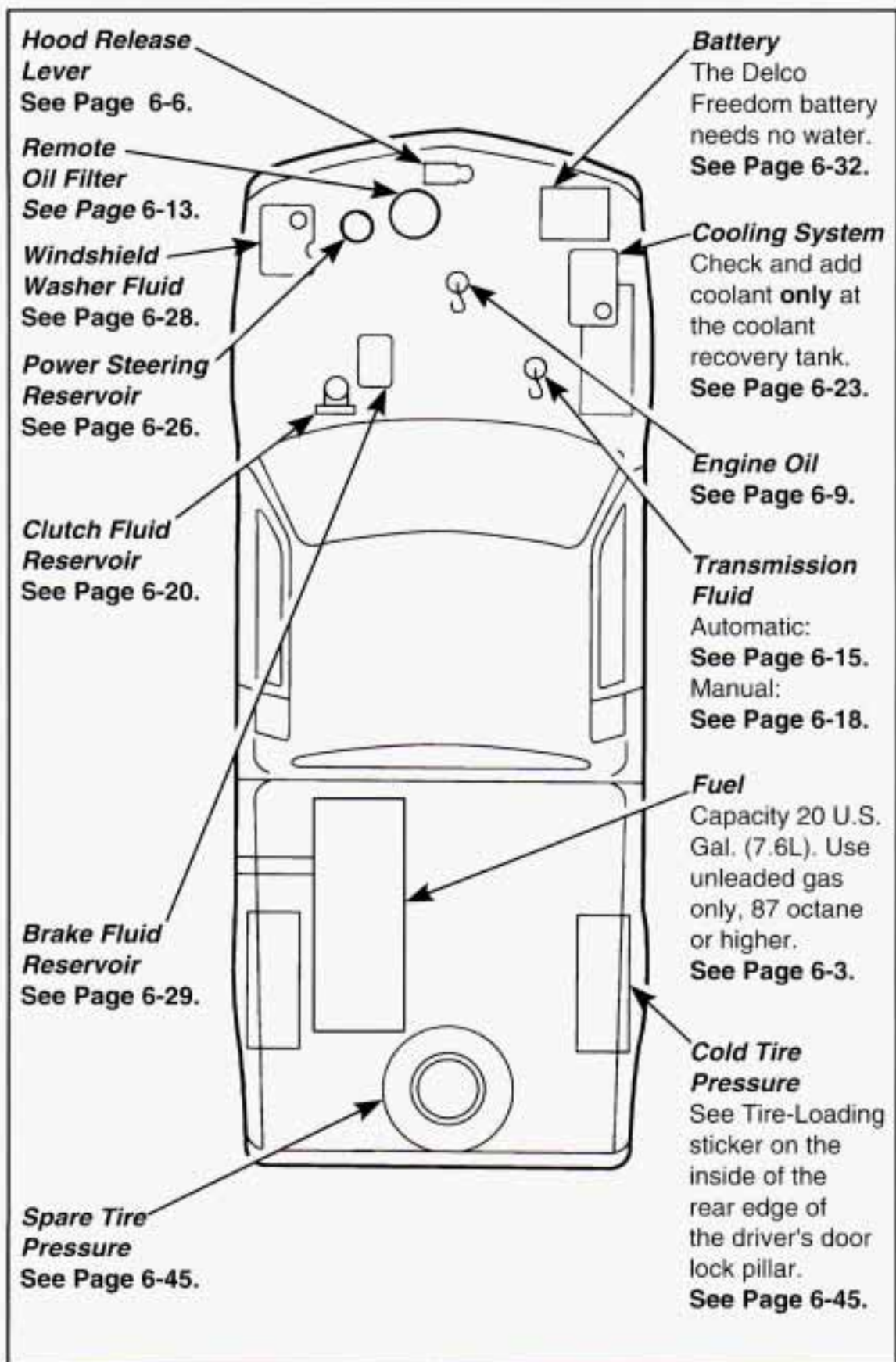

Notes

Customer Assistance Information



Section

8

Here you will find out how to contact GMC Truck if you need assistance. This section also tells you how to obtain service publications and how to report any safety defects.

Customer Satisfaction Procedure	8-2
Customer Assistance for the Hearing or Speech Impaired (TDD)	8-3
GM Participation in BBB AUTO LINE – Alternative Dispute Resolution Program	8-3
Reporting Safety Defects To the United States Government	8-4
Reporting Safety Defects To the Canadian Government	8-5
Reporting Safety Defects To General Motors	8-5
Roadside Assistance	8-6
Courtesy Transportation	8-6
Service Publications	8-7

Customer Satisfaction Procedure

Your satisfaction and goodwill are important to your dealer and GMC Truck. Normally, any concern with the sales transaction or the operation of your vehicle will be resolved by your dealer's Sales or Service Departments. Sometimes, however, despite the best intentions of all concerned, misunderstandings can occur. If your concern has not been resolved to your satisfaction, the following steps should be taken:

STEP ONE — Discuss your concern with a member of dealership management. Normally, concerns can be quickly resolved at that level. If the matter has already been reviewed with the Sales, Service, or Parts Manager, contact the owner of the dealership or the General Manager.

STEP TWO — If after contacting a member of dealership management, it appears your concern cannot be resolved by the dealership without further help, contact your GMC Truck Consumer Relations Manager by calling 1-800-GMC-TRUCK (1-800-462-8782, Customer Assistance prompt.) In Canada, contact GM of Canada Customer Assistance Center in Oshawa by calling 1-800-263-3777 (English) or 1-800-263-7854 (French).

In Mexico, call (525) 254-3777. In Puerto Rico or U.S. Virgin Islands, call 1-809-763-1315. In all other overseas locations, contact GM North American Export Sales in Canada by calling 1-416-644-4112. As of October 4, 1993, call 1-905-644-4112.

For prompt assistance, please have the following information available to give the Customer Assistance Manager:

- Your name, address, home and business telephone number
- Vehicle Identification Number (This is available from the vehicle registration or title, or the plate at the left top of the instrument panel and visible through the windshield.)
- Dealership name and location
- Vehicle delivery date and present mileage
- Nature of concern

We encourage you to call the toll free number listed previously in order to give your inquiry prompt attention. However, if you wish to write GMC Truck, write to:

GMC Truck Customer Assistance
31 E. Judson Street 1607-04
Pontiac, MI 48342-2230

Refer to your Warranty and Owner Information booklet for addresses of Canadian and GM overseas offices.

When contacting GMC Truck, please remember that your concern will likely be resolved in the dealership, using the dealership's facilities.

equipment and personnel. That is why we suggest you follow Step One first if you have a concern.

Customer Assistance for the Hearing or Speech Impaired (TDD)

To assist customers who have hearing difficulties, GMC Truck has installed special TDD (Telecommunication Devices for the Deaf) equipment at its Customer Assistance Center. Any hearing or speech impaired customer who has access to a TDD or a conventional teletypewriter (TTY) can communicate with GMC Truck by dialing: In the United States, 1-800-GMC-TKTD (1-800-462-8583). (TDD users in Canada can dial 1-800-263-3830.)

GM Participation in BBB AUTO LINE – Alternative Dispute Resolution Program*

*This program may not be available in all states, depending on state law. Canadian owners refer to your Warranty and Owner Assistance Information booklet. General Motors reserves the right to change eligibility limitations and/or to discontinue its participation in this program.

Both GMC Truck and your GMC Truck dealer are committed to making sure you are completely satisfied with your new vehicle. Our experience has shown if a situation arises where you feel your concern has not been adequately addressed, the Customer Satisfaction Procedure described earlier in this section is very successful.

There may be instances where an impartial third-party can assist in arriving at a solution to a disagreement regarding vehicle repairs or interpretation of the New Vehicle Limited Warranty. To assist in resolving these disagreements GMC Truck voluntarily participates in BBB AUTO LINE.

BBB AUTO LINE is an out-of-court program administered by the Better Business Bureau system to settle disputes between customers and automobile manufacturers. This program is available free of charge to customers who currently own or lease a GM vehicle.

If you are not satisfied after following the Customer Satisfaction Procedure, you may contact the BBB using the toll-free telephone number, or write them at the following address:

BBB AUTO LINE
Council of Better Business Bureaus
4200 Wilson Boulevard
Suite 800
Arlington, VA 22203
Telephone: 1-800-955-5100

To file a claim, you will be asked to provide your name and address, your vehicle identification number (VIN), and a statement of the nature of your complaint. Eligibility is limited by vehicle age and mileage, and other factors.

We prefer you utilize the Customer Satisfaction Procedure before you resort to AUTO LINE, but you may contact the BBB at any time. The BBB will attempt to resolve the complaint by serving as an intermediary between you and GMC Truck. If this mediation is unsuccessful, an informal hearing will be scheduled where eligible customers may present their case to an impartial third-party arbitrator.

The arbitrator will make a decision which you may accept or reject. If you accept the decision, GM will be bound by that decision. The entire dispute resolution procedure should ordinarily take about forty days from the time you file a claim until a decision is made.

Some state laws may require you to use this program before filing a claim with a state-run arbitration program or in the courts. For further information, contact the BBB at 1-800-955-5100 or the GMC Truck Customer Assistance Center at 1-800-GMC-TRUCK (1-800-462-8782).

REPORTING SAFETY DEFECTS TO THE UNITED STATES GOVERNMENT

If you believe that your vehicle has a defect which could cause a crash or could cause injury or death, you should immediately inform the National Highway Traffic Safety Administration (NHTSA), in addition to notifying General Motors.

If NHTSA receives similar complaints, it may open an investigation, and if it finds that a safety defect exists in a group of vehicles, it may order a recall and remedy campaign. However, NHTSA cannot become involved in individual problems between you, your dealer, or General Motors.

To contact NHTSA, you may either call the Auto Safety Hotline toll-free at 1-800-424-9393 (or 366-0123 in the Washington, D.C. area) or write to:

NHTSA, U.S. Department of Transportation
Washington, D.C. 20590

You can also obtain other information about motor vehicle safety from the Hotline.

REPORTING SAFETY DEFECTS TO THE CANADIAN GOVERNMENT

If you live in Canada, and you believe that your vehicle has a safety defect, you should immediately notify Transport Canada, in addition to notifying General Motors of Canada Limited. You may write to:

Transport Canada, Box 8880
Ottawa, Ontario K1G 3J2

REPORTING SAFETY DEFECTS TO GENERAL MOTORS

In addition to notifying NHTSA (or Transport Canada) in a situation like this, we certainly hope you'll notify us. Please call us at 1-800-GMC-TRUCK (1-800-462-8782), or write:

GMC Truck Consumer Relations
31 E. Judson Street 1607-04
Pontiac, MI 48342-2230

In Canada, please call us at 1-800-263-3777 (English) or 1-800-263-7854 (French). Or, write:

General Motors of Canada Limited
Customer Assistance Center
1908 Colonel Sam Drive
Oshawa, Ontario L1H 8P7

Roadside Assistance

GMC Truck's Roadside Assistance provides stranded owners with over-the-phone roadside repairs or towing service for disabled vehicles. This service combines the efforts of technically trained telephone representatives with a network of GMC Truck's dealer services.

Just dial GMC Truck Roadside Assistance at 1-800-GMC TRUCK (1-800-462-8782, Roadside Assistance prompt) to reach a qualified representative who can assist you in repair or arrange a tow. Other recommended services can also be arranged for situations such as retrieving locked-in keys, changing a tire, or delivering gasoline, at a charge to the owner. We also provide dealer information at no charge such as location of the nearest GMC Truck dealer and their hours of operation.

Roadside Assistance is available 24 hours a day, seven days a week, 365 days a year, including weekends and holidays. Should you have any questions about roadside assistance, call the GMC Truck Roadside Assistance Center or contact your dealer.

Courtesy Transportation

- The GMC Truck Commitment Plus Program offers courtesy transportation for customers when obtaining warranty service. The Courtesy Transportation Program is available to retail purchasers of Commitment Plus eligible 1994 GMC light duty trucks. This program is offered in conjunction with the 36 month/36,000 mile BUMPER TO BUMPER New Vehicle Limited Warranty.
- **In Canada**, please consult your GM Dealer for information on courtesy transportation.

COURTESY TRANSPORTATION INCLUDES:

- One way SHUTTLE RIDE from the dealership (up to 10 miles) for same-day warranty repairs.
- A loaner vehicle will be made available for overnight warranty repairs up to a 5 day maximum, or a \$30 allowance for a rental vehicle, cab, bus or other transportation in lieu of a loaner. (Bringing vehicles in late in the day, for service on the next day, **does not** constitute overnight repairs.)
- GAS allowance of \$10 a day for rides provided by another person (i.e., friend, neighbor, etc.) in lieu of rental for overnight warranty repair up to 5 day maximum.

Note: All Courtesy Transportation arrangements will be administered by your GMC Truck dealership service management. All requests should reflect actual costs up to and not to exceed the maximum allowable dollar limits.

- The Commitment Plus Courtesy Transportation Program is not part of the BUMPER TO BUMPER Limited Warranty. GMC Truck reserves the right to make any changes or discontinue the Courtesy Transportation Program at any time without notification.
- For additional program details contact your GMC Truck dealer.

Note: Because of insurance liability considerations, age restrictions exist in some states when loaning dealer owned vehicles or obtaining vehicles from rental establishments. See your dealer for details.

Service Publications

Information on how to obtain Product Service Publications (PSP's), Subscriptions, Indexes and Summaries as described below is applicable only in the fifty U.S. States (and the District of Columbia) and only for light trucks with GVWR less than 10,000 pounds (4536 kg).

In Canada, information pertaining to Product Service Bulletins and Indexes can be obtained by writing to:

General Motors of Canada Limited
Service Publications Department
1908 Colonel Sam Dr.
Oshawa, Ontario L1H 8P7

GMC Truck regularly sends its dealers useful service bulletins about GMC Truck products. GMC Truck monitors product performance in the field. We then prepare bulletins for servicing our products better. Now, you can get these bulletins too.

Bulletins cover various subjects. Some pertain to the proper use and care of your vehicle. Some describe costly repairs. Others describe inexpensive repairs which, if done on time with the latest parts, may avoid future costly repairs. Some bulletins tell a technician how to repair a new or unexpected condition. Others describe a quicker way to fix your vehicle. They can help a technician service your vehicle better.

Most bulletins apply to conditions affecting a small number of cars or trucks. Your GMC Truck dealer or a qualified technician may have to determine if a specific bulletin applies to your vehicle.

Individual PSP's

If you don't want to buy all the PSP's issued by GMC Truck for all models in the model year, you can buy individual PSP's, such as those which may pertain to a particular model. To do this, you will first need to see our index of PSP's. It provides a variety of information. Here's what you'll find in the index and how you can get one:

What You'll Find in the Index:

- A list of all PSP's published by GMC Truck in a model year. PSP's covering all models of GMC light trucks are listed in the same index.
- Ordering information so you can buy the specific PSP's you may want.
- Price information for the PSP's you may want to buy.

How You Can Get an Index:

Indexes are published periodically. Most of the PSP's which could potentially apply to the most recent GMC Truck models will be listed in the most recent publication for that model year. This means you may want to wait until the end of the model year before ordering an index, if you are interested in buying PSP's pertaining to a current model year car or truck.

Some PSP's pertaining to a particular model year vehicle may be published in later years, and these would be listed in the later year's index. When you order an index for a model year that is not over yet, we'll send you the most recently published issue. Check the ordering form for indexes for earlier model years.

Cut out the ordering form, fill it out, and mail it in. We will then see to it that an index is mailed to you. There is no charge for indexes for the 1989–1994 model years.

Toll-Free Telephone Number

If you want an additional ordering form for an index or a subscription, just call toll-free and we'll be happy to send you one. Automated recording equipment will take your name and mailing address. The number to call is 1-800-551-4123.

Copies at Participating Dealers

Copies of Indexes and individual PSP's are at your participating GMC Truck dealer. You can ask to see them.

A Very Important Reminder

These PSP's are meant for technicians. They are not meant for the "do-it-yourselfer". Technicians have the equipment, tools, safety instructions, and know-how to do a job quickly and safely.

GMC Truck reserves the right to change these procedures without notice after November, 1992.

GMC Truck Service Publications

You can get these Product Service Publications by using the order form. You can also get Service Manuals and Owner Publications.

1994 SERVICE PUBLICATIONS ORDERING INFORMATION

You can get manuals that tell how to operate and service your vehicle. To order them, fill out the order form on the next page and send it to the address below.

GMC Truck Service Publications
Post Office Box 436006
Pontiac, MI 48343

If you have questions or would like to order using your credit card, call us **TOLL FREE at 1-800-627-5699**.

From outside the Continental United States, please call 1-313-455-8016

GLOVE BOX LITERATURE FOR YOUR SONOMA

Manual	Form Number	Price
Owner's Manual	X-9408	\$10.00
Warranty Manual	X-9417	\$ 3.00
Vehicle Storage Manual	X-0101	—

You can also order the Glove Box Literature in a vinyl portfolio which includes all of these publications. Ask for form number 15959070—it costs \$15.00.

SERVICE MANUALS FOR ALL LIGHT DUTY TRUCKS

Model	Kit Number	Price
1994 C/K Models	NATP-9431K	\$120.00
1994 G Van	NATP-9457K	\$120.00
1994 P3 & P/G Models	NATP-9432K	\$120.00
1994 Safari	NATP-9430K	\$120.00
1994 S/T Models	NATP-9429K	\$120.00

Includes: Service Manual, Unit Repair Manual, Driveability, Emissions, and Electrical Diagnosis Manual.

PRODUCT SERVICE PUBLICATIONS

Description	Form Number	Price
• 1991 Model Year Index	PSP I 91	Free
• 1992 Model Year Index	PSP I 92	Free
• 1993 Model Year Index	PSP I 93	Free
For 1994 Call 1-800-782-4356		
• 1994 Model Year Index	PSP I 94	Free
• 1994 Model Year Product Service Publication Subscription	PSP 94	TBD
• Above Subscription With Binder	PSP 94B	TBD
• Binder Only	PSP B	TBD

Prices subject to change without notice.

Notes

SERVICE PUBLICATIONS ORDER FORM

NOTE: Please complete form below (Print or Type) and MAIL TO:

GMC Truck Service Publications, P.O. Box 436006, Pontiac, MI 48342

ORDER TOLL FREE
1-800-627-5699

From outside the Continental United States,
please call 1-313-455-8016

- Refunds or exchanges will not be accepted after 30 days.
- Routine orders will be shipped within 10 days of receipt.
- For an additional charge of \$9.00, Rush Orders will be shipped within 24 hours of receipt.
- Please allow adequate time for postal service.
- We also offer UPS-Overnight Express-Call for Rates.
- Prices subject to change without notice.

S H I P T O

FROM:

Adistra Corporation
Attn: GMC Service Publications
171 Hamilton St.
Plymouth, MI 48170

TO:

(COMPANY NAME)

(NAME)

(STREET ADDRESS)

(APT. NO.)

(CITY)

(STATE)

(ZIP CODE)

This is your shipping label! Please Print Clearly

O R D E R

Publication
Form Number

Description

Qty.

Price Each

Total Price

TOTAL MATERIAL

Michigan Purchasers
add 4% sales tax

Rush Order Charge

Overnight Delivery

GRAND TOTAL

MasterCard

VISA

American Express

Check or Money Order Enclosed.

Please be sure to sign your check!

Make Checks Payable to Adistra Corporation (No Stamps)

Card

Number:

Expiration

Date mo./yr.

CUSTOMER SIGNATURE _____

Index

A

Accessory Power Outlets	2-51
Air Cleaner	6-14
Air Conditioning	3-4, 6-42
Fan Switch	3-4
Function Knob	3-5
Refrigerant Capacity	6-78
Temperature Knob	3-5
Antenna, Fixed Mast	3-22
Anti-lock Brakes (See "Brakes")	
Appearance Care	6-59
Materials Chart	6-67
Arbitration Program	8-3
Audio Systems	3-5
AM Radio	3-6
AM-FM Stereo Audio Compact Disc (CD) System	3-17
AM-FM Stereo Audio System	3-8
AM-FM Stereo Audio System with Cassette Deck	3-10
AM-FM Stereo Audio System with Cassette Deck and Equalizer	3-13
Anti-Theft System (CD) System)	3-20
Cassette Tape Player Care	3-16
Compact Disc Care	3-22
Automatic Transmission	2-16
Fluid	6-15
Axle	
Front	6-22
Rear	6-20
Rear Locking	2-21

B

Battery	6-32
Belts (See "Safety Belts")	
Better Business Bureau Mediation	8-3
Blizzard	4-35
Brakes	
Adjustment	4-5
Anti-lock	4-6
Anti-lock Warning Light	2-60
Fluid	6-30
Four-Wheel Anti-lock	4-7
Rear-Wheel Anti-lock	4-7
Leak Check	6-28
Master Cylinder	6-29
Parking	2-16
Pedal Travel	4-7
Rear Drum Brakes	4-7
Replacing Parts	6-32
System Warning Light	2-59, 4-5
Trailer	4-44
Wear Indicators	4-6

Brakes (continued)	
Braking	4-5
In Emergencies	4-8
Break-In, New Vehicle	2-9
Bulb Replacement	6-33
Replacement Chart	6-78

C

Capacities and Specification Charts	6-73
Carbon Monoxide	2-25, 2-26
Cassette Tape Player (see "Audio Systems")	
Catalytic Converter	6-44
Certification/Tire Label	6-52
Changing a Flat Tire	5-20,
Chemical Paint Spotting	6-67
Child Restraints (See "Safety Belts")	
CHMSL Feed Wire	2-67
Cigarette Lighter/Ashtray	2-52
Circuit Breakers (See "Fuses")	
Cleaning	
Finish Care	6-65
Glass	6-64
Inside of Vehicle	6-60
Instrument Panel, Top	6-63
Outside of Vehicle	6-64
Special Problems	6-62, 6-66
Vinyl or Leather	6-63
Wheels and Tires	6-65
Windshield	6-64
Clock	3-8
AM Radio	3-7
AM-FM Stereo Audio Compact Disc (CD) System	3-17
AM-FM Stereo Audio System	3-8
AM-FM Stereo Audio System with Cassette Deck	3-10
AM-FM Stereo Audio System with Cassette Deck and Equalizer	3-13
Comfort Controls	3-2
Conversion to Chassis Cab	6-50
Coolant (See "Engine")	
Cooling System Capacity	6-73
Crankcase Capacity	6-74
Cruise Control	2-39
Increase Speed	2-42
On Hills	2-43
Passing	2-43
Reduce Speed	2-43
Resume	2-41
Set	2-40
To Get Out Of	2-44
Customer Assistance for the Hearing or Speech Impaired	8-3
Customer Satisfaction Procedure	8-2

D

Daytime Running Lights (Canada Only)	2-47, 2-64
Indicator Light	2-47, 2-62, 2-64
Dome Light	2-48
Doors	2-5
Locks	2-6
Driving	
Across an Incline	4-22
After Off-Road Driving	4-25
At Night	4-25
Backing Up	4-42
Defensive	4-2
Downhill	4-20
Freeway	4-29
Highway Hypnosis	4-31
Hydroplaning	4-27
In Blizzard	4-33
In City	4-28
In Mud, Sand, Snow, Or Ice	4-23, 5-35
In Rain	4-26
In Water	4-24
Loss of Control	4-12
Night Vision	4-26
Off-Roading	4-13
On Curves	4-18
On Grades	4-43
On Hill and Mountain Roads	4-31
On Off-Road Hills	4-17
On Snow or Ice	4-33
Passing	4-11
Skidding	4-12
Stuck in Deep Snow	5-35
Through Water	2-14, 4-24
Uphill	4-18
Winter	4-33
With a Trailer	4-38
Drunken Driving	4-2

E

Electrical System	
Accessory Power Outlets	2-51
Add-On Equipment	6-70
Engine	
Adding Coolant	5-15, 6-25
Air Cleaner	6-14
Coolant (Block) Heater	2-14, 3-5, 6-13
Coolant	6-23, 6-73
Coolant Temperature Gage	2-60
Crankcase	6-74
Exhaust	2-25
Fan Noise	5-19
Identification	6-69, 6-73
Oil (See "Oil")	

Engine (continued)	
Overheating	5-12
Running While Parked	2-16
Starting	2-12
Equipment, Add-On	6-47
Exhaust System	6-44

F

Fan Noise	5-19
Filter Replacement Chart	6-78
Finish	
Care	6-65
Damage	6-66
Fluid	
Automatic Transmission	6-15
Brake	6-30, 6-75
Capacities	6-74, 6-78
Coolant Recovery	5-13
Front Axle	6-23
Hydraulic Clutch	6-20
Leak Check	6-28
Manual Transmission	6-18
Power Steering	6-27
Radiator	5-17
Rear Axle	6-20
Recommended Fluids	7-13
Transfer Case	6-22
Windshield Washer	6-28
Fog Lamps	2-46
Four-Wheel Drive	2-27, 6-21
Transfer Case	6-22
Front Axle	6-23
Fuel	6-3
Filling Your Tank	6-5
Foreign Countries	6-4
Gage	2-66
Gasolines for Cleaner Air	6-4
Tank Capacity	6-74
Fuses and Circuit Breakers	6-76
Fuse Block	6-76
Headlights	6-71, 6-74
Power Windows and Other Power Options	6-71, 6-76
Trailer Wiring Harness	6-71
Windshield Wipers	6-71, 6-77

G

Gages	2-58
Coolant Temperature Gage	2-60
Fuel Gage	2-66
Odometer	2-56, 2-57
Oil Pressure Gage	2-62
Speedometer	2-56
Gages (continued)	
Tachometer	2-57
Trip Odometer	2-57
Voltmeter	2-67

H

Halogen Bulbs	6-33
Hazard Warning Flashers	5-2
Head Restraints	1-6
Headlights	6-34
High Beam Indicator Light	2-65
High-Low Beam	2-36
Reminder	2-36, 2-48
Heating System (without A/C)	3-3
Fan Switch	3-3
Function Knob	3-3
Temperature Knob	3-3
Highway Hypnosis	4-31
Hitches	4-40
Hood	
Checking Under	6-6
Latches and Hinge	6-36
Release	6-6
Horn	2-33
Hydraulic Clutch	6-20
Hydroplaning	4-27

I

If You're Stuck in Sand, Mud, Ice, or Snow	5-35
Ignition Switch	2-10
Inflation-Tire Pressure	6-52

J

Jack Storage	5-21, 5-29
Jump Starting	5-3, 5-4

K

Key Release Lever	2-11
Keys	2-3

L

Labels	
Certification/Tire	6-45, 6-52
Truck-Camper	6-48
Lights	2-45
Brake System Warning	2-59, 4-16
Bulb Replacement	6-33, 6-74
Charging System Light	2-63
Check Gages Light	2-63
Dome	2-48
Fog Lamps	2-46
Front Parking/Turn Signal	6-36
Headlights (See "Headlights")	
Indicator	2-62, 2-65
Malfunction Indicator	2-61, 6-44
Operation	2-35
Service Engine Soon	6-44
Rear	6-37, 6-74
Replacement Chart	6-74
Loading Information	4-14, 6-45, 6-48
Loading Your Vehicle	4-14, 6-38
Lubrication	6-43
Accelerator Control System	6-43
Body	6-43
Front Axle	6-22
Front Suspension and Steering Linkage	6-39
Front Wheel Bearings (Two-Wheel Drive)	6-39
Tailgate Handle	6-36
Hood Latches and Hinge	6-34
Lock Cylinders	6-44
Propeller Shaft Slip Splines/Universal Joints	6-43
Rear Axle	6-20
Recommended Lubricants	7-13
Transfer Case	6-21

M

Maintenance	
Other Items	6-39
Periodic Inspections	7-12
Record	7-16
Scheduled Maintenance	7-3
Underbody	6-67
When Towing a Trailer	4-38
Master Cylinder (See "Brakes")	
Mirrors	2-48
Convex Outside	2-50
Inside	2-48
Outside	2-49
Vanity	2-50
Model Reference	iii

O

Odometer	2-56, 2-57
Off-Road Driving (See "Driving")	
Off-Road Recovery	4-10
Oil	6-9
Additives	6-13
Disposal of Used	6-13
Pressure Gage	2-62
To Check	6-9
What Kind to Use	6-10
When to Add	6-9
When to Change	6-13
Owner Checks and Services	7-10

P

Parking	
On Hills	4-43
Over Things That Burn	2-24
Torque Lock (Automatic Transmission)	2-24
Your Vehicle (Manual Transmission)	2-24
Parking Brake	2-21, 2-28
Passing Other Vehicles	4-11
Payload Capacity	6-47
Periodic Maintenance Inspections	7-12
Power	
Door Locks	2-7
Steering	4-8
Steering Fluid	6-26
Winches	4-45
Product Service Publications	8-7

R

Radiator Pressure Cap	6-25
Radio (see "Audio Systems")	
Recommended Fluids and Lubricants	7-13
Recovery Hooks	5-35
Replacement Parts	6-73
Reporting Safety Defects	8-4
Roadside Assistance	8-5
Rocking Your Vehicle	5-35

S

Safety Belts	
Cleaning	6-63
Checking Restraint System	1-33
Child Restraints	1-25
Children	1-23
Small Children and Babies	1-23
Extender	1-33
Lap	1-20
Lap Shoulder	1-13

Safety Belts (continued)	
Large Children	1-30
Proper Wear	1-12
Questions & Answers	1-11
Reminder Light	1-12
Replacing After a Crash	1-33
Use During Pregnancy	1-19
Why They Work	1-8
Safety Chains	4-41
Safety Warnings and Symbols	vi
Scheduled Maintenance Services	7-3
Seats	
Controls	1-2
Easy Entry Seat	1-5
Front	1-2
Jump	1-6
Latches	1-4
Reclining	1-3
Seatback Latches	1-4, 1-6
Service	
Do-It-Yourself	6-2
Parts Identification Label	6-70
Publications	8-7, 8-8
Replacement Parts and Filter Recommendations	6-78
Service Engine Soon Light	2-61
Service Station Checks	7-17
Shift Indicator Light	2-64
Shifting Into Park	2-12, 2-16, 2-22
Single Belt Accessory Drive	6-39
Sliding Rear Window	2-32
Spare Tire	5-23
Removal	5-25
Storage	5-34
Specification Charts	6-73
Speedometer	2-56
Starting your Engine	2-12
Steering	4-8
In Emergencies	4-9
Tips	4-8
Storage Compartments	2-53
Sun Visors	2-50
Swing-Out Windows	2-32

T

Tachometer	2-57
Tailgate	2-7
Theft	2-4, 2-8
Thermostat	6-26
Tilt Wheel	2-33
Tires	6-51
Balancing	6-57
Chains	6-59
Changing a Flat	5-20, 5-26
Flat	5-20

Tires (continued)	6-51
Hub Caps and Wheel Nut Caps	5-27
Inspection and Rotation	6-54
Loading	6-45, 6-48
New	6-55
Pressure	6-52
Spare (See "Spare Tire")	
Underbody Carrier	5-33
Uniform Tire Quality Grading	6-56
Torque Lock	2-24
Towing	
A Trailer	4-38
Following Distance	4-42
Hitches	4-40
Maintenance	4-44
Recreational Vehicle	4-36
Towing Your Vehicle	4-36, 5-7
Trailer	
Brakes	4-41
Wiring Harness	2-68, 6-71
Trailering Package	6-47
Transfer Case	6-21
Electronic	2-29
Manual	2-27
Transmission	
Automatic	2-16
Five-Speed Manual	2-19
Fluid	6-15, 6-18
Fluid, To Add	6-18, 6-19
Four-Wheel (See "Four-Wheel Drive")	
Manual-Shift Speeds	2-20
Shift Light	2-20
Torque Lock (Automatic Transmission)	2-24
Trip Odometer	2-57
Turn Signal/Multifunction Lever	2-34

V

Vehicle	
Damage Warnings	vii
Identification Number	6-69
Loading	6-45
Storage	6-32
Symbols	vii, viii, ix, x
Ventilation System	3-2
Air Vents	3-3
Tips	3-2
Voltmeter	2-67

W

Warning	
Devices, Other	5-3
Hazard	5-2
Lights, Gages and Indicators	2-58
Wheels	
Alignment and Tire Balance	6-57
Aluminum	6-65
Hub Caps and Wheel Nut Caps	5-27
Nut Torque	6-73
Replacement	6-55, 6-57
Used Replacement	6-58
Windows	2-31
Sliding Rear	2-32
Swing-Out	2-32
Windshield Washer	2-37
Washer Fluid	2-38
Winter Driving	4-33
Wipers, Windshield	2-36, 6-71
Blade Chatter	6-64
Blade Cleaning	6-64
Blade Inserts	6-39[]

Notes

X-9408



WE SUPPORT
VOLUNTARY TECHNICIAN
CERTIFICATION THROUGH

National Institute for
**AUTOMOTIVE
SERVICE
EXCELLENCE**

**Keep with vehicle at all times.
Contains Important Operating, Safety,
and Maintenance Instructions.**



THE STRENGTH OF EXPERIENCE.