









CHEVROLET

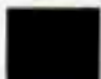

1994 CAVALIER OWNER'S MANUAL

Introduction	<b>How to Use this Manual .....</b>	<b>6</b>	
Part 1	<b>Seats &amp; Restraint Systems.....</b>	<b>11</b>	
Part 2	<b>Features &amp; Controls.....</b>	<b>41</b>	
Part 3	<b>Comfort Controls &amp; Audio Systems....</b>	<b>91</b>	
Part 4	<b>Your Driving and the Road .....</b>	<b>107</b>	
Part 5	<b>Problems on the Road.....</b>	<b>127</b>	
Part 6	<b>Service &amp; Appearance Care .....</b>	<b>153</b>	
Part 7	<b>Maintenance Schedule .....</b>	<b>203</b>	
Part 8	<b>Customer Assistance Information ....</b>	<b>221</b>	
	<small>Includes "Reporting Safety Defects" on page 224</small>		
Part 9	<b>Index.....</b>	<b>233</b>	
	<b>Service Station Information ....</b>	<b>Last Page</b>	

### ***Important Notes About this Manual***

Please keep this manual in your Chevrolet, so it will be there if you ever need it when you're on the road. If you sell the vehicle, please leave this manual in it so the new owner can use it.

This manual includes the latest information at the time it was printed. We reserve the right to make changes in the product after that time without further notice.

### ***Note to Canadian Owners***

For vehicles first sold in Canada, substitute the name "General Motors of Canada Limited" for Chevrolet Motor Division whenever it appears in this manual.

#### **For Canadian Owners Who Prefer a French Language Manual:**

**Aux propriétaires canadiens:** Vous pouvez vous procurer un exemplaire de ce guide en français chez votre concessionnaire ou au DGN Marketing Services Ltd., 1500 Bonhill Road, Mississauga, Ontario L5T 1C7.

Published by **Chevrolet Motor Division**  
**General Motors Corporation**

**General Motors, GM** and the GM emblem, the word **Chevrolet**, the Chevrolet emblem and the name Cavalier are registered trademarks of General Motors Corporation.

The word **Delco** is a registered trademark of General Motors Corporation.

© Copyright 1993 General Motors Corporation, Chevrolet Motor Division. All rights reserved.

# The Heritage of Chevrolet



*The dynamic William C. "Billy" Durant shifted gears from making carriages to making cars, forming half of the team that gave birth to Chevrolet.*

Welcome to the largest automotive family in the world—the family of Chevrolet owners. You have selected a vehicle designed, engineered and crafted by teamwork, a vehicle backed

by a proud history of performance and value. Since the first "Classic Six" rolled off the line in 1912, more than 110 million Chevrolet cars and trucks have worn the Chevrolet marque.

That kind of reception from auto owners is unmatched by any other car manufacturer in the world.

The Chevrolet blend of value and performance has

*Louis Chevrolet, the other half of the team, at the wheel of his experimental "Classic Six," which entered production in 1912. That year 2999 vehicles were produced.*





*In January 1942, Chevrolet factories were converted to military production in an all-out effort to achieve victory in Europe and the Pacific...but millions of Americans already owned a "Chevy."*

become an American tradition—whether bred for the racetrack like the legendary Corvette and Camaro, or created for the pleasure of the open road.

Every decade, Chevrolet has reinforced its heritage of affordable performance with quality and value crafted into each vehicle. It's not surprising that for eighty years

Chevrolet has been America's automobile...truly "The Heartbeat of America."

We're proud to continue that heritage in your Chevrolet, and we are pledged

*In 1932 Chevrolet introduced the Synchro-Mesh transmission and offered a host of accessories—including such niceties as a clock!*



*The legacy of America's favorite sportscar began in 1953, when 319 hand-assembled white Corvettes launched the first use of a fiberglass body in a production car.*





*The 1957 Chevy started a romance with the American public—and was powered by an available fuel-injected V8.*

to make ownership of your  
Chevrolet an enjoyable and  
rewarding experience.

Jim Perkins,  
General Manager

*'60s automotive excitement  
included Chevrolet landmarks like  
the Corvette Sting Ray, the sporty  
Camaro, and powerplants like the  
legendary 327 V8.*

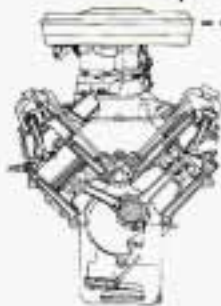

*Your new Chevrolet continues a tradition of quality and value.*

# How to Use this Manual

## ***Using Your 1994 Chevrolet Owner's Manual***

Many people read their owner's manual from beginning to end when they first receive their new vehicle. This will help you learn about the features and controls for your vehicle. In this manual, you'll find that pictures and words work together to explain things quickly.

There are nine parts with thumb-tabbed pages in this manual. Each part begins with a brief list of contents, so you can usually tell at a glance if that part contains the information you want.

You can bend the manual slightly to reveal the tabs that help you find a part.

### **Part 1: Seats & Restraint Systems**

This part tells you how to use your seats and safety belts properly.

### **Part 2: Features & Controls**

This part explains how to start and operate your Chevrolet.

### **Part 3: Comfort Controls & Audio Systems**

This part tells you how to adjust the ventilation and comfort controls and how to operate your audio system.

### **Part 4: Your Driving and the Road**

Here you'll find helpful information and tips about the road and how to drive under different conditions.

### **Part 5: Problems on the Road**

This part tells you what to do if you have a problem while driving, such as a flat tire or engine overheating.

### **Part 6: Service & Appearance Care**

Here the manual tells you how to keep your Chevrolet running properly and looking good.

### **Part 7: Maintenance Schedule**

This part tells you when to perform vehicle maintenance and what fluids and lubricants to use.

## **Part 8: Customer Assistance Information**

This part includes important information about reporting safety defects and gives you details about the "Roadside Assistance" program. You will also find customer satisfaction phone numbers (including customer satisfaction numbers for the hearing and speech impaired) as well as the mediation/ arbitration procedure. We've also included ordering information for service publications in this part.

## **Part 9: Index**

Here's an alphabetical listing of almost every subject in this manual. You can use it to quickly find something you want to read.

### **Service Station Information:**

This is a quick reference of service information. You can find it on the last page of this manual.

## **Safety Warnings and Symbols**

You will find a number of safety cautions in this book. We use a box with gray background and the word CAUTION to tell you about things that could hurt you if you were to ignore the warning.



### **CAUTION:**

These mean there is something that could hurt you or other people.



# How to Use this Manual

In the gray caution area, we tell you what the hazard is. Then we tell you what to do to help avoid or reduce the hazard. Please read these cautions. If you don't, you or others could be hurt.

You will also find a circle with a slash through it in this book. This safety symbol means:

*Don't*

*Don't do this*

*Don't let this happen*



## **Vehicle Damage Warnings**

Also, in this book you will find these notices:

### **NOTICE:**

These mean there is something that could damage your vehicle.

In the notice area, we tell you about something that can damage your vehicle. Many times, this damage would not be covered by your warranty, and it could be costly. But the notice will tell you what to do to help avoid the damage.

When you read other manuals, you might see CAUTION and NOTICE warnings in different colors or in different words.

You'll also see warning labels on your vehicle. They use yellow for cautions, blue for notices and the words CAUTION or NOTICE.

## Vehicle Symbols

These are some of the symbols you will find on your vehicle. For example, these symbols are used on an original battery:

*Caution Possible Injury*



*Protect Eyes by Shielding*



*Caustic Battery Acid  
Could Cause Burns*



*Avoid Sparks or Flames*



*Spark or Flame  
Could Explode Battery*



These symbols are important for you and your passengers whenever your vehicle is driven:

*Fasten Safety Belts*



*Door Lock/Unlock*



*Power Window*



These symbols have to do with your lights:

*Master Lighting Switch*



*Turn Signal Direction*

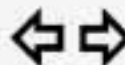

*Hazard Warning Flashers*



*Headlight High Beam*



*Parking Lights*

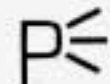

# How to Use this Manual

These symbols are on some of your controls:

*Windshield Wipers*



*Windshield Washer*



*Windshield Defroster*



*Rear Window Defogger*



*Ventilating Fan*



These symbols are used on warning and indicator lights:

*Engine Coolant Temperature*



*Battery Charging System*



*Fuel*



*Engine Oil Pressure*



*Brake*



*Anti-Lock Brakes*



Here are some other symbols you may see:

*Fuse*



*Trunk Release*



*Lighter*



*Horn*



*Speaker*



*Hood Release*





**H**ere you'll find information about the seats in your Chevrolet and how to use your safety belts properly. You can also learn about some things you should **not** do with safety belts.

## Part I Seats & Restraint Systems

Seats and Seat Controls .....	12
Safety Belts .....	17
How to Wear Safety Belts Properly .....	20
Driver Position .....	21
Safety Belt Use During Pregnancy .....	24
Right Front Passenger Position .....	25
Rear Seat Passengers .....	25
Rear Safety Belt Comfort Guides .....	27
Center Passenger Position .....	29
Children .....	30
Smaller Children and Babies .....	30
Child Restraints .....	31
Larger Children .....	38
Safety Belt Extender .....	40
Replacing Safety Belts After a Crash .....	40

# Seats & Restraint Systems

## ■ *Seats and Seat Controls*

This section tells you about the seats—how to adjust them—and also about reclining seatbacks and head restraints.

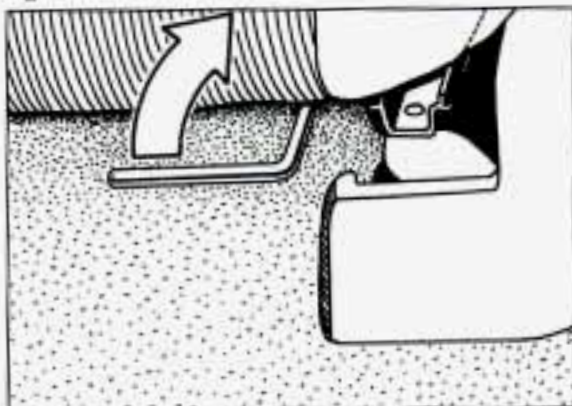

### **Manual Front Seat**



#### **CAUTION:**

You can lose control of the vehicle if you try to adjust a manual driver's seat while the vehicle is moving. The sudden movement could startle and confuse you, or make you push a pedal when you don't want to. Adjust the driver's seat only when the vehicle is not moving.

Move the lever under the front seat to unlock it. Slide the seat to where you want it. Then release the lever and try to move the seat with your body, to make sure the seat is locked into place.

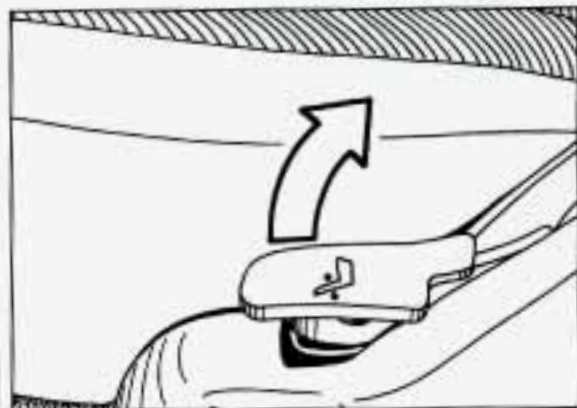

### **Reclining Front Seatback**

To adjust the seatback, lift the lever on the outer side of the seat and move the seatback to where you want it. Release the lever to lock the seatback. Pull up on the lever and the seat will go to an upright position.

But don't have a seatback reclined if your vehicle is moving.



#### **CAUTION (Continued)**

The lap belt can't do its job either. In a crash the belt could go up over your abdomen. The belt forces would be there, not at your pelvic bones. This could cause serious internal injuries.

For proper protection when the vehicle is in motion, have the seatback upright. Then sit well back in the seat and wear your safety belt properly.

#### **CAUTION:**

Sitting in a reclined position when your vehicle is in motion can be dangerous. Even if you buckle up, your safety belts can't do their job when you're reclined like this. The shoulder belt can't do its job because it won't be against your body. Instead, it will be in front of you. In a crash you could go into it, receiving neck or other injuries.

#### **CAUTION (Continued)**



#### **Head Restraints**

Head restraints are fixed on some vehicles and adjustable on others. Slide an adjustable head restraint up or down so that the top of the restraint is closest to the top of your ears.

This position reduces the chance of a neck injury in a crash.

On some models, the head restraints tilt forward and rearward also.

# Seats & Restraint Systems

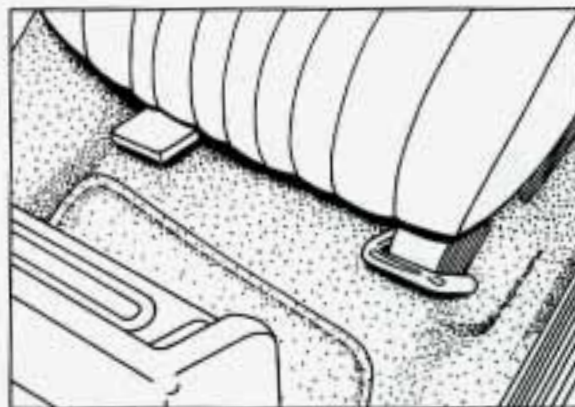

## **Manual 4-Way Adjustable Driver's Seat (OPTION)**

There are two levers at the front of the seat. The left lever adjusts the seat forward and back. The right lever adjusts the angle of the front of the seat.

### **To Adjust the Seat's Forward and Rearward Movement:**

Lift the left lever up and adjust the seat forward or back. Then release the lever and try to move the seat to be certain that it is locked in place.

### **To Raise or Lower the Front of the Seat:**

Lift the right lever, and lean forward or backward.



## **CAUTION:**

You can lose control of the vehicle if you try to adjust a manual driver's seat while the vehicle is moving. The sudden movement could startle and confuse you, or make you push a pedal when you don't want to. Adjust the driver's seat only when the vehicle is not moving.



## **Front Seatback Latches (2-DOOR MODELS)**

In 2-door models, the front seatback folds forward to let people get into the back seat. Your seatback will move back and forth freely, unless you come to a sudden stop. Then it will lock in place.

There's one time the seatback may not fold without some help from you. That's if your vehicle is parked going down a fairly steep hill.

To fold a front seatback forward, push the seatback toward the rear as you lift this latch. Then the seatback will fold forward. The latch must be down for the seat to work properly.

## **Easy-Entry Seat**

**(RS 2-DOOR AND Z-24 MODELS)**

The right front seat of your vehicle makes it easy to get in and out of the rear seat.

- When you push down on the rear latch and tilt the right front seatback fully forward, the whole seat will slide forward.
- After someone gets into the rear seat area, move the right front seatback to its original position. Then move the seat rearward until it locks.
- To get out, again tilt the seatback fully forward.



### **CAUTION:**

If an easy entry right front seat isn't locked, it can move. In a sudden stop or crash, the person sitting there could be injured. After you've used it, be sure to push rearward on an easy entry seat to be sure it is locked.

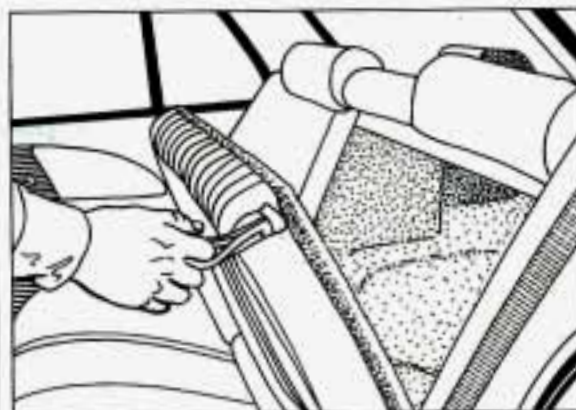

### **Split Fold-Down Rear Seat (OPTION)**

#### **To Open:**

Pull forward on the seat tab.

#### **To Close:**

Push the seatback up to its original position. Push the seatback solidly up against the back plate to ensure that the inertial latch hooks.

### **Folding Rear Seat (WAGON)**

To add more cargo room, your rear seatback can be easily folded down. Be sure to check your seatback latches now and then by pushing the seatback back and forth. If they do not latch properly, have them checked by your dealer.

Remember to keep safety belts clear of seat hinges and latches so they are not damaged when you raise and lower the seatback.



# Seats & Restraint Systems

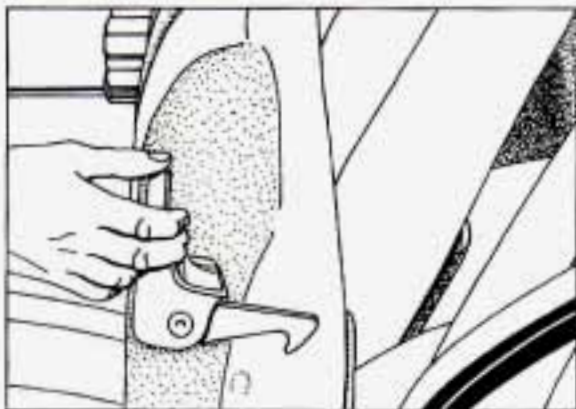

## To Lower the Split Folding Rear Seat:

1. There is a release lever on the side of each seat. Pull the release lever forward and pull the seatback forward and down.

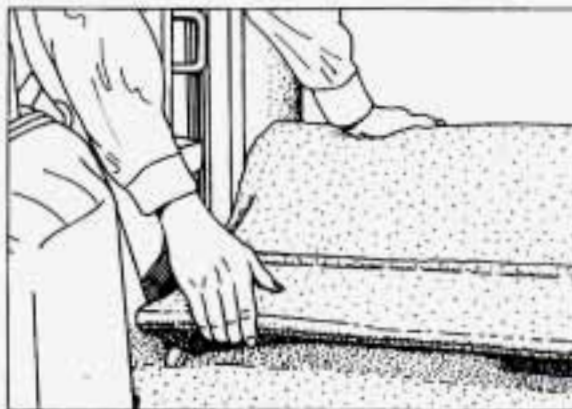

2. Push down on the filler panel and the seatback so they lock into a level position.

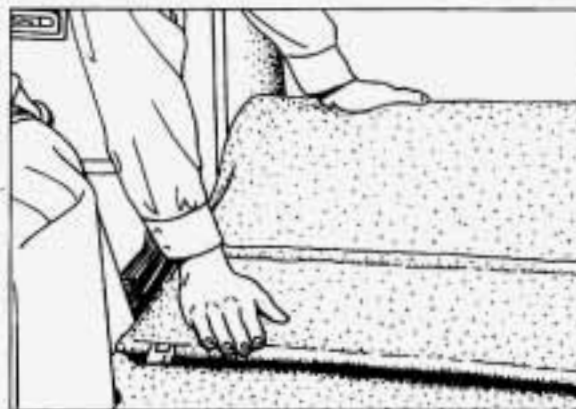

## To Raise the Split Folding Rear Seat:

1. Push down on the edge of the seatback and pull up the filler panel.
2. Lift the seatback until it locks in place. Push back and forth on the seatback to be sure it is locked in place.

## ■ *Safety Belts: They're For Everyone*

This part of the manual tells you how to use safety belts properly. It also tells you some things you should not do with safety belts.



### **CAUTION:**

Don't let anyone ride where they can't wear a safety belt properly. If you are in a crash and you're not wearing a safety belt, your injuries can be **much** worse. You can hit things inside the vehicle or be ejected from it. You can be seriously injured or killed. In the same crash, you might not be if you are buckled up. Always fasten your safety belt, and check that your passengers' belts are fastened properly too.



This figure lights up as a reminder to buckle up. (See *Safety Belt Warning Light* in the *Index*.)

In many states and Canadian provinces, the law says to wear safety belts. Here's why: **They work.**



You never know if you'll be in a crash. If you do have a crash, you don't know if it will be a bad one.

A few crashes are mild, and some crashes can be so serious that even buckled up a person wouldn't survive. But most crashes are in between. In many of them, people who buckle up can survive and sometimes walk away. Without belts they could have been badly hurt or killed.

After more than 25 years of safety belts in vehicles, the facts are clear. In most crashes buckling up does matter... a lot!

# Seats & Restraint Systems

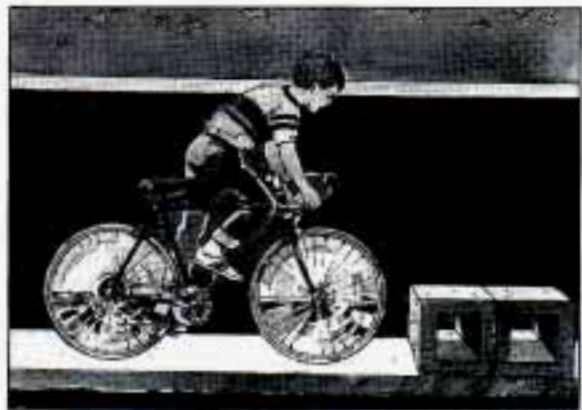

## Why Safety Belts Work

When you ride in or on anything, you go as fast as it goes.

1. For example, if the bike is going 10 mph (16 km/h), so is the child.



4. Put someone on it.

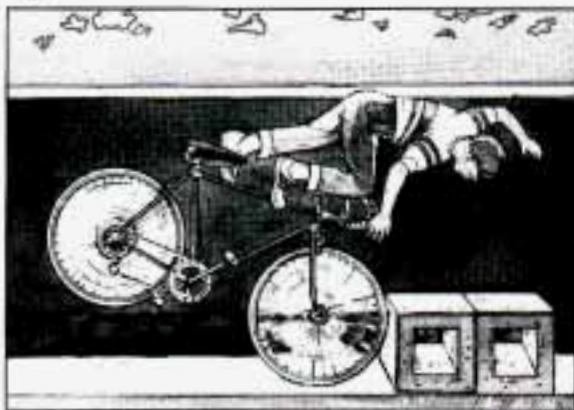

2. When the bike hits the block, it stops. But the child keeps going!

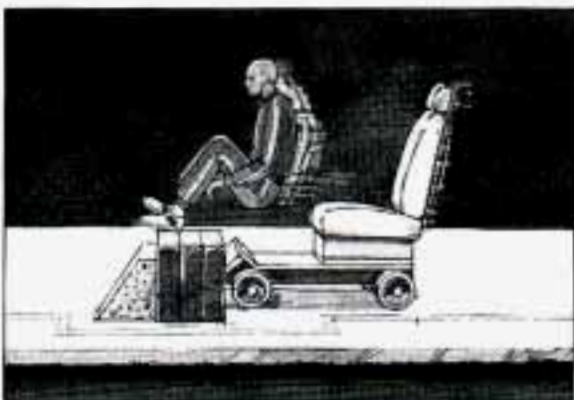

5. Get it up to speed. Then stop the vehicle. The rider doesn't stop.

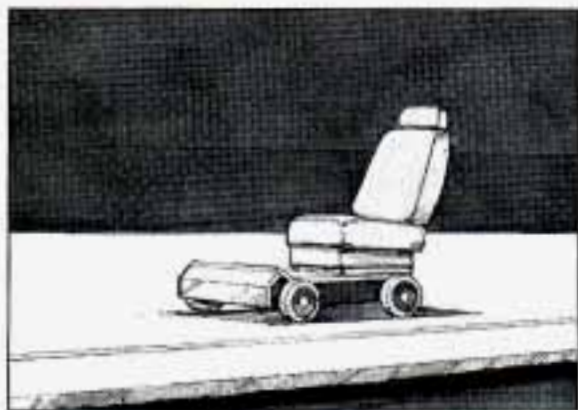

3. Take the simplest vehicle. Suppose it's just a seat on wheels.



6. The person keeps going until stopped by something.  
In a real vehicle, it could be the windshield...

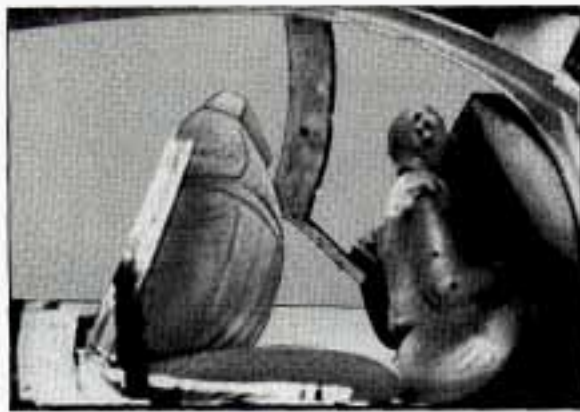

7. or the instrument panel...



8. or the safety belts!

With safety belts, you slow down as the vehicle does. You get more time to stop. You stop over more distance, and your strongest bones take the forces. That's why safety belts make such good sense.

### ■ *Here Are Questions Many People Ask About Safety Belts — and the Answers*

**Q:** Won't I be trapped in the vehicle after an accident if I'm wearing a safety belt?

**A:** You **could** be — whether you're wearing a safety belt or not. But you can easily unbuckle a safety belt, even if you're upside down. And your chance of being conscious during and after an accident, so you **can** unbuckle and get out, is **much** greater if you are belted.

**Q:** Why don't they just put in air bags so people won't have to wear safety belts?

**A:** Air bags are in some vehicles today and will be in more of them in the future. But they are supplemental

systems only — so they work **with** safety belts, not instead of them. Every air bag system ever offered for sale has required the use of safety belts. Even if you're in a vehicle that has air bags, you still have to buckle up to get the most protection. That's true not only in frontal collisions, but especially in side and other collisions.

**Q:** If I'm a good driver, and I never drive far from home, why should I wear safety belts?

**A:** You may be an excellent driver, but if you're in an accident — even one that isn't your fault — you and your passengers can be hurt. Being a good driver doesn't protect you from things beyond your control, such as bad drivers. Most accidents occur within 25 miles (40 km) of home. And the greatest number of serious injuries and deaths occur at speeds of less than 40 mph (65 km/h). Safety belts are for everyone.

# Seats & Restraint Systems

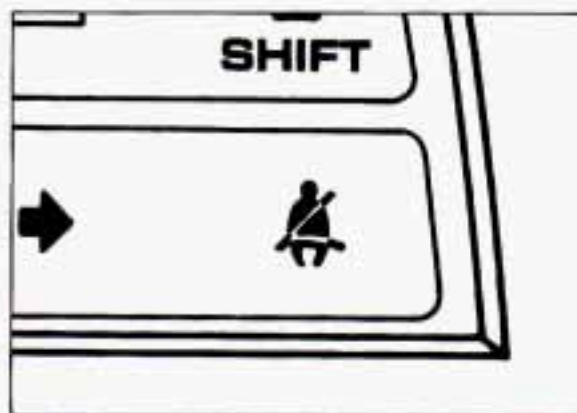

## Safety Belt Warning Light

When the key is turned to **Run** or **Start**, a chime will come on for about eight seconds to remind people to fasten their safety belts, unless the driver's safety belt is already buckled. The safety belt light will also come on and stay on for 20 seconds, then it will flash for an additional 55 seconds. If the driver's belt is already buckled, neither the chime nor the light will come on.



## CAUTION:

If your safety belt light ever comes on or stays on after the front doors are closed and the driver's belt is buckled, have your vehicle fixed. If you don't, the belt might not work as it should, and you might not have the protection you'd need in a crash.

## ■ How To Wear Safety Belts Properly

### Adults

This section is only for people of adult size.

Be aware that there are special things to know about safety belts and children. And there are different rules for smaller children and babies. If a child will be riding in your Chevrolet, see the section after this one, called *Children*. Follow those rules for everyone's protection.

First, you'll want to know which restraint systems your vehicle has. We'll start with the driver position.

## ■ Vehicles First Sold In Canada

Was your Chevrolet first sold, when new, in Canada? (If it was, a sticker on the driver's door will say "conforms to all applicable Canada motor vehicle..." etc.) If so, then the rest of Part 1 does not apply to your vehicle.

To learn how to use your safety belts, please read the **Owner's Manual Safety Belt Supplement**. It comes with every new Chevrolet first sold in Canada.

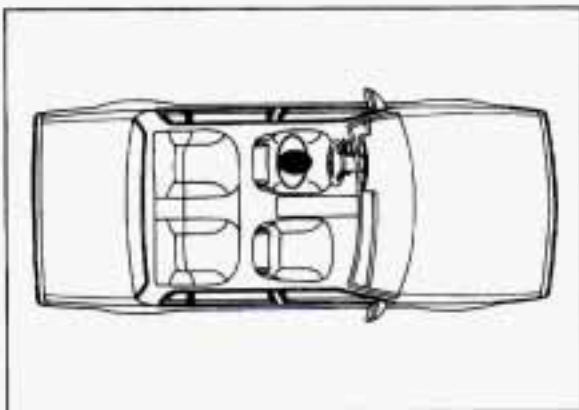

### ■ *Driver Position*

This section describes the driver's restraint system.



### *Automatic Lap-Shoulder Belt*

This safety belt is called "automatic" because you don't have to buckle up when you get into your vehicle.



And you don't have to unbuckle when you get out.

Just get into your vehicle. Then close and lock the door. Adjust the seat (to see how, see *Seats* in the *Index*) so you can sit up straight.

# Seats & Restraint Systems

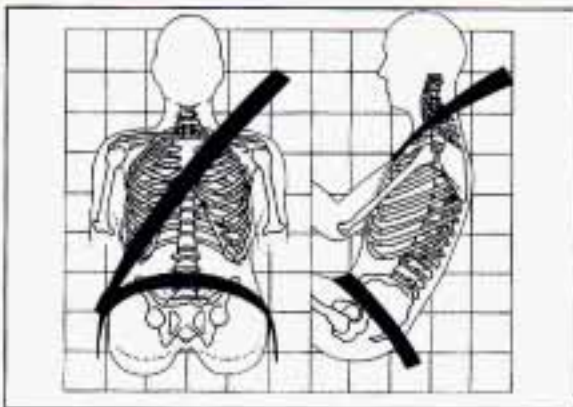

The lap belt should be worn as low on the hips as possible. In a crash, this applies force to the strong pelvic bones. And you'd be less likely to slide under the lap belt. If you slid under it, the belt would apply force at your abdomen. This could cause serious or even fatal injuries. The shoulder belt should go over the shoulder and across the chest. These parts of the body are best able to take belt restraining forces.

The safety belt locks if there's a sudden stop or a crash.

It's possible that an automatic belt could keep you from fully opening a door. That can happen if the door was slammed shut very hard. Just close the door all the way, then slowly open it. If that doesn't fix it, then your Chevrolet needs service.

We hope you'll always keep your automatic belt buckled. However, you may need to unbuckle it in an emergency.



To unbuckle the automatic belt, just push the button on the buckle.



To reattach the automatic belt:

1. Close and lock the door.
2. Adjust the seat (to see how, see *Seats in the Index*) so you can sit up straight.
3. Pick up the latch plate and pull the belt across you. Don't let it get twisted.
4. Push the latch plate into the buckle until it clicks. Pull up on the latch plate to make sure it is secure.

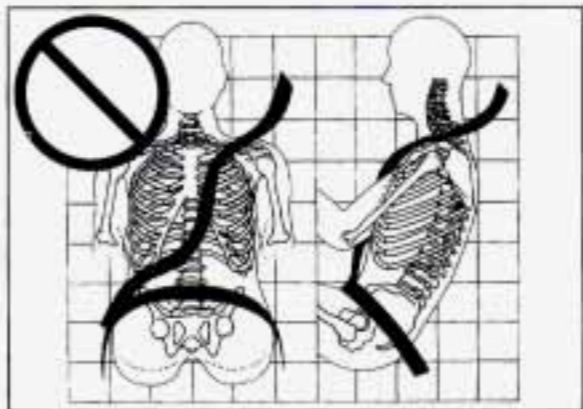

**Q: What's wrong with this?**

**A:** The shoulder belt is too loose. It won't give nearly as much protection this way.

 **CAUTION:**

You can be seriously hurt if your shoulder belt is too loose. In a crash you would move forward too much, which could significantly increase injury. The shoulder belt should fit against your body.

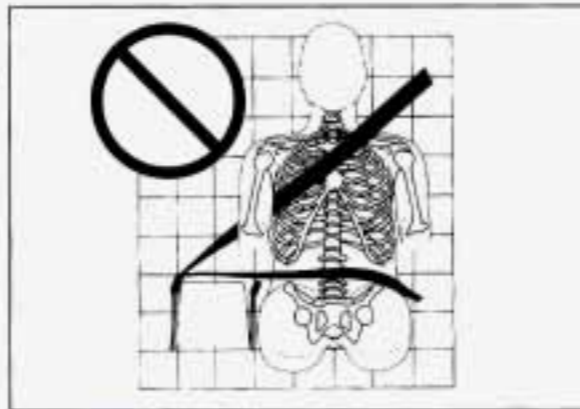

**Q: What's wrong with this?**

**A:** The belt is buckled in the wrong place.

 **CAUTION:**

You can be seriously injured if your belt is buckled in the wrong place like this. In a crash, the belt would go up over your abdomen. The belt forces would be there, not at the pelvic bones. This could cause serious internal injuries. Always buckle your belt into the buckle nearest you.



# Seats & Restraint Systems

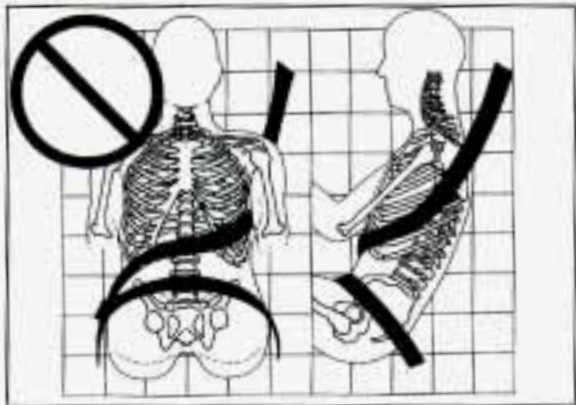

**Q: What's wrong with this?**

**A:** The shoulder belt is worn under the arm. It should be worn over the shoulder at all times.



## **CAUTION:**

You can be seriously injured if you wear the shoulder belt under your arm. In a crash, your body would move too far forward, which would increase the chance of head and neck injury. Also, the belt would apply too much force to the ribs, which aren't as strong as shoulder bones. You could also severely injure internal organs like your liver or spleen.

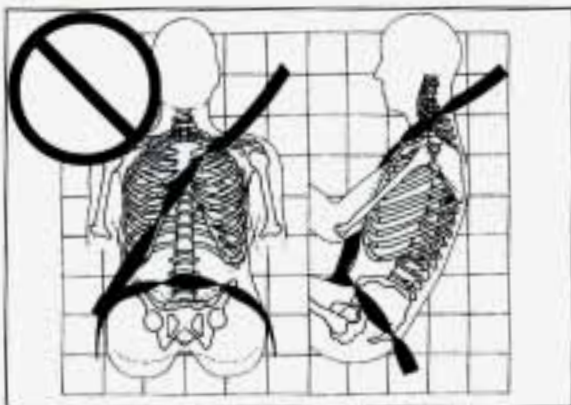

**Q: What's wrong with this?**

**A:** The belt is twisted across the body.



## **CAUTION:**

You can be seriously injured by a twisted belt. In a crash, you wouldn't have the full width of the belt to take impact forces. If a belt is twisted, make it straight so it can work properly, or ask your dealer to fix it.



## ■ *Safety Belt Use During Pregnancy*

Safety belts work for everyone, including pregnant women. Like all occupants, they are more likely to be seriously injured if they don't wear safety belts.

A pregnant woman should wear a lap-shoulder belt, and the lap portion should be worn as low as possible throughout the pregnancy.

The best way to protect the fetus is to protect the mother. When a safety belt is worn properly, it's more likely that the fetus won't be hurt in a crash. For pregnant women, as for anyone, the key to making safety belts effective is wearing them properly.

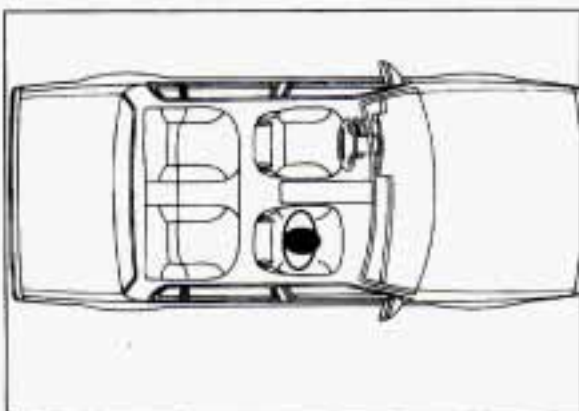

### ■ *Right Front Passenger Position*

The right front passenger's safety belt works the same way as the driver's safety belt. See *Driver Position*, earlier in this part.



Adjust the seat (to see how, see *Seats* in the *Index*) so you can sit up straight. Move your seat far enough forward that your feet touch the part of the vehicle that is called the "toeboard" (A). That way you'd be less likely to slide under the lap belt in a crash.

### ■ *Rear Seat Passengers*

It's very important for rear seat passengers to buckle up! Accident statistics show that unbelted people in the rear seat are hurt more often in crashes than those who are wearing safety belts.

Rear passengers who aren't safety belted can be thrown out of the vehicle in a crash. And they can strike others in the vehicle who are wearing safety belts.

# Seats & Restraint Systems

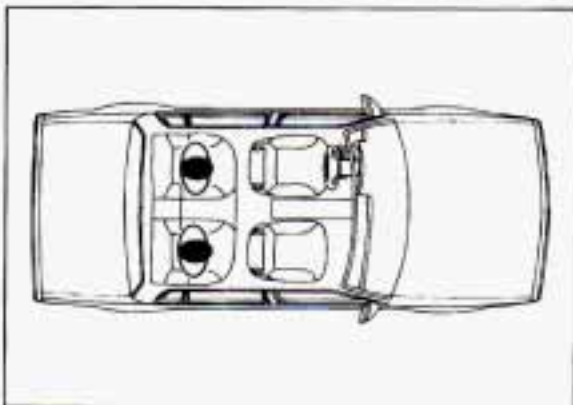

## **Rear Seat Outside Passenger Positions**

### **Lap-Shoulder Belt**

The positions next to the windows have lap-shoulder belts. Here's how to wear one properly.



1. Pick up the latch plate and pull the belt across you. Don't let it get twisted.
2. Push the latch plate into the buckle until it clicks.



If the belt stops before it reaches the buckle, tilt the latch plate and keep pulling until you can buckle it.

Pull up on the latch plate to make sure it is secure.

If the belt is not long enough, see *Safety Belt Extender* at the end of this section. Make sure the release button on the buckle is positioned so you would be able to unbuckle the safety belt quickly if you ever had to.



To make the lap part tight, pull down on the buckle end of the belt as you pull up on the shoulder part.

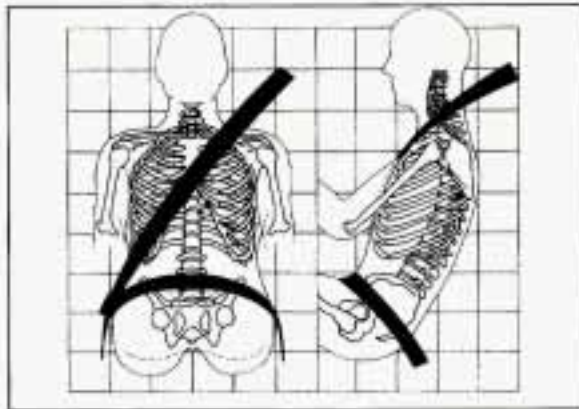

The lap part of the belt should be worn low and snug on the hips, just touching the thighs. In a crash, this applies force to the strong pelvic bones. And you'd be less likely to slide under the lap belt. If you slid under it, the belt would apply force at your abdomen. This could cause serious or even fatal injuries. The shoulder belt should go over the shoulder and across the chest. These parts of the body are best able to take belt restraining forces. The safety belt locks if there's a sudden stop or a crash.



**CAUTION:**

You can be seriously hurt if your shoulder belt is too loose. In a crash you would move forward too much, which could increase injury. The shoulder belt should fit against your body.



To unlatch the belt, just push the button on the buckle.

***Rear Safety Belt Comfort Guides for Children and Small Adults***

Your vehicle may be equipped with rear shoulder belt comfort guides. This feature will provide added comfort for children who have outgrown child restraints and for small adults. The comfort guides pull the shoulder belts away from the neck and head. (This feature is not available on vehicles with a convertible top.)

# Seats & Restraint Systems



There is one guide for each outside passenger position in the rear seat. You will find them tucked in between the seatback and the interior body, about half-way down the edge of the seatback. Here is how you should install the comfort guide on the shoulder belts:

**1.** Pull the elastic cord out from between the edge of the seatback and the interior body to remove the guide from its storage clip.



**2.** Slide the guide under and past the belt. The elastic cord must be under the belt. Then, place the guide over the belt, and insert the two edges of the belt into the slots of the guide.



**3.** Be sure that the belt is not twisted and it lies flat. The elastic cord must be under the belt and the guide on top.



4. Buckle the belt around the child, and make sure that both the lap belt and the shoulder belt are secured properly. Make sure that the shoulder belt crosses the shoulder. See *Safety Belts, Rear Seat Passengers* in the *Index*.

To remove and store the comfort guides, just perform these steps in reverse order. Squeeze the belt edges together so that you can take them out from the guides. Pull the guide upward to expose its storage clip, and then slide the guide onto the clip. Rotate the guide and clip inward and in between the seatback and the interior body, leaving only the loop of elastic cord exposed.

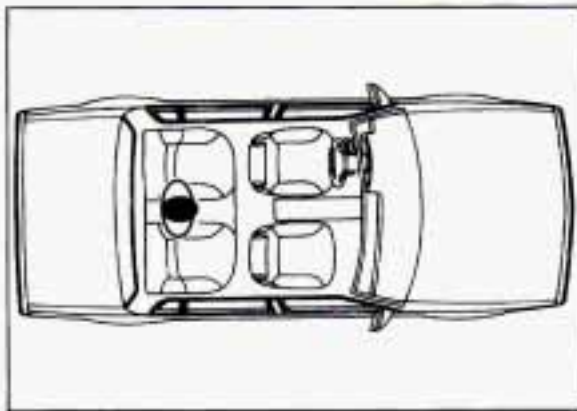

## ■ *Center Passenger Position*

### *Lap Belt*

If your vehicle has a rear bench seat, someone can sit in the center position.

When you sit in a center seating position, you have a lap safety belt, which has no retractor.



To make the belt longer, tilt the latch plate and pull it along the belt.

# Seats & Restraint Systems



To make the belt shorter, pull its free end as shown until the belt is snug.

Buckle, position and release it the same way as the lap part of a lap-shoulder belt. If the belt isn't long enough, see *Safety Belt Extender* at the end of this section.

Make sure the release button on the buckle is positioned so you would be able to unbuckle the safety belt quickly if you ever had to.



## ■ Children

Everyone in a vehicle needs protection! That includes infants and all children smaller than adult size. In fact, the law in every state in the United States and in every Canadian province says children up to some age must be restrained while in a vehicle.

### *Smaller Children and Babies*



#### **CAUTION:**

Smaller children and babies should always be restrained in a child or infant restraint. The instructions for the restraint will say whether it is the right type and size for your child. A very young child's hip bones are so small that a regular belt might not stay low on the hips, as it should. Instead, the belt will likely be over the child's abdomen. In a crash the belt would apply force right on the child's abdomen, which could cause serious or fatal injuries. So, be sure that any child small enough for one is always properly restrained in a child or infant restraint.



**⚠ CAUTION:**

Never hold a baby in your arms while riding in a vehicle. A baby doesn't weigh much — until a crash. During a crash a baby will become so heavy you can't hold it. For example, in a crash at only 25 mph (40 km/h), a 12-pound (5.5 kg) baby will suddenly become a 240-pound (110 kg) force on your arms. The baby would be almost impossible to hold.

**CAUTION (Continued)**

**CAUTION (Continued)**

Secure the baby in an infant restraint.

■ ***Child Restraints***

Be sure to follow the instructions for the restraint. You may find these instructions on the restraint itself or in a booklet, or both. These restraints use the belt system in your vehicle, but the child also has to be secured within the restraint to help reduce the chance of personal injury. The instructions that come with the infant or child restraint will show you how to do that.

***Where to Put the Restraint***

Accident statistics show that children are safer if they are restrained in the rear rather than the front seat. We at General Motors therefore recommend that you put your child restraint in the rear seat unless the child is an infant and you're the only adult in the vehicle. In that case, you might want to secure the restraint in the front seat where you can keep an eye on the baby.

Wherever you install it, be sure to secure the child restraint properly.

Keep in mind that an unsecured child restraint can move around in a collision or sudden stop and injure people in the vehicle. Be sure to properly secure any child restraint in your vehicle — even when no child is in it.



# Seats & Restraint Systems

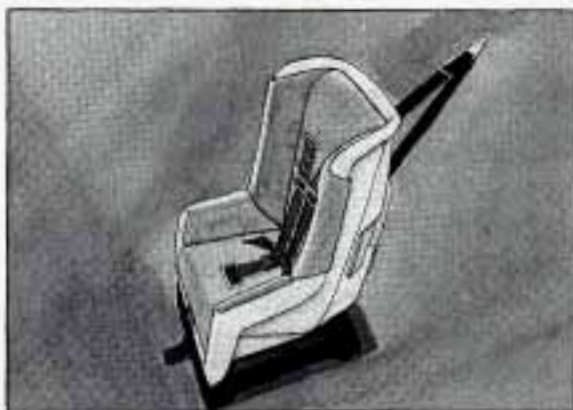

## **Top Strap**

If your child restraint has a top strap, it should be anchored.

If you need to have an anchor installed, you can ask your Chevrolet dealer to put it in for you. If you want to install an anchor yourself, your dealer can tell you how to do it.

For cars first sold in Canada, child restraints with a top strap must be anchored according to Canadian Law.

Your dealer can obtain the hardware kit and install it for you, or you may install it yourself using the instructions provided in the kit.

Use the tether hardware kit available from the dealer. The hardware and installation instructions were specifically designed for this vehicle.

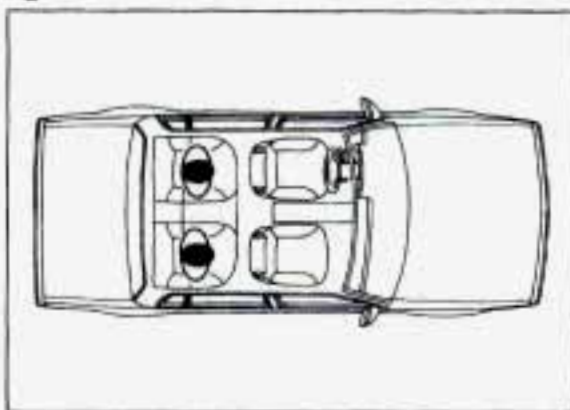

## **Securing a Child Restraint in a Rear Outside Position**

You'll be using the lap-shoulder belt. See the earlier section about the top strap if the child restraint has one.

1. Put the restraint on the seat. Follow the instructions for the child restraint.
2. Secure the child in the child restraint as the instructions say.
3. Pick up the latch plate, and run the lap and shoulder portions of the vehicle's safety belt through or around the restraint. The child restraint instructions will show you how. Tilt the latch plate to adjust the belt if needed. If the shoulder belt goes in front of the child's face or neck, put it behind the child restraint.



4. Buckle the belt. Make sure the release button is positioned so you would be able to unbuckle the safety belt quickly if you ever had to.



5. To tighten the belt, pull up on the shoulder belt while you push down on the child restraint.



6. Push and pull the child restraint in different directions to be sure it is secure.

To remove the child restraint, just unbuckle the vehicle's safety belt and let it go back all the way. The safety belt will move freely again and be ready to work for an adult or larger child passenger.

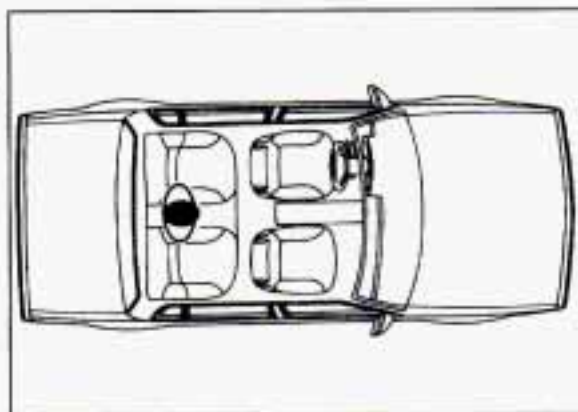

### ***Securing a Child Restraint in the Center Rear Seat Position***

When you secure a child restraint in a center seating position, you'll be using the lap belt.

See the earlier section about the top strap if the child restraint has one.

# Seats & Restraint Systems



1. Make the belt as long as possible by tilting the latch plate and pulling it along the belt.
2. Put the restraint on the seat. Follow the instructions for the child restraint.
3. Secure the child in the child restraint as the instructions say.



4. Run the vehicle's safety belt through or around the restraint. The child restraint instructions will show you how.
5. Buckle the belt. Make sure the release button is positioned so you would be able to unbuckle the safety belt quickly if you ever had to.
6. To tighten the belt, pull its free end while you push down on the child restraint.

7. Push and pull the child restraint in different directions to be sure it is secure. If the child restraint isn't secure, turn the latch plate over and buckle it again. Then see if it is secure. If it isn't, secure the restraint in a different place in the vehicle and contact the child restraint maker for their advice about how to attach the child restraint properly.

To remove the child restraint, just unbuckle the vehicle's safety belt. It will be ready to work for an adult or larger child passenger.

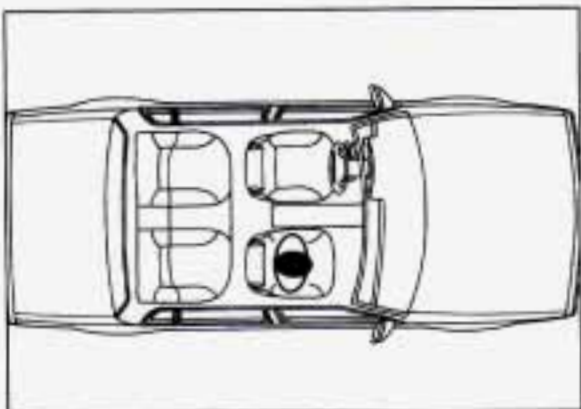

### **Securing a Child Restraint in the Right Front Seat**

To use a child restraint here, you will need a special infant/child seat attaching belt and the hardware that goes with it. See the earlier section about the top strap if the child restraint has one.

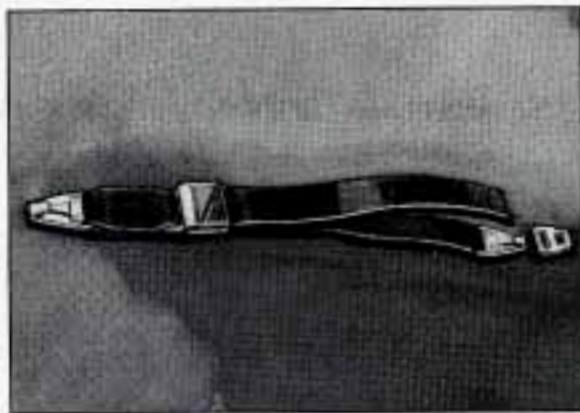

Your dealer can get this and install the hardware for you. It's free. The special belt is GM Part Number 12340286. Your dealer can find the correct hardware in the accessory section of the GM Parts Catalog.



### **CAUTION:**

Don't use the special infant/child seat attaching hardware in another vehicle. If you do, it may not work well and the child may not be protected properly in a crash. The special hardware is for your vehicle only. Also, don't use the special belt for anything but securing a child restraint in the right front seat. If an adult or older child uses it, the belt won't provide protection and may even increase injury in a crash.

# Seats & Restraint Systems



Once the special hardware is installed, please follow the instructions with it and these steps:

1. Unbuckle the automatic lap-shoulder belt by pushing the button on the buckle. It will stay on the door, ready to be rebuckled for use by adults or older children.



2. Snap one hook of the infant/child seat attaching belt near the floor at the door side of the seat.



3. Put the belt's special latch plate into the vehicle's safety belt buckle.



4. You can make the belt longer by tilting the buckle and pulling it along the belt.
5. Put the restraint on the seat. Follow the instructions for the child restraint.
6. Secure the child in the child restraint as the instructions say.
7. Run the belt through or around the child restraint. The child restraint instructions will show you how.



8. Put the hook on the free end through the slot in the latch plate.



9. To make it tight, pull the belt while you push down on the child restraint. If the belt won't stay tight, switch it end for end.
10. Push and pull the child restraint in different directions to be sure it is secure.

**To remove the infant/child seat restraint:**

1. Push the button on the safety belt buckle and remove the special latch plate. Leave the latch plate on the special belt.

# Seats & Restraint Systems



2. Push the spring on the hook near the door and remove the special belt.

Put the belt away in a safe place in your vehicle, so it won't fly around in a crash and injure someone.

Remember to reattach the automatic belt again, once the child restraint is removed. Be sure it isn't twisted.



## **Larger Children**

Children who have outgrown child restraints should wear the vehicle's safety belts.

If you have the choice, a child should sit next to a window so the child can wear a lap-shoulder belt and get the additional restraint a shoulder belt can provide.

Accident statistics show that children are safer if they are restrained in the rear seat. But they need to use the safety belts properly.

- Children who aren't buckled up can be thrown out in a crash.



- Children who aren't buckled up can strike other people who are.



**Q:** What if a child is wearing a lap-shoulder belt, but the child is so small that the shoulder belt is very close to the child's face or neck?

**A:** Move the child toward the center of the vehicle, but be sure that the shoulder belt still is on the child's shoulder, so that in a crash the child's upper body would have the restraint that belts provide. If the child is so small that the shoulder belt is still very close to the child's face or neck, you might want to place the child in the center seat position, the one that has only a lap belt. See *Rear Safety Belt Comfort Guides* in the *Index*.

 **CAUTION:**

Never do this. Here two children are wearing the same belt. The belt can't properly spread the impact forces. In a crash, the two children can be crushed together and seriously injured. A belt must be used by only one person at a time.



 **CAUTION:**

Never do this. Here a child is sitting in a seat that has a lap-shoulder belt, but the shoulder part is behind the child. If the child wears the belt in this way, in a crash the child might slide under the belt. The belt's force would then be applied right on the child's abdomen. That could cause serious or fatal injuries.

Wherever the child sits, the lap portion of the belt should be worn low and snug on the hips, just touching the child's thighs. This applies belt force to the child's pelvic bones in a crash.



# Seats & Restraint Systems

## ■ *Safety Belt Extender*

If the vehicle's safety belt will fasten around you, you should use it. The automatic lap-shoulder belt has plenty of extra length built in, so it will fasten around almost all people.

But if a safety belt isn't long enough to fasten, your dealer will order you an extender. It's free. When you go in to order it, take the heaviest coat you will wear, so the extender will be long enough for you. The extender will be just for you, and just for the seat in your vehicle that you choose. Don't let someone else use it, and use it only for the seat it is made to fit. To wear it, just attach it to the regular safety belt.

## ■ *Checking Your Restraint Systems*

Now and then, make sure all your belts, buckles, latch plates, retractors, anchorages and reminder systems are working properly. Look for any loose parts or damage. If you see anything that might keep a restraint system from doing its job, have it repaired.

## ■ *Replacing Safety Belts After a Crash*

If you've had a crash, do you need new belts?

After a very minor collision, nothing may be necessary. But if the belts were stretched, as they would be if worn during a more severe crash, then you need new belts.

If belts are cut or damaged, replace them. Collision damage also may mean you will need to have safety belt or seat parts repaired or replaced. New parts and repairs may be necessary even if the belt wasn't being used at the time of the collision.



**Q: What's wrong with this?**

**A: The belt is torn.**

Torn or frayed belts may not protect you in a crash. They can rip apart under impact forces. If a belt is torn or frayed, get a new one right away.



**H**ere you can learn about the many standard and optional features on your Chevrolet, and information on starting, shifting and braking. Also explained are the instrument panel and the warning systems that tell you if everything is working properly—and what to do if you have a problem.

## Part 2 Features & Controls

Keys.....	42
Locks.....	43
Glove Box.....	47
Ignition.....	50
Starting Your Engine.....	51
Engine Coolant Heater.....	52
Automatic Transaxle.....	53
Manual Transaxle.....	56
Parking Brake.....	58
Shifting into Park.....	58
Windows.....	62
Turn Signal/Multifunction Lever.....	63
Headlights.....	65
Interior Lights.....	67
Windshield Wipers.....	68
Windshield Washer.....	69
Cruise Control.....	70
Mirrors.....	72
Ashtrays and Lighter.....	75
Sunroof.....	75
Instrument Panel.....	80
Warning Lights, Gages and Indicators.....	84

# Features & Controls



## ■ Keys



### CAUTION:

Leaving young children in a vehicle with the ignition key is dangerous for many reasons. A child or others could be badly injured or even killed. They could operate power windows or other controls or even make the vehicle move. Don't leave the keys in a vehicle with young children.

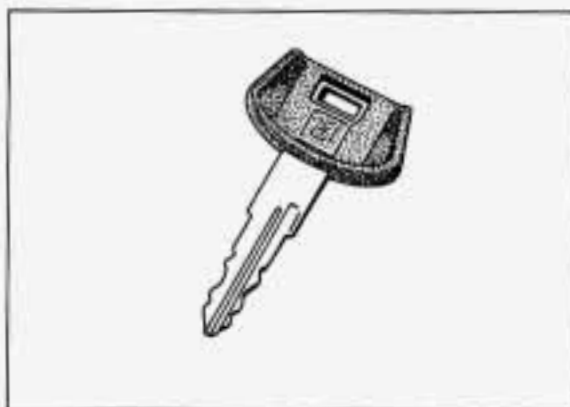

The ignition keys are for the ignition only.



The door keys are for the doors and all other locks.

When a new Chevrolet is delivered, the dealer removes the plugs from the keys, and gives them to the first owner.

Each plug has a code on it that tells your dealer or a qualified locksmith how to make extra keys. Keep the plugs in a safe place. If you lose your keys, you'll be able to have new ones made easily using these plugs.

## **NOTICE:**

Your Chevrolet has a number of new features that can help prevent theft. But you can have a lot of trouble getting into your vehicle if you ever lock your keys inside. You may even have to damage your vehicle to get in. So be sure you have extra keys.

## ■ *Door Locks*



## **CAUTION:**

Unlocked doors can be dangerous. Passengers — especially children — can easily open the doors and fall out. When a door is locked, the inside handle won't open it. Outsiders can easily enter through an unlocked door when you slow down or stop your vehicle. This may not be so obvious: You increase the chance of being thrown out of the vehicle in a crash if the doors aren't locked. Wear safety belts properly, lock your doors, and you will be far better off whenever you drive your vehicle.

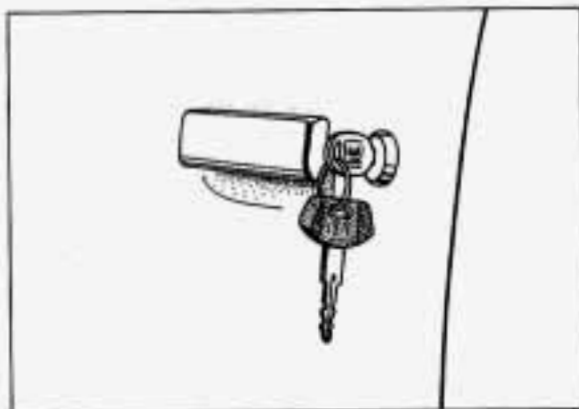

There are several ways to lock and unlock your vehicle.

### **From the Outside:**

Use your door key.

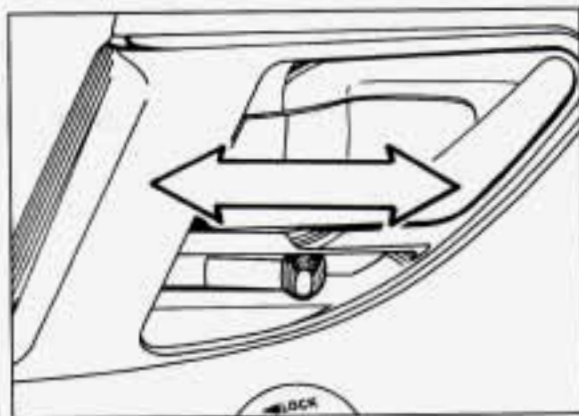

### **From the Inside:**

To lock the door, pull the sliding locking lever back.

To unlock the door, push the sliding locking lever forward.

# Features & Controls

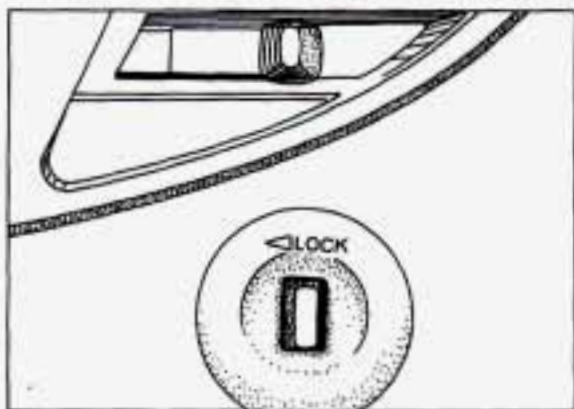

## Power Door Locks

You can lock or unlock all doors of your vehicle from the driver or passenger door lock switch.

On 4-door models, the switch on each rear door works only that door's lock. It won't lock (or unlock) all of the doors—that's a safety feature.

## Automatic Door Locks

Just close your doors and turn on the ignition. If you have an automatic transaxle, all of the doors will lock when you move your shift lever out of **P** (Park) or **N** (Neutral). If you have a manual transaxle, all of the doors will lock when the vehicle goes about 8 mph (13 km/h). If someone needs to get out while the vehicle is running, have that person use the manual or power lock. When the door is closed again, it will lock automatically when you move your shift lever out of **P** (Park) or **N** (Neutral). If you have a manual transaxle, the doors will lock when the vehicle reaches about 8 mph (13 km/h). All doors will automatically unlock when the key is turned to the **OFF** position.

If you don't want the doors to automatically unlock when the key is turned to the **OFF** position, you can remove the Automatic Door Unlock fuse. For fuse location, see the *Index* under *Fuse Usage*.

## Leaving Your Vehicle

If you are leaving the vehicle, open your door and set the locks from inside. Then get out and close the door.

# Features & Controls

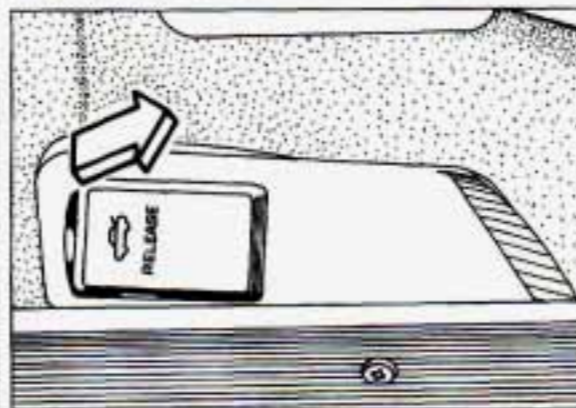

## **Remote Trunk Release (OPTION)**

Pull upward on the remote release handle, located on the floor near the left side of the driver's seat, to release the trunk lid.

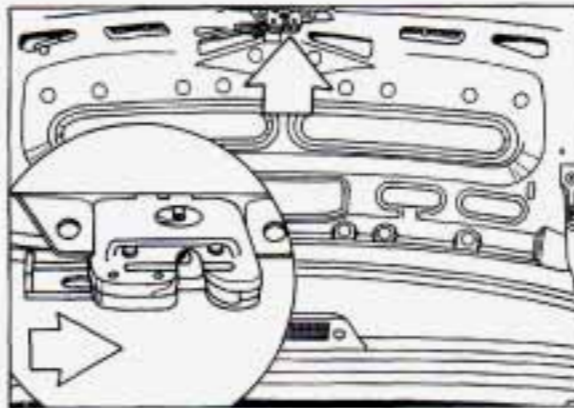

## **Lockout Feature:**

The remote trunk release is equipped with a lockout feature to help prevent unauthorized entry into the trunk when the vehicle is unattended. The switch is located on the inside of the trunk lid, mounted to the trunk lid latch.

To turn the lockout on, slide the switch all the way to the right until it clicks. When the lockout is on, the mechanical remote trunk release will not release the trunk lid. However, the trunk lid can still be opened with the key.

To turn the lockout off, slide the switch all the way to the left.

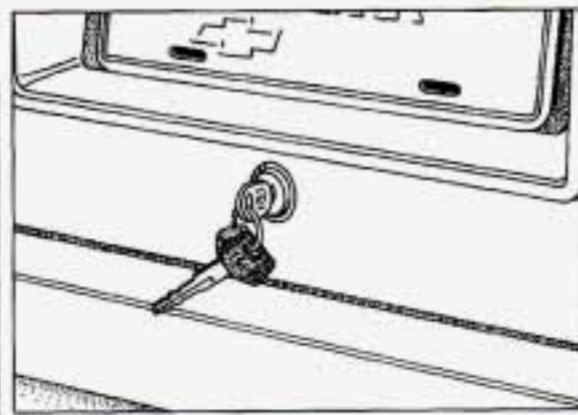

## **Liftgate Lock (WAGON)**

To unlock the liftgate from the outside, insert the door key and turn it clockwise. Then lift up the bottom of the liftgate.

Be sure there are no overhead obstructions before you open the liftgate. You could slam the liftgate into something and break the glass.



## CAUTION:

It can be dangerous to drive with the liftgate open because carbon monoxide (CO) gas can come into your vehicle. You can't see or smell CO. It can cause unconsciousness and even death. If you must drive with the liftgate open or if electrical wiring or other cable connections must pass through the seal between the body and the liftgate:

- Make sure all windows are shut.
- Turn the fan on your heating or cooling system to its highest speed with the setting on **VENT**. That will force outside air into your vehicle. See *Comfort Controls* in the *Index*.
- If you have air vents on or under the instrument panel, open them all the way.

See *Engine Exhaust* in the *Index*.

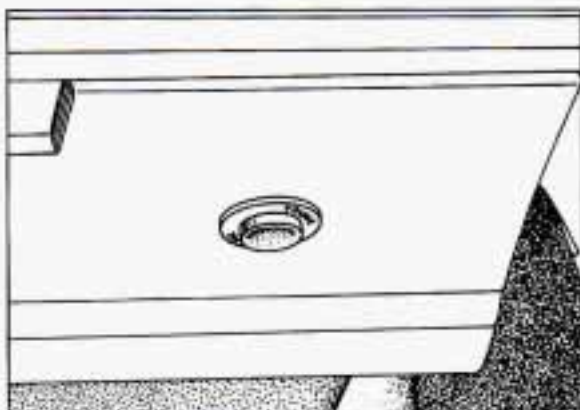

### **Remote Liftgate Release (WAGON)**

Press the yellow liftgate release button located in the glove box to release the liftgate.

The automatic transaxle must be in **P** (Park) or **N** (Neutral) for the liftgate lock release to work. With a manual transaxle, the parking brake must be set.

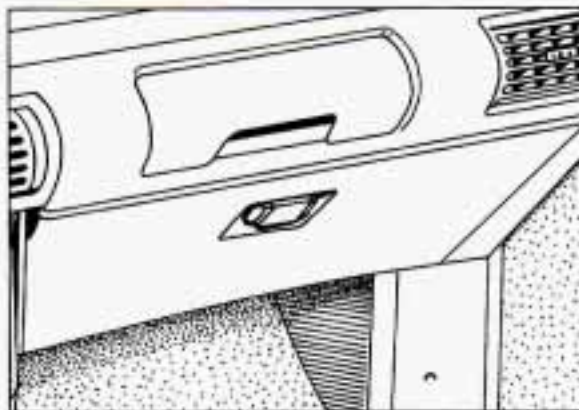

### **Glove Box**

To open, pinch the handle.

### ■ **Theft**

Vehicle theft is big business, especially in some cities. Although your Chevrolet has a number of theft deterrent features, we know that nothing we put on it can make it impossible to steal. However, there are ways you can help.

## **Illuminated Entry/Exit System**

When you lift the handle of either front door, the lights inside your vehicle will go on. (On the wagon, the rear compartment light will not go on when the doors are opened.) These lights will go off after about 40 seconds, or when the ignition is turned on.

For two minutes after you remove the key from the ignition, the lights inside your vehicle will stay on for about 15 seconds to provide an illuminated exit.

The illuminated entry/exit system is deactivated when the dome light lever is moved to the **OFF** position.

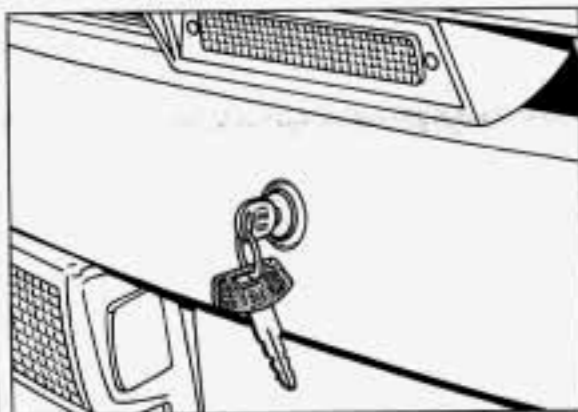

## **Trunk Lock**

To unlock the trunk from the outside, insert the door key and turn it.



## **CAUTION:**

It can be dangerous to drive with the trunk lid open because carbon monoxide (CO) gas can come into your vehicle. You can't see or smell CO. It can cause unconsciousness and even death. If you must drive with the trunk lid open or if electrical wiring or other cable connections must pass through the seal between the body and the trunk lid:

- Make sure all windows are shut.
- Turn the fan on your heating or cooling system to its highest speed with the setting on **VENT**. That will force outside air into your vehicle. See *Comfort Controls* in the *Index*.
- If you have air vents on or under the instrument panel, open them all the way.

See *Engine Exhaust* in the *Index*.



# Features & Controls

## ***Key in the Ignition***

If you walk away from your vehicle with the keys inside, it's an easy target for joy riders or professional thieves — so don't do it.

When you park your Chevrolet and open the driver's door, you'll hear a chime reminding you to remove your key from the ignition and take it with you. Always do this. Your steering wheel will be locked, and so will your ignition. If you have an automatic transaxle, taking your key out also locks your transaxle. And remember to lock the doors.

## ***Parking at Night***

Park in a lighted spot, close all windows and lock your vehicle. Remember to keep your valuables out of sight. Put them in a storage area, or take them with you.

## ***Parking Lots***

If you park in a lot where someone will be watching your vehicle, it's best to lock it up and take your keys. But what if you have to leave your ignition key? What if you have to leave something valuable in your vehicle?

- Put your valuables in a storage area, like your trunk or glove box.
- Lock all the doors except the driver's.
- Then take the door key with you.

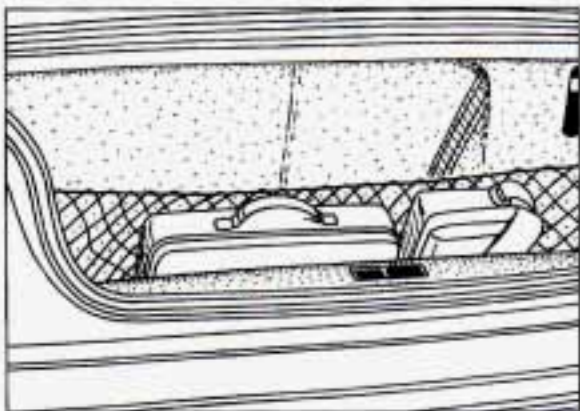

### **Convenience Net (OPTION)**

Your vehicle may have a convenience net. You'll see it just inside the back wall of the trunk. Put small loads, like grocery bags, behind the net. It can help keep them from falling over during sharp turns or quick starts and stops. Unclip a corner of the convenience net to fit larger objects behind the net, then reclip it to secure them in place.

The net isn't for larger, heavier loads. Store them in the trunk as far forward as you can.

You can unhook the net so that it will lie flat when you're not using it.

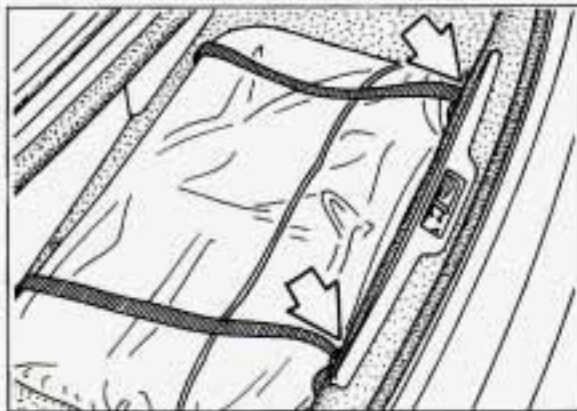

### **Trunk Cargo Anchors (OPTION)**

If your vehicle has fold-down rear seats, you'll find two or four anchors on the back wall of your trunk. You can use these anchors to tie down lighter loads. They prevent things from shifting during sudden stops, turns and maneuvers.

These anchors are not for heavier loads. Store those items as far forward in the trunk as possible.

## ■ **New Vehicle "Break-In"**

### **NOTICE:**

Your modern Chevrolet doesn't need an elaborate "break-in." But it will perform better in the long run if you follow these guidelines:

- Don't drive at any one speed — fast or slow — for the first 500 miles (804 km). Don't make full-throttle starts.
- Avoid making hard stops for the first 200 miles (322 km) or so. During this time your new brake linings aren't yet broken in. Hard stops with new linings can mean premature wear and earlier replacement. Follow this "breaking-in" guideline every time you get new brake linings.

# Features & Controls

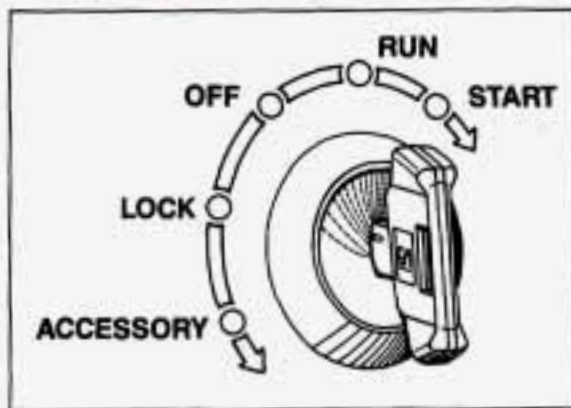

## ■ Ignition Switch

With the ignition key in the ignition switch, you can turn the switch to five positions:

**Accessory:** An "on" position in which you can operate your electrical power accessories. Press in the ignition switch as you turn the top of it toward you.

**Lock:** The only position in which you can remove the key. This locks your steering wheel, ignition and transaxle.

**Off:** Unlocks the steering wheel, ignition and transaxle, but does not send electrical power to any accessories. Use this position if your vehicle must be pushed or towed, but never try to push-start your vehicle.

A warning chime will sound if you open the driver's door when the ignition is off and the key is in the ignition.

**Run:** An "on" position to which the switch returns after you start your engine and release the switch. The switch stays in the **Run** position when the engine is running. But even when the engine is not running, you can use **Run** to operate your electrical power accessories, and to display some instrument panel warning lights.

**Start:** Starts the engine. When the engine starts, release the key. The ignition switch will return to **Run** for normal driving.

Note that even if the engine is not running, the positions **Accessory** and **Run** are "on" positions that allow you to operate your electrical accessories, such as the radio.



## CAUTION:

On manual transaxle vehicles, turning the key to **Lock** will lock the steering column and result in a loss of ability to steer the vehicle. This could cause a collision. If you need to turn the engine off while the vehicle is moving, turn the key only to **Off**. Don't press the key release button while the vehicle is moving.

## NOTICE:

If your key seems stuck in **Lock** and you can't turn it, be sure it is all the way in. If it is, then turn the steering wheel left and right while you turn the key hard. But turn the key only with your hand. Using a tool to force it could break the key or the ignition switch. If none of this works, then your vehicle needs service.

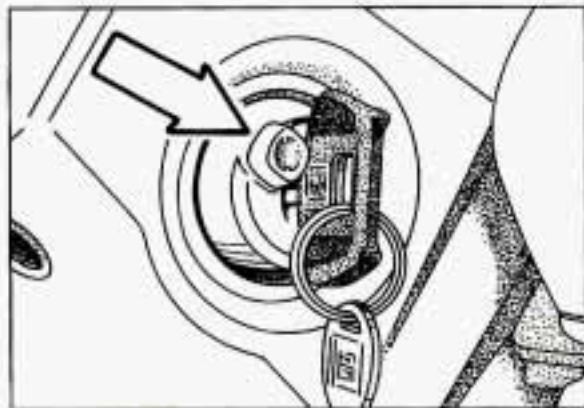

### **Key Release Button** (MANUAL TRANSAXLE)

The ignition key cannot be removed from the ignition unless the key release button is used.

#### **To Remove the Key:**

Turn the key to the **Off** position. Press the key release button while turning the key from **Off** to **Lock**. Keeping your finger on the button, pull the key straight out.

## ■ *Starting Your Engine*

Follow the proper steps to start the engine.

#### **Automatic Transaxle:**

Move your shift lever to **P** (Park) or **N** (Neutral). Your engine won't start in any other position — that's a safety feature. To restart when you're already moving, use **N** (Neutral) only.

#### **NOTICE:**

Don't try to shift to **P** (Park) if your Chevrolet is moving. If you do, you could damage the transaxle. Shift to **P** (Park) only when your vehicle is stopped.

#### **Manual Transaxle:**

Hold the clutch pedal to the floor, then shift your gear selector to **N** (Neutral) while starting the engine. Your vehicle won't start if the clutch pedal is not all the way down — that's a safety feature.

#### **To start your engine:**

1. Without pushing the accelerator pedal, turn your ignition key to **Start**. When the engine starts, let go of the key. The idle speed will go down as your engine gets warm.

#### **NOTICE:**

Holding your key in **Start** for longer than 15 seconds at a time will cause your battery to be drained much sooner. And the excessive heat can damage your starter motor.

2. If your engine still won't start (or starts but then stops), it could be flooded with too much gasoline. Try pushing your accelerator pedal all the way to the floor and holding it there as you hold the key in **Start** for about three seconds. If the vehicle starts briefly but then stops again, do the same thing, but this time keep the pedal down for five or six seconds. This clears the extra gasoline from the engine.

# Features & Controls

## NOTICE:

Your engine is designed to work with the electronics in your vehicle. If you add electrical parts or accessories, you could change the way the fuel injection system operates. Before adding electrical equipment, check with your dealer. If you don't, your engine might not perform properly. If you ever have to have your vehicle towed, see the part of this manual that tells how to do it without damaging your vehicle. See *Towing Your Vehicle* in the *Index*.

## ■ *Driving Through Deep Standing Water*

## NOTICE:

If you drive too quickly through deep puddles or standing water, water can come in through your engine's air intake and badly damage your engine. If you can't avoid deep puddles or standing water, drive through them very slowly.

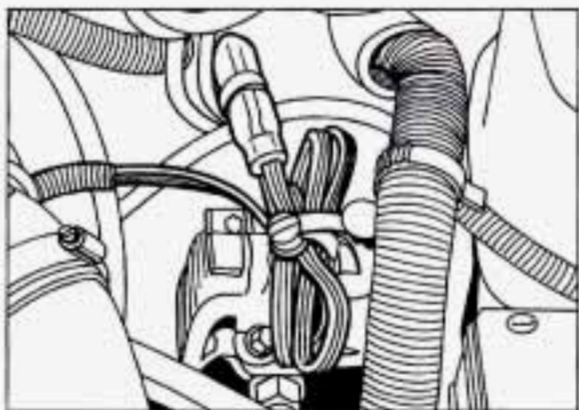

## ■ *Engine Coolant Heater (Engine Block Heater) (OPTION)*

In very cold weather, 0°F (-18°C) or colder, the engine coolant heater can help. You'll get easier starting and better fuel economy during engine warm-up. Usually, the coolant heater should be plugged in a minimum of four hours prior to starting your vehicle.

### To use the coolant heater:

1. Turn off the engine.
2. Open the hood and unwrap the electrical cord.
3. Plug it into a normal, grounded 110-volt outlet.



## CAUTION:

Plugging the cord into an ungrounded outlet could cause an electrical shock. Also, the wrong kind of extension cord could overheat and cause a fire. You could be seriously injured. Plug the cord into a properly grounded three-prong 110-volt outlet. If the cord won't reach, use a heavy-duty three-prong extension cord rated for at least 15 amps.

## NOTICE:

After you've used the coolant heater, be sure to store the cord as it was before to keep it away from moving engine parts. If you don't, it could be damaged.

How long should you keep the coolant heater plugged in? The answer depends on the weather, the kind of oil you have, and some other things. Instead of trying to list everything here, we ask that you contact a Chevrolet dealer in the area where you'll be parking your vehicle. The dealer can give you the best advice for that particular area.

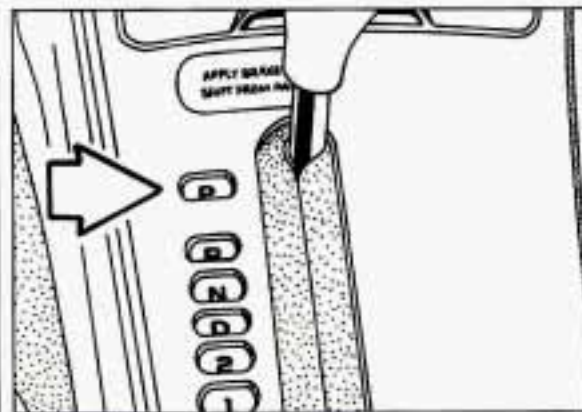
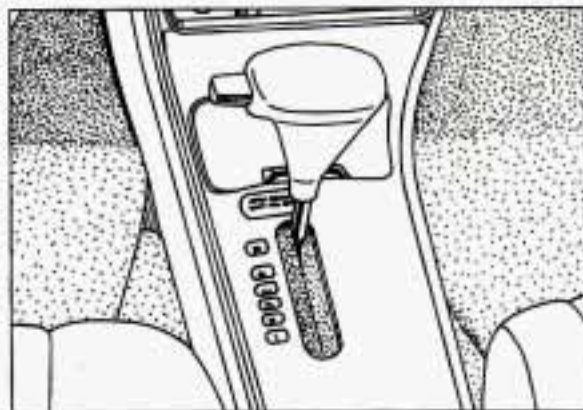

### ■ *Automatic Transaxle*

Your automatic transaxle has a shift lever located on the console between the seats.

There are several different positions for your shift lever. In this manual, these are referred to by the commonly used symbols in the right column below:

<b>Park</b>	<b>P</b>
<b>Reverse</b>	<b>R</b>
<b>Neutral</b>	<b>N</b>
<b>Drive</b>	<b>D</b>
<b>Second</b>	<b>2</b>
<b>First</b>	<b>1</b>

### *Park*

**P (Park):** This locks your front wheels. It's the best position to use when you start your engine because your vehicle can't move easily.

# Features & Controls



## CAUTION:

It is dangerous to get out of your vehicle if the shift lever is not fully in **P** (Park) with the parking brake firmly set. Your vehicle can roll. Don't leave your vehicle when the engine is running unless you have to. If you have left the engine running, the vehicle can move suddenly. You or others could be injured. To be sure your vehicle won't move, even when you're on fairly level ground, always set your parking brake and move the shift lever to **P** (Park).

See *Shifting Into P (Park)* in the *Index*.

Ensure the shift lever is fully in **P** (Park) range before starting the engine. Your Chevrolet has a brake-transaxle shift interlock. You have to fully **apply** your regular brakes **before** you can shift from **P** (Park) when the ignition key is in the **Run** position. If you cannot shift out of **P** (Park), ease pressure on the shift lever—push the shift lever all the way into **P** (Park) and also release the shift lever button as you maintain brake application. Then move the shift lever into the gear you wish. See the *Index* under *Shifting Out of P (Park)*.

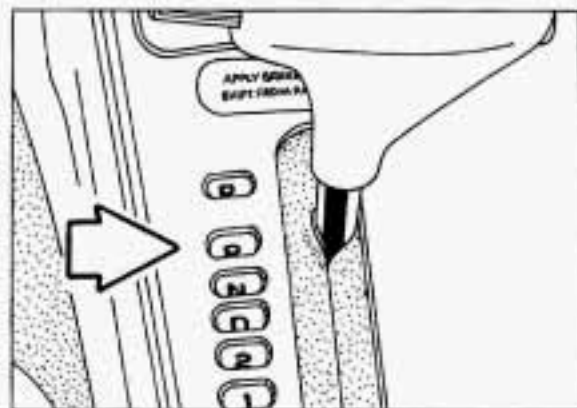

## Reverse

**R (Reverse):** Use this gear to back up.

## NOTICE:

Shifting to **R** (Reverse) while your vehicle is moving forward could damage your transaxle. Shift to **R** only after your vehicle has stopped.

To rock your vehicle back and forth to get out of snow, ice or sand without damaging your transaxle, see the *Index* under *If You're Stuck: In Sand, Mud, Ice or Snow*.



### Neutral

**N (Neutral):** In this position, your engine doesn't connect with the wheels. To restart when you're already moving, use **N (Neutral)** only. Also, use **N** when your vehicle is being towed.



### CAUTION:

Shifting out of **P (Park)** or **N (Neutral)** while your engine is "racing" (running at high speed) is dangerous. Unless your foot is firmly on the brake pedal, your vehicle could move very rapidly. You could lose control and hit people or objects. Don't shift out of **P (Park)** or **N (Neutral)** while your engine is racing.

### NOTICE:

Damage to your transaxle caused by shifting out of **P (Park)** or **N (Neutral)** with the engine racing isn't covered by your warranty.

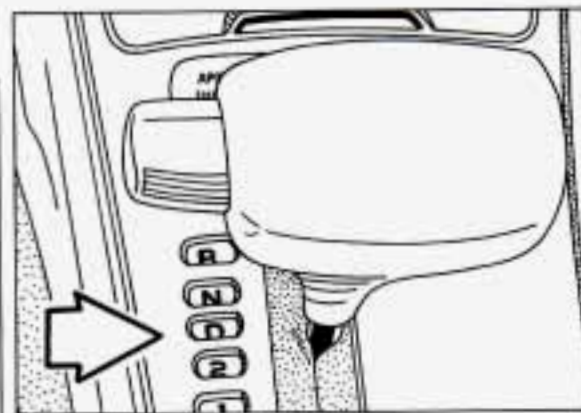

### Forward Gears

**D (Drive):** This position is for normal driving.

**2 (Second Gear):** This position gives you more power but lower fuel economy. You can use **2** on hills. It can help control your speed as you go down steep mountain roads, but then you would also want to use your brakes off and on.

### NOTICE:

Don't drive in **2 (Second Gear)** for more than 5 miles (8 km), or at speeds over 55 mph (88 km/h), or you can damage your transaxle. Use **D** as much as possible.

Don't shift into **2** unless you are going slower than 65 mph (105 km/h), or you can damage your engine.



# Features & Controls

**1 (First Gear):** This position gives you even more power (but lower fuel economy) than 2. You can use it on very steep hills, or in deep snow or mud. If the selector lever is put in 1, the transaxle won't shift into first gear until the vehicle is going slowly enough.

## NOTICE:

If your front wheels can't rotate, don't try to drive. This might happen if you were stuck in very deep sand or mud or were up against a solid object. You could damage your transaxle.

Also, if you stop when going uphill, don't hold your vehicle there with only the accelerator pedal. This could overheat and damage the transaxle. Use your brakes or shift into **P** (Park) to hold your vehicle in position on a hill.

## 3.1L V6 Engine:

Maximum engine speed is limited to protect driveline components from improper operation.



## ■ Manual Transaxle

There are seven different positions:

<b>N</b>	<b>Neutral</b>
<b>1</b>	<b>First Gear</b>
<b>2</b>	<b>Second Gear</b>
<b>3</b>	<b>Third Gear</b>
<b>4</b>	<b>Fourth Gear</b>
<b>5</b>	<b>Fifth Gear</b>
<b>R</b>	<b>Reverse</b>

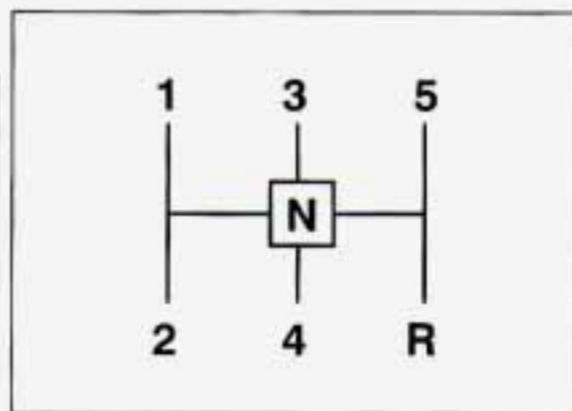

This is your shift pattern. Here's how to operate your transaxle:

**1 (First Gear):** Press the clutch pedal and shift into 1. Then, slowly let up on the clutch pedal as you press the accelerator pedal.

You can shift into 1 when you're going less than 20 mph (32 km/h). If you've come to a complete stop and it's hard to shift into 1, put the shift lever in **N** (Neutral) and let up on the clutch. Press the clutch pedal back down. Then shift into 1.

**2 (Second Gear):** Press the clutch pedal as you let up on the accelerator pedal and shift into 2. Then, slowly let up on the clutch pedal as you press the accelerator pedal.

**3, 4 and 5 (Third, Fourth and Fifth Gears):** Shift into 3, 4 and 5 the same way you do for 2. Slowly let up on the clutch pedal as you press the accelerator pedal.

**To Stop:** Let up on the accelerator pedal and press the brake pedal. Just before the vehicle stops, press the clutch pedal and the brake pedal, and shift to N (Neutral).

**N (Neutral):** Use this position when you start or idle your engine.

**R (Reverse):** To back up, press down the clutch pedal and shift into R (Reverse). Let up on the clutch pedal slowly while pressing the accelerator pedal.

#### **NOTICE:**

Shift to R (Reverse) only after your vehicle is stopped. Shifting to R (Reverse) while your vehicle is moving could damage your transaxle.

Also, use R (Reverse), along with the parking brake, for parking your vehicle.

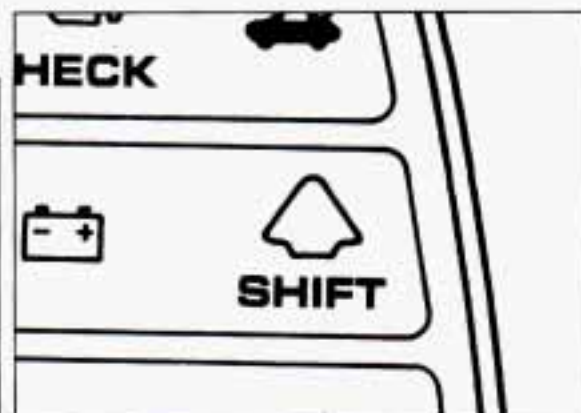

#### **Shift Light (MANUAL TRANSAXLE)**

If you have a manual transaxle, you have a **SHIFT** light. This light will show you when to shift to the next higher gear for best fuel economy.

When this light comes on, you can shift to the next higher gear if weather, road and traffic conditions let you.

For the best fuel economy, accelerate slowly and shift when the light comes on.

While you accelerate, it is normal for the light to go on and off if you quickly change the position of the accelerator. Ignore the **SHIFT** light when you downshift.

#### **Shift Speeds (MANUAL TRANSAXLE)**

This chart shows when to shift to the next higher gear for best fuel economy.

#### **Acceleration Shift Speeds:**

1st to 2nd	17 mph (27 km/h)
2nd to 3rd	30 mph (48 km/h)
3rd to 4th	39 mph (63 km/h)
4th to 5th	45 mph (72 km/h)

If your speed drops below 20 mph (32 km/h), or if the engine is not running smoothly, you should downshift to the next lower gear. You may have to downshift two or more gears to keep the engine running smoothly or for good performance.



#### **CAUTION:**

If you skip more than one gear when you downshift, you could lose control of your vehicle. And you could injure yourself or others. Don't shift from 5 to 2, or 4 to 1.

#### **NOTICE:**

If you skip more than one gear when you downshift, or if you race the engine when you downshift, you can damage the clutch or transaxle.

# Features & Controls

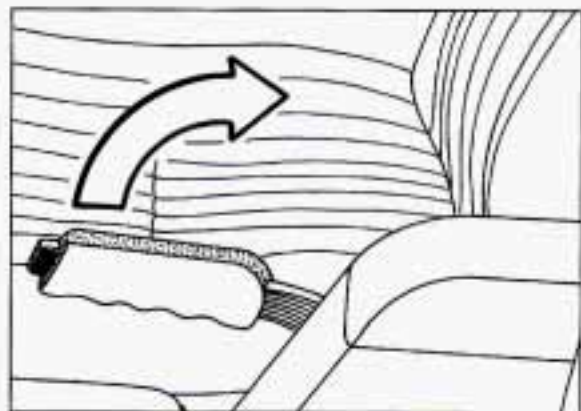

## **Parking Brake**

The parking brake lever is located between the bucket seats.

### **To Set the Parking Brake:**

Hold the brake pedal down and pull up on the parking brake lever.

If the ignition is on, the brake system warning light will come on.

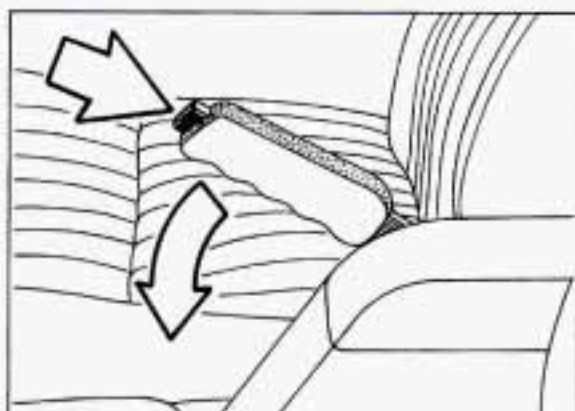

### **To Release the Parking Brake:**

Hold the brake pedal down. Pull the parking brake lever up until you can press the release button. Hold the release button in as you move the brake lever all the way down.

### **NOTICE:**

Driving with the parking brake on can cause your rear brakes to overheat. You may have to replace them, and you could also damage other parts of your vehicle.

## ■ **Shifting Into "P" (Park)**

**(AUTOMATIC TRANSAXLE MODELS ONLY)**



### **CAUTION:**

It can be dangerous to get out of your vehicle if the shift lever is not fully in **P** (Park) with the parking brake firmly set. Your vehicle can roll. If you have left the engine running, the vehicle can move suddenly. You or others could be injured. To be sure your vehicle won't move, even when you're on fairly level ground, use the steps that follow.

1. Hold the brake pedal down with your right foot and set the parking brake.

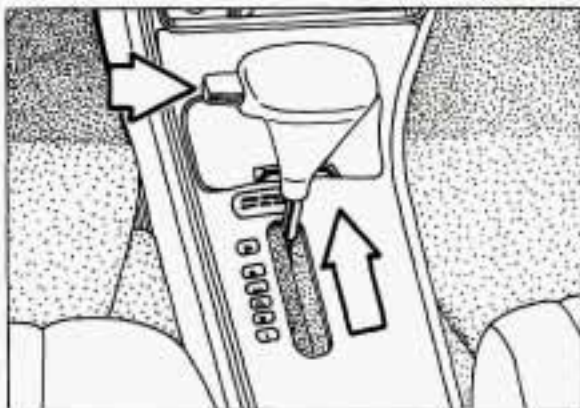

2. Move the shift lever into the **P** (Park) position like this: Hold in the button on the lever, and push the lever all the way toward the front of your vehicle.
3. Move the ignition key to **Lock**.
4. Remove the key and take it with you. If you can walk away from your vehicle with the ignition key in your hand, your vehicle is in **P** (Park).

### Leaving Your Vehicle With the Engine Running (AUTOMATIC TRANSAXLE MODELS ONLY)



#### CAUTION:

It can be dangerous to leave your vehicle with the engine running. Your vehicle could move suddenly if the shift lever is not fully in **P** (Park) with the parking brake firmly set. And, if you leave the vehicle with the engine running, it could overheat and even catch fire. You or others could be injured. Don't leave your vehicle with the engine running unless you have to.

If you have to leave your vehicle with the engine running, be sure your vehicle is in **P** (Park) and your parking brake is firmly set before you leave it. After you've moved the shift lever into the **P** (Park) position, hold the regular brake pedal down. Then, see if you can move the shift lever away from **P** (Park) without first pushing the button.

If you can, it means that the shift lever wasn't fully locked into **P** (Park).

### Torque Lock (AUTOMATIC TRANSAXLE)

If you are parking on a hill and you don't shift your transaxle into **P** (Park) properly, the weight of the vehicle may put too much force on the parking pawl in the transaxle. You may find it difficult to pull the shift lever out of **P** (Park). This is called "torque lock." To prevent torque lock, set the parking brake and then shift into **P** (Park) properly before you leave the driver's seat. To find out how, see *Shifting Into P (Park)* in the *Index*.

When you are ready to drive, move the shift lever out of **P** (Park) **BEFORE** you release the parking brake.

If "torque lock" does occur, you may need to have another vehicle push yours a little uphill to take some of the pressure from the transaxle, so you can pull the shift lever out of **P** (Park).

# Features & Controls

## **Shifting Out of P (Park)** **(AUTOMATIC TRANSAXLE)**

Your Chevrolet has a brake-transaxle shift interlock. You have to fully **apply** your regular brakes **before** you can shift from **P** (Park) when the ignition is in the **Run** position. See the *Index* under *Automatic Transaxle*. If you cannot shift out of **P** (Park), ease pressure on the shift lever—push the shift lever all the way into **P** (Park) and also release the shift lever button on floor shift console models as you maintain brake application. Then move the shift lever into the gear you wish. (Press the shift lever button before moving the shift lever on floor shift console models.)

If you ever hold the brake pedal down but still can't shift out of **P** (Park), try this:

1. Turn the key to **OFF**.
2. Apply and hold the brake until the end of Step 4.
3. Shift to **N** (Neutral).
4. Start the vehicle and then shift to the drive gear you want.
5. Have the vehicle fixed as soon as you can.

## **Parking Your Vehicle** **(MANUAL TRANSAXLE)**

Before you get out of your vehicle, put your manual transaxle in **R** (Reverse) and firmly apply the parking brake.



## ■ ***Parking Over Things That Burn***



### **CAUTION:**

Things that can burn could touch hot exhaust parts under your vehicle and ignite. Don't park over papers, leaves, dry grass or other things that can burn.

## ■ Engine Exhaust

### CAUTION:

Engine exhaust can kill. It contains the gas carbon monoxide (CO), which you can't see or smell. It can cause unconsciousness and death. You might have exhaust coming in if:

- Your exhaust system sounds strange or different.
- Your vehicle gets rusty underneath.
- Your vehicle was damaged in a collision.
- Your vehicle was damaged when driving over high points on the road or over road debris.
- Repairs weren't done correctly.
- Your vehicle or exhaust system had been modified improperly.

If you **ever** suspect exhaust is coming into your vehicle:

- Drive it only with all the windows down to blow out any CO; and
- Have your vehicle fixed **immediately**.

## ■ Running Your Engine While You're Parked

(AUTOMATIC TRANSAXLE)

It's better not to park with the engine running. But if you ever have to, here are some things to know.

### CAUTION:

Idling the engine with the air system control off could allow dangerous exhaust into your vehicle. (See the earlier caution under *Engine Exhaust*.) Also, idling in a closed-in place can let deadly carbon monoxide (CO) into your vehicle even if the fan switch is at the highest setting. One place this can happen is a garage. Exhaust — with CO — can come in easily. NEVER park in a garage with the engine running.

Another closed-in place can be a blizzard. (See *Blizzard* in the *Index*.)

### CAUTION:

It can be dangerous to get out of your vehicle if the shift lever is not fully in **P** (Park) with the parking brake firmly set. Your vehicle can roll. Don't leave your vehicle when the engine is running unless you have to. If you've left the engine running, the vehicle can move suddenly. You or others could be injured. To be sure your vehicle won't move, even when you're on fairly level ground, always set your parking brake and move the shift lever to **P** (Park).

Follow the proper steps to be sure your vehicle won't move. See *Shifting Into P (Park)* in the *Index*.

# Features & Controls

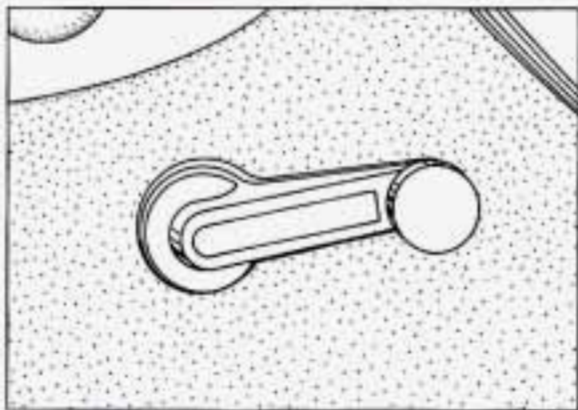

## Windows

On a vehicle with manual windows, use the window crank to open and close each window.

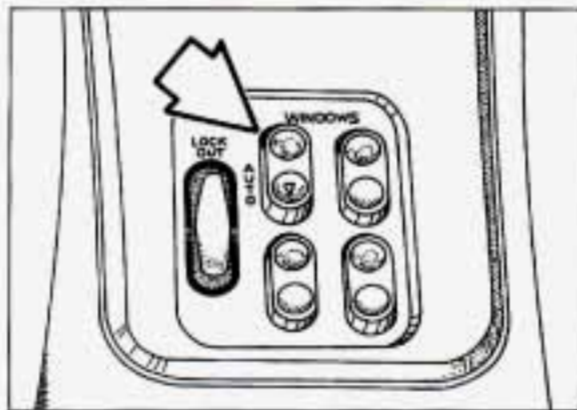

## Power Windows (OPTION)

With power windows, switches on the center console control each of the windows when the ignition is on. In addition, in 4-door models, each rear passenger door has a control switch for its own window.

The driver's window switch has an Auto Down feature. The driver's window can be opened a small amount by pushing the switch marked **AUTO** to the first detent. When the switch is fully pressed, the window will go down all the way.

To stop the window while it is lowering, press the switch forward, then release.

To raise the window, press and hold the switch forward.

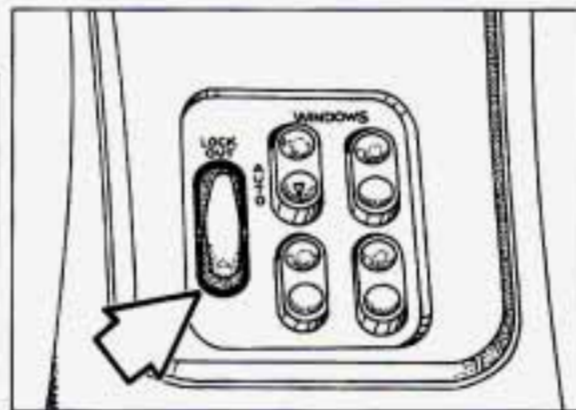

## Power Window Lock-Out Switch (OPTION)

On 4-door models, this switch disables the rear passenger power windows. Push the switch forward to lock the windows. Push the switch back to unlock the windows.

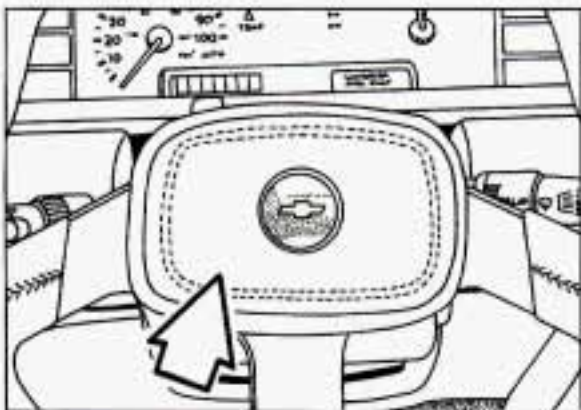

### **Horn**

You can sound the horn by pressing the horn pad on your steering wheel.

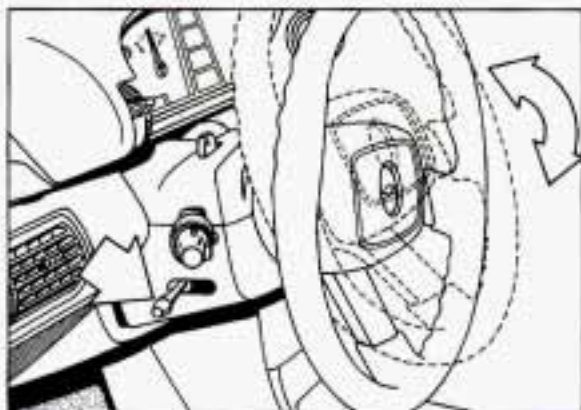

### **Tilt Steering Wheel (OPTION)**

A tilt steering wheel allows you to adjust the steering wheel before you drive. You can also raise it to the highest level to give your legs more room when you exit and enter the vehicle.

To tilt the wheel, hold the steering wheel and pull the lever. Move the steering wheel to a comfortable level, then release the lever to lock the wheel in place.

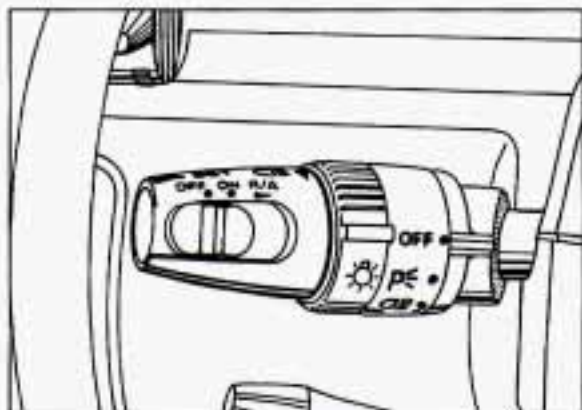

### ■ **Turn Signal/Multifunction Lever**

The lever on the left side of the steering column includes your:

- Turn Signal and Lane Change Indicator
- Headlight High-Low Beam Changer
- Parking Lights
- Cruise Control (Option)
- Flash-to-Pass Feature (except in Canada)



# Features & Controls

## Operation of Lights

Although your vehicle's lighting system (headlights, parking lights, fog lamps, side marker lights and taillights) meets all applicable federal lighting requirements, certain states and provinces may apply their own lighting regulations that may require special attention before you operate these lights.

For example, some jurisdictions may require that you operate your lower beam lights with fog lamps at all times, or that headlights be turned on whenever you must use your windshield wipers. In addition, most jurisdictions prohibit driving solely with parking lights, especially at dawn or dusk. It is recommended that you check with your own state or provincial highway authority for applicable lighting regulations.

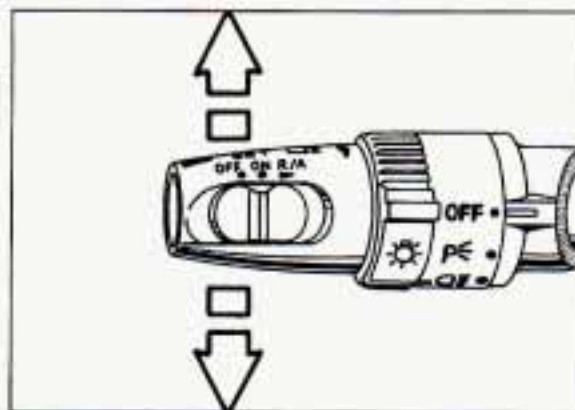

## Turn Signal and Lane Change Indicator

The turn signal has two upward (for Right) and two downward (for Left) positions. These positions allow you to signal a turn or a lane change.

To signal a turn, move the lever all the way up or down. When the turn is finished, the lever will return automatically.

A green arrow on the instrument panel will flash in the direction of the turn or lane change.

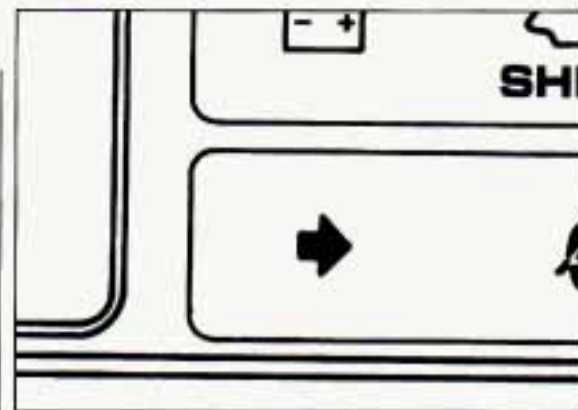

To signal a lane change, just raise or lower the lever until the green arrow starts to flash. Hold it there until you complete your lane change. The lever will return by itself when you release it.

As you signal a turn or a lane change, if the arrows don't flash but just stay on, a signal bulb may be burned out and other drivers won't see your turn signal.

If a bulb is burned out, have your dealer replace it to help avoid an accident. If the green arrows don't go on at all when you signal a turn, check the fuse (see the *Index* under *Fuses & Circuit Breakers*) and for burned-out bulbs.

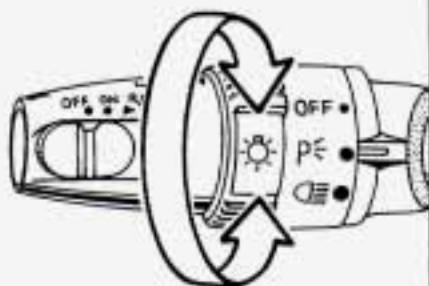



### Headlights

Turn the band marked  to  to turn on:

- Parking Lights
- Side Marker Lights
- Taillights
- License Plate Lights

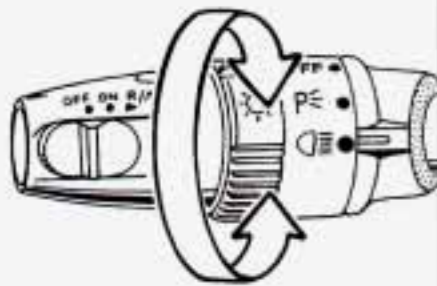
Turn the band marked  to **OFF** to turn off the lights.



Turn the band marked  to  to turn on:

- Headlights
- Parking Lights
- Side Marker Lights
- Taillights
- License Plate Lights

Turn the band marked  to **OFF** to turn off the lights.

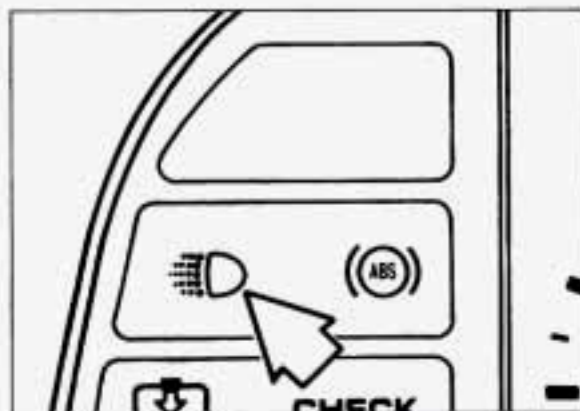

### Daytime Running Lights (DRL) Indicator Light (CANADA ONLY)

If your vehicle was first sold, when new, in Canada, you will have this light on the instrument panel. It goes on whenever the Daytime Running Lights are on.

### Daytime Running Lights (CANADA ONLY)

The Canadian federal government has decided that Daytime Running Lights (DRL) are a useful feature, in that DRL can make your vehicle more visible to pedestrians and other drivers during daylight hours. DRL are required on new vehicles sold in Canada.

# Features & Controls

The high beam headlights will come on at reduced brightness in daylight when:

- The ignition is on
- The headlight switch is off, and
- The parking brake is released.

When you turn on your headlights, the DRL will switch off and the exterior lights will come on. When you turn off the headlights, the exterior lights will go out and the high beams will change to the reduced brightness of DRL again.

The DRL indicator light on the instrument panel will go on whenever the DRL are on. This light means that only the DRL are on. When you turn on your exterior lights, this light will go out. Of course, you may still turn on the headlights any time you need to.

To idle your vehicle with the DRL off, set the parking brake. The DRL will stay off until you release the parking brake.



## Headlight High-Low Beam Changer

To change the headlights from low beam to high or high to low, pull the turn signal lever all the way toward you. Then release it. When the high beams are on, a blue light on the instrument panel also will be on.

## Flash-to-Pass (EXCEPT CANADA)

Flash-to-Pass lets you use your high beam headlights to signal a driver in front of you that you want to pass.

To use it, pull the turn signal lever toward you, then release.

### If Your Headlights Are Off:

Your high beam headlights will turn on. They'll stay on as long as you hold the lever there. Release the lever to turn them off.

### If Your Headlights Are On:

Flash-to-Pass does not operate when your headlights are on. Use the lever to change between high and low beams.

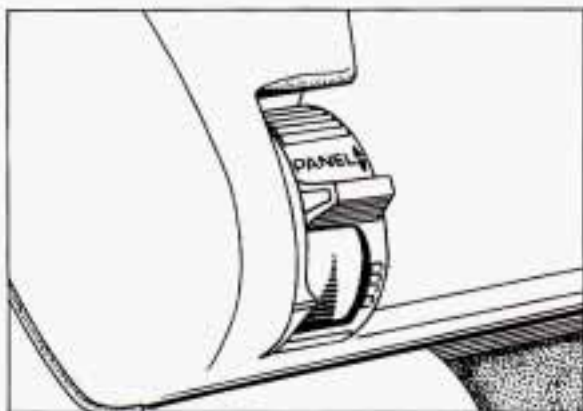

### ***Instrument Panel Intensity Control***

You can brighten or dim the instrument panel lights by moving the control lever up or down.

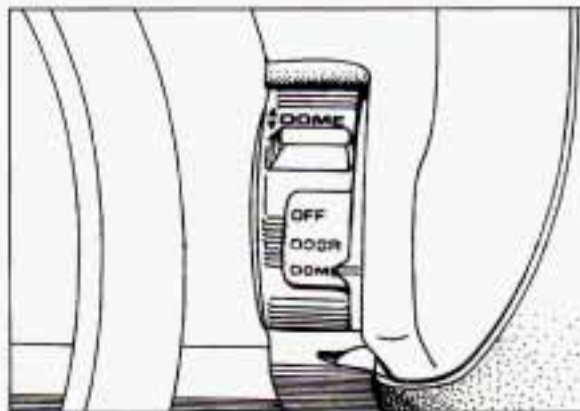

### ***Dome Light***

To turn on the dome light, move the lever all the way up.

In the **DOOR** position the illuminated entry/exit system is activated. To turn off all interior lights, move the lever to **OFF**.

#### **To Replace the Bulb:**

Grasp the center front and center rear portion of the housing and squeeze firmly but gently. The housing should pop off.

If this doesn't work, you may need to use a small, flat-head screwdriver under the side of the housing to help pry it off.

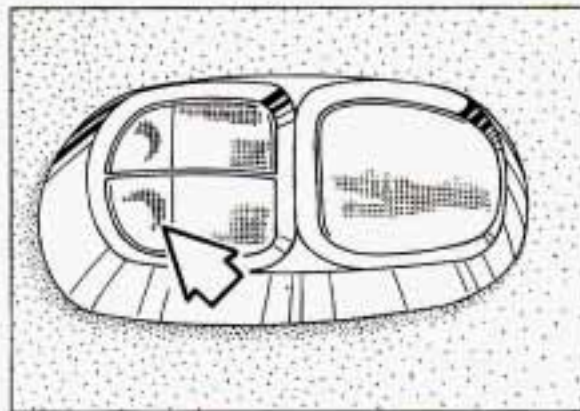

### ***Reading Light (OPTION)***

This light comes on when you open either front door or move the dome light lever to **DOME**. You can turn on either reading light by pressing the depression in either light's lens.

#### **To Replace the Bulb:**

Use a small, flat-head screwdriver under the side of the housing to help pry it off.

# Features & Controls

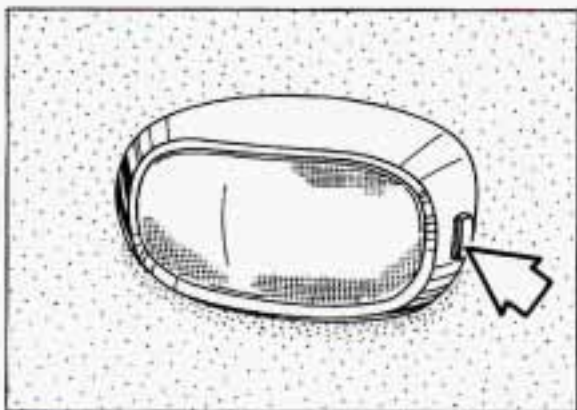

## **Rear Compartment Light (WAGON)**

To turn on the rear compartment light, press the button located on the light.

### **To Replace the Bulb:**

Grasp the center front and center rear portion of the housing and squeeze firmly but gently. The housing should pop off.

If this doesn't work, you may need to use a small, flat-head screwdriver under the side of the housing to help pry it off.

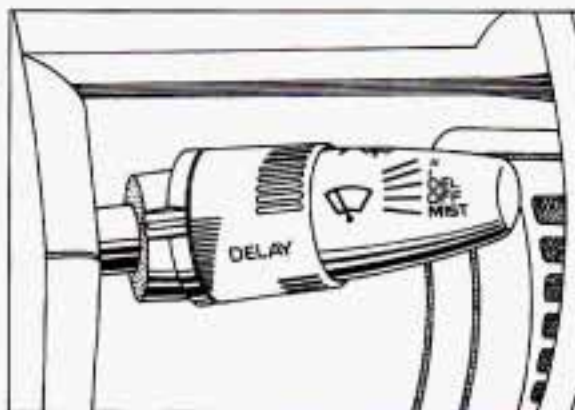

## **Windshield Wipers**

You control the windshield wipers by moving the stalk with the wiper symbol on it up or down.

### **For a Single Wiper Cycle:**

Push the stalk down to **MIST** until the wipers start, then let go. The wipers will stop after one cycle. For more cycles, hold the stalk down on **MIST** longer.

### **For Steady Wiper Cycles:**

Move the stalk up to either **I (Low)** or **II (High)**, depending on the wiper speed you want.

### **To Turn Wipers Off:**

Move the stalk to **OFF**.

Remember that damaged wiper blades may prevent you from seeing well enough to drive safely. To avoid damage, be sure to clear ice and snow from the wiper blades before using them. If they're frozen to the windshield, carefully loosen or thaw them. If your blades do become damaged, get new blades or blade inserts.

Heavy snow or ice can overload your wipers. A circuit breaker will stop them until the motor cools. Clear away snow or ice to prevent an overload.

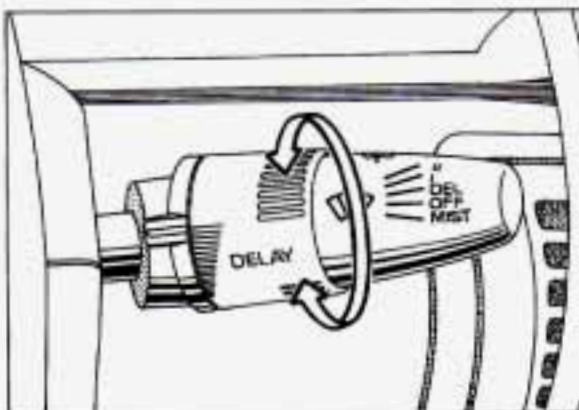

### **Intermittent Windshield Wipers (OPTION)**

If your vehicle has intermittent windshield wipers, you can set the wiper speed for a long or short delay between wipes. This can be very useful in light rain or snow.

Move the stalk to **DEL**, then rotate the band marked **DELAY** to choose the delay you want. Rotate the band up for shorter delay times between wiper cycles. Rotate the band down for longer delay times between wiper cycles.

For a single wiper cycle, push the stalk to **MIST**, then let go.

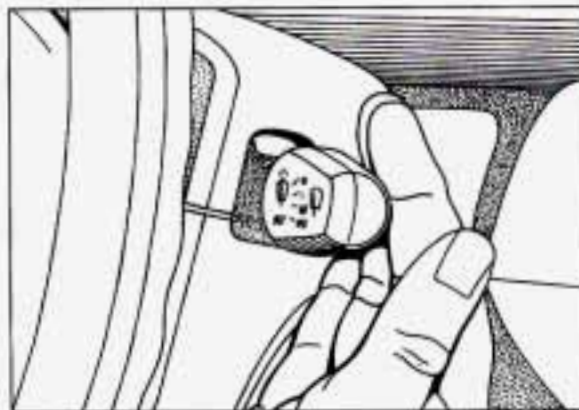

### **Windshield Washer**

#### **Standard Wipers:**

To spray washer fluid on the windshield, pull the stalk with the wiper symbol on it toward you one time. When you release the stalk the washers will stop, but the wipers will keep going in low until you move the wiper control to **OFF**.

#### **Intermittent Windshield Wipers:**

If you have intermittent windshield wipers, after each wash cycle ends the wipers will resume the delay speed you were using before. If you had no speed selected, the wipers will stop.



### **CAUTION:**

In freezing weather, don't use your washer until the windshield is warmed. Otherwise the washer fluid can form ice on the windshield, blocking your vision.

Driving without washer fluid can be dangerous. A bad mud splash can block your vision. You could hit another vehicle or go off the road. Check your washer fluid level often.

# Features & Controls

## NOTICE:

- When using concentrated washer fluid, follow the manufacturer's instructions for adding water.
- Don't mix water with ready-to-use washer fluid. Water can cause the solution to freeze and damage your washer fluid tank and other parts of the washer system. Also, water doesn't clean as well as washer fluid.
- Fill your washer fluid tank only  $\frac{3}{4}$  full when it's very cold. This allows for expansion, which could damage the tank if it is completely full.
- Don't use radiator antifreeze in your windshield washer. It can damage your washer system and paint.

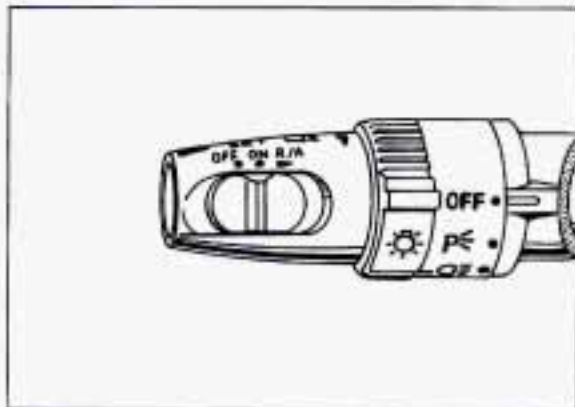

## ■ *Cruise Control* (OPTION)

With cruise control, you can maintain a speed of about 25 mph (40 km/h) or more without keeping your foot on the accelerator. This can really help on long trips. Cruise control does not work at speeds below about 25 mph (40 km/h).

When you apply your brakes, or the clutch pedal, the cruise control shuts off.



## CAUTION:

- Cruise Control can be dangerous where you can't drive safely at a steady speed. So, don't use your Cruise Control on winding roads or in heavy traffic.
- Cruise Control can be dangerous on slippery roads. On such roads, fast changes in tire traction can cause needless wheel spinning, and you could lose control. Don't use Cruise Control on slippery roads.

## To Set Cruise Control

1. Move the cruise control switch to **ON**.



## CAUTION:

If you leave your Cruise Control switch on when you're not using Cruise, you might hit a button and go into Cruise when you don't want to. You could be startled and even lose control. Keep the Cruise Control switch **OFF** until you want to use it.

2. Get up to the speed you want.

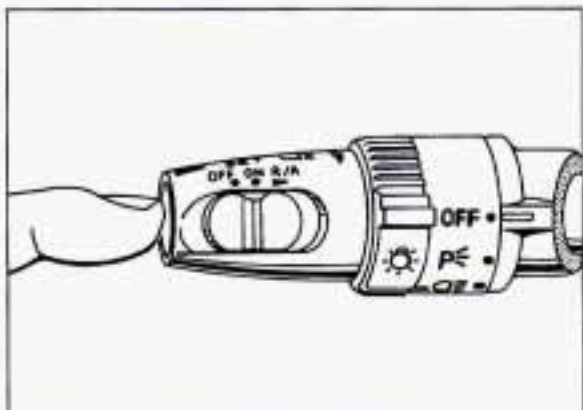

3. Push in the **SET** button at the end of the lever and release it.
4. Take your foot off the accelerator pedal.

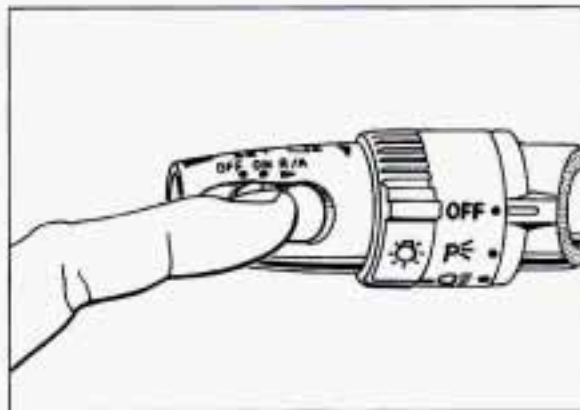

### **To Resume a Set Speed**

Suppose you set your cruise control at a desired speed and then you apply the brake or clutch pedal. This, of course, shuts off the cruise control. But you don't need to reset it. Once you're going about 25 mph (40 km/h) or more, you can move the cruise control switch from **ON** to **R/A** (which stands for Resume/Accelerate) for about half a second.

You'll go right back up to your chosen speed and stay there.

If you hold the switch at **R/A** longer than half a second, the vehicle will keep going faster until you release the switch or apply the brake or clutch pedal. You could be startled and even lose control. So unless you want to go faster, don't hold the switch at **R/A**.

### **To Increase Speed While Using Cruise Control**

There are two ways to go to a higher speed. Here's the first:

1. Use the accelerator pedal to get to the higher speed.
2. Push the button at the end of the lever, then release the button and the accelerator pedal. You'll now cruise at the higher speed.

Here's the second way to go to a higher speed:

- Move the cruise switch from **ON** to **R/A**. Hold it there until you get up to the speed you want, and then release the switch.
- To increase your speed in very small amounts, move the switch to **R/A** for less than half a second and then release it. Each time you do this, your vehicle will go about 1 mph (1.6 km/h) faster.



# Features & Controls

## **To Reduce Speed While Using Cruise Control**

There are two ways to reduce your speed while using cruise control:

- Push in the button at the end of the lever until you reach the lower speed you want, then release it.
- To slow down in very small amounts, push the button for less than half a second. Each time you do this, you'll go 1 mph (1.6 km/h) slower.

## **Passing Another Vehicle While Using Cruise Control**

Use the accelerator pedal to increase your speed. When you take your foot off the pedal, your vehicle will slow down to the cruise control speed you set earlier.

## **Using Cruise Control on Hills**

How well your cruise control will work on hills depends upon your speed, load, and the steepness of the hills. When going up steep hills, you may have to

step on the accelerator pedal to maintain your speed. When going downhill, you may have to brake or shift to a lower gear to keep your speed down. Of course, applying the brake or clutch pedal takes you out of cruise control. Many drivers find this to be too much trouble and don't use cruise control on steep hills.

## **To Get Out of Cruise Control**

There are several ways to turn off the cruise control:

- Step lightly on the brake pedal, or push the clutch pedal, if you have a manual transaxle; OR
- Move the cruise switch to **OFF**.

## **To Erase Cruise Speed Memory**

When you turn off the cruise control or the ignition, your cruise control set speed memory is erased.

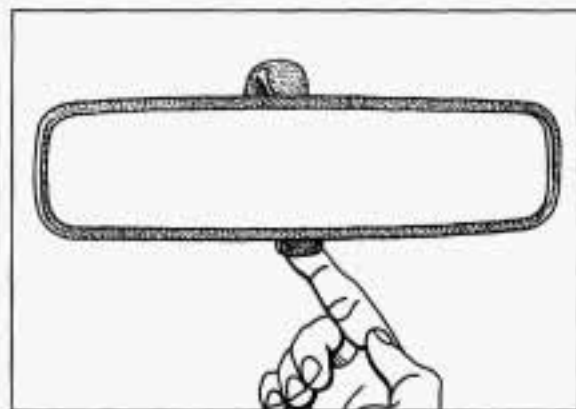

## **Inside Manual Day/Night Rearview Mirror**

To reduce glare from lights behind you, move the lever toward you to the night position.

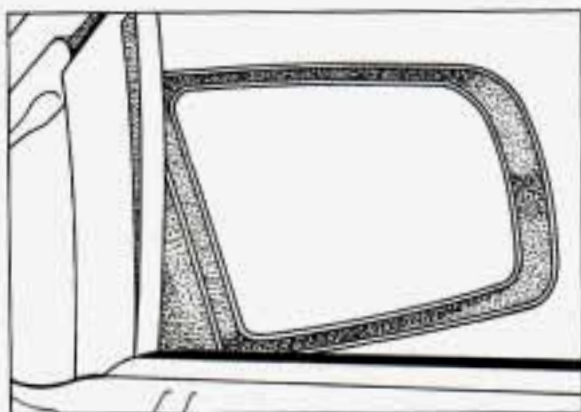

### ***Convex Outside Mirror***

Your right side mirror is convex.

A convex mirror's surface is curved so you can see more from the driver's seat.



### **CAUTION:**

If you aren't used to a convex mirror, you can hit another vehicle. A convex mirror can make things (like other vehicles) look farther away than they really are. If you cut too sharply into the right lane, you could hit a vehicle on your right. Check your inside mirror or glance over your shoulder before changing lanes.

Adjust this mirror by hand so that you just see the side of your vehicle when you are sitting in a comfortable driving position.

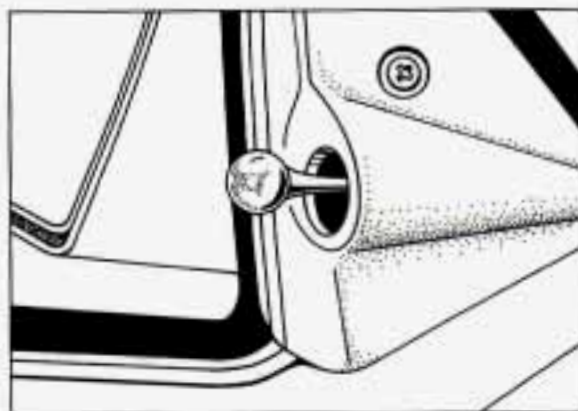

### ***Remote Control Mirror***

The driver side outside mirror should be adjusted with the control lever on the door so that you just see the side of your vehicle when you are sitting in a comfortable driving position.

# Features & Controls

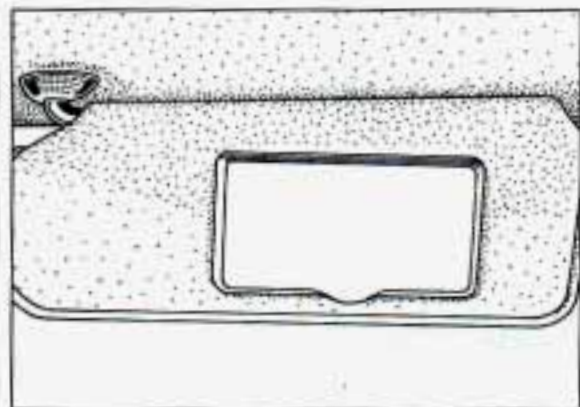

## **Sun Visors**

To block out glare, you can swing down the visors.

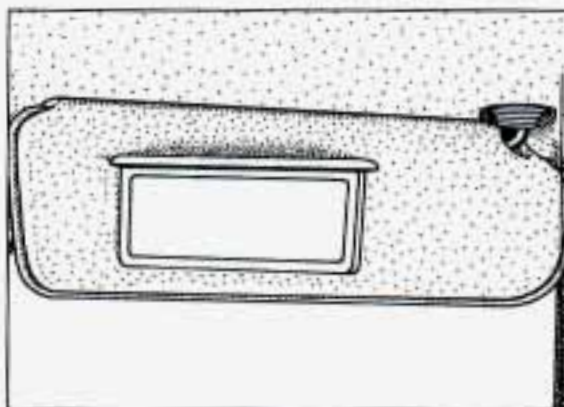

## **Visor Vanity Mirrors (OPTION)**

Pull down the sun visor and open the cover to expose the vanity mirror.

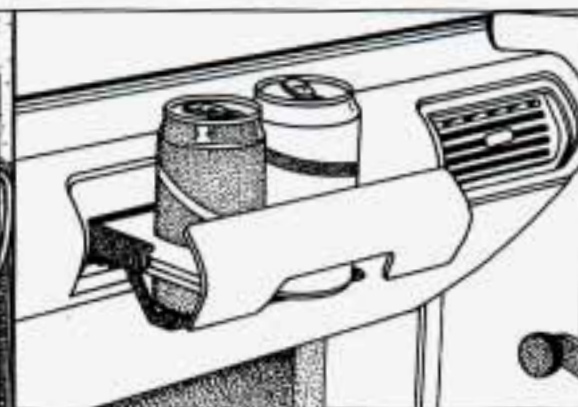

## **Cup Holder**

To use the cup holder, slide it out from the dash. Use the right side for larger containers.

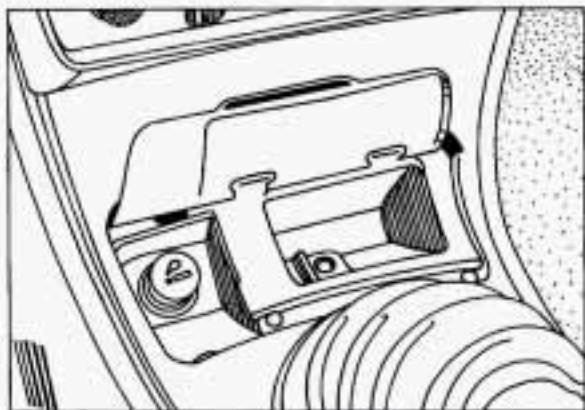

### **Ashtrays and Lighter**

To open the center console ashtray, lift the lid.

To clean the ashtray, pull up on the **LIFT** tab along the left edge.

To use the lighter, just push it in all the way and let go. When it's ready, it will pop back out by itself.

#### **NOTICE:**

Don't hold a cigarette lighter in with your hand while it is heating. If you do, it won't be able to back away from the heating element when it's ready. That can make it overheat, damaging the lighter and the heating element.

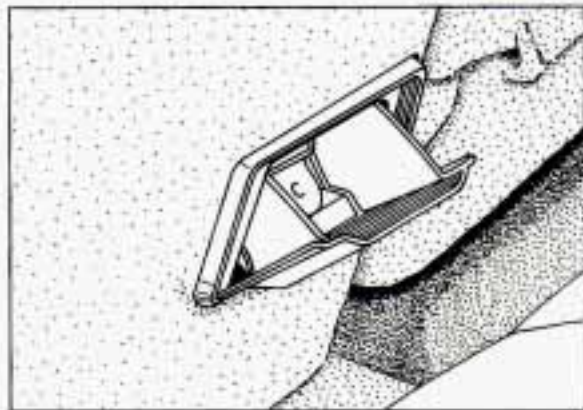

### **Rear Ashtray**

To clean the rear console-mounted ashtray, open it, push down on the snuffer and pull it out.

#### **NOTICE:**

Don't put papers and other things that burn into your ashtrays. If you do, cigarettes or other smoking materials could set them on fire, causing damage.

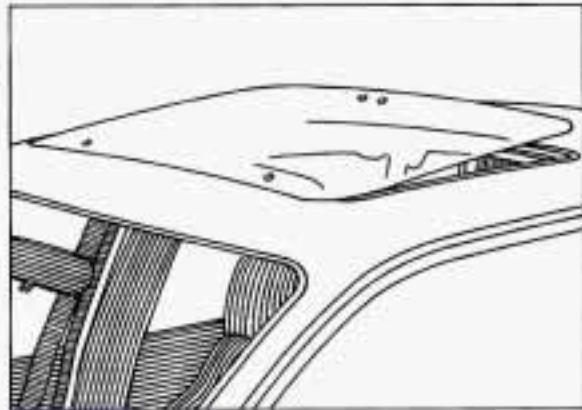

### ■ **Sunroof (OPTION)**

The sunroof includes a glass panel that opens for ventilation and is completely removable, and an air deflector that assures a smooth flow of air.

# Features & Controls

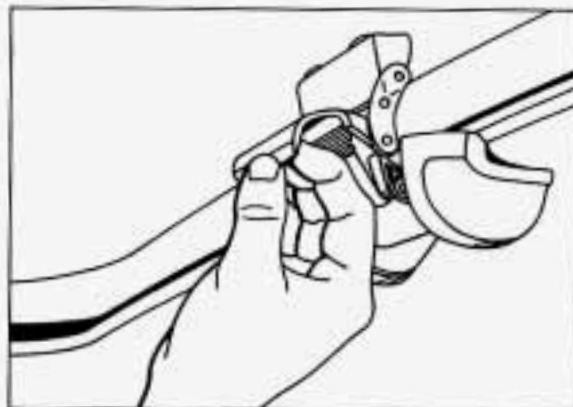

## To Open the Sunroof:

Pull down on the latch release handle and then push it forward and up until the glass panel locks into place.

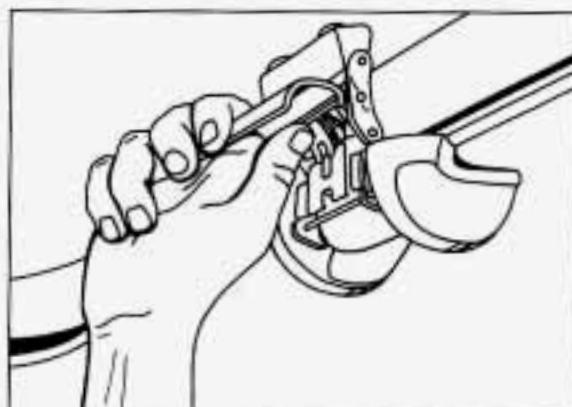

## To Remove the Sunroof Glass Panel:

1. With the sunroof open, press up on the glass release tab, located inside the latch release handle.
2. Lift the panel up and out. The air deflector will automatically pop up.



## CAUTION:

Don't try to remove the sunroof panel while the vehicle is moving. Trying to remove the sunroof panel while the vehicle is moving could cause an accident. The panel could fall into the vehicle and cause you to lose control, or it could fly off and strike another vehicle. You or others could be injured. Remove the sunroof panel only when the vehicle is parked.



3. Store the glass panel in the special storage bag in the trunk.



**CAUTION:**

If the sunroof panel is not stored properly, it could be thrown about the vehicle in a crash or sudden maneuver. People in the vehicle could be injured. Whenever you store the sunroof panel in the vehicle, always be sure that it is stored securely in the special storage bag in the trunk.

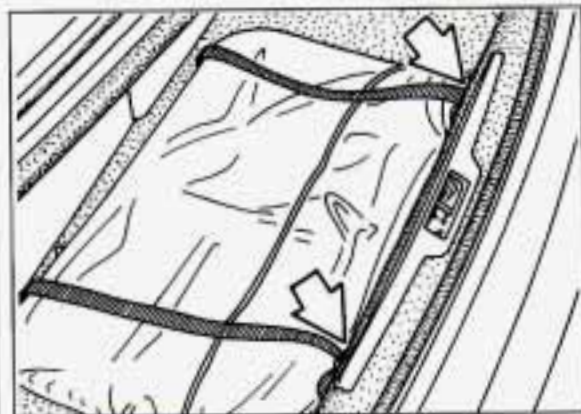

4. If you have the optional fold-down rear seat, you can secure the storage bag containing the glass panel to the trunk anchors using the straps provided.

# Features & Controls

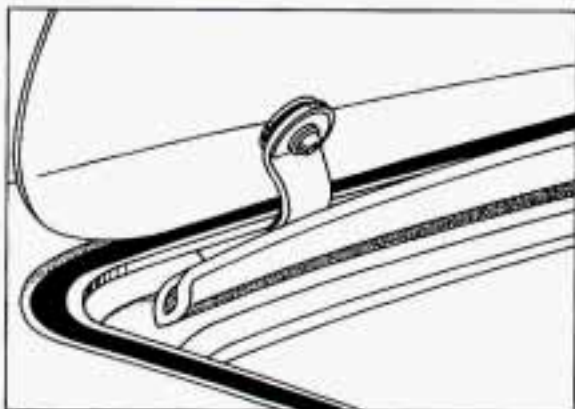

## To Install the Sunroof Glass Panel:

1. Center the glass panel upright on the weatherstrip. Then line up the hinges on the panel with the slots in the roof opening.

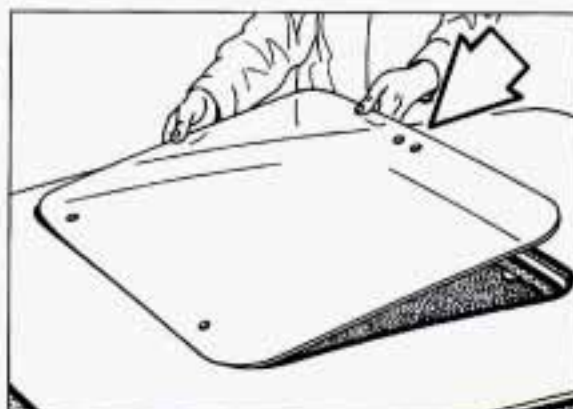

2. Push forward on the rear edge of the glass while lowering the panel. **Do not force** a hinge if it binds in a slot. Reposition the glass panel and start again.

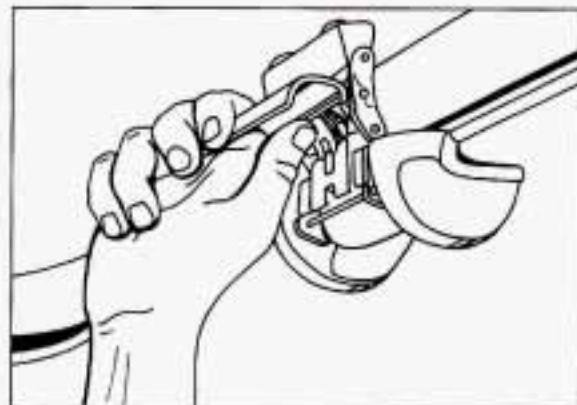

3. Push the glass release tab and engage the latch with the striker. Close the panel.



## CAUTION:

An improperly installed sunroof panel may fall into or fly off the vehicle. You or others could be injured. After installing the sunroof panel, always check that it is firmly attached by pushing up on the underside of the panel.

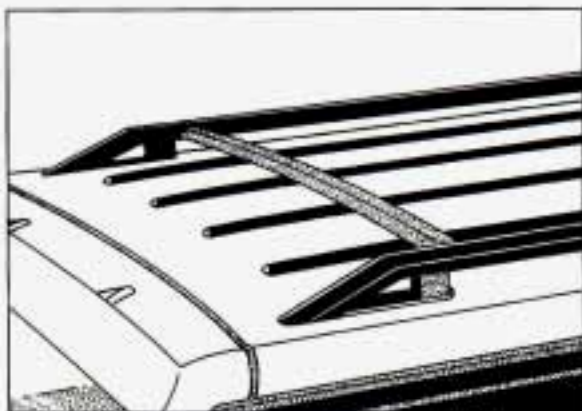

### **Roof Luggage Carrier (WAGON, OPTION)**

If you have the optional luggage carrier, you can load things on top of your vehicle.

The luggage carrier has slats attached to the roof, side rails, and tiedowns.

### **NOTICE:**

Loading cargo that weighs more than 125 pounds (57 kg) on the luggage carrier may damage your vehicle. When you carry large things, never let them hang over the rear or the sides of your vehicle. Load your cargo so that it rests on the slats and does not scratch or damage the vehicle. Put the cargo against the side rails and fasten it securely to the luggage carrier.

Don't exceed the maximum vehicle capacity when loading your Chevrolet. For more information on vehicle capacity and loading, see the *Index* under *Loading Your Vehicle*.

To prevent damage or loss of cargo as you're driving, check now and then to make sure the luggage carrier and cargo are still securely fastened.



# Features & Controls

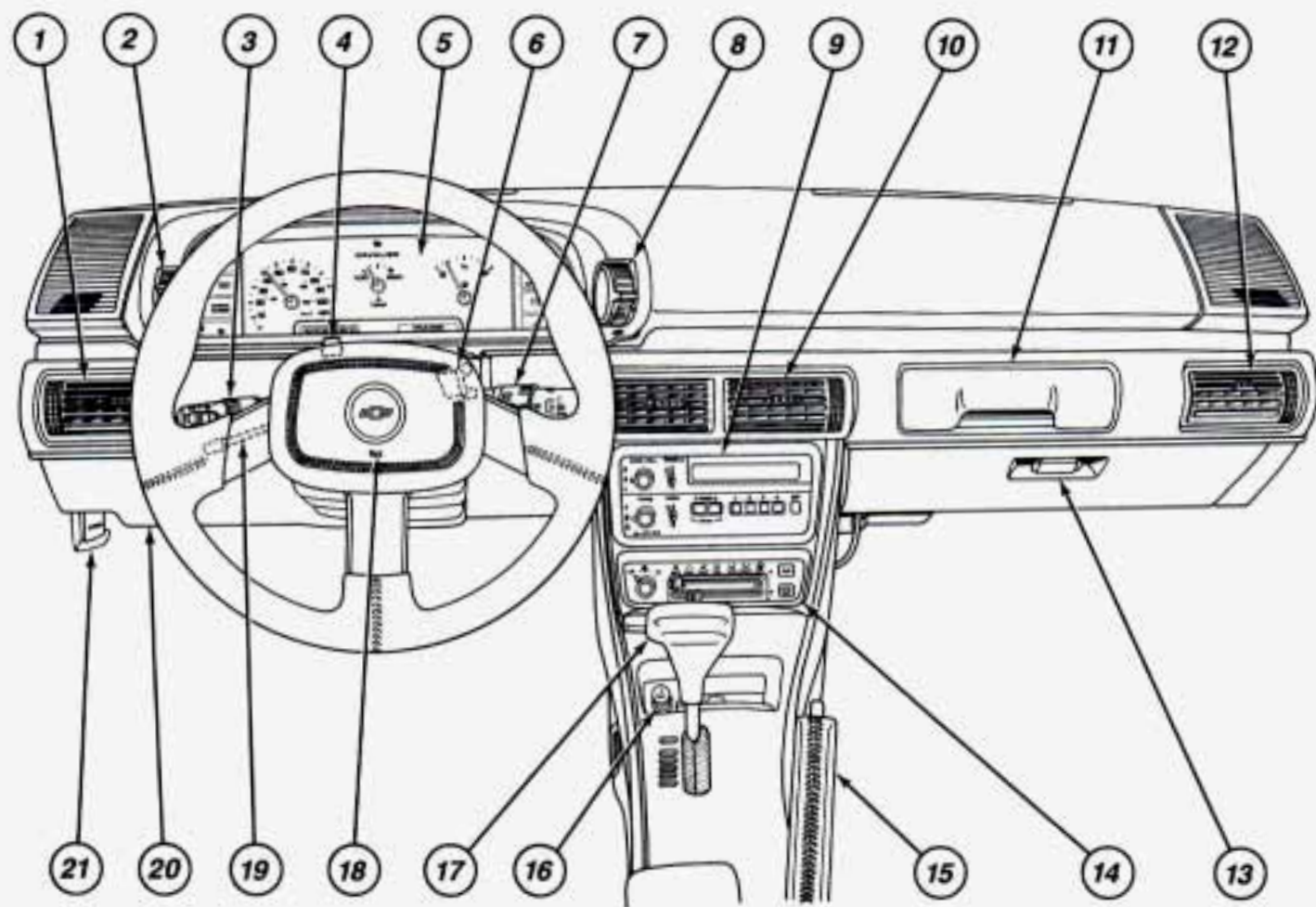

## ***The Instrument Panel— Your Information System***

Your instrument panel is designed to let you know at a glance how your vehicle is running. You'll know how fast you're going, how much fuel you're using, and many other things you'll need to drive safely and economically.

The main components of your instrument panel are:

- 1. Side Vent**
- 2. Instrument Panel Intensity Control**
- 3. Turn Signal/Multifunction Lever**
- 4. Hazard Warning Flashers Switch**
- 5. Instrument Cluster**
- 6. Ignition Switch**
- 7. Windshield Wiper/Washer Controls**
- 8. Interior Light Control**
- 9. Audio System**
- 10. Center Vents**
- 11. Cup Holder**
- 12. Side Vent**
- 13. Glove Box**
- 14. Climate Controls and Rear Window Defogger**
- 15. Parking Brake Lever**
- 16. Ashtray/Lighter**
- 17. Gearshift Lever**
- 18. Horn**
- 19. Tilt Steering Wheel Lever (Option)**
- 20. Fuse Panel**
- 21. Hood Release Lever**

# Features & Controls

## 2.2L L4 CLUSTER

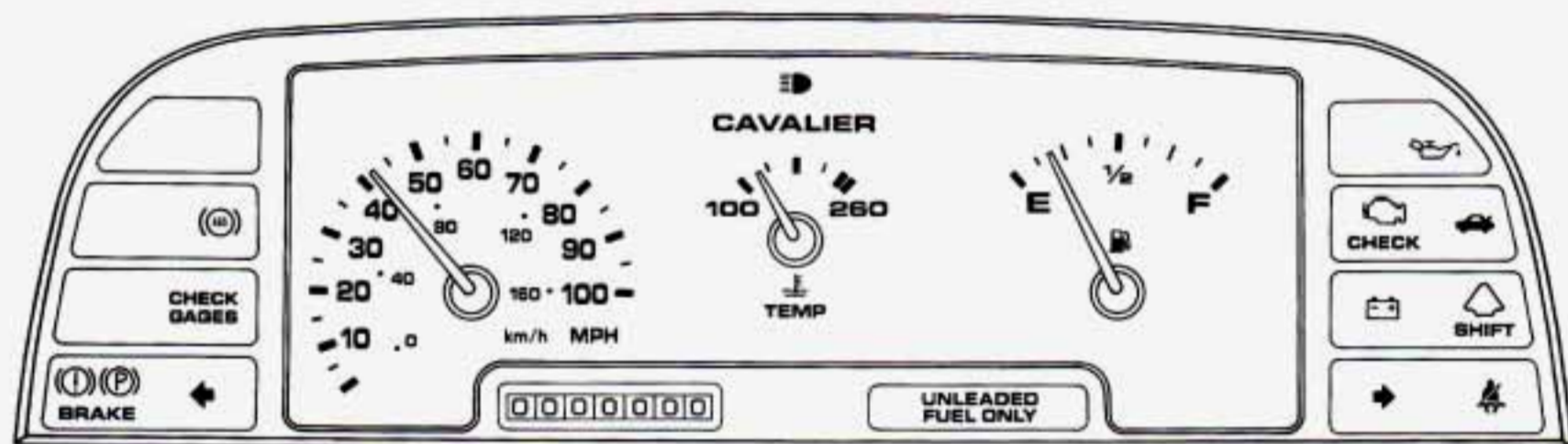

### ■ *Instrument Panel Clusters*

Your Chevrolet is equipped with one of these instrument panel clusters, which include indicator warning lights and gauges that are explained on the following pages. Be sure to read about those that apply to the instrument panel cluster for your vehicle.

### *Speedometer and Odometer*

Your speedometer lets you see your speed in both miles per hour (mph) and kilometers per hour (km/h). Your odometer shows how far your vehicle has been driven, in either miles (used in the U.S.) or kilometers (used in Canada).

### *Tamper Resistant Odometer*

Your Chevrolet has a tamper resistant odometer. If you see silver lines between the numbers, you'll know that someone has probably tried to turn it back, so the numbers may not be true.

You may wonder what happens if your vehicle needs a new odometer installed.

## 3.1L V6 CLUSTER

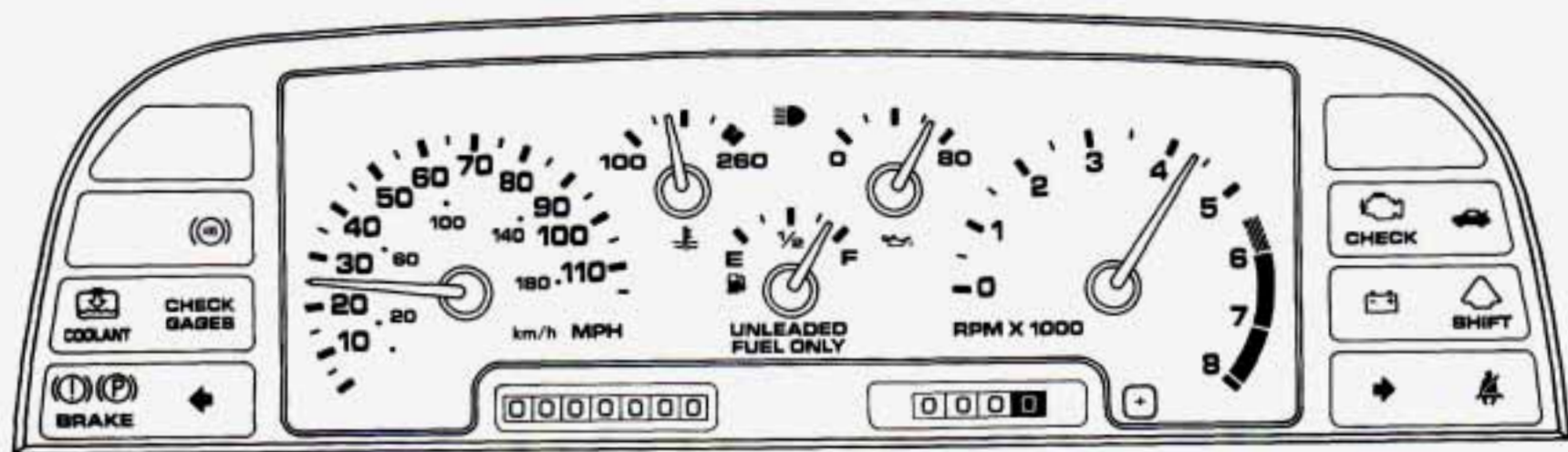

If the new one can be set to the mileage total of the old odometer, then it must be. But if it can't, then it's set at zero and a label must be put on the driver's door to show the old mileage reading when the new odometer was installed.

### **Trip Odometer (3.1L V6 ENGINE)**

The trip odometer can tell you how far your vehicle has been driven since you last set the trip odometer to zero.

To set the trip odometer to zero, press the knob to the right of it.

### **Tachometer (3.1L V6 ENGINE)**

The tachometer displays the engine speed in revolutions per minute (rpm).

#### **NOTICE:**

Do not operate the engine with the tachometer in the red area, or engine damage may occur.

# Features & Controls

## ■ *Warning Lights, Gages and Indicators*

This section describes the warning lights and gages that may be on your vehicle. The pictures will help you locate them.

Warning lights and gages can signal that something is wrong before it becomes serious enough to cause an expensive repair or replacement. Paying attention to your warning lights and gages could also save you or others from injury.

Warning lights go on when there may be or is a problem with one of your vehicle's functions. As you will see in the details on the next few pages, some warning lights come on briefly when you turn the ignition key just to let you know they're working. If you are

familiar with this section, you should not be alarmed when this happens.

Gages can indicate when there may be or is a problem with one of your vehicle's functions. Often gages and warning lights work together to let you know when there's a problem with your vehicle.

When one of the warning lights comes on and stays on when you are driving, or when one of the gages shows there may be a problem, check the section that tells you what to do about it. Please follow the manual's advice. Waiting to do repairs can be costly — and even dangerous. So please get to know your warning lights and gages. They're a big help.



### **Fuel Gage**

When the ignition is on, your fuel gage tells you about how much fuel you have left. When the indicator nears **E** (Empty), you still have a little fuel left, but you should get more soon.

Here are four things that some owners ask about. None of these show a problem with your fuel gage:

- At the gas station, the gas pump shuts off before the gage reads **F** (Full).

- It takes a little more or less fuel to fill up than the gage indicated. For example, the gage may have indicated the tank was half full, but it actually took a little more or less than half the tank's capacity to fill the tank.
- The gage moves a little when you turn a corner or speed up.
- The gage doesn't go back to **E** when you turn off the ignition.

For your fuel tank capacity, see *Service Station Information* on the last page of this manual.

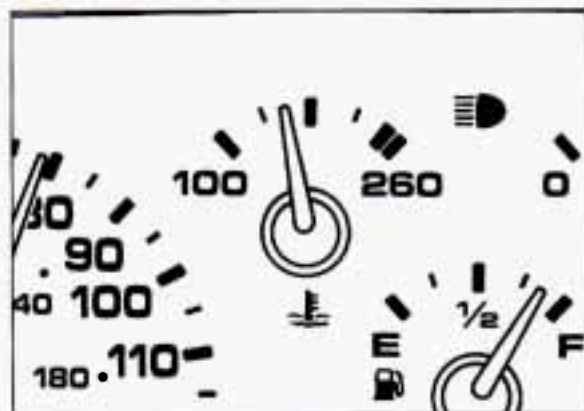

### **Engine Coolant Temperature Gage**

With the ignition in the **Run** position, this gage shows the engine coolant temperature.

If the gage pointer moves into the red area, your engine is too hot! It means that your engine coolant has overheated. If you have been operating your vehicle under normal driving conditions, you should pull off the road, stop your vehicle and turn off the engine as soon as possible.

**HOT COOLANT CAN BURN YOU BADLY!**

In *Problems on the Road*, this manual shows what to do. See the *Index* under *Engine Overheating*.



### **Low Coolant Warning Light (3.1L V6 ENGINE)**

If this light comes on and stays on, your system is low on coolant and the engine may overheat. See the *Index* under *Coolant* and have your vehicle serviced as soon as you can.

# Features & Controls

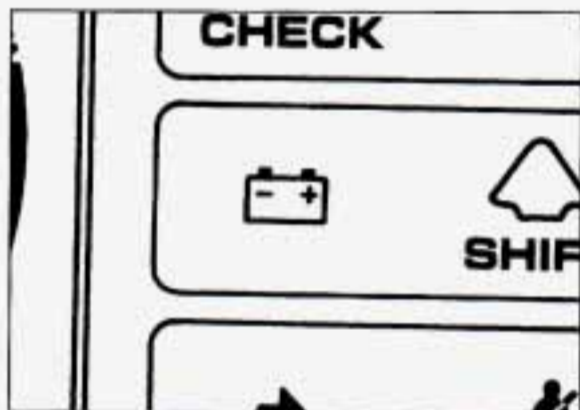

## Charging System Light

The charging system light will come on briefly when you turn on the ignition and the engine is not running, as a check to show you it is working. Then it should go out. If it stays on, or comes on while you are driving, you may have a problem with the electrical charging system. It could indicate that you have a loose generator drive belt, or another electrical problem. Have it checked right away. Driving while this light is on could drain your battery.

If you must drive a short distance with the light on, be certain to turn off all your accessories, such as the radio and air conditioner.

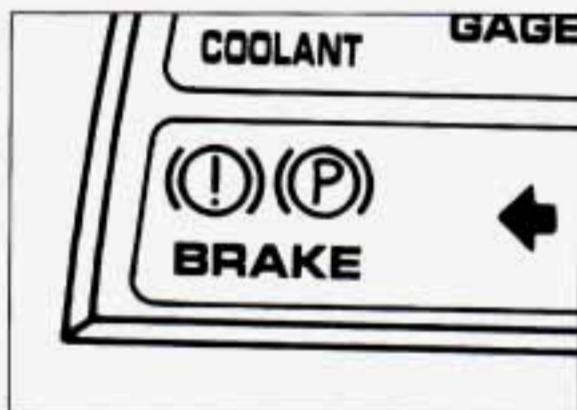

## Brake System Warning Light

Your Chevrolet's hydraulic brake system is divided into two parts. If one part isn't working, the other part can still work and stop you. For good braking, though, you need both parts working well.

If the warning light comes on, there could be a brake problem. Have your brake system inspected right away.

This light should come on as you start the vehicle. If it doesn't come on then, have it fixed so it will be ready to warn you if there's a problem.

If the light comes on while you are driving, pull off the road and stop carefully. You may notice that the pedal is harder to push. Or, the pedal may go

closer to the floor. It may take longer to stop. If the light is still on, have the vehicle towed for service. (See *Towing Your Vehicle* in the *Index*.)



## CAUTION:

Your brake system may not be working properly if the brake system warning light is on. Driving with the brake system warning light on can lead to an accident. If the light is still on or if the anti-lock brake system warning light is flashing after you've pulled off the road and stopped carefully, have the vehicle towed for service.

The brake system warning light will also come on when you set your parking brake, and it will stay on if your parking brake doesn't release fully. If it stays on after your parking brake is fully released, it means you have a brake problem.

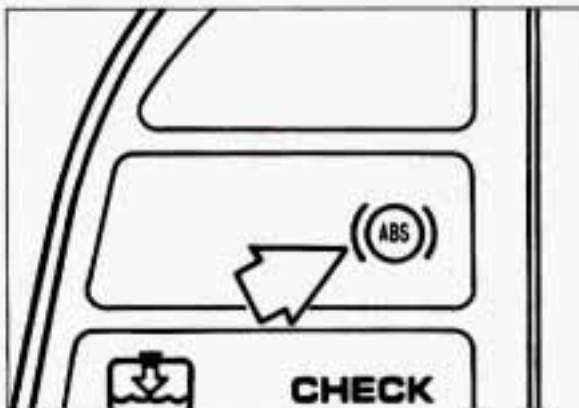

### **Anti-Lock Brake System Warning Light**

With anti-lock, this light will come on when you start your engine and it will stay on for three seconds. That's normal. If the light doesn't come on, have it fixed so it will be ready to warn you if there is a problem.

If the light stays on, turn the ignition off. Or, if the light comes on and stays on when you're driving, stop as soon as possible and turn the ignition off. Then start the engine again to reset the system. If the light still stays on, or comes on again while you're driving, your Chevrolet needs service. If the regular brake system warning light isn't on, you still have brakes, but you don't have anti-lock brakes.

If the regular brake system warning light is also on, you don't have anti-lock brakes and there's a problem with your regular brakes. See *Brake System Warning Light* earlier in this part. If the anti-lock brake system warning light ever flashes, your anti-lock brake system is still working but needs service as soon as possible.

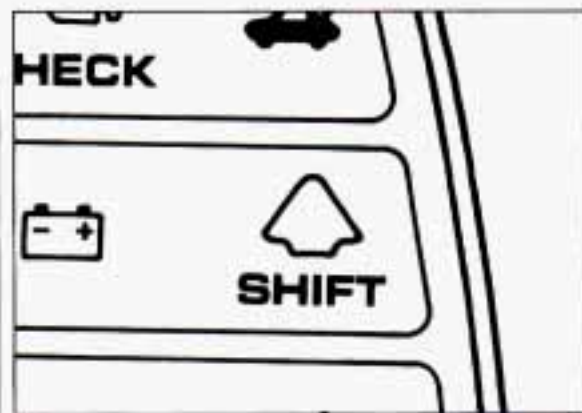

### **Shift Light (MANUAL TRANSAXLE)**

This light comes on when you need to shift to the next higher gear. See the *Index* under *Manual Transaxle*.



# Features & Controls



## ***Malfunction Indicator Lamp (Check Engine Light)***

A computer monitors operation of your fuel, ignition and emission control systems. This light should come on when the ignition is on, but the engine is not running, as a check to show you it is working. If it does not come on at all, have it fixed right away. If it stays on, or it comes on while you are driving, the computer is indicating that you have a problem. You should take your vehicle in for service soon.

## **NOTICE:**

If you keep driving your vehicle with this light on, after a while the emission controls won't work as well, your fuel economy won't be as good and your engine may not run as smoothly. This could lead to costly repairs not covered by your warranty.

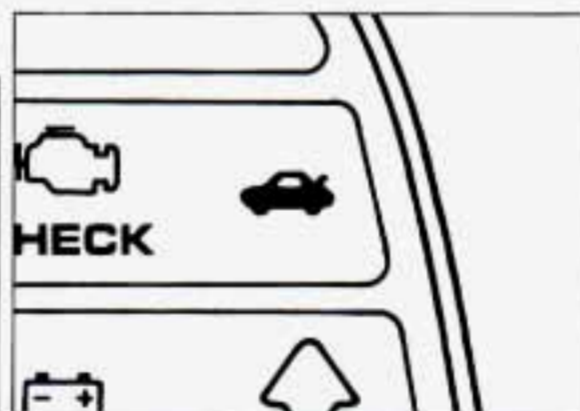

## ***Liftgate Ajar Light (WAGON)***

This light will come on if the liftgate is not fully closed. Have your vehicle serviced if this light comes on and stays on after the liftgate is closed.

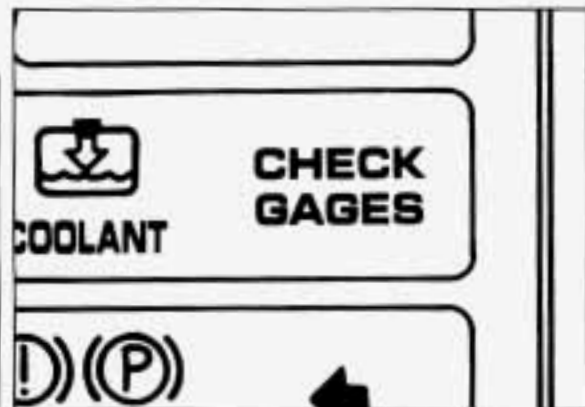

### Check Gages Light

This light will come on briefly when you are starting the engine. If the light comes on and stays on while you are driving, check your various gages to see if they are in the warning zones.

This light will also come on when the fuel level is low, 1 to 3 gallons (3.8 to 11.4 liters).



### Oil Warning Light (2.2L L4 ENGINE)

If you have a low engine oil pressure problem, this light will stay on after you start your engine, or come on when you are driving. This indicates that your engine is not receiving enough oil. The engine could be low on oil, or could have some other oil problem. Have it fixed immediately.

The oil light could also come on in two other situations:

- When the ignition is on but the engine is not running, the light will come on as a test to show you it is working, but the light will go out when you turn the ignition to **Start**. If it doesn't come on with the ignition on, you may have a problem with the fuse or bulb. Have it fixed right away.

- If you make a hard stop, the light may come on for a moment. This is normal.



### CAUTION:

Don't keep driving if the oil pressure is low. If you do, your engine can become so hot that it catches fire. You or others could be burned. Check your oil as soon as possible and have your vehicle serviced.

### NOTICE:

Damage to your engine from neglected oil problems can be costly and is not covered by your warranty.

# Features & Controls

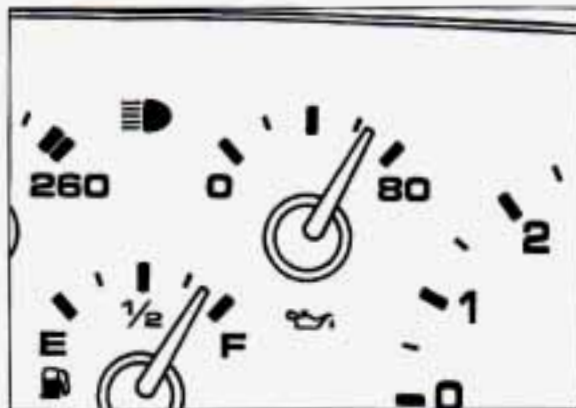

## **Oil Pressure Gage (3.1L V6 ENGINE)**

The oil pressure gage shows the engine oil pressure in psi (pounds per square inch) when the engine is running. Canadian vehicles indicate pressure in kPa. Oil pressure may vary with engine speed, outside temperature, and oil viscosity, but readings above the red warning zone indicate the normal operating range.

A reading in the red zone may be caused by a dangerously low oil level or other problem causing low oil pressure. Have your vehicle serviced immediately.



## **CAUTION:**

Don't keep driving if the oil pressure is low. If you do, your engine can become so hot that it catches fire. You or others could be burned. Check your oil as soon as possible and have your vehicle serviced.

## **NOTICE:**

Damage to your engine from neglected oil problems can be costly and is not covered by your warranty.

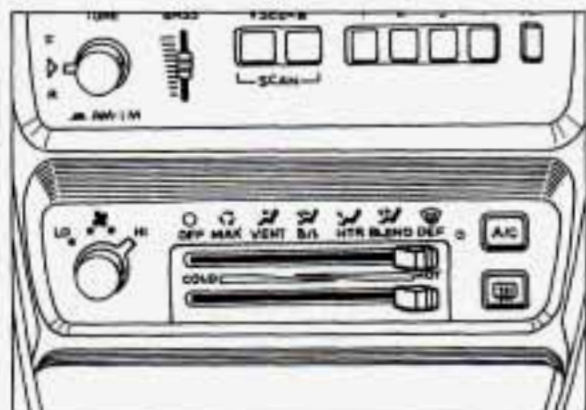

In this part you'll find out how to operate the comfort control systems and audio systems offered with your Chevrolet. Be sure to read about the particular system supplied with your vehicle.

## Part 3 Comfort Controls & Audio Systems

Climate Control System .....	92
Air Conditioning System .....	93
Rear Window Defogger .....	95
Setting the Clock .....	97
AM/FM Stereo Radio.....	97
AM/FM Stereo Radio with Cassette Tape Player.....	99
AM/FM Stereo Radio with Compact Disc Player.....	101
Understanding Radio Reception.....	104
Care of Your Cassette Tape Player .....	104
Care of Your Compact Discs .....	105
Fixed Mast Antenna.....	105

# Comfort Controls & Audio Systems

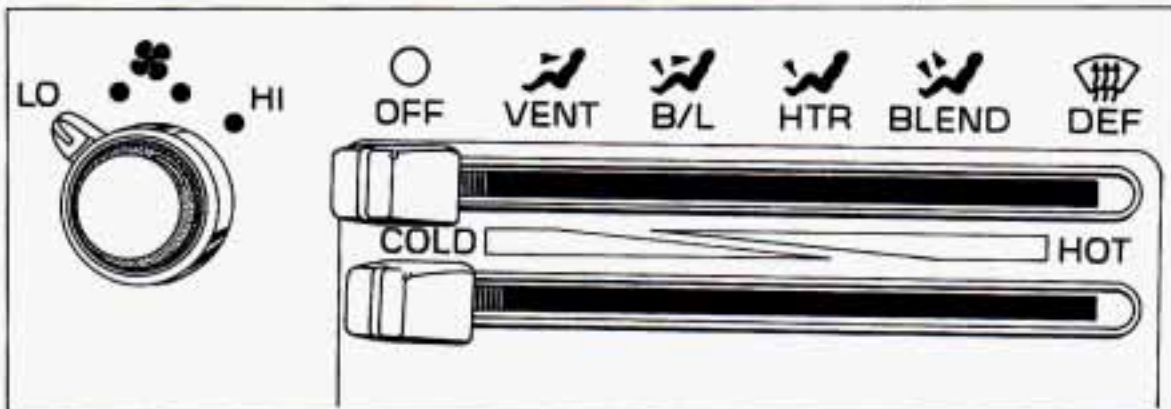

## ■ *Climate Control System*

With this system, you can control the ventilation and heating in your vehicle.

Your vehicle also has the flow-through ventilation system described later in this section.

**Lever Controls:** The upper lever changes the functions of your system. The lower lever changes the temperature of the air coming through the system. Slide the upper control lever to **OFF** to turn off the system.

: Sets the fan speed. To select the force of air you want, turn the knob.

**VENT:** Use when outside temperatures are mild and little heating or cooling is needed. Air flow is through the instrument panel outlets. Set the lower lever to the temperature desired.

**B/L (Bi-Level):** Use on cool, but sunny days. This setting brings in the outside air, but directs it in two ways. Cool air is directed to the upper portion of your body through the instrument panel outlets, and slightly warmer air is directed through the heater ducts and defroster vents. At times, this temperature difference may be more apparent than others.

**HTR (Heater):** This setting brings heated air through the heater ducts, and some through the windshield defroster vents. If you have the optional engine coolant heater and use it during cold weather, 0°F (-18°C) or lower, your heating system will more quickly provide heat because the engine coolant is already warmed. See the *Index* under *Engine Coolant Heater*.

**BLEND:** This setting divides the air flow equally between the heater ducts and the windshield defroster vents.

**DEF (Defrost):** This setting directs most air through the windshield defroster vents, and some through the heater ducts.

## *Defogging Windows*

To defog the windows, slide the lower lever to **HOT**, set the upper lever to **DEF** and turn the fan control to **HI**.

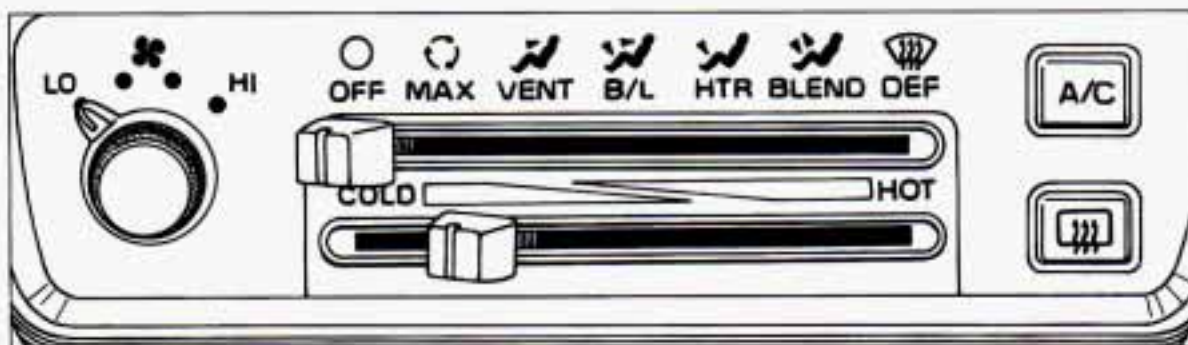

## ■ Air Conditioning System

(OPTION)

The air conditioner and heater work best if you keep your windows closed while using them. Your vehicle also has the flow-through ventilation system described later in this section.

**Lever Controls:** The upper lever changes the functions of your system. The lower lever changes the temperature of the air coming through the system. Slide the upper control lever to **OFF** to turn off the system.

**☸:** Selects the fan speed. To select the force of air you want, turn the knob.

The fan is always running unless the upper lever is moved to **OFF**.

## Air Conditioning

The upper lever has three air conditioner settings. On very hot days, open the windows long enough to let hot inside air escape. This reduces the amount of work your air conditioner's compressor will have to do, which should help fuel economy.

**A/C (Air Conditioning):** Press this button to enable the air conditioner compressor. The indicator light will glow when the button is pressed. Press the button again to turn off the air conditioner compressor.

The air conditioner compressor operates automatically (and the light glows) when in the **MAX** setting, or in the **DEF** (Defrost) setting when the

outside temperature is higher than about 40°F (4.5°C). Below 40°F (4.5°C), the light will glow in these settings, but the compressor will not turn on.

**MAX (Maximum):** Use for maximum cooling. This setting recirculates much of the air inside your vehicle so it maximizes fuel economy and your air conditioner's performance.

**VENT:** Use on pleasant days when little heating or cooling is needed, to direct outside air into the vehicle. In this setting, the air flow is through the instrument panel outlets.

**B/L (Bi-Level):** Use on cool, but sunny days. This setting brings in the outside air, but directs it in two ways. Cool air is directed to the upper portion of your body through the instrument panel outlets, and slightly warmer air is directed to the lower portion of your body through the heater ducts and defroster vents. At times, this temperature difference may be more apparent than others.

# Comfort Controls & Audio Systems

**HTR (Heater):** Use this setting to direct most of the air flow through the heater ducts, and some through the windshield defroster vents.

If you have the optional engine coolant heater and use it during cold weather, 0°F (-18°C) or lower, your heating system will more quickly provide heat because the engine coolant is already warmed. See the *Index* under *Engine Coolant Heater*.

**BLEND:** This setting divides the air flow equally between the heater ducts and the windshield defroster vents.

**DEF (Defrost):** This setting directs most air through the windshield defroster vents, and some through the heater ducts.

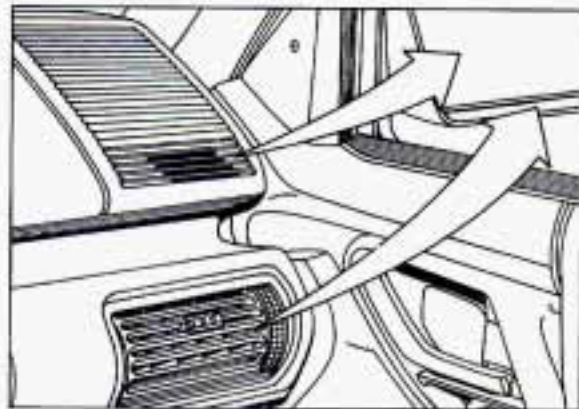
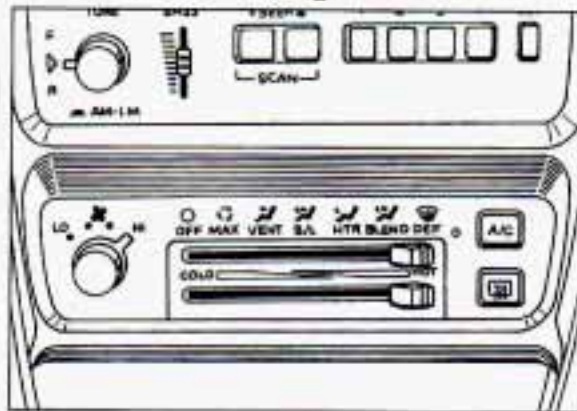

## Defogging Windows with the Air Conditioning System

Slide the lower lever to **HOT**.

To defog the windshield, set the upper lever to **DEF** and turn the fan control to **HI**.

To defog the side windows, set the upper lever to **B/L**, the fan control to **HI**, and press the **A/C** button. Aim the side vents toward the side windows. For increased air flow to the side vents, close the center vents.

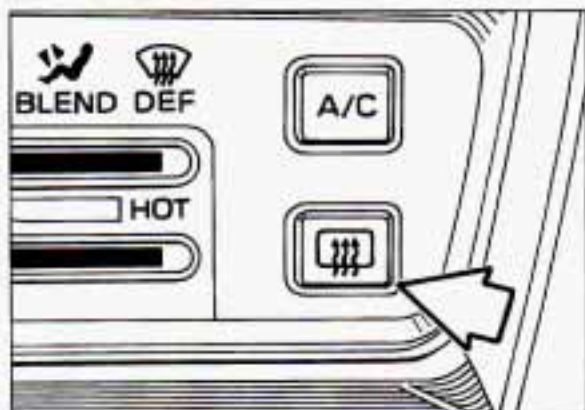

### **Rear Window Defogger (OPTION)**

The rear window defogger uses a warming grid to remove fog from the rear window. Press the  button and an indicator light will glow. The defogger will turn off automatically after about 10 minutes of use. If you turn it on again, the defogger will operate for about five minutes only. You can also turn the defogger off by pressing the button again, or by turning off the ignition.

Do not attach a temporary vehicle license across the defogger grid on the rear window.

### **NOTICE:**

Don't use a razor blade or something else sharp on the inside of the rear window. If you do, you could cut or damage the warming grid, and the repairs wouldn't be covered by your warranty.

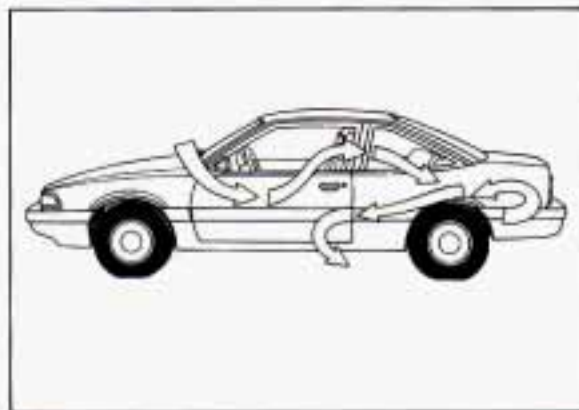

### **Flow-Through Ventilation System**

Your Chevrolet's flow-through ventilation system lets outside air into the vehicle when it is moving. Outside air will also enter the vehicle when the heater or the air conditioning fan is running.



# Comfort Controls & Audio Systems



## Ventilation Tips

- Keep the hood and front air inlet free of ice, snow, or any other obstruction (such as leaves). The heater and defroster will work far better, reducing the chance of fogging the inside of your windows.
- In cold weather, turn the blower fan to **HI** for a few moments before driving off. This helps clear the intake ducts of snow and moisture, and reduces the chance of fogging the inside of your windows.
- Keep the air path under the front seats clear of objects. This helps air to circulate throughout your vehicle.

## ■ *Audio Systems*

The following pages describe the audio systems available for your Chevrolet, and how to get the best performance from them. Please read about the system in your vehicle.

Hearing damage from loud noise is almost undetectable until it is too late. Your hearing can adapt to higher volumes of sound. Sound that seems normal can be loud and harmful to your hearing. Take precautions by adjusting the volume control on your radio to a safe sound level before your hearing adapts to it. To help avoid hearing loss or damage:

- Adjust the volume control to the lowest setting.
- Increase volume slowly until you hear comfortably and clearly.

## **NOTICE:**

Before you add any sound equipment to your vehicle — like a tape player, CB radio, mobile telephone or two-way radio — be sure you can add what you want. If you can, it's very important to do it properly. Added sound equipment may interfere with the operation of your vehicle's engine, Delco® radio or other systems, and even damage them. And, your vehicle's systems may interfere with the operation of sound equipment that has been added improperly. So, before adding sound equipment, check with your dealer and be sure to check Federal rules covering mobile radio and telephone units.

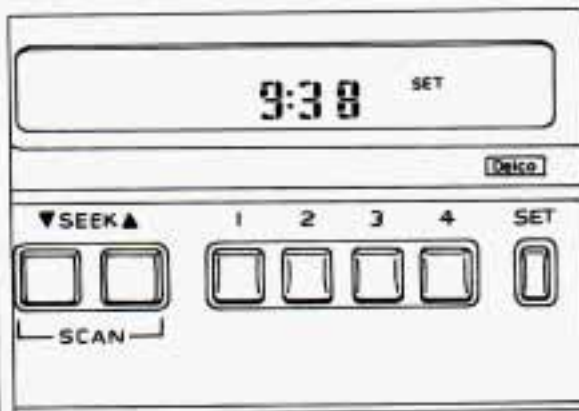

## Setting the Clock

No matter which audio system you have in your vehicle, setting the clock is easy.

1. With the ignition on and the radio on or off, press **SET**. The **SET** indicator will appear on the digital screen for five seconds.
2. You must begin to set the clock to the correct hour and minute during those five seconds. If your audio system does not have a CD player:

- Press **SEEK** (down arrow) to set the hour.
- Press **SEEK** (up arrow) to set the minute.

If your audio system has a CD player:

- Press **SCAN** to set the hour.
- Press **SEEK** (down arrow) to decrease minutes or **SEEK** (up arrow) to increase minutes.

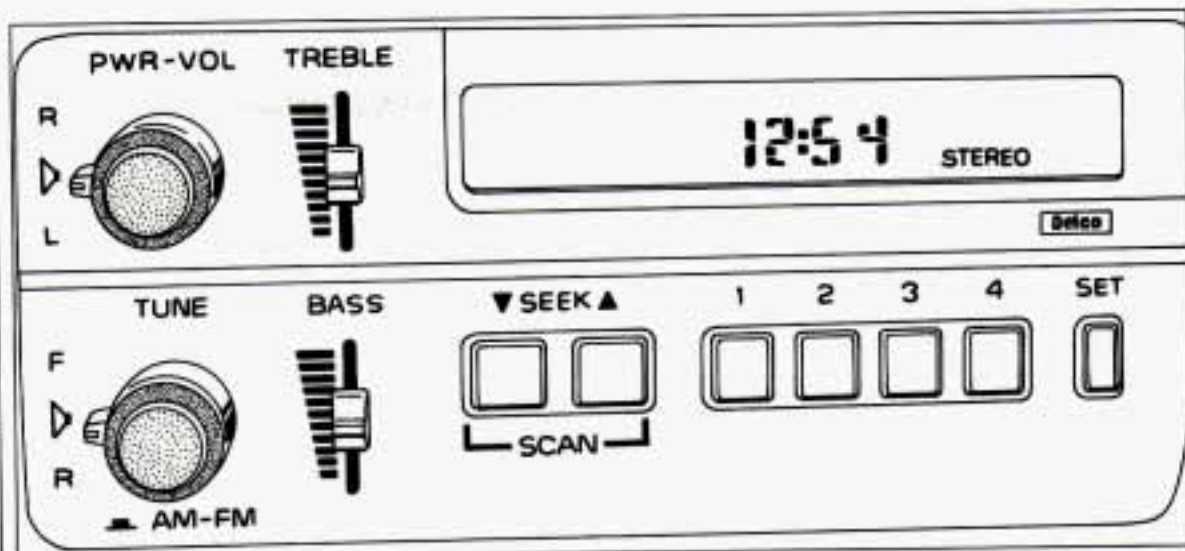

## AM/FM Stereo Radio

The digital display indicates information on time or radio station frequency, the AM or FM radio band, whether the station is in stereo, and other radio functions.

**PWR-VOL (Power-Volume):** With the ignition on, rotate the upper knob to turn the system on and off, and to control the volume.

Press the upper knob to change between the clock and the radio station frequency displayed when the radio is on, and to display the time when the ignition is off.

**R ▸ L (Balance):** The control ring behind the upper knob adjusts the right/left speaker balance.

**TUNE:** Rotate the lower knob to tune in radio stations.

**AM/FM:** Press the lower knob to change between AM and FM bands.

**F ▸ R (Fade):** The control ring behind the lower knob adjusts the front/rear speaker balance.

**TREBLE:** Slide this lever up to increase treble, or down to decrease it. If a station is weak or noisy, reduce the treble.

# Comfort Controls & Audio Systems

**BASS:** Slide this lever up to increase bass, or down to decrease it.

**▼SEEK▲:** Press to seek and stop on the next station higher or lower on the radio band.

**SCAN:** Press both **SEEK** buttons together to listen for a few seconds to the next station on the AM or FM band; the scan will continue every few seconds to the next station on the AM or FM band.

The radio will scan upward if you press **SEEK▲** first and downward if you press **▼SEEK** first. When the radio is scanning stations, the word **SCAN** will appear on the digital display.

Press either of the **SEEK** buttons or the **PWR-VOL** knob to cancel **SCAN** and select a station.

## To Preset Radio Stations:

The four pushbuttons under the digital display can be used to preset up to 14 radio stations (seven AM and seven FM stations).

1. Tune in the desired station.
2. Press **SET**. The word **SET** will appear on the digital screen for five seconds.
3. While **SET** is displayed, press one of the four pushbuttons. Whenever you press this button again, the preset station will be tuned in.
4. Repeat steps 1-3 for each of the four AM and four FM stations.

Up to three additional stations on each band may be preset by "pairing" pushbuttons:

1. Tune in the desired station.
2. Press **SET**, and within five seconds press any two adjacent pushbuttons at the same time. Whenever you press these buttons again, the preset station will be tuned in.

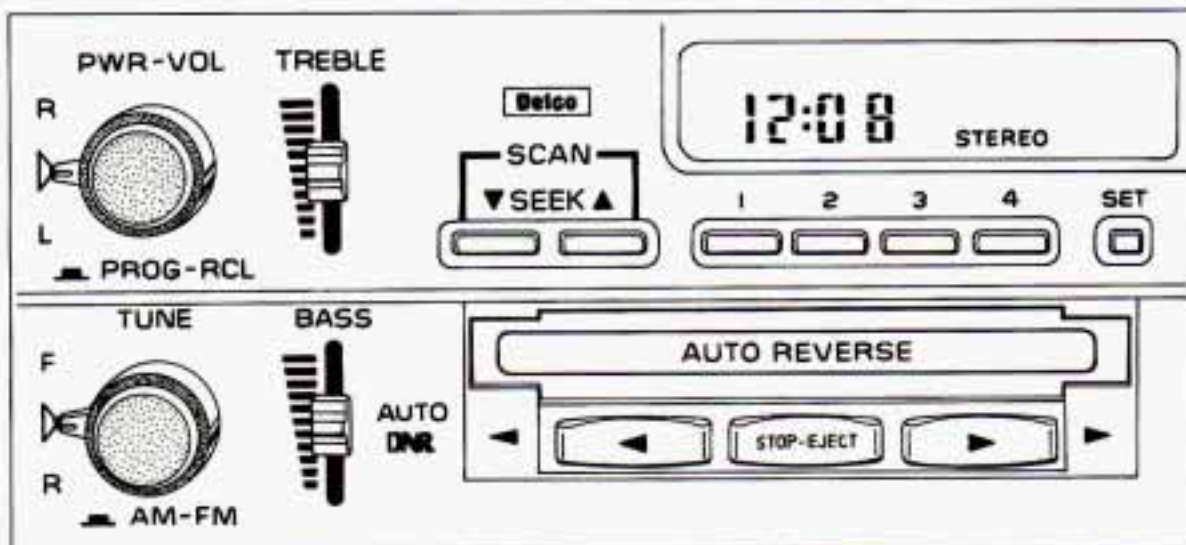

## AM/FM Stereo Radio with Cassette Tape Player

The digital display indicates information on time or radio station frequency, the AM or FM radio band, whether the station is in stereo, and other radio functions.

**PWR-VOL (Power-Volume):** With the ignition on, rotate the upper knob to turn the system on and off, and to control the volume.

**PROG-RCL (Program-Recall):** Press the upper knob to change between the clock and radio station frequency

displayed when the radio is on, to display the time when the ignition is off, and to change sides of the tape when a cassette is playing.

**R ▸ L (Balance):** The control ring behind the upper knob adjusts the right/left speaker balance.

**TUNE:** Rotate the lower knob to tune in radio stations.

**AM/FM:** Press the lower knob to change between the AM and FM bands.

**F ▸ R (Fade):** The control ring behind the lower knob adjusts the front/rear speaker balance.

**TREBLE:** Slide this lever up to increase treble, or down to decrease it. If a station is weak or noisy, reduce the treble.

**BASS:** Slide this lever up to increase bass, or down to decrease it.

**▼SEEK▲:** Press to seek and stop on the next station higher or lower on the radio band.

**SCAN:** Press both **SEEK** buttons together to listen for a few seconds to the next station on the AM or FM band; the scan will continue every few seconds to the next station on the AM or FM band.

The radio will scan upward if you press **SEEK▲** first and downward if you press **▼SEEK** first. When the radio is scanning stations, the word **SCAN** will appear on the digital display.

Press either of the **SEEK** buttons or the **PWR-VOL** knob to cancel **SCAN** and select a station.

### To Preset Radio Stations:

The four pushbuttons under the digital display can be used to preset up to 14 radio stations (seven AM and seven FM stations).

# Comfort Controls & Audio Systems

1. Tune in the desired station.
2. Press **SET**. The word **SET** will appear on the digital display for five seconds.
3. While **SET** is displayed, press one of the four pushbuttons. Whenever you press this button again, the preset station will be tuned in.
4. Repeat steps 1-3 for each of the four AM and four FM stations.

Up to three additional stations on each band may be preset by "pairing" pushbuttons:

1. Tune in the desired station.
2. Press **SET**, and within five seconds press any two adjacent pushbuttons at the same time. Whenever you press these buttons again, the preset station will be tuned in.

**AUTO DNR:** This unit is equipped with an automatic Dynamic Noise Reduction system that reduces background hiss on AM or FM radio broadcasts, as well as on cassette tapes.

## Cassette Tape Player

With the power on, insert a tape into the cassette door. Do not use tapes that are longer than 45 minutes on each side.

When the left arrow is lit, selections listed on the top side of the cassette are playing. When the right indicator arrow is lit, selections listed on the bottom side of the cassette are playing. To change sides of the tape, press the upper control knob (**PROG**) while the cassette is playing. The tape player automatically begins playing the other side when it reaches the end of the tape.

**Fast Forward:** Press the button with the arrow pointing in the same direction that the tape is playing. To stop fast forward, press the **STOP-EJECT** button.

**Reverse:** Press the button with the arrow pointing in the opposite direction that the tape is playing. To stop reverse, press the **STOP-EJECT** button.

**STOP-EJECT:** To stop playing a tape, fully press this button (the cassette will be partially ejected, and the radio will begin playing).

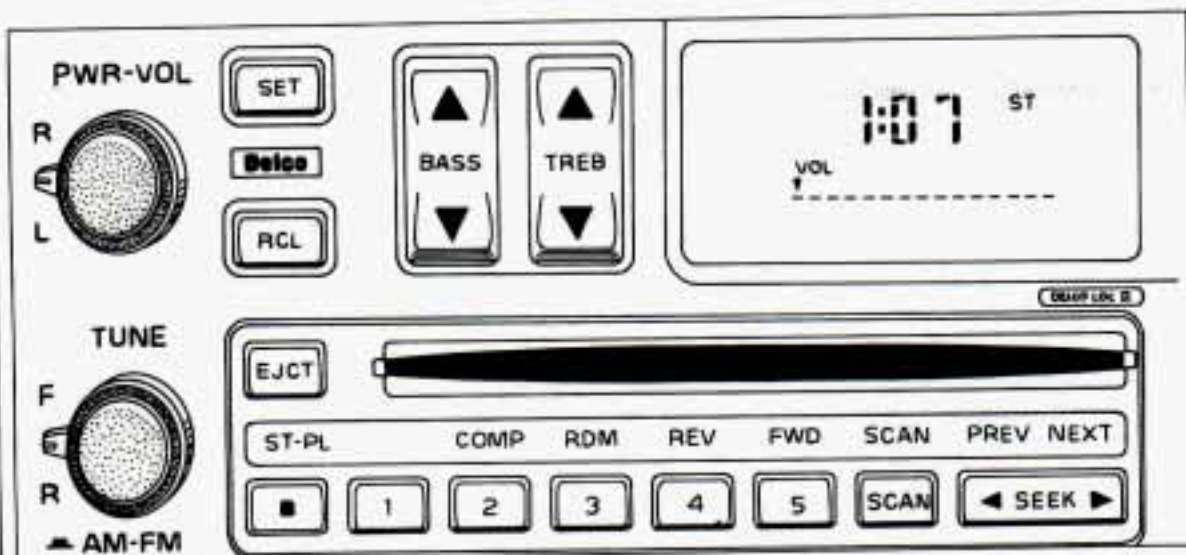

## AM/FM Stereo Radio with Compact Disc Player

The digital display indicates information on time or radio station frequency, the AM or FM radio band, whether the station is in stereo, and other radio functions.

**PWR-VOL (Power-Volume):** With the ignition on, rotate the upper knob to turn the system on and off and to control the volume.

**R/L (Balance):** The control ring behind the upper knob adjusts the right/left speaker balance.

**TUNE:** Rotate the lower knob to tune in radio stations.

**AM/FM:** Press the lower knob to change between AM and FM bands.

**F/R (Fade):** The control ring behind the lower knob adjusts the front/rear speaker balance.

**RCL (Recall):** Press this to change between the clock and radio frequency on the display. With the ignition off, you can press **RCL** to see the clock displayed.

**BASS:** Press this button to adjust the bass level up or down; press the center of the button for the factory preset level.

**TREB (Treble):** Press this button to adjust the treble level up or down; press the center of the button for the factory preset level. If a station is weak or noisy, reduce the treble.

## Radio Controls

**SEEK:** When you press the left side of this button, the radio automatically tunes to the next lower frequency on the band. When you press the right side, it automatically tunes to the next higher frequency on the band.

**SCAN:** Press to listen for a few seconds to the next station up or down on the AM or FM band. Press again to stop scanning.

## To Preset Radio Stations:

The five pushbuttons can be used to preset up to ten radio stations (five AM and five FM stations).

1. Tune in the desired station.
2. Press **SET**. The **SET** indicator will appear on the digital screen for five seconds.
3. While the **SET** indicator is displayed, press one of the five pushbuttons. Whenever you press this button again, the preset station will be tuned in.

# Comfort Controls & Audio Systems

- Repeat steps 1-3 for each of five AM and five FM stations.

## Compact Disc Player

Many of the controls for the radio also have functions for the compact disc player, as explained here.

Don't use mini-discs that are called singles. They won't eject. Use only full-size compact discs.

- Turn the **PWR-VOL** knob to turn on the power.
- Insert a disc part-way into the slot, with the label side up. The player will pull it in. Within a few seconds, the disc should play.

If the disc comes back out and/or **Err** appears on the display:

- The disc may be upside down.
- The disc may be dirty, scratched or wet.
- There may be too much moisture in the air (wait about one hour and try again).
- The player may be too hot, or the road may be too rough for the disc to play. As soon as things get back to normal, the disc should play.

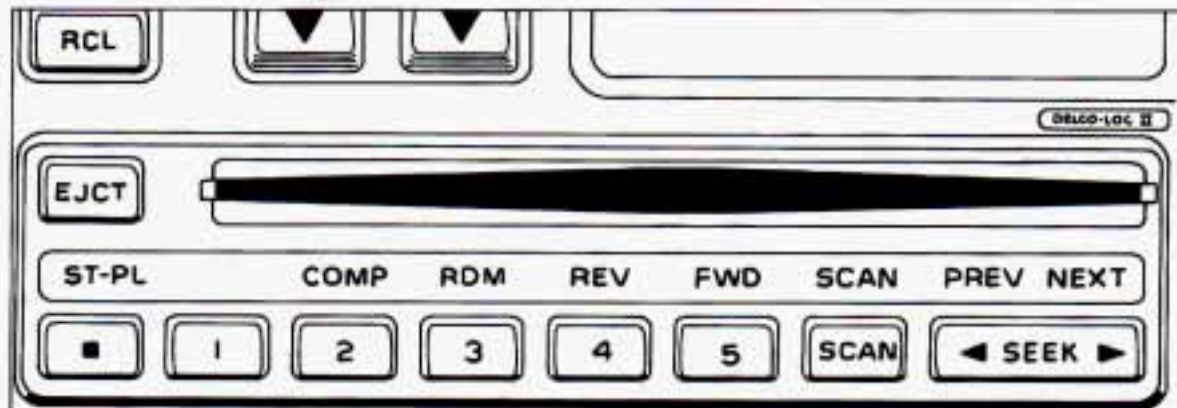

While a disc is playing, the CD indicator is displayed on the digital screen, as is the clock.

**RCL (Recall):** Press this button once to see which track is playing. Press again while the track number is still displayed to see how long your selection has been playing. The track number also will be displayed when the volume, bass, or treble is changed or a new track starts to play.

**COMP (Compression):** Pressing this button makes soft and loud passages more equal in volume. Press again to resume normal play.

**RDM (Random):** Press to play tracks in random, rather than sequential, order. This feature remains active until the **RDM** button is pressed again.

**REV (Reverse):** Press and hold to rapidly reverse the disc. Release to resume playing.

**FWD (Fast Forward):** Press and hold to rapidly advance the disc. Release to resume playing.

**SCAN:** Press this button to sample ten seconds of each track. Press again to stop scanning.

**PREV (Previous):** Press to play a track again. If you keep pressing the **PREV** button, the disc will keep backing up to previous tracks.

**NEXT:** Press to advance to the next track. If you keep pressing the **NEXT** button, the disc will keep advancing to other tracks.

## When Finished with the Compact Disc Player:

If you turn off the radio, or turn off the ignition, the disc will stay in the player

and start again when you turn on the ignition or the **PWR-VOL** button. The disc will begin playing at the point where it had been stopped.

**ST-PL (Stop-Play):** Press to stop the disc player; the radio will play. Press again to play the disc (the player will start playing the disc where it had stopped earlier).

**EJCT (Eject):** Press to eject the disc; the radio will play. The disc will start at track **1** when you reinsert it. **EJCT** works even when the radio or the ignition is off.

### **CD Player Anti-Theft Feature**

Delco LOC II® is a security feature that can be used or ignored. If you ignore it, the radio will play normally. If you use it, your radio cannot be turned on if it is stolen. These instructions will tell you how to enter a secret code into the radio. If battery power is lost for any reason, the secret code must be entered again before your audio system can be turned on.

#### **To Set the Anti-Theft System:**

1. Write down any six-digit number and keep it in a safe place. This is your secret code.

2. Turn the ignition on.
3. Rotate the **PWR-VOL** knob to turn the radio off.
4. Press station preset buttons **1** and **4** at the same time and hold until “- - -” shows on the display. You now have only 15 seconds between each of the following steps.
5. Press **SET** and **000** will appear on the display.
6. Press **SCAN** until the first digit of your code appears.
7. Press **SEEK** until the second and third digits of your code appear.
8. Press the **TUNE** knob (**000** will appear on the display).
9. Press **SCAN** until the fourth digit of your code appears.
10. Press **SEEK** until the fifth and sixth digits of your code appear.
11. Press the **TUNE** knob (**rEP** will appear for five seconds, then **000**).
12. Repeat steps 6 through 10. Then press the **TUNE** knob again. **SEC**

will appear, indicating that Delco LOC II® is set, and your radio is secure. If “- - -” appears, the steps were not successful and you must repeat the entire procedure.

#### **To Disable the Anti-Theft System:**

Enter your secret code by following these steps (you will have only 15 seconds between each step).

1. Turn the ignition on and the radio off, then press station preset buttons **1** and **4**. **SEC** will appear, showing the radio is secure.
2. Press **SET** and **000** will appear on the display.
3. Press **SCAN** until the first digit of your secret code appears.
4. Press **SEEK** until the second and third digits of your code appear.
5. Press the **TUNE** knob (**000** will appear on the display).
6. Press **SCAN** until the fourth digit of your code appears.
7. Press **SEEK** until the fifth and sixth digits of your code appear.



# Comfort Controls & Audio Systems

8. Press the **TUNE** knob. If the display shows " - - -," the radio is unsecured and will play again. If the display shows **SEC**, the steps were not successful and the numbers did not match the secret code.

If you lose or forget your code, see your dealer.

If you lose battery power, when the battery is reconnected the radio will not turn on and **LOC** will appear. Follow steps 1-8 for disabling your system, and the time will appear if you are successful. If **SEC** appears, the numbers did not match and your unit is still locked.

## *Understanding Radio Reception*

### **FM Stereo**

FM Stereo will give you the best sound, but FM signals will reach only about 10 to 40 miles (16 to 65 km). Tall buildings or hills can interfere with FM signals, causing the sound to come and go.

### **AM**

The range for most AM stations is greater than for FM, especially at night. The longer range, however, can cause stations to interfere with each other. AM can also pick up noise from things like storms and power lines. To lower this noise, try reducing the treble level.



## *Care of Your Cassette Tape Player*

A tape player that is not cleaned regularly is subject to reduced sound quality, ruining the cassette, or damaging the mechanism. Tape cassettes that are not properly stored in their plastic cases away from contaminants, direct sunlight, and extreme heat may not operate properly and could cause premature failure of the tape player.

Your tape player should be cleaned monthly or with every 15 hours of use, as regular maintenance. If you notice a reduction in sound quality, try a good cassette to see if the tape or the tape player is at fault. If the second cassette results in no improvement in sound

quality, try cleaning the tape player.

Proper tape player cleaning should be done with a **wiping action** nonabrasive cleaner cassette. To properly clean your tape player, you should follow the directions on the cleaning cassette.

Cassettes are subject to wear and the sound quality may degrade over time. Always verify that the cassette tape is in good condition before obtaining service on your tape player.



### **Care of Your Compact Discs**

Handle discs carefully. Store them in their original cases or other protective cases and away from direct sunlight and dust. If the surface of a disc is soiled, dampen a clean, soft cloth in a mild, neutral detergent solution and clean it, wiping from the center to the edge.

Be sure never to touch the signal surface when handling discs. Pick up discs by grasping the outer edges or the edge of the hole and the outer edge.

### **Fixed Mast Antenna**

The fixed mast antenna can withstand most car washes without being damaged. If the mast should ever become slightly bent, you can straighten it out by hand. If the mast is badly bent, as it might be by vandals, you should replace it.

Check every once in a while to be sure the mast is still tightened to the fender.

# Notes



**H**ere you'll find information about driving on different kinds of roads and in varying weather conditions. We've also included many other useful tips on driving.

## Part 4 Your Driving and the Road

Defensive Driving.....	108
Drunken Driving.....	108
Control of a Vehicle	
Braking.....	110
Anti-Lock Brakes.....	111
Steering Tips.....	113
Steering in Emergencies.....	114
Passing.....	115
Driving at Night.....	117
Driving in the Rain.....	118
City Driving.....	119
Freeway Driving.....	120
Before Leaving on a Long Trip.....	121
Hill and Mountain Roads.....	122
Winter Driving.....	123
Recreational Towing.....	125
Towing a Trailer.....	126

# Your Driving and the Road

## ■ *Defensive Driving*

The best advice anyone can give about driving is: Drive defensively.

Please start with a very important safety device in your Chevrolet: Buckle up. (See *Safety Belts* in the *Index*.)

Defensive driving really means “be ready for anything.” On city streets, rural roads, or freeways, it means “always expect the unexpected.”

Assume that pedestrians or other drivers are going to be careless and make mistakes. Anticipate what they might do. Be ready for their mistakes.

Rear-end collisions are about the most preventable of accidents. Yet they are common. Allow enough following distance. It's the best defensive driving maneuver, in both city and rural driving. You never know when the vehicle in front of you is going to brake or turn suddenly.

## ■ *Drunken Driving*

Death and injury associated with drinking and driving is a national tragedy. It's the number one contributor to the highway death toll, claiming thousands of victims every year. Alcohol takes away three things that anyone needs to drive a vehicle:

- Judgment
- Muscular Coordination
- Vision

Police records show that almost half of all motor vehicle-related deaths involve alcohol — a driver, a passenger or someone else, such as a pedestrian, had been drinking. In most cases, these deaths are the result of someone who was drinking and driving. About 20,000 motor vehicle-related deaths occur each year because of alcohol, and thousands of people are injured.

Just how much alcohol is too much if a person plans to drive? Ideally, no one should drink alcohol and then drive. But if one does, then what's “too much”? It can be a lot less than many might think. Although it depends on each person and situation, here is some general information on the problem.

The Blood Alcohol Content (BAC) of someone who is drinking depends upon four things:

- How much alcohol is in the drink.
- The drinker's body weight.
- The amount of food that is consumed before and during drinking.
- The length of time it has taken the drinker to consume the alcohol.



According to the American Medical Association, a 180-pound (82 kg) person who drinks three 12-ounce (355 ml) bottles of beer in an hour will end up with a BAC of about 0.06 percent. The person would reach the same BAC by drinking three 4-ounce (120 ml) glasses of wine or three mixed drinks if each had 1½ ounces (45 ml) of a liquor like whiskey, gin or vodka.

It's the amount of alcohol that counts. For example, if the same person drank three double martinis (3 ounces or 90 ml of liquor each) within an hour, the person's BAC would be close to 0.12 percent. A person who consumes food just before or during drinking will have a slightly lower BAC level.

### **Drinking That Will Result in a BAC of .05% in the Time Shown**

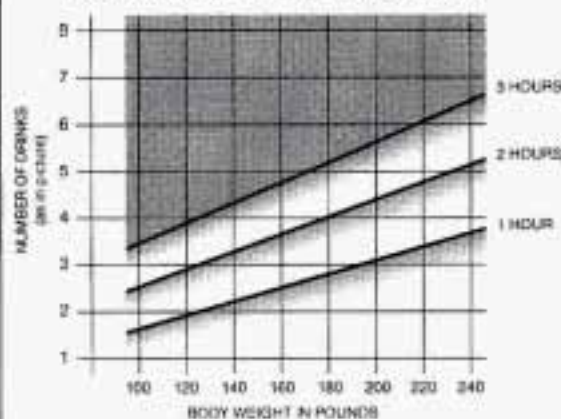

The law in most U.S. states sets the legal limit at a BAC of 0.10 percent. In Canada the limit is 0.08 percent, and in some other countries it's lower than that. The BAC will be over 0.10 percent after three to six drinks (in one hour). Of course, as we've seen, it depends on how much alcohol is in the drinks, and how quickly the person drinks them.

But it's very important to keep in mind that the ability to drive is affected well below a BAC of 0.10 percent. Research shows that the driving skills of many people are impaired at a BAC approaching 0.05 percent, and that the

effects are worse at night. All drivers are impaired at BAC levels above 0.05 percent. Statistics show that the chance of being in an accident increases sharply for drivers who have a BAC of 0.05 percent or above. A driver with a BAC level of 0.06 percent (three beers in one hour for a 180-pound or 82 kg person) has doubled his or her chance of having an accident. At a BAC level of 0.10 percent, the chance of that driver having an accident is six times greater; at a level of 0.15 percent, the chances are twenty-five times greater! And, the body takes about an hour to rid itself of the alcohol in one drink. No amount of coffee or number of cold showers will speed that up.

"I'll be careful" isn't the right answer. What if there's an emergency, a need to take sudden action, as when a child darts into the street? A person with a higher BAC might not be able to react quickly enough to avoid the collision.

There's something else about drinking and driving that many people don't know. Medical research shows that alcohol in a person's system can make crash injuries worse. That's especially

# Your Driving and the Road

true for brain, spinal cord and heart injuries. That means that if anyone who has been drinking — driver or passenger — is in a crash, the chance of being killed or permanently disabled is higher than if that person had not been drinking. And we've already seen that the chance of a crash itself is higher for drinking drivers.



## CAUTION:

Drinking and then driving is very dangerous. Your reflexes, perceptions, and judgment will be affected by even a small amount of alcohol. You could have a serious — or even fatal — accident if you drive after drinking. Please don't drink and drive or ride with a driver who has been drinking. Ride home in a cab; or if you're with a group, designate a driver who will not drink.



## ■ *Control of a Vehicle*

You have three systems that make your vehicle go where you want it to go. They are the brakes, the steering and the accelerator. All three systems have to do their work at the places where the tires meet the road.

Sometimes, as when you're driving on snow or ice, it's easy to ask more of those control systems than the tires and road can provide. That means you can lose control of your vehicle.

## ■ *Braking*

Braking action involves **perception time** and **reaction time**.

First, you have to decide to push on the brake pedal. That's **perception time**. Then you have to bring up your foot and do it. That's **reaction time**.

Average **reaction time** is about 3/4 of a second. But that's only an average. It might be less with one driver and as long as two or three seconds or more with another. Age, physical condition, alertness, coordination, and eyesight all play a part. So do alcohol, drugs and frustration. But even in 3/4 of a second, a vehicle moving at 60 mph (100 km/h) travels 66 feet (20 m). That could be a lot of distance in an emergency, so keeping enough space between your vehicle and others is important.

And, of course, actual stopping distances vary greatly with the surface of the road (whether it's pavement or gravel); the condition of the road (wet, dry, icy); tire tread; and the condition of your brakes.

Avoid needless heavy braking. Some people drive in spurts — heavy acceleration followed by heavy braking — rather than keeping pace with traffic. This is a mistake. Your brakes may not have time to cool between hard stops. Your brakes will wear out much faster if you do a lot of heavy braking. If you keep pace with the traffic and allow

realistic following distances, you will eliminate a lot of unnecessary braking. That means better braking and longer brake life.

If your engine ever stops while you're driving, brake normally but don't pump your brakes. If you do, the pedal may get harder to push down. If your engine stops, you will still have some power brake assist. But you will use it when you brake. Once the power assist is used up, it may take longer to stop and the brake pedal will be harder to push.

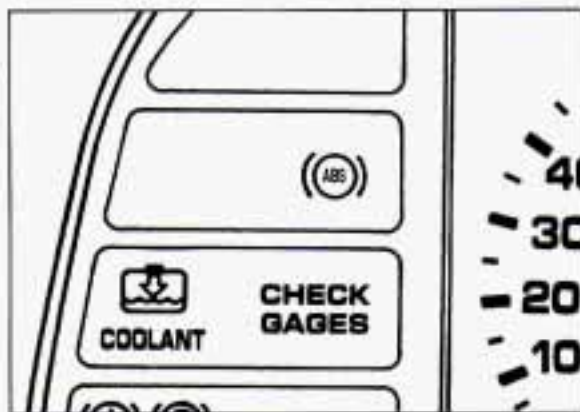

### ***Anti-Lock Brakes (ABS)***

Your Chevrolet has an advanced electronic braking system that will help prevent skidding.

This light on the instrument panel will go on when you start your vehicle.

When you start your vehicle, or when you begin to drive away, you may hear a momentary motor or clicking noise.



# Your Driving and the Road



And you may even notice that your brake pedal moves a little while this is going on. This is the ABS system testing itself. If there's a problem with the anti-lock brake system, the anti-lock brake system warning light will stay on or flash.

See *Anti-lock Brake System Warning Light* in the *Index*.



Here's how anti-lock works. Let's say the road is wet. You're driving safely. Suddenly an animal jumps out in front of you.

You slam on the brakes. Here's what happens with ABS.

A computer senses that wheels are slowing down. If one of the wheels is about to stop rolling, the computer will separately work the brakes at each front wheel and at the rear wheels.

The anti-lock system can change the brake pressure faster than any driver could. The computer is programmed to make the most of available tire and road conditions.



You can steer around the obstacle while braking hard.

As you brake, your computer keeps receiving updates on wheel speed and controls braking pressure accordingly.

Remember: Anti-lock doesn't change the time you need to get your foot up to the brake pedal. If you get too close to the vehicle in front of you, you won't have time to apply your brakes if that vehicle suddenly slows or stops. Always leave enough room up ahead to stop, even though you have anti-lock brakes.

## **To Use Anti-Lock**

Don't pump the brakes. Just hold the brake pedal down and let anti-lock work for you. You may feel the system working, or you may notice some noise, but this is normal.

## ***Braking in Emergencies***

Use your anti-lock braking system when you need to. With anti-lock, you can steer and brake at the same time. In many emergencies, steering can help you more than even the very best braking.

## ■ ***Steering***

### ***Power Steering***

If you lose power steering assist because the engine stops or the system is not functioning, you can steer but it will take much more effort.

## ***Steering Tips***

### ***Driving on Curves***

It's important to take curves at a reasonable speed.

A lot of the "driver lost control" accidents mentioned on the news happen on curves. Here's why:

Experienced driver or beginner, each of us is subject to the same laws of physics when driving on curves. The traction of the tires against the road surface makes it possible for the vehicle to change its path when you turn the front wheels. If there's no traction, inertia will keep the vehicle going in the same direction. If you've ever tried to steer a vehicle on wet ice, you'll understand this.

The traction you can get in a curve depends on the condition of your tires and the road surface, the angle at which the curve is banked, and your speed. While you're in a curve, speed is the one factor you can control.

Suppose you're steering through a sharp curve. Then you suddenly

accelerate. Both control systems — steering and acceleration — have to do their work where the tires meet the road. Adding the sudden acceleration can demand too much of those places. You can lose control.

What should you do if this ever happens? Ease up on the accelerator pedal, steer the vehicle the way you want it to go, and slow down.

Speed limit signs near curves warn that you should adjust your speed. Of course, the posted speeds are based on good weather and road conditions. Under less favorable conditions you'll want to go slower.

If you need to reduce your speed as you approach a curve, do it before you enter the curve, while your front wheels are straight ahead.

Try to adjust your speed so you can "drive" through the curve. Maintain a reasonable, steady speed. Wait to accelerate until you are out of the curve, and then accelerate gently into the straightaway.

# Your Driving and the Road



## Steering in Emergencies

There are times when steering can be more effective than braking. For example, you come over a hill and find a truck stopped in your lane, or a car suddenly pulls out from nowhere, or a child darts out from between parked cars and stops right in front of you. You can avoid these problems by braking — if you can stop in time. But sometimes you can't; there isn't room. That's the time for evasive action — steering around the problem.

Your Chevrolet can perform very well in emergencies like these. First apply your brakes. It is better to remove as much speed as you can from a possible

collision. Then steer around the problem, to the left or right depending on the space available.

An emergency like this requires close attention and a quick decision. If you are holding the steering wheel at the recommended 9 and 3 o'clock positions, you can turn it a full 180 degrees very quickly without removing either hand. But you have to act fast, steer quickly, and just as quickly straighten the wheel once you have avoided the object.

The fact that such emergency situations are always possible is a good reason to practice defensive driving at all times and wear safety belts properly.



## ■ Off-Road Recovery

You may find sometime that your right wheels have dropped off the edge of a road onto the shoulder while you're driving.

If the level of the shoulder is only slightly below the pavement, recovery should be fairly easy. Ease off the accelerator and then, if there is nothing in the way, steer so that your vehicle straddles the edge of the pavement. You can turn the steering wheel up to 1/4 turn until the right front tire contacts the pavement edge. Then turn your steering wheel to go straight down the roadway.

## ■ *Passing*

The driver of a vehicle about to pass another on a two-lane highway waits for just the right moment, accelerates, moves around the vehicle ahead, then goes back into the right lane again. A simple maneuver?

Not necessarily! Passing another vehicle on a two-lane highway is a potentially dangerous move, since the passing vehicle occupies the same lane as oncoming traffic for several seconds. A miscalculation, an error in judgment, or a brief surrender to frustration or anger can suddenly put the passing driver face to face with the worst of all traffic accidents — the head-on collision.

So here are some tips for passing:

- “Drive ahead.” Look down the road, to the sides, and to crossroads for situations that might affect your passing patterns. If you have any doubt whatsoever about making a successful pass, wait for a better time.
- Watch for traffic signs, pavement markings, and lines. If you can see a sign up ahead that might indicate a turn or an intersection, delay your

pass. A broken center line usually indicates it’s all right to pass (providing the road ahead is clear). Never cross a solid line on your side of the lane or a double solid line, even if the road seems empty of approaching traffic.

- Do not get too close to the vehicle you want to pass while you’re awaiting an opportunity. For one thing, following too closely reduces your area of vision, especially if you’re following a larger vehicle. Also, you won’t have adequate space if the vehicle ahead suddenly slows or stops. Keep back a reasonable distance.
- When it looks like a chance to pass is coming up, start to accelerate but stay in the right lane and don’t get too close. Time your move so you will be increasing speed as the time comes to move into the other lane. If the way is clear to pass, you will have a “running start” that more than makes up for the distance you would lose by dropping back. And if something happens to cause you to cancel your pass, you need only slow down and drop back again and wait for another opportunity.
- If other cars are lined up to pass a slow vehicle, wait your turn. But take care that someone isn’t trying to pass you as you pull out to pass the slow vehicle. Remember to glance over your shoulder and check the blind spot.
- Check your mirrors, glance over your shoulder, and start your left lane change signal before moving out of the right lane to pass. When you are far enough ahead of the passed vehicle to see its front in your inside mirror, activate your right lane change signal and move back into the right lane. (Remember that your right outside mirror is convex. The vehicle you just passed may seem to be farther away from you than it really is.)
- Try not to pass more than one vehicle at a time on two-lane roads. Reconsider before passing the next vehicle.
- Don’t overtake a slowly moving vehicle too rapidly. Even though the brake lights are not flashing, it may be slowing down or starting to turn.

# Your Driving and the Road

- If you're being passed, make it easy for the following driver to get ahead of you. Perhaps you can ease a little to the right.

## ■ *Loss of Control*

Let's review what driving experts say about what happens when the three control systems (brakes, steering and acceleration) don't have enough friction where the tires meet the road to do what the driver has asked.

In any emergency, don't give up. Keep trying to steer and constantly seek an escape route or area of less danger.

## *Skidding*

In a skid, a driver can lose control of the vehicle. Defensive drivers avoid most skids by taking reasonable care suited to existing conditions, and by not "overdriving" those conditions. But skids are always possible.

The three types of skids correspond to your Chevrolet's three control systems. In the braking skid your wheels aren't rolling. In the steering or cornering skid, too much speed or steering in a curve causes tires to slip and lose cornering force. And in the acceleration skid too much throttle causes the driving wheels to spin.

A cornering skid and an acceleration skid are best handled by easing your foot off the accelerator pedal.

If your vehicle starts to slide, ease your foot off the accelerator pedal and quickly steer the way you want the vehicle to go. If you start steering quickly enough, your vehicle may straighten out. Always be ready for a second skid if it occurs.

Of course, traction is reduced when water, snow, ice, gravel, or other material is on the road. For safety, you'll want to slow down and adjust your driving to these conditions. It is important to slow down on slippery surfaces because stopping distance will be longer and vehicle control more limited.

While driving on a surface with reduced traction, try your best to avoid sudden steering, acceleration, or braking (including engine braking by shifting to a lower gear). Any sudden changes could cause the tires to slide. You may not realize the surface is slippery until your vehicle is skidding. Learn to recognize warning clues — such as enough water, ice or packed snow on the road to make a "mirrored surface" — and slow down when you have any doubt.

Remember: Any anti-lock braking system (ABS) helps avoid only the braking skid.



## ■ *Driving at Night*

Night driving is more dangerous than day driving. One reason is that some drivers are likely to be impaired — by alcohol or drugs, with night vision problems, or by fatigue.

Here are some tips on night driving.

- Drive defensively.
- Don't drink and drive.
- Adjust your inside rearview mirror to reduce the glare from headlights behind you.
- Since you can't see as well, you may need to slow down and keep more space between you and other vehicles.

- Slow down, especially on higher speed roads. Your headlights can light up only so much road ahead.
- In remote areas, watch for animals.
- If you're tired, pull off the road in a safe place and rest.

## *Night Vision*

No one can see as well at night as in the daytime. But as we get older these differences increase. A 50-year-old driver may require at least twice as much light to see the same thing at night as a 20-year-old.

What you do in the daytime can also affect your night vision. For example, if you spend the day in bright sunshine you are wise to wear sunglasses. Your eyes will have less trouble adjusting to night. But if you're driving, don't wear sunglasses at night. They may cut down on glare from headlights, but they also make a lot of things invisible.

You can be temporarily blinded by approaching lights. It can take a second or two, or even several seconds, for

your eyes to readjust to the dark. When you are faced with severe glare (as from a driver who doesn't lower the high beams, or a vehicle with misaimed headlights), slow down a little. Avoid staring directly into the approaching lights.

Keep your windshield and all the glass on your vehicle clean — inside and out. Glare at night is made much worse by dirt on the glass. Even the inside of the glass can build up a film caused by dust. Dirty glass makes lights dazzle and flash more than clean glass would, making the pupils of your eyes contract repeatedly.

Remember that your headlights light up far less of a roadway when you are in a turn or curve. Keep your eyes moving; that way, it's easier to pick out dimly lighted objects. Just as your headlights should be checked regularly for proper aim, so should your eyes be examined regularly. Some drivers suffer from night blindness — the inability to see in dim light — and aren't even aware of it.

# Your Driving and the Road



## ■ *Driving in the Rain*

Rain and wet roads can mean driving trouble. On a wet road you can't stop, accelerate or turn as well because your tire-to-road traction isn't as good as on dry roads. And, if your tires don't have much tread left, you'll get even less traction. It's always wise to go slower and be cautious if rain starts to fall while you are driving. The surface may get wet suddenly when your reflexes are tuned for driving on dry pavement.

The heavier the rain, the harder it is to see. Even if your windshield wiper blades are in good shape, a heavy rain can make it harder to see road signs and traffic signals, pavement markings, the edge of the road, and even people walking.

It's wise to keep your wiping equipment in good shape and keep your windshield washer tank filled. Replace your windshield wiper inserts when they show signs of streaking or missing areas on the windshield, or when strips of rubber start to separate from the inserts.



Driving too fast through large water puddles or even going through some car washes can cause problems, too. The water may affect your brakes. Try to avoid puddles. But if you can't, try to slow down before you hit them.



### **CAUTION:**

Wet brakes can cause accidents. They won't work well in a quick stop and may cause pulling to one side. You could lose control of the vehicle. After driving through a large puddle of water or a car wash, apply your brake pedal lightly until your brakes work normally.

## Hydroplaning

Hydroplaning is dangerous. So much water can build up under your tires that they can actually ride on the water. This can happen if the road is wet enough and you're going fast enough. When your vehicle is hydroplaning, it has little or no contact with the road.

Hydroplaning doesn't happen often. But it can if your tires haven't much tread or if the pressure in one or more is low. It can happen if a lot of water is standing on the road. If you can see reflections from trees, telephone poles, or other vehicles, and raindrops "dimple" the water's surface, there could be hydroplaning.

Hydroplaning usually happens at higher speeds. There just isn't a hard and fast rule about hydroplaning. The best advice is to slow down when it is raining.

## Some Other Rainy Weather Tips

- Turn on your low-beam headlights — not just your parking lights — to help make you more visible to others.
- Besides slowing down, allow some extra following distance. And be especially careful when you pass another vehicle. Allow yourself more clear room ahead, and be prepared to have your view restricted by road spray.
- Have good tires with proper tread depth. (See *Tires* in the *Index*.)



## ■ City Driving

One of the biggest problems with city streets is the amount of traffic on them. You'll want to watch out for what the other drivers are doing and pay attention to traffic signals.

Here are ways to increase your safety in city driving:

- Know the best way to get to where you are going. Get a city map and plan your trip into an unknown part of the city just as you would for a cross-country trip.
- Try to use the freeways that rim and crisscross most large cities. You'll save time and energy. (See the next section, *Freeway Driving*.)



# Your Driving and the Road

- Treat a green light as a warning signal. A traffic light is there because the corner is busy enough to need it. When a light turns green, and just before you start to move, check both ways for vehicles that have not cleared the intersection or may be running the red light.



## ■ *Freeway Driving*

Mile for mile, freeways (also called thruways, parkways, expressways, turnpikes, or superhighways) are the safest of all roads. But they have their own special rules.

The most important advice on freeway driving is: Keep up with traffic and keep to the right. Drive at the same speed most of the other drivers are driving. Too-fast or too-slow driving breaks a smooth traffic flow. Treat the left lane on a freeway as a passing lane.

At the entrance there is usually a ramp that leads to the freeway. If you have a clear view of the freeway as you drive along the entrance ramp, you should begin to check traffic. Try to determine where you expect to blend with the

flow. Try to merge into the gap at close to the prevailing speed. Switch on your turn signal, check your mirrors and glance over your shoulder as often as necessary. Try to blend smoothly with the traffic flow.

Once you are on the freeway, adjust your speed to the posted limit or to the prevailing rate if it's slower. Stay in the right lane unless you want to pass.

Before changing lanes, check your mirrors. Then use your turn signal.

Just before you leave the lane, glance quickly over your shoulder to make sure there isn't another vehicle in your "blind" spot.

Once you are moving on the freeway, make certain you allow a reasonable following distance. Expect to move slightly slower at night.

When you want to leave the freeway, move to the proper lane well in advance. If you miss your exit do not, under any circumstances, stop and back up. Drive on to the next exit.

The exit ramp can be curved, sometimes quite sharply.

The exit speed is usually posted.

Reduce your speed according to your speedometer, not to your sense of motion. After driving for any distance at higher speeds, you may tend to think you are going slower than you actually are.

## ■ *Before Leaving on a Long Trip*

Make sure you're ready. Try to be well rested. If you must start when you're not fresh — such as after a day's work — don't plan to make too many miles that first part of the journey. Wear comfortable clothing and shoes you can easily drive in.

Is your vehicle ready for a long trip? If you keep it serviced and maintained, it's ready to go. If it needs service, have it done before starting out. Of course, you'll find experienced and able service experts in Chevrolet dealerships all across North America. They'll be ready and willing to help if you need it.

Here are some things you can check before a trip:

- **Windshield Washer Fluid:** Is the reservoir full? Are all windows clean inside and outside?

- **Wiper Blades:** Are they in good shape?
- **Fuel, Engine Oil, Other Fluids:** Have you checked all levels?
- **Lights:** Are they all working? Are the lenses clean?
- **Tires:** They are vitally important to a safe, trouble-free trip. Is the tread good enough for long-distance driving? Are the tires all inflated to the recommended pressure?
- **Weather Forecasts:** What's the weather outlook along your route? Should you delay your trip a short time to avoid a major storm system?
- **Maps:** Do you have up-to-date maps?

## ■ *Highway Hypnosis*

Is there actually such a condition as "highway hypnosis"? Or is it just plain falling asleep at the wheel? Call it highway hypnosis, lack of awareness, or whatever.

There is something about an easy stretch of road with the same scenery, along with the hum of the tires on the road, the drone of the engine, and the

rush of the wind against the vehicle that can make you sleepy. Don't let it happen to you! If it does, your vehicle can leave the road in **less than a second**, and you could crash and be injured.

What can you do about highway hypnosis? First, be aware that it can happen.

Then here are some tips:

- Make sure your vehicle is well ventilated, with a comfortably cool interior.
- Keep your eyes moving. Scan the road ahead and to the sides. Check your rearview mirrors and your instruments frequently.
- If you get sleepy, pull off the road into a rest, service, or parking area and take a nap, get some exercise, or both. For safety, treat drowsiness on the highway as an emergency.

# Your Driving and the Road



## ■ *Hill and Mountain Roads*

Driving on steep hills or mountains is different from driving in flat or rolling terrain.

If you drive regularly in steep country, or if you're planning to visit there, here are some tips that can make your trips safer and more enjoyable.

- Keep your vehicle in good shape. Check all fluid levels and also the brakes, tires, cooling system and transaxle. These parts can work hard on mountain roads.
- Know how to go down hills. The most important thing to know is this: let your engine do some of the slowing down. Shift to a lower gear when you go down a steep or long hill.



### **CAUTION:**

If you don't shift down, your brakes could get so hot that they wouldn't work well. You would then have poor braking or even none going down a hill. You could crash. Shift down to let your engine assist your brakes on a steep downhill slope.



### **CAUTION:**

Coasting downhill in N (Neutral) or with the ignition off is dangerous. Your brakes will have to do all the work of slowing down. They could get so hot that they wouldn't work well. You could crash. Always have your engine running and your vehicle in gear when you go downhill.

- Know how to go uphill. You may want to shift down to a lower gear. The lower gears help cool your engine and transaxle, and you can climb the hill better.
- Stay in your own lane when driving on two-lane roads in hills or mountains. Don't swing wide or cut across the center of the road. Drive at speeds that let you stay in your own lane.
- As you go over the top of a hill, be alert. There could be something in your lane, like a stalled car or an accident.
- You may see highway signs on mountains that warn of special problems. Examples are long grades, passing or no-passing zones, a falling rocks area, or winding roads. Be alert to these and take appropriate action.



## ■ *Winter Driving*

Here are some tips for winter driving:

- Have your Chevrolet in good shape for winter. Be sure your engine coolant mix is correct.



- You may want to put winter emergency supplies in your trunk.

Include an ice scraper, a small brush or broom, a supply of windshield washer fluid, a rag, some winter outer clothing, a small shovel, a flashlight, a red cloth, and a couple of reflective warning triangles. And, if you will be driving under severe conditions, include a small bag of sand, a piece of old carpet or a couple of burlap bags to help provide traction. Be sure you properly secure these items in your vehicle.



## *Driving on Snow or Ice*

Most of the time, those places where your tires meet the road probably have good traction.

However, if there is snow or ice between your tires and the road, you can have a very slippery situation. You'll have a lot less traction or "grip" and will need to be very careful.

What's the worst time for this? "Wet ice." Very cold snow or ice can be slick and hard to drive on. But wet ice can be even more trouble because it may offer the least traction of all. You can get "wet ice" when it's about freezing (32°F; 0°C) and freezing rain begins to fall. Try to avoid driving on wet ice until salt and sand crews can get there.

# Your Driving and the Road

Whatever the condition — smooth ice, packed, blowing or loose snow — drive with caution. Accelerate gently. Try not to break the fragile traction. If you accelerate too fast, the drive wheels will spin and polish the surface under the tires even more.

Your anti-lock brakes improve your ability to make a hard stop on a slippery road. Even though you have the anti-lock braking system, you'll want to begin stopping sooner than you would on dry pavement. See *Anti-lock* in the *Index*.

- Allow greater following distance on any slippery road.
- Watch for slippery spots. The road might be fine until you hit a spot that's covered with ice. On an otherwise clear road, ice patches may appear in shaded areas where the sun can't reach: around clumps of trees, behind buildings, or under bridges. Sometimes the surface of a curve or an overpass may remain icy when the surrounding roads are clear. If you see a patch of ice ahead of you, brake before you are on it. Try not to brake while you're actually on the ice, and avoid sudden steering maneuvers.



## ***If You're Caught in a Blizzard***

If you are stopped by heavy snow, you could be in a serious situation. You should probably stay with your vehicle unless you know for sure that you are near help and you can hike through the snow. Here are some things to do to summon help and keep yourself and your passengers safe: Turn on your hazard flashers. Tie a red cloth to your vehicle to alert police that you've been stopped by the snow. Put on extra clothing or wrap a blanket around you. If you have no blankets or extra clothing, make body insulators from newspapers, burlap bags, rags, floor mats — anything you can wrap around yourself or tuck under your clothing to keep warm. You can run the engine to keep warm, but be careful.



## **CAUTION:**

Snow can trap exhaust gases under your vehicle. This can cause deadly CO (carbon monoxide) gas to get inside. CO could overcome you and kill you. You can't see it or smell it, so you might not know it is in your vehicle. Clear away snow from around the base of your vehicle, especially any that is blocking your exhaust pipe. And check around again from time to time to be sure snow doesn't collect there. Open a window just a little on the side of the vehicle that's away from the wind. This will help keep CO out.

Run your engine only as long as you must. This saves fuel. When you run the engine, make it go a little faster than just idle. That is, push the accelerator slightly. This uses less fuel for the heat that you get and it keeps the battery charged. You will need a well-charged battery to restart the vehicle, and possibly for signaling later on with your headlights. Let the heater run for awhile.

Then, shut the engine off and close the window almost all the way to preserve the heat. Start the engine again and repeat this only when you feel really uncomfortable from the cold. But do it as little as possible. Preserve the fuel as long as you can. To help keep warm, you can get out of the vehicle and do some fairly vigorous exercises every half hour or so until help comes.



### ■ *Recreational Towing*

If your vehicle has a manual transaxle, you can tow your vehicle behind another vehicle for use at your destination. Be sure to use proper towing equipment designed for recreational towing. Follow the instructions for the towing equipment.

### ***Towing Your Vehicle from the Front***

Tow your vehicle with all four wheels on the ground. Follow these steps:

1. Set the parking brake.
2. Turn the ignition key to **OFF** to unlock the steering wheel. **OFF** will also prevent the automatic door locks from locking.
3. Shift your manual transaxle to **N** (Neutral).
4. Release the parking brake.

#### **NOTICE:**

Make sure that the towing speed does not exceed 55 mph (90 km/h), or your vehicle could be badly damaged.

# Your Driving and the Road

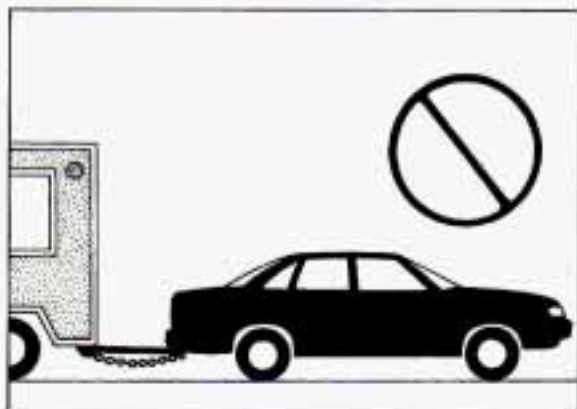

## *Towing Your Vehicle from the Rear*

### **NOTICE:**

Do not tow your vehicle from the rear. Your vehicle could be badly damaged and the repairs would not be covered by your warranty.

### ■ *Towing A Trailer*

Your Chevrolet is neither designed nor intended to tow a trailer.



## Part 5 Problems on the Road

**H**ere you'll find what to do about some problems that can occur on the road.

Hazard Warning Flashers .....	128
Jump Starting .....	128
Towing Your Vehicle .....	132
Engine Overheating.....	136
If a Tire Goes Flat .....	145
Changing a Flat Tire.....	146
Compact Spare Tire .....	151
If You're Stuck: In Sand, Mud, Ice or Snow .....	152



# Problems on the Road



## ■ Hazard Warning Flashers

Your hazard warning flashers let you warn others. They also let police know you have a problem. Your front and rear turn signal lights will flash on and off.

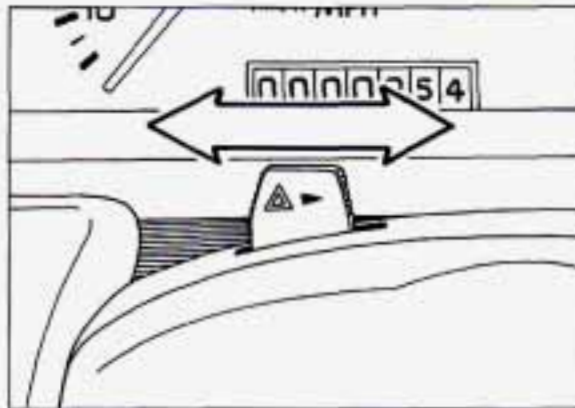

Move the switch to the right to make your front and rear turn signal lights flash on and off.

Your hazard warning flashers work no matter what position your key is in, and even if the key isn't in.

To turn off the flashers, move the switch to the left.

When the hazard warning flashers are on, your turn signals won't work.

## ■ Other Warning Devices

If you carry reflective triangles, you can set one up at the side of the road about 300 feet (100 m) behind your vehicle.

## ■ Jump Starting

If your battery has run down, you may want to use another vehicle and some jumper cables to start your Chevrolet. But please follow the steps below to do it safely.



### CAUTION:

Batteries can hurt you. They can be dangerous because:

- They contain **acid** that can burn you.
- They contain **gas** that can explode or ignite.
- They contain enough **electricity** to burn you.

If you don't follow these steps exactly, some or all of these things can hurt you.

**NOTICE:**

Ignoring these steps could result in costly damage to your vehicle that wouldn't be covered by your warranty. Trying to start your Chevrolet by pushing or pulling it could damage your vehicle, even if you have a manual transaxle. And if you have an automatic transaxle, it won't start that way.

**To Jump Start Your Chevrolet:**

1. Check the other vehicle. It must have a 12-volt battery with a negative ground system.

**NOTICE:**

If the other system isn't a 12-volt system with a negative ground, both vehicles can be damaged.

2. Get the vehicles close enough so the jumper cables can reach, but be sure the vehicles aren't touching each other. If they are, it could cause a ground connection you don't want. You wouldn't be able to start your Chevrolet, and the bad grounding could damage the electrical systems.

You could be injured if the vehicles roll. Set the parking brake firmly on each vehicle. Put an automatic transaxle in **P** (Park) or a manual transaxle in **N** (Neutral).

3. Turn off the ignition on both vehicles. Turn off all lights that aren't needed, and radios. This will avoid sparks and help save both batteries. And it could save your radio!

**NOTICE:**

If you leave your radio on, it could be badly damaged. The repairs wouldn't be covered by your warranty.

4. Open the hoods and locate the batteries.

**CAUTION:**

An electric fan can start up even when the engine is not running and can injure you. Keep hands, clothing and tools away from any underhood electric fan.

Find the positive (+) and negative (-) terminals on each battery.

# Problems on the Road



## CAUTION:

Using a match near a battery can cause battery gas to explode. People have been hurt doing this, and some have been blinded. Use a flashlight if you need more light. Be sure the battery has enough water. You don't need to add water to the Delco Freedom<sup>®</sup> battery installed in every new GM vehicle. But if a battery has filler caps, be sure the right amount of fluid is there. If it is low, add water to take care of that first. If you don't, explosive gas could be present.

Battery fluid contains acid that can burn you. Don't get it on you. If you accidentally get it in your eyes or on your skin, flush the place with water and get medical help immediately.

5. Check that the jumper cables don't have loose or missing insulation. If they do, you could get a shock. The vehicles could be damaged, too. Before you connect the cables, here are some basic things you should know. Positive (+) will go to positive (+) and negative (-) will go to negative (-) or a metal engine part. Don't connect (+) to (-) or you'll get a short that would damage the battery and maybe other parts, too.



## CAUTION:

Fans or other moving engine parts can injure you badly. Keep your hands away from moving parts once the engines are running.

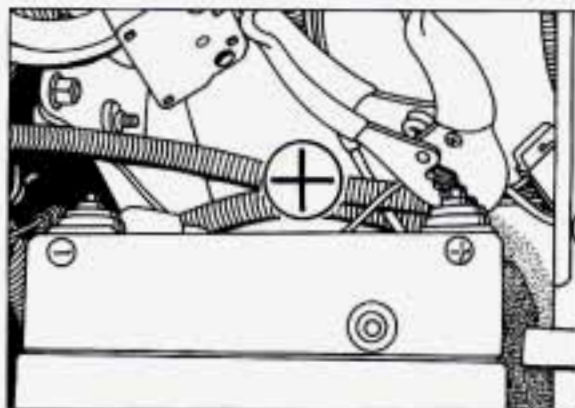

6. Connect the red positive (+) cable to the positive (+) terminal of the vehicle with the dead battery. Use a remote positive (+) terminal if the vehicle has one.

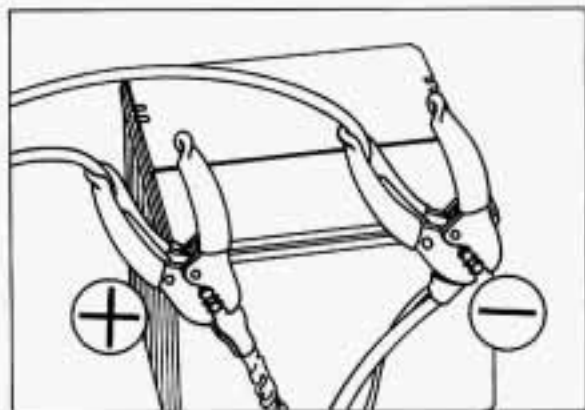

7. Don't let the other end touch metal. Connect it to the positive (+) terminal of the good battery. Use a remote positive (+) terminal if the vehicle has one.
8. Now connect the black negative (-) cable to the good battery's negative (-) terminal. Don't let the other end touch anything until the next step. The other end of the negative cable **doesn't** go to the dead battery. It goes to a heavy unpainted metal part on the engine of the vehicle with the dead battery.

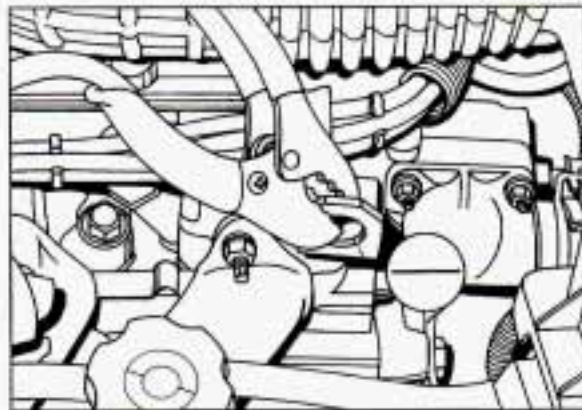

9. Attach the cable at least 18 inches (45 cm) away from the dead battery, but not near engine parts that move. The electrical connection is just as good there, but the chance of sparks getting back to the battery is much less.
10. Now start the vehicle with the good battery and run the engine for a while.
11. Try to start the vehicle with the dead battery. If it won't start after a few tries, it probably needs service.

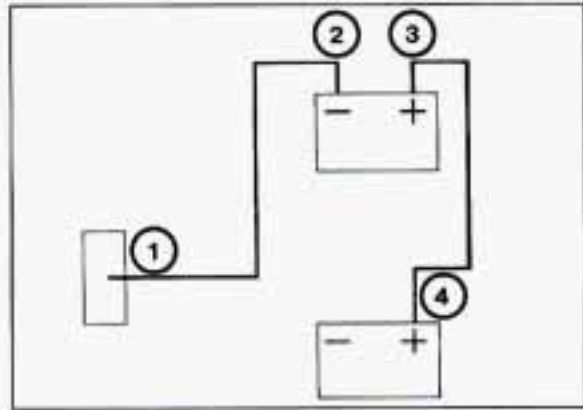

12. Remove the cables in reverse order to prevent electrical shorting. Take care that they don't touch each other or any other metal.

# Problems on the Road

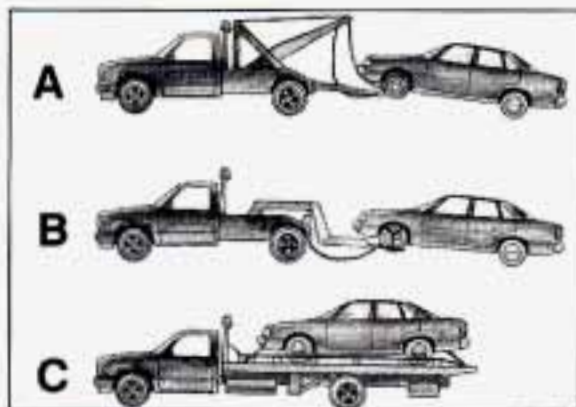

## ■ *Towing Your Vehicle*

Try to have a GM dealer or a professional towing service tow your Chevrolet. The usual towing equipment is:

- (A) Sling-type tow truck
- (B) Wheel-lift tow truck
- (C) Car carrier

If your vehicle has been changed or modified since it was factory-new by adding aftermarket items like fog lamps, aero skirting, or special tires and wheels, these instructions and illustrations may not be correct.

Before you do anything, turn on the hazard warning flashers.

When you call, tell the towing service:

- That your vehicle cannot be towed from the front with sling-type equipment.
- That, if you have the Z-24, your vehicle cannot be towed from the front or rear with sling-type equipment.
- That your vehicle has front-wheel drive.
- The make, model, and year of your vehicle.
- Whether you can still move the shift lever.
- If there was an accident, what was damaged.

When the towing service arrives, let the tow operator know that this manual contains detailed towing instructions and illustrations. The operator may want to see them.



## **CAUTION:**

To help avoid injury to you or others:

- Never let passengers ride in a vehicle that is being towed.
- Never tow faster than safe or posted speeds.
- Never tow with damaged parts not fully secured.
- Never get under your vehicle after it has been lifted by the tow truck.
- Always secure the vehicle on each side with separate safety chains when towing it.
- Never use "J" hooks. Use T-hooks instead.

When your vehicle is being towed, have the ignition key off. The steering wheel should be clamped in a straight-ahead position, with a clamping device designed for towing service. Do not use the vehicle's steering column lock for this. The transaxle should be in N (Neutral) and the parking brake released.

Don't have your vehicle towed on the front wheels, unless you must. If the vehicle must be towed on the front wheels, don't go more than 35 mph (56 km/h) or farther than 50 miles (80 km) or your transaxle will be damaged. If these limits must be exceeded, then the front wheels have to be supported on a dolly.



### CAUTION:

A vehicle can fall from a car carrier if it isn't adequately secured. This can cause a collision, serious personal injury and vehicle damage. The vehicle should be tightly secured with chains or steel cables before it is transported. Don't use substitutes (ropes, leather straps, canvas webbing, etc.) that can be cut by sharp edges underneath the towed vehicle. Always use T-hooks inserted in the T-hook slots. Never use J-hooks. They will damage drivetrain and suspension components.

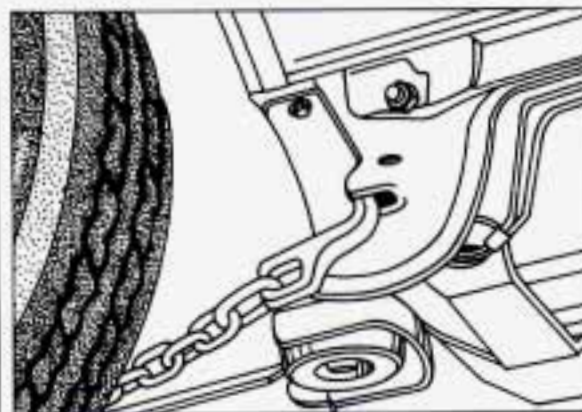

### ***Towing from the Front—Vehicle Hook-Up***

Before hooking up to a tow truck, be sure to read all the information in *Towing Your Vehicle* earlier in this section.

1. Attach T-hook chains into the slots in the bottom of the floor pan, just behind the front wheels, on both sides.

# Problems on the Road

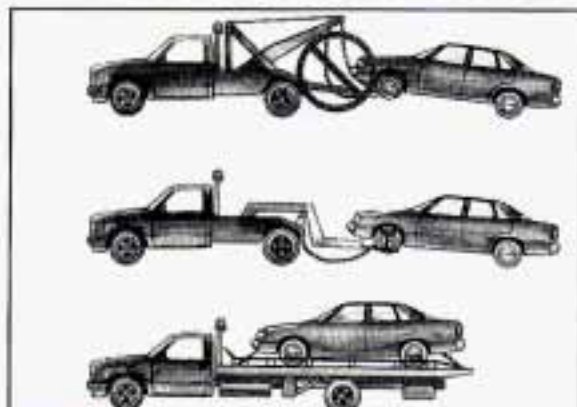

## NOTICE:

Do not tow with sling-type equipment or fascia damage will occur. Use wheel-lift or car carrier equipment. Additional ramping may be required for car carrier equipment. Use safety chains and wheel straps.

## NOTICE:

Towing a vehicle over rough surfaces could damage a vehicle. Damage can occur from vehicle to ground or vehicle to wheel-lift equipment. To help avoid damage, install a towing dolly and raise vehicle until adequate clearance is obtained between the ground and/or wheel-lift equipment.

Do not attach winch cables or J-hooks to suspension components when using car carrier equipment. Always use T-hooks inserted in the T-hook slots.



2. Attach a separate safety chain around the outboard end of each lower control arm.

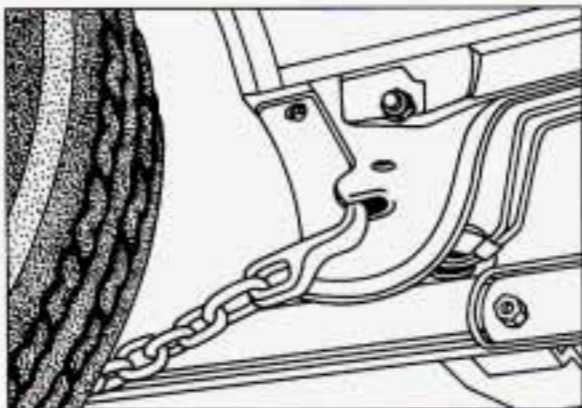

### **Towing from the Rear— Vehicle Hook-Up**

Before hooking up to a tow truck, be sure to read all the information in *Towing Your Vehicle* earlier in this section. Also be sure to use the proper hook-up for your particular vehicle.

#### **All Models:**

1. Attach T-hook chains on both sides in the slotted holes in the bottom of the frame rail just ahead of the rear wheels.

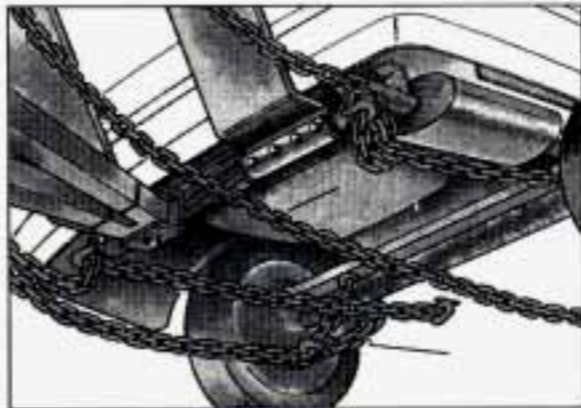

2. Position lower sling crossbar directly under the rear bumper.

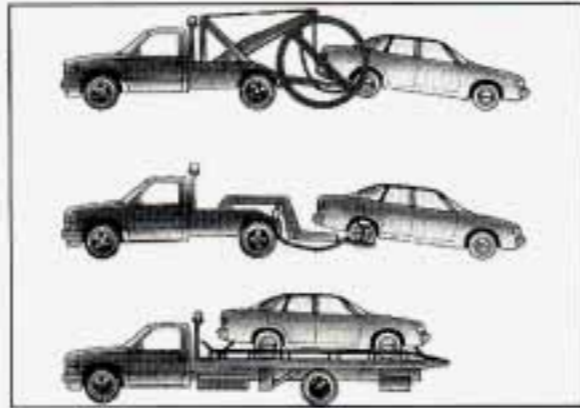

#### **Z-24 Model:**

### **NOTICE:**

Do not tow with sling-type equipment or rear bumper valance will be damaged. Use wheel-lift or car carrier equipment. Additional ramping may be required for car carrier equipment. Use safety chains and wheel straps.

Note: The ignition must be in the **Off** position to keep automatic door locks from locking during tow.



# Problems on the Road

## All Models:

### NOTICE:

Towing a vehicle over rough surfaces could damage a vehicle. Damage can occur from vehicle to ground or vehicle to wheel-lift equipment. To help avoid damage, install a towing dolly and raise vehicle until adequate clearance is obtained between the ground and/or wheel-lift equipment.

Do not attach winch cables or J-hooks to suspension components when using car carrier equipment. Always use T-hooks inserted in the T-hook slots.

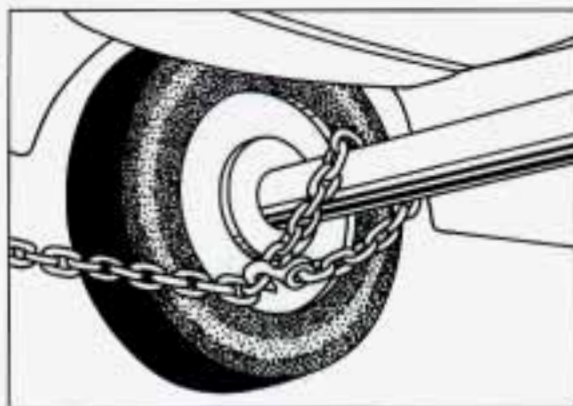

3. Attach a separate safety chain to each side of the axle inboard of the spring.

### ■ *Engine Overheating*

You will find a coolant temperature gage on your Chevrolet's instrument panel.



### *If Steam Is Coming From Your Engine*



### CAUTION:

Steam from an overheated engine can burn you badly, even if you just open the hood. Stay away from the engine if you see or hear steam coming from it. Just turn it off and get everyone away from the vehicle until it cools down. Wait until there is no sign of steam or coolant before opening the hood. If you keep driving when your engine is overheated, the liquids in it can catch fire. You or others could be badly burned. Stop your engine if it overheats, and get out of the vehicle until the engine is cool.

## NOTICE:

If your engine catches fire because you keep driving with no coolant, your vehicle can be badly damaged. The costly repairs would not be covered by your warranty.

### ***If No Steam Is Coming From Your Engine***

If you get the overheat warning but see or hear no steam, the problem may not be too serious. Sometimes the engine can get a little too hot when you:

- Climb a long hill on a hot day.
- Stop after high speed driving.
- Idle for long periods in traffic.

If you get the overheat warning with no sign of steam, try this for a minute or so:

1. If you have an air conditioner, turn it off.
2. Turn on your heater to full hot at the highest fan speed and open the windows as necessary.
3. Try to keep your engine under load (in a drive gear where the engine runs slower).

If you no longer have the overheat warning, you can drive. Just to be safe, drive slower for about ten minutes. If the warning doesn't come back on, you can drive normally.

If the warning continues, pull over, stop, and park your vehicle right away.

If there's still no sign of steam, you can idle the engine for two or three minutes while you're parked, to see if the warning stops. But then, if you still have the warning, **TURN OFF THE ENGINE AND GET EVERYONE OUT OF THE VEHICLE** until it cools down.

You may decide not to lift the hood but to get service help right away.

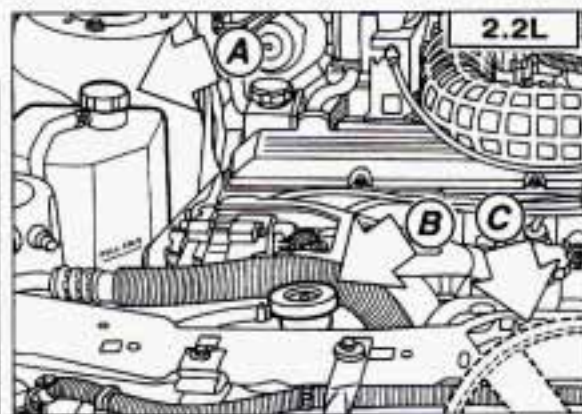

### ■ ***Cooling System (2.2L L4 ENGINE)***

When you decide it's safe to lift the hood, here's what you'll see:

- (A) Coolant recovery tank
- (B) Radiator pressure cap
- (C) Electric engine fan



## CAUTION:

An electric fan under the hood can start up even when the engine is not running and can injure you. Keep hands, clothing and tools away from any underhood electric fan.

If the coolant inside the coolant recovery tank is boiling, don't do anything else until it cools down.

# Problems on the Road

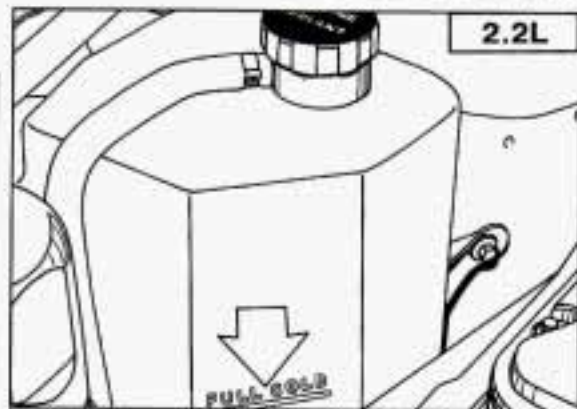

The coolant level should be at or above **FULL COLD**. If it isn't, you may have a leak in the radiator hoses, heater hoses, radiator, water pump or somewhere else in the cooling system.

## CAUTION:

Heater and radiator hoses, and other engine parts, can be very hot. Don't touch them. If you do, you can be burned. Don't run the engine if there is a leak. If you run the engine, it could lose all coolant. That could cause an engine fire, and you could be burned. Get any leak fixed before you drive the vehicle.

## NOTICE:

Engine damage from running your engine without coolant isn't covered by your warranty.

If there seems to be no leak, check to see if the electric engine fan is running. If the engine is overheating, the fan should be running. If it isn't, your vehicle needs service.

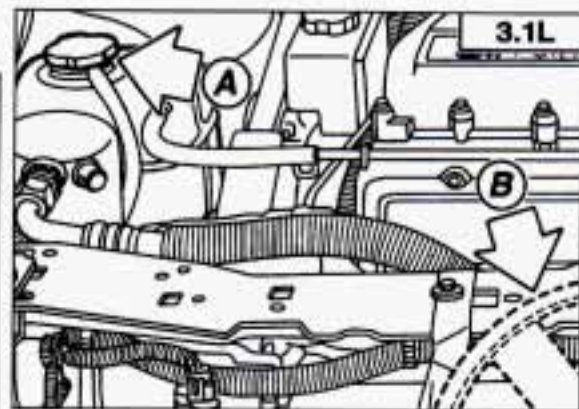

## ■ *Cooling System (3.1L V6 ENGINE)*

When you decide it's safe to lift the hood, here's what you'll see:

- (A) Coolant surge tank with pressure cap
- (B) Electric engine fan

## CAUTION:

An electric fan under the hood can start up even when the engine is not running and can injure you. Keep hands, clothing and tools away from any underhood electric fan.

If the coolant inside the coolant surge tank is boiling, don't do anything else until it cools down.

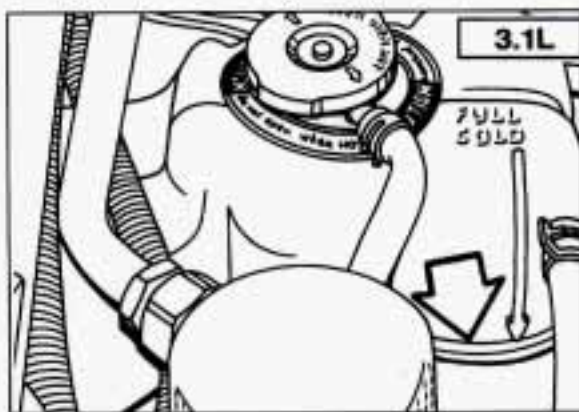

The coolant level should be at or above **FULL COLD**. If it isn't, you may have a leak in the radiator hoses, heater hoses, radiator, water pump or somewhere else in the cooling system.

 **CAUTION:**

Heater and radiator hoses, and other engine parts, can be very hot. Don't touch them. If you do, you can be burned. Don't run the engine if there is a leak. If you run the engine, it could lose all coolant. That could cause an engine fire, and you could be burned. Get any leak fixed before you drive the vehicle.

**NOTICE:**

Engine damage from running your engine without coolant isn't covered by your warranty.

If there seems to be no leak, check to see if the electric engine fan is running. If the engine is overheating, the fan should be running. If it isn't, your vehicle needs service.

**How to Add Coolant to the Coolant Recovery Tank—2.2L L4 Engine**

If you haven't found a problem yet, but the coolant level isn't at or above the **FULL COLD** mark, add a 50/50 mixture of **clean water** (preferably distilled) and a proper antifreeze at the coolant recovery tank. (See *Coolant* in the *Index* for more information about the proper coolant mix.)

# Problems on the Road



## CAUTION:

Adding only plain water to your cooling system can be dangerous. Plain water, or some other liquid like alcohol, can boil before the proper coolant mix will. Your vehicle's coolant warning system is set for the proper coolant mix. With plain water or the wrong mix, your engine could get too hot but you wouldn't get the overheat warning. Your engine could catch fire and you or others could be burned. Use a 50/50 mix of **clean water** and a proper antifreeze.

## NOTICE:

In cold weather, water can freeze and crack the engine, radiator, heater core and other parts. Use the recommended coolant.

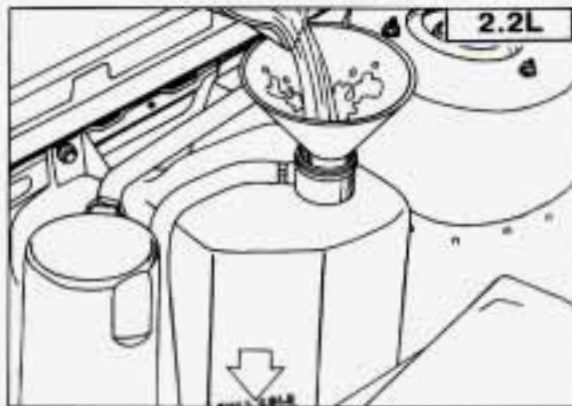

## CAUTION:

You can be burned if you spill coolant on hot engine parts. Coolant contains ethylene glycol and it will burn if the engine parts are hot enough. Don't spill coolant on a hot engine.

When the coolant in the coolant recovery tank is at or above the **FULL COLD** mark, start your vehicle.

If the overheat warning continues, there's one more thing you can try. You can add the proper coolant mix directly to the radiator but be sure the cooling system is cool before you do it.



## CAUTION:

Steam and scalding liquids from a hot cooling system can blow out and burn you badly. They are under pressure, and if you turn the radiator pressure cap — even a little — they can come out at high speed. Never turn the cap when the cooling system, including the radiator pressure cap, is hot. Wait for the cooling system and radiator pressure cap to cool if you ever have to turn the pressure cap.

2.2L

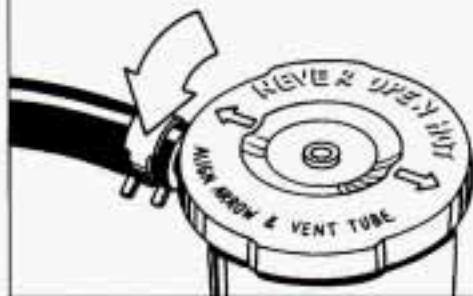

### How to Add Coolant to the 2.2L L4 Engine at the Radiator

1. You can remove the radiator pressure cap when the cooling system, including the radiator pressure cap and upper radiator hose, is no longer hot. Turn the pressure cap slowly to the left until it first stops. (Don't press down while turning the pressure cap.) If you hear a hiss, wait for that to stop. A hiss means there is still some pressure left.

2.2L

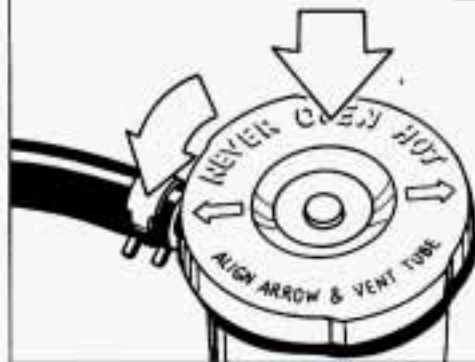

2. Then keep turning the pressure cap, but now push down as you turn it. Remove the pressure cap.

2.2L

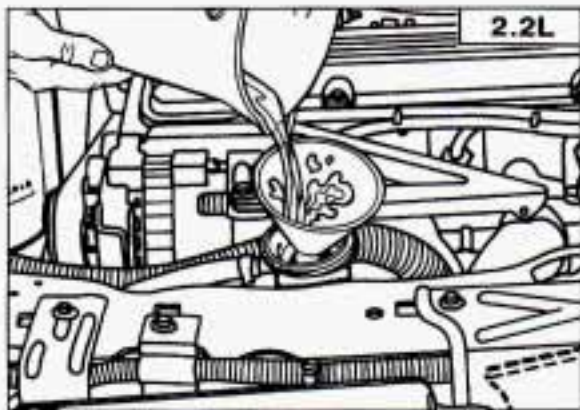

3. Fill the radiator with the proper mix, up to the base of the filler neck.

# Problems on the Road

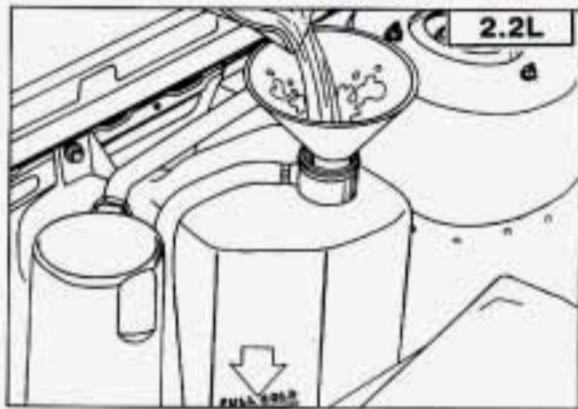

4. Then fill the coolant recovery tank to **FULL COLD**.

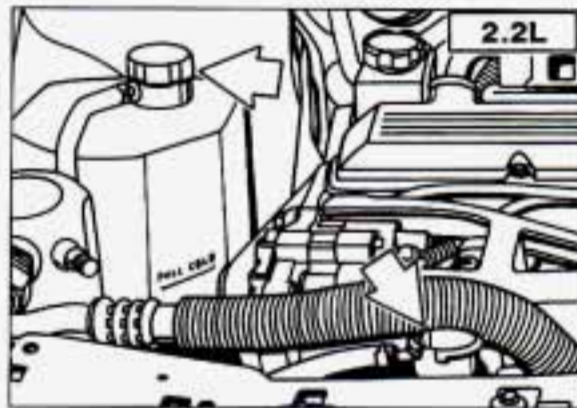

5. Put the cap back on the coolant recovery tank, but leave the radiator pressure cap off.



6. Start the engine and let it run until you can feel the upper radiator hose getting hot. Watch out for the engine fan.
7. By this time the coolant level inside the radiator filler neck may be lower. If the level is lower, add more of the proper mix through the filler neck until the level reaches the base of the filler neck.

2.2L

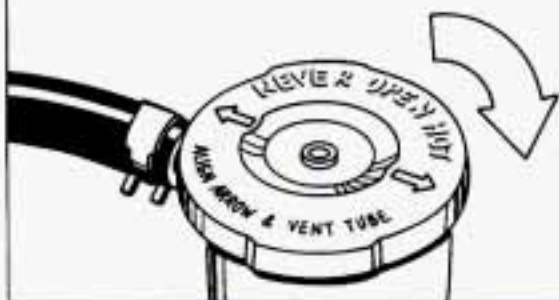

8. Then replace the pressure cap. At any time during this procedure if coolant begins to flow out of the filler neck, reinstall the pressure cap. Be sure the arrows on pressure cap line up like this.

### **How to Add Coolant to the 3.1L V6 Engine at the Coolant Surge Tank**

If you haven't found a problem yet, but the coolant level isn't at or above the **FULL COLD** mark, add a 50/50 mixture of **clean water** (preferably distilled) and a proper antifreeze at the coolant surge tank, but be sure the cooling system, including the coolant surge tank pressure cap, is cool before you do it. (See *Coolant* in the *Index* for more information about the proper coolant mix.)



### **CAUTION:**

Steam and scalding liquids from a hot cooling system can blow out and burn you badly. They are under pressure, and if you turn the coolant surge tank pressure cap — even a little — they can come out at high speed. Never turn the cap when the cooling system, including the coolant surge tank pressure cap, is hot. Wait for the cooling system and coolant surge tank pressure cap to cool if you ever have to turn the pressure cap.

### **CAUTION:**

Adding only plain water to your cooling system can be dangerous. Plain water, or some other liquid like alcohol, can boil before the proper coolant mix will. Your vehicle's coolant warning system is set for the proper coolant mix. With plain water or the wrong mix, your engine could get too hot but you wouldn't get the overheat warning. Your engine could catch fire and you or others could be burned. Use a 50/50 mix of **clean water** and a proper antifreeze.

### **NOTICE:**

In cold weather, water can freeze and crack the engine, radiator, heater core and other parts. So use the recommended coolant.



# Problems on the Road

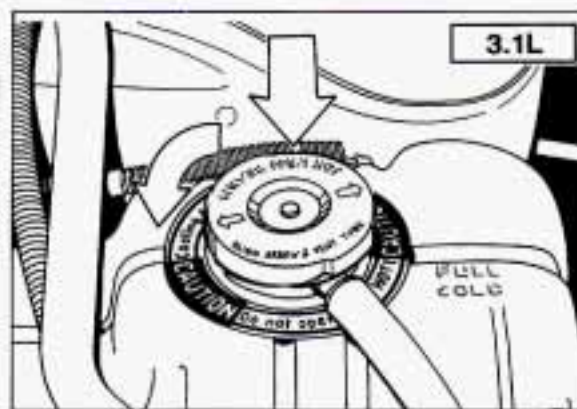
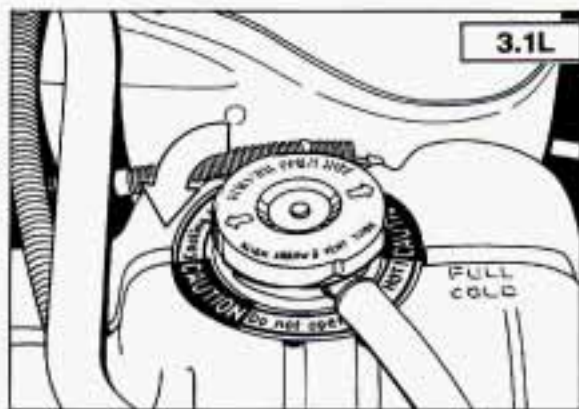
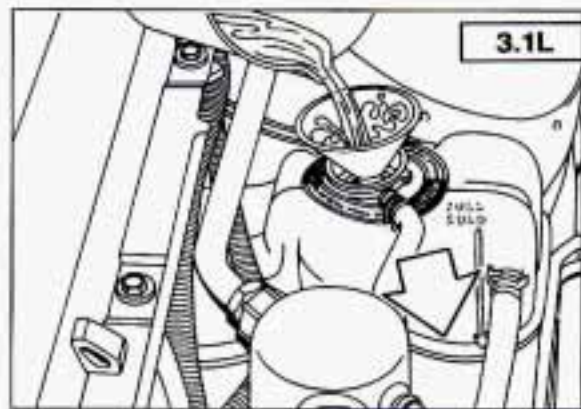

## CAUTION:

You can be burned if you spill coolant on hot engine parts. Coolant contains ethylene glycol and it will burn if the engine parts are hot enough. Don't spill coolant on a hot engine.

1. You can remove the coolant surge tank pressure cap when the cooling system, including the coolant surge tank pressure cap and upper radiator hose, is no longer hot. Turn the pressure cap slowly to the left until it first stops. (Don't press down while turning the pressure cap.) If you hear a hiss, wait for that to stop. A hiss means there is still some pressure left.

2. Then keep turning the cap, but now push down as you turn it. Remove the pressure cap.

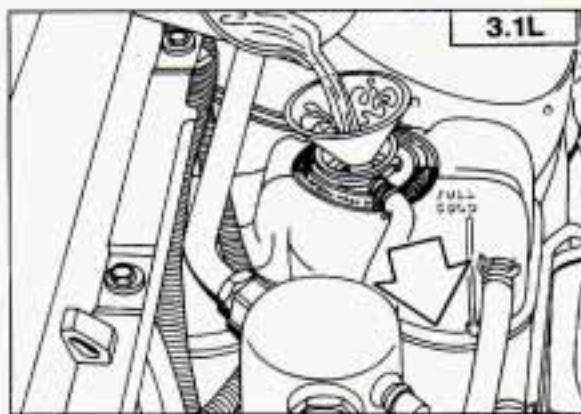

3. Fill the coolant surge tank with the proper mix, up to the **FULL COLD** mark.

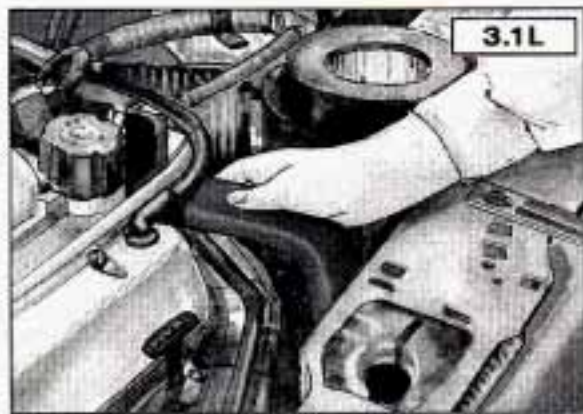

4. With the coolant surge tank pressure cap off, start the engine and let it run until you can feel the upper radiator hose getting hot. Watch out for the engine fan.

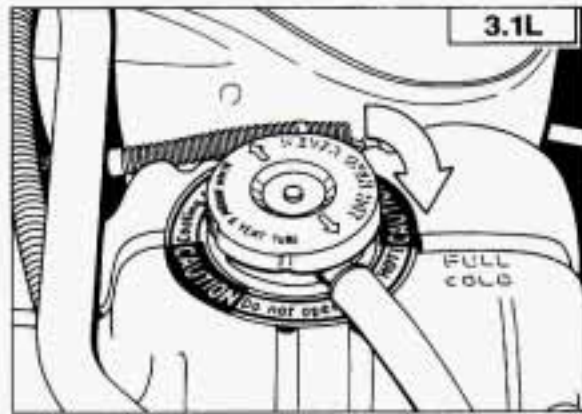

5. By this time, the coolant level inside the coolant surge tank may be lower. If the level is lower, add more of the proper mix to the coolant surge tank until the level reaches the **FULL COLD** mark.
6. Then replace the pressure cap. Be sure the arrows on the pressure cap line up like this.

### ■ *If a Tire Goes Flat*

It's unusual for a tire to "blow out" while you're driving, especially if you maintain your tires properly. If air goes out of a tire, it's much more likely to leak out slowly. But if you should ever have a "blowout," here are a few tips about what to expect and what to do:

# Problems on the Road

If a front tire fails, the flat tire will create a drag that pulls the vehicle toward that side. Take your foot off the accelerator pedal and grip the steering wheel firmly. Steer to maintain lane position, then gently brake to a stop well out of the traffic lane.

A rear blowout, particularly on a curve, acts much like a skid and may require the same correction you'd use in a skid. In any rear blowout, remove your foot from the accelerator pedal. Get the vehicle under control by steering the way you want the vehicle to go. It may be very bumpy and noisy, but you can still steer. Gently brake to a stop, well off the road if possible.

If a tire goes flat, the next section shows how to use your jacking equipment to change a flat tire safely.

## ■ *Changing a Flat Tire*

If a tire goes flat, avoid further tire and wheel damage by driving slowly to a level place. Turn on your hazard warning flashers.



### **CAUTION:**

Changing a tire can cause an injury. The vehicle can slip off the jack and roll over you or other people. You and they could be badly injured. Find a level place to change your tire. To help prevent the vehicle from moving:

1. Set the parking brake firmly.
2. Put an automatic transaxle shift lever in **P** (Park), or shift a manual transaxle to **1** (First) or **R** (Reverse).
3. Turn off the engine.

**CAUTION (Continued)**

### **CAUTION (Continued)**

To be even more certain the vehicle won't move, you can put chocks at the front and rear of the tire farthest away from the one being changed. That would be the tire on the other side of the vehicle, at the opposite end.

The following steps will tell you how to use the jack and change a tire.

The equipment you'll need is in the trunk or rear area.

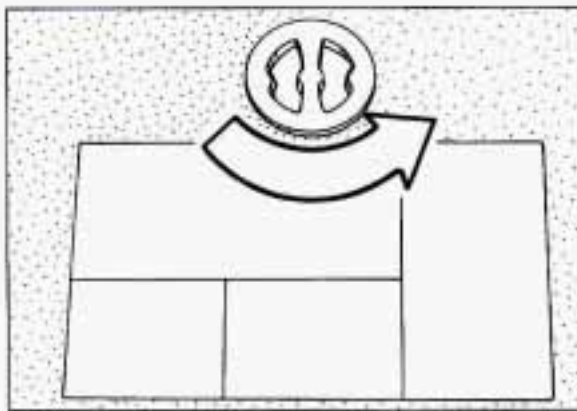

1. If you have carpeting, pull it back from the floor of the trunk or rear area.
2. Turn the center retainer nut on the compact spare tire housing counterclockwise to remove it, then lift the tire cover. You will find the jacking instructions label on the underside of the tire cover.

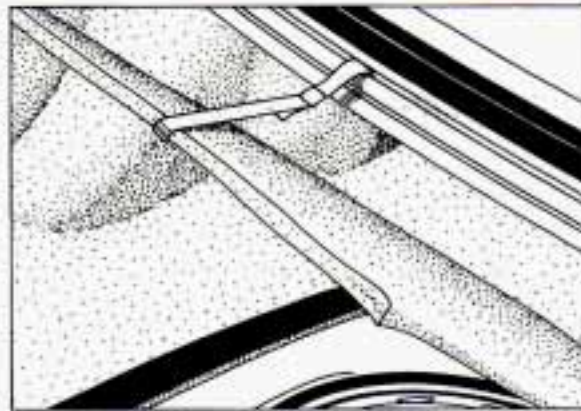

3. If your vehicle is equipped with a spare tire housing lid hook, pull the front of the lid up and hook it to the rear upper edge of the trunk.

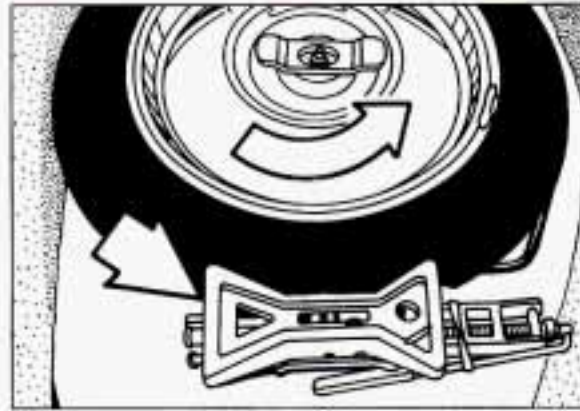

4. Remove the wing bolt securing the compact spare tire, spacer and wheel wrench by turning it counterclockwise. Then lift off the spacer and remove the spare tire.
5. Your vehicle may use a foam tray, or a bracket and wing bolt, for storing the jack and the tools. Remove the bolt securing the jack by turning it counterclockwise. Then remove the jack. Or, remove the jack and the wheel wrench from the foam tray.

# Problems on the Road

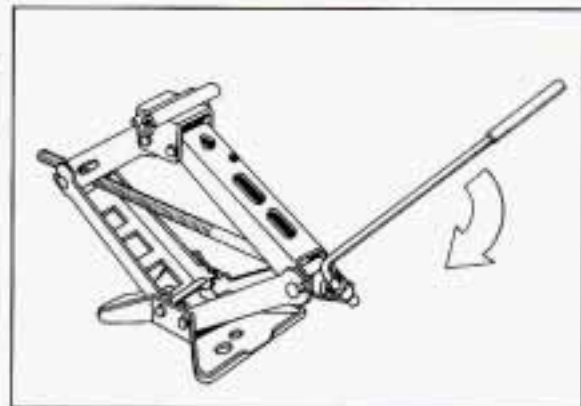

6. Remove the band around the jack. Turn the jack handle clockwise to raise the jack head a few inches.

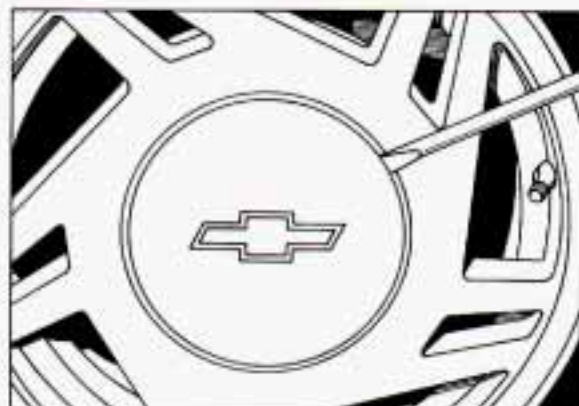

## For Z-24 Models:

On Z-24 models, a cover plate must be removed to access the wheel nuts. Remove the cover plate using the flat end of a wheel wrench.



7. Using the wheel wrench, remove the plastic cap nuts and **loosen** all the wheel nuts. Don't remove the wheel nuts yet.

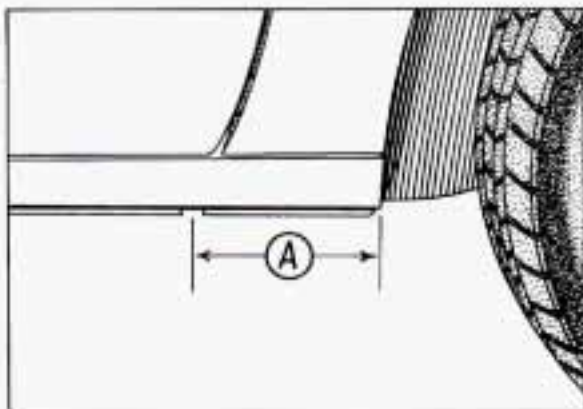

8. Near each wheel well is a notch in the frame which the jack head fits in (A). The front notch is 9" (23 cm) back from the rear wheel well. The rear notch is 8" (20 cm) forward from the rear wheel well. If your vehicle has flared side moldings, both front and rear notches are 18" (46 cm) from the wheel wells.

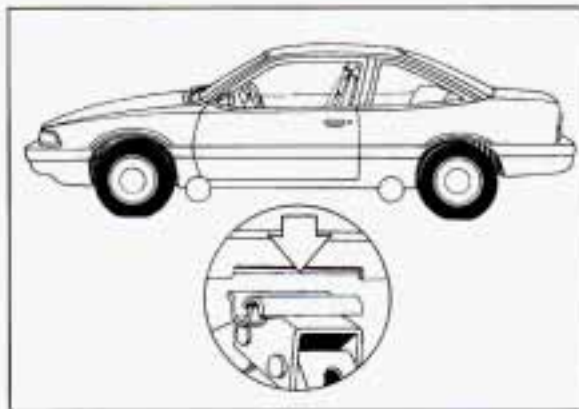

9. Position the jack under the vehicle. Raise the jack head until it fits firmly into the notch in the vehicle's frame nearest the flat tire. Do not raise the vehicle yet. Put the compact spare tire near you.

#### **NOTICE:**

Raising your vehicle with the jack improperly positioned will damage the vehicle or may allow the vehicle to fall off the jack. Be sure to fit the jack lift head into the proper location before raising your vehicle.

#### **NOTICE:**

Do not jack or lift the vehicle using the oil pan. Pans could crack and begin to leak fluid.

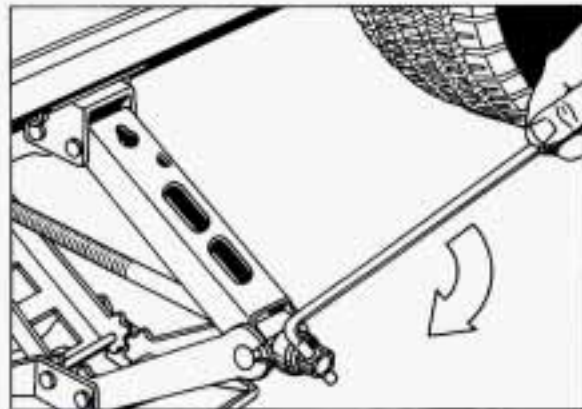

10. Raise the vehicle by rotating the jack handle clockwise. Raise the vehicle far enough off the ground so there is enough room for the spare tire to fit.
11. Remove all of the wheel nuts and, if you have a wheel cover, use your fingers to carefully pry the wheel cover from the wheel. Then take off the flat tire.



#### **CAUTION:**

Getting under a vehicle when it is jacked up is dangerous. If the vehicle slips off the jack, you could be badly injured or killed. Never get under a vehicle when it is supported only by a jack.

# Problems on the Road



## CAUTION:

Rust or dirt on the wheel, or on the parts to which it is fastened, can make the wheel nuts become loose after a time. The wheel could come off and cause an accident. When you change a wheel, remove any rust or dirt from the places where the wheel attaches to the vehicle. In an emergency, you can use a cloth or a paper towel to do this; but be sure to use a scraper or wire brush later, if you need to, to get all the rust or dirt off.

12. Remove any rust or dirt from the wheel bolts, mounting surfaces and spare wheel. Place the spare on the wheel mounting surface.

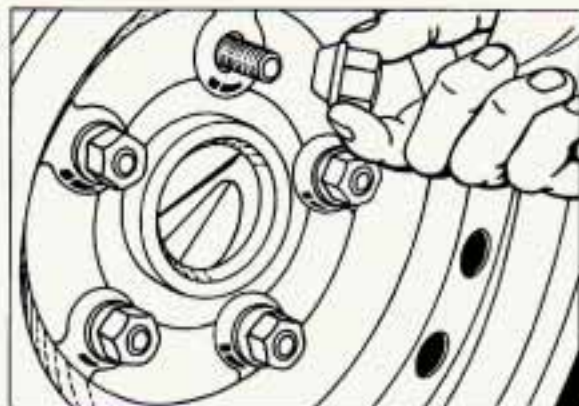

## CAUTION:

Never use oil or grease on studs or nuts. If you do, the nuts might come loose. Your wheel could fall off, causing a serious accident.

13. Replace the wheel nuts with the rounded end of the nuts toward the wheel. Tighten each nut by hand until the wheel is held against the hub.

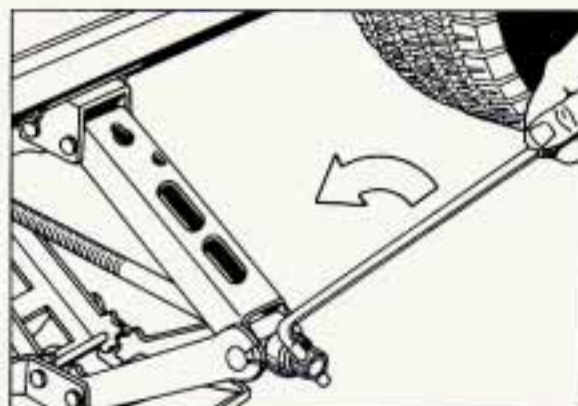

14. Lower the vehicle by rotating the jack handle counterclockwise. Lower the jack completely.

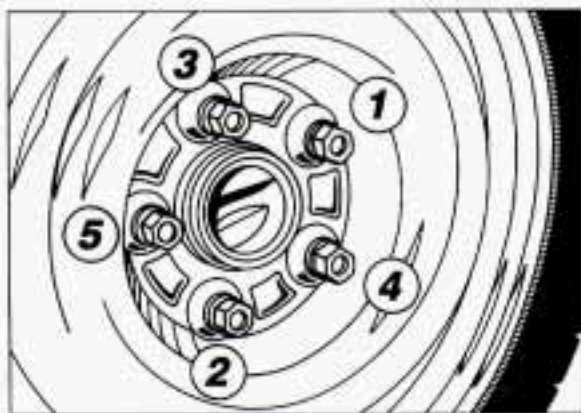

15. Tighten the wheel nuts firmly in a criss-cross sequence, as shown.

**⚠ CAUTION:**

Incorrect wheel nuts or improperly tightened wheel nuts can cause the wheel to become loose and even come off. This could lead to an accident. Be sure to use the correct wheel nuts. If you have to replace them, be sure to get the right kind. Stop somewhere as soon as you can and have the nuts tightened with a torque wrench to 100 pound-feet (140 N•m).

Don't try to put a wheel cover on your compact spare tire. It won't fit. Store

the wheel cover and plastic cap nuts in the trunk or rear area until you have the flat tire repaired or replaced.

**NOTICE:**

Wheel covers won't fit on your compact spare. If you try to put a wheel cover on your compact spare, you could damage the cover or the spare.

16. Store the flat tire in the compact spare tire compartment, and secure with the wing bolt and extension. Store the jack and wheel wrench in their compartment, also.

The compact spare is for temporary use only. Replace the compact spare tire with a full-size tire as soon as you can. See *Compact Spare Tire* next in this section.

**⚠ CAUTION:**

Storing a jack, a tire or other equipment in the passenger compartment of the vehicle could cause injury. In a sudden stop or collision, loose equipment could strike someone. Store all these in the proper place.

## ■ *Compact Spare Tire*

Although the compact spare was fully inflated when your vehicle was new, it can lose air after a time. Check the inflation pressure regularly. It should be 60 psi (420 kPa). After installing the compact spare on your vehicle, you should stop as soon as possible and make sure your spare tire is correctly inflated. The compact spare is made to perform well at posted speed limits for distances up to 3,000 miles (5 000 km), so you can finish your trip and have your full-size tire repaired or replaced where you want. Of course, it's best to replace your spare with a full-size tire as soon as you can. Your spare will last longer and be in good shape in case you need it again.

**NOTICE:**

Don't take your compact spare through an automatic car wash with guide rails. The compact spare can get caught on the rails. That can damage the tire and wheel, and maybe other parts of your vehicle.



# Problems on the Road

Don't use your compact spare on some other vehicle.

And don't mix your compact spare or wheel with other wheels or tires. They won't fit. Keep your spare and its wheel together.

## NOTICE:

Tire chains won't fit your compact spare. Using them will damage your vehicle and destroy the chains too. Don't use tire chains on your compact spare.

## ■ *If You're Stuck: In Sand, Mud, Ice or Snow*

What you don't want to do when your vehicle is stuck is to spin your wheels. The method known as "rocking" can help you get out when you're stuck, but you must use caution.



## CAUTION:

If you let your tires spin at high speed, they can explode and you or others could be injured. And, the transaxle or other parts of the vehicle can overheat. That could cause an engine compartment fire or other damage. When you're stuck, spin the wheels as little as possible. Don't spin the wheels above 35 mph (55 km/h) as shown on the speedometer.

## NOTICE:

Spinning your wheels can destroy parts of your vehicle as well as the tires. If you spin the wheels too fast while shifting your transaxle back and forth, you can destroy your transaxle.

## Rocking your vehicle to get it out:

First, turn your steering wheel left and right. That will clear the area around your front wheels. Then shift back and forth between **R** (Reverse) and a forward gear (or with a manual transaxle, between First or Second gear and Reverse), spinning the wheels as little as possible. Release the accelerator pedal while you shift, and press lightly on the accelerator pedal when the transaxle is in gear. If that doesn't get you out after a few tries, you may need to be towed out. If you do need to be towed out, see *Towing Your Vehicle* in the *Index*.



**H**ere you will find information about the care of your Chevrolet. This part begins with service and fuel information, and then it shows how to check important fluid and lubricant levels. There is also technical information about your vehicle, and a section devoted to its appearance care.

## Part 6

# Service and Appearance Care

Service .....	154
Fuel .....	154
Hood Release.....	158
Engine Oil.....	162
Air Cleaner .....	165
Automatic Transaxle Fluid .....	167
Manual Transaxle Fluid .....	169
Engine Coolant.....	170
Power Steering Fluid.....	173
Windshield Washer Fluid.....	173
Brakes .....	174
Battery .....	176
Bulb Replacement .....	176
Windshield Wiper Blade Replacement .....	179
Loading Your Vehicle .....	180
Tires .....	181
Appearance Care .....	187
Vehicle Identification Number (VIN) .....	194
Add-On Electrical Equipment .....	195
Fuses & Circuit Breakers.....	195
Capacities & Specifications.....	198
Fluids & Lubricants .....	199
Replacement Bulbs.....	200
Engine Specifications.....	202
Normal Maintenance Replacement Parts.....	202

# Service & Appearance Care



## ■ Service

Your Chevrolet dealer knows your vehicle best and wants you to be happy with it. We hope you'll go to your dealer for all your service needs. You'll get genuine GM parts and GM-trained and supported service people.

We hope you'll want to keep your GM vehicle all GM. Genuine GM parts have one of these marks.

## Doing Your Own Service Work

If you want to do some of your own service work, you'll want to get the proper Chevrolet Service Manual. It tells you much more about how to service your Chevrolet than this manual can. To order the proper service manual, see *Service Publications* in the *Index*.

You should keep a record with all parts receipts and list the mileage and the date of any service work you perform. See *Maintenance Record* in the *Index*.



## CAUTION:

You can be injured if you try to do service work on a vehicle without knowing enough about it.

- Be sure you have sufficient knowledge, experience, and the proper replacement parts and tools before you attempt any vehicle maintenance task.
- Be sure to use the proper nuts, bolts and other fasteners. "English" and "metric" fasteners can be easily confused. If you use the wrong fasteners, parts can later break or fall off. You could be hurt.

## NOTICE:

If you try to do your own service work without knowing enough about it, your vehicle could be damaged.



## ■ Fuel

Use regular unleaded gasoline rated at 87 octane or higher. It should meet specifications ASTM D4814 in the U.S. and CGSB 3.5-92 in Canada. These fuels should have the proper additives, so you should not have to add anything to the fuel.

In the U.S. and Canada, it's easy to be sure you get the right kind of gasoline (unleaded). You'll see "UNLEADED" right on the pump. And only unleaded nozzles will fit into your vehicle's filler neck.

Be sure the posted octane is at least 87. If the octane is less than 87, you may get a heavy knocking noise when you drive. If it's bad enough, it can damage your engine.

If you're using fuel rated at 87 octane or higher and you still hear heavy knocking, your engine needs service. But don't worry if you hear a little pinging noise when you're accelerating or driving up a hill. That's normal, and you don't have to buy a higher octane fuel to get rid of pinging. It's the heavy, constant knock that means you have a problem.

What about gasoline with blending materials that contain oxygen (oxygenates), such as MTBE or alcohol?

**MTBE** is "methyl tertiary-butyl ether." Fuel that is no more than 15% MTBE is fine for your vehicle.

**Ethanol** is ethyl or grain alcohol. Properly-blended fuel that is no more than 10% **ethanol** is fine for your vehicle.

**Methanol** is methyl or wood alcohol.

### **NOTICE:**

Fuel that is more than 5% **methanol** is bad for your vehicle. Don't use it. It can corrode metal parts in your fuel system and also damage plastic and rubber parts. That damage wouldn't be covered under your warranty. And even at 5% or less, there must be "cosolvents" and corrosion preventers in this fuel to help avoid these problems.

### ***Gasolines for Cleaner Air***

Your use of gasoline with deposit control additives will help prevent deposits from forming in your engine and fuel system. That helps keep your engine in tune and your emission control system working properly. It's good for your vehicle, and you'll be doing your part for cleaner air.

Many gasolines are now blended with oxygenates. General Motors recommends that you use gasolines with these blending materials, such as

MTBE and ethanol. By doing so, you can help clean the air, especially in those parts of the country that have high carbon monoxide levels.

In addition, some gasoline suppliers are now producing reformulated gasolines. These gasolines are specially designed to reduce vehicle emissions. General Motors recommends that you use reformulated gasoline. By doing so, you can help clean the air, especially in those parts of the country that have high ozone levels.

You should ask your service station operators if their gasolines contain deposit control additives and oxygenates, and if they have been reformulated to reduce vehicle emissions.

# Service & Appearance Care



## ■ *Fuels in Foreign Countries*

If you plan on driving in another country outside the U.S. or Canada, unleaded fuel may be hard to find. Do not use leaded gasoline. If you use even one tankful, your emission controls won't work well or at all. With continuous use, spark plugs can get fouled, the exhaust system can corrode, and your engine oil can deteriorate quickly. Your vehicle's oxygen sensor will be damaged. All of that means costly repairs that wouldn't be covered by your warranty.

To check on fuel availability, ask an auto club, or contact a major oil company that does business in the country where you'll be driving.

You can also write us at the following address for advice. Just tell us where you're going and give your Vehicle Identification Number (VIN).

General Motors Overseas Distribution Corporation  
North American Export Sales (NAES)  
1908 Colonel Sam Drive  
Oshawa, Ontario L1H 8P7

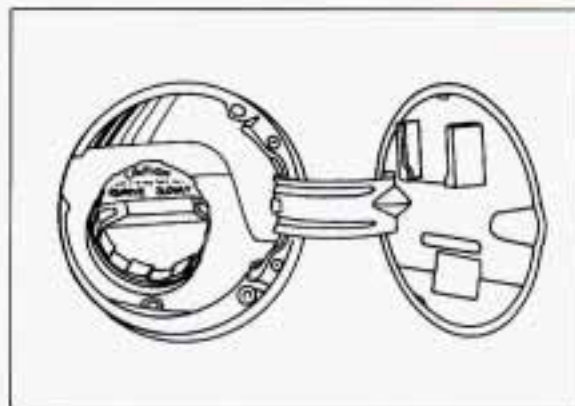

## ■ *Filling Your Tank*

Fuel Capacity: 15.2 U.S. Gallons (57.5 L). Use unleaded fuel only.



### **CAUTION:**

Gasoline vapor is highly flammable. It burns violently, and that can cause very bad injuries. Don't smoke if you're near gasoline or refueling your vehicle. Keep sparks, flames, and smoking materials away from gasoline.

The cap is behind a hinged door on the right side of your vehicle.

To take off the cap, turn it slowly to the left (counterclockwise).

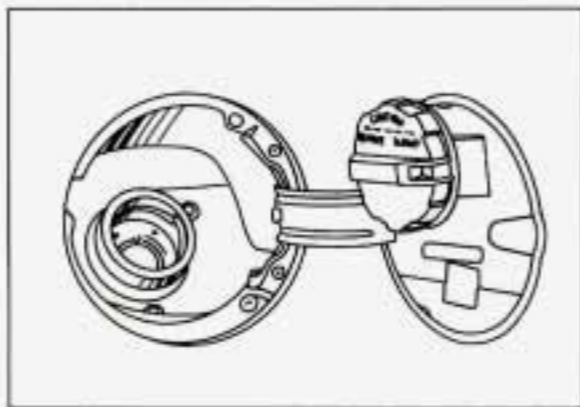

While refueling, hang the cap inside the fuel door.



### CAUTION:

If you get gasoline on you and then something ignites it, you could be badly burned. Gasoline can spray out on you if you open the fuel filler cap too quickly. This spray can happen if your tank is nearly full, and is more likely in hot weather. Open the fuel filler cap slowly and wait for any "hiss" noise to stop. Then unscrew the cap all the way.

Be careful not to spill gasoline. Clean gasoline from painted surfaces as soon as possible. See *Cleaning the Outside of Your Chevrolet* in the *Index*.

When you put the cap back on, turn it to the right until you hear at least three clicks.

### NOTICE:

If you need a new cap, be sure to get the right type. Your dealer can get one for you. If you get the wrong type, it may not fit or have proper venting, and your fuel tank and emissions system might be damaged.

## ■ *Checking Things Under the Hood*

The following sections tell you how to check fluids, lubricants and important parts underhood.

# Service & Appearance Care



## Hood Release

To open the hood, first pull the hood release handle inside the vehicle.

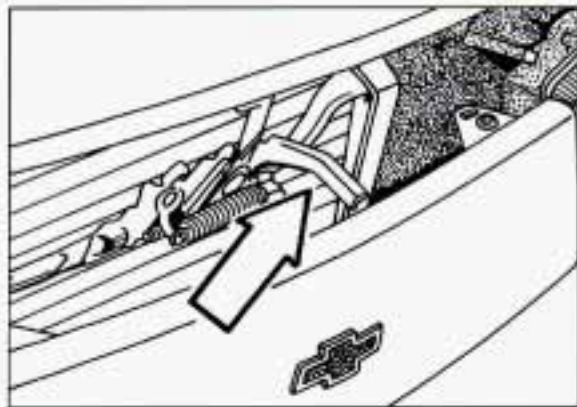

Then go to the front of the vehicle and push the secondary hood release handle to the right.

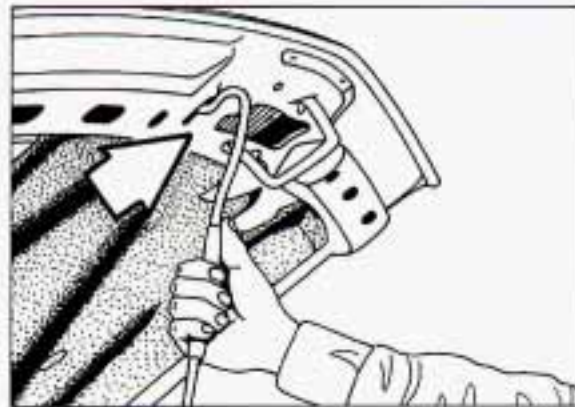

Lift the hood, release the hood prop from its retainer and put the hood prop into the slot in the hood. Use the prop rod sleeve when handling the prop rod.

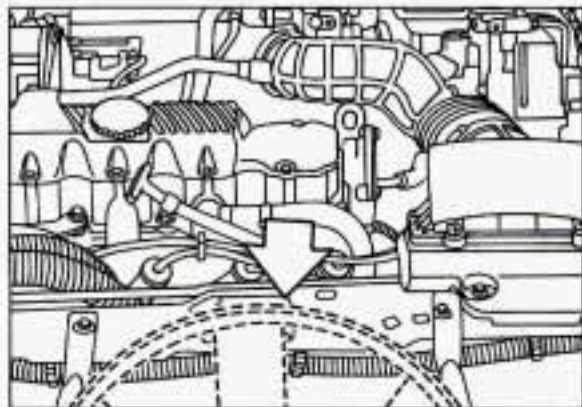

 **CAUTION:**

An electric fan under the hood can start up and injure you even when the engine is not running. Keep hands, clothing and tools away from any underhood electric fan.

 **CAUTION:**

Things that burn can get on hot engine parts and start a fire. These include liquids like gasoline, oil, coolant, brake fluid, windshield washer and other fluids, and plastic or rubber. You or others could be burned. Be careful not to drop or spill things that will burn onto a hot engine.

Before closing the hood, be sure all the filler caps are on properly. Then lift the hood to relieve pressure on the hood prop. Remove the hood prop from the slot in the hood and return the prop to its retainer. Then just let the hood down and close it firmly.



# Service & Appearance Care

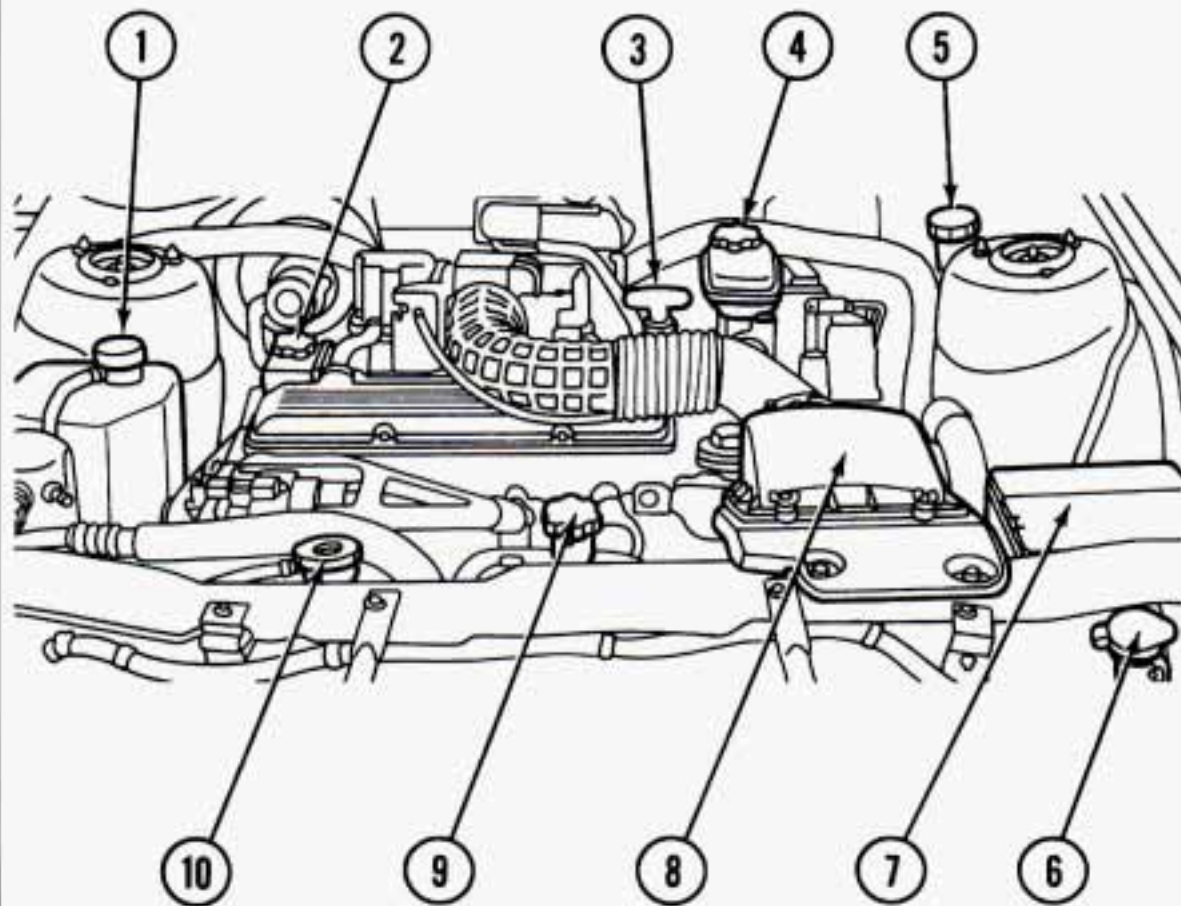

## 2.2L L4 Engine (CODE 4)

When you open the hood, you'll see:

1. Engine Coolant Recovery Tank
2. Power Steering Fluid Reservoir
3. Automatic Transaxle Fluid Dipstick (if equipped)
4. Brake Fluid Reservoir
5. Hydraulic Clutch Fluid Reservoir (if equipped)
6. Windshield Washer Fluid Reservoir
7. Battery
8. Air Cleaner
9. Engine Oil Dipstick, Engine Oil Fill Cap
10. Thermostat Housing Pressure Cap

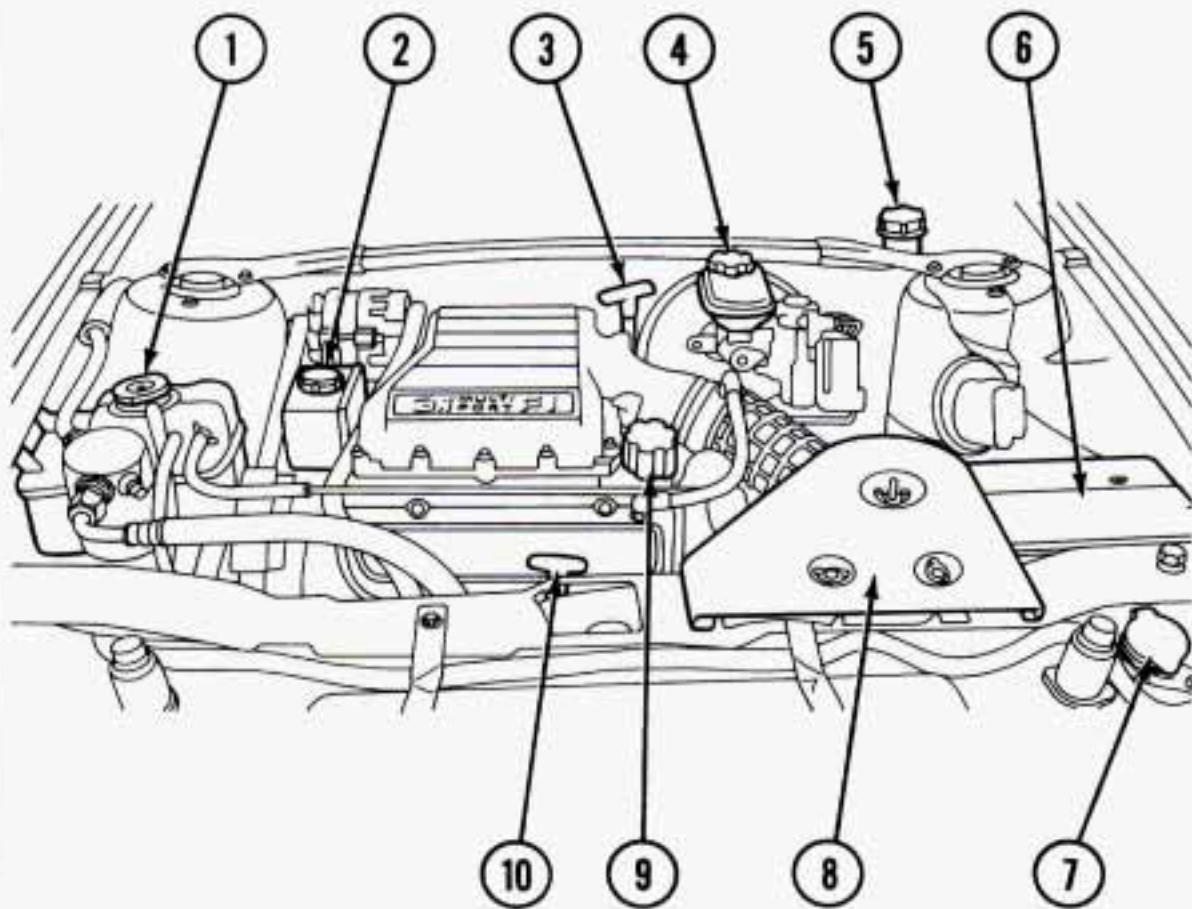

### **3.1L V6 Engine (CODE T)**

When you open the hood, you'll see:

1. Coolant Surge Tank
2. Power Steering Fluid Reservoir
3. Automatic Transaxle Fluid Dipstick (if equipped)
4. Brake Fluid Reservoir
5. Hydraulic Clutch Fluid Reservoir (if equipped)
6. Battery
7. Windshield Washer Fluid Reservoir
8. Air Cleaner
9. Engine Oil Fill Cap
10. Engine Oil Dipstick

# Service & Appearance Care

## ■ Engine Oil

If the oil warning light on the instrument panel comes on, it means you need to check your engine oil level right away. For more information, see *Engine Oil Warning Light* in the *Index*. You should check your engine oil level regularly; this is an added reminder.

It's a good idea to check your engine oil every time you get fuel. In order to get an accurate reading, the oil must be warm and the vehicle must be on level ground.

Turn off the engine and give the oil a few minutes to drain back into the oil pan. If you don't, the oil dipstick might not show the actual level.

### To Check Engine Oil

Pull out the dipstick and clean it with a paper towel or cloth, then push it back in all the way. Remove it again, keeping the tip lower, and check the level.

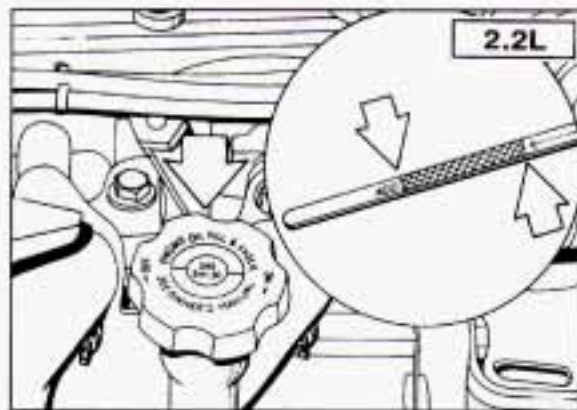

2.2L L4: Checking Engine Oil

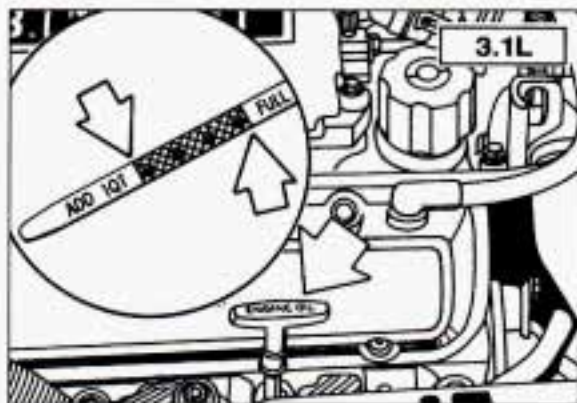

3.1L V6: Checking Engine Oil

### When to Add Oil

If the oil is at or below the ADD line, then you'll need to add some oil. But you must use the right kind. This section explains what kind of oil to use. For crankcase capacity, see *Capacities and Specifications* in the *Index*.

### NOTICE:

Don't add too much oil. If your engine has so much oil that the oil level gets above the cross-hatched area that shows the proper operating range, your engine could be damaged.

Just fill it enough to put the level somewhere in the proper operating range. Push the dipstick all the way back in when you're through.

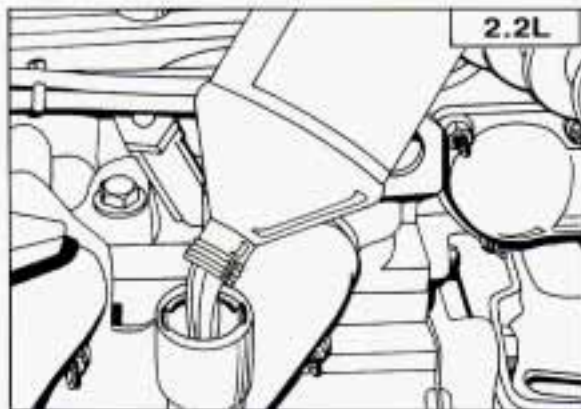

2.2L L4: Adding Engine Oil

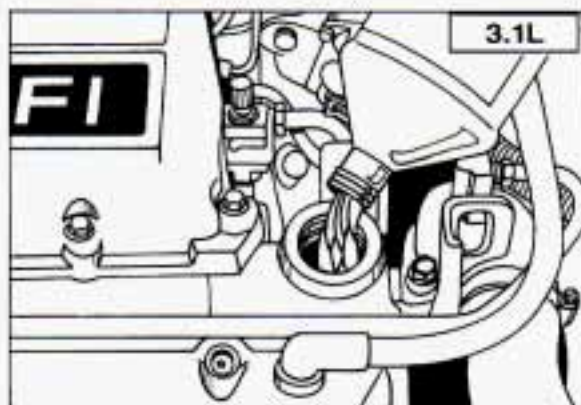

3.1L V6: Adding Engine Oil



### What Kind of Oil to Use

Beginning midyear 1993, oils of the proper quality for your vehicle will be identified with this new "starburst" symbol. The "starburst" symbol indicates that the oil has been certified by the American Petroleum Institute (API), and is preferred for use in your gasoline engine.

You should look for this on the front of the oil container, and use only oils that display this new symbol.

You should also use the proper viscosity oil for your vehicle, as shown in the following chart:

As shown in the chart, SAE 5W-30 is best for your vehicle. However, you can

### RECOMMENDED SAE VISCOSITY GRADE ENGINE OILS

FOR BEST FUEL ECONOMY AND COLD STARTING, SELECT THE LOWEST SAE VISCOSITY GRADE OIL FOR THE EXPECTED TEMPERATURE RANGE.

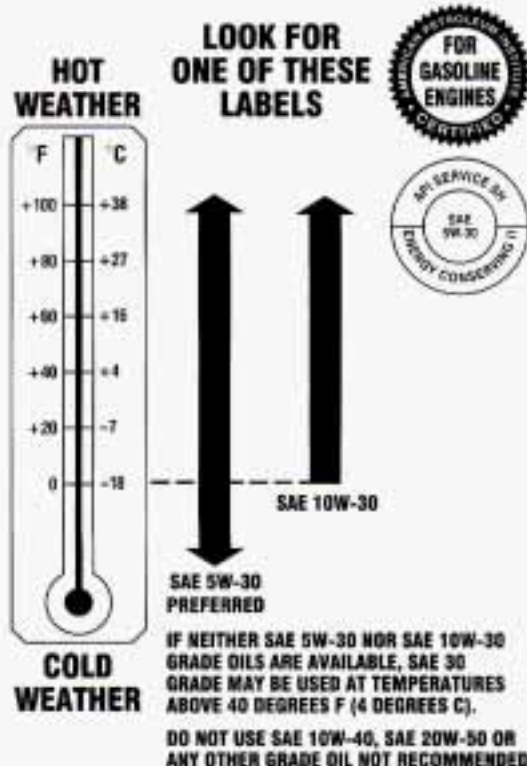

# Service & Appearance Care

use SAE 10W-30 if it's going to be 0°F (-18°C) or above. These numbers on an oil container show its viscosity, or thickness. Do not use other viscosity oils, such as SAE 10W-40 or SAE 20W-50.

If you cannot find oils with the new "starburst" symbol on the front of the container, you should look for and use oils containing the following three things:

- **SH or SG**

"SH" or "SG" must be on the oil container, either by itself or combined with other quality designations, such as "SH/CD," "SH,SG,CD," "SG/CD," etc. These letters show American Petroleum Institute (API) levels of quality.

- **SAE 5W-30**

- **Energy Conserving II**

Oils with these words on the container will help you save fuel.

These three things are usually included in a doughnut shaped logo (symbol) on most containers. If you cannot find oils with the "starburst" symbol, you should look for oils with the doughnut shaped symbol, containing the three things noted above.



## NOTICE:

If you use oils that do not have either the "starburst" symbol or an API SH or SG designation, you can cause engine damage not covered by your warranty.

GM Goodwrench® oil (in Canada, GM Engine Oil) meets all the requirements for your vehicle.

## Engine Oil Additives

Don't add anything to your oil. Your Chevrolet dealer is ready to advise if you think something should be added.

## When to Change Engine Oil

See if any one of these is true for you:

- Most trips are less than 4 miles (6 km).
- It's below freezing outside and most trips are less than 10 miles (16 km).
- The engine is at low speed most of the time (as in door-to-door delivery, or in stop-and-go traffic).
- Most trips are through dusty places.

If any one of these is true for your vehicle, then you need to change your **oil and filter** every 3,000 miles (5 000 km) or 3 months — whichever comes first.

If none of them is true, change the oil every 7,500 miles (12 500 km) or 12 months — whichever comes first. Change the filter at the first oil change and at every other oil change after that.

### **Engine Coolant Heater (Engine Block Heater)**

An engine coolant heater can be a big help if you have to park outside in very cold weather, 0°F (-18°C) or colder. If your vehicle has this option, see *Engine Coolant Heater* in the *Index*.

### **What to Do with Used Oil**

Did you know that used engine oil contains certain elements that may be unhealthy for your skin and could even cause cancer? Don't let used oil stay on your skin for very long. Clean your skin and nails with soap and water, or a good hand cleaner. Wash or properly throw away clothing or rags containing used engine oil. (See the manufacturer's warnings about the use and disposal of oil products.)

Used oil can be a real threat to the environment. If you change your own oil, be sure to drain all free-flowing oil from the filter before disposal. Don't ever dispose of oil by putting it in the trash, pouring it on the ground, into sewers, or into streams or bodies of water. Instead, recycle it by taking it to a place that collects used oil. If you have a problem properly disposing of your used oil, ask your dealer, a service station or a local recycling center for help.

### **■ Air Cleaner**

Refer to the Maintenance Schedule to determine when to replace the air filter. See *Scheduled Maintenance Services* in the *Index*.



### **CAUTION:**

Operating the engine with the air cleaner off can cause you or others to be burned. The air cleaner not only cleans the air, it stops flame if the engine backfires. If it isn't there, and the engine backfires, you could be burned. Don't drive with it off, and be careful working on the engine with the air cleaner off.

### **NOTICE:**

If the air cleaner is off, a backfire can cause a damaging engine fire. And, dirt can easily get into your engine, which will damage it. Always have the air cleaner in place when you're driving.

# Service & Appearance Care

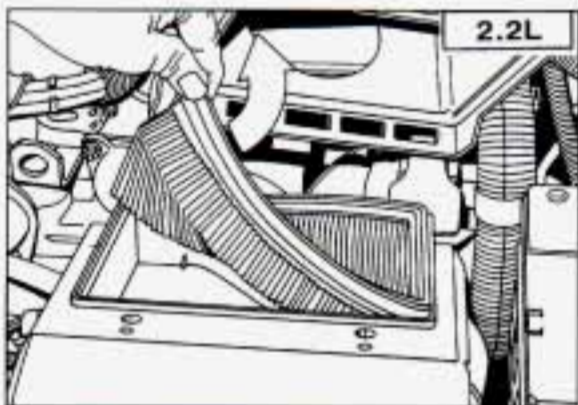
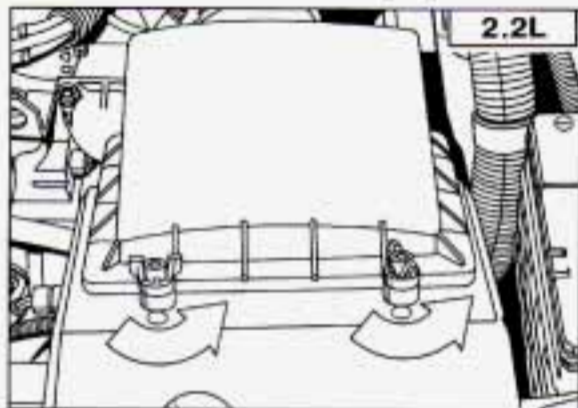

## 2.2L L4: Air Filter Replacement

To check or replace the filter, remove the two wing nuts and lift the cover.

Be sure to reinstall the air cleaner filter and replace the cover tightly.

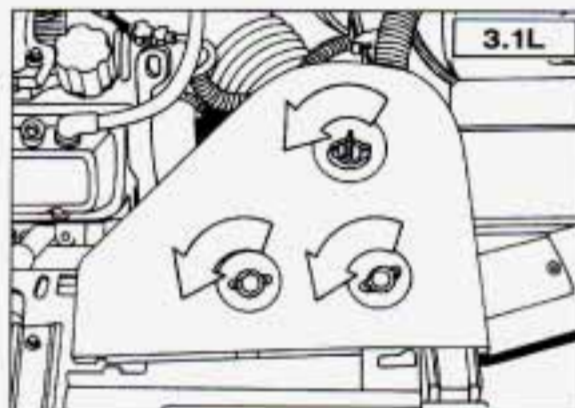

## 3.1L V6 (Except Z-24): Air Filter Replacement

To check or replace the filter, remove the three wing nuts and lift the cover.

Be sure to reinstall the air cleaner filter and replace the cover tightly.

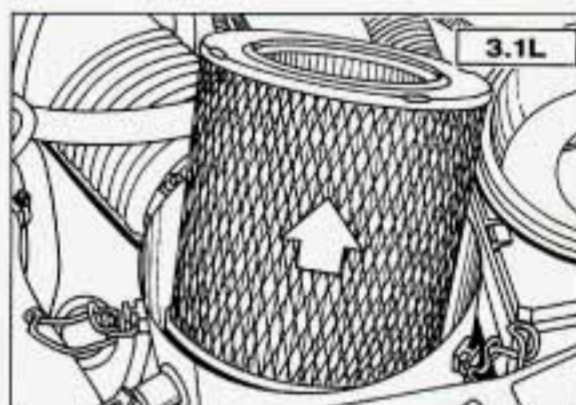
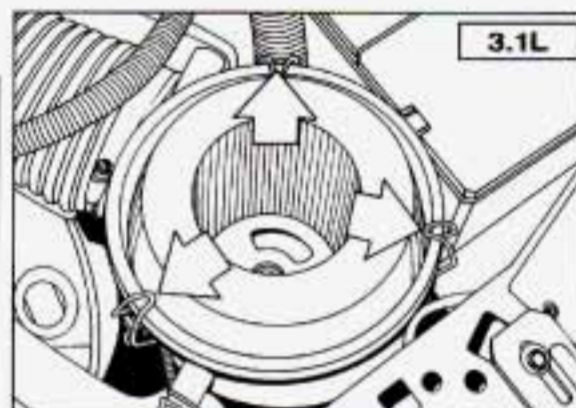

## 3.1L V6 (Z-24): Air Filter Replacement

To check or replace the filter, unclip the three clips and remove the cover.

Be sure to reinstall the air cleaner filter and replace the cover tightly.

## ■ *Automatic Transaxle Fluid*

### **When to Check and Change**

A good time to check your automatic transaxle fluid level is when the engine oil is changed. Refer to the Maintenance Schedule to determine when to change your fluid. See *Scheduled Maintenance Services* in the *Index*.

### **How to Check**

Because this operation can be a little difficult, you may choose to have this done at your Chevrolet dealership Service Department.

If you do it yourself, be sure to follow all the instructions here, or you could get a false reading on the dipstick.

### **NOTICE:**

Too much or too little fluid can damage your transaxle. Too much can mean that some of the fluid could come out and fall on hot engine parts or exhaust system, starting a fire. Be sure to get an accurate reading if you check your transaxle fluid.

Wait at least 30 minutes before checking the transaxle fluid level if you have been driving:

- When outside temperatures are above 90°F (32°C).
- At high speed for quite a while.
- In heavy traffic — especially in hot weather.

To get the right reading, the fluid should be at normal operating temperature, which is 180°F to 200°F (82°C to 93°C).

Get the vehicle warmed up by driving about 15 miles (24 km) when outside temperatures are above 50°F (10°C). If it's colder than 50°F (10°C), you may have to drive longer.

### **To check the fluid level**

- Park your vehicle on a level place.
- With the parking brake applied, place the shift lever in **P** (Park).
- With your foot on the brake pedal, move the shift lever through each gear range, pausing for about three seconds in each range. Then, position the shift lever in **P** (Park).
- Let the engine run at idle for three to five minutes.

**Then, without shutting off the engine, follow these steps:**

1. Pull out the dipstick and wipe it with a clean rag or paper towel.
2. Push it back in all the way, wait three seconds and then pull it back out again.
3. Check both sides of the dipstick, and read the lower level. The fluid level must be in the cross-hatched area.
4. If the fluid level is in the acceptable range, push the dipstick back in all the way.



# Service & Appearance Care

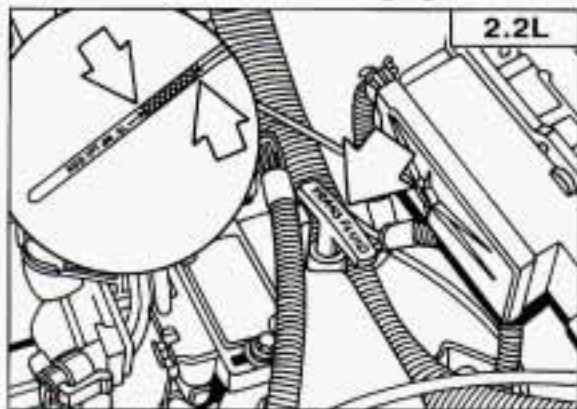

**2.2L L4: Checking Automatic Transaxle Fluid**

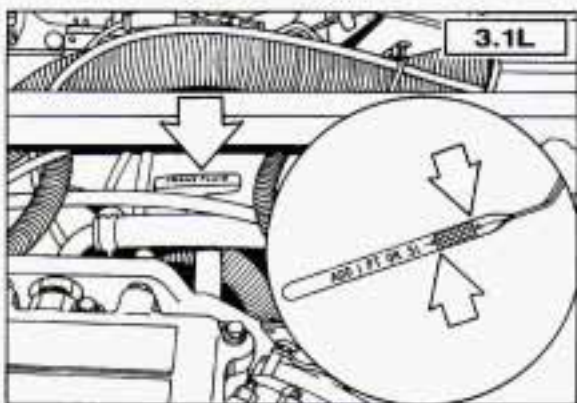

**3.1L V6: Checking Automatic Transaxle Fluid**

## How to Add Fluid

Refer to the Maintenance Schedule to determine what kind of transaxle fluid to use. See *Recommended Fluids and Lubricants* in the *Index*.

If the fluid level is low, add only enough of the proper fluid to bring the level into the cross-hatched area on the dipstick.

1. Pull out the dipstick.
2. Using a long-neck funnel, add enough fluid at the dipstick hole to bring it to the proper level.

It doesn't take much fluid, generally less than a pint (0.5L). **Don't overfill.** We recommend you use only fluid labeled DEXRON®-III or DEXRON®-III-E, because fluids with that label are made especially for your automatic transaxle. Damage caused by fluid other than DEXRON®-III or DEXRON®-III-E is not covered by your new vehicle warranty.

- After adding fluid, recheck the fluid level as described under *How to Check*.
- When the correct fluid level is obtained, push the dipstick back in all the way.

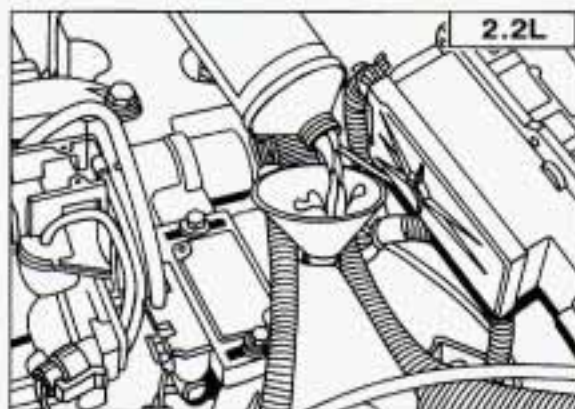

**2.2L L4: Adding Automatic Transaxle Fluid**

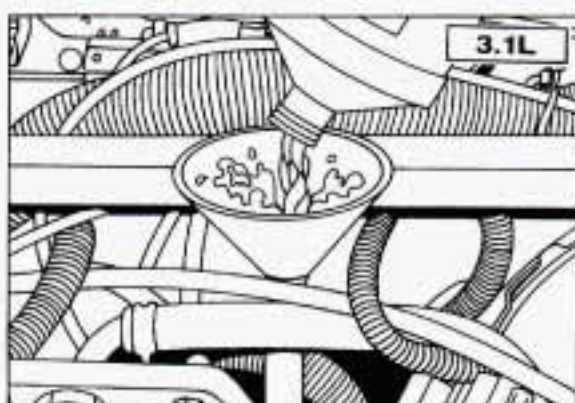

**3.1L V6: Adding Automatic Transaxle Fluid**

## ■ Manual Transaxle Fluid

### When to Check

A good time to have it checked is when the engine oil is changed. However, the fluid in your manual transaxle doesn't require changing.

### How to Check

Because this operation can be a little difficult, you may choose to have this done at a Chevrolet dealership Service Department.

If you do it yourself, be sure to follow all the instructions here, or you could get a false reading on the dipstick.

#### **NOTICE:**

Too much or too little fluid can damage your transaxle. Too much can mean that some of the fluid could come out and fall on hot engine parts or exhaust system, starting a fire. Be sure to get an accurate reading if you check your transaxle fluid.

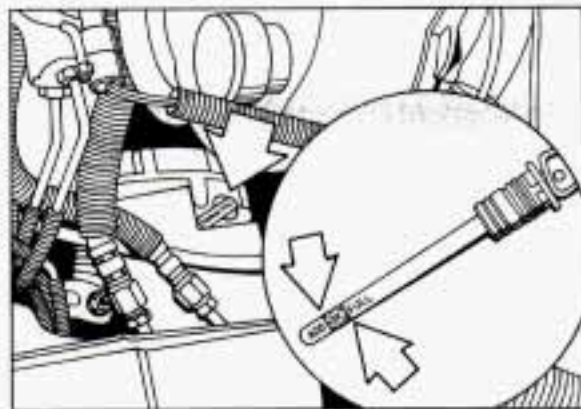

Check the fluid level only when your engine is off, the vehicle is parked on a level place and the transaxle is cool enough for you to rest your fingers on the transaxle case.

#### **Then, follow these steps:**

1. The manual transaxle dipstick is located below the brake master cylinder, near the rear of the transaxle case. Flip the handle up and then pull out the dipstick and clean it with a rag or paper towel.
2. Push it back in all the way and remove it.
3. Check both sides of the dipstick and read the lower level. The fluid level must be between the **ADD** and **FULL** marks. (Note: Fluid may appear at the bottom of the dipstick even when the fluid level is several pints low.)

4. If the fluid level is where it should be, push the dipstick back in all the way and flip the handle down. If the fluid level is low, add more fluid as described in the next steps.

### How to Add Fluid

Here's how to add fluid. Refer to the Maintenance Schedule to determine what kind of fluid to use. See *Recommended Fluids and Lubricants* in the *Index*.

1. Remove the dipstick.
2. Add fluid at the dipstick hole. Add only enough fluid to bring the fluid level up to the **FULL** mark on the dipstick.
3. Push the dipstick back in all the way; then flip the handle down to lock the dipstick in place.

# Service & Appearance Care

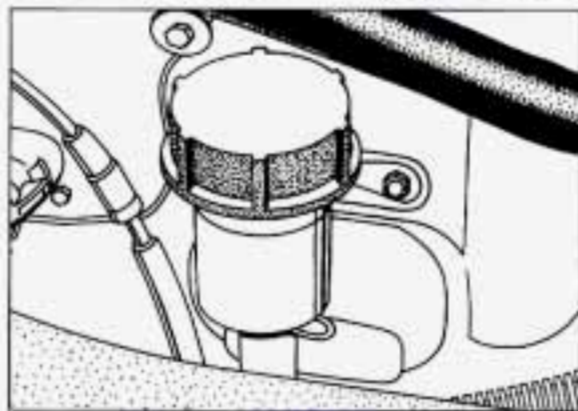

## ■ Hydraulic Clutch

The hydraulic clutch in your vehicle is self-adjusting. The clutch master cylinder reservoir is filled with hydraulic clutch fluid.

It isn't a good idea to "top off" your clutch fluid. Adding fluid won't correct a leak.

A fluid loss in this system could indicate a problem. Have the system inspected and repaired.

### **When to Check and What to Use**

Refer to the Maintenance Schedule to determine how often you should check the fluid level in your clutch master cylinder reservoir and for the proper

fluid. See *Owner Checks and Services* and *Recommended Fluids and Lubricants* in the *Index*.

### **How to Check**

You do not need to check the fluid level unless you suspect a clutch problem. To check the fluid level, take the cap off. If the fluid reaches the step inside the reservoir, the fluid level is correct.

## ■ Engine Coolant

The following explains your cooling system and how to add coolant when it is low. If you have a problem with engine overheating, see *Engine Overheating* in the *Index*.

The proper coolant for your Chevrolet will:

- Give freezing protection down to -34°F (-37°C).
- Give boiling protection up to 262°F (128°C).
- Protect against rust and corrosion.
- Help keep the proper engine temperature.
- Let the warning lights work as they should.

### **What to Use**

Use a mixture of one-half **clean water** (preferably distilled) and one-half antifreeze that meets "GM Specification 1825-M," which won't damage aluminum parts. You can also use a recycled coolant conforming to GM Specification 1825-M with a complete coolant flush and refill. If you use this mixture, you don't need to add anything else.



### **CAUTION:**

Adding only plain water to your cooling system can be dangerous. Plain water, or some other liquid like alcohol, can boil before the proper coolant mix will. Your vehicle's coolant warning system is set for the proper coolant mix. With plain water or the wrong mix, your engine could get too hot but you wouldn't get the overheat warning. Your engine could catch fire and you or others could be burned. Use a 50/50 mix of clean water and a proper antifreeze.

## NOTICE:

If you use an improper coolant mix, your engine could overheat and be badly damaged. The repair cost wouldn't be covered by your warranty. Too much water in the mix can freeze and crack the engine, radiator, heater core and other parts.



### **Adding Coolant—2.2L L4 Engine** **To Check Coolant**

When your engine is cold, the coolant level should be at **FULL COLD**, or a little higher. When your engine is warm, the level should be at **FULL COLD** or higher.

### **To Add Coolant**

If you need more coolant, add the proper mix **at the coolant recovery tank**.



## CAUTION:

Turning the radiator pressure cap when the engine and radiator are hot can allow steam and scalding liquids to blow out and burn you badly. With the coolant recovery tank, you will almost never have to add coolant at the radiator. Never turn the radiator pressure cap — even a little — when the engine and radiator are hot. You can be burned if you spill coolant on hot engine parts. Coolant contains ethylene glycol, and it will burn if the engine parts are hot enough. Don't spill coolant on a hot engine.

# Service & Appearance Care

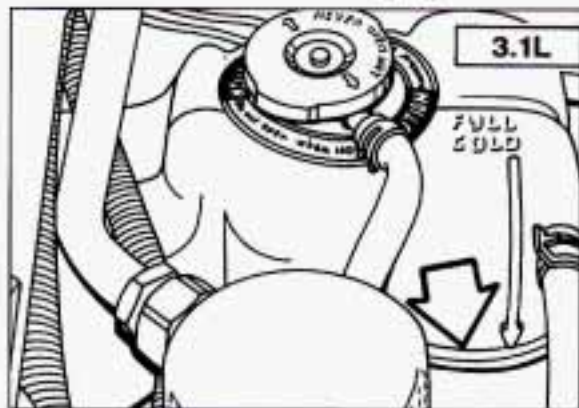

## **Adding Coolant—3.1L V6 Engine**

### **To Check Coolant**

When your engine is cold, the coolant level should be at **FULL COLD**, or a little higher.

### **To Add Coolant**

If you need more coolant, add the proper mix **at the surge tank**.



### **CAUTION:**

Turning the surge tank pressure cap when the engine and radiator are hot can allow steam and scalding liquids to blow out and burn you badly. Never turn the surge tank pressure cap — even a little — when the engine and radiator are hot. You can be burned if you spill coolant on hot engine parts. Coolant contains ethylene glycol, and it will burn if the engine parts are hot enough. Don't spill coolant on a hot engine.

## ■ **Radiator Pressure Cap**

### **NOTICE:**

Your radiator cap is a 15 psi (105 kPa) pressure-type cap and must be tightly installed to prevent coolant loss and possible engine damage from overheating. Be sure the arrows on the cap line up with the overflow tube on the radiator filler neck.

When you replace your radiator pressure cap, a GM cap is recommended.

### **Thermostat**

Engine coolant temperature is controlled by a thermostat in the engine coolant system. The thermostat stops the flow of coolant through the radiator until the coolant reaches a preset temperature.

When you replace your thermostat, an AC® thermostat is recommended.



## ■ *Power Steering Fluid*

### *How To Check Power Steering Fluid*

Unscrew the cap and wipe the dipstick with a clean rag. Replace the cap and completely tighten it. Then remove the cap again and look at the fluid level on the dipstick.

- When the engine compartment is hot, the level should be near the **H** mark.
- When the engine compartment is cool, the level should be near the **C** mark.

### **What to Add**

Refer to the Maintenance Schedule to determine what kind of fluid to use. See *Recommended Fluids and Lubricants* in the *Index*.

### **NOTICE:**

When adding power steering fluid or making a complete fluid change, always use the proper fluid. Failure to use the proper fluid can cause leaks and damage hoses and seals.

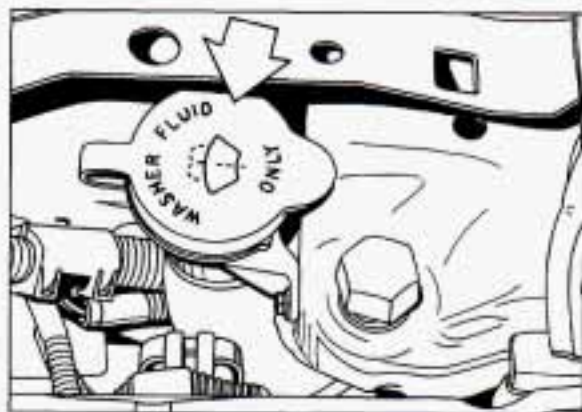

## ■ *Windshield Washer Fluid*

### *To Add*

Open the cap labeled **WASHER FLUID ONLY**. Add washer fluid until the bottle is full.

# Service & Appearance Care

## NOTICE:

- When using concentrated washer fluid, follow the manufacturer's instructions for adding water.
- Don't mix water with ready-to-use washer fluid. Water can cause the solution to freeze and damage your washer fluid tank and other parts of the washer system. Also, water doesn't clean as well as washer fluid.
- Fill your washer fluid tank only  $\frac{3}{4}$  full when it's very cold. This allows for expansion, which could damage the tank if it is completely full.
- Don't use radiator antifreeze in your windshield washer. It can damage your washer system and paint.

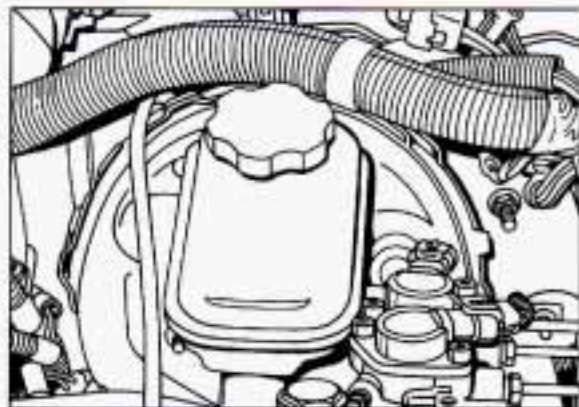

## ■ Brakes

### Brake Master Cylinder

Your brake master cylinder is here. It is filled with DOT-3 brake fluid.

There are only two reasons why the brake fluid level in your master cylinder might go down. The first is that the brake fluid goes down to an acceptable level during normal brake lining wear. When new linings are put in, the fluid level goes back up. The other reason is that fluid is leaking out of the brake system. If it is, you should have your brake system fixed, since a leak means that sooner or later your brakes won't work well, or won't work at all. So, it isn't a good idea to "top off" your brake

fluid. Adding brake fluid won't correct a leak. If you add fluid when your linings are worn, then you'll have too much fluid when you get new brake linings. You should add (or remove) brake fluid, as necessary, only when work is done on the brake hydraulic system.



## CAUTION:

If you have too much brake fluid, it can spill on the engine. The fluid will burn if the engine is hot enough. You or others could be burned, and your vehicle could be damaged. Add brake fluid only when work is done on the brake hydraulic system.

When your brake fluid falls to a low level, your brake warning light will come on. See *Brake System Warning Light* in the *Index*.

### What to Add

When you do need brake fluid, use only DOT-3 brake fluid — such as Delco Supreme 11® (GM Part No.1052535).

Use new brake fluid from a sealed container only, and always clean the brake fluid reservoir cap before removing it.

### **NOTICE:**

- DOT-5 silicone brake fluid can damage your vehicle. Don't use it.
- Don't let someone put in the wrong kind of fluid. For example, just a few drops of mineral-based oil, such as engine oil, in your brake system can damage brake system parts so badly that they'll have to be replaced.
- Brake fluid can damage paint, so be careful not to spill brake fluid on your vehicle. If you do, wash it off immediately. See *Appearance Care* in the *Index*.

### **Brake Wear**

Your Chevrolet has front disc brakes and rear drum brakes.

Disc brake pads have built-in wear indicators that make a high-pitched

warning sound when the brake pads are worn and new pads are needed. The sound may come and go or be heard all the time your vehicle is moving (except when you are pushing on the brake pedal firmly).



### **CAUTION:**

The brake wear warning sound means that sooner or later your brakes won't work well. That could lead to an accident. When you hear the brake wear warning sound, have your vehicle serviced.

### **NOTICE:**

Continuing to drive with worn-out brake pads could result in costly brake repair.

Some driving conditions or climates may cause a brake squeal when the brakes are first applied or lightly applied. This does not mean something is wrong with your brakes.

Your rear drum brakes don't have wear indicators, but if you ever hear a rear brake rubbing noise, have the rear brake linings inspected. Also, the rear brake drums should be removed and inspected each time the tires are removed for rotation or changing. When you have the front brakes replaced, have the rear brakes inspected, too.

Brake linings should always be replaced as complete axle sets.

### **Brake Pedal Travel**

See your dealer if the brake pedal does not return to normal height, or if there is a rapid increase in pedal travel. This could be a sign of brake trouble.

### **Brake Adjustment**

Every time you make a moderate brake stop, your disc brakes adjust for wear. If you rarely make a moderate or heavier stop, then your brakes might not adjust correctly. If you drive in that way, then — very carefully — make a few moderate brake stops about every 1,000 miles (1600 km), so your brakes will adjust properly.



# Service & Appearance Care

If your brake pedal goes down farther than normal, your rear drum brakes may need adjustment. Adjust them by backing up and firmly applying the brakes a few times.

## Replacing Brake System Parts

The braking system on a modern vehicle is complex. Its many parts have to be of top quality and work well together if the vehicle is to have really good braking. Vehicles we design and test have top-quality GM brake parts in them, as your Chevrolet does when it is new. When you replace parts of your braking system — for example, when your brake linings wear down and you have to have new ones put in — be sure you get new genuine GM replacement parts. If you don't, your brakes may no longer work properly. For example, if someone puts in brake linings that are wrong for your vehicle, the balance between your front and rear brakes can change, for the worse. The braking performance you've come to expect can change in many other ways if someone puts in the wrong replacement brake parts.



## ■ Battery

Every new Chevrolet has a Delco Freedom® battery. You never have to add water to one of these. When it's time for a new battery, we recommend a Delco Freedom® battery. Get one that has the catalog number shown on the original battery's label.

## Vehicle Storage

If you're not going to drive your vehicle for 25 days or more, take off the black, negative (-) cable from the battery. This will help keep your battery from running down.



## CAUTION:

Batteries have acid that can burn you and gas that can explode. You can be badly hurt if you aren't careful. See *Jump Starting* in the *Index* for tips on working around a battery without getting hurt.

Contact your dealer to learn how to prepare your vehicle for longer storage periods.

## ■ Halogen Bulbs



## CAUTION:

Halogen bulbs have pressurized gas inside and can burst if you drop or scratch the bulb. You or others could be injured. Take special care when handling and disposing of halogen bulbs.

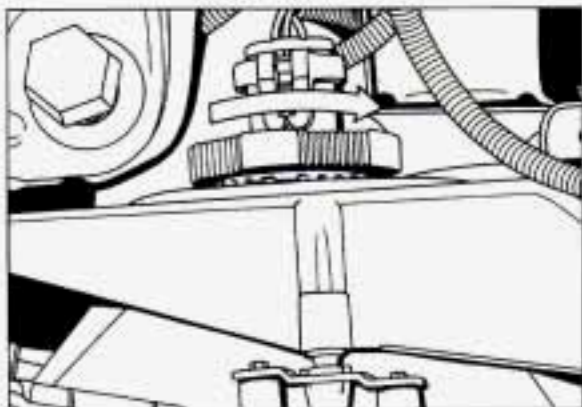

### **Headlight Bulb Replacement**

For the type of bulb, see the *Index* under *Replacement Bulbs*.

1. Turn the lock ring clockwise until the flanges align with the slots in the housing. Then pull the ring back from the housing.

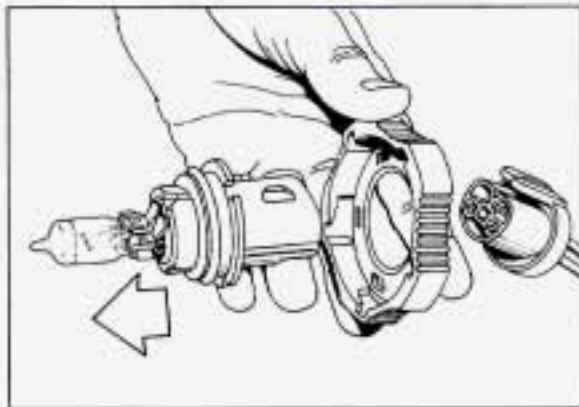

2. Pull out the bulb assembly.
3. Disconnect the bulb base from the socket by lifting the plastic locking tab.
4. Snap a new bulb into the socket.
5. Replace the bulb assembly by reversing steps 1-3.

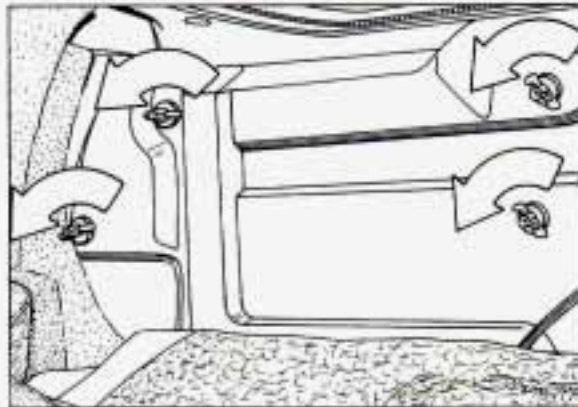

### **Taillight Bulb Replacement**

For the type of bulb, see the *Index* under *Replacement Bulbs*.

#### **4-Door Models:**

1. If your vehicle has a convenience net at the back of the trunk, remove it and pull the carpet away from the rear of the trunk. Next remove the four wing nuts.

# Service & Appearance Care

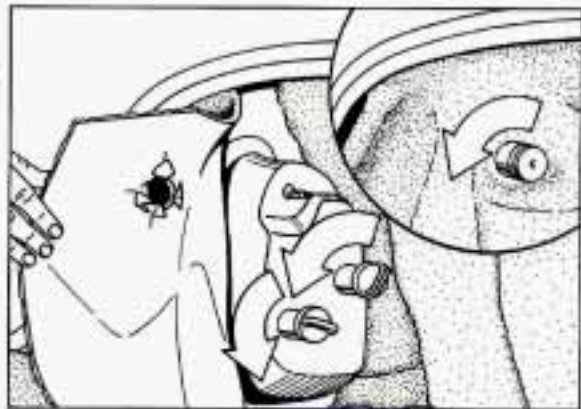

## 2-Door Models:

1. Pull the carpet back from the corner and remove the plastic wing nuts. If you have the optional convenience net, first unhook the net from the retainer and remove the retainer knob.

## Both 4-Door and 2-Door Models:

2. From outside the vehicle, gently pull back on the taillight housing.

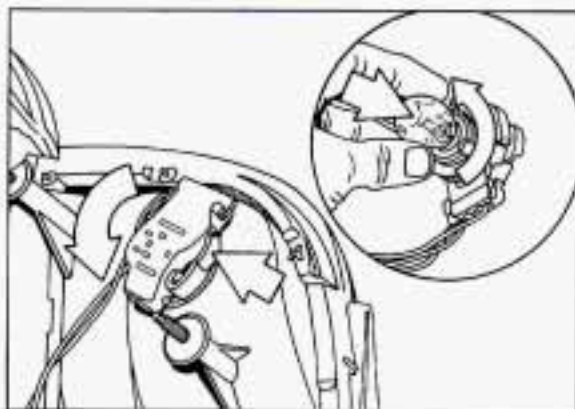

3. Press the bulb housing release lever and turn the housing 1/6 turn counterclockwise to remove it.
4. To remove the bulb, push in and turn it counterclockwise.
5. Push in the new bulb and turn it clockwise.
6. Reverse all steps to reassemble the taillight housing.

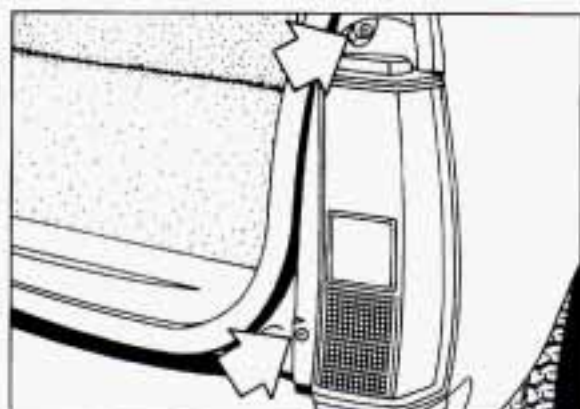

## Wagon:

1. Open the liftgate.
2. Remove the two Torx® screws.

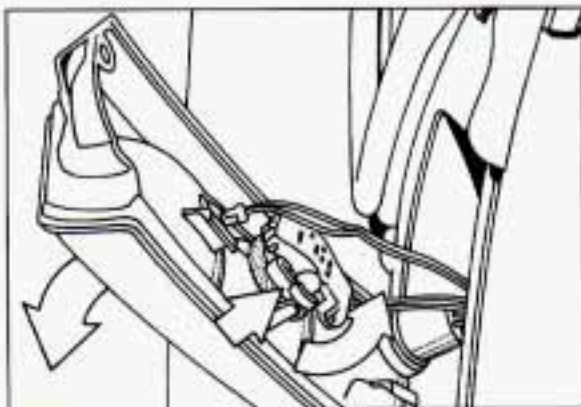

3. Pull back gently on the taillight housing.
4. Press the bulb housing tab, rotate the housing counterclockwise  $\frac{1}{8}$  turn and remove it.



5. To remove the bulb, push the bulb in, and rotate it counterclockwise.
6. Push in the new bulb and turn it clockwise.
7. Reverse all steps to reassemble the taillight housing.

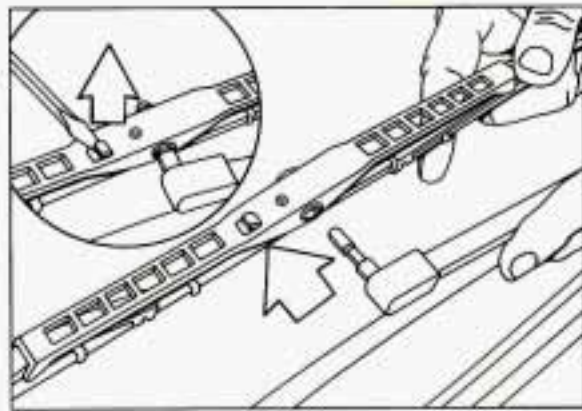

### **Windshield Wiper Blade Replacement**

Replacement blades come in different types and are removed in different ways. Here's how to remove the type with a release clip:

1. Pull the windshield wiper arm away from the windshield.
2. Lift the release clip with a screwdriver and pull the blade assembly off the wiper arm.
3. Push the new wiper blade securely on the wiper arm.

# Service & Appearance Care



## ■ Loading Your Vehicle

Two labels on your vehicle show how much weight it may properly carry. The Tire-Loading Information label found on the rear edge of the driver's door tells you the proper size, speed rating and recommended inflation pressures for the tires on your vehicle. It also gives you important information about the number of people that can be in your vehicle and the total weight that you can carry. This weight is called the Vehicle Capacity Weight and includes the weight of all occupants, cargo, and all nonfactory-installed options.

The other label is the Certification label, found on the rear edge of the driver's door. It tells you the gross weight capacity of your vehicle, called the GVWR (Gross Vehicle Weight Rating). The GVWR includes the weight of the vehicle, all occupants, fuel and cargo. Never exceed the GVWR for your vehicle, or the Gross Axle Weight Rating (GAWR) for either the front or rear axle.

And, if you do have a heavy load, you should spread it out. Don't carry more than 132 lbs. (60 kg) in your trunk, or 88 lbs. (40 kg) in your wagon's rear area.



## CAUTION:

Do not load your vehicle any heavier than the GVWR or the maximum front and rear GAWRs. If you do, parts on your vehicle can break, or it can change the way your vehicle handles. These could cause you to lose control. Also, overloading can shorten the life of your vehicle.

If you put things inside your vehicle — like suitcases, tools, packages, or anything else — they will go as fast as the vehicle goes. If you have to stop or turn quickly, or if there is a crash, they'll keep going.



## **CAUTION:**

Things you put inside your vehicle can strike and injure people in a sudden stop or turn, or in a crash.

- Put things in the trunk or rear area of your vehicle. In a trunk, put them as far forward as you can. Try to spread the weight evenly.

If you have fold-down rear seats, you'll find four anchors on the back wall of your trunk. You can use these anchors to tie down lighter loads. They're not strong enough for heavy things, however, so put them as far forward as you can in the trunk or rear area.

**CAUTION (Continued)**

## **CAUTION (Continued)**

- Never stack heavier things, like suitcases, inside the vehicle so that some of them are above the tops of the seats.
- Don't leave an unsecured child restraint in your vehicle.
- When you carry something inside the vehicle, secure it whenever you can.
- Don't leave a seat folded down unless you need to.

## ■ *Tires*

We don't make tires. Your new vehicle comes with high quality tires made by a leading tire manufacturer. These tires are warranted by the tire manufacturers and their warranties are delivered with every new Chevrolet. If your spare tire is a different brand than your road tires, you will have a tire warranty folder from each of these manufacturers.

# Service & Appearance Care



## CAUTION:

Poorly maintained and improperly used tires are dangerous.

- Overloading your tires can cause overheating as a result of too much friction. You could have an air-out and a serious accident. See *Loading Your Vehicle* in the *Index*.
- Underinflated tires pose the same danger as overloaded tires. The resulting accident could cause serious injury. Check all tires frequently to maintain the recommended pressure. Tire pressure should be checked when your tires are cold.
- Overinflated tires are more likely to be cut, punctured, or broken by a sudden impact, such as when you hit a pothole. Keep tires at the recommended pressure.
- Worn, old tires can cause accidents. If your tread is badly worn, or if your tires have been damaged, replace them.

## Inflation—Tire Pressure

The Tire-Loading Information label which is on the rear edge of the driver's door shows the correct inflation pressures for your tires, when they're cold. **Cold** means your vehicle has been sitting for at least three hours or driven no more than a mile.

## NOTICE:

Don't let anyone tell you that underinflation **or** overinflation is all right. It's not. If your tires don't have enough air (underinflation) you can get:

- Too much flexing
- Too much heat
- Tire overloading
- Bad wear
- Bad handling
- Bad fuel economy.

If your tires have too much air (overinflation), you can get:

- Unusual wear
- Bad handling
- Rough ride
- Needless damage from road hazards.

### When to Check

Check your tires once a month or more. Don't forget your compact spare tire. It should be at 60 psi (420 kPa).

### How to Check

Use a good quality pocket-type gage to check tire pressure. Simply looking at the tires will not tell you the pressure, especially if you have radial tires — which may look properly inflated even if they're underinflated.

If your tires have valve caps, be sure to put them back on. They help prevent leaks by keeping out dirt and moisture.

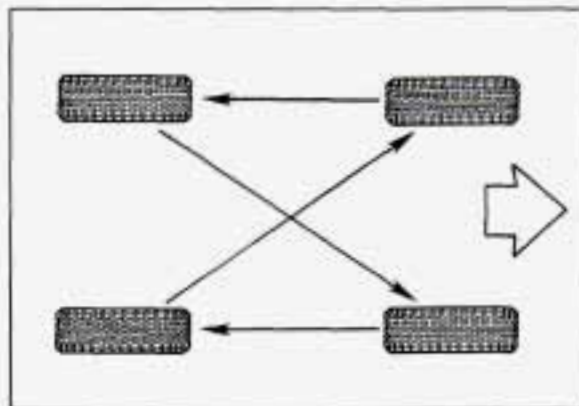

### Tire Inspection and Rotation

To make your tires last longer, have them inspected and rotated at the mileages recommended in the Maintenance Schedule. See *Scheduled Maintenance Services* in the *Index*.

Use this rotation pattern.

After the tires have been rotated, adjust the front and rear inflation pressure as shown on the Tire-Loading Information label. Make certain that all wheel nuts are properly tightened. See *Wheel Nut Torque* in the *Index*.



### CAUTION:

Rust or dirt on a wheel, or on the parts to which it is fastened, can make wheel nuts become loose after a time. The wheel could come off and cause an accident. When you change a wheel, remove any rust or dirt from places where the wheel attaches to the vehicle. In an emergency, you can use a cloth or a paper towel to do this; but be sure to use a scraper or wire brush later, if you need to, to get all the rust or dirt off. (See *Changing a Flat Tire* in the *Index*.)



# Service & Appearance Care

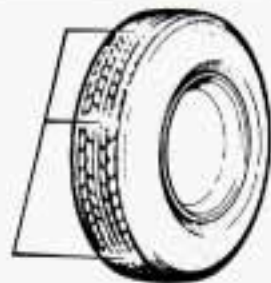

TREAD WEAR INDICATORS

## When It's Time for New Tires

One way to tell when it's time for new tires is to check the treadwear indicators, which will appear when your tires have only  $\frac{1}{2}$  inch (1.6 mm) or less of tread remaining.

You need a new tire if:

- You can see the indicators at three or more places around the tire.
- You can see cord or fabric showing through the tire's rubber.
- The tread or sidewall is cracked, cut or snagged deep enough to show cord or fabric.
- The tire has a bump, bulge or split.
- The tire has a puncture, cut, or other damage that can't be repaired well because of the size or location of the damage.

## Buying New Tires

To find out what kind and size of tires you need, look at the Tire-Loading Information label.

The tires installed on your vehicle when it was new had a Tire Performance Criteria Specification (TPC Spec) number on each tire's sidewall. When you get new tires, get ones with that same TPC Spec number. That way, your vehicle will continue to have tires that are designed to give proper endurance, handling, speed rating, traction, ride and other things during normal service on your vehicle. If your tires have an all-season tread design, the TPC number will be followed by a "MS" (for mud and snow).

If you ever replace your tires with those not having a TPC Spec number, make sure they are the same size, load range, speed rating and construction type (bias, bias-belted or radial) as your original tires.



## CAUTION:

Mixing tires could cause you to lose control while driving. If you mix tires of different sizes or types (radial and bias-belted tires), the vehicle may not handle properly, and you could have a crash. Be sure to use the same size and type tires on all four wheels. It's all right to drive with your compact spare, though. It was developed for use on your vehicle.

## **Uniform Tire Quality Grading**

The following information relates to the system developed by the United States National Highway Traffic Safety Administration which grades tires by treadwear, traction and temperature performance. (This applies only to vehicles sold in the United States.)

### **Treadwear**

The treadwear grade is a comparative rating based on the wear rate of the tire when tested under controlled conditions on a specified government test course. For example, a tire graded 150 would wear one and a half (1½) times as well on the government course as a tire graded 100. The relative performance of tires depends upon the actual conditions of their use, however, and may depart significantly from the norm due to variations in driving habits, service practices and differences in road characteristics and climate.

### **Traction—A, B, C**

The traction grades, from highest to lowest are: A, B, and C. They represent the tire's ability to stop on wet pavement as measured under controlled conditions on specified government test surfaces of asphalt and concrete. A tire marked C may have poor traction performance.

**Warning:** The traction grade assigned to this tire is based on braking (straight-ahead) traction tests and does not include cornering (turning) traction.

### **Temperature—A, B, C**

The temperature grades are A (the highest), B, and C, representing the tire's resistance to the generation of heat and its ability to dissipate heat when tested under controlled conditions on a specified indoor laboratory test wheel. Sustained high temperature can cause the material of the tire to degenerate and reduce tire life, and excessive temperature can lead to sudden tire failure. The grade C corresponds to a level of performance which all passenger car tires must meet under the Federal Motor Vehicle Safety

Standard No. 109. Grades B and A represent higher levels of performance on the laboratory test wheel than the minimum required by law.

**Warning:** The temperature grade for this tire is established for a tire that is properly inflated and not overloaded. Excessive speed, underinflation, or excessive loading, either separately or in combination, can cause heat buildup and possible tire failure.

These grades are molded on the sidewalls of passenger car tires.

While the tires available as standard or optional equipment on General Motors vehicles may vary with respect to these grades, all such tires meet General Motors performance standards and have been approved for use on General Motors vehicles. All passenger type (P Metric) tires must conform to Federal safety requirements in addition to these grades.

# Service & Appearance Care

## **Wheel Alignment and Tire Balance**

The wheels on your vehicle were aligned and balanced carefully at the factory to give you the longest tire life and best overall performance.

In most cases, you will not need to have your wheels aligned again. However, if you notice unusual tire wear or your vehicle pulling one way or the other, the alignment may need to be reset. If you notice your vehicle vibrating when driving on a smooth road, your wheels may need to be rebalanced.

## **Wheel Replacement**

Replace any wheel that is bent, cracked or badly rusted. If wheel nuts keep coming loose, the wheel, wheel bolts, and wheel nuts should be replaced. If the wheel leaks air, replace it (except some aluminum wheels, which can sometimes be repaired). See your Chevrolet dealer if any of these conditions exist.

Your dealer will know the kind of wheel you need.

Each new wheel should have the same load carrying capacity, diameter, width, offset, and be mounted the same way as the one it replaces.

If you need to replace any of your wheels, wheel bolts, or wheel nuts, replace them only with new GM original equipment parts. This way, you will be sure to have the right wheel, wheel bolts, and wheel nuts for your Chevrolet model.



## **CAUTION:**

Using the wrong replacement wheels, wheel bolts, or wheel nuts on your vehicle can be dangerous. It could affect the braking and handling of your vehicle, make your tires lose air and make you lose control. You could have a collision in which you or others could be injured. Always use the correct wheel, wheel bolts, and wheel nuts for replacement.

## **NOTICE:**

The wrong wheel can also cause problems with bearing life, brake cooling, speedometer/odometer calibration, headlight aim, bumper height, vehicle ground clearance, and tire or tire chain clearance to the body and chassis.

## Used Replacement Wheels



### CAUTION:

Putting a used wheel on your vehicle is dangerous. You can't know how it's been used or how many miles it's been driven. It could fail suddenly and cause an accident. If you have to replace a wheel use a **new** GM original equipment wheel.

## Tire Chains

### NOTICE:

If your Chevrolet has P195/70R14, P195/65R15 or P205/60R15 size tires, don't use tire chains; they can damage your vehicle. If you have other tires, use tire chains only where legal and only when you must. Use only SAE Class "S" type chains that are the proper size for your tires. Install them on the front tires and tighten them as tightly as possible with the ends securely fastened. Drive slowly and follow the chain manufacturer's instructions. If you can hear the chains contacting your vehicle, stop and retighten them. If the contact continues, slow down until it stops. Driving too fast with chains on will damage your vehicle.

## ■ Appearance Care

Remember, cleaning products can be hazardous. Some are toxic. Others can burst into flame if you strike a match or get them on a hot part of the vehicle. Some are dangerous if you breathe their fumes in a closed space. When you use anything from a container to clean your Chevrolet, be sure to follow the manufacturer's warnings and instructions. And always open your doors or windows when you're cleaning the inside.

# Service & Appearance Care

**Never** use these to clean your vehicle:

- Gasoline
- Benzene
- Naphtha
- Carbon Tetrachloride
- Acetone
- Paint Thinner
- Turpentine
- Lacquer Thinner
- Nail Polish Remover

They can all be hazardous — some more than others — and they can all damage your vehicle, too.

## **NOTICE:**

Don't use any of these unless this manual says you can. In many uses, these will damage your vehicle:

- Alcohol
- Laundry Soap
- Bleach
- Reducing Agents

## ■ *Cleaning the Inside of Your Chevrolet*

Use a vacuum cleaner often to get rid of dust and loose dirt. Wipe vinyl or leather with a clean, damp cloth.

Your Chevrolet dealer has two GM cleaners, a solvent-type spot lifter and a foam-type powdered cleaner. They will clean normal spots and stains very well. Do not use them on vinyl or leather.

Here are some cleaning tips:

- Always read the instructions on the cleaner label.
- Clean up stains as soon as you can — before they set.
- Use a clean cloth or sponge, and change to a clean area often. A soft brush may be used if stains are stubborn.
- Use solvent-type cleaners in a well-ventilated area only. If you use them, don't saturate the stained area.
- If a ring forms after spot cleaning, clean the entire area immediately or it will set.

## *Using Foam-Type Cleaner on Fabric*

- Vacuum and brush the area to remove any loose dirt.
- Always clean a whole trim panel or section. Mask surrounding trim along stitch or welt lines.
- Mix Multi-Purpose Powdered Cleaner following the directions on the container label.
- Use suds only and apply with a clean sponge.
- Don't saturate the material.
- Don't rub it roughly.
- As soon as you've cleaned the section, use a sponge to remove the suds.
- Rinse the section with a clean, wet sponge.
- Wipe off what's left with a slightly damp paper towel or cloth.
- Then dry it immediately with a blow dryer or a heat lamp.

## **NOTICE:**

Be careful with a hair dryer or heat lamp. You could scorch the fabric.

- Wipe with a clean cloth.

### ***Using Solvent-Type Cleaner on Fabric***

First, see if you have to use solvent-type cleaner at all. Some spots and stains will clean off better with just water and mild soap.

If you need to use a solvent:

- Gently scrape excess soil from the trim material with a clean, dull knife or scraper. Use very little cleaner, light pressure and clean cloths (preferably cheesecloth). Cleaning should start at the outside of the stain, "feathering" toward the center. Keep changing to a clean section of the cloth.
- When you clean a stain from fabric, immediately dry the area with an air hose, hair dryer, or heat lamp to help prevent a cleaning ring. (See the previous NOTICE.)

### ***Fabric Protection***

Your Chevrolet has upholstery that has been treated with Scotchgard™ Fabric Protector, a 3M product. Scotchgard™ protects fabrics by repelling oil and water, which are the carriers of most stains. Even with this protection, you still need to clean your upholstery often to keep it looking new.

Further information on cleaning is available by calling 1-800-433-3296 (in Minnesota, 1-800-642-6167).

### ***Special Cleaning Problems***

#### **Greasy or Oily Stains**

Such as grease, oil, butter, margarine, shoe polish, coffee with cream, chewing gum, cosmetic creams, vegetable oils, wax crayon, tar and asphalt.

- Carefully scrape off excess stain.
- Follow the solvent-type instructions described earlier.
- Shoe polish, wax crayon, tar and asphalt will stain if left on a vehicle seat fabric. They should be removed as soon as possible. Be careful, because the cleaner will dissolve them and may cause them to spread.

### **Non-Greasy Stains**

Such as catsup, coffee (black), egg, fruit, fruit juice, milk, soft drinks, wine, vomit, urine and blood.

- Carefully scrape off excess stain, then sponge the soiled area with cool water.
- If a stain remains, follow the foam-type instructions described earlier.
- If an odor lingers after cleaning vomit or urine, treat the area with a water/baking soda solution: 1 teaspoon (5 ml) of baking soda to 1 cup (250 ml) of lukewarm water.
- If needed, clean lightly with solvent-type cleaner.

#### **Combination Stains**

Such as candy, ice cream, mayonnaise, chili sauce and unknown stains.

- Carefully scrape off excess stain, then clean with cool water and allow to dry.
- If a stain remains, clean it with solvent-type cleaner.

# Service & Appearance Care

## **Cleaning Vinyl**

Use warm water and a clean cloth.

- Rub with a clean, damp cloth to remove dirt. You may have to do it more than once.
- Things like tar, asphalt and shoe polish will stain if you don't get them off quickly. Use a clean cloth and a solvent-type vinyl cleaner.

## **Cleaning the Top of the Instrument Panel**

Use only mild soap and water to clean the top surfaces of the instrument panel. Sprays containing silicones or waxes may cause annoying reflections in the windshield and even make it difficult to see through the windshield under certain conditions.

## ■ **Cleaning the Cupholder**

If beverages get spilled on your cupholder, it may become difficult to operate. The slider mechanism can become clogged with pop, coffee, etc. To clean and return the cupholder to

normal operation, simply spray a water-based cleaner (such as Glass Plus® or Windex®) on the tracks of the slider mechanism, and then slide the cupholder in and out until normal operation is regained. Hold a paper towel under the cupholder to catch any excess cleaner which could drip on your carpet or seats.

## ■ **Care of Safety Belts**

Keep belts clean and dry.



### **CAUTION:**

Do not bleach or dye safety belts. If you do, it may severely weaken them. In a crash they might not be able to provide adequate protection. Clean safety belts only with mild soap and lukewarm water.

## ■ **Glass**

Glass should be cleaned often. GM Glass Cleaner (GM Part No. 1050427) or a liquid household glass cleaner will remove normal tobacco smoke and dust films.

Don't use abrasive cleaners on glass, because they may cause scratches. Avoid placing decals on the inside rear window, since they may have to be scraped off later. If abrasive cleaners are used on the inside of the rear window, an electric defogger element may be damaged. Any temporary license should not be attached across the defogger grid.

## ■ **Cleaning the Outside of the Windshield and Wiper Blades**

If the windshield is not clear after using the windshield washer, or if the wiper blade chatters when running, wax or other material may be on the blade or windshield.

Clean the outside of the windshield with GM Windshield Cleaner, Bon-Ami Powder® (GM Part No. 1050011). The windshield is clean if beads do not form when you rinse it with water.

Clean the blade by wiping vigorously with a cloth soaked in full strength windshield washer solvent. Then rinse the blade with water.

Wiper blades should be checked on a regular basis and replaced when worn.

## ■ *Cleaning the Outside of Your Chevrolet*

The paint finish on your vehicle provides beauty, depth of color, gloss retention and durability.

### *Washing Your Vehicle*

The best way to preserve your vehicle's finish is to keep it clean by washing it often with lukewarm or cold water.

Don't wash your vehicle in the direct rays of the sun. Don't use strong soaps or chemical detergents. Use liquid hand, dish or car washing (mild detergent)

soaps. Don't use cleaning agents that contain acid or abrasives. All cleaning agents should be flushed promptly and not allowed to dry on the surface, or they could stain. Dry the finish with a soft, clean chamois or a 100% cotton towel to avoid surface scratches and water spotting.

High pressure car washes may cause water to enter your vehicle.

### *Finish Care*

Occasional waxing or mild polishing of your Chevrolet may be necessary to remove residue from the paint finish. You can get GM approved cleaning products from your dealer.

Your Chevrolet has a "basecoat/clearcoat" paint finish. The clearcoat gives more depth and gloss to the colored basecoat. Always use waxes and polishes that are non-abrasive and made for a basecoat/clearcoat paint finish.

## **NOTICE:**

Machine compounding or aggressive polishing on a basecoat/clearcoat paint finish may dull the finish or leave swirl marks.

## ■ *Textured-Surface Bumper Covers (VL AND RS MODELS)*

Cleaning with a brush, a soft terry cloth or a commercial car wash is recommended for normal dirt. Never use a wire brush or abrasives.

Avoid applying wax or polish to the textured-surface bumper covers. To remove wax, a commercially available wax solvent should be used. Tar and Oil Remover (GM Part No.1050172) is also recommended. It's also recommended for cleaning difficult soils like road tar and oil. Also recommended are solvent-type fabric cleaners such as GM Part No. 1050214.



# Service & Appearance Care

To clean white bumper covers, first use Tar and Oil Remover. If the dark areas are still visible, whiten with White Sidewall Tire Cleaner, such as GM Part No. 1050174.

## ■ *Finish Care of Textured Surface Bumper Covers*

To touch up any small spots after regular washing, use a solvent-type fabric cleaner such as GM Part No. 1050214 and a clean, dry cloth.

To help maintain bumper covers, after washing use a cleaner/protectant like GM/Armor All™ Part No. 1052919.

## ■ *Aluminum Wheels (If So Equipped)*

Your aluminum wheels have a protective coating similar to the painted surface of your vehicle. Don't use strong soaps, chemicals, chrome polish, abrasive cleaners or abrasive cleaning brushes on them because you could damage this coating. After rinsing thoroughly, a wax may be applied.

### **NOTICE:**

If you have aluminum wheels, don't use an automatic vehicle wash that has hard silicon carbide cleaning brushes. These brushes can take off the protective coating.

## ■ *Tires*

Your Chevrolet dealer has a GM White Sidewall Tire Cleaner. You can use a stiff brush with the cleaner.

When applying a tire dressing always take care to wipe off any overspray or splash from painted surfaces. Petroleum-based products may damage the paint finish.

## ■ *Weatherstrips*

Silicone grease on weatherstrips will make them last longer, seal better, and not stick or squeak. Apply silicone grease with a clean cloth at least every six months. During very cold, damp weather more frequent application may be required. (See *Recommended Fluids & Lubricants* in the *Index*.)

## ■ *Sheet Metal Damage*

If your vehicle is damaged and requires sheet metal repair or replacement, make sure the body repair shop applies anti-corrosion material to the parts repaired or replaced to restore corrosion protection.

## ■ *Foreign Material*

Calcium chloride and other salts, ice melting agents, road oil and tar, tree sap, bird droppings, chemicals from industrial chimneys, and other foreign matter can damage your vehicle's finish if they remain on painted surfaces. Use cleaners that are marked safe for painted surfaces to remove foreign matter.

### ■ *Finish Damage*

Any stone chips, fractures or deep scratches in the finish should be repaired right away. Bare metal will corrode quickly and may develop into a major repair expense.

Minor chips and scratches can be repaired with touch-up materials available from your dealer or other service outlets. Larger areas of finish damage can be corrected in your dealer's body and paint shop.

### ■ *Underbody Maintenance*

Chemicals used for ice and snow removal and dust control can collect on the underbody. If these are not removed, accelerated corrosion (rust) can occur on the underbody parts such as fuel lines, frame, floor pan, and exhaust system even though they have corrosion protection.

At least every spring, flush these materials from the underbody with plain water. Clean any areas where mud and other debris can collect. Dirt packed in closed areas of the frame should be loosened before being flushed. Your dealer or an underbody vehicle washing system can do this for you.

### ■ *Chemical Paint Spotting*

Some weather and atmospheric conditions can create a chemical fallout. Airborne pollutants can fall upon and attack painted surfaces on your vehicle. This damage can take two forms: blotchy, ringlet-shaped discolorations, and small irregular dark spots etched into the paint surface.

Although no defect in the paint job causes this, Chevrolet will repair, at no charge to the owner, the surfaces of new vehicles damaged by this fallout condition within 12 months or 12,000 miles (20 000 km) of purchase, whichever comes first.

# Service & Appearance Care

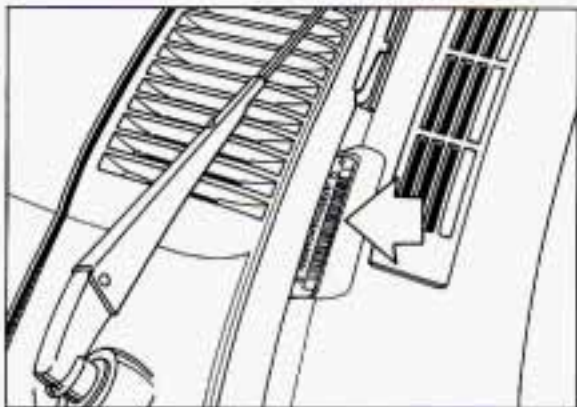

## ■ *Vehicle Identification Number (VIN)*

This is the legal identifier for your Chevrolet. It appears on a plate in the front corner of the instrument panel, on the driver's side. You can see it if you look through the windshield from outside your vehicle. The VIN also appears on the Vehicle Certification and Service Parts labels and the certificates of title and registration.

## *Engine Identification*

The eighth character in your VIN is the engine code. This code will help you identify your engine, specifications, and replacement parts.

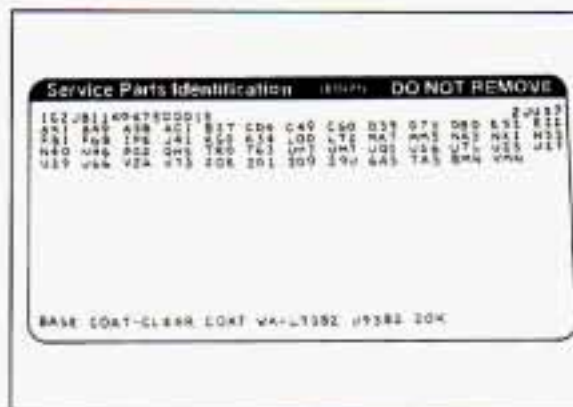

## ■ *Service Parts Identification Label*

You'll find this label on your spare tire cover or on the inside of your trunk lid. It's very helpful if you ever need to order parts. On this label is:

- your VIN,
- the model designation,
- paint information, and
- a list of all production options and special equipment.

Be sure that this label is not removed from the vehicle.

## ■ *Add-On Electrical Equipment*

### **NOTICE:**

Don't add anything electrical to your Chevrolet unless you check with your dealer first. Some electrical equipment can damage your vehicle and the damage wouldn't be covered by your warranty. Some add-on electrical equipment can keep other components from working as they should.

## ■ *Fuses & Circuit Breakers*

The wiring circuits in your vehicle are protected from short circuits by a combination of fuses, circuit breakers, and fusible thermal links in the wiring itself. This greatly reduces the chance of damage caused by electrical problems.

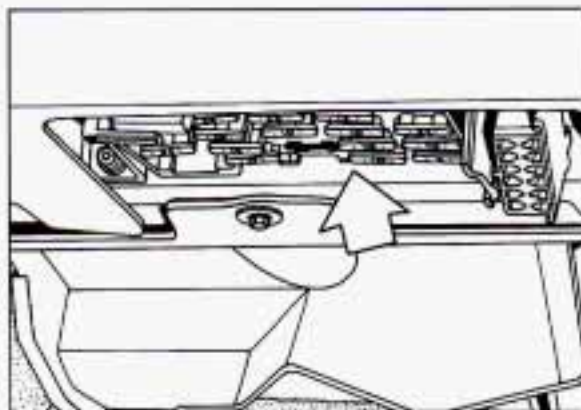

The fuse panel is located under the lower left side of the instrument panel. To identify and check fuses, refer to the Fuse Usage chart.

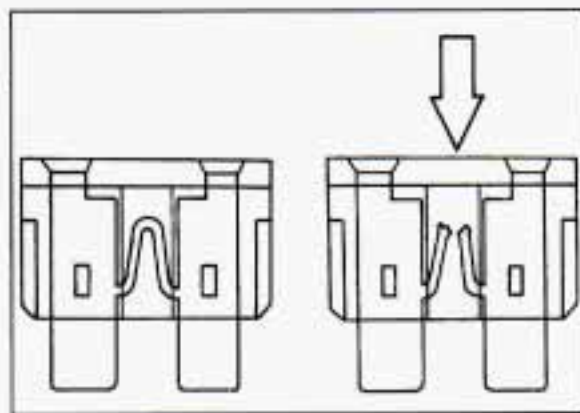

Look at the silver-colored band inside the fuse. If the band is broken or melted, replace the fuse. Be sure you replace a bad fuse with a new one of the identical size and rating.

# Service & Appearance Care

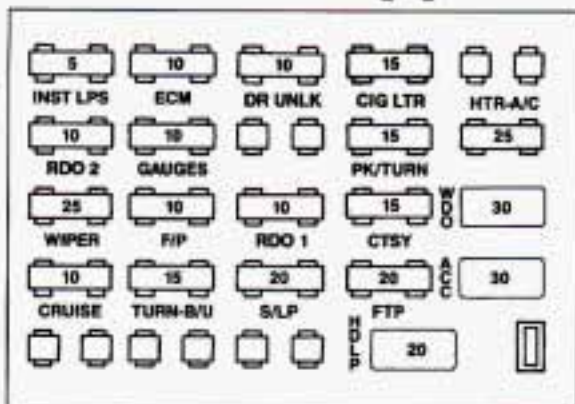

## Fuse Usage

Fuse	Rating (AMP.)	Circuitry
INST LPS	5	Instrument Panel Lamps
ECM	10	Electronic Control Module, Fuel Injectors
DR UNLK	10	Automatic Door Unlock (Remove to Disable)
CIG LTR	15	Cigarette Lighter, Glove Box Light
RDO 2	10	Radio Power
GAUGES	10	Gages, Audio Warning System, Cluster Telltales, TCC, Rear Defogger Relay, Brake Transaxle Shift Interlock, Multiport Fuel Injection
PK/TURN	15	Park and Turn Lamps
HTR-A/C	25	Heater and A/C Power, Daytime Running Lights (Canada), Anti-Lock Brakes
WIPER	25	Windshield Wipers
F/P	10	Fuel Pump
RDO 1	10	Radio Memory, Digital Clock
CTSY	15	Interior Lights, Horn, Power Locks, Audible Warning System, Remote Liftgate Release, Check Oil Light
WDO	30	Power Window (Circuit Breaker)
CRUISE	10	Cruise Control
TURN-B/U	15	Turn Signal, Back-Up Lamps
S/LP	20	Stop Lamps, Hazard Flashers
FTP	20	Flash-To-Pass
ACC	30	Power Locks, Rear Window Defogger (Circuit Breaker)
HDLP	20	Headlamp (Circuit Breaker)

### ***Headlight Wiring***

The headlight wiring is protected by a circuit breaker in the fuseblock. An electrical overload will cause the lights to go on and off, or in some cases to remain off. If this happens, have your headlight system checked right away.

To access the headlight circuit breaker, squeeze the plastic clip together and remove.

### ***Windshield Wipers***

The windshield wiper motor is protected by a circuit breaker and a fuse. If the motor overheats due to heavy snow, etc., the wiper will stop until the motor cools. If the overload is caused by some electrical problem, have it fixed.

### ***Power Windows and Other Power Options***

Circuit breakers in the fuse panel protect the power windows and other power accessories. When the current load is too heavy, the circuit breaker opens and closes, protecting the circuit until the problem is fixed.

# Service & Appearance Care

## Capacities & Specifications

**Engine Crankcase** .....4.0 quarts                      3.80 L

*When changing filter, up to 0.5 quart (0.5 liter) more oil may be needed.*

### Automatic Transaxle

Pan Removal and Replacement.....4.0 quarts                      3.80 L

After Complete Overhaul .....6.9 quarts                      6.60 L

*When draining or replacing torque converter, more fluid may be needed.*

### Manual Transaxle

Complete Drain and Refill.....2.0 quarts                      1.90 L

### Cooling System

2.2L L4.....11.7 quarts                      11.1 L

3.1L V6.....14.2 quarts                      13.5 L

**Refrigerant (R-12), Air Conditioning** .....2.25 pounds                      1.02 kg

*Not all air conditioning refrigerants are the same. If the air conditioning system in your vehicle needs refrigerant, be sure the proper refrigerant is used. If you're not sure, ask your Chevrolet dealer. For additional information, see your "Warranty and Owner Assistance Information" booklet.*

**Fuel Tank** .....15.2 gallons                      57.5 L

### Power Steering

Pump Only .....1.00 pint                      0.50 L

Complete System .....2.25 pints                      1.25 L

**Tire Pressures, Sizes** .....See Tire-Loading Information label on driver's door.

**Wheel Nut Torque** .....100 pound-feet 140 N•m

NOTE: All capacities are approximate. When adding, be sure to fill to the appropriate level, as recommended in this manual.

## Fluids & Lubricants

ITEM	APPLICATION	GM PART NUMBER	SIZE	
Antifreeze Coolant (Ethylene Glycol Base)	Year-Round Antifreeze for Coolant Mixtures	1052753	1 gal.	(3.8 L)
Chassis Lubricant (Grease Gun Insert)	General Chassis Lube, etc.	1052497	14 oz.	(397 g)
Delco Supreme 11® Brake Fluid	Brake System and Clutch Master Cylinder	1052535	16 oz.	(0.5 L)
Automatic Transmission Fluid	Automatic Transaxle			
DEXRON®-III		12346143	32 oz.	(1.0 L)
DEXRON®-IIE		12345881	32 oz.	(1.0 L)
Synchromesh Transmission Fluid	Manual Transaxle	12345349	32 oz.	(1.0 L)
GM Hydraulic Fluid	Clutch Master Cylinder	12345347	16 oz.	(0.5 L)
Engine Oil	Engine Lubrication	See the <i>Index</i> under <i>Engine Oil</i> .		
GM Engine Oil Supplement (E.O.S.)	See your dealer for advice	1052367	16 oz.	(0.5 L)
Engine Oil	Hood, Trunk and Door Hinges			
Windshield Washer Solvent	Windshield Washer Fluid			
Power Steering Fluid	Power Steering System	1050017	32 oz.	(1.0 L)
		1052884	16 oz.	(0.5 L)
Dielectric Silicone Grease	Weatherstrips	12345579	1 oz.	(0.028 kg)
Spray-A-Squeak Silicone Lubricant	General Purpose Silicone Lubricant, Weatherstrips	1052276 (aerosol)	4.5 oz.	(127 g)
		1052277	12 oz.	(0.35 L)



# Service & Appearance Care

## *Replacement Bulbs*

<b>OUTSIDE LIGHTS</b>	<b>BULB</b>
Back-Up Lights .....	1156
Front Parking/Turn Signal Lights .....	2357NA
Center High Mount Stoplight	
Inside (Carpet Covered) .....	1141
Inside (Pedestal Mount) .....	1156
Outside .....	577
Halogen Headlights	
High/Low Beam .....	9004
Front Side Marker Lights .....	194
Rear Side Marker Lights .....	24
Stop/Tail/Turn Signal Lights (Coupe) .....	2057
Stop/Turn Signal Lights (Sedan) .....	2057
Taillights (Sedan) .....	194
Trunk Light .....	912
Wagon: Rear Side Marker Lights .....	194

<b>INSIDE LIGHTS</b>	<b>BULB</b>
Dome Light	
Wagon Rear Compartment and Base .....	562
Dome/Reading Light	
Front .....	168
Rear .....	194
Heater & A/C Control .....	74
High-Beam Indicator .....	194
Indicator Lights	
Brake, Oil, Turn Signals .....	194
Charge, Malfunction Indicator, Fasten Safety Belts, Temp ..	168
Tailgate Ajar .....	37
PRNDL .....	74
Glove Box .....	194
Wagon: Rear Compartment Light .....	561

# Service & Appearance Care

## Engine Specifications

	2.2L L4	3.1L V6
VIN Engine Code .....	4	T
Type .....	L4	V6
Displacement .....	2.2 Liters	3.1 Liters
Compression Ratio .....	8.85:1	8.80:1
Firing Order .....	1-3-4-2	1-2-3-4-5-6
Thermostat Temperature .....	195°F (91°C)	195°F (91°C)

## Normal Maintenance Replacement Parts

### Air Cleaner Element

2.2L L4.....	AC Type A-1172C
3.1L V6 .....	AC Type A-1098C
Z-24 .....	AC Type A-925C

### Engine Oil Filter

2.2L L4 .....	AC Type PF-47
3.1L V6 .....	AC Type PF-47

### PCV Valve

2.2L L4 .....	AC Type CV-900C
3.1L V6 .....	AC Type CV-892C

### Spark Plugs

2.2L L4 .....	AC Type •41-908 Gap: 1.52 mm (0.060 inch)
3.1L V6 .....	AC Type •R44LTSM Gap: 1.14 mm (0.045 inch)

**IMPORTANT**  
**KEEP ENGINE OIL**  
**AT THE PROPER**  
**LEVEL AND CHANGE AS**  
**RECOMMENDED**

**T**his part covers the maintenance required for your Chevrolet. Your vehicle needs these services to retain its safety, dependability and emission control performance.



**Protection  
Plan**

Have you purchased the  
GM Protection Plan?  
The Plan supplements your new  
vehicle warranties.  
See your Chevrolet dealer for details.

## Part 7 Maintenance Schedule

### Section

#### Introduction

A Word About Maintenance .....	204
Your Vehicle and the Environment.....	204
How This Part is Organized.....	204

#### A. Scheduled Maintenance Services

Using Your Maintenance Schedule.....	205
Selecting the Right Schedule.....	205
Schedule I.....	206
Schedule II.....	208
Explanation of Scheduled Maintenance Services.....	210

#### B. Owner Checks & Services

At Each Fuel Fill .....	212
At Least Once a Month .....	213
At Least Twice a Year.....	213
At Least Once a Year.....	214

#### C. Periodic Maintenance Inspections .....

#### D. Recommended Fluids & Lubricants .....

#### E. Maintenance Record .....

# Maintenance Schedule

## ■ Introduction

### A Word About Maintenance

We at General Motors want to help you keep your vehicle in good working condition. But we don't know exactly how you'll drive it. You may drive very short distances only a few times a week. Or you may drive long distances all the time in very hot, dusty weather. You may use your vehicle in making deliveries. Or you may drive it to work, to do errands or in many other ways.

Because of all the different ways people use their GM vehicles, maintenance needs vary. You may even need more frequent checks and replacements than you will find in the schedules in this part. So please read this part and note how you drive. If you have any questions on how to keep your vehicle in good condition, see your Chevrolet dealer, the place many GM owners choose to have their maintenance work done. Your dealer can be relied upon to use proper parts and practices.

### Your Vehicle and the Environment

Proper vehicle maintenance not only helps to keep your vehicle in good working condition, but also helps the environment. All recommended maintenance procedures are important. Improper vehicle maintenance or the removal of important components can significantly affect the quality of the air we breathe. Improper fluid levels or even the wrong tire inflation can increase the level of emissions from your vehicle. To help protect our environment, and to help keep your vehicle in good condition, please maintain your vehicle properly.

### How This Part is Organized

The remainder of this part is divided into five sections:

"Section A: Scheduled Maintenance Services" shows what to have done and how often. Some of these services can be complex, so unless you are technically qualified and have the necessary equipment, you should let your dealer's service department or another qualified service center do these jobs.



### CAUTION:

Performing maintenance work on a vehicle can be dangerous. In trying to do some jobs, you can be seriously injured. Do your own maintenance work only if you have the required know-how and the proper tools and equipment for the job. If you have any doubt, have a qualified technician do the work.

If you are skilled enough to do some work on your vehicle, you will probably want to get the service information GM publishes. You will find a list of publications and how to get them in this manual. See *Service Publications* in the *Index*.

"Section B: Owner Checks and Services" tells you what should be checked whenever you stop for fuel. It also explains what you can easily do to help keep your vehicle in good condition.

"Section C: Periodic Maintenance Inspections" explains important

inspections that your Chevrolet dealer's service department or another qualified service center should perform.

"Section D: Recommended Fluids and Lubricants" lists some products GM recommends to help keep your vehicle properly maintained. These products, or their equivalents, should be used whether you do the work yourself or have it done.

"Section E: Maintenance Record" provides a place for you to record the maintenance performed on your vehicle. Whenever any maintenance is performed, be sure to write it down in this section. This will help you determine when your next maintenance should be done. In addition, it is a good idea to keep your maintenance receipts. They may be needed to qualify your vehicle for warranty repairs.

## ■ *Section A: Scheduled Maintenance Services*

### **Using Your Maintenance Schedule**

This section tells you the maintenance services you should have done and when you should schedule them. Your Chevrolet dealer knows your vehicle best and wants you to be happy with it. If you go to your dealer for your service needs, you'll know that GM-trained and supported service people will perform the work using genuine GM parts.

These schedules are for vehicles that:

- carry passengers and cargo within recommended limits. You will find these limits on your vehicle's Tire-Loading Information label. See *Loading Your Vehicle* in the *Index*.
- are driven on reasonable road surfaces within legal driving limits.
- use the recommended unleaded fuel. See *Fuel* in the *Index*.

### **Selecting the Right Schedule**

First you'll need to decide which of the two schedules is right for your vehicle. Here's how to decide which schedule to follow:

#### **Schedule I**

Is any one of these true for your vehicle?

- Most trips are less than 4 miles (6 km).
- Most trips are less than 10 miles (16 km) when outside temperatures are below freezing.
- The engine is at low speed most of the time (as in door-to-door delivery, or in stop-and-go traffic).
- You operate your vehicle in dusty areas.

If any one (or more) of these is true for your driving, follow Schedule I.

#### **Schedule II**

Follow Schedule II **only** if none of the above conditions is true.

# Maintenance Schedule

## Schedule I

Follow Schedule I if your vehicle is **MAINLY** driven under one or more of the following conditions:

- When most trips are less than 4 miles (6 km).
- When most trips are less than 10 miles (16 km) and outside temperatures remain below freezing.
- When most trips include extended idling and/or frequent low-speed operation, as in stop-and-go traffic.
- When operating in dusty areas.

**Schedule I should also be followed if the vehicle is used for delivery service, police, taxi or other commercial applications.**

\* = An Emission Control Service.

† = The U.S. Environmental Protection Agency or the California Air Resources Board has determined that the failure to perform this maintenance item will not nullify the emission warranty or limit recall liability prior to the completion of vehicle useful life. General Motors, however, urges that all recommended maintenance services be performed at the indicated intervals and the maintenance be recorded in "Section E: Maintenance Record."

ITEM NO.	TO BE SERVICED <i>See Explanation of Scheduled Maintenance Services following Schedules I and II.</i>	WHEN TO PERFORM <i>Miles (kilometers) or Months (whichever occurs first).</i>
1	Engine Oil Change & Filter Change*	Every 3,000 Miles (5 000 km) or 3 Months.
2	Chassis Lubrication	Every other oil change.
3	Tire and Wheel Inspection & Rotation	At 6,000 Miles (10 000 km) and then every 15,000 Miles (25 000 km) or as necessary.
4	Engine Accessory Drive Belt(s) Inspection*	Every 30,000 Miles (50 000 km) or 24 Months.
5	Cooling System Service*	Every 30,000 Miles (50 000 km) or 24 Months.
6	Transaxle Service	<i>See Explanation of Scheduled Maintenance Services following Schedules I and II.</i>
7	Spark Plug Replacement (Except 2.2L Code 4 engine)*	Every 30,000 Miles (50 000 km).
8	Spark Plug Replacement (2.2L Code 4 engine only)*	Every 100,000 Miles (166 000 km).
9	Spark Plug Wire Inspection*†	Every 30,000 Miles (50 000 km).
10	Exhaust Gas Recirculation (EGR) System Inspection (2.2L Code 4 engine only)*†	Every 30,000 Miles (50 000 km).
11	Air Cleaner Filter Replacement*	<i>See Explanation of Scheduled Maintenance Services following Schedules I and II.</i>
12	Fuel Tank, Cap and Lines Inspection*†	Every 30,000 Miles (50 000 km).

The services shown on this chart up to 60,000 miles (100 000 km) should be performed after 60,000 miles at the same intervals.

**MILES (000)**

3 6 9 12 15 18 21 24 27 30 33 36 39 42 45 48 51 54 57 60

**KILOMETERS (000)**

5 10 15 20 25 30 35 40 45 50 55 60 65 70 75 80 85 90 95 100

•	•	•	•	•	•	•	•	•	•	•	•	•	•	•	•	•	•	•	•	•
•		•		•		•		•		•		•		•		•		•		•
	•					•					•					•				
									•											•
									•											•
									•											•
									•											•
									•											•



# Maintenance Schedule

## Schedule II

Follow Schedule II ONLY if none of the driving conditions specified in Schedule I apply.

ITEM NO.	TO BE SERVICED <i>See Explanation of Scheduled Maintenance Services following Schedules I and II.</i>	WHEN TO PERFORM <i>Miles (kilometers) or Months (whichever occurs first).</i>
1	Engine Oil Change*	Every 7,500 Miles (12 500 km) or 12 Months.
	Oil Filter Change*	At first and every other oil change.
2	Chassis Lubrication	Every 7,500 Miles (12 500 km) or 12 Months.
3	Tire and Wheel Inspection & Rotation	At 7,500 Miles (12 500 km) and then every 15,000 Miles (25 000 km) or as necessary.
4	Engine Accessory Drive Belt(s) Inspection*	Every 30,000 Miles (50 000 km) or 24 Months.
5	Cooling System Service*	Every 30,000 Miles (50 000 km) or 24 Months.
6	Transaxle Service	<i>See Explanation of Scheduled Maintenance Services following Schedules I and II.</i>
7	Spark Plug Replacement (Except 2.2L Code 4 engine)*	Every 30,000 Miles (50 000 km).
8	Spark Plug Replacement (2.2L Code 4 engine only)*	Every 100,000 Miles (166 000 km).
9	Spark Plug Wire Inspection*†	Every 30,000 Miles (50 000 km).
10	Exhaust Gas Recirculation (EGR) System Inspection (2.2L Code 4 engine only)*†	Every 30,000 Miles (50 000 km).
11	Air Cleaner Filter Replacement*	<i>See Explanation of Scheduled Maintenance Services following Schedules I and II.</i>
12	Fuel Tank, Cap & Lines Inspection*†	Every 30,000 Miles (50 000 km).

\* = An Emission Control Service.

† = The U.S. Environmental Protection Agency or the California Air Resources Board has determined that the failure to perform this maintenance item will not nullify the emission warranty or limit recall liability prior to the completion of vehicle useful life. General Motors, however, urges that all recommended maintenance services be performed at the indicated intervals and the maintenance be recorded in "Section E: Maintenance Record."

The services shown on this chart up to 60,000 miles (100 000 km) should be performed after 60,000 miles at the same intervals.

**MILES (000)**

5 7.5 10 15 20 22.5 25 30 35 37.5 40 45 50 52.5 55 60

**KILOMETERS (000)**

8 12.5 16 25 32 37.5 40 50 56 62.5 64 75 83.5 87.5 92 100

	•		•		•		•		•		•		•		•
	•				•				•				•		
	•		•		•		•		•		•		•		•
	•				•				•				•		
							•								•
							•								•
							•								•
							•								•
							•								•

# Maintenance Schedule

## **Explanation of Scheduled Maintenance Services**

Following are explanations of the services listed in Schedule I and Schedule II.

The proper fluids and lubricants to use are listed in Section D. Make sure whoever services your vehicle uses these. All parts should be replaced and all necessary repairs done before you or anyone else drives the vehicle.

ITEM NO.	SERVICE
----------	---------

- 1. Engine Oil and Filter Change\*** — Always use SH or SG Energy Conserving II oils of proper viscosity. The "SH" or "SG" designation may be shown alone or in combination with others, such as "SH/CD," "SH, SG, CD," "SG/CD," etc. To determine the preferred viscosity for your vehicle's engine (e.g., SAE 5W-30 or SAE 10W-30), see *Engine Oil* in the *Index*.
- 2. Chassis Lubrication** — Lubricate the suspension and steering linkage. Lubricate the transaxle shift linkage.
- 3. Tire and Wheel Rotation and Inspection** — For proper wear and maximum tire life, rotate your tires following the instructions in this manual. See *Tires, Inspection & Rotation* in the *Index*. Check the tires for uneven wear or damage. If you see irregular or premature wear, check the wheel alignment. Check for damaged wheels also.

- 4. Engine Accessory Drive Belt(s) Inspection \*** — Inspect the belt(s) for cracks, fraying, wear and proper tension. Replace as needed. (Belts can have many small cracks in individual ribs without affecting performance.)
- 5. Cooling System Service\*** — Drain, flush and refill the system with new or approved recycled coolant conforming to GM Specification 1825M. Keep coolant at the proper mixture as specified. See *Coolant* in the *Index*. This provides proper freeze and boil protection, corrosion inhibitor level and maintains proper engine operating temperature. Inspect hoses and replace if they are cracked, swollen or deteriorated. Tighten screw-type hose clamps. Clean the outside of the radiator and air conditioning condenser. Wash the pressure cap and neck.  
  
To help ensure proper operation, we recommend a pressure test of both the cooling system and the pressure cap.

**6. Transaxle Service** — For manual transaxles, fluid doesn't require changing. See *Periodic Maintenance Inspections* in the *Index*. For automatic transaxles, change both the fluid and filter every 15,000 miles (25 000 km) if the vehicle is mainly driven under one or more of these conditions:

- In heavy city traffic where the outside temperature regularly reaches 90°F (32°C) or higher.
- In hilly or mountainous terrain.
- Uses such as found in taxi, police car or delivery service.

If you do not use your vehicle under any of these conditions, change both the fluid and filter every 100,000 miles (166 000 km).

**7. Spark Plug Replacement (Except 2.2L Code 4 engine)\*** — Replace spark plugs with the proper type. See *Replacement Parts* in the *Index*.

**8. Spark Plug Replacement (2.2L Code 4 engine only)\*** — Replace spark plugs with the proper type. See *Replacement Parts* in the *Index*.

**9. Spark Plug Wire Inspection\*†** — Inspect for burns, cracks or other damage. Check the boot fit at the coils and at the spark plugs. Replace wires as needed.

**10. Exhaust Gas Recirculation (EGR) System Inspection (2.2L Code 4 engine only)\*†** — Conduct the EGR system service as described in the service manual. To purchase a service manual, see *Service Publications* in the *Index*.

**11. Air Cleaner Filter Replacement\*** — Replace every 30,000 miles (50 000 km) or more often under dusty conditions. Ask your dealer for the proper replacement intervals for your driving conditions.

## **12. Fuel Tank, Cap and Lines**

**Inspection\*†** — Inspect fuel tank, cap and lines (including fuel rails and injection assembly) for damage or leaks. Inspect fuel cap gasket for an even filler neck imprint or any damage. Replace parts as needed. Periodic replacement of the fuel filter is not required.

NOTE: To determine your engine's displacement and code, see *Engine Identification* in the *Index*.

\* = An Emission Control Service.

† = The U.S. Environmental Protection Agency or the California Air Resources Board has determined that the failure to perform this maintenance item will not nullify the emission warranty or limit recall liability prior to the completion of vehicle useful life. General Motors, however, urges that all recommended maintenance services be performed at the indicated intervals and the maintenance be recorded in "Section E: Maintenance Record."

# Maintenance Schedule

## Section B: Owner Checks and Services

Listed below are owner checks and services which should be performed at the intervals specified to help ensure the safety, dependability and emission control performance of your vehicle.

Be sure any necessary repairs are completed at once. Whenever any fluids or lubricants are added to your vehicle, make sure they are the proper ones, as shown in Section D.

**At Each Fuel Fill** (*It is important for you or a service station attendant to perform these underhood checks at each fuel fill.*)

<b>CHECK OR SERVICE</b>	<b>WHAT TO DO</b>
Engine Oil Level	Check the engine oil level and add the proper oil if necessary. See <i>Engine Oil</i> in the <i>Index</i> for further details.
Engine Coolant Level	Check the engine coolant level and add the proper coolant mix if necessary. See <i>Coolant</i> in the <i>Index</i> for further details.
Windshield Washer Fluid Level	Check the windshield washer fluid level in the windshield washer tank and add the proper fluid if necessary. See <i>Windshield Washer Fluid</i> in the <i>Index</i> for further details.

### ***At Least Once a Month***

<b>CHECK OR SERVICE</b>	<b>WHAT TO DO</b>
Tire Inflation	Check tire inflation. Make sure they are inflated to the pressures specified on the Tire-Loading Information label located on the rear edge of the driver's door. See <i>Tires</i> in the <i>Index</i> for further details.
Cassette Deck	Clean cassette deck. Cleaning should be done every 15 hours of tape play. See <i>Audio Systems</i> in the <i>Index</i> for further details.

### ***At Least Twice a Year***

<b>CHECK OR SERVICE</b>	<b>WHAT TO DO</b>
Hydraulic Clutch System Inspection	Check the fluid level in the clutch reservoir. See <i>Hydraulic Clutch Fluid</i> in the <i>Index</i> . A fluid loss in this system could indicate a problem. Have the system inspected and repaired at once.

# Maintenance Schedule

At Least Once a Year

CHECK OR SERVICE	WHAT TO DO
Key Lock Cylinders	Lubricate the key lock cylinders with the lubricant specified in Section D.
Body Lubrication	Lubricate all body door hinges, rear compartment or tailgate. Also lubricate all hinges and latches, including those for the hood, glove box door, console door and any folding seat hardware. Section D tells you what to use.
Starter Switch	<p><b>CAUTION: When you are doing this check, the vehicle could move suddenly. If it does, you or others could be injured. Follow the steps below.</b></p> <ol style="list-style-type: none"><li>1. Before you start, be sure you have enough room around the vehicle.</li><li>2. Firmly apply both the parking brake (see <i>Parking Brake</i> in the <i>Index</i> if necessary) and the regular brake.</li></ol> <p>NOTE: Do not use the accelerator pedal, and be ready to turn off the engine immediately if it starts.</p> <ol style="list-style-type: none"><li>3. On automatic transaxle vehicles, try to start the engine in each gear. The starter should work only in <b>P</b> (Park) or <b>N</b> (Neutral). If the starter works in any other position, your vehicle needs service.</li></ol> <p>On manual transaxle vehicles, put the shift lever in <b>N</b> (Neutral), push the clutch down halfway and try to start the engine. The starter should work only when the clutch is pushed down all the way to the floor. If the starter works when the clutch isn't pushed all the way down, your vehicle needs service.</p>
Brake-Transaxle Shift Interlock — BTSI (Automatic Transaxle)	<p><b>CAUTION: When you are doing this check, the vehicle could move suddenly. If it does, you or others could be injured. Follow the steps below.</b></p> <ol style="list-style-type: none"><li>1. Before you start, be sure you have enough room around the vehicle. It should be parked on a level surface.</li><li>2. Firmly apply the parking brake (see <i>Parking Brake</i> in the <i>Index</i> if necessary).</li></ol> <p>NOTE: Be ready to apply the regular brake immediately if the vehicle begins to move.</p> <ol style="list-style-type: none"><li>3. With the engine off, turn the key to the <b>RUN</b> position, but don't start the engine. Without applying the regular brake, try to move the shift lever out of <b>P</b> (Park) with normal effort. If the shift lever moves out of <b>P</b> (Park), your vehicle's BTSI needs service.</li></ol>

CHECK OR SERVICE	WHAT TO DO
Steering Column Lock	<p>While parked, and with the parking brake set, try to turn the key to <b>LOCK</b> in each shift lever position.</p> <ul style="list-style-type: none"> <li>• With an automatic transaxle, the key should turn to <b>LOCK</b> only when the shift lever is in <b>P</b> (Park).</li> <li>• With a manual transaxle, the key should turn to <b>LOCK</b> only when the shift lever is in <b>R</b> (Reverse).</li> </ul> <p>On vehicles with a key release button, try to turn the key to <b>LOCK</b> without pressing the button. The key should turn to <b>LOCK</b> only with the key button depressed. On all vehicles, the key should come out only in <b>LOCK</b>.</p> <p>Turn the steering wheel to the left and to the right. It should only lock when turned to the right.</p>
Parking Brake and Automatic Transaxle <b>P</b> (Park) Mechanism Check	<p><b>CAUTION: When you are doing this check, your vehicle could begin to move. You or others could be injured and property could be damaged. Make sure there is room in front of your vehicle in case it begins to roll. Be ready to apply the regular brake at once should the vehicle begin to move.</b></p> <p>Park on a fairly steep hill, with the vehicle facing downhill. Keeping your foot on the regular brake, set the parking brake.</p> <ul style="list-style-type: none"> <li>• To check the parking brake: With the engine running and transaxle in <b>N</b> (Neutral), slowly remove foot pressure from the regular brake pedal. Do this until the vehicle is held by the parking brake only.</li> <li>• To check the <b>P</b> (Park) mechanism's holding ability: Shift to <b>P</b> (Park). Then release all brakes.</li> </ul>
Underbody Flushing	<p>At least every spring, use plain water to flush any corrosive materials from the underbody. Take care to clean thoroughly any areas where mud and other debris can collect.</p>



# Maintenance Schedule

## Section C: Periodic Maintenance Inspections

Listed below are inspections and services which should be performed at least twice a year (for instance, each spring and fall). You should let your GM dealer's service department or other qualified service center do these jobs. Make sure any necessary repairs are completed at once.

INSPECTION OR SERVICE	WHAT SHOULD BE DONE
Restraint Systems	Now and then, make sure all your belts, buckles, latch plates, retractors, anchorages and reminder systems are working properly. Look for any loose parts or damage. If you see anything that might keep a restraint system from doing its job, have it repaired.
Steering, Suspension and Front-Wheel-Drive Axle Boot and Seal Inspection	Inspect the front and rear suspension and steering system for damaged, loose or missing parts, signs of wear, or lack of lubrication. Inspect the power steering lines and hoses for proper hook-up, binding, leaks, cracks, chafing, etc. Clean and then inspect the drive axle boot seals for damage, tears or leakage. Replace seals if necessary.
Exhaust System Inspection	Inspect the complete exhaust system. Inspect the body near the exhaust system. Look for broken, damaged, missing or out-of-position parts as well as open seams, holes, loose connections, or other conditions which could cause a heat build-up in the floor pan or could let exhaust fumes into the vehicle. See <i>Engine Exhaust</i> in the <i>Index</i> .
Throttle Linkage Inspection	Inspect the throttle linkage for interference or binding, and for damaged or missing parts. Replace parts as needed.
Manual Transaxle	Check the transaxle fluid level; add if needed. See <i>Manual Transaxle</i> in the <i>Index</i> . A fluid loss may indicate a problem. Check the system and repair if needed.
Brake System Inspection	Inspect the complete system. Inspect brake lines and hoses for proper hook-up, binding, leaks, cracks, chafing, etc. Inspect disc brake pads for wear and rotors for surface condition. Also inspect drum brake linings for wear and cracks. Inspect other brake parts, including drums, wheel cylinders, calipers, parking brake, etc. Check parking brake adjustment. You may need to have your brakes inspected more often if your driving habits or conditions result in frequent braking. NOTE: A low brake fluid level can indicate worn disc brake pads which may need to be serviced. Also, if the brake system warning light stays on or comes on, something may be wrong with the brake system. See <i>Brake System Warning Light</i> in the <i>Index</i> . If your anti-lock brake system warning light stays on, comes on or flashes, something may be wrong with the anti-lock brake system. See <i>Anti-Lock Brake System Warning Light</i> in the <i>Index</i> .

# Maintenance Schedule

## Section D: Recommended Fluids and Lubricants

NOTE: Fluids and lubricants identified below by name, part number or specification may be obtained from your GM dealer.

USAGE	FLUID/LUBRICANT
Engine Oil	API service SH or SG Energy Conserving II oils of the proper viscosity. The "SH" or "SG" designation may be shown alone or in combination with others, such as "SH/CD," "SH,SG,CD," "SG/CD," etc. To determine the preferred viscosity for your vehicle's engine, see <i>Engine Oil</i> in the <i>Index</i> .
Engine Coolant	50/50 mixture of water (preferably distilled) and good quality ethylene glycol base antifreeze (GM Part No. 1052753 or equivalent) conforming to GM Specification 1825M or approved recycled coolant conforming to GM Specification 1825M.
Hydraulic Brake System	Delco Supreme 11 <sup>®</sup> Brake Fluid (GM Part No. 1052535 or equivalent DOT-3 brake fluid).
Hydraulic Clutch System	Hydraulic Clutch Fluid (GM Part No. 12345347 or equivalent).
Power Steering System	GM Hydraulic Power Steering Fluid (GM Part No. 1052884 or equivalent).
Manual Transaxle	Synchromesh Transmission Fluid (GM Part No. 12345349 or equivalent).
Automatic Transaxle	DEXRON <sup>®</sup> -III or DEXRON <sup>®</sup> -IIE Automatic Transmission Fluid.
Key Lock Cylinders	Lubricate with Multi-Purpose Lubricant (GM Part No. 12345120) or synthetic SAE 5W-30 engine oil.
Manual Transaxle Shift Linkage	Chassis lubricant (GM Part No. 1052497 or equivalent) or lubricant meeting requirements of NLGI Grade 2, Category LB or GC-LB.

# Maintenance Schedule

USAGE	FLUID/LUBRICANT
Automatic Transaxle Shift Linkage	Engine oil.
Clutch Linkage Pivot Points	Engine oil.
Chassis Lubrication	Chassis lubricant (GM Part No. 1052497 or equivalent) or lubricant meeting requirements of NLGI Grade 2, Category LB or GC-LB.
Windshield Washer Solvent	GM Optikleen <sup>®</sup> Washer Solvent (GM Part No. 1051515) or equivalent.
Hood Latch Assembly a. Pivots and Spring Anchor b. Release Pawl	a. Engine oil. b. Chassis lubricant (GM Part No. 1052497 or equivalent) or lubricant meeting requirements of NLGI Grade 2, Category LB or GC-LB.
Hood and Door Hinges, Fuel Door Hinge, Rear Compartment Lid Hinges, Wagon Tailgate Hinge, Rear Folding Seat	Engine oil or Lubriplate Lubricant (GM Part No. 1050109).
Weatherstrips	Dielectric Silicone Grease (GM Part No. 12345579 or equivalent).

See *Replacement Parts* in the *Index* for recommended replacement filters, valves and spark plugs.

## Section E: Maintenance Record

After the scheduled services are performed, record the date, odometer reading and who performed the service in the columns indicated. When completing the Maintenance Performed column, insert the numbers from the Schedule I or Schedule II maintenance charts which correspond to the maintenance performed. Also, you should retain all maintenance receipts. Your owner information portfolio is a convenient place to store them.

<i>DATE</i>	<i>ODOMETER READING</i>	<i>SERVICED BY</i>	<i>MAINTENANCE PERFORMED</i>

# Maintenance Schedule

<i>DATE</i>	<i>ODOMETER READING</i>	<i>SERVICED BY</i>	<i>MAINTENANCE PERFORMED</i>



**H**ere you will find out how to contact Chevrolet if you need assistance. This part also tells you how to obtain service publications and how to report any safety defects.

## Part 8 Customer Assistance Information

Customer Satisfaction Procedure.....	222
Customer Assistance for Hearing or Speech Impaired .....	223
BBB Auto Line-Alternative Dispute Resolution Program.....	223
Reporting Safety Defects .....	224
Chevrolet Roadside Assistance Program.....	225
Service Publications.....	227

# Customer Assistance Information



## ■ *Customer Satisfaction Procedure*

Your satisfaction and goodwill are important to your dealer and Chevrolet. Normally, any concern with the sales transaction or the operation of your vehicle will be resolved by your dealer's Sales or Service Departments. Sometimes, however, despite the best intentions of all concerned, misunderstandings can occur. If your concern has not been resolved to your satisfaction, the following steps should be taken:

**STEP ONE** — Discuss your concern with a member of dealership management. Normally, concerns can be quickly resolved at that level. If the matter has already been reviewed with the Sales, Service, or Parts Manager, contact the owner of the dealership or the General Manager.

**STEP TWO** — If after contacting a member of dealership management, it appears your concern cannot be resolved by the dealership without further help, contact the **Chevrolet Customer Assistance Center** by calling 1-800-222-1020. In Canada, contact GM of Canada Customer Assistance Center in Oshawa by calling 1-800-263-3777 (English) or 1-800-263-7854 (French).

In Mexico, call (525) 254-3777. In Puerto Rico or U.S. Virgin Islands, call 1-809-763-1315. In all other overseas locations, contact GM North American Export Sales in Canada by calling 1-905-644-4112.

For prompt assistance, please have the following information available to give the Customer Assistance Representative:

- Your name, address, home and business telephone numbers
- Vehicle Identification Number (This is available from the vehicle registration or title, or the plate at the left top of the instrument panel and visible through the windshield.)
- Dealership name and location
- Vehicle delivery date and present mileage
- Nature of concern

We encourage you to call the toll free number listed previously in order to give your inquiry prompt attention. However, if you wish to write Chevrolet, write to:

Chevrolet Motor Division  
Chevrolet Customer Assistance Center  
P. O. Box 7047  
Troy, MI 48007-7047

Refer to your Warranty and Owner Assistance Information booklet for addresses of Canadian and GM Overseas offices.

When contacting Chevrolet, please remember that your concern will likely be resolved in the dealership, using the dealership's facilities, equipment and personnel. That is why we suggest you follow Step One first if you have a concern.

### ■ *Customer Assistance for the Hearing or Speech Impaired (TDD)*

To assist owners who have hearing difficulties, Chevrolet has installed special TDD (Telecommunication Devices for the Deaf) equipment at its Customer Assistance Center. Any hearing or speech impaired customer who has access to a TDD or a conventional teletypewriter (TTY) can communicate with Chevrolet by dialing: 1-800-TDD-CHEV. (TDD users in Canada can dial 1-800-263-3830.)

### ■ *GM Participation in BBB AUTO LINE- Alternative Resolution Program\**

Both Chevrolet and your Chevrolet dealer are committed to making sure you are completely satisfied with your new vehicle. If a situation arises where you feel your concern has not been adequately addressed, our experience has shown that the Customer Satisfaction Procedure described earlier in this section is very successful.

There may be instances where an impartial third-party can assist in arriving at a solution to a disagreement regarding vehicle repairs or interpretation of the New Vehicle Limited Warranty. To assist in resolving these disagreements Chevrolet voluntarily participates in BBB AUTO LINE.

BBB AUTO LINE is an out-of-court program administered by the Better Business Bureau system to settle disputes between customers and automobile manufacturers. This

program is available free of charge to customers who currently own or lease a GM vehicle.

If you are not satisfied after following the Customer Satisfaction Procedure, you may contact the BBB using the toll-free telephone number, or write them at the following address:

BBB AUTO LINE  
Council of Better Business Bureaus  
4200 Wilson Boulevard  
Suite 800  
Arlington, VA 22203  
Telephone: 1-800-955-5100

To file a claim, you will be asked to provide your name and address, your vehicle identification number (VIN), and a statement of the nature of your complaint. Eligibility is limited by vehicle age and mileage, and other factors.

We prefer you utilize the Customer Satisfaction Procedure before you resort to AUTO LINE, but you may contact the BBB at any time. The BBB will attempt to resolve the complaint serving as an intermediary between you and Chevrolet. If this mediation is



# Customer Assistance Information

unsuccessful, an informal hearing will be scheduled where eligible customers may present their case to an impartial third-party arbitrator.

The arbitrator will make a decision which you may accept or reject. If you accept the decision, GM will be bound by that decision. The entire dispute resolution procedure should ordinarily take about forty days from the time you file a claim until a decision is made.

Some state laws may require you to use this program before filing a claim with a state-run arbitration program or in the courts. For further information, contact the BBB at 1-800-955-5100 or the Chevrolet Customer Assistance Center at 1-800-222-1020.

*\*This program may not be available in all states, depending on state law. Canadian owners refer to your Warranty and Owner Assistance information booklet. General Motors reserves the right to change eligibility limitations and/or to discontinue its participation in this program.*

## ■ **REPORTING SAFETY DEFECTS TO THE UNITED STATES GOVERNMENT**

If you believe that your vehicle has a defect which could cause a crash or could cause injury or death, you should immediately inform the National Highway Traffic Safety Administration (NHTSA), in addition to notifying General Motors.

If NHTSA receives similar complaints, it may open an investigation, and if it finds that a safety defect exists in a group of vehicles, it may order a recall and remedy campaign. However, NHTSA cannot become involved in individual problems between you, your dealer, or General Motors.

To contact NHTSA, you may either call the Auto Safety Hotline toll-free at 1-800-424-9393 (or 366-0123 in the Washington, D.C. area) or write to:

NHTSA  
U.S. Department of Transportation  
Washington, D.C. 20590

You can also obtain other information about motor vehicle safety from the Hotline.

## ■ **REPORTING SAFETY DEFECTS TO THE CANADIAN GOVERNMENT**

If you live in Canada, and you believe that your vehicle has a safety defect, you should immediately notify Transport Canada, in addition to notifying General Motors of Canada Limited. You may write to:

Transport Canada  
Box 8880  
Ottawa, Ontario K1G 3J2

■ **REPORTING SAFETY  
DEFECTS TO GENERAL  
MOTORS**

In addition to notifying NHTSA (or Transport Canada) in a situation like this, we certainly hope you'll notify us. Please call us at 1-800-222-1020, or write:

Chevrolet Motor Division  
Chevrolet Customer Assistance Center  
P. O. Box 7047

Troy, MI 48007-7047

In Canada, please call us at  
1-800-263-3777 (English) or  
1-800-263-7854 (French). Or, write:

General Motors of Canada Limited  
Customer Assistance Center  
1908 Colonel Sam Drive  
Oshawa, Ontario L1H 8P7



■ ***Chevrolet Roadside  
Assistance Program***

To enhance Chevrolet's strong commitment to customer satisfaction, Chevrolet is excited to announce the establishment of the Chevrolet/Geo Roadside Assistance Center. As the owner of a 1994 Chevrolet/Geo, your membership in Roadside Assistance is free.

**24-Hour Roadside Assistance  
Number**

Roadside Assistance is available 24 hours a day, 365 days a year, by calling 1-800-CHEV USA (1-800-243-8872). This toll-free number will provide you over-the-phone roadside assistance with minor mechanical problems. If your problem cannot be resolved over the phone, our advisors have access to a nationwide network of dealer-recommended service providers. The following services are available:

- Towing
- Locksmith
- Tire repair
- Glass replacement
- Rental car or taxi
- Additional services as necessary
- Courtesy Transportation

# Customer Assistance Information

Chevrolet/Geo offers Courtesy Transportation for customers needing warranty service. Courtesy Transportation will be offered in conjunction with the coverage provided by the Bumper-to-Bumper New Vehicle Limited Warranty to retail purchasers of 1994 Chevrolet/Geo passenger car and light duty trucks.

Courtesy Transportation includes:

- One way shuttle ride for any warranty repair.
- Up to \$30 maximum daily vehicle rental allowance for any overnight warranty repair up to 5 days.
- Up to \$30 maximum daily cab, bus, or other transportation allowance in lieu of rental for any overnight warranty repair up to 5 days.
- Up to \$10 daily fuel allowance for rides provided by another person (i.e., friend, neighbor, etc.) in lieu of rental for any overnight warranty repair up to 5 days.

Note: All Courtesy Transportation arrangements will be administered by your Chevrolet/Geo dealership service management. Claim amounts should reflect all actual costs.

- Chevrolet/Geo Courtesy Transportation is not part of the Bumper-to-Bumper New Vehicle Limited Warranty. Chevrolet/Geo reserves the right to make any changes or discontinue Courtesy Transportation at any time without notification.
- For additional program details contact your Chevrolet/Geo dealer. **In Canada**, please consult your GM dealer for information on Courtesy Transportation.

The Roadside Assistance Center uses companies that will provide you with quality and priority service. When roadside services are required, our advisors will explain any payment obligations that may be incurred for utilizing outside services.

For prompt assistance when calling, please have the following available to give to the advisor:

- Vehicle Identification Number
- License plate number
- Vehicle color
- Vehicle location
- Telephone number where you can be reached
- Vehicle mileage
- Description of problem

Please refer to the Roadside Assistance brochure inside your owner information portfolio for full program details.

## **Canadian Roadside Assistance**

Vehicles purchased in Canada have an extensive Roadside Assistance program accessible from anywhere in Canada or the U.S.A. Please refer to the separate brochure provided by the dealer or call 1-800-268-6800 for emergency services.

## ■ *Service Publications*

Information on how to obtain Product Service Publications and Indexes as described below is applicable only in the fifty U.S. states (and the District of Columbia) and only for cars and light trucks with GVWR less than 10,000 pounds ( 4 536 kg).

In Canada, information pertaining to Product Service Bulletins and Indexes can be obtained by writing to:

General Motors of Canada Limited  
Service Publications Department  
1908 Colonel Sam Dr.  
Oshawa, Ontario L1H 8P7

Chevrolet regularly sends its dealers useful service bulletins about Chevrolet products. Chevrolet monitors product performance in the field. We then prepare bulletins for servicing our products better. Now, you can get these bulletins too.

Bulletins cover various subjects. Some pertain to the proper use and care of your vehicle. Some describe costly repairs. Others describe inexpensive repairs which, if done on time with the latest parts, may avoid future costly repairs. Some bulletins tell a technician how to repair a new or unexpected condition. Others describe a quicker way to fix your vehicle. They can help a technician service your vehicle better.

Most bulletins apply to conditions affecting a small number of cars or trucks. Your Chevrolet dealer or a qualified technician may have to determine if a specific bulletin applies to your vehicle.

### *Individual PSP's*

If you don't want to buy all the PSP's issued by Chevrolet for all models in the model year, you can buy individual PSP's, such as those which may pertain to a particular model. To do this, you will first need to see our index of PSP's. It provides a variety of information. Here's what you'll find in the index and how you can get one:

### *What You'll Find in the Index:*

- A list of all PSP's published by Chevrolet in a model year (1990 or later). PSP's covering all models of Chevrolet vehicles are listed in the same index.
- Ordering information so you can buy the specific PSP's you may want.
- Price information for the PSP's you may want to buy.

### *How You Can Get an Index:*

Indexes are published periodically. Most of the PSP's which could potentially apply to the most recent Chevrolet models will be listed in the most recent publication for that model year. This means you may want to wait until the end of the model year before ordering an index, if you are interested in buying PSP's pertaining to a current model year car or truck.

Some PSP's pertaining to a particular model year vehicle may be published in later years, and these would be listed in the later year's index. When you order an index for a model year that is not

# Customer Assistance Information

over yet, we'll send you the most recently published issue. Check the ordering form for indexes for earlier model years.

Cut out the ordering form, fill it out, and mail it in. We will then see to it that an index is mailed to you. There is no charge for indexes for the 1990-1994 model years.

## ***Toll-Free Telephone Number***

If you want an additional ordering form for an index or a subscription, just call toll-free and we'll be happy to send you one. Automated recording equipment will take your name and mailing address. The number to call is 1-800-551-4123.

**A VERY IMPORTANT REMINDER:** These PSP's are meant for technicians. They are not meant for the "do-it-yourselfer." Technicians have the equipment, tools, safety instructions, and know-how to do a job quickly and safely.

## ***Chevrolet Service Publications***

You can get these by using the order form. Chevrolet Division service manuals are intended for use by professional, qualified technicians. Attempting repairs or service without the appropriate training, tools and equipment could cause injury to you or others and damage to your vehicle that may cause it not to operate properly.

## 1994 CHEVROLET SERVICE PUBLICATIONS ORDERING INFORMATION

The following publications covering the operation and servicing of your vehicle can be purchased by filling out the Service Publications Order Form in this book and mailing it with your check, money order or credit card information to Helm, Incorporated (address listed below).

### CURRENT PUBLICATIONS FOR 1994 CHEVROLET CAVALIER

#### PRODUCT SERVICE PUBLICATIONS

Product Service Publications (PSP's), are bulletins, letters and articles published for trained dealer service personnel. See Service Publications listed previously in this section.

A cumulative index is published quarterly during the current model year. The indexes list all PSP's published by Chevrolet in the model year.

#### PSP Index

Year	Form Number	Price
1994	PSPI-94 .....	Free
1993	PSPI-93 .....	Free
1990-92	PSPI-90-92 .....	Free

**NOTE:** Form Numbers for individual Product Service Publications may be found in the PSP Index. Prices are \$4.00 for the first PSP and \$2.00 for each additional PSP on the same order.

#### PSP Bound Bulletin Book (Complete Year Bulletins)

Year	Description	Form Number	Price
1991	All PSP's .....	PSP-91-4	40.00
1990	All PSP's .....	PSP-90-4	40.00

**NOTE:** For 1992 Model Year and Later, Product Service Publications (PSP's) can only be purchased individually.

**For subscription information call Helm, Incorporated.**

#### CURRENT & PAST MODEL ORDER FORMS

Service Publications are available for current and past model Chevrolet vehicles. To request an order form, please specify year and model name of vehicle.

#### SERVICE MANUALS

Service Manuals have the diagnosis, repair and overhaul information on engines, transmission, axle, suspension, brakes, electrical, steering, body, etc.

Model	Form Number	Price
1994 Chevrolet Cavalier .....	ST-366-94	<b>TBA*</b>

**NOTE:** Please specify special body or engine types on order form. Write information in the Form Number column. For example: Turbo, Convertible.

\*Price to be announced at a later date. Call 1-800-782-4356 for further information.

#### OWNER'S INFORMATION

Owner publications are written directly for owners and intended to provide basic operational information about the vehicle.

#### 1994 Chevrolet Cavalier Owner's Manual

**In Portfolio:** Includes Portfolio, Owner's Manual and Warranty Booklet.

1994 Chevrolet Cavalier In-Portfolio .....	10233995	\$15.00
--	----------	---------

**Without Portfolio:** Includes Owner's Manual.

1994 Chevrolet Cavalier Without Portfolio ..	10234005	\$10.00
--	----------	---------

**Address all inquiries to:** HELM, INCORPORATED  
P.O. Box 07130  
Detroit, MI 48207

**For information and inquiries call: 1-800-782-4356**









# Index

- A**BS (Anti-Lock Brakes) ..... 111
- Adding
- Brake Fluid ..... 174,199
  - Electrical Equipment ..... 52,96,195
  - Engine Coolant ..... 139,143,170
  - Engine Oil ..... 162,198,199
  - Hydraulic Clutch Fluid ..... 170,199
  - Power Steering Fluid ..... 173,198,199
  - Sound Equipment ..... 96
  - Transaxle Fluid
    - Automatic ..... 168,198,199
    - Manual ..... 169,198,199
  - Windshield Washer Fluid ..... 173
- Air Cleaner Filter ..... 165,202
- Air Conditioner ..... 93
- Alcohol, Driving Under the
- Influence of ..... 108
  - Alcohol in Gasoline ..... 155
- Aluminum Wheels, Cleaning ..... 192
- Antenna ..... 105
- Antifreeze ..... 137,170,198,199
- Anti-Lock Brake System ..... 111
- Warning Light ..... 87
- Appearance Care ..... 187
- Ashtrays & Lighter ..... 75
- Audio Systems ..... 96
- AM/FM Stereo Radio ..... 97
  - AM/FM Stereo Radio with Cassette Player ..... 99
  - AM/FM Stereo Radio with Compact Disc Player ..... 101
  - Care of Audio Systems ..... 104
  - Radio Reception, Understanding.. 104
  - Setting the Clock ..... 97
- Automatic Door Locks ..... 44
- Automatic Lap-Shoulder Belt (see *Safety Belts*)
- Automatic Transaxle ..... 53
- Adding Fluid ..... 168,198,199
  - Brake-Transaxle
    - Shift Interlock ..... 54,60
  - Checking Fluid ..... 167
  - Shifting ..... 53
  - Starting Your Engine ..... 51
- B**attery ..... 176
- Jump Starting ..... 128
- Battery Warning ..... 130,176
- Battery Warning Light ..... 86
- Blizzard, Caught In a ..... 124
- Block Heater, Engine ..... 52,165
- Blowout, Tire ..... 145
- Brake
- Adjustment ..... 175
  - Fluid ..... 174,199
  - Master Cylinder ..... 174
  - Parking ..... 58
  - Pedal Travel ..... 175
  - Rear ..... 175
  - Warning Light ..... 86
  - Wear Indicators—Front Brakes... 175
- Brake System Warning Light ..... 86
- Brake-Transaxle Shift Interlock... 54,60
- Brakes, Anti-Lock ..... 111
- Braking ..... 110
- Braking in Emergencies ..... 113
- Braking Technique ..... 110
- Break-In, New Vehicle ..... 49
- Buckling Up (see *Safety Belts*)
- Bulb Replacement
- Headlight ..... 177,200
  - Taillight ..... 177,200
- C**apacities and Specifications ..... 198
- Carbon Monoxide in
- Exhaust ..... 45,47,61,124
- Cassette Tape Player (see *Audio Systems*)
- Center Console Ashtray ..... 75
- Center Passenger Position ..... 29
- Chains, Tire ..... 152,187
- Changing a Flat Tire ..... 146
- Charging System Warning Light ..... 86
- “Check Engine” Light ..... 88
- “Check Gages” Light ..... 89
- Checking
- Brake Fluid ..... 174
  - Engine Coolant ..... 137,170
  - Engine Oil Level ..... 162
  - Hydraulic Clutch ..... 170
  - Power Steering Fluid ..... 173
  - Safety Belt Systems ..... 40
  - Transaxle Fluid
    - Automatic ..... 167
    - Manual ..... 169

# Index

- Checking Things Under the Hood .. 157  
Chemical Paint Spotting..... 193  
Child Restraints..... 31  
Children and Safety Belts ..... 30,38  
Cigarette Lighter ..... 75  
Circuit Breakers & Fuses ..... 195  
City Driving..... 119  
Cleaner, Air ..... 165,202  
Cleaning  
  Aluminum Wheels..... 192  
  Antenna ..... 105  
  Bumpers..... 191  
  Cassette Player ..... 104  
  Compact Discs..... 105  
  Cupholder ..... 190  
  Fabric ..... 188  
  Glass ..... 190  
  Inside of Your Chevrolet..... 188  
  Instrument Panel..... 190  
  Outside of Your Chevrolet..... 191  
  Safety Belts ..... 190  
  Scotchgard™ Fabric Protection ... 189  
  Special Problems ..... 189  
  Textured-Surface Bumper Covers 191  
  Underbody Maintenance..... 193  
  Vinyl..... 190  
  Warnings ..... 188,189,190,191,192  
  Waxing..... 191  
  Weatherstrips..... 192  
  White Sidewall Tires ..... 192  
  Windshield and Wiper Blades..... 190  
Climate Control System..... 92  
  Ventilation ..... 95  
Clock, Setting the..... 97  
Clutch, Hydraulic  
  Adding Fluid..... 170,199  
  Checking Fluid ..... 170  
Comfort Controls  
  Air Conditioning System..... 93  
Compact Disc Player (see *Audio Systems*)  
Compact Spare Tire ..... 151  
Control of a Vehicle ..... 110  
Convenience Net..... 49  
Convex Outside Mirror..... 73  
Coolant ..... 170  
  Checking & Adding ..... 137,140,143,  
    170,198,217  
  Low Coolant Warning Light ..... 85  
  Proper Mixture to Use .... 139,143,170  
  Safety Warnings About ..... 138, 139,  
    140,143,144,159,171,172  
  Temperature Gage..... 85  
Cruise Control..... 70  
Cup Holder..... 74  
Curves, Driving on ..... 113  
Customer Assistance Information... 221  
**D**aytime Running Lights ..... 65  
Dead Battery: What to Do..... 128  
Defects, Safety (see *Safety Defects*)  
Defensive Driving ..... 108  
Defogger, Rear Window ..... 95  
Defogging Your Windows ..... 92,94,95  
Defrosting..... 92,94,95  
Dome Light ..... 67  
Door Locks..... 43  
Downshifting ..... 55,57,122  
Driver Position ..... 21  
Driving..... 107  
  At Night..... 117  
  City..... 119  
  Controlling a Skid ..... 116  
  Defensively ..... 108  
  Drunken..... 108  
  Freeway..... 120  
  Hill and Mountain..... 122  
  In a Foreign Country..... 156  
  In the Rain..... 118  
  Long Distance ..... 121  
  Loss of Control..... 116  
  On Curves..... 113  
  Passing..... 115  
  Through Deep Standing Water..... 52  
  Winter Driving..... 123  
Drunken Driving..... 108  
**E**asy-Entry Seat ..... 15  
Electrical Equipment, Adding...52,96,195  
Emergencies, Braking ..... 113  
Emergencies on the Road ..... 127  
Emergencies, Steering in ..... 114  
Emergency Starting..... 128  
Emergency Towing ..... 132  
Engine Block Heater..... 52,165  
Engine Coolant Heater ..... 52,165  
Engine Coolant (see *Coolant*)

Engine Coolant Temperature Warning Gage (see <i>Coolant</i> )	
Engine Exhaust	
Dangerous Gas in	45,47,61,124
Parking with the Engine	
Running	59,61
Engine Identification	194
Engine Oil	162
Additives	164
Check Oil Light	89
Checking & Adding	162,198,199
Crankcase Capacity	198
Disposing of Used Oil	165
Energy Conserving	164
Filter	164,202
Pressure Gage	90
Starburst	163
Warning Light	89
When to Change	164
Engine Overheating	136
Engine Specifications	202
Engine, Starting	51
Automatic Transaxle	51
Manual Transaxle	51
Ethanol in Gasoline	155
Expectant Mothers, Use of Safety Belts	24
Expressway Driving	120
Extender, Safety Belt	40
Exterior Appearance (see <i>Appearance Care</i> )	

<b>F</b> abric Cleaning (see <i>Appearance Care</i> )	
Fan Warnings	129,130,137,138,159
Filling the Fuel Tank	156,198
Filter, Oil	164,202
Finish Care	191
Finish Damage	193
Flashers, Hazard Warning	128
Flash-To-Pass	66
Flat Tire	145
Flooded Engine	51
Fluid	
Brake	174,199
Capacities	198
Hydraulic Clutch	170,199
Power Steering	173,198,199
Transaxle	
Automatic	167,198,199
Manual	169,198,199
Windshield Washer	177,199
Fluids & Lubricants	199
Folding Rear Seats	15
Foreign Material	192
Freeway Driving	120
French Language Manual	2
Fuel	154
Alcohol in Fuel	155
Capacity	156,198
Exhaust Warnings	45,47,61,124
Filling Your Tank	156,198
Fuels with Alcohol	155

Gage	84
In Foreign Countries	156
Requirements	154
Fuse Usage	196
Fuses & Circuit Breakers	195

<b>G</b> ages	
Coolant Temperature	85
Fuel	84
Oil Pressure	90
Tachometer	83
Gasoline	154
Gasoline Tank, Filling Your	156,198
Gas Station Information	240
Gear Positions (see <i>Shifting the Transaxle</i> )	
Gearshift Lever (see <i>Shifting the Transaxle</i> )	
Glove Box	47
Graphic Equalizer (see <i>Audio Systems</i> )	

<b>H</b> alogen Bulbs	176,200
Hazard Warning Flashers	128
Head Restraints	13
Headlight & Taillight, Removing and Replacing	177,200
Headlights	65
Flash-To-Pass	66
High-Low Beam Changer	66
Replacement Bulb	177,200
Wiring	197
Heater (see <i>Comfort Controls</i> )	

# Index

Heater, Engine Block.....	52,165
High Beams.....	66
Highway Hypnosis.....	121
Hill and Mountain Roads.....	122
Hood Release.....	158
Warning, Overheated Engine.....	159
Horn.....	63
Hot Engine, Safety Warnings..	138, 139, 140, 143, 144, 159, 171, 172
How to Use Manual.....	6
Hydraulic Clutch.....	170,199
Hydroplaning.....	119
<b>I</b> dentification Number, Vehicle.....	194
Idling Your Engine.....	59,61
If You're Stuck: In Sand, Mud, Ice or Snow.....	152
Ignition	
Key.....	48
Key Release Button.....	51
Positions.....	50
Illuminated Entry System.....	45
Indicator Lights (see <i>Warning Lights</i> )	
Infant Restraint (see <i>Child Restraints</i> )	
Inflation, Tires.....	182
Inside Rearview Mirror.....	72
Instrument Panel.....	81
Instrument Panel Clusters.....	82,83
Instrument Panel Intensity	
Control.....	67
Instrument Panel Warning Lights.....	84
Intermittent Windshield Wipers.....	69

<b>J</b> ack, Tire.....	146
Jump Starting.....	128
<b>K</b> ey Release Button.....	51
Keys.....	42
<b>L</b> ane Change Indicator.....	64
Lap-Shoulder Safety Belt.....	21
Front.....	20,25
Rear.....	26
Use by Children.....	30,38
Latches, Seatback.....	14
Liftgate	
Ajjar Light.....	88
Lock.....	46
Lock Release.....	47
Safety Warning.....	47
Lighter.....	75
Lights	
Daytime Running Lights.....	65
Dome/Map.....	67
Flash-To-Pass.....	66
Headlights.....	65
Instrument Panel Intensity Control..	67
Rear Compartment.....	68
Removing & Replacing Bulbs..	177,200
Replacement Bulbs.....	200
Taillights.....	177,200
Turn Signal.....	64
Warning Lights.....	84
Loading Your Vehicle.....	79,180

Locks.....	43
Long Distance Driving.....	121
Low Battery.....	128
Low Oil Pressure Warning.....	89
Luggage Carrier.....	79
<b>M</b> aintenance Record.....	219
Maintenance Schedule.....	203
Malfunction Indicator Lamp (Check Engine Light).....	88
Manual Front Seat.....	12
Manual Sunroof.....	75
Manual Transaxle	
Adding Fluid.....	169,198,199
Checking Fluid.....	169
Shifting.....	56
Starting Your Engine.....	51
Master Cylinder, Brake.....	174
Methanol in Gasoline.....	155
Mileage Indicator (see <i>Odometer &amp; Speedometer</i> )	
Mirrors	
Convex Outside.....	73
Inside Manual Day/Night.....	72
Manual Adjust.....	72
Manual Remote Control.....	73
Mountain Driving.....	122
<b>N</b> ew Vehicle Break-In	
Requirements.....	49
Night Driving.....	117

<b>O</b> ctane Requirements (see <i>Fuel Requirements</i> )	
Odometer & Speedometer	82
Oil, Engine	162
Pressure Gage	90
Quality	163
Starburst	163
Thickness	163
Used Oil	165
When to Add	162
When to Change	164
Oil Warning Light	89
Operation of Lights	64
Outside Rearview Mirrors	73
Overheated Engine	136
Overheated Engine Coolant Warning Gage	85
Owner Checks & Services	212
Owner's Manual, How to Use	6
<b>P</b> aint Spotting, Chemical	193
Park, Shifting Into	51,58
Parking	
Over Things That Burn	60
Torque Lock	59
With the Engine Running	54,59,61
Parking Brake	58
Passenger Belts (see <i>Safety Belts</i> )	
Passing	72,115
Periodic Maintenance	
Inspections	216

Polishing and Waxing (see <i>Appearance Care</i> )	
Power Door Locks	44
Power Steering Fluid	173,198,199
Power Windows	62
Power Window Lock-out Switch	62
Pregnancy, Use of Safety Belts	
During	24
Problems on the Road	127
Publications (see <i>Service Publications</i> )	

<b>R</b> adiator Overheating (see <i>Overheated Engine</i> )	
Radiator Pressure Cap	172
Radio (see <i>Audio Systems</i> )	
Reading Light	67
Rear Safety Belt Comfort Guides	27
Rear Seat, Split Fold-Down	15
Rearview Mirrors	72
Rear Window Defogger	95
Reclining Seatbacks	12
Recommended Fluids & Lubricants	217
Recreational Towing	125
Replacement Bulbs	200
Replacement Fuses	196
Replacement Parts	202
Replacement, Windshield Wiper	179
Replacing Safety Belts	40
Replacing Tires	184
Replacing Wheels	186
Reporting Safety Defects	224

Restraints, Child	31
Roads, Hill and Mountain	122
Rocking Your Vehicle	54,152
Roof Luggage Carrier	79
Rotation, Tire	183

<b>S</b> afety Belts	17
Adults	20
Automatic Lap-Shoulder Belt	21
Care	190
Center Passenger Position	29
Checking	40
Children	30,38
Child Restraints	31
Child Restraints—How to Install Them	32
Child Restraints, Where to Put	31,35
Cleaning	190
Comfort Guides, Rear	27
Driver Position	21
Extender	40
How to Wear	20
Passenger Belts	25
Pregnancy, Use During	24
Questions & Answers	19,23,24,39,40
Rear Safety Belts	26
Rear Seat Passengers	25
Replacement	40
Right Front, Adult Passenger	25
Smaller Children and Babies	30
Top Strap	32

# Index

- Torn ..... 40  
Twisted ..... 24  
Vehicles First Sold in Canada ..... 20  
Warning Light ..... 17,20  
Why You Should Wear Safety Belts ..... 18  
Safety Defects, Reporting ..... 224  
Scheduled Maintenance Services ..... 205  
Seat Belts (see *Safety Belts*)  
Seat Controls  
  Easy-Entry ..... 15  
  Head Restraints ..... 13  
  Manual 4-Way Adjustable ..... 14  
  Manual Front Seat ..... 12  
  Manual Reclining Seatback ..... 12  
  Seat, Split Fold-Down Rear ..... 15  
  Seats, Split Folding, Rear Wagon ... 15  
  Seatback Latches ..... 14  
Service Parts Identification Label ... 194  
Service Publications ..... 227  
Service Station Information ..... 240  
Setting the Clock ..... 97  
Setting the Trip Odometer ..... 83  
Shift Light ..... 57,87  
Shifting Into P (Park) ..... 58  
Shifting Out of P (Park) ..... 60  
Shifting the Transaxle  
  Automatic Transaxle ..... 53  
  Manual Transaxle ..... 56  
Signaling Turns ..... 64  
Skidding ..... 116  
Snow or Ice, Driving On ..... 123  
Snowstorm, If You're Caught in a .. 124  
Sound Equipment, Adding ..... 96  
Sound Systems (see *Audio Systems*)  
Spare Tire, Compact ..... 151  
Specifications and Capacities ..... 198  
Speed Control (see *Cruise Control*)  
Speedometer & Odometer ..... 82  
  Trip Odometer ..... 83  
Stains, Removing ..... 189  
Starting Your Engine ..... 51  
  Automatic Transaxle ..... 53  
  Manual Transaxle ..... 56  
Starting Your Vehicle if the Battery is Dead (see *Jump Starting*)  
Steering  
  In Emergencies ..... 114  
  Off-Road Recovery ..... 114  
  Tips ..... 113  
Steering Wheel, Tilt ..... 63  
Stereo Sound Systems (see *Audio Systems*)  
Storing Your Vehicle ..... 176  
Stuck, If You Are ..... 152  
Sunroof ..... 75  
Sun Visors ..... 74  
**T**achometer ..... 83  
Taillight Bulb Replacement ..... 177,200  
Tape Player (see *Audio Systems*)  
Technical Facts & Specifications  
  Bulbs ..... 200  
Electrical Equipment,  
  Add-On ..... 52,96,195  
Fluid Capacities & Types ..... 198,199  
Fuses & Circuit Breakers ..... 195  
Service Parts Identification Label...194  
Vehicle Identification Number (VIN) ..... 194  
Temperature Gage ..... 85  
Theft ..... 47  
Thermostat ..... 172  
Tilt Steering Wheel ..... 63  
Time, Setting the ..... 97  
Tires ..... 181  
  Buying New ..... 184  
  Chains ..... 152,187  
  Flat, Changing ..... 146  
  Inflation ..... 182  
  Inspection & Rotation ..... 183  
  Loading ..... 182  
  Pressure ..... 182  
  Quality Grading ..... 185  
  Spare, Compact ..... 151  
  Tread Wear Indicators ..... 184  
Wheel Alignment and Tire  
  Balance ..... 186  
  Wheel Replacement ..... 186  
  When to Replace Wheels ..... 186  
  Winter Driving and Tires ..... 123,187  
Top Strap ..... 32  
Torque Lock ..... 59  
Towing a Trailer ..... 126  
Towing Your Vehicle ..... 125,132

Trailer Towing.....	126
Transaxle, Automatic (see <i>Automatic Transaxle</i> )	
Transaxle, Manual (see <i>Manual Transaxle</i> )	
Transmission, Automatic (see <i>Automatic Transaxle</i> )	
Transmission, Manual (see <i>Manual Transaxle</i> )	
Trip Odometer .....	83
Trunk.....	45,46
Trunk Cargo Anchors .....	49
Trunk Convenience Net .....	49
Trunk/Liftgate Release, Lockout ..	46,47
Turn Signal Indicator.....	64
Turn Signal/Multifunction Lever .....	63
Cruise Control .....	70
Headlight High/Low Beam.....	66
Turn & Lane Change Indicator .....	64
<b>U</b> nleaded Gasoline.....	154
Upholstery Care .....	188
Upshift Indicator Light.....	57,87
Urban Driving .....	119

<b>V</b> ehicle Damage Warnings .....	8
Vehicle Identification Number (VIN) .....	194
Vehicle Loading .....	79,180
Vehicle Storage .....	176
Vehicles First Sold in Canada .....	20
Ventilation .....	92,93,95,96
VIN.....	194
Visor Vanity Mirror .....	74
<b>W</b> agon	
Folding Rear Seats .....	15
Liftgate Ajar Light.....	88
Liftgate Lock .....	46
Liftgate Release Button.....	47
Rear Compartment Light .....	68
Roof Luggage Carrier .....	79
Taillight Bulb Replacement ...	177,200
Warning Flashers, Hazard .....	128
Warning Lights.....	84
Anti-Lock Brake System .....	87
Battery .....	86
Brake.....	86
Charging System .....	86
Check Coolant.....	85
Check Engine.....	88
Check Gages .....	89
Check Oil.....	89

Liftgate Ajar.....	88
Low Coolant .....	85
Oil .....	89
Safety Belt .....	17,20
Upshift Indicator .....	57,87
Washer, Windshield .....	69,173
Weight	
Gross Axle Rating (GAWR) .....	180
Gross Vehicle Rating (GVWR).....	180
Wheel Alignment and Tire Balance..	186
Wheel Covers, How to Remove.....	149
Wheel Nuts.....	149
Wheel Nut Torque .....	151,198
Wheel Replacement .....	186
Windows	
Power .....	62,197
Standard .....	62
Windshield Washer .....	69,173
Windshield Wipers.....	68,197
Cleaning.....	190
Windshield Wiper Blade	
Replacement .....	179
Winter Driving .....	123
Driving On Snow or Ice.....	123
If Your Vehicle is Stuck in Deep Snow .....	124,152
If You're Caught in a Blizzard .....	124
Wrecker Towing.....	132



# Service Station Information

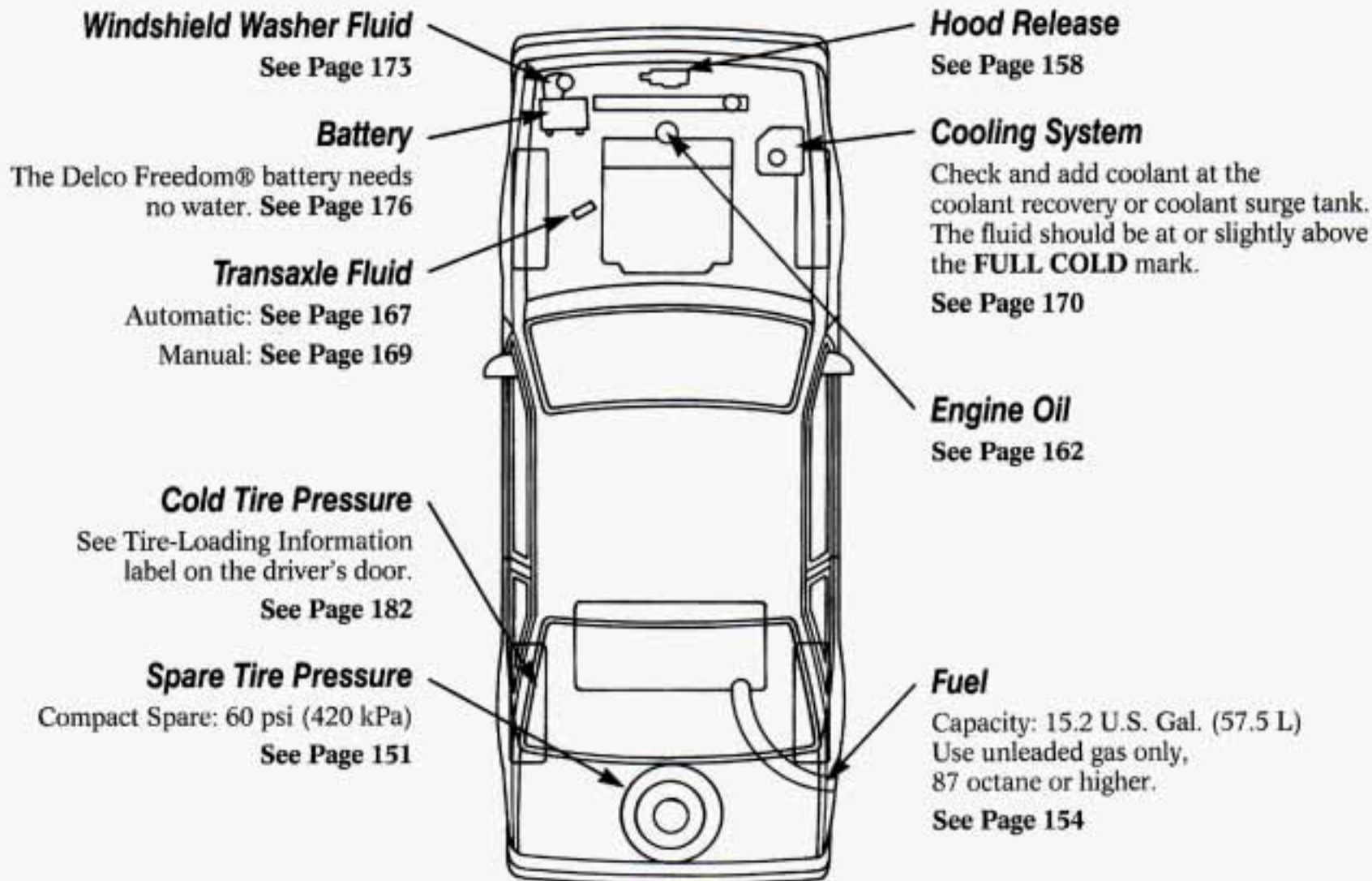



WE SUPPORT  
VOLUNTARY TECHNICIAN  
CERTIFICATION THROUGH

National Institute for  
**AUTOMOTIVE  
SERVICE  
EXCELLENCE**



CHEVROLET



GM

# **1994 Owner's Manual Supplement**

## **Chevrolet Cavalier**

This information replaces the air conditioning refrigerant specifications on page 198 of the 1994 Chevrolet Cavalier Owner's Manual.

If your Cavalier has air conditioning, the system could be filled with R-12 or R-134a refrigerant. These refrigerants are not interchangeable. If service is required, please refer to the refrigerant charge label under the hood for refrigerant charge type and quantity.