



**BUICK**  
PREMIUM AMERICAN  
MOTOR CARS

**Park Avenue**





## The 1994 Buick Park Avenue Owner's Manual

Litho in USA  
Part No. 25609656 B • First Edition

© Copyright General Motors Corporation 1993  
All Rights Reserved



GENERAL MOTORS, GM and the GM Emblem, Buick, and the Buick Emblem are registered trademarks of General Motors Corporation.

This manual includes the latest information at the time it was printed. We reserve the right to make changes in the product after that time without further notice. For vehicles first sold in Canada, substitute the name "General Motors of Canada Limited" for Buick Motor Division whenever it appears in this manual.

Please keep this manual in your Buick, so it will be there if you ever need it when you're on the road. If you sell the vehicle, please leave this manual in it so the new owner can use it.



We support voluntary technician certification.

## For Canadian Owners Who Prefer a French Language Manual:

Aux propriétaires canadiens: Vous pouvez vous procurer un exemplaire de ce guide en français chez votre concessionnaire ou au DGN Marketing Services Ltd., 1500 Bonhill Rd., Mississauga, Ontario L5T 1C7.



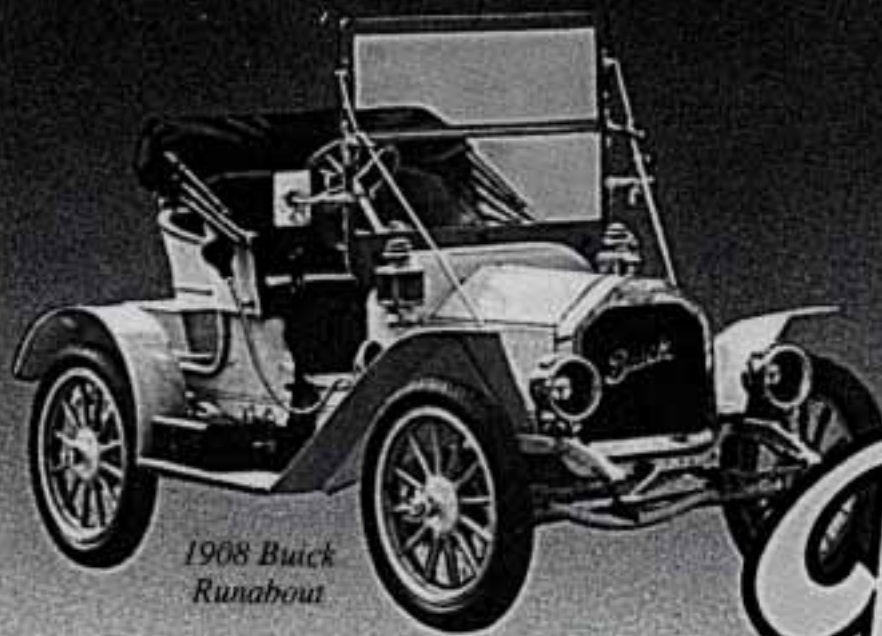

*1908 Buick  
Runabout*

*Buick Motor Division  
provides one of the most dramatic  
and important chapters in the history  
of the American automobile*

# Buick



*David Dunbar Buick*



*Walter Marr and Thomas Buick*

Buick's chief engineer, Walter L. Marr (left), and Thomas D. Buick, son of founder David Dunbar Buick, drove the first Flint Buick in a successful Flint-Detroit round trip in July 1904.

David Buick was building gasoline engines by 1899, and Marr, his engineer, apparently built the first auto to be called a Buick in 1900. However, Buick traditionally dates its beginnings to 1903. That was the year the company was reorganized, refinanced and moved from Detroit to Flint. Buick has always been a product

innovator. Buick engineers developed the "valve-in-head" engine, a light, powerful and reliable engine which would eventually influence the entire automotive industry.

William C. Durant was instrumental in promoting Buicks across the country using his Durant-Dort Carriage Co. outlets and salespeople as the nucleus of a giant distribution system. He knew the Buick as a "self-seller". If automobiles could be this good, he thought, maybe it was time to switch from the horse and buggy business to automobiles.



*William C. (Billy) Durant*

At the 1905, New York Auto Show, Durant took orders for 1,000 Buicks before the company had built 40. On Buick's success, Durant created a holding company, September 16, 1908. He called it General Motors.



Durant also created a racing team that won 500 racing trophies in 1909 and 1910, including successes at Indianapolis two years before the Indy 500 began.

The success of Buick engines was visible not only on the race track, but in endurance tests across the country and around the world. Buick was the only car to complete a 1,000-mile Chicago-to-New York race in 1906. And a Buick was the first car to travel across South America, driven from Buenos Aires, Argentina, over the Andes to Santiago, Chile in 1914.



*1911 Model 21 Touring Car on Buick's Test Hill*

Buick drew plenty of attention because it could climb hills and run through mud like no other car. Buick's endurance and reliability were world famous.

During World War I, Buick built Liberty aircraft engines as well as Red Cross ambulances so successful that one Buick ambulance was awarded the Croix de Guerre by the French government.

As a builder of premier automobiles, Buick was hard hit by the Great Depression. However, new General Manager, Harlow H. Curtice created popular new models including the Special and the Roadmaster. Buick sales soon flourished.



*First Buick Factory*

In World War II, Buick built aircraft engines, tanks and other military hardware. This post-war period brought great styling and engineering changes which resulted in increased sales. The torque converter automatic transmission, Dynaflo, was introduced in the 1948 Roadmaster. Buick's famous "portholes" came along in 1949.



*1949 Roadmaster*

A high-compression V-8 engine was introduced in 1953. And Buick's famous vertical pillar "toothy" grille, (introduced in 1942), became more massive in the post-war era.



*1953 Skylark*

Motor Trend magazine named the 1962 Buick Special, "Car of the Year". The first production V-6 engine was used in the Special.





*1962 Buick Special*

Built inside the walls of the old buildings in Buick's former Flint complex, which formed the cornerstone of General Motors, Buick City, is a state-of-the-art assembly facility with more than 200 robots and other high-tech equipment. It was completed in the fall of 1985.

Buicks are, and will continue to be, premium American motorcars with smooth power, high performance, rich detail and comfortable accommodation.



*Ed Mertz, General Manager, Buick Motor Division*

Our mission is simple:

"Buick will provide Premium American Motorcars backed with services that exceed our customers' expectations, throughout the purchase, ownership, service and repurchase experience."

Buicks are SUBSTANTIAL.

Buicks are DISTINCTIVE.

Buicks are POWERFUL.

Buicks are MATURE.





*1923 Sport Roadster*



# Table of Contents

<b>How to Use this Manual</b> .....	10
This part tells you how to use your manual and includes safety and vehicle damage warnings and symbols.	
<b>Seats and Restraint Systems</b> .....	13
This part tells you how to use your seats and safety belts properly. It also explains the "SRS" system.	
<b>Features and Controls</b> .....	63
This part explains how to start and operate your Buick.	
<b>Comfort Controls and Audio Systems</b> .....	131
This part tells you how to adjust the ventilation and comfort controls and how to operate your sound system.	
<b>Your Driving and the Road</b> .....	161
Here you'll find helpful information and tips about the road and how to drive under different conditions.	
<b>Problems on the Road</b> .....	195
This part tells you what to do if you have a problem while driving, such as a flat tire or engine overheating, etc.	
<b>Service and Appearance Care</b> .....	227
Here the manual tells you how to keep your Buick running properly and looking good.	
<b>Maintenance Schedule</b> .....	283
This part tells you when to perform vehicle maintenance and what fluids and lubricants to use.	
<b>Customer Assistance Information</b> .....	303
This part tells you how to contact Buick for assistance and how to get service publications. It also gives you information on "Reporting Safety Defects" on page 305.	
<b>Index</b> .....	311
Here's an alphabetical listing of almost every subject in this manual. You can use it to quickly find something you want to read.	

## How to Use This Manual

Many people read their owner's manual from beginning to end when they first receive their new vehicle. This will help you learn about the features and controls for your vehicle. In this manual, you'll find that pictures and words work together to explain things quickly.

## Safety Warnings and Symbols

You will find a number of safety cautions in this book. We use a box with gray background and the word **CAUTION** to tell you about things that could hurt you if you were to ignore the warning.

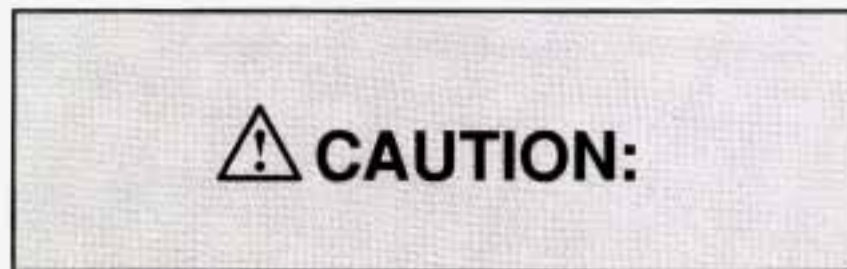

In the gray caution area, we tell you what the hazard is. Then we tell you what to do to help avoid or reduce the hazard. Please read these cautions. If you don't, you or others could be hurt.

You will also find a circle with a slash through it in this book.



This safety symbol means "Don't," "Don't do this," or "Don't let this happen."

## Vehicle Damage Warnings

Also, in this book you will find these notices:

**NOTICE:**

In the notice area, we tell you about something that can damage your vehicle. Many times, this damage would not be covered by your warranty, and it could be costly. But the notice will tell you what to do to help avoid the damage.

When you read other manuals, you might see CAUTION and NOTICE warnings in different colors or in different words.

You'll also see warning labels on your vehicle. They use yellow for cautions, blue for notices and the words CAUTION or NOTICE.



## Vehicle Symbols

These are some of the symbols you may find on your vehicle.

For example, these symbols are used on an original battery:

CAUTION  
POSSIBLE  
INJURY



PROTECT  
EYES BY  
SHIELDING



CAUSTIC  
BATTERY  
ACID COULD  
CAUSE  
BURNS



AVOID  
SPARKS OR  
FLAMES



SPARK OR  
FLAME  
COULD  
EXPLODE  
BATTERY



These symbols are important for you and your passengers whenever your vehicle is driven:

DOOR LOCK  
UNLOCK



FASTEN  
SEAT  
BELTS



POWER  
WINDOW



AIR BAG



These symbols have to do with your lights:

MASTER  
LIGHTING  
SWITCH



TURN  
SIGNALS

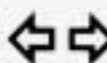

PARKING  
LIGHTS

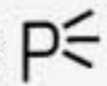

HAZARD  
WARNING  
FLASHER



LIGHTS OR  
HIGH BEAM



FOG LAMPS

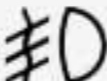

These symbols are on some of your controls:

WINDSHIELD  
WIPER



WINDSHIELD  
WASHER



WINDSHIELD  
DEFROSTER



REAR  
WINDOW  
DEFOGGER

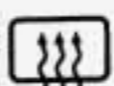

VENTILATING  
FAN



These symbols are used on warning and indicator lights:

ENGINE  
COOLANT  
TEMP

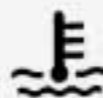

BATTERY  
CHARGING  
SYSTEM



BRAKE



RADIATOR  
COOLANT



FUEL



ENGINE OIL  
PRESSURE



ENGINE OIL  
TEMP



ANTILOCK  
BRAKE



Here are some other symbols you may see:

FUSE



RADIO  
SELECTOR



RADIO  
VOLUME



AIR  
CONDITIONING



TRUNK  
RELEASE



LIGHTER



HORN



SPEAKER







## Part 1 Seats and Restraint Systems

Here you'll find information about the seats in your Buick, and how to use your safety belts properly. You can also learn about some things you should not do with safety belts.

### Part 1 includes:

Seats and Seat Controls .....	14
Head Restraints .....	18
Safety Belts .....	19
How to Wear Safety Belts Properly .....	26
Lap-Shoulder Belt .....	27
Supplemental Restraint System (Air bag) .....	34
Safety Belt Use During Pregnancy .....	41
Children .....	46
Smaller Children and Babies .....	46
Child Restraints .....	48
Larger Children .....	58
Safety Belt Extender .....	61
Checking Your Restraint System .....	61
Replacing Safety Belts After a Crash .....	62

## Seats and Seat Controls

This section tells you about the seats -- how to adjust them, and also about memory seats, reclining seatbacks and head restraints.

### Manual Seat



Move the lever under the front seat to unlock it. Slide the seat to where you want it. Then release the lever and try to move the seat with your body, to make sure the seat is locked into place.

### Power Seat

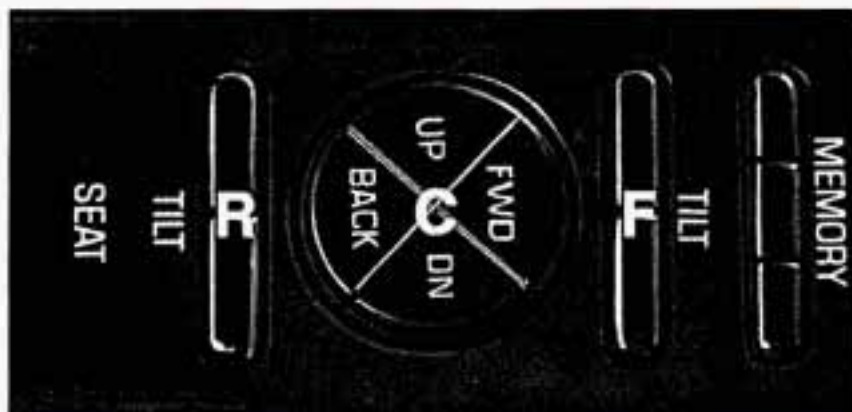

**Front Control (F):** Raise the front of the seat by pushing on the left side of the switch. Push on the right side of the switch to lower the front of the seat.

**Center Control (C):** Move the seat forward or back by holding the control to the front or back. Raise the seat by holding the control to the left. Hold the control to the right to lower the seat.

**Rear Control (R):** Raise the rear of the seat by holding the switch to the left. Holding the switch to the right lowers the rear of the seat.

## Memory Seat and Mirrors (Option)

If your Buick has this option, the control looks like this:



You can use this when you want to save a seat and mirror adjustment.

Here's how to make it work:

1. Adjust the driver's seat to your desired position. Adjust both outside mirrors to suit you. See "Outside Mirrors" in the Index.

2. Press the SET button, and then one of the two memory buttons within 5 seconds. You will hear one beep when you press the set button, and two beeps when you press the memory button to confirm that the mirror and seat positions are entered in memory.

Now it's set. When your Buick is in PARK with the ignition ON, push the memory button you just set and the seat and mirrors will go to where you've just set them. With the ignition OFF, the system will work in any shift lever position.

To do the same thing for a second driver, follow the steps above but use the other memory button.

If you hit the wrong memory setting, or if there is a third driver, the seat adjuster will still work, so you can adjust the seat to where you want it.

The EXIT button allows you to get out of the car more easily. Push it while you're in PARK with the ignition ON, or anytime with the ignition OFF, to make the seat go all the way down and back. Also, you will hear a beep when the EXIT button is pushed.

## Reclining Front Seatback(s)

To adjust the seatback, lift the lever on the outer side of the seat. Release the lever to lock the seatback where you want it. Pull up on the lever and the seat will go to its upright position.

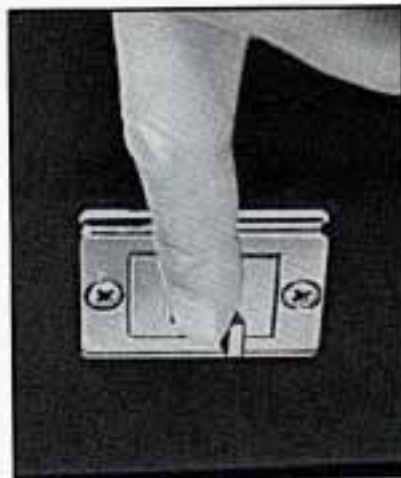

If you have the power recline option, it works with the switch on the side of the seat. Push it back to recline the seat, push it forward to return the seatback to the up position.

But don't have a seatback reclined if your vehicle is moving.





**⚠ CAUTION:**

Sitting in a reclined position when your vehicle is in motion can be dangerous. Even if you buckle up, your safety belts can't do their job when you're reclined like this.

The shoulder belt can't do its job because it won't be against your body. Instead, it will be in front of you. In a crash you could go into it, receiving neck or other injuries.

The lap belt can't do its job either. In a crash the belt could go up over your abdomen. The belt forces would be there, not at your pelvic bones. This could cause serious internal injuries.

For proper protection when the vehicle is in motion, have the seatback upright. Then sit well back in the seat and wear your safety belt properly.



## Heated Seat (Option)



If your vehicle has this option, push the switch on the side of the driver's seat forward and the driver's seat will start to warm up. The light on top of the switch will turn orange for low or red for high. Push the switch rearward to stop the seat from warming.

## Head Restraints



Slide the head restraint up or down so that the top of the restraint is closest to the top of your ears.

This position reduces the chance of a neck injury in a crash.

## Safety Belts: They're For Everyone

This part of the manual tells you how to use safety belts properly. It also tells you some things you should not do with safety belts.

And it explains the Supplemental Restraint System, or "air bag" system.

### CAUTION:

**Don't let anyone ride where they can't wear a safety belt properly. If you are in a crash and you're not wearing a safety belt, your injuries can be much worse. You can hit things inside the vehicle or be ejected from it. You can be seriously injured or killed. In the same crash, you might not be if you are buckled up. Always fasten your safety belt, and check that your passengers' belts are fastened properly too.**



This figure lights up as a reminder to buckle up. (See "Safety Belt Reminder Light" in the Index.)

In many states and Canadian provinces, the law says to wear safety belts. Here's why: They work.

You never know if you'll be in a crash. If you do have a crash, you don't know if it will be a bad one.

A few crashes are mild, and some crashes can be so serious that even buckled up a person wouldn't survive. But most crashes are in between. In many of them, people who buckle up can survive and sometimes walk away. Without belts they could have been badly hurt or killed.

After more than 25 years of safety belts in vehicles, the facts are clear. In most crashes buckling up does matter ... a lot!



## Why Safety Belts Work

When you ride in or on anything, you go as fast as it goes.

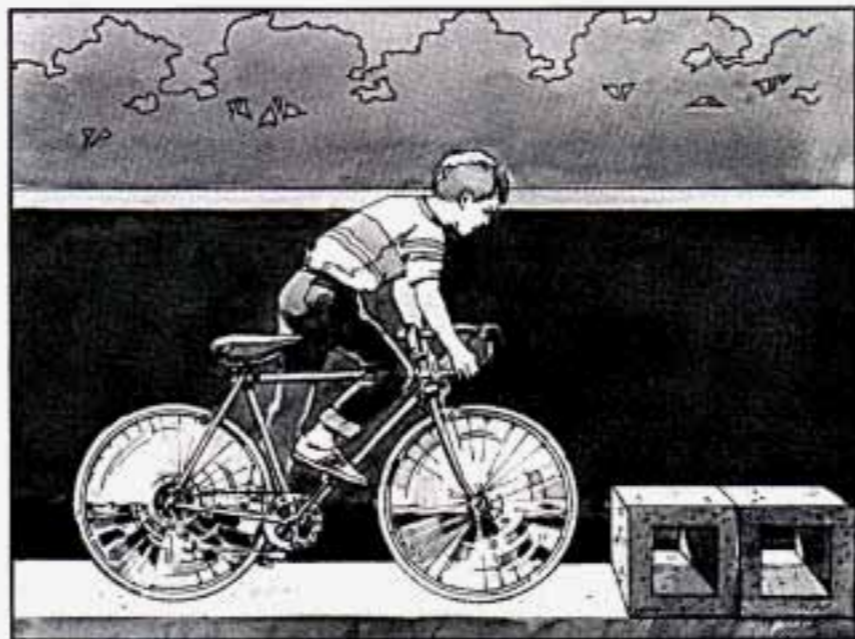

For example, if the bike is going 10 mph (16 km/h), so is the child.



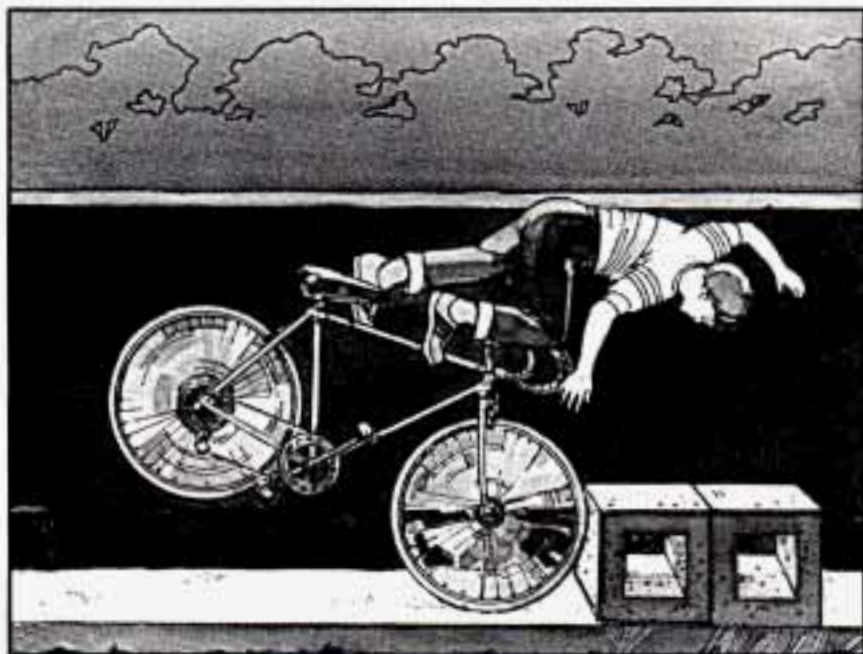

When the bike hits the block, it stops. But the child keeps going!

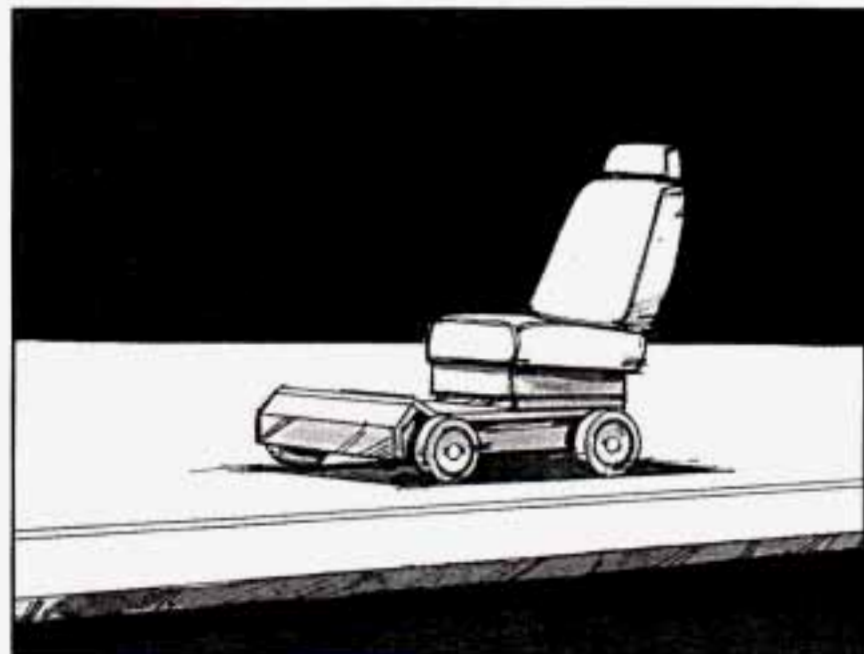

Take the simplest vehicle. Suppose it's just a seat on wheels.

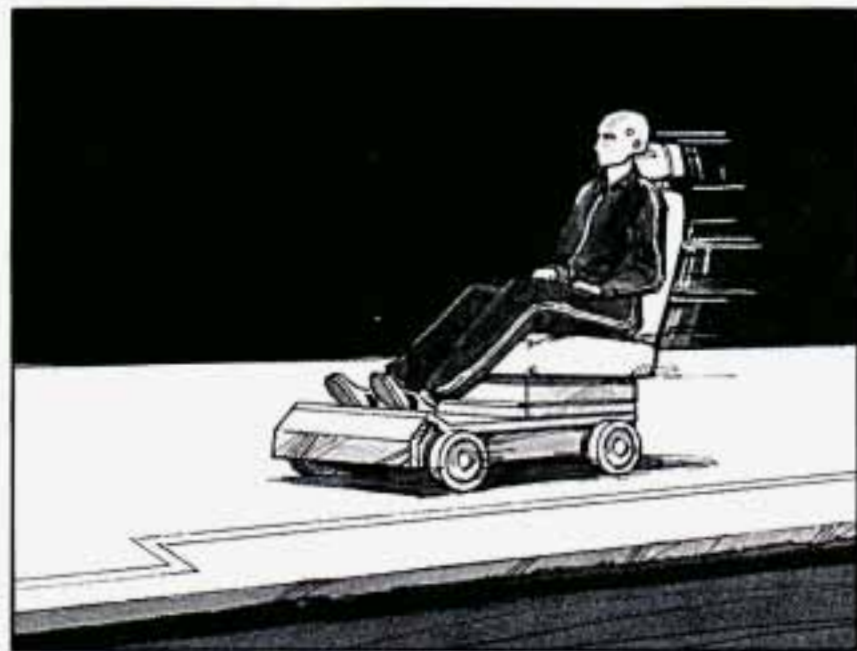

Put someone on it.

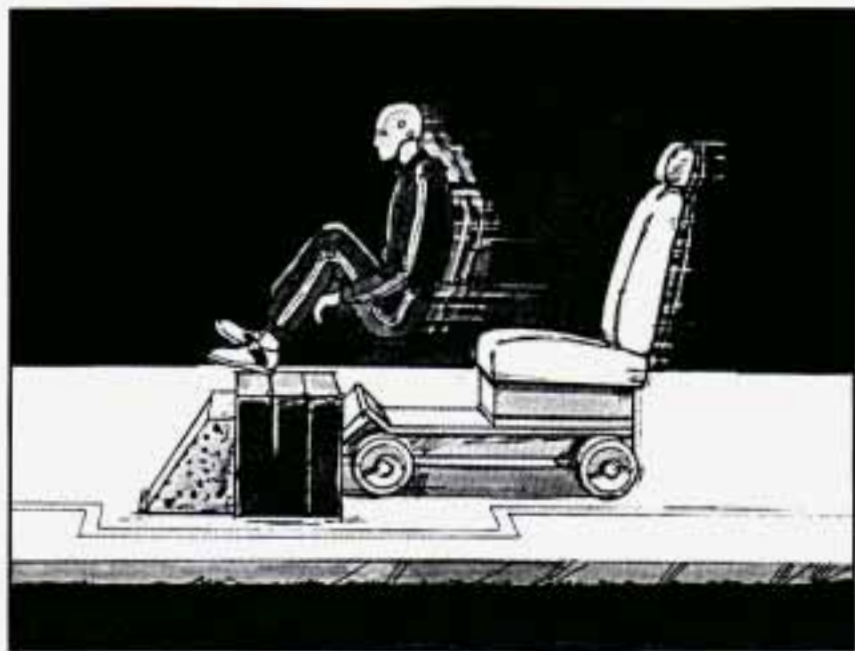

Get it up to speed. Then stop the vehicle. The rider doesn't stop.





The person keeps going until stopped by something.  
In a real vehicle, it could be the windshield ...

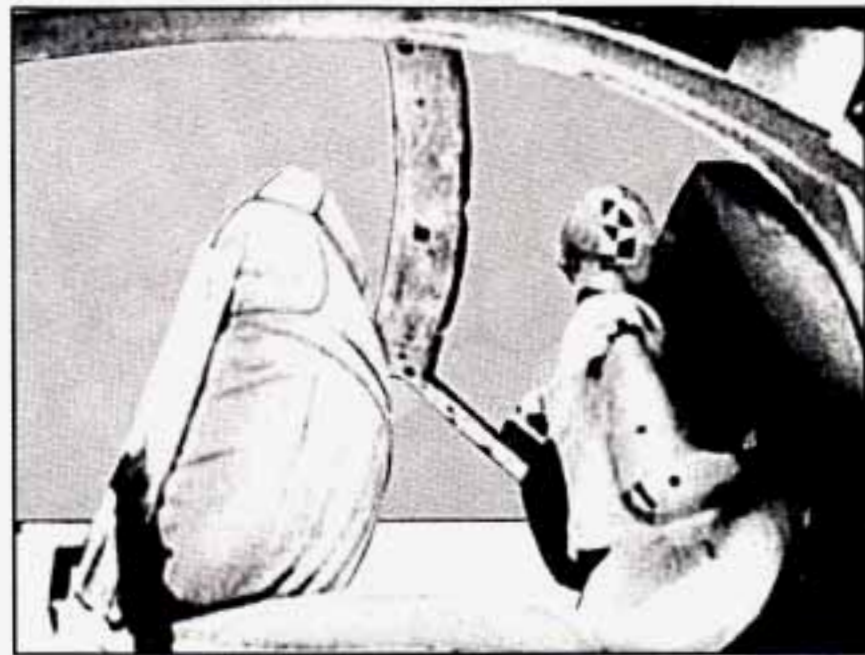

or the instrument panel ...



or the safety belts!

With safety belts, you slow down as the vehicle does. You get more time to stop. You stop over more distance, and your strongest bones take the forces. That's why safety belts make such good sense.

## Here Are Questions Many People Ask About Safety Belts -- and the Answers

**Q:** Won't I be trapped in the vehicle after an accident if I'm wearing a safety belt?

**A:** You could be -- whether you're wearing a safety belt or not. But you can easily unbuckle a safety belt, even if you're upside down. And your chance of being conscious during and after an accident, so you can unbuckle and get out, is much greater if you are belted.

**Q:** Why don't they just put in air bags so people won't have to wear safety belts?

**A:** Air bags, or Supplemental Restraint Systems, are in some vehicles today and will be in more of them in the future. But they are supplemental systems only -- so they work with safety belts, not instead of them. Every air bag system ever offered for sale has required the use of safety belts. Even if you're in a vehicle that has air bags, you still have to buckle up to get the most protection. That's true not only in frontal collisions, but especially in side and other collisions.

**Q:** If I'm a good driver, and I never drive far from home, why should I wear safety belts?

**A:** You may be an excellent driver, but if you're in an accident -- even one that isn't your fault -- you and your passengers can be hurt. Being a good driver doesn't protect you from things beyond your control, such as bad drivers.

Most accidents occur within 25 miles (40 km) of home. And the greatest number of serious injuries and deaths occur at speeds of less than 40 mph (65 km/h).

Safety belts are for everyone.

## Safety Belt Reminder Light



When the key is turned to "Run" or "Start," a chime will come on for about eight seconds to remind people to fasten their safety belts. The safety belt light will also come on and stay on for about 70 seconds. If the driver's belt is already buckled, neither the chime nor the light will come on.



## How To Wear Safety Belts Properly

### Adults

This section is only for people of adult size.

Be aware that there are special things to know about safety belts and children. And there are different rules for smaller children and babies. If a child will be riding in your Buick, see the section after this one, called "Children." Follow those rules for everyone's protection.

First, you'll want to know which restraint systems your vehicle has.

We'll start with the driver position.

## Driver Position

This section describes the driver's restraint system.

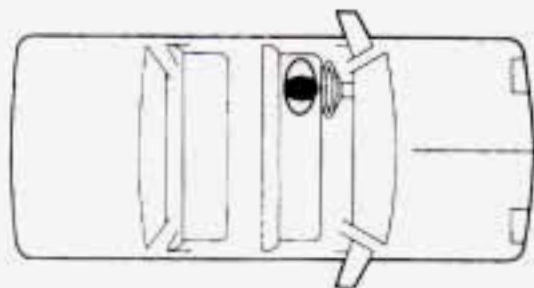

## Lap-Shoulder Belt



The driver has a lap-shoulder belt. Here's how to wear it properly.

1. Close and lock the door.
2. Adjust the seat (to see how, see "Seats" in the Index) so you can sit up straight.



3. Pick up the latch plate and pull the belt across you. Don't let it get twisted.
4. Push the latch plate into the buckle until it clicks. Pull up on the latch plate to make sure it is secure. If the belt isn't long enough, see "Safety Belt Extender" at the end of this section.

Make sure the release button on the buckle is positioned so you would be able to unbuckle the safety belt quickly if you ever had to.

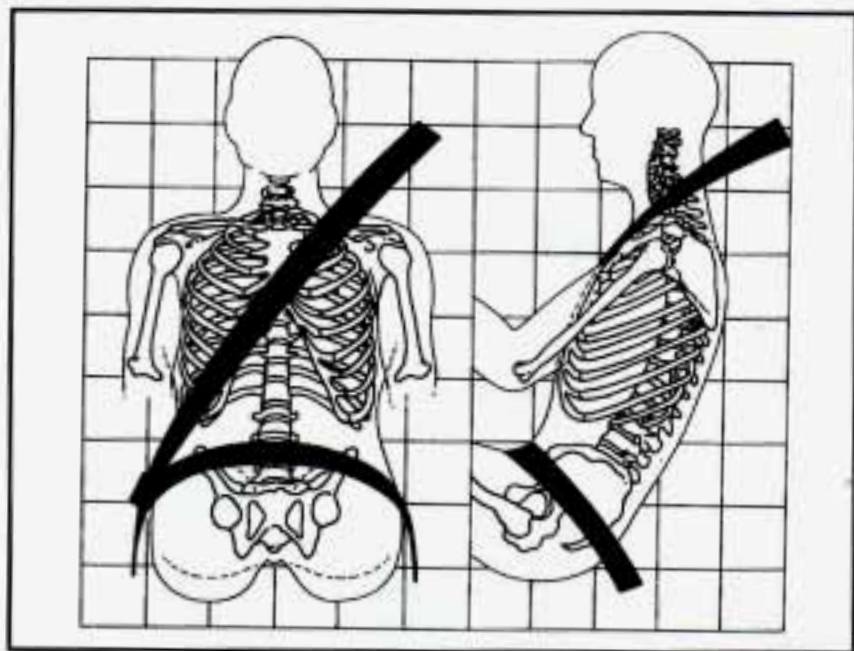

The lap part of the belt should be worn low and snug on the hips, just touching the thighs. In a crash, this applies force to the strong pelvic bones. And you'd be less likely to slide under the lap belt. If you slid under it, the belt would apply force at your abdomen. This could cause serious or even fatal injuries. The shoulder belt should go over the shoulder and across the chest. These parts of the body are best able to take belt restraining forces. The safety belt locks if there's a sudden stop or crash.

### Shoulder Belt Height Adjuster

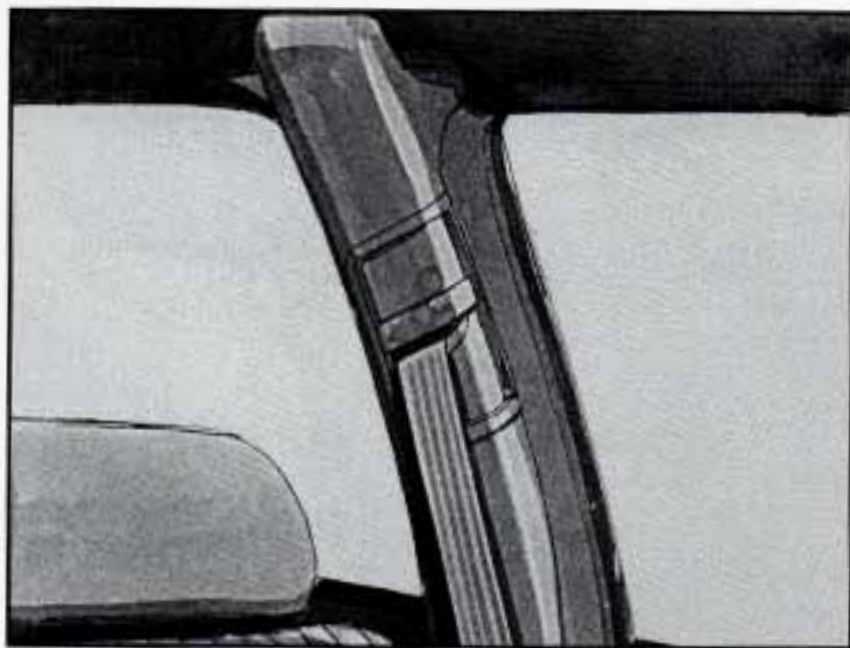

You can move the shoulder belt adjuster to the height that is right for you.





To move it up or down, squeeze the release handle.  
When you release the handle, try to move it down a little to make sure it has locked into position.

You can move the adjuster up from a lower position by pushing the bottom of the release handle.



Adjust the height so that the shoulder portion of the belt is properly positioned on your shoulder, away from your face and neck.

To help you find a height that is right for you, follow these guidelines:

For a tall person: Use the upper or upper-middle position.

For a person of average height: Use a position somewhere in the middle.

For a short person: Use the lower or lower-middle position.

**Q:** What's wrong with this?

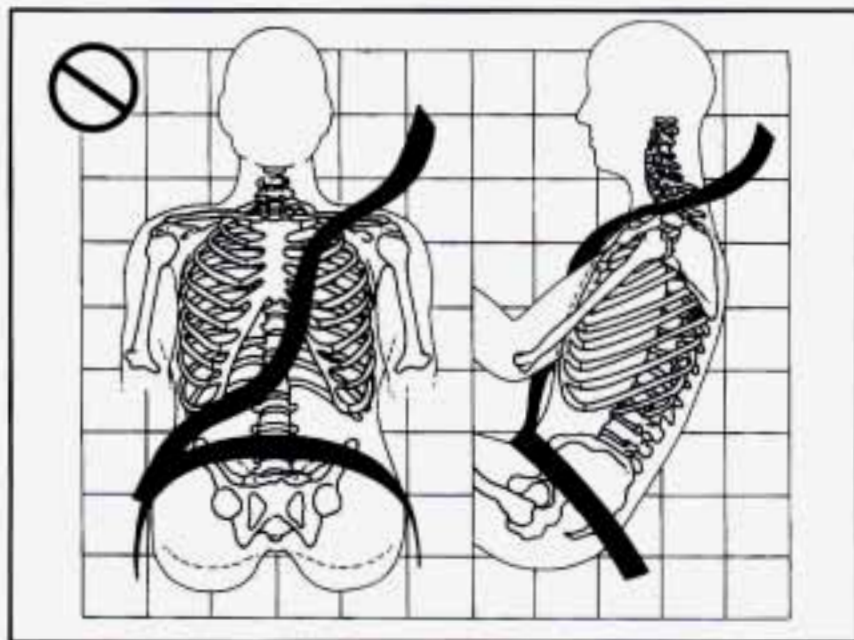

**A:** The shoulder belt is too loose. It won't give nearly as much protection this way.

**⚠ CAUTION:**

You can be seriously hurt if your shoulder belt is too loose. In a crash you would move forward too much, which could increase injury. The shoulder belt should fit against your body.

**Q:** What's wrong with this?

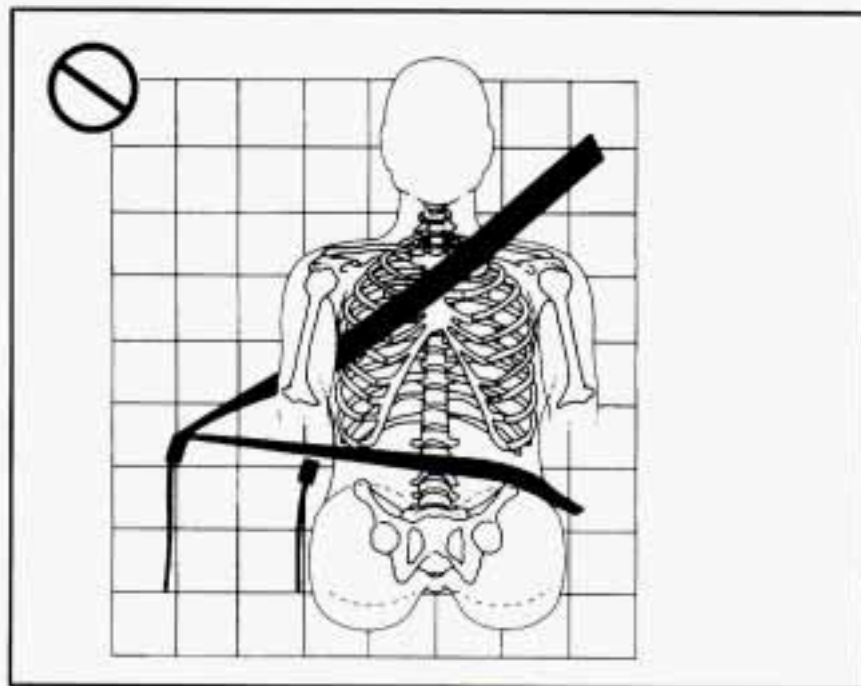

**⚠ CAUTION:**

You can be seriously injured if your belt is buckled in the wrong place like this. In a crash, the belt would go up over your abdomen. The belt forces would be there, not at the pelvic bones. This could cause serious internal injuries. Always buckle your belt into the buckle nearest you.

**A:** The belt is buckled in the wrong place.



**Q:** What's wrong with this?

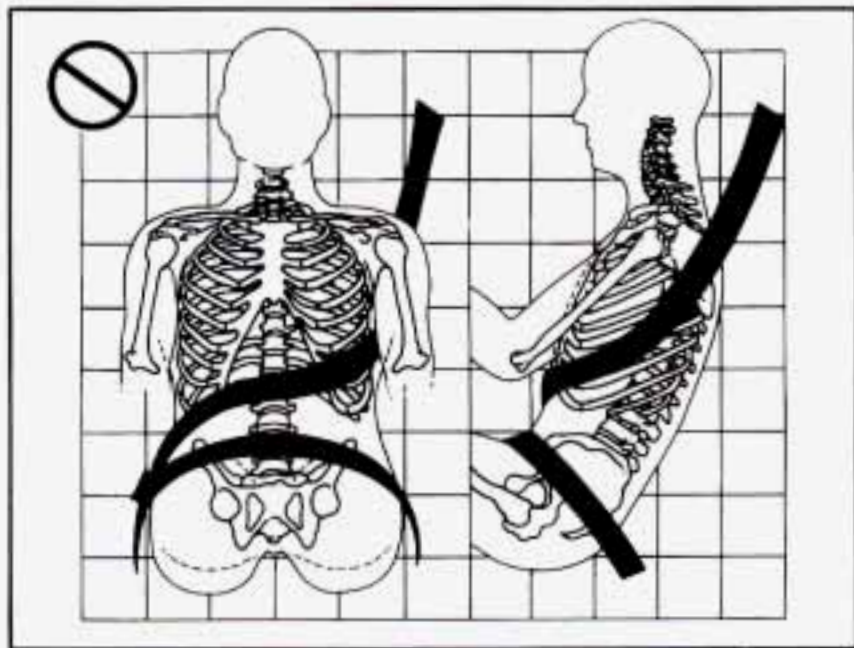

**⚠ CAUTION:**

You can be seriously injured if you wear the shoulder belt under your arm. In a crash, your body would move too far forward, which would increase the chance of head and neck injury. Also, the belt would apply too much force to the ribs, which aren't as strong as shoulder bones. You could also severely injure internal organs like your liver or spleen.

**A:** The shoulder belt is worn under the arm. It should be worn over the shoulder at all times.

**Q:** What's wrong with this?

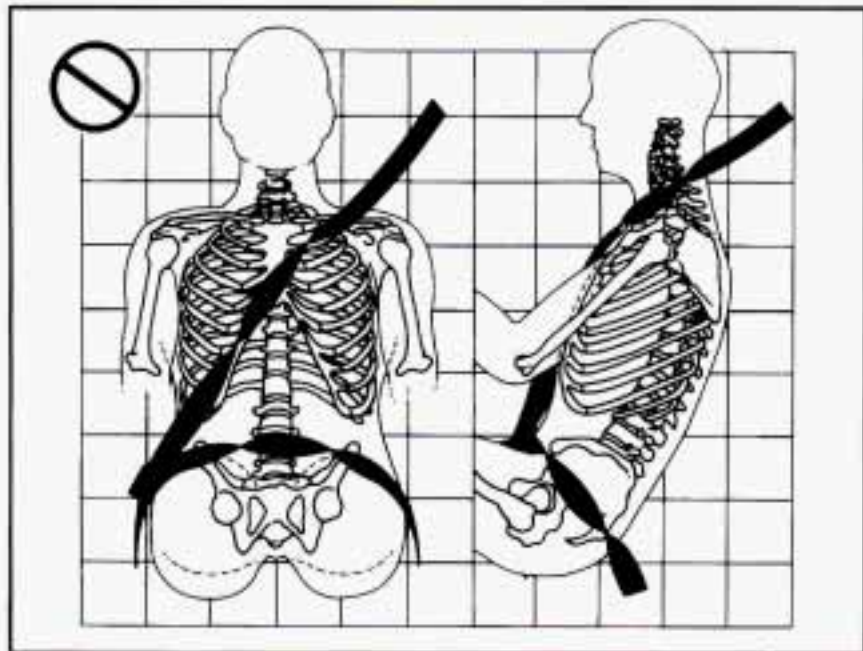

**A:** The belt is twisted across the body.



**CAUTION:**

You can be seriously injured by a twisted belt. In a crash, you wouldn't have the full width of the belt to spread impact forces. If a belt is twisted, make it straight so it can work properly, or ask your dealer to fix it.

To unlatch the belt, just push the button on the buckle. The belt should go back out of the way.



Before you close the door, be sure the belt is out of the way. If you slam the door on it, you can damage both the belt and your vehicle.

## Supplemental Restraint System (Air Bags)

This section explains the Supplemental Restraint System (SRS), or "air bag," system. Your Buick has an air bag for the driver and for the right-front passenger.

Here's the most important thing to know:



### **CAUTION:**

Even with an air bag, if you're not wearing a safety belt and you're in a crash, your injuries may be much worse. Air bags are not designed to inflate in rollovers or in rear, side or low-speed frontal crashes. You need to wear your safety belt to reduce the chance of hitting things inside the vehicle or being ejected from it. Always wear your safety belt, even with an air bag.



 **CAUTION:**

Air bags inflate with great force, faster than the blink of an eye. If you're too close to an inflating air bag, it could seriously injure you. Safety belts help keep you in position for an air bag inflation in a crash. Always wear your safety belt, even with an air bag, and the driver should sit as far back as possible while still maintaining control of the vehicle.

 **CAUTION:**

When an air bag inflates, there is dust in the air. This dust could cause breathing problems for people with a history of asthma or other breathing trouble. To avoid this, everyone in the vehicle should get out as soon as it is safe to do so. If you have breathing problems but can't get out of the vehicle after an air bag inflates, then get fresh air by opening a window or door.

 **CAUTION:**

An inflating air bag can seriously injure small children. Always secure children properly in your vehicle. To read how, see the "Children and Safety Belts" section of this manual, and read the caution label on the front-passenger's safety belt.

 **CAUTION:**

Don't put anything on, or attach anything to, the driver air bag or instrument panel. Also, don't put anything (such as pets, or objects) between any occupant and the driver air bag or instrument panel. If something is between an occupant and an air bag, it could affect the performance of the air bag, or, worse, it could cause injury.

## Air Bag Readiness Light

There is an air bag readiness light on the instrument panel, which shows INFLATABLE RESTRAINT. The system checks for electrical malfunctions, and the light tells you if there is a problem.

INFLATABLE  
RESTRAINT

INFL.  
REST.

You will see this light flash for a few seconds when you turn your ignition to "Run" or "Start." Then the light should go out, which means the system is ready.

Remember, if the air bag readiness light doesn't come on when you start your vehicle, or stays on, or comes on when you are driving, your air bag system may not work properly. Have your vehicle serviced right away.

## How The Air Bag System Works





### **Where is the air bag?**

The driver's air bag is in the middle of the steering wheel. The right-front passenger's air bag is located in the instrument panel on the passenger's side.

### **When is an air bag expected to inflate?**

The air bag is designed to inflate in moderate to severe frontal or near-frontal crashes. The air bag will only inflate if the velocity of the impact is above the designed threshold level. When impacting straight into a wall that does not move or deform, the threshold level for most GM vehicles is between 9 and 15 mph (14 and 23 km/h). However, this velocity threshold depends on the vehicle design and may be several miles-per-hour faster or slower. In addition, this threshold velocity will be considerably higher if the vehicle strikes an object such as a parked car which will move and deform on impact. The air bag is also not designed to inflate in rollovers, side impacts, or rear impacts where the inflation would provide no occupant protection benefit.

It is possible that in a crash, only one of the two air bags in your Park Avenue will deploy. This is rare, but can happen in a crash just severe enough to make an air bag inflate.



In any particular crash, the determination of whether the air bag should have inflated cannot be based solely on the level of damage on the vehicle(s). Inflation is determined by the angle of the impact and the vehicle's deceleration, of which vehicle damage is only one indication. Repair cost is not a good indicator of whether an air bag should have deployed.

### **What makes an air bag inflate?**

In a frontal or near-frontal impact of sufficient severity, the air bag sensing system detects that the vehicle is suddenly stopping as a result of a crash. The sensing system triggers a chemical reaction of the sodium azide sealed in the inflator. The reaction produces nitrogen gas, which inflates a cloth bag. The inflator, cloth bag, and related hardware are all part of the air bag inflator modules packed inside the steering wheel and in the instrument panel in front of the passenger.

### **How does an air bag restrain?**

In moderate to severe frontal or near-frontal collisions, even belted occupants can contact the steering wheel or the instrument panel. The air bag supplements the protection provided by safety belts. Air bags distribute the force of the impact more evenly over the occupant's upper body, stopping the occupant more gradually. But air bags would not provide protection in many types of collisions, including rollovers and rear and side impacts, primarily because an occupant's motion is not toward the air bag. Air bags should never be regarded as anything more than a supplement to safety belt protection in moderate to severe frontal and near-frontal collisions.

## What will you see after an air bag inflation?

After the air bag has inflated, it will then quickly deflate. This occurs so quickly that some people may not even realize that the air bag inflated. Some components of the air bag module in the steering wheel hub for the driver's air bag or the instrument panel for the passenger's bag may be hot for a short time, but the portion of the bag that comes into contact with you will not be hot to the touch. There will be small amounts of smoke and dust coming from vents in the deflated air bags. The air bag will not impede the driver's vision or ability to steer the vehicle, nor will it hinder the occupants from exiting the vehicle.

In many crashes severe enough to inflate an air bag, windshields are broken by vehicle deformation. Additional windshield breakage may occur in vehicles with passenger air bags because the windshield acts as a reaction surface for the inflating air bag.

- The air bags are designed to inflate only once. After they inflate, you'll need some new parts for your air bag system. If you don't get them, the air bag system won't be there to help protect you in another crash. A new system will include air bag modules and possibly other parts. The service manual has information about the need to replace other parts.

- Your vehicle is equipped with a diagnostic module, which records information about the air bag system. The module records information about the readiness of the system, when the sensors are activated and whether the driver's safety belt was in use.
- Let only qualified technicians work on your air bag system. Improper service can mean that your air bag system won't work properly. See your dealer for service.

### **NOTICE:**

**If you damage the cover for the driver's or the right-front passenger's air bag, they may not work properly. You may have to replace the air bag on the steering wheel or both the air bag and the instrument panel for the passenger's air bag. Do not open or break the air bag covers.**

### **Is the smoke from an air bag inflation harmful?**

The particles emitted during air bag inflation are not harmful to most people. Some people with respiratory ailments may experience difficulty breathing if they stay in the vehicle with the windows closed after air bag inflation. So, if your air bag inflates, you and any passengers should exit the vehicle if and when it is safe to do so. If you or your passengers can't get out of the vehicle, try to get fresh air by opening a window, turning on the fan, or opening a door.

### **Servicing Your Air Bag-Equipped Buick**

Air bags affect how your Buick should be serviced. There are parts of the air bag system in several places around your vehicle. You don't want the system to inflate while someone is working on your vehicle. Your Buick dealer and the 1994 Park Avenue Service Manual have information about servicing your vehicle and the air bag system. The air bag system does not need regular maintenance.



### **CAUTION:**

**For up to 2 minutes after the ignition key is turned off and the battery is disconnected, an air bag can still inflate during improper service. You can be injured if you are close to an air bag when it inflates. Avoid wires wrapped with yellow tape, or yellow connectors. They are probably part of the air bag system. Be sure to follow the proper service procedures, and make sure the person performing the work for you is qualified to do so.**



## Safety Belt Use During Pregnancy

Safety belts work for everyone, including pregnant women. Like all occupants, they are more likely to be seriously injured if they don't wear safety belts.

A pregnant woman should wear a lap-shoulder belt, and the lap portion should be worn as low as possible throughout the pregnancy.

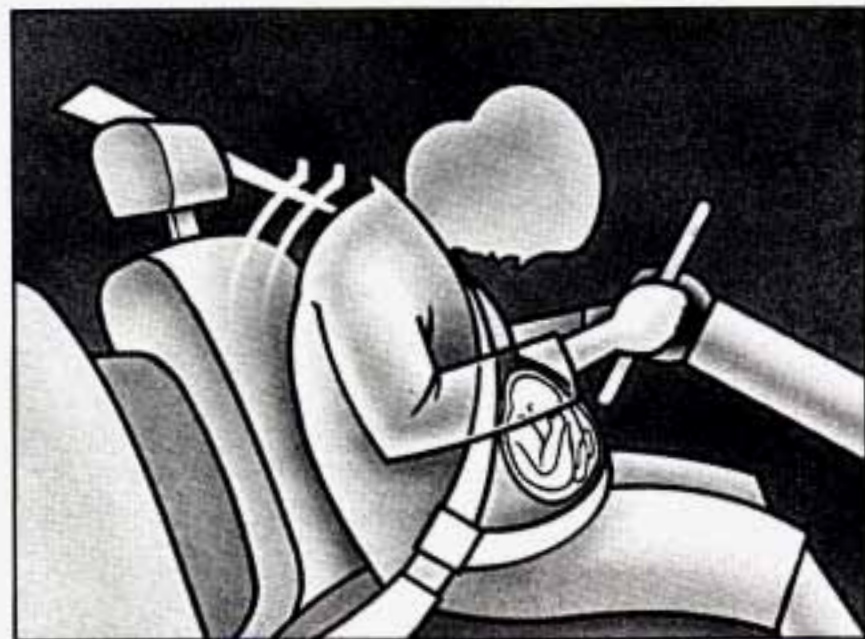

The best way to protect the fetus is to protect the mother. When a safety belt is worn properly, it's more likely that the fetus won't be hurt in a crash. For pregnant women, as for anyone, the key to making safety belts effective is wearing them properly.

## Right Front Passenger Position

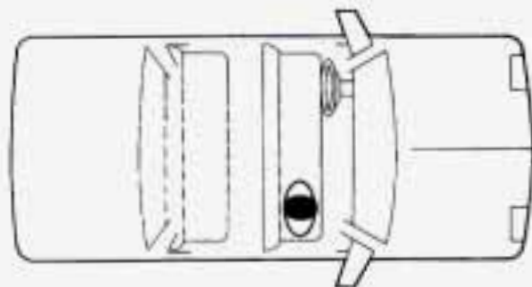

The right front passenger's safety belt works the same way as the driver's safety belt. See "Driver Position," earlier in this part.

When the lap portion of the belt is pulled out all the way, it will lock. If it does, let it go back all the way and start again.

If your vehicle has a center passenger position, be sure to use the correct buckle when buckling your lap-shoulder belt. If you find that the latch plate will not go fully into the buckle, see if you are using the buckle for the center passenger position.

## Center Passenger Position

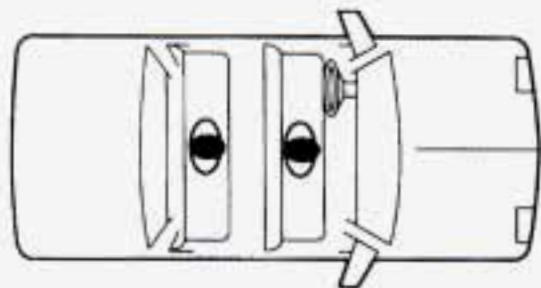

## Lap Belt



When you sit in a center seating position, you have a lap safety belt, which has no retractor. To make the belt longer, tilt the latch plate and pull it along the belt.

To make the belt shorter, pull its free end as shown until the belt is snug.



Buckle, position and release it the same way as the lap part of a lap-shoulder belt. If the belt isn't long enough, see "Safety Belt Extender" at the end of this section.

Make sure the release button on the buckle is positioned so you would be able to unbuckle the safety belt quickly if you ever had to.

## Rear Seat Passengers

It's very important for rear seat passengers to buckle up! Accident statistics show that unbelted people in the rear seat are hurt more often in crashes than those who are wearing safety belts.

Rear passengers who aren't safety belted can be thrown out of the vehicle in a crash. And they can strike others in the vehicle who are wearing safety belts.

### Rear Seat Outside Passenger Positions

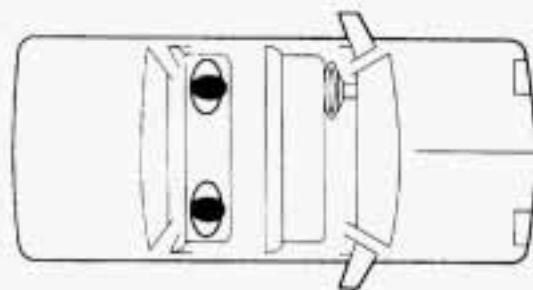



## Lap-Shoulder Belt

The positions next to the windows have lap-shoulder belts. Here's how to wear one properly.



1. Pick up the latch plate and pull the belt across you. Don't let it get twisted.
2. Push the latch plate into the buckle until it clicks. Pull up on the latch plate to make sure it is secure.

When the lap belt is pulled out all the way, it will lock. If it does, let it go back all the way and start again. If the belt is not long enough, see "Safety Belt Extender" at the end of this section. Make sure the release button on the buckle is positioned so you would be able to unbuckle the safety belt quickly if you ever had to.

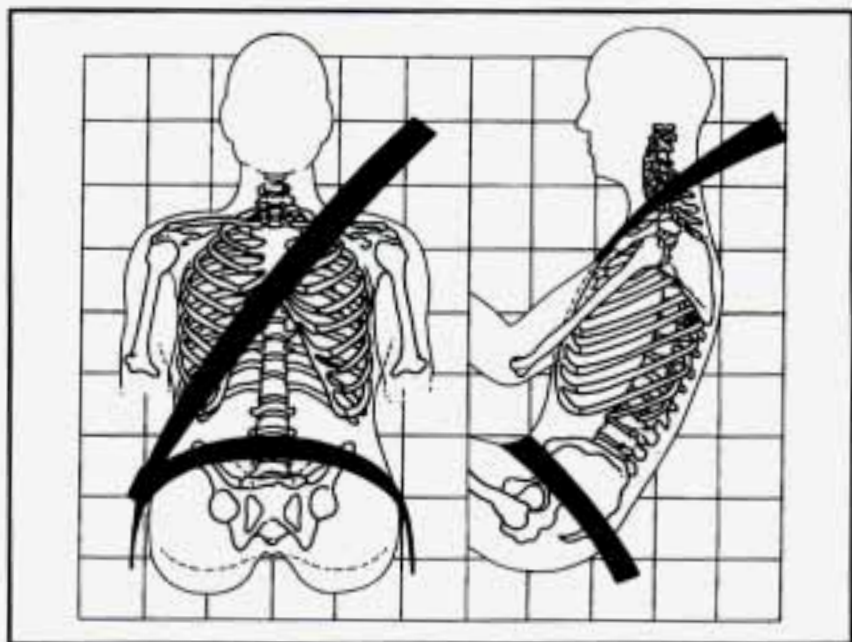

The lap part of the belt should be worn low and snug on the hips, just touching the thighs. In a crash, this applies force to the strong pelvic bones. And you'd be less likely to slide under the lap belt. If you slid under it, the belt would apply force at your abdomen. This could cause serious or even fatal injuries. The shoulder belt should go over the shoulder and across the chest. These parts of the body are best able to take belt restraining forces.

The safety belt locks if there's a sudden stop or a crash.

 **CAUTION:**

**You can be seriously hurt if your shoulder belt is too loose. In a crash you would move forward too much, which could increase injury. The shoulder belt should fit against your body.**



- To unlatch the belt, just push the button on the buckle.

## Children



Everyone in a vehicle needs protection! That includes infants and all children smaller than adult size. In fact, the law in every state in the United States and in every Canadian province says children up to some age must be restrained while in a vehicle.

## Smaller Children and Babies



### **CAUTION:**

Smaller children and babies should always be restrained in a child or infant restraint. The instructions for the restraint will say whether it is the right type and size for your child. A very young child's hip bones are so small that a regular belt might not stay low on the hips, as it should. Instead, the belt will likely be over the child's abdomen. In a crash the belt would apply force right on the child's abdomen, which could cause serious or fatal injuries. So, be sure that any child small enough for one is always properly restrained in a child or infant restraint.





**CAUTION: (Continued)**

baby will suddenly become a 240-pound (110 kg) force on your arms. The baby would be almost impossible to hold.

Secure the baby in an infant restraint.

 **CAUTION:**

Never hold a baby in your arms while riding in a vehicle. A baby doesn't weigh much -- until a crash. During a crash a baby will become so heavy you can't hold it. For example, in a crash at only 25 mph (40 km/h), a 12-pound (5.5 kg)

**CAUTION: (Continued)**



## Child Restraints

Be sure to follow the instructions for the restraint. You may find these instructions on the restraint itself or in a booklet, or both. These restraints use the belt system in your vehicle, but the child also has to be secured within the restraint to help reduce the chance of personal injury. The instructions that come with the infant or child restraint will show you how to do that.

### Where to Put the Restraint

Accident statistics show that children are safer if they are restrained in the rear rather than the front seat. We at General Motors therefore recommend that you put your child restraint in the rear seat. NEVER put a rear-facing child restraint in the front passenger seat. Here's why:



### CAUTION:

A child in a rear-facing child restraint can be seriously injured if the right-front passenger's air bag inflates. This is because the back of a rear-facing child restraint would be very close to the inflating air bag. If your vehicle has a right-front passenger's air bag, always secure a rear-facing child restraint in the rear seat.

You may, however, secure a forward-facing child restraint in the right-front seat. Before you secure a forward-facing child restraint, **ALWAYS** move the front passenger seat as far back as it will go. Or, secure the child restraint in the rear seat.

**⚠ CAUTION:**

**A child in a child restraint in the front-center seat can be badly injured by the passenger air bag if it inflates. NEVER use a child restraint in the front-center seat. It's always better to secure a child restraint in the rear seat. You may, however, secure a forward-facing child restraint in the right-front passenger seat only with the seat moved all the way back.**

Wherever you install it, be sure to secure the child restraint properly.

Keep in mind that an unsecured child restraint can move around in a collision or sudden stop and injure people in the vehicle. Be sure to properly secure any child restraint in your vehicle -- even when no child is in it.

## Top Strap

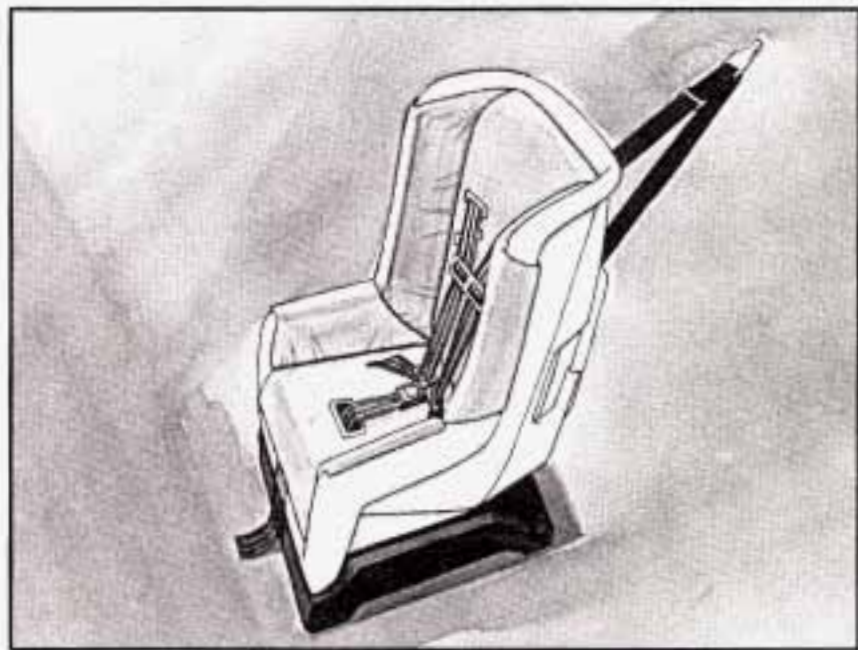

If your child restraint has a top strap, it should be anchored.

If you need to have an anchor installed, you can ask your Buick dealer to put it in for you. If you want to install an anchor yourself, your dealer can tell you how to do it.



For cars first sold in Canada, child restraints with a top strap must be anchored according to Canadian Law.

Your dealer can obtain the hardware kit and install it for you, or you may install it yourself using the instructions provided in the kit.

Use the tether hardware kit available from the dealer. The hardware and installation instructions were specifically designed for this vehicle.

## Securing a Child Restraint in a Rear Outside Position

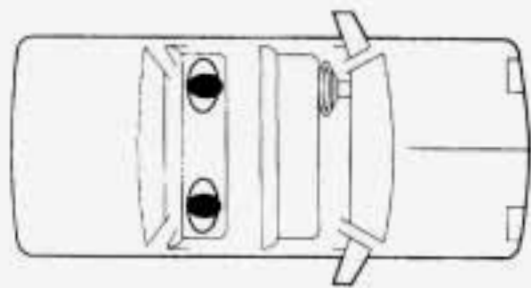

You'll be using the lap-shoulder belt. See the earlier section about the top strap if the child restraint has one.

1. Put the restraint on the seat. Follow the instructions for the child restraint.
2. Secure the child in the child restraint as the instructions say.
3. Pick up the latch plate, and run the lap and shoulder portions of the vehicle's safety belt through or around the restraint. The child restraint instructions will show you how.

If the shoulder belt goes in front of the child's face or neck, put it behind the child restraint.

4. Buckle the belt. Make sure the release button is positioned so you would be able to unbuckle the safety belt quickly if you ever had to.



5. Pull the rest of the lap belt all the way out of the retractor to set the lock.



6. To tighten the belt, feed the lap belt into the retractor while you push down on the child restraint.

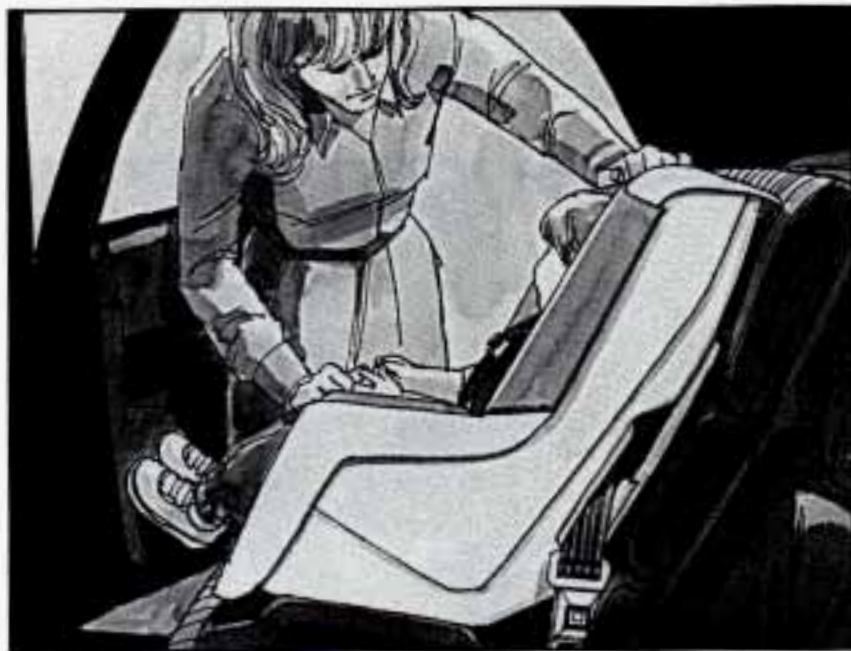

7. Push and pull the child restraint in different directions to be sure it is secure.



To remove the child restraint, just unbuckle the vehicle's safety belt and let it go back all the way. The safety belt will move freely again and be ready to work for an adult or larger child passenger.

### Securing a Child Restraint in a Center Seat Position

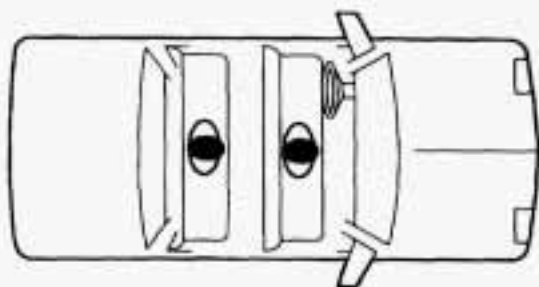

When you secure a child restraint in a center seating position, you'll be using the lap belt.



### CAUTION:

**A child in a child restraint in the front-center seat can be badly injured by the passenger air bag if it inflates. NEVER use a child restraint in the front-center seat. It's always better to secure a child restraint in the rear seat. You may, however, secure a forward-facing child restraint in the right-front passenger seat, but only with the seat moved all the way back.**

See the earlier section about the top strap if the child restraint has one.

1. Make the belt as long as possible by tilting the latch plate and pulling it along the belt.



2. Put the restraint on the seat. Follow the instructions for the child restraint.
3. Secure the child in the child restraint as the instructions say.

4. Run the vehicle's safety belt through or around the restraint. The child restraint instructions will show you how.



5. Buckle the belt. Make sure the release button is positioned so you would be able to unbuckle the safety belt quickly if you ever had to.
6. To tighten the belt, pull its free end while you push down on the child restraint.

7. Push and pull the child restraint in different directions to be sure it is secure. If the child restraint isn't secure, turn the latch plate over and buckle it again. Then see if it is secure. If it isn't, secure the restraint in a different place in the vehicle and contact the child restraint maker for their advice about how to attach the child restraint properly.

To remove the child restraint, just unbuckle the vehicle's safety belt. It will be ready to work for an adult or larger child passenger.

## Securing a Child Restraint in the Right Front Seat

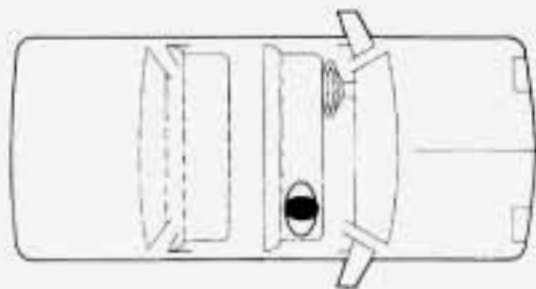

Your vehicle has a right-front passenger's air bag. NEVER put a rear-facing child restraint in this seat. Here's why:

### CAUTION:

**A rear-facing child restraint in the front seat could be pushed into the seatback by the right-front passenger's air bag if it inflates. A child in a rear-facing child restraint can be seriously injured if this happens. Always secure a rear-facing child restraint in the rear seat.**

You'll be using the lap-shoulder belt. See the earlier section about the top strap if the child restraint has one.

1. Because your vehicle has a right-front passenger's air bag, always move the seat as far back as it will go before securing a front-facing child restraint.
2. Put the restraint on the seat. Follow the instructions for the child restraint.
3. Secure the child in the child restraint as the instructions say.
4. Pick up the latch plate, and run the lap and shoulder portions of the vehicle's safety belt through or around the restraint. The child restraint instructions will show you how.



If the shoulder belt goes in front of the child's face or neck, put it behind the child restraint.



5. Buckle the belt.

Make sure the release button is positioned so you would be able to unbuckle the safety belt quickly if you ever had to.

6. Pull the rest of the lap belt all the way out of the retractor to set the lock.





7. To tighten the belt, feed the lap belt back into the retractor while you push down on the child restraint.



8. Push and pull the child restraint in different directions to be sure it is secure.

To remove the child restraint, just unbuckle the vehicle's safety belt and let it go back all the way.

The safety belt will move freely again and be ready to work for an adult or larger child passenger.

## Larger Children



Children who have outgrown child restraints should wear the vehicle's safety belts.

If you have the choice, a child should sit next to a window so the child can wear a lap-shoulder belt and get the additional restraint a shoulder belt can provide.

Accident statistics show that children are safer if they are restrained in the rear seat. But they need to use the safety belts properly.

- Children who aren't buckled up can be thrown out in a crash.



- Children who aren't buckled up can strike other people who are.





**Q:** What if a child is wearing a lap-shoulder belt, but the child is so small that the shoulder belt is very close to the child's face or neck?

**A:** Move the child toward the center of the vehicle, but be sure that the shoulder belt still is on the child's shoulder, so that in a crash the child's upper body would have the restraint that belts provide. If the child is so small that the shoulder belt is still very close to the child's face or neck, you might want to place the child in the center seat position, the one that has only a lap belt.



### **CAUTION:**

**Never do this.**

Here two children are wearing the same belt. The belt can't properly spread the impact forces. In a crash, the two children can be crushed together and seriously injured. A belt must be used by only one person at a time.



**⚠ CAUTION:**

**Never do this.**

**Here a child is sitting in a seat that has a lap-shoulder belt, but the shoulder part is behind the child. If the child wears the belt in this way, in a crash the child might slide under the belt. The belt's force would then be applied right on the child's abdomen. That could cause serious or fatal injuries.**

Wherever the child sits, the lap portion of the belt should be worn low and snug on the hips, just touching the child's thighs. This applies belt force to the child's pelvic bones in a crash.

## Safety Belt Extender

If the vehicle's safety belt will fasten around you, you should use it.

But if a safety belt isn't long enough to fasten, your dealer will order you an extender. It's free. When you go in to order it, take the heaviest coat you will wear, so the extender will be long enough for you. The extender will be just for you, and just for the seat in your vehicle that you choose. Don't let someone else use it, and use it only for the seat it is made to fit. To wear it, just attach it to the regular safety belt.

## Checking Your Restraint Systems

Now and then, make sure all your belts, buckles, latch plates, retractors, anchorages and reminder systems are working properly. Look for any loose parts or damage. If you see anything that might keep a restraint system from doing its job, have it repaired.



## Replacing Safety Belts After a Crash

If you've had a crash, do you need new belts?

After a very minor collision, nothing may be necessary. But if the belts were stretched, as they would be if worn during a more severe crash, then you need new belts.

If belts are cut or damaged, replace them. Collision damage also may mean you will need to have safety belt or seat parts repaired or replaced. New parts and repairs may be necessary even if the belt wasn't being used at the time of the collision.

If your seat adjuster won't work after a crash, the special part of the safety belt that goes through the seat to the adjuster may need to be replaced.

**Q:** What's wrong with this?

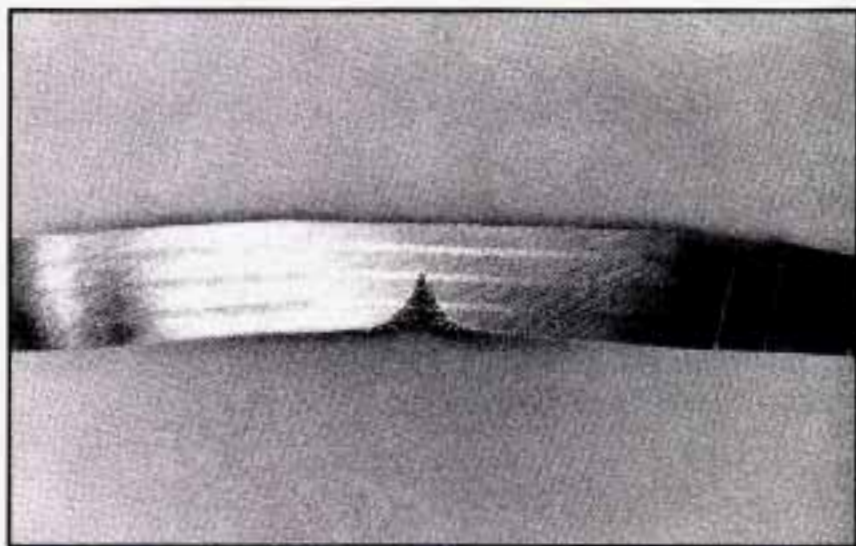

**A:** The belt is torn.

Torn or frayed belts may not protect you in a crash. They can rip apart under impact forces. If a belt is torn or frayed, get a new one right away.



## Part 2 Features and Controls

Here you can learn about the many standard and optional features on your Buick, and information on starting, shifting and braking. Also explained are the instrument panel and the warning systems that tell you if everything is working properly -- and what to do if you have a problem.

### Part 2 includes:

Keys .....	64
Door Locks .....	65
New Vehicle Break-In .....	79
Starting the Engine .....	81
Shifting the Transaxle .....	83
Windows .....	93
Tilt Steering Wheel .....	93
Turn Signal/Headlight Beam Lever .....	94
Headlight High-Low Beam Changer .....	96
Windshield Wiper/Washer .....	96
Cruise Control .....	98
Headlights .....	103
Mirrors .....	108
Instrument Panel .....	119
Speedometer and Odometer .....	119
Warning Lights, Gages and Indicators .....	120

## Keys

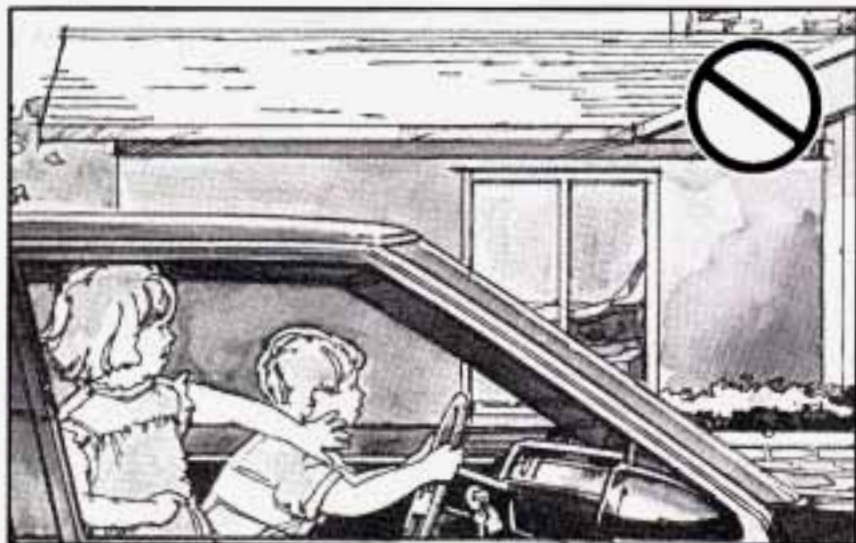

### CAUTION:

Leaving young children in a vehicle with the ignition key is dangerous for many reasons. A child or others could be badly injured or even killed.

They could operate power windows or other controls or even make the vehicle move. Don't leave the keys in a vehicle with young children.



The ignition keys are for the ignition only.



The door keys are for the doors and all other locks.



When a new Park Avenue is delivered, the dealer removes the plugs from the keys, and gives them to the first owner. However, if the ignition key does not have a plug, there may be a bar-coded key tag instead.

Each plug has a code on it that tells your dealer or a qualified locksmith how to make extra keys. Keep the plugs in a safe place. If you lose your keys, you'll be able to have new ones made easily using these plugs. If your ignition keys don't have plugs, go to your Buick dealer for the correct key code if you need a new ignition key.

### **NOTICE:**

Your Buick has a number of new features that can help prevent theft. But you can have a lot of trouble getting into your vehicle if you ever lock your keys inside. You may even have to damage your vehicle to get in. So be sure you have extra keys.

## **Key Reminder Warning**

If you leave your keys in the ignition, you will hear a warning tone when you turn off the ignition and open the driver's door.

## **Door Locks**



### **CAUTION:**

**Unlocked doors can be dangerous.**

**Passengers -- especially children -- can easily open the doors and fall out. When a door is locked, the inside handle won't open it.**

**Outsiders can easily enter through an unlocked door when you slow down or stop your vehicle.**

**This may not be so obvious. You increase the chance of being thrown out of the vehicle in a crash if the doors aren't locked. Wear safety belts properly, lock your doors, and you will be far better off whenever you drive your vehicle.**

There are several ways to lock and unlock your vehicle:



From the outside: use your door key.



From the inside: to lock the door, move the lock control on the door down.

To unlock the door, move the lock control on the door up.

If your vehicle has a theft deterrent system and it is activated, unlock the doors only with the key or Remote Keyless Entry System. This will avoid setting off the alarm.

## Power Door Locks



Push a power door lock switch to lock or unlock all of the doors.

## Programmable Automatic Door Locks (Option)

Close your doors and turn on the ignition. Every time you move your shift lever out of “P” (Park) all of the doors will lock. And, every time you stop and move your shift lever into “P” (Park), your doors will unlock. If someone needs to get out while you’re not in “P” (Park), have that person use the manual or power lock. When the door is closed again, it will not lock automatically. Just use the manual or power lock to lock the door again.

You can program the automatic door lock feature to allow the doors to remain locked after you shift into “P” (Park).

To program the automatic door locks:

1. Close your doors and turn the ignition ON.
2. Keep your foot on the brake pedal.
3. Press and hold the driver’s power door **lock** switch.
4. Move your shift lever out of “P” (Park), then move the shift lever back into “P” (Park).
5. Release the **lock** switch.

Your doors will now lock when you shift out of “P” (Park), and remain locked until you use the manual or power door unlock switch.



To reprogram the door locks to lock and unlock when you shift in and out of “P” (Park) do the following:

1. Close your doors and turn the ignition ON.
2. Keep your foot on the brake pedal.
3. Press and hold the driver’s power door **unlock** switch.
4. Move the shift lever out of “P” (Park), then move the shift lever back into “P” (Park).
5. Release the **unlock** switch.

## Leaving Your Vehicle

If you are leaving the vehicle, take your keys, open your door and set the locks from inside. Then get out and close the door.

If your vehicle has a theft deterrent system, see “Universal Theft Deterrent” in the Index.

## Trunk

### Remote Trunk Release



The trunk release switch in the glove box must be ON for the TRUNK release button to work. This feature allows you to secure items in the trunk. To secure, turn OFF the TRUNK RELEASE, lock the glove box, then take the door key with you.

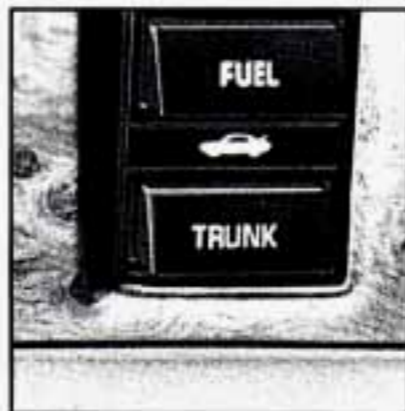

The TRUNK button is on the instrument panel to the left of the steering column. It will release the trunk lock when the transaxle is in PARK or NEUTRAL. If you have the Remote Keyless Entry System, it will also unlock your trunk.

### Automatic Pull-Down Feature (Option)

If you have this feature, it pulls the trunk lid closed. This allows you to gently push the trunk lid down and the pull-down feature then secures it completely.

#### **NOTICE:**

Do not slam your trunk lid down if you have the pull-down feature. If you do, you may damage the pull-down system.

#### **CAUTION:**

Your car may have an automatic pull down feature that helps close the trunk electronically. Your fingers can be trapped under the trunk lid as it goes down. Your fingers could be injured, and you would need someone to help you free them. Keep your fingers away from the trunk lid as you close it and as it is going down.

#### **CAUTION:**

It can be dangerous to drive with the trunk lid open because carbon monoxide (CO) gas can come into your vehicle. You can't see or smell CO. It can cause unconsciousness and even death.

**CAUTION: (Continued)**

**CAUTION: (Continued)**

If you must drive with the truck lid open or if electrical wiring or other cable connections must pass through the seal between the body and the trunk lid:

- Make sure all windows are shut.
- Turn the fan on your heating or cooling system to its highest speed with the setting on ECON. That will force outside air into your vehicle. See "Comfort Controls" in the Index.
- If you have air vents on or under the instrument panel, open them all the way. See "Engine Exhaust" in the Index.

## Remote Keyless Entry System (Option)



If your Buick has this option, you can lock and unlock your doors or unlock your trunk from up to 30 feet (9 m) away using the key chain transmitter supplied with your vehicle.

Your Remote Keyless Entry System operates on a radio frequency subject to Federal Communications Commission (FCC) Rules.



This device complies with Part 15 of the FCC Rules. Operation is subject to the following two conditions:  
(1) This device may not cause harmful interference, and  
(2) This device must accept any interference received, including interference that may cause undesired operation.

Should interference to this system occur, try this:

- Check to determine if battery replacement is necessary. See the instructions on battery replacement.
- Check the distance. You may be too far from your vehicle. This product has a maximum range.
- Check the location. Other vehicles or objects may be blocking the signal.
- See your Buick dealer or a qualified technician for service.

Changes or modifications to this system by other than an authorized service facility could void authorization to use this equipment.

## **Operation**

The driver's door will unlock automatically when UNLOCK is pressed. If quickly pressed again, all doors will unlock. All doors will lock when LOCK is pressed.

The trunk will unlock when the opened trunk symbol is pressed, but only when the ignition is off.

## **Illuminated Entry System**

If your Buick also has this option, the key tag will make it work. Touch any button on the key tag to light up the door locks and the inside of your car. The lights will stay on for 15 to 30 seconds.

## **Theft Deterrent System**

If your Buick also has this option, the key tag will arm it whenever the doors are closed and you push the LOCK button. It will disarm the system when you push UNLOCK.

## **Matching Transmitter(s) To Your Vehicle**

Each key chain transmitter is coded to prevent another transmitter from unlocking your vehicle. If a transmitter is lost or stolen, a replacement can be purchased through your dealer. Remember to bring the remaining transmitters with you when you go to your dealer. When the dealer matches the replacement transmitter to your vehicle, the remaining transmitters must also be matched. Once the new transmitter is coded, the lost transmitter will not unlock your vehicle.

You can match a transmitter to as many different vehicles as you own, provided they are equipped with exactly the same model system. (General Motors offers several different models of these systems on their vehicles.) Each vehicle can have only two transmitters matched to it.

To match a transmitter, use the following instructions.

1. Have both transmitters that will be matched to the car present, even if only one is new. Remove the car keys from the ignition and have them with you.
2. Find the 16 pin diagnostic connector above the accelerator pedal.

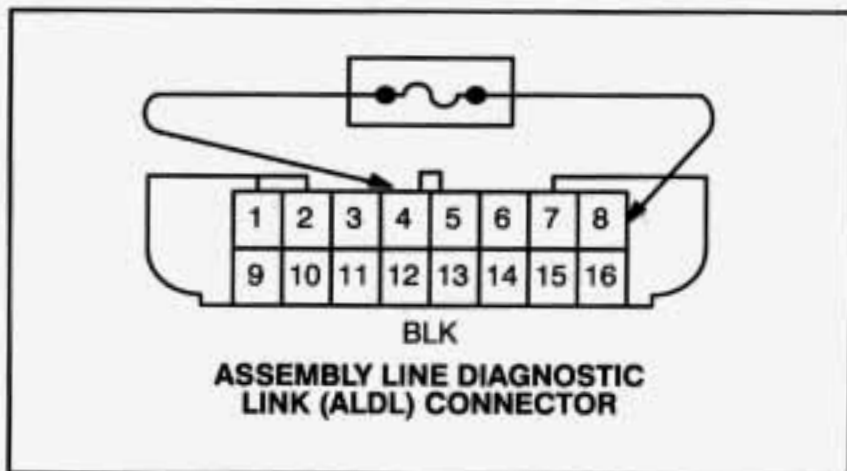

3. Use a jumper wire with alligator clips at both ends to ground (Terminal 4) to program (Terminal 8). Grounding the program terminal erases the system memory and causes the doors to lock and unlock once. This means the system is ready to be matched to the transmitter.
4. Keeping the program terminal grounded, press the UNLOCK button on the first transmitter. The door locks will lock and unlock again to indicate the transmitter is now matched. If there is no response, check the transmitter batteries. If you do not want to match a second transmitter, proceed to Step 6.
5. Still keeping the program terminal grounded, repeat Step 4 with the second transmitter. If you disconnect the ground wire before completing this step, only the first transmitter is matched. If you make a mistake, disconnect the jumper wire and start over at Step 3.
6. Remove the jumper wire. (Note: The system will not operate if the jumper wire is still connected.)
7. Test the operation of both transmitters with the vehicle.

If the lock control does not work as it should, see your Buick dealer.

## Battery Replacement

Under normal use, the batteries in your key chain transmitter should last about two years.

You can tell the batteries are weak if the transmitter won't work at the normal range in any location. If you have to get close to your vehicle before the transmitter works, it's probably time to change the batteries.



For battery replacement, use two Duracell<sup>®</sup> batteries, type DL-2016, or a similar type.

To replace the batteries:

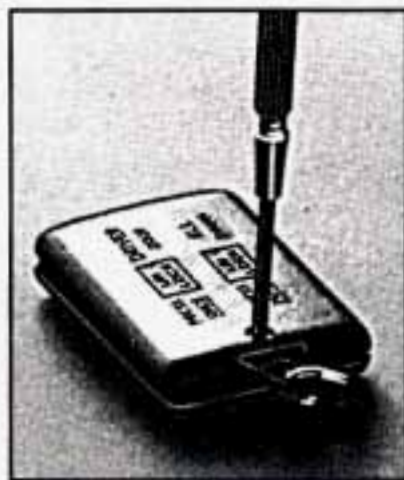

1. Remove the screw from the back cover.
2. Lift off the front cover, bottom half first.

3. Remove and replace the batteries. Put them in as the instructions under the batteries indicate.
4. Replace the front cover. Make sure the cover is on tightly, so water won't get in. Replace the screw in the back cover.



## Rear Door Security Lock

Your Buick is equipped with rear door security locks that help prevent passengers from opening the rear doors of your car from the inside. To use one of these locks:



1. Open one of the rear doors.
2. Move the lever all the way up.
3. Close the door.
4. Do the same thing to the other rear door lock.

The rear doors of your vehicle cannot be opened from inside when this feature is in use. If you want to open a rear door when the security lock is on:

1. Unlock the door from the inside.
2. Then open the door from the outside.

If you don't cancel the security lock feature, adults or older children who ride in the rear won't be able to open the rear door from the inside. You should let adults and older children know how these security locks work, and how to cancel the locks.

To cancel the rear door lock:

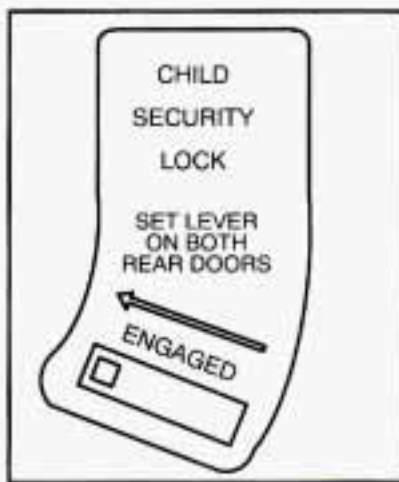

1. Unlock the door from the inside and open the door from the outside.
2. Move the lever all the way down.
3. Do the same for the other rear door.

The rear door locks will now work normally.

## Illuminated Entry System (Option)



With this option, when you push the door handle button, a light around the door lock will come on for about 25 seconds.

You'll be able to see where to put the door key when it's dark, and the lights inside your Buick will go on. They'll go off when you start your engine, or when 25 seconds have passed. If you have the Remote Keyless Entry System option, it can make the illuminated entry system work too. (See Remote Keyless Entry System in the Index.)

If you have this option, your interior lights will automatically shut off after a 10 minute period if a door is left ajar. This feature is designed to help eliminate battery wear down.

## Theft

Vehicle theft is big business, especially in some cities. Although your Buick has a number of theft deterrent features, we know that nothing we put on it can make it impossible to steal. However, there are ways you can help.

### Key in the Ignition

If you walk away from your vehicle with the keys inside, it's an easy target for joy riders or professional thieves -- so don't do it.

When you park your Buick and open the driver's door, you'll hear a chime reminding you to remove your key from the ignition and take it with you. Always do this. Your steering wheel will be locked, and so will your ignition and transaxle. And remember to lock the doors.

### Parking at Night

Park in a lighted spot, close all windows and lock your vehicle. Remember to keep your valuables out of sight. Put them in a storage area, or take them with you.

## Parking Lots

If you park in a lot where someone will be watching your vehicle, it's best to lock it up and take your keys. But what if you have to leave your ignition key? What if you have to leave something valuable in your vehicle?

1. Put your valuables in a storage area, like your trunk or glove box.
2. Lock the glove box.
3. Lock all the doors except the driver's.
4. Then take the door key with you.

## Universal Theft Deterrent (Option)

If your Buick has this option, it has a theft deterrent alarm system. With this system, the "SECURITY" light will flash as you open the door (if your ignition is off).

This light reminds you to activate the theft deterrent system. Here's how to do it:

1. Open the door.
2. Lock the door with the power door lock switch or Remote Keyless Entry System. The "SECURITY" light should come on and stay on.

3. Close all doors. The "SECURITY" light should go off.

If a door or the trunk is opened without the key or Remote Keyless Entry System, the alarm will go off. It will also go off if a door lock or the trunk lock is damaged. Your vehicle's lights will flash and the horn will sound for several minutes, then will go off to save battery power.

Remember, the theft deterrent system won't activate if you lock the doors with a key or manual door lock. It activates only if you use a power door lock switch or Remote Keyless Entry System. You should also remember that you can start your vehicle with the correct ignition key if the alarm has been set off. You must still shut off the alarm by inserting the key in the door lock.

Here's how to avoid setting off the alarm by accident:

1. If you don't want to activate the theft deterrent system, the vehicle should be locked **after** the doors are closed.
2. Always unlock a door with a key, or use the Remote Keyless Entry System. Unlocking a door any other way will set off the alarm.



If you set off the alarm by accident, unlock any door with your key.

You can also turn off the alarm by using the Keyless Entry System, if you have it. The alarm won't stop if you try to unlock a door any other way.

## How to Test The Alarm

The alarm can be tested by first having the driver's window down. Activate the system by locking the doors with the power door lock switch or the Remote Keyless Entry System. Get out of the car and close the door and wait for the SECURITY light to go out. Then reach in through the window, unlock the door with the manual door lock, and open the door. This should set off the alarm.

If the alarm does not sound when it should, check to see if the horn works. The horn fuse may be blown. To replace the fuse, see "Fuses and Circuit Breakers" in the Index.

To reduce the possibility of theft, always activate the theft deterrent system when leaving your vehicle.

## PASS-Key® II



Your vehicle is equipped with the PASS-Key® II (Personalized Automotive Security System) theft deterrent system. PASS-Key® II is a passive theft deterrent system. This means you don't have to do anything different to arm or disarm the system. It works when you insert or remove the key from the ignition. PASS-Key® II uses a resistor pellet in the ignition key that matches a decoder in your vehicle.

When the PASS-Key® II system senses that someone is using the wrong key, it shuts down the vehicle's starter and fuel systems. For about three minutes, the starter won't work and fuel won't go to the engine. If someone tries to start your vehicle again or uses another key during this time, the vehicle will not start. This discourages someone from randomly trying different keys with different resistor pellets in an attempt to make a match.

The ignition key must be clean and dry before it's inserted in the ignition or the engine may not start. If the engine does not start and the "SECURITY" light comes on, the key may be dirty or wet. Turn the ignition off.

Clean and dry the key. Wait about three minutes and try again. The security light may remain on during this time. If the starter still won't work, and the key appears to be clean and dry, wait about three minutes and try the other ignition key. At this time, you may also want to check the fuse (see "Fuses and Circuit Breakers" in the Index). If the starter won't work with the other key, your

vehicle needs service. If your vehicle does start, the first ignition key may be faulty. See your Buick dealer or a locksmith who can service the PASS-Key® II.

If you accidentally use a key that has a damaged or missing resistor pellet, the starter won't work and the "SECURITY" light will flash. But you don't have to wait three minutes before trying one of the other ignition keys.

See your Buick dealer or a locksmith who can service the PASS-Key® II to have a new key made.

If you're ever driving and the "SECURITY" light comes on and stays on, you will be able to restart your engine if you turn it off. Your PASS-Key® II system, however, is not working properly and must be serviced by your Buick dealer. Your vehicle is not protected by the PASS-Key® II system.

If you lose or damage a PASS-Key® II ignition key, see your Buick dealer or a locksmith who can service PASS-Key® II to have a new key made.

## New Vehicle “Break-In”

### **NOTICE:**

Your modern Buick doesn't need an elaborate “break-in.” But it will perform better in the long run if you follow these guidelines:

1. Don't drive at any one speed -- fast or slow -- for the first 500 miles (804 km). Don't make full-throttle starts.
2. Avoid making hard stops for the first 200 miles (322 km) or so. During this time your new brake linings aren't yet broken in. Hard stops with new linings can mean premature wear and earlier replacement. Follow this “breaking-in” guideline every time you get new brake linings.

## Ignition Key Positions



Your square-headed key operates your ignition lock.



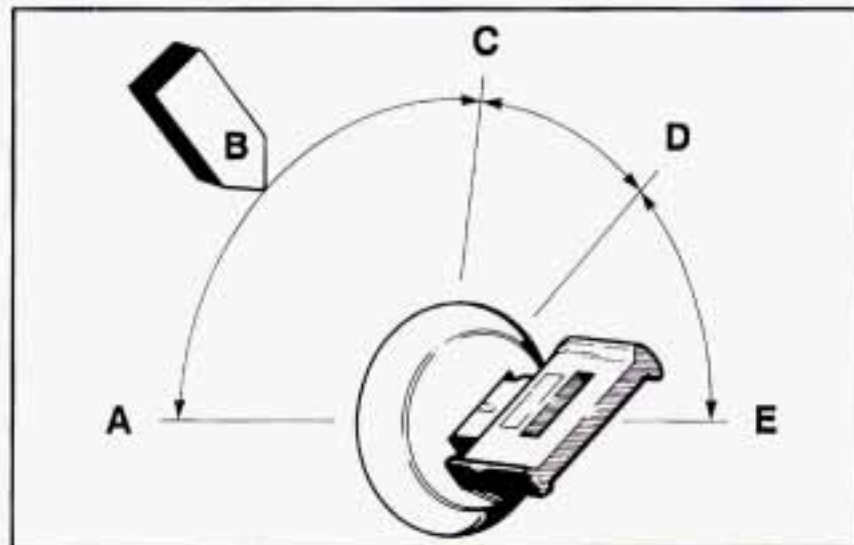

With the ignition key in the ignition switch, you can turn the switch to five different positions:

**(A) Accessory:** This position lets you use things like the radio and the windshield wipers when the engine is off. To use, push in the key and turn it toward you. Your steering wheel will remain locked, just as it was before you inserted the key.

**(B) Lock:** Before you put the key in, your ignition will be in the Lock position. This position locks your ignition, steering wheel and transaxle. It's a theft deterrent feature.

**(C) Off:** This position lets you turn off the engine but still turn the steering wheel. It doesn't lock the steering wheel like Lock. Use "Off" if you must have your car in motion while the engine is off.

**(D) Run:** This is the position for driving.

**(E) Start:** This key position starts your engine.

## NOTICE:

If your key seems stuck in "Lock" and you can't turn it, be sure it is all the way in. If it is, then turn the steering wheel left and right while you turn the key hard. But turn the key only with your hand. Using a tool to force it could break the key or the ignition switch. If none of this works, then your vehicle needs service.

## Retained Accessory Power (Option)

After the ignition is turned off, and before any door is opened, the following systems will work for ten minutes:

- Power Windows
- Radio
- Optional Astrorooft

## Starting Your Engine

Move your shift lever to "P" (Park) or "N" (Neutral). Your engine won't start in any other position -- that's a safety feature. To restart when you're already moving, use "N" (Neutral) only.

### **NOTICE:**

**Don't try to shift to "P" (Park) if your Buick is moving. If you do, you could damage the transaxle. Shift to "P" (Park) only when your vehicle is stopped.**

1. Without pushing the accelerator pedal, turn your ignition key to "Start." When the engine starts, let go of the key. The idle speed will go down as your engine gets warm.

### **NOTICE:**

**Holding your key in "Start" for longer than 15 seconds at a time will cause your battery to be drained much sooner. And the excessive heat can damage your starter motor.**

2. If it doesn't start right away, hold your key in "Start" for about three to five seconds at a time until your engine starts. Wait about 15 seconds between each try to help avoid draining your battery.

3. If your engine still won't start (or starts but then stops), it could be flooded with too much gasoline. Try pushing your accelerator pedal all the way to the floor and holding it there as you hold the key in "Start" for about three seconds. If the car starts briefly but then stops again, do the same thing, but this time keep the pedal down for five or six seconds. This clears the extra gasoline from the engine. After waiting about 15 seconds, repeat the normal starting procedure.

### **NOTICE:**

**Your engine is designed to work with the electronics in your vehicle. If you add electrical parts or accessories, you could change the way the fuel injection system operates. Before adding electrical equipment, check with your dealer. If you don't, your engine might not perform properly.**

**If you ever have to have your vehicle towed, see the part of this manual that tells how to do it without damaging your vehicle. See "Towing Your Car" in the Index.**

## **Driving Through Deep Standing Water**

### **NOTICE:**

**If you drive too quickly through deep puddles or standing water, water can come in through your engine's air intake and badly damage your engine. If you can't avoid deep puddles or standing water, drive through them very slowly.**

## **Engine Coolant Heater (Engine Block Heater) (Canada Only)**

In very cold weather, 0°F (-18°C) or colder, the engine coolant heater can help. You'll get easier starting and better fuel economy during engine warm-up. Usually, the coolant heater should be plugged in a minimum of four hours prior to starting your vehicle.

To use the coolant heater:

1. Turn off the engine.
2. Open the hood and unwrap the electrical cord.
3. Plug it into a normal, grounded 110-volt outlet.



## CAUTION:

Plugging the cord into an ungrounded outlet could cause an electrical shock. Also, the wrong kind of extension cord could overheat and cause a fire. You could be seriously injured. Plug the cord into a properly grounded three-prong 110-volt outlet. If the cord won't reach, use a heavy-duty three-prong extension cord rated for at least 15 amps.

## NOTICE:

After you've used the coolant heater, be sure to store the cord as it was before to keep it away from moving engine parts. If you don't, it could be damaged.

How long should you keep the coolant heater plugged in? The answer depends on the weather, the kind of oil you have, and some other things. Instead of trying to list everything here, we ask that you contact a Buick dealer in the area where you'll be parking your vehicle. The dealer can give you the best advice for that particular area.

## Automatic Transaxle



There are several different positions for your shift lever.

- **P (Park)**

This locks your front wheels. It's the best position to use when you start your engine because your vehicle can't move easily.

 **CAUTION:**

It is dangerous to get out of your vehicle if the shift lever is not fully in "P" (Park) with the parking brake firmly set. Your vehicle can roll.

Don't leave your vehicle when the engine is running unless you have to. If you have left the engine running, the vehicle can move suddenly. You or others could be injured. To be sure your vehicle won't move, when you're on fairly level ground, always set your parking brake and move the shift lever to "P" (Park).

See "Shifting Into "P" (Park)" in the Index. If you're pulling a trailer, see "Towing a Trailer" in the Index.

Ensure the shift lever is fully in "P" (Park) range before starting the engine. Your Buick has a brake-transaxle shift interlock. You have to fully **apply** your regular brakes **before** you can shift from "P" (Park) when the ignition key is in the "Run" position. If you cannot shift out of "P" (Park), ease pressure on the shift lever - push

the shift lever all the way into "P" (Park) as you maintain brake application. Then move the shift lever into the gear you wish. See "Shifting Out of 'P' (Park)" in this part.

- **R (Reverse)**

Use this gear to back up.

**NOTICE:**

Shifting to "R" (Reverse) while your vehicle is moving forward could damage your transaxle. Shift to "R" only after your vehicle is stopped.

To rock your vehicle back and forth to get out of snow, ice or sand without damaging your transaxle, see "If You're Stuck in Sand, Mud, Ice or Snow" in the Index.

- **N (Neutral)**

In this position, your engine doesn't connect with the wheels. To restart when you're already moving, use "N" (Neutral) only. Also, use "N" when your vehicle is being towed.



## CAUTION:

Shifting out of "P" (Park) or "N" (Neutral) while your engine is "racing" (running at high speed) is dangerous. Unless your foot is firmly on the brake pedal, your vehicle could move very rapidly. You could lose control and hit people or objects. Don't shift out of "P" (Park) or "N" (Neutral) while your engine is racing.

## NOTICE:

Damage to your transaxle caused by shifting out of "P" (Park) or "N" (Neutral) with the engine racing isn't covered by your warranty.

- **Ⓓ Automatic Overdrive**

This position is for normal driving. If you need more power for passing, and you're:

- Going less than about 35 mph (56 km/h), push your accelerator pedal about halfway down.
- Going about 35 mph (56 km/h) or more, push the accelerator all the way down.

You'll shift down to the next gear and have more power.

- **D or 3 (Third Gear)**

This is like Ⓓ, but you never go into Overdrive.

Here are some times you might choose "D or 3" instead of Ⓓ:

- When driving on hilly, winding roads
- When towing a trailer, so there is less shifting between gears
- When going down a steep hill

- **2 (Second Gear)**

This position gives you more power but lower fuel economy. You can use "2" on hills. It can help control your speed as you go down steep mountain roads, but then you would also want to use your brakes off and on.



## **NOTICE:**

**Don't drive in "2" (Second Gear) for more than 5 miles (8 km), or at speeds over 55 mph (88 km/h), or you can damage your transaxle. Use "D" or "D" or 3" as much as possible.**

**Don't shift into "2" unless you are going slower than 65 mph (105 km/h), or you can damage your engine.**

- **1 (First Gear)**

This position gives you even more power (but lower fuel economy) than "2." You can use it on very steep hills, or in deep snow or mud. If the selector lever is put in "1," the transaxle won't shift into first gear until the vehicle is going slowly enough.

## **NOTICE:**

**If your front wheels can't rotate, don't try to drive. This might happen if you were stuck in very deep sand or mud or were up against a solid object. You could damage your transaxle.**

**Also, if you stop when going uphill, don't hold your vehicle there with only the accelerator pedal. This could overheat and damage the transaxle. Use your brakes or shift into "P" Park to hold your vehicle in position on a hill.**

## Parking Brake



**To set the parking brake:** Hold the regular brake pedal down with your right foot. Push down the parking brake pedal with your left foot. If the ignition is on, the brake system warning light will come on.

The parking brake uses the brakes on the rear wheels.

**To release the parking brake:** This vehicle has a push to release parking brake pedal. Hold the regular brake pedal down and push the parking brake pedal with your left foot. This will unlock the pedal. When you lift your left foot, the parking brake pedal will follow it to the release position.

If you try to drive off with the parking brake on, the brake light stays on and a chime sounds until you release the parking brake or recycle the ignition.

### **NOTICE:**

**Driving with the parking brake on can cause your rear brakes to overheat. You may have to replace them, and you could also damage other parts of your vehicle.**

**If you are towing a trailer and are parking on any hill:** See "Towing a Trailer" in the Index. That section shows what to do first to keep the trailer from moving.

## Shifting Into “P” (Park)

### CAUTION:

It can be dangerous to get out of your vehicle if the shift lever is not fully in “P” (Park) with the parking brake firmly set. Your vehicle can roll. If you have left the engine running, the vehicle can move suddenly. You or others could be injured. To be sure your vehicle won’t move, even when you’re on fairly level ground, use the steps that follow. If you’re pulling a trailer, see “Towing a Trailer” in the Index.

1. Hold the brake pedal down with your right foot and set the parking brake.

2. Move the shift lever into “P” (Park) position like this:



- Pull the lever toward you.



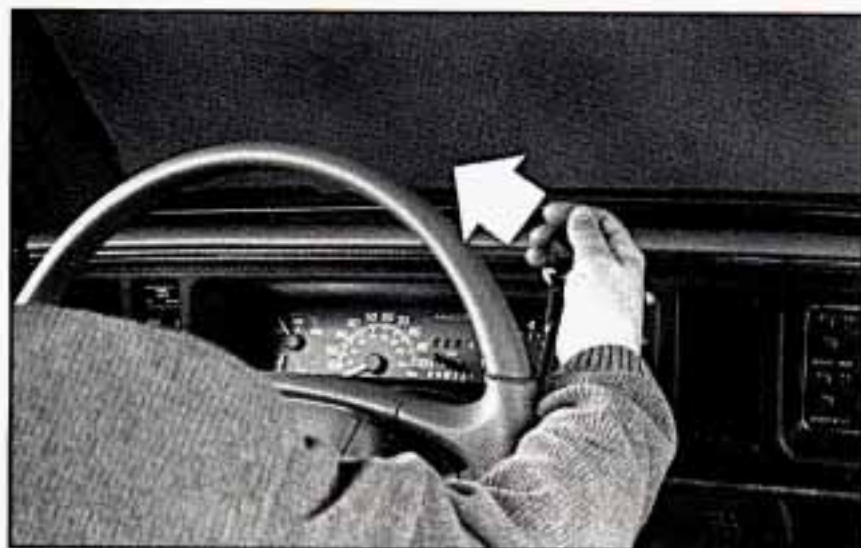

- Move the lever up as far as it will go.
- 3. Move the ignition key to "Lock."
- 4. Remove the key and take it with you. If you can walk away from your vehicle with the ignition key in your hand, your vehicle is in "P" (Park).

## Leaving Your Vehicle With the Engine Running

### CAUTION:

It can be dangerous to leave your vehicle with the engine running. Your vehicle could move suddenly if the shift lever is not fully in "P" (Park) with the parking brake firmly set. And, if you leave the vehicle with the engine running, it could overheat and even catch fire. You or others could be injured. Don't leave your vehicle with the engine running unless you have to.

If you have to leave your vehicle with the engine running, be sure your vehicle is in "P" (Park) and your parking brake is firmly set before you leave it. After you've moved the shift lever into the "P" (Park) position, hold the regular brake pedal down. Then, see if you can move the shift lever away from "P" (Park) without first pulling it toward you. If you can, it means that the shift lever wasn't fully locked into "P" (Park).

## Torque Lock

If you are parking on a hill and you don't shift your transaxle into "P" (Park) properly, the weight of the vehicle may put too much force on the parking pawl in the transaxle. You may find it difficult to pull the shift lever out of "P" (Park). This is called "torque lock." To prevent torque lock, set the parking brake and then shift into "P" (Park) properly before you leave the driver's seat. To find out how, see "Shifting Into 'P' (Park)" in the Index.

When you are ready to drive, move the shift lever out of "P" (Park) BEFORE you release the parking brake.

If "torque lock" does occur, you may need to have another vehicle push yours a little uphill to take some of the pressure from the transaxle, so you can pull the shift lever out of "P" (Park).

## Shifting Out of "P" (Park)

Your Buick has a brake-transaxle shift interlock. You have to fully **apply** your regular brake **before** you can shift from "P" (Park) when the ignition is in the "Run" position. See "Automatic Transaxle" in the Index.

If you cannot shift out of "P" (Park), ease pressure on the shift lever -- push the shift lever all the way into "P" (Park) as you maintain brake application. Then move the shift lever into the gear you want. If you ever hold the brake pedal down but still can't shift out of "P" (Park), try this:

1. Turn the key to "Off." Open and close the driver's door to turn off the Retained Accessory Power feature, if you have it.
2. Apply and hold the brake until the end of Step 4.
3. Shift to "N" (Neutral).
4. Start the vehicle and then shift to the drive gear you want.
5. Have the vehicle fixed as soon as you can.



## Parking Over Things That Burn



### CAUTION:

Things that can burn could touch hot exhaust parts under your vehicle and ignite. Don't park over papers, leaves, dry grass or other things that can burn.

## Engine Exhaust

### CAUTION:

Engine exhaust can kill. It contains the gas carbon monoxide (CO), which you can't see or smell. It can cause unconsciousness and death.

You might have exhaust coming in if:

- Your exhaust system sounds strange or different.
- Your vehicle gets rusty underneath.
- Your vehicle was damaged in a collision.
- Your vehicle was damaged when driving over high points on the road or over road debris.
- Repairs weren't done correctly.
- Your vehicle or exhaust system had been modified improperly.

If you ever suspect exhaust is coming into your vehicle:

- Drive it only with all the windows down to blow out any CO; and
- Have your vehicle fixed immediately.



## Running Your Engine While You're Parked

It's better not to park with the engine running. But if you ever have to, here are some things to know.

### CAUTION:

Idling the engine with the air system control off could allow dangerous exhaust into your vehicle. (See the earlier caution under "Engine Exhaust".)

Also, idling in a closed-in place can let deadly carbon monoxide (CO) into your vehicle even if the fan switch is at the highest setting. One place this can happen is a garage. Exhaust -- with CO -- can come in easily. NEVER park in a garage with the engine running.

Another closed-in place can be a blizzard. (See "Blizzard" in the Index.)

### CAUTION:

It can be dangerous to get out of your vehicle if the shift lever is not fully in "P" (Park) with the parking brake firmly set. Your vehicle can roll. Don't leave your vehicle when the engine is running unless you have to. If you've left the engine running, the vehicle can move suddenly. You or others could be injured. To be sure your vehicle won't move, even when you're on fairly level ground, always set your parking brake and move the shift lever to "P" (Park).

Follow the proper steps to be sure your vehicle won't move. See "Shifting Into 'P' (Park)" in the Index.

If you are parking on a hill and if you're pulling a trailer, also see "Towing a Trailer" in the Index.

## Power Windows



Your power window controls are on the armrest. The switch for the driver's window has an express-down feature. Pull the switch back all the way, release it and the window will lower automatically. To stop the window from lowering, push the switch forward. To partially open the window, pull the switch back and quickly release it.

You may also have a lock out button. Push LOCK to disable the power window switches. This will prevent passengers from opening and closing the windows. The

driver can still control all the windows with the switch in the locked position. Push UNLOCK to allow your passengers to use their window switches again.

## Horn

To sound the horn, press a pad with the horn symbol on either side of the steering wheel.

## Tilt Wheel



A tilt steering wheel allows you to adjust the steering wheel before you drive.

You can also raise it to the highest level to give your legs more room when you exit and enter the vehicle.

To tilt the wheel, hold the steering wheel and pull the lever toward you. Move the steering wheel to a comfortable position, then release the lever to lock the wheel in place.

## The Turn Signal/Headlight Beam Lever

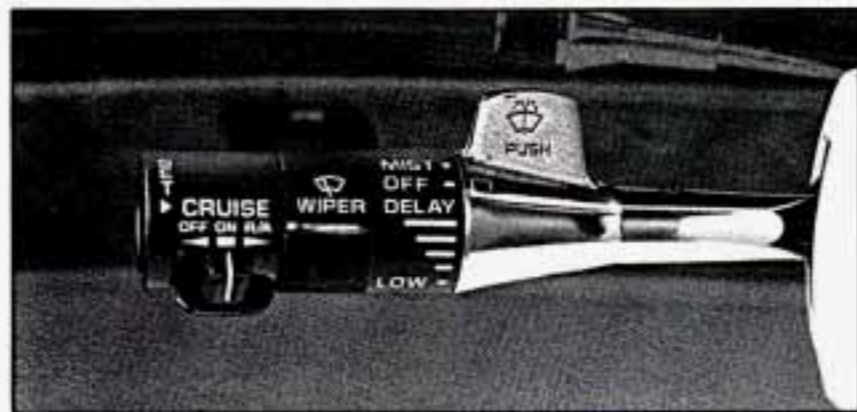

The lever on the left side of the steering column includes your:

- Turn Signal and Lane Change Indicator
- Headlight High-Low Beam & Passing Signal
- Windshield Wipers
- Windshield Washer
- Cruise Control

## Turn Signal and Lane Change Indicator

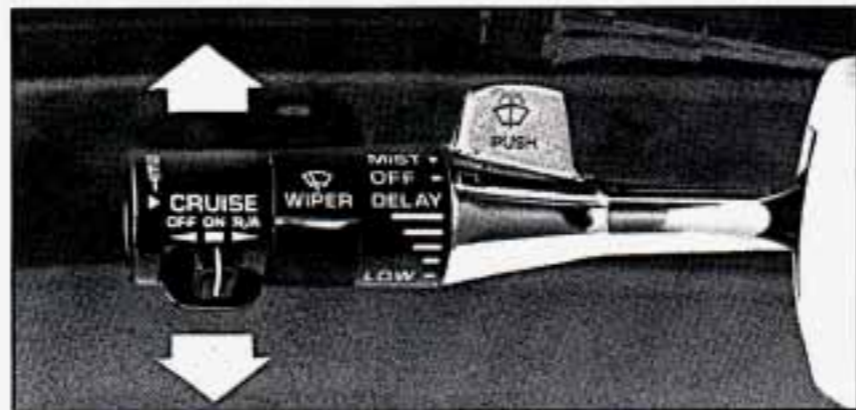

The turn signal has two upward (for right) and two downward (for left) positions. These positions allow you to signal a turn or a lane change.

To signal a turn, move the lever all the way up or down. When the turn is finished, the lever will return automatically.



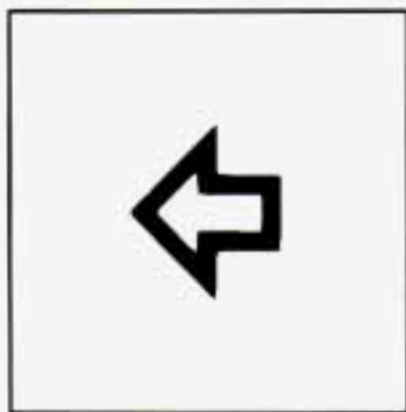

A green arrow on the instrument panel will flash in the direction of the turn or lane change.

To signal a lane change, just raise or lower the lever until the green arrow starts to flash. Hold it there until you complete your lane change. The lever will return by itself when you release it.

As you signal a turn or a lane change, if the arrows don't flash but just stay on, a signal bulb may be burned out and other drivers won't see your turn signal.

If a bulb is burned out, replace it to help avoid an accident. If the green arrows don't go on at all when you signal a turn, check the fuse (see "Fuses" in the Index) and for burned-out bulbs.

If you have a trailer towing option with added wiring for the trailer lights, a different turn signal flasher is used. With this flasher installed, the signal indicator will flash even if a turn signal bulb is burned out. Check the front and rear turn signal lights regularly to make sure they are working.

## Operation of Lights

Although your vehicle's lighting system (headlights, parking lights, fog lamps, side marker lights and taillights) meets all applicable federal lighting requirements, certain states and provinces may apply their own lighting regulations that may require special attention before you operate these lights.

For example, some jurisdictions may require that you operate your fog lamps only when your lower beam lights are also on, or that headlights be turned on whenever you must use your windshield wipers. In addition, most jurisdictions prohibit driving solely with parking lights, especially at dawn or dusk. It is recommended that you check with your own state or provincial highway authority for applicable lighting regulations.

## Headlight High-Low Beam



To change the headlights from low beam to high or high to low, pull the turn signal lever toward you. Then release it. When the high beams are on, this blue light on the instrument panel also will be on.

## Windshield Wipers

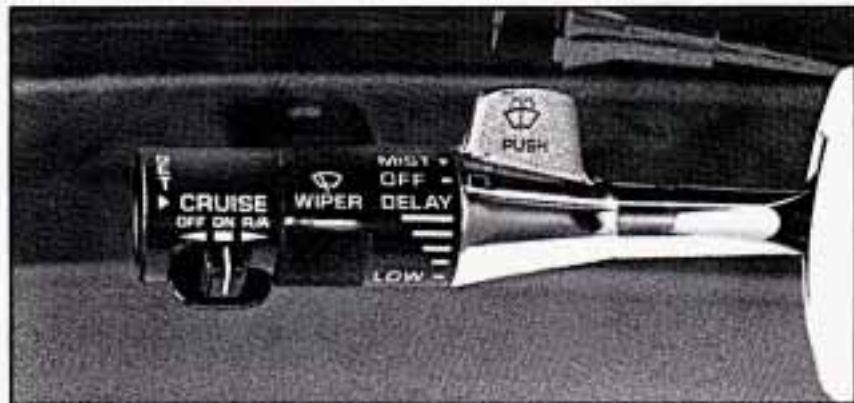

You control the windshield wipers by turning the band marked "WIPER."

For a single wiping cycle, turn the band to "MIST." Hold it there until the wipers start, then let go. The wipers will stop after one cycle. If you want more cycles, hold the band on "MIST" longer.

You can set the wiper speed for a long or short delay between wipes. This can be very useful in light rain or snow. Turn the band to choose the delay time. The closer to "LOW," the shorter the delay.

For steady wiping at low speed, turn the band away from you to the "LOW" position. For high speed wiping, turn the band further, to "HIGH." To stop the wipers, move the band to "OFF."

Remember that damaged wiper blades may prevent you from seeing well enough to drive safely. To avoid damage, be sure to clear ice and snow from the wiper blades before using them. If they're frozen to the windshield, carefully loosen or thaw them. If your blades become damaged, get new blades or blade inserts.

Heavy snow or ice can overload your wiper motor. A circuit breaker will stop the motor until it cools. Clear away snow or ice to prevent an overload.

## Windshield Washer

At the top of the multifunction lever there's a paddle with the word "PUSH" on it. To spray washer fluid on the windshield, push the paddle for less than a second. The washer will spray several times, then stop. Unless they are already turned on, the wipers will operate at low speed for several sweeps, then turn off.

To get more fluid on the windshield, push and hold the paddle. Spraying will continue as long as the paddle is held.

**WASHER  
FLUID LOW**

If this light comes on, it means you're low on washer fluid.

Driving without washer fluid can be dangerous. A bad mud splash can block your vision. You could hit another vehicle or go off the road. Check your washer fluid level often.



### **CAUTION:**

**In freezing weather, don't use your washer until the windshield is warmed. Otherwise the washer fluid can form ice on the windshield, blocking your vision.**



## NOTICE:

- When using concentrated washer fluid, follow the manufacturer's instructions for adding water.
- Don't mix water with ready-to use washer fluid. Water can cause the solution to freeze and damage your washer fluid tank and other parts of the washer system. Also, water doesn't clean as well as washer fluid.
- Fill your washer fluid tank only 3/4 full when it's very cold. This allows for expansion, which could damage the tank if it is completely full.
- Don't use radiator antifreeze in your windshield washer. It can damage your paint.

## Cruise Control



With Cruise Control, you can maintain a speed of about 25 mph (40 km/h) or more without keeping your foot on the accelerator. This can really help on long trips. Cruise Control does not work at speeds below about 25 mph (40 km/h).

When you apply your brakes, the Cruise Control shuts off.

## CAUTION:

- Cruise Control can be dangerous where you can't drive safely at a steady speed. So, don't use your Cruise Control on winding roads or in heavy traffic.
- Cruise Control can be dangerous on slippery roads. On such roads, fast changes in tire traction can cause needless wheel spinning, and you could lose control. Don't use Cruise Control on slippery roads.

## To Set Cruise Control

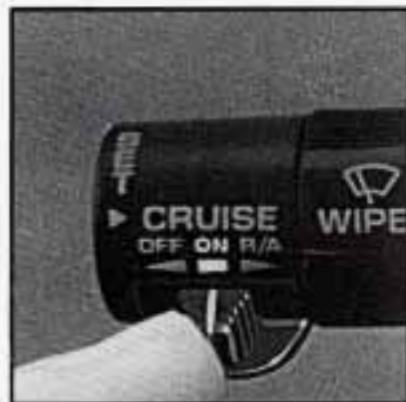

1. Move the Cruise Control switch to "ON."

## CAUTION:

If you leave your Cruise Control switch on when you're not using Cruise, you might hit a button and go into Cruise when you don't want to. You could be startled and even lose control. Keep the Cruise Control switch "OFF" until you want to use it.

2. Get up to the speed you want.



3. Push in the set button at the end of the lever and release it. (The "CRUISE" light on the instrument panel will come on.)
4. Take your foot off the accelerator pedal.

## To Resume a Set Speed

Suppose you set your Cruise Control at a desired speed and then you apply the brake. This, of course, shuts off the Cruise Control. But you don't need to reset it.



Once you're going about 25 mph (40 km/h) or more, you can move the Cruise Control switch from "ON" to "R/A" (Resume/Accelerate) for about half a second. You'll go right back up to your chosen speed and stay there.

Remember if you hold the switch at "Resume/Accelerate" longer than half a second, the vehicle will keep going faster until you release the switch or apply the brake. You could be startled and even lose control. So unless you want to go faster, don't hold the switch at "Resume/Accelerate."

## To Increase Speed While Using Cruise Control

There are two ways to go to a higher speed. Here's the first:

1. Use the accelerator pedal to get to the higher speed.

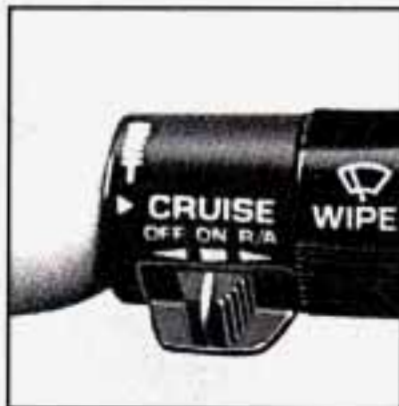

2. Push the button at the end of the lever, then release the button and the accelerator pedal. You'll now cruise at the higher speed.



Here's the second way to go to a higher speed:



1. Move the Cruise switch from "ON" to "Resume/Accelerate." Hold it there until you get up to the speed you want, and then release the switch.

2. To increase your speed in very small amounts, move the switch to "Resume/Accelerate" for less than half a second and then release it. Each time you do this, your vehicle will go about 1 mph (1.6 km/h) faster.

The accelerate feature will only work after you have set the Cruise Control speed by pushing the "SET" button.

## To Reduce Speed While Using Cruise Control

There are two ways to reduce your speed while using cruise control:

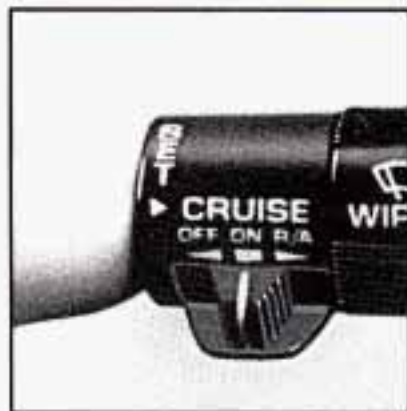

1. Push in the button at the end of the lever until you reach the lower speed you want, then release it.

2. To slow down in very small amounts, push the button for less than half a second. Each time you do this, you'll go 1 mph (1.6 km/h) slower.

## Passing Another Vehicle While Using Cruise Control

Use the accelerator pedal to increase your speed. When you take your foot off the pedal, your vehicle will slow down to the Cruise Control speed you set earlier.

## Using Cruise Control on Hills

How well your Cruise Control will work on hills depends upon your speed, load, and the steepness of the hills. When going up steep hills, you may have to step on the accelerator pedal to maintain your speed. When going downhill, you may have to brake or shift to a lower gear to keep your speed down. Of course, applying the brake takes you out of Cruise Control. Many drivers find this to be too much trouble and don't use Cruise Control on steep hills.

## To Get Out of Cruise Control

There are two ways to turn off the Cruise Control:



1. Step lightly on the brake pedal **OR**,



2. Move the Cruise switch to "OFF." (The "CRUISE" light will go out.)

## To Erase Speed Memory

When you turn off the Cruise Control or the ignition, or shift into "P" (Park), your Cruise Control set speed memory is erased.

## Lights



This switch controls these light systems:

- Headlights
- Taillights
- Parking Lights
- License Lights
- Sidemarket Lights
- Instrument Panel Lights

Press the LIGHTS switch to turn the headlights on. Press it again to turn them off.

Press the PARK switch to turn the parking lights on. Press it again to turn them off. (If the parking lights were turned on with the PARK switch, they must be turned off with that switch).

## Lights "On" Warning

If the parking light or headlight switch is left on you'll hear a warning tone when you turn the ignition off and open the driver's door.

## Panel Lights



Instrument panel light brightness can be adjusted by moving this lever between LO and HI. Interior courtesy lights can be turned on by sliding the lever all the way to the right.



## Courtesy Lights

When any door is opened, several lights go on. They make it easy for you to enter and leave the car. You also can turn these lights on by sliding the panel lights lever to INT (interior).

## Time Out Feature

The interior lights will automatically shut off after a 10 minute period if a door is left open. This feature is designed to help eliminate battery wear down.

## Twilight Sentinel (Option)

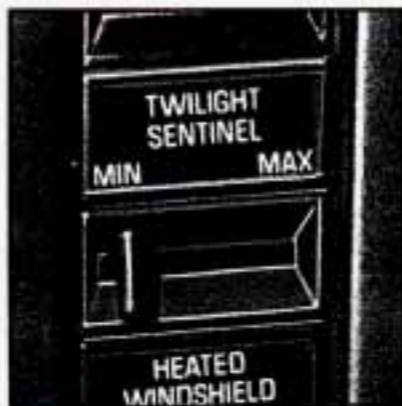

Twilight Sentinel turns your lights on and off by sensing how dark it is outside.

To operate it, leave the light switch off and move the Twilight Sentinel control to any position but MIN.

If you move the control all the way to MAX, your lights will remain on for three minutes after you turn off your engine. If you move the control almost all the way in the other direction, so it's just on, the lights will go off quickly when you turn off your engine. You can change this delay time from only a few seconds to three minutes.

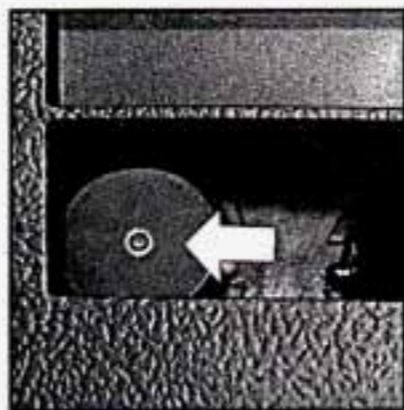

Please don't cover the light sensor. If you cover the sensor, it will read "dark" and your lights will come on. It is on top of the instrument panel, on the driver's side of the defroster outlets.

## Daytime Running Lights (Canada Only)

The Canadian Federal Government has decided that “Daytime Running Lights” (DRL) are a useful feature, in that DRL can make your vehicle more visible to pedestrians and other drivers during daylight hours. DRL are required on new vehicles sold in Canada.

Your DRL works with a light sensor on top of the instrument panel. Don't cover it up.

The low beam headlights will come on at reduced brightness in daylight when:

- The ignition is on,
- The headlight switch is off and,
- The transaxle is not in “P” (Park).

At dusk, if the Twilight Sentinel feature is turned on, the exterior lights will come on automatically and the low beams will change to full brightness. At dawn, the exterior lights will go out and the low beams will change to the reduced brightness of DRL (if the headlight switch is off).

Of course, you may still turn on the headlights any time you need to.

To idle your vehicle with the DRL off, shift the transaxle into “P” (Park). The DRL will stay off until you shift out of “P” (Park).

To turn off all exterior lighting at night when you are parked, move the twilight sentinel control from ON to OFF, if it was on from the start. Or, move the control from OFF to ON, then back to OFF, if it was off from the start. The lights will come back on when you move the transaxle out of PARK.

## Front Seat Reading Lights



Front seat reading lights are turned on by pressing the LAMP switch.

## Rear Seat Reading Lights

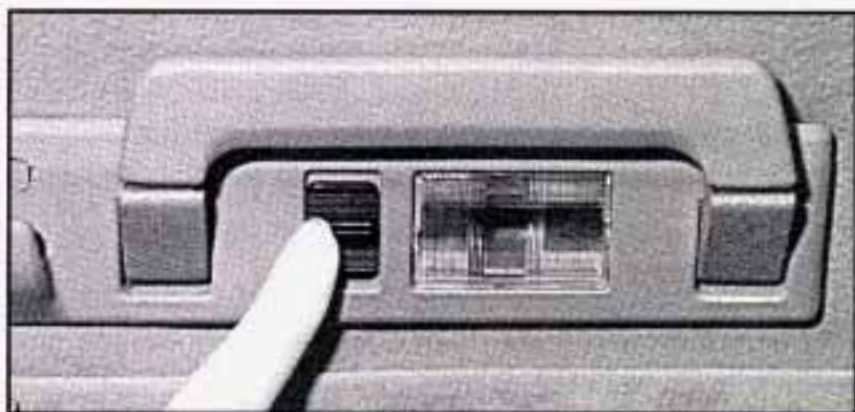

You may also have reading lights in the rear seat.



## Lamp Monitors (Option)

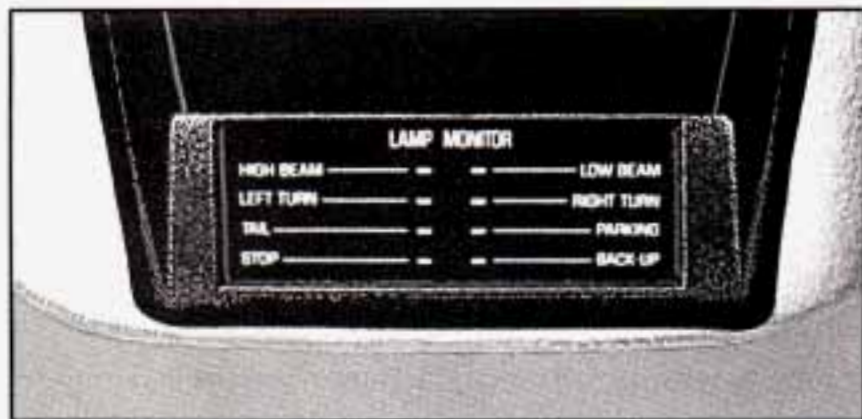

This system will let you know when certain exterior light bulbs fail. When you start your car all eight lights come on briefly to show that the system is working.

When a bulb fails an indicator will flash for several seconds and then stay on until the failed bulb is replaced and lit. For example, if a burned out back-up light bulb is replaced, the indicator for back-up lamps will stay on until the transaxle is put in reverse with the ignition on. The bulbs are monitored only while they are being used.

If you have recently had a low battery condition or the battery has been disconnected and reconnected, the indicators will flash when you turn the ignition switch to RUN. Turning on the parking lamps will return the lamp monitor system to normal operation.

## Bulbs Monitored

Indicator	Bulbs Monitored
High Beam	Both Headlight High Beams
Low Beam	Both Headlight Low Beams
Left Turn	1 Front Left Turn/Park 2 Rear Left Turn/Stop
Right Turn	1 Front Right Turn/Park 2 Rear Right Turn/Stop
Tail	2 Tail Only 4 Tail/Turn Right and Left Rear Side Marker 2 License
Parking	2 Park/Turn 2 Front Park Right and Left Front Side Marker
Stop	4 Rear Stop/Turn 1 Center High Mounted
Backup	2 Back up

## Mirrors

### Manual Inside Mirror

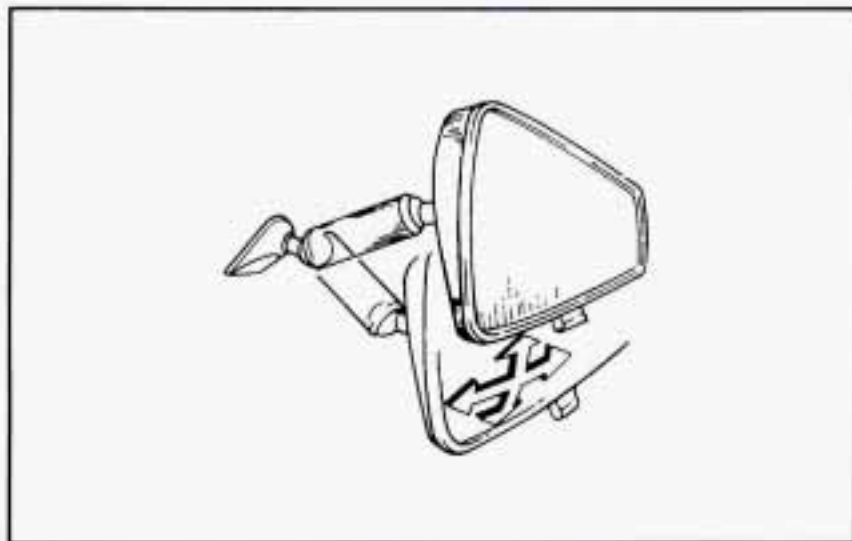

When you are sitting in a comfortable driving position, adjust the mirror so you can see clearly behind your car. Grip the mirror in the center to move it up or down and sided to side. The day-night adjustment allows you to adjust the mirror to avoid glare from the lights behind you. Pull the tab forward for daytime use. Push it back for night use.

The mirror mount is designed to detach during air bag deployment. Excessive force and/or excessive up, down, side-to-side adjustment can cause the mirror to detach from the windshield. If this occurs, re-install the mirror according to this procedure.

1. Center the bottom of the mirror mount against the windshield at the top of the button.
2. Slide the mount onto the button keeping the mount parallel to the windshield.
3. While pushing the mount against the button, maintain a downward force until the support clicks onto the button. A click indicates the mount is fully engaged, it requires approximately 20 pounds of force.
4. Check to make sure the mirror is securely attached to the button by adjusting the mirror normally.

## Automatic Inside Mirror

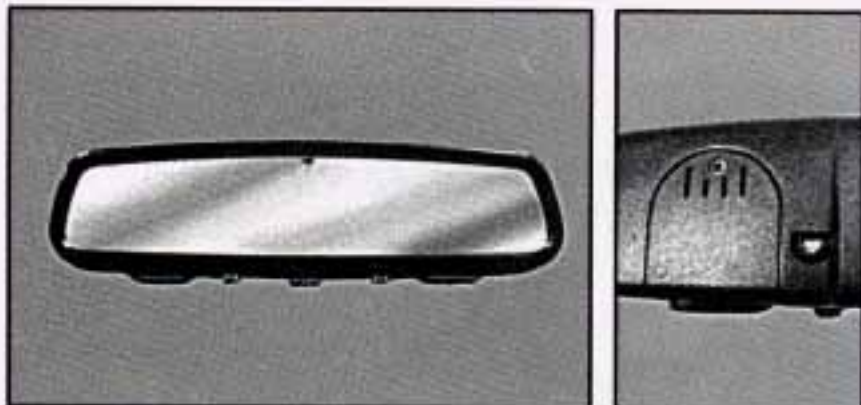

Your Buick may have an automatic inside mirror.

The automatic mirror adjusts for the glare of headlights behind you. It detects changes in light, and then adjusts for day or night operation.

During the day the mirror reflects all the light from behind your car. At night, when the glare is too high, it changes to the night mode. Then, it reflects only part of the light from behind you. When the mirror changes to the night mode, it holds that position until glare is no longer present.

## Automatic Mirror Settings

There is an automatic and an off position. When the button on the bottom of the mirror is pressed up and has a green halo, the mirror is on automatic. Press again to turn off.

## Time Delay

The mirror delays before changing from the night to the day position. This delay prevents rapid changing of the mirror as you drive under lights and through traffic.

## Reverse Gear Day Mode

The reverse mode is another important feature of the automatic mirror. When the shift lever is placed in "R" (Reverse), the mirror changes to the day mode. This gives you a bright image in the mirror as you back up.



## Front Reading Lights

There are two reading lights located on the rearview mirror. Push the switch closest to the light to turn it on or off.

## Cleaning Photocells

Use a cotton swab and glass cleaner to clean the two photocells that make the mirror work.

## Outside Mirrors

### Remote Mirror Control



Your Buick has an electric mirror control located on the driver's door.

Move the switch in the middle of the control to choose the right or left mirror. To adjust the mirror, push the arrow control in the direction you want the mirror to go.

Adjust each mirror so you can just see the side of your car and the area behind your vehicle.

## Heated Outside Rearview Mirror (Option)

If you have this option, the left outside mirror is heated when you activate the rear window defogger.

## Convex Outside Mirror

Your right side mirror is convex.

A convex mirror's surface is curved so you can see more from the driver's seat.

### CAUTION:

**If you aren't used to a convex mirror, you can hit another vehicle. A convex mirror can make things (like other vehicles) look farther away than they really are. If you cut too sharply into the right lane, you could hit a vehicle on your right. Check your inside mirror or glance over your shoulder before changing lanes.**

## Convenience Net (Option)

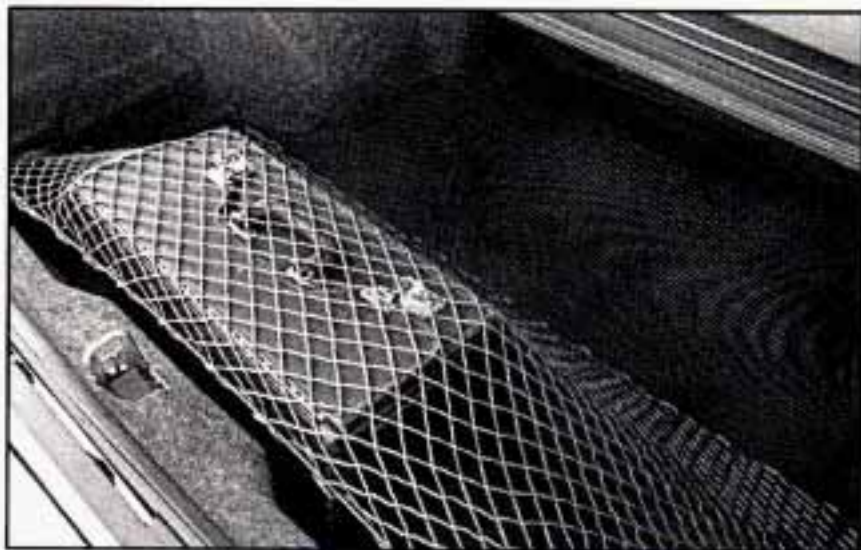

Your vehicle may have a convenience net. You'll see it just inside the back wall of the trunk.

Put small loads, like grocery bags, behind the net. It can help keep them from falling over during sharp turns or quick starts and stops.

The net isn't for larger, heavier loads. Store them in the trunk as far forward as you can.

You can unhook the net so that it will lie flat when you're not using it.

## Astrorooft (Option)

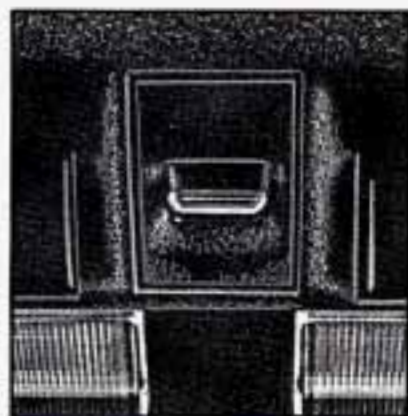

If you have the Astrorooft option, the switch is on the roof between the sun visors. It will open the astrorooft when in Retained Accessory Power or when the ignition is ON.

To fully open the glass panel and sunshade, press the switch rearward and release. To stop the panel in a partially open position, press the switch again at the desired point. To continue to open fully, press the switch rearward again and release. The sunshade can be opened manually.

To close the glass panel, press and hold the switch forward. The sunshade must be manually closed.

Once the astrorooft is closed, it can be opened to a vent position. Press the switch forward to vent. To close, press the switch rearward.

## Garage Door Opener Storage



The garage door opener storage area is located in the headliner.

To use your garage door opener in the storage area, see the following chart. If your garage door opener is not listed on the chart you still may be able to find a pin and hole combination that will work. Once you have found a pin and hole combination, follow these instructions:



Model	Pin Length				Hole Location			
	A	B	C	D	1	2	3	4
Chamberlain								
50		x						x
53		x						x
54LM		x					x	
EZ-Lift								
1089			x		x			
3089			x		x			
Genie								
AT-35A							x	
AT-85/AT-95							x	
AT-90	x							
MAT 85/90		x					x	
Moore-O-Matic								
DT		x					x	
DT2		x					x	
Ladybug (MIN)				x			x	
Sears								
652030								
53706/53707			x		x			
53708/53718		x					x	
53738			x				x	
Stanley								
1047			x		x			
1050			x			x		
1052			x			x		
1075								
1077			x			x		
1079			x			x		
Tru-Guard								
50TV		x						x
54TV		x					x	

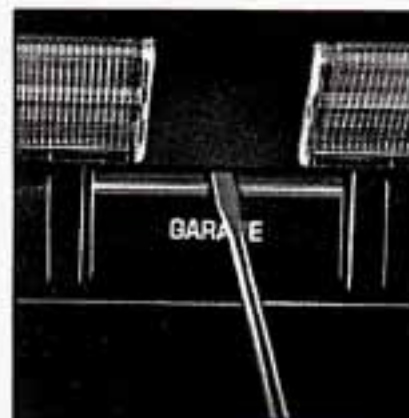

1. To place your garage door opener in the storage area, carefully open the cover with a screwdriver, as shown. Insert a screwdriver in the slot located above the word "GARAGE" and pry down on the cover.

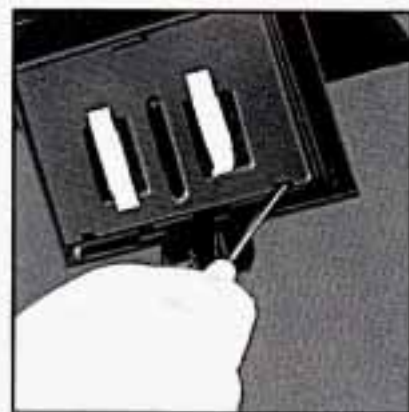

2. Next, carefully pry the panel out of the slots in the cover to disassemble the panel and lever.



3. Now install the selected pin into the specified hole on the lever as indicated from the chart.

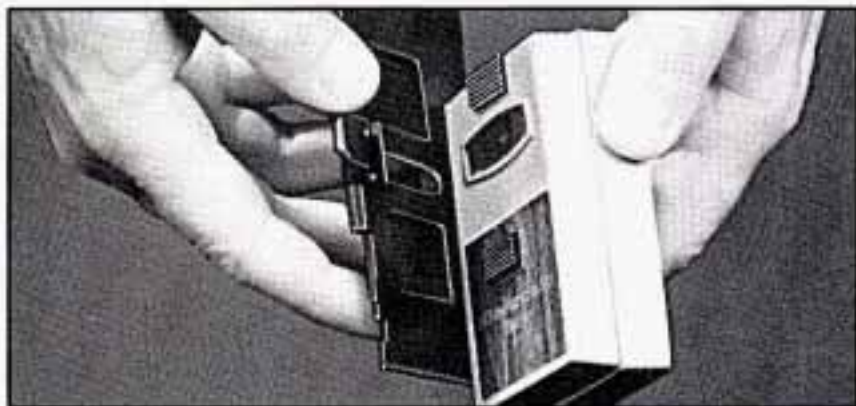

4. While holding the panel and lever, place the panel over your garage door opener so that the button is over the pin.

5. Remove the backing from the adhesive strips on the panel and place your garage door opener on the panel.

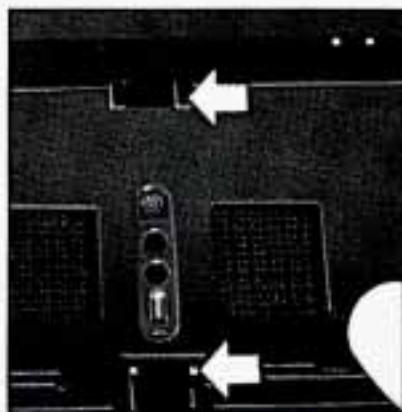

6. If the adhesive strips won't hold your opener in place, tie down loops may be used.

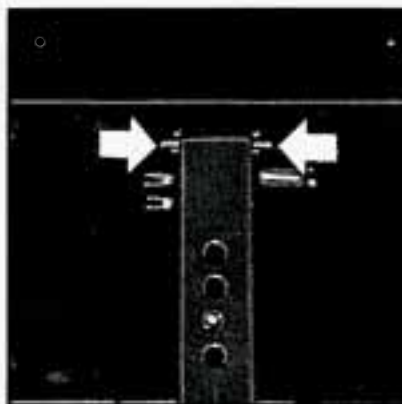

7. Place the tabs from the panel into the slots on the cover so that pivots are positioned as shown.

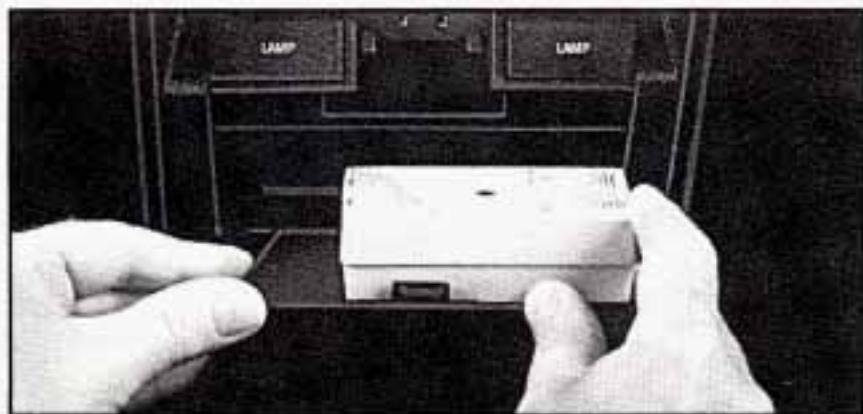

8. Snap the panel with your garage door opener into the cover.

If your garage door opener doesn't work after it is installed, another pin and hole combination will have to be tried. If the opener doesn't shut off after the lever is released, the pin will have to be filed down.

## Automatic Ride Control

Your Park Avenue Automatic Ride Control provides a comfortable controlled ride. This suspension system keeps adjusting your car's ride and handling depending upon speed and road conditions. Automatic Ride Control uses three levels of control to ensure a combination of balance and stability.

## Electronic Level Control

This feature keeps the rear of your car level as the load changes. It is automatic — you don't need to adjust anything.

## Storage Armrest

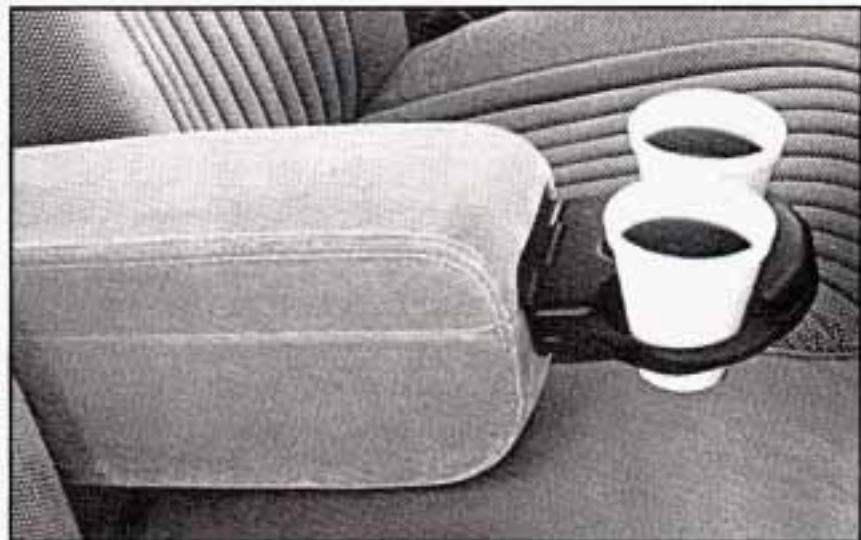

The armrest between the front seats opens into a storage area.

To open it, press the lever at the front edge. Inside are cup holders which can be rotated forward for use with



the cover closed. There is also a removeable coin holder, cassette tape and compact disc storage area.

## Assist Handles



A folding handle over each rear door and the front passenger's door can be used to help you get in or out of your Buick.

## Dual Sun Visors

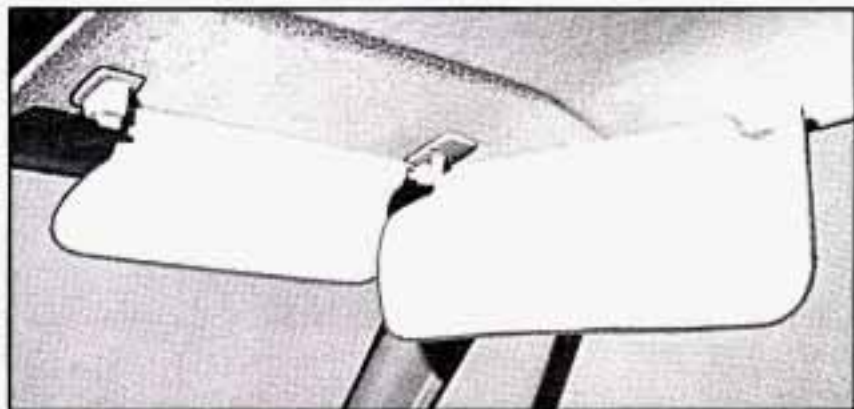

Each sun visor has two parts, so that both the windshield and door glass can be shaded at the same time.

## Visor Vanity Mirror (Option)

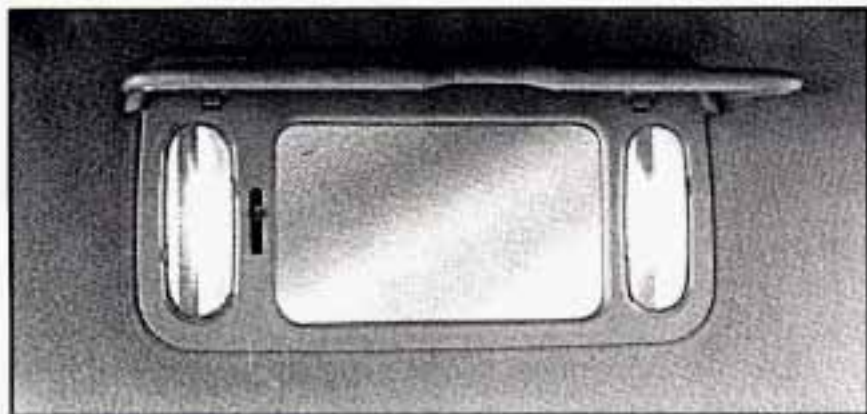

This mirror is on the larger of the passenger's sun visors. It may also be on the larger of the driver's sun visors. When you open it by moving this latch, the lights turn on.

The brightness of the lights can be adjusted by sliding this switch. The Park Avenue Ultra also has visor vanity mirrors for the rear seat passengers.

## Rear License Plate Holder

To use it, open the trunk lid and slide your license plate into the slot. Always close the trunk to prevent theft of the plate.

## Ashtrays



The front center ashtray may be removed for cleaning.



## Cigarette Lighter

It's near the ashtray. To use one, push it in all the way and let go. When it's ready, it will pop back by itself.

### **NOTICE:**

If you hold a cigarette lighter in with your hand while it is heating, it won't be able to back away from the heating element when it's ready. That can make it overheat, damaging the lighter and the heating element.

The rear ashtrays may also be removed for cleaning.

### **NOTICE:**

Don't put papers or other flammable things into your ashtrays. Hot cigarettes or other smoking materials could ignite them, causing a damaging fire.



## The Instrument Panel: Your Information System



Your instrument panel is designed to let you know at a glance how your car is running. You'll know how fast you're going, how much fuel you're using, and many other things you'll need to know to drive safely and economically.

## Speedometer and Odometer

Your speedometer lets you see your speed in both miles per hour (mph) and kilometers per hour (km/h). Your odometer shows how far your vehicle has been driven, in either miles (used in the U.S.) or kilometers (used in Canada).

Your Buick has a "tamper-resistant odometer." If you can see very noticeable bright silver lines between the numbers, probably someone has tried to turn it back. The numbers may not be true.

You may wonder what happens if a car has to have a new odometer installed. If possible, the new one has to be set to the same reading the old one had. If it can't be, then it's set at zero, and a label on the driver's door must show the old reading and when the new one was installed.

## Trip Odometer

A trip odometer can tell how far you've driven since you last set it back to zero. To reset it, push the button.

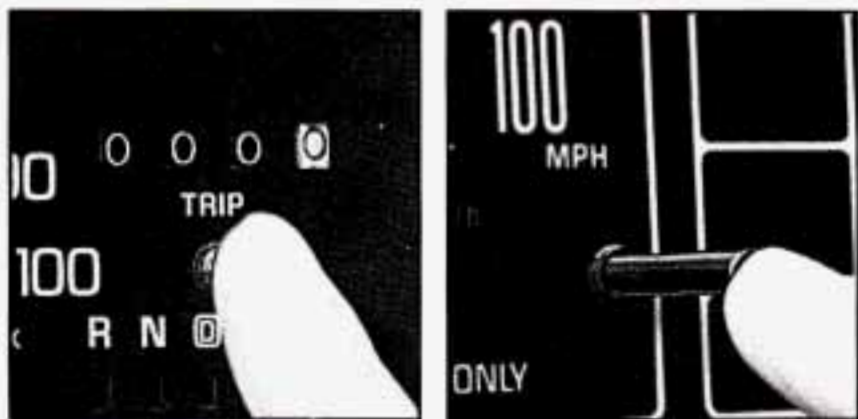

## Warning Lights, Gages and Indicators

This section describes the warning lights and gages that may be on your vehicle. The pictures will help you locate them.

Warning lights and gages can signal that something is wrong before it becomes serious enough to cause an expensive repair or replacement. Paying attention to

your warning lights and gages could also save you or others from injury.

Warning lights go on when there may be or is a problem with one of your vehicle's functions. As you will see in the details on the next few pages, some warning lights come on briefly when you turn the ignition key just to let you know they're working. If you are familiar with this section, you should not be alarmed when this happens.

Gages can indicate when there may be or is a problem with one of your vehicle's functions. Often gages and warning lights work together to let you know when there's a problem with your vehicle.

When one of the warning lights comes on and stays on when you are driving, or when one of the gages shows there may be a problem, check the section that tells you what to do about it. Please follow the manual's advice. Waiting to do repairs can be costly -- and even dangerous. So please get to know your warning lights and gages. They're a big help.

## Fuel Gage



Your fuel gage shows about how much fuel is in your tank. It works only when the engine is on. When the indicator nears "E," you still have a little fuel left. You need to get more fuel right away.

Here are some concerns owners have had about the fuel gage. All these situations are normal and indicate nothing wrong with the fuel gage.

- At the gas station, the gas pump shuts off before the gage reads "F".
- It takes more (or less) gas to fill up than the gage indicated. For example, the gage may have indicated 1/2 full, but it took more (or less) than half of the tank's capacity to fill it.
- The gage moves a little when you turn a corner, speed up, or stop your vehicle.
- When you turn the engine off, the gage doesn't go all the way back to "E".

### Low Fuel Light (Option)



If your Buick has this option, a yellow light near the fuel gage will go on when you are low on fuel. You should get more fuel as soon as you can.



## Brake System Warning Light

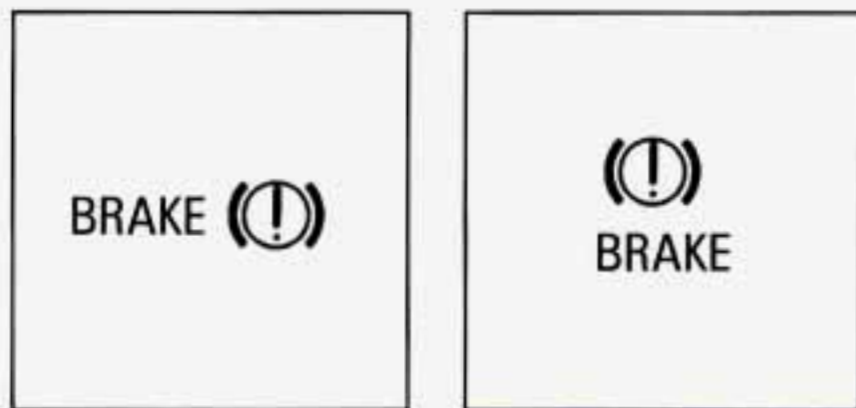

Your Buick's hydraulic brake system is divided into two parts. If one part isn't working, the other part can still work and stop you. For good braking, though, you need both parts working well.

If the warning light comes on, there could be a brake problem. Have your brake system inspected right away.

This light should come on as you start the vehicle. If it doesn't come on then, have it fixed so it will be ready to warn you if there's a problem.

If the light and chime come on while you are driving, pull off the road and stop carefully. You may notice that the pedal is harder to push. Or, the pedal may go closer to the floor. It may take longer to stop. If the light is still on, have the vehicle towed for service. (See "Towing Your Car" in the Index.)

### CAUTION:

**Your brake system may not be working properly if the brake system warning light is on. Driving with the brake system warning light on can lead to an accident. If the light is still on after you've pulled off the road and stopped carefully, have the vehicle towed for service.**

The brake system warning light will also come on when you set your parking brake, and it will stay on if your parking brake doesn't release fully. If you try to drive off with the parking brake set, a chime will also come on until you release the parking brake. If the light and chime stay on after your parking brake is fully released, it means you have a brake problem.

## Anti-Lock Brake System Warning Light



With anti-lock, this light will come on when you start your engine and may stay on for several seconds. That's normal. If the light doesn't come on, have it fixed so it will be ready to warn you if there is a problem.

If the light stays on, turn the ignition off. Or, if the light comes on when you're driving, stop as soon as possible and turn the ignition off. Then start the engine again to reset the system. If the light still stays on, or comes on again while you're driving, your Buick needs service. If the regular brake system warning light isn't on, you still have brakes, but you don't have anti-lock brakes. If the regular brake system warning light is also on, you don't

have anti-lock brakes and there's a problem with your regular brakes. See "Brake System Warning Light" earlier in this part.

## Traction Control System Warning Light (Option)



The "TRACTION OFF" warning light means that the system is not working. When this warning light is on, the system will not limit wheel spin. Adjust your driving accordingly. The warning light may come on for the following reasons:

- If your brakes overheat, the traction control system will go off and the warning light will come on until your brakes cool down.
- Some engine related problems may cause the "TRACTION OFF" warning light to come on.

Press the "TRACTION ON/OFF" switch to turn the Traction Control system on or off.

If the "TRACTION OFF" warning light comes on and stays on for an extended period of time, your vehicle needs service.

### Engine Coolant Temperature Warning Light

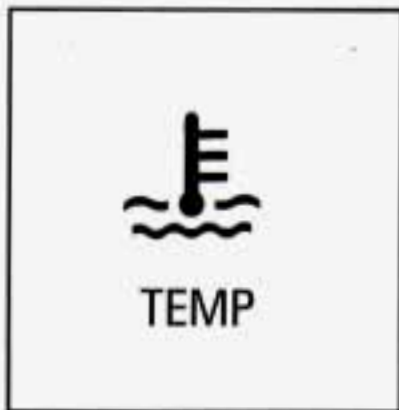

This light tells you that your engine coolant has overheated or your radiator cooling fans are not working. If you have been operating your vehicle under normal driving conditions, you should pull off the road, stop your vehicle and turn the engine off as soon as possible.

The chapter "Problems on the Road," in this manual explains what to do. See "Engine Overheating" in the Index.

### Engine Coolant Temperature Gage

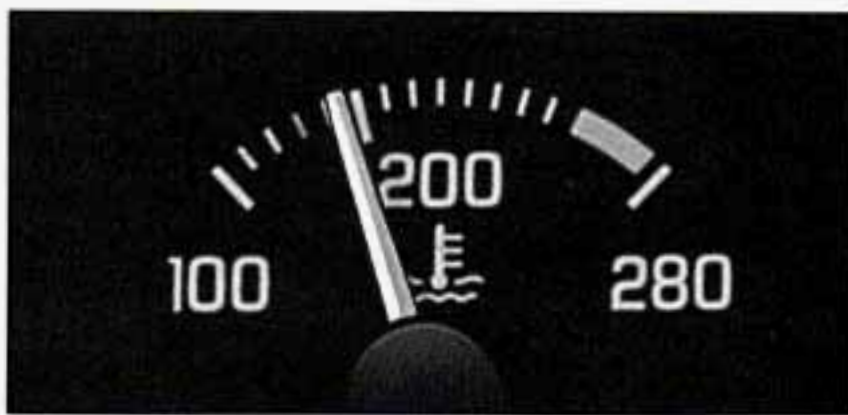

If you have the Gage Cluster, you have a gage that shows the engine coolant temperature. If the gage pointer moves into the red area, your engine is too hot!

That reading means the same thing as the warning light. It means that your engine coolant has overheated. If you have been operating your vehicle under normal driving conditions, you should pull off the road, stop your vehicle and turn off the engine as soon as possible.

The chapter "Problems on the Road," in this manual explains what to do. See "Engine Overheating" in the Index.



## Low Coolant Warning Light

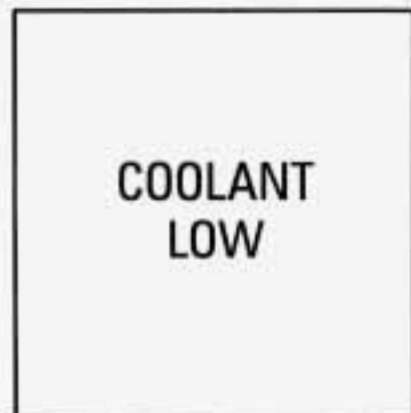

When this light comes on, the cooling system is low on coolant. As a bulb check, it will come on when the ignition is in the RUN position and then go off.

If the coolant level is low, the light will come back on and a warning chime will sound. If this happens, see “Engine Coolant” in the Index for proper cooling system fill.

After the coolant level is returned to its proper level, the LOW COOLANT light will go off after 20 seconds or remain off on the next ignition cycle.

## Engine Oil Pressure Light and Gage



This light tells you if there could be a problem with your engine oil pressure.

If your car has the optional gage cluster, you can read your oil pressure directly from the gage on your instrument panel.

There are three ways this light can come on briefly, which is normal and doesn't show a problem. They are:

- The light comes on when you turn your key to “Run.” It goes off once you turn the key to “Start.” That's just a check to be sure the light works. If it doesn't, be sure to have it fixed so it will be there to warn you if something goes wrong.

- If you're "idling" at a stop sign, the light may blink on and then off.
- If you make a hard stop, the light may come on for a moment.

When this light **comes** on and **stays** on, it means oil isn't going through your engine properly. You could be low on oil, or you might have some other oil problem.

 **CAUTION:**

**Don't keep driving if the oil pressure is low. If you do, your engine can become so hot that it catches fire. You or others could be burned. Check your oil as soon as possible and have your vehicle serviced.**

**NOTICE:**

**Damage to your engine from neglected oil problems can be costly and is not covered by your warranty.**

## "Check Oil Level" Light (Option)

**CHECK  
OIL LEVEL**

The "Check Oil Level" light is lit for three seconds as a bulb check each time the ignition key is turned to the RUN position. If the light doesn't come on, have your vehicle serviced.

If the engine oil is more than one quart low, the light will come on briefly, then go off for 15-25 seconds, and then come back on for 20-40 seconds.

However, the system will not register low engine oil if it has not been more than eight minutes since the engine was last shut off.

If the "Check Oil Level" light comes back on, the engine oil should be checked at the dipstick then brought up to the proper level if necessary. See "Engine Oil" in the Index.

## “Change Oil Soon” Light (Option)

**CHANGE  
OIL SOON**

This light is activated by the engine oil life monitor system. The system determines the condition of the engine oil and lets you know when the oil should be changed. (See “Engine Oil” in the Index).

It does this using information about engine speed (revolutions per minute), coolant temperature and vehicle speed. The system uses this data to determine how much oil has degraded.

When to change your oil depends on driving habits and conditions because these directly affect engine speed, coolant temperature and vehicle speed. Because of this, the “Change Oil Soon” light may come on as early as 2,000 miles or less for harsh conditions.

The “Change Oil Soon” light is lit for five seconds as a bulb check each time the ignition key is turned to the RUN position. It will stay on for 60 seconds once 90%

of the oil life has been used and each time the engine is started after that. If the “Change Oil Soon” light is on continuously, there is a problem with the Oil Life Monitor System and service is required.

**After changing the engine oil, the system should be reset.** This will cause the “Change Oil Soon” light to be lit again for the bulb check period of three seconds.



The reset button is in the glove box. With the ignition key in the RUN position push the reset button, hold it in for at least 5 seconds but not more than 60 seconds. After 5 seconds, the “Change Oil Soon” light will flash 4 times and then go off. This indicates that the Oil Life Monitor System has been reset.



## Malfunction Indicator Lamp (Service Engine Soon Light)



SERVICE  
ENGINE SOON



SERVICE  
ENGINE  
SOON

A computer monitors operation of your fuel, ignition and emission control systems. This light should come on when the ignition is on and the engine is not running, as a check to show you it is working. If it does not come on at all, have it fixed right away. If it stays on, or it comes on while you are driving, the computer is indicating that you have a problem. You should take your vehicle in for service soon.

### NOTICE:

If you keep driving your vehicle with this light on, after a while the emission controls won't work as well, your fuel economy won't be as good and your engine may not run as smoothly. This could lead to costly repairs not covered by your warranty.

## Battery Light

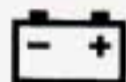

VOLTS

When you turn the key to RUN, this light will come on briefly, to show that your alternator and battery charging systems are working. If the light stays on, you need

service, and you should take your Buick to the dealer at once. To save your battery until you get there, turn off all accessories and set your air system to OFF.

## Voltage Indicator

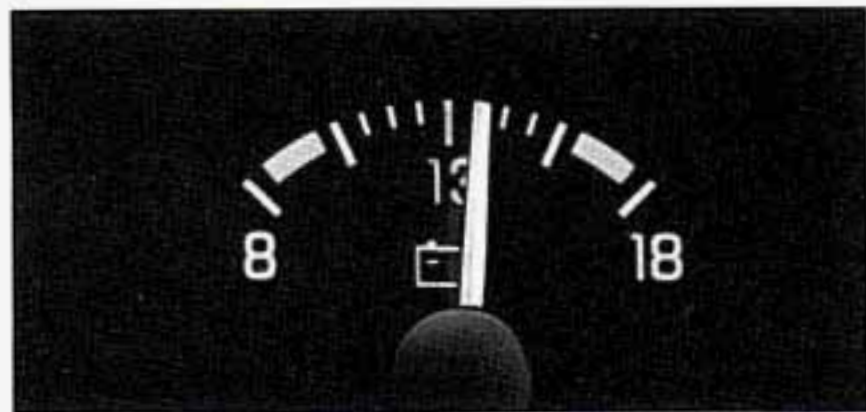

If you have the optional gage cluster, this gage shows voltage in the electrical system. The normal range is 11 to 15 volts. If the reading stays outside the normal range, have your Buick dealer check the electrical system.

## Tachometer



The tachometer tells you how fast the engine is running. It displays engine speed in thousands of revolutions per minute (RPM).

### **NOTICE:**

Do not operate the engine with the tachometer in the red area, or engine damage may occur.

### **Door Ajar Light (Option)**

**DOOR  
AJAR**

When the ignition is ON, this light will stay on until all the doors are closed and completely latched.

### **Trunk Ajar Light (Option)**

**TRUNK  
AJAR**

If this light stays on with the ignition ON, it means that the trunk lid is open or not completely latched.





## Part 3 Comfort Controls and Audio Systems

In this part you'll find out how to operate the comfort control systems and audio systems offered with your Buick. Be sure to read about the particular system supplied with your vehicle.

### Part 3 includes:

Comfort Control System	132
Heater and Defroster	137, 138
Air Conditioner	134, 140
Rear Window Defogger	139, 140
Ventilation	141
Steering Wheel Controls	155
Audio Systems	143
Understanding Radio Reception	143
Radio Controls	144, 147, 151
Setting the Clock	146, 149, 152
Tape Player Controls	146, 149
CD Player Controls	153
Steering Wheel Controls	155
Care of Cassette Tape Player and Tapes	157
Care of Compact Discs	158
Antenna Care	158

## Your Buick Comfort Control System

This part tells you how to make your air system work for you. The Comfort Control System uses the new ozone friendly R134a refrigerant.

Fresh air from outside your vehicle flows through your Buick when the car is moving. When the vehicle is not moving, you can get outside air to flow through by selecting any upper buttons (except the rear window defogger) and the HI fan speed.

### Air Outlets

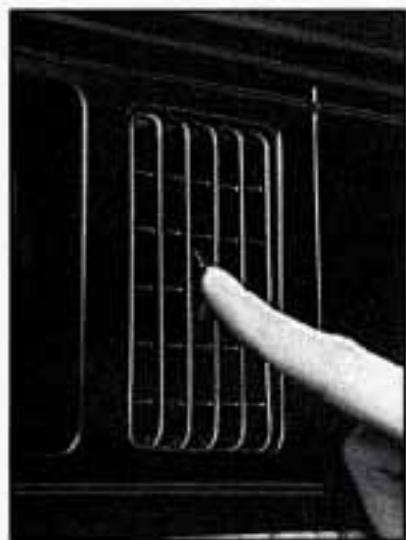

Adjust the direction of air flow by moving the louvered vents.

### Rear Passenger ComforTemp (Option)



If you have this option, you can adjust the direction of the air flow to the rear seating area.

If your Buick has the Dual Automatic ComforTemp Climate Control option, it looks like this:



The following information tells you how it works.

You will hear a beep each time a button is pushed. The display will show fan, temperature and mode settings.

Sun and temperature sensors automatically adjust air temperature to maintain your comfort. The system tends to supply cooler air to the side towards the sun. Be careful not to put anything over the sun sensors on the top of the dash. The system may not respond correctly.

The air conditioning compressor operates when the outside temperature is above 45°F (7°C). Besides cooling, this is used to dehumidify and filter the air. The compressor works when AUTO, HTR, DEFOG or defrost is selected.

## Ext Temp

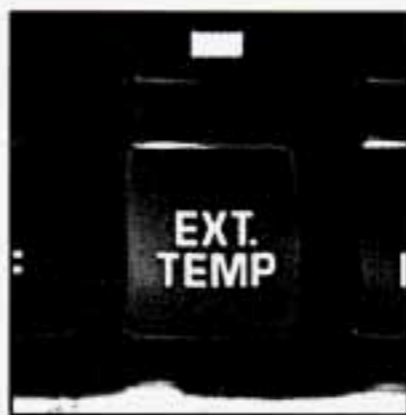

Push this button and the display will indicate the outside temperature (unless the system is OFF). Push it again to return to the regular system display.

The outside temperature reading is most accurate when driving. During stops, the display shows the previous temperature for best accuracy and system control.



## Cool/Warm

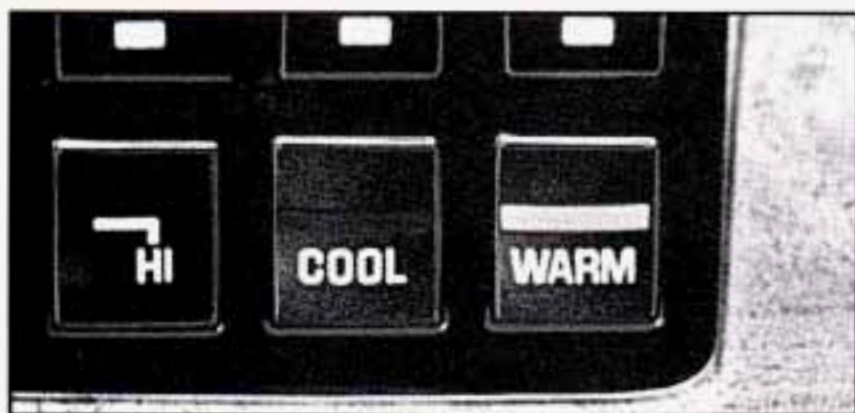

To adjust the temperature to a comfortable level, push either COOL or WARM.

You can choose a temperature between 60°F (16°C) for maximum cooling, and 90° F (33°C) for maximum heating. It is not necessary to choose the extreme temperature to get the system to heat or cool at the maximum. The system does it automatically.

## Off

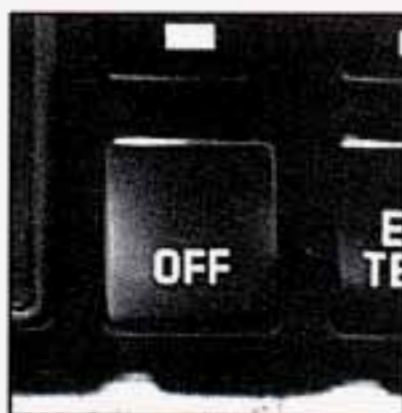

When the system is OFF, the ventilation system will allow air to flow through your Buick when the vehicle is moving.

The system will try to keep the air at the chosen temperature. The outside temperature will show in the display area unless the system is OFF.

## Auto



AUTO is used when you want the system to adjust automatically to changes in temperature. When the system is set for automatic, air will come from the floor outlets, the instrument panel outlets or windshield outlets.

Fan speed will vary as the system gets to and maintains the temperature setting you have selected (unless a blower LO or HI button has been pushed).

To find your comfort zone, start with 75 AUTO, give the car about 20 minutes to stabilize, and adjust the temperature setting if necessary.

In cold weather the system will delay turning on the fan, to avoid blowing cold air. The length of the delay depends on engine coolant temperature, outside temperature and time since the engine was last started. Pushing a LO or HI blower button will override this delay, and cause the fan to start.

To rid the system of stale air in warm weather, air will come out of the floor outlets for a short time.

## Dual Zone



The front seat passenger can control the air temperature in their seating area.

This control can be up to 5°F cooler or warmer than the primary setting.

The control is on the passenger's door. Press the DUAL ZONE button. Adjust the temperature using the passengers COOL/WARM settings. Both DUAL ZONE and AUTO buttons will light up.



The right front seat passenger can also activate the DUAL ZONE function by pressing the WARM or COOL buttons on the passenger door.

The indicator above the control will show the difference from the main temperature setting. To turn off this part of the system, push the DUAL ZONE button again.

## Fan Speeds



The speed of the blower fan is controlled automatically if you have the fan on AUTO.



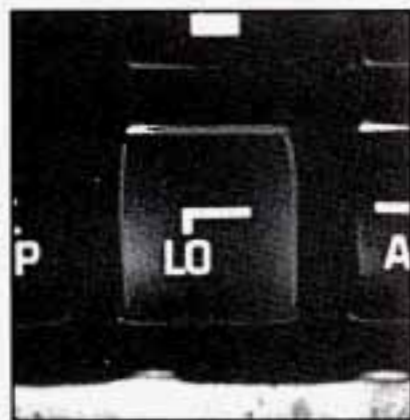

If you want the blower fan to run at a lower speed, push the LO button. The blower speed will decrease with every push of the button until the lowest speed is reached.

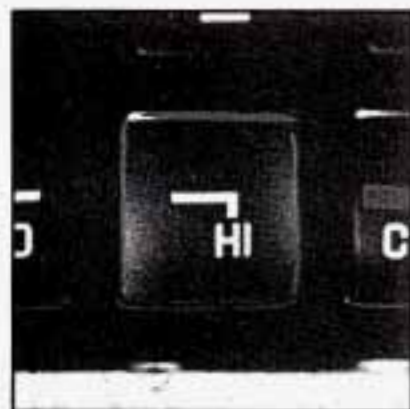

If you want to raise the blower speed, push HI. The blower speed will increase with every push of the button until maximum speed is reached.

## Econ

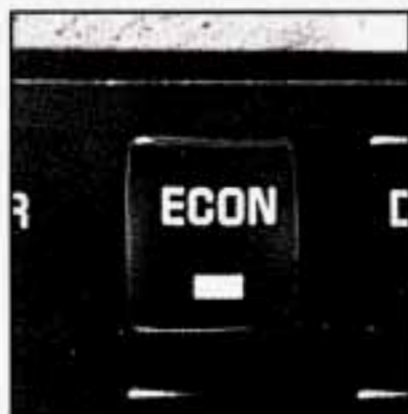

You can use ECON when you don't need to cool the outside air. The system will work like the AUTO mode without cooling. The air flow will come from the instrument panel outlets. ECON does not have the blower delay feature as the AUTO mode setting.

This setting turns off the air conditioner allowing better fuel economy.

## Heater

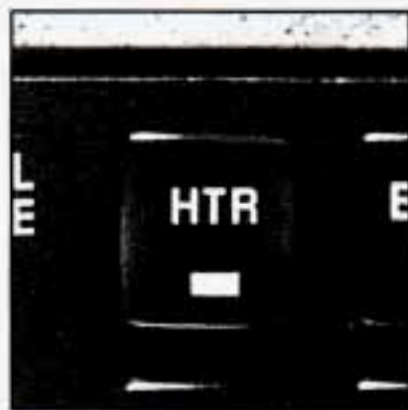

To warm the air, press HTR and adjust the temperature and fan speed for your comfort. Most of the air will come from the floor outlets.

## Defog



When the outside temperature is mild, use DEFOG to keep fog off the windshield.

Air entering the vehicle will be evenly split between the floor outlets and the outlets near the windshield.

The blower speed will be controlled automatically, or you can choose another fan speed by pushing the HI or LO buttons.

## Defrost

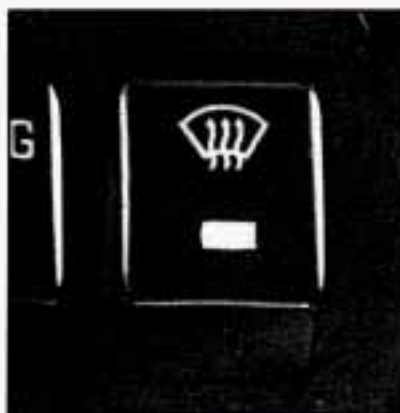

This setting directs most of the air flow toward the windshield. Use DEFROST when there is fog or ice on the windshield.

Defrost will work better if any ice and snow is cleared from the hood and the air inlet area between the hood and the windshield.

Blower speed will be controlled automatically, but you can choose another speed by pushing the HI or LO buttons.

## Rear Window Defogger

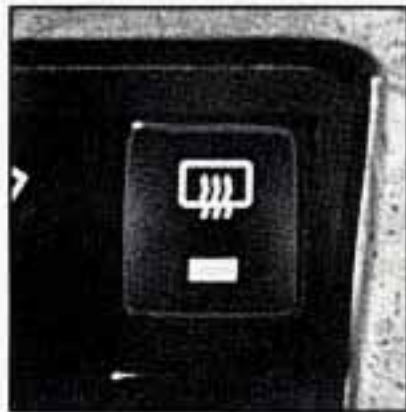

The lines you see on the rear window will warm the glass. Press the button to start warming your window.

After 10 minutes, it will go off by itself, or pressing the button again during the heating cycle will shut it off. If you need additional warming time, push the button again.

If you have the heated outside rearview mirror option, the mirror will be warmed when the rear defogger is on.

## NOTICE:

Scraping the inside of your rear window could cut and damage the heater. Your warranty would not cover this damage. Don't put decals there, you might have to scrape them off.

If your Buick has the Electronic Touch Climate Control System, the following information tells you how it works.

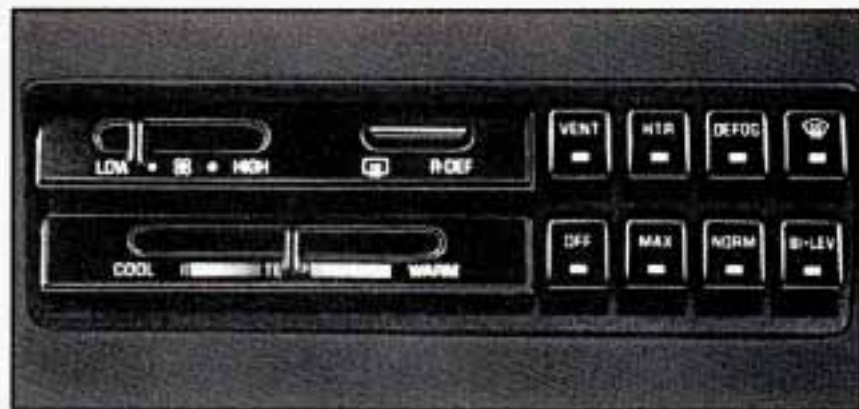



## Fan Speeds

The fan control is used to select the speed of the blower fan. There are four speeds to choose from. Moving the lever to the right or left will increase or decrease the fan speed. The fan will be off when the system is off.

## Temperature

The lower lever changes the temperature of the air coming through your air outlets. Moving the lever between COOL and WARM will raise or lower the temperature.

## Off

When the system is off, the ventilation system will allow air to flow through your Buick when the vehicle is moving. The system will try to keep the air at the chosen temperature, unless it is very hot or very cold outside. When the system is off, the blower fan is also off.

## Air Conditioner

The next three selections cool the air. The air conditioner won't work well unless all the windows are closed. On very hot days, open the windows long enough to let the hot inside air out. This reduces the amount of work your air conditioner's compressor will have to do, which should help fuel economy.

The air conditioning compressor operates in all Air Conditioning positions and the Defrost position when the outside temperature is above 47°F (8°C).

Selecting OFF, VENT or HTR turns off the air conditioning compressor.

When you don't need to cool the outside air, use the VENT, HEAT and DEFROST settings. Adjust the temperature control for comfort. You'll get better fuel economy (gas mileage) if you're not cooling the outside air. When you cool the air, your engine runs a refrigeration compressor, and it has to work a little harder.

## **Max**

This setting provides maximum cooling with the least amount of work. MAX recirculates much of the air inside your vehicle so it maximizes your air conditioner's performance and fuel economy. Air is directed through the instrument panel outlets.

## **Norm**

Use NORM for normal cooling on hot days. This setting cools outside air and directs it through the instrument panel outlets.

## **Bi-Level**

This setting is designed for use on sunny days when the air is only moderately warm or cool. On days like these, the sun may adequately warm your upper body, but your lower body may not be warm enough.

The Bi-level setting directs vehicle air in two ways. Cool air is directed toward your upper body through instrument panel outlets, while slightly warmed air is directed through the heater outlet at your feet.

## **Vent**

For mild outside temperatures when little heating or cooling is needed, use the VENT setting. Air will flow through the instrument panel outlets. Use the air outlets to turn on, adjust and turn off the air flow. Adjust the temperature lever to the desired temperature.

## **Heater**

When outside temperatures are cold, pressing the HTR setting and adjusting the temperature lever will send warm air through the floor outlets and some through the defroster vents.

## **Defrost**

The DEFROST setting directs most of the air flow toward the windshield. Use defrost when you want to remove fog or ice from the windshield. When it's 42°F (6°C) or **warmer**, you'll get cooled air.

## Defog

When the outside temperature is mild, use Defog to keep the fog off the windshield.

Air entering the vehicle will be evenly split between the floor outlets and the outlets near the windshield. You can control the temperature of the air and the fan speed to clear the foggy windows.

## Rear Window Defogger



The lines you see on the rear window warm the glass. Press the button to start warming your window.

After 10 minutes, it will go off by itself, or pressing the button again during the heating cycle will shut it off. If you need additional warming time, push the button again.

### **NOTICE:**

**Scraping the inside of your rear window could cut and damage the heater. Your warranty would not cover this damage. Don't put decals there, you might have to scrape them off.**



## Audio Systems

Your Delco® audio system has been designed to operate easily and give years of listening pleasure. You will get the most enjoyment out of it if you acquaint yourself with it first. Find out what your Delco® system can do and how to operate all its controls, to be sure you're getting the most out of the advanced engineering that went into it.

### FM Stereo

FM stereo will give you the best sound. But FM signals will reach only about 10 to 40 miles (16 to 65 km). And, tall buildings or hills can interfere with FM signals, causing the sound to come and go.

### AM

The range for most AM stations is greater than for FM, especially at night. The longer range, however, can cause stations to interfere with each other. AM can pick up noise from things like storms and power lines. Try reducing the treble to reduce this noise.

### AM Stereo

This means the Delco® system can receive C-QUAM® stereo broadcasts. Many AM stations around the country use C-QUAM® to produce stereo, though some do not. (C-QUAM® is a registered trademark of Motorola, Inc.) If your Delco® system can get C-QUAM®, your "STEREO" light will come on when you're receiving it.

Be aware that hearing damage from loud noise is almost undetectable until it is too late. Your hearing can adapt to higher volumes of sound. Sound that seems normal can be loud and harmful to your hearing. Take precautions by adjusting the volume control on your radio to a safe sound level before your hearing adapts to it.

To help avoid hearing loss or damage:

- Adjust the volume control to the lowest setting.
- Increase volume slowly until you hear comfortably and clearly.

## NOTICE:

Before you add any sound equipment to your vehicle -- like a tape player, CB radio, mobile telephone or two-way radio -- be sure you can add what you want. If you can, it's very important to do it properly. Added sound equipment may interfere with the operation of your vehicle's engine, Delco® radio or other systems, and even damage them. And, your vehicle's systems may interfere with the operation of sound equipment that has been added improperly.

So, before adding sound equipment, check with your dealer and be sure to check Federal rules covering mobile radio and telephone units.



## To Play This Radio

### The Upper Knob

The upper knob does these things:

- It turns the system on and off.
- It controls the volume.
- It tells you the time. (When the ignition is off, push the knob to display the time.)

- It allows you to hear the other side of a tape. (Press the knob while a cassette is playing.)
- When the radio is playing, with the time displayed, it can tell you the frequency (push the knob).

### **Balance**

The BAL control behind the upper knob allows you to balance the sound between the right and left speakers.

### **The Lower Knob**

Turn the lower knob to tune radio stations. Push it to get AM or FM.

### **Fade**

The FADE control behind the lower knob moves the sound between your front and rear speakers.

### **Seek**

Pressing the SEEK button will cause the receiver to seek the next higher station and stop.

### **Scan**

When you press SCAN, the radio will go to the next station and pause and keep doing that until you press SCAN again. SCAN appears in the display.

### **Pushbuttons**

The four pushbuttons let you return to favorite stations. You can set the pushbuttons for up to fourteen stations (7 AM and 7 FM).

- Tune in the desired station.
- Press the SET pushbutton. SET appears in the display.
- Within 5 seconds, push one of the four pushbuttons.

Whenever you press that button, the preset station will return.

Up to three more stations may be preset on each band by pressing two pushbuttons that are next to each other, at the same time.

- Tune in the desired station.
- Press the SET pushbutton.
- Within the 5 seconds, press any two pushbuttons that are next to each other. (The station will return when the same two pushbuttons are pressed again.)



## Clock

To set the clock:

- Press the SET button.
- Within 5 seconds, press and hold SCAN until the correct hour appears on the display.
- Press and hold SEEK until the correct minute appears on the display.

## Treble

Slide the TREBLE lever up to increase the treble response. If the station is weak or noisy, slide the TREBLE lever down to reduce the noise.

## Bass

Slide the BASS lever up to increase the bass response. Adjust the BASS lever to give a pleasing sound to your ear.

## DNR<sup>®</sup>

This is the Dynamic Noise Reduction button. DNR<sup>®</sup> helps remove background hiss from the radio or tape player. You may want to leave it pushed in all the time.

## To Play A Cassette

Your tape player is built to work best with tapes that are 30 to 45 minutes long on each side. Tapes longer than that are so thin they may not work well in this player.

With the radio on, press a tape into the slot marked AUTO REVERSE (the tape side goes in first).

Once the tape is playing, use the upper and lower knobs for volume, balance, and fade just as you did for radio. The arrows indicate which side of the tape is being played.

When the end of the tape is reached, it will automatically reverse and play the other side of the tape.

## Forward

To rapidly advance the tape, press ► and the tape will rapidly go forward until you press the ◀ button or STOP-EJECT lightly.

## Reverse

To rapidly reverse the tape, press ◀ and the tape will rapidly go backward until you press the ▶ button or STOP-EJECT lightly.

## Program

To go from one side of the tape to the other, press the RCL-PROG (upper knob). Note the lighted arrows next to the ▶ and ◀.

## Stop-Eject

To remove or stop the tape and change to radio, press the STOP-EJECT button.



## To Play This Radio

### Power

To turn the radio on, press the PWR button.

## The Upper Knob

The upper knob does these things:

- It controls the volume. The volume knob increases and decreases volume when it is held slightly rotated against the spring load.
- It allows you to mute the radio or tape play. Press to mute; press again to listen.

## Balance

The control behind the upper knob allows you to balance the sound between the right and left speakers. Notice the display arrows to see where the balance is set.

## The Lower Knob

Turn the lower knob to tune radio stations. The tune knob increases and decreases frequency when it is held slightly rotated against the spring load. Push it to get AM, FM1 or FM2 frequencies.

## Fade

The control behind the lower knob moves the sound between your front and rear speakers. Notice the display arrows to see how FADE is set.

## Recall

Push RCL to display the time when the ignition is off. With the radio on, and the time displayed, push RCL to display the frequency.

## Seek◀ or ▶

Pressing the SEEK ◀ or ▶ button will cause the receiver to seek the next lower or higher station and stop.

## Scan

When you press SCAN, the radio will go to the next station and pause and keep doing that until you press SCAN again. SC will appear in the display.



## Pushbuttons

The five pushbuttons let you return to favorite stations. You can set the pushbuttons for up to fifteen stations (5 AM and 10 FM).

- Tune in the desired station.
- Push the SET button.
- Within 5 seconds, push one of the five pushbuttons. SET will disappear from the display when the station is set.

Whenever you press that button, the preset station will return.

## Clock

To set the clock:

- Press the SET button.
- Within 5 seconds, press and hold SCAN until the correct hour appears on the display.
- Press and hold SEEK until the correct minute appears on the display.

## Treble

Adjust the treble response up or down. If the station is weak or noisy, adjust the treble down to reduce the noise.

## Bass

Adjust the bass response up or down. Pressing the button in the center will set the bass level to a factory preset level.

## To Play a Cassette

Your tape player is built to work best with tapes that are 30 to 45 minutes long on each side. Tapes longer than that are so thin they may not work well in this player.

With the radio on, press a tape into the slot marked AUTO REVERSE (the tape side goes in first).

Once the tape is playing, use the upper and lower knobs for volume, balance, and fade just as you did for the radio. The arrow in the graphic display above the word TAPE indicates which side of the tape is being played. When the end of the tape is reached, it will automatically reverse and play the other side of the tape.

## **Program**

To go from one side of the tape to the other, press the PROG button. The PROG button will also stop REV, FWD, PREV or NEXT and play the tape.

## **CrO<sub>2</sub>**

This button sets the tape bias. When playing high bias chrome or metal tapes marked CrO<sub>2</sub>, press the button to turn on the CrO<sub>2</sub>. CrO<sub>2</sub> will appear in the display. When playing standard bias tapes, press again to turn off the CrO<sub>2</sub>.

## **Reverse**

To rapidly reverse the tape, press REV and the tape will rapidly reverse to the beginning or until you press REV or the PROG button again. The radio will play during reverse.

## **Forward**

To rapidly advance the tape, press FWD and the tape will rapidly go forward to the end of the tape or until you press PROG or the FWD button again. The radio will play during forward.

## **Previous**

To hear a passage on the tape that has just played, press PREV and the tape will back up and stop, at either the first 4-second quiet spot in the tape, or when you press PROG or PREV again.

## **Next**

To go directly to the next selection on the tape, press NEXT. A 4-second quiet interval must be present for the tape to stop. Pressing PROG or NEXT again will play the tape.

## **Eject**

To remove or stop the tape and switch to radio, press the EJECT button.

## **Stop-Play**

To immediately switch from tape to radio, press the ST-PL button and the radio will resume playing the station that was tuned in when you inserted a tape. Pressing ST-PL again will allow the tape to resume where it stopped.



## To Play This Radio

### Power

To turn on the radio, press the PWR button.

### The Upper Knob

The upper knob does these things:

- It controls the volume. The volume knob increases and decreases volume when it is held slightly rotated against the spring load.

- It allows you to mute the radio or CD player. Press to mute; press again to listen.

### Balance

The control behind the upper knob allows you to balance the sound between the right and left speakers. Notice the display arrow to see where the balance is set.

### The Lower Knob

Turn the lower knob to tune radio stations. The tune knob increases and decreases station frequency when it is held slightly rotated against the spring load. Turn the knob to tune slowly. If you hold it for more than a few seconds, it will tune rapidly. Push it to get AM, FM1 or FM2 frequencies.

### Fade

The control behind the lower knob moves the sound between your front and rear speakers. Notice the display arrows to see how FADE is set.



## Recall

When the ignition is off, push RCL to display the time. With the radio on, and the time displayed, push RCL to see the frequency.

## Seek ◀ or ▶

Pressing the SEEK ◀ or ▶ will cause the receiver to seek the next lower or higher station and stop.

## Scan

When you press SCAN, the radio will go to the next station and pause and keep doing that until you press SCAN again. SC will appear in the display.

## Pushbuttons

The five pushbuttons let you return to favorite stations. You can set the pushbuttons for up to fifteen stations (5 AM and 10 FM).

- Tune in the desired station.
- Press the SET pushbutton.
- Within 5 seconds, push one of the five pushbuttons. SET will disappear from the display when the station is set.

Whenever you press that button, the preset station will return.

## Clock

To set the clock:

- Press the SET pushbutton.
- Within 5 seconds, press and hold SCAN until the correct hour appears on the display.
- Press and hold SEEK ▶ or ◀ until the correct minute appears on the display.

## Treble

Adjust the treble response up or down. If the station is weak or noisy, adjust the treble down to reduce the noise. Pressing the control in the center will set the bass to a factory preset level.

## Bass

Use the BASS control to adjust bass response up or down. Pressing the control in the center will set the bass to a factory preset level.

## To Play A Compact Disc

Before you begin, please note: DO NOT use mini-discs that are called singles. They won't eject. *Use full-size compact discs only.*

Press PWR to turn the system on.

Insert a disc partway into the slot, label side up. The player will pull it in. Wait a few seconds and the disc should play.

If the disc comes back out, check to see if:

- The disc is upside down.
- It is dirty, scratched, or wet.
- There's too much moisture in the air. (If there is, wait about one hour and try again.)
- The disc player is too hot. If you're driving on a very rough road, the disc may come out, or just not play and ERR will appear in the display. As soon as things get back to normal, the disc should play again.

## Recall

Press RCL to see what track is playing. Press it again within 5 seconds to see how long the CD has been playing that track. The display will automatically return to the time of day.

The track number also appears when you change the volume, or when a new track starts to play.

## Compression

Pressing the COMP button makes soft and loud passages more equal in volume. COMP will appear in the display.

## Random

The RDM button means random and when it is pressed, your CD player will play the tracks in random order rather than sequential 1,2,3 ... order. Pressing RDM again will play the disc in sequential order.

## **Reverse**

Press and hold REV to return rapidly to a favorite passage in a track. Release it to play the passage. Note the seconds counter reading in the display.

## **Forward**

Press and hold FWD to advance quickly within a track. Release it to resume playing. Watch the display to stop at a specific passage.

## **Previous**

Press PREV to hear the previous track. If you hold this button or press it more than once, the disc will retreat to previous tracks.

## **Next**

Press NEXT to hear the next track now (instead of waiting until the present track is finished.) If you hold this button, or press it more than once, the disc will advance further.

## **Stop/Play**

Press ST/PL the disc will stop and the radio will play. Press ST/PL again to restart the disc at the point where it stopped.

Press the PWR button or turn the ignition key off to stop the disc player. The disc stays in the player and will resume playing at the point where it stopped.

## **Eject**

Press EJCT and the disc will eject and the radio will play. The disc will start at track 1 when you reinsert it.

As a feature to protect the disc, if you turn off the ignition with the disc partway out of the slot (after eject), it will be drawn back into the player in about 30 seconds. The disc will play at track 1 when the radio is turned on again.



## Steering Wheel Controls

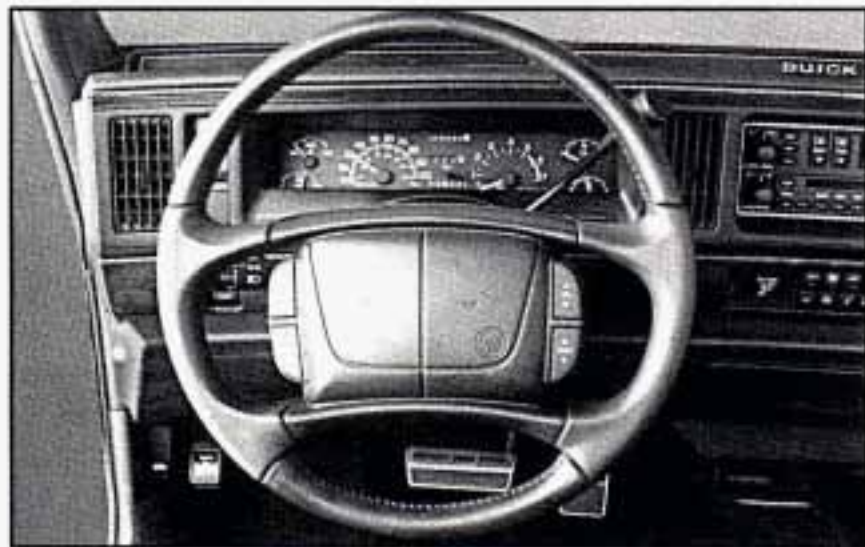

If your car has this feature, you can control certain radio and comfort control functions using the pads on the steering wheel.

You can select radio stations by pressing the pad marked SEEK ▲ or ▼.

Press PROG ▲ to hear the stations preset on your radio pushbuttons.

Press BAND ▼ to receive AM, FM1 or FM2 radio signals.

To increase or decrease the volume, press the pad marked VOL ▲ or ▼.

The pad marked TEMP ▲ or ▼ allows you to select higher or lower temperature for the climate control system.

## Anti-Theft Feature

Delco-Loc II is a security feature for the compact disc player. It can be used or ignored. If ignored, the system plays normally. If security system is used, your player won't be usable if it's ever stolen, because it won't turn on.

The instructions below tell you how to enter your personal secret code into the system. If your vehicle loses battery power **for any reason**, you must unlock the system with the secret code again before the system will turn on.

Be sure to read through the entire procedure and become familiar with the appropriate buttons and knobs before starting.

1. Write down any 6-digit number and keep it in a safe place.
2. Turn the ignition to the ACC or RUN position.
3. Press PWR to turn the radio **off**.

4. Press preset 1 and 4 buttons together. Hold them until “---” shows on the display (at least 5 seconds).  
You are now ready to enter your secret code. If you pause more than 15 seconds between steps you may have to start over.
5. Press SET and “000” will appear on the display.
6. Press SEEK and hold it until the first digit of your code appears.
7. Rotate the TUNE knob right or left to make the next two numbers agree with your code.
8. Press the BAND knob and “000” will appear. Now you are ready to enter the second three digits of the code according to steps 6 and 7.
9. Press the BAND knob. The display will show “rEP” for 5 seconds, and then “000” will appear indicating that some steps are to be repeated for verification.
10. Repeat steps 6, 7, and 8.
11. Press the BAND knob. If the display shows “SEC”, the verification process was successful and the system is SECURE. If the display shows “---”, the verification steps were not successful and the entire sequence must be started again.

## To Unlock The System After a Power Loss

When battery power is reapplied to a secured radio, the radio won't turn on and “LOC” will appear in the display.

Enter your secret code as follows. Pause no more than 15 seconds between steps.

- Turn the ignition ON (radio off.)
- Press the SET button. The display will show “000”.
- Enter the six digits of the code following steps 6 thru 9 on the preceding page. The display will show the number as entered.
- Press the BAND knob and the time appears -- indicating that the disabling sequence was successful. If the display indicates “SEC”, the number **did not** match and the unit is still secured.

## Disabling The Theft System

- Press preset buttons 1 and 4, for 5 seconds with the ignition "On" and radio power "Off". The display will show "SEC", indicating the unit is in the secure mode.
- Press the SET button. The display will show "000".
- Enter the first three digits of the code following step 6 and 7 of the preceding directions. The display will show the numbers as entered.
- Press the BAND knob. The radio will display "000".
- Enter the second three digits of the code. The display will show the numbers as entered.
- Press the BAND knob. If the display shows "---", the disabling sequence was successful. (The numbers matched the user-selected code or the factory back-up code) and the unit is in the UNSECURED mode. If the display shows "SEC", the disabling sequence was unsuccessful and the numbers did not match either of the codes and the unit will remain in the SECURED mode.

## Care of Your Cassette Tape Player



A tape player that is not cleaned regularly can cause reduced sound quality, ruined cassettes, or a damaged mechanism. Cassette tapes should be stored in their cases away from contaminants, direct sunlight, and extreme heat. If they aren't, they may not operate properly or cause failure of the tape player.



Your tape player should be cleaned regularly each month or after every 15 hours of use. If you notice a reduction in sound quality, try a known good cassette to see if the tape or the tape player is at fault. If this other cassette has no improvement in sound quality, clean the tape player.

Clean your tape player with a wiping-action, non-abrasive cleaning cassette, and follow the directions provided with it.

Cassettes are subject to wear and the sound quality may degrade over time. Always make sure that the cassette tape is in good condition before you have your tape player serviced.

## **Care of Your Compact Discs**

Handle discs carefully. Store them in their original cases or other protective cases and away from direct sunlight and dust. If the surface of a disc is soiled, dampen a clean, soft cloth in a mild, neutral detergent solution and clean it, wiping only from the center to the edge.

Be sure **never** to touch the signal surface when handling discs. Pick up discs by grasping the outer edges or the edge of the hole and the outer edge.

## **Fixed Mast Antenna**

The fixed mast antenna can withstand most car washes without being damaged. If the mast should ever become slightly bent, you can straighten it out by hand. If the mast is badly bent, as it might be by vandals, you should replace it.

Check every once in a while to be sure the mast is still tightened to the fender.

## **Power Antenna Mast Care**

Your power antenna will look its best and work well if it's cleaned from time to time.

### **To Clean the Antenna Mast:**

1. Turn on the ignition and radio to raise the antenna to full mast extension.

2. Dampen a clean cloth with mineral spirits or equivalent solvent.

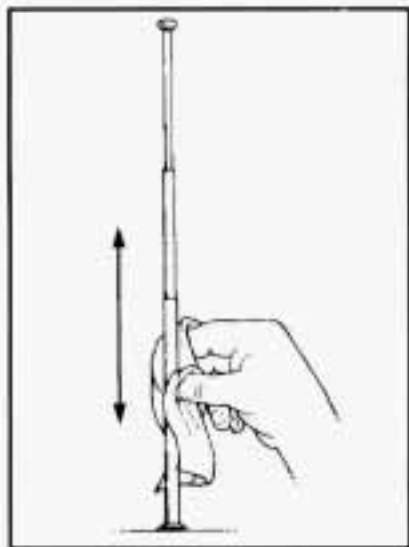

3. Wipe cloth over the mast sections, removing any dirt.

4. Wipe dry with clean cloth before retracting.
5. Make the antenna go up and down by turning the radio or ignition on and off.
6. Then repeat if necessary.

## **NOTICE:**

**Don't lubricate the power antenna. Lubrication could damage it.**

## **NOTICE:**

**Before entering an automatic car wash, turn off your radio to make the power antenna go down. This will prevent the mast from possibly getting damaged. If the antenna does not go down when you turn the radio off, it may be damaged or need to be cleaned. In either case, lower the antenna by hand by carefully pressing the antenna down.**

If the mast portion of your antenna is damaged, you can easily replace it. See your dealer for a replacement kit and follow the instructions in the kit.

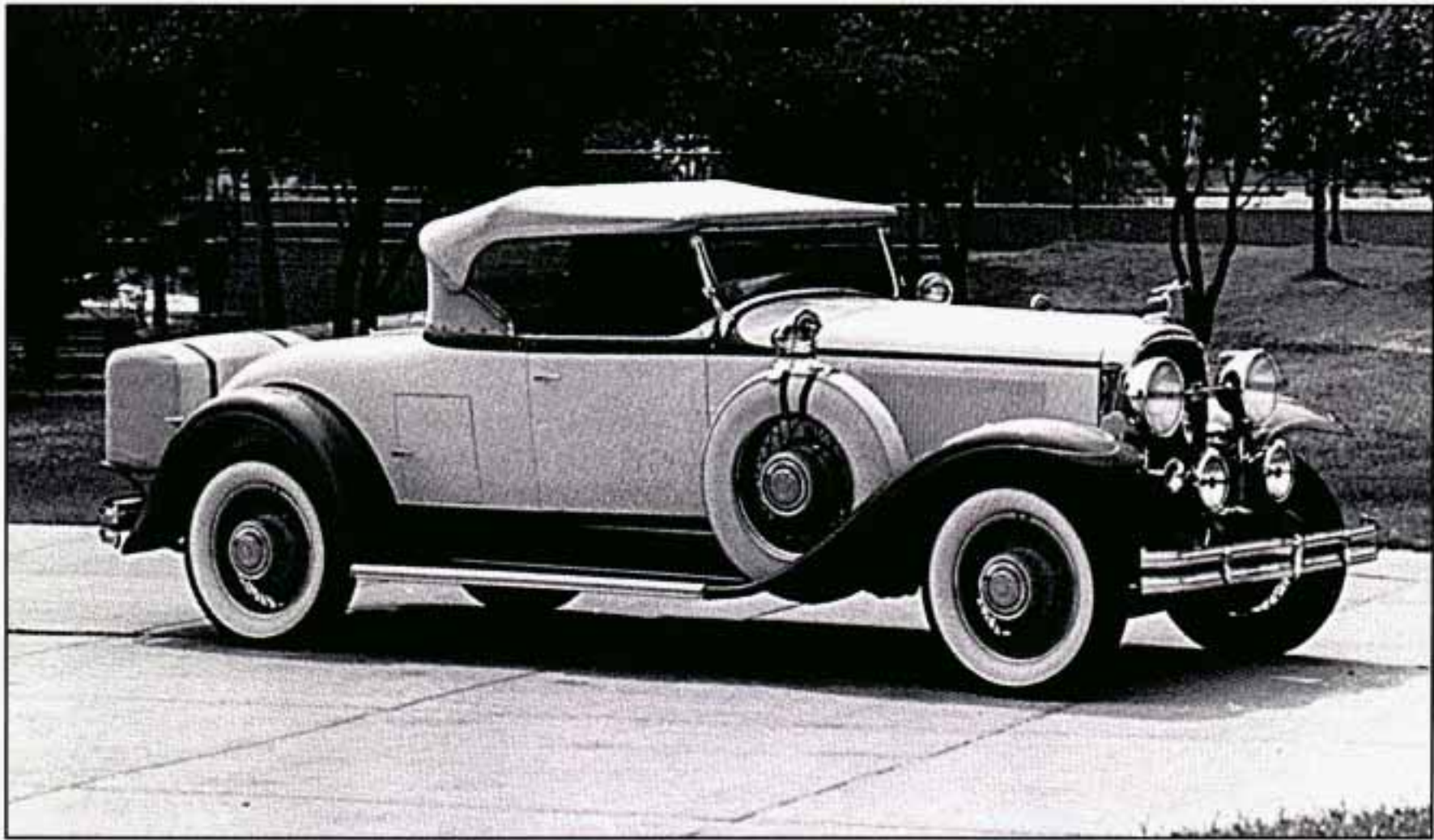

*1931 Buick Model 90*





## Part 4 Your Driving and the Road

Here you'll find information about driving on different kinds of roads and in varying weather conditions. We've also included many other useful tips on driving.

### Part 4 includes:

Defensive Driving .....	162
Drunken Driving .....	162
Control of a Vehicle .....	165
Braking .....	166
Steering .....	170
Passing .....	172
Loss of Control .....	173
Driving at Night .....	175
Driving in the Rain .....	176
City Driving .....	179
Freeway Driving .....	180
Hill and Mountain Roads .....	182
Winter Driving .....	184
Towing a Trailer .....	184



## Defensive Driving

The best advice anyone can give about driving is: Drive defensively.

Please start with a very important safety device in your Buick: Buckle up. (See "Safety Belts" in the Index.)

Defensive driving really means "be ready for anything." On city streets, rural roads, or freeways, it means "always expect the unexpected."

Assume that pedestrians or other drivers are going to be careless and make mistakes. Anticipate what they might do. Be ready for their mistakes.

Rear-end collisions are about the most preventable of accidents. Yet they are common. Allow enough following distance. It's the best defensive driving maneuver, in both city and rural driving. You never know when the vehicle in front of you is going to brake or turn suddenly.

## Drunken Driving

Death and injury associated with drinking and driving is a national tragedy. It's the number one contributor to the highway death toll, claiming thousands of victims every year. Alcohol takes away three things that anyone needs to drive a vehicle:

- Judgment
- Muscular Coordination
- Vision

Police records show that almost half of all motor vehicle-related deaths involve alcohol — a driver, a passenger or someone else, such as a pedestrian, had been drinking. In most cases, these deaths are the result of someone who was drinking and driving. About 20,000 motor vehicle-related deaths occur each year because of alcohol, and thousands of people are injured.

Just how much alcohol is too much if a person plans to drive? Ideally, no one should drink alcohol and then drive. But if one does, then what's "too much"? It can be a lot less than many might think. Although it depends on each person and situation, here is some general information on the problem.

The Blood Alcohol Content (BAC) of someone who is drinking depends upon four things:

- How much alcohol is in the drink.
- The drinker's body weight.
- The amount of food that is consumed before and during drinking.
- The length of time it has taken the drinker to consume the alcohol.



According to the American Medical Association, a 180-pound (82 kg) person who drinks three 12-ounce (355 ml) bottles of beer in an hour will end up with a BAC of about 0.06 percent. The person would reach the same BAC by drinking three 4-ounce (120 ml) glasses of wine or three mixed drinks if each had 1-1/2 ounces (45 ml) of a liquor like whiskey, gin or vodka.



It's the amount of alcohol that counts. For example, if the same person drank three double martinis (3 ounces or 90 ml of liquor each) within an hour, the person's BAC would be close to 0.12 percent. A person who consumes food just before or during drinking will have a slightly lower BAC level.

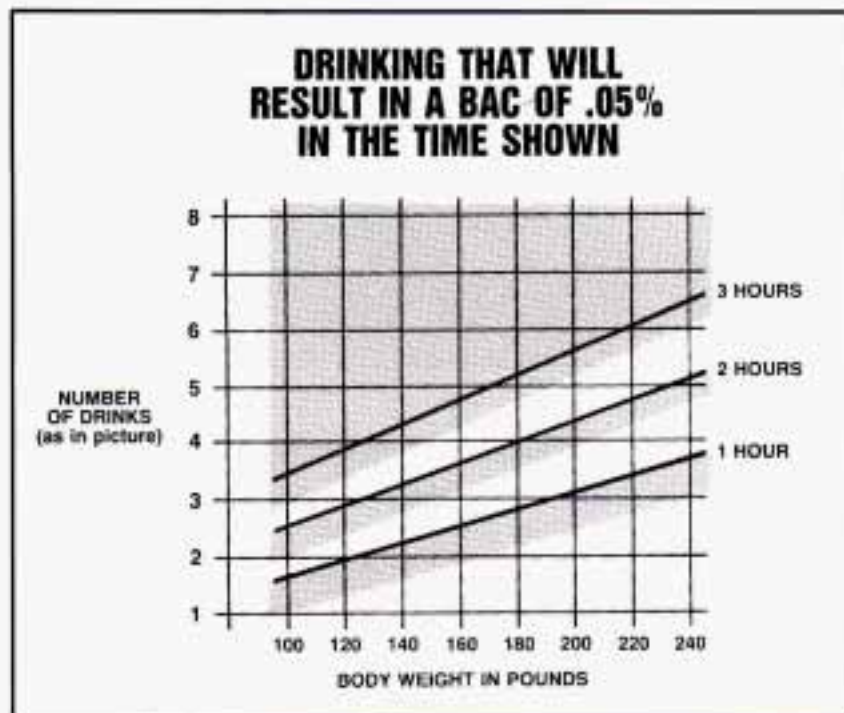

The law in most U.S. states sets the legal limit at a BAC of 0.10 percent. In Canada the limit is 0.08 percent, and

in some other countries it's lower than that. The BAC will be over 0.10 percent after three to six drinks (in one hour). Of course, as we've seen, it depends on how much alcohol is in the drinks, and how quickly the person drinks them.

But it's very important to keep in mind that the ability to drive is affected well below a BAC of 0.10 percent. Research shows that the driving skills of many people are impaired at a BAC approaching 0.05 percent, and that the effects are worse at night. All drivers are impaired at BAC levels above 0.05 percent. Statistics show that the chance of being in an accident increases sharply for drivers who have a BAC of 0.05 percent or above. A driver with a BAC level of 0.06 percent (three beers in one hour for a 180-pound or 82 kg person) has doubled his or her chance of having an accident. At a BAC level of 0.10 percent, the chance of that driver having an accident is six times greater; at a level of 0.15 percent, the chances are twenty-five times greater! And, the body takes about an hour to rid itself of the alcohol in one drink. No amount of coffee or number of cold showers will speed that up.

"I'll be careful" isn't the right answer. What if there's an emergency, a need to take sudden action, as when a child darts into the street? A person with a higher BAC might not be able to react quickly enough to avoid the collision.

There's something else about drinking and driving that many people don't know. Medical research shows that alcohol in a person's system can make crash injuries worse. That's especially true for brain, spinal cord and heart injuries. That means that if anyone who has been drinking -- driver or passenger -- is in a crash, the chance of being killed or permanently disabled is higher than if that person had not been drinking. And we've already seen that the chance of a crash itself is higher for drinking drivers.

**⚠ CAUTION:**

**Drinking and then driving is very dangerous. Your reflexes, perceptions, and judgment will be affected by even a small amount of alcohol. You could have a serious -- or even fatal -- accident if you drive after drinking. Please don't drink and drive or ride with a driver who has been drinking. Ride home in a cab; or if you're with a group, designate a driver who will not drink.**

## Control of a Vehicle

You have three systems that make your vehicle go where you want it to go. They are the brakes, the steering and the accelerator. All three systems have to do their work at the places where the tires meet the road.

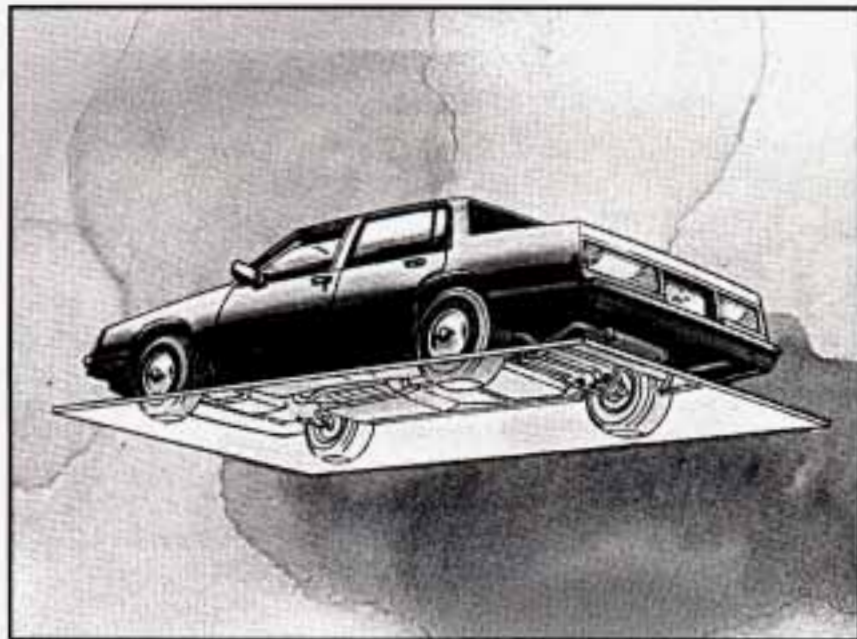

Sometimes, as when you're driving on snow or ice, it's easy to ask more of those control systems than the tires and road can provide. That means you can lose control of your vehicle.



## Braking

Braking action involves perception time and reaction time.

First, you have to decide to push on the brake pedal. That's perception time. Then you have to bring up your foot and do it. That's reaction time.

Average reaction time is about 3/4 of a second. But that's only an average. It might be less with one driver and as long as two or three seconds or more with another. Age, physical condition, alertness, coordination, and eyesight all play a part. So do alcohol, drugs and frustration. But even in 3/4 of a second, a vehicle moving at 60 mph (100 km/h) travels 66 feet (20 m). That could be a lot of distance in an emergency, so keeping enough space between your vehicle and others is important.

And, of course, actual stopping distances vary greatly with the surface of the road (whether it's pavement or gravel); the condition of the road (wet, dry, icy); tire tread; and the condition of your brakes.

Avoid needless heavy braking. Some people drive in spurts -- heavy acceleration followed by heavy braking -- rather than keeping pace with traffic. This is a mistake. Your brakes may not have time to cool between hard stops. Your brakes will wear out much faster if you do a lot of heavy braking. If you keep pace with the traffic and allow realistic following distances, you will eliminate a lot of unnecessary braking. That means better braking and longer brake life.

If your engine ever stops while you're driving, brake normally but don't pump your brakes. If you do, the pedal may get harder to push down. If your engine stops, you will still have some power brake assist. But you will use it when you brake. Once the power assist is used up, it may take longer to stop and the brake pedal will be harder to push.



## Anti-Lock Brakes (ABS)

Your Buick has an advanced electronic braking system that will help prevent skidding.

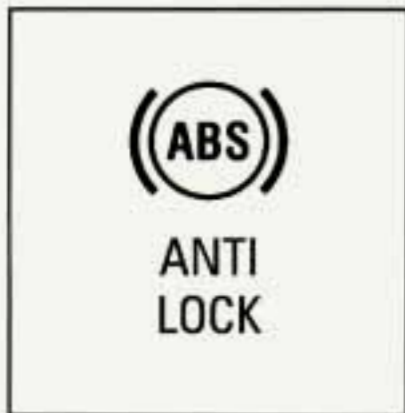
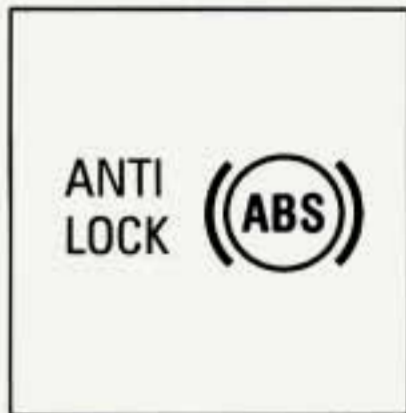

This light on the instrument panel will go on when you start your vehicle.

When you start your vehicle and begin to drive away, you may hear a momentary motor or clicking noise. And you may even notice that your brake pedal moves a little while this is going on. This is the ABS system testing itself. If there's a problem with the anti-lock brake system, the anti-lock brake system warning light will stay on.

See "Anti-lock Brake System Warning Light" in the Index.



Here's how anti-lock works. Let's say the road is wet. You're driving safely. Suddenly an animal jumps out in front of you.

You slam on the brakes. Here's what happens with ABS.

A computer senses that wheels are slowing down. If one of the wheels is about to stop rolling, the computer will separately work the brakes at each front wheel and at the rear wheels.

The anti-lock system can change the brake pressure faster than any driver could. The computer is programmed to make the most of available tire and road conditions.



You can steer around the obstacle while braking hard.

As you brake, your computer keeps receiving updates on wheel speed and controls braking pressure accordingly.

Remember: Anti-lock doesn't change the time you need to get your foot up to the brake pedal. If you get too close to the vehicle in front of you, you won't have time to apply your brakes if that vehicle suddenly slows or stops. Always leave enough room up ahead to stop, even though you have anti-lock brakes.

### **To Use Anti-Lock**

Don't pump the brakes. Just hold the brake pedal down and let anti-lock work for you. You may hear a motor or clicking noise during a hard stop, but this is normal.

### **Traction Control System (Option)**

Your vehicle may have a traction control system that limits wheel spin. This is especially useful in slippery road conditions. The system operates only if it senses that one or both of the front wheels are spinning or beginning to lose traction. When this happens, the system works the front brakes and reduces engine power (by shutting off fuel injectors and managing spark) to limit wheel spin.

You may feel the system working, or you may notice some noise, but this is normal. If your vehicle is in cruise control when the traction control system begins to



limit wheel spin, the cruise control will automatically disengage. When road conditions allow you to safely use it again, you may re-engage the cruise control. (See “Cruise Control” in the Index.)



The “TRACTION OFF” warning light will come on when you turn the traction control system off. When the system is on, this light will come on to let you know if there’s a problem with your traction control system. See “Traction Control System Warning Light” in the Index. When this warning light is on, the system will not limit wheel spin. Adjust your driving accordingly.

The traction control system automatically comes on whenever you start your vehicle. To limit wheel spin, especially in slippery road conditions, you should always leave the system on. But you can turn the

traction control system off if you ever need to. (You should turn the system off if your vehicle ever gets stuck in sand, mud, ice or snow. See “Rocking Your Vehicle” in the Index.)



To turn the system off, press the “TRACTION CONTROL” button on the instrument panel to the left of the steering wheel.

The “TRACTION OFF” warning light will come on and stay on. If the system is limiting wheel spin when you press the button, the system won’t turn off right away. It will wait until there’s no longer a current need to limit wheel spin.

You can turn the system back on at any time by pressing the button again. The “TRACTION OFF” warning light should go off.



## Braking in Emergencies

Use your anti-lock braking system when you need to. With anti-lock, you can steer and brake at the same time. In many emergencies, steering can help you more than even the very best braking.

## Steering

### Power Steering

If you lose power steering assist because the engine stops or the system is not functioning, you can steer but it will take much more effort.

### Steering Tips

#### Driving on Curves

It's important to take curves at a reasonable speed.

A lot of the "driver lost control" accidents mentioned on the news happen on curves. Here's why:

Experienced driver or beginner, each of us is subject to the same laws of physics when driving on curves. The traction of the tires against the road surface makes it possible for the vehicle to change its path when you turn the front wheels. If there's no traction, inertia will keep the vehicle going in the same direction. If you've ever tried to steer a vehicle on wet ice, you'll understand this.

The traction you can get in a curve depends on the condition of your tires and the road surface, the angle at which the curve is banked, and your speed. While you're in a curve, speed is the one factor you can control.

Suppose you're steering through a sharp curve. Then you suddenly accelerate. Both control systems -- steering and acceleration -- have to do their work where the tires meet the road. Unless you have traction control and the system is on, adding the sudden acceleration can demand too much of those places. You can lose control.

What should you do if this ever happens? Ease up on the accelerator pedal, steer the vehicle the way you want it to go, and slow down.

Speed limit signs near curves warn that you should adjust your speed. Of course, the posted speeds are based on good weather and road conditions. Under less favorable conditions you'll want to go slower.

If you need to reduce your speed as you approach a curve, do it before you enter the curve, while your front wheels are straight ahead.

Try to adjust your speed so you can “drive” through the curve. Maintain a reasonable, steady speed. Wait to accelerate until you are out of the curve, and then accelerate gently into the straightaway.

## Steering in Emergencies

There are times when steering can be more effective than braking. For example, you come over a hill and find a truck stopped in your lane, or a car suddenly pulls out from nowhere, or a child darts out from between parked cars and stops right in front of you. You can avoid these problems by braking -- if you can stop in time. But sometimes you can't; there isn't room. That's the time for evasive action -- steering around the problem.

Your Buick can perform very well in emergencies like these. First apply your brakes. It is better to remove as much speed as you can from a possible collision. Then steer around the problem, to the left or right depending on the space available.

An emergency like this requires close attention and a quick decision. If you are holding the steering wheel at the recommended 9 and 3 o'clock positions, you can turn it a full 180 degrees very quickly without removing either hand. But you have to act fast, steer quickly, and just as quickly straighten the wheel once you have avoided the object.

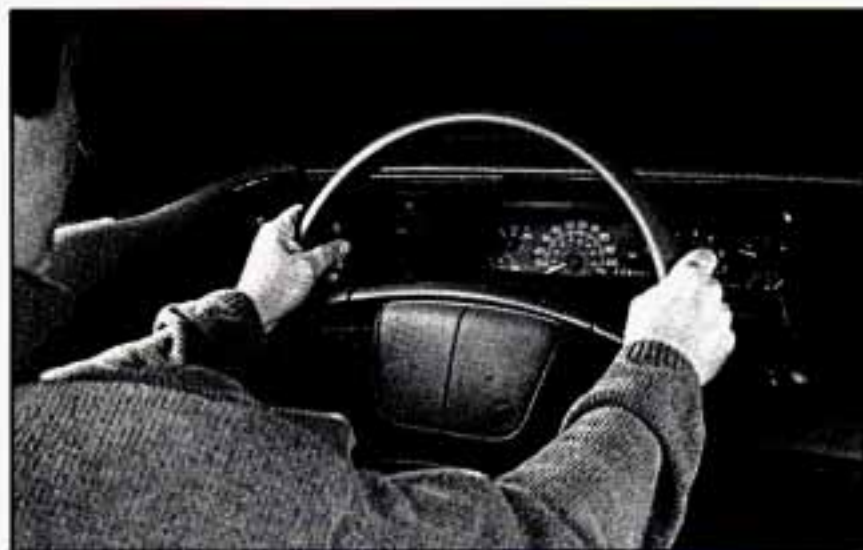

The fact that such emergency situations are always possible is a good reason to practice defensive driving at all times and wear safety belts properly.



## Off-Road Recovery

You may find sometime that your right wheels have dropped off the edge of a road onto the shoulder while you're driving.

If the level of the shoulder is only slightly below the pavement, recovery should be fairly easy. Ease off the accelerator and then, if there is nothing in the way, steer so that your vehicle straddles the edge of the pavement. You can turn the steering wheel up to 1/4 turn until the right front tire contacts the pavement edge. Then turn your steering wheel to go straight down the roadway.

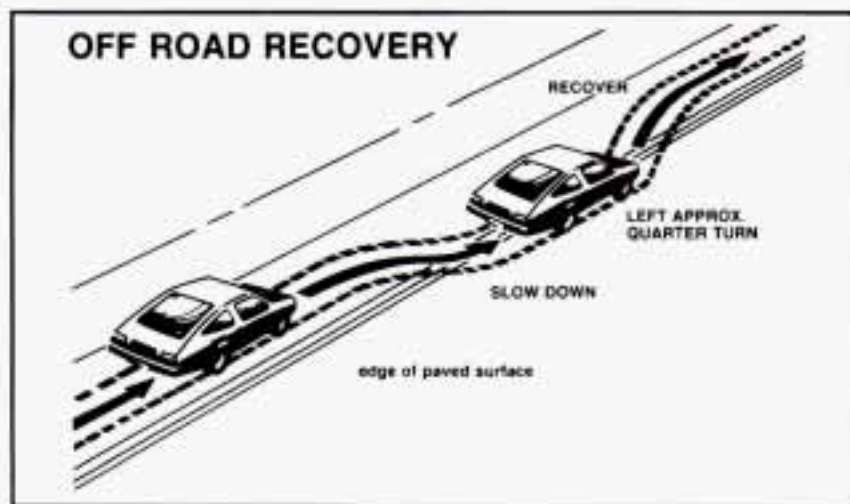

## Passing

The driver of a vehicle about to pass another on a two-lane highway waits for just the right moment, accelerates, moves around the vehicle ahead, then goes back into the right lane again. A simple maneuver?

Not necessarily! Passing another vehicle on a two-lane highway is a potentially dangerous move, since the passing vehicle occupies the same lane as oncoming traffic for several seconds. A miscalculation, an error in judgment, or a brief surrender to frustration or anger can suddenly put the passing driver face to face with the worst of all traffic accidents -- the head-on collision.

So here are some tips for passing:

- "Drive ahead." Look down the road, to the sides, and to crossroads for situations that might affect your passing patterns. If you have any doubt whatsoever about making a successful pass, wait for a better time.
- Watch for traffic signs, pavement markings, and lines. If you can see a sign up ahead that might indicate a turn or an intersection, delay your pass. A broken center line usually indicates it's all right to pass (providing the road ahead is clear). Never cross a solid line on your side of the lane or a double solid line, even if the road seems empty of approaching traffic.



- Do not get too close to the vehicle you want to pass while you're awaiting an opportunity. For one thing, following too closely reduces your area of vision, especially if you're following a larger vehicle. Also, you won't have adequate space if the vehicle ahead suddenly slows or stops. Keep back a reasonable distance.
- When it looks like a chance to pass is coming up, start to accelerate but stay in the right lane and don't get too close. Time your move so you will be increasing speed as the time comes to move into the other lane. If the way is clear to pass, you will have a "running start" that more than makes up for the distance you would lose by dropping back. And if something happens to cause you to cancel your pass, you need only slow down and drop back again and wait for another opportunity.
- If other cars are lined up to pass a slow vehicle, wait your turn. But take care that someone isn't trying to pass you as you pull out to pass the slow vehicle. Remember to glance over your shoulder and check the blind spot.
- Check your mirrors, glance over your shoulder, and start your left lane change signal before moving out of the right lane to pass. When you are far enough

ahead of the passed vehicle to see its front in your inside mirror, activate your right lane change signal and move back into the right lane. (Remember that your right outside mirror is convex. The vehicle you just passed may seem to be farther away from you than it really is.)

- Try not to pass more than one vehicle at a time on two-lane roads. Reconsider before passing the next vehicle.
- Don't overtake a slowly moving vehicle too rapidly. Even though the brake lights are not flashing, it may be slowing down or starting to turn.
- If you're being passed, make it easy for the following driver to get ahead of you. Perhaps you can ease a little to the right.

## Loss of Control

Let's review what driving experts say about what happens when the three control systems (brakes, steering and acceleration) don't have enough friction where the tires meet the road to do what the driver has asked.

In any emergency, don't give up. Keep trying to steer and constantly seek an escape route or area of less danger.

## Skidding

In a skid, a driver can lose control of the vehicle. Defensive drivers avoid most skids by taking reasonable care suited to existing conditions, and by not “overdriving” those conditions. But skids are always possible.

The three types of skids correspond to your Buick’s three control systems. In the braking skid your wheels aren’t rolling. In the steering or cornering skid, too much speed or steering in a curve causes tires to slip and lose cornering force. And in the acceleration skid too much throttle causes the driving wheels to spin.

A cornering skid is best handled by easing your foot off the accelerator pedal.

If you have the traction control system, remember: It helps avoid only the acceleration skid.

If you do not have traction control, or if the system is off, then an acceleration skid is also best handled by easing your foot off the accelerator pedal.

If your vehicle starts to slide, ease your foot off the accelerator pedal and quickly steer the way you want the vehicle to go. If you start steering quickly enough, your vehicle may straighten out. Always be ready for a second skid if it occurs.

Of course, traction is reduced when water, snow, ice, gravel, or other material is on the road. For safety, you’ll want to slow down and adjust your driving to these conditions. It is important to slow down on slippery surfaces because stopping distance will be longer and vehicle control more limited.

While driving on a surface with reduced traction, try your best to avoid sudden steering, acceleration, or braking (including engine braking by shifting to a lower gear). Any sudden changes could cause the tires to slide. You may not realize the surface is slippery until your vehicle is skidding. Learn to recognize warning clues -- such as enough water, ice or packed snow on the road to make a “mirrored surface” -- and slow down when you have any doubt.

Remember: Any anti-lock braking system (ABS) helps avoid only the braking skid.



## Driving at Night

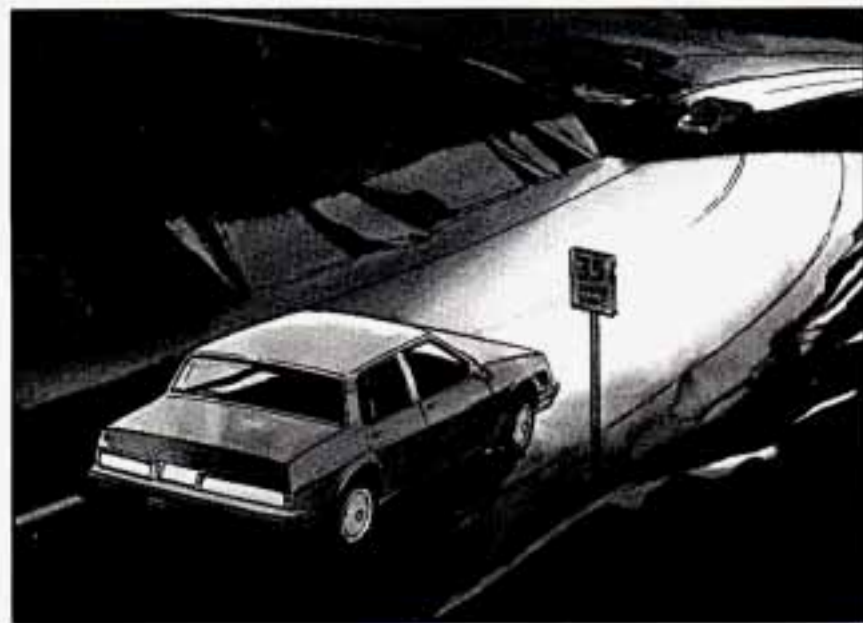

Night driving is more dangerous than day driving. One reason is that some drivers are likely to be impaired -- by alcohol or drugs, with night vision problems, or by fatigue.

Here are some tips on night driving.

- Drive defensively.
- Don't drink and drive.

- Adjust your inside rearview mirror to reduce the glare from headlights behind you.
- Since you can't see as well, you may need to slow down and keep more space between you and other vehicles.
- Slow down, especially on higher speed roads. Your headlights can light up only so much road ahead.
- In remote areas, watch for animals.
- If you're tired, pull off the road in a safe place and rest.

### Night Vision

No one can see as well at night as in the daytime. But as we get older these differences increase. A 50-year-old driver may require at least twice as much light to see the same thing at night as a 20-year-old.

What you do in the daytime can also affect your night vision. For example, if you spend the day in bright sunshine you are wise to wear sunglasses. Your eyes will have less trouble adjusting to night. But if you're driving, don't wear sunglasses at night. They may cut down on glare from headlights, but they also make a lot of things invisible.

You can be temporarily blinded by approaching lights. It can take a second or two, or even several seconds, for



your eyes to readjust to the dark. When you are faced with severe glare (as from a driver who doesn't lower the high beams, or a vehicle with misaimed headlights), slow down a little. Avoid staring directly into the approaching lights.

Keep your windshield and all the glass on your vehicle clean -- inside and out. Glare at night is made much worse by dirt on the glass. Even the inside of the glass can build up a film caused by dust. Dirty glass makes lights dazzle and flash more than clean glass would, making the pupils of your eyes contract repeatedly.

Remember that your headlights light up far less of a roadway when you are in a turn or curve. Keep your eyes moving; that way, it's easier to pick out dimly lighted objects. Just as your headlights should be checked regularly for proper aim, so should your eyes be examined regularly. Some drivers suffer from night blindness -- the inability to see in dim light -- and aren't even aware of it.

## Driving in the Rain



Rain and wet roads can mean driving trouble. On a wet road you can't stop, accelerate or turn as well because your tire-to-road traction isn't as good as on dry roads. And, if your tires don't have much tread left, you'll get even less traction. It's always wise to go slower and be cautious if rain starts to fall while you are driving. The surface may get wet suddenly when your reflexes are tuned for driving on dry pavement.

The heavier the rain, the harder it is to see. Even if your windshield wiper blades are in good shape, a heavy rain can make it harder to see road signs and traffic signals, pavement markings, the edge of the road, and even people walking.

It's wise to keep your wiping equipment in good shape and keep your windshield washer tank filled. Replace your windshield wiper inserts when they show signs of streaking or missing areas on the windshield, or when strips of rubber start to separate from the inserts.



Driving too fast through large water puddles or even going through some car washes can cause problems, too. The water may affect your brakes. Try to avoid puddles. But if you can't, try to slow down before you hit them.

 **CAUTION:**

**Wet brakes can cause accidents. They won't work well in a quick stop and may cause pulling to one side. You could lose control of the vehicle. After driving through a large puddle of water or a car wash, apply your brake pedal lightly until your brakes work normally.**

## Hydroplaning

Hydroplaning is dangerous. So much water can build up under your tires that they can actually ride on the water. This can happen if the road is wet enough and you're going fast enough. When your vehicle is hydroplaning, it has little or no contact with the road.

Hydroplaning doesn't happen often. But it can if your tires haven't much tread or if the pressure in one or more is low. It can happen if a lot of water is standing on the road. If you can see reflections from trees, telephone poles, or other vehicles, and raindrops "dimple" the water's surface, there could be hydroplaning.

Hydroplaning usually happens at higher speeds. There just isn't a hard and fast rule about hydroplaning. The best advice is to slow down when it is raining.

## Some Other Rainy Weather Tips

- Turn on your low-beam headlights -- not just your parking lights -- to help make you more visible to others.
- Besides slowing down, allow some extra following distance. And be especially careful when you pass another vehicle. Allow yourself more clear room ahead, and be prepared to have your view restricted by road spray.
- Have good tires with proper tread depth. (See "Tires" in the Index.)



## City Driving



One of the biggest problems with city streets is the amount of traffic on them. You'll want to watch out for what the other drivers are doing and pay attention to traffic signals.

Here are ways to increase your safety in city driving:

- Know the best way to get to where you are going. Get a city map and plan your trip into an unknown part of the city just as you would for a cross-country trip.
- Try to use the freeways that rim and crisscross most large cities. You'll save time and energy. (See the next section, "Freeway Driving.")
- Treat a green light as a warning signal. A traffic light is there because the corner is busy enough to need it. When a light turns green, and just before you start to move, check both ways for vehicles that have not cleared the intersection or may be running the red light.

## Freeway Driving

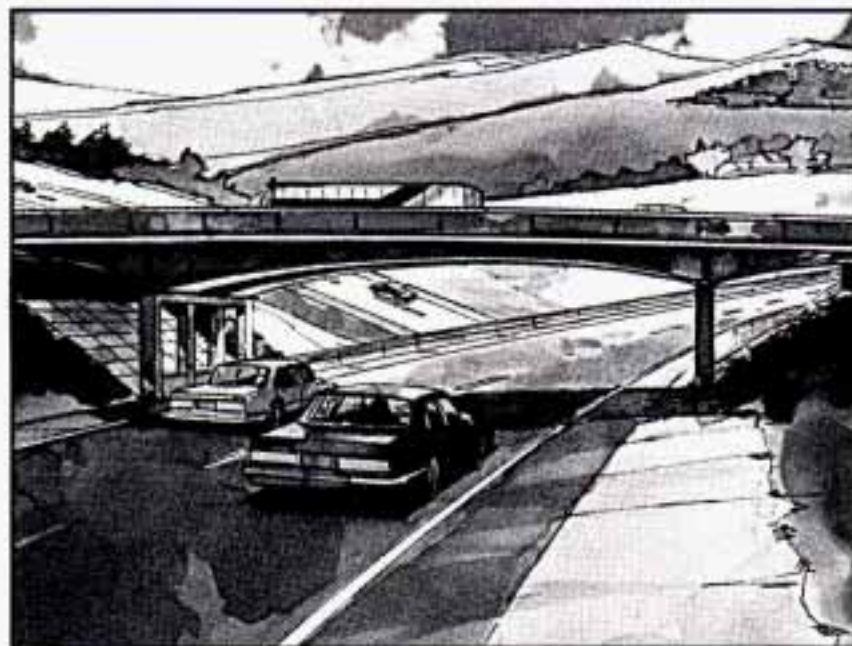

Mile for mile, freeways (also called thruways, parkways, expressways, turnpikes, or superhighways) are the safest of all roads. But they have their own special rules.

The most important advice on freeway driving is: Keep up with traffic and keep to the right. Drive at the same speed most of the other drivers are driving. Too-fast or too-slow driving breaks a smooth traffic flow. Treat the left lane on a freeway as a passing lane.

At the entrance there is usually a ramp that leads to the freeway. If you have a clear view of the freeway as you drive along the entrance ramp, you should begin to check traffic. Try to determine where you expect to blend with the flow. Try to merge into the gap at close to the prevailing speed. Switch on your turn signal, check your mirrors and glance over your shoulder as often as necessary. Try to blend smoothly with the traffic flow.

Once you are on the freeway, adjust your speed to the posted limit or to the prevailing rate if it's slower. Stay in the right lane unless you want to pass.

Before changing lanes, check your mirrors. Then use your turn signal.

Just before you leave the lane, glance quickly over your shoulder to make sure there isn't another vehicle in your "blind" spot.

Once you are moving on the freeway, make certain you allow a reasonable following distance. Expect to move slightly slower at night.

When you want to leave the freeway, move to the proper lane well in advance. If you miss your exit do not, under any circumstances, stop and back up. Drive on to the next exit.

The exit ramp can be curved, sometimes quite sharply.

The exit speed is usually posted.

Reduce your speed according to your speedometer, not to your sense of motion. After driving for any distance at higher speeds, you may tend to think you are going slower than you actually are.

## **Before Leaving on a Long Trip**

Make sure you're ready. Try to be well rested. If you must start when you're not fresh -- such as after a day's work -- don't plan to make too many miles that first part of the journey. Wear comfortable clothing and shoes you can easily drive in.

Is your vehicle ready for a long trip? If you keep it serviced and maintained, it's ready to go. If it needs service, have it done before starting out. Of course, you'll find experienced and able service experts in Buick dealerships all across North America. They'll be ready and willing to help if you need it.

Here are some things you can check before a trip:

- Windshield Washer Fluid: Is the reservoir full? Are all windows clean inside and outside?
- Wiper Blades: Are they in good shape?
- Fuel, Engine Oil, Other Fluids: Have you checked all levels?
- Lights: Are they all working? Are the lenses clean?
- Tires: They are vitally important to a safe, trouble-free trip. Is the tread good enough for long-distance driving? Are the tires all inflated to the recommended pressure?
- Weather Forecasts: What's the weather outlook along your route? Should you delay your trip a short time to avoid a major storm system?
- Maps: Do you have up-to-date maps?



## Highway Hypnosis

Is there actually such a condition as “highway hypnosis”? Or is it just plain falling asleep at the wheel? Call it highway hypnosis, lack of awareness, or whatever.

There is something about an easy stretch of road with the same scenery, along with the hum of the tires on the road, the drone of the engine, and the rush of the wind against the vehicle that can make you sleepy. Don't let it happen to you! If it does, your vehicle can leave the road in less than a second, and you could crash and be injured.

What can you do about highway hypnosis? First, be aware that it can happen.

Then here are some tips:

- Make sure your vehicle is well ventilated, with a comfortably cool interior.
- Keep your eyes moving. Scan the road ahead and to the sides. Check your rearview mirrors and your instruments frequently.
- If you get sleepy, pull off the road into a rest, service, or parking area and take a nap, get some exercise, or both. For safety, treat drowsiness on the highway as an emergency.

## Hill and Mountain Roads

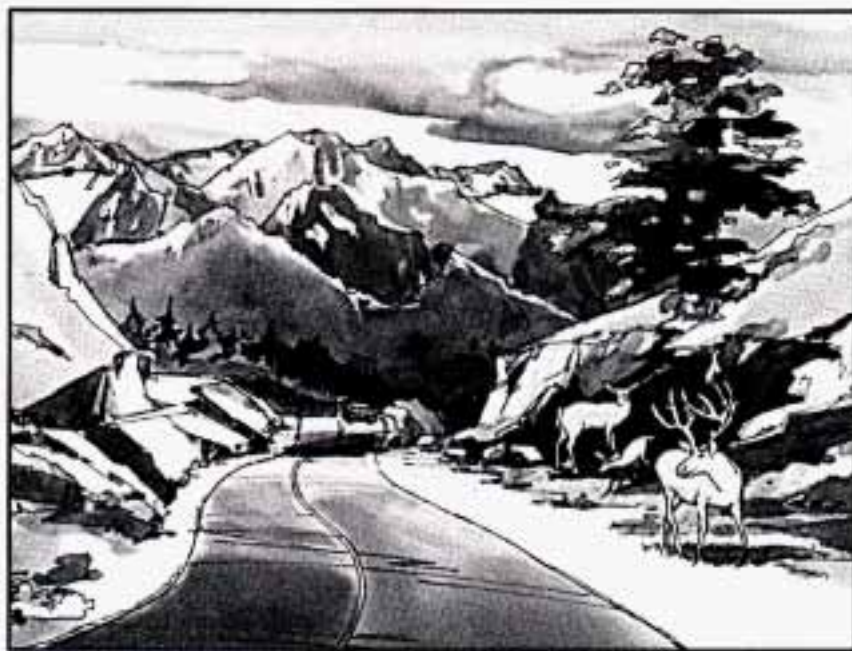

Driving on steep hills or mountains is different from driving in flat or rolling terrain.

If you drive regularly in steep country, or if you're planning to visit there, here are some tips that can make your trips safer and more enjoyable.

- Keep your vehicle in good shape. Check all fluid levels and also the brakes, tires, cooling system and transaxle. These parts can work hard on mountain roads.
- Know how to go down hills. The most important thing to know is this: let your engine do some of the slowing down. Shift to a lower gear when you go down a steep or long hill.

**CAUTION:**

**If you don't shift down, your brakes could get so hot that they wouldn't work well. You would then have poor braking or even none going down a hill. You could crash. Shift down to let your engine assist your brakes on a steep downhill slope.**

**CAUTION:**

**Coasting downhill in "N" (Neutral) or with the ignition off is dangerous. Your brakes will have to do all the work of slowing down. They could get so hot that they wouldn't work well. You could crash. Always have your engine running and your vehicle in gear when you go downhill.**

- Know how to go uphill. Shift down to "D" (Drive). This will help cool your engine and transaxle, and you can climb the hill better.
- Stay in your own lane when driving on two-lane roads in hills or mountains. Don't swing wide or cut across the center of the road. Drive at speeds that let you stay in your own lane.
- As you go over the top of a hill, be alert. There could be something in your lane, like a stalled car or an accident.
- You may see highway signs on mountains that warn of special problems. Examples are long grades, passing or no-passing zones, a falling rocks area, or winding roads. Be alert to these and take appropriate action.



## Winter Driving

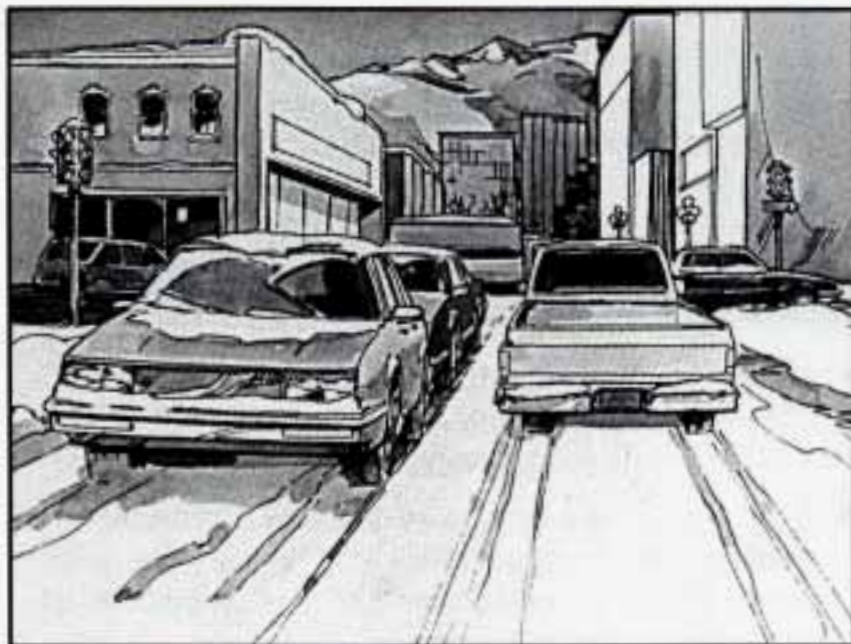

Here are some tips for winter driving:

- Have your Buick in good shape for winter. Be sure your engine coolant mix is correct.
- You may want to put winter emergency supplies in your trunk.

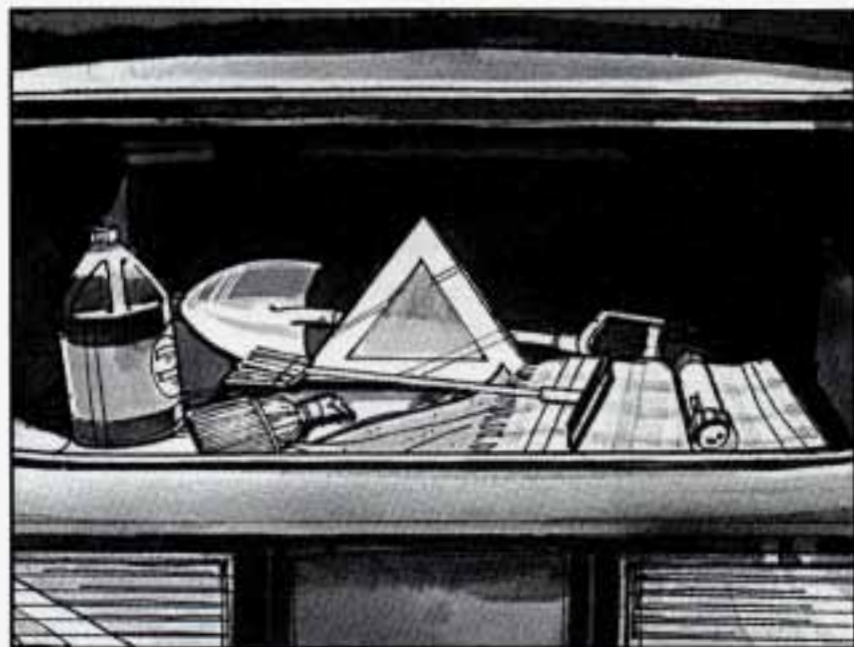

Include an ice scraper, a small brush or broom, a supply of windshield washer fluid, a rag, some winter outer clothing, a small shovel, a flashlight, a red cloth, and a couple of reflective warning triangles. And, if you will be driving under severe conditions, include a small bag of sand, a piece of old carpet or a couple of burlap bags to help provide traction. Be sure you properly secure these items in your vehicle.



## Driving on Snow or Ice

Most of the time, those places where your tires meet the road probably have good traction.

However, if there is snow or ice between your tires and the road, you can have a very slippery situation. You'll have a lot less traction or "grip" and will need to be very careful.

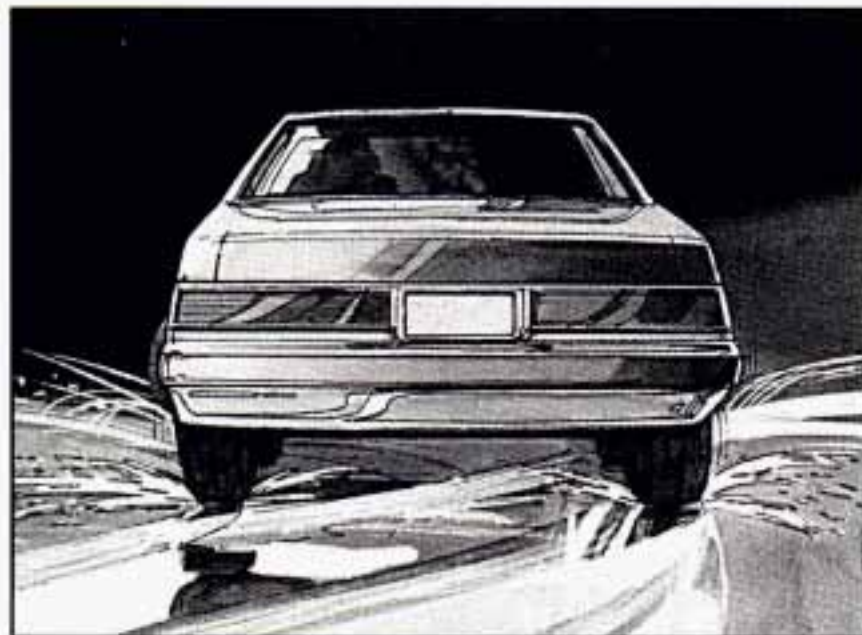

What's the worst time for this? "Wet ice." Very cold snow or ice can be slick and hard to drive on. But wet ice can be even more trouble because it may offer the least traction of all. You can get "wet ice" when it's about freezing (32°F; 0°C) and freezing rain begins to fall. Try to avoid driving on wet ice until salt and sand crews can get there.

Whatever the condition -- smooth ice, packed, blowing or loose snow -- drive with caution.

If you have traction control, keep the system on. It will improve your ability to accelerate when driving on a slippery road. Even though your vehicle has a traction control system, you'll want to slow down and adjust your driving to the road conditions. See "Traction Control System" in the Index.

If you don't have the traction control system, accelerate gently. Try not to break the fragile traction. If you accelerate too fast, the drive wheels will spin and polish the surface under the tires even more.

Your anti-lock brakes improve your ability to make a hard stop on a slippery road. Even though you have the anti-lock braking system, you'll want to begin stopping sooner than you would on dry pavement. See "Anti-lock" in the Index.

- Allow greater following distance on any slippery road.
- Watch for slippery spots. The road might be fine until you hit a spot that's covered with ice. On an otherwise clear road, ice patches may appear in shaded areas where the sun can't reach: around clumps of trees, behind buildings, or under bridges. Sometimes the surface of a curve or an overpass may remain icy when the surrounding roads are clear. If you see a patch of ice ahead of you, brake before you are on it. Try not to brake while you're actually on the ice, and avoid sudden steering maneuvers.

## If You're Caught in a Blizzard



If you are stopped by heavy snow, you could be in a serious situation. You should probably stay with your vehicle unless you know for sure that you are near help and you can hike through the snow. Here are some things to do to summon help and keep yourself and your passengers safe: Turn on your hazard flashers. Tie a red cloth to your vehicle to alert police that you've been stopped by the snow. Put on extra clothing or wrap a

blanket around you. If you have no blankets or extra clothing, make body insulators from newspapers, burlap bags, rags, floor mats -- anything you can wrap around yourself or tuck under your clothing to keep warm.

You can run the engine to keep warm, but be careful.



**⚠ CAUTION:**

**Snow can trap exhaust gases under your vehicle. This can cause deadly CO (carbon monoxide) gas to get inside. CO could overcome you and kill you. You can't see it or smell it, so you might not know it is in your vehicle. Clear away snow from around the base of your vehicle, especially any that is blocking your exhaust pipe. And check around again from time to time to be sure snow doesn't collect there.**

**Open a window just a little on the side of the vehicle that's away from the wind. This will help keep CO out.**



Run your engine only as long as you must. This saves fuel. When you run the engine, make it go a little faster than just idle. That is, push the accelerator slightly. This uses less fuel for the heat that you get and it keeps the battery charged. You will need a well-charged battery to restart the vehicle, and possibly for signaling later on with your headlights. Let the heater run for awhile.

Then, shut the engine off and close the window almost all the way to preserve the heat. Start the engine again and repeat this only when you feel really uncomfortable from the cold. But do it as little as possible. Preserve the fuel as long as you can. To help keep warm, you can get out of the vehicle and do some fairly vigorous exercises every half hour or so until help comes.

## Towing a Trailer



### **CAUTION:**

**If you don't use the correct equipment and drive properly, you can lose control when you pull a trailer. For example, if the trailer is too heavy, the brakes may not work well -- or even at all. You and your passengers could be seriously injured. Pull a trailer only if you have followed all the steps in this section. Ask your Buick dealer for advice and information about towing a trailer with your vehicle.**

### **NOTICE:**

**Pulling a trailer improperly can damage your vehicle and result in costly repairs not covered by your warranty. To pull a trailer correctly, follow the advice in this section, and see your Buick dealer for important information about towing a trailer with your vehicle .**

Your car can tow a trailer if it is equipped with the 3800 (L27) engine or (L67) Supercharged engine and proper trailer towing equipment. To identify what the vehicle trailering capacity is for your vehicle, you should read the information in “Weight of the Trailer” that appears later in this section. But trailering is different than just driving your vehicle by itself. Trailering means changes in handling, durability, and fuel economy. Successful, safe trailering takes correct equipment, and it has to be used properly.

That’s the reason for this section. In it are many time-tested, important trailering tips and safety rules. Many of these are important for your safety and that of your passengers. So please read this section carefully before you pull a trailer.

Load-pulling components such as the engine, transaxle, wheel assemblies, and tires are forced to work harder against the drag of the added weight. The engine is required to operate at relatively higher speeds and under greater loads, generating extra heat. What’s more, the trailer adds considerably to wind resistance, increasing the pulling requirements.

## If You Do Decide To Pull A Trailer

If you do, here are some important points.

- There are many different laws having to do with trailering. Make sure your rig will be legal, not only where you live but also where you’ll be driving. A good source for this information can be state or provincial police.
- Consider using a sway control if your trailer will weigh 2,000 pounds (900 kg) or less. You should always use a sway control if your trailer will weigh more than 2,000 pounds (900 kg).

You can ask a hitch dealer about sway controls.

- Don’t tow a trailer at all during the first 500 miles (800 km) your new vehicle is driven. Your engine, axle or other parts could be damaged.
- Then, during the first 500 miles (800 km) that you tow a trailer, don’t drive over 50 mph (80 km/h) and don’t make starts at full throttle. This helps your engine and other parts of your vehicle wear in at the heavier loads.

Three important considerations have to do with weight:



## Weight of the Trailer

How heavy can a trailer safely be?

It should never weigh more than 1,000 pounds (450 kg), unless you have the optional 3,000 pound (1350 kg) trailer towing package. But even that can be too heavy.

It depends on how you plan to use your rig. For example, speed, altitude, road grades, outside temperature and how much your vehicle is used to pull a trailer are all important. And, it can also depend on any special equipment that you have on your vehicle.

You can ask your dealer for our trailering information or advice, or you can write us at Buick Motor Division, Customer Assistance Center, 902 E. Hamilton Avenue, Flint, MI 48550.

In Canada, write to General Motors of Canada Limited, Customer Assistance Center, 1908 Colonel Sam Drive, Oshawa, Ontario L1H 8P7.

## Weight of the Trailer Tongue

The tongue load (A) of any trailer is an important weight to measure because it affects the total capacity weight of your vehicle. The capacity weight includes the curb weight of the vehicle, any cargo you may carry in it, and the people who will be riding in the vehicle. And

if you will tow a trailer, you must subtract the tongue load from your vehicle's capacity weight because your vehicle will be carrying that weight, too. See "Loading Your Vehicle" in the Index for more information about your vehicle's maximum load capacity.

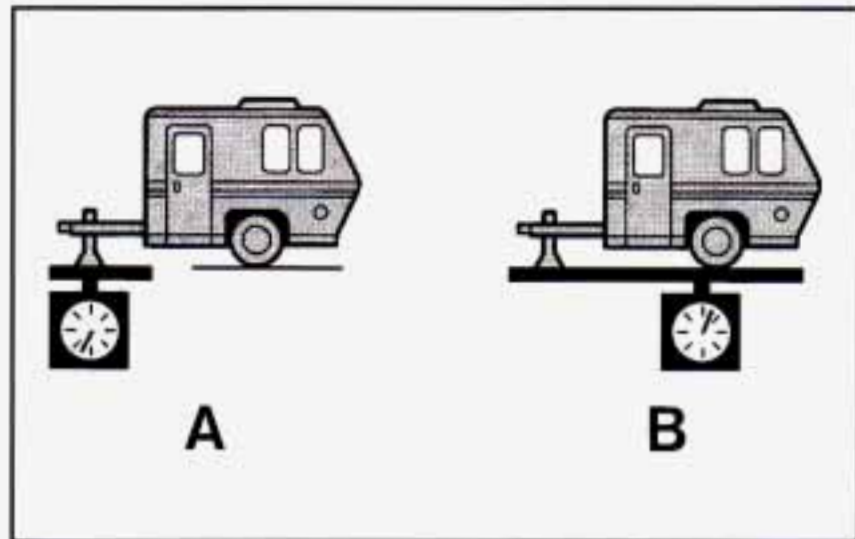

If you're using a "dead-weight" hitch, the trailer tongue (A) should weigh 10% of the total loaded trailer weight (B). If you have a "weight-distributing" hitch, the trailer tongue (A) should weigh 12% of the total loaded trailer weight (B).



After you've loaded your trailer, weigh the trailer and then the tongue, separately, to see if the weights are proper. If they aren't, you may be able to get them right simply by moving some items around in the trailer.

## **Total Weight on Your Vehicle's Tires**

Be sure your vehicle's tires are inflated to the limit for cold tires. You'll find these numbers on the Certification label at the rear edge of the driver's door or see "Loading Your Vehicle" in the Index. Then be sure you don't go over the GVW limit for your vehicle.

## **Hitches**

It's important to have the correct hitch equipment. Crosswinds, large trucks going by, and rough roads are a few reasons why you'll need the right hitch. Here are some rules to follow:

- If you'll be pulling a trailer that, when loaded, will weigh more than 2,000 pounds (900 kg), be sure to use a properly mounted, weight-distributing hitch and sway control of the proper size. This equipment is very important for proper vehicle loading and good handling when you're driving.
- Will you have to make any holes in the body of your vehicle when you install a trailer hitch? If you do, then be sure to seal the holes later when you remove

the hitch. If you don't seal them, deadly carbon monoxide (CO) from your exhaust can get into your vehicle (see "Carbon Monoxide" in the Index). Dirt and water can, too.

- The bumpers on your vehicle are not intended for hitches. Do not attach rental hitches or other bumper-type hitches to them. Use only a frame-mounted hitch that does not attach to the bumper.

## **Safety Chains**

You should always attach chains between your vehicle and your trailer. Cross the safety chains under the tongue of the trailer so that the tongue will not drop to the road if it becomes separated from the hitch. Instructions about safety chains may be provided by the hitch manufacturer or by the trailer manufacturer. Follow the manufacturer's recommendation for attaching safety chains. Always leave just enough slack so you can turn with your rig. And, never allow safety chains to drag on the ground.

## **Trailer Brakes**

If your trailer weighs more than 1,000 pounds (450 kg) loaded, then it needs its own brakes -- and they must be adequate. Be sure to read and follow the instructions for

the trailer brakes so you'll be able to install, adjust and maintain them properly. Because you have anti-lock brakes, do not try to tap into your vehicle's brake system. If you do, both brake systems won't work well, or at all.

## **Driving with a Trailer**

Towing a trailer requires a certain amount of experience. Before setting out for the open road, you'll want to get to know your rig. Acquaint yourself with the feel of handling and braking with the added weight of the trailer. And always keep in mind that the vehicle you are driving is now a good deal longer and not nearly so responsive as your vehicle is by itself.

Before you start, check the trailer hitch and platform, safety chains, electrical connector, lights, tires and mirror adjustment. If the trailer has electric brakes, start your vehicle and trailer moving and then apply the trailer brake controller by hand to be sure the brakes are working. This lets you check your electrical connection at the same time.

During your trip, check occasionally to be sure that the load is secure, and that the lights and any trailer brakes are still working.

## **Following Distance**

Stay at least twice as far behind the vehicle ahead as you would when driving your vehicle without a trailer. This can help you avoid situations that require heavy braking and sudden turns.

## **Passing**

You'll need more passing distance up ahead when you're towing a trailer. And, because you're a good deal longer, you'll need to go much farther beyond the passed vehicle before you can return to your lane.

## **Backing Up**

Hold the bottom of the steering wheel with one hand. Then, to move the trailer to the left, just move that hand to the left. To move the trailer to the right, move your hand to the right. Always back up slowly and, if possible, have someone guide you.

## **Making Turns**

When you're turning with a trailer, make wider turns than normal. Do this so your trailer won't strike soft shoulders, curbs, road signs, trees, or other objects. Avoid jerky or sudden maneuvers. Signal well in advance.



## Turn Signals When Towing a Trailer

When you tow a trailer, your vehicle has to have a different turn signal flasher and extra wiring. The green arrows on your instrument panel will flash whenever you signal a turn or lane change. Properly hooked up, the trailer lights will also flash, telling other drivers you're about to turn, change lanes or stop.

When towing a trailer, the green arrows on your instrument panel will flash for turns even if the bulbs on the trailer are burned out. Thus, you may think drivers behind you are seeing your signal when they are not. It's important to check occasionally to be sure the trailer bulbs are still working.

Your vehicle has bulb warning lights. When you plug trailer lights into your vehicle's lighting system, its bulb warning lights may not let you know if one of your lights goes out. So, when you have trailer lights plugged in, be sure to check your vehicle and trailer lights from time to time to be sure they're all working. Once you disconnect the trailer lights, the bulb warning lights again can tell you if one of your vehicle lights is out.

## Driving On Grades

Reduce speed and shift to a lower gear **before** you start down a long or steep downgrade. If you don't shift

down, you might have to use your brakes so much that they would get hot and no longer work well.

On a long uphill grade, shift down to "D or 3" (Drive) and reduce your speed to around 45 mph (70 km/h) to reduce the possibility of engine and transaxle overheating.

## Parking on Hills

You really should not park your vehicle, with a trailer attached, on a hill. If something goes wrong, your rig could start to move. People can be injured, and both your vehicle and the trailer can be damaged.

But if you ever have to park your rig on a hill, here's how to do it:

1. Apply your regular brakes, but don't shift into "P" (Park) yet.
2. Have someone place chocks under the trailer wheels.
3. When the wheel chocks are in place, release the regular brakes until the chocks absorb the load.
4. Reapply the regular brakes. Then apply your parking brake, and the shift to "P" (Park).
5. Release the regular brakes.



## **When You Are Ready to Leave After Parking on a Hill**

1. Apply your regular brakes and hold the pedal down while you:
  - Start your engine;
  - Shift into a gear; and
  - Release the parking brake.
2. Let up on the brake pedal.
3. Drive slowly until the trailer is clear of the chocks.
4. Stop and have someone pick up and store the chocks.

## **Maintenance When Trailer Towing**

Your vehicle will need service more often when you're pulling a trailer. See the Maintenance Schedule for more on this. Things that are especially important in trailer operation are automatic transaxle fluid (don't overfill), engine oil, belts, cooling system, and brake adjustment. Each of these is covered in this manual, and the Index will help you find them quickly. If you're trailering, it's a good idea to review these sections before you start your trip.

Check periodically to see that all hitch nuts and bolts are tight.



## Part 5 Problems on the Road

---

---

Here you'll find what to do about some problems that can occur on the road.

**Part 5 includes:**

Hazard Warning Flashers .....	196
Other Warning Devices .....	197
“Jump” Starting .....	198
Towing Your Buick .....	203
Engine Overheating .....	207
If a Tire Goes Flat .....	214
Changing a Flat Tire .....	215
Compact Spare Tire .....	224
If You're Stuck in Sand, Mud, Ice or Snow .....	225

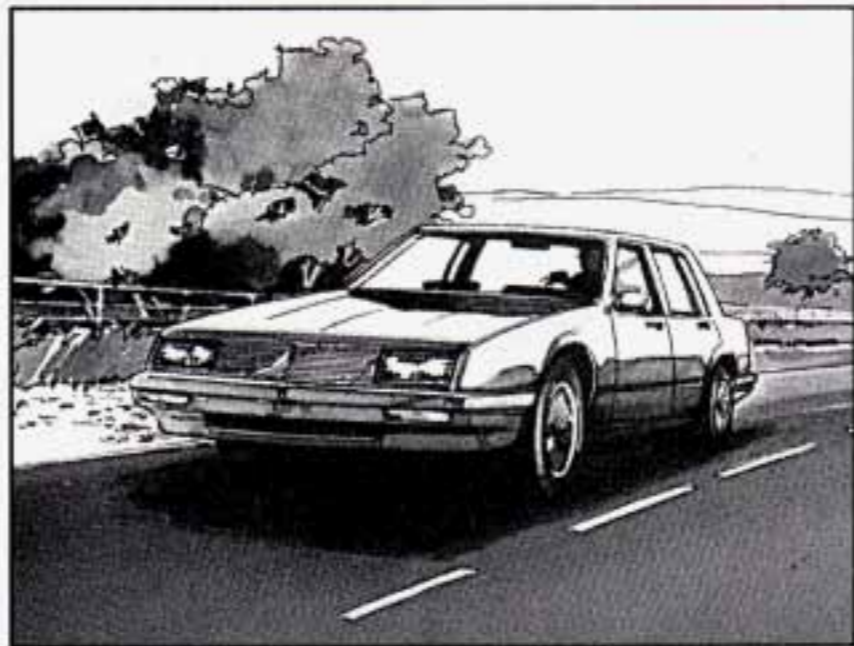

## Hazard Warning Flashers

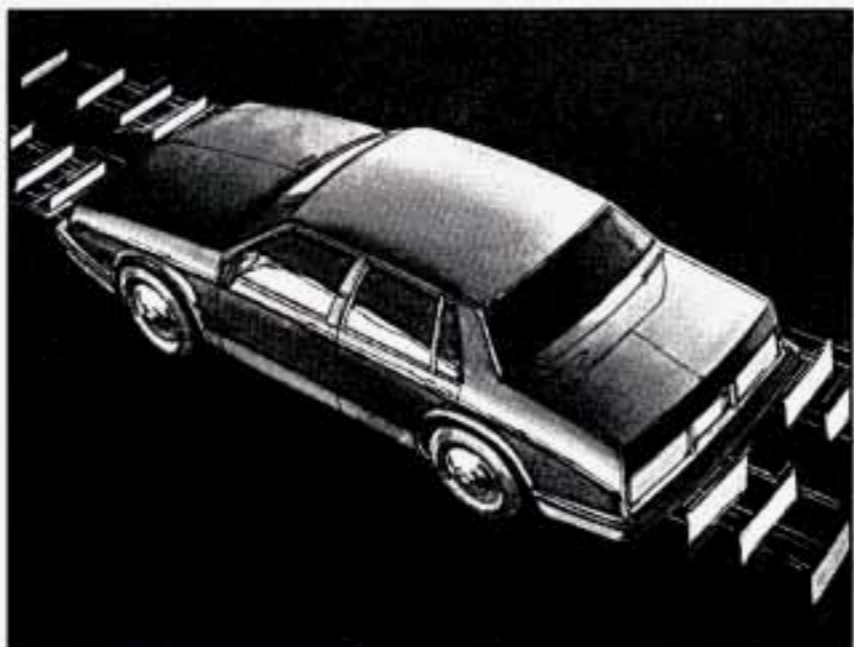

Your hazard warning flashers let you warn others. They also let police know you have a problem. Your front and rear turn signal lights will flash on and off.





Press the button in to make your front and rear turn signal lights flash on and off.

Your hazard warning flashers work no matter what position your key is in, and even if the key isn't in.



To turn off the flashers, pull out on the collar.

When the hazard warning flashers are on, your turn signals won't work.

## Other Warning Devices

If you carry reflective triangles, you can set one up at the side of the road about 300 feet (100 m) behind your vehicle.

## Jump Starting

If your battery has run down, you may want to use another vehicle and some jumper cables to start your Buick. But please follow the steps below to do it safely.

### CAUTION:

**Batteries can hurt you. They can be dangerous because:**

- They contain **acid** that can burn you.
- They contain **gas** that can explode or ignite.
- They contain enough **electricity** to burn you.

**If you don't follow these steps exactly, some or all of these things can hurt you.**

### NOTICE:

**Ignoring these steps could result in costly damage to your vehicle that wouldn't be covered by your warranty.**

**Trying to start your Buick by pushing or pulling it won't work, and it could damage your vehicle.**

### To Jump Start Your Buick:

1. Check the other vehicle. It must have a 12-volt battery with a negative ground system.

### NOTICE:

**If the other system isn't a 12-volt system with a negative ground, both vehicles can be damaged.**

2. Get the vehicles close enough so the jumper cables can reach, but be sure the vehicles aren't touching each other. If they are, it could cause a ground connection you don't want. You wouldn't be able to start your Buick, and the bad grounding could damage the electrical systems.

You could be injured if the vehicles roll. Set the parking brake firmly on each vehicle. Put an automatic transaxle in "P" (Park) or a manual transaxle in "N" (Neutral).

3. Turn off the ignition on both vehicles. Turn off the radios and all lights that aren't needed. This will avoid sparks and help save both batteries. It could save your radio!

### **NOTICE:**

**If you leave your radio on, it could be badly damaged. The repairs wouldn't be covered by your warranty.**

4. Open the hoods and locate the batteries.



### **CAUTION:**

**An electric fan can start up even when the engine is not running and can injure you. Keep hands, clothing and tools away from any underhood electric fan.**

Find the positive (+) and negative (-) terminals on each battery.



 **CAUTION:**

**Using a match near a battery can cause battery gas to explode. People have been hurt doing this, and some have been blinded. Use a flashlight if you need more light.**

**Be sure the battery has enough water. You don't need to add water to the Delco Freedom<sup>®</sup> battery installed in every new GM vehicle. But if a battery has filler caps, be sure the right amount of fluid is there. If it is low, add water to take care of that first. If you don't, explosive gas could be present.**

**Battery fluid contains acid that can burn you. Don't get it on you. If you accidentally get it in your eyes or on your skin, flush the place with water and get medical help immediately.**

Before you connect the cables, here are some basic things you should know. Positive (+) will go to positive (+) and negative (-) will go to negative (-) or a metal engine part. Don't connect (+) to (-) or you'll get a short that would damage the battery and maybe other parts, too.

 **CAUTION:**

**Fans or other moving engine parts can injure you badly. Keep your hands away from moving parts once the engines are running.**

5. Check that the jumper cables don't have loose or missing insulation. If they do, you could get a shock and the vehicles could be damaged.



6. Connect the red positive (+) cable to the positive (+) terminal of the vehicle with the dead battery. Use a remote positive (+) terminal if the vehicle has one.



7. Don't let the other end touch metal. Connect it to the positive (+) terminal of the good battery. Use a remote positive (+) terminal if the vehicle has one.



8. Now connect the black negative (-) cable to the good battery's negative (-) terminal.

Don't let the other end touch anything until the next step. The other end of the negative cable **doesn't** go to the dead battery. It goes to a heavy unpainted metal part on the engine of the vehicle with the dead battery.



9. Attach the cable at least 18 inches (45 cm) away from the dead battery, but not near engine parts that move. The electrical connection is just as good there, but the chance of sparks getting back to the battery is much less.

10. Now start the vehicle with the good battery and run the engine for a while.

11. Try to start the vehicle with the dead battery.

If it won't start after a few tries, it probably needs service.

12. Remove the cables in reverse order to prevent electrical shorting. Take care that they don't touch each other or any other metal.

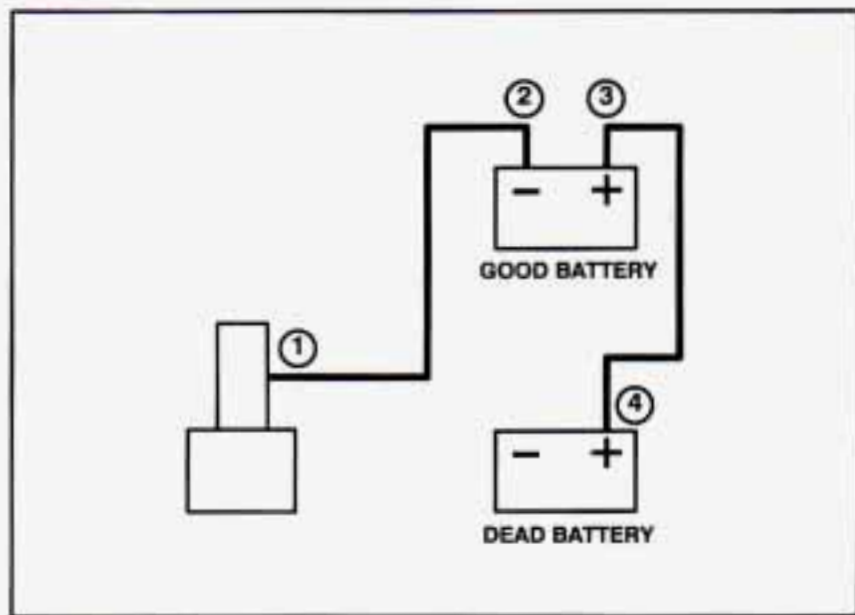

Remove the cables in this order.



## Towing Your Park Avenue

Try to have a GM dealer or a professional towing service tow your Buick. The usual towing equipment is a sling-type (A), wheel-lift (B) or car carrier (C) tow truck.

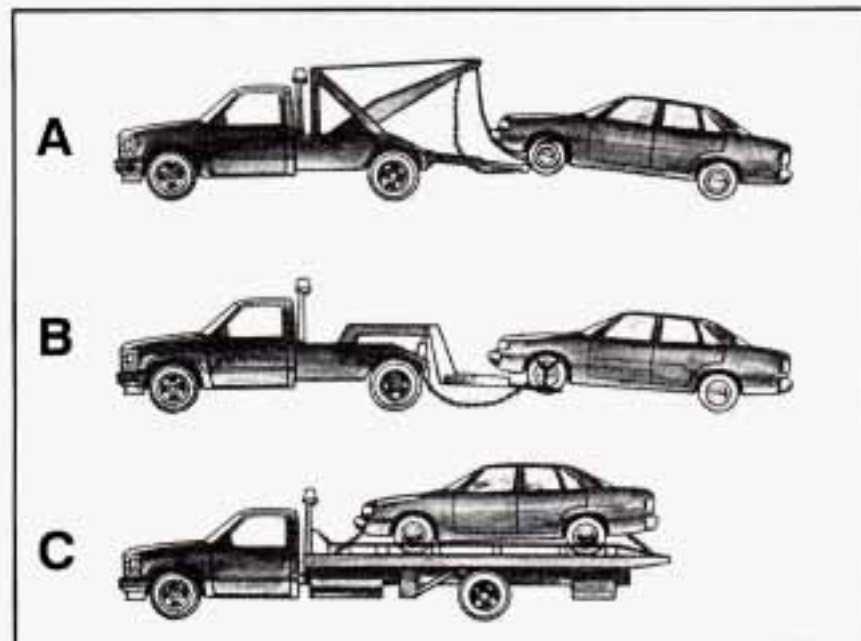

If your vehicle has been changed or modified since it was factory-new by adding after market items like fog lamps, aero skirting, or special tires and wheels, these instructions and illustrations may not be correct.

Before you do anything, turn on the hazard warning flashers.

When you call, tell the towing service:

- That your vehicle has front-wheel drive.
- The make, model, and year of your vehicle.
- Whether you can still move the shift lever.
- If there was an accident, what was damaged.

When the towing service arrives, let the tow operator know that this manual contains detailed towing instructions and illustrations. The operator may want to see them.

 **CAUTION:**

To help avoid injury to you or others:

- Never let passengers ride in a vehicle that is being towed.
- Never tow faster than safe or posted speeds.
- Never tow with damaged parts not fully secured.
- Never get under your vehicle after it has been lifted by the tow truck.
- Always secure the vehicle on each side with separate safety chains when towing it.
- Never use "J" hooks. Use T-hooks instead.

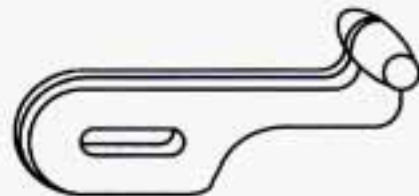

When your vehicle is being towed, have the ignition key off. The steering wheel should be clamped in a straight-ahead position, with a clamping device designed for towing service. Do not use the vehicle's steering column lock for this. The transaxle should be in Neutral and the parking brake released.

Don't have your vehicle towed on the front wheels, unless you must. If the vehicle must be towed on the front wheels, don't go more than **55 mph (88 km/h)** or farther than **500 miles (800 km)** or your transaxle will be damaged. If these limits must be exceeded, then the front wheels have to be supported on a dolly.

 **CAUTION:**

A vehicle can fall from a car carrier if it isn't adequately secured. This can cause a collision, serious personal injury and vehicle damage. The vehicle should be tightly secured with chains or steel cables before it is transported.

Don't use substitutes (ropes, leather straps, canvas webbing, etc.) that can be cut by sharp edges underneath the towed vehicle. Always use T-hooks inserted in the T-hook slots. Never use J-hooks. They will damage drivetrain and suspension components.

## Front Towing Hookups

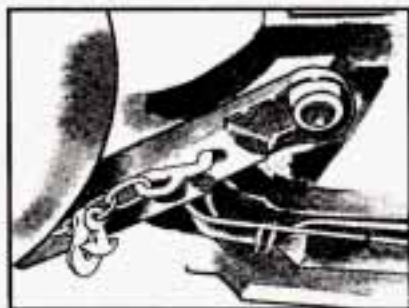

Attach "T" hook chains behind the front wheels into the bottom slots of the cradle rails on both sides.

Position a 4" x 4" wood beam across the sling chains contacting the bottom of the radiator support. Position the lower sling crossbar just behind the rear edge of the front bumper.

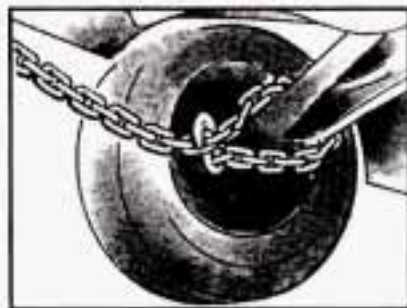

Attach a separate safety chain around the outboard end of each lower control arm.

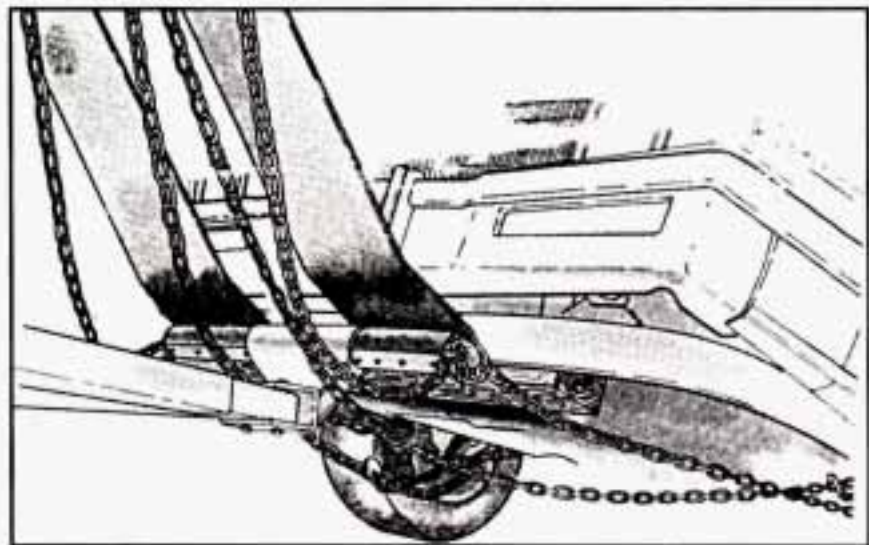



## Rear Towing Hookups

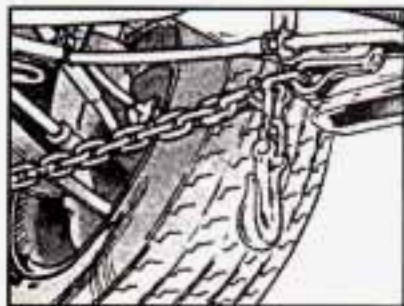

Attach "T" hook chains to the slots in the bottom of the floor pan of the rear wheels on both sides.

Position the lower sling crossbar directly under the rear bumper. A 4" x 4" wood beam is not needed.

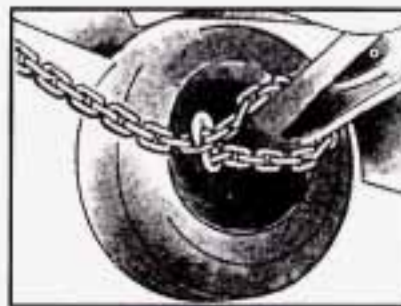

Attach a separate safety chain around the outboard end of each lower control arm.

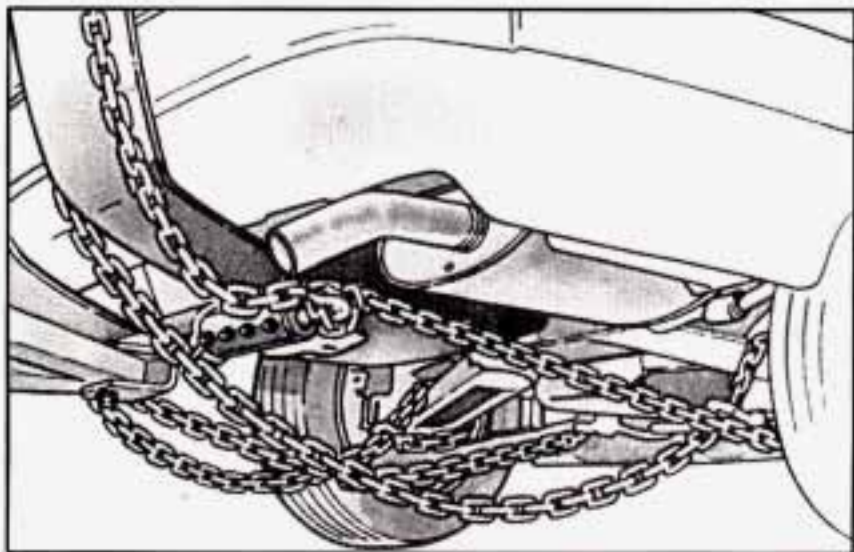

## Engine Overheating

You will find a warning light about a hot engine on your Buick instrument panel and if you have the optional gage cluster, a coolant temperature gage. You will also find a low coolant warning light.

### If Steam Is Coming From Your Engine



#### **CAUTION:**

**Steam from an overheated engine can burn you badly, even if you just open the hood. Stay away from the engine if you see or hear steam coming from it. Just turn it off and get everyone away from the vehicle until it cools down. Wait until there is no sign of steam or coolant before opening the hood.**

**If you keep driving when your engine is overheated, the liquids in it can catch fire. You or others could be badly burned. Stop your engine if it overheats, and get out of the vehicle until the engine is cool.**

#### **NOTICE:**

**If your engine catches fire because you keep driving with no coolant, your vehicle can be badly damaged. The costly repairs would not be covered by your warranty.**

### If No Steam Is Coming From Your Engine

If you get the overheat warning but see or hear no steam, the problem may not be too serious. Sometimes the engine can get a little too hot when you:

- Climb a long hill on a hot day.
- Stop after high speed driving.
- Idle for long periods in traffic.
- Tow a trailer.

If you get the overheat warning with no sign of steam, try this for a minute or so:

1. Turn off your air conditioner.
2. Turn on your heater to full hot at the highest fan speed and open the window as necessary.
3. If you're in a traffic jam, shift to "N" (Neutral).

If you no longer have the overheat warning, you can drive. Just to be safe, drive slower for about ten minutes. If the warning doesn't come back on, you can drive normally.

If the warning continues, pull over, stop, and park your vehicle right away.

If there's still no sign of steam, you can idle the engine for two or three minutes while you're parked, to see if the warning stops. But then, if you still have the warning, **TURN OFF THE ENGINE AND GET EVERYONE OUT OF THE VEHICLE** until it cools down.

You may decide not to lift the hood but to get service help right away.

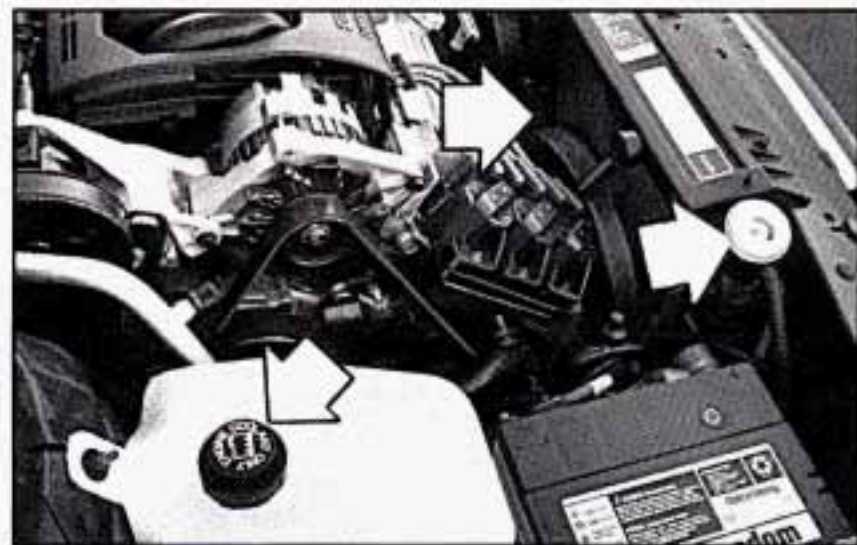

When you decide it's safe to lift the hood, here's what you'll see:

- Coolant recovery tank
- Radiator pressure cap
- Electric engine fans



**⚠ CAUTION:**

**An electric fan under the hood can start up even when the engine is not running and can injure you. Keep hands, clothing and tools away from any underhood electric fan.**

If the coolant inside the coolant recovery tank is boiling, don't do anything else until it cools down.



The coolant level should be at or above "FULL COLD." If it isn't, you may have a leak in the radiator hoses, heater hoses, radiator, water pump or somewhere else in the cooling system.

**⚠ CAUTION:**

**Heater and radiator hoses, and other engine parts, can be very hot. Don't touch them. If you do, you can be burned.**

**Don't run the engine if there is a leak. If you run the engine, it could lose all coolant. That could cause an engine fire, and you could be burned. Get any leak fixed before you drive the vehicle.**

**NOTICE:**

**Engine damage from running your engine without coolant isn't covered by your warranty.**

If there seems to be no leak, check to see if the electric engine fans are running. If the engine is overheating, both fans should be running. If they aren't, your vehicle needs service.

## How to Add Coolant to the Coolant Recovery Tank

If you haven't found a problem yet, but the coolant level isn't at or above the "FULL COLD" mark, add a 50/50 mixture of clean water (preferably distilled) and a proper antifreeze at the coolant recovery tank. (See "Engine Coolant" in the Index for more information about the proper coolant mix.)

### CAUTION:

Adding only plain water to your cooling system can be dangerous. Plain water, or some other liquid like alcohol, can boil before the proper coolant mix will. Your vehicle's coolant warning system is set for the proper coolant mix. With plain water or the wrong mix, your engine could get too hot but you wouldn't get the overheat warning. Your engine could catch fire and you or others could be burned. Use a 50/50 mix of clean water and a proper antifreeze.

### NOTICE:

In cold weather, water can freeze and crack the engine, radiator, heater core and other parts. Use the recommended coolant.





 **CAUTION:**

**You can be burned if you spill coolant on hot engine parts. Coolant contains ethylene glycol and it will burn if the engine parts are hot enough. Don't spill coolant on a hot engine.**

When the coolant in the coolant recovery tank is at or above the "FULL COLD" mark, start your vehicle.

If the overheat warning continues, there's one more thing you can try. You can add the proper coolant mix directly to the radiator but be sure the cooling system is cool before you do it.

 **CAUTION:**

**Steam and scalding liquids from a hot cooling system can blow out and burn you badly. They are under pressure, and if you turn the radiator pressure cap -- even a little -- they can come out at high speed. Never turn the cap when the cooling system, including the radiator pressure cap, is hot. Wait for the cooling system and radiator pressure cap to cool if you ever have to turn the pressure cap.**

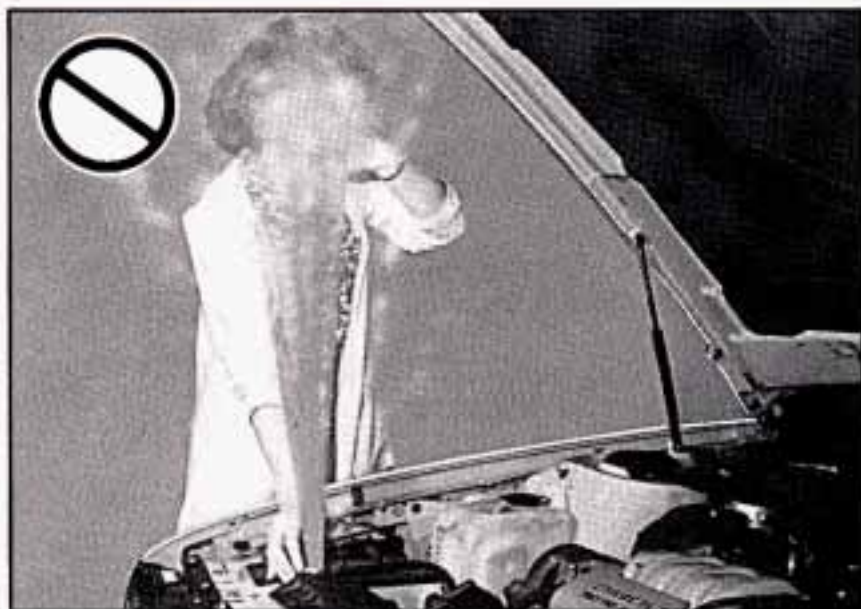



## How to Add Coolant to the Radiator

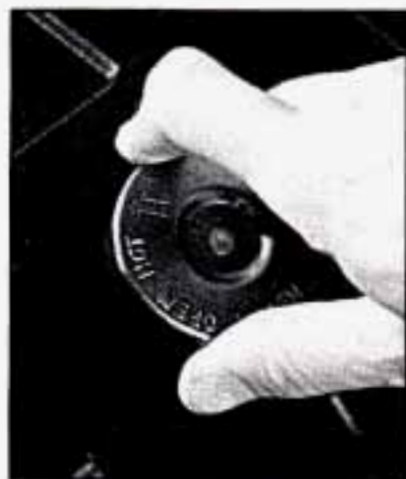

1. You can remove the radiator pressure cap when the cooling system, including the radiator pressure cap and upper radiator hose, is no longer hot. Turn the pressure cap slowly to the left until it first stops. (Don't press down while turning the pressure cap.)

If you hear a hiss, wait for that to stop. A hiss means there is still some pressure left.



2. Then keep turning the pressure cap, but now push down as you turn it. Remove the pressure cap.



3. Fill the radiator with the proper mix, up to the base of the filler neck.

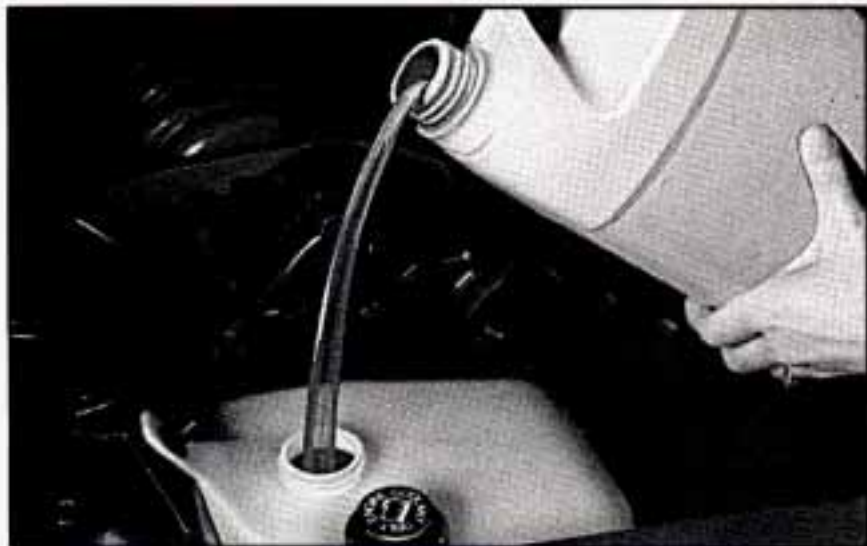

4. Then fill the coolant recovery tank to "FULL COLD."
5. Put the cap back on the coolant recovery tank, but leave the radiator pressure cap off.



6. Start the engine and let it run until you can feel the upper radiator hose getting hot. Watch out for the engine fans.
7. By this time the coolant level inside the radiator filler neck may be lower. If the level is lower, add more of the proper mix through the filler neck until the level reaches the base of the filler neck.



8. Then replace the pressure cap. At any time during this procedure if coolant begins to flow out of the filler neck, reinstall the pressure cap. Be sure the arrows on pressure cap line up like this.

## If a Tire Goes Flat

It's unusual for a tire to "blow out" while you're driving, especially if you maintain your tires properly. If air goes out of a tire, it's much more likely to leak out slowly. But if you should ever have a "blowout," here are a few tips about what to expect and what to do:

If a front tire fails, the flat tire will create a drag that pulls the vehicle toward that side. Take your foot off the accelerator pedal and grip the steering wheel firmly. Steer to maintain lane position, then gently brake to a stop well out of the traffic lane.

A rear blowout, particularly on a curve, acts much like a skid and may require the same correction you'd use in a skid. In any rear blowout, remove your foot from the accelerator pedal. Get the vehicle under control by steering the way you want the vehicle to go. It may be very bumpy and noisy, but you can still steer. Gently brake to a stop, well off the road if possible.

If a tire goes flat, the next section shows how to use your jacking equipment to change a flat tire safely.



## Changing a Flat Tire

If a tire goes flat, avoid further tire and wheel damage by driving slowly to a level place. Turn on your hazard warning flashers.

### CAUTION:

Changing a tire can cause an injury. The vehicle can slip off the jack and roll over you or other people. You and they could be badly injured. Find a level place to change your tire. To help prevent the vehicle from moving:

1. Set the parking brake firmly.
2. Put the shift lever in "P" (Park).
3. Turn off the engine.

To be even more certain the vehicle won't move, you can put chocks at the front and rear of the tire farthest away from the one being changed. That would be the tire on the other side of the vehicle, at the opposite end.

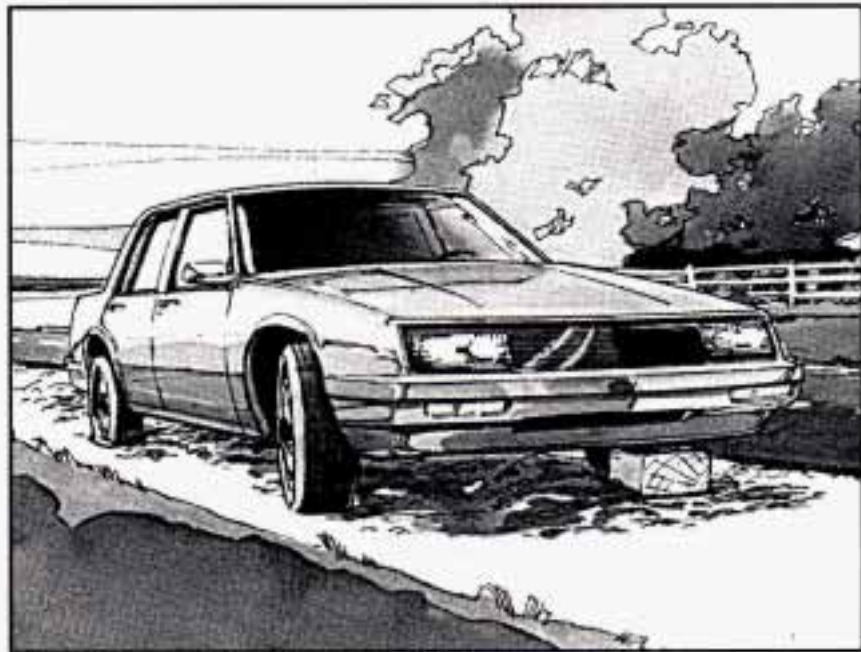

The following steps will tell you how to use the jack and change a tire.

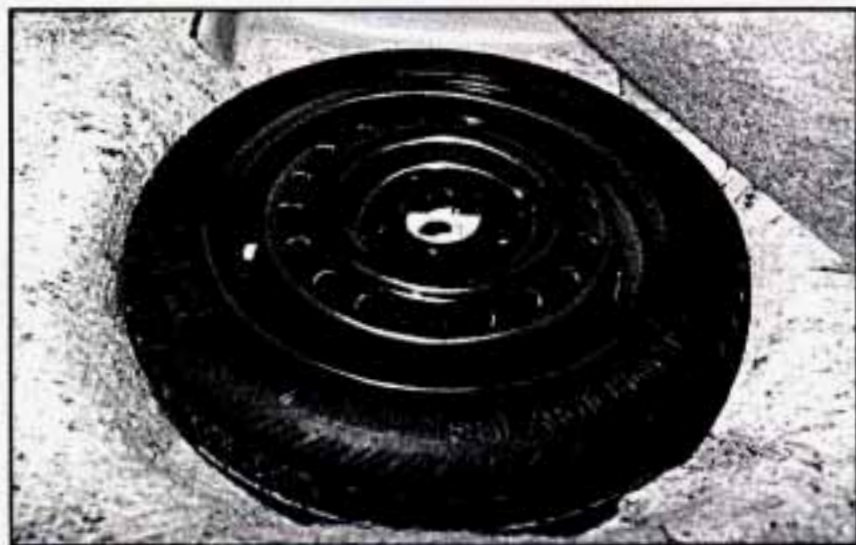

Start with the jack and the wheel wrench.

The equipment you'll need is in the trunk.







The jack has a bolt at the end. Attach the wheel wrench to the jack bolt.



Rotate the wheel wrench clockwise (to the right). That will raise the lift head a little.

If your Buick has a wheel cover, you must take it off to reach the wheel nuts.



If your vehicle has an aluminum wheel with a center cover, remove it using the flat end of the wheel wrench.





If your vehicle has this aluminum wheel, you may have plastic wheel nut caps. Use the wheel nut wrench to remove the wheel nut caps and to loosen the wheel nuts.

When reinstalling the decorative nut caps, tighten the caps snug with the wheel wrench, then continue 1/8 rotation for steel caps and 1/4 rotation for plastic caps.



If your vehicle has wire wheel covers, remove them as follows:

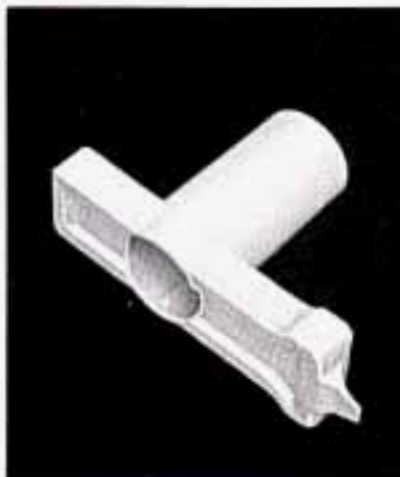

Use the wire wheel key wrench to remove the wire wheel cover.



Using the flat end of the key wrench handle, between the wire wheel cover and the center cap, pry off the center cap.



Remove the theft deterrent wheel nut, by placing the key end of the wire wheel key wrench over the nut and turning it to the left. Pull off the wire wheel cover. Note: When replacing the wheel cover, carefully line up the tire valve stem and the notch in the wheel cover.

Using the wheel wrench, loosen all the wheel nuts. Don't remove them yet. Next, attach the wheel wrench to the bolt on the end of the jack. Raise the jack a little by rotating the wheel wrench clockwise (to the right).

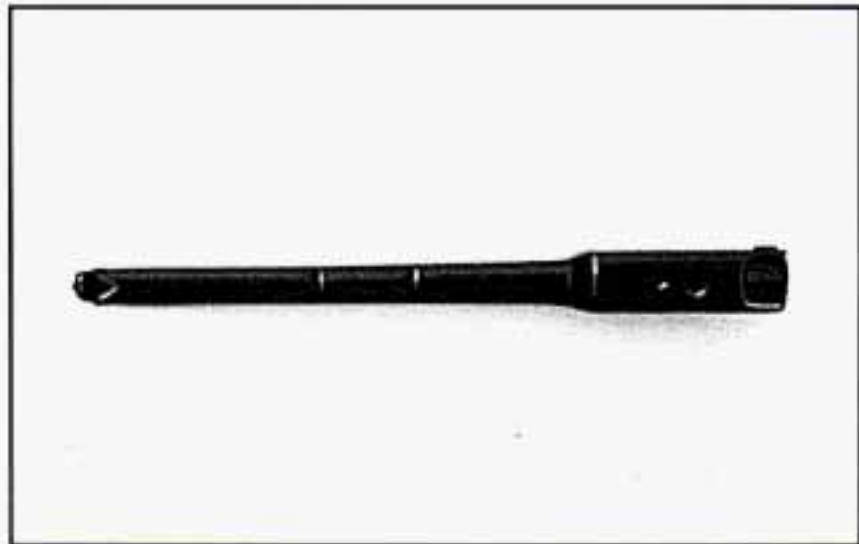

The jack handle has markings at 8" for the rear and 10" for the front, which will help you to locate the jacking notches in the frame.



Position the jack under the vehicle. There is a notch in the frame near each of the wheels. Fit the top of the jack into the notch nearest the wheel with the flat tire.

## **NOTICE:**

Raising your vehicle with the jack improperly positioned will damage the vehicle or may allow the vehicle to fall off the jack. Be sure to fit the jack lift head into the proper location before raising your vehicle.



Raise the vehicle by rotating the wheel wrench clockwise. Raise the vehicle far enough off the ground so there is enough room for the spare tire to fit.



## **CAUTION:**

Getting under a vehicle when it is jacked up is dangerous. If the vehicle slips off the jack, you could be badly injured or killed. Never get under a vehicle when it is supported only by a jack.



Remove all the wheel nuts and take off the flat tire.

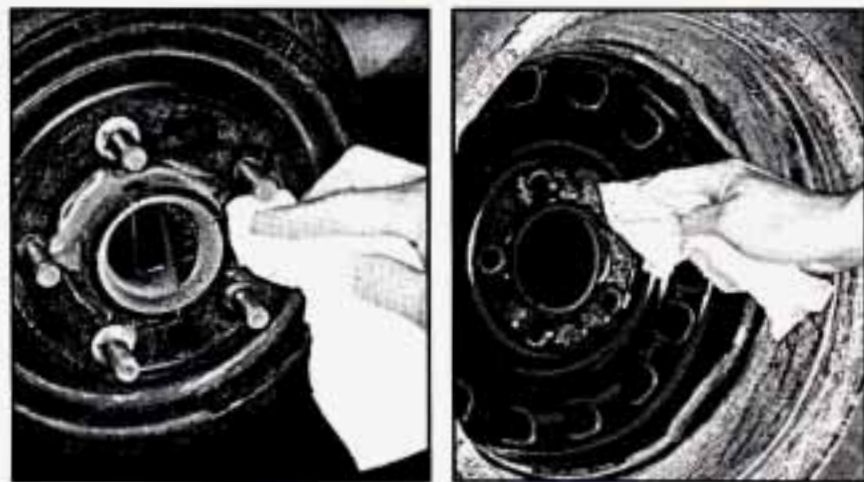

Remove any rust or dirt from the wheel bolts, mounting surfaces or spare wheel.

 **CAUTION:**

Rust or dirt on the wheel, or on the parts to which it is fastened, can make the wheel nuts become loose after a time. The wheel could come off and cause an accident. When you change a wheel, remove any rust or dirt from the places where the wheel attaches to the vehicle. In an emergency, you can use a cloth or a paper towel to do this; but be sure to use a scraper or wire brush later, if you need to, to get all the rust or dirt off.

 **CAUTION:**

Never use oil or grease on studs or nuts. If you do, the nuts might come loose. Your wheel could fall off, causing a serious accident.



Place the spare on the wheel mounting surface.



Replace the wheel nuts with the rounded end of the nuts toward the wheel. Tighten each nut by hand until the wheel is held against the hub.

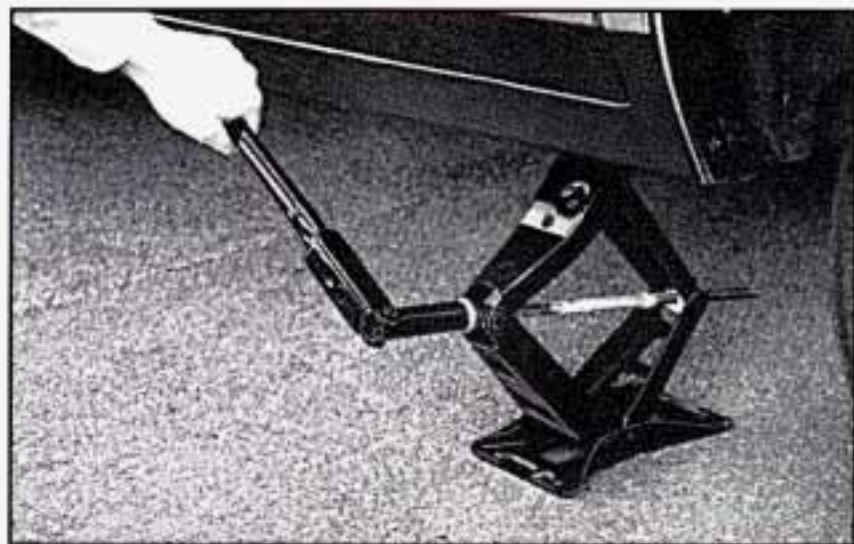

Lower the vehicle by rotating the wheel wrench counterclockwise. Lower the jack completely.

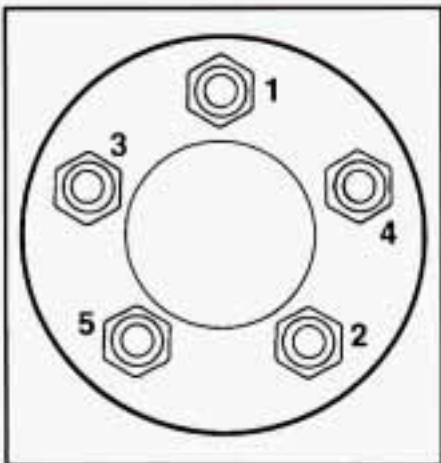

Tighten the wheel nuts firmly in a criss-cross sequence as shown.

Don't try to put a wheel cover on your compact spare tire. It won't fit. Store the wheel cover in the trunk until you have the flat tire repaired or replaced.

### **NOTICE:**

**Wheel covers won't fit on your compact spare. If you try to put a wheel cover on your compact spare, you could damage the cover or the spare.**

Now put all the equipment back in the trunk.



### **CAUTION:**

**Incorrect wheel nuts or improperly tightened wheel nuts can cause the wheel to become loose and even come off. This could lead to an accident. Be sure to use the correct wheel nuts. If you have to replace them, be sure to get the right kind.**

**Stop somewhere as soon as you can and have the nuts tightened with a torque wrench to 100 lb. ft. (140 N·m).**

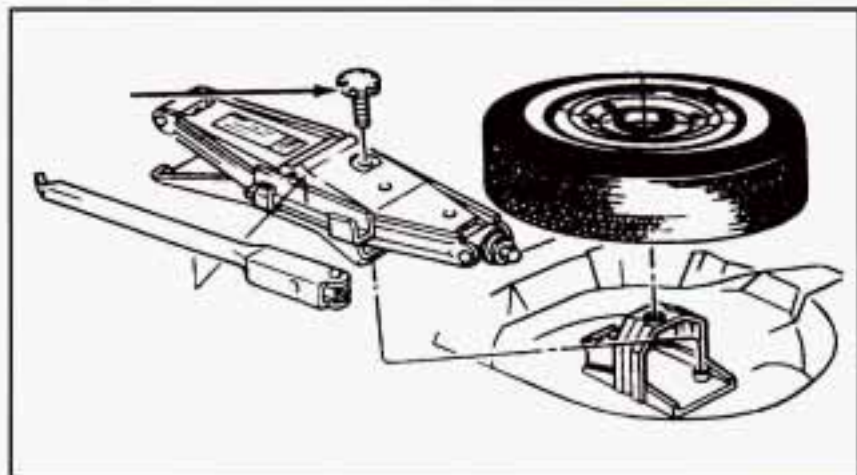





## **CAUTION:**

**Storing a jack, a tire or other equipment in the passenger compartment of the vehicle could cause injury. In a sudden stop or collision, loose equipment could strike someone. Store all these in the proper place.**

## **Compact Spare Tire**

Although the compact spare was fully inflated when your vehicle was new, it can lose air after a time. Check the inflation pressure regularly. It should be 60 psi (420 kPa). After installing the compact spare on your vehicle, you should stop as soon as possible and make sure your spare tire is correctly inflated. The compact spare is made to perform well at posted speed limits for distances up to 3,000 miles (5 000 km). The compact spare is made to go up to 3,000 miles (5 000 km), so you can finish your trip and have your full-size tire repaired or replaced where you want. Of course, it's best to replace your spare with a full-size tire as soon as you can. Your spare will last longer and be in good shape in case you need it again.

## **NOTICE:**

**Don't take your compact spare through an automatic car wash with guide rails. The compact spare can get caught on the rails. That can damage the tire and wheel, and maybe other parts of your vehicle.**

Don't use your compact spare on some other vehicle.

And don't mix your compact spare or wheel with other wheels or tires. They won't fit. Keep your spare and its wheel together.

## **NOTICE:**

**Tire chains won't fit your compact spare. Using them will damage your vehicle and destroy the chains too. Don't use tire chains on your compact spare.**

## **If You're Stuck: In Sand, Mud, Ice or Snow**

What you don't want to do when your vehicle is stuck is to spin your wheels. The method known as "rocking" can help you get out when you're stuck, but you must use caution.



## **CAUTION:**

**If you let your tires spin at high speed, they can explode and you or others could be injured. And, the transaxle or other parts of the vehicle can overheat. That could cause an engine compartment fire or other damage. When you're stuck, spin the wheels as little as possible. Don't spin the wheels above 35 mph (55 km/h) as shown on the speedometer.**

## **NOTICE:**

**Spinning your wheels can destroy parts of your vehicle as well as the tires. If you spin the wheels too fast while shifting your transaxle back and forth, you can destroy your transaxle.**

### **Rocking your vehicle to get it out:**

First, turn your steering wheel left and right. That will clear the area around your front wheels. You should turn your traction control system off. (See “Traction Control System” in the Index.) Then shift back and forth between “R” (Reverse) and a forward gear, spinning the wheels as little as possible. Release the accelerator pedal while you shift, and press lightly on the accelerator pedal when the transaxle is in gear. If that doesn’t get you out after a few tries, you may need to be towed out. If you do need to be towed out, see “Towing Your Car” in the Index.





## Part 6 Service and Appearance Care

Here you will find information about the care of your Buick. This part begins with service and fuel information, and then it shows how to check important fluid and lubricant levels. There is also technical information about your vehicle, and a section devoted to its appearance care.

### Part 6 includes:

Service .....	228
Fuel .....	229
Hood Release .....	234
Engine Oil .....	238
Air Cleaner .....	243
Automatic Transaxle Fluid .....	244
Engine Coolant .....	247
Power Steering Fluid .....	250
Windshield Washer Fluid .....	251
Brakes .....	252
Battery .....	255
Bulb Replacement .....	256
Loading Your Vehicle .....	258
Tires .....	260
Appearance Care .....	268
Vehicle Identification Number (VIN) .....	276
Fuses and Circuit Breakers .....	277
Capacities and Specifications .....	282

## Service

Your Buick dealer knows your vehicle best and wants you to be happy with it. We hope you'll go to your dealer for all your service needs. You'll get genuine GM parts and GM-trained and supported service people.

We hope you'll want to keep your GM vehicle all GM. Genuine GM parts have one of these marks:



## Doing Your Own Service Work

If you want to do some of your own service work, you'll want to get the proper Buick Service Manual. It tells you much more about how to service your Buick than this manual can. To order the proper service manual, see "Service Publications" in the Index.

Your vehicle has an air bag system. Before attempting to do your own service work, see "Servicing Your Air Bag-Equipped Buick" in the Index.

You should keep a record with all parts receipts and list the mileage and the date of any service work you perform. See "Maintenance Record" in the Index.

### CAUTION:

**You can be injured if you try to do service work on a vehicle without knowing enough about it.**

- **Be sure you have sufficient knowledge, experience, and the proper replacement parts and tools before you attempt any vehicle maintenance task.**
- **Be sure to use the proper nuts, bolts and other fasteners. "English" and "metric" fasteners can be easily confused. If you use the wrong fasteners, parts can later break or fall off. You could be hurt.**

### NOTICE:

**If you try to do your own service work without knowing enough about it, your vehicle could be damaged.**

## Fuel

### 3800 (L27) Engine

The 8th digit of your Vehicle Identification Number (VIN) shows the code letter for your engine. You will find the VIN at the top left of your instrument panel. (See “Vehicle Identification Number” in the Index.)

Use regular unleaded gasoline rated at 87 octane or higher. It should meet specifications ASTM D4814 in the U.S. and CGSB 3.5-92 in Canada. These fuels should have the proper additives, so you should not have to add anything to the fuel.

In the U.S. and Canada, it's easy to be sure you get the right kind of gasoline (unleaded). You'll see “UNLEADED” right on the pump. And only unleaded nozzles will fit into your vehicle's filler neck.

Be sure the posted octane is at least 87. If the octane is less than 87, you may get a heavy knocking noise when you drive. If it's bad enough, it can damage your engine.

If you're using fuel rated at 87 octane or higher and you still hear heavy knocking, your engine needs service. But don't worry if you hear a little pinging noise when you're accelerating or driving up a hill. That's normal,

and you don't have to buy a higher octane fuel to get rid of pinging. It's the heavy, constant knock that means you have a problem.

What about gasoline with blending materials that contain oxygen (oxygenates), such as MTBE or alcohol?

MTBE is “methyl tertiary-butyl ether.” Fuel that is no more than 15% MTBE is fine for your vehicle.

Ethanol is ethyl or grain alcohol. Properly-blended fuel that is no more than 10% ethanol is fine for your vehicle.

Methanol is methyl or wood alcohol.

### **NOTICE:**

**Fuel that is more than 5% methanol is bad for your vehicle. Don't use it. It can corrode metal parts in your fuel system and also damage plastic and rubber parts. That damage wouldn't be covered under your warranty. And even at 5% or less, there must be “cosolvents” and corrosion preventers in this fuel to help avoid these problems.**



## Gasolines for Cleaner Air

Your use of gasoline with deposit control additives will help prevent deposits from forming in your engine and fuel system. That helps keep your engine in tune and your emission control system working properly. It's good for your vehicle, and you'll be doing your part for cleaner air.

Many gasolines are now blended with oxygenates. General Motors recommends that you use gasolines with these blending materials, such as MTBE and ethanol. By doing so, you can help clean the air, especially in those parts of the country that have high carbon monoxide levels.

In addition, some gasoline suppliers are now producing reformulated gasolines. These gasolines are specially designed to reduce vehicle emissions. General Motors recommends that you use reformulated gasoline. By doing so, you can help clean the air, especially in those parts of the country that have high ozone levels.

You should ask your service station operators if their gasolines contain deposit control additives and oxygenates, and if they have been reformulated to reduce vehicle emissions.

## Fuel

### 3800 Supercharged (L67) Engine

The 8th digit of your Vehicle Identification Number (VIN) shows the code letter for your engine. You will find the VIN at the top left of your instrument panel. (See "Vehicle Identification Number" in the Index.)

Use premium unleaded gasoline rated at 91 octane or higher. You may use middle grade or regular unleaded gasolines, but your vehicle may not accelerate as well. The gasoline you use should meet specifications ASTM D4814 in the U.S. and CGSB 3.5-92 in Canada. These fuels should have the proper additives, so you should not have to add anything to the fuel.

In the U.S. and Canada, it's easy to be sure you get the right kind of gasoline (unleaded). You'll see "UNLEADED" right on the pump. And only unleaded nozzles will fit into your vehicle's filler neck.

Be sure the posted octane for premium is at least 91 (at least 89 for middle grade and 87 for regular). If the octane is less than 87, you may get a heavy knocking noise when you drive. If it's bad enough, it can damage your engine.

If you're using fuel rated at 91 octane or higher and you still hear heavy knocking, your engine needs service.

But don't worry if you hear a little pinging noise when you're accelerating or driving up a hill. That's normal and you don't have to buy a higher octane fuel to get rid of pinging. It's the heavy, constant knock that means you have a problem.

What about gasoline with blending materials that contain oxygen (oxygenates), such as MTBE or alcohol?

MTBE is "methyl tertiary-butyl ether." Fuel that is no more than 15% MTBE is fine for your vehicle.

Ethanol is ethyl or grain alcohol. Properly-blended fuel that is no more than 10% ethanol is fine for your vehicle.

Methanol is methyl or wood alcohol.

## **NOTICE:**

**Fuel that is more than 5% methanol is bad for your vehicle. Don't use it. It can corrode metal parts in your fuel system and also damage plastic and rubber parts. That damage wouldn't be covered under your warranty. And even at 5% or less, there must be "cosolvents" and corrosion preventers in this fuel to help avoid these problems.**

## **Gasolines for Cleaner Air**

Your use of gasoline with deposit control additives will help prevent deposits from forming in your engine and fuel system. That helps keep your engine in tune and your emission control system working properly. It's good for your vehicle, and you'll be doing your part for cleaner air.

Many gasolines are now blended with oxygenates. General Motors recommends that you use gasolines with these blending materials, such as MTBE and ethanol. By doing so, you can help clean the air, especially in those parts of the country that have high carbon monoxide levels.

In addition, some gasoline suppliers are now producing reformulated gasolines. These gasolines are specially designed to reduce vehicle emissions. General Motors recommends that you use reformulated gasoline. By doing so, you can help clean the air, especially in those parts of the country that have high ozone levels.

You should ask your service station operators if their gasolines contain deposit control additives and oxygenates, and if they have been reformulated to reduce vehicle emissions.



## Fuels in Foreign Countries

If you plan on driving in another country outside the U.S. or Canada, unleaded fuel may be hard to find. Do not use leaded gasoline. If you use even one tankful, your emission controls won't work well or at all. With continuous use, spark plugs can get fouled, the exhaust system can corrode, and your engine oil can deteriorate quickly. Your vehicle's oxygen sensor will be damaged. All of that means costly repairs that wouldn't be covered by your warranty.

To check on fuel availability, ask an auto club, or contact a major oil company that does business in the country where you'll be driving.

You can also write us at the following address for advice. Just tell us where you're going and give your Vehicle Identification Number (VIN).

General Motors Overseas Distribution Corporation,  
North American Export Sales (NAES)  
1908 Colonel Sam Drive  
Oshawa, Ontario L1H 8P7

## Filling Your Tank

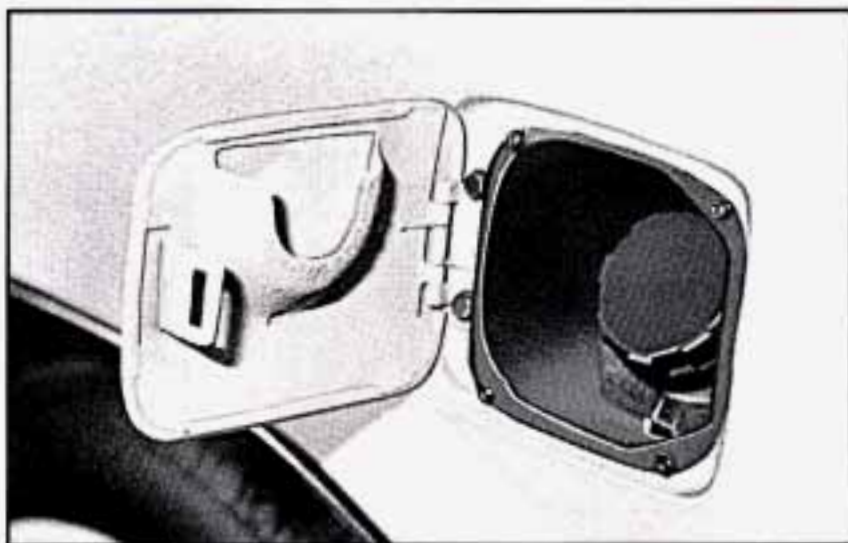

The cap is behind a hinged door on the left side of your vehicle. To take off the cap, turn it slowly to the left (counterclockwise).



**⚠ CAUTION:**

Gasoline vapor is highly flammable. It burns violently, and that can cause very bad injuries. Don't smoke if you're near gasoline or refueling your vehicle. Keep sparks, flames, and smoking materials away from gasoline.

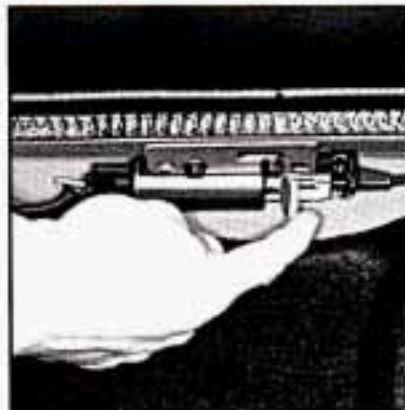

Or, you can use the release lever in the trunk.



The release button for the fuel door is to the left of the steering column.

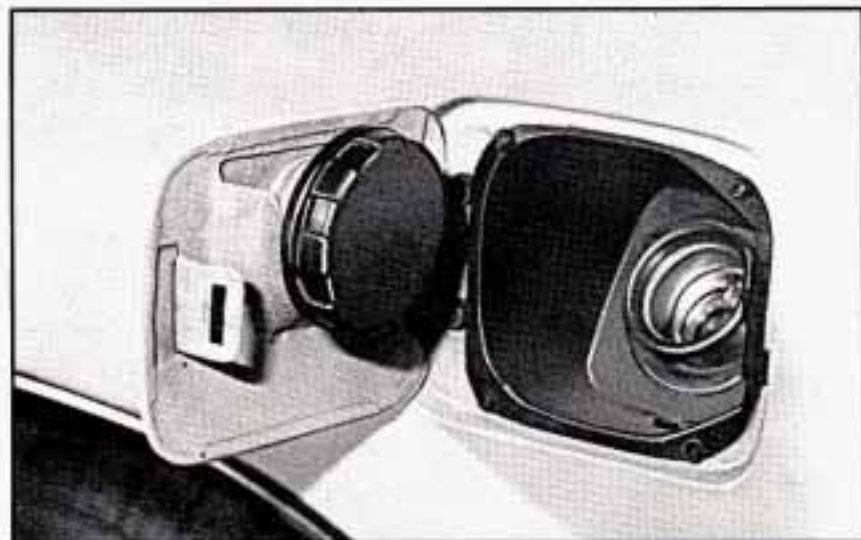

While refueling, hang the cap inside the fuel door.

## CAUTION:

If you get gasoline on you and then something ignites it, you could be badly burned. Gasoline can spray out on you if you open the fuel filler cap too quickly. This spray can happen if your tank is nearly full, and is more likely in hot weather. Open the fuel filler cap slowly and wait for any "hiss" noise to stop. Then unscrew the cap all the way.

Be careful not to spill gasoline. Clean gasoline from painted surfaces as soon as possible. See "Cleaning the Outside of Your Buick" in the Index.

When you put the cap back on, turn it to the right until you hear a clicking noise.

## NOTICE:

If you need a new cap, be sure to get the right type. Your dealer can get one for you. If you get the wrong type, it may not fit or have proper venting, and your fuel tank and emissions system might be damaged.

## Checking Things Under the Hood

### Hood Release



To open the hood, pull the handle inside the vehicle. It is located on the lower left side of the instrument panel.

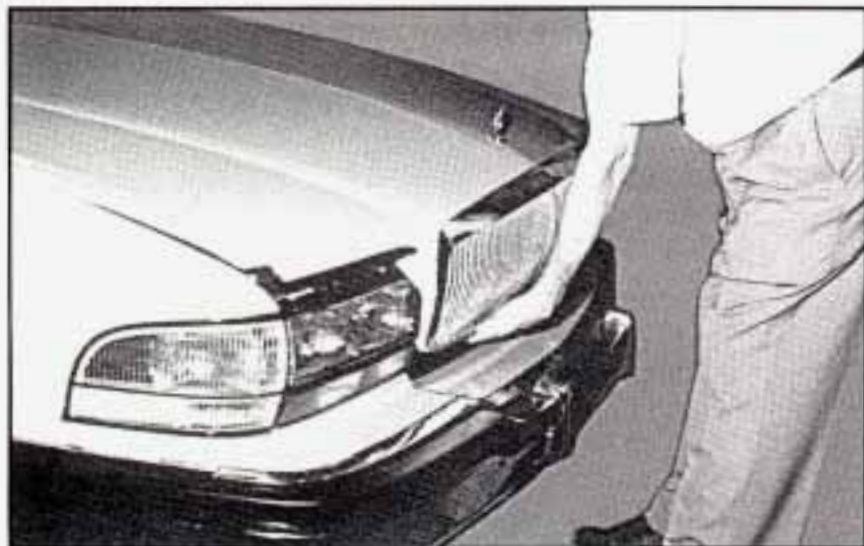

Lift up on this lever as you lift up the hood.

Then go to the front of the vehicle and locate the secondary hood release. It is under the front edge of the grille.



**⚠ CAUTION:**

An electric fan under the hood can start up and injure you even when the engine is not running. Keep hands, clothing and tools away from any underhood electric fan.

**⚠ CAUTION:**

Things that burn can get on hot engine parts and start a fire. These include liquids like gasoline, oil, coolant, brake fluid, windshield washer and other fluids, and plastic or rubber. You or others could be burned. Be careful not to drop or spill things that will burn onto a hot engine.

Before closing the hood, be sure all the filler caps are on properly. Then pull the hood down and close it firmly.

## Engine Accessory Belt

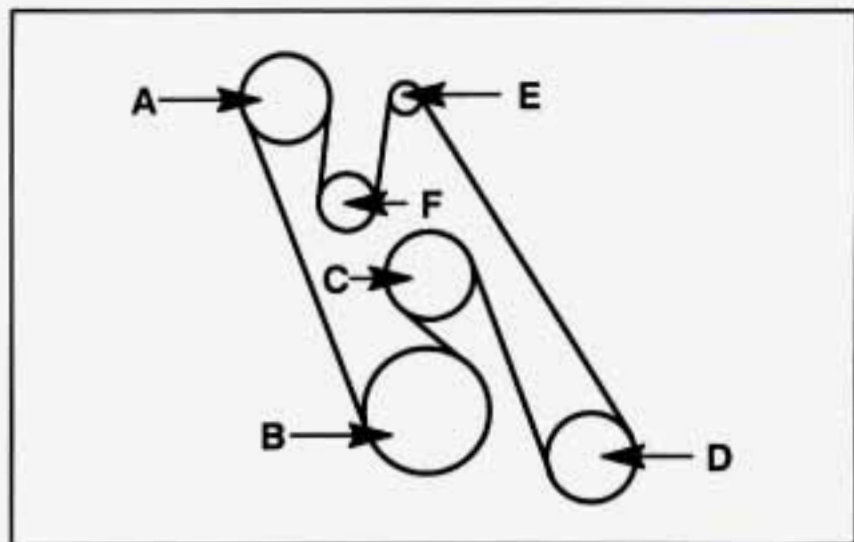

The 3800 (L27) engine uses an engine accessory belt. This diagram shows the features connected by the belt routing. See "Maintenance Schedule" in the Index for when to check the belt.

- |                   |                     |
|-------------------|---------------------|
| A. Power Steering | D. Air Conditioning |
| B. Crank          | E. Alternator       |
| C. Coolant Pump   | F. Tensioner        |

## 3800 Supercharged (L67) Engine (Option)

Your Park Avenue Ultra has a 3800 Supercharged engine. Buick chose supercharging rather than turbocharging because Buick emphasizes smooth, refined power.

The Supercharger is a device which is designed to pump more air into the engine than it would normally use. This air mixed with fuel, creates increased engine power. Since the Supercharger is a pump and is driven from an engine accessory drive belt, increased pressure is available at all driving conditions.

The powertrain control module (PCM), works with a vacuum control to regulate the increased pressure required during specific driving conditions. When this increased pressure or boost is not desired, such as during idling and light throttle cruising, the excess air that the Supercharger is pumping is routed through a bypass. All of these controls, working together provide high performance character and fuel efficiency in the 3800 V6 Supercharged Buick engine.

The power steering pump uses a remote reservoir mounted on the throttle and cruise control cable bracket. See "Maintenance Schedule" in the Index for when you should check the fluid.

## Engine Accessory Belt

The Supercharged 3800 engine uses two accessory drive belts. One belt drives the generator and the power steering pump. The second belt drives the supercharger, coolant pump and air conditioning compressor. Each belt has its own tensioner and idler pulley.

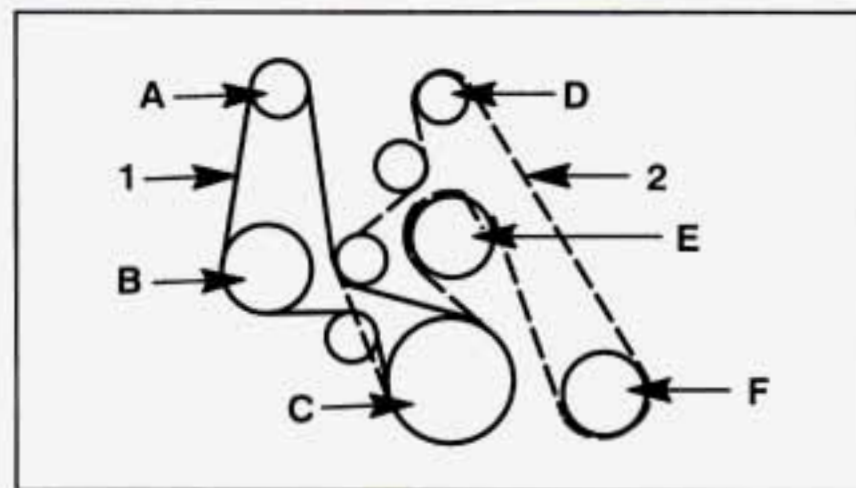

- |                        |                     |
|------------------------|---------------------|
| 1. Front Belt          | C. Crank            |
| 2. Back belt           | D. Supercharger     |
| A. Generator           | E. Coolant Pump     |
| B. Power Steering Pump | F. Air Conditioning |

## Supercharger Oil

Unless you are technically qualified and have the proper tools, you should let your dealer or a qualified service center perform this maintenance.

**When to Check:** Check oil level every 30,000 miles (50,000 km) or every 36 months.

**What Kind of Oil to Use:** See “Recommended Fluids and Lubricants” in the Index. Use only the recommended oil.

**How to Check and Add Oil:** Check oil only when the engine is cold. Allow the engine to cool 2 to 3 hours after running.

### CAUTION:

**If you remove the supercharger oil fill plug while the engine is hot, pressure may cause hot oil to blow out of the oil fill hole. You may be burned. Do not remove the plug until the engine cools.**

1. Remove the wiring harness shield.
2. Clean the area around the oil fill plug before removing it.

3. Remove the oil fill plug using a 3/16 allen wrench.
4. The oil level is correct when it just reaches the bottom of the threads of the inspection hole.
5. Replace the oil plug with the O-ring in place. Torque to 10 N•m (88 lb. in.).
6. Replace the wiring harness shield.

## Engine Oil

CHECK  
OIL LEVEL

If the “CHECK OIL LEVEL” light on the instrument panel comes on, it means you need to check your engine oil level right away.

For more information, see “CHECK OIL LEVEL” light in the Index. You should check your engine oil level regularly; this is an added reminder.



It's a good idea to check your engine oil every time you get fuel. In order to get an accurate reading, the oil must be warm and the vehicle must be on level ground.



The engine oil dipstick is directly behind the engine fan.

Turn off the engine and give the oil a few minutes to drain back into the oil pan. If you don't, the oil dipstick might not show the actual level.

## To Check Engine Oil



Pull out the dipstick and clean it with a paper towel or cloth, then push it back in all the way. Remove it again, keeping the tip lower, and check the level.

## When to Add Oil

If the oil is at or below the ADD line, then you'll need to add some oil. But you must use the right kind. This section explains what kind of oil to use. For crankcase capacity, see "Capacities and Specifications" in the Index.

### **NOTICE:**

**Don't add too much oil. If your engine has so much oil that the oil level gets above the cross-hatched area that shows the proper operating range, your engine could be damaged.**

Just fill it enough to put the level somewhere in the proper operating range. Push the dipstick all the way back in when you're through.

## What Kind of Oil to Use

Beginning midyear 1993, oils of the proper quality for your vehicle will be identified with this new "starburst" symbol. The "starburst" symbol indicates that the oil has been certified by the American Petroleum Institute (API), and is preferred for use in your gasoline engine.



You should look for this on the front of the oil container, and use only oils that display this new symbol.

You should also use the proper viscosity oil for your vehicle, as shown in the following chart:

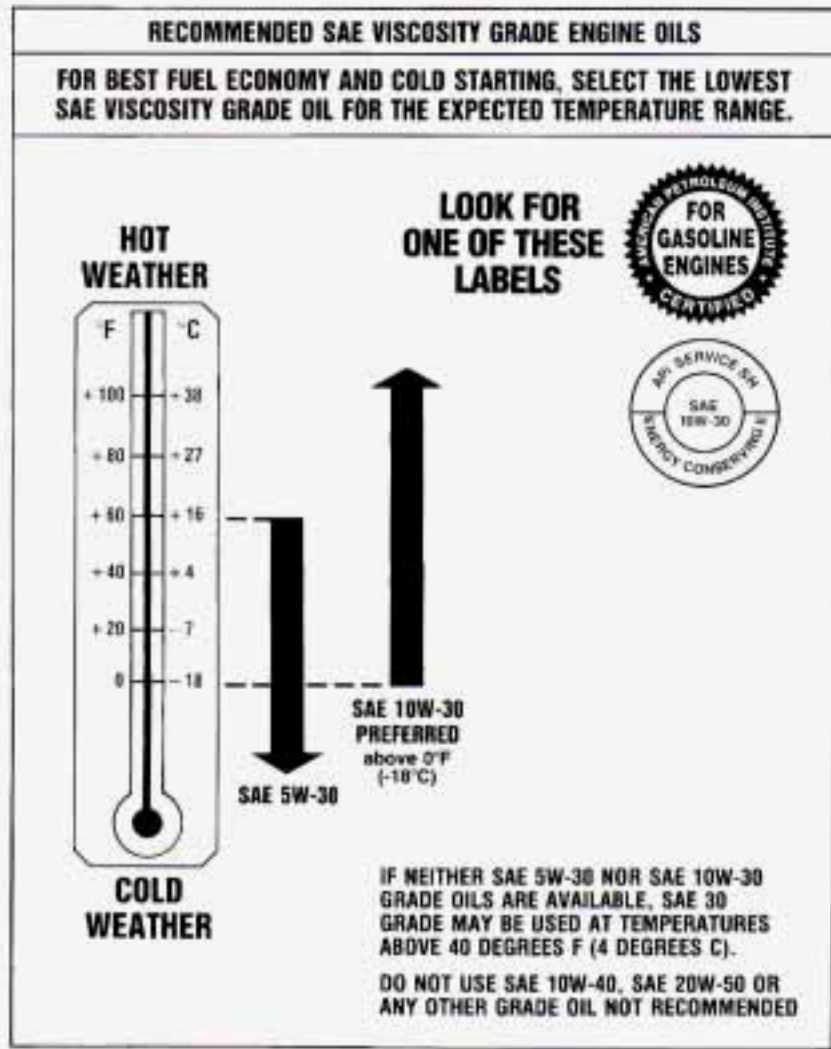

As shown in the chart, SAE 10W-30 is best for your vehicle. However, you can use SAE 5W-30 if it's going to be colder than 60°F (16°C) before your next oil change. When it's very cold, you should use SAE 5W-30. These numbers on an oil container show its viscosity, or thickness. Do not use other viscosity oils, such as SAE 10W-40 or SAE 20W-50.

If you cannot find oils with the new "starburst" symbol on the front of the container, you should look for and use oils containing the following three things:

- SH or SG

"SH" or "SG" must be on the oil container, either by itself or combined with other quality designations, such as "SH/CD," "SH,SG,CD," "SG/CD" etc. These letters show American Petroleum Institute (API) levels of quality.

- SAE 10W-30
- Energy Conserving II

Oils with these words on the container will help you save fuel.

These three things are usually included in a doughnut shaped logo (symbol) on most containers. If you cannot find oils with the "starburst" symbol, you should look for oils with the doughnut shaped symbol, containing the three things noted above.

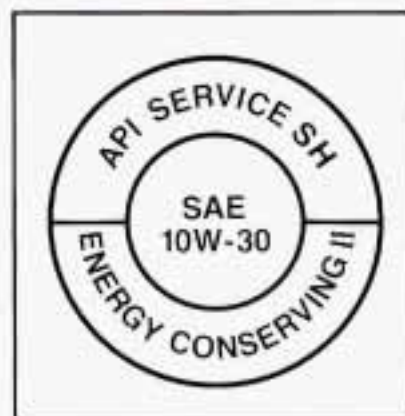

## NOTICE:

If you use oils that do not have either the "starburst" symbol or an API SH or SG designation, you can cause engine damage not covered by your warranty.

GM Goodwrench<sup>®</sup> oil (in Canada, GM Engine Oil) meets all the requirements for your vehicle.



## Engine Oil Additives

Don't add anything to your oil. Your Buick dealer is ready to advise if you think something should be added.

## When to Change Engine Oil

See if any one of these is true for you:

- Most trips are less than 4 miles (6 km).
- It's below freezing outside and most trips are less than 10 miles (16 km).
- The engine is at low speed most of the time (as in door-to-door delivery, or in stop-and-go traffic).
- You tow a trailer often.
- Most trips are through dusty places.

If any one of these is true for your vehicle, then you need to change your oil and filter every 3,000 miles (5 000 km) or 3 months -- whichever comes first. (See "Change Oil Soon" in the Index.)

If none of them is true, change the oil every 7,500 miles (12 500 km) or 12 months -- whichever comes first. Change the filter at the first oil change and at every other oil change after that.

If the optional "Change Oil Soon" light comes on you will need to change your oil sooner than either mileage specified. Depending upon driving habits, the "Change Oil Soon" light may come on as early as 2,000 miles or less from the last time the oil life monitor was reset (See "Oil Life Monitor" in the Index.) **Always reset the oil life monitor after every oil change.**

## Engine Coolant Heater (Engine Block Heater)

An engine coolant heater can be a big help if you have to park outside in very cold weather, 0°F (-18°C) or colder. If your vehicle has this option, see "Engine Coolant Heater" in the Index.

## What to Do with Used Oil

Did you know that used engine oil contains certain elements that may be unhealthy for your skin and could even cause cancer? Don't let used oil stay on your skin for very long. Clean your skin and nails with soap and water, or a good hand cleaner. Wash or properly throw away clothing or rags containing used engine oil. (See the manufacturer's warnings about the use and disposal of oil products.)

Used oil can be a real threat to the environment. If you change your own oil, be sure to drain all free-flowing oil from the filter before disposal. Don't ever dispose of oil by putting it in the trash, pouring it on the ground, into sewers, or into streams or bodies of water. Instead, recycle it by taking it to a place that collects used oil. If you have a problem properly disposing of your used oil, ask your dealer, a service station or a local recycling center for help.

## Air Cleaner

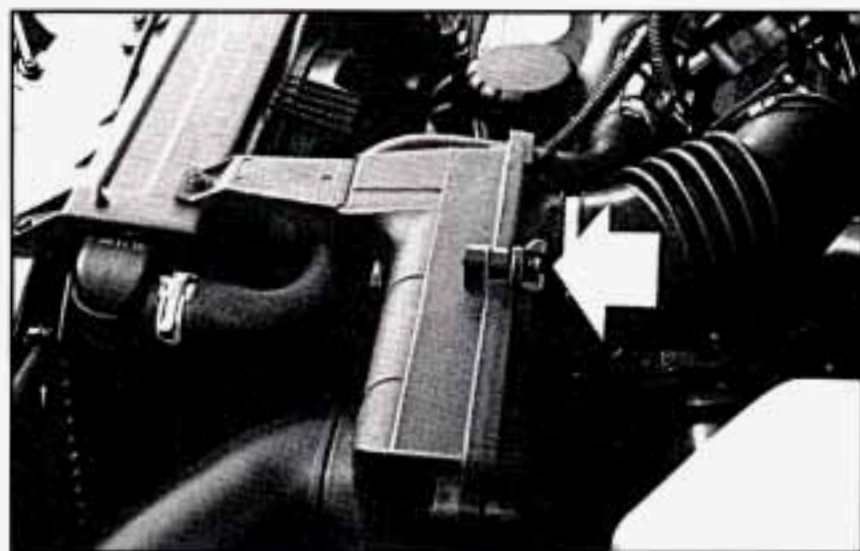

The air cleaner is in the front right section of the engine compartment. To check or replace the filter, undo the wing screws and pull the air cleaner open. Replace the air filter, close the cover and tighten the wing screws.

Refer to the Maintenance Schedule to determine when to replace the air filter.

See “Scheduled Maintenance Services” in the Index.

 **CAUTION:**

**Operating the engine with the air cleaner off can cause you or others to be burned. The air cleaner not only cleans the air, it stops flame if the engine backfires. If it isn't there, and the engine backfires, you could be burned. Don't drive with it off, and be careful working on the engine with the air cleaner off.**

**NOTICE:**

**If the air cleaner is off, a backfire can cause a damaging engine fire. And, dirt can easily get into your engine, which will damage it. Always have the air cleaner in place when you're driving.**

## **Automatic Transaxle Fluid**

### **When to Check and Change**

A good time to check your automatic transaxle fluid level is when the engine oil is changed. Refer to the Maintenance Schedule to determine when to change your fluid. See “Scheduled Maintenance Services” in the Index.

### **How to Check**

Because this operation can be a little difficult, you may choose to have this done at a Buick dealership Service Department.

If you do it yourself, be sure to follow all the instructions here, or you could get a false reading on the dipstick.

**NOTICE:**

**Too much or too little fluid can damage your transaxle. Too much can mean that some of the fluid could come out and fall on hot engine parts or exhaust system, starting a fire. Be sure to get an accurate reading if you check your transaxle fluid.**



Wait at least 30 minutes before checking the transaxle fluid level if you have been driving:

- When outside temperatures are above 90°F (32°C).
- At high speed for quite a while.
- In heavy traffic -- especially in hot weather.
- While pulling a trailer.

To get the right reading, the fluid should be at normal operating temperature, which is 180°F to 200°F (82°C to 93°C).

Get the vehicle warmed up by driving about 15 miles (24 km) when outside temperatures are above 50°F (10°C). If it's colder than 50°F (10°C), you may have to drive longer.

#### **To check the fluid level**

- Park your vehicle on a level place. Keep the engine running.
- With the parking brake applied, place the shift lever in "P" (Park).

- With your foot on the brake pedal, move the shift lever through each gear range, pausing for about three seconds in each range. Then, position the shift lever in "P" (Park).
- Let the engine run at idle for three to five minutes.

Then, without shutting off the engine, follow these steps:



1. Pull out the dipstick and wipe it with a clean rag or paper towel.

2. Push it back in all the way, wait three seconds and then pull it back out again.



3. Check both sides of the dipstick, and read the lower level. The fluid level must be in the cross-hatched area.
4. If the fluid level is in the acceptable range, push the dipstick back in all the way.

## How to Add Fluid

Refer to the Maintenance Schedule to determine what kind of transaxle fluid to use. See “Recommended Fluids and Lubricants” in the Index.

If the fluid level is low, add only enough of the proper fluid to bring the level into the cross-hatched area on the dipstick.

1. Pull out the dipstick.
  2. Using a long-neck funnel, add enough fluid at the dipstick hole to bring it to the proper level. It doesn't take much fluid, generally less than a pint (0.5L).  
**Don't overfill.** We recommend you use only fluid labeled DEXRON<sup>®</sup>-III or DEXRON<sup>®</sup>-IIE, because fluids with that label are made especially for your automatic transaxle. Damage caused by fluid other than DEXRON<sup>®</sup>-III or DEXRON<sup>®</sup>-IIE is not covered by your new vehicle warranty.
- After adding fluid, recheck the fluid level as described under “How to Check.”
  - When the correct fluid level is obtained, push the dipstick back in all the way.

## Engine Coolant

The following explains your cooling system and how to add coolant when it is low. If you have a problem with engine overheating, see “Engine Overheating” in the Index.

The proper coolant for your Buick will:

- Give freezing protection down to  $-34^{\circ}\text{F}$  ( $-37^{\circ}\text{C}$ ).
- Give boiling protection up to  $262^{\circ}\text{F}$  ( $128^{\circ}\text{C}$ ).
- Protect against rust and corrosion.
- Help keep the proper engine temperature.
- Let the warning lights work as they should.

### What to Use

Use a mixture of one-half clean water (preferably distilled) and one-half antifreeze that meets “GM Specification 1825-M,” which won’t damage aluminum parts. You can also use a recycled coolant conforming to GM Specification 1825-M with a complete coolant flush and refill. If you use this mixture, you don’t need to add anything else.



### CAUTION:

**Adding only plain water to your cooling system can be dangerous. Plain water, or some other liquid like alcohol, can boil before the proper coolant mix will. Your vehicle’s coolant warning system is set for the proper coolant mix. With plain water or the wrong mix, your engine could get too hot but you wouldn’t get the overheat warning. Your engine could catch fire and you or others could be burned. Use a 50/50 mix of clean water and a proper antifreeze.**

### NOTICE:

**If you use an improper coolant mix, your engine could overheat and be badly damaged. The repair cost wouldn’t be covered by your warranty. Too much water in the mix can freeze and crack the engine, radiator, heater core and other parts.**



## Adding Coolant



The coolant recovery tank is located at the left of the engine compartment.

### To Check Coolant

When your engine is cold, the coolant level should be at "FULL COLD" or a little higher. When your engine is warm, the level should be up to "FULL HOT" or a little higher.



If this light comes on, it means you're low on engine coolant.

### To Add Coolant

If you need more coolant, add the proper mix at the coolant recovery tank.

 **CAUTION:**

Turning the radiator pressure cap when the engine and radiator are hot can allow steam and scalding liquids to blow out and burn you badly. With the coolant recovery tank, you will almost never have to add coolant at the radiator. Never turn the radiator pressure cap -- even a little -- when the engine and radiator are hot.

Add coolant mix at the recovery tank, but be careful not to spill it.

 **CAUTION:**

You can be burned if you spill coolant on hot engine parts. Coolant contains ethylene glycol, and it will burn if the engine parts are hot enough. Don't spill coolant on a hot engine.

## Radiator Pressure Cap

**NOTICE:**

Your radiator pressure cap is a 15 psi (105 kPa) pressure-type cap and must be tightly installed to prevent coolant loss and possible engine damage from overheating. Be sure the arrows on the cap line up with the overflow tube on the radiator filler neck.

When you replace your radiator pressure cap, an AC<sup>®</sup> cap is recommended.

## Thermostat

Engine coolant temperature is controlled by a thermostat in the engine coolant system. The thermostat stops the flow of coolant through the radiator until the coolant reaches a preset temperature.

When you replace your thermostat, an AC<sup>®</sup> thermostat is recommended.

## Power Steering Fluid



### How To Check Power Steering Fluid

Unscrew the cap and wipe the dipstick with a clean rag. Replace the cap and completely tighten it. Then remove the cap again and look at the fluid level on the dipstick.

- When the engine compartment is hot, the level should be at the “HOT” mark.

- When the engine compartment is cool, the level should be at the “FULL COLD” mark.

### What to Add

Refer to the Maintenance Schedule to determine what kind of fluid to use. See “Recommended Fluids and Lubricants” in the Index.

### **NOTICE:**

**When adding power steering fluid or making a complete fluid change, always use the proper fluid. Failure to use the proper fluid can cause leaks and damage hoses and seals.**



## Windshield Washer Fluid

### To Add



Open the cap labeled  
“WASHER FLUID ONLY.”  
Add washer fluid until the  
bottle is full.

### NOTICE:

- When using concentrated washer fluid, follow the manufacturer’s instructions for adding water.
- Don’t mix water with ready-to-use washer fluid. Water can cause the solution to freeze and damage your washer fluid tank and other parts of the washer system. Also, water doesn’t clean as well as washer fluid.
- Fill your washer fluid tank only 3/4 full when it’s very cold. This allows for expansion, which could damage the tank if it is completely full.
- Don’t use radiator antifreeze in your windshield washer. It can damage your washer system and paint.

## Brakes

### Brake Master Cylinder

Your brake master cylinder is here. It is filled with DOT-3 brake fluid.

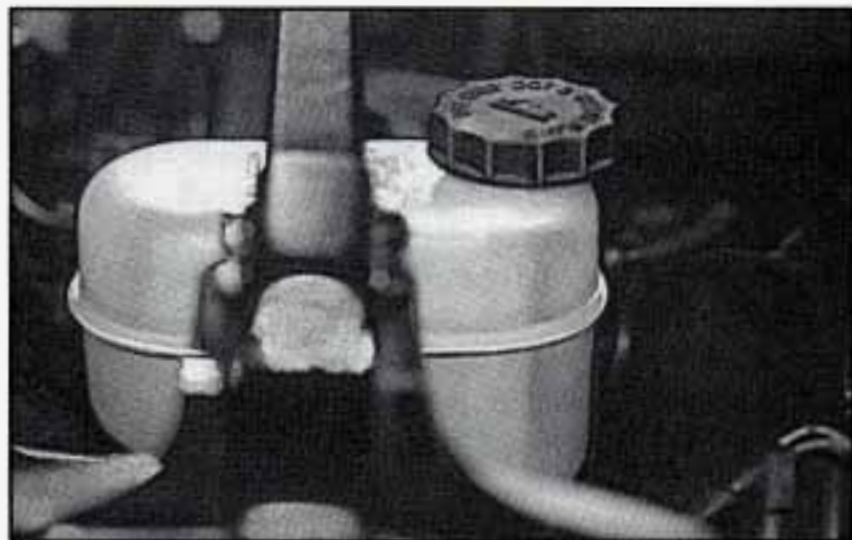

There are only two reasons why the brake fluid level in your master cylinder might go down. The first is that the brake fluid goes down to an acceptable level during normal brake lining wear. When new linings are put in, the fluid level goes back up. The other reason is that

fluid is leaking out of the brake system. If it is, you should have your brake system fixed, since a leak means that sooner or later your brakes won't work well, or won't work at all. So, it isn't a good idea to "top off" your brake fluid. Adding brake fluid won't correct a leak. If you add fluid when your linings are worn, then you'll have too much fluid when you get new brake linings. You should add (or remove) brake fluid, as necessary, only when work is done on the brake hydraulic system.



#### **CAUTION:**

**If you have too much brake fluid, it can spill on the engine. The fluid will burn if the engine is hot enough. You or others could be burned, and your vehicle could be damaged. Add brake fluid only when work is done on the brake hydraulic system.**

When your brake fluid falls to a low level, your brake warning light will come on. A chime will sound if you try to drive with this warning light on. See "Brake System Warning Light" in the Index.

## What to Add

When you do need brake fluid, use only DOT-3 brake fluid -- such as Delco Supreme 11<sup>®</sup> (GM Part No.1052535). Use new brake fluid from a sealed container only, and always clean the brake fluid reservoir cap before removing it.

### NOTICE:

- DOT-5 silicone brake fluid can damage your vehicle. Don't use it.
- Don't let someone put in the wrong kind of fluid. For example, just a few drops of mineral-based oil, such as engine oil, in your brake system can damage brake system parts so badly that they'll have to be replaced.
- Brake fluid can damage paint, so be careful not to spill brake fluid on your vehicle. If you do, wash it off immediately. See "Appearance Care" in the Index.

## Brake Wear

Your Buick has front disc brakes and rear drum brakes.

Disc brake pads have built-in wear indicators that make a high-pitched warning sound when the brake pads are worn and new pads are needed. The sound may come and go or be heard all the time your vehicle is moving (except when you are pushing on the brake pedal firmly).



### CAUTION:

The brake wear warning sound means that sooner or later your brakes won't work well. That could lead to an accident. When you hear the brake wear warning sound, have your vehicle serviced.



## **NOTICE:**

**Continuing to drive with worn-out brake pads could result in costly brake repair.**

Some driving conditions or climates may cause a brake squeal when the brakes are first applied or lightly applied. This does not mean something is wrong with your brakes.

Your rear drum brakes don't have wear indicators, but if you ever hear a rear brake rubbing noise, have the rear brake linings inspected. Also, the rear brake drums should be removed and inspected each time the tires are removed for rotation or changing. When you have the front brakes replaced, have the rear brakes inspected, too.

Brake linings should always be replaced as complete axle sets.

### **Brake Pedal Travel**

See your dealer if the brake pedal does not return to normal height, or if there is a rapid increase in pedal travel. This could be a sign of brake trouble.

## **Brake Adjustment**

Every time you apply the brakes moderately, with or without the vehicle moving, your brakes adjust for wear.

### **Replacing Brake System Parts**

The braking system on a modern vehicle is complex. Its many parts have to be of top quality and work well together if the vehicle is to have really good braking. Vehicles we design and test have top-quality GM brake parts in them, as your Buick does when it is new. When you replace parts of your braking system -- for example, when your brake linings wear down and you have to have new ones put in -- be sure you get new genuine GM replacement parts. If you don't, your brakes may no longer work properly. For example, if someone puts in brake linings that are wrong for your vehicle, the balance between your front and rear brakes can change, for the worse. The braking performance you've come to expect can change in many other ways if someone puts in the wrong replacement brake parts.

## Battery

Every new Buick has a Delco Freedom<sup>®</sup> battery. You never have to add water to one of these. When it's time for a new battery, we recommend a Delco Freedom<sup>®</sup> battery. Get one that has the catalog number shown on the original battery's label.

## Vehicle Storage

If you're not going to drive your vehicle for 25 days or more, take off the black, negative (-) cable from the battery. This will help keep your battery from running down.



### CAUTION:

**Batteries have acid that can burn you and gas that can explode. You can be badly hurt if you aren't careful. See "Jump Starting" in the Index for tips on working around a battery without getting hurt.**

Contact your dealer to learn how to prepare your vehicle for longer storage periods.

## Halogen Bulbs



### CAUTION:

**Halogen bulbs have pressurized gas inside and can burst if you drop or scratch the bulb. You or others could be injured. Take special care when handling and disposing of halogen bulbs.**

## Headlamp Bulb Replacement

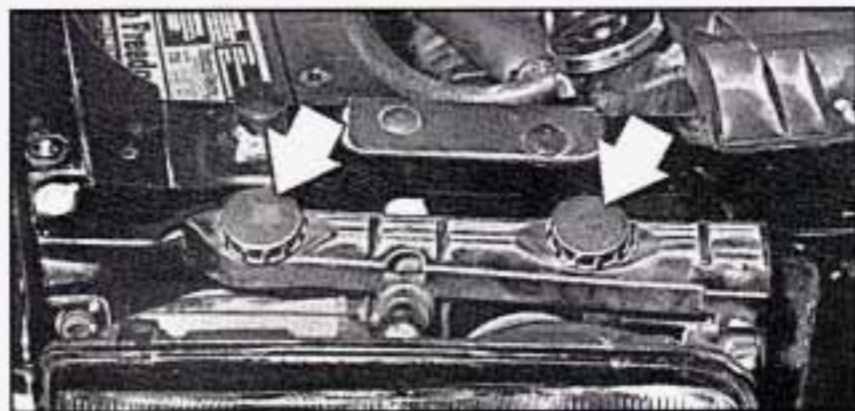

Each headlamp is attached by retainers with round plastic knobs.

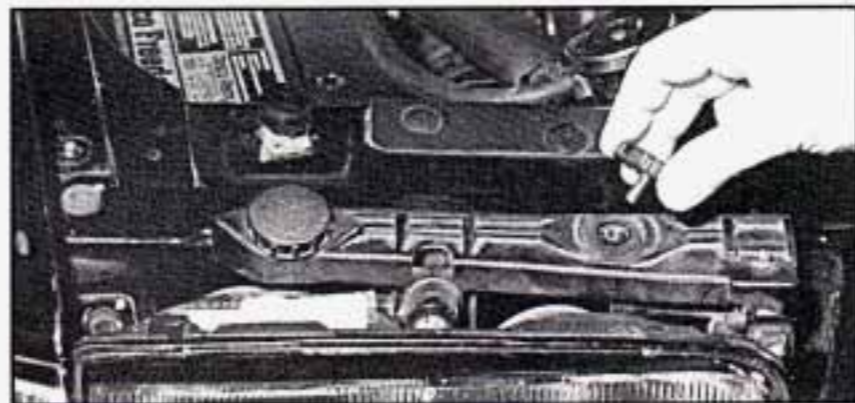

Remove the retainers by turning in a counter-clockwise direction.



Lift the headlamp away from the car.



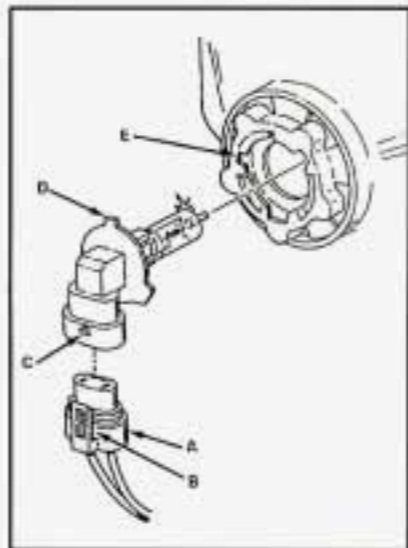

Turn the bulb socket 1/4 turn counter-clockwise, while pressing it firmly.

Remove the wire connector from the bulb by lifting the lock tab and pulling it away from the plastic base.

To reassemble, attach the wire connector (A) to the plastic base making sure the lock tab (B) is over the lock (C). Install the bulb by putting the small tab (D) into the small notch in the lamp (E). Turn the bulb socket 1/4 turn clockwise to lock into place. When reinstalling the headlamp assembly into the headlamp mounting panel, make sure the tab is properly engaged in the panel slot.

## Taillamp Bulb Replacement

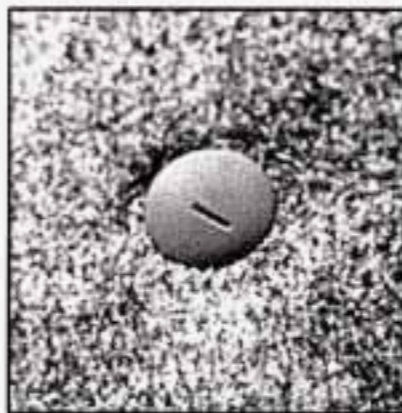

Open the trunk. On either side of the rear of the trunk are two plastic nuts. Remove only the side that you need to access. Pull the carpet back away from the rear area. The taillamp, sidemarker and back-up lights can now be accessed.

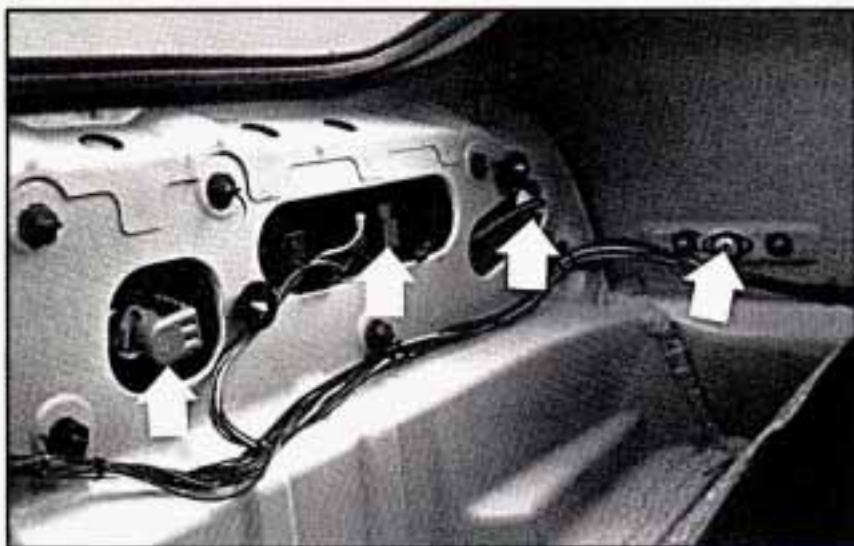

Two taillamp bulbs are a tabbed assembly. Squeeze the release in and pull the assembly out. Pull the bulb straight out from the socket. To replace the assembly, insert the tabs into the slots and push in until it locks into place.

To replace the third taillamp bulb and sidemarkers bulb, turn the socket 1/4 turn and pull it out. Pull the bulb straight out from the socket.

The backup bulb can be replaced by squeezing the lock on the socket, turning it 1/4 turn and pulling it out. Pull the bulb straight out. Reverse the above steps to reassemble the light and the trunk trim.

## Loading Your Vehicle

TIRE-LOADING INFORMATION				
OCCUPANTS		VEHICLE CAP. WT.		
FRT.	CTR.	RR.	TOTAL	LBS. KG
MAX. LOADING & GVWR SAME AS VEHICLE				
CAPACITY WEIGHT		XXX	COLD TIRE	
TIRE SIZE		SPEED	PRESSURE	
		RTG	PSI/KPa	
FRT.				
RR.				
SPA.				
IF TIRES ARE HOT, ADD 4PSI/28KPa				
SEE OWNER'S MANUAL FOR ADDITIONAL INFORMATION				



Two labels on your vehicle show how much weight it may properly carry. The Tire Loading Information label found on the rear edge of the driver's door tells you the proper size, speed rating and recommended inflation pressures for the tires on your vehicle. It also gives you important information about the number of people that can be in your vehicle and the total weight that you can carry. This weight is called the Vehicle Capacity Weight and includes the weight of all occupants, cargo, and all nonfactory-installed options.



MFD BY GENERAL MOTORS CORP  
DATE GVWR GAWR FRT GAWR RR

THIS VEHICLE CONFORMS TO ALL APPLICABLE U.S. FEDERAL MOTOR VEHICLE SAFETY, BUMPER, AND THEFT PREVENTION STANDARDS IN EFFECT ON THE DATE OF MANUFACTURE SHOWN ABOVE.

GENE



## CAUTION:

Do not load your vehicle any heavier than the GVWR or the maximum front and rear GAWRs. If you do, parts on your vehicle can break, or it can change the way your vehicle handles. These could cause you to lose control. Also, overloading can shorten the life of your vehicle.

## NOTICE:

Your warranty does not cover parts or components that fail because of overloading.

The other label is the Certification label, found on the rear edge of the driver's door. It tells you the gross weight capacity of your vehicle, called the GVWR (Gross Vehicle Weight Rating). The GVWR includes the weight of the vehicle, all occupants, fuel and cargo. Never exceed the GVWR for your vehicle, or the Gross Axle Weight Rating (GAWR) for either the front or rear axle.

And, if you do have a heavy load, you should spread it out. Don't carry more than 176 pounds (80 kilograms) in your trunk.

If you put things inside your vehicle -- like suitcases, tools, packages, or anything else -- they will go as fast as the vehicle goes. If you have to stop or turn quickly, or if there is a crash, they'll keep going.



 **CAUTION:**

Things you put inside your vehicle can strike and injure people in a sudden stop or turn, or in a crash.

- Put things in the trunk of your vehicle. Put them as far forward as you can. Try to spread the weight evenly.
- Never stack heavier things, like suitcases, inside the vehicle so that some of them are above the tops of the seats.
- Don't leave an unsecured child restraint in your vehicle.
- When you carry something inside the vehicle, secure it whenever you can.
- Don't leave a seat folded down unless you need to.

## Tires

We don't make tires. Your new vehicle comes with high quality tires made by a leading tire manufacturer. These tires are warranted by the tire manufacturers and their warranties are delivered with every new Buick. If your spare tire is a different brand than your road tires, you will have a tire warranty folder from each of these manufacturers.



## **CAUTION:**

**Poorly maintained and improperly used tires are dangerous.**

- **Overloading your tires can cause overheating as a result of too much friction. You could have an air-out and a serious accident. See "Loading Your Vehicle" in the Index.**
- **Underinflated tires pose the same danger as overloaded tires. The resulting accident could cause serious injury. Check all tires frequently to maintain the recommended pressure. Tire pressure should be checked when your tires are cold.**
- **Overinflated tires are more likely to be cut, punctured, or broken by a sudden impact, such as when you hit a pothole. Keep tires at the recommended pressure.**
- **Worn, old tires can cause accidents. If your tread is badly worn, or if your tires have been damaged, replace them.**

## **Inflation - Tire Pressure**

The Tire-Loading Information label which is located on the rear edge of the driver's door shows the correct inflation pressures for your tires, when they're cold. "Cold" means your vehicle has been sitting for at least three hours or driven no more than a mile.

## **NOTICE:**

**Don't let anyone tell you that underinflation or overinflation is all right. It's not. If your tires don't have enough air (underinflation) you can get:**

- Too much flexing
- Too much heat
- Tire overloading
- Bad wear
- Bad handling
- Bad fuel economy.

**If your tires have too much air (overinflation), you can get:**

- Unusual wear
- Bad handling
- Rough ride
- Needless damage from road hazards.

## When to Check

Check your tires once a month or more.

Don't forget your compact spare tire. It should be at 60 psi (420 kPa).

## How to Check

Use a good quality pocket-type gage to check tire pressure. Simply looking at the tires will not tell you the pressure, especially if you have radial tires -- which may look properly inflated even if they're underinflated.

If your tires have valve caps, be sure to put them back on. They help prevent leaks by keeping out dirt and moisture.

## Tire Inspection and Rotation

To make your tires last longer, have them inspected and rotated at the mileages recommended in the Maintenance Schedule. See "Scheduled Maintenance Services" in the Index.

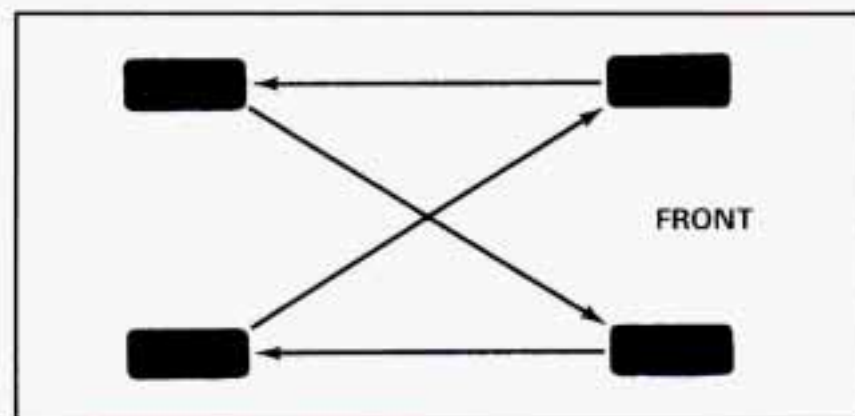

Use this rotation pattern.

After the tires have been rotated, adjust the front and rear inflation pressure as shown on the Tire-Loading Information label. Make certain that all wheel nuts are properly tightened. See "Wheel Nut Torque" in the Index.





## CAUTION:

Rust or dirt on a wheel, or on the parts to which it is fastened, can make wheel nuts become loose after a time. The wheel could come off and cause an accident. When you change a wheel, remove any rust or dirt from places where the wheel attaches to the vehicle. In an emergency, you can use a cloth or a paper towel to do this; but be sure to use a scraper or wire brush later, if you need to, to get all the rust or dirt off. (See "Changing a Flat Tire" in the Index.)

## When It's Time for New Tires

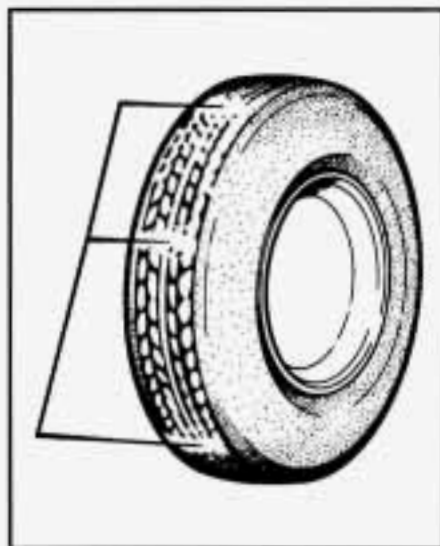

One way to tell when it's time for new tires is to check the treadwear indicators, which will appear when your tires have only  $\frac{2}{32}$  inch (1.6 mm) or less of tread remaining.

You need a new tire if:

- You can see the indicators at three or more places around the tire.
- You can see cord or fabric showing through the tire's rubber.
- The tread or sidewall is cracked, cut or snagged deep enough to show cord or fabric.
- The tire has a bump, bulge or split.

- The tire has a puncture, cut, or other damage that can't be repaired well because of the size or location of the damage.

## Buying New Tires

To find out what kind and size of tires you need, look at the Tire-Loading Information label.

The tires installed on your vehicle when it was new had a Tire Performance Criteria Specification (TPC Spec) number on each tire's sidewall. When you get new tires, get ones with that same TPC Spec number. That way, your vehicle will continue to have tires that are designed to give proper endurance, handling, speed rating, traction, ride and other things during normal service on your vehicle. If your tires have an all-season tread design, the TPC number will be followed by a "MS" (for mud and snow).

If you ever replace your tires with those not having a TPC Spec number, make sure they are the same size, load range, speed rating and construction type (bias, bias-belted or radial) as your original tires.



### **CAUTION:**

**Mixing tires could cause you to lose control while driving. If you mix tires of different sizes or types (radial and bias-belted tires), the vehicle may not handle properly, and you could have a crash. Be sure to use the same size and type tires on all four wheels.**

**It's all right to drive with your compact spare, though. It was developed for use on your vehicle.**

## Uniform Tire Quality Grading

The following information relates to the system developed by the United States National Highway Traffic Safety Administration which grades tires by treadwear, traction and temperature performance. (This applies only to vehicles sold in the United States.)

### **Treadwear**

The treadwear grade is a comparative rating based on the wear rate of the tire when tested under controlled conditions on a specified government test course. For example, a tire graded 150 would wear one and a half (1 1/2) times as well on the government course as a tire

graded 100. The relative performance of tires depends upon the actual conditions of their use, however, and may depart significantly from the norm due to variations in driving habits, service practices and differences in road characteristics and climate.

### **Traction - A, B, C**

The traction grades, from highest to lowest are: A, B, and C. They represent the tire's ability to stop on wet pavement as measured under controlled conditions on specified government test surfaces of asphalt and concrete. A tire marked C may have poor traction performance.

Warning: The traction grade assigned to this tire is based on braking (straight-ahead) traction tests and does not include cornering (turning) traction.

### **Temperature - A, B, C**

The temperature grades are A (the highest), B, and C, representing the tire's resistance to the generation of heat and its ability to dissipate heat when tested under controlled conditions on a specified indoor laboratory test wheel. Sustained high temperature can cause the material of the tire to degenerate and reduce tire life, and excessive temperature can lead to sudden tire failure. The grade C corresponds to a level of performance

which all passenger car tires must meet under the Federal Motor Vehicle Safety Standard No. 109. Grades B and A represent higher levels of performance on the laboratory test wheel than the minimum required by law.

Warning: The temperature grade for this tire is established for a tire that is properly inflated and not overloaded. Excessive speed, underinflation, or excessive loading, either separately or in combination, can cause heat buildup and possible tire failure.

These grades are molded on the sidewalls of passenger car tires.

While the tires available as standard or optional equipment on General Motors vehicles may vary with respect to these grades, all such tires meet General Motors performance standards and have been approved for use on General Motors vehicles. All passenger type (P Metric) tires must conform to Federal safety requirements in addition to these grades.

### **Wheel Alignment and Tire Balance**

The wheels on your vehicle were aligned and balanced carefully at the factory to give you the longest tire life and best overall performance.



In most cases, you will not need to have your wheels aligned again. However, if you notice unusual tire wear or your vehicle pulling one way or the other, the alignment may need to be reset. If you notice your vehicle vibrating when driving on a smooth road, your wheels may need to be rebalanced.

## Wheel Replacement

Replace any wheel that is bent, cracked or badly rusted. If wheel nuts keep coming loose, the wheel, wheel bolts, and wheel nuts should be replaced. If the wheel leaks air, replace it (except some aluminum wheels, which can sometimes be repaired). See your Buick dealer if any of these conditions exist.

Your dealer will know the kind of wheel you need.

Each new wheel should have the same load carrying capacity, diameter, width, offset, and be mounted the same way as the one it replaces.

If you need to replace any of your wheels, wheel bolts, or wheel nuts, replace them only with new GM original equipment parts. This way, you will be sure to have the right wheel, wheel bolts, and wheel nuts for your Buick model.



### **CAUTION:**

**Using the wrong replacement wheels, wheel bolts, or wheel nuts on your vehicle can be dangerous. It could affect the braking and handling of your vehicle, make your tires lose air and make you lose control. You could have a collision in which you or others could be injured. Always use the correct wheel, wheel bolts, and wheel nuts for replacement.**

### **NOTICE:**

**The wrong wheel can also cause problems with bearing life, brake cooling, speedometer/odometer calibration, headlight aim, bumper height, vehicle ground clearance, and tire or tire chain clearance to the body and chassis.**

## Used Replacement Wheels



### **CAUTION:**

Putting a used wheel on your vehicle is dangerous. You can't know how it's been used or how many miles it's been driven. It could fail suddenly and cause an accident. If you have to replace a wheel use a new GM original equipment wheel.

## Tire Chains

### **NOTICE:**

If your Buick has P215/70R15 size tires, don't use tire chains; they can damage your vehicle.

If you have other tires, use tire chains only where legal and only when you must. Use only SAE Class "S" type chains that are the proper size for your tires. Install them on the front tires and tighten them as tightly as possible with the ends securely fastened. Drive slowly and follow the chain manufacturer's instructions. If you can hear the chains contacting your vehicle, stop and retighten them. If the contact continues, slow down until it stops. Driving too fast with chains on will damage your vehicle.

## Appearance Care

Remember, cleaning products can be hazardous. Some are toxic. Others can burst into flame if you strike a match or get them on a hot part of the vehicle. Some are dangerous if you breathe their fumes in a closed space. When you use anything from a container to clean your Buick, be sure to follow the manufacturer's warnings and instructions. And always open your doors or windows when you're cleaning the inside.

Never use these to clean your vehicle:

- Gasoline
- Benzene
- Naphtha
- Carbon Tetrachloride
- Acetone
- Paint Thinner
- Turpentine
- Lacquer Thinner
- Nail Polish Remover

They can all be hazardous -- some more than others -- and they can all damage your vehicle, too.

### **NOTICE:**

**Don't use any of these unless this manual says you can. In many uses, these will damage your vehicle:**

- Laundry Soap
- Bleach
- Reducing Agents

## Cleaning the Inside of Your Buick

Use a vacuum cleaner often to get rid of dust and loose dirt. Wipe vinyl or leather with a clean, damp cloth.

Your Buick dealer has two GM cleaners, a solvent-type spot lifter and a foam-type powdered cleaner. They will clean normal spots and stains very well. Do not use them on vinyl or leather.

Here are some cleaning tips:

- Always read the instructions on the cleaner label.
- Clean up stains as soon as you can -- before they set.
- Use a clean cloth or sponge, and change to a clean area often. A soft brush may be used if stains are stubborn.



- Use solvent-type cleaners in a well-ventilated area only. If you use them, don't saturate the stained area.
- If a ring forms after spot cleaning, clean the entire area immediately or it will set.

### Using Foam-Type Cleaner on Fabric

- Vacuum and brush the area to remove any loose dirt.
- Always clean a whole trim panel or section. Mask surrounding trim along stitch or welt lines.
- Mix Multi-Purpose Powdered Cleaner following the directions on the container label.
- Use suds only and apply with a clean sponge.
- Don't saturate the material.
- Don't rub it roughly.
- As soon as you've cleaned the section, use a sponge to remove the suds.
- Rinse the section with a clean, wet sponge.
- Wipe off what's left with a slightly damp paper towel or cloth.
- Then dry it immediately with a blow dryer or a heat lamp.

### **NOTICE:**

**Be careful with a hair dryer or heat lamp. You could scorch the fabric.**

- Wipe with a clean cloth.

### Using Solvent-Type Cleaner on Fabric

First, see if you have to use solvent-type cleaner at all. Some spots and stains will clean off better with just water and mild soap.

If you need to use a solvent:

- Gently scrape excess soil from the trim material with a clean, dull knife or scraper. Use very little cleaner, light pressure and clean cloths (preferably cheesecloth). Cleaning should start at the outside of the stain, "feathering" toward the center. Keep changing to a clean section of the cloth.
- When you clean a stain from fabric, immediately dry the area with an air hose, hair dryer, or heat lamp to help prevent a cleaning ring. (See the previous NOTICE.)

## Special Cleaning Problems

### Greasy or Oily Stains

Such as grease, oil, butter, margarine, shoe polish, coffee with cream, chewing gum, cosmetic creams, vegetable oils, wax crayon, tar and asphalt.

- Carefully scrape off excess stain.
- Follow the solvent-type instructions described earlier.
- Shoe polish, wax crayon, tar and asphalt will stain if left on a vehicle seat fabric. They should be removed as soon as possible. Be careful, because the cleaner will dissolve them and may cause them to spread.

### Non-Greasy Stains

Such as catsup, coffee (black), egg, fruit, fruit juice, milk, soft drinks, wine, vomit, urine and blood.

- Carefully scrape off excess stain, then sponge the soiled area with cool water.
- If a stain remains, follow the foam-type instructions described earlier.

- If an odor lingers after cleaning vomit or urine, treat the area with a water/baking soda solution: 1 teaspoon (5 ml) of baking soda to 1 cup (250 ml) of lukewarm water.
- If needed, clean lightly with solvent-type cleaner.

### Combination Stains

Such as candy, ice cream, mayonnaise, chili sauce and unknown stains.

- Carefully scrape off excess stain, then clean with cool water and allow to dry.
- If a stain remains, clean it with solvent-type cleaner.

### Cleaning Vinyl

Use warm water and a clean cloth.

- Rub with a clean, damp cloth to remove dirt. You may have to do it more than once.
- Things like tar, asphalt and shoe polish will stain if you don't get them off quickly. Use a clean cloth and a solvent-type vinyl cleaner.

### Cleaning Leather

Use a soft cloth with lukewarm water and a mild soap or saddle soap.

- For stubborn stains, use a mild solution of 10% isopropyl alcohol (rubbing alcohol) and 90% water.
- Never use oils, varnishes, solvent-based or abrasive cleaners, furniture polish or shoe polish on leather.
- Soiled leather should be cleaned immediately. If dirt is allowed to work into finish, it can harm the leather.

### Cleaning the Top of the Instrument Panel

Use only mild soap and water to clean the top surfaces of the instrument panel. Sprays containing silicones or waxes may cause annoying reflections in the windshield and even make it difficult to see through the windshield under certain conditions.

### Cleaning Speaker Covers

Vacuum around a speaker cover gently, so that the speaker won't be damaged. If something gets on one of them, follow the steps earlier under "Using Solvent-Type Cleaner on Fabric." Use as little solvent as you can.

## Care of Safety Belts

Keep belts clean and dry.



### CAUTION:

**Do not bleach or dye safety belts. If you do, it may severely weaken them. In a crash they might not be able to provide adequate protection. Clean safety belts only with mild soap and lukewarm water.**

## Glass

Glass should be cleaned often. GM Glass Cleaner (GM Part No. 1050427) or a liquid household glass cleaner will remove normal tobacco smoke and dust films.

Don't use abrasive cleaners on glass, because they may cause scratches. Avoid placing decals on the inside rear window, since they may have to be scraped off later. If abrasive cleaners are used on the inside of the rear window, an electric defogger element may be damaged. Any temporary license should not be attached across the defogger grid.



## **Cleaning the Outside of the Windshield and Wiper Blades**

If the windshield is not clear after using the windshield washer, or if the wiper blade chatters when running, wax or other material may be on the blade or windshield.

Clean the outside of the windshield with GM Windshield Cleaner, Bon-Ami Powder<sup>®</sup> (GM Part No. 1050011). The windshield is clean if beads do not form when you rinse it with water.

Clean the blade by wiping vigorously with a cloth soaked in full strength windshield washer solvent. Then rinse the blade with water.

Wiper blades should be checked on a regular basis and replaced when worn.

## **Cleaning the Outside of Your Buick**

The paint finish on your vehicle provides beauty, depth of color, gloss retention and durability.

## **Washing Your Vehicle**

The best way to preserve your vehicle's finish is to keep it clean by washing it often with lukewarm or cold water.

Don't wash your vehicle in the direct rays of the sun. Don't use strong soaps or chemical detergents. Use liquid hand, dish or car washing (mild detergent) soaps. Don't use cleaning agents that contain acid or abrasives. All cleaning agents should be flushed promptly and not allowed to dry on the surface, or they could stain. Dry the finish with a soft, clean chamois or a 100% cotton towel to avoid surface scratches and water spotting.

High pressure car washes may cause water to enter your vehicle.

## **Finish Care**

Occasional waxing or mild polishing of your Buick may be necessary to remove residue from the paint finish. You can get GM approved cleaning products from your dealer. (See "Appearance Care and Materials" in the Index.)

Your Buick has a “basecoat/clearcoat” paint finish. The clearcoat gives more depth and gloss to the colored basecoat. Always use waxes and polishes that are non-abrasive and made for a basecoat/clearcoat paint finish.

### **NOTICE:**

**Machine compounding or aggressive polishing on a basecoat/clearcoat paint finish may dull the finish or leave swirl marks.**

## **Aluminum Wheels (If So Equipped)**

Your aluminum wheels have a protective coating similar to the painted surface of your car. Don't use strong soaps, chemicals, chrome polish, abrasive cleaners or abrasive cleaning brushes on them because you could damage this coating. After rinsing thoroughly, a wax may be applied.

### **NOTICE:**

**If you have aluminum wheels, don't use an automatic vehicle wash that has hard silicon carbide cleaning brushes. These brushes can take off the protective coating.**

## **White Sidewall Tires**

Your Buick dealer has a GM White Sidewall Tire Cleaner. You can use a stiff brush with the cleaner.

## **Weatherstrips**

Silicone grease on weatherstrips will make them last longer, seal better, and not stick or squeak. Apply silicone grease with a clean cloth at least every six months. During very cold, damp weather more frequent application may be required. (See “Recommended Fluids & Lubricants” in the Index.)

## **Sheet Metal Damage**

If your vehicle is damaged and requires sheet metal repair or replacement, make sure the body repair shop applies anti-corrosion material to the parts repaired or replaced to restore corrosion protection.

## Foreign Material

Calcium chloride and other salts, ice melting agents, road oil and tar, tree sap, bird droppings, chemicals from industrial chimneys, and other foreign matter can damage your vehicle's finish if they remain on painted surfaces. Use cleaners that are marked safe for painted surfaces to remove foreign matter.

## Finish Damage

Any stone chips, fractures or deep scratches in the finish should be repaired right away. Bare metal will corrode quickly and may develop into a major repair expense.

Minor chips and scratches can be repaired with touch-up materials available from your dealer or other service outlets. Larger areas of finish damage can be corrected in your dealer's body and paint shop.

## Underbody Maintenance

Chemicals used for ice and snow removal and dust control can collect on the underbody. If these are not removed, accelerated corrosion (rust) can occur on the

underbody parts such as fuel lines, frame, floor pan, and exhaust system even though they have corrosion protection.

At least every spring, flush these materials from the underbody with plain water. Clean any areas where mud and other debris can collect. Dirt packed in closed areas of the frame should be loosened before being flushed. Your dealer or an underbody vehicle washing system can do this for you.

## Chemical Paint Spotting

Some weather and atmospheric conditions can create a chemical fallout. Airborne pollutants can fall upon and attack painted surfaces on your vehicle. This damage can take two forms: blotchy, ringlet-shaped discolorations, and small irregular dark spots etched into the paint surface.

Although no defect in the paint job causes this, Buick will repair, at no charge to the owner, the surfaces of new vehicles damaged by this fallout condition within 12 months or 12,000 miles (20 000 km) of purchase, whichever comes first.



## Appearance Care and Maintenance Materials

You can get these from your Buick dealer.

PART NUMBER	SIZE	DESCRIPTION	USAGE
12345343	16 oz. (0.473L)	Magic Mirror Creme Wax	Exterior cleaner and polish
1052277	12 oz. (0.354L)	Spray-A-Squeak	Weather strips,
1052863	1 oz. (0.028kg)	Silicone Grease	Stops squeaks
1050172	16 oz. (0.473L)	Tar and Road Oil Remover	Also removes old waxes, polishes
1050173	16 oz. (0.473L)	Chrome Cleaner and Polish	Removes rust and corrosion
1050174	16 oz. (0.473L)	White Sidewall Tire Cleaner	Cleans white and black tires
1050214	32 oz. (0.946L)	Vinyl/Leather Cleaner	Spot and stain removal
1050244	16 oz. (0.473L)	Fabric Cleaner	Spot and stain removal
1050427	23 oz. (0.680L)	Glass Cleaner	Also spot cleans vinyls
1050429	6 lb. (2.72kg)	Multi-Purpose Powdered Cleaner	Cleans vinyl and cloth, also, tires and mats
1052349	12 oz. (0.340kg)	Lubriplate (White Grease)	For hood, trunk, door hinges and latches
1051055	16 oz. (0.473L)	Preservatone	Vinyl Top Dressing
1051398*	8 oz. (0.237L)	Spot Lifter	For cloth
1051515	32 oz. (0.946L)	Washer Solvent	Windshield-washing system
1052870	16 oz. (0.473L)	Wash-Wax (conc.)	Exterior Wash

\* Not recommended for pigskin suede leather.

See Your General Motors Dealers for These Products.

See Your Maintenance Schedule for Other Products.

## Vehicle Identification Number (VIN)



This is the legal identifier for your Buick. It appears on a plate in the front corner of the instrument panel, on the driver's side. You can see it if you look through the windshield from outside your vehicle. The VIN also appears on the Vehicle Certification and Service Parts labels and the certificates of title and registration.

### Engine Identification

The eighth character in your VIN is the engine code. This code will help you identify your engine, specifications, and replacement parts.

## Service Parts Identification Label

You'll find this label on the spare tire cover. It's very helpful if you ever need to order parts. On this label is:

- your VIN,
- the model designation,
- paint information, and
- a list of all production options and special equipment.

Be sure that this label is not removed from the vehicle.

## Add-On Electrical Equipment

### NOTICE:

**Don't add anything electrical to your Buick unless you check with your dealer first. Some electrical equipment can damage your vehicle and the damage wouldn't be covered by your warranty. Some add-on electrical equipment can keep other components from working as they should.**

Your vehicle has an air bag system. Before attempting to add anything electrical to your Buick, see “Servicing Your Air Bag-Equipped Buick” in the Index.

## Fuses and Circuit Breakers

The wiring circuits in your car are protected from short circuits by a combination of fuses, circuit breakers and fusible thermal links in the wiring itself.

The fuse panel is located under the instrument panel, next to the parking brake.



Remove the cover to access the fuses. To put the cover on, insert the tabs into the lower part of the fuse panel and snap it in place.

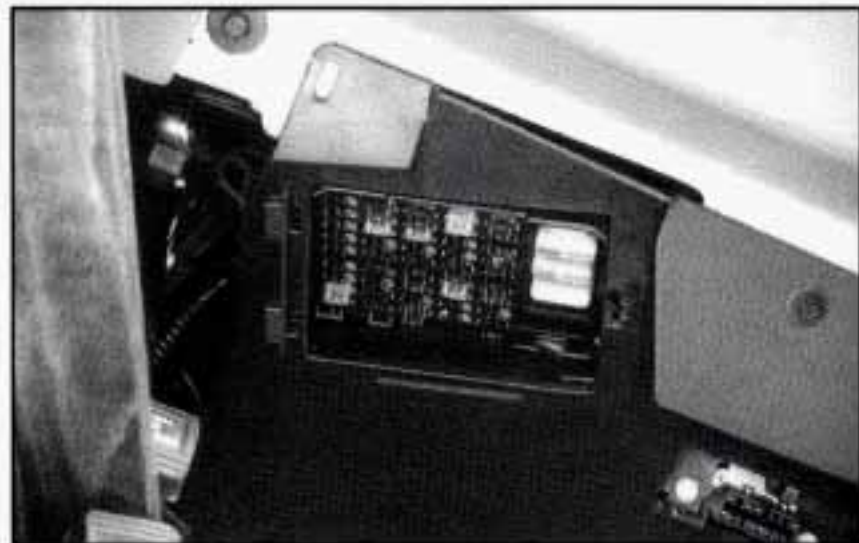



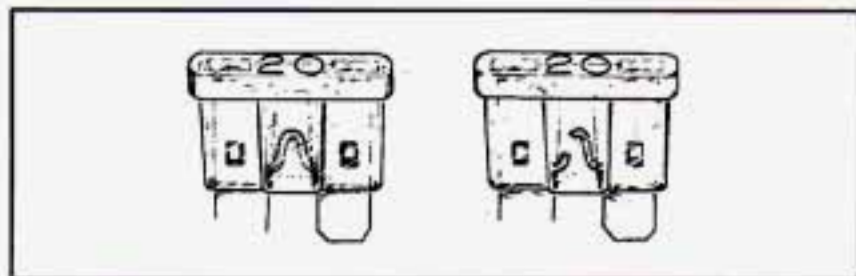

Look at the silver-colored band inside the fuse. If the band is broken or melted, replace the fuse. Be sure you replace a bad fuse with a new one of the identical size and rating.

There are additional fuses located behind the right sound insulator panel on the passenger side. If these require service, see your Buick dealer.

### **Maxifuse/Relay Center**

To check the fuses in this underhood fuse center, turn the two knobs 1/4 turn counterclockwise and remove the cover. There is a chart inside the cover that explains the features and controls governed by each fuse and relay.

The PASS-Key II<sup>®</sup> fuse is located in the right side relay center.

### **Headlights**

The headlight wiring is protected by a circuit breaker in the underhood fuse center. An electrical overload will cause the lights to go on and off, or in some cases to remain off. If this happens, have your headlight wiring checked right away.

### **Windshield Wipers**

The windshield wiper motor is protected by a circuit breaker and a fuse. If the motor overheats due to heavy snow, etc., the wiper will stop until the motor cools. If the overload is caused by some electrical problem and not snow, etc., be sure to get it fixed.

### **Power Windows and Other Power Options**

Circuit breakers in the fuse panel protect the power windows and other power accessories. When the current load is too heavy, the circuit breaker opens and closes, protecting the circuit until the problem is fixed or goes away.

## Fuse Usage

Amp	Description
1	30 BRKR – Power Window/Sunroof
2	Not Used
3	25 BRKR – Power Seats
4	Not Used
5	Not Used
1A	10 SIR DERM/Crank
1B	20 Signal/Cornering/Back-up Lamps
1C	10 SIR
1D	15 Cluster/Telltale/Chime/HTD Seat/Day-Night Mirror/ MEM Seat
1E	Not Used
2A	10 Spare
2B	15 Spare
2C	20 Spare
2D	25 Spare
2E	Not Used
3A	Not Used
3B	Not Used
3C	Not Used
3D	10 Heated Mirrors
3E	Not Used
4A	10 Mirror Illumination
4B	Not Used
4C	Not Used
4D	Not Used
4E	Not Used

## Fuse Usage

Amp	Description
5A	10 Uplevel HVAC/Lamp Monitor/Oil Level/Low Coolant
5B	10 ABS/CCR
5C	10 Transmission/Cooling Fans
5D	25 Base HVAC
5E	Not Used
6A	15 Courtesy Lamps/Power Mirrors
6B	20 Brake & Hazard Lamps
6C	15 Park Lamps
6D	Not Used
6E	Not Used
7A	Not Used
7B	Not Used
7C	Not Used
7D	Not Used
7E	Not Used
8A	Not Used
8B	Not Used
8C	Not Used
8D	10 Radio
8E	25 Wiper/Washer
9A	15 Ash Tray Cigar Lighter
9B	20 Electronic Level Control
9C	10 Radio/Ignition
9D	15 Rear Cigar Lighters
9E	30 Rear Window Defog

## Park Avenue Dimensions

Inches Unless Otherwise Noted

### Overall:

Length .....	205.2
Width .....	73.6
Height .....	55.1
Wheel Base .....	110.8
Front Tread .....	60.5
Rear Tread .....	60.2

### Interior Front:

Leg Room .....	42.0
Head Room .....	38.8
Shoulder Room .....	59.1
Hip Room .....	55.1

### Interior Rear:

Leg Room .....	41.6
Head Room .....	38.8
Shoulder Room .....	59.1
Hip Room .....	55.1

**Trunk Capacity – Cu. Ft.** ..... 20.3

### Passengers:

Front .....	3
Rear .....	3

**Base Curb Weight – Lbs.** ..... 3536  
(ULTRA) ..... 3639



## Replaceable Light Bulbs

Application	Number	Application	Number
<b>Exterior</b>		<b>Interior Illumination</b>	
Headlight		Ashtray .....	161
High Beam .....	9005	Dome/Reading, Front .....	564
Low Beam .....	9006	Reading, Rear .....	A3173B
Park/Turn .....	2057NA	Door Warning .....	PC168
Park .....	194NA	Engine Compartment .....	561
Side Marker, Front .....	194NA	Footwell Courtesy .....	168
Backup .....	1156	Glove Box .....	194
High Level Stop .....	3156	Luggage Compartment .....	93
License .....	194	Vanity Mirror, Front .....	7056
Side Marker, Rear .....	24	Vanity Mirror, Rear .....	564
Tail .....	194		
Tail/stop/turn .....	3057		

## Capacities and Specifications

**Engine Code L (L27) 3.8L V-6 SFI**

**Engine Code 1 (L67) 3.8L V-6 SFI**

**Belt Tensions —**

Automatically controlled by a Self-Tension idler pulley. Tension adjustment should never be necessary.

**Cooling System Capacity —**

With air conditioning: 13 quarts/12.5 liters

**Crankcase Capacity —**

4 quarts/3.8 liters (oilchange without filter)

5 quarts/4.75 liters (oilchange with filter change)

**Air Conditioning Capacity —**

R134a — 2.2 lbs. (.99 kilograms)

**Fuel Tank Capacity —**

18.0 gallons/68 liters

**Transaxle —**

Drain & Refill — 6 quarts/5.6 liters

**Maintenance Item Part Numbers —**

Air Filter — A1096C

Fuel Filter — GF580

Oil Filter — PF47

PCV Valve — CV892C

Radiator Cap — RC27

Spark Plug — 41-601, GAP 0.060"

---

**Air Conditioning Refrigerants** Not all air conditioning refrigerants are the same. If the air conditioning system in your vehicle needs refrigerant, be sure the proper refrigerant is used. If you're not sure ask your Buick dealer. For additional information, see your "Warranty and Owner Assistance Information" booklet.



## Part 7 Maintenance Schedule

This part covers the maintenance required for your Buick. Your vehicle needs these services to retain its safety, dependability and emission control performance.

### Part 7 includes:

Introduction .....	284
A Word About Maintenance .....	284
Your Vehicle and the Environment .....	285
How This Part is Organized .....	285
Section A: Scheduled Maintenance Services .....	287
Using Your Maintenance Schedules .....	287
Selecting the Right Schedule .....	287
Schedule I .....	288
Schedule II .....	290
Explanation of Scheduled Maintenance Services .....	292
Section B: Owner Checks and Services .....	294
At Each Fuel Fill .....	294
At Least Once a Month .....	295
At Least Once a Year .....	295
Section C: Periodic Maintenance Inspections .....	298
Section D: Recommended Fluids and Lubricants .....	299
Section E: Maintenance Record .....	301



**IMPORTANT:  
KEEP ENGINE OIL  
AT THE PROPER  
LEVEL AND CHANGE AS  
RECOMMENDED**



***Protection  
Plan***

**Have you purchased the GM Protection Plan? The Plan supplements your new vehicle warranties. See your Buick dealer for details.**

## **Introduction**

### **A Word About Maintenance**

We at General Motors want to help you keep your vehicle in good working condition. But we don't know exactly how you'll drive it. You may drive very short distances only a few times a week. Or you may drive long distances all the time in very hot, dusty weather. You may use your vehicle in making deliveries. Or you may drive it to work, to do errands or in many other ways.

Because of all the different ways people use their GM vehicles, maintenance needs vary. You may even need more frequent checks and replacements than you will find in the schedules in this part. So please read this part and note how you drive. If you have any questions on how to keep your vehicle in good condition, see your Buick dealer, the place many GM owners choose to have their maintenance work done. Your dealer can be relied upon to use proper parts and practices.

## Your Vehicle and the Environment

Proper vehicle maintenance not only helps to keep your vehicle in good working condition, but also helps the environment. All recommended maintenance procedures are important. Improper vehicle maintenance or the removal of important components can significantly affect the quality of the air we breathe. Improper fluid levels or even the wrong tire inflation can increase the level of emissions from your vehicle. To help protect our environment, and to help keep your vehicle in good condition, please maintain your vehicle properly.

### How This Part is Organized

The remainder of this part is divided into five sections: “Section A: Scheduled Maintenance Services” shows what to have done and how often. Some of these services can be complex, so unless you are technically qualified and have the necessary equipment, you should let your dealer’s service department or another qualified service center do these jobs.



### **CAUTION:**

**Performing maintenance work on a vehicle can be dangerous. In trying to do some jobs, you can be seriously injured. Do your own maintenance work only if you have the required know-how and the proper tools and equipment for the job. If you have any doubt, have a qualified technician do the work.**

If you are skilled enough to do some work on your vehicle, you will probably want to get the service information GM publishes. You will find a list of publications and how to get them in this manual. See “Service Publications” in the Index.

“Section B: Owner Checks and Services” tells you what should be checked whenever you stop for fuel. It also explains what you can easily do to help keep your vehicle in good condition.

“Section C: Periodic Maintenance Inspections” explains important inspections that your Buick dealer’s service department or another qualified service center should perform.

“Section D: Recommended Fluids and Lubricants” lists some products GM recommends to help keep your vehicle properly maintained. These products, or their equivalents, should be used whether you do the work yourself or have it done.

“Section E: Maintenance Record” provides a place for you to record the maintenance performed on your vehicle. Whenever any maintenance is performed, be sure to write it down in this section. This will help you determine when your next maintenance should be done. In addition, it is a good idea to keep your maintenance receipts. They may be needed to qualify your vehicle for warranty repairs.



## Section A: Scheduled Maintenance Services

### Using Your Maintenance Schedules

This section tells you the maintenance services you should have done and when you should schedule them. Your Buick dealer knows your vehicle best and wants you to be happy with it. If you go to your dealer for your service needs, you'll know that GM-trained and supported service people will perform the work using genuine GM parts.

These schedules are for vehicles that:

- carry passengers and cargo within recommended limits. You will find these limits on your vehicle's Tire-Loading Information label. See "Loading Your Vehicle" in the Index.
- are driven on reasonable road surfaces within legal driving limits.
- use the recommended unleaded fuel. See "Fuel" in the Index.

### Selecting the Right Schedule

First you'll need to decide which of the two schedules is right for your vehicle. Here's how to decide which schedule to follow:

#### Schedule I

Is any one of these true for your vehicle?

- Most trips are less than 4 miles (6 km).
- Most trips are less than 10 miles (16 km) when outside temperatures are below freezing.
- The engine is at low speed most of the time (as in door-to-door delivery, or in stop-and-go traffic).
- You operate your vehicle in dusty areas.
- You tow a trailer. (With some models, you should never tow a trailer. See "Towing a Trailer" in the Index.)

If any one (or more) of these is true for your driving, follow Schedule I.

#### Schedule II

Follow Schedule II **only** if none of the above conditions is true.

## Scheduled Maintenance Services Schedule I

Follow Schedule I if your car is **MAINLY** driven under one or more of the following conditions:

- When most trips are less than 4 miles (6 kilometers).
- When most trips are less than 10 miles (16 kilometers) and outside temperatures remain below freezing.
- When most trips include extended idling and/or frequent low-speed operation as in stop-and-go traffic.
- Towing a trailer.\*†
- When operating in dusty areas.

Schedule I should also be followed if the car is used for delivery service, police, taxi or other commercial applications.

TO BE SERVICED (See Explanation of Scheduled Maintenance Services Following Schedules I and II)  <i>Item No.</i>	WHEN TO PERFORM Miles (kilometers) or Months, Whichever Occurs First	MILES (000)															
		3	6	9	12	15	18	21	24	27	30	33	36	39	42	45	48
		KILOMETERS (000)															
		5	10	15	20	25	30	35	40	45	50	55	60	65	70	75	80
1. Engine Oil & Filter Change*	Every 3 000 mi. (5000 km) or 3 months.	●	●	●	●	●	●	●	●	●	●	●	●	●	●	●	●
2. Chassis Lubrication	Every other oil change		●		●		●		●		●		●		●		●
3. Tire & Wheel Inspection & Rotation	At 6 000 mi. (10 000 km) and then every 15 000 mi. (25 000 km) or as necessary		●					●					●				
4. Engine Accessory Drive Belt(s) Inspection*	Every 30 000 mi. (50 000 km) or 24 months.										●						
5. Cooling System Service*	Every 30 000 mi. (50 000 km) or 24 months.										●						

TO BE SERVICED (See Explanation of Scheduled Maintenance Services Following Schedules I and II)  <i>Item No.</i>	WHEN TO PERFORM Miles (kilometers) or Months, Whichever Occurs First	MILES (000)															
		3	6	9	12	15	18	21	24	27	30	33	36	39	42	45	48
		KILOMETERS (000)															
		5	10	15	20	25	30	35	40	45	50	55	60	65	70	75	80
6. Transaxle Service	See Explanation of Scheduled Maintenance Service Following Schedules I and II																
7. Spark Plug Replacement*	Every 30 000 mi (50 000 km)										•						
8. Spark Plug Wire Inspection*†											•						
9. Supercharger Oil Check (3.8L Code 1 engine only)	Every 30 000 mi (50 000 km) or 36 months										•						
10. Air Cleaner Filter Replacement*†	See Explanation of Scheduled Maintenance Service Following Schedules I and II										•						
11. Fuel Tank, Cap & Lines Inspection	Every 30 000 mi (50 000 km)										•						

**The services shown in this schedule up to 48 000 miles (80 000 km) should be performed after 48 000 miles at the same intervals.**

\* An Emission Control Service.

† The U.S. Environmental Protection Agency or the California Air Resources Board has determined that the failure to perform this maintenance item will not nullify the emission warranty or limit recall liability prior to the completion of vehicle useful life. General Motors, however, urges that all recommended maintenance services be performed at the indicated intervals and the maintenance be recorded in "Section E: Maintenance Record".



## Scheduled Maintenance Services Schedule II

Follow Schedule II ONLY if none of the driving conditions specified in Schedule I apply.

Item No.	TO BE SERVICED (See Explanation of Scheduled Maintenance Services Following Schedules I and II)	WHEN TO PERFORM Miles (kilometers) or Months, Whichever Occurs First	MILES (000)					
			7.5	15	22.5	30	37.5	45
			KILOMETERS (000)					
			12.5	25	37.5	50	62.5	75
1.	Engine Oil Change*	Every 7 500 mi. (12 500 km) or 12 mos.	•	•	•	•	•	•
	Oil Filter Change*	At first and then every other oil change	•		•		•	
2.	Chassis Lubrication	Every 7 500 mi. (12 500 km) or 12 mos.	•	•	•	•	•	•
3.	Tire & Wheel Inspection & Rotation	At 7 500 mi. (12 500 km) and then every 15 000 mi. (25 000 km) or as necessary	•		•		•	
4.	Engine Accessory Drive Belt(s) Inspection*	Every 30 000 mi. (50 000 km) or 24 mos.				•		
5.	Cooling System Service*					•		
6.	Transaxle Service	See Explanation of Scheduled Maintenance Services Following Schedules I and II						
7.	Spark Plug Replacement*	Every 30 000 mi. (50 000 km)				•		

<b>TO BE SERVICED</b> (See Explanation of Scheduled Maintenance Services Following Schedules I and II)	<b>WHEN TO PERFORM</b> <b>Miles (kilometers) or</b> <b>Months, Whichever</b> <b>Occurs First</b>	<b>MILES (000)</b>					
		7.5	15	22.5	30	37.5	45
		<b>KILOMETERS (000)</b>					
<b>Item No.</b>		12.5	25	37.5	50	62.5	75
8. Spark Plug Wire Inspection*†	Every 30 000 mi. (50 000 km)				•		
9. Supercharger Oil Check (3.8L Code I engine only)	Every 30 000 mi. (50 000 km) or 36 months				•		
10. Air Cleaner Filter Replacement*	See Explanation of Scheduled Maintenance Services Following Schedules I and II				•		
11. Fuel Tank, Cap & Lines Inspection*†	Every 30 000 mi. (50 000 km)				•		

**The services shown in this schedule up to 45 000 miles (75 000 km) should be performed after 45 000 miles at the same intervals.**

\* An Emission Control Service.

† The U.S. Environmental Protection Agency or the California Air Resources Board has determined that the failure to perform this maintenance item will not nullify the emission warranty or limit recall liability prior to the completion of vehicle useful life. General Motors, however, urges that all recommended maintenance services be performed at the indicated intervals and the maintenance be recorded in "Section E: Maintenance Record".

## Explanation of Scheduled Maintenance Services

Following are explanations of the services listed in Schedule I and Schedule II.

The proper fluids and lubricants to use are listed in Section D. Make sure whoever services your vehicle uses these. All parts should be replaced and all necessary repairs done before you or anyone else drives the vehicle.

NOTE: To determine your engine's displacement and code, see "Engine Identification" in the Index.

1. **Engine Oil and Filter Change\*** -- Always use SH or SG Energy Conserving II oils of proper viscosity. The "SH" or "SG" designation may be shown alone or in combination with others, such as "SH/CD" or "SH, SG, CD," "SG/CD," etc. To determine the preferred viscosity for your vehicle's engine (e.g., SAE 5W-30 or SAE 10W-30), see "Engine Oil" in the Index.

If your vehicle has an Engine Oil Life Monitor, the monitor will show you when to change the oil. See "Engine Oil Life Monitor" in the Index.

2. **Chassis Lubrication** -- Lubricate the transaxle shift linkage, parking brake cable guides, underbody contact points and linkage. If your vehicle is equipped with grease fittings, lubricate the suspension and steering linkage.
3. **Tire and Wheel Rotation and Inspection** -- For proper wear and maximum tire life, rotate your tires following the instructions in this manual. See "Tires, Inspection & Rotation" in the Index. Check the tires for uneven wear or damage. If you see irregular or premature wear, check the wheel alignment. Check for damaged wheels also.
4. **Engine Accessory Drive Belt(s) Inspection** -- Inspect the belt(s) for cracks, fraying, wear and proper tension. Replace as needed.
5. **Cooling System Service\*** -- Drain, flush and refill the system with new or approved recycled coolant conforming to GM Specification 1825M. Keep coolant at the proper mixture as specified. See "Coolant" in the Index. This provides proper freeze protection, corrosion inhibitor level and engine operating temperature.



Inspect hoses and replace if they are cracked, swollen or deteriorated. Tighten screw-type hose clamps. Clean the outside of the radiator and air conditioning condenser. Wash the pressure cap and neck.

To help ensure proper operation, we recommend a pressure test of both the cooling system and the pressure cap.

6. **Transaxle Service** -- Change both the fluid and filter every 15,000 miles (25 000 km) if the vehicle is mainly driven under one or more of these conditions:

- In heavy city traffic where the outside temperature regularly reaches 90°F (32°C) or higher.
- In hilly or mountainous terrain.
- When doing frequent trailer towing. (With some models, you shouldn't ever tow a trailer. See "Towing a Trailer" in the Index.)
- Uses such as found in taxi, police car or delivery service.

If you do not use your vehicle under any of these conditions, change both the fluid and filter every 100,000 miles (160 000 km).

7. **Spark Plug Replacement\*** -- Replace spark plugs with the proper type. See "Specifications Chart" in the Index.
8. **Spark Plug Wire Inspection\*†** -- Inspect for burns, cracks or other damage. Check the boot fit at the distributor and at the spark plugs. Replace wires as needed.
9. **Supercharger Oil Check**--Check oil every 30,000 (50 000km) or 36 months. Check oil level only on cold engine. Add the proper synthetic oil. See "Recommended Fluids and Lubricants" in the Index.
10. **Air Cleaner Filter Replacement\*** -- Replace every 30,000 miles (50 000 km) or more often under dusty conditions. Ask your dealer for the proper replacement intervals for your driving conditions.
11. **Fuel Tank, Cap and Lines Inspection\*†** -- Inspect fuel tank, cap and lines (including fuel rails and injection assembly) for damage or leaks. Inspect fuel cap gasket for an even filler neck imprint or any damage. Replace parts as needed. Periodic replacement of the fuel filter is not required.

\* An Emission Control Service.

† The U.S. Environmental Protection Agency or the California Air Resources Board has determined that the failure to perform this maintenance item will not nullify the emission warranty or limit recall liability prior to the completion of vehicle useful life. General Motors, however, urges that all recommended maintenance services be performed at the indicated intervals and the maintenance be recorded in "Section E: Maintenance Record".

## Section B: Owner Checks and Services

Listed below are owner checks and services which should be performed at the intervals specified to help ensure the safety, dependability and emission control performance of your vehicle.

Be sure any necessary repairs are completed at once. Whenever any fluids or lubricants are added to your vehicle, make sure they are the proper ones, as shown in Section D.

**At Each Fuel Fill (It is important for you or a service station attendant to perform these underhood checks at each fuel fill.)**

CHECK OR SERVICE	WHAT TO DO
Engine Oil Level	Check the engine oil level and add the proper oil if necessary. See "Engine Oil" in the Index for further details.
Engine Coolant Level	Check the engine coolant level in the coolant recovery tank and add the proper coolant mix if necessary. See "Coolant" in the Index for further details.
Windshield Washer Fluid Level	Check the windshield washer fluid level in the windshield washer tank and add the proper fluid if necessary. See "Windshield Washer Fluid" in the Index for further details.

## At Least Once a Month

CHECK OR SERVICE	WHAT TO DO
Tire Inflation	Check tire inflation. Make sure they are inflated to the pressures specified on the Tire-Loading Information label located on the rear edge of the driver's door. See "Tires" in the Index for further details.
Cassette Deck	Clean cassette deck. Cleaning should be done every 15 hours of tape play. See "Audio Systems" in the Index for further details.

## At Least Once a Year

CHECK OR SERVICE	WHAT TO DO
Key Lock Cylinders	Lubricate the key lock cylinders with the lubricant specified in Section D.
Body Lubrication	Lubricate all body door hinges. Also lubricate all hinges and latches, including those for the hood, glove box door and console door. Section D tells you what to use.
Starter Switch	<p><b>CAUTION: When you are doing this check, the vehicle could move suddenly. If it does, you or others could be injured. Follow the steps below.</b></p> <ol style="list-style-type: none"><li>1. Before you start, be sure you have enough room around the vehicle.</li><li>2. Firmly apply both the parking brake (see "Parking Brake" in the index if necessary) and the regular brake.</li></ol> <p>NOTE: Do not use the accelerator pedal, and be ready to turn off the engine immediately if it starts.</p> <ol style="list-style-type: none"><li>3. Try to start the engine in each gear. The starter should work only in "P" (Park) or "N" (Neutral). If the starter works in any other position, your vehicle needs service.</li></ol>



CHECK OR SERVICE	WHAT TO DO
Brake-Transmission Shift Interlock -- BTSI (Automatic)	<p><b>CAUTION: When you are doing this check, the vehicle could move suddenly. If it does, you or others could be injured. Follow the steps below.</b></p> <ol style="list-style-type: none"> <li>1. Before you start, be sure you have enough room around the vehicle. It should be parked on a level surface.</li> <li>2. Firmly apply the parking brake (see "Parking Brake" in the Index if necessary).</li> </ol> <p>NOTE: Be ready to apply the regular brake immediately if the vehicle begins to move.</p> <ol style="list-style-type: none"> <li>3. With the engine off, turn the key to the "RUN" position, but don't start the engine. Without applying the regular brake, try to move the shift lever out of "P" (Park) with normal effort. If the shift lever moves out of "P" (Park), your vehicle's BTSI needs service.</li> </ol>

CHECK OR SERVICE	WHAT TO DO
Steering Column Lock	<p>While parked, and with the parking brake set, try to turn the key to "LOCK" in each shift lever position.</p> <ul style="list-style-type: none"> <li>● The key should turn to "LOCK" only when the shift lever is in "P" (Park).</li> <li>● The key should come out only in "LOCK."</li> </ul>

CHECK OR SERVICE	WHAT TO DO
Parking Brake and Automatic Transmission "P" (Park) Mechanism Check	<p><b>CAUTION: When you are doing this check, your vehicle could begin to move. You or others could be injured and property could be damaged. Make sure there is room in front of your vehicle in case it begins to roll. Be ready to apply the regular brake at once should the vehicle begin to move.</b></p> <p>Park on a fairly steep hill, with the vehicle facing downhill. Keeping your foot on the regular brake, set the parking brake.</p> <ul style="list-style-type: none"> <li>● To check the parking brake: With the engine running and transmission in "N" (Neutral), slowly remove foot pressure from the regular brake pedal. Do this until the vehicle is held by the parking brake only.</li> <li>● To check the "P" (Park) mechanism's holding ability: Shift to "P" (Park). Then release all brakes.</li> </ul>

CHECK OR SERVICE	WHAT TO DO
Underbody Flushing	At least every spring, use plain water to flush any corrosive materials from the underbody. Take care to clean thoroughly any areas where mud and other debris can collect.

## Section C: Periodic Maintenance Inspections

Listed below are inspections and services which should be performed at least twice a year (for instance, each spring and fall). You should let your GM dealer's service department or other qualified service center do these jobs. Make sure any necessary repairs are completed at once.

INSPECTION OR SERVICE	WHAT SHOULD BE DONE
Restraint System	Now and then, make sure all your belts, buckles, latch plates, retractors, anchorages and reminder systems are working properly. Look for any loose parts or damage. If you see anything that might keep a restraint system from doing its job, have it repaired.

INSPECTION OR SERVICE	WHAT SHOULD BE DONE
Steering, Suspension and Front-Wheel-Drive Axle Boot and Seal Inspection	Inspect the front and rear suspension and steering system for damaged, loose or missing parts, signs of wear, or lack of lubrication. Inspect the power steering lines and hoses for proper hookup, binding, leaks, cracks, chafing, etc. Clean and then inspect the drive axle boot seals for damage, tears or leakage. Replace seals if necessary.
Exhaust System Inspection	Inspect the complete exhaust system. Inspect the body near the exhaust system. Look for broken, damaged, missing or out-of-position parts as well as open seams, holes, loose connections, or other conditions which could cause a heat build-up in the floor pan or could let exhaust fumes into the vehicle. See "Engine Exhaust" in the Index.
Throttle Linkage Inspection	Inspect the throttle linkage for interference or binding, and for damaged or missing parts. Replace parts as needed.



## Section D: Recommended Fluids and Lubricants

NOTE: Fluids and lubricants identified below by name, part number or specification may be obtained from your GM dealer.

USAGE	FLUID/LUBRICANT
Engine Oil	API service SH or SG Energy Conserving II oils of the proper viscosity. The "SH" or "SG" designation may be shown alone or in combination with others, such as "SH/CD," or "SH, SG, CD," "SG/CD" etc. To determine the preferred viscosity for your vehicle's engine, see "Engine Oil" in the Index.
Engine Coolant	50/50 mixture of water (preferably distilled) and good quality ethylene glycol base antifreeze (GM Part No. 1052753 or equivalent) conforming to GM Specification 1825M or approved recycled coolant conforming to GM Specification 1825M.
Hydraulic Brake System	Delco Supreme 11 <sup>®</sup> Brake Fluid (GM Part No. 1052535) or equivalent DOT-3 brake fluid.

INSPECTION OR SERVICE	WHAT SHOULD BE DONE
Brake System Inspection	<p>Inspect the complete system. Inspect brake lines and hoses for proper hookup, binding, leaks, cracks, chafing, etc. Inspect disc brake pads for wear and rotors for surface condition. Also inspect drum brake linings for wear and cracks. Inspect other brake parts, including drums, wheel cylinders, calipers, parking brake, etc. Check parking brake adjustment. You may need to have your brakes inspected more often if your driving habits or conditions result in frequent braking.</p> <p>NOTE: A low brake fluid level can indicate worn disc brake pads which may need to be serviced. Also, if the brake system warning light stays on or comes on, something may be wrong with the brake system. See "Brake System Warning Light" in the Index. If your anti-lock brake system warning light stays on, comes on or flashes, something may be wrong with the anti-lock brake system. See "Anti-Lock Brake System Warning Light" in the Index.</p>

USAGE	FLUID/LUBRICANT
Parking Brake Guides	Chassis lubricant (GM Part No. 1052497 or equivalent) or lubricant meeting requirements of NLGI Grade 2, Category LB or GC-LB.
Power Steering System	GM Hydraulic Power Steering Fluid (GM Part No. 1052884 or equivalent).
Automatic Transaxle	DEXRON <sup>®</sup> III or DEXRON <sup>®</sup> IIE Automatic Transmission Fluid.
Key Lock Cylinders	Lubricate with Multi-Purpose Lubricant (GM Part No. 12345120), synthetic SAE 5W-30 engine oil or silicone lubricant (GM Part No. 1052276 or 1052277).
Supercharger	Supercharger Oil (GM Part No. 12345982)
Automatic Transaxle Shift Linkage	Engine oil.
Chassis Lubrication	Chassis lubricant (GM Part No. 1052497 or equivalent) or lubricant meeting requirements of NLGI Grade 2, Category LB or GC-LB.
Windshield Washer Solvent	GM Optikleen <sup>®</sup> Washer Solvent (GM Part No. 1051515) or equivalent.

USAGE	FLUID/LUBRICANT
Hood Latch Assembly	
a. Pivots and Spring Anchor	a. Engine oil.
b. Release Pawl	b. Chassis lubricant meeting requirements of NLGI Grade 2, Category LB or GC-LB (GM Part No. 1052497 or equivalent).
Hood and Door Hinges	Engine oil or Lubriplate Lubricant (GM Part No. 1050109).
Weatherstrips	Dielectric Silicone Grease (GM Part No. 12345579 or equivalent).

See "Specifications Chart" in the Index for recommended replacement filters, valves and spark plugs.

## Section E: Maintenance Record

After the scheduled services are performed, record the date, odometer reading and who performed the service in the columns indicated. When completing the Maintenance Performed column, insert the numbers

from the Schedule I or Schedule II maintenance charts which correspond to the maintenance performed. Also, you should retain all maintenance receipts. Your owner information portfolio is a convenient place to store them.

<b>Maintenance Record</b>			
<b>DATE</b>	<b>ODOMETER READING</b>	<b>SERVICED BY</b>	<b>MAINTENANCE PERFORMED</b>



## Maintenance Record

DATE	ODOMETER READING	SERVICED BY	MAINTENANCE PERFORMED



## Part 8 Customer Assistance Information

Here you will find out how to contact Buick if you need assistance. This part also tells you how to obtain service publications and how to report any safety defects.

### Part 8 includes:

Customer Satisfaction .....	314
Customer Assistance for Hearing/Speech Impaired .....	314
Reporting Safety Defects .....	315
Courtesy Transportation .....	316
Roadside Assistance .....	316
Service Publications .....	316

### Customer Satisfaction Procedure

Your satisfaction and goodwill are important to your dealer and Buick. Normally, any concern with the sales transaction or the operation of your vehicle will be resolved by your dealer's Sales or Service Departments. Sometimes, however, despite the best intentions of all concerned, misunderstandings can occur. If your concern has not been resolved to your satisfaction, the following steps should be taken:

**STEP ONE** -- Discuss your concern with a member of dealership management. Normally, concerns can often be quickly resolved at that level. If the matter has already been reviewed with the Sales, Service, or Parts Manager, contact the owner of the dealership or the General Manager.

**STEP TWO** -- If after contacting a member of dealership management, it appears your concern cannot be resolved by the dealership without further help, contact the Buick Customer Assistance Center by calling 1-800-521-7300. In Canada, contact GM of Canada Customer Assistance Center in Oshawa by calling 1-800-263-3777 (English) or 1-800-263-7854 (French).

In Mexico, call (525) 254-3777 . In Puerto Rico or U.S. Virgin Islands, call 1-809-763-1315. In all other overseas locations, contact GM North American Export Sales in Canada by calling 1-905-644-4112.

For prompt assistance, please have the following information available to give the Customer Assistance Representative:

- Your name, address, home and business telephone numbers
- Vehicle Identification Number (This is available from the vehicle registration or title, or the plate at the left top of the instrument panel and visible through the windshield.)
- Dealership name and location
- Vehicle delivery date and present mileage
- Nature of concern

We encourage you to call the toll free number listed previously in order to give your inquiry prompt attention. However, if you wish to write Buick, write to:

Buick Motor Division,  
Customer Assistance Center,  
902 E. Hamilton Avenue,  
Flint, MI 48550.

A listing of all Buick Zone Offices and offices outside the U.S. which can assist you can also be found in the Warranty and Owner Assistance Information booklet.

When contacting Buick, please remember that your concern will likely be resolved in the dealership, using the dealership's facilities, equipment and personnel. That is why we suggest you follow Step One first if you have a concern.

## **Customer Assistance for the Hearing or Speech Impaired (TDD)**

To assist customers who have hearing difficulties, Buick has installed special TDD (Telecommunication Devices for the Deaf) equipment at its Customer Assistance Center. Any hearing or speech impaired customer who has access to a TDD or a conventional teletypewriter (TTY) can communicate with Buick by dialing: 1-800-TD-BUICK. (TDD users in Canada can dial 1-800-263-3830.)



## **REPORTING SAFETY DEFECTS TO THE UNITED STATES GOVERNMENT**

If you believe that your vehicle has a defect which could cause a crash or could cause injury or death, you should immediately inform the National Highway Traffic Safety Administration (NHTSA), in addition to notifying General Motors.

If NHTSA receives similar complaints, it may open an investigation, and if it finds that a safety defect exists in a group of vehicles, it may order a recall and remedy campaign. However, NHTSA cannot become involved in individual problems between you, your dealer, or General Motors.

To contact NHTSA, you may either call the Auto Safety Hotline toll-free at 1-800-424-9393 (or 366-0123 in the Washington, D.C. area) or write to:

NHTSA, U.S. Department of  
Transportation  
Washington, D.C. 20590

You can also obtain other information about motor vehicle safety from the Hotline.

## **REPORTING SAFETY DEFECTS TO THE CANADIAN GOVERNMENT**

If you live in Canada, and you believe that your vehicle has a safety defect, you should immediately notify Transport Canada, in addition to notifying General Motors of Canada Limited. You may write to:

Transport Canada at Box 8880  
Ottawa, Ontario K1G 3J2.

## **REPORTING SAFETY DEFECTS TO GENERAL MOTORS**

In addition to notifying NHTSA (or Transport Canada) in a situation like this, we certainly hope you'll notify us. Please call us at 1-800-521-7300, or write:

Buick Motor Division  
Customer Assistance Center  
902 E. Hamilton Avenue  
Flint, MI 48550.

In Canada, please call us at 1-800-263-3777 (English) or 1-800-263-7854 (French). Or, write:

General Motors of Canada Limited  
Customer Assistance Center  
1908 Colonel Sam Drive  
Oshawa, Ontario L1H 8P7

## Courtesy Transportation

To Buick Motor Division, Quality Means Service -- and service means "keeping you on the road."

Included with your 1994 Buick new car warranty, (36 months, or 36,000 miles), is Courtesy Transportation, a program which will provide Buick retail customers with:

- Reimbursement toward a loaner vehicle, courtesy of Buick Motor Division, for up to five days for vehicles requiring overnight warranty repairs. Also, reimbursement up to \$30 a day (5 days maximum) may be available for the cost of a rental car, bus or even a cab.
- A free one-way shuttle ride up to 10 miles from the dealership is available for customers whose vehicles require same-day warranty repairs.

Courtesy Transportation is Buick's way of extending the Premium Service you've come to expect for Buick and its 3,000 dealers. Please review the Courtesy Transportation glove-box card contained in your vehicle, or consult your Buick dealer for details.

**In Canada,** please consult your GM dealer for information on Courtesy Transportation.

## Roadside Assistance

Buick Motor Division is proud to offer Buick Roadside Assistance to customers for vehicles covered under the 36 month/36,000 mile new car warranty (whichever comes first).

Our commitment to Buick owners has always included superior service through our network of 3,000 Buick dealers. Buick Roadside Assistance provides an extra measure of convenience and security.

Buick Roadside Assistance:

- Provides owners with access to minor repairs or towing for disabled vehicles.
- Takes the anxiety out of uncertain situations by providing easy access to service professionals trained to work with Buick owners, 24-hour a day, 365 days a year, including weekends and holidays.

For details of Buick Roadside Assistance, please consult your Buick Roadside Assistance owner booklet included with your owner's manual. For needed assistance, call the Buick Roadside Assistance toll-free hotline: 1-800-252-1112.



## Canada Roadside Assistance

Vehicles purchased in Canada have an extensive Roadside Assistance program accessible from anywhere in Canada or the United States. Please refer to the separate brochure provided by the dealer or call 1-800-268-6800 for emergency services.

## Service Publications

Information on how to obtain Product Service Publications, Subscriptions and Indexes as described below is applicable only in the fifty U.S. states (and the District of Columbia) and only for cars and light trucks with GVWR less than 10,000 pounds (4 536 kg).

In Canada, information pertaining to Product Service Bulletins and Indexes can be obtained by writing to:

General Motors of Canada Limited  
Service Publications Department  
1908 Colonel Sam Dr.  
Oshawa, Ontario L1H 8P7

Buick regularly sends its dealers useful service bulletins about Buick products. Buick monitors product performance in the field. We then prepare bulletins for servicing our products better. Now, you can get these bulletins too.

Bulletins cover various subjects. Some pertain to the proper use and care of your vehicle. Some describe costly repairs. Others describe inexpensive repairs which, if done on time with the latest parts, may avoid future costly repairs. Some bulletins tell a technician how to repair a new or unexpected condition. Others describe a quicker way to fix your vehicle. They can help a technician service your vehicle better.

Most bulletins apply to conditions affecting a small number of cars or trucks. Your Buick dealer or a qualified technician may have to determine if a specific bulletin applies to your vehicle.

You can subscribe to all Buick bulletins. This way you'll get them as they come out. You can wait a while and get an index to the bulletins. You can also get individual bulletins. However, you'll need the index to identify them.

## Subscriptions

You can subscribe to all GM Product Service Publications (PSP's). This will include bulletins for all cars sold by GM and will not be limited to PSP's applicable to any particular model. When you buy a subscription, you will receive the PSP's in periodic mailings, shortly after they come out. A subscription entitles you to all PSP's published by GM during the model year. You can purchase a subscription and get pricing information by calling HELM at 1-800-782-4356.



## Individual PSP's

If you don't want to buy all the PSP's issued by GM for all models in the model year, you can buy individual PSP's, such as those which may pertain to a particular model. To do this, you will first need to see our index of PSP's. It provides a variety of information. Here's what you'll find in the index and how you can get one:

### What You'll Find in the Index:

- A list of all PSP's published by GM in a model year (1990 or later). PSP's covering all models of GM cars are listed in the same index.
- Ordering information so you can buy the specific PSP's you may want.
- Price information for the PSP's you may want to buy.

### How You Can Get an Index:

Indexes are published periodically. Most of the PSP's which could potentially apply to the most recent GM models will be listed in the most recent publication for that model year. This means you may want to wait until the end of the model year before ordering an index, if

you are interested in buying PSP's pertaining to a current model year car or truck.

Some PSP's pertaining to a particular model year vehicle may be published in later years, and these would be listed in the later year's index. When you order an index for a model year that is not over yet, we'll send you the most recently published issue. Check the ordering form for indexes for earlier model years.

Cut out the ordering form, fill it out, and mail it in. We will then see to it that an index is mailed to you. There is no charge for indexes for the 1990-1994 model years.

### Copies at Participating Dealers

Copies of Indexes and individual PSP's are at your participating Buick dealer. You can ask to see them.

**A VERY IMPORTANT REMINDER:** These PSP's are meant for technicians. They are not meant for the "do-it-yourselfer." Technicians have the equipment, tools, safety instructions, and know-how to do a job quickly and safely.

### Buick Service Publications

You can get these by using the order form:



**VERY IMPORTANT - PLEASE INCLUDE YEAR AND MODEL**

CHASSIS SERVICE MANUALS	QTY	RETAIL PRICE	YEAR OF CAR	MODEL OF CAR	NO LONGER AVAILABLE
1989 LUSABRE/ELECTRA/PARK AVE SERVICE MANUAL		\$ 49.00			
1988 CHASSIS SERVICE MANUAL (EXCEPT REGAL)		\$ 29.00			
1983 THRU 1987 CHASSIS SERVICE MANUAL WITHOUT BINDERS		\$ 60.00			94
1974 THRU 1982 CHASSIS SERVICE MANUAL (EXCEPT 1980 OR 1981 SKYLARK, 1982 SKYHAWK OR SKYLARK/CENTURY)		\$ 20.00			1976, 77, 79 +
<b>CHASSIS AND BODY SERVICE MANUALS</b>					
1994 CENTURY SKYLARK CHASSIS & BODY SERVICE MANUAL		\$ 60.00			
1994 ROADMASTER REGAL, LUSABRE/PARK AVE CHASSIS/BODY & SERVICE MANUAL		\$ 90.00			
1993 LUSABRE/PARK AVENUE CHASSIS & BODY SERVICE MANUAL		\$ 49.00			
1991 THRU 1992 LUSABRE or PARK AVE ULTRA CHASSIS & BODY		\$ 49.00			
1991 ULTRA SERVICE MANUAL SUPPLEMENT FOR SUPER-CHARGER		\$ 14.50			
1990 LUSABRE/ELECTRA/PARK AVE CHASSIS & BODY SERVICE MANUAL		\$ 49.00			
1989 THRU 1993 CHASSIS & BODY SERVICE MANUAL (INCLUDE YEAR & MODEL NEEDED (EXCEPT LUSABRE/ELECTRA/PARK AVE))		\$ 26.00			
1988 REGAL CHASSIS & BODY SERVICE MANUAL		\$ 26.00			
1982 SKYHAWK OR 1982 SKYLARK/CENTURY CHASSIS & BODY SERVICE MANUAL		\$ 26.00			
1980 OR 1981 SKYLARK CHASSIS & BODY SERVICE MANUAL		\$ 26.00			
<b>BODY SERVICE MANUALS</b>					
1989 LUSABRE/ELECTRA/PARK AVE BODY SERVICE MANUAL		\$ 20.00			
1988 BODY SERVICE MANUAL (EXCEPT REGAL)		\$ 20.00			
1973 THRU 1987 BODY SERVICE MANUAL		\$ 20.00			1976, 77, 78 +
<b>GLOVE BOX MATERIAL - Please include year and model</b>					
1990 THRU 1994 BUICK OWNERS MANUAL		\$ 10.00			
1989 LUSABRE OR ELECTRA/PARK AVE OWNERS MANUAL		\$ 10.00			
1975 THRU 1989 OWNERS MANUAL (EXCEPT 1988 LUSABRE/ELECTRA/PARK AVE)		\$ 5.00			
1981 THRU 1984 BUICK WARRANTY INFORMATION		\$ 3.50			1982 CAL GAS
GAS <input type="checkbox"/> DIESEL <input type="checkbox"/> CALIFORNIA <input type="checkbox"/>		\$ 3.50			
1973 THRU 1990 BUICK MAINTENANCE SCHEDULE		\$ 3.50			
GAS <input type="checkbox"/> DIESEL <input type="checkbox"/> CALIFORNIA <input type="checkbox"/> 1980 TURBO		\$ 3.50			
REALTY CONVERTIBLE TOP INSTRUCTION FOLDER		\$ 3.50			
<b>OPEL MANUALS</b>					
1977 THRU 1979 OPEL SERVICE MANUAL		\$ 20.00			
1972 THRU 1979 OPEL OWNERS MANUAL		\$ 0.00			1974, 75
1977 THRU 1979 OPEL MAINTENANCE SCHEDULE		\$ 3.50			1972 GT, T4 ALL
<b>PRODUCT SERVICE PUBLICATIONS</b>					
1991 THRU 1990 PSP INDEX		N/C			
1991 THRU 1990 PSP SUBSCRIPTION		\$ 86.50			
PSP SUBSCRIPTION BINDER		\$ 20.00			
1994 PSP INDEX OR SUBSCRIPTION CONTACT HELM @ 1.800.782.4356					
INDIVIDUAL		PRINT TITLE	\$ 4.00		
PSP		EACH ADDITIONAL	\$ 2.00		
		EACH ADDITIONAL	\$ 2.00		
		EACH ADDITIONAL	\$ 2.00		

\* FOR OUT OF PRINT SERVICE MANUALS  
CONTACT NATIONAL REPRODUCTIONS, INC.  
508 E. LIBERTY  
ANN ARBOR, MI 48106 1.800.445.3182

PRICES SUBJECT TO CHANGE WITHOUT NOTICE





## Part 9 INDEX

- A**ccessory Power, Retained . . . . . 81
- Adding
- Brake Fluid . . . . . 252
  - Electrical Equipment . . . . . 141,276
  - Engine Coolant . . . . . 247
  - Engine Oil . . . . . 238
  - Power Steering Fluid . . . . . 250
  - Transaxle Fluid . . . . . 244
  - Windshield Washer Fluid . . . . . 251
- Air Bag (Supplemental Restraint System) . . . . . 34
- Air Bag Readiness Light . . . . . 36
- Air Cleaner . . . . . 243
- Air Conditioner . . . . . 140
- Air Conditioner Refrigerant . . . . . 282
- Alcohol, Driving Under the Influence . . . . . 167
- Alcohol in Gasoline . . . . . 229
- Aluminum Wheels, Cleaning . . . . . 273
- Antenna Care . . . . . 158
- Antifreeze . . . . . 247
- Anti-lock Brake System . . . . . 167
- Anti-lock Braking System Warning Light . . . . . 123
- Appearance Care . . . . . 268
- Appearance Care and Maintenance Materials . . . . . 275
- Ashtrays and Lighter . . . . . 117
- Astrorooft . . . . . 112
- Assistance, Roadside . . . . . 306
- Audio Systems . . . . . 143
- Automatic Door Locks . . . . . 67
- Automatic Overdrive . . . . . 85
- Automatic Ride Control . . . . . 115
- Automatic Transaxle . . . . . 83
- Fluid . . . . . 244
  - Shifting . . . . . 88
- B**attery . . . . . 255
- Jump Starting . . . . . 198
  - Warning Light . . . . . 128
- Blizzard . . . . . 186
- Block Heater (Engine Coolant Heater) . . . . . 82
- Blowout, Tire . . . . . 215
- Brake
- Adjustment . . . . . 254
  - Anti-lock . . . . . 167
  - Fluid . . . . . 252
  - Master Cylinder . . . . . 252
  - Parking . . . . . 87
  - Pedal Travel . . . . . 254
  - Replacement . . . . . 254

System, Anti-lock Warning Light .....	123	Underhood .....	234
System Warning Light .....	122	Windshield Washer Fluid .....	251
Transaxle Shift Interlock .....	84,90	Chemical Paint Spotting .....	274
Wear .....	253	Child Restraints .....	48
Brakes, Trailer .....	191	Children and Safety Belts .....	46
Braking .....	166	Cigarette Lighter .....	118
Braking in Emergencies .....	170	Circuit Breakers and Fuses .....	277
Break-In, New Vehicle .....	79	City Driving .....	179
Bulb Chart .....	281	Cleaner, Air .....	243
Bulb Replacement .....	256	Cleaning	
Bulbs, Halogen .....	255	Aluminum Wheels .....	273
<b>C</b> anadian Roadside Assistance .....	307	Antenna .....	158
Capacities and Specifications Chart .....	282	Cassette Player .....	157
Carbon Monoxide .....	91	Fabric .....	269
Cassette Tape Player .....	146,149	Glass .....	271
Cassette Tape Player Care .....	157	Inside Your Buick .....	268
Cautions, Safety .....	10	Instrument Panel .....	271
CB Radio, Adding .....	144	Leather .....	270
Cellular Telephone, Adding .....	144	Outside Your Buick .....	272
Chains, Tire .....	267	Power Antenna .....	158
Change Oil Soon Light .....	127	Safety Belts .....	271
Changing a Flat Tire .....	215	Speaker Covers .....	271
Check Oil Level Light .....	126	Underbody Maintenance .....	274
Checking		Vinyl .....	270
Brake Fluid .....	252	White Sidewall Tires .....	273
Engine Coolant .....	247	Windshield and Wiper Blades .....	272
Engine Oil .....	238	Clock Setting .....	146,149,152
Power Steering Fluid .....	250	Comfort Controls .....	131
Restraint Systems .....	61	Compact Disc .....	153
Transaxle Fluid .....	244	Compact Disc Care .....	158
		Compact Spare Tire .....	224
		Control of a Vehicle .....	165

Controls, Features and	63
Convenience Net	111
Coolant	
Engine	247
Engine, Warning Light/Gage	124
Heater	82,242
Safety Warnings	207
Courtesy Lights	104
Courtesy Transportation	306
Cruise Control	98
Customer Assistance	
Hearing/Speech Impaired	304
Satisfaction Procedure	303
<b>D</b> aytime Running Lights	105
Defensive Driving	162
Defogger, Rear Window	139
Defrost	138
Dimensions Chart	280
Disc Brake Wear Indicators	253
Disposal of Used Oil	243
Door Ajar Light	130
Door Locks	65
Downshifting	85
Driving	
City	179
Curve	170
Defensive	162
Drunken	162
Foreign Country	232
Freeway	180

Hill and Mountain Roads	182
Long Distance	181
Night	175
Rain	176
Through Deep Standing Water	82
Winter	184

<b>E</b> lectrical Equipment, Adding	144,276
Electronic Level Control	115
Emergency	
Braking	170
Starting	198
Steering	171
Towing	205
Engine	
Accessory Belt	236,237
Block Heater (Coolant Heater)	82,242
Coolant	247
Coolant Temperature Warning Light	124
Exhaust	91
Identification (VIN)	276
Oil	238
Oil Additives	242
Oil Life Monitor	127
Oil Pressure Warning Light/Gage	125
Overheating	207
Starting	81
Ethanol In Gasoline	229
Expectant Mothers, Use of Safety Belts	41
Extender, Safety Belt	61



<b>F</b> abric Cleaning	269
Features and Controls	63
Filling the Fuel Tank	232
Filter, Oil	242,282
Finish Care	272
Finish Damage	274
First Gear	86
Flashers, Hazard Warning	196
Flat Tire	215
Flooded Engine	81
<b>Fluid</b>	
Brake	252
Capacities	282
Power Steering	250
Transaxle	244
Windshield Washer	251
Fluids and Lubricants Recommended	299
Foreign Operation	232
Francais, Guide En	2
Freeway Driving	180
French Language Manual	2
<b>Fuel</b>	229,230
Capacity	282
Filling Your Tank	232
Gage	121
In Foreign Countries	232
Low Warning Light	121
Fuse Usage Chart	279
Fuses and Circuit Breakers	277

<b>G</b> age	
Battery (Voltage Indicator)	129
Engine Coolant Temperature	124
Engine Oil Pressure	125
Fuel	121
Garage Door Opener Storage	112
Gasoline	229,230
Gasoline Tank Filling	232
Gear Positions	83
Glass Cleaning	271

<b>H</b> alogen Bulbs	255
Hazard Warning Flasher	196
Headlamp Bulb Replacement	256
Headlights	103
High-Low Beam Changer	96
"On" Warning	103
Head Restraints	18
Hearing Impaired Assistance	304
Heated Seat	18
Heater	137
Heater, Engine Block ((Engine Coolant Heater)	79,242
Highway Hypnosis	182
Hill and Mountain Roads	182
Hitches, Trailer	191
Hood Release	234
Horn	93
Hot Coolant Warning Light	124
Hot Engine Safety Warnings	207
Hydroplaning	178

Identification Label, Service Parts	276
Identification Number, Vehicle VIN)	276
Idling Your Engine	89
Indicators, Warning Lights, Gages	120
Infant Restraint	46
Inflation, Tire	261
Instrument Panel	119

Jack, Tire	215
Jump Starting	198
Keyless Entry System, Remote	70

Key	64
Ignition Positions	79
PASS	77
Reminder Warning	65

Label, Service Parts Identification	276
Lamp Monitors	107
Lane Change Indicator	94
Lap Belt	42
Lap-Shoulder Belt	
Front	27
Rear	44
Leather Cleaning	270
Leaving Your Vehicle	89
Level Control, Electronic	115
License Plate Holder	117

Lighter, Cigarette	118
Lights	
Air Bag Readiness	36
Courtesy	104
Daytime Running	105
Headlights	103
Illuminated Entry System	75
Operation	95
"On "Warning	103
Reading	106
Removing & Replacing Bulbs	256
Replacement Bulbs	281
Time Out Feature	104
Warning	120
Loading Your Vehicle	258
Locks	65
Locks, Rear Door Security	74
Long Distance Driving	181
Loss of Control	173
Low Coolant Warning Light	125
Lubricants and Fluids, Recommended	299

Maintenance	
Inspections	298
Materials	275
Record	301
Schedule	283
Underbody	274
Malfunction Indicator Light (Service Engine Soon Light)	128
Manual Seat	14

Master Cylinder, Brake .....	252
Memory Seat and Mirrors .....	15
Methanol in Gasoline .....	229
Mirrors .....	108
Monitors, Lamp .....	107

<b>N</b> et, Convenience .....	111
Neutral Gear Position .....	84
New Vehicle Break-In .....	79
Night Driving .....	175
Number, Vehicle Identification (VIN) .....	276

<b>O</b> ctane Requirements .....	229,230
Odometer .....	119
Off-Road Recovery .....	172
Oil, Engine .....	238
Change .....	242
Quality .....	240
Warning Light .....	125
Overdrive, Automatic .....	85
Overheated Engine .....	207

<b>P</b> aint Spotting .....	274
Park Position .....	83
Park, Shifting Into .....	88
Park, Shifting Out .....	90

Parking .....	
Brake .....	87
Over Things That Burn .....	91
With A Trailer .....	193
With the Engine Running .....	89
Passing .....	172
PASS-Key, Theft Deterrent System .....	77
Polishing and Waxing .....	272
Power .....	
Accessory Power, Retained .....	81
Antenna .....	158
Door Locks .....	67
Mirrors .....	108
Seats .....	14
Steering .....	170
Steering Fluid .....	250
Windows .....	93
Pregnancy, Safety Belts Use .....	41
Problems on the Road .....	195
Publications, Service .....	308

<b>R</b> adiator Overheating .....	207
Radiator Pressure Cap .....	249
Radio .....	143
Reading Lights .....	106
Rear Door Security Lock .....	74
Rear Passenger ComforTemp .....	132
Rear Window Defogger .....	139
Rearview Mirror .....	108



Reclining Seatbacks	16
Recommended Fluids and Lubricants	299
Remote Keyless Entry System	70
Remote Trunk Release	68
Replacing	
Brake System Parts	254
Light Bulbs	256,281
Safety Belts	62
Tires	264
Wheels	266
Reporting Safety Defects	305
Restraint System, Supplemental (Air Bag)	34
Restraint Systems	19
Restraints, Child	48
Restraints, Head	18
Retained Accessory Power	81
Reverse Gear Position	84
Ride Control, Auto	115
Roads, Hill and Mountain	182
Roadside Assistance	306
Rocking Your Vehicle	226
Rotation, Tire	262
Running Your Engine While Parked	92

<b>S</b> afety Belts	19
Adults	26
Care	271
Center Passenger Position	42
Checking	61
Children	46
Driver Position	26

Extender	61
Lap	42
Lap-Shoulder	27,44
Larger Children	58
Pregnancy, Use During	41
Properly Worn	26
Questions About	24
Rear Seat Passengers	43
Reminder Light	25
Replacement	62
Right Front Passenger Position	41
Shoulder Belt Height Adjuster	28
Smaller Children and Babies	46
Torn	62
Twisted	33
Why Safety Belts Work	20
Safety Cautions	10
Safety Defects, Reporting	305
Scheduled Maintenance Services	288,290
Seat Adjustment	14,62
Seats and Restraint Systems	13
Second Gear Position	85
Securing a Child Restraint	50,53,55
Security Light	76
Security Lock, Rear Door	74
Service and Appearance Care	227
Service Engine Soon (Malfunction Indicator Lamp)	128
Service Information	228
Service Parts Identification Label	276
Service Publications	307
Servicing Your Air Bag-Equipped Buick	40
Sheet Metal Damage	273

Shift Brake-Transaxle Interlock	84,90	Theft	75
Shifting the Transaxle	83	Deterrent System, PASS-Key	77
Shoulder Belt Height Adjuster	28	Deterrent System, Universal	76
Skidding	174	Thermostat	249
Sound Equipment, Adding	144	Third Gear Position	85
Sound Systems	143	Tilt Steering Wheel	93
Spare Tire	224	Time (Setting the Clock)	146,149,152
Specifications Chart	282	Tire	260
Speech Impaired Customer Assistance	304	Balance	265
Speed Control	98	Chains	267
Speedometer	119	Flat	215
Stains	270	Inflation	261
Starting Your Car (Jump Starting)	198	Inspection and Rotation	262
Starting Your Engine	81	Quality Grading	264
Steering	170	Replacement	264
Emergencies	171	Spare	224
Wheel Controls	155	Wear Indicators	263
Wheel, Tilt	93	White Sidewall	273
Stereo Sound Systems	143	Torque Lock	90
Storage Armrest	115	Towing Your Buick	203
Storage, Garage Door Opener	112	Towing Hookups	205,206
Storing Your Car	255	Traction Control System	168
Stuck, If Your Car is	225	Traction Control System Warning Light	123
Sunroof	112	Trailer Brakes	191
Supercharged Engine	237	Trailer Towing	188
Supplemental Inflatable Restraint System (Air Bag)	34	Transaxle, Automatic	83
		Transaxle Fluid	244
		Trip Odometer	120
		Trunk Ajar Light	130
		Trunk	
<b>T</b> achometer	129	Release, Remote	68
Taillamp Bulb Replacement	257	Automatic Pull-Down	69
Tape Player Care	157		
Temperature Warning Light	124		



Turn Signal/Headlight Beam Lever .....	94
Turn Signal Indicator .....	94
Twilight Sentinel .....	104

<b>U</b> nderbody Maintenance .....	274
Universal Theft Deterrent .....	76
Unleaded Gasoline .....	229
Upholstery Care .....	268
Used Oil Disposal .....	243

<b>V</b> ehicle Identification Number (VIN) .....	276
Vehicle Loading .....	258
Vehicle Storage .....	255
Ventilation .....	141
Vinyl, Cleaning .....	270
Voltage Indicator .....	129

<b>W</b> arning Flashers, Hazard .....	196
Warning Lights .....	120
Air Bag .....	36
Anti-lock Brake System .....	123
Battery .....	128
Brake .....	122
Change Oil Soon .....	127
Check Oil Level .....	126
Door Ajar .....	130
Engine Coolant Temperature .....	124
Engine Oil .....	125

Lights ON .....	103
Low Coolant .....	125
Low Fuel .....	121
Safety Belt .....	25
Security .....	76
Service Engine Soon (Malfunction Indicator Lamp) ..	128
Traction Control System .....	123
Trunk Ajar .....	130
Washer Fluid Low .....	97
Washer, Windshield .....	97, 251
Washing Your Vehicle .....	272
Weatherstrips .....	273
<b>W</b> eight .....	
Gross Axle Weight Rating (GAWR) .....	259
Gross Vehicle Weight Rating (GVWR) .....	259
Trailer .....	190
<b>W</b> heel .....	
Alignment .....	265
Aluminum .....	273
Cover Removal .....	217
Nut Torque .....	223
Replacement .....	266
Windows .....	93
<b>W</b> indshield .....	
Cleaning .....	272
Washer .....	97
Washer Fluid .....	251
Wipers .....	96
Winter Driving .....	184
Wrecker Towing .....	203
Your Driving and the Road .....	161
Your Vehicle and the Environment .....	285



# Fuel Mileage Chart

## MILES PER GALLON

		10	11	12	13	14	15	16	17	18	19	20	21	22	23	24	25	26	27	28	29	30	31	32	33	34	35	36
GALLONS PURCHASED	5	50	55	60	65	70	75	80	85	90	95	100	105	110	115	120	125	130	135	140	145	150	155	160	165	170	175	180
	6	60	66	72	78	84	90	96	102	108	114	120	126	132	138	144	150	156	162	168	174	180	186	192	198	204	210	216
	7	70	77	84	91	98	105	112	119	126	133	140	147	154	161	168	175	182	189	196	203	210	217	224	231	238	245	252
	8	80	88	96	104	112	120	128	136	144	152	160	168	176	184	192	200	208	216	224	232	240	248	256	264	272	280	288
	9	90	99	108	117	126	135	144	153	162	171	180	189	198	207	216	225	234	243	252	261	270	279	288	297	306	315	324
	10	100	110	120	130	140	150	160	170	180	190	200	210	220	230	240	250	260	270	280	290	300	310	320	330	340	350	360
	11	110	121	132	143	154	165	176	187	198	209	220	231	242	253	264	275	286	297	308	319	330	341	352	363	374	385	396
	12	120	132	144	156	168	180	192	204	216	228	240	252	264	276	288	300	312	324	336	348	360	372	384	396	408	420	432
	13	130	143	156	169	182	195	208	221	234	247	260	273	286	299	312	325	338	351	364	377	390	403	416	429	442	455	468
	14	140	154	168	182	196	210	224	238	252	266	280	294	308	322	336	350	364	378	392	406	420	434	448	462	476	490	504
	15	150	165	180	195	210	225	240	255	270	285	300	315	330	345	360	375	390	405	420	435	450	465	480	495	510	525	540
	16	160	176	192	208	224	240	256	272	288	304	320	336	352	368	384	400	416	432	448	464	480	496	512	528	544	560	576
	17	170	187	204	221	238	255	272	289	306	323	340	357	374	391	408	425	442	459	476	493	510	527	544	561	578	595	612
	18	180	198	216	234	252	270	288	306	324	342	360	378	396	414	432	450	468	486	504	522	540	558	576	594	612	630	648
	19	190	209	228	247	266	285	304	323	342	361	380	399	418	437	456	475	494	513	532	551	570	589	608	627	646	665	684
	20	200	220	240	260	280	300	320	340	360	380	400	420	440	460	480	500	520	540	560	580	600	620	640	660	680	700	720
	21	210	231	252	273	294	315	336	357	378	399	420	441	462	483	504	525	546	567	588	609	630	651	672	693	714	735	756
	22	220	242	264	286	308	330	352	374	396	418	440	462	484	506	528	550	572	594	616	638	660	682	704	726	748	770	792





**THIS MANUAL IS PRINTED ON RECYCLED PAPER USING  
MINIMUM 50% WASTEPAPER, 10% POST CONSUMER WASTE**