



# GRAND MARQUIS

---

Your satisfaction is our #1 goal. If you have questions or concerns with your vehicle, we suggest you follow these steps:

1. Contact your Sales Representative or Service Advisor at your selling/servicing dealership.
2. If the inquiry or concern remains unresolved, contact the Sales Manager or Service Manager at the dealership.
3. If the inquiry or concern cannot be resolved at the dealership level, please contact the Ford Customer Assistance Center.

In the United States:

**Ford Motor Company  
Customer Assistance Center  
300 Renaissance Center  
P.O. Box 43360  
Detroit, MI 48243  
1-800-392-3673 (FORD)  
TDD for the hearing impaired: 1-800-232-5952**

In Canada:

**Ford Motor Company of Canada, Limited  
Customer Assistance Centre  
P.O. Box 2000  
Oakville, Ontario L6J 5E4  
1-800-565-3673 (FORD)**

Outside the U.S. or Canada:

**Ford Motor Company  
Worldwide Export Operations  
1555 Fairlane Drive  
Fairlane Business Park #3  
Allen Park, Michigan 48101  
Telephone: (313) 594-4857  
Fax: (313) 390-0804**

All rights reserved. Reproduction by any means, electronic or mechanical, including photocopying, recording, or by any information storage and retrieval system or translation in whole or part is not permitted without written authorization from Ford Motor Company.

Copyright © 1996 Ford Motor Company

---

# Table of Contents

---

<b>Introduction</b> .....	1
<b>Instrumentation</b> .....	7
<b>Electronic Sound Systems</b> .....	45
<b>Controls and Features</b> .....	67
<b>Seating and Safety Restraints</b> .....	119
<b>Starting</b> .....	151
<b>Driving</b> .....	157
<b>Roadside Emergencies</b> .....	175
<b>Maintenance and Care</b> .....	205
<b>Capacities and Specifications</b> .....	253
<b>Reporting Safety Defects (U.S. Only)</b> .....	259
<b>Customer Assistance</b> .....	261
<b>Accessories</b> .....	273
<b>Quick Index</b> .....	285
<b>Index</b> .....	295
<b>Service Station Information</b> .....	316

---

# Introduction

---

## Ford's Commitment to You

At Ford Motor Company, excellence is the continuous commitment to achieve the best result possible. It is dedication to learning what you want, determination to develop the right concept, and execution of that concept with care, precision, and attention to detail. In short, excellence means being the standard by which others are judged.

### Our Guiding Principles

- Quality comes first.** For your satisfaction, the quality of our products and services must be our number one priority.
- You are the focus of everything we do.** Our work must be done with you in mind, providing better products and services than our competition.
- Continuous improvement is essential to our success.** We must strive for excellence in everything we do: in our products — in their safety and value — and in our services, our human relations, our competitiveness, and our profitability.
- Employee involvement is our way of life.** We are a team. We must treat one another with trust and respect.
- Dealers and suppliers are our partners.** We must maintain mutually beneficial relationships with dealers, suppliers, and our other business associates.

- ❑ **Integrity is never compromised.** Our conduct worldwide must be pursued in a manner that is socially responsible and commands respect for its integrity and for its positive contributions to society.

## **Things to Know About Using This Guide**

Congratulations on the purchase of your new vehicle. This guide has information about the equipment and the options for your new vehicle. You may not have bought all of the options available to you. If you do not know which information applies to your vehicle, talk to your dealer.

This guide describes equipment and gives specifications for equipment that was in effect when this guide was approved for printing. Ford may discontinue models or change specifications or design without any notice and without incurring obligation.

### **NOTES and WARNINGS**

**NOTES** give you additional information about the subject matter you are referencing.

**WARNINGS** remind you to be especially careful in those areas where carelessness can cause damage to your vehicle or personal injury to yourself, your passengers or other people. Please read all **WARNINGS** carefully.



## **Finding Information in This Guide**

After you have read this guide once, you will probably return to it when you have a specific question or need additional information. To help you find specific information quickly, you can use the Quick Index or the Index.

The **Quick Index** at the end of the book provides a page number following each item which indicates where detailed information can be found.

To use the **Index**, turn to the back of the book and search in the alphabetical listing for the word that best describes the information you need. If the word you chose is not listed, think of other related words and look them up. We have designed the Index so that you can find information under a technical term.

## **Canadian Owners — French Version**

French Owner Guides can be obtained from your dealer or by writing to Ford Motor Company of Canada, Limited, Service Publications, P.O. Box 1580, Station B, Mississauga, Ontario L4Y 4G3.

## **Your Maintenance Schedule and Record Booklet**

The *Maintenance Schedule* booklet lists the services that are most important for keeping your vehicle in good condition. A record log is also provided to help you keep track of all services performed.

## About the Warranties

Your vehicle is covered by three types of warranties: **Basic Vehicle Warranty**, **Extended Warranties** on certain parts, and **Emissions Warranties**.

Read your *Warranty Information Booklet* carefully to find out about your vehicle's warranties and your basic rights and responsibilities.

If you lose your *Warranty Information Booklet*, you can get a new one free of charge. Contact any Ford or Lincoln-Mercury dealer, or refer to the addresses and phone numbers on the first page of this Owner's Guide.

### Ford Extended Service Plan

#### *More Protection for Your Vehicle*

You can get more protection for your new car or light truck by purchasing a Ford Extended Service Plan (Ford ESP). Ford ESP is the only extended service program with the Ford name on it and the only service contract backed by Ford Motor Company.

Ford ESP is an optional service contract, backed and administered by Ford. It provides:

- protection against repair costs after your Bumper to Bumper Warranty expires;

and

- other benefits during the warranty period (such as: reimbursement for rentals; coverage for certain maintenance and wear items).

You may purchase Ford ESP from any participating Ford Motor Company dealer. There are several Ford ESP plans available in various time-and-mileage combinations. Each plan can be tailored to fit your own driving needs, including reimbursement benefits for towing and rental. (In Hawaii, rules vary. See your dealer for details.)

When you buy Ford ESP, you receive peace-of-mind protection throughout the United States and Canada, provided by a network of more than 5,100 participating Ford Motor Company dealers.

**NOTE: Repairs performed outside the United States and Canada are not eligible for ESP coverage.**

This information is subject to change. Ask your dealer for complete details about Ford ESP coverage.



## Breaking Your Vehicle In

Your new vehicle goes through an adjustment or break-in period during the first 1,000 miles (1,600 km) that you drive it. During the break-in period, you need to pay careful attention to how you drive your vehicle.

**Avoid sudden stops.** Because your vehicle has new brake linings, you should take these steps:

- Watch traffic carefully so that you can anticipate when to stop.
- Begin braking well in advance.
- Apply the brakes gradually.

The break-in period for new brake linings lasts for 100 miles (160 km) of city driving or 1,000 miles (1,600 km) of highway driving.

**Use only the type of engine oil that Ford recommends.** See *Engine oil recommendations* in the Index. Do not use special “break-in” oils.

Your vehicle is equipped with an Electronic Powertrain Control Module that limits engine and/or vehicle speeds with a cut-out mode to promote durability.

# Instrumentation

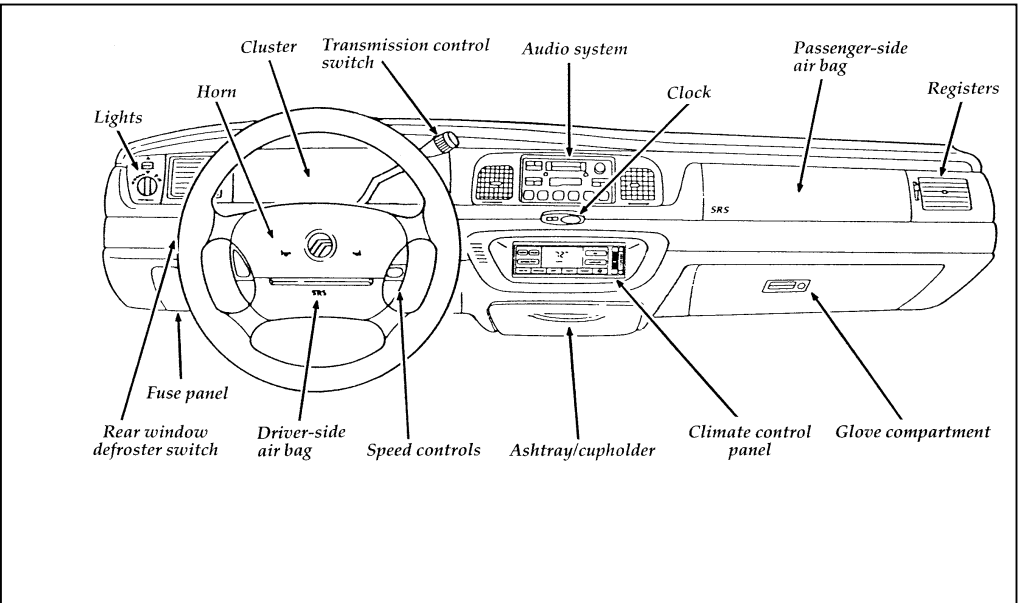

Grand Marquis instrument panel

The instrument panel (dashboard) on your vehicle is divided into several different sections. The illustrations on the following pages show the major parts of the instrument panel that are described in this chapter. Some items shown may not be on all vehicles.

Your vehicle is equipped with one of the following clusters:

- a mechanical cluster
- an electronic cluster

The mechanical cluster

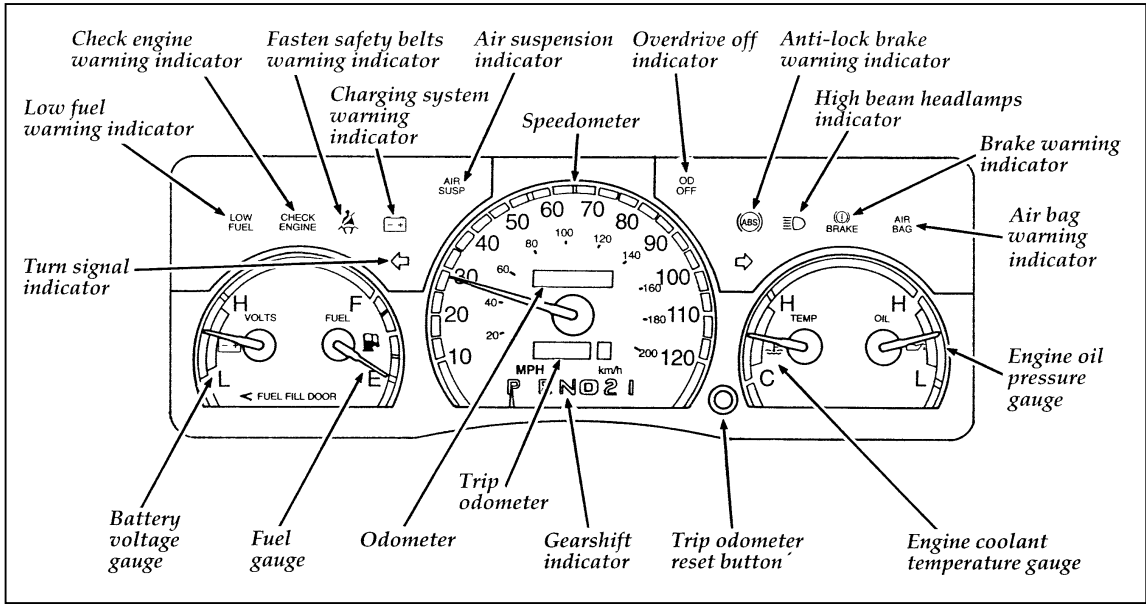

## The Mechanical Cluster

The following warning lights and gauges are on the mechanical cluster. All of the warning lights and gauges alert you to possible problems with your vehicle. Some of the lights listed are optional. The following sections detail what each of these indicators means.

### Brake System Warning Light

The warning light for the brakes can show two things — that the parking brake is not fully released, or that the brake fluid level is low in the master cylinder reservoir. If the fluid level is low, the brake system should be checked by a qualified service technician.

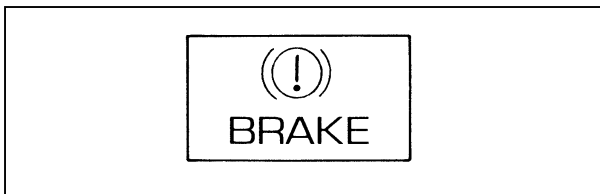

#### The brake system warning light

This light comes on when the parking brake is set, or if it is not set, it comes on briefly when you turn the ignition key to START. It normally goes off shortly after the engine starts and you release the parking brake. If the light stays on after you have fully released the parking brake, have the hydraulic brake system serviced.

<b>⚠ WARNING</b>
<b>The BRAKE light indicates that the brakes may not be working properly. Have the brakes checked immediately.</b>

## **Anti-Lock Brake System Light (If equipped)**

This warning light will go on each time you start your vehicle. If it remains on for longer than five seconds, you should shut off your engine and restart. If the anti-lock brake light stays on, this indicates that the anti-lock feature is disabled and should receive immediate attention by a qualified service technician. Normal braking is not affected unless the brake warning light is also lit.

The Anti-Lock Brake System has self-check capabilities. As previously described, the system turns on the anti-lock light each time you start your engine. After the engine is started and the anti-lock light is out, the system performs another test the first time the vehicle reaches 14 mph (22 km/h). The system turns on the Anti-Lock Brake System (ABS) pump motor for approximately 1/2 second. At this time a mechanical noise may be heard. This is a normal part of the self-check feature. If a malfunction is found during this check the anti-lock light will come on.

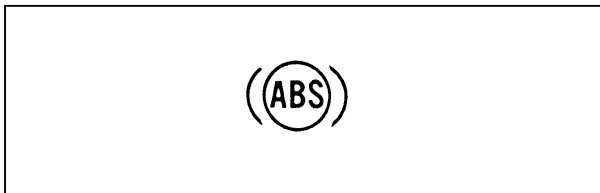

**The anti-lock brake system light**

**⚠ WARNING**

**If the anti-lock brake system warning light remains on or comes on while driving, have the braking system checked by a qualified service technician as soon as possible.**

**NOTE: If a fault occurs in the anti-lock system, and the brake warning light is not lit, the anti-lock system is disabled but normal brake function remains operational.**

### **Safety Belt Warning Light and Chime**

This warning light and chime remind you to fasten your safety belt. The following conditions will take place:

- If the driver's safety belt is not buckled when the ignition is turned to the ON position, the light will turn on for 1 to 2 minutes and the chime will sound for 4 to 8 seconds.
- If the driver's safety belt is buckled while the light is on or the chime is sounding, both the light and the chime will turn off.
- If the driver's safety belt is buckled before the ignition is turned to the ON position, neither the light nor the chime will turn on.



The safety belt warning light

## **Air Bag Readiness Light**

The air bag system uses a readiness light and a tone to indicate the condition of the system. The readiness light is in the instrument cluster. When you turn the ignition key to the ON position, this light will light up for six (6) seconds and then turn off. This indicates that the system is operating normally. NOTE: Regularly scheduled maintenance of the air bag system is not required.

If the light fails to illuminate, continues to flash, remains on, or you hear a beeping sound, have the system serviced at your Ford or Lincoln-Mercury dealer immediately.



The air bag readiness light

## **Charging System Light**

This light indicates that your battery is not being charged and that you need to have the electrical system checked.

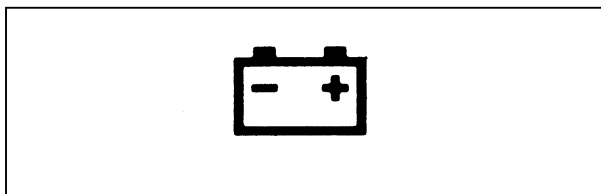

The charging system light



This light illuminates every time you turn the ignition to the ON or START position (engine off). The light should go off when the engine starts and the alternator begins to charge.

If the light stays on or illuminates when the engine is running, have the electrical system checked as soon as possible.

### **Overdrive Off Indicator**

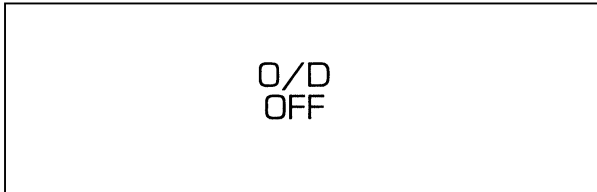

#### **The overdrive off indicator light**

This light tells you that the Transmission Control Switch (TCS) has been pushed. When the light is on, the transmission will not shift into overdrive. Depressing the button will return the vehicle to “overdrive on” mode. The transmission will be in the “overdrive on” mode when the vehicle is started even if the O/D OFF mode was selected when the vehicle was last shut off.

**NOTE: If the light does not come on when the TCS is depressed or if the light flashes when you are driving, have your vehicle serviced at the first opportunity. If this condition persists, damage could occur to the transmission.**

## High Beam Light

This light illuminates when the headlamps are turned to high beam or when you flash the lights.

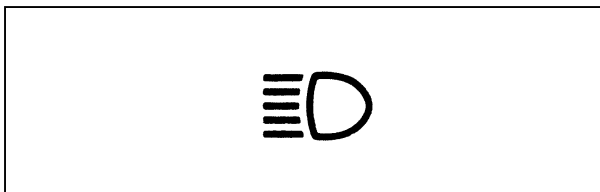

The high beam light

## Low Fuel Alert Light

This light comes on when your fuel gauge indicates between 1/8 and 1/16 of a tank. Your car must be turned to ON for this light to come on.

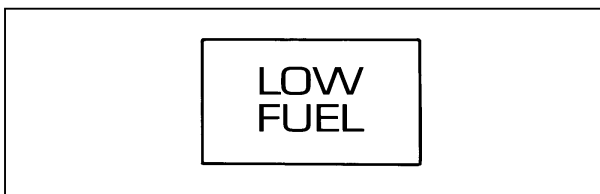

The low fuel alert light

## Air Suspension Light (If equipped)

This light tells you if the air suspension needs repair or if the air suspension switch (in the trunk on the right side) is OFF.



The air suspension light

Normally, the light will glow momentarily as you turn the ignition key to the ON position. If it glows continuously:

1. Safely pull off the road as soon as possible. Turn the ignition key from ON to OFF and ON again.
2. If the light still glows, check to see if the air suspension switch is OFF. If it is OFF, push the switch ON. If it is ON, push the switch OFF and have the system checked as soon as possible.

### **Check Engine Warning Light**

This light illuminates when the engine's Emission Control System requires service. It will also illuminate when the ignition key is in the ON position and the engine is off.



The check engine warning light

### **Turn Signal Indicator Lights**

The turn signal arrow will flash to indicate the direction in which you are going to be turning.

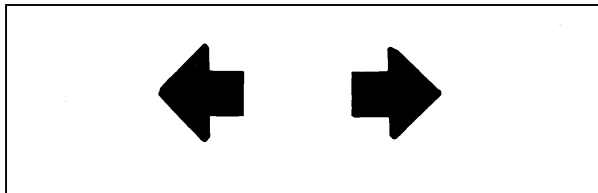

The turn signal indicator light

## Fuel Gauge

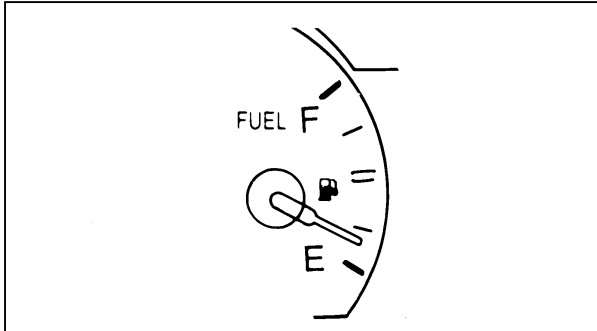

### The fuel gauge

The fuel gauge displays approximately how much fuel is in the fuel tank only when the ignition switch is ON. For proper fuel gauge indication after adding fuel, turn the ignition switch OFF while refueling the vehicle.

The fuel gauge indicator may vary slightly when the vehicle is in motion. The most accurate reading is obtained with the vehicle on level ground.

With ignition switch OFF, the fuel gauge indicator may drift from the ignition switch ON position.

When you turn the ignition key to the ON or ACC position, all the display segments will light up, then go off for a second indicating the gauge is working. Then the gauge will show you how much fuel you have in the tank.

## Engine Coolant Temperature Gauge

This gauge indicates the temperature of the engine coolant, not the coolant level. If the coolant is not at its proper level or mixture, the gauge indication will not be accurate.

The pointer moves from the C (cold) mark into the normal band as your engine coolant warms up. Under normal driving conditions, the pointer should stay in the normal band. It is acceptable for the pointer to fluctuate within the normal band under normal driving conditions, and under certain driving conditions such as, heavy stop and go traffic, or driving up hills in hot weather, for the pointer to indicate at the top of the normal band.

If, under any circumstances, the pointer moves above the normal band, the engine is overheating and continued operation may cause engine damage.

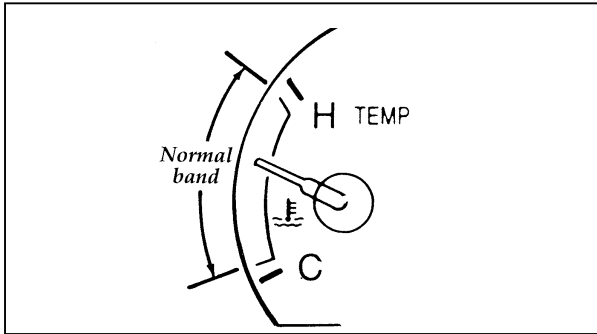

The engine coolant temperature gauge

If your engine overheats:

1. Pull off the road as soon as safely possible.
2. Turn off the engine.
3. Let the engine cool. **DO NOT REMOVE COOLANT SYSTEM FILL CAP UNTIL THE ENGINE IS COOL.**

4. Check the coolant level following the instructions on checking and adding coolant to your engine, see *Engine Coolant* in the Index. If you do not follow these instructions, you or others could be injured.

If the coolant continues to overheat, have the coolant system serviced.

### **Speedometer**

The speedometer tells you how many miles (kilometers) per hour your vehicle is moving.

### **Odometer**

The odometer tells you the total number of miles (kilometers) your vehicle has been driven.

### **Trip Odometer**

If you want to track your mileage up to 999.9 miles (kilometers), use the trip odometer. Simply set the trip odometer to zero by pressing the reset control firmly when beginning the distance you wish to measure.

Since the trip odometer displays distance independent of the odometer it will not always advance to the next mile (kilometer) at the same time as the odometer.

### **Battery Voltage Gauge**

This gauge shows you the battery voltage when the ignition key is in the ON position.

If the battery is operating under cold weather conditions, the pointer may indicate in the upper range of the normal band while the battery is charging. If you are running electrical accessories with the engine off or idling at a low speed, or the battery is not fully charged, the pointer may move toward the lower end of the normal band.

If it stays outside the normal band, have your vehicle's electrical system checked as soon as it is safely possible.

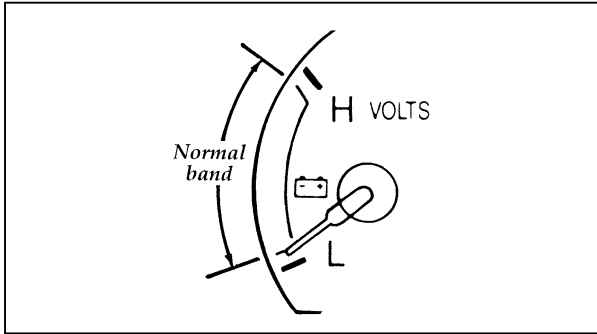

The battery voltage gauge

### Engine Oil Pressure Gauge

This gauge indicates the engine oil pressure, not the oil level. However, if your engine's oil level is low, it could affect the oil pressure. With the engine running, the pointer should move into the normal band. If the pointer drops below the normal band while the engine is running, you have lost oil pressure and continued operation will cause severe engine damage.

If you lose engine oil pressure:

1. Pull off the road as soon as safely possible.
2. Shut off the engine immediately or severe engine damage could result.
3. Check the engine's oil level, following the instructions on checking and adding engine oil, see the *Engine Oil* in the Index. If you do not follow these instructions, you or others could be injured. To assure an accurate reading, your car should be on level ground.

4. If the level is low, add oil as necessary before you start the engine again. Do not overfill. Do not operate the engine if the pointer in the oil pressure gauge is below the normal band, regardless of the oil level. Contact your nearest dealer for further service actions.

For more information about adding oil, see *Engine Oil Recommendations* in the Index.

## **The Electronic Cluster**

The electronic cluster works only when your ignition is in the ON position. Each time you start your vehicle, the displays go through a self-test by flashing on and off once before the actual readings are displayed. (Neither the turn signals nor the high beam indicator light will flash like the other indicators do for the self-test.) Some of the warning lights will flash on and remain on (will not immediately flash off) until the normal cluster display is lit. This self-test is used to indicate that all of the warning/indicator lights are working properly.

Your electronic cluster tells you about the condition of your vehicle by using two types of equipment:

- warning lights and gauges
- message center



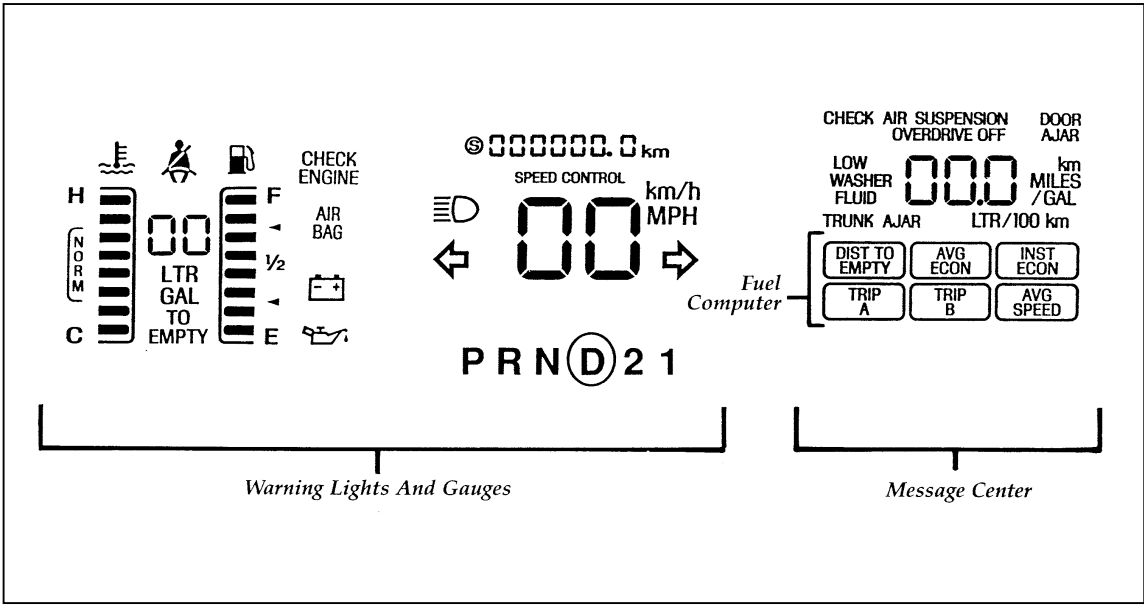

Warning Lights And Gauges

Message Center

## Engine Coolant Temperature Gauge

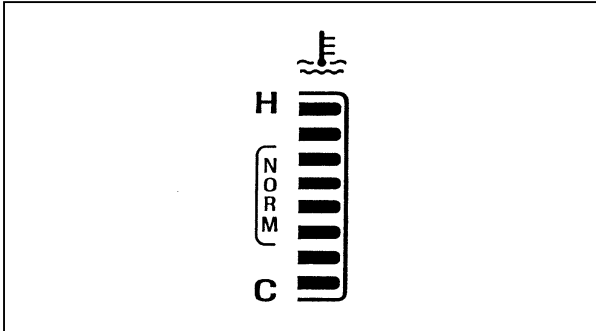

The engine coolant temperature gauge

This gauge indicates the engine coolant temperature not the coolant level. If the coolant is not at its proper level or mixture, the gauge indication will not be accurate. It is identified by a thermometer symbol, an “H” (hot), and a “C” (cold). The “NORM” indicates the normal operating range. The bars will move into the normal operating range as the engine coolant warms up. It is acceptable under certain driving conditions such as, heavy stop and go traffic, or driving up hills in hot weather, for the gauge to indicate at the top of the NORM band.

If, under any circumstance, the pointer moves above the NORM band, the temperature symbol flashes and a tone will sound to alert the driver that the engine coolant is overheating and continued operation may cause engine damage.

If your engine overheats:

1. Pull off the road as soon as it is safely possible.
2. Turn off the engine. If you do not stop the engine as soon as safely possible, severe engine damage could result.

3. Let the engine cool. **DO NOT REMOVE COOLANT SYSTEM FILL CAP UNTIL THE ENGINE IS COOL.**
4. Check the coolant level following the instructions on checking and adding coolant to your engine, see *Engine Coolant* in the Index. If you do not follow these instructions, you or others could be injured.

If the coolant continues to overheat, have the coolant system serviced.

If only the top two and bottom two bars appear on the gauge, then the system is indicating that it requires servicing. Contact your dealer for service as soon as possible.

### **Safety Belt Warning Light and Chime**

This warning light and chime remind you to fasten your safety belt. The following conditions will take place:

- If the driver's safety belt is not buckled when the ignition is turned to the ON position, the light will turn on for 1 to 2 minutes and the chime will sound for 4 to 8 seconds.
- If the driver's safety belt is buckled while the light is on or the chime is sounding, both the light and the chime will turn off.
- If the driver's safety belt is buckled before the ignition is turned to the ON position, neither the light nor the chime will turn on.



The safety belt warning light

## High Beam Light

This light illuminates when the headlamps are turned to high beam or when you flash the lights.

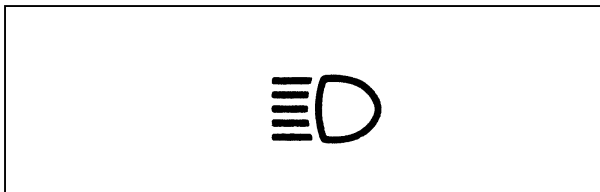

The high beam light

## Check Engine Warning Light

This light illuminates when the engine's Emission Control System requires service. It will also illuminate when the ignition key is in the ON position and the engine is off.



The check engine warning light

## Air Bag Readiness Light

The air bag system uses a readiness light and a tone to indicate the condition of the system. The readiness light is in the instrument cluster. When you turn the ignition key to the ON position, this light will light up for six (6) seconds and then turn off. This indicates that the system is operating normally. NOTE: Regularly scheduled maintenance of the air bag system is not required.

If the light fails to illuminate, continues to flash, remains on, or you hear a beeping sound, have the system serviced at your Ford or Lincoln-Mercury dealer immediately.



The air bag readiness light

### **Charging System Warning Light**

This light comes on when you turn your ignition key from OFF to ON. The light should go out when the engine starts and the alternator begins to charge.

If this light stays on or comes on while your engine is running, this tells you that your battery is not being charged and that you need to have the electrical system checked as soon as possible.

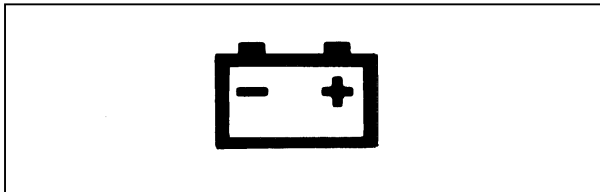

The charging system warning light

## Engine Oil Pressure Light

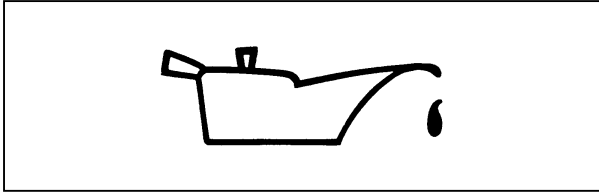

### The engine oil pressure light

This light indicates the engine oil pressure, not the oil level. However, if your engine's oil level is low, it could affect the oil pressure. The light should come on every time your ignition key is turned to ON or START, and should go out when the engine starts. If the light stays on or turns on while the engine is running, you have lost oil pressure and **continued operation will cause severe engine damage.**

If you lose engine oil pressure:

1. Pull off the road as soon as safely possible.
2. Shut off the engine immediately. If you do not stop the engine as soon as safely possible, severe engine damage could result.
3. Check the engine's oil level, following the instructions on checking and adding engine oil, see *Engine Oil* in the Index. If you do not follow these instructions, you or others could be injured. To assure an accurate reading, your vehicle should be on level ground.
4. If the level is low, add only as much oil as necessary before you start the engine again. Do not overfill. Do not operate the engine if the light is on, regardless of the oil level. Contact your nearest dealer for service as soon as possible.

For more information about adding oil, see *Adding engine oil* in the *Maintenance and Care* chapter of this guide.

### **Turn Signal Indicator Lights**

The turn signal arrow will flash to indicate the direction in which you are going to be turning.

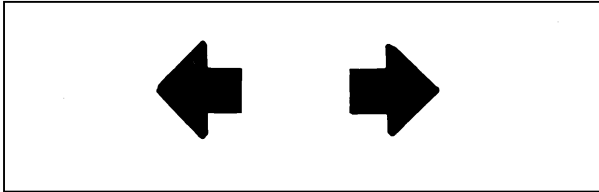

The turn signal indicator lights

### **Speed Control Indicator Light**

This light comes on when the speed control system is actively maintaining the set speed. It will go off when the brakes are used or if the speed control is turned off.



The speed control indicator light

This light does not indicate any problems but is only a convenience to tell when the speed control is active.

## Fuel Gauge

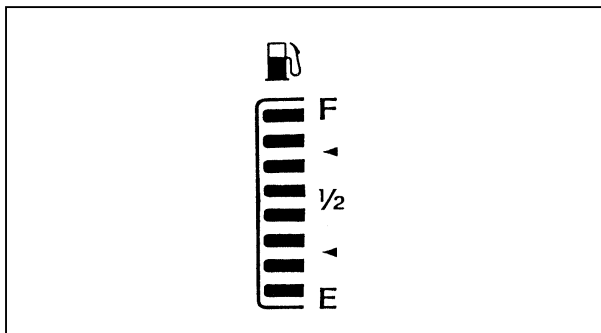

### The fuel gauge

The fuel gauge tells you approximately how many gallons/liters of fuel you have in the tank.

When your tank reaches  $1/8$  or approximately 2 gallons (8 liters), a flashing fuel pump will appear.

Turn the ignition switch off while fueling to obtain an accurate fuel gauge indication.

**NOTE: At least 2.5 gallons (9.5 liters) of fuel must be added for the fuel gauge to immediately show the new level of fuel. If less than 2.5 gallons (9.5 liters) of fuel is added, the gauge will reach the new level slowly.**

If the fuel gauge displays only the top two bars and the bottom two bars, or, if fuel remaining or distance to empty functions display CO or CS, then there is a problem. Take your vehicle in for service.



## **FUEL REMAIN — Fuel Remaining for the Electronic Cluster**

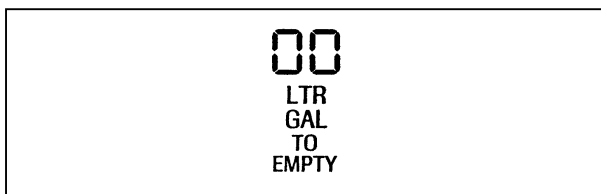

This function shows you how many gallons (liters) of fuel you have left in the fuel tank.

If your fuel level is above 20 gallons (76 liters), the letter “F” (full) will appear on the display. But if your fuel level has dropped to below 1 gallon (4 liters), the letter “E” (empty) will appear in the display.

Because of factors like rounding of numbers and fuel movement in the tank, your fuel gauge and the service station fuel pump readings may disagree slightly.

A problem is indicated if the fuel gauge bar graph displays only the top two and bottom two bars and the message center display for Distance To Empty or Fuel Remaining functions display the letters “CO” or “CS”. If this happens, contact your dealer for service as soon as possible.

### **Speedometer**

The speedometer tells you how many miles (kilometers) per hour your vehicle is moving. It indicates the speed up to 120 mph or up to 195 km/h.

You can press the E/M (English/Metric) button located just below the message center display to show the speed you are going in either miles per hour or kilometers per hour.

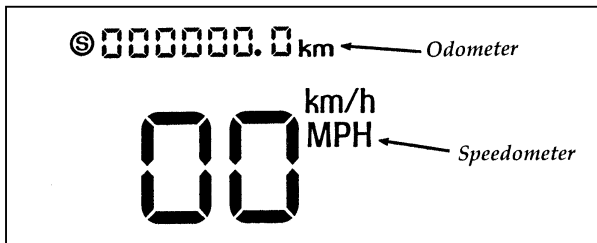

The speedometer

## Odometer

The odometer tells you the total number of miles or kilometers your vehicle has been driven. If the cluster is replaced, and the accumulated mileage on the odometer is unknown, the replacement cluster will have the circled “S” illuminated with zero miles on the odometer. If the actual vehicle mileage can be verified, then an authorized service center can program the actual mileage into the odometer of the replacement cluster. The actual mileage (if known) or an estimated mileage (if unknown) is shown on a label affixed on the door pillar.

Press the E/M (English/Metric) button located just below the message center display to show miles or kilometers.

If the odometer displays the word “ERROR” contact your dealer for service.

## The Electronic Message Center

Along with information the warning lights and gauges provide, the electronic message center lets you:

- see problems such as Door Ajar, Air Suspension, Trunk Ajar, Washer Fluid
- see how many miles/kilometers you can drive with the fuel remaining in your tank

- see when overdrive has been turned off
- monitor your average fuel economy
- monitor your instantaneous fuel economy
- check the distance you have travelled during a trip on either Trip A or Trip B
- monitor your average speed

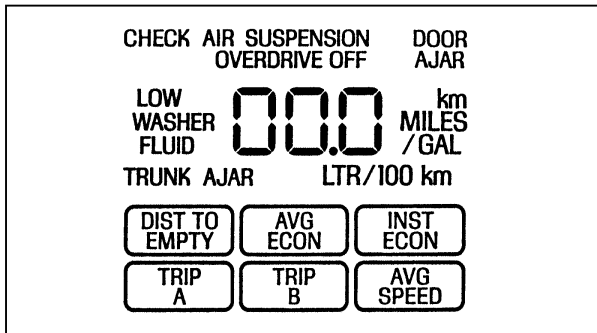

**Message center display showing all segments on**

All of the message center functions are controlled by the three switches located just below the message center display:

- E/M** — Changes the electronic instrument cluster display to read in either English or Metric units.
- Reset** — Sets the selected function to zero (if resettable).
- Select** — Selects the function. This is a dual action switch, the right side advances function to the right, the left side advances function to the left.

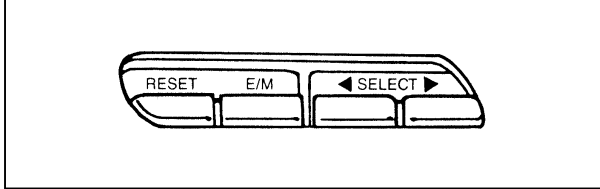

Buttons for the message center

### ***How to use the message center***

To reset any function:

1. Push either the right or left side of the SELECT button to choose the function you would like to set.
2. Push the RESET button and the selected message center function will be reset to zero. (The only functions which can be reset to zero are: AVG ECON, TRIP A or TRIP B, and AVG SPEED.)

### ***What the message center functions can show you***

#### **DIST TO EMPTY — Distance to Empty (DTE)**

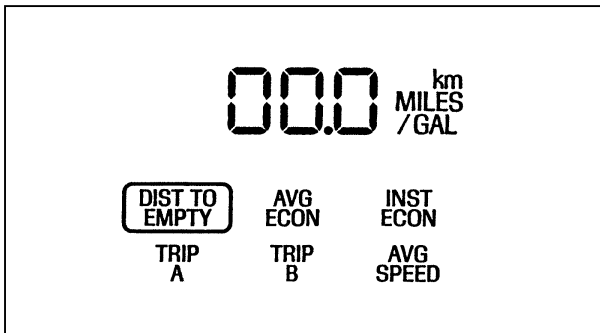

Message center display showing the DTE function selected

This function estimates how many miles or kilometers you can drive with the fuel remaining in your tank under standard driving conditions.

Remember to turn off the ignition when filling up with fuel. Otherwise, the display will not show the addition of fuel for a few miles.

**NOTE: At least 2.5 gallons (9.5 liters) of fuel must be added for the fuel gauge to immediately show the new level of fuel.**

When you have approximately 50 miles (80 km) left before you run out of fuel, the DTE function will flash for five (5) seconds and sound a tone for one (1) second. The message center will remain in the DTE function until you push the select button to change it. This low fuel warning also happens at 25 miles (40 km), and 10 miles (16 km).

Displayed DTE will not be equal to AVG ECON multiplied by the FUEL REMAIN value. This is because DTE is calculated using a method that takes into consideration the fuel economy of the last 500 miles (800 Km) driven.



If "CO" or "CS" is displayed, this means that there is a problem with the fuel indication system and you should contact your dealer for service as soon as possible.

## **AVG ECON — Average Fuel Economy**

Select this function to display your average fuel economy in miles per gallon or liters per 100 kilometers. Your message center computes this figure using the distance traveled and fuel used information. If you want to reset this function, press the RESET button while the average fuel economy feature is displayed.

The average shown is the average since the reset.

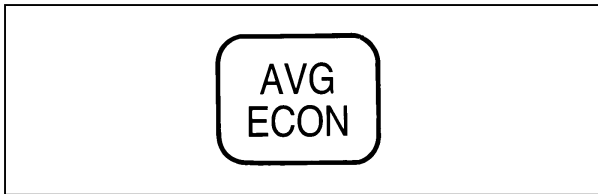

If you calculate your average fuel economy by dividing miles traveled by gallons used, your figure may be different than displayed because of:

- Your vehicle not being perfectly level during fill-up
- Differences in the automatic shut-off points on the fuel pumps at service stations
- Variations in top-off procedure from one fill-up to another
- Rounding of the displayed values to the nearest 0.1 gallon (liters) on the fuel gauge.

## **INST ECON — Instantaneous Fuel Economy**

Select this function to calculate your instantaneous fuel economy. Your instantaneous fuel economy is the fuel economy you get at any particular moment. For example, you can see what your fuel economy is in heavy traffic or on an open highway.

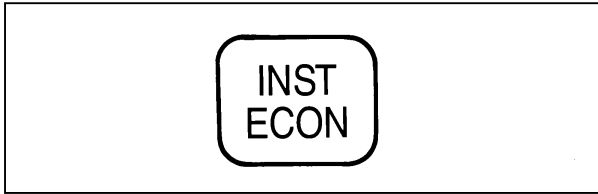

Your vehicle must be moving to calculate fuel economy. When your vehicle is not moving, instantaneous fuel economy is displayed at 0 miles per gallon or 99 liters per 100 kilometers. When you are moving, the display may read anything between 0 and 99 miles/gallon (1 to 99 L/km). Instantaneous fuel economy cannot be reset.

## **TRIP A and TRIP B — Elapsed Distance Traveled**

These two functions of the message center allow you to see how far you have traveled since you last reset. Trip A and Trip B are completely independent and must be reset individually.

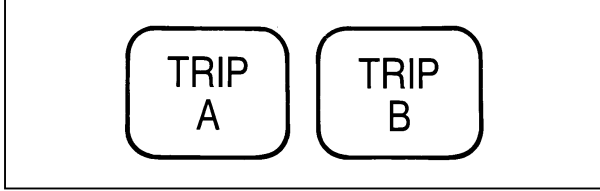

To reset either trip feature to zero, press the RESET switch while a trip distance feature (Trip A or Trip B) is displayed.

### **AVG SPEED — Average Speed**

Select this function to display your average speed in miles per hour or kilometers per hour.

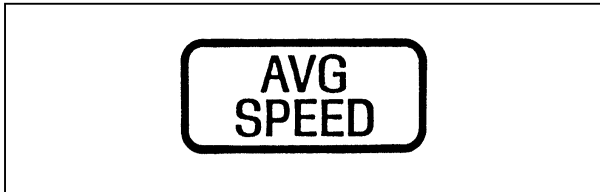

Your vehicle must be moving to calculate your average speed. When your vehicle is not moving, the average speed is displayed at 0 miles per hour or 0 kilometers per hour.

### **Check Air Suspension Light (If equipped)**

This light glows momentarily when the ignition is turned to the ON position. With the ignition on this light will remain on to indicate that the air suspension switch (located in the trunk on the right side) is off or to indicate a possible system fault.



If the light is displayed while driving and the air suspension switch is not turned off, safely pull off the road as soon as possible. Turn the ignition switch from ON to OFF and to ON again. If the light continues to be displayed turn the air suspension switch (located in the trunk on the right side) off and take your vehicle to a dealership for service as soon as possible.

**CHECK AIR SUSPENSION**

The check air suspension light

### **Overdrive Off Indicator**

**OVERDRIVE OFF**

The overdrive off indicator light

This light tells you that the Transmission Control Switch (TCS) has been pushed. When the light is on, the transmission will not shift into overdrive. Depressing the button will return the vehicle to “overdrive on” mode. The transmission will be in the “overdrive on” mode when the vehicle is started even if the O/D OFF mode was selected when the vehicle was last shut off.

**NOTE: If the light does not come on when the TCS is depressed or if the light flashes when you are driving, have your vehicle serviced at the first opportunity. If this condition persists, damage could occur to the transmission.**

### **Low Washer Fluid Light**

This light comes on when there is less than a quarter of the container of washer fluid left. With the ignition ON this light will flash five (5) times and a tone will sound for one (1) second, and then the light will remain on.

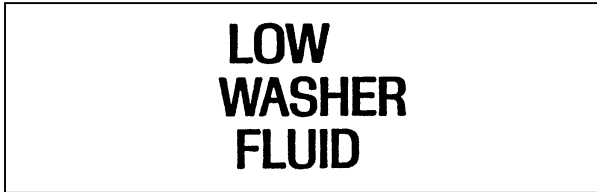

The low washer fluid light

### **Door Ajar Light**

If one of the doors is not completely shut, this light comes on when you turn the ignition to ON. With the ignition on this light will flash five (5) times and sound a tone for one (1) second, and then the light will remain on.



The door ajar light

## Trunk Ajar Light

If the trunk is not completely closed, this light comes on when you turn the ignition to ON. With the ignition ON this light will flash five (5) times and sound a tone for one (1) second, and then the light will remain on.



The trunk ajar light

## Indicator Lamp Module

The following warning lights are on the indicator lamp module. The following section details what each of these indicators mean.

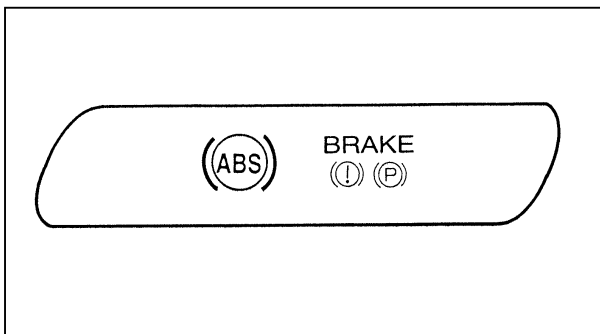

The indicator lamp module

## **Anti-Lock Brake System Light (If equipped)**

This warning light will go on each time you start your vehicle. If it remains on for longer than 5 seconds, you should shut off your engine and restart. If the anti-lock brake light stays on, this indicates that the anti-lock feature is disabled and should receive immediate attention by a qualified service technician. Normal braking is not affected unless the brake warning light is also lit.

The Anti-Lock Brake System has self-check capabilities. As previously described, the system turns on the anti-lock light each time you start your engine. After the engine is started and the anti-lock light is out, the system performs another test the first time the vehicle reaches 14 mph (22 km/h). The system turns on the Anti-Lock Brake System (ABS) pump motor for approximately 1/2 second. At this time a mechanical noise may be heard. This is a normal part of the self-check feature. If a malfunction is found during this check the anti-lock light will come on.

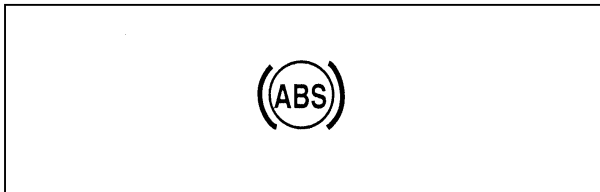

**The anti-lock brake system light**

**⚠ WARNING**

**If the anti-lock brake system warning light remains on or comes on while driving, have the braking system checked by a qualified service technician as soon as possible.**

**NOTE: If a fault occurs in the anti-lock system, and the brake warning light is not lit, the anti-lock system is disabled but normal brake function remains operational.**

### **Brake System Light**

The warning light for the brakes can show two things — that the parking brake is not fully released, or that the brake fluid level is low in the master cylinder reservoir. If the fluid level is low, the brake system should be checked by a qualified service technician.



**The brake system light**

This light comes on when the parking brake is set, or if it is not set, it comes on briefly when you turn the ignition key to START. It normally goes off shortly after the engine starts and you release the parking brake. If the light stays on after you have fully released the parking brake, have the hydraulic brake system serviced.

 **WARNING**

**The BRAKE light indicates that the brakes may not be working properly. Have the brakes checked immediately.**

# Electronic Sound Systems

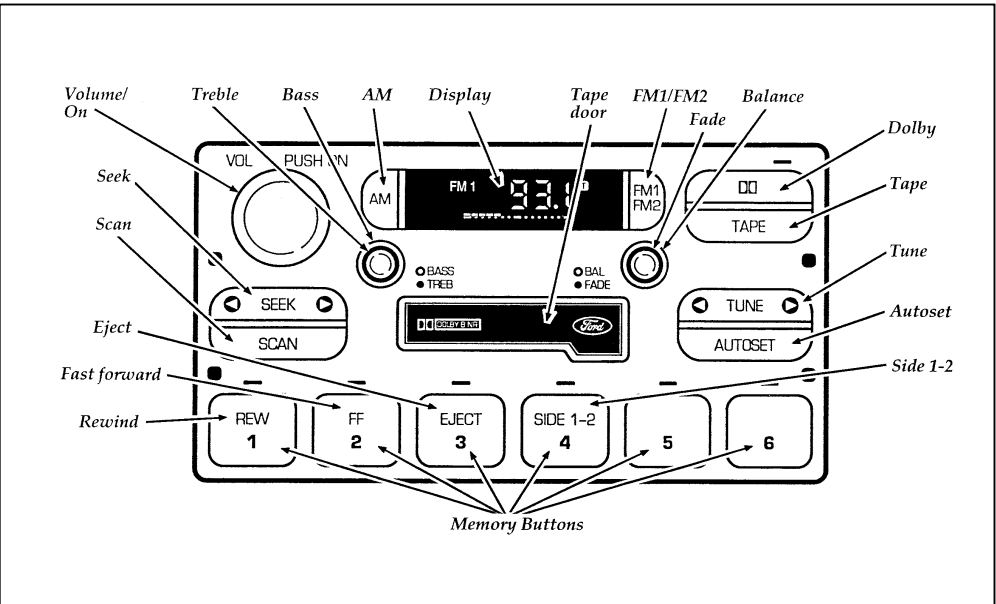

Luxury Audio System (Analog)

## **Luxury Audio System**

### **Using the Controls on Your New Radio**

#### ***How to turn the radio on and off***

Press the “VOL/PUSH ON” knob to turn the radio on. Press again to turn it off.

#### ***How to adjust the volume***

Turn the “VOL/PUSH ON” knob to the right to increase the volume and to the left to decrease the volume.

#### ***Selecting the AM or FM frequency band***

Push the “AM/FM” button to select the desired frequency band. Pushing the “AM/FM” button causes the frequency band to switch from “AM” to “FM1” to “FM2” to “AM”, changing one band to the next each time the button is pressed. These functions are used with the station memory buttons described under *How to tune radio stations*.

#### ***How to tune radio stations***

There are four ways for you to tune in a particular station. You can use the “TUNE”, “SEEK”, “SCAN” or memory buttons.

##### Using the “TUNE” function

You can change the frequency up or down one increment at a time by pressing and releasing either the left ◀ or right ▶ side of the “TUNE” button. To change frequencies quickly, press and hold down either the right or left side of the “TUNE” button.

Manual tuning adjusts your radio to any allowable broadcast frequency, whether or not a station is present on that frequency. (See *All About Radio Frequencies* in this section.)



Using the “SEEK” function

Press the right ► side of the “SEEK” button to select the next listenable station up the frequency band. Press the left ◀ side of the button to select the next listenable station down the frequency band. By holding the button down, listenable stations can be passed over to reach the desired station.

Using the “SCAN” function

Pressing the “SCAN” button will begin the scan mode up the frequency band, stopping on each listenable station for approximately five seconds.

To stop the scan mode on the presently sampled station, press the “SCAN” button again.

Setting the station MEMORY PRESET buttons

Your radio is equipped with 6 station memory buttons. These buttons can be used to select up to 6 preset AM stations and 12 FM stations (6 in FM1 and 6 in FM2)

Follow the easy steps below to set these buttons to the desired frequencies:

1. Select a band, then select a frequency.
2. Press one of the memory preset buttons and hold the button until the sound returns. That station is now held in memory on that button.
3. Follow the two steps above for each station memory preset button you want to set.

### ***Using the Automatic Memory Store feature (“AUTOSET”)***

If the memory buttons have been set, either by using the Auto Memory Load feature or if you have set them manually, the system is prepared to let you use a convenient feature called **Automatic Memory Store**.

With Auto Memory Store, you can continually set strong stations into your memory buttons without losing your originally set stations. Your radio will automatically set your memory buttons to the strong local stations.

Activate Auto Memory Store by pushing the “AUTOSET” button once. Your radio will set the first six strong stations of the band you are in (AM, FM1 or FM2) into the memory buttons. The display will flash “AUTO” and display the autose icon “A” while the stations are being set in the memory buttons.

**NOTE: If there are fewer than six strong stations in the frequency band, the remaining unfilled buttons will store the last strong station detected on the band. After all stations have been filled, the radio will begin playing the station stored on memory button 1.**

To deactivate the Auto Memory Store mode and return to the manually-set memory button stations, simply push the “AUTOSET” button. Display will show “AUTO” then “OFF”. The next time Auto Memory Store is activated on that band, the radio will store the next set of six strong stations.

## ***Adjusting the tone balance of your radio***

- Increasing or decreasing bass and treble response

Push the “BASS/TREB” popout knob to gain access to the bass and treble controls. Bass control allows you to adjust the lower, bass frequencies to your preference. The outer ring of the “BASS/TREB” knob adjusts the bass (turn clockwise to increase bass; counterclockwise to decrease bass).

Treble control allows you to adjust the higher, treble frequencies of your radio to your preference. The inner ring of the “BASS/TREB” knob adjusts the treble (turn clockwise to increase treble; counterclockwise to decrease treble).

- Adjusting speaker balance and speaker fader

Push the “BAL/FADE” popout knob to gain access to the speaker balance and fader controls. Balance control allows you to adjust the sound distribution between the right and left speakers. The outer ring of “BAL/FADE” knob adjusts the speaker balance control. (Turn clockwise to shift the sound to the right speakers, and turn counterclockwise to shift the sound to the left speakers.)

Fade control allows you to adjust the sound distribution between the front and rear speakers. The inner ring of the “BAL/FADE” knob adjusts the speaker fader. (Turn clockwise to shift the sound to the rear speakers, and turn counterclockwise to shift the sound to the front speakers.)

## **Your Antenna**

Antennas for both AM and FM reception are hidden in the back glass of your vehicle. There is an internal antenna module that will switch between AM and FM, when bands are changed, for maximum reception performance.

**NOTE: Do not attempt to adapt any other type of antenna system to your audio system.**

## **Using the Controls of Your Cassette Tape Player**

**NOTE: Radio power must be on to use the cassette tape player.**

### ***How to insert a tape***

Your cassette tape player is equipped with power loading. Once you insert a tape and push slightly (with the **open edge to the right**), the loading mechanism draws the tape the rest of the way in and play will begin after a momentary tape tightening process. Display indicates "TAPE" while tape is playing.

If the player is in the tape mode but not in play, pressing the "TAPE" button will activate play. If the "TAPE" button is pressed with no tape inserted, the display will flash "NO TAPE".

### ***How to locate a desired track on the tape***

There are six ways to quickly locate a desired selection on the tape. You can use the fast forward, rewind, Blank Skip, "SEEK", "SCAN" or "SIDE 1-2" functions. Following are brief descriptions of each:

Fast forwarding the tape

To fast forward the tape, press the “FF” button. The radio will play while the tape is in fast forward. The light above the “FF” button will blink while in the fast forward mode. Press “FF” again or press the “TAPE” button to stop fast forwarding. At the end of the tape, the direction automatically reverses and plays the other side of the tape.

Rewinding the tape

To rewind the tape, press the “REW” button. The radio will automatically begin playing while the tape is rewinding. The light above the “REW” button will blink while in the rewind mode. Press “REW” again or press the “TAPE” button to stop rewinding.

Using the “SEEK” function with your cassette tape player

While in the tape mode, push the right ► side of the “SEEK” button to seek forward to the next selection on the tape. Push the left ◀ side to restart a currently playing tape selection.

Using the “Blank Skip” function with your cassette tape player

Press the “Blank Skip” button to activate the blank skip mode. After approximately 20 seconds of blank program, the tape will seek forward to the next program.

Using the “SCAN” function with your cassette tape player

Pushing the “SCAN” button will begin the forward scan mode on the tape currently playing, stopping on each tape selection for approximately eight seconds.

To stop the scan mode on the presently sampled tape selection, press the "SCAN" button or the "TAPE" button.

- How to change the side of the tape being played

The alternate side of the tape can be selected by pressing the "SIDE 1-2" button.

### ***How to eject the tape***

To stop the tape and eject the cassette, press the "EJECT" button. The tape will eject only when in the tape mode. The cassette **cannot** be ejected when the radio is playing an "AM" or "FM" station. The system will revert to radio mode when the cassette is ejected.

### ***Using the Dolby® B noise reduction feature***

**NOTE: Noise reduction system manufactured under license from Dolby Labs Licensing Corporation. "Dolby" and double-D symbol are trademarks of Dolby Laboratories Licensing Corporation.**

Push the   button to activate. When activated, the light above the   button will be illuminated.

### ***Tape error messages***

Your cassette tape player is equipped to diagnose certain problems you may experience. Error codes are as follows:

TD E1 — Radio tries to change sides of tape 3 times in a 10 second span. Push "EJECT" and try another tape. If problem persists, refer problem to qualified personnel for service.

TD E2 — Tape eject failure. Radio tries to eject tape and it will not eject. Push “EJECT” to eject tape. If the tape will not eject, refer problem to qualified personnel for service.

TD E3 — Loading error. Push “EJECT” to eject tape. Reload tape. If the same error code appears in the display, try another tape.

### **Tips on Caring for the Cassette Player and Tapes**

In order to keep your cassette tape player performing the way it was meant to, read and follow these simple precautions:

- Using a Ford or equivalent cassette cleaning cartridge to clean the tape player head after 10-12 hours of play will help maintain the best playback sound and proper tape operation.
- Only cassettes that are 90 minutes long or less should be used. Tapes longer than 90 minutes are thinner and subject to breakage or may jam the tape player mechanism.
- Protect cassettes from exposure to direct sunlight, high humidity and extreme heat or cold. If they are exposed to extreme conditions, allow them to reach a moderate temperature before playing.
- If a tape is loose inside the cassette, tighten it before playing by putting your finger or a pencil into one of the holes and turning the hub until the tape is tight.
- Loose labels on cassette tapes can become lodged in the mechanism. Remove any loose label material before inserting a cassette.
- Do not leave a tape in the cassette tape player when not in use. High heat in the vehicle can cause the cassette to warp.

Electronic Search Cassette

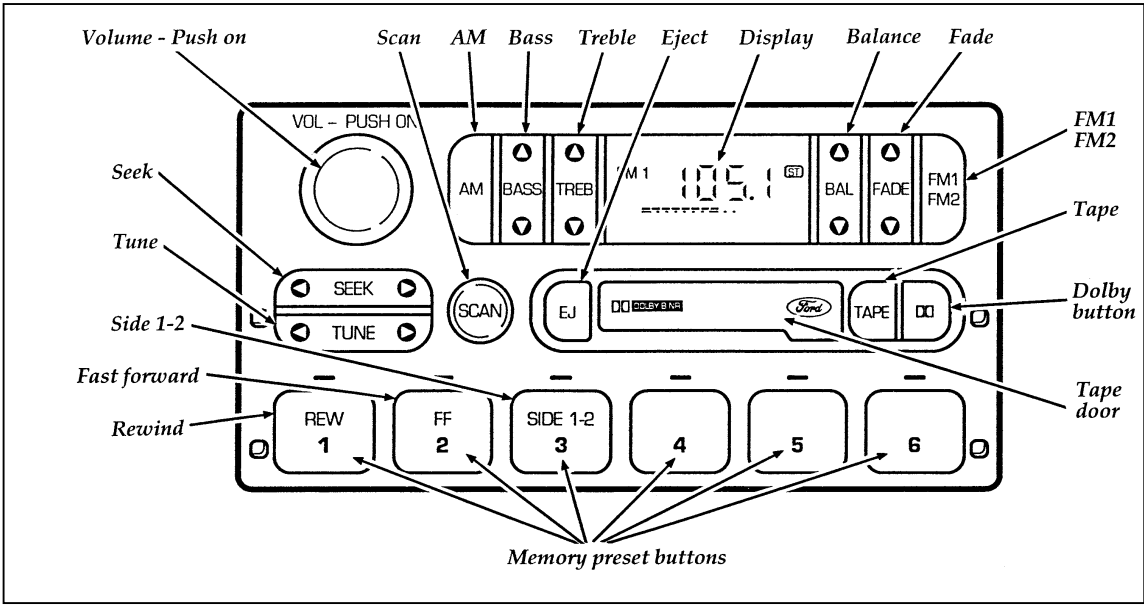



## **Electronic Search Cassette Radio**

### **Using the Controls on Your New Radio**

#### ***How to turn the radio on and off***

Press the “VOL/PUSH ON” knob to turn the radio on. Press again to turn it off.

#### ***How to adjust the volume***

Turn the “VOL/PUSH ON” knob to the right to increase the volume and to the left to decrease the volume. Bars illuminate in the display to show relative volume level.

**NOTE:** If the volume level is set above a certain listening level when the ignition switch is turned off, when the ignition switch is turned back on, the volume will come back to a “nominal” listening level. However, if the radio power is turned off, the volume will remain in the position it was set at when radio power was switched off.

#### ***Selecting the AM or FM frequency band***

Push the “AM/FM” button to select the desired frequency band or to stop/store cassette tape (when in cassette mode). Pushing the button more than once will alternate between AM, FM1 and FM2. These functions are used with the station memory buttons described under *How to tune radio stations*.

### ***How to tune radio stations***

There are four ways for you to tune in a particular station. You can manually locate the station using the “SCAN/TUNE” button, “SEEK” the station, “SCAN” to the station or select the station by using the memory buttons, which you can set to any desired frequency. These four methods are described below.

#### Using the “TUNE” function

You can change the frequency up or down one increment at a time by pressing and releasing either the left ◀ or right ▶ side of the “TUNE” button.

Manual tuning adjusts your radio to any allowable broadcast frequency, whether or not a station is present on that frequency. (See *All About Radio Frequencies* in this section.)

#### Using the “SEEK” function

This feature on your radio allows you to automatically select listenable stations up or down the frequency band. Press the right ▶ side of the “SEEK” button to select the next listenable station up the frequency band. Press the left ◀ side of the button to select the next listenable station down the frequency band. By holding the button down, listenable stations can be passed over to reach the desired station.

Using the “SCAN” function

Pressing the “SCAN” button will begin the scan mode up the frequency band, stopping on each listenable station for approximately five seconds.

To stop the scan mode on the presently sampled station, press the “SCAN” button again.

Setting the Station Memory Preset buttons

Your radio is equipped with 6 station memory buttons. These buttons can be used to select up to 6 preset AM stations and 12 FM stations (6 in FM1 and 6 in FM2).

Follow the easy steps below to set these buttons to the desired frequencies:

1. Select a band, then select a frequency.
2. Press one of the memory preset buttons and hold the button until the sound returns. That station is now held in memory on that button.
3. Follow the two steps above for each station memory preset button you want to set.

**NOTE: If the vehicle’s battery is disconnected the station memory preset buttons will need to be reset.**

## ***Adjusting the tone balance and speaker output of your radio***

### Increasing or decreasing bass response

Press the top ▲ of the “BASS” button to increase bass; press the bottom ▼ of the “BASS” button to decrease bass.

### Increasing or decreasing treble response

Press the top ▲ of the “TREBLE” button to increase treble; press the bottom ▼ of the treble button to decrease treble.

### Adjusting speaker balance

Balance control allows you to adjust the sound distribution between the right and left speakers. Press the top ▲ of the “BAL” button to shift the sound to the right speakers, and press the bottom ▼ of the “BAL” button to shift the sound to the left speakers.

### Adjusting speaker fader

Fade control allows you to adjust the sound distribution between the front and rear speakers. Press the top ▲ of the “FADE” button to shift the sound to the front speakers, and press the bottom ▼ of the “FADE” button to shift the sound to the back speakers.

**NOTE: Illuminated bars in the display show relative levels of bass and treble, and positions of speaker balance and fader functions (left to right, front to rear).**

## **Using the Controls of Your Cassette Tape Player**

**NOTE: Radio power must be on to use the cassette tape player or eject a tape.**

### ***How to insert a tape***

Your cassette tape player is equipped with power loading. Once you insert a tape and push slightly (with the **open edge to the right**), the loading mechanism draws the tape the rest of the way in and play will begin after a momentary tape tightening process.

**NOTE: A cassette tape can be loaded with the ignition on whether or not the radio power is on. Inserting a cassette tape with the radio power off will turn the audio system on. After the cassette is ejected, radio play will return. Also, the antenna will be in the up position whenever the radio is playing but will go down anytime the radio is not playing (i.e., when a cassette or compact disc is playing or when the radio power is off).**

### ***How to locate a desired track on the tape***

There are four ways to quickly locate a desired selection on the tape. You can use the fast forward, rewind, "SEEK", or "SCAN" function. Following are brief descriptions of each.

#### Fast forwarding the tape

To fast forward the tape, press the "FF" button. The radio will begin playing until fast forward is manually stopped (by pushing the "TAPE" button) or the end of the tape is reached.

At the end of the tape, the direction automatically reverses and plays the other side of the tape.

Rewinding the tape

To rewind the tape, press the “REW” button. The radio will begin playing until rewind is manually stopped (by pushing the “TAPE” button) or the beginning of the tape is reached.

Using the “SEEK” function with your cassette tape player

While in the tape mode, push the right ► side of the “SEEK” button to seek forward to the next selection on the tape. Push the left ◀ side to seek the previous tape selection.

Using the “SCAN” function with your cassette tape player

Press the “SCAN” button to begin the forward scan mode on the tape currently playing, stopping on each tape selection for approximately an eight-second sampling (display indicates “SC”).

To stop the scan mode on the presently sampled tape selection, press “SCAN” a second time.

How to change the side of the tape being played

The alternate side of the tape can be selected by pressing the “SIDE 1-2” button.

### ***How to eject the tape***

To stop the tape and eject the cassette, press the “EJ” button. The radio will resume playing if the radio power is on. The tape cartridge can be ejected with radio power (and/or ignition) on or off.

### ***How to store the tape***

Press the “AM/FM” button to stop the tape player and resume radio play.

### ***Using the Dolby® B noise reduction feature***

**NOTE: Noise reduction system manufactured under license from Dolby Labs Licensing Corporation. “Dolby” and double-D symbol are trademarks of Dolby Laboratories Licensing Corporation.**

Push the   button to activate Dolby B Noise Reduction. Push again to deactivate.

### **Tips on Caring for the Cassette Player and Tapes**

In order to keep your cassette tape player performing the way it was meant to, read and follow these simple precautions:

- Using a Ford or equivalent cassette cleaning cartridge to clean the tape player head after 10-12 hours of play will help maintain the best playback sound and proper tape operation.
- Only cassettes that are 90 minutes long or less should be used. Tapes longer than 90 minutes are thinner and subject to breakage or may jam the tape player mechanism.

- Protect cassettes from exposure to direct sunlight, high humidity and extreme heat or cold. If they are exposed to extreme conditions, allow them to reach a moderate temperature before playing.
- If a tape is loose inside the cassette, tighten it before playing by putting your finger or a pencil into one of the holes and turning the hub until the tape is tight.
- Loose labels on cassette tapes can become lodged in the mechanism. Remove any loose label material before inserting cassette.
- Do not leave a tape in the cassette tape player. High heat in the vehicle can cause the cassette to warp.

## **Common Radio Reception Conditions**

Several conditions prevent FM reception from being completely clear and noise-free, such as the following:

### **1. Distance/Strength**

The strength of the FM signal is directly related to the distance the signal must travel. The listenable range of an average FM signal is approximately 25 miles (40 kilometers). Beyond this distance, the radio is operating in a fringe area and the signal becomes weaker.

**NOTE: Always make sure your antenna is fully extended to the maximum length for proper reception. If your antenna is not fully extended, you may experience signal loss while traveling in fringe reception areas.**



## 2. Terrain

The terrain (hilly, mountainous, tall buildings) of the area over which the signal travels may prevent the FM signal from being noise-free.

If there is a building or large structure between the antenna and station, some of the signal “bends” around the building, but certain spots receive almost no signal. Moving out of the “shadow” of the structure will allow the station to return to normal.

When the radio waves are reflected off objects or structures, the reflected signal cancels the normal signal, causing the antenna to pick up noise and distortion. Cancellation effects are most prominent in metropolitan areas, but also can become quite severe in hilly terrain and depressed roadways.

To minimize these conditions, a stereo/mono blend circuit has been incorporated into this system. This feature automatically switches a weak stereo signal to a clearer monaural signal, which improves the quality of reception.

Several sources of static are normal conditions on AM frequencies. These can be caused by power lines, electric fences, traffic lights and thunderstorms.

Another reception phenomenon is **Strong Signal Capture and Overload**. This can occur when listening to a weak station and when passing another broadcast tower. The close station may capture the more distant station, although the displayed frequency does not change. While passing the tower, the station may switch back and forth a few times before returning to the original station.

When several broadcast towers are present (common in metropolitan areas), several stations may overload the receiver, resulting in considerable station changing, mixing and distortion.

Automatic gain control circuitry for both AM and FM bands has been incorporated into this system to reduce strong signal capture and overload.

## **All About Radio Frequencies**

The Federal Communications Commission (FCC) and the Canadian Radio Telecommunications Commission (CRTC) establish the frequencies that AM and FM radio stations may use for their broadcasts. The allowable frequencies are, AM: 530, 540...1600, 1610 kHz in 10 kHz steps; FM: 87.9, 88.1...107.7, 107.9 MHz in 0.2 MHz steps.

Not all frequencies will be assigned to a given area. This radio will tune to each of these frequencies using manual tune and no fine tuning is necessary as radio stations may not use other frequencies.

Some FM radio stations advertise a “rounded-off” frequency which is not the frequency they actually broadcast on. For example, a radio station that is assigned a frequency of 98.7 MHz may call itself “Radio 99” even though 99.0 MHz is not an allowable FM broadcast frequency.

## **Important Warranty and Service Information**

### Warranty

Your sound system is warranted for three years or 36,000 miles (60,000 kilometers), whichever comes first. Consult your vehicle warranty booklet for further information. Ask your dealer for a copy of this limited warranty.

### Service

At Ford, we stand behind our audio systems with a comprehensive service and repair program. If anything should go wrong with your Ford audio system, return to your dealer for service. There is a nationwide network of qualified Ford authorized repair centers to assist you.

---

# Controls and Features

---

The main controls for the climate control system, clock, and radio are on the instrument panel.

**NOTE: Any cleaner or polish that increases the gloss (shine) of the upper part of the instrument panel should be avoided. The dull finish in this area is to help protect the driver from undesirable windshield reflection.**

Your vehicle has a variety of features designed for your comfort, convenience and safety. Read this chapter to find out about standard and optional features.

## The Climate Control Systems

Your vehicle has one of two different climate control systems. The two systems are:

- a manual heating and air conditioning system
- an electronic automatic temperature control system

If you are not sure which system your vehicle has, see the diagrams on the following pages.

## The Manual Heating and Air Conditioning System

You can heat the inside of your vehicle, defrost the windshield, and turn on the air conditioning with the three controls in the center of the instrument panel:

- FAN
- TEMP
- SELECT

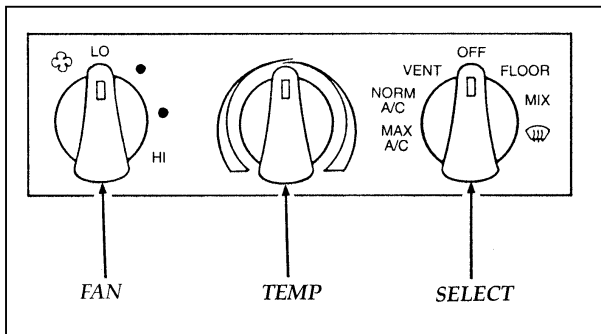

**The controls for the manual heating and air conditioning system**

For maximum heating, move the SELECT knob to FLOOR, move the TEMP knob to the end of the red range (full clockwise) and move the fan speed to HI.

To heat the interior of your vehicle and defrost the windshield at the same time, move the SELECT knob to MIX and select the temperature and fan speed desired.

For maximum defrosting, move the SELECT knob to DEFROST , move the temperature to the end of the red range (full clockwise) and operate the fan as necessary to provide the volume of air required.

For ventilation, move the SELECT knob to VENT and select the temperature and blower speed desired.

To cool the inside of your vehicle quickly, in warm weather, move the SELECT knob to MAX A/C, move the TEMP knob to the end of the blue range (full counterclockwise) and move the fan to HI.

If the inside of the vehicle is very warm, drive for the first few minutes with the windows open to force the hot, stale air out of the vehicle.

Fan speed can be reduced, after a comfortable temperature has been reached, to provide quieter system operation.

To cool your vehicle using outside air, move the SELECT knob to NORM A/C, move the TEMP knob to the end of the blue range (full counterclockwise) and set the fan to the desired speed. Cooling your vehicle in this way provides quieter operation, but it is not as economical as MAX A/C.

The instrument panel registers may be adjusted to control the quantity and direction of air being discharged. The thumbwheel controls the volume of air and the knob in the center of the register directs the air up and down or side to side.

When the SELECT knob is moved to OFF, the system is off and the fan will not operate.

### ***Adjusting the panel register airflow***

The instrument panel registers may be adjusted to your comfort needs. The thumbwheel controls the volume of air and the control in the center of the register controls direction up or down or side to side.

### **Electronic Automatic Temperature Control System**

The Electronic Automatic Temperature Control (EATC) module is located at the center of the instrument panel and operates only when the key is in the ON position.

The EATC feature maintains the temperature you select and automatically controls the airflow for your comfort. It also allows you to override the automatic operation with manual override buttons.

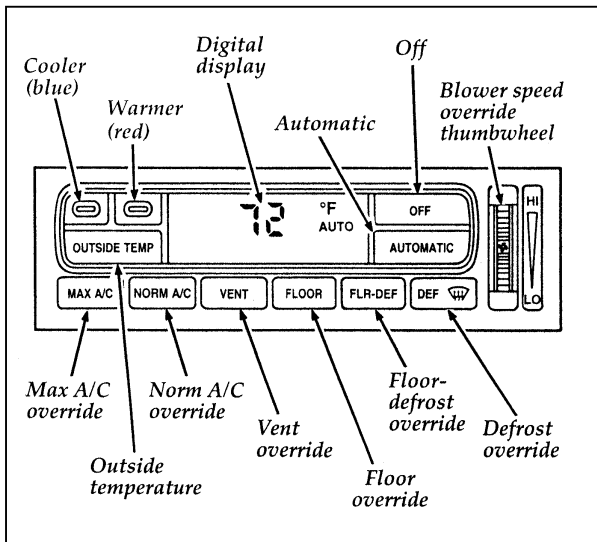

**The controls for the electronic automatic temperature control**

To turn your EATC on, push the AUTOMATIC button or any of the six override buttons along the bottom of the control.

To turn your EATC off, press the OFF button. When the system is off, the display window will be blank (dark) except when OUTSIDE TEMP has been selected. Then, OUTSIDE TEMP and the temperature will appear in the window.

If you select AUTOMATIC, the system will automatically determine fan speed and airflow location. If an override button is selected, your selection determines airflow location only. Fan speed remains automatic unless you override it by rotating the vertical thumbwheel located at the extreme right of the control panel.

To change the temperature in the display window, select any temperature between 65°F (18°C) and 85°F (29°C) using the BLUE (cooler) or RED (warmer) buttons. The Electronic Automatic Temperature Control will do the rest.

If you want continuous maximum cooling, push the BLUE button until 60°F (16°C) is shown in the display window. Your EATC will cool at maximum and disregard the 60°F (16°C) setting until you select a warmer temperature with the RED button. If you want continuous maximum heating, push the RED button until 90°F (32°C) is shown in the display window. Your EATC will provide maximum heat regardless of the 90°F (32°C) setting until you select a cooler temperature with the BLUE button.

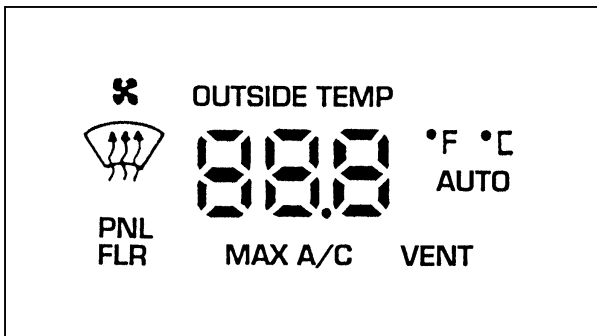

The display window tells you how the system is operating. It will indicate the selected temperature and the operating function you have chosen; AUTO or one of the six manual overrides. It will also indicate manual (thumbwheel) control of the fan speed with the  symbol. The display window with all possible displays and their positions are shown here. Normally not all are shown at the same time but are included here to familiarize you with the names and symbols.



### ***Automatic operation***

Push the AUTOMATIC button and select the desired temperature. The selected temperature and AUTO will be shown in the display window. The EATC will automatically heat or cool to achieve the set temperature. Under normal conditions, your EATC will need no additional attention.

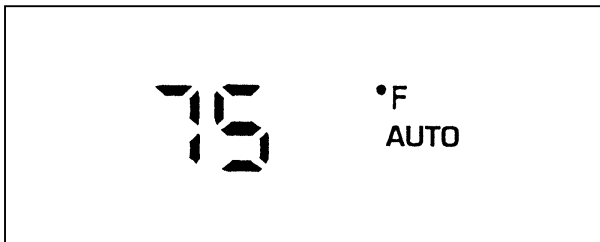

When in AUTOMATIC and weather conditions require heat, air will be sent to the floor. But, a feature is included in your EATC to prevent blowing cold air to the floor if the engine coolant is not warm enough to allow heating. For a short time the fan will be at low speed and air directed to the windshield. In 3-1/2 minutes or less, the fan speed will start to increase and the airflow will change to the floor area.

If unusual conditions exist (i.e., window fogging, etc.), the six manual override buttons allow you to select special air discharge locations. A thumbwheel allows you to adjust the fan speed to suit your needs.

### ***Temperature selection***

The RED and BLUE buttons at the upper left of the Control are for temperature selection. The RED button will increase the set temperature and the BLUE button will lower the set temperature. Pressing a button and releasing it will change the set temperature one degree. Holding either button in will rapidly change the temperature setting in one degree increments to either 65°F (18°C) (BLUE) or 85°F (29°C)(RED). Then, the set temperature will jump 5° and stop at either 60°F (16°C) which is maximum cooling or 90°F (32°C) which is maximum heating.

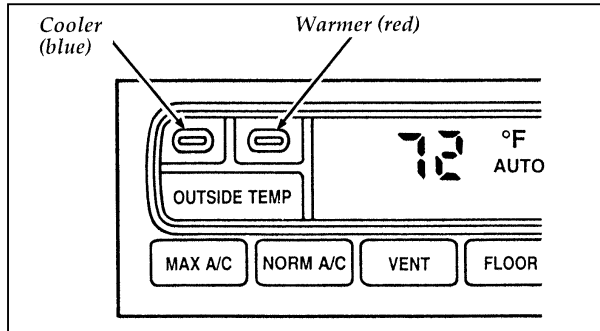

The average temperature range used is between 68°F (20°C) and 78°F (26°C). Changing the temperature setting by several degrees outside this range will not speed up the heating or cooling process.

### ***Temperature display***

The selected temperature displayed in the window can be set for either °F or °C. Your car may have an English/Metric (E/M) Button to change your speedometer from miles to kilometers. When pressed, this button also changes the temperature display. With or

without an E/M Button, the temperature display can also be changed to °F or °C using the MAX A/C and DEFrost override buttons.

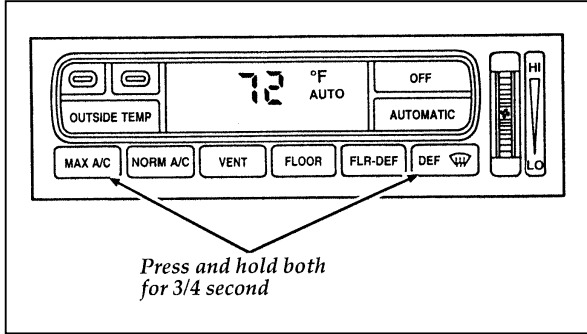

To change the temperature display to °F or °C, press and hold the MAX A/C and DEF Buttons at the same time for 3/4 second. The display will change. If you continue to press the two buttons, the display will continuously switch between °F and °C. If the temperature display does not agree with the speedometer on vehicles with an E/M button, pressing the E/M button will make them agree.

### ***Fan speed and thumbwheel***

Your EATC automatically adjusts the fan speed to the existing conditions. You must push AUTOMATIC for automatic fan speed operation. To control the fan speed yourself, use the thumbwheel which will cancel the automatic fan speed control. The thumbwheel is located at the extreme right side of the EATC control panel. It is a vertical control marked with a fan symbol. Rotate up for HI and down for LO speeds.

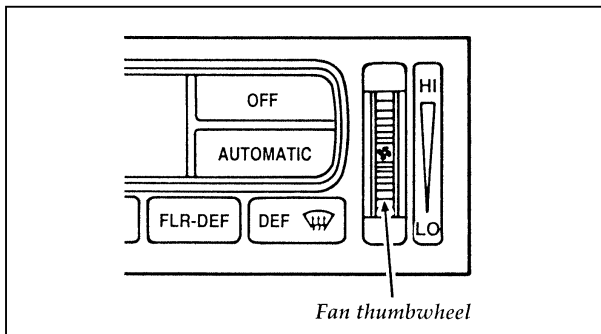

When you move the thumbwheel, the fan speed will go to manual control. The display window will show the  symbol in the upper left corner along with the selected temperature and operating function.

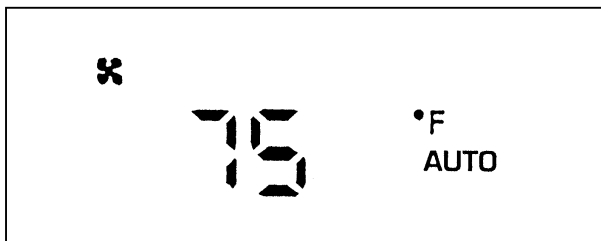

You can override the fan speed at any time. If you use the thumbwheel to override the fan speed, the EATC will continue to control the temperature but you control the fan speed. To return to auto fan control, press the AUTOMATIC button. If you are operating in one of the override functions (FLOOR, MAX A/C, etc.), automatic fan control will continue unless you rotate the fan thumbwheel. To return to automatic fan control, press the AUTOMATIC

button. The EATC will return to Automatic operation. If you want to return to any override function, press the button for that function. The fan speed will continue to be automatically controlled.

### ***Manual override buttons***

Your EATC has six buttons which allow you to make special selections. The buttons are located along the bottom edge of the EATC control and allow you to determine where the air will be discharged. Pressing any override button changes the air discharge location only. It does not affect the ability of the system to control temperature or the fan speed. Return to fully Automatic operation by pushing the AUTOMATIC button.

#### **MAX A/C button**

The MAX A/C feature allows for faster cooling because air is drawn from inside the car. Using inside air causes the fan to sound louder which is normal for this selection. The Display window will indicate MAX A/C under the selected temperature. The airflow will be from the instrument panel registers.

#### **NORM A/C button**

When you push this button, you select air conditioning using outside air. The Display window will indicate A/C under the selected temperature. The cooled air will flow from the instrument panel registers. The fan speed will continue on automatic.

### **VENT button**

Push this button to select outside air through the instrument panel registers. The display window will show the set temperature and VENT to the lower right of the temperature. Your EATC will heat the air if the temperature you have selected is warmer than the outside air coming into the vehicle. However, the air will NOT be cooled regardless of the temperature setting. Airflow will be from the instrument panel registers.



### **FLOOR button**

Airflow will be to the floor when the FLOOR button is pressed. The display window will show the set temperature and FLR to the left of the temperature. The air cannot be cooled in the FLOOR position, only heated. Fan speed will be automatic unless manually controlled. If you override the fan speed and wish to return to automatic fan control, push AUTOMATIC. Then, again select FLOOR for airflow to the floor.

### **FLR & DEF button**

Push this button to get air to the floor and windshield defrosters at the same time. The display will show the set temperature, FLR and the Defrost symbol  to indicate FLR-DEF has been selected. If the outside temperature is about 50°F (10°C) and above, the air will be dehumidified to remove moisture. This will help to prevent fogging in humid weather.

### **DEF button**

Press the DEF  Button to obtain maximum airflow to the windshield. Adjust the temperature setting as required for defrosting. The Display window will show the temperature setting with the defrost symbol  to the left of the temperature. When the outside temperature

is about 50°F (10°C) and above, the air will be dehumidified to remove moisture. This will help prevent fogging in humid weather.

### **OUTSIDE TEMP button**

By pressing this button the temperature of the air outside of the vehicle will show in the display. The outside temperature will continue to be displayed until the OUTSIDE TEMP button is pressed again to cancel. If the selected temperature setting is changed while the outside temperature is displayed, the new selected temperature will be displayed for 4 seconds after it is changed. Then, the outside temperature will return to the window. If a manual override is pressed or the thumbwheel is rotated while the outside temperature is displayed, the window will show the change for 4 seconds. Then, the outside temperature will return along with the changed override selection.

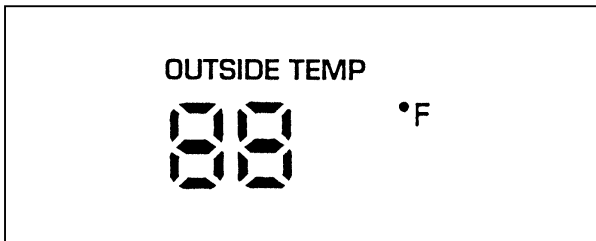

If the EATC is turned OFF while the outside temperature is displayed, the temperature will continue to be displayed. Press the OUTSIDE TEMP button to clear the display window. When the ignition key is turned OFF the display will be blank (dark).

**NOTE: The outside temperature reading is most accurate when the vehicle is moving. Higher readings may be obtained when the vehicle is not moving. The readings that you get may not agree with temperatures given on the radio due to differences in vehicle and station locations.**

### ***Operating tips***

The following tips will help you to get the most satisfaction from your Electronic Automatic Temperature Control system.

- In humid weather, select DEF  before starting your engine. This will help to prevent windshield fogging. After a few minutes of operation, switch to AUTOMATIC or an override selection of your choice.
- To prevent humidity buildup inside your vehicle, always drive with the EATC System turned on.
- Do not put objects under the front seats that interfere with the flow of air to the back seat area.
- Remove any snow, ice, or leaves from the air intake area of your EATC System which could block the air intake. The intake area is located at the bottom of the windshield, under the hood at the passenger side rear corner.

### ***Service***

If your EATC is not operating as described here, take it to your dealer to have it checked. System diagnostics are built in which will allow your dealer to readily identify problems that might occur.



## Rear Window Defroster

The defroster for the rear window clears frost, fog, or thin ice from both the inside and outside of the rear window.

The button for the rear window defroster is located on the left hand (driver's) side of the instrument panel.

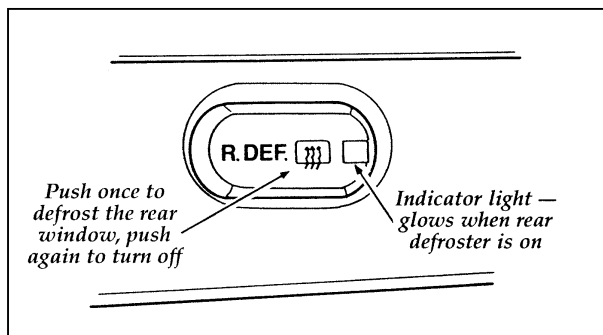

**The button that controls the rear window defroster**

Clear away any snow that is on the rear window before using the defroster. With the engine running, push the defrost button.

After approximately 10 minutes, the defroster will turn off. If the window is still not clear, turn the defroster on again.

The defroster will turn off when the ignition key is turned to the OFF position.

The heating elements are bonded to the inside of the rear window. Do not use sharp objects to scrape the inside of the rear window or use abrasive cleaners to clean it. Doing so could damage the heating elements.

## The Interior and Exterior Lights

### Daytime Running Light System

*(Canadian vehicles only)*

The Daytime Running Light (DRL) system turns the high beam headlamps on, with a reduced light output, when:

- The headlamp system is in the OFF position, and
- The vehicle is running, and
- The vehicle has a fully released parking brake.

**NOTE:** If you have a vehicle with an automatic lighting system, the DRL system is active until the automatic system turns on the headlamps.

**NOTE:** The high beam indicator will not turn on in the flash-to-pass mode during nighttime driving.

**NOTE:** You may notice that the lights flicker when the vehicle is turned on or off. This is a normal condition.

**⚠ WARNING**

**The Daytime Running Light (DRL) system will not illuminate the tail lamps and parking lamps. Turn on your headlamps at dusk. Failure to do so may result in a collision.**

### **Turning On the Exterior Lights**

To turn on the headlamps, parking lamps, side markers, license plate lamps and tail lamps, use the rotary control that is to the left of the steering wheel.

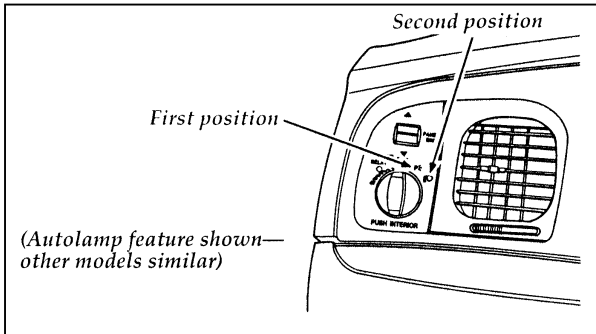

**The knob that controls the headlamps and parking lamps**

To turn on the parking lamps, license plate lamps, tail lamps and marker lamps, move the knob to the first position.

To turn on the headlamps, parking lamps, license plate lamps, tail lamps and marker lamps, move the knob to the second position.

For more information about how the high beams work, see the high beam section later in this chapter.

### ***Chime for headlamps on***

This chime sounds if the driver or any passenger door is open when the parking lamps or headlamps are on. The chime sounds until you close the door, turn off the lamps or turn the ignition to the ON position.

### **Setting the Autolamp On/Off Delay System**

The autolamp sets the headlamps to turn on and off automatically. You can use the autolamp to:

- turn on the lamps automatically at night
- turn off the lamps automatically during daylight
- keep the lamps on for up to three minutes after you turn the key to OFF.

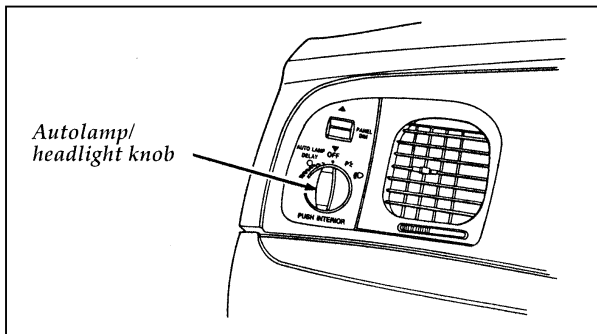

**The autolamp system on the left side of the instrument panel**

To activate the autolamp feature, simply turn the headlamp knob counterclockwise towards the autolamp delay area. The autolamp automatically turns the lamps on and off for you.

Do not put any articles on top of the photocell that is located in the top right corner of the instrument panel. This photocell controls the autolamp. If you cover it, the photocell reacts as if it is nighttime, and the lamps turn on.

You can adjust the autolamp to keep the lamps on after you leave your vehicle. The further you move the headlamp knob to the left (counterclockwise), the longer the lamps stay on.

You can set the autolamp so the lamps stay on for up to three minutes after you turn your vehicle off.

### **Lighting Up the Interior and Instrument Panel**

With the parking lamps or headlamps illuminated, you can brighten or dim the lights in the instrument panel. To do this, locate the switch above the headlight control knob and press it up (to brighten the lights) or down (to dim the lights). To turn the interior lights on and off, push the headlamp knob in.

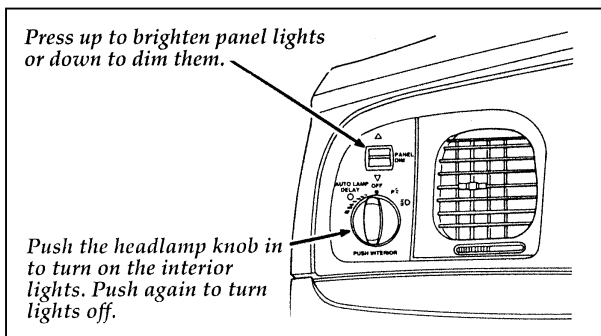

The knob controls the light on the instrument panel and the interior light (autolamp feature shown — other models similar)

## Clock

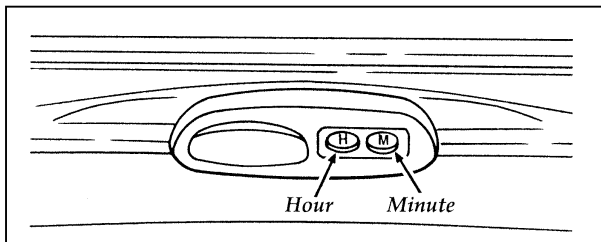

### The digital clock

1. To set the hour, press and hold the H button. When the desired hour appears, release the button.
2. To set the minutes, press and hold the M button. When the desired minute appears, release the button.

## Ashtray and Cupholder

Your vehicle is equipped with an ashtray/cupholder mounted to the lower center of the instrument panel.

To open the ashtray, pull out the bottom edge of the drawer until it stops.

To close, remove cup(s) and push drawer forward until closed.

## Storage Compartments

Your vehicle may have several small storage compartments:

- a glove compartment that locks. Use the round key to lock and unlock it.

 <b>WARNING</b>
<b>Do not put objects on the ledge between the back seat and the rear window, as they can become dangerous projectiles and injure someone.</b>

## Using the Remote Control for the Trunk (If equipped)

You can use the remote control on the driver's door to unlock and open the trunk unless you lock the button with main key. The valet key equipped with your vehicle can only open the doors and start the engine.

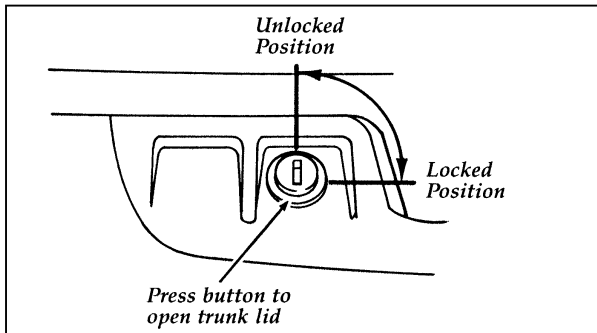

The remote control for the trunk



# Ignition

## Understanding the Positions of the Ignition

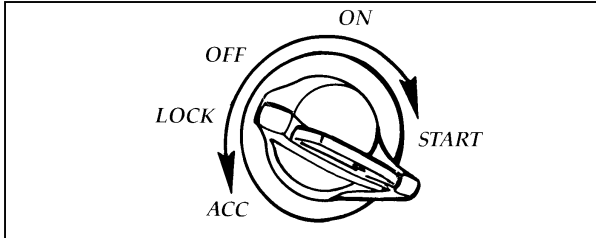

### The positions of the key in the ignition

ACC allows some of your vehicle's electrical accessories such as the radio and the windshield wipers to operate while the engine is not running.

LOCK locks the steering wheel. It also locks the automatic transmission gearshift lever.

LOCK is the only position that allows you to remove the key. The LOCK feature helps to protect your vehicle from theft.

OFF allows you to shut off the engine and all accessories without locking the steering wheel or the automatic transmission gearshift lever.

ON allows you to test your vehicle's warning lights (except the brake system warning light) to make sure they work before you start the engine. The key returns to the ON position once the engine is started and remains in this position while the engine runs.

START cranks the engine. Release the key once the engine starts so that you do not damage the starter. The key should return to ON when you release it. The START position also allows you to test the brake warning light.

## Removing the Key From the Ignition

1. Put the gearshift in P (Park).
2. Set the parking brake fully.
3. Turn the ignition key to LOCK.
4. Remove the key.

**NOTE: The automatic transmission gearshift must be in P (Park) to move the key to the lock position.**

If the key is stuck in the LOCK position, move the steering wheel left or right until the key turns freely.

If the driver's door is open while the key is still in the ignition, a warning chime sounds.

 <b>WARNING</b>
--

<b>Always set the parking brake fully and make sure the gearshift is latched in P (Park). Turn off the ignition whenever you leave your vehicle.</b>
--

 <b>WARNING</b>
--

<b>Do not leave children, unreliable adults, or pets unattended in your vehicle.</b>
--

## The Turn Signal Lever

You can use the turn signal lever on the left side of the steering column to:

- operate the turn signals
- turn the high beams on/off
- flash the lamps
- turn the windshield wipers and washer on/off
- turn the cornering lamps on

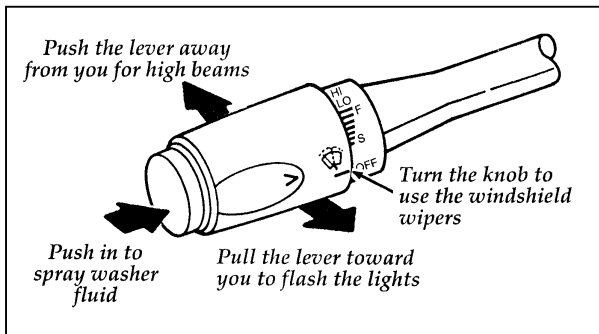

The turn signal lever

## Turn Signals

Move the lever up to signal a right turn. Move it down to signal a left turn. The corresponding indicator light in the instrument cluster will flash.

If the turn signal stays on after you turn, move the lever back to the center (off) position.

For lane changes, move the lever far enough to signal but not to latch. The lever will return to the off position when you release it.

If your vehicle is equipped with cornering lamps, they will automatically light on either the right or left side (depending on the direction of the turn), when the headlamps are ON.

## High Beams

To turn on the high beams, turn the headlamp control knob to the headlamp ON position and push the turn signal lever away from you until it latches. When the high beams are ON, the high beam indicator light on the instrument panel comes on.

To turn off the high beams, pull the lever toward you until it latches. The high beam indicator light turns off.

### **Flashing the Lights**

To flash the headlamps, pull the lever toward you for a moment and then release it. The headlamps will flash whether the headlamp knob is in the on or off position.

### **Windshield Wipers and Washer**

To turn on the windshield wipers, the ignition key must be turned to the ON or ACC position.

Rotate the end of the lever away from you to activate the wipers. The first seven detents are interval wipe positions, the eighth detent is the LO position and the ninth detent is the HI position.

To turn the wipers off, turn the knob toward you to the OFF position.

### **Variable Interval Wipers**

In addition to two speed wipers, your vehicle has wipers that you can set to operate at varying intervals. For example, you can set the interval so they wipe less often when it drizzles or more often in heavier rain.

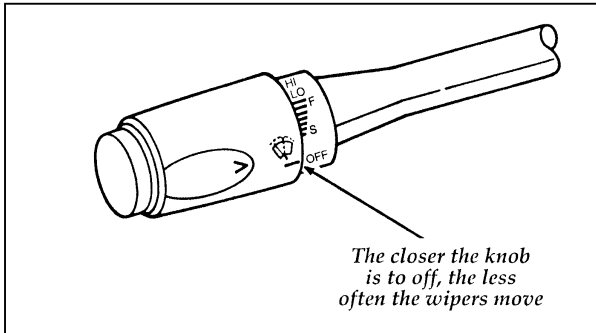

#### **The variable interval wiper on the turn signal lever**

To set the interval wipers, turn the knob at the end of the turn signal lever toward or away from you until the wipers are going at the desired interval.

#### **Windshield Washer**

To clean the windshield, push in the end of the wiper knob. For a constant spray, keep the knob pushed in. After you release the knob, the wipers operate for two to three cycles before turning off (if the wipers were OFF) or returning to HI, LO, or the interval setting selected.

If the washer does not work, check the washer fluid level and fill it if it is low. See the *Maintenance and Care* chapter. If there is enough fluid, consult your nearest Ford or Lincoln-Mercury dealer.

Do not try to clean the windshield when the washer fluid container is empty or activate the washers at any time for more than 15 seconds continuously. This could damage the washer pump system.

**⚠ WARNING**

**Always warm up the windshield with the defroster before you use the washer fluid. In freezing weather, the washer solution may freeze on the windshield and obscure your vision.**

For information about refilling the washer fluid or replacing your windshield wiper blades, see *Windshield washer fluid and Wipers* in the Index.

## **Hazard Flasher**

To alert other drivers to hazardous situations, push in the hazard flasher on the top of the steering column. The same control turns the flashers off.

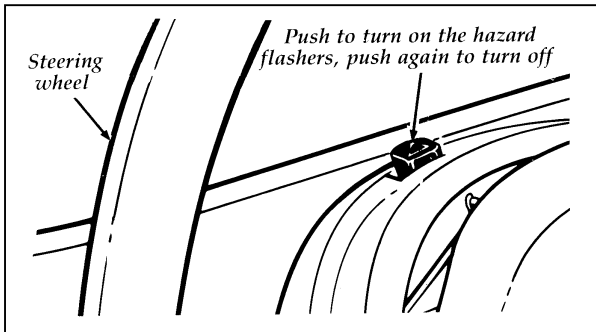

**The control for the hazard flashers**

## Horn

To sound the horn, push the center pad area of the steering wheel.

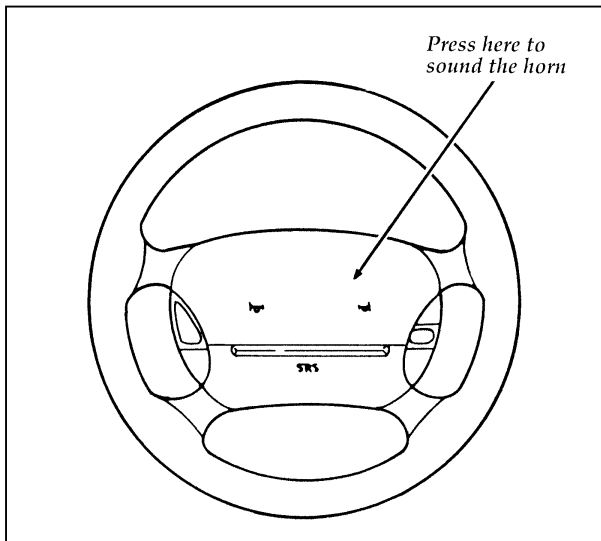

The horn on the steering wheel

## Tilt Steering

**⚠ WARNING**

**Never adjust the steering wheel when the vehicle is moving.**

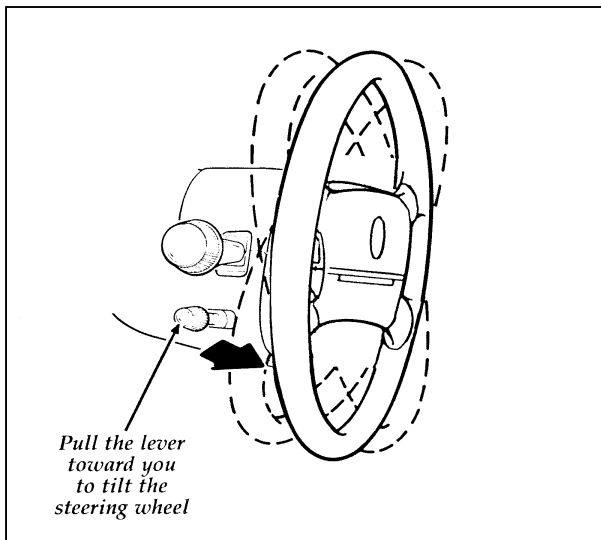

### **The lever to tilt the steering wheel**

To change the position of the steering wheel, pull the release lever on the column toward you. Tip the steering wheel to the desired position. Release the lever to lock the steering wheel in place.



## Speed Control (If equipped)

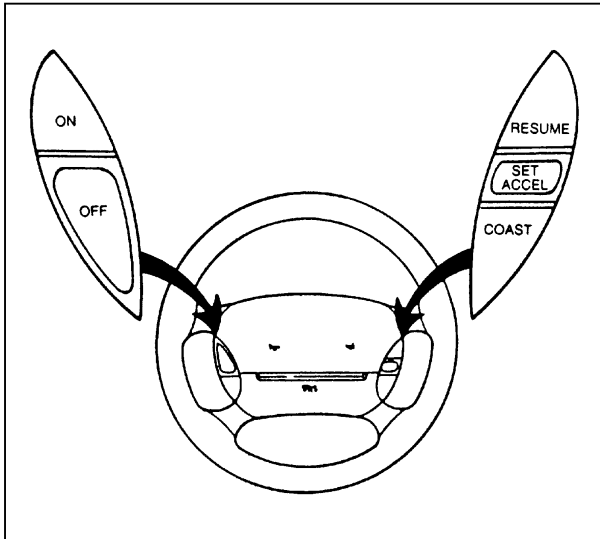

The speed control switches on the steering wheel

### To Turn Speed Control Off

- Press OFF, OR
- Turn off the vehicle ignition.

Once speed control is switched off, the previously programmed set speed will be erased.

### To Turn Speed Control On

- Press ON

### To Set a Speed

Press SET ACCEL. For speed control to operate, the speed control must be ON and the vehicle speed must be greater than 30 mph (48 km/h).

If you drive up or down a steep hill, your vehicle speed may vary momentarily slower or faster than the set speed. This is normal.

Speed control cannot reduce the vehicle speed if it increases above the set speed on a downhill. If your vehicle speed is faster than the set speed while driving on a downhill in **D** (Overdrive), you may want to shift to the next lower gear to reduce your vehicle speed.

If your vehicle slows down more than 10 mph (16 km/h) below your set speed on an uphill, your speed control will disengage. This is normal. Pressing RESUME will re-engage it.

**⚠ WARNING**

**To keep your vehicle under control, do not use speed control in heavy traffic or on roads that are winding, slippery, or unpaved.**

### **To Set a Higher Set Speed**

- Press and hold SET ACCEL. Release the switch when the desired vehicle speed is reached. OR
- Press and release SET ACCEL. Each press will increase the set speed by 1 mph (1.6 km/h). OR
- Accelerate with your accelerator pedal, then press SET ACCEL.

You may accelerate with the accelerator pedal at any time during speed control usage. Releasing the accelerator pedal will return your vehicle speed to the previously programmed set speed.

### To Set a Lower Set Speed

- Press and hold COAST. Release the switch when the desired vehicle speed is reached.  
OR
- Press and release COAST. Each press will decrease the set speed by 1 mph (1.6 km/h).  
OR
- Depress the brake pedal. When the desired vehicle speed is reached, press SET ACCEL.

### To Disengage Speed Control

- Depress the brake pedal.

Disengaging the speed control will not erase the previously programmed set speed.

### To Return to a Set Speed

- Press RESUME. For RESUME to operate, the vehicle speed must be faster than 30 mph (48 km/h).

## Map and Reading Lamps

Your vehicle has two map lamps for the passenger and the driver. To turn on the map lamps, push the switch next to each lamp.

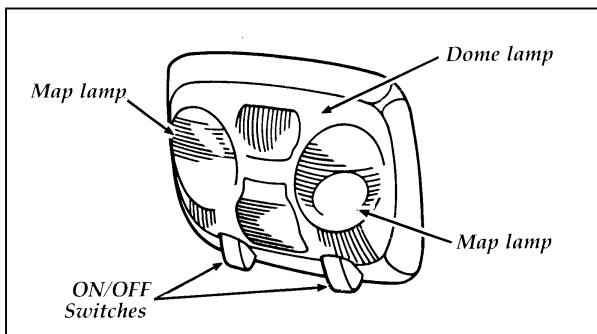

Front seat map and dome lamps

The dual beam map lamps are located on each side of the dome lamp. Each map lamp can be turned on by the switches on the lamp.

## **Rear Courtesy/Reading Lamps (If equipped)**

Your vehicle may be equipped with a courtesy/reading lamp located at the rear-center of the headliner (roof). The right lamp is for the right side passenger and the left lamp is for the left side passenger.

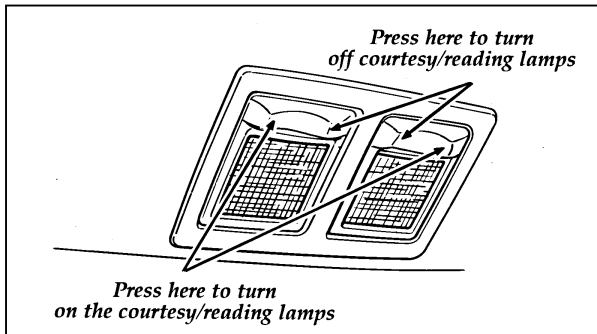

### **Rear seat courtesy/reading lamps (optional)**

With the lens in the flat position, the courtesy/reading lamp will illuminate when any door is opened or when the headlamp dimmer knob is rotated to the courtesy lamp position.

With the lens in the rotated position and the key in the ON or ACC position, the courtesy/reading lamp will illuminate.

## **Mirrors**

You can adjust your rearview mirror in any direction. The special swivel bracket lets you move the mirror up or down and from side to side.

**⚠ WARNING**

**Make sure you can see clearly through the rearview mirror at all times. Do not block your vision. If you cannot see through the mirror, it could result in a collision, injuring yourself and others.**

**Automatic Dimming Inside Rearview Mirror (If equipped)**

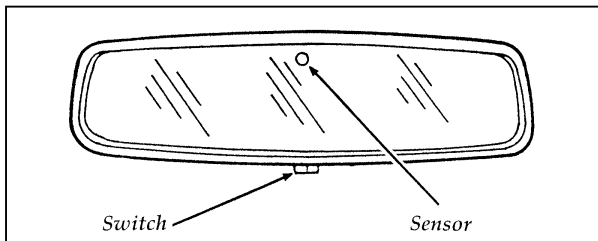

**The automatic non-glare mirror**

The electronic day/night mirror will change from the normal state to the non-glare state when bright lights (glare) reach the mirror. This mirror functions at night, and has a limited function at dusk or dawn. From the non-glare state, the mirror will return to the normal state after a short delay. The delay starts when the glare goes away. The delay prevents excessive changing of the mirror as traffic moves behind and around the vehicle, or on rolling hills and curves.

To turn the mirror on, push the ON/OFF switch, located on the bottom of the mirror, to latch it in the ON position. The switch will illuminate and the mirror will be in the automatic dimming mode. To turn the switch illumination and automatic dimming feature off, push the ON/OFF switch again.

The electronic mirror measures the brightness of the light coming in from the rear of the vehicle. It automatically makes a correction in the glare state. The mirror may be turned off in either the normal or non-glare position.

There are two light sensors (photocells) in this mirror. The sensor that detects rear glare is located inside a window in the center of the mirror. The second light sensor which determines outside light level is located on the backside of the mirror case.

**NOTE: Do not block the sensor on the backside of the mirror (i.e., with a parking tag, car deodorizer, etc.) since this may impair proper mirror performance.**

One important safety feature is that the mirror automatically returns to the normal position whenever the vehicle is placed in R (Reverse) (when the mirror is in the ON position). This feature ensures a bright clear view in the mirror when backing up.

## Sun Visors

### Turning on the Mirror Light on the Sun Visors (If equipped)

To turn on the visor mirror light, lift the mirror cover.

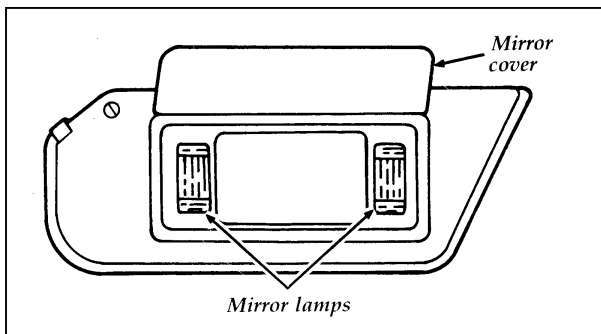

The mirror on the sun visor

## Doors

Two map pockets are provided on the panels of the front doors.

### Childproof Locks for the Rear Doors

In addition to power locks, your vehicle has childproof locks for the rear doors. If you set these locks, the rear doors cannot be opened from the inside of the vehicle. The doors can still be opened from the outside when the lock knobs are raised.

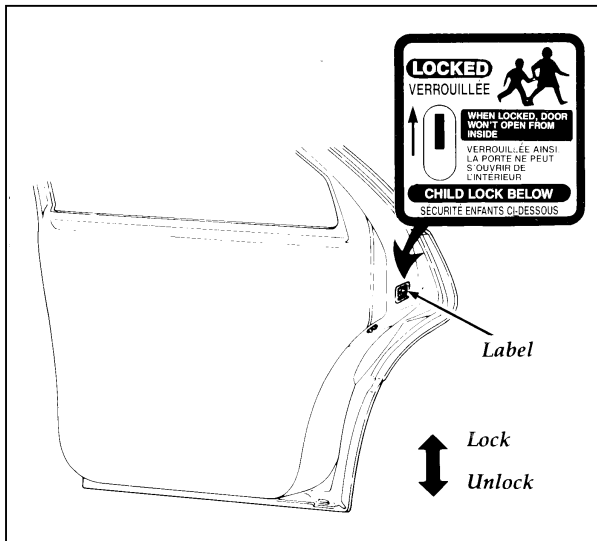

#### The childproof locks for the rear doors

To set the childproof lock on each rear door, open the rear door.

Find the lever inside the label with the word LOCKED. Move the lever up.

To release the childproof lock, open the rear door from the outside and move the lever down.

Move the lever down.



## Power Door Locks (If equipped)

If your vehicle has power door locks, the controls to lock the doors are on the trim panel of the front door. When you close the doors after you set the door locks, the doors remain locked. If the power mechanism fails, the manual door locks will override the power controls. Pulling on a front inside door handle will automatically override and release the front door lock.

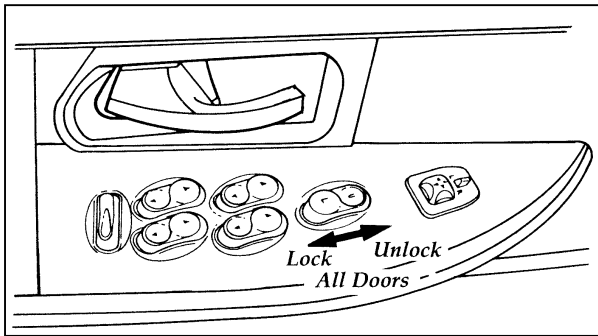

The power locks on the driver's door

## Using the Illuminated Entry System

The interior lights will illuminate for approximately 25 seconds on vehicles without the keyless entry system

- when the outside driver door handle is lifted
- when the front passenger door handle is lifted

and on vehicles with the keyless entry system

- when any button on the keyless entry pad is pushed
- when the remote entry system UNLOCK button is pressed.

If the Autolamp is turned to the on position and the amount of light outside is below a predetermined level, the exterior lamps will also illuminate.

## Windows

### Using the Power Windows

Each door has a power control that opens and closes the window on that door. The driver's door has a master control panel that operates all four windows.

Power windows can only be opened or closed when the ignition switch is in the ON or ACC position.

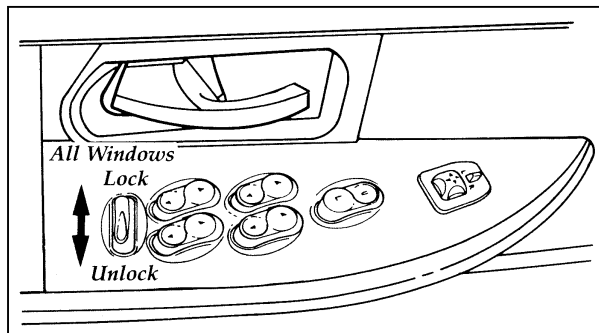

The master controls on the driver's door

To lock out all window switches except the master controls, press the right side of the window lock switch. To restore control to the individual windows, press the left side of the switch.

There is also an Express Down feature on the driver's power window.

To operate, briefly press the driver's window switch to the down position. The window will then open automatically. To stop automatic operation, briefly press the switch again to either the up or down position. More than a quick press of the switch provides conventional power window operation. Closing of the power window is conventional operation only.

## **Adjusting the Dual Electric Remote Control Mirrors**

Your vehicle is equipped with electric remote control side view mirrors; the switch for controlling their operation is a control knob in the armrest.

Do not clean the housing or glass of any mirror with harsh abrasives, fuel or other petroleum-based cleaning products.

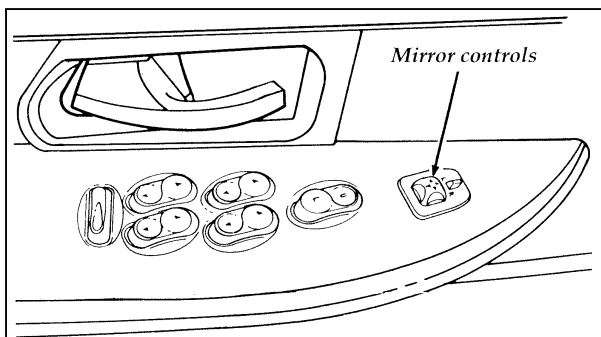

**The mirror controls on the driver's left armrest**

To adjust the side mirrors:

1. Find the control switch in the driver's door panel.
2. Select the right or left mirror by moving the selector switch to R or L.
3. Move the knob in the direction of the arrows for the direction you want to move the mirror.
4. Return the selector switch to the middle position to keep the mirror in place.

### **The Right Side Convex Mirror**

The side view mirror on the right is a convex mirror. This mirror gives you a wider view of the lanes on your right and behind you.

 <b>WARNING</b>
<b>The right side view mirror makes objects appear smaller and farther away than they actually are.</b>

### **Positive Location Floor Mat**

When installing or removing the driver's side floor mat you must attach/detach the positive location grommet from the hook on the floor. The hook is just forward of the center of the driver's seat. This is done by rotating the grommet one quarter turn, slipping the eyelet onto the hook, and sliding it to the floor.

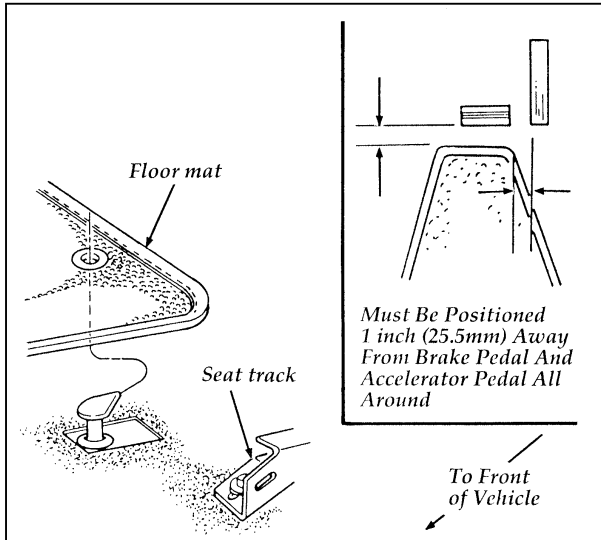

The positive location floor mat hook

## Trunk

### Opening the Trunk Manually

The trunk in your vehicle gives you plenty of room for storage — 20.6 cubic feet (.58 cubic meters).

To open and close the trunk from the outside:

1. Insert the key into the lock on the trunk.
2. Turn the key to the right until the trunk opens.
3. Remove the key before you close and lock the lid.
4. Shut the trunk lid completely.

## Keyless Entry System (If equipped)

If your vehicle has the keyless entry system, you can lock or unlock the vehicle doors and trunk without using a key. The buttons for the system are above the outside door handle on the driver's side.

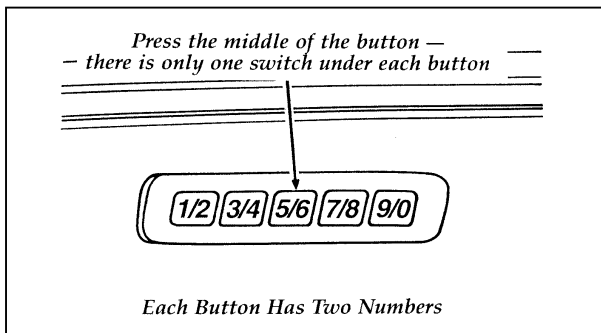

### The keyless entry buttons

When you bought your vehicle, you were given a computer code that operates the system for your vehicle. For your convenience, we have duplicated this code in two places.

The code is:

- on your owner's wallet card found in the glove compartment
- taped to the underside of the trunk lid

When you use this entry system, the illuminated entry system turns on the interior lights for 25 seconds and the buttons on the keypad light up. Do not push the buttons with a key, ballpoint pen, pencil, or any other hard object. These objects could damage the buttons.

## **Unlocking the Doors with the Keyless Entry System**

You must unlock the driver's door before you unlock any of the other doors or trunk. If you let more than five seconds pass between pressing numbers, the system shuts down, and you have to enter the code again. The system has shut down if the keypad light is out. If the keyless entry system does not work properly, use the key or transmitter(s) to lock and unlock the doors or unlock the trunk.

1. To unlock the driver's door, enter the factory code or your personal code. All codes have five numbers. After you press the fifth number, the driver's door unlocks.
2. To unlock the passenger's door, press the 3/4 button within five seconds of unlocking the driver's door or trunk, or re-enter the code to open the driver's door, then press 3/4.
3. To unlock the trunk, press the 5/6 button within five seconds of unlocking the driver's or passenger's doors, or re-enter the code to open the driver's door, then press 5/6.

As long as the driver's door has been unlocked first, you can open the passenger door or the trunk in any order.

## **Locking the Doors with the Keyless Entry System**

Along with unlocking your doors, you can use the keyless entry system to lock the doors. You can also use the Autolock feature to automatically lock the doors after you get in the vehicle.

To lock all of the vehicle's doors at the same time, press 7/8 and 9/0 at the same time. It is not necessary to first enter the keypad code.

## **Autolock (With Keyless Entry if Equipped)**

The Autolock feature will automatically lock all the doors when:

- the vehicle doors are fully closed
- the ignition key is turned to the ON position
- someone is sitting in the driver's seat or a heavy object is placed on the seat, and
- the vehicle is in any forward or reverse gear.

The Autolock feature will repeat when:

- the ignition key remains in the ON position
- someone remains sitting in the driver's seat or a heavy object is on the seat
- a door is opened and then closed
- the vehicle is in any forward or reverse gear.

If you do not want to use the Autolock feature, it can be deactivated by using the buttons for the keyless entry system.

To deactivate the Autolock feature:

1. Enter your permanent five-digit entry code (not the user code you may have set).
2. Within 5 seconds, press and hold 7/8.
3. Within 5 more seconds, press and release 3/4.
4. Release 7/8.

To reactivate the Autolock feature, simply repeat the instructions for deactivating the system. The Autolock feature can be turned on and off using the instructions above.



## **Programming Your Own Entry Code**

You can program a personal code to unlock your vehicle. This code does not replace the permanent code that the dealership gave you. Use your personal code in the same manner as you would your original code.

To program your own code:

1. Select five digits for your personal code.
2. Enter the permanent code that the dealership gave you.
3. Within five seconds, press 1/2.
4. Within five seconds of pressing 1/2, enter your personal code, pressing each digit within five seconds of the previous digit.
5. Five seconds after you press the fifth digit, your door lock system will lock and unlock the vehicle doors to confirm successful programming.

The keyless entry system registers this second code. To open your vehicle, you can now use either code. The module remembers only one personal code at a time. Entering a second personal code will erase the first, replacing it with the new second one.

To erase your personal code:

1. Enter the original permanent code.
2. Press and release 1/2 within five seconds of Step 1.
3. Press the 1/2 button a second time and hold for two seconds.

The keyless entry system automatically erases your personal code. The system will now only respond to the permanent code.

Do not set a code that presents the numbers in sequential order, such as 1/2, 3/4, 5/6, 7/8, 9/0. Studies show that people who idly press the buttons usually press a sequential pattern. Also, do not select a code that uses the same button five times. Thieves can easily figure out these types of codes.

Your door lock system will lock and unlock the vehicle doors to confirm successful erasure. The system will now only respond to the permanent code.

### **Battery Saver**

When the ignition is turned off, the vehicle will turn off battery voltage to the vehicle lamps as follows:

- Courtesy lights (lights which come on when a door is opened): after 10 minutes.
- Map/Glove compartment/Trunk/Hood lamps: after 30 minutes.
- Headlamps/Park lamps (only if headlamp switch is left in Headlamp position): after 10 minutes.

This will prevent draining of the battery if those lights have been left on inadvertently or if a door is not completely closed. Battery voltage to these lamps will be restored when the keyless entry keypad is used, the remote entry transmitter is used, any door is opened, the trunk is opened, or the ignition key is turned to the ON position.

## **Remote Entry System (If equipped)**

If your vehicle has the remote entry system, you can lock and unlock the vehicle doors and open the trunk without using a key. The remote also has a personal alarm feature. The controls for the system are located on the hand held transmitter(s) that came with your vehicle.

The system will work with up to four transmitters. Your vehicle came with two transmitters. Additional transmitters can be ordered from your dealer.

The remote entry features only operate with the transmission in P (Park) or N (Neutral).

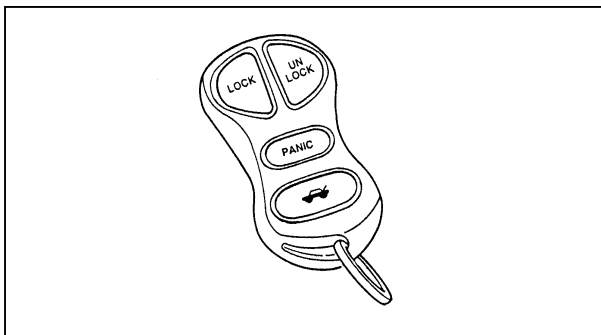

**Remote entry transmitter**

### **Unlocking the doors and opening the trunk**

To unlock the driver's door, press the UNLOCK control.

To unlock the other doors, press the UNLOCK control a second time within five seconds of unlocking the driver's door.

To open the trunk, press the TRUNK control.

To open the trunk, press the TRUNK control twice within five seconds.

### **Locking the doors**

To lock all the doors, press the LOCK control.

The doors will lock and the horn will chirp to indicate the vehicle is locked.

The door lock Horn Chirp is a programmable feature. To deactivate the Horn Chirp feature:

1. Enter your permanent five-digit code (not the user code you may have set).
2. Within five seconds, press and hold 7/8.
3. Within five more seconds, press and release 1/2.
4. Release 7/8.

To reactivate the Horn Chirp feature, simply repeat the instructions for deactivating the feature.

### **Activating the remote personal alarm**

If you wish to activate the remote personal alarm, press the PANIC control. This will honk the horn and flash the parking lamps and tail lamps for approximately two minutes and forty-five seconds. You can turn it OFF by pressing the PANIC control again or by turning the ignition key to the RUN position.

When you use the remote entry UNLOCK, TRUNK or PANIC controls, the illuminated entry system turns on the interior lights for 25 seconds. You can turn these lights off with the LOCK control or by turning the ignition to the

RUN position. The interior lights will not turn off if you have turned them on manually or if a door is open.

### **Replacing the batteries**

The remote entry transmitter is powered by two coin type three-volt lithium 1616 batteries (included) that should last for several years of normal use. If you notice a significant decrease in operating range, the batteries should be replaced. Replacement batteries can be purchased at most pharmacies, watch stores or at your Ford or Lincoln-Mercury dealer.

**NOTE: The operating range of the remote entry system can also be affected by weather conditions (such as very cold temperatures) or structures around the vehicle (buildings, other vehicles, radio and TV towers, etc.). Typical operating range will allow you to be up to 33 feet (10 meters) away from your vehicle.**

### **Replacement/additional transmitters**

In the event a transmitter is lost, a new one may be purchased from your dealer.

To program replacement or additional transmitters you must have all the transmitters intended for use on your vehicle.

Initiating the following procedure erases all prior programmed transmitters, thus ALL must be reprogrammed at the same time.

1. Enter the factory keyless entry code. Your personal code will not allow programming.
2. Press the 1/2 button.

3. Press one button on each of the transmitters to be programmed. Each transmitter button must be pressed within seven (7) seconds of the prior one. Each time a transmitter is successfully programmed, all of the vehicle doors will lock and then unlock to verify programming. If the doors did not lock/unlock, your transmitter was not programmed.

Additional transmitters may be purchased from your dealer (remote entry system will work with up to four transmitters). Follow the same programming procedure as above.

**THIS DEVICE COMPLIES WITH PART 15 OF THE FCC RULES. OPERATION IS SUBJECT TO THE FOLLOWING TWO CONDITIONS: (1) THIS DEVICE MAY NOT CAUSE HARMFUL INTERFERENCE, AND (2) THIS DEVICE MUST ACCEPT ANY INTERFERENCE RECEIVED, INCLUDING INTERFERENCE THAT MAY CAUSE UNDESIRED OPERATION.**

**NOTE: All transmitters to be used on your vehicle must be programmed/reprogrammed at the same time.**

---

# Seating and Safety Restraints

---

## Seats

### Head Restraints

If you use them properly, head restraints will help protect your head and neck in a collision.

A head restraint helps protect you best if you position it behind your head and not behind your neck.

#### ***Standard head restraints***

You can adjust the head restraints for your comfort and protection.

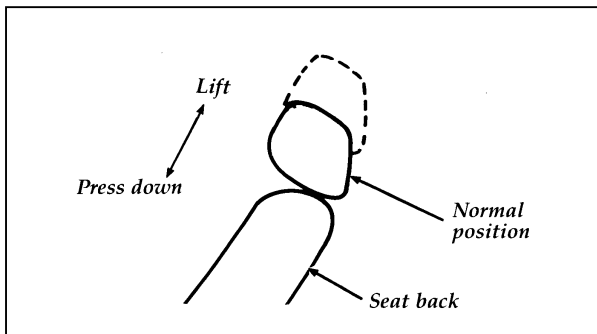

Adjusting the head restraint

## Adjusting the Front Passenger Seat Manually

In the front seats, you can move the whole seat forward or backward or tilt the back of the seat forward or backward.

To move the seat forward or backward:

1. Find the adjustment bar underneath the front part of the seat.
2. Lift the bar to unlatch the seat.
3. Move the seat to the desired position.
4. Release the bar to latch the seat in its new position. Make sure the seat locks securely in place.

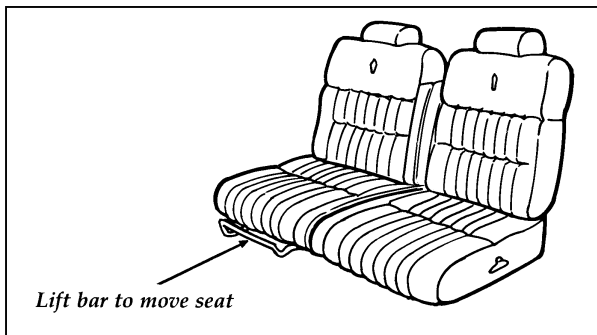

The front seat adjustment bar



To recline the front seat:

1. On the side of the seat, find the handle for the recliner.
2. Lift the handle up and hold it in place.
3. Lean against the back of the seat and adjust it to the position you want. You can tilt the seat back or bring it forward.
4. Release the handle to lock the seat in its new position.

**WARNING**

**Never adjust the driver's seat or seatback when the vehicle is moving.**

**WARNING**

**Always drive and ride with your seatback upright and the lap belt snug and low across the hips.**

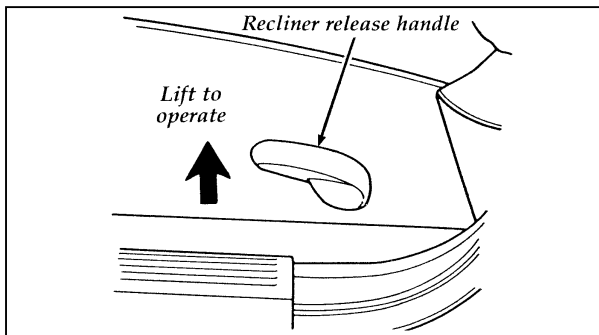

**The seatback recliner handle**

## Using the Power Seats (If equipped)

If your vehicle has power seats, you can adjust them in several directions. The controls are located on the driver and passenger door trim panels or on the side of the driver's seat.

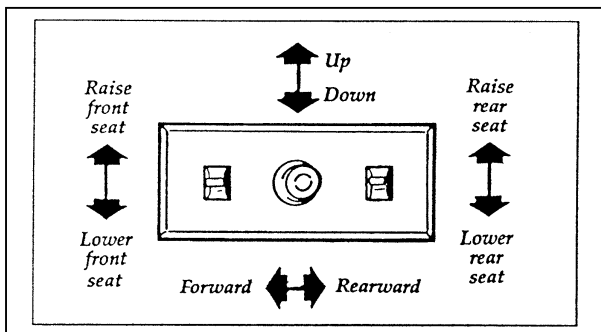

The power seat controls on the driver's seat — Base models

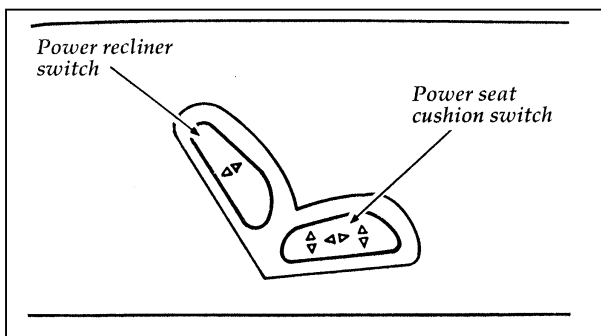

The power seat controls on the driver's door trim panel

### Power Seat Recliner/Lumbar Option

The arrows on the power seat control panel indicate the direction the seat or seatback will move. To adjust the seat or seatback move the control knob in the desired direction.

The power lumbar switch controls the inflation of the lumbar support pad in the seatback. To inflate the lumbar pad, push the forward portion

of the switch. To deflate the pad, press the rear portion of the switch.

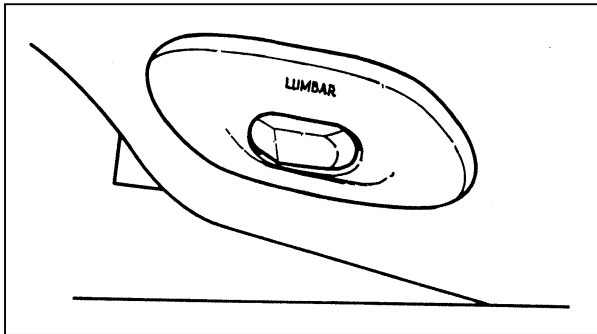

The power lumbar switch

## Important Safety Belt Information

The use of safety belts helps to restrain you and your passengers in case of a collision. In most states and in Canada, the law requires their use.

Safety belts provide best restraint when:

- the seatback is upright
- the occupant is sitting upright (not slouched)
- the lap belt is snug and low on the hips
- the shoulder belt is snug against the chest
- the knees are straight forward

To help you remember to fasten your safety belt, a warning light may come on and a chime may sound. See *Safety Belt Warning Light and Chime* in the *Instrumentation* chapter.

See the following sections in this chapter for directions on how to properly use these safety belts. Also see *Safety Restraints for Children* in this chapter for special instructions about using safety belts for children.

**WARNING**

**It is extremely dangerous to ride in a cargo area, inside or outside of a vehicle. In a collision, people riding in these areas are more likely to be seriously injured or killed. Do not allow people to ride in any area of your vehicle that is not equipped with seats and safety belts. Be sure everyone in your vehicle is in a seat and using a safety belt properly.**

**WARNING**

**Always drive and ride with your seatback upright and the lap belt snug and low across the hips.**

**WARNING**

**Ford recommends that all safety belt assemblies and attaching hardware should be inspected by a qualified technician after any collision. Safety belt assemblies not in use during a collision should also be inspected and replaced if either damage or improper operation is noted.**

**WARNING**

**Children should always ride with the seatback in the fully upright position.**

<b>WARNING</b>
----------------

<b>Never let a passenger hold a child on his or her lap while the vehicle is moving. The passenger cannot protect the child from injury in a collision.</b>
---

<b>WARNING</b>
----------------

<b>Lock the doors of your vehicle before driving to lessen the risk of the door coming open in a collision.</b>
---

## **Combination Lap and Shoulder Belts**

While your vehicle is in motion, the combination lap and shoulder belt adjusts to your movement. However, if you brake hard, corner hard or if your vehicle receives an impact of 5 mph (8 km/h) or more, the lap and shoulder belt locks and helps reduce your forward movement.

After you get into your vehicle, close the door and lock it. Then adjust the seat to the position that suits you best.

**To fasten the belt**, pull the lap/shoulder belt from the retractor so that the shoulder portion of the belt crosses your shoulder and chest. Be sure the belt is not twisted. If it is, remove the twist. Insert the belt tongue into the proper buckle until you hear a snap and feel it latch. Make sure the tongue is securely fastened in the buckle.

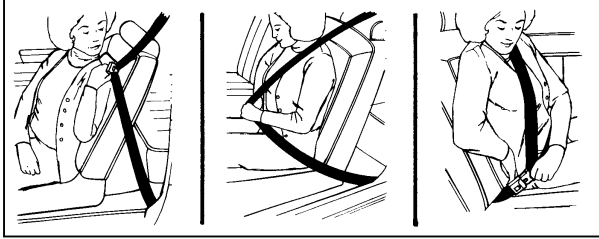

**Fastening the front seat combination lap and shoulder belt**



**Fastening the rear seat combination lap and shoulder belt**

**NOTE:** Be sure to read and understand *Important Safety Belt Information* in this chapter.

### **Safety Belts for All Passenger Outboard Seating Positions**

Your vehicle is equipped with a dual locking mode retractor on the shoulder belt portion of the combination lap/shoulder safety belt for the front and rear outboard passenger seats.

**Dual locking mode retractors operate in two ways:**

***Vehicle sensitive (emergency) locking mode***

In this operating mode, the shoulder belt retractor will allow the occupant freedom of movement, locking tight only on hard braking, hard cornering or impacts of approximately 5 mph (8 km/h) or more.

***Automatic locking mode***

In this operating mode, the shoulder belt retractor will be automatically locked and remain locked when the combination lap/shoulder safety belt is buckled, and does not allow the occupant freedom of movement. This mode provides the following:

- A tight lap/shoulder belt fit on the occupant.
- Child seat or infant carrier installation restraint.

<b>WARNING</b>
<b>Rear-facing child seats or infant carriers should never be placed in the front seats.</b>

This mode **must be used** when installing a child safety seat on the front passenger seat and rear outboard seats where dual locking retractors are provided.

To switch the retractor from the emergency locking mode to the automatic locking mode, perform the following steps:

1. Buckle the lap/shoulder combination belt.
2. Grasp the shoulder portion of the belt and pull downward until all of the belt is extracted and, when allowed to retract, a clicking sound is heard. At this time, the belt retractor is in the automatic locking mode (child restraint mode).
3. A clicking sound will continue to be heard as the belt is allowed to retract.

**NOTE: When the combination lap/shoulder belt is unbuckled and allowed to retract completely, the retractor will switch back to the vehicle sensitive (emergency) locking mode. See the detailed instructions under *Safety Seats for Children* in this chapter.**

## **Shoulder Belt Height Adjustment**

### ***Driver and right front passenger***

You can adjust the shoulder belt height to one of five (5) positions. To adjust, pinch the release button (see Figures 1 and 2) and slide it up or down until the belt rests across the middle of your shoulder. Release the button and make sure the adjuster is firmly in one of the five (5) positions.

<b>WARNING</b>
<b>If the shoulder belt is off your shoulder or on your upper arm, there is a greater risk of severe injury in a collision.</b>



**BE SURE THE BELT IS PROPERLY POSITIONED ON YOUR SHOULDER EACH TIME YOU USE THE BELT.**

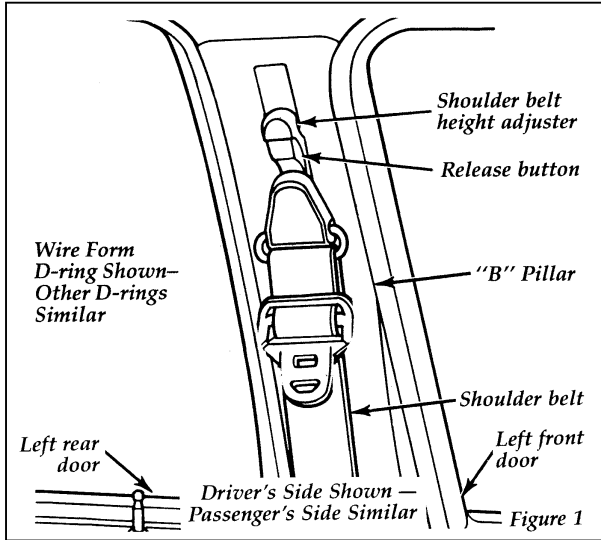

**The shoulder belt height adjuster**

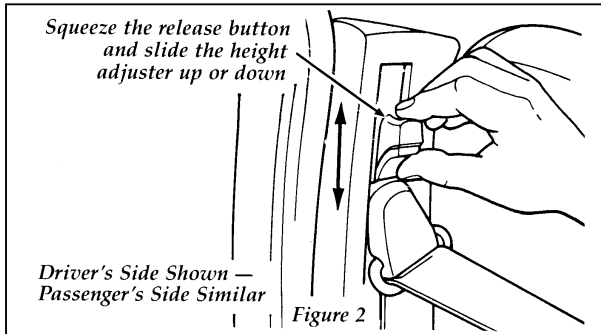

**The shoulder belt height adjuster**

**WARNING**

**The lap belts should fit snugly and as low as possible around the hips, not around the waist.**

**WARNING**

**Front and rear seat occupants, including pregnant women, should wear safety belts for optimum protection in an accident.**

**WARNING**

**Each seating position in your vehicle has a specific safety belt assembly which is made up of one buckle and one tongue that are designed to be used as a pair. 1) Use the shoulder belt on the outside shoulder only. Never wear the shoulder belt under the arm. 2) Never swing it around your neck over the inside shoulder. 3) Never use a single belt for more than one person.**

**To unfasten all the belts:**

1. Push the release button in the center of the buckle. This allows the tongue to unlatch from the buckle.

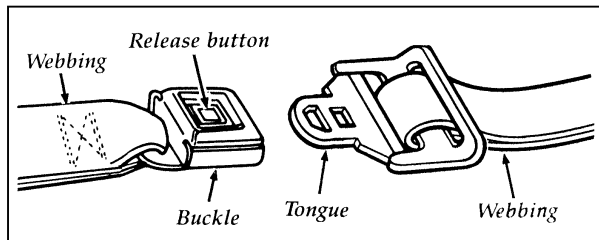

**Unfastening the outboard lap/shoulder belts**

2. While the belt retracts, guide the tongue to its stowed position. If you do not guide the tongue, it may strike you or part of the vehicle.

## **Lap Belts — Center Seating Positions**

The lap belts in the center of the front and rear seats do not adjust automatically. You must adjust them to fit snugly and as low as possible around your hips. Do not wear them around your waist.

Pull the belt across your hips and **insert the tongue into the correct buckle** on your seat until you hear a snap and feel it lock. Make sure the buckle is securely fastened.

If you need to lengthen the belt, unfasten it and tip the belt tongue at a right angle to the belt. Pull the belt tongue over your lap until it reaches the buckle.

If you need to shorten the belt, pull on the loose end of the webbing until the belt fits snugly.

**To unfasten the belt**, push the release button on the buckle. This allows the tongue to unlatch from the buckle.

Because the center lap belts do not have retractors, they should be shortened and fastened when not in use.

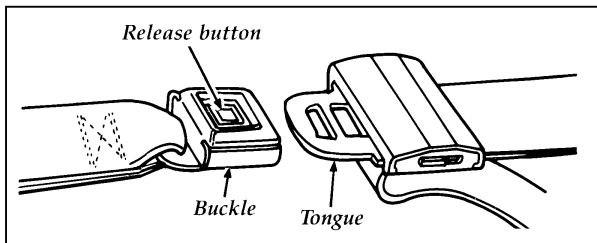

Unfastening center lap safety belts

### **Safety Belt Extension Assembly**

For some people, the safety belt may be too short even when it is fully extended. You can add about eight inches (20 cm) to the belt length with a safety belt extension assembly (part number 611C22). Safety belt extensions are available at no cost from your dealer.

#### **WARNING**

**Failure to follow these instructions will affect the performance of the safety belts and increase the risk of personal injury.**

Use only extensions manufactured by the same supplier as the safety belt. Manufacturer identification is located at the end of the webbing on the label. Also, use the safety belt extension only if the safety belt is too short for you when fully extended. Do not use extension to change the fit of the shoulder belt across the torso.

## **Safety Belt Maintenance**

Check the safety belt systems periodically to make sure that they work properly and are not damaged.

All safety belt assemblies, including retractors, buckles, front seat belt buckle support assemblies (slide bar) (if equipped), shoulder belt height adjusters (if equipped), child safety seat tether bracket assemblies (if equipped), and attaching hardware, should be inspected after any collision. Ford recommends that all safety belt assemblies used in vehicles involved in a collision be replaced. However, if the collision was minor and a qualified technician finds that the belts do not show damage and continue to operate properly, they do not need to be replaced. Safety belt assemblies not in use during a collision should also be inspected and replaced if either damage or improper operation is noted.

## **Air Bag Supplemental Restraint System (SRS)**

### **Important Air Bag Precautions**

Your vehicle is equipped with a supplemental restraint system designed to work with the safety belts to help protect you and your right front seat passenger in the event of a collision. The Air Bag Supplemental Restraint System is primarily designed to reduce certain upper body injuries.

**WARNING**

**All occupants of the vehicle, including the driver, should always wear their safety belts, failure to do so may increase the risk of personal injury in the event of a collision.**

**WARNING**

**The right front passenger air bag is not designed to restrain occupants in the center front seating position.**

**WARNING**

**Do not place objects or mount equipment on or near the air bag covers that may come into contact with an inflating air bag. Failure to follow these instructions may increase the risk of personal injury in the event of a collision.**

**WARNING**

**Do not attempt to service, repair, or modify the air bag Supplemental Restraint System or its fuses. See your Ford or Lincoln-Mercury dealer.**

**WARNING**

**If you are close to an inflating air bag, it could seriously injure you. Position your seat such that it is as far back from the steering wheel as possible but still allows you to properly control the vehicle.**

## Children and Air Bags

**NOTE:** For additional important safety information on the proper use of seat belts, child seats, and infant seats, please read the entire Safety Restraints chapter in this owner guide.

<b>WARNING</b>
<b>Children should always wear their safety belts. Failure to follow these instructions may increase the risk of personal injury in the event of a collision.</b>

<b>WARNING</b>
<b>Rear-facing child seats and infant carriers should never be placed in the front seats.</b>

### How Does the Air Bag Supplemental Restraint System Work?

The Air Bag Supplemental Restraint System is designed to activate when the vehicle is in a collision similar to hitting a fixed barrier head on at 8-14 mph (13-23 km/h). The fact that the air bags did not inflate in a collision does not mean that something is wrong with the system. Rather, it means the forces were not of the type sufficient to cause activation.

If the vehicle is in a moderate or severe frontal collision, the system is activated and the air bags inflate rapidly. After the air bag inflates, it will quickly deflate. After the air bag deployment, you may notice a smoke-like, powdery residue or smell the burnt propellant. This is normal. The residue may consist of cornstarch or talcum powder (which is used to lubricate the air bag) or sodium compounds, such as sodium carbonates (e.g. baking soda) that result from the

combustion process that inflates the air bag. Small amounts of sodium hydroxide may be present which may irritate the skin and eyes, but none of the residue is toxic. The Air Bag Supplemental Restraint System will reduce, but not eliminate all injuries in an accident.

**WARNING**

**Several air bag system components get hot after inflation. Do not try to touch them after inflation.**

**WARNING**

**The air bag will inflate only once. The system is designed to function on a one-time-only basis. If the air bag is inflated, THE AIR BAG WILL NOT FUNCTION AGAIN AND MUST BE REPLACED IMMEDIATELY. If the air bag is not replaced, this will increase the risk of injury in a subsequent collision.**

The Air Bag Supplemental Restraint System consists of:

- driver and passenger air bag modules (which include the inflators and air bags),
- one or more impact and safing sensors,
- a system diagnostic module,
- a readiness light and tone,
- and the electrical wiring which connects the components.

The diagnostic module monitors its own circuits, the air bag electrical system, the air bag readiness light, the air bag power, and the air bag inflators.



## **Determining if System Is Operational**

The Air Bag Supplemental Restraint System uses a readiness light and a tone to indicate the condition of the system. The readiness light is in the instrument cluster. When you turn the ignition key to ON, this light will illuminate for approximately six (6) seconds and then turn off. This indicates that the system is operating normally. NOTE: Routine maintenance of the air bag system is not required.

A problem with the system is indicated by one or more of the following:

- the readiness light will either flash or stay lit,
- the readiness light will not light immediately after ignition is turned on,
- a group of five beeps will be heard. The tone pattern will repeat periodically until the problem and light are repaired.

If any of these things happen, even intermittently, have the Air Bag Supplemental Restraint System serviced at your Ford or Lincoln-Mercury dealer immediately. Unless serviced, the system may not function properly in the event of a collision.

## **Disposal of Air Bags and Air Bag Equipped Vehicles**

For disposal of air bags or air bag equipped vehicles, see your local Ford or Lincoln-Mercury dealer. Air bags **MUST BE** disposed of by qualified personnel.

## Safety Restraints for Children

In the U.S. and Canada, you are required by law to use safety restraints for children. If small children ride in your vehicle — this generally includes children who are four years old or younger and who weigh 40 pounds (18 kg) or less — you must put them in safety seats that are made specially for children. Safety belts alone do not provide maximum protection for these children. Check your local and state laws for specific requirements.

WARNING
<b>Never let a passenger hold a child on his or her lap while the vehicle is moving. The passenger cannot protect the child from injury in a collision.</b>

WARNING
<b>Cargo should always be secured to prevent it from shifting and causing damage to the vehicle or harm to passengers.</b>

When possible, put children in the rear seat of your vehicle. Accident statistics suggest that children are safer when properly restrained in the rear seating positions than in the front seating positions.

WARNING
<b>Carefully follow all of the manufacturer's instructions included with the safety seat you put in your vehicle. If you do not install and use the safety seat properly, the child may be injured in a sudden stop or collision.</b>

**WARNING**

**Safety belts and seats can become hot in a vehicle that has been closed up in sunny weather; they could burn a small child. Check seat covers and buckles before you place a child anywhere near them.**

**WARNING**

**Do not leave children, unreliable adults, or pets unattended in your vehicle.**

**WARNING**

**When using forward-facing child seats move the passenger seat as far back from the instrument panel as possible. Never secure rear-facing child seats or infant carriers in the front seat.**

### **Safety Seats for Children**

Use a safety seat that is recommended for the size and weight of the child. Always follow the safety seat manufacturer's instructions when installing and using the safety seat.

When installing a child safety seat, be sure to use the correct safety belt buckle for that seating position, and make sure the tongue is securely fastened in the buckle. For a shoulder/lap belt combination with a sliding tongue, make sure the retractor is in the automatic locking mode.

Children weighing less than 40 lbs. (18 kg) should use child or infant seats. Forward facing child seats must have the passenger seat moved as far back from the instrument panel as possible.

**WARNING**

**Rear-facing child seats or infant carriers should never be placed in the front seats.**

All child restraint systems are designed to be secured in vehicle seats by lap belts or by the lap portion of a lap-shoulder belt.

**WARNING**

**If you do not properly secure the safety seat, the child occupying the seat may be injured during a collision or sudden stop. An unsecured safety seat could also injure other passengers.**

**WARNING**

**Carefully follow all of the manufacturer's instructions included with the safety seat you put in your vehicle. If you do not install and use the safety seat properly, the child may be injured in a sudden stop or collision.**

### **Installing Safety Seats in the Front and Rear Outboard Passenger Seating Positions**

For seating positions equipped with a dual locking mode retractor, use the following procedure.

If you choose to install a forward-facing child safety seat in the front seating positions, move vehicle seat as far back as possible.

1. Position the child seat in the center of the passenger seating position.
2. Pull down on shoulder belt, then grasp shoulder belt and lap belt together. See Figure 1.

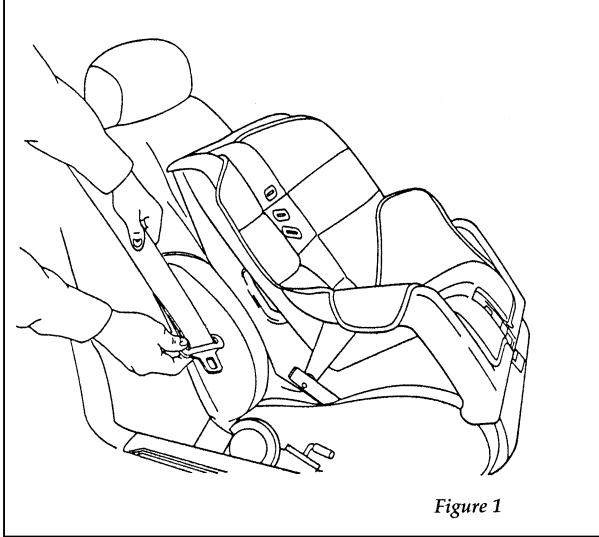

*Figure 1*

**Pulling out belt webbing**

3. While holding the shoulder and lap belt portions together, route the tongue through the child seat according to the child seat manufacturer's instructions. See Figure 2. Be sure that the belt webbing is not twisted.

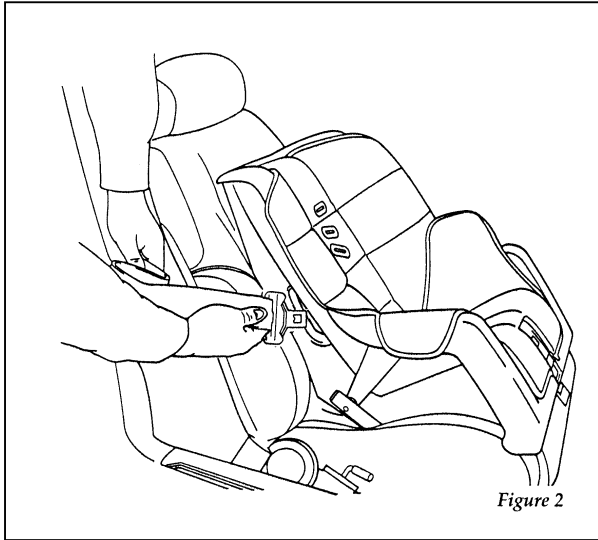

**Routing the lap/shoulder belt**

4. Insert the belt tongue into the buckle for that seating position until you hear and feel the latch engage. See Figure 3. Make sure tongue is latched securely to buckle by pulling on tongue.

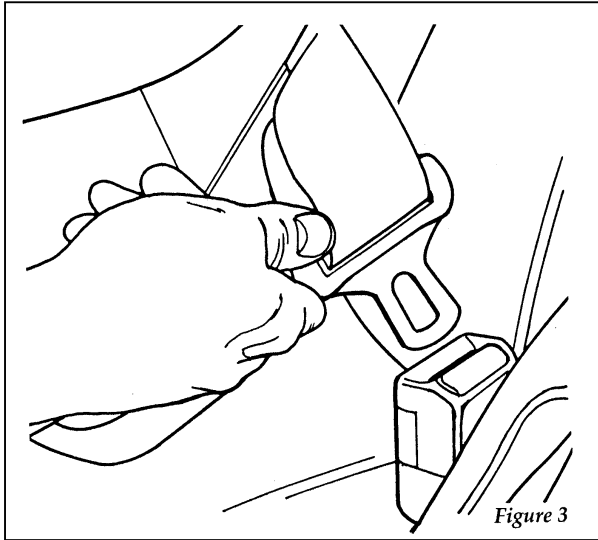

**Buckling the belt**

5. Grasp the shoulder portion of the belt and pull downward until all of the belt is extracted and a click is heard. At this time, the retractor is in the automatic locking mode (child seat restraint mode). See Figure 4.

**NOTE: The dual-locking mode retractor must be in the automatic locking mode to properly restrain a child.**

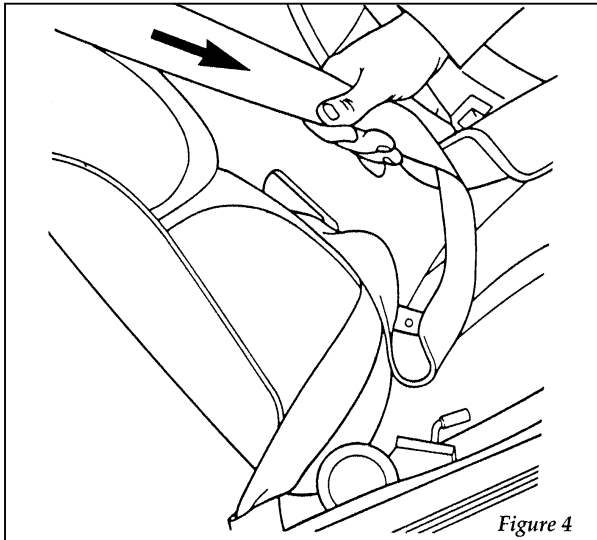

*Figure 4*

**Setting the retractor to automatic locking mode**

6. Allow the belt to retract. Pull up on the shoulder webbing. A clicking sound will be heard as the belt retracts. This indicates the retractor is in the automatic locking mode. Push down on the child seat while you pull up on the belt to remove any slack in the belt. See Figures 5 and 6.



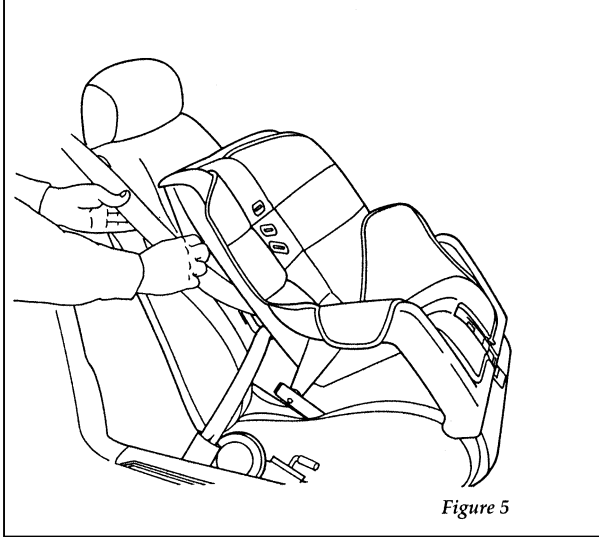

Figure 5

**Allowing shoulder belt to retract**



Figure 6

**Removing slack from belt**

7. Before placing the child in the child seat, forcibly tilt the seat from side to side, and tug it forward to make sure that the seat is securely held in place. See Figure 7.

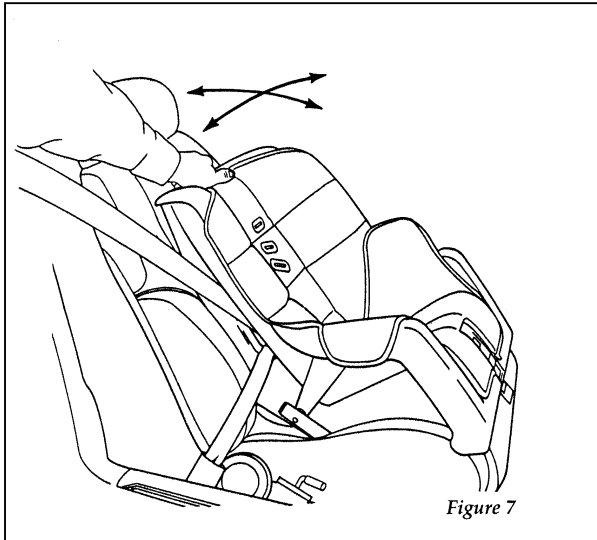

**Checking that the seat is secure**

8. Double check that the retractor is in the automatic locking mode. Try to pull more belt out of the retractor. If you cannot, the belt is in the automatic locking mode. See Figure 8.

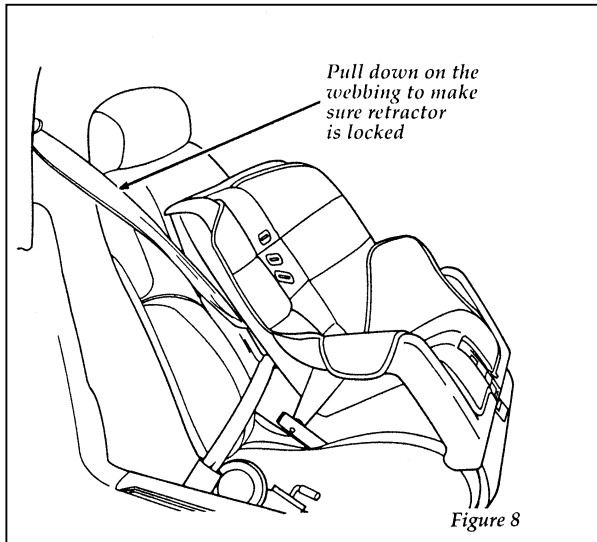

#### Checking the retractor

9. Check to make sure that the child seat is properly secured prior to each use. If the retractor is not locked, repeat steps 4 through 7.

## **Installing a Child Safety Seat at a Center Seating Position with Adjustable Lap Belt**

1. Lengthen the lap belt. To lengthen the belt, hold the tongue so that its bottom is perpendicular to the direction of webbing while sliding the tongue up the webbing.
2. Place the child safety seat in the center seating position.
3. Route the tongue and webbing through the child seat according to the child seat manufacturer's instructions.
4. Insert the belt tongue into the proper buckle for the center seating position until you hear a snap and feel it latch. Make sure the tongue is securely fastened to the buckle by pulling on tongue.
5. Push down on the child seat while pulling on the loose end of the lap belt webbing to tighten the belt.
6. Before placing the child into child seat, forcibly tilt the child seat from side-to-side and in forward direction to ensure that the seat is held securely in place. If the child seat moves excessively, repeat steps 5 through 6, or properly install the child seat in a different position.

## **Attaching Safety Seats with Tether Straps**

Some manufacturers make safety seats that include a tether strap that goes over the back of the vehicle seat and attaches to an anchoring point. Other manufacturers offer the tether strap as an accessory. Contact the manufacturer of your child safety seat for information about ordering a tether strap.

### ***Tether anchorage hardware***

Attachment holes (at each rear seating position) have been provided in your vehicle to attach anchor hardware, if required. Tether anchor hardware kits (Part number 613D74), including instructions, may be obtained at no charge from any Ford or Lincoln-Mercury dealer. All vehicles built for sale in Canada include a tether anchor hardware kit.

### **Safety Belts for Children**

Children who are too large for child safety seats should always wear safety belts. (See instructions with your child seat, or contact its manufacturer, to determine maximum size of child that will safely fit in the seat.)

<b>WARNING</b>
<b>If safety belts are not properly worn and adjusted as described, the risk of serious injury to the child in a collision will be much greater.</b>

If the shoulder belt portion of one of the lap and shoulder belts can be positioned so that it does not cross or rest in front of the child's face or neck, the child should wear the lap and shoulder belt. Moving the child closer to the center of the vehicle may help provide a good shoulder belt fit.

<b>WARNING</b>
<b>If the shoulder belt cannot be properly positioned, the child should sit in the center rear seat and use the lap belt or, if that seat is unavailable, in the center front seat and use the lap belt.</b>

To improve the fit of lap and shoulder belts on children who have outgrown child safety seats, Ford recommends use of a belt-positioning booster seat that is labelled as conforming to all Federal motor vehicle safety standards. Belt-positioning booster seats raise the child and provide a shorter, firmer seating cushion that encourages safer seating posture and better fit of lap and shoulder belts on the child. A belt-positioning booster should be used if the shoulder belt rests in front of the child's face or neck, or if the lap belt does not fit snugly on both thighs, or if the thighs are too short to let the child sit all the way back on the seat cushion when the lower legs hang over the edge of the seat cushion. You may wish to discuss the specific needs of your child with your pediatrician.

<b>WARNING</b>
----------------

<b>Do not use a belt-positioning booster with a lap-only belt.</b>
--

Lap belts and the lap belt portion of lap and shoulder belts should always be worn snugly and below the hips, touching the child's thighs.

<b>WARNING</b>
----------------

<b>Children should always ride with the seatback in the fully upright position.</b>
---

---

# Starting

---

## Fuel-Injected Engines

When starting a fuel-injected engine, **the most important thing to remember is to avoid pressing down on the accelerator before or during starting.** Only use the accelerator when you have problems getting your vehicle started. See *Starting Your Engine* in this chapter for details about when to use the accelerator while you start your vehicle.

## Starting Your Vehicle

### Preparing to Start Your Vehicle

 <b>WARNING</b>
--

<p><b>Do not start your vehicle in a closed garage or in other enclosed areas. Exhaust fumes can be toxic. Always open the garage door before you start the engine.</b></p>
---

Before you start your vehicle, do the following:

1. Make sure all occupants in the vehicle buckle their safety belts. See *Safety Restraints* in the Index for more details.
2. Make sure the headlamps and other accessories are turned off when starting.
3. Make sure that the gearshift is in P (Park) and the parking brake is set before you turn the key.

Before you start your vehicle, you should test the warning lights on the instrument panel to make sure that they work. Refer to the *Instrumentation* chapter.

## Starting Your Engine

To start your engine:

1. Follow the steps under *Preparing to Start Your Vehicle* at the beginning of this section.
2. Turn the ignition key to the ON position.
3. DO NOT depress the accelerator pedal when starting your engine. DO NOT use the accelerator while the vehicle is parked.
4. Turn the key to the START position (cranking) until the engine starts. Allow the key to return to the ON position after the engine has started.

If you have difficulty in turning the key, rotate the steering wheel slightly because it may be binding.

### For a cold engine:

- At temperatures **10°F (-12°C) and below**: If the engine does not start in **fifteen (15) seconds** on the first try, turn the key to OFF, wait approximately ten (10) seconds so you do not flood the engine, then try again.
- At temperatures **above 10°F (-12°C)**: If the engine does not start in **five (5) seconds** on the first try, turn the key to OFF, wait approximately ten (10) seconds so you do not flood the engine, then try again.



**For a warm engine:**

- Do not hold the key in the START position for more than **five (5) seconds** at a time. If the engine does not start within five (5) seconds on the first try, turn the key to the OFF position. Wait a few seconds after the starter stops, then try again.

Whenever you start your vehicle, release the key as soon as the engine starts. Excessive cranking could damage the starter.

After you start the engine, let it idle for a few seconds. Keep your foot on the brake pedal and put the gearshift lever in gear. Release the parking brake. Slowly release the brake pedal and drive away in the normal manner.

**NOTE: Your vehicle has an interlock that prevents you from shifting out of P (Park) unless your foot is on the brake pedal.**

**If the engine does not start after two attempts:**

1. Turn the ignition key to the OFF position.
2. Press the accelerator all the way to the floor and hold it.
3. Turn the ignition key to the START position.
4. Release the ignition key when the engine starts.
5. Release the accelerator gradually as the engine speeds up.

If the engine still does not start, the fuel pump shut-off switch may have been triggered. For directions on how to reset the switch see *Fuel Pump Shut-Off Switch* in the Index.

A computer system controls the engine's idle speed. When you start your vehicle, the engine's idle speed normally runs higher than when it's warmed up. These faster engine speeds will make your vehicle move slightly faster than its normal idle speed. It should, however, slow down after a short time. If it does not, have the idle speed checked.

If the engine idle speed does not slow down automatically, do not allow your vehicle to idle for more than 10 minutes. Have the vehicle checked.

**⚠️ WARNING**

**Extended idling at high engine speeds can produce very high temperatures in the engine and exhaust system, creating the risk of fire or other damage.**

**⚠️ WARNING**

**Do not park, idle, or drive your vehicle in dry grass or other dry ground cover. The emission system heats up the engine compartment and exhaust system, which can start a fire.**

If you consistently start your vehicle in subzero temperatures, use an engine block heater (if your vehicle has this option).

### **Engine Block Heater (If equipped)**

Engine block heaters are strongly recommended if you live in a region where temperatures reach -10°F (-23°C) or below. An engine block heater warms the engine coolant, which improves starting, warms up the engine faster, and allows the heater-defrost system to respond quickly.

To turn the heater on, simply plug it into a grounded 110-volt outlet. Ford recommends that you use a 110-volt circuit that is protected by a ground fault circuit interrupter.

**⚠ WARNING**

**To prevent electrical shock, do not use your heater with ungrounded electrical systems or two-pronged (cheater) adapters.**

For best results, plug the heater in at least three hours before you start your vehicle. Using the heater for longer than three hours will not damage the engine, so you can plug it in at night to start your vehicle the following morning.

**NOTE: Be sure to disconnect the engine block heater before driving your vehicle.**

## **Guarding Against Exhaust Fumes**

Carbon monoxide, although colorless and odorless, is present in exhaust fumes. Take precautions to avoid its dangerous effects.

**⚠ WARNING**

**Do not start your vehicle in a closed garage or in other enclosed areas. Exhaust fumes can be toxic. Always open the garage door before you start the engine.**

**⚠ WARNING**

**If you smell exhaust fumes inside your vehicle, have your dealer inspect your vehicle immediately. Do not drive if you smell exhaust fumes.**

Have the exhaust and body ventilation systems checked whenever:

- your vehicle is raised for service
- the sound of the exhaust system changes
- your vehicle has been damaged in a collision

Improve your ventilation by keeping all air inlet vents clear of snow, leaves, and other debris.

If the engine is idling while you are stopped in an open area for long periods of time, open the windows at least one inch (2.5 cm). Also, the heating or air conditioning system should be set to any function except MAX A/C or AUTO.

- If you use the heater, set the fan speed on MEDIUM or HIGH with the function control on any position except OFF and the temperature control at any desired position.
- If you use the air conditioner, set the fan speed on MEDIUM or HIGH with the function control on any position except OFF or MAX and the temperature control at any desired position.

## **Pushing**

Vehicles with automatic transmissions cannot be started by pushing. Follow the directions under *If Your Vehicle Needs a Jump-Start*.

---

# Driving

---

## Brakes

### Applying the Brakes

#### *Braking non ABS models*

Your vehicle has front and rear disc brakes with anti-lock (optional). They adjust automatically as the brake pads wear down.

Apply the brake pedal gradually. Use the “squeeze” technique — push on the brake pedal with a steadily increasing force. This allows the wheels to continue to roll while you are slowing down, which lets you steer properly.

On vehicles without anti-lock brakes, extreme braking can make the wheels lock and slide, possibly decreasing your control of the steering. If you lock the wheels, release the brake pedal and repeat the “squeeze” technique.

#### *Braking with ABS brakes*

On vehicles with anti-lock brakes, the wheels will not lock and slide when you press down hard on the brake pedal. The anti-lock brakes automatically start releasing and reapplying the front brakes independently and the rear brakes together whenever your wheels start to lock. Do not “pump” the brake pedal on vehicles equipped with anti-lock brakes. When this happens, you will feel the brake pedal pulse. This “pulse” may be an unfamiliar feeling but it is normal and indicates the ABS is working as designed.

Do not drive with your foot resting on the brake pedal; you will wear out the linings and increase your vehicle's stopping distance. Brake rotor damage may also eventually occur.

**NOTE: If you are driving down a long or steep hill, shift to a lower gear and do not apply your brakes continuously. If you apply your brakes continuously, they may overheat and become less effective.**

Occasional brake squeal during light to moderate stops does not affect the function of the brake system and is normal. However, if the squeal becomes louder or more frequent, have your brakes inspected by your dealer or a qualified service technician.

Ford Motor Company has not found any detrimental effects of popular mobile radio transmitting equipment installed on vehicles with the anti-lock brake system, if the equipment is installed according to the manufacturer's instructions. However, if mobile radio transmitting equipment is installed in your vehicle and, if either the anti-lock brake system cycles or the check anti-lock light comes on at any time other than right after you turn the key to ON or during a sudden stop, have your mobile radio dealer inspect the installation.

## Parking Brake

**The parking brake should be used whenever you park your vehicle.**

The parking brake pedal is suspended just below the bottom of the instrument panel to the left of the brake pedal.

To manually set the parking brake after parking your vehicle, apply the brake pedal with your right foot and hold it while you push the parking brake down firmly and fully with your left foot. The brake system warning light will glow. The parking brake will not set with the transmission in any forward gear position.

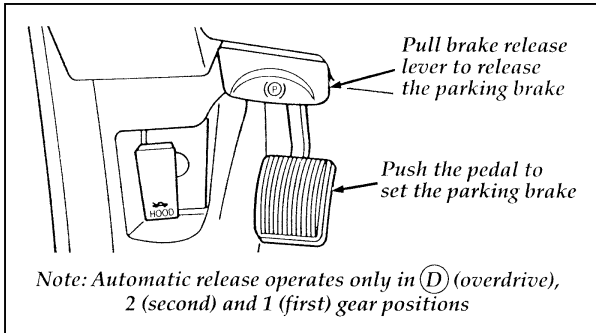

**The parking brake**

### **⚠ WARNING**

**Always set the parking brake fully and make sure the gearshift is latched in P (Park). Turn off the ignition whenever you leave your vehicle.**

Your vehicle has an automatic parking brake release. As you move the gearshift selector to any forward gear with the engine running, the parking brake automatically releases. Your parking brake will not release automatically

when you shift into R (Reverse). To release the parking brake manually, pull the brake release handle [marked (P)] located on the lower left corner of the instrument panel. The pedal is now released and will reset the next time you press the pedal. The Brake System Warning Light will glow if the parking brake is not fully released when the engine is running.

 **WARNING**

**To prevent personal injury, do not release the parking brake while outside the vehicle.**

Always check the Brake Warning Light each time you start your engine. Driving with the parking brake on will cause the brakes to wear out quickly and will reduce the fuel economy.

 **WARNING**

**If the parking brake is fully released, but the Brake System light remains on, have the brakes checked immediately. They may not be working properly.**

The parking brake system is designed for static parking only and is not designed to stop a moving vehicle, but you can use the parking brake to stop your vehicle in an emergency if the normal brakes fail. However, since the parking brake applies only the rear brakes, the stopping distance will increase greatly and the handling of your vehicle will be adversely affected.



## **Traction-Lok Axle (If equipped)**

This axle provides added traction on slippery surfaces, particularly when one wheel is on a poor traction surface. Under normal conditions the Traction-Lok axle functions as a standard rear axle.

Extended use of other than matching size tires on a Traction-Lok rear axle could result in a permanent reduction in effectiveness. This loss of effectiveness does not affect normal driving and should not be noticeable to the driver.

<b>⚠ WARNING</b>
------------------

<b>To avoid injury, never run the engine with one wheel off the ground, such as when changing a tire.</b>
---

## **Traction Assist™ (If equipped)**

Your vehicle may be equipped with the optional Traction Assist™ system. This system helps prevent wheel spin in order to improve tire traction and is an especially useful feature when you drive in hilly areas or on slippery, icy or snowy roads.

Traction Assist™ works automatically by rapidly applying and releasing the brakes to prevent one or both of the rear drive wheels from spinning during acceleration.

During the Traction Assist™ function, which most often occurs during low speed acceleration on slippery surfaces, a noise may be heard coming from the engine compartment. This noise is created by the ABS pump and is normal and may last for a few seconds during the acceleration of the vehicle.

In general, this system improves your vehicle's stability and acceleration performance when road conditions warrant. Traction Assist™ is fully effective up to approximately 25 mph (40 km/h). At 25 mph (40 km/h) the function begins to taper off until it no longer operates above 34 mph (55 km/h).

If the Traction Assist™ system is cycled excessively, the system will shut down to prevent the rear brakes from overheating. During this shutdown period, the word OFF in the traction assist switch will be illuminated showing that the traction assist system is inoperative. A cooling down period is required to prevent damage to the rear brakes. This time period varies and depends on brake usage during the cooling down period. Anti-Lock braking is not affected and will function normally during the cool down period.

**NOTE: Traction-Lok axles are not an available option on vehicles equipped with traction assist.**

## **Steering Your Vehicle**

Your vehicle comes with power steering. Power steering uses energy from the engine to help steer your vehicle.

If the amount of effort needed to steer your vehicle changes at a constant vehicle speed, have the power steering system checked. If the power steering system breaks down (or if the engine is turned off), you can steer the vehicle manually but it takes more effort.

Never hold the steering wheel to the extreme right or left for more than five seconds if the engine is running. This can damage the power steering pump.

### **Speed Sensitive Power Steering**

The steering system in your vehicle is speed sensitive. This means that the steering effort is light for parking and heavier for highway driving. However, if you have to swerve around an object or another vehicle, your steering will have full power assist.

### **Rear Air Suspension System (If equipped)**

If your vehicle is equipped with an automatic load leveling rear air suspension system, it will maintain the rear vehicle height at a constant level by automatically adding air or releasing air from the rear air springs to offset changes in vehicle loads.

A shutoff switch is located in the trunk on the right hand vertical trim panel. If this switch is in the OFF position, the automatic leveling system will not operate. The switch should be OFF whenever jacking up or towing the vehicle. If you have the mechanical cluster, "AIR SUSP" will appear in the cluster, if you have an electronic cluster, "CHECK AIR SUSPENSION" will appear in the message center when the ignition switch is in the ON position, and either the shutoff switch is in the OFF position, or a system fault has been detected.

Normal vehicle operation does not require any action by the driver.

**⚠ WARNING**

**On vehicles equipped with Air Suspension, turn OFF the Air Suspension switch prior to jacking, hoisting or towing your vehicle.**

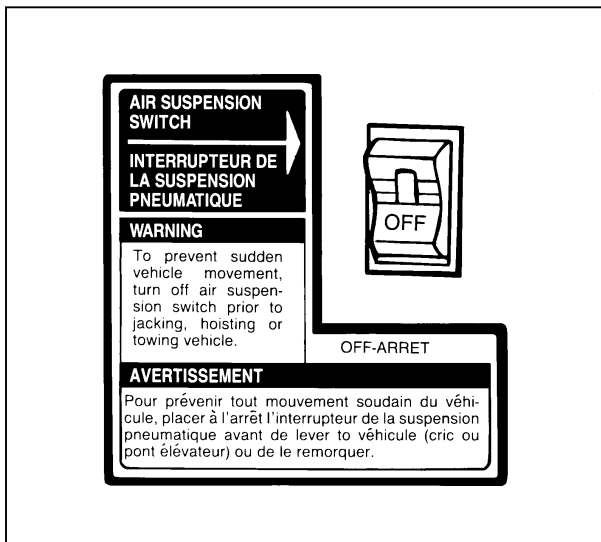

The air suspension switch — located on the right-hand vertical trim panel

## Driving with an Automatic Overdrive Transmission

The automatic overdrive transmission operates very much like a regular automatic transmission, except it offers the extra overdrive feature.

## Putting Your Vehicle in Gear

 **WARNING**

**Hold the brake pedal down while you move the gearshift lever from position to position. If you do not hold the brake pedal down, your vehicle may move unexpectedly and injure someone.**

To move the shifter out of P (Park), the ignition key must be turned to the ON position. This vehicle is also equipped with the brake shift interlock safety feature which prevents shifting the transmission out of the P (Park) position without the brake pedal being depressed if the key is in the ON position.

To operate:

1. Start the engine.
2. Depress and hold the brake pedal.
3. Move the gearshift lever out of P (Park).

Your vehicle is equipped with a Brake Shift Interlock safety feature. This feature prevents the gearshift from being moved from the P (Park) position until the brake pedal is depressed. This feature is active when the ignition is in the ON position. If the gearshift lever CANNOT be moved from P (Park) with the brake pedal depressed:

1. Turn the engine off and remove the ignition key.
2. Apply parking brake.
3. Reinsert the ignition key and turn clockwise to the first position.
4. Depress the brake pedal, move the gearshift lever to N (Neutral) and start the engine.

**⚠ WARNING**

**DO NOT DRIVE YOUR VEHICLE UNTIL YOU VERIFY THAT THE BRAKELAMPS ARE WORKING.**

If you need to shift out of P (Park) by using the alternate procedure described above, it is possible that a fuse has blown and that your brakelamps may also not be functional. Please refer to the chapter titled *Roadside Emergencies* in this Owner Guide for instructions on checking and replacing fuses.

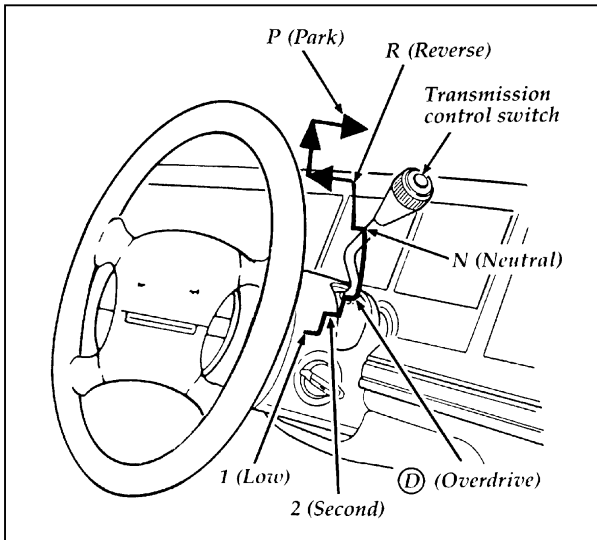

**The positions of the gearshift**

Once the gearshift is secure in the desired position, release the brake pedal and use the accelerator as necessary.

## **R (Reverse)**

With the gearshift in the R (Reverse) position, the vehicle will move backward. You should always come to a complete stop before shifting into or out of R (Reverse).

## **N (Neutral)**

As in P (Park), there is no power transferred through the transmission. However, the final drive is not locked so the wheels are free to rotate. The vehicle may be started in the N position, but the ignition key cannot be removed.

## **Driving**

Your vehicle's gearshift is on the steering column. The Transmission Control Switch (TCS) is located on the end of the gearshift lever. The Transmission Control Indicator Light (O/D OFF) is located on the instrument panel. You can put the gearshift lever in any of the several positions.

The O/D OFF light is off (not illuminated) during normal vehicle operation. This allows the transmission to upshift and downshift from 1st through 4th gears. When the TCS is pressed, the Transmission Control Indicator Light will illuminate (O/D OFF) on the instrument panel. When this O/D OFF is illuminated the transmission will upshift and downshift from 1st through 3rd gears.

If the O/D OFF light does not come "on" when the TCS is depressed or if the light "FLASHES" when you are driving, have your vehicle serviced at the first opportunity. If this condition persists, damage could occur to the transmission.

To return the transmission to normal operation (1st through 4th gear) depress the TCS again. This switch may be used to cancel overdrive any time the vehicle is being driven. Each time your vehicle is started, the overdrive system will automatically be in the normal overdrive mode and the light will not be illuminated.

***When to use **D** (Overdrive)***

Overdrive is the usual driving position for an automatic overdrive transmission. It works the same way Drive works, automatically upshifting or downshifting as the vehicle speeds or slows.

However, Overdrive also shifts into a fourth gear —an overdrive gear — when your vehicle cruises at an appropriate consistent speed for any length of time. This fourth gear will increase your fuel economy when you travel at cruising speeds.

***When to use **D** (Overdrive) — with Transmission Control Switch activated (TCS)***

Overdrive may not be appropriate for certain terrain. If the transmission shifts back and forth between Third and Fourth gears while you are driving on hilly roads or if your vehicle does not have adequate power for climbing hills, press the TCS located on the shift lever.

You can depress the TCS at any speed.

***When to use 2 (Second)***

Use 2 (Second) for start-up on slippery roads or to give you more engine braking to slow your vehicle on downgrades.



### **When to use 1 (Low)**

Use 1 (Low) when driving down steep grades. It gives more engine braking to slow your vehicle than 2 (Second) on the downgrades. You can upshift from 1 (Low) to 2 (Second) or from 1 (Low) to Overdrive at any speed.

### **P (Park)**

Always come to a complete stop before you shift into P (Park). Make sure that the gearshift is securely latched in P (Park). This locks the transmission and prevents the rear wheels from rotating.

<b>⚠ WARNING</b>
------------------

<b>Always set the parking brake fully and make sure the gearshift is latched in P (Park). Turn off the ignition whenever you leave your vehicle.</b>
--

<b>⚠ WARNING</b>
------------------

<b>Never leave your vehicle unattended while it is running.</b>
---

You can tell a column-mounted gearshift is securely latched in P (Park) if the lever is adjacent to the P (Park) and you cannot move it without pulling it toward you and rotating it downward.

### **Driving With a Heavy Load**

There are limits to the amount of weight your vehicle can carry or tow. The total weight of your vehicle, plus the weight of the passengers and cargo, should never be more than the Gross Vehicle Weight Rating (GVWR). Also, the weight

that your vehicle carries over the front axle and rear axle should never be more than the Gross Axle Weight Rating (GAWR) for the respective axle.

You can find your vehicle's GVWR and GAWR on the Safety Compliance Certification Label on the left front door lock facing or the door latch post pillar.

The weight limits of your vehicle's tires affect the GVWR or GAWR limitations. Usage of replacement tires with higher weight limits than originals does not increase GVWR or GAWR. Usage of lower capacity replacement tires may lower GVWR and GAWR limitations.

 <b>WARNING</b>
<b>Do not exceed the GVWR or the GAWR specified on the Safety Compliance Certification Label.</b>

### **Limiting Your Vehicle's Load**

The load that you add to your vehicle must not exceed the maximum load stated on the Safety Compliance Certification Decal attached to the left front door pillar.

To figure the weight of your vehicle's load, add the weights of:

- the driver and passengers
- luggage and any other items that you put in your vehicle
- the weight of any equipment that has been added to your vehicle since it was delivered to your dealer

If you do not know the actual weights of these items, use the following procedure to figure the weight of a load:

1. Weigh your vehicle without the driver, passengers and luggage. You might take your vehicle to a shipping company or an inspection station for trucks.
2. Then weigh your vehicle with the driver, passengers and luggage.
3. Subtract the first reading from the second to figure the total weight of the load.

After determining this load, you must also make sure that the total weight of your vehicle, plus the load it carries, is less than its GVWR. Also, make sure that the weight your vehicle carries over each axle is less than the GAWR for the respective axle.

If your vehicle exceeds the GVWR, remove cargo from your vehicle accordingly. If your vehicle exceeds the GAWR for either axle, shift the load or remove cargo accordingly.

 **WARNING**

**Improper distribution of your vehicle's load or carrying weight in excess of the amount shown on the tire decal can cause rapid tire wear or loss of vehicle control.**

## **Trailer Towing**

Your vehicle is not equipped to tow. No towing packages are available through Ford or Lincoln/Mercury dealers.

## Driving Under Special Conditions

### Tips for Safe Driving

As with any new vehicle, yours may drive and handle differently from your previous vehicle. Use care until you become accustomed to its various features and driving characteristics.

Operate your vehicle within reasonable limits. Sudden acceleration, deceleration, turning, or combinations of these maneuvers can cause a vehicle to behave differently than anticipated.

### Driving in Bad Weather

#### *Slippery roads*

Drive cautiously on wet or snowy roads:

- Do not quickly move the steering wheel unless necessary.
- Drive slower than you normally would.
- Do not use speed control.
- Give your vehicle more distance to stop.
- Pump the brake pedal steadily and evenly to avoid locking your wheels. (Does not apply to vehicles with anti-lock brakes.)
- Consider using one of the lower gears.

 <b>WARNING</b>
<b>To avoid skidding and losing control on slippery roads, do not downshift into 1 (First) when you are moving faster than 20 mph (30 km/h).</b>

**⚠️ WARNING**

**Do not use the speed control in heavy traffic or on roads that are winding, slippery, or unpaved.**

If your vehicle gets stuck (for example, in mud or snow), you may try to “rock” it out of the spot. Shift, in a steady rhythm, between forward (2 [Second] gear is the recommended forward gear) and reverse gears. At the same time, press lightly on the accelerator.

**⚠️ WARNING**

**Do not spin the wheels at over 35 mph (55 km/h). The tires may fail and injure a passenger or bystander.**

By moving the vehicle backward and forward, you may gain enough momentum to move out of the spot. Do not rock the vehicle for more than a few minutes. This may overheat the engine, damage the transmission, or damage the tires. If you are still stuck after a minute or two of rocking, call for a tow truck.

***High water***

Do not drive through flooded areas unless you are sure that the water is below the bottom of the wheel rims.

If you must drive through high water, drive slowly. You may have limited traction or wet brakes, so allow extra stopping distance because your vehicle will not stop as quickly as usual.

After you drive through the standing water, apply your brakes gently several times as your vehicle moves slowly. This helps to dry the brakes.

---

# Roadside Emergencies

---

## Hazard Flashers

The flashers work whether your vehicle is running or not. The flashers work for up to two hours when the battery is fully charged and in good condition without draining the battery excessively. If the flashers run for longer than two hours or if the battery is not fully charged, the battery can be drained.

## Fuses, High Current Fuses, Fuse Links, and Circuit Breakers

Fuses (conventional and high current) and circuit breakers protect your vehicle's wiring system from overloading. If electrical parts in your vehicle are not working, the system may have been overloaded and blown a fuse or tripped a circuit breaker. Before you replace or repair any electrical parts, check the appropriate fuses (conventional and high current) or circuit breakers.

The following charts tell you which fuses or circuit breakers protect the wiring for each electrical part of your vehicle. If a fuse blows or a circuit breaker opens a circuit, **all** the parts of your vehicle that use that circuit will not work.

Once you have determined which fuses or circuit breakers to check, follow the procedures under *Checking and replacing fuses* or *Checking and replacing circuit breakers* in this chapter.

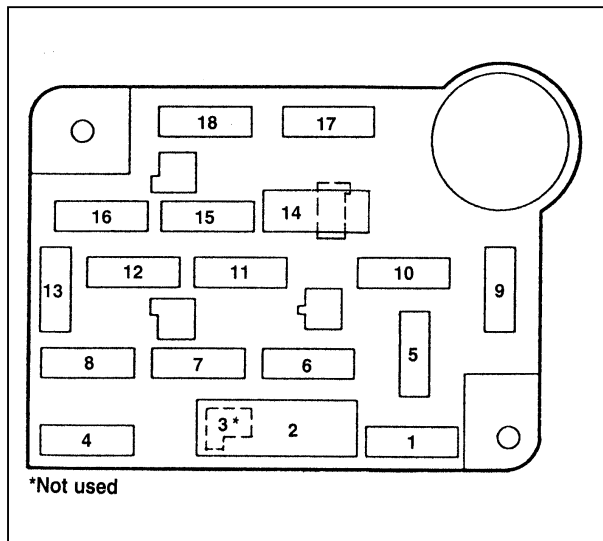

The instrument panel fuse panel

## The Instrument Panel Fuses, Circuit Breakers and Relays

Fuse	Amps	Circuits Protected
1	15	<ul style="list-style-type: none"> <li>• Hazard Flasher</li> <li>• Stop Lamps</li> </ul>
2	30	<ul style="list-style-type: none"> <li>• Wiper Control Module</li> <li>• Windshield Wiper Motor</li> </ul>
3	—	Not Used
4	15	<ul style="list-style-type: none"> <li>• Lighting Control Module</li> <li>• Headlamp Dimmer Switch</li> </ul>
5	15	<ul style="list-style-type: none"> <li>• Backup Lamps</li> <li>• Variable Assist Power Steering (VAPS)</li> <li>• Turn Signals</li> <li>• Air Suspension</li> <li>• Daytime Running Lamps</li> <li>• Electronic Day/Night Mirror</li> <li>• Shift Lock</li> <li>• EATC</li> </ul>
6	15	<ul style="list-style-type: none"> <li>• Speed Control</li> <li>• Main Light Switch</li> <li>• Headlamp Dimmer Switch</li> <li>• Lighting Control Module</li> <li>• Clock</li> </ul>
7	25	<ul style="list-style-type: none"> <li>• Powertrain Control Module (PCM) Power Diode</li> <li>• Ignition Coils</li> </ul>



Fuse	Amps	Circuits Protected
8	15	<ul style="list-style-type: none"> <li>• Lighting Control Module</li> <li>• Power Mirrors</li> <li>• Remote Keyless Entry</li> <li>• Clock Memory</li> <li>• Radio Memory</li> <li>• Electronic Automatic Temperature Control (EATC)</li> <li>• Power Seats</li> <li>• Power Windows</li> </ul>
9	30	<ul style="list-style-type: none"> <li>• Blower Motor</li> <li>• A/C — Heater Mode Switch</li> </ul>
10	10	<ul style="list-style-type: none"> <li>• Air Bag Module</li> </ul>
11	15	<ul style="list-style-type: none"> <li>• Radio</li> </ul>
12	18 CB	<ul style="list-style-type: none"> <li>• Lighting Control Module</li> <li>• Flash-to-Pass</li> <li>• Main Light Switch</li> </ul>
13	15	<ul style="list-style-type: none"> <li>• Air Bag Module</li> <li>• Warning Lamps</li> <li>• Analog Cluster Gauges and Indicators</li> <li>• Electronic Automatic Transmission</li> <li>• Lighting Control Module</li> <li>• Front Control Unit</li> </ul>
14	20 CB	<ul style="list-style-type: none"> <li>• Window/Door Lock Control</li> <li>• Driver's Door Module</li> <li>• One Touch Down</li> </ul>
15	10	<ul style="list-style-type: none"> <li>• Anti-Lock Brakes</li> <li>• Charge Indicator</li> </ul>
16	20	<ul style="list-style-type: none"> <li>• Cigar Lighter</li> <li>• Emergency Flasher Relays</li> </ul>
17	10	<ul style="list-style-type: none"> <li>• Power Mirrors</li> <li>• Rear Defrost</li> </ul>
18	15	<ul style="list-style-type: none"> <li>• Air Bag Module</li> <li>• Digital Instrument Cluster</li> </ul>

## High Current Fuses

High current fuses are circuit protectors that are part of the wiring harness for some electrical equipment. These, like fuses, open when the circuit load exceeds their amperage rating. High current fuses may be purchased from your Ford or Lincoln-Mercury dealer.

The high current fuse panel is located in the engine compartment near the battery.

 <b>WARNING</b>
<b>Always disconnect the battery before servicing high current fuses.</b>

Ford recommends that high current fuses be replaced by a qualified technician.

## The high current fuse panel

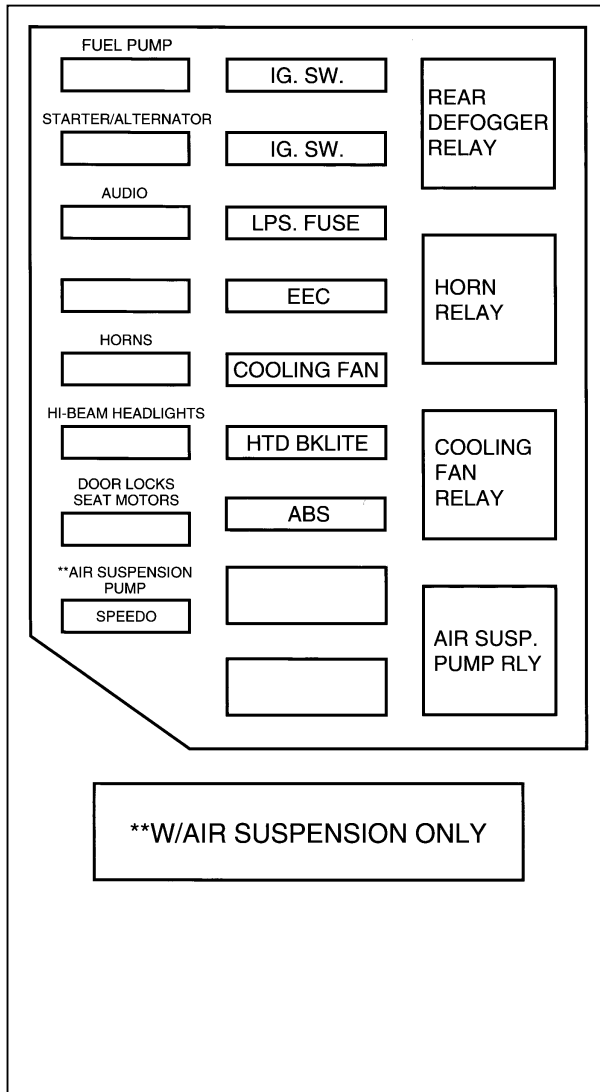

### ***The high current fuses and relays***

<b>MAXI-Fuse</b>	<b>Amps</b>	<b>Circuits Protected</b>
IGN. SW.	50	<ul style="list-style-type: none"> <li>• See Fuses 1, 2, 6, 7, 10, 11, 13 and Circuit Breaker 14</li> </ul>
IGN. SW.	50	<ul style="list-style-type: none"> <li>• Starter Relay</li> <li>• Also see Fuses 5, 9</li> </ul>
LAMPS FUSE PANEL	40	<ul style="list-style-type: none"> <li>• Headlamps</li> <li>• Daytime Running Lamps</li> <li>• Also see Fuses 4, 8, 16 and Circuit Breaker 12</li> </ul>
EEC	30	<ul style="list-style-type: none"> <li>• PCM Power Relay</li> <li>• PCM</li> </ul>
COOLING FAN	50	<ul style="list-style-type: none"> <li>• Cooling Fan Relay</li> </ul>
HTD BACKLITE	40	<ul style="list-style-type: none"> <li>• Rear Window Defrost Relay</li> <li>• Also see Fuse 17</li> </ul>
ABS CONTROLLER	30	<ul style="list-style-type: none"> <li>• Anti-Lock Brake Module</li> </ul>
**AIR SUSP. PUMP/SPEEDO	30	<ul style="list-style-type: none"> <li>• Air Suspension Compressor Relay</li> <li>• Air Spring Solenoids</li> </ul>

Fuse	Amps	Circuits Protected
FUEL PUMP	20	• Electric Fuel Pump Relay
STARTER/ ALTERNATOR	30	• Starter Relay • Generator • Fuses 15, 18
AUDIO	25	• Radio Amplifier • Subwoofer Amplifier
HORNS	15	• Horn Relay • Horns
HI-BEAM HEADLIGHTS	20	• Lighting Control Module • DRL
DOOR LOCKS/ SEAT MOTORS	20 CB	• Power Door Locks • Power Seats • Trunk Lid Release • Fuel Filler Door Release

\*\*with air suspension only

## Checking and Replacing Fuses

If you need to check a fuse, follow these steps:

1. Find the fuse panel to the left of the steering column. Remove the fuse panel cover to expose the fuse panel.
2. Check the fuse to see if it is blown. Look through the clear side of the fuse to see if the metal wire inside is separated. If it is, the fuse should be replaced.

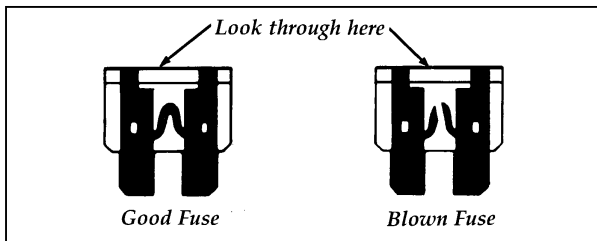

The side view of a fuse

3. Replace the fuse with one that has the right amperage rating. (See the following charts.)

Instrument Panel Fuse Color	Amperage
Tan	5A
Red	10A
Blue	15A
Yellow	20A
Natural	25A
Green	30A

High Current Fuse Color	Amperage
Yellow	20A
Green	30A
Orange	40A
Red	50A
Blue	60A

 <b>WARNING</b>
<b>Always replace a fuse with one that has the specified amperage rating. Using a fuse with a higher amperage rating can cause severe wire damage and could start a fire.</b>

4. Replace the lower steering column fuse panel cover.

Even after you replace a fuse, it may continue to blow if you do not find what caused the overload. If the fuse continues to blow, have your electrical system checked.

## **Circuit Breakers**

If you need to check a circuit breaker that is on the fuse panel, see *Checking and replacing fuses* in this chapter to find out how to locate the fuse panel.

Circuit breakers will reset themselves and allow the electrical parts to work again once the overload on the circuit is removed. If the circuit breakers continue to cut off electricity, have your vehicle's electrical system checked.

Diagnostic equipment is needed to check circuit breakers. Refer to the manufacturer's instructions.

If you replace a circuit breaker, use one with the same amperage rating. To remove a circuit breaker mounted in the fuse panel, grip it with your finger and thumb and pull it straight out of its socket.

Since the circuit breaker for the headlamps is mounted in the headlamp switch, you must replace the entire switch to install a new circuit breaker.

## **Fuse Links**

Fuse links are circuit protectors that are part of the wiring harness for some electrical equipment. These, like fuses, open when the circuit load exceeds their amperage rating. Fuse links may be purchased from your Ford or Lincoln-Mercury dealer. See the following charts to find out which electrical parts are protected by a fuse link.

<b>If these circuits do not work...</b>	<b>Check the fuse link in the wiring assembly located</b>
• battery charge load circuit	between alternator and power distribution box
• alternator output	between alternator and power distribution box

## **If the Engine Cranks but Does Not Start or Does Not Start After a Collision**

### **Fuel System Shut-off Switch**

If the engine cranks but does not start or does not start after a collision, the fuel system shut-off switch may have been activated. The shut-off switch is a device intended to stop the fuel system when your vehicle has been involved in a substantial jolt.

Once the shut-off switch is activated, you must reset the switch by hand before you can start your vehicle. The switch is on the left side of the trunk.



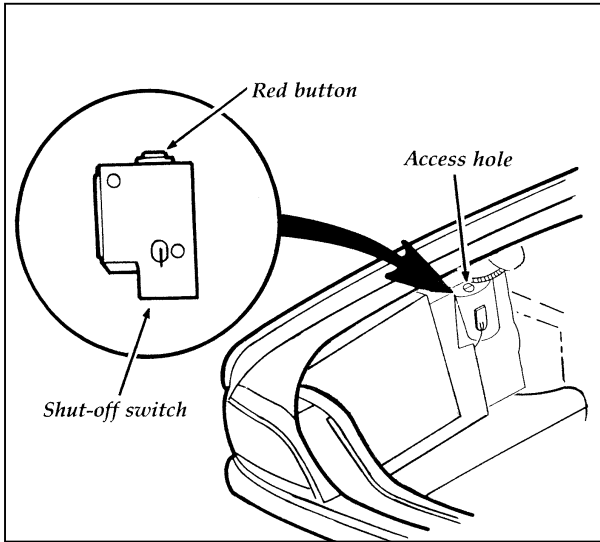

The fuel system shut-off switch

**⚠ WARNING**

**If you see or smell fuel, do not reset the switch or try to start your vehicle. Have all the passengers get out of the vehicle and call the local fire department or a towing service.**

If your engine cranks but does not start after a collision or substantial jolt:

1. Turn the ignition key to the OFF position.
2. Check under the vehicle for leaking fuel.
3. If you do not see or smell fuel, push the red reset button down. If the button is already set, you may have a different mechanical problem.

4. Turn the ignition key to the ON position for a few seconds, then turn it to the OFF position.
5. Check under the vehicle again for leaking fuel. **If you see or smell fuel, do not start your vehicle again.** If you do not see or smell fuel, you can try to start your vehicle again.
6. Check all vehicle warning lights before driving the vehicle.

## Changing a Tire

If you get a flat tire while you are driving, do not apply the brake heavily. Instead, gradually decrease the speed. Hold the steering wheel firmly and slowly move to a safe place on the side of the road. Park on a level spot, turn off the ignition, set the parking brake, and turn on the hazard flashers.

## The Temporary Spare Tire

You may have a high pressure temporary spare tire. This spare tire is smaller than a regular tire and is designed for emergency use only. Use it only when you get a flat tire and replace it as soon as you can. This spare tire is marked with the words "TEMPORARY USE ONLY" so that you can easily identify it.

**NOTE: Extended use of other than conventional spare tires on a Traction-Lok rear axle could result in a permanent reduction in effectiveness. This loss of effectiveness does not affect normal driving and should not be noticeable to the driver.**

**⚠ WARNING**

**If you use the temporary spare tire continuously or do not follow these precautions, the tire could fail, causing you to lose control of the vehicle, possibly injuring yourself or others.**

**When you drive with the temporary spare tire, DO NOT:**

- exceed 50 mph (80 km/h) under any circumstances.
- load your vehicle so that it is heavier than the maximum vehicle load rating listed on the tire decal.
- tow a trailer.
- use tire chains on this tire.
- try to repair the temporary spare tire or remove it from its wheel.
- use the wheel for any other type of vehicle.
- drive through an automatic car wash with this tire. Because the temporary spare tire is smaller than a conventional tire, it reduces the ground clearance. Your vehicle may get caught in the rails and it could be damaged.

## Using the Conventional Spare Tire (If equipped)

If you have the conventional spare tire, you can use it as a spare tire only. This spare tire is identical to the other tires that come with your vehicle, although the wheel may not match.

### Spare Tire Location

The spare is stored in the trunk.

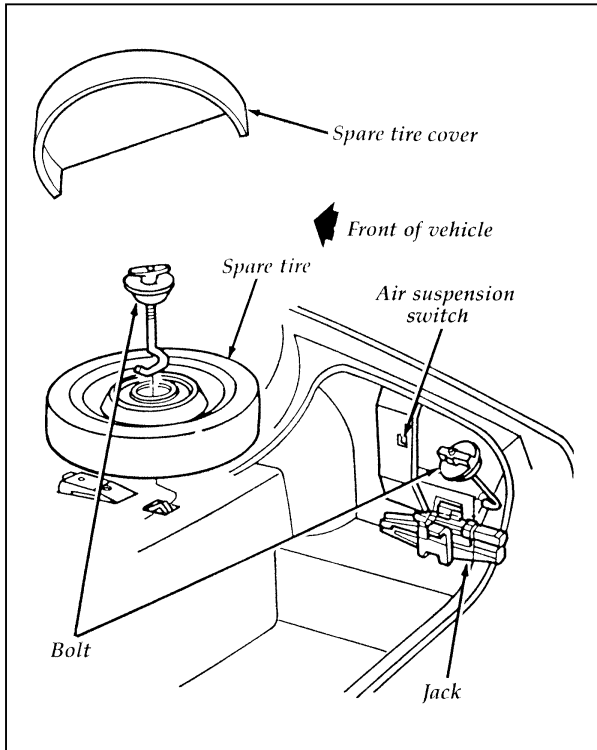

The spare tire location

**To remove the spare tire:**

1. Lift off the spare tire cover (if equipped).
2. Unscrew the wing-nut holding down the spare tire.
3. Lift out the spare tire.

**Preparing to Change the Tire**

1. Make sure that your vehicle will not move or roll. Put the gearshift in P (Park). Set the parking brake and block the wheel that is diagonally opposite the tire that you are changing.

When one of the back wheels is off the ground, the transmission alone will not prevent the vehicle from moving or slipping off the jack, even if the vehicle is in P (Park). To prevent the vehicle from moving when you change a tire, be sure the parking brake is set, then block the wheel (both directions) that is diagonally opposite (other side and end of the vehicle) to the tire being changed.

**⚠ WARNING**

**If the vehicle slips off the jack, you or someone else could be seriously injured.**

Turn off the air suspension switch (if equipped) prior to jacking.

**⚠ WARNING**

**On vehicles equipped with Air Suspension, turn OFF the Air Suspension switch prior to jacking, hoisting or towing your vehicle.**

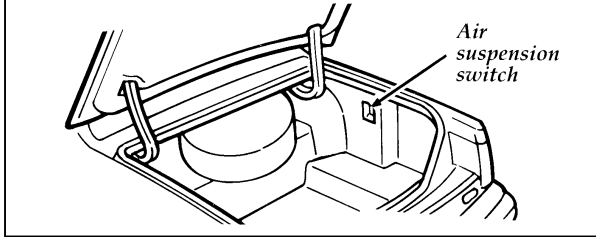

The air suspension switch — located in the trunk

**⚠ WARNING**

**To avoid injury, never run the engine with one wheel off the ground, such as when changing a tire.**

2. Get out the spare tire and jack.

**⚠ WARNING**

**On vehicles equipped with Air Suspension, turn OFF the Air Suspension switch prior to jacking, hoisting or towing your vehicle.**

3. Remove any optional wheel covers or wheel ornaments with the tapered end of a wheel nut wrench. Insert the handle of the wrench and twist it against the inner wheel cover flange. For more about removing wheel covers, see the information later in this section.
4. Loosen each wheel lug nut one-half turn counterclockwise, but do not remove them until the tire is raised off the ground. You should pull up on the handle rather than push to develop maximum force to loosen wheel lug nuts.

## Removing and Replacing the Tire

1. Find the jacking location notches (a depression on plastic moulding) near the tire that you are changing. Align the two tabs on jack with rectangular notch on sheet metal. Slowly push jack straight until the tabs are against the side of the frame. **MAKE SURE THE JACK IS PROPERLY POSITIONED UNDER THE FRAME.** Turn the handle of the jack clockwise until the wheel is completely off the ground.

### **WARNING**

**To lessen the risk of personal injury, do not put any part of your body under the vehicle while changing a tire. Do not start the engine when your vehicle is on the jack. The jack is only meant for changing the tire.**

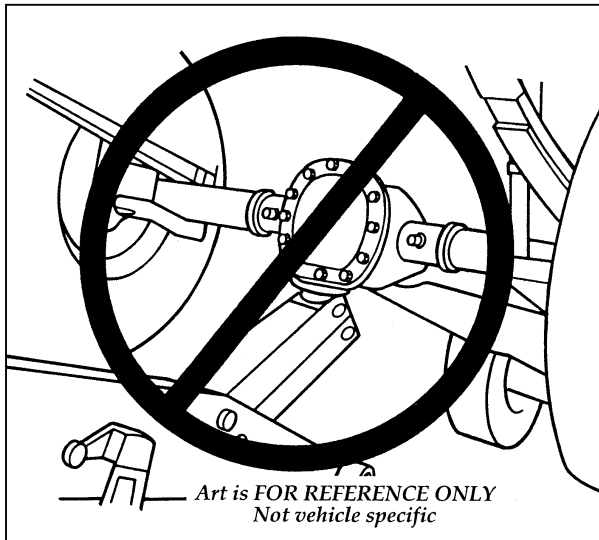

**The improper lift point**

**NOTE:** Never use the differential housing as a lift point.

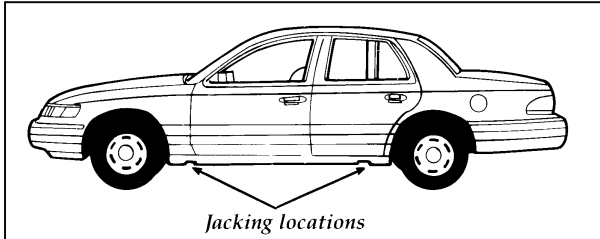

**Jacking locations**

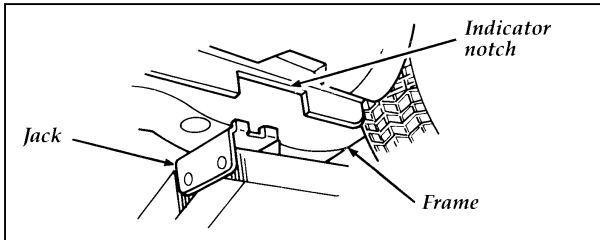

**Locating the notch for the jack — rear wheels**

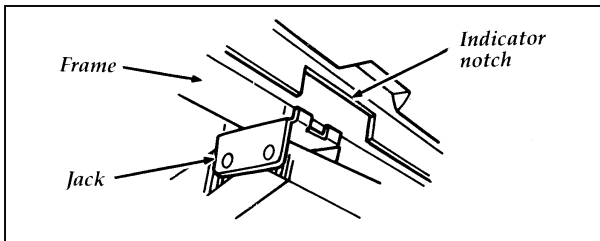

**Locating the notch for the jack — front wheels**



2. Turn the jack handle clockwise until the wheel clears the ground. Remove the wheel lug nuts.
3. If you are replacing the front tire (with aluminum wheels) with the temporary spare tire, you need to remove the black dust shield. Gently pull the shield over the rubber o-rings and slide it off the wheel studs. Because the rubber o-rings are soft, they should pass through the holes in the shield. If the rings do not pass through the holes, remove them from the wheel studs. Save the black dust shield for future use, and ensure the rubber o-rings are removed from wheel studs.
4. Replace the flat tire with the spare tire, making sure that the air valve stem is facing outward.
5. Reinstall the lug nuts, tightening until the wheel is snug against the hub. The beveled edges on the lug nuts face inward. Do not fully tighten the lug nuts until you lower the vehicle. If you do, you could force the vehicle off the jack.
6. Lower the vehicle by turning the jack handle counterclockwise.

7. Remove the jack and fully tighten the lug nuts in the order shown in the following illustration. As soon as possible, have your dealer or a qualified service technician check the lug nuts for proper torque specifications.

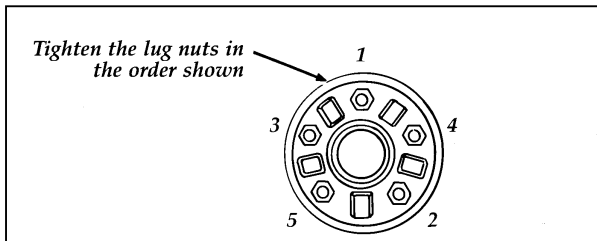

**The lug nuts on the wheel**

8. Place any wheel covers and ornaments in the trunk.
9. Put the tire, jack, and wrench away. Make sure the jack is securely fastened so it does not rattle when you drive.
10. Unblock the wheels.
11. Turn the air suspension ON (if so equipped).

### ***Installation of the black dust shield***

When installing the full size tire, reinstall the black dust shield by orienting and sliding the shield until it is flush with the hub/rotor assembly.

## *Aluminum wheel*

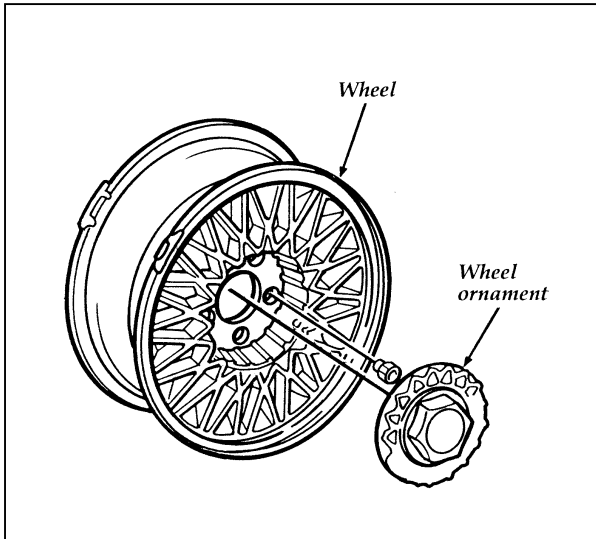

### **The center wheel ornament**

Remove the center ornament from the wheel with the tapered end of the wheel nut wrench by inserting it under the notch, and rotating the handle and then prying against the wheel.

Install the center ornament on the wheel and be sure it is snapped into place all the way around using the palm of the hand or a rubber mallet.

### ***Steel wheel with full wheelcover***

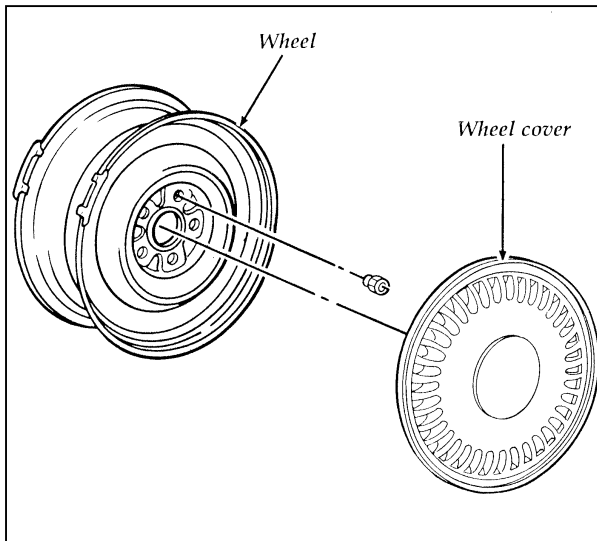

#### **Steel wheel with full wheelcover**

Remove the wheelcover from the wheel using the flanged end of the wheel nut wrench by inserting the handle and then prying against the inner wheelcover flange.

Install the wheelcover on the wheel with the valve stem in the wheel matching the hole in the wheelcover. Push by hand on the outside edges of the wheelcover until it is snapped firmly in place on the wheel.

**NOTE: DO NOT USE A STEEL HAMMER.**

If you have the anti-theft locking spoked wheel cover, each wheel cover has a lock bolt behind the center hub ornament. You need a special key wrench (stored in the glove box) to pry this ornament off and to remove the lock bolt. Do not lose this wrench or you will not be able to remove the wheel cover.

The key wrench has a registration number attached to it. Keep the registration number in a safe place. Complete the registration card and return it to the manufacturer as soon as you buy the vehicle. To replace the key wrench, send the I.D. card to the manufacturer.

## **Jump-Starting Your Vehicle**

Your vehicle's battery may die if you leave the lights on or any electrical equipment on after you turn the engine off. If this happens, you may be able to jump-start your vehicle with a booster battery.

<b>⚠️ WARNING</b>
-------------------

<b>The gases around the battery can explode if exposed to flames, sparks, or lit cigarettes. An explosion could result in injury or vehicle damage.</b>
---

<b>⚠️ WARNING</b>
-------------------

<b>To protect yourself when charging a battery, always shield your face and eyes. Make sure that you can breathe fresh air.</b>
---

<b>⚠️ WARNING</b>
-------------------

<b>Applying too much pressure on the ends when lifting a battery could cause acid to spill. Lift the battery with a carrier or with your hands on the opposite corners.</b>
---

<b>⚠️ WARNING</b>
-------------------

<b>Batteries contain sulfuric acid which burns skin, eyes, and clothing.</b>
--

If the acid touches someone's skin, eyes, or clothing, immediately flush the area with water for at least 15 minutes. If someone swallows the acid, have him or her drink lots of milk or water first, then Milk of Magnesia, a beaten egg, or vegetable oil. Call a doctor immediately.

To avoid damaging your vehicle or your battery, and to avoid injury to yourself, follow these directions for preparing your vehicle to jump-start and connecting the jumper cables in the order they are given. If in doubt, call for road service.

### **Preparing Your Vehicle**

**NOTE: also see label on battery.**

1. Your vehicle has a 12-volt starting system, so you need to use a 12-volt jumper system. You will damage your starting motor, ignition system, and other electrical parts if you connect them to a 24-volt power supply (either two 12-volt batteries in series or a 24-volt generator set).
2. Do not disconnect the battery of the disabled vehicle. You could damage the vehicle's electrical system.
3. Park the booster vehicle close to the hood of the disabled vehicle. **Make sure the vehicles do not touch each other.** Set the parking brake on both vehicles and stay clear of the engine cooling fan and other moving parts.
4. Check all battery terminals and remove any excessive corrosion before you attach the jumper cables.

5. Turn on the heater fan in both vehicles. Turning on the fan helps protect the electrical system from voltage surges. Turn off all other switches and lights in both vehicles to prevent possible damage to either vehicle's electrical systems.

### ***Connecting the jumper cables***

1. Connect one end of the first jumper cable to the positive (+) terminal of the discharged battery. (You can connect either jumper cable to the positive (+) terminal, as long as you use the same cable for both positive terminals.) Most jumper cables have a red cable and a black cable. The red cable is generally used for the positive terminals and the black for the negative ones.
2. Connect the other end of the first cable to the positive (+) terminal of the booster battery.
3. Connect one end of the second cable to the negative (–) terminal of the booster battery — NOT to the discharged battery.
4. Connect the other end of that cable to a good metallic surface on the engine or frame of the disabled vehicle making sure it is clear of any rotating engine components. The following illustrations show where you can find a metallic surface.

 <b>WARNING</b>
<b>Do not connect the end of the second cable to the negative (–) terminal of the battery to be jumped. A spark may cause an explosion of the gases that surround the battery.</b>

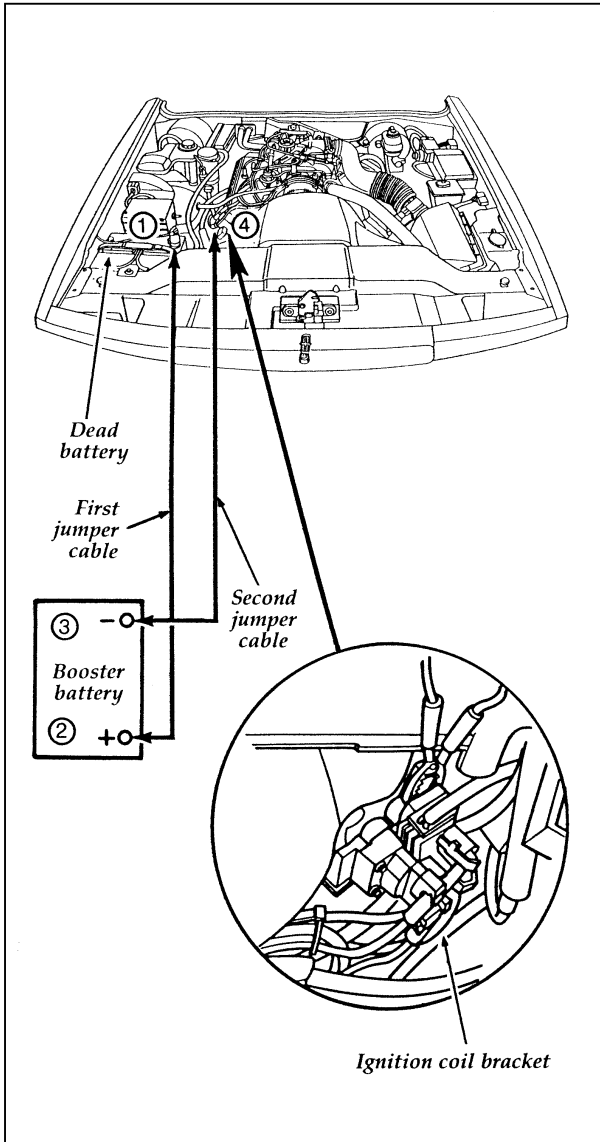

The 4.6L SFI engine



## **Jump-Starting**

1. Make sure that the jumper cables are not in the way of moving engine parts, then start the booster vehicle. Run the engine at a moderate speed.
2. Let the discharged battery charge for a few minutes and then start the disabled vehicle. It may take a couple of tries before the vehicle starts. If the vehicle does not start after several attempts, there may be a different problem.
3. When both vehicles are running, let them idle for a few minutes to charge the discharged battery.

### ***Removing jumper cables***

1. **Always remove the jumper cables in the reverse order.** Remove the negative (–) end of the jumper cable from the metallic surface on the engine or frame of the disabled vehicle.
2. Remove the negative (–) cable from the booster battery.
3. Remove the positive (+) cable from the booster battery.
4. Remove the other end of the positive (+) cable from the discharged battery.

After the vehicle is started, let it idle for a while to let the engine “relearn” its idle conditions. Drive it around for a while with all electrical accessories turned off to let the battery recharge. Driveability may be deteriorated slightly until all drive modes are “relearned.” **You may need to use a battery charger to fully recharge the battery.**

## **Towing Your Vehicle**

If you need to have your vehicle towed, contact a professional towing service or, if you are a member, your roadside assistance center.

Before your vehicle can be towed, the air suspension switch in the luggage compartment needs to be turned to the OFF position. It is recommended that your Grand Marquis be towed with wheel lift or flatbed equipment. If slingbelt equipment must be used, the towbar will deform the soft fascia (bumper). However, it will return to an acceptable shape.

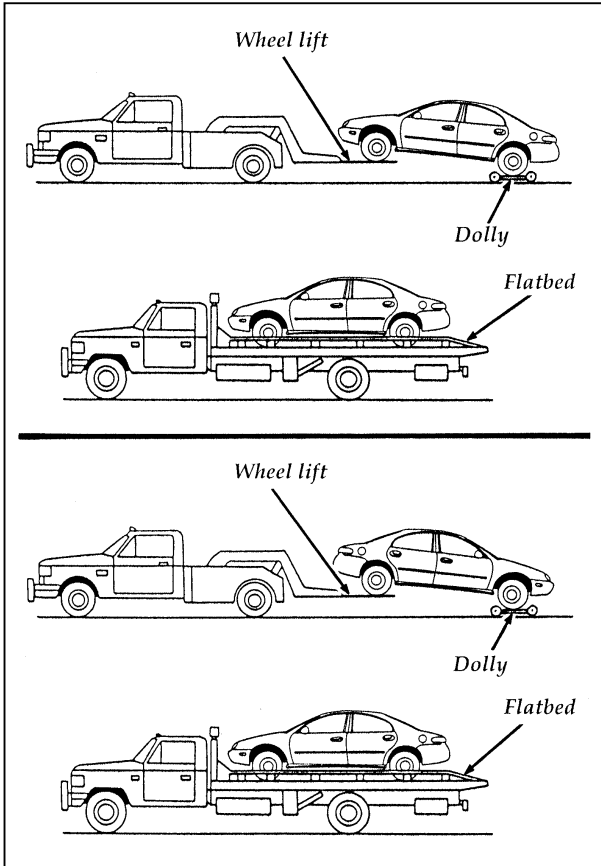

**Steel wheel with full wheelcover**

When calling for a tow truck, tell the operator what kind of vehicle you have. A towing manual is available from Ford Motor Company for all authorized tow truck operators. Have your tow truck driver refer to this manual for the proper hook-up and towing procedures for your vehicle.

---

# Maintenance and Care

---

## Service Made Easy

Ford has two goals for servicing your vehicle.

1. When we can, we design parts that do not need to be serviced.
2. We want to make servicing your vehicle as easy as possible. To help you:
  - We highlight do-it-yourself items in yellow in the engine compartment so that you can find them easily.
  - When possible, we design parts that can be replaced without tools.
  - We give you a Maintenance Schedule that makes tracking routine service for your vehicle easy. The maintenance schedule is located in the *Maintenance Schedule* booklet.

This chapter tells you about the basic parts that you need to check and service regularly.

If your vehicle needs professional servicing, your dealership can provide the parts and service required. Check your *Warranty Information Booklet* to find out which parts and services are covered. Also see the *Customer Assistance* chapter of this Owner Guide.

Ford Motor Company recommends that the Owner Maintenance Checks listed in the *Maintenance Schedule* booklet be performed for the proper operation of your vehicle. In addition to the conditions listed in the *Owner Maintenance Checklist*, be alert for any unusual noise,

vibration, or other indication that your vehicle may need service. If you do notice something unusual, see that your vehicle is serviced promptly.

Use only recommended fuels, lubricants, fluids, and service parts conforming to Ford specifications. Motorcraft parts are designed and built to provide the best performance in your vehicle. Using these parts for replacement is your assurance that Ford-built quality stays in your vehicle.

**NOTE: Always dispose of used automotive fluids in a responsible manner. Follow your community's standards for disposing of these types of fluids. Call your local recycling center to find out about recycling automotive fluids.**

## **Precautions When Servicing Your Vehicle**

Be especially careful when inspecting or servicing your vehicle. Here are some general precautions for your safety:

- If you must work with the engine running, avoid wearing loose clothing or jewelry that could get caught in moving parts. Take appropriate precautions with long hair.
- Do not work on a vehicle in an enclosed space with the engine running, unless you are sure you have enough ventilation.
- Never get under a vehicle while it is supported only by a jack. If you must work under a vehicle, use safety stands.
- Keep all lit cigarettes and other smoking materials away from the battery and all fuel-related parts.

***Working with the engine off:***

1. Set the parking brake fully and make sure that the gearshift is securely latched in P (Park).
2. Remove the key from the ignition after you turn the engine off.
3. Block the wheels. This will prevent your vehicle from moving unexpectedly.

***Working with the engine on:***

1. Set the parking brake fully and make sure that the gearshift is securely latched in P (Park).
2. Block the wheels. This will prevent your vehicle from moving unexpectedly.

 <b>WARNING</b>
<b>Do not start your engine with the air cleaner removed and do not remove it while the engine is running.</b>

## Opening the Hood

1. Inside the vehicle, pull the hood release located under the lower left corner of the instrument panel.

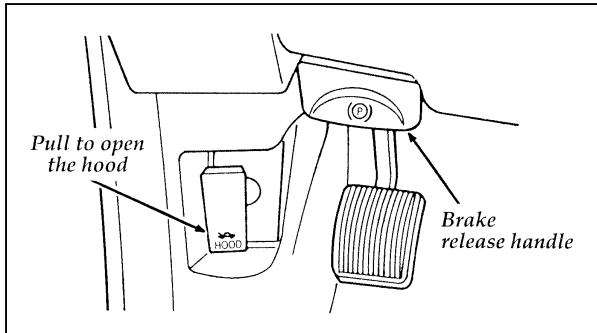

### The hood release under the instrument panel

2. Go around to the front of the vehicle, and release the auxiliary catch that is located under the front edge of the hood at the center of the vehicle.

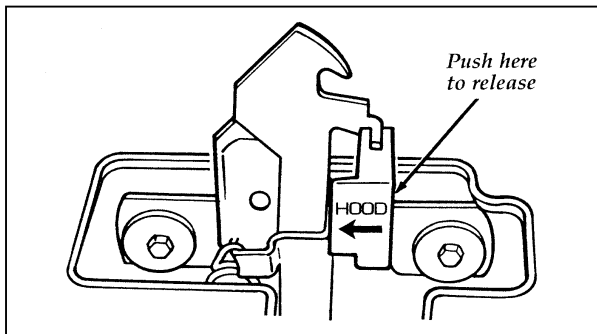

### The auxiliary catch under the front edge of the hood

3. Lift the hood until the counterbalanced hinges hold it open.

Whenever you close the hood, latch it securely.

**NOTE: Apply lubricant to the hood latch at six-month intervals to maintain smooth and trouble-free operation.**

## **Engine Compartment**

Your vehicle has a 4.6 liter engine. The following page shows a diagram of where to find items that you should regularly service.



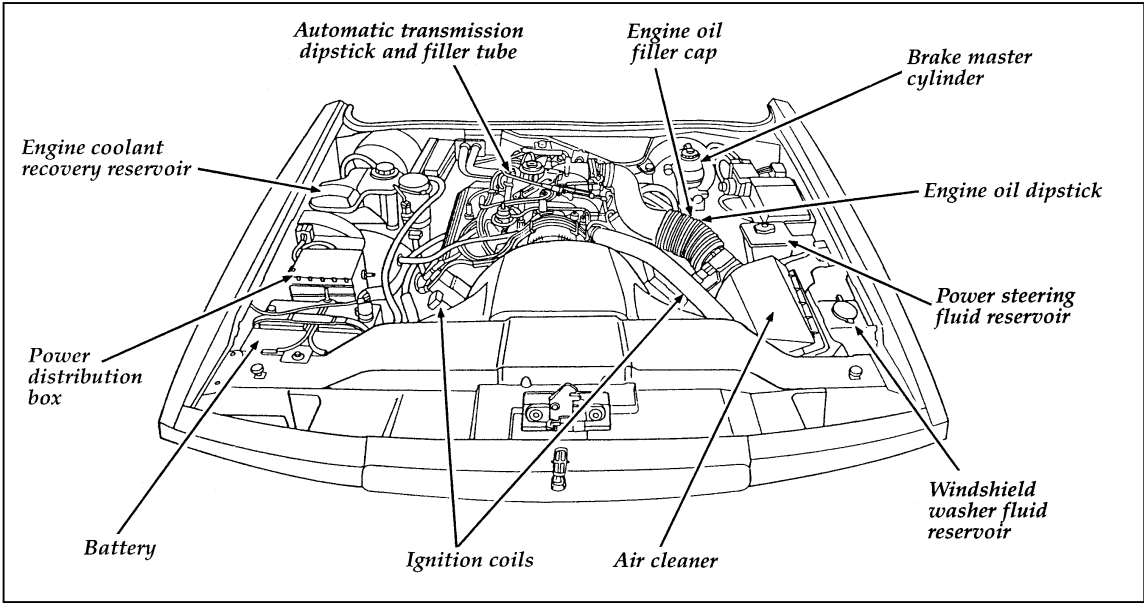

## Engine Oil Recommendations

We recommend using Motorcraft oil or an equivalent oil meeting Ford Specification WSS-M2C153-F and displaying the American Petroleum Institute CERTIFICATION MARK on the front of the container.

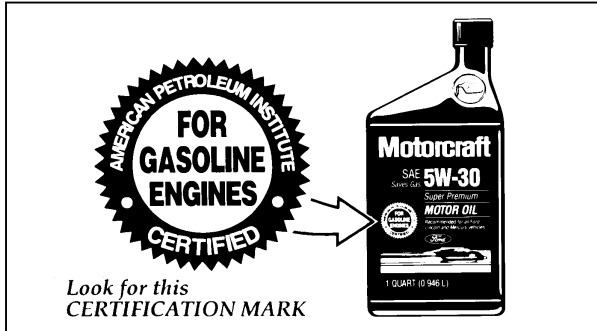

The API Certification Mark

Never use:

- “Non-Detergent” oils
- Oils labeled API SA, SB, SC, SD, SE, SF or SG
- Additional engine oil additives, oil treatments or engine treatments

Engine oils with an **SAE 5W-30** viscosity are **PREFERRED** for your vehicle. They provide the best engine performance, fuel economy and engine protection for all climates down to -15°F (-25°C).

Synthetic engine oils which are **CERTIFIED** and of the preferred viscosity may be used in your engine. The engine oil and oil filter must still be changed according to the maintenance schedule.

## Checking and Adding Engine Oil

Since the proper amount of engine oil is important for safe engine operation, check the oil using the dipstick each time you put fuel in your vehicle. Remember the engine must be off, the oil must be warm and the vehicle must be parked on level ground.

Checking the engine oil level:

1. Turn the engine off after it has warmed up and allow a few minutes for the engine oil to drain back into the oil pan.
2. Set the parking brake, making sure the gearshift is securely latched in P (Park).
3. Open the hood. Protect yourself from engine heat.
4. Locate the engine oil dipstick (highlighted in yellow) and carefully pull it out of the engine.
5. Wipe the dipstick clean and put it back into position, making sure it is fully seated.

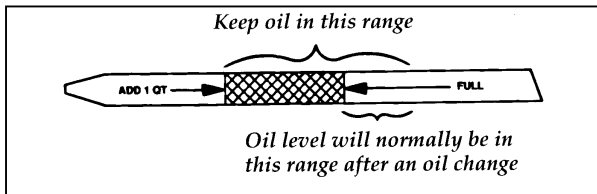

Engine oil dipstick

6. Carefully pull the dipstick out again. If the oil level is below the "ADD 1 QT" line, add engine oil as necessary. If the oil level is beyond the letter "F" in Full, engine damage or high oil consumption may occur and some oil must be removed from the engine.

7. Put the dipstick back in and make sure it is fully seated.

It may be necessary to add some oil between oil changes. Make sure you use a CERTIFIED engine oil of the preferred viscosity. Your vehicle's warranty coverage may not apply if engine damage is caused by the use of improper engine oil.

Add engine oil through the oil filler cap highlighted in yellow. To add oil, remove the filler cap and use a funnel to pour oil into the opening. Be careful not to overfill the engine. Recheck the oil level after you finish adding oil.

### **Changing the Engine Oil and the Oil Filter**

**Change the engine oil and oil filter** per the following, whichever occurs first.

5,000 MILES (8,000 KM) OR 6 MONTHS  
NORMAL SCHEDULE

---

3,000 MILES (5,000 KM) OR 3 MONTHS  
SEVERE DUTY SCHEDULE

EXTENSIVE IDLING  
TRAILER TOWING  
DRIVING IN SEVERE DUST  
POLICE, TAXI, OR DELIVERY

Refer to the *Maintenance Schedule* booklet for additional information.

**NOTE: Always dispose of used automotive fluids in a responsible manner. Follow your community's standards for disposing of these types of fluids. Call your local recycling center to find out about recycling automotive fluids.**

**⚠ WARNING**

**Continuous contact with USED motor oil has caused cancer in laboratory mice.**

Protect your skin by washing with soap and water.

## **Brake Fluid**

Under normal circumstances, your vehicle should not use up brake fluid rapidly. However, expect the level of the brake fluid to slowly fall as you put more mileage on your vehicle and the brake lining wears.

Check the brake fluid at each scheduled engine oil change or at least once a year. You can do this by looking at the fluid level in the plastic reservoir on the master cylinder. Also, see label on reservoir cap. (To locate the master cylinder, see *The Engine Types* in the Index.) The fluid level should be between the MAX fill mark and 3/8" below the MAX fill line.

**⚠ WARNING**

**Brake fluid is toxic.**

If brake fluid contacts eyes, flush eyes with running water for 15 minutes. Get medical attention if irritation persists. If taken internally, drink water and induce vomiting. Get medical attention immediately.

If the fluid is low, carefully clean and remove the filler cap from the reservoir. Fill the reservoir to the MAX line with Ford High Performance DOT 3 Brake Fluid C6AZ-19542-AB or DOT 3 equivalent fluid meeting Ford specification ESA-M6C25-A.

**⚠ WARNING**

**If you use a brake fluid that is not DOT 3, you will cause permanent damage to your brakes.**

**Do not fill the reservoir above the MAX line.**

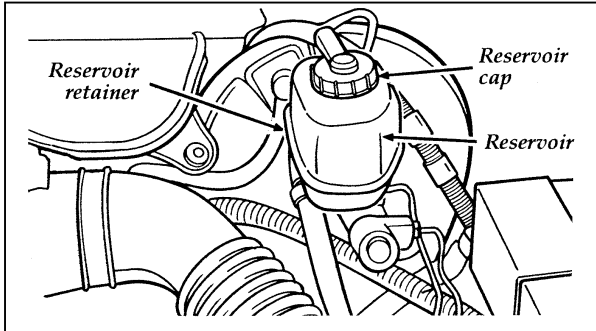

**The brake fluid reservoir**

If you find that the fluid level is excessively low — below the seam or ridge on the outside of the plastic reservoir — have the brake system inspected.

**⚠ WARNING**

**Do not let the reservoir for the master cylinder run dry. This may cause the brakes to fail.**

# Windshield Washer Fluid

## Washer Fluid

Check the level of the windshield washer fluid periodically. The reservoir for washer fluid is located on the driver's side of the engine compartment. Do not operate the washer when the reservoir is empty.

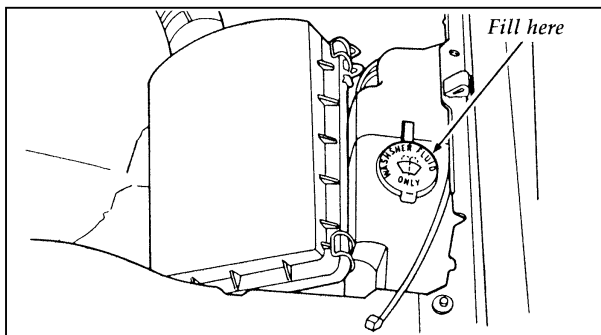

The reservoir for the windshield washer fluid

### **! WARNING**

**Do not put windshield washer fluid in the container for the engine coolant.**

Use specially formulated windshield washer fluid rather than plain water, because specially formulated washer fluids contain additives that dissolve road grime. For safety reasons, washer fluids containing an appropriate antifreeze such as methanol should be used in freezing weather (temperatures below 32°F [0°C]). State or local regulations on Volatile Organic Compounds (VOCs) may restrict use of the most common antifreeze, methanol. Washer fluids containing non-methanol antifreeze agents should be used only if they provide cold weather protection without damaging the vehicle's paint finish, wiper blades, and windshield washer system.

# Engine Coolant

## Checking the Engine Coolant

**NOTE:** Be sure to read and understand *Precautions When Servicing Your Vehicle* at the beginning of this chapter.

 <b>WARNING</b>
--

<p><b>The cooling fan is automatic and may come on at any time. Always disconnect the negative terminal of the battery before working near the fan.</b></p>
---

Your vehicle's coolant protects your engine from overheating in the summer and from freezing in the winter. Check the level of the coolant at least once a month. Simply look at the engine coolant reservoir located in the engine compartment. To locate the reservoir, see the diagram of your vehicle's engine under *Engine Type*, in this chapter.

The coolant additives also protect the entire cooling system from internal passageway corrosion and these additives lubricate the water pump. The coolant should be serviced as noted in the *Maintenance Schedule* booklet.



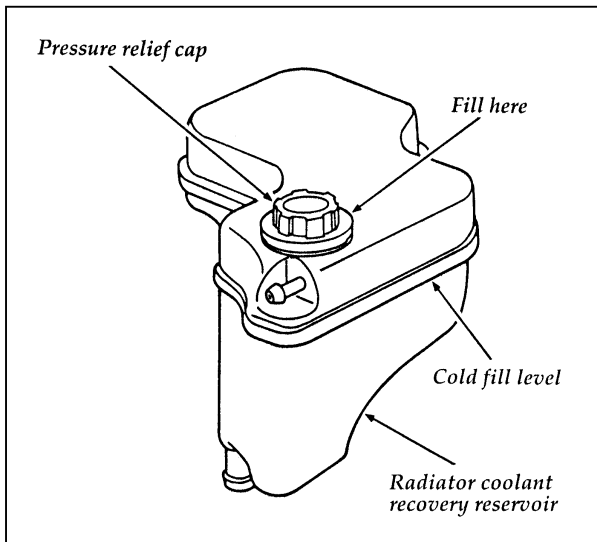

The engine coolant reservoir

## Checking Hoses

Inspect all engine and heater system hoses and hose connections for deterioration, leaks, and loose hose clamps as specified in the *Maintenance Schedule* booklet. Repair or replace with Motorcraft hoses or equivalent as necessary.

## Adding Engine Coolant

**⚠ WARNING**

**Do not put engine coolant in the container for the windshield washer fluid.**

If sprayed on the windshield, engine coolant could make it difficult to see through the windshield.

When the engine is cool, add a 50/50 mixture of engine coolant and water to the engine coolant recovery reservoir — DO NOT ADD DIRECTLY TO THE RADIATOR. Add straight water only in an emergency, but you should replace it with a 50/50 mixture of coolant and distilled water as soon as possible.

Check the coolant level in the coolant recovery reservoir the next few times you drive the vehicle. If necessary, add enough of a 50/50 mixture of coolant and water to bring the liquid level to the fill line on the reservoir.

**⚠ WARNING**

**Never remove the coolant recovery cap while the engine is running or hot.**

If you must remove the coolant recovery cap, follow these steps to avoid personal injury:

1. Before you remove the cap, turn the engine off and let it cool.
2. When the engine is cool, wrap a thick cloth around the cap. Slowly turn cap counterclockwise to the first stop.
3. Step back while the pressure releases.
4. When you are sure that all the pressure has been released, use the cloth to press the cap down, turn it counterclockwise, and remove it.

Use Ford Premium Cooling System Fluid E2FZ-19549-AA (in Canada, Motorcraft CXC-8-B) or an equivalent premium engine coolant that meets Ford specification ESE-M97B44-A. Ford Premium Engine Coolant is an optimized formula that will protect all metals and rubber elastomers used in Ford cooling systems for 4 years or 50,000 miles (80,000 km).

Do not use alcohol or methanol antifreeze or any engine coolants mixed with alcohol or methanol antifreeze. Do not use supplemental coolant additives in your vehicle. These additives may harm your engine cooling system. The use of an improper coolant may void the warranty of your vehicle's engine cooling system.

### ***Recycled engine coolant***

Ford Motor Company recommends that Ford and Lincoln-Mercury dealers use recycled engine coolant produced by Ford-approved processes. Not all coolant recycling processes produce coolant which meets Ford specification ESE-M97B44-A, and use of such coolant may harm engine and cooling system components.

Always dispose of used automotive fluids in a responsible manner. Follow your community's regulations and standards for recycling and disposing of automotive fluids.

### ***Coolant refill capacity***

To find out how much fluid your vehicle's cooling system can hold, refer to *Refill capacities* in the *Capacities and specifications* chapter.

Have your dealer check the engine cooling system for leaks if you have to add more than a quart (liter) of engine coolant per month.

### ***Severe winter climate***

If you drive in extremely cold climates (less than -34°F [-36°C]), it may be necessary to increase the coolant concentration above 50%. Refer to the chart on the coolant container to ensure the coolant concentration in your vehicle is such that the coolant will not freeze at the temperature level in which you drive during winter months.

Never increase the engine coolant concentration above 60%. Leave a 50/50 mixture of engine coolant and water in your vehicle year-round in non-extreme climates.

### **Engine Coolant Drain and Flush**

Proper procedures for a complete coolant drain and flush of the cooling system can be found in the *Car Service Manual*. Following these recommended procedures will ensure that the specified coolant level and a 50/50 or appropriate mixture of coolant and water is maintained.

### **Engine Coolant Refill Procedure**

When the entire cooling system is drained and refilled, the following procedure should be used to ensure a complete fill:

**NOTE: It is imperative the following procedure be adhered to. Failure to do so could result in damage to your engine.**

- With the engine OFF and cool, remove the pressure cap, located on the coolant reservoir. Remove the heater hose and clamp, located on the rear of the intake manifold.
- Add a 50/50 mixture of specified coolant and water to the coolant reservoir. Refer to *Refill Capacities* later in this chapter for the correct amount. Add coolant to the reservoir until the coolant continuously flows out of the tube in the rear of engine. Reattach hose and secure clamp.
- Continue to fill the reservoir until the coolant is at the FULL COLD level.
- Reinstall the pressure cap to the fully installed position.

- Start and idle the engine until the radiator upper hose is warm (this indicates the thermostat is open and coolant is flowing through the entire system).
- Immediately shut off the engine and let cool. Cautiously remove the pressure relief cap and add a 50/50 mixture of specified coolant and water until the coolant is at the COLD FILL level in the coolant reservoir.
- Reinstall the pressure cap securely.
- Check for leaks at the draincock.
- Recheck the engine coolant level, using the recommended procedure, after one or two occasions of vehicle use.

## **Power Steering Fluid**

Check the level of the power steering fluid at least twice a year (i.e., every Spring and Fall).

### **Checking and Adding Power Steering Fluid**

1. Start the engine and let it run until the power steering fluid reaches normal operating temperature. The power steering fluid will be at the right temperature when the engine coolant temperature gauge in the instrument cluster is near the center of the NORMAL operating temperature range.
2. While the engine idles, turn the steering wheel back and forth several times. Make sure that the cap assembly is installed at this time.
3. Turn the engine off.

4. Check the fluid level in the power steering fluid reservoir. The fluid level should be between the MIN and MAX lines on the side of the reservoir.
5. If the power steering fluid is below the MIN mark, add fluid in small amounts until the level is between the MIN and MAX lines on the side of the reservoir.
6. When you are finished, put the cap assembly back on the reservoir.

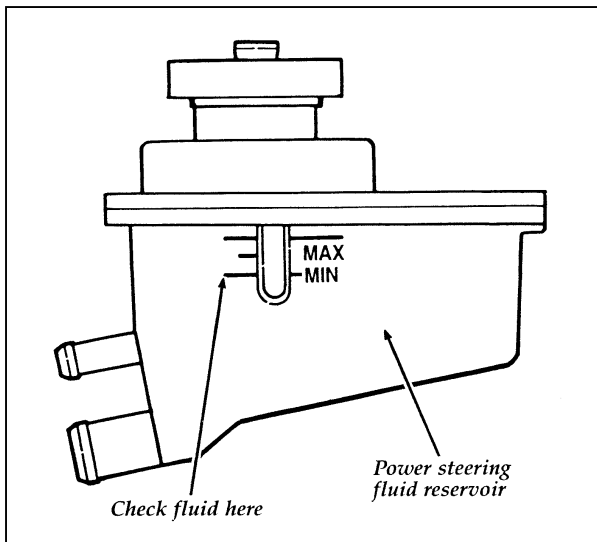

#### Fluid level for power steering

Use only power steering fluid that meets Ford Specification Mercon<sup>®</sup> ATF XT-2-QDX or an equivalent.

If the power steering fluid is low, do not drive your vehicle for a long period of time before adding fluid. This can damage the power steering pump.

If you must check the power steering fluid when it is cold, make sure that the fluid reaches the MIN mark on the reservoir.

## **Automatic Transmission Fluid**

Under normal circumstances, you do not need to check the fluid level of the transmission, since your vehicle does not use up transmission fluid. Refer to the *Maintenance Schedule* booklet for replacement intervals. However, if the transmission is not working properly — for instance, the transmission may slip or shift slowly, or you may notice some sign of fluid leakage — the fluid level should be checked.

### **Checking the Automatic Transmission Fluid**

It is preferable to check the transmission fluid level at normal operating temperature 150°F-170°F (66°C-77°C), after approximately 20 miles (30 km) of driving. However, if necessary, you can check the fluid level without having to drive 20 miles (30 km) to obtain a normal operating temperature if outside temperatures are above 50°F (10°C).

With the vehicle on a level surface, start the engine and, while fully applying the brake pedal, move the transmission shift selector through all of the gear ranges allowing sufficient time for each position to engage. **Securely latch the transmission shift selector in the P (Park) position, fully set the parking brake and leave the engine running.**

**NOTE: Your vehicle should not be driven if the fluid level is below the bottom hole on the dipstick.**

Wipe off the dipstick cap, pull the dipstick out and wipe the indicator end clean. Put the dipstick back into the filler tube and make sure it is fully seated. Pull the dipstick out and read the fluid level.

When checking fluid at normal operating temperatures 150°F-170°F (66°C-77°C), the fluid level should be within the crosshatched area on the dipstick. When the vehicle has not been driven, and outside temperatures are above 68°F (20°C), the fluid levels should be between the holes on the dipstick.

**NOTE: If the vehicle has been operated for an extended period at high speeds or in city traffic during hot weather, or pulling a trailer, the vehicle should be turned off for about 30 minutes to allow the fluid to cool before checking.**

### **Adding Automatic Transmission Fluid**

Before adding any fluid, be sure that the correct type will be used. Use only MERCON® fluid.

Add fluid in 1/2 pint (.25L) increments through the filler tube to bring the level to the correct area on the dipstick. DO NOT OVERFILL. If the level is above the top hole on the dipstick, excess fluid should be removed by a qualified technician.

**NOTE: Always dispose of used automotive fluids in a responsible manner. Follow your community's standards for disposing of these types of fluids. Call your local recycling center to find out about recycling automotive fluids.**



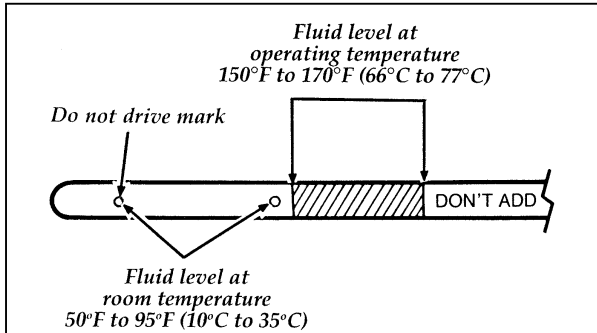

**Detail of the automatic transmission dipstick**

## Battery

Your vehicle may have a Motorcraft maintenance-free battery. When the original equipment battery is replaced under warranty, it may be replaced by a Motorcraft Low-Maintenance Battery.

The Low-Maintenance Battery has removable vent caps for checking the electrolyte level and for adding water, if necessary. The electrolyte level should be checked at least every 24 months or 24,000 miles (40,000 km) in temperatures up to 90°F (32°C) and more often in temperatures above 90°F (32°C). Keep the electrolyte level in each cell up to the level indicator. Do not overfill.

If the level gets low, you can add tap water to the battery, provided the water isn't hard or doesn't have a high mineral or alkali content. However, if possible you should refill the battery with distilled water. If the battery needs water quite often, have the charging system checked for a possible malfunction.

## Help Us Protect Our Environment

Ford Motor Company strongly recommends that used lead-acid batteries be returned to an authorized recycling facility for disposal.



### Battery recycling symbol

Because your vehicle's engine is electronically controlled by a computer, some control conditions are maintained by power from the battery. If you ever disconnect the battery or install a new battery, you must allow the computer to "relearn" its idle conditions before your vehicle will drive properly. To let the engine do this, put the gearshift in P (Park), turn off all the accessories, and start the vehicle. Let the engine idle for at least one minute. (Engine must be warm in order to "learn.") Also, allow approximately 10 miles (16 km) of stop and go traffic for your vehicle's engine to completely "relearn" its idle.

## Wiper Blades

Check the windshield wiper blades at least twice a year. Also check them whenever they seem less effective than usual. Substances such as tree sap and some hot wax treatments used by commercial car washes reduce the effectiveness of wiper blades.

If the blades do not wipe properly, clean both the windshield and the wiper blades. Use undiluted windshield washer solution or a mild detergent. Rinse thoroughly with clear water. Do

not use fuel, kerosene, paint thinner, or other solvents to clean your wiper blades. These will damage your blades.

To make reaching the wiper blades easy, simply turn the ignition to the ACC position and turn your wipers on. Wait for them to reach a vertical position and turn the ignition to the OFF position. Do not move the wipers manually. Manually moving the wipers across the windshield may damage them.

### **Wiper blade replacement**

If the wiper blades still do not work properly after you clean them, you may need to replace the wiper blade assembly or the blade element. When replacing the wiper blade assembly, blade refill, or wiper arm always use a Motorcraft part or equivalent. To replace the blades, follow the instructions that come with them.

## **Tires**

### **Checking Tire Pressure**

- Use an accurate tire pressure gauge.
- Check the tire pressure when tires are cold, after the vehicle has been parked for at least one hour or has been driven less than 3 miles (5 km).
- Adjust tire pressure to recommended specifications found on the Safety Compliance Certification Label.

 <b>WARNING</b>
<b>Improperly inflated tires can affect vehicle handling and can fail suddenly, possibly resulting in loss of vehicle control.</b>

## Tire Rotation

Because your vehicle's front and rear tires perform different jobs, they often wear differently. To make sure your tires wear evenly and last longer, rotate them as indicated in the following diagram.

For tire rotation intervals, see the *Maintenance Schedule*. If you notice that the tires wear unevenly, have them checked.

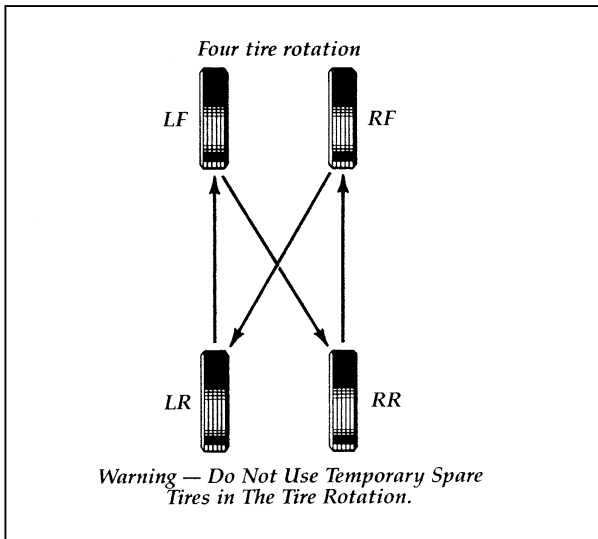

**Rotating the tires**

**NOTE: Do not mix the steel wheel with aluminum wheels in tire rotation sequence.**

## **Replacing the Tires**

Replace any tires that show wear bands. When your tire shows a wear band, it has only 1/16 inch (2 mm) of tread left.

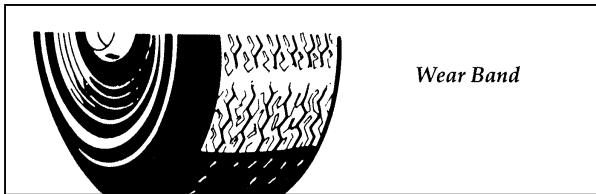

**A worn-out tire**

Because your vehicle's tires may wear unevenly, you may need to replace them before a wear band appears across the entire tread.

### **⚠ WARNING**

**When replacing full size tires, never mix radial, bias-belted, or bias-type tires. Use only the tire sizes that are listed on the tire pressure decal. Make sure that all tires are the same size, speed rating, and load-carrying capacity. Use only the tire combinations recommended on the decal. If you do not follow these precautions, your vehicle may not drive properly and safely.**

Tires that are larger or smaller than your vehicle's original tires may also affect the accuracy of your speedometer.

## **Information About Tire Quality Grades**

New vehicles are fitted with tires that have their Tire Quality Grade (described below) molded into the tire's sidewall. These Tire Quality Grades are determined by standards that the United States Department of Transportation has set.

Tire Quality Grades apply to new pneumatic tires for use on passenger cars. They do not apply to deep tread, winter-type snow tires, space-saver or temporary use spare tires, tires with nominal rim diameters of 10 to 12 inches or limited production tires as defined in Title 49 Code of Federal Regulations Part 575.104(c)(2).

**U.S. Department of Transportation — Tire quality grades:** The U.S. Department of Transportation requires Ford to give you the following information about tire grades exactly as the government has written it.

### **Treadwear**

The treadwear grade is a comparative rating based on the wear rate of the tire when tested under controlled conditions on a specified government test course. For example, a tire graded 150 would wear one and one-half (1 1/2) times as well on the government course as a tire graded 100. The relative performance of tires depends upon the actual conditions of their use, however, and may depart significantly from the norm due to variations in driving habits, service practices and differences in road characteristics and climate.

## Traction A B C

The traction grades, from highest to lowest, are A, B, and C, and they represent the tire's ability to stop on wet pavement as measured under controlled conditions on specified government test surfaces of asphalt and concrete. A tire marked C may have poor traction performance.

 <b>WARNING</b>
<b>The traction grade assigned to this tire is based on braking (straightahead) traction tests and does not include cornering (turning) traction.</b>

## Temperature A B C

The temperature grades are A (the highest), B, and C, representing the tire's resistance to the generation of heat and its ability to dissipate heat when tested under controlled conditions on a specified indoor laboratory test wheel. Sustained high temperature can cause the material of the tire to degenerate and reduce tire life, and excessive temperature can lead to sudden tire failure. The grade C corresponds to a level of performance which all passenger car tires must meet under the Federal Motor Vehicle Safety Standard No. 109. Grades B and A represent higher levels of performance on the laboratory test wheel than the minimum required by law.

**⚠ WARNING**

**The temperature grade for this tire is established for a tire that is properly inflated and not overloaded. Excessive speed, underinflation, or excessive loading, either separately or in combination, can cause heat buildup and possible tire failure.**

**⚠ WARNING**

**Driving too fast for conditions creates the possibility of loss of vehicle control. Driving at very high speeds for extended periods of time may result in damage to vehicle components.**

### **Snow Tires and Chains**

The tires on your vehicle have all-weather treads that provide traction in rain or snow. However, during the winter months in some climates, you may need to use snow tires and occasionally chains for your tires.

**⚠ WARNING**

**Snow tires must be the same size and grade as the tires you currently have on your vehicle.**



Use chains on the tires only in an emergency or if the law requires them where you live. If you choose to use chains on your vehicle's tires, be aware of the following:

- Make sure the chains are the right size for your tires. Use only SAE Class "S" chains. Other types may damage your vehicle.
- Put the chains on tightly with the ends held down securely. Verify that no chain touches any wiring, brake lines, or fuel lines. Follow the chain manufacturer's instructions.
- Drive slowly. If you can hear the chains rub or bang against your vehicle, stop the vehicle and tighten the chains. If you continue to hear the chains rub or bang against your vehicle, remove the chains to prevent damage to your vehicle.
- Avoid fully loading your vehicle if possible.
- Remove tire chains at the first opportunity after using them on snow and ice. Do not use the chains on dry roads.

## Filling the Fuel Tank

The fuel filler door is outside the vehicle on the driver's side near the back. To fill the fuel tank:

1. After opening the fuel filler door, remove the cap carefully and slowly by turning it counterclockwise 1/2 to 3/4 turn.

<b>⚠ WARNING</b>
<b>The fuel system may be under pressure. If the fuel cap is venting vapor or if you hear a hissing sound, wait until it stops before completely removing the cap.</b>

2. Put the nozzle all the way inside the fuel filler pipe before pumping the fuel.

**NOTE: If you spill any fuel on the body of your vehicle, clean it off immediately. The fuel may dull or soften the paint if you do not wash it off.**

3. Replace the fuel cap completely when you are finished. Turn it clockwise 1/4 turn until it is tight. It will click when it is fully tightened.
4. Push the fuel door closed.

**⚠ WARNING**

**If you do not use the proper fuel cap, the pressure in the fuel tank can damage the fuel system or cause it to work improperly in a collision.**

**NOTE: If you replace your fuel cap with an aftermarket fuel filler cap, the customer warranty may be void for any damage to the fuel tank and/or fuel system.**

### **Choosing the Right Fuel**

Use only UNLEADED FUEL. The use of leaded fuel is prohibited by law and could damage your vehicle. The damage may not be covered by your warranty.

Your vehicle was not designed to use fuel containing manganese-based additives such as MMT. Additionally, vehicles certified to California emission standards (indicated on the underhood Vehicle Emissions Control Information label) are designed to operate on California reformulated gasolines. If California reformulated gasoline is not available when you

refuel, your vehicle can be operated on non-California fuels. However, even though your engine will perform adequately on other gasolines, the performance of the emission control devices and systems may be adversely affected. Repair of damage caused by using a fuel that your vehicle was not designed for may not be covered by your warranty.

### ***Octane recommendation***

**Your vehicle is designed to use regular gasoline with an (R+M)/2 octane rating of 87. We do not recommend gasolines labeled as “regular” in high altitude areas that are sold with octane ratings of 86 or even less.**

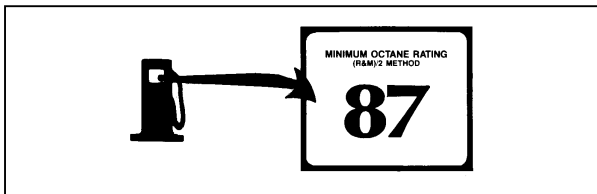

Do not be concerned if your vehicle sometimes knocks lightly. However, if it knocks heavily under most driving conditions on the recommended octane fuel, see your dealer or a qualified service technician to prevent any engine damage.

### ***Fuel quality***

If you are experiencing starting, rough idle or hesitation problems try a different brand of fuel. If the condition persists, see your dealer or a qualified service technician.

The American Automobile Manufacturers Association (AAMA) issued a gasoline specification to provide information on high quality fuels that optimize the performance of

your vehicle. We recommend the use of gasolines that meet the AAMA specification if they are available.

It should not be necessary to add any aftermarket products to your fuel tank if you continue to use a high-quality fuel.

### ***Clean air***

Ford approves the use of gasolines to improve air quality, including reformulated gasolines that contain oxygenates such as a maximum of 10% ethanol or 15% MTBE. There should be no more than 5% methanol with cosolvents and additives to protect the fuel system.

### **Safety Information Relating to Automotive Fuels**

 <b>WARNING</b>
--

<b>Automotive fuels can cause serious injury or death if misused or mishandled.</b>
---

- Turn vehicle off when refueling.
- Do not smoke when refueling. Fuels are extremely flammable.
- Do not siphon any fuel by mouth.

 <b>WARNING</b>
--

<b>Gasoline or gasoline blended with methanol can cause blindness and possible death when swallowed. If any fuel is swallowed, call a physician or poison control center immediately.</b>
---

- Avoid breathing vapors while refueling.
- If fuel is splashed on the skin, wash with soap and water.

- If fuel is splashed in the eyes, remove contact lenses (if worn), flush with water for 15 minutes, and seek medical attention.

Gasoline and gasoline blends may contain small amounts of carcinogens, such as benzene. Long-term exposure to unleaded gasoline vapors has caused cancer in laboratory animals.

If you are taking the medication “Antabuse” or other forms of disulfiram for the treatment of alcoholism, vapor or skin contact with a gasoline-methanol blend may cause the same kind of adverse reaction as drinking an alcoholic beverage. In sensitive individuals, serious personal injury or sickness could result. Consult a physician promptly if you experience an adverse reaction.

### **Running Out of Fuel**

**NOTE: Avoid running out of fuel because this situation may have an adverse effect on modern powertrain components.**

You may need to crank the engine several times before the fuel system starts to pump fuel from the tank to the engine.

### **Calculating Fuel Economy**

Fuel economy is an estimate of the efficiency of your vehicle, and can be calculated as Miles Per Gallon (MPG) or Liters Per 100 Kilometers (L/100K).

Do not calculate fuel economy during your vehicle’s break-in period. This would not be an accurate estimate of how much fuel your vehicle will normally use.

To calculate fuel economy:

1. Fill the fuel tank completely and record the initial odometer reading.
2. Every time you buy fuel, record the amount (in gallons or liters) purchased.
3. After at least 3-5 tankfuls, fill the fuel tank and record the final odometer reading.
4. Use these equations to calculate your fuel economy:

English:  $\text{MPG} = (\text{total miles driven}) \div (\text{gallons used})$

Metric:  $\text{L}/100\text{k} = (\text{liters used}) \div (100 \text{ kilometers})$

### **Comparisons With EPA Estimates**

EPA fuel economy figures are obtained from laboratory tests under simulated road conditions and may not reflect the actual conditions you experience or your style of driving. The EPA fuel economy estimate is not a guarantee that you will achieve the fuel economy shown.

The following decrease fuel economy:

- Lack of regular, scheduled maintenance
- Rapid acceleration and excessive speed
- Driving with your foot on the brake
- Sudden stops
- Extended engine idling
- Using speed control in hilly terrain

- Extended use of the A/C, defroster, rear window defroster and other accessories
- Underinflated tires
- Heavy loads
- Aftermarket add-ons such as bike, ski or luggage racks, bug deflectors, etc.

### **Self-Service Pointers**

If you choose to do your own fueling, you should also perform a few simple maintenance routines. This extra effort will save you additional money and contribute to the driving efficiency of your vehicle.

The following procedures require only a tire gauge, a rag, an oil can spout and windshield washer fluid.

- Check the engine oil at every refueling stop
- Clean the windshield, outside mirrors and headlights
- Check windshield washer fluid
- Check tires for excessive wear or worn edges
- Check the tire pressure at least monthly

## Emission Control System

Your vehicle is equipped with a catalytic converter which enables your vehicle to comply with applicable exhaust emission requirements.

### WARNING

**Exhaust leaks may result in the entry of harmful and potentially lethal fumes into the passenger compartment. Under extreme conditions excessive exhaust temperatures could damage the fuel system, the interior floor covering, or other vehicle components, possibly causing a fire.**

To make sure that the catalytic converter and the other emission control parts continue to work properly:

- Use only unleaded fuel.
- Avoid running out of fuel.
- Do not turn off the ignition while your vehicle is moving, especially at high speeds.
- Do not push start your vehicle.
- Have the services listed in the *Maintenance Schedule* booklet performed according to the specified schedule. The scheduled maintenance services are required because they are considered essential to the life and performance of your vehicle and to its emissions system.

In general, maintenance, replacement, or service of the emissions control devices or systems in your new Ford Motor Company vehicle or engine may be performed at your expense by



any automotive repair establishment or individual using automotive parts equivalent to those which your vehicle or engine was originally equipped.

Ford strongly recommends the use of genuine Ford replacement parts. If other than Ford or Motorcraft parts or Ford authorized remanufactured parts are used for maintenance replacements or for the service of components affecting emission control, such non-Ford parts should be equivalent to genuine Ford Motor Company parts in performance and durability. It is the owner's responsibility to determine the equivalency of such parts. Please consult your warranty booklet for complete warranty information.

 **WARNING**

**Do not park, idle, or drive your vehicle in dry grass or other dry ground cover. The emission system heats up the engine compartment and exhaust system, which can start a fire.**

Watch for fluid leaks, strange odors, smoke, loss of oil pressure, the charge warning light, the check engine light, or the temperature warning light. These sometimes indicate that the emission system is not working properly.

Do not make any unauthorized changes to your vehicle or engine. Changes that cause more unburned fuel to reach the exhaust system can increase the temperature of the engine or exhaust system.

By law, anyone who manufactures, repairs, services, sells, leases, trades vehicles, or supervises a fleet of vehicles is not permitted to intentionally remove an emission control device or prevent it from working. In some of the United States and in Canada, vehicle owners may be liable if their emission control device is removed or is prevented from working.

Never use a metal exhaust collector when you service your vehicle. If the metal collector contacts any of your vehicle's plastic trim or bumper parts they could melt or deform.

Do not drive your vehicle if it does not operate properly. See your dealer if the engine runs on for more than five seconds after you shut it off or if it misfires, surges, stalls, or backfires.

Information about your vehicle's emission control system is on the Vehicle Emission Control Information decal located on or near the engine. This decal identifies engine displacement and gives some tune-up specifications.

### **How to Prepare Your Vehicle for Inspection/Maintenance (I/M) Testing**

In some localities it may become a legal requirement to pass an Inspection/Maintenance (I/M) test of the On-Board Diagnostic (OBD) II system. If the vehicle's powertrain system or its battery has just been serviced, the OBD II system is reset to a not ready for I/M testing condition. To prepare for I/M testing, the law specifies that additional city and highway driving is necessary to complete the check of the OBD II system.

The driving modes required to reach the ready condition consist of a minimum of 30 minutes of city and highway driving as described below:

- At least twenty minutes driving in stop and go, city type traffic with at least four idle periods.
- At least ten minutes of driving on an expressway or highway.

Before completing the above driving modes, the engine must be warmed up and at operating temperature. Once started, the vehicle must not be turned off during these driving modes.

## **Lights and Bulb Replacement**

It is a good idea to check the operation of the following lights frequently:

- headlamps
- tail lamps
- brakelamps
- hazard flasher
- high-mount brakelamp
- turn signals
- side markers
- license plate lamps

The alignment of your headlamps should be checked if:

- oncoming motorists frequently signal you to turn off your vehicle's high beams when you do not have the high beams on
- the headlamps do not seem to give you enough light to see clearly at night

- the headlamp beams are pointed substantially away from a position slightly down and to the right

## Headlamp Bulb

The headlamps on your vehicle use replaceable bulbs. When the lamp burns out, simply replace the bulb, rather than the whole lamp.

### WARNING

**Handle a halogen headlamp bulb carefully and keep out of children's reach. Grasp the bulb only by its plastic base and do not touch the glass. The oil from your hand could cause the bulb to break the next time the headlamps are operated.**

Do not remove the burned-out bulb unless you can immediately replace it with a new one. If a bulb is removed for an extended period of time, contaminants may enter the headlamp housing and affect its performance.

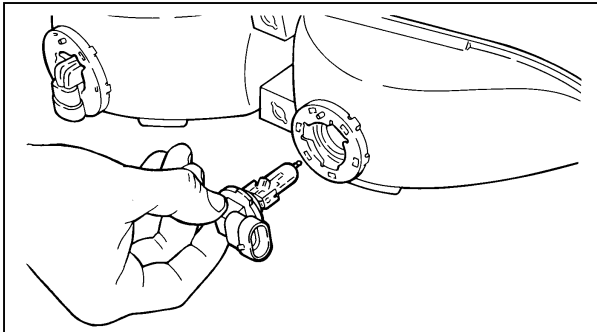

**Headlamp bulb removal**

### ***Removing the headlamp bulb***

1. Make sure that the headlamp switch is in the OFF position.
2. Lift the hood, open access panel above headlamp and find the bulb in the headlamp socket.
3. Remove the electrical connector by pulling off the bulb base.
4. Remove the bulb by turning it 1/4 of a turn to free it from the socket.

### ***Installing the headlamp bulb***

1. Insert the glass envelope of the bulb into the socket while aligning the locking tabs.
2. Rotate the bulb 1/4 turn to lock.
3. Push the electrical connector into the rear of the plastic base until it snaps, locking it into position.
4. Close the access panel.

### **High-Mount Brakelamp Bulbs**

Your vehicle has a brakelamp mounted in the rear window, called a high-mount brakelamp. You may need to remove this lamp at times to replace the brakelamp bulb or to clean the rear window.

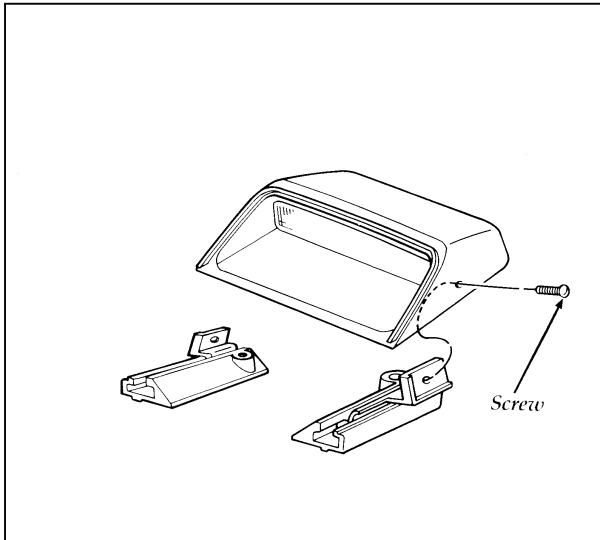

**Parts of the high-mount brakelamp**

To **remove** the high-mount brakelamp:

1. Remove the two retaining screws with a Phillips screwdriver.
2. Then lift the whole assembly up and over the retaining brackets. Do not move upper part of plastic attachment brackets.
3. Twist socket counterclockwise to remove from lamp.
4. Pull bulb out of socket.
5. Replace the burned out bulbs.

To **install** the high-mount brakelamp:

1. Position the brakelamp over the retaining brackets.
2. Install and tighten the two retaining screws.

## Using the Right Bulbs

Function	Trade number
<b>Exterior lights front</b>	
Headlamps lo beam	9006
Headlamps hi beam	9005
Parklamp, turnlamp and side marker	3157NAK*
Cornering lamp (opt.)	3156K
<b>Exterior lights rear</b>	
Tail, stop, turn and side marker	3157K
Backup lamp	3156K
License plate lamp	168
High-mounted brakelamp	912
<b>Interior lights</b>	
Luggage compartment lamp	906
Dome lamp	906
Dome/map lamp (opt.)	
Dome	906
Map	168
Sun visor lighted mirror (opt.)	194
Visor vanity lamp	168
Dual floorwell lamps	906
<b>Instrument panel</b>	
Glove compartment	194
Radio illumination	**
Cluster — standard	
Warning lamps	194
Illumination	194
Cluster — electronic	***
PRN <sup>®</sup> 21	***

\* NA means Natural Amber

\*\*Refer bulb replacement to a Ford authorized radio service center.

\*\*\*Refer bulb replacement to a Ford or Lincoln-Mercury dealer.

## **Cleaning Your Vehicle**

Pollen, bird droppings and tree sap can damage the paint, especially in hot weather. Wash your vehicle as often as necessary to keep it clean.

Take similar precautions if your vehicle is exposed to chemical industrial fallout.

Paint damage resulting from fallout is not related to a defect in paint materials or workmanship and therefore is not covered by warranty. Ford, however, believes that continual improvement in customer satisfaction is a high priority. For this reason, Ford has authorized its dealers to repair, at no charge to the owner, the surfaces of new vehicles damaged by environmental fallout within 12 months or 12,000 miles (20,000 km) of purchase, whichever comes first. Customers may be required to bring their vehicle in for inspection by a Ford representative.

## **Washing and Polishing Your Vehicle**

Wash the outside of your vehicle, including the underside, with a mild detergent.

DO NOT:

- Wash your vehicle with hot water
- Wash your vehicle while it sits in direct sunlight
- Wash your vehicle while the body is hot

Polish your vehicle to remove harmful deposits and protect the finish.



## **Cleaning Chrome and Aluminum Parts**

Wash chrome and aluminum parts with a mild detergent. Do not use steel wool, abrasive cleaners, fuel, or strong detergents.

## **Cleaning Plastic Parts**

Some of your vehicle's exterior trim parts are plastic. Clean with a tar and road oil remover if necessary. Use a vinyl cleaner for routine cleaning.

Do not clean plastic parts with thinners, solvents or petroleum-based cleaners.

If you have your vehicle rustproofed, remove oversprayed rustproofing with a tar and road oil remover. If rustproofing is not removed from plastic and rubber parts, it can cause deterioration.

## **Cleaning the Safety Belts**

Clean the safety belts with any mild soap solution that is recommended for cleaning upholstery or carpets. Do not bleach or dye the belt webbing because this may weaken it.

## **Cleaning the Exterior Lamps**

Do not use dry paper towel, chemical solvents or abrasive cleaners to clean the lamps, as these may cause scratches or crack the lamps.

## **Cleaning the Interior Lamps**

Your interior dome lamps and map lamps are plastic and should be cleaned with a mild detergent diluted in water. Rinse them with clear water.

## **Cleaning the Instrument Panel Lens**

Clean the instrument panel lens with a soft cloth and a glass cleaner, such as Ford Ultra-Clear Spray Glass Cleaner, or equivalent. Do not use paper towel or any abrasive cleaner to clean the lens as these may cause scratches.

## **Cleaning the Seats**

### ***Leather and vinyl***

For routine cleaning, wipe the surface with a soft, damp cloth. For more thorough cleaning, wipe the surface with a leather and vinyl cleaner or a mild soap.

### ***Fabric***

Remove dust and loose dirt with a whisk broom or a vacuum cleaner. Remove fresh spots immediately. Follow the directions that come with the cleaner.

**NOTE: Before using any cleaner, test it on a small, hidden area of fabric. If the fabric's color or texture is adversely affected by a particular cleaner, do not use it.**

## **Cleaning the Engine**

A clean engine is more efficient because a buildup of grease and dirt acts as an insulator, keeping the engine warmer than usual.

- Extreme care must be used if a power washer is used to clean the engine. The high pressure fluid could penetrate sealed parts and assemblies causing damage or malfunctions.
- In order to avoid possible cracking of the engine block or fuel injection pump, do not spray a hot engine or injection pump with cold water.

- The alternator, distributor and air intake must be covered. Covering these components will help prevent water damage.
- Never wash or rinse the engine while it is running. Water getting into the engine may cause internal damage.

### **Cleaning the Wheels**

Wash the wheels with the same detergent you use to wash your vehicle's body. Do not use acid-based wheel cleaners, steel wool, abrasives, fuel, or strong detergents. These substances will damage protective coatings. Use tar and road oil remover to remove grease and tar.

**NOTE: Before going to a car wash, find out if the brushes are abrasive.**

---

# Capacities and Specifications

---

## Refill Capacities, Motorcraft Parts, and Lubricant Specifications

### Motorcraft Parts

Component	Part Number
	4.6L SFI Engine
Spark plug*	AWSF-32PP
Air filter	FA-1032
Fuel filter	FG-800A
Oil filter	FL-820S
PCV valve	EV-98
Battery standard optional police option	BXT-59 BXT-65-650 BXT-65-850

\*Refer to Vehicle Emission Control Information (VECI) decal for spark plug and gap specifications.

If a spark plug is removed for examination, it must be reinstalled in the same cylinder.

**For 4.6L (2V) engines:**

Cylinders #1, #2, #3, #4 have a PG suffix.

Cylinders #5, #6, #7, #8 have a P suffix.

If a spark plug needs to be replaced, use only spark plugs with the service number suffix letter as shown on the engine decal.

## Fluid Specifications and Capacities

FLUID	FORD PART NAME	VEHICLE TYPE	CAPACITY
Brake Fluid	High Performance DOT 3 Brake Fluid	All	Fill to line in reservoir <sup>2</sup>
Engine Coolant (including heater)	Premium Cooling System Fluid	4.6L	14.1 qts (13.3L)
Engine Oil	Motorcraft Motor Oil 5W-30 Super Premium	4.6L	5.0 qts <sup>1</sup> (4.7L)
Fuel	N/A	All	20.0 gal (75.7L)
Power Steering Fluid	Motorcraft MERCON® ATF	With Cooler Without Cooler	2.6 pints (1.2L) 2.2 pints (1.1L)
Rear Axle	Motorcraft Premium Rear Axle Lubricant	Conventional and Traction-Lok <sup>3</sup> 8.8" ring gear	3.75 pints <sup>4</sup> (1.8L)
Transmissions Fluid Automatic	Motorcraft MERCON® ATF	Automatic Overdrive	13.9 qts (13.1L)
Windshield Washer	Ultra-Clear Windshield Washer Concentrate	All	Fill to top of reservoir <sup>2</sup>

1: Includes 1/2 qt for filter replacement

2: Refer to *Index* for refill instructions

3: For Traction-Lok add 4 oz. C8AZ-19B546-MA Friction Modifier, Ford Specification EST-M2C118-A for complete refill of rear axle.

4: Service refill capacities are determined by filling the rear axle 1/4 inch to 9/16 inch (6.4 mm to 14.2 mm) below bottom of filler hole.

**NOTE: Rear axle lube quantities must be replaced every 100,000 miles (160,000 km) or if the axle has been submerged in water. Otherwise, the lube should not be checked or changed unless a leak is suspected or repair required.**

## Lubricant Specifications

FLUID	FORD PART NAME OR EQUIVALENT	FORD PART NUMBER	FORD SPECIFICATION
Brake Fluid	High Performance DOT 3 Brake Fluid	C6AZ-19542-AA	ESA-M6C25-A
Engine Coolant	Premium Engine Coolant	E2FZ-19549-AA CXC-8-B*	ESE-M97B44-A
Engine Oil	Motorcraft Motor Oil 5W-30 Super Premium	XO-5W30-QSP	WSS-M2C153-F with API Certification Mark
Power Steering Fluid and	Motorcraft MERCON® ATF	XT-2-QDX	MERCON®
Transmissions Fluid	Motorcraft MERCON® ATF	XT-2-QDX	MERCON®
Windshield Washer Fluid	Ultra-Clear Windshield Washer Concentrate	C9AZ-19550-AA or BA	ESR-M17P5-A

\* Canada

**NOTE: Rear axle lube quantities must be replaced every 100,000 miles (160,000 km) or if the axle has been submerged in water. Otherwise, the lube should not be checked or changed unless a leak is suspected or repair required.**

# Vehicle Storage

## Maintenance Tips

If you plan on storing your vehicle for an extended period of time (60 days or more), refer to the following maintenance recommendations to ensure your vehicle stays in good operating condition.

### **General**

- Store all vehicles in a dry, ventilated place.
- Protect from sunlight, if possible.
- If vehicles are stored outside, they require regular maintenance to protect against rust and damage.

### **Body**

- Wash vehicle thoroughly to remove dirt, grease, oil, tar or mud from exterior surfaces, rear wheel housing and underside of front fenders.
- Periodically wash vehicles stored in exposed locations.
- Touch-up raw or primed metal to prevent rust.
- Cover chrome and stainless steel parts with a thick coat of auto wax to prevent discoloration. Re-wax as necessary when the vehicle is washed.
- Lubricate all hood, door and trunk lid hinges and latches with a light grade oil.
- Cover interior soft trim to prevent fading.
- Keep all rubber parts free from oil and solvents.

### ***Engine***

- Start engine every 15 days. Run at fast idle until it reaches normal operating temperature.
- With your foot on the brake, shift through all the gears while the engine is running.

### ***Fuel system***

- Fill fuel tank with high-quality unleaded fuel until the first automatic shutoff of the fuel pump nozzle.

**NOTE: During extended periods of vehicle storage (60 days or more), fuel may deteriorate due to oxidation. This can damage rubber and other polymers in the fuel system and may also clog small orifices.**

Ford Gas Stabilizer should be added whenever actual or expected storage periods exceed 60 days. Follow the instructions on the label. The vehicle should then be operated at idle speed to circulate the additive throughout the fuel system.

### ***Cooling system***

- Protect against freezing temperatures.

### ***Battery***

- Check and recharge as necessary.
- Keep connections clean and covered with a light coat of grease.
- If storing your vehicle for more than 30 days without recharging the battery, it may be advisable to disconnect the battery cables to ensure battery charge is maintained for quick starting.



**NOTE: If battery cables are disconnected, it will be necessary to reset memory features.**

***Brakes***

- Make sure brakes and parking brake are fully released.

***Tires***

- Maintain recommended air pressure.

***Miscellaneous***

- Make sure all linkages, cables, levers and clevis pins under vehicle are covered with grease to prevent rust.
- Move vehicles at least 25 feet (8 m) every 15 days to lubricate working parts and prevent corrosion.

---

## **Reporting Safety Defects (U.S. Only)**

---

If you believe that your vehicle has a defect which could cause a crash or could cause injury or death, you should immediately inform the National Highway Traffic Safety Administration (NHTSA) in addition to notifying Ford Motor Company.

If NHTSA receives similar complaints, it may open an investigation, and if it finds that a safety defect exists in a group of vehicles, it may order a recall and remedy campaign. However, NHTSA cannot become involved in individual problems between you, your dealer, or Ford Motor Company.

To contact NHTSA, you may either call the Auto Safety Hotline toll-free at 1-800-424-9393 (or 366-0123 in the Washington, D.C. area) or write to: NHTSA, U.S. Department of Transportation, 400 Seventh Street, Washington D.C. 20590. You can also obtain other information about motor vehicle safety from the Hotline.

---

# Customer Assistance

---

## Roadside Assistance

Ford Motor Company has set up a 24-hour, seven-day-a-week hotline with trained operators who put you in touch with the help you need if you experience a problem with your vehicle. This complimentary service is provided to you throughout your warranty period of 3 years or 36,000 miles (60,000 km), whichever comes first. To purchase Roadside Assistance coverages beyond this period (available through Ford Auto Club in the United States or Ford and Lincoln-Mercury dealers in Canada), contact your Ford or Lincoln-Mercury dealer. Additional Roadside Assistance coverage is unavailable in Puerto Rico and the Virgin Islands.

Roadside Assistance will cover the following:

- Mount your spare if you have a flat tire.
- Jump-start your battery if it is dead.
- Unlock your vehicle if you are locked out.
- Bring you fuel if you run out.
- Tow your vehicle if you are stranded. Even non-warranty related tows, like accidents or getting stuck in mud or snow, are covered (some exclusions apply, such as impound towing and repossession).

## **How to use Roadside Assistance**

Your Roadside Assistance identification card can be found in the Owner Guide portfolio in your glove compartment. Complete the card and place it in your wallet for quick reference.

To receive roadside assistance in the United States call 1-800-241-FORD (in Canada call 1-800-665-2006).

Should you need to arrange for roadside assistance yourself, Ford Motor Company will reimburse the reasonable cost. To obtain information about reimbursement call 1-800-241-FORD (in Canada call 1-800-665-2006).

## **If You Have a Service Problem**

Ford Motor Company has authorized Ford and Lincoln-Mercury dealerships that can service your vehicle for you. This chapter tells you how to get service or maintenance for your vehicle.

### **Service/Maintenance Concerns (U.S. or Canada)**

Ford recommends taking your vehicle to your selling dealer who wants to ensure your continued satisfaction. You may, however, take your vehicle to any authorized Ford or Lincoln-Mercury dealer. In most cases, your dealer will be able to resolve your concern.

If you are not satisfied with the service you received from your dealership's service department, talk to the service manager at the dealership, or if you still are not satisfied, talk to the owner or general manager of the dealership. In most cases, you will have your concern resolved at this level.

If you are away from home when your vehicle needs to be serviced, or if you need more help than the dealer gave you, contact the Ford Customer Assistance Center to find an authorized dealership that may be able to help.

In the U.S., contact:

*Ford Motor Company  
Customer Assistance Center  
300 Renaissance Center  
P.O. Box 43360  
Detroit, Michigan 48243  
1-800-392-3673 (FORD)  
TDD for the hearing impaired: 1-800-232-5952*

If you live in Canada and have any questions or concerns that the dealership cannot answer, contact the Customer Assistance Centre.

*Customer Assistance Centre  
Ford Motor Company of Canada, Limited  
P.O. Box 2000  
Oakville, Ontario L6J 5E4  
1-800-565-3673 (FORD)*

Please have the following information available when contacting Ford Customer Assistance:

- your telephone number (both business and home)
- the name of the dealer and the city where the dealership is located
- the year and make of your vehicle
- the date purchased

- the current mileage on your vehicle
- your Vehicle Identification Number (VIN) listed on your vehicle ownership license

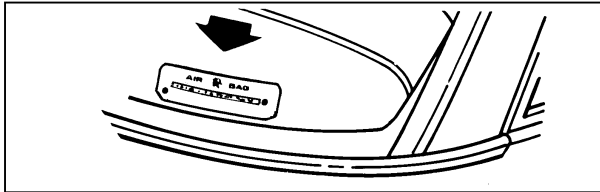

#### Vehicle Identification Number (VIN/Serial Number)

If you still have a complaint involving a warranty dispute, you may wish to contact the Dispute Settlement Board (U.S. only) or the Canadian Motor Vehicle Arbitration Plan (CAMVAP) in Canada.

A warranty dispute must be submitted to the Dispute Settlement Board before taking action under the Magnuson-Moss Warranty Act, or to the extent allowed by state law, before pursuing replacement or repurchase remedies provided by certain state laws. This dispute handling procedure is not required prior to enforcing state created rights or other rights which are independent of the Magnuson-Moss Warranty Act or state replacement or repurchase laws.

### **The Dispute Settlement Board (U.S. Only)**

The Dispute Settlement Board is:

- an independent, third-party arbitration program for warranty disputes
- available free to owners and lessees of qualifying Ford Motor Company vehicles

The Dispute Settlement Board may not be available in all states. Ford Motor Company reserves the right to change eligibility limitations, modify procedures and/or to discontinue this service without notice and without incurring obligations.

### **What Kind of Cases Does the Board Review?**

The Board reviews all warranty performance complaints on Ford, Mercury and Lincoln cars and Ford and Mercury light trucks under the new vehicle limited warranty that have not been resolved by either a dealer or Ford Motor Company, except those involving:

- a non-Ford product
- a non-Ford dealership
- a vehicle sales transaction
- request for reimbursement of consequential expenses. Expenses incidental to the warranty complaint being reviewed are eligible for consideration.
- items not covered by the new vehicle limited warranty
- items covered by a service contract
- alleged liability claims
- property damage where the damage is significant when compared to the economic loss alleged under the warranty dispute
- cases currently in litigation
- vehicles not used primarily for family, personal, or household purposes (except in states where the Dispute Settlement Board is required to review commercial vehicles)

Complaints involving vehicles in which applicable new vehicle limited warranties have expired at receipt of your application are not eligible. Eligibility may differ according to state law. For example, see the unique brochures for California and Wisconsin purchasers/lessees.

### **How does the Board Work?**

The Board consists of:

- three consumer representatives
- a Ford or Lincoln/Mercury dealer

Consumer candidates for Board membership are recruited and trained by an independent consulting firm. Dealers are chosen because of their business leadership qualities.

### ***What the Board needs***

To have your case reviewed you must complete the application in the DSB brochure and mail it to the address provided on the application form.

Your application is reviewed and, if it is determined to be eligible, you will receive an acknowledgment indicating:

- the file number assigned to your application
- the toll-free phone number of the DSB's independent administrator

Your dealership and a Ford Motor Company representative are asked to submit statements at this time.



To review your case properly, the Board needs the following information:

- legible copies of all documents and maintenance or repair orders relevant to the case
- the year, make, model, and Vehicle Identification Number (VIN) listed on your vehicle ownership license
- the date of repair(s) and mileage at the time of occurrence(s)
- the current mileage
- the name of the dealer who sold or serviced the vehicle
- a brief description of your unresolved concern
- a brief summary of the action taken with the dealer and Ford Motor Company
- the names (if known) of all the people you contacted at the dealership
- a description of the action you expect to resolve your concern

Should your case NOT qualify for review, a letter of explanation will be mailed to you.

### ***Oral presentations***

If the involved vehicle is within 36 months and 36,000 miles of the warranty start date, you have the right to make an oral presentation before the Board. Indicate your choice to do so on the application. Oral presentations may also be requested by the Board.

### ***Making a decision***

Board members will review all available information related to the complaint, including oral presentations, if necessary. They then arrive at a fair and impartial decision, decided by a simple majority vote.

Because the Board usually meets only once a month, some cases may take longer than 30 days to be reviewed. The Board makes every effort to resolve each case within 40 days of receiving the consumer application form.

After your case is reviewed, the Board mails you a decision letter. The Board also provides a form on which to accept or reject the Board's decision. The decisions of the Board are binding on the dealer and Ford, but not on consumers who may elect to pursue other remedies available to them under state or federal law. Decisions of the Board may be presented as evidence by any party in subsequent legal proceedings that may be initiated, where allowed by law.

### **To Request a DSB Brochure/Application**

For a brochure/application, speak to your dealer or write to the Board at the following address:

*Dispute Settlement Board  
P.O. Box 5120  
Southfield, MI 48086-5120*

## **Ford of Canada Customer Assistance**

### **Ford Motor Company of Canada, Limited**

If you live in Canada and have any questions or concerns that the dealership cannot answer, contact the Customer Assistance Centre.

*Customer Assistance Centre  
Ford Motor Company of Canada, Limited  
P.O. Box 2000  
Oakville, Ontario L6J 5E4  
1-800-565-3673 (FORD)*

### **Mediation/Arbitration Program (Canada Only)**

In those cases where you continue to feel that the efforts by Ford and the dealer to resolve a factory-related vehicle service concern have been unsatisfactory, Ford of Canada participates in an impartial third party mediation/arbitration program administered by the Canadian Motor Vehicle Arbitration Plan (CAMVAP).

The CAMVAP program is a straight-forward and relatively speedy alternative to resolve a disagreement when all other efforts to produce a settlement have failed. This procedure is without cost to you and is designed to eliminate the need for lengthy and expensive legal proceedings.

In the CAMVAP program, impartial third-party Arbitrators conduct hearings at mutually convenient times and places in an informal environment. These impartial Arbitrators review the positions of the parties, make decisions and, where appropriate, render awards to resolve

disputes. CAMVAP decisions are fast, fair and final as the arbitrator's award is binding on both you and Ford of Canada.

CAMVAP services are available in all territories and provinces, except Quebec. For more information, without charge or obligation, call your CAMVAP Provincial Administrator directly at 1-800-207-0685.

## **Getting Help Outside the U.S. and Canada**

Before you export your vehicle to a foreign country, contact the appropriate foreign embassy or consulate to make sure local regulations do not prevent you from registering your vehicle. Officials at the embassy can also help you decide whether you should import your vehicle to that country.

Officials at the embassy or consulate can tell you where to get unleaded fuel. If you cannot get unleaded fuel or can get only fuel with an anti-knock index that is lower than your vehicle needs, contact a district or owner relations office before you leave the U.S. or Canada.

Use of leaded fuel in your vehicle without a proper conversion may damage the effectiveness of your emissions control system and may cause engine knocking or serious engine damage. Ford Motor Company is not responsible for any damage that is caused by use of improper fuel.

You may also have difficulty importing your vehicle back into the U.S. if you use leaded fuel.

If your vehicle must be serviced while you are traveling or living in Central or South America, the Caribbean, or the Middle East, contact the nearest Ford dealership. If the dealership cannot help you, write to:

*FORD MOTOR COMPANY  
WORLDWIDE EXPORT OPERATIONS  
1555 Fairlane Drive  
Fairlane Business Park #3  
Allen Park, Michigan 48101 U.S.A.  
Telephone: (313) 594-4857  
Fax: (313) 390-0804*

If you are in other foreign countries, contact the nearest Ford dealership. If the dealership cannot help you, they can direct you to the appropriate Ford affiliate office.

If you buy your vehicle in North America and then relocate outside of the U.S. or Canada, register your Vehicle Identification Number and new address with Ford Motor Company Export Operations.

---

# Accessories

---

## Ford Accessories for Your Vehicle

Ford has many fine products available from your dealer to clean your vehicle and protect its finishes. For best results, use the following, or products of equivalent quality:

- Ford Custom Clear Coat Polish
- Ford Custom Silicone Gloss Polish
- Ford Custom Vinyl Protectant
- Ford Deluxe Leather and Vinyl Cleaner
- Ford Extra Strength Spot and Stain Remover
- Ford Extra Strength Tar and Road Oil Remover
- Ford Extra Strength Upholstery Cleaner
- Ford Extra Strength Whitewall Tire Cleaner
- Ford Multi-Purpose Cleaner
- Ford Premium Car Wash Concentrate
- Ford Triple Clean
- Ford Ultra-Clear Spray Glass Cleaner

A wide selection of accessories is available through your local authorized dealer. These fine accessories have been engineered specifically to fulfill your automotive needs. They are custom designed to complement the style and aerodynamic appearance of your Ford-built vehicle. In addition, each accessory is made from high quality materials and meets or exceeds Ford's rigid engineering and safety specifications. That is why Ford brand accessories are warranted for up to 12 months or 12,000 miles (20,000 km), whichever comes first. See your dealer for complete warranty information and accessory availability.

## **Safety, Comfort, and Convenience**

### **Safety**

Vehicle security system

### **Travel**

Heavy-duty battery

Multi-sport removable rack

– Bike adapter

– Ski/snowboard adapter

– Water sport adapter

Soft luggage cover

### **Comfort and convenience**

Engine block heater

### **Protection and appearance**

Cargo liner (soft)

Cargo net

Chemicals and paints

Door edge guards

Floor mats (carpeted)

Remote keyless entry system

Side window deflectors

Styled wheel protector locks

Super Seal fabric protector (in U.S. only)

Super Seal undercoating (in U.S. only)

**NOTE: When adding accessories, equipment, passengers, and luggage to your vehicle, do not exceed the total weight capacity of the vehicle or of the front or rear axle (GVWR, GAWR as shown on the Safety Compliance Certification Label). Consult your dealer for specific weight information.**

**NOTE:** The Federal Communications Commission (FCC) or in Canada the Canadian Radio Telecommunications Commission (CRTC) regulates the use of mobile communications systems — such as two-way radios, telephones, and theft alarms — that are equipped with radio transmitters. Any such equipment installed in your vehicle should comply with FCC regulation and should be installed only by a qualified technician.

**NOTE:** Mobile communications systems may harm the operation of your vehicle, particularly if they are not properly designed for automotive use or are not properly installed. For example, when operated, such systems may cause the engine to stumble or stall. In addition, such systems may themselves be damaged or their operation affected by operating your vehicle. (Citizens band [CB] transceivers, garage door openers, and other transmitters whose power output is 5 watts or less will not ordinarily affect your vehicle's operation.)

**NOTE:** Because we have no control over the installation, design, or manufacture of such systems, Ford cannot assume responsibility for any adverse effects or damage that may result if you use this equipment.



**FOR INFORMATION ON  
ORDERING SERVICE  
PUBLICATIONS, CONTACT:**

**U.S. RESIDENTS  
CALL  
HELM, INCORPORATED  
1-800-782-4356**

**Monday - Friday 8:00 A.M. - 6:30 P.M. EST  
For Credit Card Holder Orders Only**

---

**CANADIAN RESIDENTS  
CALL  
Ford Motor Company of Canada, Ltd.  
1-800-387-4966**

**Monday - Friday 8:00 A.M. - 6:30 P.M. EST  
For Credit Card Holder Orders Only**

**All rights reserved. Reproduction by any means, electronic or mechanical including photocopying, recording or by any information storage and retrieval system or translation in whole or part is not permitted without written authorization from Ford Motor Company.**

**Copyright © 1996 Ford Motor Company**

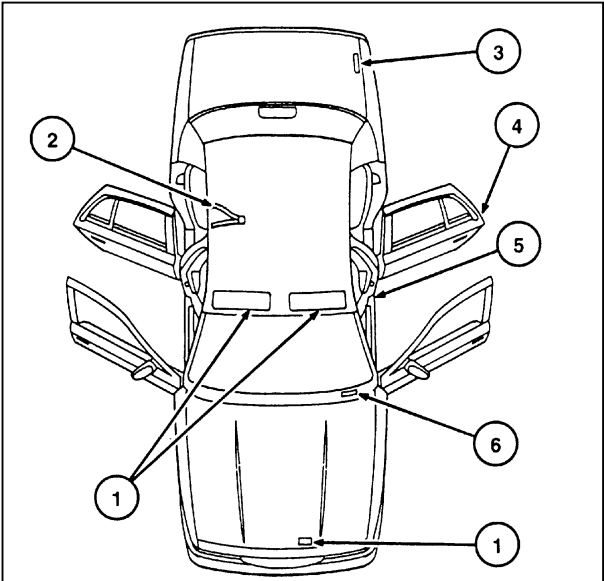

No.	Description	Refer to this label for information regarding:
1	Air Bag Warning Labels	Air bag precautions
2	Child Seat Label	Child seat installation precautions
3	Fuel Pump Shut-Off Label	Fuel pump shut off location
4	Child Proof Lock for the Rear Doors	How to set and release the child proof lock
5	Safety Compliance Certification Label	Name and date of manufacturer, GVWR*, GAWR**
6	Vehicle Identification Information Number (VIN) Label	Servicing or warranty information specific to your vehicle

\*Gross Vehicle Weight Rating

\*\*Gross Axle Weight Rating

**Label Locations**

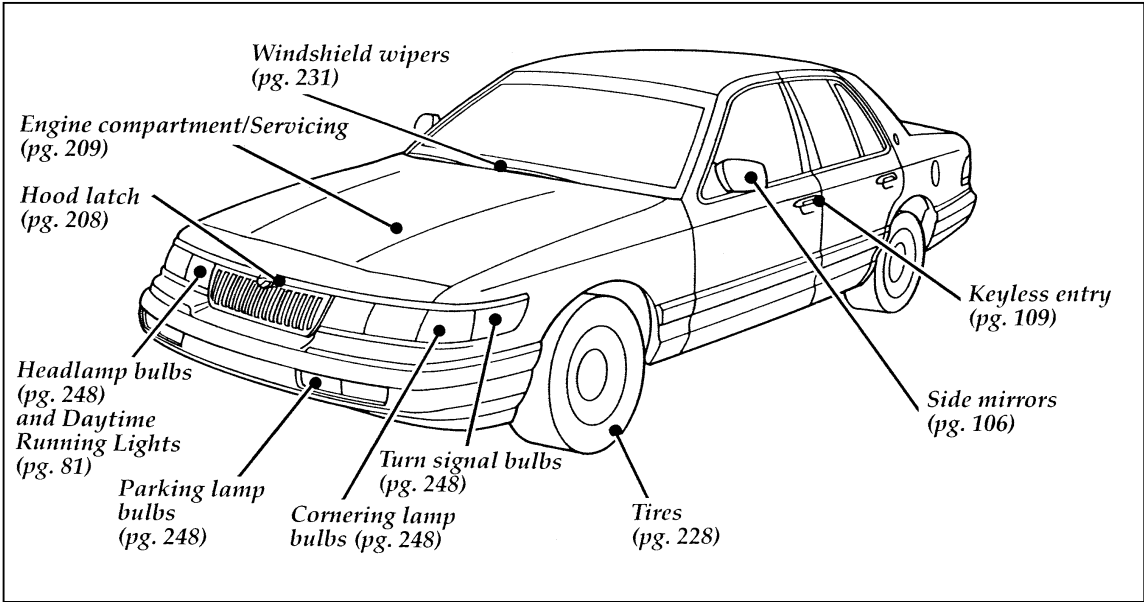

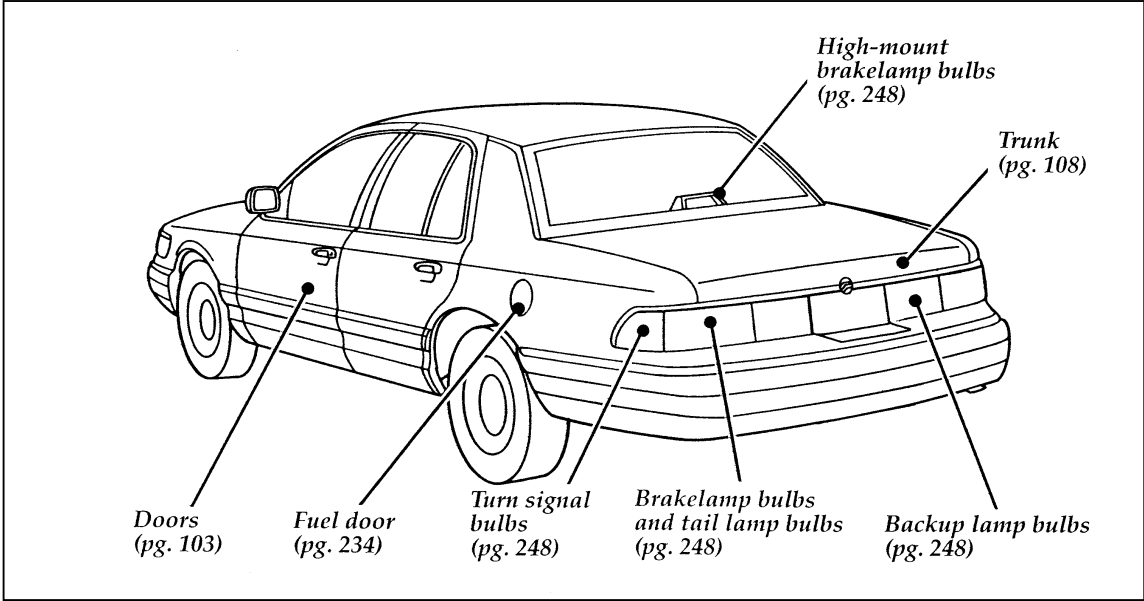

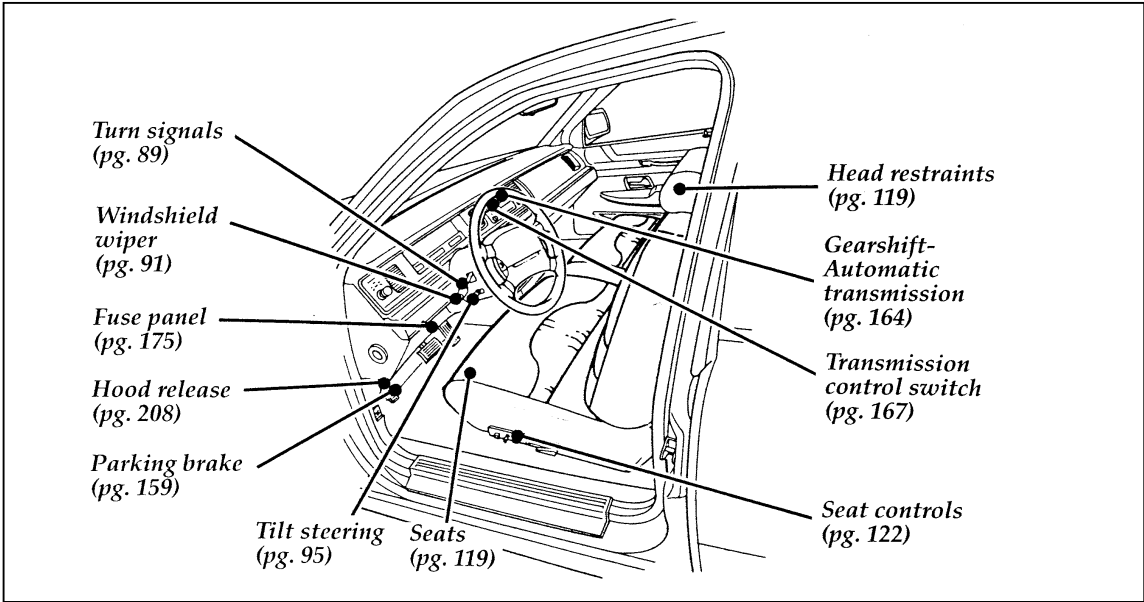

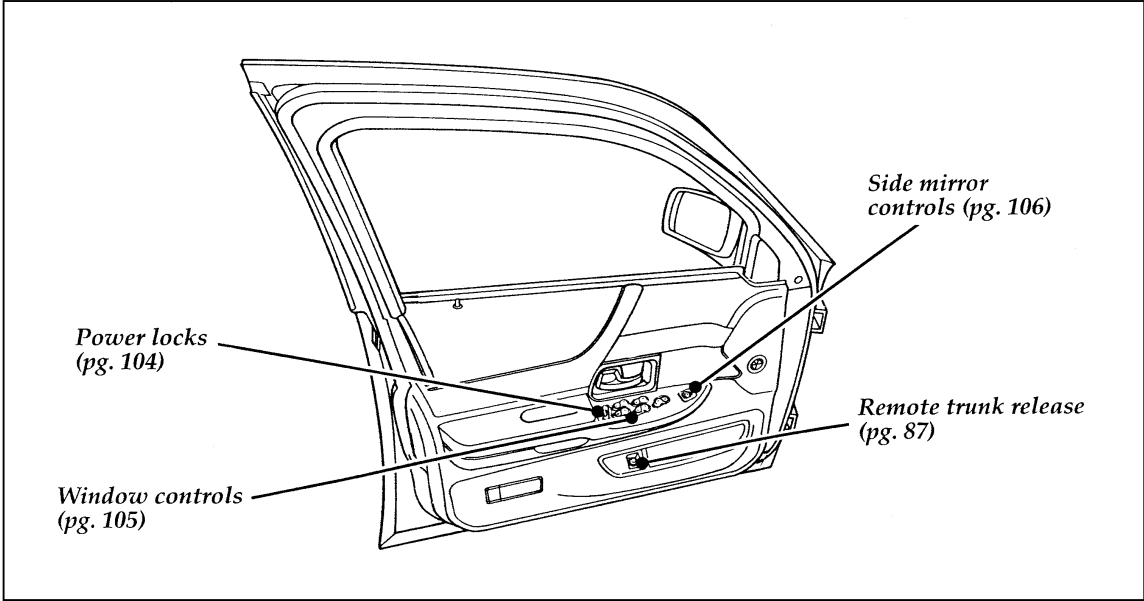

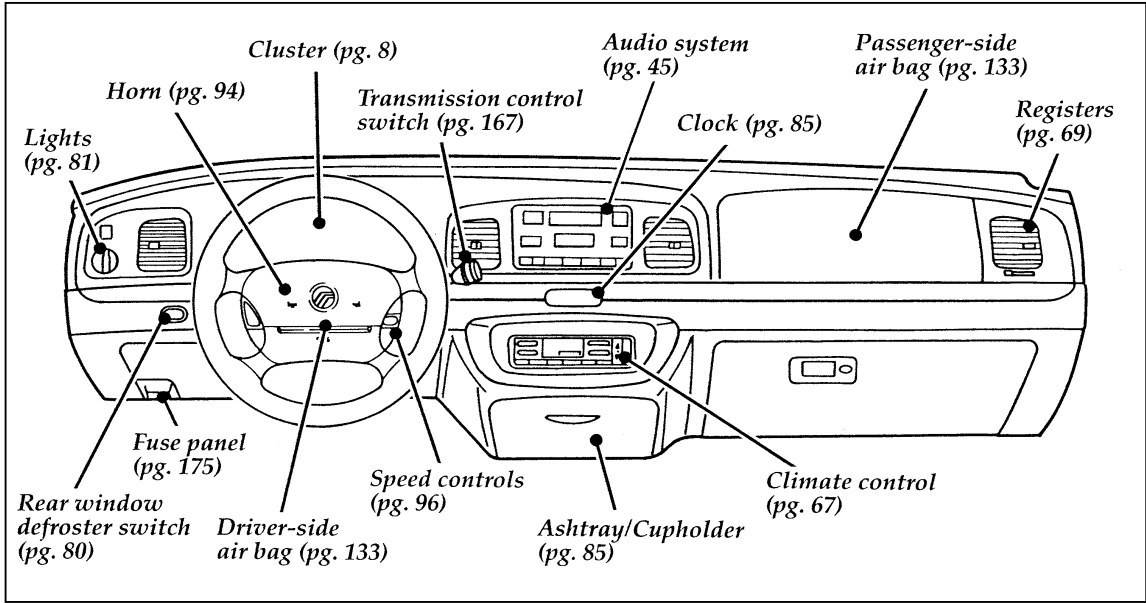

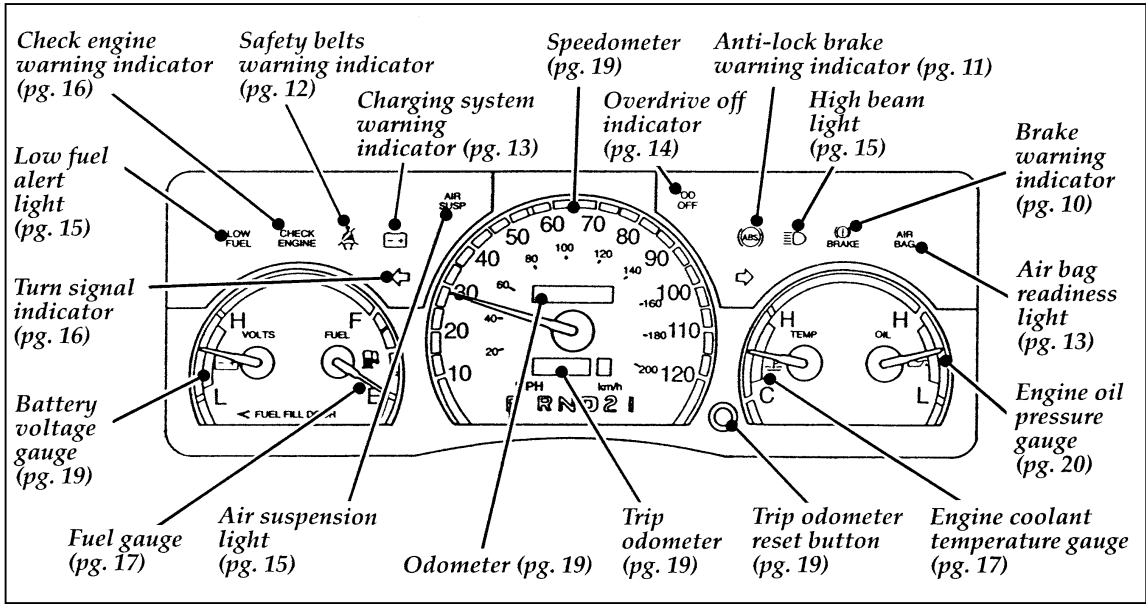



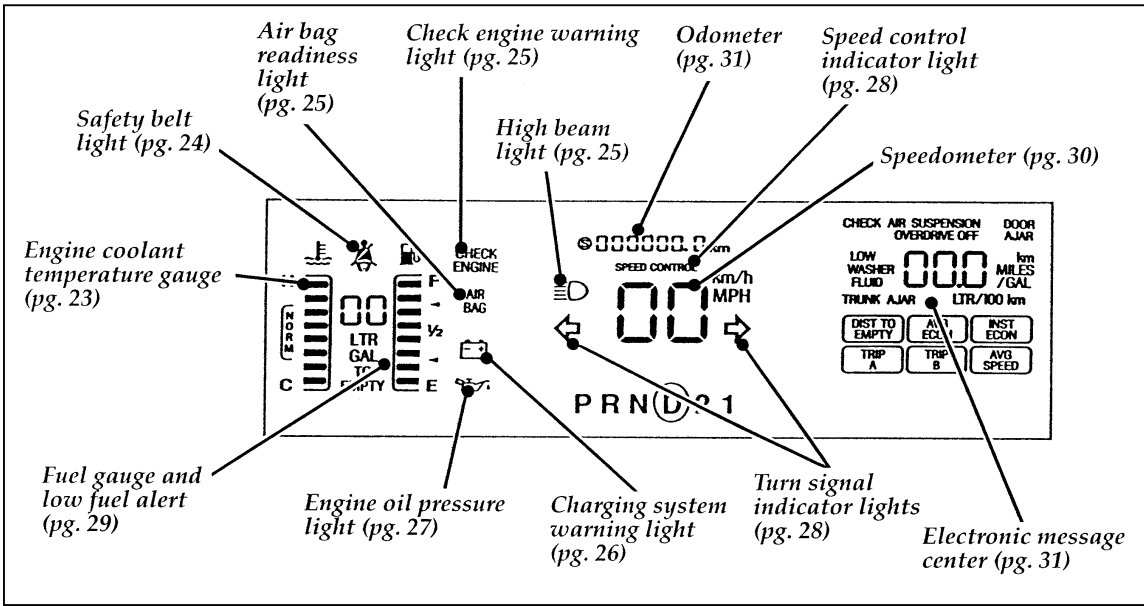

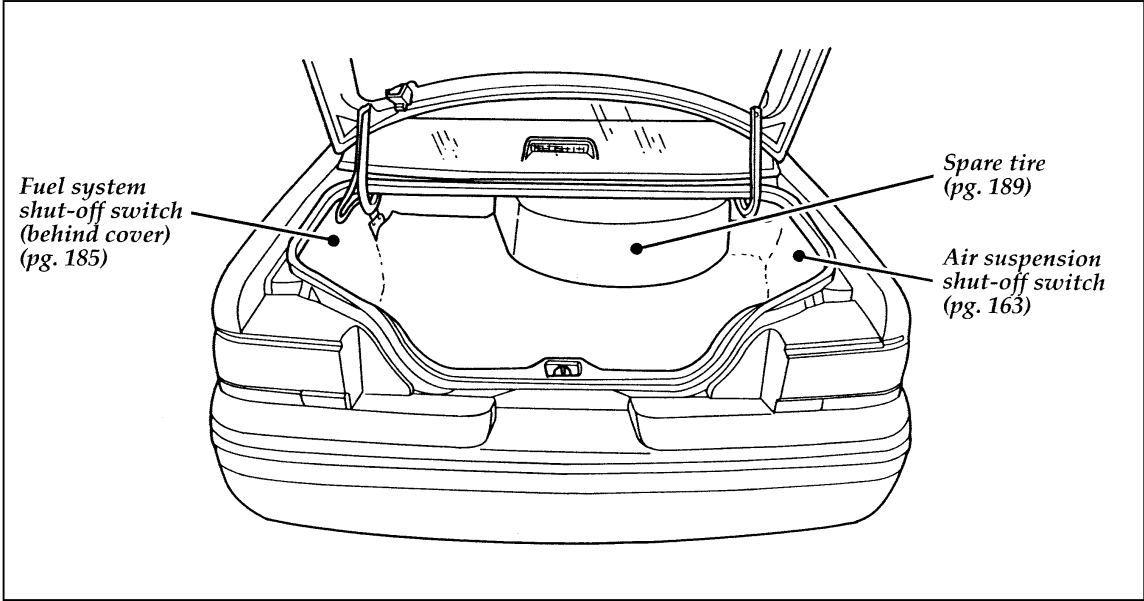

*Fuel system  
shut-off switch  
(behind cover)  
(pg. 185)*

*Spare tire  
(pg. 189)*

*Air suspension  
shut-off switch  
(pg. 163)*

4.6L Engine Compartment

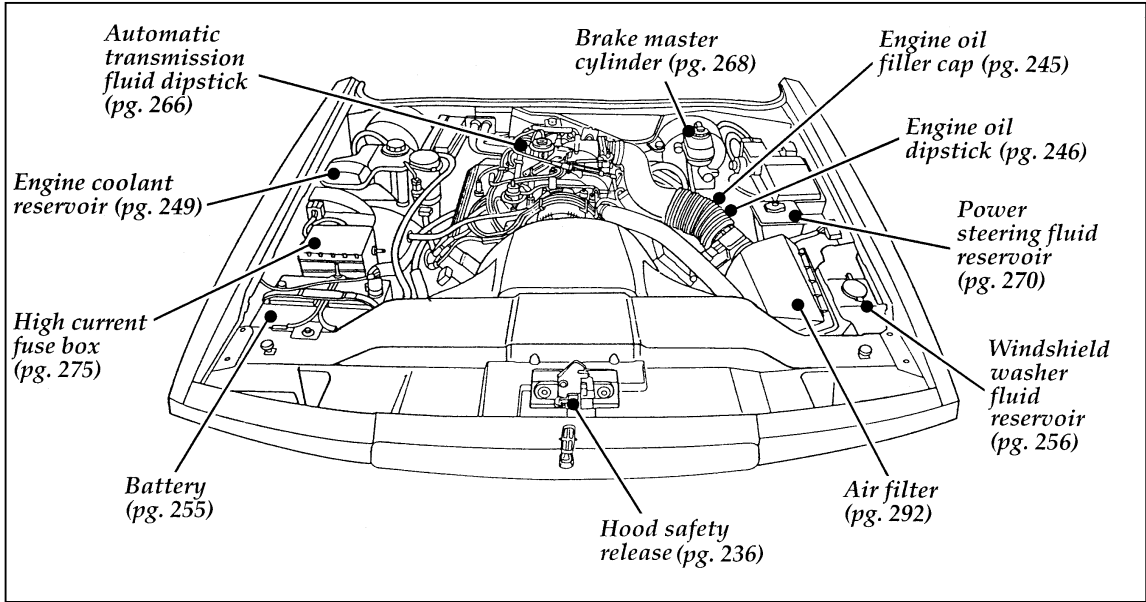

---

# Index

---

## A

- ABS warning light (see Anti-lock  
brake system) . . . . . 11, 41
- Accessory position on the ignition . . . . . 87
- Additives, engine oil . . . . . 211
- Air bag supplemental
  - restraint system. . . . . 133
  - and child safety seats . . . . . 139
  - description . . . . . 133
  - driver air bag . . . . . 133
  - indicator light . . . . . 13, 25
  - operation . . . . . 135
  - passenger air bag. . . . . 135
  - service and information labels . . . . . 135
  - tone generator . . . . . 137
- Air cleaner filter
  - location . . . . . 209
  - specifications . . . . . 253
- Air conditioning
  - electronic automatic temperature control  
system . . . . . 69
  - manual heating and air  
conditioning system . . . . . 67
- Air suspension
  - description . . . . . 163
  - see also Rear air suspension system . . . 163
- Alarm, activating remote personal . . . . . 115
- Aluminum wheels. . . . . 196
- Antenna, radio (see Electronic  
sound system) . . . . . 50
- Antifreeze (see Engine coolant). . . . . 217
- Anti-lock brake system (ABS)
  - description . . . . . 157
  - see also Brake . . . . . 157
  - warning light. . . . . 11, 41

Appeals (see Dispute settlement board) . . .	264
Ashtray(s) . . . . .	85
Assistance (see Customer assistance). . . .	261
Audio system (see Electronic sound system) . . . . .	45
Autolamp system (see Headlamps) . . . . .	81
Automatic transmission	
driving an automatic overdrive. . . . .	164
fluid, adding . . . . .	225
fluid, checking . . . . .	224
fluid, refill capacities . . . . .	254
fluid, specification. . . . .	255
Axle	
refill capacities . . . . .	254
traction lok. . . . .	161

## **B**

Basic vehicle warranty . . . . .	4
Battery . . . . .	226
acid, treating emergencies . . . . .	198
battery saver . . . . .	113
charging system warning light . . . . .	13, 26
disconnecting . . . . .	202, 227
how to service . . . . .	226
jumping a disabled battery. . . . .	198
maintenance-free . . . . .	226
proper disposal, recycling . . . . .	227
replacement, specifications . . . . .	253
servicing . . . . .	226
voltage gauge. . . . .	13
when storing your vehicle . . . . .	257
Brake fluid . . . . .	214
brake warning light . . . . .	10, 42
checking and adding . . . . .	214
description . . . . .	214
specifications . . . . .	214, 255

Brakelamp . . . . .	246
bulb replacement . . . . .	246, 248
high-mount brakelamp . . . . .	246
Brakes . . . . .	157
adjustment . . . . .	157
anti-lock . . . . .	157
anti-lock brake system (ABS)	
warning light . . . . .	11, 41
applying the brakes. . . . .	157
brake warning light. . . . .	10, 42
fluid, checking and adding . . . . .	214
fluid, refill capacities . . . . .	214, 254
fluid, specifications . . . . .	214, 255
front disc . . . . .	157
if brakes do not grip well . . . . .	157
master cylinder. . . . .	214
new brake linings. . . . .	6
noise . . . . .	157
parking . . . . .	159
power braking . . . . .	157
servicing. . . . .	214
when storing your vehicle. . . . .	258
Brake-shift interlock . . . . .	165
Break-in period . . . . .	6
Brights (high beams) . . . . .	15, 25
Bulbs, replacing. . . . .	244
halogen . . . . .	245
headlamps . . . . .	245
high-mount brakelamp . . . . .	246
specifications. . . . .	248

## C

Canada, customer assistance . . . . .	269
Canada, warranty information . . . . .	4
Canadian Motor Vehicle Arbitration Plan (CAMVAP). . . . .	269
Capacities for refilling fluids . . . . .	254
Carbon monoxide in exhaust. . . . .	155

Car seats for children (see Child safety seats) . . . . .	139
Cassette tape player (see Electronic sound system) . . . . .	50, 59
Catalytic converter. . . . .	241
Chains, tires . . . . .	233
Changing a tire . . . . .	187
Charging system warning light . . . . .	13, 26
Childproof locks. . . . .	103
Child safety restraints . . . . .	138
child safety belts . . . . .	149
child safety seats . . . . .	139
Child safety seats . . . . .	139
and air bags . . . . .	139
automatic locking mode (retractor) . . . . .	127, 139
in front seat . . . . .	139
in rear outboard seat . . . . .	139
in rear seat . . . . .	139
tether anchorage hardware. . . . .	149
Chime	
key in ignition . . . . .	88
safety belt . . . . .	12, 24
Circuit breakers	
checking and replacing . . . . .	184
see also fuses. . . . .	175
Cleaning your vehicle . . . . .	249
chrome and aluminum parts . . . . .	250
engine compartment. . . . .	251
exterior . . . . .	249
exterior lamps . . . . .	250
fabric . . . . .	251
headlamps . . . . .	250
instrument panel . . . . .	67, 250
instrument panel lens . . . . .	251
interior. . . . .	251
interior lamps. . . . .	250
mirrors. . . . .	106
plastic parts . . . . .	250
polishing. . . . .	249

Cleaning your vehicle (continued)	
rustproofing . . . . .	250
safety belts . . . . .	250
tail lamps . . . . .	250
upholstery and interior trim . . . . .	251
washing . . . . .	249
waxing . . . . .	249
wheels . . . . .	252
Climate control system . . . . .	67
air conditioning . . . . .	67, 69
electronic automatic temperature control. . . . .	69
heating . . . . .	67, 69
Clock . . . . .	85
Cold engine starting. . . . .	152
Combination lap and shoulder belts . . . . .	125
Controls	
mirrors . . . . .	99
power seat . . . . .	122
Coolant (see Engine coolant) . . . . .	217
checking and adding . . . . .	217
drain and flush. . . . .	221
preparing for storage . . . . .	257
refill capacities . . . . .	254
specifications . . . . .	255
temperature gauge . . . . .	17, 23
Cooling fan. . . . .	206
Cupholder(s) . . . . .	85
Customer Assistance Center, Ford (U.S.). . . . .	263
Customer Assistance Centre, Ford of Canada. . . . .	263, 269



## D

Daytime running light system . . . . .	81
Defrost	
rear window . . . . .	80
windshield . . . . .	68, 77
Dipstick . . . . .	212
automatic transmission fluid . . . . .	224
engine oil . . . . .	212
power steering fluid. . . . .	222
Disabled vehicle (see Towing) . . . . .	203
Dispute Settlement Board . . . . .	264
Doors . . . . .	103
door ajar warning message. . . . .	39
lubricant specifications. . . . .	255
Driving under special conditions . . . . .	172
bad weather . . . . .	172
heavy load . . . . .	169
high water . . . . .	173
slippery roads . . . . .	172
tips for safe driving . . . . .	172
towing a trailer . . . . .	171

## E

Electrical system	
circuit breakers . . . . .	184
fuses. . . . .	175, 182
Electronic message center (see Message center). . . . .	31
Electronic sound system	
antenna . . . . .	50
tuning the radio . . . . .	46, 56
warranty and service information. . . . .	65
Electronic stereo cassette radio (see Electronic sound system) . . . . .	46
Electronic stereo radio (see Electronic sound system) . . . . .	46
Emergencies, roadside	
assistance. . . . .	261
battery acid spills . . . . .	198

Emergencies, roadside (continued)	
fuel . . . . .	238
jump-starting . . . . .	198
towing . . . . .	203
Emergency brake (parking brake) . . . . .	159
Emission control system . . . . .	241
catalytic converter . . . . .	241
emissions warranty . . . . .	4, 241
Engine	
check engine warning light . . . . .	16, 25
does not start . . . . .	153, 185
fuel injected engine, starting . . . . .	151
fuel pump shut-off switch . . . . .	185
preparing to start . . . . .	151
refill capacities . . . . .	254
service points . . . . .	209
starting . . . . .	152
starting after a collision . . . . .	185
storing your vehicle . . . . .	256
Engine block heater . . . . .	154
Engine coolant . . . . .	217
checking and adding . . . . .	217
checking hoses . . . . .	218
disposal . . . . .	220
drain and flush . . . . .	221
preparing for storage . . . . .	257
proper solution . . . . .	206
recovery reservoir . . . . .	209
refill capacities . . . . .	254
specifications . . . . .	255
temperature gauge . . . . .	17, 23
Engine coolant temperature gauge . . . . .	17, 23
description . . . . .	17, 23
electronic . . . . .	23
mechanical . . . . .	17
Engine fan . . . . .	206

Engine oil . . . . .	211
changing oil and oil filter . . . . .	212
checking and adding . . . . .	212
dipstick . . . . .	212
disposal . . . . .	213
engine oil pressure gauge . . . . .	20
engine oil pressure warning light. . . . .	27
filter, specifications . . . . .	253
refill capacities . . . . .	254
specifications . . . . .	211, 255
synthetic oil . . . . .	211
“break-in” oils . . . . .	6
viscosity . . . . .	211
Entry system	
illuminated . . . . .	104
keyless . . . . .	109
remote . . . . .	114
Exhaust fumes . . . . .	155
Extended Service Plan, Ford . . . . .	4

## F

Fan, engine fan, avoiding injury . . . . .	206
Federal Communications Commission . . . . .	64
Flashers, hazard . . . . .	93
Flashing the lights. . . . .	90
Flat tire. . . . .	187
Floor mats . . . . .	107
Fluid refill capacities. . . . .	254
Ford Customer Assistance Center . . . . .	263
Ford Dispute Settlement Board . . . . .	264
Ford Extended Service Plan . . . . .	4
Ford Motor Company of Canada . . . . .	269
Ford of Canada Customer Assistance Centre . . . . .	269
Foreign registration . . . . .	270
French owner guides, how to obtain . . . . .	3
Fuel . . . . .	234
capacity . . . . .	254
choosing the right fuel. . . . .	235
filling your vehicle with fuel. . . . .	234

Fuel (continued)	
filter, specifications . . . . .	253
fuel filler door release lever . . . . .	234
fuel gauge . . . . .	17, 29
octane rating . . . . .	236
quality. . . . .	236
running out of fuel . . . . .	238
safety information relating to	
automotive fuels . . . . .	237
storing your vehicle. . . . .	257
treating emergencies . . . . .	237
Fuel and distance computer	
average economy . . . . .	35
english/metric button . . . . .	32
fuel remaining . . . . .	30
instant economy . . . . .	36
reset button . . . . .	32
select button . . . . .	32
to empty indicator . . . . .	33
trip distance . . . . .	36
trip/reset button . . . . .	36
Fuel cap . . . . .	234
removing . . . . .	234
replacing. . . . .	234
Fuel filler door . . . . .	234
Fuel filter, specifications . . . . .	253
Fuel gauge . . . . .	17, 29
Fuel pump shut-off switch	
engine does not start . . . . .	185
starting after a collision . . . . .	185
Fuse panels	
engine compartment . . . . .	179
high current fuse panel . . . . .	180
instrument panel . . . . .	182
Fuses	
charts . . . . .	177, 182
checking and replacing . . . . .	182
circuit breakers . . . . .	184

## G

Gas cap (see Fuel cap) . . . . .	234
Gas mileage (see Fuel economy) . . . . .	238
Gasoline (see Fuel). . . . .	234
Gauges, Electronic	
charging system gauge . . . . .	26
engine coolant temperature gauge . . . . .	23
fuel gauge . . . . .	29
odometer. . . . .	31
speedometer . . . . .	30
Gauges, Mechanical	
engine coolant temperature gauge . . . . .	17
engine oil pressure gauge . . . . .	20
fuel gauge . . . . .	17
odometer. . . . .	19
speedometer . . . . .	19
trip odometer. . . . .	19
GAWR (Gross Axle Weight Rating)	
calculating . . . . .	170
definition. . . . .	169
driving with a heavy load . . . . .	169
location . . . . .	169
Gearshift	
automatic operation . . . . .	164
column-mounted . . . . .	164
locking the gearshift. . . . .	87
positions . . . . .	164
shifting the gears . . . . .	164
shift-lock . . . . .	165
GVWR (Gross Vehicle Weight Rating) . . . . .	169
calculating . . . . .	170
definition. . . . .	169
driving with a heavy load . . . . .	169
location . . . . .	169

## H

Hazard flashers . . . . .	93
Headlamps	
aiming . . . . .	244
autolamp system . . . . .	83
bulb specification . . . . .	248
checking alignment . . . . .	244
cleaning . . . . .	250
daytime running lights . . . . .	81
flashing . . . . .	90
high beam . . . . .	90
replacing bulbs . . . . .	244
turning on and off . . . . .	82
Head restraints . . . . .	119
Heating	
electronic automatic temperature control system . . . . .	69
manual heating and air conditioning system . . . . .	67
High beams	
indicator light . . . . .	15, 25
operation . . . . .	90
High-mount brakelamp . . . . .	246
description . . . . .	246
replacing the bulb . . . . .	246
Hood . . . . .	208
latch location . . . . .	208
release lever . . . . .	208
working under the hood . . . . .	206
Horn. . . . .	94
Hoses, checking. . . . .	218

## I

Identification Number, Vehicle (VIN) . . . . .	264
Idle, relearning . . . . .	202, 227
Ignition	
chime . . . . .	88
positions of the ignition . . . . .	87

Ignition (continued)	
removing the key . . . . .	88
Indicator lights and chimes (see Lights) . . . . .	8
Infant seats (see Safety seats) . . . . .	139
Instrument cluster	
electronic . . . . .	21
mechanical . . . . .	9
Instrument panel . . . . .	67
cleaning . . . . .	251
lighting up panel and interior . . . . .	84
Interval wipers . . . . .	91

## J

Jack . . . . .	189
operation . . . . .	192
positioning . . . . .	192
storage . . . . .	189
Jump-starting your vehicle	
attaching cables . . . . .	200
disconnecting cables . . . . .	202

## K

Keyless entry system	
autolock . . . . .	111
locking and unlocking doors . . . . .	110
programming entry code . . . . .	112
Keys	
key in ignition chime . . . . .	88
positions of the ignition . . . . .	87
removing from the ignition . . . . .	88
stuck in lock position . . . . .	87

## L

Lamps	
autolamp delay system . . . . .	83
bulb replacement specifications chart . . . . .	248
checking . . . . .	244
courtesy lamps . . . . .	99
daytime running light system . . . . .	81

Lamps (continued)	
dome lamps . . . . .	84
flashing the lamps . . . . .	90
hazard flashers . . . . .	93
headlamps . . . . .	82
high beams . . . . .	90
high-mount brakelamp . . . . .	246
illuminated entry system . . . . .	104
illuminated mirrors . . . . .	102
instrument panel, dimming . . . . .	84
interior lamps . . . . .	81
replacing bulbs . . . . .	244
Lane change indicator	
(see Turn signal) . . . . .	89
Lights, warning and indicator	
air bag. . . . .	13, 25
air suspension . . . . .	15
anti-lock brakes (ABS). . . . .	11, 41
brake . . . . .	10, 42
charging system . . . . .	13, 26
check engine . . . . .	16, 25
door ajar. . . . .	39
engine oil pressure . . . . .	20, 27
hazard warning light . . . . .	93
high beam . . . . .	15, 25
low fuel . . . . .	15
low washer fluid . . . . .	39
oil pressure . . . . .	20, 27
overdrive off. . . . .	14, 38
safety belt . . . . .	12, 24
trunk ajar . . . . .	40
turn signal indicator . . . . .	16, 28
Load limits . . . . .	169
GAWR. . . . .	169
GVWR. . . . .	169
trailer towing. . . . .	171
Lubricant specifications . . . . .	255



Lug nuts . . . . .	190
standard . . . . .	192
tightening sequence . . . . .	195

## M

Maintenance schedule and record (see separate Maintenance Schedule and Record booklet) . . . . .	3
Maintenance (see Servicing) . . . . .	205
Master cylinder, brakes . . . . .	214
Message center	
door ajar . . . . .	39
english/metric button . . . . .	32
low washer fluid . . . . .	39
reset button . . . . .	32
select button . . . . .	32
trunk ajar . . . . .	40
Mirrors . . . . .	99
automatic dimming rearview mirror . . . . .	100
rearview . . . . .	99
side view mirrors . . . . .	99
side view mirrors (power) . . . . .	106
vanity mirror, illuminated . . . . .	102
Motorcraft parts . . . . .	253

## N

New vehicle break-in . . . . .	6
--------------------------------	---

## O

Octane rating . . . . .	236
Odometer . . . . .	19, 31
description . . . . .	19, 31
trip odometer . . . . .	19
Oil filter . . . . .	213, 253
Oil (see Engine oil) . . . . .	211
Oil viscosity . . . . .	211

On-board diagnostic (OBD II) system . . . . .	243
Overdrive . . . . .	168
Overseas offices. . . . .	270

## P

Panic alarm feature, remote	
entry system . . . . .	115
Parking brake. . . . .	159
operation . . . . .	159
warning light. . . . .	10, 42
Parts (see Motorcraft Parts) . . . . .	253
PCV valve, specifications . . . . .	253
Power distribution box (see Fuses) . . . . .	175
Power door locks . . . . .	104
Power features	
door locks . . . . .	104
lumbar support. . . . .	122
mirrors . . . . .	106
seats. . . . .	122
windows. . . . .	105
Power steering	
dipstick . . . . .	222
driving with power steering . . . . .	162
fluid, checking and adding . . . . .	222
fluid, refill capacity . . . . .	254
fluid, specifications . . . . .	255
servicing. . . . .	162

## R

Radio (see Electronic sound systems) . . . . .	45
Rear air suspension system . . . . .	163
Rear axle	
refill capacity. . . . .	254
Rearview mirror . . . . .	100
Rear window	
defroster. . . . .	80

Refill capacities for fluids . . . . .	254
Relays . . . . .	175
Remote control, trunk . . . . .	87
Remote entry system. . . . .	114
locking/unlocking doors. . . . .	114
opening the trunk. . . . .	114
panic alarm. . . . .	115
replacement/additional transmitters. . . . .	116
replacing the batteries . . . . .	116
Restraints, safety (see Safety restraints)	
adult. . . . .	123
child. . . . .	138
head. . . . .	119
infant . . . . .	138
Reverse. . . . .	167
Roadside assistance . . . . .	261
Roadside emergencies . . . . .	175
Rotating the tires . . . . .	229

## S

Safe driving tips. . . . .	172
Safety belts (see Safety restraints) . . . . .	123
Safety information relating to	
automotive fuels . . . . .	237
Safety restraints	
adjusting the safety belts. . . . .	125, 128, 131
automatic locking mode . . . . .	127
automatic locking mode (retractor) . . . . .	127
cleaning the safety belts . . . . .	250
extension assembly . . . . .	132
for adults . . . . .	123
for children. . . . .	138
for infants . . . . .	138
for pregnant women. . . . .	123
head. . . . .	119
lap and shoulder belts. . . . .	125
maintenance . . . . .	133
proper use . . . . .	123

Safety restraints (continued)	
replacement . . . . .	133
warning light and chime . . . . .	12, 24
Safety seats for children . . . . .	139
and air bags . . . . .	139
automatic locking mode	
(retractor) . . . . .	127, 139
in front seat . . . . .	140
in rear outboard . . . . .	140
in rear seat. . . . .	139
Seat belts (see Safety restraints). . . . .	123
Seats. . . . .	119
adjusting the seat, manual. . . . .	120
adjusting the seats, power . . . . .	122
child safety seats . . . . .	139
cleaning upholstery . . . . .	251
head restraints . . . . .	119
reclining the seat . . . . .	122
Serial number (VIN). . . . .	264
Service concerns . . . . .	262
Servicing your vehicle. . . . .	205
precautions when servicing . . . . .	206
servicing when you tow. . . . .	203
Shift-lock system . . . . .	165
Shift positions (see Gearshift). . . . .	164
Shoulder and lap belts	
(see Safety restraints) . . . . .	125
Shoulder belts (see Safety restraints) . . . . .	125
Side mirrors . . . . .	99
adjusting. . . . .	106
Snow tires and chains . . . . .	233
Spare tire. . . . .	187
changing the tire . . . . .	187, 190
conventional spare . . . . .	189
finding the spare . . . . .	189
removing the spare tire . . . . .	189
storing the flat tire . . . . .	192
temporary spare . . . . .	187
Spark plugs, specifications . . . . .	253
Special driving conditions . . . . .	172

Specification chart, lubricants . . . . .	255
Speed control, turning off . . . . .	96
Speedometer . . . . .	19, 30
Starting your vehicle	
preparing to start your vehicle . . . . .	151
starting a cold engine . . . . .	152
starting after a collision . . . . .	185
starting a warm engine . . . . .	153
starting your vehicle if the battery is disabled . . . . .	198
Steering, power . . . . .	162
Steering wheel	
horn . . . . .	94
locking . . . . .	87
tilting . . . . .	95
Storing your vehicle . . . . .	256
Sun visor . . . . .	102
Supplemental air bag readiness light . . .	13, 25
Supplemental Restraint System (SRS) . . .	133

## T

Tail lamps	
bulb replacement . . . . .	244
cleaning . . . . .	249
Temperature control (see Climate control) . .	67
Tilt steering wheel. . . . .	95
Tires . . . . .	228
changing . . . . .	187
checking the pressure . . . . .	228
cleaning . . . . .	252
inspection and maintenance . . . . .	228
replacing . . . . .	230
rotating . . . . .	229
snow tires and chains . . . . .	233
spare tire. . . . .	189
storing your vehicle . . . . .	258
tire grades . . . . .	230
treadwear . . . . .	231
wear bands. . . . .	230

Towing a trailer (see Trailer towing) . . . . .	171
Towing your vehicle . . . . .	203
using wheel dollies . . . . .	203
with a tow truck . . . . .	203
Traction assist . . . . .	161
Traction-lok rear axle . . . . .	161
Transmission	
automatic operation. . . . .	164
fluid, checking and adding (automatic) . . . . .	224
fluid, refill capacities . . . . .	254
lubricant specifications . . . . .	255
Transmission control switch . . . . .	167
Transmitter (see Remote entry). . . . .	114
Trip odometer . . . . .	19
Trunk	
remote release lever. . . . .	87
trunk ajar warning light. . . . .	40
using the remote entry system to open . . . . .	114
Tune-up specifications (VECI) . . . . .	243
Turn signal. . . . .	89
indicator lights . . . . .	16, 28
lever . . . . .	89

## U

Used engine oil, disposal . . . . .	213
-------------------------------------	-----

## V

Vanity mirror. . . . .	102
Variable interval wipers . . . . .	91
VECI (Vehicle Emission Control Information)	
decals . . . . .	243
Vehicle Identification Number (VIN) . . . . .	264
Vehicle loading	
automatic transmissions . . . . .	170
calculating the load . . . . .	170
understanding loading information . . . . .	169

Vehicle storage . . . . .	256
Ventilating your vehicle (see Climate control) . . . . .	67
Viscosity (see Engine oil). . . . .	211
Visor (see Sun visor). . . . .	102
Voltmeter (see Battery voltage gauge) . . . . .	13, 26

## W

Warm engine, starting . . . . .	153
Warning chimes	
key in ignition . . . . .	88
safety belt . . . . .	12, 24
Warning lights (see Lights). . . . .	8
Warranties . . . . .	4
basic. . . . .	4
Canada. . . . .	4
radio. . . . .	65
Warranty Information Booklet . . . . .	4
Washer fluid . . . . .	91
reservoir . . . . .	216
warning light . . . . .	39
windshield . . . . .	216
Weight limits (GAWR, GVWR) . . . . .	169
Wheel dollies (see Towing). . . . .	203
Wheels	
cleaning . . . . .	252
covers . . . . .	190, 196
inspection and maintenance . . . . .	228
lug nuts . . . . .	190

Windows. . . . .	105
manual windows, operating . . . . .	105
one-touch down . . . . .	105
power windows, operating . . . . .	105
rear, defrosting. . . . .	80
Windshield, washing . . . . .	91
Windshield washer fluid and wipers . . . . .	91
checking and adding fluid. . . . .	216
checking and replacing wiper blades . . . . .	227
low washer fluid light. . . . .	39
operation . . . . .	91
reservoir. . . . .	216
specifications. . . . .	255
variable interval wipers . . . . .	91
Windshield wipers and washer. . . . .	91
Wrecker towing. . . . .	203



---

# Service Station Information

---

Engine	4.6L SFI OHC V8
Fuel	UNLEADED FUEL ONLY — Octane 87
Fuel Tank Capacity	20 gallons (75.7 Liters)
Tire Size	See tire pressure decal below the right door jamb
Tire Pressure	See tire pressure decal below the right door jamb
Hood Release	Pull handle under left side of dash
Engine Oil	Use only engine oil displaying the American Petroleum Institute Certification Mark — SAE 5W-30 preferred
Engine Oil Capacity w/filter	5.0 quarts (4.7 Liters)
Automatic Transmission Capacity	Motorcraft Mercon® (ATF) 13.9 quarts (13.1 Liters)
Power Steering Fluid	Use only power steering fluid that meets Ford's Specification Motorcraft Mercon®
Engine Coolant	14.1 quarts (13.3 Liters)