





Prizm

1993 Owner's Manual
Table of Contents

Welcome to Geo

Introduction	How to Use This Manual 4
Part 1	Seats & Safety Belts 11
Part 2	Features & Controls 47
Part 3	Comfort Controls & Audio Systems 99
Part 4	Your Driving and the Road 127
Part 5	Problems on the Road 181
Part 6	Service & Appearance Care 211
Part 7	Maintenance Schedule 267
Part 8	Customer Assistance Information 293 Including "Reporting Safety Defects" on page 298.
Part 9	Index 311
	Service Station Information Last Page

Please keep this manual in your Geo, so it will be there if you ever need it when you're on the road. If you sell the vehicle, please leave this manual in it so the new owner can use it.

This manual includes the latest information at the time it was printed. We reserve the right to make changes in the product after that time without further notice.

Published by **Chevrolet/Geo**
General Motors Corporation

General Motors, GM and the GM emblem,
Chevrolet and the Chevrolet emblem, **Geo** and the
Geo emblem, are registered trademarks of General
Motors Corporation.

© Copyright 1992 General Motors Corporation, Chevrolet/Geo. All rights reserved.

Welcome to Geo

World-class vehicles for the world-wise vehicle buyer. Feature by feature, every Geo shows that quality, value and technology can exist hand-in-hand with affordability. And Geo adds something special to vehicle ownership — fun. There's a Geo out there for everyone. It could be the economical Geo Metro or the sporty Geo Storm. Maybe the five-passenger Geo flagship, Prizm, or the adventurous off-roader, Geo Tracker.

No matter what Geo you drive, you'll find designed-in comfort and owner enjoyment in detail after careful detail. Geo's are savvy vehicles that answer the needs of the road and — with Tracker — even the off-road.

Sold and serviced by thousands of Chevrolet/Geo dealers, Geo is earning its stripes as a serious contender in today's value-conscious marketplace. We know your ownership experience will be a rewarding one.

Welcome to the world of Geo.



Jim Perkins
General Manager

How to Use This Manual



■ *How to Use This Manual*

Many people read their owner's manual from beginning to end when they first receive their new vehicle. This will help you learn about the features and controls for your vehicle. In this manual, you'll find that pictures and words work together to explain things quickly.

Index: A good place to look for what you need is the Index in back of the manual. It's an alphabetical list of all that's in the manual, and the page number where you'll find it.

Parts 1-8: Each part of this manual begins with a brief list of its contents, so you can often find at a glance if a part contains the information you want.

How to Use This Manual

This part tells you how to use your manual and includes Safety and Vehicle Damage Warnings and Symbols.

Part 1: Seats & Safety Belts

This part tells you how to use your seats and safety belts properly.

Part 2: Features & Controls

This part explains how to start and operate your Geo.

Part 3: Comfort Controls & Audio Systems

This part tells you how to adjust the ventilation and comfort controls and how to operate your sound system.

Part 4: Your Driving and the Road

Here you'll find helpful information and tips about the road and how to drive under different conditions.

CAUTION



These mean there is something that could hurt you or other people.

Safety Warnings and Symbols

You will find a number of safety cautions in this book. We use yellow and the word CAUTION to tell you about things that could hurt you if you were to ignore the warning.

In the yellow caution area, we tell you what the hazard is. Then we tell you what to do to help avoid or reduce the hazard. Please read these cautions. If you don't, you or others could be hurt.

Part 5: Problems on the Road

This part tells you what to do if you have a problem while driving, such as a flat tire or engine overheating.

Part 6: Service & Appearance Care

Here the manual tells you how to keep your Geo running properly and looking good.

Part 7: Maintenance Schedule

This part tells you when to perform vehicle maintenance and what fluids and lubricants to use.

Part 8: Customer Assistance Information

This part includes important information about reporting safety defects and gives you details about the "Roadside Assistance" program. You will also find customer satisfaction phone numbers (including customer satisfaction numbers for the hearing and speech impaired) as well as the mediation/arbitration procedure. We've also included ordering information for service publications in this part.

Service Station Information

This is a quick reference of service information. You can find it on the last page of this manual.

How to Use This Manual



You will also find a red circle with a slash through it in this book. This safety symbol means "Don't," "Don't do this," or "Don't let this happen."

NOTICE

These mean there is something that could damage your vehicle.

Vehicle Damage Warnings

Also, in this book you will find these blue notices:

In the blue notice area, we tell you about something that can damage your vehicle. Many times, this damage would not be covered by your warranty, and it could be costly. But the notice will tell you what to do to help avoid the damage.

When you read other manuals, you might see **CAUTION** and **NOTICE** warnings in different colors or in different words. In this manual, we've used the familiar words and colors that Geo has used for years.

You'll also see warning labels on your vehicle. They use the same colors, and the words **CAUTION** or **NOTICE**.

Vehicle Symbols

These are some of the symbols you will find on your vehicle. For example, these symbols are used on an original battery:

Caution Possible Injury



Protect Eyes by Shielding



*Caustic Battery Acid
Could Cause Burns*



Avoid Sparks or Flames



*Sparks or Flame Could
Explode Battery*



These symbols are important for you and your passengers whenever your vehicle is driven:

Fasten Safety Belts



These symbols have to do with your lights:

Master Lighting Switch



Turn Signal Direction

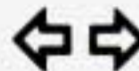

Hazard Warning Flasher



Headlight High Beam



Brightness Control



How to Use This Manual

These symbols are on some of your controls:

Windshield Wiper and Washer



Windshield Washer



Windshield Defroster



Rear Window Defogger



Ventilating Fan



These symbols are used on warning and indicator lights:

Engine Coolant Temperature



Battery Charging System



Fuel



Engine Oil Pressure



*Malfunction Indicator
(Check Engine
Electrical System)*



Here are some other symbols you may see:

Fuse



Lighter



Door Ajar



Trunk Release



Hood Release



Horn



Speaker



Notes

Part 1

Seats & Safety Belts



Here you'll find information about the seats in your Geo and how to use your safety belts properly. You can also learn about some things you should **not** do with safety belts.

Seats and Seat Controls	12
Safety Belts: They're for Everyone.....	15
Why Safety Belts Work	16
Here are Questions Many People Ask about	
Safety Belts — and the Answers	19
Safety Belt Reminder Light	20
How to Wear Safety Belts Properly	20
Children	34
Child Restraints.....	35
Larger Children.....	42
Safety Belt Extender	44
Checking Your Restraint Systems	44
Replacing Safety Belts after a Crash.....	45

Seats & Safety Belts



■ *Seats and Seat Controls*

This section tells you about the seats — how to adjust them, and also about reclining front seatbacks, head restraints and rear folding seatbacks.

Manual Front Seat

CAUTION

 You can lose control of the vehicle if you try to adjust a manual driver's seat while the vehicle is moving. The sudden movement could startle and confuse you, or make you push a pedal when you don't want to. Adjust the driver's seat only when the vehicle is not moving.

Move the lever under the front seat to unlock it. Slide the seat to where you want it. Then release the lever and try to move the seat with your body, to make sure the seat is locked into place.



Reclining Front Seatbacks

To adjust the seatback, lift the lever on the outer side of the seat. Release the lever to lock the seatback where you want it. Pull up on the lever and the seat will go to its original upright position. But don't have a seatback reclined if your vehicle is moving.



CAUTION



Sitting in a reclined position when your vehicle is in motion can be dangerous. Even if you buckle up, your safety belts can't do their job when you're reclined like this.

The shoulder belt can't do its job because it won't be against your body. Instead, it will be in front of you. In a crash you could go into it, receiving neck or other injuries.

The lap belt can't do its job either. In a crash the belt could go up over your abdomen. The belt forces would be there, not at your pelvic bones. This could cause serious internal injuries.

For proper protection when the vehicle is in motion, have the seatback upright. Then sit well back in the seat and wear your safety belt properly.

Seats & Safety Belts



Head Restraints

Slide the head restraint up or down so that the top of the restraint is closest to the top of your ears. This position reduces the chance of a neck injury in a crash.

Pull up to raise the restraint. To lower it, push the release button and push down.



Rear Folding Seatback

You can fold either side of the seatback down in your Geo for more cargo space.

To fold either seatback down:

1. Push the button on the side of the seatback while you pull down on the seatback.



2. Fold the seatback down.

To raise the seatback:

1. Pull the seatback up and push it back to lock it into place.
2. Be sure sides of the seatback are latched. Push and pull the top of the seatback to be sure it is locked in position.

■ *Safety Belts: They're for Everyone*

This part of the manual tells you how to use safety belts properly. It also tells you some things you should not do with safety belts.

And it explains the Supplemental Restraint System, or "air bag" system.

CAUTION



Don't let anyone ride where they can't wear a safety belt properly. If you are in a crash and you're not wearing a safety belt, your injuries can be **much** worse. You can hit things inside the vehicle or be ejected from it. You can be seriously injured or killed. In the same crash, you might not be if you are buckled up. Always fasten your safety belt, and check that your passengers' belts are fastened properly too.



This figure lights up when you turn the key to **ON** or **START** when your safety belt isn't buckled, and you'll hear a buzzer, too. It's the reminder to buckle up.

In many states and Canadian provinces, the law says to wear safety belts. Here's why: **They work.**

Seats & Safety Belts



You never know if you'll be in a crash. If you do have a crash, you don't know if it will be a bad one.

A few crashes are very mild. In them, you won't get hurt even if you're not buckled up. And some crashes can be so serious, like being hit by a train, that even buckled up a person wouldn't survive. But most crashes are in between. In many of them, people who buckle up can survive and sometimes walk away. Without belts they could be badly hurt or killed.

After 25 years of safety belts in vehicles, the facts are clear. In most crashes buckling up does matter . . . a lot!

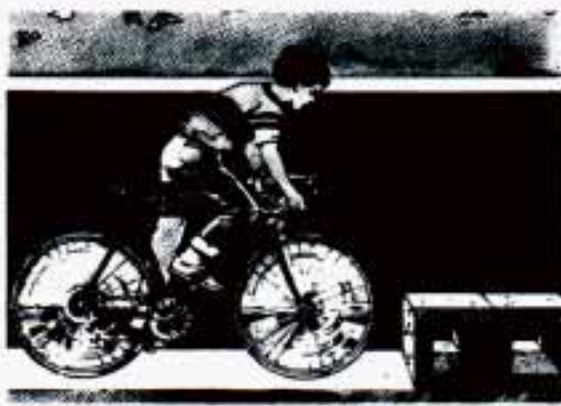

■ *Why Safety Belts Work*

When you ride in or on anything, you go as fast as it goes.

For example, if the bike is going 10 mph (16 km/h), so is the child.

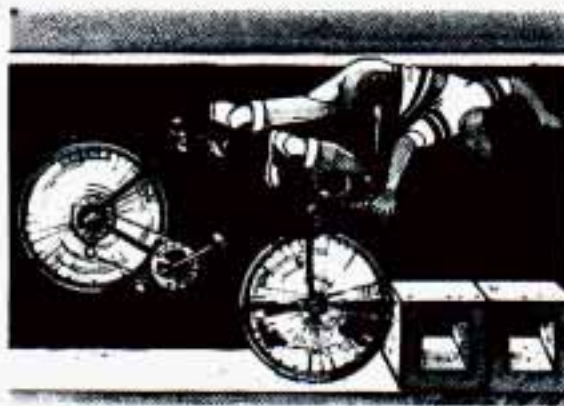

When the bike hits the block, it stops. But the child keeps going!



Take the simplest "car." Suppose it's just a seat on wheels.



Put someone on it.



Get it up to speed. Then stop the "car."
The rider doesn't stop.

Seats & Safety Belts



The person keeps going until stopped by something.

In a real vehicle, it could be the windshield . . .



or the instrument panel . . .



or the safety belts!

With safety belts, you slow down as the vehicle does. You get more time to stop. You stop over more distance, and your strongest bones take the forces. That's why safety belts make such good sense.

■ ***Here Are Questions
Many People Ask about
Safety Belts — and the
Answers***

Q: Won't I be trapped in the vehicle after an accident if I'm wearing a safety belt?

A: You could be — whether you're wearing a safety belt or not. But you can easily unbuckle a safety belt, even if you're upside down. And your chance of being conscious during and after an accident, so you can unbuckle and get out, is **much** greater if you are belted.

Q: Why don't they just put in air bags so people won't have to wear safety belts?

A: "Air bags," or Supplemental Restraint Systems, are in some vehicles today and will be in more of them in the future. But they are supplemental systems only — so they work **with** safety belts, not instead of them. Every "air bag" system ever offered for sale has required the use of safety belts. Even if you're in a vehicle that has "air bags," you still have to buckle up to get the most protection. That's true not only in frontal collisions, but especially in side and other collisions.

Q: If I'm a good driver, and I never drive far from home, why should I wear safety belts?

A: You may be an excellent driver, but if you're in an accident — even one that isn't your fault — you and your passengers can be hurt. Being a good driver doesn't protect you from things beyond your control, such as bad drivers.

Most accidents occur within 25 miles (40 km) of home. And the greatest number of serious injuries and deaths occur at speeds of less than 40 mph (65 km/h).

Safety belts are for everyone.

Seats & Safety Belts



■ *Safety Belt Reminder Light*

When the key is turned to **ON** or **START**, a buzzer will come on for about eight seconds to remind people to fasten their safety belts, unless the driver's safety belt is buckled.

This light will also come on and stay on until the driver's safety belt is buckled.

■ *How to Wear Safety Belts Properly*

Adults

This section is only for people of adult size.

CAUTION

 There are special things to know about safety belts and children. And there are different rules for babies and smaller children. If a child will be riding in your Geo, see the section after this one, called "Children." Follow those rules for everyone's protection.

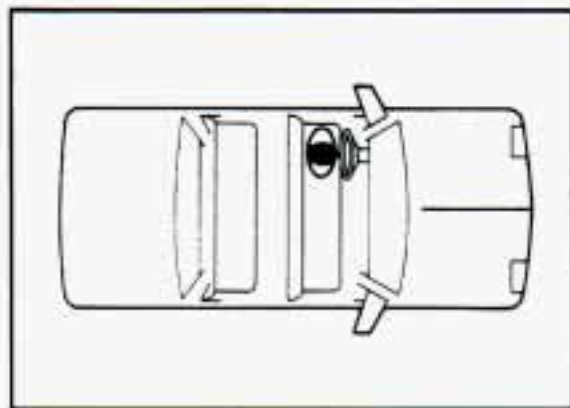

First, you'll want to know which restraint system your vehicle has. We'll start with the driver position.

Driver Position

This section describes the driver's restraint system.



Lap-Shoulder Belt

The driver has a lap-shoulder belt. Here's how to wear it properly.

1. Close and lock the door.
2. Adjust the seat (to see how, see "Seats" in the Index) so you can sit up straight.



3. Pick up the latch plate and pull the belt across you. Don't let it get twisted.
4. Push the latch plate into the buckle until it clicks.

If the safety belt isn't long enough, see "Safety Belt Extender" at the end of this part. Make sure the release button on the buckle faces upward or outward so you would be able to unbuckle it quickly if you ever had to.



5. To make the lap part tight, pull down on the buckle end of the belt as you pull up on the shoulder belt.

Seats & Safety Belts

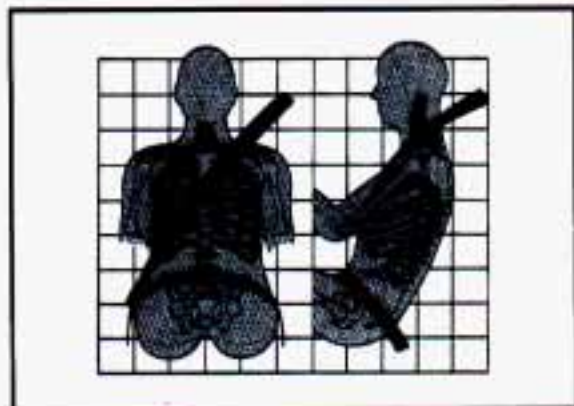

The lap part of the belt should be worn low and snug on the hips, just touching the thighs. In a crash, this applies force to the strong pelvic bones. And you'd be less likely to slide under the lap belt. If you slid under it, the belt would apply force at your abdomen. This could cause serious or even fatal injuries. The shoulder belt should go over the shoulder and across the chest. These parts of the body are best able to take belt restraining forces.

The safety belt locks if there's a sudden stop or crash.

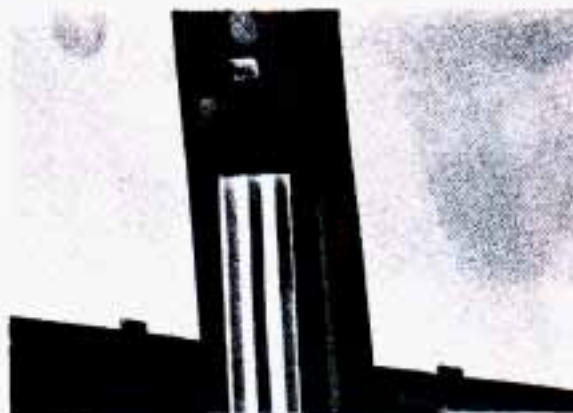

Shoulder Belt Height Adjuster

You can move the shoulder belt adjuster to the height that is right for you.



To move it up or down, squeeze the release handle. When you release the handle, try to move it down a little to make sure it has locked into position.

You can move the adjuster up from a lower position by pushing the bottom of the release handle.



Adjust the height so that the shoulder portion of the belt is properly positioned on your shoulder, away from your face and neck.

To help you find a height that is right for you, follow these guidelines:

For a tall person: Use the upper or upper-middle position.

For a person of average height: Use a position somewhere in the middle.

For a short person: Use the lower or lower-middle position.

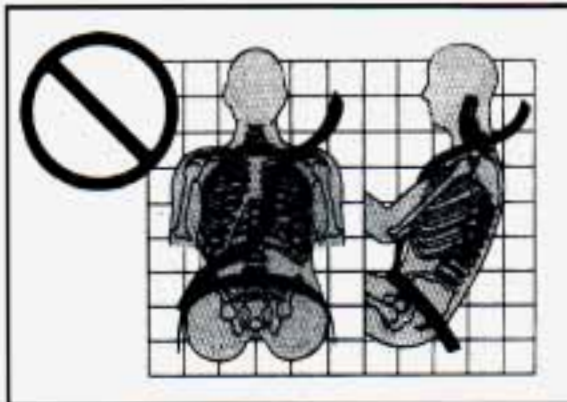

Q: What's wrong with this?

A: The shoulder belt is too loose. It won't give nearly as much protection this way.

CAUTION



You can be seriously hurt if your shoulder belt is too loose. In a crash you would move forward too much, which could increase injury. The shoulder belt should fit against your body.

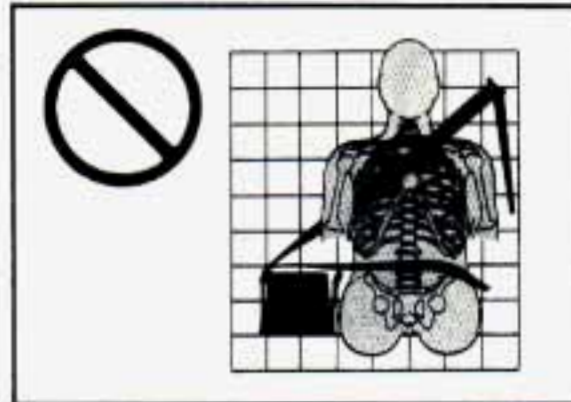

Q: What's wrong with this?

A: The belt is buckled in the wrong place.

CAUTION



You can be seriously injured if your belt is buckled in the wrong place like this. In a crash, the belt would go up over your abdomen. The belt forces would be there, not at the pelvic bones. This could cause serious internal injuries. Always buckle your belt into the buckle nearest you.

Seats & Safety Belts

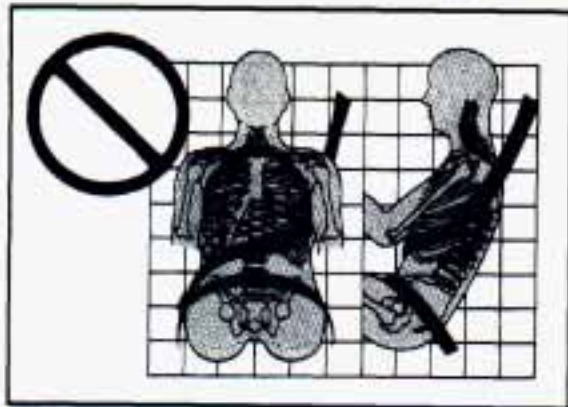

Q: What's wrong with this?

A: The shoulder belt is worn under the arm. It should be worn over the shoulder at all times.

CAUTION

 You can be seriously injured if you wear the shoulder belt under your arm. In a crash, your body would move too far forward, which would increase the chance of head and neck injury. Also, the belt would apply too much force to the ribs, which aren't as strong as shoulder bones. You could also severely injure internal organs like your liver or spleen.

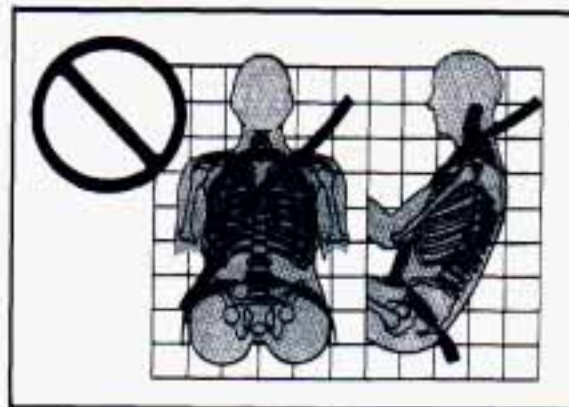

Q: What's wrong with this?

A: The belt is twisted across the body.

CAUTION

 You can be seriously injured by a twisted belt. In a crash, you wouldn't have the full width of the belt to spread impact forces. If a belt is twisted, make it straight so it can work properly, or ask your dealer to fix it.



To unlatch the belt, just push the button on the buckle. The belt should go back out of the way.

Before you close the door, be sure the belt is out of the way. If you slam the door on it, you can damage both the belt and your vehicle.

Seats & Safety Belts

The Supplemental Restraint System (Air Bag)

This section explains the driver's Supplemental Restraint System (SRS) system, commonly referred to as an air bag. Here are the most important things to know:

CAUTION



Even with an air bag, if you're not wearing a safety belt and you're in a crash, your injuries may be much worse. Air bags are not designed to inflate in rollovers or in rear, side or low-speed frontal crashes. You need to wear your safety belt to reduce the chance of hitting things inside the vehicle or being ejected from it. Always wear your safety belt, even with an air bag.

CAUTION



Air bags inflate with great force, faster than the blink of an eye. If you're too close to an inflating air bag, it could seriously injure you. Safety belts help keep you in position for an air bag inflation in a crash. Always wear your safety belt, even with an air bag, and sit as far back as you can while still maintaining control of your vehicle.

Seats & Safety Belts



Air Bag System Light

There is an air bag readiness light on the instrument panel which shows **AIR BAG**. The system checks itself and the light tells you if there is a problem.

You will see this light flash for a few seconds when you turn your ignition to **ACC, ON** or **START**. Then the light should go out, which means the system is ready.

CAUTION



If the air bag readiness light doesn't come on when you start your vehicle, or stays on, or comes on when you are driving, your air bag system may not work properly. Have your vehicle serviced right away.



How the Air Bag System Works

Where is the air bag?

The driver's air bag is in the middle of the steering wheel.

When is the air bag expected to inflate?

The air bag is designed to inflate in moderate to severe frontal or near-frontal crashes. The air bag will only inflate if the velocity of the impact is above the designed threshold level. When impacting straight into a wall that does not move or deform, the threshold level for most GM vehicles is between 9 and 14 mph. However, this velocity threshold depends on the vehicle design and may be several miles-per-hour faster or slower. In addition, this threshold velocity will be considerably higher if the vehicle strikes an object such as a parked car which will move and deform

on impact. The air bag is also not designed to inflate in rollovers, side impacts, or rear impacts where the inflation would provide no occupant protection benefit.

In any particular crash, the determination of whether the air bag should have inflated cannot be based solely on the level of damage on the vehicle(s). Inflation is determined by the angle of the impact and the vehicle's deceleration, of which vehicle damage is only one indication. Repair cost is not a good indicator of whether an air bag should have deployed.

What makes an air bag inflate?

In a frontal impact of sufficient severity, sensors strategically located on the vehicle detect that the vehicle is suddenly stopping as a result of a crash. These sensors complete an electrical circuit, triggering a chemical reaction of the sodium azide sealed in the inflator. The reaction produces nitrogen gas, which inflates the cloth bag. The inflator, cloth bag, and related hardware are all part of the air bag inflator module packed inside the steering wheel.

Seats & Safety Belts

How does an air bag restrain?

In moderate to severe frontal or near-frontal collisions, even belted occupants can contact the steering wheel. The air bag supplements the protection provided by safety belts. Air bags distribute the force of the impact more evenly over the occupant's upper body, stopping the occupant more gradually. But air bags would not provide protection in many types of collisions, including rollovers and rear and side impacts, primarily because an

occupant's motion is not toward the air bag. Air bags should never be regarded as anything more than a supplement to safety belt protection in moderate to severe frontal and near-frontal collisions.

What will you see after an air bag inflation?

After the air bag has inflated, it will then quickly deflate. This occurs so quickly that some people may not even realize that the air bag inflated. The air bag will **not** impede the driver's vision or ability to steer the vehicle, nor will it hinder the occupants from exiting the vehicle. There will be small amounts of smoke coming from vents in the deflated air bag. Some components of the air bag module in the steering wheel hub may

be hot for a short time, but the portion of the bag that comes into contact with you will not be hot to the touch. The nitrogen gas used to inflate the bag will have vented into the passenger compartment, and the bag will be deflated within seconds after the collision. Nitrogen makes up about 80% of the air we breathe and is not hazardous. As the nitrogen vents from the bag, small particles are also vented into the passenger compartment.

CAUTION



- Don't attach anything to the steering wheel pad. It might injure the driver if the air bag inflates.
- The air bag is designed to inflate only once. After it inflates, you'll need some new parts for your air bag system. If you don't get them, the air bag system won't be there to help protect you in another crash. A new system will include the air bag module and possibly other parts. The service manual has information about the need to replace other parts.
- Let only qualified technicians work on your air bag system. Improper service can mean that your air bag system won't work properly. See your dealer for service.

Servicing Your Geo with the Air Bag System

Please tell or remind anyone who works on your Geo that it has the air bag system. There are parts of the air bag system in several places around your vehicle. You don't want the system to inflate while someone is working on your vehicle. The air bag system does not need regular maintenance. Your Geo dealer and the 1993 Prizm Service Manual have information about the air bag system, including repair or disposal.

Seats & Safety Belts

CAUTION



For up to 60 seconds after the ignition key is turned off and the battery disconnected, an air bag can still inflate during improper service. You can be injured if you are close to an air bag when it inflates. Be sure to follow the proper service procedures.

When electrical work is done under the hood or inside your vehicle, the ignition should be in **LOCK** if possible.

Avoid wires wrapped with yellow tape, or yellow connectors. They are probably part of the air bag system.

But if the ignition has to be on for electrical work, or if the steering column is to be disassembled, the air bag system must be disconnected. To do this:

- Turn off the ignition.
- Remove the SRS (air bag) fuse (see "Fuses and Circuit Breakers" in the Index).
- Remove both the CIG fuse and the IGN fuse, which are connected to the SRS (air bag) system (see "Fuses and Circuit Breakers" in the Index).
- Disconnect the yellow connector at the base of the steering column.

When the work is complete, if the air bag system was disconnected, be sure to reattach everything and replace the fuse before turning the ignition to **ACC**, **ON** or **START**. When you turn the ignition key to **ACC**, **ON** or **START** be sure you see the air bag readiness light on the instrument panel. If you don't see this light flash and then go out as usual, have your air bag system repaired.



Safety Belt Use during Pregnancy

Safety belts work for everyone, including pregnant women. Like all occupants, they are more likely to be seriously injured if they don't wear safety belts.

A pregnant woman should wear a lap-shoulder belt, and the lap portion should be worn as low as possible throughout the pregnancy.

The best way to protect the fetus is to protect the mother. When a safety belt is worn properly, it's more likely that the fetus won't be hurt in a crash. For pregnant women, as for anyone, the key to making safety belts effective is wearing them properly.

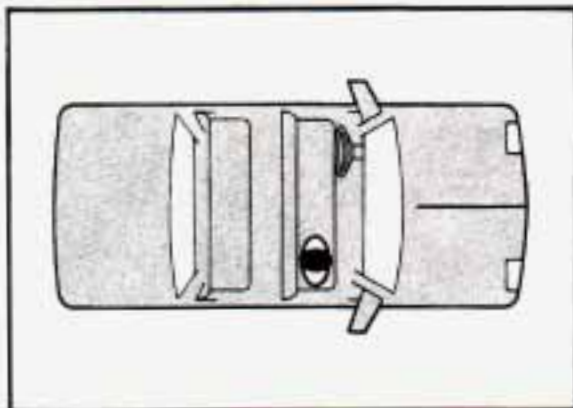

Passenger Positions

Right Front Passenger Position

The right front passenger's safety belt works the same way as the driver's safety belt. See "Driver Position," earlier in this part.

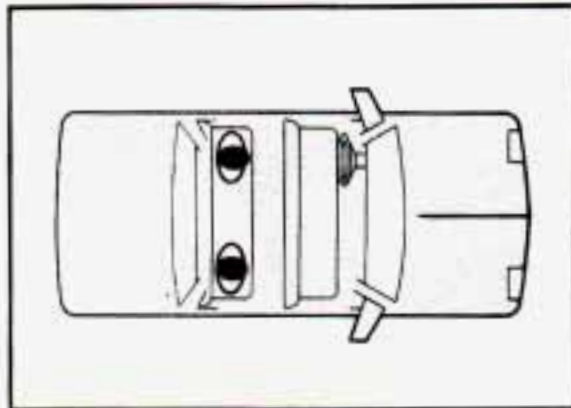

Rear Seat Passengers

It's very important for rear seat passengers to buckle up! Accident statistics show that unbelted people in the rear seat are hurt more often in crashes than those who are wearing safety belts.

Rear passengers who aren't safety belted can be thrown out of the vehicle in a crash. And they can strike others in the vehicle who are wearing safety belts.

Rear Seat Outside Passenger Positions

The positions next to windows have lap-shoulder belts. Here's how to wear one properly.

Seats & Safety Belts



1. Pick up the latch plate and pull the belt across you. Don't let it get twisted.
2. Push the latch plate into the buckle until it clicks.

If the belt is not long enough, see "Safety Belt Extender" at the end of this part. Make sure the release button on the buckle faces upward or outward so you would be able to unbuckle it quickly if you ever had to.



3. To make the lap part tight, pull down on the buckle end of the belt as you pull up on the shoulder part.

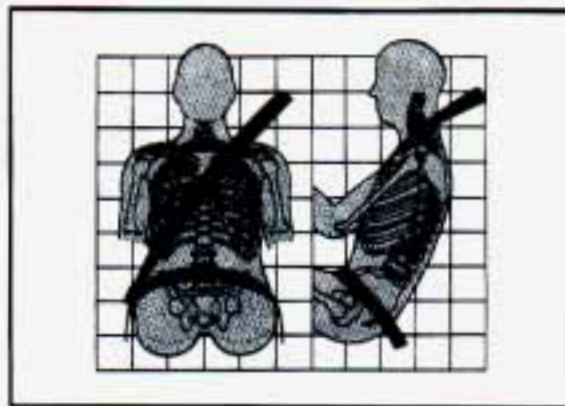

The lap part of the belt should be worn low and snug on the hips, just touching the thighs. In a crash, this applies force to the strong pelvic bones. And you'd be less likely to slide under the lap belt. If you slid under it, the belt would apply force at your abdomen. This could cause serious or even fatal injuries. The shoulder belt should go over the shoulder and across the chest. These parts of the body are best able to take belt restraining forces.

The safety belt locks if there's a sudden stop or a crash.

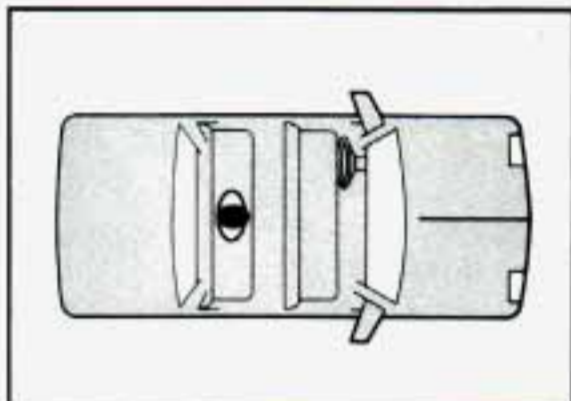

CAUTION

 You can be seriously hurt if your shoulder belt is too loose. In a crash you would move forward too much, which could increase injury. The shoulder belt should fit against your body.

- To unlatch the belt, just push the button on the buckle.

Center Passenger Position

If your vehicle has a rear bench seat, someone can sit in the center position.

When you sit in a center seating position, you have a lap safety belt, which has no retractor. To make the belt longer, tilt the latch plate and pull it along the belt.

Seats & Safety Belts



To make the belt shorter, pull its free end as shown until the belt is snug.

Buckle, position and release it the same way as the lap part of a lap-shoulder belt. If the belt isn't long enough, see "Safety Belt Extender" at the end of this part.

Make sure the release button on the buckle faces upward or outward so you would be able to unbuckle it quickly if you ever had to.



■ *Children*

Everyone in a vehicle needs protection! That includes infants and all children smaller than adult size. In fact, the law in every state and Canadian province says children up to some age must be restrained while in a vehicle.

Smaller Children and Babies

CAUTION



Smaller children and babies should always be restrained in a child or infant restraint. The instructions for the restraint will say whether it is the right type and size for your child. A very young child's hip bones are so small that a regular belt might not stay low on the hips, as it should. Instead, the belt will likely be over the child's abdomen. In a crash the belt would apply force right on the child's abdomen, which could cause serious or fatal injuries. So, be sure that any child small enough for one is always properly restrained in a child or infant restraint.



CAUTION

 Never hold a baby in your arms while riding in a vehicle. A baby doesn't weigh much — until a crash. During a crash a baby will become so heavy you can't hold it. For example, in a crash at only 25 mph (40 km/h), a 12-pound (5.5 kg) baby will suddenly become a 240-pound (110 kg) force on your arms. The baby would be almost impossible to hold.

Secure the baby in an infant restraint.

■ *Child Restraints*

Be sure to follow the instructions for the restraint. You may find these instructions on the restraint itself or in a booklet, or both. These restraints use the belt system in your vehicle, but the child also has to be secured within the restraint to help reduce the chance of personal injury. The instructions that come with the infant or child restraint will show you how to do that.

Where to Put the Restraint

Accident statistics show that children are safer if they are restrained in the rear rather than the front seat. We at General Motors therefore recommend that you put your child restraint in the rear seat unless the child is an infant and you're

Seats & Safety Belts

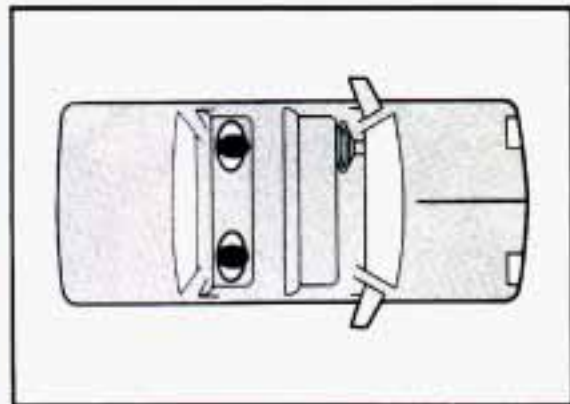

the only adult in the vehicle. In that case, you might want to secure the restraint in the front seat where you can keep an eye on the baby.

Wherever you install it, be sure to secure the child restraint properly.

CAUTION



An unsecured child restraint can move around in a collision or sudden stop and injure people in the vehicle. Be sure to properly secure any child restraint in your vehicle — even when no child is in it.

Top Strap

If your child restraint has a top strap, it should be anchored.

If you need to have an anchor installed, you can ask your Geo dealer to put it in for you. If you want to install an anchor yourself, your dealer can tell you how to do it.

Securing a Child Restraint in a Rear Outside Position

You'll be using the lap-shoulder belt. See the earlier section about the top strap if the child restraint has one.

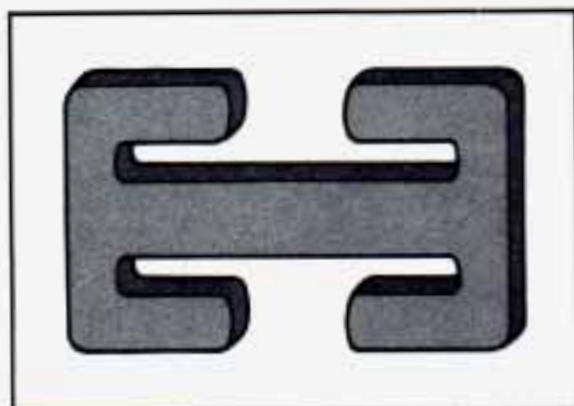

You'll need a safety locking clip to properly secure a child restraint in this position. You can get a locking clip where child restraints are sold, or from your Geo dealer (GM Part No. 94844571). The locking clip must be the same as the one shown here.

Until you have this clip, secure a child restraint only in a seat that has a separate lap belt (and a way to anchor a top strap, if the child restraint has one). See the following section about securing a child restraint in a center position. Once you have the clip, follow these instructions:



1. Put the restraint on the seat. Follow the instructions for the child restraint.
2. Secure the child in the child restraint as the instructions say.
3. Pull out the vehicle's safety belt and run the lap part through or around the restraint. The child restraint instructions will show you how. See if the shoulder belt would go in front of the child's face or neck. If so, put it behind the child restraint.
4. Buckle the belt. Make sure the release button faces upward or outward, so you'll be able to unbuckle it quickly if you ever need to.

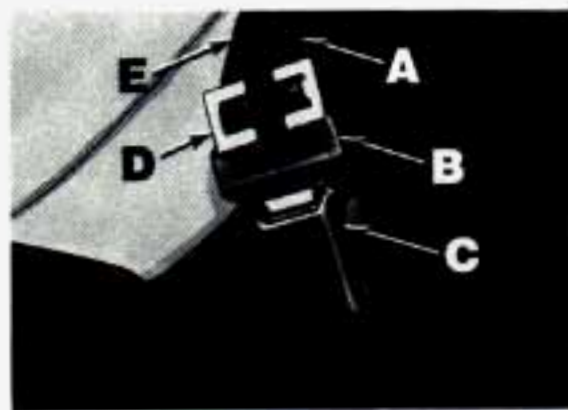

5. Then thread both the lap and shoulder belt portions through the locking clip.
 - A. Lap Belt Portion
 - B. Latch Plate
 - C. Buckle
 - D. Locking Clip
 - E. Shoulder Belt Portion

Seats & Safety Belts



CAUTION

 If a locking clip is not used or is not installed properly, the child restraint may move or tip over when your vehicle turns or stops quickly. The child or others could be injured. When you secure a child restraint with a lap-shoulder belt, always thread both the lap and shoulder belt portions through a locking clip.

6. Push and pull the child restraint in different directions to be sure it is secure.

To remove the child restraint, just unbuckle the vehicle's safety belt and remove the locking clip. Let the safety belt go back all the way. The safety belt will move freely again and be ready to work for an adult or larger child passenger.

CAUTION

 When not used with a child restraint seat, a safety belt with a child restraint locking clip still attached can cause serious injury in a crash. Always remove the clip when you are not using it with a child restraint.

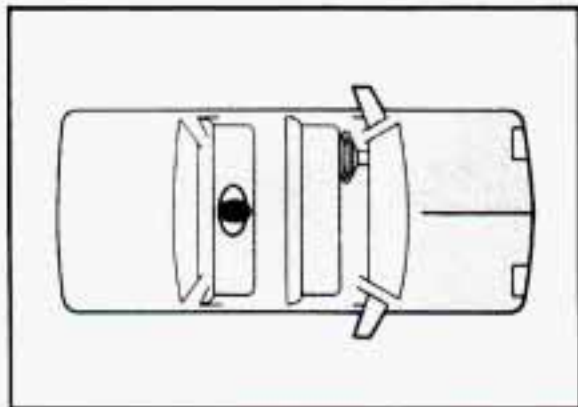

Securing a Child Restraint in the Center Rear Seat Position

When you secure a child restraint in a center seating position, you'll be using the lap belt.

See the earlier section about the top strap if the child restraint has one.



1. Make the belt as long as possible by tilting the latch plate and pulling it along the belt.
2. Put the restraint on the seat. Follow the instructions for the child restraint.
3. Secure the child in the child restraint as the instructions say.



4. Run the vehicle's safety belt through or around the restraint. The child restraint instructions will show you how.
5. Buckle the belt. Make sure the release button faces upward or outward, so you'll be able to unbuckle it quickly if you ever need to.
6. To tighten the belt, pull its free end while you push down on the child restraint.

Seats & Safety Belts

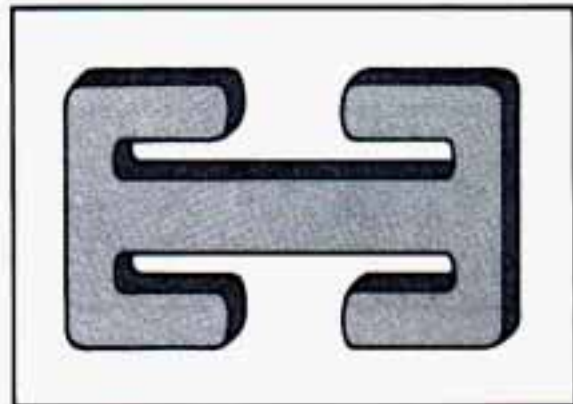
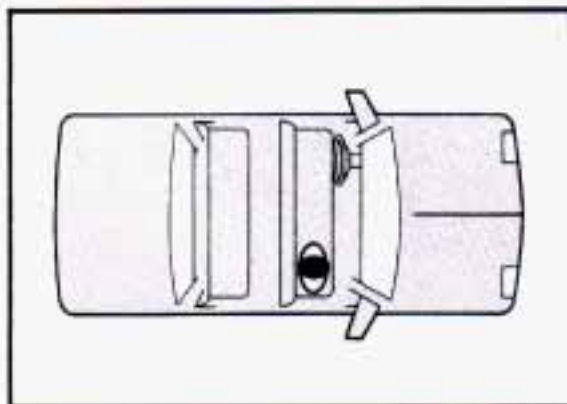

7. Push and pull the child restraint in different directions to be sure it is secure. If the child restraint isn't secure, turn the latch plate over and buckle it again. Then see if it is secure. If it isn't, secure the restraint in a different place in the vehicle and contact the child restraint maker for their advice.

To remove the child restraint, just unbuckle the vehicle's safety belt. It will be ready to work for an adult or larger child passenger.

Securing a Child Restraint in the Right Front Seat

You'll be using the lap-shoulder belt. See the earlier section about the top strap if the child restraint has one.

You'll need a safety locking clip to properly secure a child restraint in this position. You can get a locking clip where child restraints are sold, or from your Geo dealer (GM Part No. 94844571). The locking clip must be the same as the one shown here.

Until you have this clip, secure a child restraint only in a seat that has a separate lap belt (and a way to anchor a top strap, if the child restraint has one). See the earlier section about securing a child restraint in a center position. Once you have the clip, follow these instructions:

1. Put the restraint on the seat. Follow the instructions for the child restraint.



2. Secure the child in the child restraint as the instructions say.
3. Pull out the vehicle's safety belt and run the lap part through or around the restraint. The child restraint instructions will show you how.

See if the shoulder belt would go in front of the child's face or neck. If so, put it behind the child restraint.

4. Buckle the belt. Make sure the release button faces upward or outward, so you'll be able to unbuckle it quickly if you ever need to.
5. Then thread both lap and shoulder belt portions through the locking clip.

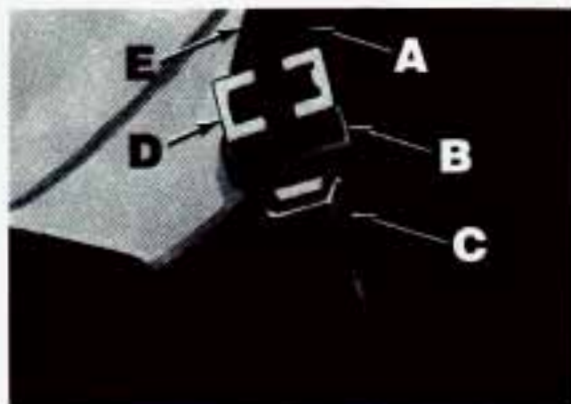

- A. Lap Belt Portion
- B. Latch Plate
- C. Buckle
- D. Locking Clip
- E. Shoulder Belt Portion

CAUTION



If a locking clip is not used or is not installed properly, the child restraint may move or tip over when your vehicle turns or stops quickly. The child or others could be injured. When you secure a child restraint with a lap-shoulder belt, always thread both the lap and shoulder belt portions through a locking clip.



6. Push and pull the child restraint in different directions to be sure it is secure.

To remove the child restraint, just unbuckle the vehicle's safety belt and remove the locking clip. Let the safety belt go back all the way.

Seats & Safety Belts



CAUTION



When not used with a child restraint seat, a safety belt with a child restraint locking clip still attached can cause serious injury in a crash. Always remove the clip when you are not using it with a child restraint.

The safety belt will move freely again and be ready to work for an adult or larger child passenger.

■ *Larger Children*

Children who have outgrown child restraints should wear the vehicle's safety belts.

If you have the choice, a child should sit next to a window so the child can wear a lap-shoulder belt and get the additional restraint a shoulder belt can provide.

Accident statistics show that children are safer if they are restrained in the rear seat. But they need to use the safety belts properly.

- Children who aren't buckled up can be thrown out in a crash.
- Children who aren't buckled up can strike other people who are.



CAUTION



Never do this.

Here two children are wearing the same belt. The belt can't properly spread the impact forces. In a crash, the two children can be crushed together and seriously injured. A belt must be used by only one person at a time.

Q: What if a child is wearing a lap-shoulder belt, but the child is so small that the shoulder belt is very close to the child's face or neck?

A: Move the child toward the center of the vehicle, but be sure that the shoulder belt still is on the child's shoulder, so that in a crash the child's upper body would have the restraint that belts provide.

If the child is so small that the shoulder belt is still very close to the child's face or neck, you might want to place the child in the center seat position, the one that has only a lap belt.



CAUTION



Never do this.

Here a child is sitting in a seat that has a lap-shoulder belt, but the shoulder part is behind the child. If the child wears the belt in this way, in a crash the child might slide under the belt. The belt's force would then be applied right on the child's abdomen. That could cause serious or fatal injuries.

Seats & Safety Belts

Wherever the child sits, the lap portion of the belt should be worn low and snug on the hips, and just touching the child's thighs. This applies belt force to the child's pelvic bones in a crash.

■ *Safety Belt Extender*

If the vehicle's safety belt will fasten around you, you should use it.

But if a safety belt isn't long enough to fasten, your dealer will order you an extender. It's free. When you go in to order it, take the heaviest coat you will wear, so the extender will be long enough for you. The extender will be just for you, and just for the seat in your vehicle that you choose. Don't let someone else use it, and use it only for the seat it is made to fit. To wear it, just attach it to the regular safety belt.

■ *Checking Your Restraint Systems*

Now and then, make sure all your belts, buckles, latch plates, retractors, anchorages and reminder systems are working properly. Look for any loose parts or damage. If you see anything that might keep a restraint system from doing its job, have it repaired.

■ *Replacing Safety Belts after a Crash*

If you've had a crash, do you need new belts?

After a very minor collision, nothing may be necessary. But if the belts were stretched, as they would be if worn during a more severe crash, then you need new belts.

If belts are cut or damaged, replace them. Collision damage also may mean you will have to have safety belt parts, like the retractor, replaced or anchorage locations repaired — even if the belt wasn't being used at the time of the collision.



Q: What's wrong with this?

A: The belt is torn.

CAUTION



Torn or frayed belts may not protect you in a crash. They can rip apart under impact forces. If a belt is torn or frayed, get a new one right away.

Notes



Here you can learn about the many standard and optional features on your Geo, and information on starting, shifting and braking. Also explained are the instrument panel and the warning systems that tell you if everything is working properly — and what to do if you have a problem.

Part 2

Features & Controls

Keys	48
Door Locks	49
Theft	53
New Vehicle "Break-In"	54
Ignition Switch	54
Starting Your Engine	55
Driving through Deep Standing Water	58
Automatic Transaxle	58
Five-Speed Manual Transaxle	62
Parking	64
Engine Exhaust	68
Windows	70
Horn	71
Tilt Wheel	71
The Turn Signal/Lights Control/Headlight Beam Lever	71
Operation of Lights	72
Interior Lights	74
Windshield Wiper/Washer Lever	75
Cruise Control	77
Mirrors	82
Sunroof	83
Storage and Compartments	84
Sun Visors	85
Passenger Assist Grips	86
Ashtrays and Lighter	86
Instrument Panel and Clusters	90
Warning Lights, Gages and Indicators	92

Features & Controls



■ Keys

CAUTION



Leaving young children in a vehicle with the ignition key is dangerous for many reasons. A child or others could be badly injured or even killed.

They could operate power windows or other controls or even make the vehicle move. Don't leave the keys in a vehicle with young children.

One key is used for the ignition, the doors, and all other locks.

When a new Geo is delivered, the dealer removes the metal plate from the key ring and gives it to the first owner.

The metal plate has a code on it that tells your dealer or a qualified locksmith how to make extra keys. Keep the code in a safe place. If you lose your keys, you'll be able to have new ones made easily using this code.

NOTICE

Your Geo has a number of new features that can help prevent theft. But you can have a lot of trouble getting into your vehicle if you ever lock your keys inside. You may even have to damage your vehicle to get in. So be sure you have an extra key.

■ *Door Locks*

CAUTION



Unlocked doors can be dangerous.

Passengers — especially children — can easily open the doors and fall out. When a door is locked, the inside handle won't open it.

Outsiders can easily enter through an unlocked door when you slow down or stop your vehicle.

This may not be so obvious: You increase the chance of being thrown out of the vehicle in a crash if the doors aren't locked. Wear safety belts properly, lock your doors, and you will be far better off whenever you drive your vehicle.



There are several ways to lock and unlock your vehicle:

From the outside: Use your key. To lock the door, turn the key clockwise as far as it will go.

The lock switch on the driver's door will not work when the door is open. This prevents the driver from being locked out.

If your vehicle has power door locks, you can lock or unlock all of the doors by holding the key in the turned position for a few seconds.



From the inside: To lock the door, push down the button on the door.

To unlock the door, pull up on the button.

Features & Controls



Power Door Locks (Option)

Push the power door lock switch to lock or unlock all the doors at once.

Your door locks will also lock automatically when the ignition is on and you shift out of **P** (Park).

The switch on each rear door works only that door's lock. It won't lock (or unlock) all of the doors — that's a safety feature.

Leaving Your Vehicle

If you are leaving the vehicle, take your keys, open your door and set the locks from the inside. Then get out and close the door. Pull up on the outside door handle as you close the door.



Rear Door Security Lock

Your Geo is equipped with rear door security locks that help prevent passengers from opening the rear doors of your car from the inside.



To use one of these locks:

1. Turn the knob so the bar is in a vertical position 
2. Close the door.
3. Do the same thing to the other rear door lock.



The rear doors of your vehicle cannot be opened from inside when this feature is in use.

If you want to open a rear door when the security lock is on:

1. Unlock the door from the inside.



2. Then open the door from the outside.

If you don't cancel the security lock feature, adults or older children who ride in the rear won't be able to open the rear door from the inside. You should let adults and older children know how these security locks work, and how to cancel the locks.

Features & Controls



To cancel the rear door lock:

1. Unlock the door from the inside and open the door from the outside.
2. Turn the knob to this position .
3. Do the same for the other rear door.

The rear door locks will now work normally.



Trunk Lock Release

To open the trunk lid, use your key and turn it to the right.

To close the lid, lower and press down on it. After closing the lid, try pulling it up to make sure it is closed.



Remote Trunk Lock Release

To open the trunk lid while sitting in the driver's seat, pull the lever up. The remote trunk release is on the floor to the left of the driver's seat.

■ *Theft*

Vehicle theft is big business, especially in some cities. Although your Geo has a number of theft-deterrent features, we know that nothing we put on it can make it impossible to steal. However, there are ways you can help.

Key in the ignition:

If you walk away from your vehicle with the keys inside, it's an easy target for joy riders or professional thieves — so don't do it. When you park your Geo and open the driver's door, you'll hear a tone reminding you to remove your key from the ignition and take it with you. Always do this. Your steering wheel will be locked, and so will your ignition. If you have an automatic transaxle, taking your key out also locks your transaxle. And remember to lock the doors.

Parking at night:

Park in a lighted spot, close all windows and lock your vehicle. Remember to keep your valuables out of sight. Put them in a storage area, or take them with you.

Features & Controls

■ *New Vehicle “Break-In”*

NOTICE

Your modern Geo doesn't need an elaborate “break-in.” But it will perform better in the long run if you follow these guidelines:

- Don't drive at any one speed — fast or slow — for the first 500 miles (804 km). Don't make full-throttle starts.
- Avoid making hard stops for the first 200 miles (322 km) or so. During this time your new brake linings aren't yet broken in. Hard stops with new linings can mean premature wear and earlier replacement. Follow this “breaking-in” guideline every time you get new brake linings.

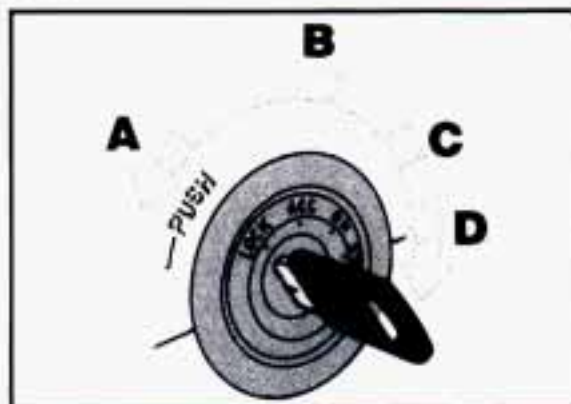

■ *Ignition Switch*

With the key in the ignition switch, you can turn the switch to four positions:

LOCK (A): The only position in which you can remove the key. This locks your steering wheel, ignition and automatic transaxle. You must push the key in to remove it.

If you have an automatic transaxle, the ignition switch can't be turned to **LOCK** unless the shift lever is in the **P** (Park) position.

ACC (B): Position in which you can operate some of your electrical power accessories. It unlocks the steering wheel and ignition. A warning tone will

sound if you open the driver's door when the ignition is in **ACC** or **LOCK** and the key is in the ignition.

ON (C): Position to which the switch returns after you start your engine and release the switch. The switch stays in the **ON** position when the engine is running.

START (D): Starts the engine. When the engine starts, release the key. The ignition switch will return to **ON** for normal driving.

Note that even if the engine is not running, the **ACC** and **ON** allow you to operate your electrical accessories, such as the radio and ventilation fan.

CAUTION



On manual transaxle vehicles, turning the key to **LOCK** will lock the steering column and result in a loss of ability to steer the vehicle. This could cause a collision. If you need to turn the engine off while the vehicle is moving, turn the key only to **ACC**. Don't push the key in while the vehicle is moving.

NOTICE

If your key seems stuck in **LOCK** and you can't turn it, be sure it is all the way in. If it is, then turn the steering wheel left and right while you turn the key hard. But turn the key only with your hand. Using a tool to force it could break the key or the ignition switch. If none of this works, then your vehicle needs service.

■ Starting Your Engine

1. Automatic Transaxle:

Move your shift lever to **P** (Park) or **N** (Neutral). Your engine won't start in any other position — that's a safety feature. To restart when you're already moving, use **N** (Neutral) only.

NOTICE

Don't try to shift to **P** (Park) if your Geo is moving. If you do, you could damage the transaxle. Shift to **P** (Park) only when your vehicle is stopped.

Features & Controls

Manual Transaxle:

Shift your gear selector to neutral and hold the clutch pedal to the floor while starting the engine. Your vehicle won't start if the clutch pedal is not all the way down — that's a safety feature.

2. Don't push the accelerator pedal before starting your engine. In some other vehicles you might need to do this, but because of your vehicle's computer systems, you don't.
3. Turn your ignition key to **START**. When the engine starts, let go of the key. The idle speed will go down as your engine gets warm.
4. If it doesn't start in three seconds, wait about 15 seconds and try again to start the engine by turning the ignition key to **START**. Wait about 15 seconds between each try to help avoid draining your battery.

NOTICE

Holding your key in **START** for longer than 15 seconds at a time will cause your battery to be drained much sooner. And the excessive heat can damage your starter motor.

When your engine has run about 10 seconds to warm up, your vehicle is ready to be driven. Don't "race" your engine when it's cold.

If the weather is below freezing (32°F or 0°C), let the engine run for a few minutes to warm up.

5. If your engine still won't start (or starts but then stops), it could be flooded with too much gasoline. Try pushing your accelerator pedal all the way to the floor and holding it there

as you hold the key in **START** for about three seconds. If the vehicle starts briefly but then stops again, do the same thing, but this time keep the pedal down for five or six seconds. This clears the extra gasoline from the engine.

6. If your engine stalls, restart it as explained earlier. If it stalls often, have the engine checked by your dealer as soon as possible.

NOTICE

Your engine is designed to work with the electronics in your vehicle. If you add electrical parts or accessories, you could change the way the fuel injection system operates. Before adding electrical equipment, check with your dealer. If you don't, your engine might not perform properly.

If you ever have to have your vehicle towed, see the part of this Manual that tells how to do it without damaging your vehicle. See "Towing Your Vehicle" in the Index.

Features & Controls

■ *Driving through Deep Standing Water*

NOTICE

If you drive too quickly through deep puddles or standing water, water can come in through your engine's air intake and badly damage your engine. If you can't avoid deep puddles or standing water, drive through them very slowly.



■ *Automatic Transaxle*

There are several different positions for your shift lever.

- **P (Park)**

This locks your front wheels. It's the best position to use when you start your engine because your vehicle can't move easily.

CAUTION



It is dangerous to get out of your vehicle if the shift lever is not fully in **P** (Park) with the parking brake firmly set. Your vehicle can roll.

Don't leave your vehicle when the engine is running unless you have to. If you have left the engine running, the vehicle can move suddenly. You or others could be injured. To be sure your vehicle won't move, when you're on fairly level ground, always set your parking brake and move the shift lever to **P** (Park).

See "Shifting into **P** (Park)" in the Index. If you are parking on a hill, or if you're pulling a trailer, also see "Parking on Hills" or "Towing a Trailer" in the Index.

Ensure the shift lever is fully in **P** (Park) range before starting the engine. Your Geo has a brake-transaxle shift interlock. You have to fully **apply** your regular brake **before** you can shift from **P** (Park) when the ignition key is in the **ON** position. If you cannot shift out of **P** (Park), ease pressure on the shift lever — push the shift lever all the way into **P** (Park) and also release the shift lever button on floor shift console models — as you maintain brake application. Then move the shift lever into the gear you wish. (Press the shift lever button before moving the shift lever on floor shift console models.) See “Shifting out of **P** (Park)” in this section.

- **R (Reverse)**

Use this gear to back up.

NOTICE

Shifting to **R** (Reverse) while your vehicle is moving forward could damage your transaxle. Shift to **R** (Reverse) only after your vehicle is stopped.

To rock your vehicle back and forth to get out of snow, ice or sand without damaging your transaxle, see “If You’re Stuck: In Sand, Mud, Ice or Snow” in the Index.

- **N (Neutral)**

In this position, your engine doesn’t connect with the wheels. To restart when you’re already moving, use **N** (Neutral) only. Also, use **N** (Neutral) when your vehicle is being towed.

Features & Controls

CAUTION



Shifting out of **P** (Park) or **N** (Neutral) while your engine is “racing” (running at high speed) is dangerous. Unless your foot is firmly on the brake pedal, your vehicle could move very rapidly. You could lose control and hit people or objects. Don't shift out of **P** (Park) or **N** (Neutral) while your engine is racing.

NOTICE

Damage to your transaxle caused by shifting out of **P** (Park) or **N** (Neutral) with the engine racing isn't covered by your warranty.

• **D (Drive)**

This position is for normal driving.

If you need more power for passing, and you're:

- Going less than about 27 mph (43 km/h), push your accelerator pedal about halfway down
- Going about 29 mph (47 km/h) or more, push your accelerator pedal all the way down

You'll shift down to the next gear and have more power.

• **2 (Second Gear)**

This position gives you more power but lower fuel economy. You can use **2** on hills. It can help control your speed as you go down steep mountain roads, but then you would also want to use your brakes off and on.

NOTICE

Don't drive in 2 (Second Gear) for more than 5 miles (8 km) or at speeds over 55 mph (88 km/h), or you can damage your transaxle. Use **D** as much as possible.

Don't shift into 2 unless you are going slower than 65 mph (105 km/h), or you can damage your engine.

- **L (Low Gear)**

This position gives you even more power (but lower fuel economy) than 2. You can use it on very steep hills, or in deep snow or mud. If the selector lever is put in L, the transaxle won't shift into low gear until the vehicle is going slowly enough.

NOTICE

If your front wheels can't rotate, don't try to drive. This might happen if you were stuck in very deep sand or mud or were up against a solid object. You could damage your transaxle.

Also, if you stop when going uphill, don't hold your vehicle there with only the accelerator pedal. This could overheat and damage the transaxle. Use your brakes to hold your vehicle in position on a hill.

Features & Controls



Overdrive (Option)

If your automatic transaxle has Overdrive, you can use it for better fuel economy. After starting your engine, always push the Overdrive switch in.

Then select the gear you want and press the accelerator. Gradual starts give you the best fuel economy. Fast starts use the most fuel.

A light on the instrument panel will come on whenever you turn off Overdrive. See "Overdrive Off Light" in the Index.



■ Five-Speed Manual Transaxle

This is your shift pattern. Here's how to operate your transaxle:

- **1 (First Gear)** — Press the clutch pedal and shift into **1**. Then, slowly let up on the clutch pedal as you press the accelerator pedal.

You can shift into **1** when you're going less than 20 mph (32 km/h). If you've come to a complete stop and it's hard to shift into **1**, put the shift lever in **Neutral** and let up on the clutch. Press the clutch pedal back down. Then shift into **1**.

- **2 (Second Gear)** — Press the clutch pedal as you let up on the accelerator pedal and shift into **2**. Then, slowly let up on the clutch pedal as you press the accelerator pedal.
- **3, 4 and 5 (Third, Fourth and Fifth Gears)** — Shift into **3**, **4** and **5** the same way you do for **2**. Slowly let up on the clutch pedal as you press the accelerator pedal.
- **To Stop** — Let up on the accelerator pedal and press the brake pedal. Just before the vehicle stops, press the clutch pedal and the brake pedal, and shift to **Neutral**.

- **Neutral** — Use this position when you start or idle your engine.
- **R (Reverse)** — To back up, press down the clutch pedal and shift into **R**. Let up on the clutch pedal slowly while pressing the accelerator pedal.

NOTICE

Shift to **R (Reverse)** only after your vehicle is stopped. Shifting to **R (Reverse)** while your vehicle is moving could damage your transaxle.

Also, use Reverse, along with the parking brake, for parking your vehicle.

Shift Speeds (MANUAL TRANSAXLE)

This chart shows when to shift to the next higher gear for best fuel economy.

1st to 2nd or	
2nd to 1st	15 mph (24 km/h)
2nd to 3rd or	
3rd to 2nd	25 mph (40 km/h)
3rd to 4th or	
4th to 3rd	40 mph (64 km/h)
4th to 5th or	
5th to 4th	45 mph (72 km/h)

If your speed drops below 20 mph (32 km/h), or if the engine is not running smoothly, you should downshift to the next lower gear. You may have to downshift two or more gears to keep the engine running smoothly or for good performance.

CAUTION



If you skip more than one gear when you downshift, you could lose control of your vehicle. And you could injure yourself or others. Don't shift from **5** to **1**.

NOTICE

If you skip more than one gear when you downshift, or if you race the engine when you downshift, you can damage the clutch or transaxle.

Features & Controls

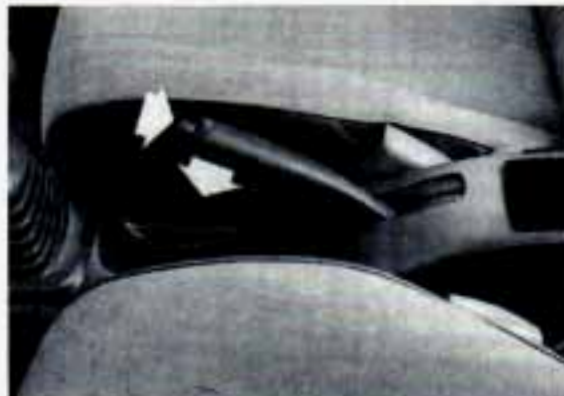

■ *Parking*

Parking Brake

To set the parking brake:

Hold the brake pedal down and pull up on the parking brake lever. If the ignition is on, the brake system warning light will come on.

To release the parking brake:

Hold the brake pedal down. Pull the parking brake lever up until you can push in the release button. Hold the release button in as you move the brake lever all the way down.

NOTICE

Driving with the parking brake on can cause your rear brakes to overheat. You may have to replace them, and you could also damage other parts of your vehicle.

If you are on a hill: See "Parking on Hills" in the Index. That section shows how to turn your front wheels.

If you are towing a trailer and are parking on any hill: See "Towing a Trailer" in the Index. That section shows what to do first to keep the trailer from moving.

Shifting into **P** (Park) (AUTOMATIC TRANSAXLE)

CAUTION



It can be dangerous to get out of your vehicle if the shift lever is not fully in **P** (Park) with the parking brake firmly set. Your vehicle can roll.

If you have left the engine running, the vehicle can move suddenly. You or others could be injured. To be sure your vehicle won't move, when you're on fairly level ground, use the steps that follow. If you are parking on a hill, or if you're pulling a trailer, also see "Parking on Hills" or "Towing a Trailer" in the Index.

1. Hold the brake pedal down with your right foot and set the parking brake.
2. Move the shift lever into **P** (Park) position like this:



- Hold in the button on the lever, and push the lever all the way toward the front of your vehicle.
3. Move the ignition key to **LOCK**.
 4. Remove the key and take it with you. If you can walk away from your vehicle with the ignition key in your hand, your vehicle is in **P** (Park).

Features & Controls

Leaving Your Vehicle with the Engine Running

(AUTOMATIC TRANSAXLE)

CAUTION



It can be dangerous to leave your vehicle with the engine running. Your vehicle could move suddenly if the shift lever is not fully in **P** (Park) with the parking brake firmly set. And, if you leave the vehicle with the engine running, it could overheat and even catch fire. You or others could be injured. Don't leave your vehicle with the engine running unless you have to.

If you have to leave your vehicle with the engine running, be sure your vehicle is in **P** (Park) and your parking brake is firmly set before you leave it. After you've moved the shift lever into the **P** (Park) position, hold the regular brake pedal down. Then, see if you can move the shift lever away from **P** (Park) without first pushing the button. If you can, it means that the shift lever wasn't fully locked into **P** (Park).

Shifting out of P (Park)

(AUTOMATIC TRANSAXLE)

Your Geo has a brake-transaxle shift interlock. You have to fully **apply** your regular brake **before** you can shift from **P** (Park) when the ignition is in the **ON** position. See "Automatic Transaxle" in the Index.

If you cannot shift out of **P** (Park), ease pressure on the shift lever — push the shift lever all the way into **P** (Park) and also release the shift lever button on floor shift console models as you maintain brake application. Then move the shift lever into the gear you wish. (Press the shift lever button before moving the shift lever.)



If you ever hold the brake pedal down but still can't shift out of **P** (Park), try this:

1. Carefully pry the shift lock override cover from the floor shift console using the edge of your key.
2. Insert the tip of your key into the rectangular slot and press down firmly.
3. While maintaining brake application, move the shift lever into the drive gear you want.
4. Have the vehicle fixed as soon as possible.

Parking Your Vehicle

(MANUAL TRANSAXLE)

Before you get out of your vehicle, put your manual transaxle in **R** (Reverse) and firmly apply the parking brake.

If you are parking on a hill, or if your vehicle is equipped to tow a trailer, see "Parking on Hills" or "Towing a Trailer" in the Index.

Features & Controls



Parking over Things That Burn

CAUTION

 Things that can burn could touch hot exhaust parts under your vehicle and ignite. Don't park over papers, leaves, dry grass or other things that can burn.

■ *Engine Exhaust*

CAUTION

 Engine exhaust can kill. It contains the gas carbon monoxide (CO), which you can't see or smell. It can cause unconsciousness and death.

You might have exhaust coming in if:

- Your exhaust system sounds strange or different.
- Your vehicle gets rusty underneath.
- Your vehicle was damaged in a collision.
- Your vehicle was damaged when driving over high points on the road or over road debris.
- Repairs weren't done correctly.
- Your vehicle or exhaust system had been modified improperly.

If you **ever** suspect exhaust is coming into your vehicle:

- Drive it only with all the windows down to blow out any CO; and
- Have it fixed **immediately**.

Running Your Engine while You're Parked

(AUTOMATIC TRANSAXLE)

It's better not to park with the engine running. But if you ever have to, here are some things to know.

CAUTION



Idling the engine with the air system control **off** could allow dangerous exhaust into your vehicle (see the earlier Caution under "Engine Exhaust").

Also, idling in a closed-in place can let deadly carbon monoxide (CO) into your vehicle, even if the fan switch is at the highest setting. One place this can happen is a garage. Exhaust — with CO — can come in easily. **NEVER** park in a garage with the engine running.

Another closed-in place can be a blizzard. (See "Blizzard" in the Index.)

It can be dangerous to get out of your vehicle if the shift lever is not fully in **P (Park)** with the parking brake firmly set. Your vehicle can roll. Don't leave your vehicle when the engine is running unless you have to. If you've left the engine running, the vehicle can move suddenly. You or others could be injured. To be sure your vehicle won't move, when you're on fairly level ground, always set your parking brake and move the shift lever to **P (Park)**.

Follow the proper steps to be sure your vehicle won't move. See "Shifting Into P (Park)" in the Index.

If you are parking on a hill, or if you're pulling a trailer, also see "Parking on Hills" or "Towing a Trailer" in the Index.

Features & Controls

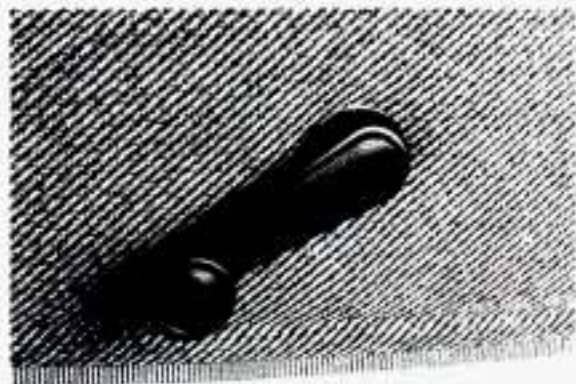

■ *Windows*

Manual Windows

Use the window crank to open and close each window.

Power Windows (Option)

With power windows, switches on the driver's door control each window when the ignition is on.

There are individual controls near each window. Push the bottom of the switch to open a window.

The switch for the driver's window has an Express Down feature. To use the Express Down, pull the switch back all the way. Release the switch and the window will lower completely. When the window has lowered, the driver's switch will return to the center position.

You can also open this window any amount by pulling the switch back slightly and releasing it when you want the window to stop.

To raise the window move the switch forward.

Do not push the switch when the window is in the Express Down mode.

Press the window lock switch if you wish to keep passengers from using their individual window switches.

Press the switch again to unlock the windows.



■ *Horn*

To sound the horn, press the horn symbol on your steering wheel.



■ *Tilt Wheel* (OPTION)

A tilt steering wheel allows you to adjust the steering wheel before you drive.

You can also raise it to the highest level to give your legs more room when you exit and enter the vehicle.

To tilt the wheel, hold the steering wheel and pull the lever. Move the steering wheel to a comfortable level, then release the lever to lock the wheel in place.

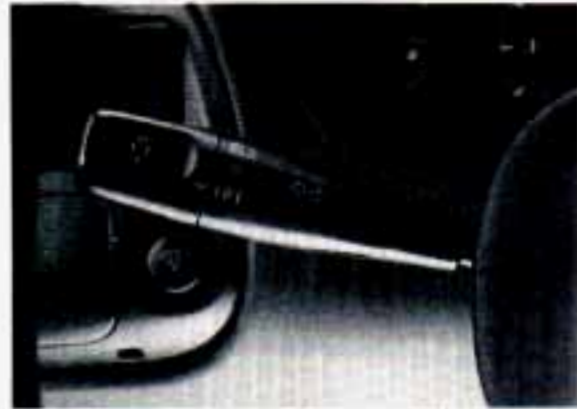

■ *The Turn Signal/Lights Control/Headlight Beam Lever*

The lever on the left side of the steering column includes your:

- Turn Signal and Lane Change Indicator
- Headlight High/Low Beam and Passing Signal
- Operation of Lights

Features & Controls



Turn Signal and Lane Change Indicator

The turn signal has two upward (for Right) and two downward (for Left) positions. These positions allow you to signal a turn or a lane change.

To signal a turn, move the lever all the way up or down. When the turn is finished, the lever will return automatically.

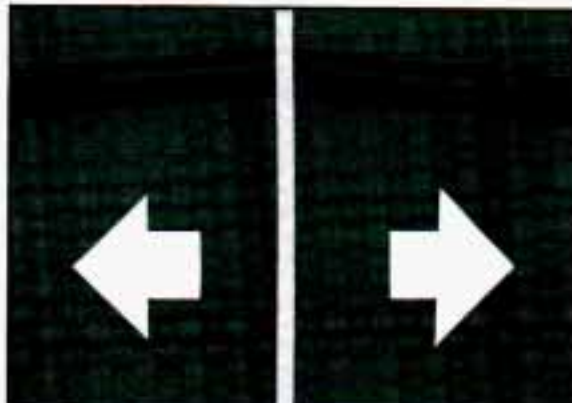

A green arrow on the instrument panel will flash in the direction of the turn or lane change.

To signal a lane change, just raise or lower the lever until the green arrow starts to flash. Hold it there until you complete your lane change. The lever will return by itself when you release it.

As you signal a turn or a lane change, if the arrows don't flash but just stay on, a signal bulb may be burned out and other drivers won't see your turn signal.

If a bulb is burned out, replace it to help avoid an accident. If the green arrows don't go on at all when you signal a turn, check the fuse (see "Fuses" in the Index) and for burned-out bulbs.

■ *Operation of Lights*

Although your vehicle's lighting system (headlamps, parking lamps, fog lamps, side marker lamps and taillamps) meet all applicable federal lighting requirements, certain states and provinces may apply their own lighting regulations that may require special attention before you operate these lamps. For example, some jurisdictions may require that you operate your lower beam lamps with fog lamps at all times, or that headlamps be turned on

whenever you must use your windshield wipers. In addition, most jurisdictions prohibit driving solely with parking lamps, especially at dawn or dusk. It is recommended that you check with your own state or provincial highway authority for applicable lighting regulations.



Turn the outside portion of the lever to control the lights. There are three positions for the light switch.

- In **OFF**, all lights are turned off.
- The middle position turns on the parking lights, taillights, license plate light and the instrument panel lighting; the headlights are off.
- The third position turns on the headlights.



Headlight High/Low Beam

First, you must have the headlights on. (See "Lights" in the Index.) Pull the turn signal lever toward you for high beams. Then release it. When the high beams are on, a blue light on the instrument panel also will be on. It will go off when you switch to low beam.

Features & Controls

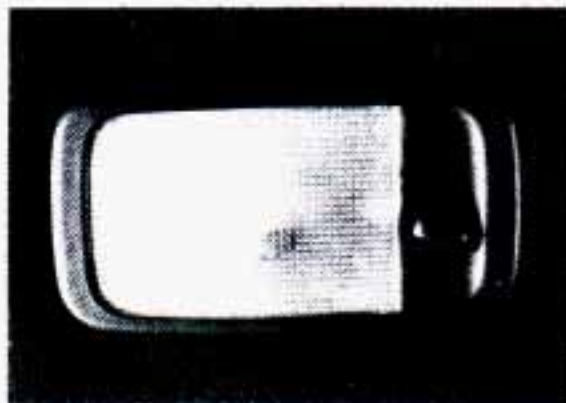

Flash-to-Pass

With the lever in the low beam position, pull the lever toward you to momentarily switch to high beam (to signal that you are going to pass). When you release the lever, the headlights will return to low beam operation.

Headlights ON Reminder

If you turn the ignition key to **LOCK** or **ACC** and the light switch is not in the **OFF** position, a tone will sound to remind you to turn off your lights.

■ ***Interior Lights***

Dome Light

The dome light has a three position switch.

- **ON:** The light turns on and stays on whether or not a door is open.
- **OFF:** The light stays off even when a door is open.
- **DOOR:** The light comes on when a door is open.

If you have a sunroof, you have a reading light near the sunroof switch. Press the switch to turn the light on and press it again to turn it off.

Courtesy Lights

When any door is opened, several lights go on. These lights are courtesy lights. They make it easier for you to enter and leave your car. Any light on your door or under your instrument panel is a courtesy light. The dome light above your head is a courtesy light too. You can turn on these lights by turning the main light control knob to the center position. See "Interior Lights" in this section.



Brightness Control

This knob controls the brightness of your instrument panel lights. Turn the knob to the right to make the lights brighter or to the left to make them dimmer. If you turn the knob all the way to the left, the instrument panel lights will go off.



■ Windshield Wiper/Washer Lever

The lever on the right side of the steering column controls the windshield wipers and washer.

Rotate the wiper switch to the position you want:

- **OFF** — The wipers are off.
- **INT** — Intermittent wiper operation (if your Geo has this). In light rain or snow, you might want to use this position rather than continuous wiping. You can change the time between wipes by turning the **INT TIME** band.

Features & Controls

- **LO** — The wipers will run continuously at low speed.
- **HI** — The wipers will run continuously at high speed.
- **MIST** — (If you have mist type wipers, the lever doesn't have an **INT** position.) For a single wiping cycle, push the lever to the **MIST** position. Hold it there for a second, then let go. The wipers will stop after one cycle. If you want more cycles, hold the lever in the **MIST** position longer.

CAUTION



Damaged wiper blades may prevent you from seeing well enough to drive safely. To avoid damage, be sure to clear ice and snow from the wiper blades before using them. If they're frozen to the windshield, carefully loosen or thaw them. If your blades do become damaged, get new blades or blade inserts.

Heavy snow or ice can overload your wipers. A circuit breaker will stop them until the motor cools. Clear away snow or ice to prevent an overload.

Washers

Press the button on the end of the lever to spray washer fluid on the windshield. It will spray as long as you hold the button in.

CAUTION



- Driving without washer fluid can be dangerous. A bad mud splash can block your vision. You could hit another vehicle or go off the road. Check your washer fluid level often.
- In freezing weather, don't use your washer until the windshield is warmed. Otherwise the washer fluid can form ice on the windshield, blocking your vision.

NOTICE

- When using concentrated washer fluid, follow the manufacturer's instructions for adding water.
- Don't mix water with ready-to-use washer fluid. Water can cause the solution to freeze and damage your washer fluid tank and other parts of the washer system. Also, water doesn't clean as well as washer fluid.
- Fill your washer fluid tank only 3/4 full when it's very cold. This allows for expansion, which could damage the tank if it is completely full.
- Don't use radiator antifreeze in your windshield washer. It can damage your paint.



■ Cruise Control (OPTION)

With Cruise Control, you can maintain a speed of about 25 mph (40 km/h) or more without keeping your foot on the accelerator. This can really help on long trips. Cruise Control does not work at speeds below about 25 mph (40 km/h).

When you apply your brakes, or push the clutch pedal, if you have a manual transaxle, the Cruise Control shuts off.

Features & Controls



CAUTION



- Cruise Control can be dangerous where you can't drive safely at a steady speed. So don't use your Cruise Control on winding roads or in heavy traffic.
- Cruise Control can be dangerous on slippery roads. On such roads, fast changes in tire traction can cause needless wheel spinning, and you could lose control. Don't use Cruise Control on slippery roads.

To Set Cruise Control

1. Push the end of the Cruise Control lever.

CAUTION



If you leave your Cruise Control switch on when you're not using Cruise, you might move a lever and go into Cruise when you don't want to. You could be startled and even lose control. Keep the Cruise Control switch **OFF** until you want to use it.

2. Get up to the speed you want.



3. Push the lever down to **SET/COAST** and release it. (The **CRUISE** light on the instrument panel will come on.)
4. Take your foot off the accelerator pedal.



To Resume a Set Speed

Suppose you set your Cruise Control at a desired speed and then you apply the brake. This, of course, shuts off the Cruise Control. But you don't need to reset it. Unless you're going about 25 mph (40 km/h) or less or you slowed down to 10 mph (16 km/h) less than your preset speed, you can press the lever up to **RES/ACC** for about half a second.

You'll go right back up to your chosen speed and stay there.

If your preset speed cancels out when it shouldn't, there may be a problem with your Cruise Control. See your dealer.

CAUTION



If you hold the switch at **RES/ACC** longer than half a second, the vehicle will keep going faster until you release the lever or apply the brake. You could be startled and even lose control. So unless you want to go faster, don't hold the lever at **RES/ACC**.

Features & Controls



To Increase Speed While Using Cruise Control

There are two ways to go to a higher speed. Here's the first:

1. Use the accelerator pedal to get to the higher speed.
2. Push the lever to **SET/COAST** and hold it for less than a second. Release the lever and the accelerator pedal.
You'll now cruise at the higher speed.



Here's the second way to go to a higher speed:

- Move the Cruise lever from **ON** to **RES/ACC**. Hold it there until you get up to the speed you want, and then release the lever.
- To increase your speed in very small amounts, move the lever to **RES/ACC** for less than half a second and then release it. Each time you do this, your vehicle will go about 1 mph (1.6 km/h) faster.



To Reduce Speed While Using Cruise Control

There are two ways to reduce your speed while using cruise control:

- Push the lever to **SET/COAST** until you reach the lower speed you want, then release it.
- To slow down in very small amounts, push the lever for less than half a second. Each time you do this, you'll go 1 mph (1.6 km/h) slower.

Passing Another Vehicle While Using Cruise Control

Use the accelerator pedal to increase your speed. When you take your foot off the pedal, your vehicle will slow down to the Cruise Control speed you set earlier.

Using Cruise Control on Hills

How well your Cruise Control will work on hills depends upon your speed, load, and the steepness of the hills. When going up steep hills, you may have to step on the accelerator pedal to maintain your speed. When going downhill, you may have to brake or shift to a lower gear to keep your speed down. Of course, applying the brake takes you out of Cruise Control. Many drivers find this to be too much trouble and don't use Cruise Control on steep hills.



To Get Out of Cruise Control

There are several ways to turn off the Cruise Control:

1. Step lightly on the brake pedal or push the clutch pedal, if you have a manual transaxle.
2. Move the shift lever to N (Neutral) if you have an automatic transaxle.
3. Press the Cruise **ON-OFF** button again or pull the lever toward you to cancel.

To Erase Speed Memory

When you turn off the Cruise Control or the ignition, your Cruise Control set speed memory is erased.

Features & Controls

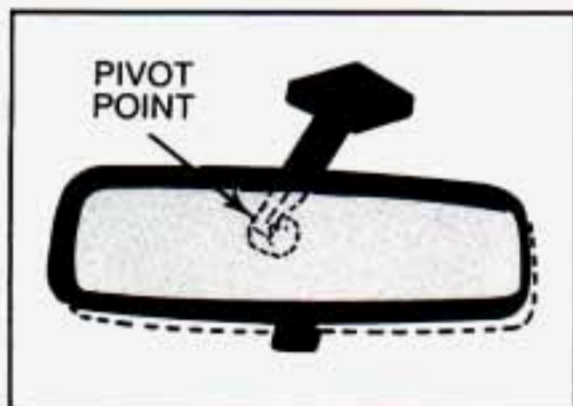

■ Mirrors

Inside Day/Night Rearview Mirror

An inside rearview mirror is attached to your roof. The mirror has one pivot so that you can adjust it up and down or side to side.

You can adjust the mirror for day or night driving. Pull the tab for night driving, and push it for day driving.

Convex Outside Mirror

Your right side mirror may be convex. A convex mirror's surface is curved so you can see more from the driver's seat.

CAUTION



If you aren't used to a convex mirror, you can hit another vehicle. A convex mirror can make things (like other vehicles) look farther away than they really are. If you cut too sharply into the right lane, you could hit a vehicle on your right. Check your inside mirror or glance over your shoulder before changing lanes.

Manual Adjust Mirrors

These mirrors should be adjusted by hand so that you can just see the side of your vehicle when you are sitting in a comfortable driving position.

Manual Remote Control Mirror

Adjust the mirror with the lever on the door. Adjust the mirror so that you just see the side of your vehicle when you are in a comfortable position.



Electric Mirror Control (Option)

The electric mirror control is to the left of your steering wheel. To adjust an outside mirror, move the switch to **L** (driver's side) or **R** (passenger's side). Then use the round touch pad to move the mirror in the direction chosen.



■ Sunroof

You can tilt **and** open your sunroof. To tilt the sunroof, press the switch marked **UP**. Press the other end of the switch to lower the sunroof. Your ignition must be on for this switch to work.



To open the electric sunroof, push the **SLIDE** arrow that points to the rear of the vehicle. To close it, push the other arrow that points to the front of the vehicle. The sunroof will close partially then stop. Push the arrow again to close it completely. You can open the sunroof to any position.

Features & Controls



If the electric sunroof will not close, follow these instructions:

1. Remove the cover screw and take off the sunroof control cover.
2. Carefully remove the inside screw, washers and spacers. Be careful not to lose this screw, the washers, or the spacers because the sunroof won't work without them.

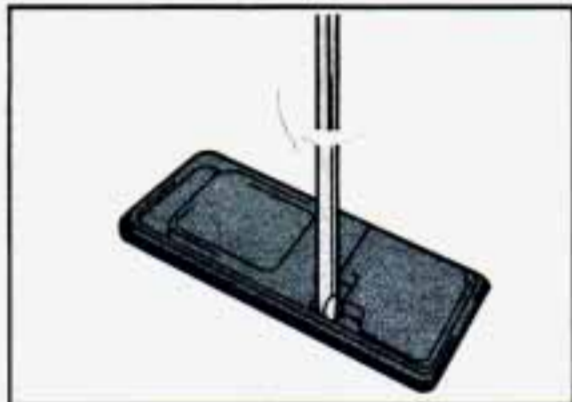

3. Close the sunroof by hand as far as it will go. Then find the special crank-shaped screwdriver in your tool bag. It is in your trunk. Insert the screwdriver into the hole and turn it clockwise until the sunroof is closed.

Be sure to have the electric sunroof checked by your Geo dealer as soon as possible.



■ *Storage and Compartments*

Cupholder

To open the cupholder, push the bar and the cupholder will slide out automatically. With cups removed, push it back in to store.

Console Storage Area

A small storage area is in the console between the seats. If there is a cover, lift it up to access the storage area.



Door Storage Compartments

The driver's door has a map/storage compartment. You may also have a storage compartment on your passenger door.



Glove Box

To open the glove box door, squeeze the buttons.

Always keep the glove box door closed while driving.



■ Sun Visors

To block out glare, you can swing down the visors. You can also swing them to the side. If the visors swing too easily, tighten the screw on the rear of the visors.

Features & Controls

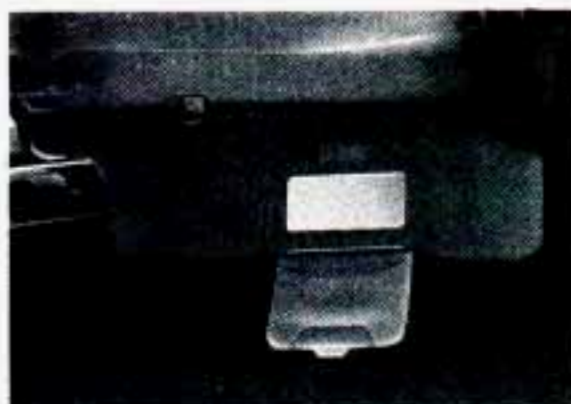

Visor Vanity Mirrors (Option)

Pull down the sun visor to expose the vanity mirror.

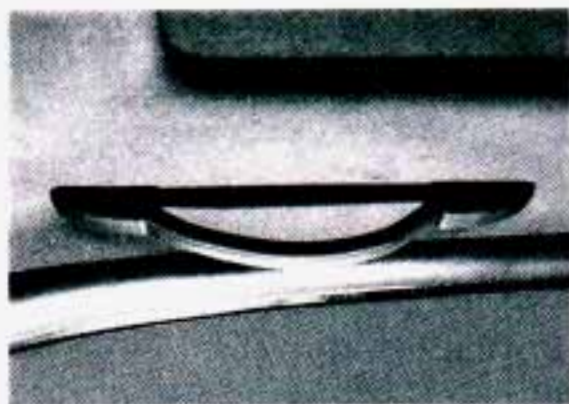

■ *Passenger Assist Grips*

Your Geo has assist grips. Passengers can use the grips to help keep their balance over rough roads or during sharp turns.



■ *Ashtrays and Lighter*

Cigarette Lighter

To use the lighter, push the lighter in all the way and let go. When it's ready, it will pop back by itself.

NOTICE

Don't hold a cigarette lighter in with your hand while it is heating. If you do, it won't be able to back away from the heating element when it's ready. That can make it overheat, damaging the lighter and the heating element.



Front Ashtray

Pull the door to open the ashtray. To remove it, push down on the part marked **PUSH** at the back, then pull it out.



Rear Ashtray

You have an ashtray behind the console. Pull the door to open it. To remove it, press the tab and pull it out.

NOTICE

Don't put papers and other things that burn into your ashtrays. If you do, cigarettes or other smoking materials could set them on fire, causing damage.

When you are done using the ashtray, push it back to close it.

Features & Controls

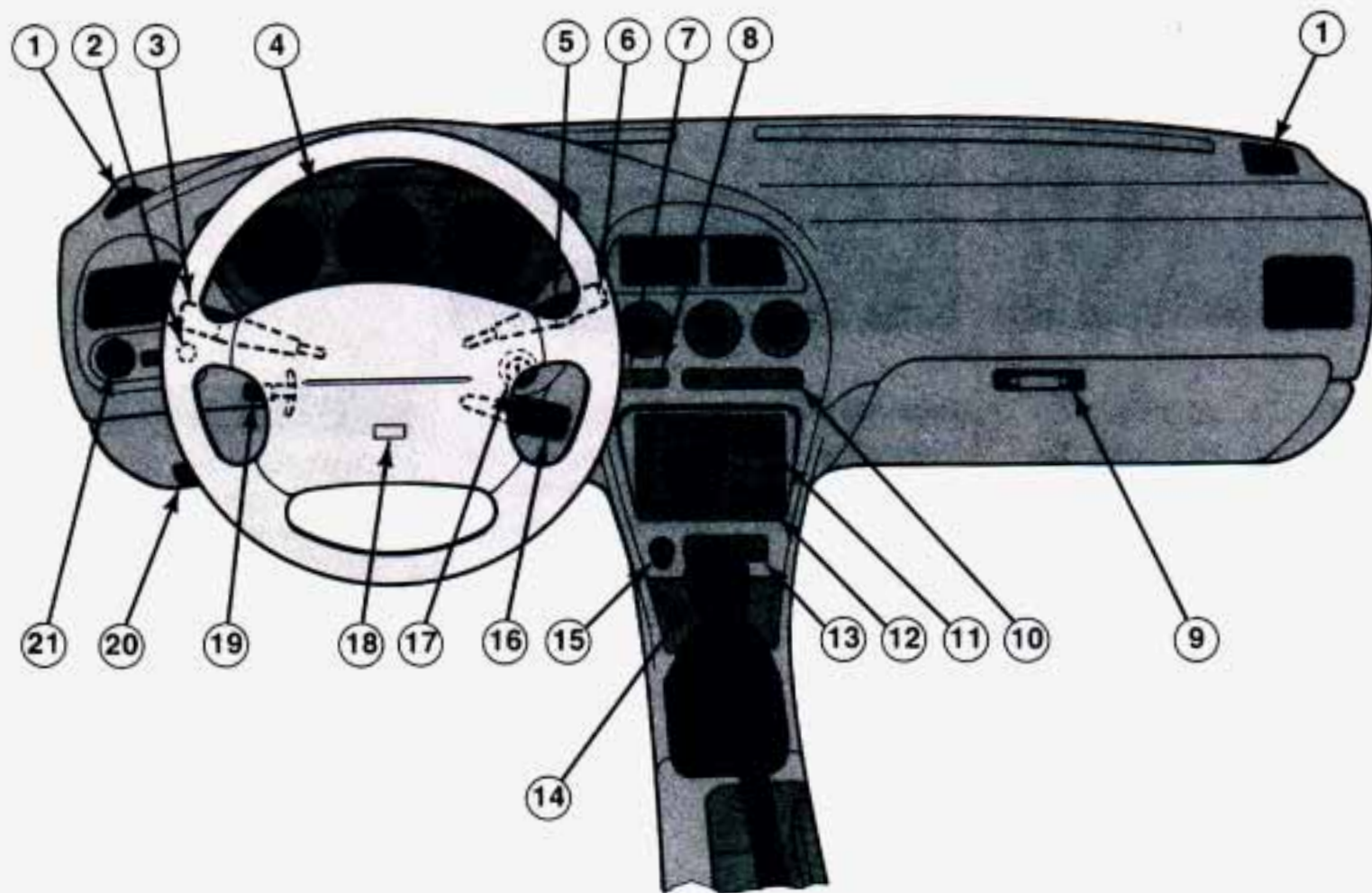

Instrument Panel

1. Side Window Defogger Vents
2. Brightness Control
3. Turn Signal/Lights Control/Headlight Beam Lever
4. Instrument Cluster
5. Windshield Wiper Control
6. Windshield Washer Button
7. Rear Window Defogger
8. Hazard Warning Flashers
9. Glove Box
10. Comfort Control System
11. Audio System
12. Cupholder
13. Ashtray
14. Shift Lever
15. Lighter
16. Cruise Control
17. Ignition Switch
18. Horn
19. Tilt Wheel Lever
20. Hood Release
21. Electric Mirror Control

Features & Controls



■ *Instrument Panel and Clusters*

Standard Cluster

Your instrument panel is designed to let you know at a glance how your vehicle is running. You'll know how fast you're going, about how much fuel you have left in your fuel tank, and many other things you'll need to know to drive safely and economically.

Optional Cluster

If you have the optional cluster, your instrument panel gives you additional information. This cluster includes a tachometer.

Speedometer and Odometer

Your speedometer lets you see your speed in both miles per hour (mph) and kilometers per hour (km/h). Your odometer shows how far your vehicle has been driven, in miles.



Trip Odometer

The trip odometer can tell you how far your vehicle has been driven since you last set the trip odometer to zero.

To set the trip odometer to zero, press the knob.

Tachometer (Option)

The tachometer shows engine speed in thousands of revolutions per minute (rpm).

NOTICE

Do not operate the engine with the tachometer in the red area, or engine damage may occur.

Features & Controls

■ *Warning Lights, Gages and Indicators*

This section describes the warning lights and gages that are on your vehicle. The pictures will help you locate them.

Warning lights and gages can signal that something is wrong before it becomes serious enough to cause an expensive repair or replacement. Paying attention to your warning lights and gages could also save you or others from injury.

Warning lights go on when there may be or is a problem with one of your vehicle's functions. As you will see in the details on the next few pages, some warning lights come on briefly when you turn the ignition key just to let you know they're working. If you are familiar with this section, you should not be alarmed when this happens.

Gages can indicate when there may be or is a problem with one of your vehicle's functions. Often gages and warning lights work together to let you know when there's a problem with your vehicle.

When one of the warning lights comes on and stays on when you are driving, or when one of the gages shows there may be a problem, check the section that tells you what to do about it. Please follow the manual's advice. Waiting to do repairs can be costly — and even dangerous. So please get to know your warning lights and gages. They're a big help.

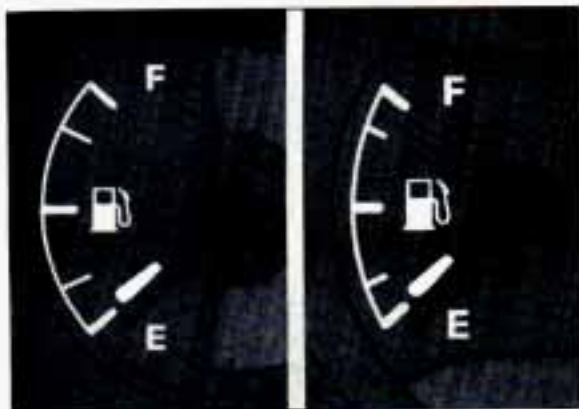

Fuel Gage

Your fuel gage shows about how much fuel is in your tank. The fuel gage works only when the ignition switch is in the **ON** position. When the gage pointer first indicates **E**, you still have a little fuel left (about one to two gallons) but you need to get more right away.

Here are four concerns some owners have had about the fuel gage. All these situations are normal and do not indicate that anything is wrong with the fuel gage.

- At the gas station, the gas pump shuts off before the gage reads **F**.

- It takes more (or less) gas to fill up than the gage said. For example, the gage said 1/2 full, but it took more (or less) than half of the tank's capacity to fill it.
- The gage moves a little when you turn, stop or speed up.
- When you turn the engine off, the gage doesn't go back to **E**.



Brake System Warning Light

Your Geo's hydraulic brake system is divided into two parts. If one part isn't working, the other part can still work and stop you. For good braking, though, you need both parts working well.

If the warning light goes on, there could be a brake problem. Have your brake system inspected right away.

This light should come on as you start the vehicle. If it doesn't come on then, have it fixed so it will be ready to warn you if there's a problem.

Features & Controls

This light will also come on when you set your parking brake, and it will stay on if your parking brake doesn't release fully. If it stays on after your parking brake is fully released, it means you may have a brake problem.

If the light comes on while driving, pull off the road and stop carefully. You may notice that the pedal is harder to push. Or, the pedal may go closer to the floor. It may take longer to stop. If the light is still on, have the vehicle towed for service. (See "Towing Your Vehicle" in the Index.)

CAUTION



Your brake system may not be working properly if the brake warning light is on. Driving with the brake warning light on can lead to an accident. If the light is still on after you've pulled off the road and stopped carefully, have the vehicle towed for service.



Anti-Lock Brake System Warning Light (Option)

With anti-lock, this light will go on when you start your engine and may stay on for several seconds or so. If the light doesn't come on, have it fixed so it will be ready to warn you if there is a problem.

If the light stays on or comes on when you're driving, stop as soon as possible and turn the key off. Then start the engine to reset the system. If the light still stays on, or comes on again while you're driving, your Geo needs service. Unless your regular brake system warning light is also on, you will still have brakes, but not anti-lock brakes. If

the regular brake system warning light is also on, see "Brake System Warning Light" earlier in this part.

If the anti-lock brake system warning light ever flashes, your anti-lock brake system is still working but needs service.

The anti-lock brake system warning light may also come on when you are driving with a compact spare tire. If this happens, the light means you won't have anti-lock until you replace the compact spare with a full-size tire. If the warning light stays on after you replace the compact spare with a full-size tire, or if it comes on again when you're driving, your Geo needs service.

ABS Active Light

When your anti-lock brake system is working, the message **ABS ACTIVE** light will come on. This means that slippery road conditions may exist. Adjust your driving accordingly.

Engine Coolant Temperature Gage

This gage shows the engine coolant temperature. If the gage pointer moves into the red area, your engine is too hot! It means that your engine coolant has overheated. If you have been operating your vehicle under normal driving conditions, you should pull off the road, stop your vehicle and turn off the engine as soon as possible.

HOT COOLANT CAN BURN YOU BADLY!

In "Problems on the Road," this manual shows what to do. See "Engine Overheating" in the Index.

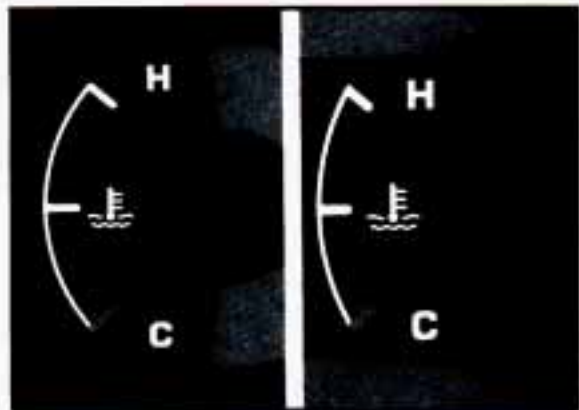

Features & Controls



Engine Oil Pressure Light

If you have a problem with your oil, this light may stay on after you start your engine, or come on when you are driving. This indicates that there is not enough oil pressure to keep your engine properly lubricated and cool. The engine could be low on oil, or could have some other oil related problem. Have it fixed right away.

The oil light could also come on in three other situations:

- When the ignition is on but the engine is not running, the light will come on as a test to show you it is working, but the light will go out when you turn the ignition to **START**. If it doesn't come on with the ignition on, you may have a problem with the fuse or bulb. Have it fixed right away.
- Sometimes when the engine is idling at a stop, the light may blink on and off. This is normal.
- If you make a hard stop, the light may come on for a moment. This is normal.

CAUTION



Don't keep driving if the oil pressure is low. If you do, your engine can become so hot that it catches fire. You or others could be burned. Check your oil as soon as possible and have your vehicle serviced.

NOTICE

Damage to your engine from neglected oil problems can be costly and is not covered by your warranty.



Charging System Light

This light will come on briefly when you turn on the ignition, but the engine is not running, as a check to show you it is working. Then it should go out when the engine starts. If it stays on, or comes on while you are driving, you may have a problem with the electrical charging system. It could indicate that you have a loose generator drive belt, or another electrical problem. Have it checked right away. Driving while this light is on could drain your battery.

If you must drive a short distance with the charging system light on, be certain to turn off all your accessories, such as the radio and air conditioner.



Malfunction Indicator Lamp (Check Engine Light)

A computer monitors operation of your fuel, ignition and emission control systems. This light should come on when the ignition is on, but the engine is not running, as a check to show you it is working. If it does not come on at all, have it fixed right away. If it stays on, or comes on while you are driving, the computer is indicating that you have a problem. You should take your vehicle in for service soon.

NOTICE

If you keep driving your vehicle with this light on, after a while the emission controls won't work well, your fuel economy won't be as good, and your engine may not run as smoothly. This could lead to costly repairs not covered by your warranty.

Features & Controls



Rear Window Defogger Light

This light will come on whenever the rear window defogger is on. See "Rear Window Defogger" in the Index.



Door Warning Light

This light stays on if any door is not completely closed and the ignition switch is **ON**. The light should also come on briefly when you turn your key to **START**. If the light doesn't come on as it should, have it fixed.



Overdrive Off Light

If you have an automatic transaxle with Overdrive, this light appears on your instrument cluster. The light will come on whenever you turn off the Overdrive.



In this part you'll find out how to operate the comfort control systems and audio systems offered with your Geo. Be sure to read about the particular system supplied with your vehicle.

Part 3

Comfort Controls & Audio Systems

Comfort Controls	100
Heater Controls	100
Heating	101
Bi-Level Heating	101
Ventilation	102
Defogging and Defrosting Windows	102
Air Conditioner Controls	103
Cooling	103
Dehumidifying	103
Rear Window Defogger	104
Flow-Through Ventilation System	104
Audio Systems	105
Setting the Clock	106
AM/FM Stereo	107
AM/FM Stereo with Cassette Tape Player	109
AM/FM Stereo with Cassette Tape and Compact Disc Player	116
Understanding Radio Reception	124
Care of Your Cassette Tape Player	124
Care of Your Compact Disc	125
Antenna	125

Comfort Controls & Audio Systems



■ *Comfort Controls*

With this system, you can control the heating and ventilation in your Geo. If you have the air conditioning option, you can also control cooling.

Your vehicle also has the flow-through ventilation system described later in this part.

Heater Controls

Air Intake Lever

 : Choose this position to recirculate the inside air through the comfort control system.

 : Choose this position to circulate outside air through the comfort control system.

Airflow Knob

Use this knob to direct the airflow.

 : This position directs the airflow through the instrument panel vents.

 : This position directs the airflow through the instrument panel vents and toward the floor.

 : This position directs the airflow toward the floor.

 : This position directs the airflow toward the floor and the windshield.

 : This position directs the airflow to the windshield.



Fan Knob

 : Turn this knob to turn the heating system on or off. Turn the knob toward **HI** to increase the fan's speed.

Temperature Knob



Turn the knob toward the right to increase the temperature. Turn the knob toward the left to decrease the temperature. The temperature of the air cannot be less than the temperature of the outside air.

Heating

1. For the quickest results, move the air intake lever to .
2. Turn the airflow knob to .
3. Turn the temperature knob toward the right for warmer air.
4. Turn the fan knob toward **HI**.
5. You should switch to  once in a while to avoid stale air and cloudy windows.

Bi-Level Heating

You may want to use bi-level heating on cool, but sunny days. This setting directs cool air toward your body and warmer air toward your feet.



1. Move the air intake lever to .
2. Turn the airflow knob to .
3. Turn the temperature knob to the center.
4. Turn the fan knob toward **HI**.

Comfort Controls & Audio Systems





Ventilation

When the outside temperatures are mild, very little heating is required. You can direct outside air through your vehicle in this way:

1. Move the air intake lever to .
2. Turn the airflow knob to .
3. Turn the temperature knob to a comfortable setting.
4. Turn the fan knob toward **HI**.

Defogging and Defrosting Windows

1. Slide the air intake lever to .
2. Turn the airflow knob to  to direct air to the windshield vents.
3. Turn the temperature knob toward the right.
4. Turn the fan knob to **HI**.

When the windshield is clear, turn down the fan speed.

To defog the side windows, aim the side vents toward the windows. If you have the air conditioning option, push the A/C button for quicker defogging.





Air Conditioner Controls (OPTION)

The air conditioning system uses the same controls as the heating system. The function of each knob and lever is explained under "Heater Controls" on the previous pages. The incoming air is cooled and dehumidified instead of being heated.

A/C: Push this button to change your comfort control system from heating to air conditioning. A light will come on when the air conditioning is on. The A/C button can also control the humidity in your vehicle.



Cooling

The air conditioner works best if you keep your windows closed. On very hot days, open the windows just long enough for the hot air to escape.

1. Push the A/C button.
2. Move the air intake lever to  for normal cooling. For faster cooling move the lever to .
3. Turn the airflow knob to .
4. Turn the temperature knob to the left.
5. Turn the fan knob to **HI**.

Dehumidifying

On days when it is raining or the humidity is high, follow these dehumidifying steps instead of the cooling directions. It will help clean windows that are cloudy with moisture.

1. Push the A/C button.
2. Move the air intake lever to .
3. Turn the airflow knob to .
4. Turn the fan knob toward **HI**.
5. Adjust the temperature knob to a comfortable setting.

Comfort Controls & Audio Systems



Rear Window Defogger (OPTION)

The rear window defogger uses a warming grid to remove fog from the rear window.

Press the switch to turn on the defogger. The defogger will stay on until you turn it off by pressing the switch again. Use it only when the engine is running. Make sure you turn the defogger off when the window is clear. Leaving the defogger on for a long time could cause the battery to run down, especially during stop and go driving. The defogger is not designed for drying water or melting snow.

Do not attach anything like a temporary vehicle license or a decal across the defogger grid on the rear window.

NOTICE

Don't use a razor blade or something else sharp on the inside of the rear window. If you do, you could cut or damage the warming grid, and the repairs wouldn't be covered by your warranty.

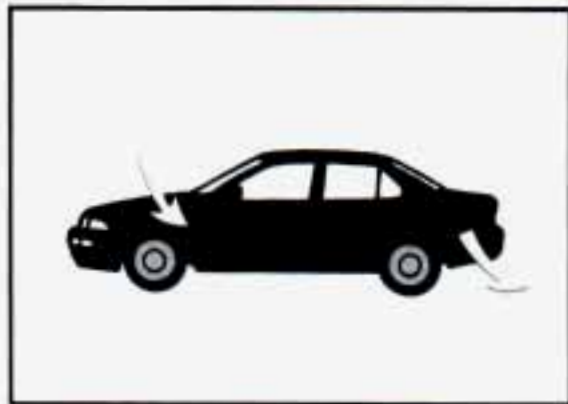

Flow-Through Ventilation System

Your Geo's flow-through ventilation system supplies outside air into the vehicle when it is moving. Outside air will also enter the vehicle when the heater or the air conditioning fan is running.

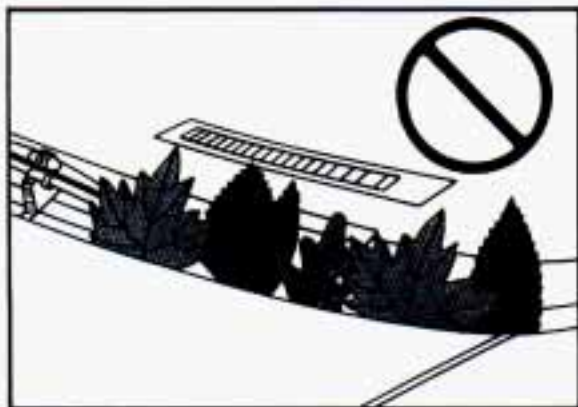

Ventilation Tips

- Keep the hood and front air inlet free of ice, snow, or any other obstruction (such as leaves). The heater and defroster will work far better, reducing the chance of fogging the inside of your windows.
- When you enter a vehicle in cold weather, move the fan knob toward **HI** for a few moments before driving off. This helps clear the intake ducts of snow and moisture, and reduces the chance of fogging the inside of your windows.
- Keep the air path under the front seats clear of objects. This helps air to circulate throughout your vehicle.

■ Audio Systems

Your Delco® audio system has been designed to operate easily and give years of listening pleasure. But you will get the most enjoyment out of it if you acquaint yourself with it first. Find out what your Delco® system can do and how to operate all its controls, to be sure you're getting the most out of the advanced engineering that went into it.

CAUTION



Hearing damage from loud noise is almost undetectable until it is too late. Your hearing can adapt to higher volumes of sound. Sound that seems normal can be loud and harmful to your hearing. Take precautions by adjusting the volume control on your radio to a safe sound level before your hearing adapts to it.

To help avoid hearing loss or damage:

- Adjust the volume control to the lowest setting.
- Increase volume slowly until you hear comfortably and clearly.

Comfort Controls & Audio Systems

NOTICE

Before you add any sound equipment to your vehicle — like a tape player, CB radio, mobile telephone or two-way radio — be sure you can add what you want. If you can, it's very important to do it properly. Added sound equipment may interfere with the operation of your vehicle's engine, Delco® radio or other systems, and even damage them. And, your vehicle's systems may interfere with the operation of sound equipment that has been added improperly.

So, before adding sound equipment, check with your dealer and be sure to check Federal rules covering mobile radio and telephone units.

Setting the Clock

AM/FM Stereo

1. Press and hold **RCL** (TIME SET). At the same time press and hold **TUNE** ◀ (HR) until the correct hour appears.
2. Press and hold **RCL** (TIME SET). At the same time press and hold **TUNE** ▶ (MIN) until the correct minute appears.

AM/FM Stereo with Cassette Tape Player

1. Press and hold **RCL/PROG** (TIME SET). At the same time press and hold **TUNE** ◀ (HR) until the correct hour appears.

2. Press and hold **RCL/PROG** (TIME SET). At the same time press and hold **TUNE** ▶ (MIN) until the correct minute appears.

AM/FM Stereo with Cassette Tape and Compact Disc Player

1. Press and hold **RCL** ▼▲ (TIME SET). At the same time press and hold **TUNE** ◀ (HR) until the correct hour appears.
2. Press and hold **RCL** ▼▲ (TIME SET). At the same time press and hold **TUNE** ▶ (MIN) until the correct minute appears.



AM/FM Stereo

To Play the Radio

Turn the **ON/VOL** knob to turn the system on or off.

Volume

Turn the **ON/VOL** knob to adjust the volume.

AM-FM

Press **AM-FM** to get AM or FM. The lighted display shows your selection.

Tune

Press **TUNE ►** or **TUNE ◀** to go to a higher or lower station. Press either button and hold to continue tuning and release when you find your station. The display will indicate the frequency of each station tuned.

Seek

Press **SEEK ►** or **SEEK ◀** and the radio will tune to the next higher or lower station and stay there.

Comfort Controls & Audio Systems

Pushbuttons

The six pushbuttons let you return to your favorite stations. To set the pushbuttons for up to 12 stations (6 AM and 6 FM), just:

1. Tune in the station.
2. Press and hold one of the pushbuttons for at least two seconds. The sound will go away for a second and will return when the station is stored.

Repeat these steps for each pushbutton.

Setting the Tone

Bass: Turn the **BASS** knob to the right to hear more bass.

Treble: Turn the **TREB** knob to the right to hear more treble.

Adjusting the Speakers

Fade: Turn the **FADE** knob to move the sound between the front and rear speakers.

Balance: Turn the **BAL** control behind the **FADE** knob to move the sound between the right and left speakers.

Recall

Press **RCL** to switch the display between time and frequency. Or, press it if you want to see the time when the ignition is off.



AM/FM Stereo with Cassette Tape Player

To Play the Radio

Turn the **ON/VOL** knob to turn the system on or off.

Volume

Turn the **ON/VOL** knob to adjust the volume.

AM-FM

Press **AM-FM** to get AM, FM1 or FM2. The lighted display shows your selection.

Tune

Press **TUNE ►** or **TUNE ◀** to go to a higher or lower station. Press either button and hold to continue tuning and release when you find your station. The display will indicate the frequency of each station tuned.

Seek

Press **SEEK ►** or **SEEK ◀** and the radio will tune to the next higher or lower station and stay there.

Pushbuttons

The six pushbuttons let you return to your favorite stations. To set the pushbuttons for up to 18 stations (6 AM, 6 FM1 and 6 FM2), just:

1. Tune in the station.
2. Press and hold one of the pushbuttons for at least two seconds. The sound will go away for a second and will return when the station is stored.

Repeat these steps for each pushbutton.

Comfort Controls & Audio Systems

Setting the Tone

Bass: Turn the **BASS** control to the right to hear more bass.

Treble: Turn the **TREB** knob in front of the **BASS** control to the right to hear more treble.

Loud

To increase the bass tone at low volumes, press the **LOUD** button.

Tone Select

Press **TONE SELECT** to choose preset treble and bass equalization settings designed for "ROCK," "NEWS," "POP," "JAZZ" and "CLASSICAL." "ROCK" will appear when you first press **TONE SELECT**. Each time you press **TONE SELECT** another setting will appear on the display. Press **TONE SELECT** again after "CLASSICAL" and control of the tone will be back to the treble and bass knobs.

Adjusting the Speakers

Fade: Turn the **FADE** knob to move the sound between the front and rear speakers.

Balance: Turn the **BAL** control behind the **FADE** knob to move the sound between the right and left speakers.

Preset Scan

Press the **PRESET SCAN** button to hear each of your preset stations for a few seconds. When you want to stop at a chosen station, press **PRESET SCAN** again.

Recall

Press **RCL/PROG** to switch the display between time and frequency. Or, press it if you want to see the time when the ignition is off.

To Play a Cassette Tape

Your tape player is built to work best with tapes that are 30 to 45 minutes long on each side. Tapes longer than that are so thin they may not work well in this player.

The longer side with the tape visible should face to the right. If you hear nothing or hear just a garbled sound, it may not be in squarely. Press **■▲** (Stop/Eject) to remove the tape and start over. Once the tape is playing, use the knobs for volume and balance, just as you do for radio. The lighted arrows show which side of the tape is playing.

Your bias is set automatically. When a metal or chrome tape is inserted, "MTL" is shown on the display.

Fast Forward

Press **FF** to rapidly advance to another part of the tape. Press **FF, RCL/PROG** or **■▲** to return to playing speed.

Rewind

Press **REW** to rapidly reverse the tape. Press **REW, RCL/PROG** or **■▲** to return to playing speed.

To Play the Next Selection

Press **NEXT** to go forward to the beginning of the next selection.

Comfort Controls & Audio Systems

For **NEXT** to work properly, your tape must have at least three or four seconds of silence between each selection.

Previous

Press **PREV** to hear the last selection over. Press **PREV** again or press **RCL/PROG** or **■▲** to cancel this function.

Program

Press **RCL/PROG** to switch from one side of the tape to the other.

Your cassette tape player can play continuously because the player has an auto-reverse feature.

Dolby DD®

Press **□□** to remove noise from Dolby DD® NR-encoded tapes.

Dolby® Noise Reduction is manufactured under license from Dolby Laboratories Licensing Corporation. **Dolby** and the double-D symbol are trademarks of Dolby Laboratories Licensing Corporation.

Eject

Press **■▲** to remove the tape or stop the tape and switch to radio.

Radio Monitor

Press the **RADIO MNTR** button to hear the radio when you are fast forwarding or reversing a cassette tape. You can use the **TUNE**, **SEEK** and **PRESET SCAN** buttons while in the radio monitor mode.

Theft-Deterrent Feature

The theft-deterrent feature for the audio system with cassette tape player can be used or ignored. If ignored, the system plays normally. If it is used, your system won't be usable if it's ever stolen.

Setting Your Security Code

The instructions below tell you how to enter a security code into the system. If your vehicle loses battery power for any

reason, you must enter the security code again before the system will turn on.

1. Write down any four-digit number and keep it in a safe place.
2. Turn the ignition switch to the **ACC** or **ON** position.
3. Turn the audio system off.
4. Press the **1** and **4** buttons together. Hold them down until "----" shows on the display.

You are now ready to enter your security code. Don't wait more than 15 seconds between steps.

5. Press **◀ SEEK ▶** and/or **◀ TUNE ▶** and "0000" will appear on the display.
6. Press **SEEK ◀** and hold it until the first digit of your code appears. Release the button.
7. Press **SEEK ▶** and hold it until the second digit of your code appears. Release the button.
8. Press **TUNE ◀** and hold it until the third digit of your code appears. Release the button.

Comfort Controls & Audio Systems

9. Press **TUNE ►** and hold it until the fourth digit of your code appears. Release the button.
10. Press **AM-FM** after you have checked that the code you entered is the one you wrote down. Your code is now stored and "SEC" will appear on the display.

How to Shut Off the Theft-Deterrent Feature

If your radio is secured ("SEC" shows on the display) and you wish to disable it, enter your security code as follows pausing no more than 15 seconds between steps:

1. Press the **1** and **4** buttons together. Hold them down until "----" shows on the display. You are now ready to enter your security code.
2. Press the **SEEK ◀** button and hold it until the first digit of your code appears.
3. Press the **SEEK ►** button and hold it until the second digit of your code appears.
4. Press the **TUNE ◀** button and hold it until the third digit of your code appears.
5. Press the **TUNE ►** button and hold it until the fourth digit of your code appears.

6. Press **AM-FM** after you have checked that the code you entered matches the one you wrote down. "----" should now appear in the display.

If the code is correct, the radio will operate. If the code is wrong, "Err" will appear in the display.

To Unlock the System after a Power Loss

If power is disrupted to the radio while in the "SEC" mode, the unit will not work and "LOC" will show on the display whenever the ignition is on. To unlock the unit:

1. Press **◀ SEEK ▶** and/or **◀ TUNE ▶** and "0000" will appear on the display.
2. Press the **SEEK ◀** button and hold it until the first digit of your code appears.

3. Press the **SEEK ▶** button and hold it until the second digit of your code appears.
4. Press the **TUNE ◀** button and hold it until the third digit of your code appears.
5. Press the **TUNE ▶** button and hold it until the fourth digit of your code appears.
6. Press **AM-FM** after you have checked that the code matches the one you wrote down. Now "SEC" will appear in the display.

Comfort Controls & Audio Systems



AM/FM Stereo with Cassette Tape and Compact Disc Player

To Play the Radio

Turn the **ON/VOL** knob to turn the system on or off.

Volume

Turn the **ON/VOL** knob to adjust the volume.

AM-FM

Press **AM-FM** to get AM, FM1 or FM2. The lighted display shows your selection.

Tune

Press **TUNE** ► or **TUNE** ◀ to go to a higher or lower station. Press either button and hold to continue tuning and release when you find your station. The display will indicate the frequency of each station tuned.

Seek

Press **SEEK** ► or **SEEK** ◀ and the radio will tune to the next higher or lower station and stay there.

Pushbuttons

The six pushbuttons let you return to your favorite stations. To set the pushbuttons for up to 18 stations (6 AM, 6 FM1 and 6 FM2), just:

1. Tune in the station.
2. Press and hold one of the pushbuttons for at least two seconds. The sound will go away for a second and will return when the station is stored.

Repeat these steps for each pushbutton.

Setting the Tone

Bass: Turn the **BASS** control to the right to hear more bass.

Treble: Turn the **TREB** knob in front of the **BASS** control to the right to hear more treble.

Loud

To increase the bass tone at low volumes, press the **LOUD** button.

Tone Select

Press **TONE SELECT** to choose preset treble and bass equalization settings designed for "ROCK," "NEWS," "POP," "JAZZ" and "CLASSICAL." "ROCK" will appear when you first press **TONE SELECT**. Each time you press **TONE SELECT** another setting will appear on the display. Press **TONE SELECT** again after "CLASSICAL" and control of the tone will be back to the treble and bass knobs.

Adjusting the Speakers

Fade: Turn the **FADE** knob to move the sound between the front and rear speakers.

Balance: Turn the **BAL** control behind the **FADE** knob to move the sound between the right and left speakers.

Preset Scan

Press the **PSCAN** button to hear each of your preset stations for a few seconds. When you want to stop at a chosen station, press **PSCAN** again.

Comfort Controls & Audio Systems

Recall

Press **RCL ▼▲** to switch the display between time and frequency. Or, press it if you want to see the time when the ignition is off.

To Play a Cassette Tape

Your tape player is built to work best with tapes that are 30 to 45 minutes long on each side. Tapes longer than that are so thin they may not work well in this player.

The longer side with the tape visible should face to the right. If you hear nothing or hear just a garbled sound, it may not be in squarely. Press **STOP** or **EJECT** to remove the tape and start

over. Once the tape is playing, use the knobs for volume and balance, just as you do for radio. The lighted arrows show which side of the tape is playing. Your bias is set automatically. When a metal or chrome tape is inserted, "MTL" will appear in the display.

Fast Forward

Press **FF** to rapidly advance to another part of the tape. Press **FF**, **RCL ▼▲** or **STOP** to return to playing speed.

Rewind

Press **REW** to rapidly reverse the tape. Press **REW**, **RCL ▼▲** or **STOP** to return to playing speed.

To Play the Next Selection

Press **NXT** to go forward to the beginning of the next selection.

Repeat

Press **RPT** to go back to the beginning of the selection.

For **NXT** and **RPT** to work properly, your tape must have at least three or four seconds of silence between each selection.

Previous

Press **PRV** to hear a selection again.

Dolby DD®

Press **DD** to remove noise from Dolby DD® NR-encoded tapes.

Dolby® Noise Reduction is manufactured under license from Dolby Laboratories Licensing Corporation.

Dolby and the double-D symbol are trademarks of Dolby Laboratories Licensing Corporation.

Radio Monitor

When playing a tape, press **RDM** during **FF** or **REW** to hear the radio. Press **RDM** again to turn the radio off.

During **RDM** operation, only **TUNE**, **SEEK** and **PSCAN** will work.

Recall

Press **RCL** **▼▲** to switch from one side of the tape to the other.

STOP

Press **STOP** to stop the tape and switch to radio.

To Play a Compact Disc

Before you begin, please note: don't use the mini-discs that are called "singles." They won't eject. Use full-size compact discs.

Insert your disc into the CD slot on your audio system.

If the disc comes back out, it could be that:

- The disc is upside down.
- It is dirty, scratched, or wet.
- There is too much moisture in the air. (If there is, wait about one hour and try again).

If you see "Err" on the display, the disc player is too hot to play the disc. Press **RCL** **▼▲** to take "Err" off the display.

Comfort Controls & Audio Systems

Recall

Press **RCL** ▼▲ to see which track is playing. Press it again within 5 seconds to see how long it has been playing.

The track number also appears when the disc is inserted or you change the volume.

Previous

Press **PRV** to hear a track again.

If you hold this button, or press it more than once, the disc will return to previous tracks.

NEXT

Press **NXT** to hear the next track now (instead of waiting until the present track is finished).

If you hold this button, or press it more than once, the disc will advance further.

Rewind

Press and hold **REW** to rapidly return to a favorite passage. Release it to play the passage.

Fast Forward

Press and hold **FF** to advance quickly within a track. Release it to resume playing.

Compression

Press **COMP** to make soft and loud passages more nearly equal in volume.

Repeat

Press **RPT** once to hear a selection over again.

Random

Pressing **RDM** will cause the CD player to play the tracks back in random order. To cancel the random feature, press **RDM**, **STOP** or **RPT**.

STOP

Press **STOP** to stop playing the disc and switch to radio. Press **STOP** again to restart the disc at the point where it stopped.

AM-FM

In the CD mode, pressing **AM-FM** will cancel the CD operation and return to radio.

CD-TAPE

Press **CD-TP** to switch between playing a tape and a CD when both are inserted.

EJECT

Press **EJECT** to eject the disc and the radio will play. The disc will start playing at track 1 when you reinsert it.

Special Eject

If you choose, you can eject only the tape or CD when you have both a CD and a tape in your audio system.

CD Only: To eject only the CD, press **EJECT** and then press **REW**.

Tape Only: To eject only the tape, press **EJECT** and then press **PRV**.

Theft-Deterrent Feature

The theft-deterrent feature for the AM/FM stereo with cassette tape and compact disc player can be used or ignored. If ignored, the system plays normally. If it is used, your system won't be usable if it's ever stolen.

Setting Your Security Code

The instructions below tell you how to enter a security code into the system. If your vehicle loses battery power for any

Comfort Controls & Audio Systems

reason, you must enter the security code again before the system will turn on.

1. Write down any four-digit number and keep it in a safe place.
2. Turn the ignition switch to the **ACC** or **ON** position.
3. Turn the audio system off.
4. Press the **1** and **4** buttons together. Hold them down until "----" shows on the display.

You are now ready to enter your security code. Don't wait more than 15 seconds between steps.

5. Press **◀ SEEK ▶** and/or **◀ TUNE ▶** and "0000" will appear on the display.
6. Press **SEEK ◀** and hold it until the first digit of your code appears. Release the button.
7. Press **SEEK ▶** and hold it until the second digit of your code appears. Release the button.
8. Press **TUNE ◀** and hold it until the third digit of your code appears. Release the button.
9. Press **TUNE ▶** and hold it until the fourth digit of your code appears. Release the button.

10. Press **AM-FM** after you have checked that the code you entered is the one you wrote down. "rEP" will appear in the display which means you need to repeat steps 5-9.
11. Press **AM-FM** again and the display will now show "SEC."

How to Shut Off the Theft-Deterrent Feature

If your radio is secured ("SEC" shows on the display) and you wish to disable it, enter your security code as follows pausing no more than 15 seconds between steps:

pausing no more than 15 seconds between steps:

1. Press the **1** and **4** buttons together. Hold them down until "----" shows on the display. You are now ready to enter your security code.
2. Press the **SEEK** ◀ button and hold it until the first digit of your code appears.
3. Press the **SEEK** ▶ button and hold it until the second digit of your code appears.
4. Press the **TUNE** ◀ button and hold it until the third digit of your code appears.

5. Press the **TUNE** ▶ button and hold it until the fourth digit of your code appears.
6. Press **AM-FM** after you have checked that the code you entered matches the one you wrote down. "----" should now appear in the display.

If the code is correct, the radio will operate. If the code is wrong, "Err" will appear in the display.

To Unlock the System after a Power Loss

If power is disrupted to the radio while in the "SEC" mode, the unit will not work and "LOC" will show on the display whenever the ignition is on. To unlock the unit:

1. Press ◀ **SEEK** ▶ and/or ◀ **TUNE** ▶ and "0000" will appear on the display.
2. Press the **SEEK** ◀ button and hold it until the first digit of your code appears.
3. Press the **SEEK** ▶ button and hold it until the second digit of your code appears.

Comfort Controls & Audio Systems



4. Press the **TUNE ◀** button and hold it until the third digit of your code appears.
5. Press the **TUNE ▶** button and hold it until the fourth digit of your code appears.
6. Press **AM-FM** after you have checked that the code matches the one you wrote down. Now "SEC" will appear in the display.

Understanding Radio Reception

FM Stereo

FM Stereo will give you the best sound, but FM signals will reach only about 10 to 40 miles (16 to 65 km). And, tall buildings or hills can interfere with FM signals, causing the sound to come and go.

AM

The range for most AM stations is greater than for FM, especially at night. The longer range, however, can cause stations to interfere with each other. AM can pick up noise from things like storms and power lines. Try reducing the treble to reduce this noise if you ever get it.

Care of Your Cassette Tape Player

A tape player that is not cleaned regularly can cause reduced sound quality, ruined cassettes, or a damaged mechanism. Cassette tapes should be stored in their cases away from contaminants, direct sunlight, and extreme heat. If they aren't, they may not operate properly or cause failure of the tape player.

Your tape player should be cleaned regularly each month or after every 15 hours of use. If you notice a reduction

in sound quality, try a known good cassette to see if the tape or the tape player is at fault. If this other cassette has no improvement in sound quality, clean the tape player.

Clean your tape player with a wiping-action, non-abrasive cleaning cassette and follow the directions provided with it.

Cassettes are subject to wear and the sound quality may degrade over time. Always make sure that the cassette tape is in good condition before you have your tape player serviced.



Care of Your Compact Disc

Handle discs carefully. Store them in their original cases or other protective cases and away from direct sunlight and dust. If the surface of a disc is soiled, dampen a clean, soft cloth in a mild, neutral detergent solution and clean it, wiping from the center to the edge.

Be sure to never touch the signal surface when handling discs. Pick up discs by grasping the outer edges or the edge of the hole and the outer edge.



Antenna

Use the knob on the end of the antenna to raise the antenna or to push it back down. Keep the antenna mast clean for good performance.

Always lower the antenna before entering a car wash.

Notes



Part 4 Your Driving and the Road

Here you'll find information about driving on different kinds of roads and in varying weather conditions. We've also included many other useful tips on driving.

Road Signs.....	128
Defensive Driving.....	132
Drunken Driving.....	133
Control of a Vehicle.....	137
Driving at Night.....	150
Driving in the Rain.....	153
Driving in Fog, Mist and Haze.....	155
City Driving.....	157
Freeway Driving.....	158
Driving a Long Distance.....	161
Hill and Mountain Roads.....	163
Parking on Hills.....	165
Winter Driving.....	167
Towing a Trailer.....	171

Your Driving and the Road

■ Road Signs

The road signs you see everywhere are coded by color, shape and symbols. It's a good idea to know these codes so that you can quickly grasp the basic meaning or intent of the sign even before you have a chance to read it.



Color of Road Signs

RED means STOP. It may also indicate that some movement is not allowed. Examples are DO NOT ENTER and WRONG WAY.



YELLOW indicates a general warning. Slow down and be careful when you see a yellow sign. It may signal a railroad crossing ahead, a no-passing zone, or some other potentially dangerous situation. Likewise, a yellow solid line painted on the road means "Don't Cross."



ORANGE indicates road construction or maintenance. You'll want to slow down when you see an orange sign, as part of the road may be closed off or torn up. And there may be workers and maintenance vehicles around, too.



GREEN is used to guide the driver. Green signs may indicate upcoming freeway exits or show the direction you should turn to reach a particular place.



HOSPITAL



INFORMATION

BLUE signs with white letters show motorists' services.



CANOEING



SWIMMING

BROWN signs point out recreation areas or points of historic or cultural interest.



Shape of Road Signs

The shape of the sign will tell you something, too.

An **OCTAGONAL** (eight-sided) sign means **STOP**. It is always red with white letters.



END DIVIDED HIGHWAY

A **DIAMOND**-shaped sign is a warning of something ahead — for example, a curve, steep hill, soft shoulder, or a narrow bridge.



A **TRIANGLE**, pointed downward, indicates **YIELD**. It assigns the right-of-way to traffic on certain approaches to an intersection.



A **TRIANGULAR** sign also is used on two-lane roads to indicate a **NO PASSING ZONE**. This sign will be on the left side of the roadway.

Your Driving and the Road



KEEP
RIGHT



LEFT OR
THROUGH



RIGHT TURN
ONLY



FOOD



NO RIGHT
TURN



RECTANGULAR (square or oblong) signs show speed limits, parking regulations, give directions and such information as distances to cities.

Symbols on Road Signs

There are many international road signs in use today.



NO U
TURN



NO
BICYCLES



NO
PARKING

The basic message of many of these signs is in pictures or graphic symbols. A picture within a circle with a diagonal line across it shows what **not** to do.

Traffic Lights

We're all familiar with traffic lights or stop lights. Often green arrows are being used in the lights for improved traffic control. On some multilane roads, green arrows light up, indicating that traffic in one or more lanes can move or make a turn. Green arrows don't mean "go no matter what." You'll still need to proceed with caution, yielding the right of way to pedestrians and sometimes to other vehicles.

Some traffic lights also use red arrows to signify that you must stop before turning.

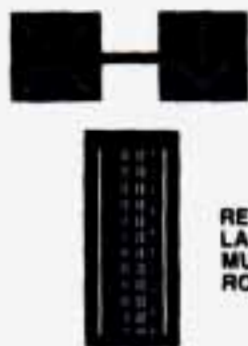

REVERSIBLE
LANE ON
MULTI-LANE
ROADWAY



NO PASSING ZONE

Many city roads and expressways, and even bridges, use reversible-lane traffic control during rush hours. A red X light above a lane means no driving in that lane at that time. A green arrow means you may drive in that lane. Look for the signs posted to warn drivers what hours and days these systems are in effect.

Pavement Markings

Pavement markings add to traffic signs and signals. They give information to drivers without taking attention from the roadway. A solid yellow line on your side of the road or lane means "don't cross."

Your Own Signals

Drivers signal to others, too. It's not only more polite, it's safer to let other drivers know what you are doing. And in some places the law requires driver signals.

Turn and lane change signals: Always signal when you plan to turn or change lanes.

If necessary, you can use hand signals out the window: Left arm straight out for a left turn, down for slow or about-to-stop, and up for a right turn.

Your Driving and the Road

Slowing down: If time allows, tap the brake pedal once or twice in advance of slowing or stopping. This warns the driver behind you.

Disabled: Your four-way flashers signal that your vehicle is disabled or is a hazard. See "Hazard Warning Flashers" in the Index.

Traffic Officer

The traffic police officer is also a source of important information. The officer's signals govern, no matter what the traffic lights or other signs say.

The next section discusses some of the road conditions you may encounter.

■ *Defensive Driving*

The best advice anyone can give about driving is: Drive defensively.

Please start with a very important safety device in your Geo: Buckle up. (See "Safety Belts" in the Index.)

Defensive driving really means "be ready for anything." On city streets, rural roads, or freeways, it means "always expect the unexpected."

Assume that pedestrians or other drivers are going to be careless and make mistakes. Anticipate what they might do. Be ready for their mistakes.

Expect children to dash out from behind parked cars, often followed by other children. Expect occupants in parked

cars to open doors into traffic. Watch for movement in parked cars — someone may be about to open a door.

Expect other drivers to run stop signs when you are on a through street. Be ready to brake if necessary as you go through intersections. You may not have to use the brake, but if you do, you will be ready.

If you're driving through a shopping center parking lot where there are well-marked lanes, directional arrows, and designated parking areas, expect some drivers to ignore all these markings and dash straight toward one part of the lot.

Pedestrians can be careless. Watch for them. In general, you must give way to pedestrians even if you know you have the right of way.

Rear-end collisions are about the most preventable of accidents. Yet they are common. Allow enough following distance. It's the best defensive driving maneuver, in both city and rural driving. You never know when the vehicle in front of you is going to brake or turn suddenly.

Here's a final bit of information about defensive driving. The most dangerous time for driving in the U.S. is very early on Sunday morning. In fact, GM Research studies show that the most and

the least dangerous times for driving, every week, fall on the same day. That day is Sunday. The most dangerous time is Sunday from 3 a.m. to 4 a.m. The safest time is Sunday from 10 a.m. to 11 a.m. Driving the same distance on a Sunday at 3 a.m. isn't just a little more dangerous than it is at 10 a.m. It's about 134 times more dangerous!

That leads to the next section.

■ *Drunken Driving*

Death and injury associated with drinking and driving is a national tragedy. It's the number one contributor to the highway death toll, claiming thousands of victims every year. Alcohol takes away three things that anyone needs to drive a vehicle:

- Judgment
- Muscular Coordination
- Vision

Police records show that half of all motor vehicle-related deaths involve alcohol — a driver, a passenger or someone else, such as a pedestrian, had been drinking. In most cases, these

Your Driving and the Road



deaths are the result of someone who was drinking and driving. Over 25,000 motor vehicle-related deaths occur each year because of alcohol, and thousands of people are injured.

Just how much alcohol is too much if a person plans to drive? Ideally, no one should drink alcohol and then drive. But if one does, then what's "too much" can be a lot less than many might think. Although it depends on each person and situation, here is some general information on the problem.

The Blood Alcohol Content (BAC) of someone who is drinking depends upon four things:

- How much alcohol is in the drink.
- The drinker's body weight.
- The amount of food that is consumed before and during drinking
- The length of time it has taken the drinker to consume the alcohol.

According to the American Medical Association, a 180-pound (82 kg) person who drinks three 12-ounce (355 ml) bottles of beer in an hour will end up with a BAC of about 0.06 percent. The person would reach the same BAC by drinking three 4-ounce (120 ml) glasses of wine or three mixed drinks if each had 1-1/2 ounces (45 ml) of a liquor like whiskey, gin or vodka.

**DRINKING THAT WILL
RESULT IN A BAC OF .05%
IN THE TIME SHOWN**

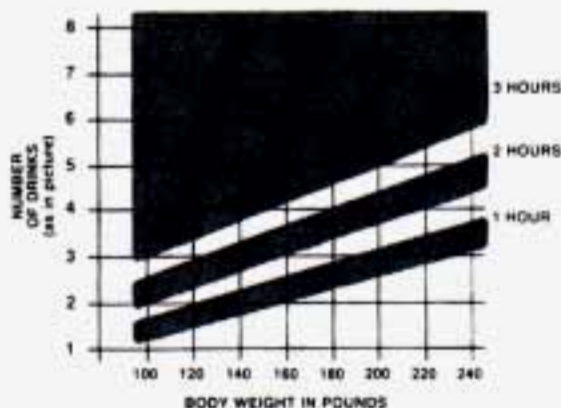

It's the amount of alcohol that counts. For example, if the same person drank three double martinis (3 ounces or 90 ml of liquor each) within an hour, the person's BAC would be close to 0.12 percent. A person who consumes food just before or during drinking will have a slightly lower BAC level.

The law in most U.S. states sets the legal limit at a BAC of 0.10 percent. In Canada the limit is 0.08 percent, and in some other countries it's lower than that. The BAC will be over 0.10 percent after three to six drinks (in one hour). Of course, as we've seen, it depends on how much alcohol is in the drinks, and how quickly the person drinks them.

But it's very important to keep in mind that the ability to drive is affected well below a BAC of 0.10 percent. Research shows that the driving skills of many people are impaired at a BAC

approaching 0.05 percent, and that the effects are worse at night. All drivers are impaired at BAC levels above 0.05 percent. Statistics show that the chance of being in an accident increases sharply for drivers who have a BAC of 0.05 percent or above. A driver with a BAC level of 0.06 percent (three beers in one hour for a 180-pound or 82 kg person) has doubled his or her chance of having an accident. At a BAC level of 0.10 percent, the chance of that driver having an accident is six times greater; at a level of 0.15 percent, the chances are twenty-five times greater! And, the body takes about an hour to rid itself of the

Your Driving and the Road

alcohol in one drink. No amount of coffee or number of cold showers will speed that up.

“I’ll be careful” isn’t the right answer. What if there’s an emergency, a need to take sudden action, as when a child darts into the street? A person with a higher BAC might not be able to react quickly enough to avoid the collision.

There’s something else about drinking and driving that many people don’t know. Medical research shows that alcohol in a person’s system can make crash injuries worse. That’s especially true for brain, spinal cord and heart injuries. That means that if anyone who has been drinking — driver or passenger — is in a crash, the chance of being killed or permanently disabled is higher than if that person had not been drinking. And we’ve already seen that the chance of a crash itself is higher for drinking drivers.

CAUTION



Drinking and then driving is very dangerous. Your reflexes, perceptions, and judgment will be affected by even a small amount of alcohol. You could have a serious — or even fatal — accident if you drive after drinking. Please don’t drink and drive or ride with a driver who has been drinking. Ride home in a cab; or if you’re with a group, designate a driver who will not drink.

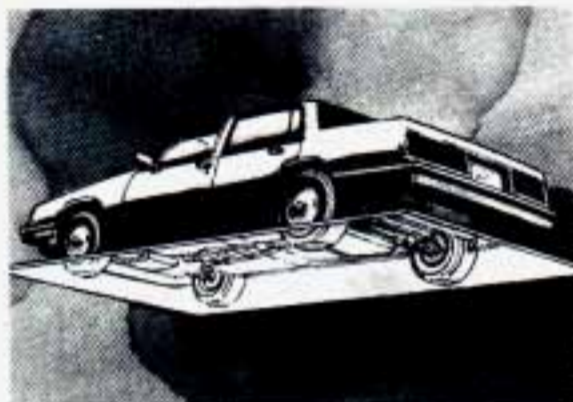

■ *Control of a Vehicle*

You have three systems that make your vehicle go where you want it to go. They are the brakes, the steering and the accelerator. All three systems have to do their work at the places where the tires meet the road.

Sometimes, as when you're driving on snow or ice, it's easy to ask more of those control systems than the tires and road can provide. That means you can lose control of your vehicle.

Braking

Braking action involves **perception time** and **reaction time**.

First, you have to decide to push on the brake pedal. That's **perception time**. Then you have to bring up your foot and do it. That's **reaction time**.

Average **reaction time** is about 3/4 of a second. But that's only an average. It might be less with one driver and as long as two or three seconds or more with another. Age, physical condition, alertness, coordination, and eyesight all play a part. So do alcohol, drugs and frustration. But even in 3/4 of a second, a vehicle moving at 60 mph (100 km/h) travels 66 feet (20 m). That could be a lot of distance in an emergency, so

keeping enough space between your vehicle and others is important.

And, of course, actual stopping distances vary greatly with the surface of the road (whether it's pavement or gravel); the condition of the road (wet, dry, icy); tire tread; and the condition of your brakes.

Most drivers treat their brakes with care. Some, however, overwork the braking system with poor driving habits.

- Avoid needless heavy braking. Some people drive in spurts — heavy acceleration followed by heavy braking — rather than keeping pace

Your Driving and the Road



with traffic. This is a mistake. Your brakes may not have time to cool between hard stops. Your brakes will wear out much faster if you do a lot of heavy braking.

- Don't "ride" the brakes by letting your left foot rest lightly on the brake pedal while driving.

CAUTION



"Riding" your brakes can cause them to overheat to the point that they won't work well. You might not be able to stop your vehicle in time to avoid an accident. If you "ride" your brakes, they will get so hot they will require a lot of pedal force to slow you down. Avoid "riding" the brakes.

NOTICE

"Riding" your brakes wears them out much faster. You would need costly brake replacement much sooner than normal, and it also reduces fuel economy.

If you keep pace with the traffic and allow realistic following distances, you will eliminate a lot of unnecessary braking. That means better braking and longer brake life.

- If your engine ever stops while you're driving, brake normally but don't pump your brakes. If you do, the pedal may get harder to push down. If your engine stops, you will still have some power brake assist. But you will use it when you brake. Once the power assist is used up, it may take longer to stop and the brake pedal will be harder to push.

Anti-Lock Brakes (OPTION)

If your Geo has this system, your Geo has an advanced electronic braking system that will help prevent skidding. If you have an anti-lock brake system (ABS), the brake pedal will say so.



And this light on the instrument panel will go on when you start your vehicle. When you start your vehicle and begin to drive away, you may hear a momentary motor or clicking noise. And you may even notice that your brake pedal moves a little while this is going on. This is the ABS system testing itself. If you have your foot on the brake pedal, this check won't happen until the vehicle goes about 4 mph (6 km/h) or until you take your foot off the brake pedal.

Your Driving and the Road



After an ABS stop, you may hear a clicking noise the next time the vehicle goes about 4 mph (6 km/h).

If there's a problem with the anti-lock brake system, the anti-lock brake system warning light will stay on or flash. See "Anti-lock Brake Warning Light" in the Index.

Here's how anti-lock works. Let's say the road is wet. You're driving safely. Suddenly an animal jumps out in front of you.

You slam on the brakes. Here's what happens with ABS.

A computer senses that wheels are slowing down. The computer separately works the brakes at each front wheel and at the rear wheels.

The anti-lock system can change the brake pressure faster than any driver could. The computer is programmed to make the most of available tire and road conditions.

You can steer around the obstacle while braking hard.

As you brake, your computer keeps receiving updates on wheel speed and controls braking pressure accordingly.

CAUTION



Anti-lock doesn't change the time you need to get your foot up to the brake pedal. If you get too close to the vehicle in front of you, you won't have time to apply your brakes if that vehicle suddenly slows or stops. Always leave enough room up ahead to stop, even though you have anti-lock brakes.

To Use Anti-Lock: Don't pump the brakes. Just hold the brake pedal down and let anti-lock work for you. You also may hear a clicking noise as you accelerate after a hard stop. When the ABS is active, the "ABS ACTIVE" light comes on to indicate low traction conditions. Adjust your driving accordingly.

Disc Brake Wear Indicators

Your Geo has front disc brakes and rear drum brakes. Disc brake pads have built-in wear indicators that make a high-pitched warning sound when the brake pads are worn and new pads are needed. The sound may come and go or

be heard all the time your vehicle is moving (except when you are pushing on the brake pedal firmly).

CAUTION



The brake wear warning sound means that sooner or later your brakes won't work well. That could lead to an accident. When you hear the brake wear warning sound, have your vehicle serviced.

NOTICE

Continuing to drive with worn-out brake pads could result in costly brake repair.

Some driving conditions or climates may cause a brake squeal when the brakes are first applied or lightly applied. This does not mean something is wrong with your brakes.

Your Driving and the Road

Rear Drum Brakes

Your rear drum brakes don't have wear indicators, but if you ever hear a rear brake rubbing noise, have the rear brake linings inspected. Also, the rear brake drums should be removed and inspected each time the tires are removed for rotation or changing. When you have the front brakes replaced, have the rear brakes inspected, too.

Brake linings should always be replaced as complete axle sets.

Brake Pedal Travel

See your dealer if the brake pedal does not return to normal height, or if there is a rapid increase in pedal travel. This could be a sign of brake trouble.

Brake Adjustment

Every time you make a moderate brake stop, your disc brakes adjust for wear. If you rarely make a moderate or heavier stop, then your brakes might not adjust correctly. If you drive in that way, then — very carefully — make a few moderate brake stops about every 1,000 miles (1 600 km), so your brakes will adjust properly.

If your brake pedal goes down farther than normal, your rear drum brakes may need adjustment. Adjust them by backing up and firmly applying the brakes a few times.

Braking in Emergencies

At some time, nearly every driver gets into a situation that requires hard braking. If you have anti-lock, you can steer and brake at the same time. However, if you don't have anti-lock, your first reaction — to hit the brake pedal hard and hold it down — may be the wrong thing to do. Your wheels can stop rolling. Once they do, the vehicle can't respond to your steering. Momentum will carry it in whatever direction it was headed when the wheels stopped rolling. That could be off the road, into the very thing you were trying to avoid, or into traffic.

If you don't have anti-lock, use a "squeeze" braking technique. This will give you maximum braking while maintaining steering control. You do this by pushing on the brake pedal with steadily increasing pressure.

In an emergency you will probably want to "squeeze" the brakes hard without locking the wheels. If you hear or feel the wheels sliding, ease off the brake pedal. This will help you retain steering control. (If you **do** have anti-lock, it's different: see Index under "Anti-Lock Brake System.")

In many emergencies, steering can help you more than even the very best braking.

Steering

Power Steering

If you lose power steering assist because the engine stops or the system fails to function, you can steer but it will take much more effort.

Steering Tips

Driving on Curves

It's important to take curves at a reasonable speed.

A lot of the "driver lost control" accidents mentioned on the news happen on curves. Here's why:

Experienced driver or beginner, each of us is subject to the same laws of physics when driving on curves. The traction of

the tires against the road surface makes it possible for the vehicle to change its path when you turn the front wheels. If there's no traction, inertia will keep the vehicle going in the same direction. If you've ever tried to steer a vehicle on wet ice, you'll understand this.

The traction you can get in a curve depends on the condition of your tires and the road surface, the angle at which the curve is banked, and your speed. While you're in a curve, speed is the one factor you can control.

Suppose you're steering through a sharp curve. Then you suddenly apply the brakes. Both control systems — steering

Your Driving and the Road

and braking — have to do their work where the tires meet the road. Unless you have four-wheel anti-lock brakes, adding the hard braking can demand too much at those places. You can lose control.

The same thing can happen if you're steering through a sharp curve and you suddenly accelerate.

Those two control systems — steering and acceleration — can overwhelm those places where the tires meet the road and make you lose control.

What should you do if this ever happens? Let up on the brake or accelerator pedal, steer the vehicle the way you want it to go, and slow down.

Speed limit signs near curves warn that you should adjust your speed. Of course, the posted speeds are based on good weather and road conditions. Under less favorable conditions you'll want to go slower.

If you need to reduce your speed as you approach a curve, do it before you enter the curve, while your front wheels are straight ahead.

Try to adjust your speed so you can "drive" through the curve. Maintain a reasonable, steady speed. Wait to accelerate until you are out of the curve, and then accelerate gently into the straightaway.

When you drive into a curve at night, it's harder to see the road ahead of you because it bends away from the straight beams of your lights. This is one good reason to drive slower.



Steering in Emergencies

There are times when steering can be more effective than braking. For example, you come over a hill and find a truck stopped in your lane, or a car suddenly pulls out from nowhere, or a child darts out from between parked cars and stops right in front of you. You can avoid these problems by braking — if you can stop in time. But sometimes you can't; there isn't room. That's the time for evasive action — steering around the problem.

Your Geo can perform very well in emergencies like these. First apply your brakes — but, unless you have anti-lock, not enough to lock your wheels.

It is better to remove as much speed as you can from a possible collision. Then steer around the problem, to the left or right depending on the space available.

An emergency like this requires close attention and a quick decision. If you are holding the steering wheel at the recommended 9 and 3 o'clock positions, you can turn it a full 180 degrees very quickly without removing either hand. But you have to act fast, steer quickly, and just as quickly straighten the wheel once you have avoided the object. You must then be prepared to steer back to your original lane and then brake to a controlled stop.

Depending on your speed, this can be rather violent for an unprepared driver. This is one of the reasons driving experts recommend that you use your safety belts and keep both hands on the steering wheel.

The fact that such emergency situations are always possible is a good reason to practice defensive driving at all times.

Your Driving and the Road

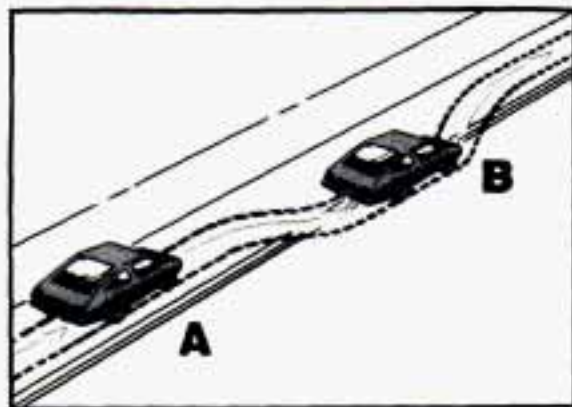

Off-Road Recovery

You may find sometime that your right wheels have dropped off the edge of a road onto the shoulder (A) while you're driving.

If the level of the shoulder is only slightly below the pavement, recovery should be fairly easy. Ease off the accelerator and then, if there is nothing in the way, steer so that your vehicle straddles the edge of the pavement. You can turn the steering wheel up to 1/4 turn (B) until the right front tire contacts the pavement edge. Then turn your steering wheel to go straight down the roadway.

If the shoulder appears to be about four inches (100 mm) or more below the pavement, this difference can cause problems. If there is not enough room to pull entirely onto the shoulder and stop, then follow the same procedures. But if the right front tire scrubs against the side of the pavement, do NOT steer more sharply. With too much steering angle, the vehicle may jump back onto the road with so much steering input that it crosses over into the oncoming traffic before you can bring it back under control.

Instead, ease off again on the accelerator and steering input, straddle the pavement once more, then try again.

Passing

The driver of a vehicle about to pass another on a two-lane highway waits for just the right moment, accelerates, moves around the vehicle ahead, then goes back into the right lane again. A simple maneuver?

Not necessarily! Passing another vehicle on a two-lane highway is a potentially dangerous move, since the passing vehicle occupies the same lane as oncoming traffic for several seconds. A miscalculation, an error in judgment, or a brief surrender to frustration or anger can suddenly put the passing driver face to face with the worst of all traffic accidents — the head-on collision.

So here are some tips for passing:

- “Drive ahead.” Look down the road, to the sides, and to crossroads for situations that might affect your passing patterns. If you have any doubt whatsoever about making a successful pass, wait for a better time.
- Watch for traffic signs, pavement markings, and lines. If you can see a sign up ahead that might indicate a turn or an intersection, delay your pass. A broken center line usually indicates it’s all right to pass (providing the road ahead is clear).

Never cross a solid line on your side of the lane or a double solid line, even if the road seems empty of approaching traffic.

- If you suspect that the driver of the vehicle you want to pass isn’t aware of your presence, tap the horn a couple of times before passing.
- Do not get too close to the vehicle you want to pass while you’re awaiting an opportunity. For one thing, following too closely reduces your area of vision, especially if you’re following a larger vehicle.

Also, you won’t have adequate space if the vehicle ahead suddenly slows or stops. Keep back a reasonable distance.

- When it looks like a chance to pass is coming up, start to accelerate but stay in the right lane and don’t get too close. Time your move so you will be increasing speed as the time comes to move into the other lane. If the way is clear to pass, you will have a “running start” that more than makes up for the distance you would lose by dropping back. And if something happens to cause you to cancel your pass, you need only slow down and drop back again and wait for another opportunity.

Your Driving and the Road

- If other cars are lined up to pass a slow vehicle, wait your turn. But take care that someone isn't trying to pass you as you pull out to pass the slow vehicle. Remember to glance over your shoulder and check the blind spot.
- Check your mirrors, glance over your shoulder, and start your left lane change signal before moving out of the right lane to pass. When you are far enough ahead of the passed vehicle to see its front in your inside mirror, activate your right lane change signal and move back into the

right lane. (Remember that your right outside mirror is convex. The vehicle you just passed may seem to be further away from you than it really is).

- Try not to pass more than one vehicle at a time on two-lane roads. Reconsider before passing the next vehicle.
- Don't overtake a slowly moving vehicle too rapidly. Even though the brake lights are not flashing, it may be slowing down or starting to turn.
- If you're being passed, make it easy for the following driver to get ahead of you. Perhaps you can ease a little to the right.

Loss of Control

Let's review what driving experts say about what happens when the three control systems (brakes, steering and acceleration) don't have enough friction where the tires meet the road to do what the driver has asked.

In any emergency, don't give up. Keep trying to steer and constantly seek an escape route or area of less danger.

Skidding

In a skid, a driver can lose control of the vehicle. Defensive drivers avoid most skids by taking reasonable care suited to existing conditions, and by not "overdriving" those conditions. But skids are always possible.

The three types of skids correspond to your Geo's three control systems. In the braking skid your wheels aren't rolling. In the steering or cornering skid, too much speed or steering in a curve causes tires to slip and lose cornering force. And in the acceleration skid too much throttle causes the driving wheels to spin.

A cornering skid and an acceleration skid are best handled by easing your foot off the accelerator pedal.

If your vehicle starts to slide (as when you turn a corner on a wet, snow- or ice-covered road), ease your foot off the accelerator pedal as soon as you feel the vehicle start to slide. Quickly steer the

way you want the vehicle to go. If you start steering quickly enough, your vehicle will straighten out. As it does, straighten the front wheels.

Of course, traction is reduced when water, snow, ice, gravel, or other material is on the road. For safety, you'll want to slow down and adjust your driving to these conditions. It is important to slow down on slippery surfaces because stopping distance will be longer and vehicle control more limited.

While driving on a surface with reduced traction, try your best to avoid sudden steering, acceleration, or braking (including engine braking by shifting to a lower gear). Any sudden changes could cause the tires to slide. You may not realize the surface is slippery until your vehicle is skidding. Learn to recognize warning clues — such as enough water, ice or packed snow on the road to make a "mirrored surface" — and slow down when you have any doubt.

Your Driving and the Road



■ *Driving at Night*

If you have the anti-lock braking system, remember: It helps avoid only the braking skid. If you do not have anti-lock, then in a braking skid (where the wheels are no longer rolling), release enough pressure on the brakes to get the wheels rolling again. This restores steering control. Push the brake pedal down steadily when you have to stop suddenly. As long as the wheels are rolling, you will have steering control. Steer the way you want to go.

Night driving is more dangerous than day driving. One reason is that some drivers are likely to be impaired — by alcohol or drugs, with night vision problems, or by fatigue.

Here are some tips on night driving.

- Drive defensively. Remember, this is the most dangerous time.
- Don't drink and drive. (See "Drunken Driving" in the Index for more on this problem.)
- Adjust your inside rearview mirror to reduce the glare from the headlights behind you.

- Since you can't see as well, you may need to slow down and keep more space between you and other vehicles. It's hard to tell how fast the vehicle ahead is going just by looking at its taillights.
- Slow down, especially on higher speed roads. Your headlights can light up only so much road ahead.
- In remote areas, watch for animals.
- If you're tired, pull off the road in a safe place and rest.

Night Vision

No one can see as well at night as in the daytime. But as we get older these differences increase. A 50-year-old driver may require at least twice as much light to see the same thing at night as a 20-year-old.

What you do in the daytime can also affect your night vision. For example, if you spend the day in bright sunshine you are wise to wear sunglasses. Your eyes will have less trouble adjusting to night.

But if you're driving, don't wear sunglasses at night. They may cut down on glare from headlights, but they also make a lot of things invisible that should remain visible — such as parked cars, obstacles, pedestrians, or even trains blocking railway crossings. You may want to put on your sunglasses after you have pulled into a brightly-lighted service or refreshment area. Eyes shielded from that glare may adjust more quickly to darkness back on the road. But be sure to remove your sunglasses before you leave the service area.

You can be temporarily blinded by approaching lights. It can take a second or two, or even several seconds, for your eyes to readjust to the dark. When you are faced with severe glare (as from a driver who doesn't lower the high beams, or a vehicle with misaimed headlights), slow down a little. Avoid staring directly into the approaching lights. If there is a line of opposing traffic, make occasional glances over the line of headlights to make certain that one of the vehicles isn't starting to move into your lane. Once you are past the bright lights, give your eyes time to readjust before resuming speed.

Your Driving and the Road

High Beams

If the vehicle approaching you has its high beams on, signal by flicking yours to high and then back to low beam. This is the usual signal to lower the headlight beams. If the other driver still doesn't lower the beams, resist the temptation to put your high beams on. This only makes two half-blinded drivers.

On a freeway, use your high beams only in remote areas where you won't impair approaching drivers. In some places, like cities, using high beams is illegal.

When you follow another vehicle on a freeway or highway, use low beams. True, most vehicles now have day-night mirrors that enable the driver to reduce glare. But outside mirrors are not of this type and high beams from behind can bother the driver ahead.

A Few More Night Driving Suggestions

Keep your windshield and all the glass on your vehicle clean — inside and out. Glare at night is made much worse by dirt on the glass. Even the inside of the glass can build up a film caused by dust. Tobacco smoke also makes inside glass surfaces very filmy and can be a vision hazard if it's left there.

Dirty glass makes lights dazzle and flash more than clean glass would, making the pupils of your eyes contract repeatedly. You might even want to keep a cloth and some glass cleaner in your vehicle if you need to clean your glass frequently.

Remember that your headlights light up far less of a roadway when you are in a turn or curve.

Keep your eyes moving; that way, it's easier to pick out dimly lighted objects.

Just as your headlights should be checked regularly for proper aim, so should your eyes be examined regularly. Some drivers suffer from night blindness — the inability to see in dim light — and aren't even aware of it.



■ *Driving in the Rain*

Rain and wet roads can mean driving trouble. On a wet road you can't stop, accelerate or turn as well because your tire-to-road traction isn't as good as on dry roads. And, if your tires don't have much tread left, you'll get even less traction.

It's always wise to go slower and be cautious if rain starts to fall while you are driving. The surface may get wet suddenly when your reflexes are tuned for driving on dry pavement.

The heavier the rain, the harder it is to see. Even if your windshield wiper blades are in good shape, a heavy rain can make it harder to see road signs and traffic signals, pavement markings, the edge of the road, and even people walking. Road spray can often be worse for vision than rain, especially if it comes from a dirty road.

So it is wise to keep your wiping equipment in good shape and keep your windshield washer tank filled. Replace your windshield wiper inserts when they show signs of streaking or missing areas on the windshield, or when strips of rubber start to separate from the inserts.



Driving too fast through large water puddles, or even going through some car washes can cause problems, too. The water may affect your brakes. Try to avoid puddles, but if you can't, try to slow down before you hit them.

Your Driving and the Road

CAUTION



Wet brakes can cause accidents. They won't work well in a quick stop and may cause pulling to one side. You could lose control of the vehicle.

After driving through a large puddle of water, or a car wash, apply your brake pedal lightly until your brakes work normally.

Hydroplaning

Hydroplaning is dangerous. So much water can build up under your tires that they can actually ride on the water. This can happen if the road is wet enough and you're going fast enough. When your vehicle is hydroplaning, it has little or no contact with the road.

You might not be aware of hydroplaning. You could drive along for some time without realizing your tires aren't in constant contact with the road. You could find out the hard way: when you have to slow, turn, move out to pass — or if you get hit by a gust of wind. You could suddenly find yourself out of control.

Hydroplaning doesn't happen often. But it can if your tires haven't much tread or if the pressure in one or more is low. It can happen if a lot of water is standing on the road. If you can see reflections from trees, telephone poles, or other vehicles, and raindrops "dimple" the water's surface, there could be hydroplaning.

Hydroplaning usually happens at higher speeds. There just isn't a hard and fast rule about hydroplaning. The best advice is to slow down when it is raining, and be careful.

Some Other Rainy Weather Tips

- Turn on your headlights — not just your parking lights — to help make you more visible to others.
- Look for hard-to-see vehicles coming from behind. You may want to use your headlights even in daytime if it's raining hard.
- Besides slowing down, allow some extra following distance. And be especially careful when you pass another vehicle. Allow yourself more clear room ahead, and be prepared to

have your view restricted by road spray. If the road spray is so heavy you are actually blinded, drop back. Don't pass until conditions improve. Going more slowly is better than having an accident.

- Use your defogger if it helps.
- Have good tires with proper tread depth. (See "Tires" in the Index.)



■ *Driving in Fog, Mist and Haze*

Fog can occur with high humidity or heavy frost. It can be so mild that you can see through it for several hundred feet (meters). Or it might be so thick that you can see only a few feet (meters) ahead. It may come suddenly to an otherwise clear road. And it can be a major hazard.

When you drive into a fog patch, your visibility will be reduced quickly. The biggest dangers are striking the vehicle ahead or being struck by the one behind.

Your Driving and the Road

Try to “read” the fog density down the road. If the vehicle ahead starts to become less clear or, at night, if the taillights are harder to see, the fog is probably thickening. Slow down to give traffic behind you a chance to slow down. Everybody then has a better chance to avoid hitting the vehicle ahead.

A patch of dense fog may extend only for a few feet (meters) or for miles (kilometers); you can't really tell while you're in it. You can only treat the situation with extreme care.

One common fog condition — sometimes called mist or ground fog — can happen in weather that seems perfect, especially at night or in the early morning in valley and low, marshy areas. You can be suddenly enveloped in thick, wet haze that may even coat your windshield. You can often spot these fog patches or mist layers with your headlights. But sometimes they can be waiting for you as you come over a hill or dip into a shallow valley. Start your windshield wipers and washer to help clear accumulated road dirt. Slow down carefully.

Tips on Driving in Fog

If you get caught in fog, turn your headlights on low beam, even in daytime. You'll see — and be seen — better.

Don't use your high beams. The light will bounce off the water droplets that make up fog and reflect back at you.

Use your defogger. In high humidity, even a light build-up of moisture on the inside of the glass will cut down on your already limited visibility. Run your windshield wiper and washer occasionally. Moisture can build up on the outside glass, and what seems to be fog may actually be moisture on the outside of your windshield.

Treat dense fog as an emergency. Try to find a place to pull off the road. Of course you want to respect another's property, but you might need to put something between you and moving vehicles — space, trees, telephone poles, a private driveway, anything that removes you from other traffic.

If visibility is near zero and you must stop but are unsure whether you are away from the road, turn your lights on, start your hazard flashers and sound your horn at intervals, or when you hear approaching traffic.

Pass other vehicles in fog only if you can see far enough ahead to pass safely. Even then, be prepared to delay your pass if you suspect the fog is worse up ahead. If other vehicles try to pass you, make it easy for them.



■ *City Driving*

One of the biggest problems with city streets is the amount of traffic on them. You'll want to watch out for what the other drivers are doing and pay attention to traffic signals.

Here are ways to increase your safety in city driving:

- Know the best way to get to where you are going. Try not to drive around trying to pick out a familiar street or landmark. Get a city map and plan your trip into an unknown part of the city just as you would for a cross-country trip.

Your Driving and the Road

- Try to use the freeways that rim and crisscross most large cities. You'll save time and energy. (See the next section, "Freeway Driving.")
- Treat a green light as a warning signal. A traffic light is there because the corner is busy enough to need it. When a light turns green, and just before you start to move, check both ways for vehicles that have not cleared the intersection or may be running the red light.

- Obey all posted speed limits. But remember that they are for ideal road, weather and visibility conditions. You may need to drive below the posted limit in bad weather or when visibility is especially poor.
- Pull to the right (with care) and stop clear of intersections when you see or hear emergency vehicles.



■ *Freeway Driving*

Mile for mile, freeways (also called thruways, parkways, expressways, turnpikes, or superhighways) are the safest of all roads. But they have their own special rules.

The most important advice on freeway driving is: Keep up with traffic and keep to the right. Drive at the same speed most of the other drivers are driving. Too-fast or too-slow driving breaks a smooth traffic flow. Treat the left lane on a freeway as a passing lane.

Entering the Freeway

At the entrance there is usually a ramp that leads to the freeway. If you have a clear view of the freeway as you drive along the entrance ramp, you should begin to check traffic. Try to determine where you expect to blend with the flow. If traffic is light, you may have no problem. But if it is heavy, find a gap as you move along the entering lane and time your approach. Try to merge into the gap at close to the prevailing speed. Switch on your turn signal, check your rearview mirrors as you move along, and glance over your shoulder as often as necessary. Try to blend smoothly with the traffic flow.

Driving on the Freeway

Once you are on the freeway, adjust your speed to the posted limit or to the prevailing rate if it's slower. Stay in the right lane unless you want to pass. If you are on a two-lane freeway, treat the right lane as the slow lane and the left lane as the passing lane.

If you are on a three-lane freeway, treat the right lane as the slower-speed through lane, the middle lane as the higher-speed through lane, and the left lane as the passing lane.

Before changing lanes, check your rearview mirrors. Then use your turn signal. Just before you leave the lane, glance quickly over your shoulder to

make sure there isn't another vehicle in your "blind" spot.

If you are moving from an outside to a center lane on a freeway having more than two lanes, make sure another vehicle isn't about to move into the same spot. Look at the vehicles two lanes over and watch for telltale signs: turn signals flashing, an increase in speed, or moving toward the edge of the lane. Be prepared to delay your move.

Once you are moving on the freeway, make certain you allow a reasonable following distance. Expect to move slightly slower at night.

Your Driving and the Road

Leaving the Freeway

When you want to leave the freeway, move to the proper lane well in advance. Dashing across lanes at the last minute is dangerous. If you miss your exit do not, under any circumstances, stop and back up. Drive on to the next exit.

At each exit point is a deceleration lane. Ideally it should be long enough for you to enter it at freeway speed (after signaling, of course) and then do your braking before moving onto the exit ramp. Unfortunately, not all deceleration lanes are long enough — some are too short for all the braking. Decide when

to start braking. If you must brake on the through lane, and if there is traffic close behind you, you can allow a little extra time and flash your brake lights (in addition to your turn signal) as extra warning that you are about to slow down and exit.

The exit ramp can be curved, sometimes quite sharply.

The exit speed is usually posted. Reduce your speed according to your speedometer, not to your sense of motion. After driving for any distance at higher speeds, you may tend to think you are going slower than you actually are. For example, 40 mph (65 km/h) might seem like only 20 mph (30 km/h). Obviously, this could lead to serious trouble on a ramp designed for 20 mph (30 km/h)!

■ *Driving a Long Distance*

Although most long trips today are made on freeways, there are still many made on regular highways.

Long-distance driving on freeways and regular highways is the same in some ways. The trip has to be planned and the vehicle prepared, you drive at higher-than-city speeds, and there are longer turns behind the wheel. You'll enjoy your trip more if you and your vehicle are in good shape. Here are some tips for a successful long trip.

Before Leaving on a Long Trip

Make sure you're ready. Try to be well rested. If you must start when you're not fresh — such as after a day's work — don't plan to make too many miles that first part of the journey. Wear comfortable clothing and shoes you can easily drive in.

Is your vehicle ready for a long trip? If you keep it serviced and maintained, it's ready to go. If it needs service, have it done before starting out. Of course, you'll find experienced and able service experts in Geo dealerships all across North America. They'll be ready and willing to help if you need it.

Here are some things you can check before a trip:

- **Windshield Washer Fluid:** Is the reservoir full? Are all windows clean inside and outside?
- **Wiper Blades:** Are they in good shape?
- **Fuel, Engine Oil, Other Fluids:** Have you checked all levels?
- **Lights:** Are they all working? Are the lenses clean?
- **Tires:** They are vitally important to a safe, trouble-free trip. Is the tread good enough for long distance driving? Are the tires all inflated to the recommended pressure?

Your Driving and the Road

- **Weather Forecasts:** What's the weather outlook along your route? Should you delay your trip a short time to avoid a major storm system?
- **Maps:** Do you have up-to-date maps?

On the Road

Unless you are the only driver, it is good to share the driving task with others. Limit turns behind the wheel to about 100 miles (160 km) or two hours at a sitting. Then, either change drivers or stop for some refreshment like coffee, tea or soft drinks and some limbering up. But do stop and move around. Eat lightly along the way. Heavier meals tend to make some people sleepy.

On two-lane highways or undivided multilane highways that do not have controlled access, you'll want to watch for some situations not usually found on freeways. Examples are: stop signs and signals, shopping centers with direct access to the highway, no-passing zones and school zones, vehicles turning left and right off the road, pedestrians, cyclists, parked vehicles, and even animals.

Highway Hypnosis

Is there actually such a condition as "highway hypnosis"? Or is it just plain falling asleep at the wheel? Call it highway hypnosis, lack of awareness, or whatever.

There is something about an easy stretch of road with the same scenery, along with the hum of the tires on the road, the drone of the engine, and the rush of the wind against the vehicle that can make you sleepy. Don't let it happen to you! If it does, your vehicle can leave the road in **less than a second**, and you could crash and be injured.

What can you do about highway hypnosis? First, be aware that it can happen.

Then here are some tips:

- Make sure your vehicle is well ventilated, with a comfortably cool interior.
- Keep your eyes moving. Scan the road ahead and to the sides. Check your rearview mirrors frequently and your instruments from time to time. This can help you avoid a fixed stare.

- Wear good sunglasses in bright light. Glare can cause drowsiness. But don't wear sunglasses at night. They will drastically reduce your overall vision at the very time you need all the seeing power you have.
- If you get sleepy, pull off the road into a rest, service, or parking area and take a nap, get some exercise, or both. For safety, treat drowsiness on the highway as an emergency.

As in any driving situation, keep pace with traffic and allow adequate following distances.



■ *Hill and Mountain Roads*

Driving on steep hills or mountains is different from driving in flat or rolling terrain.

If you drive regularly in steep country, or if you're planning to visit there, here are some tips that can make your trips safer and more enjoyable.

- Keep your vehicle in good shape. Check all fluid levels and also your brakes, tires, cooling system and transaxle. These parts can work hard on mountain roads.

Your Driving and the Road

- Know how to go down hills. The most important thing to know is this: let your engine do some of the slowing down. Don't make your brakes do it all. Shift to a lower gear when you go down a steep or long hill. That way, you will slow down without excessive use of your brakes.

CAUTION



If you don't shift down, your brakes could get so hot that they wouldn't work well. You would then have poor braking or even none going down a hill. You could crash. Shift down to let your engine assist your brakes on a steep downhill slope.

CAUTION



Coasting downhill in N (Neutral) or with the ignition off is dangerous. Your brakes will have to do all the work of slowing down. They could get so hot that they wouldn't work well. You could crash. Always have your engine running and your vehicle in gear when you go downhill.

- Know how to go uphill. You may want to shift down to a lower gear. The lower gears help cool your engine and transaxle, and you can climb the hill better.

- Stay in your own lane when driving on two-lane roads in hills or mountains. Don't swing wide or cut across the center of the road. Drive at speeds that let you stay in your own lane. That way, you won't be surprised by a vehicle coming toward you in the same lane.
- It takes longer to pass another vehicle when you're going uphill. You'll want to leave extra room to pass. If a vehicle is passing you and doesn't have enough room, slow down to make it easier for the other vehicle to get by.

- As you go over the top of a hill, be alert. There could be something in your lane, like a stalled car or an accident.
- You may see highway signs on mountains that warn of special problems. Examples are long grades, passing or no-passing zones, a falling rocks area, or winding roads. Be alert to these and take appropriate action.
- Winter driving can present special problems. See "Winter Driving" in the Index.



■ *Parking on Hills*

Hills and mountains mean spectacular scenery. But please be careful where you stop if you decide to look at the view or take pictures. Look for pull-offs or parking areas provided for scenic viewing.

Another part of this manual tells how to use your parking brake (see "Parking Brake" in the Index). But on a mountain or steep hill, you can do one more thing. You can turn your front wheels to keep your vehicle from rolling downhill or out into traffic.

Here's how:

Your Driving and the Road



Parking Downhill

Turn your wheels to the right.

You don't have to jam your tires against the curb, if there is a curb. A gentle contact is all you need.



Parking Uphill

If there is a curb, turn your wheels to the left if the curb is at the right side of your vehicle.



If you're going uphill on a one-way street and you're parking on the left side, your wheels should point to the right.



If there is no curb when you're parking uphill, turn the wheels to the right.

If there is no curb when you're parking uphill on the left side of a one-way street, your wheels should be turned to the left.



■ *Winter Driving*

Here are some tips for winter driving.

- Have your Geo in good shape for winter. Be sure your engine coolant mix is correct.

- Snow tires can help in loose snow, but they may give you less traction on ice than regular tires. If you do not expect to be driving in deep snow, but may have to travel over ice, you may not want to switch to snow tires at all.

Your Driving and the Road



- You may want to put winter emergency supplies in your vehicle. Include an ice scraper, a small brush or broom, a supply of windshield washer fluid, a rag, some winter outer clothing, a small shovel, a flashlight, a red cloth, and a couple of reflective warning triangles. And, if you will be driving under severe conditions, include a small bag of sand, a piece of old carpet or a couple of burlap bags to help provide traction. Be sure you properly secure these items in your vehicle.

Driving on Snow or Ice

Most of the time, those places where your tires meet the road probably have good traction.

However, if there is snow or ice between your tires and the road, you can have a very slippery situation. You'll have a lot less traction or "grip" and will need to be very careful.



What's the worst time for this? "Wet ice." Very cold snow or ice can be slick and hard to drive on. But wet ice can be even more trouble because it may offer the least traction of all. You can get "wet ice" when it's about freezing (32°F; 0°C) and freezing rain begins to fall. Try to avoid driving on wet ice until salt and sand crews can get there.

Whatever the condition — smooth ice, packed, blowing or loose snow — drive with caution. Accelerate gently. Try not to break the fragile traction. If you accelerate too fast, the drive wheels will spin and polish the surface under the tires even more.

Unless you have the anti-lock braking system, you'll want to brake very gently, too. (If you do have anti-lock, see "Anti-Lock" in the Index. This system improves your vehicle's ability to make a hard stop on a slippery road.) Whether you have the anti-lock braking system or not, you'll want to begin stopping sooner than you would on dry pavement. Without anti-lock brakes, if you feel your vehicle begin to slide, let up on the brakes a little. Push the brake pedal down steadily to get the most traction you can.

Remember, unless you have anti-lock, if you brake so hard that your wheels stop rolling, you'll just slide. Brake so your wheels always keep rolling and you can still steer.

Whatever your braking system, allow greater following distance on any slippery road.

- Watch for slippery spots. The road might be fine until you hit a spot that's covered with ice. On an otherwise clear road, ice patches may appear in shaded areas where the sun can't reach: around clumps of trees, behind buildings, or under bridges. Sometimes the surface of a curve or an overpass may remain icy when the surrounding roads are clear. If you see a patch of ice ahead of you, brake before you are on it. Try not to brake while you're actually on the ice, and avoid sudden steering maneuvers.

Your Driving and the Road



If You're Caught in a Blizzard

If you are stopped by heavy snow, you could be in a serious situation. You should probably stay with your vehicle unless you know for sure that you are near help and you can hike through the snow. Here are some things to do to summon help and keep yourself and your passengers safe: Turn on your hazard flashers. Tie a red cloth to your vehicle to alert police that you've been

stopped by the snow. Put on extra clothing or wrap a blanket around you. If you have no blankets or extra clothing, make body insulators from newspapers, burlap bags, rags, floor mats — anything you can wrap around yourself or tuck under your clothing to keep warm.

You can run the engine to keep warm, but be careful.

CAUTION



Snow can trap exhaust gases under your vehicle. This can cause deadly CO (carbon monoxide) gas to get inside. CO could overcome you and kill you. You can't see it or smell it, so you might not know it was in your vehicle. Clear away snow from around the base of your vehicle, especially any that is blocking your exhaust pipe. And check around again from time to time to be sure snow doesn't collect there.

Open a window just a little on the side of the vehicle that's away from the wind. This will help keep CO out.



Run your engine only as long as you must. This saves fuel. When you run the engine, make it go a little faster than just idle. That is, push the accelerator slightly. This uses less fuel for the heat that you get and it keeps the battery charged. You will need a well-charged battery to restart the vehicle, and possibly for signaling later on with your headlights. Let the heater run for awhile. Then, shut the engine off and close the window almost all the way to preserve the heat. Start the engine again and repeat this only when you feel really uncomfortable from the cold. But do it as little as possible. Preserve the fuel as

long as you can. To help keep warm, you can get out of the vehicle and do some fairly vigorous exercises every half hour or so until help comes.

If You're Stuck in Deep Snow

This manual explains how to get the vehicle out of deep snow without damaging it. See "Rocking Your Vehicle" in the Index.

■ *Towing a Trailer*

CAUTION



If you don't use the correct equipment and drive properly, you can lose control when you pull a trailer. For example, if the trailer is too heavy, the brakes may not work well — or even at all. You and your passengers could be seriously injured. Pull a trailer only if you have followed all the steps in this section.

Your Driving and the Road

NOTICE

Pulling a trailer improperly can damage your vehicle and result in costly repairs not covered by your warranty. To pull a trailer correctly, follow the advice in this section.

Your Geo can tow a trailer. To identify what the vehicle trailering capacity is for your vehicle, you should read the information in "Weight of the Trailer" that appears later in this section. But trailering is different than just driving your vehicle by itself. Trailering means changes in handling, durability, and fuel

economy. Successful, safe trailering takes correct equipment, and it has to be used properly.

That's the reason for this section. In it are many time-tested, important trailering tips and safety rules. Many of these are important for your safety and that of your passengers. So please read this section carefully before you pull a trailer.

Load-pulling components such as the engine, transaxle, wheel assemblies, and tires are forced to work harder against the drag of the added weight. The engine is required to operate at relatively higher speeds and under greater loads, generating extra heat.

What's more, the trailer adds considerably to wind resistance, increasing the pulling requirements.

All of that means changes in:

- Handling
- Durability
- Fuel economy

If You Do Decide to Pull a Trailer

If you do, here are some important points.

- There are many different laws having to do with trailering. Make sure your rig will be legal, not only where you live but also where you'll be driving. A good source for this information can be state or provincial police.

- Consider using a sway control. You can ask a hitch dealer about sway controls.
- Don't tow a trailer at all during the first 500 miles (800 km) your new vehicle is driven. Your engine, axle or other parts could be damaged.
- Then, during the first 500 miles (800 km) that you tow a trailer, don't drive over 50 mph (80 km/h) and don't make starts at full throttle. This helps your engine and other parts of your vehicle wear in at the heavier loads.

- Three important considerations have to do with weight:

Weight of the Trailer

How heavy can a trailer safely be? It should never weigh more than 1,000 pounds (450 kg).

But even that can be too heavy.

It depends on how you plan to use your rig. For example, speed, altitude, road grades, outside temperature, and how much your vehicle is used to pull a trailer are all important. And, it can also depend on any special equipment that you have on your vehicle.

You can ask your dealer for our trailering information or advice, or write us at:

Chevrolet/Geo Customer Services
P.O. Box 7047
Troy, MI 48007-7047

In Canada, write to:
General Motors of Canada Limited
Customer Assistance Center
1908 Colonel Sam Drive
Oshawa, Ontario L1H 8P7

Your Driving and the Road

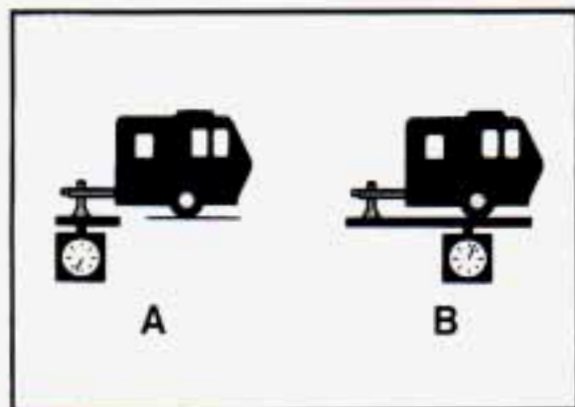

Weight of the Trailer Tongue

The tongue load (A) of any trailer is an important weight to measure because it affects the total capacity weight of your vehicle. The capacity weight includes the curb weight of the vehicle, any cargo you may carry in it, and the people who will be riding in the vehicle. And if you will tow a trailer, you must subtract the tongue load from your vehicle's capacity weight because your vehicle will be carrying that weight, too. See "Loading Your Vehicle" in the Index for more information about your vehicle's maximum load capacity.

The trailer tongue (A) should weigh 10% of the total loaded trailer weight (B). After you've loaded your trailer, weigh the trailer and then the tongue, separately, to see if the weights are proper. If they aren't, you may be able to get them right simply by moving some items around in the trailer.

Total Weight on Your Vehicle's Tires

Be sure your vehicle's tires are inflated to the limit for cold tires. You'll find these numbers on the Certification label at the rear edge of the driver's door (or see "Tire-Loading" in the Index). Then be sure you don't go over the GVW limit for your vehicle.

Hitches

It's important to have the correct hitch equipment. Crosswinds, large trucks going by, and rough roads are a few reasons why you'll need the right hitch. Here are some rules to follow:

- Will you have to make any holes in the body of your vehicle when you install a trailer hitch? If you do, then be sure to seal the holes later when you remove the hitch. If you don't seal them, deadly carbon monoxide (CO) from your exhaust can get into your vehicle (see "Carbon Monoxide" in the Index). Dirt and water can, too.

- The bumpers on your vehicle are not intended for hitches. Do not attach rental hitches or other bumper type hitches to them. Use only a frame-mounted hitch that does not attach to the bumper.

Safety Chains

You should always attach chains between your vehicle and your trailer. Cross the safety chains under the tongue of the trailer so that the tongue will not drop to the road if it becomes separated from the hitch. Instructions about safety chains may be provided by the hitch manufacturer or by the trailer manufacturer. Follow the manufacturer's recommendation for attaching safety chains. Always leave just enough slack so you can turn with your rig. And, never allow safety chains to drag on the ground.

Your Driving and the Road

Trailer Brakes

Does your trailer have its own brakes? Be sure to read and follow the instructions for the trailer brakes so you'll be able to install, adjust and maintain them properly.

If your vehicle has anti-lock brakes, don't try to tap into your vehicle's brake system. If you do, both brake systems won't work well or at all.

Even if your vehicle doesn't have anti-lock brakes, don't tap into your vehicle's brake system if the trailer's brake system will use more than 0.02 cubic inch (0.3 cc) of fluid from your

vehicle's master cylinder. If it does, both braking systems won't work well. You could even lose your brakes.

- Will the trailer brake parts take 3,000 psi (20 650 kPa) of pressure? If not, the trailer brake system must not be used with your vehicle.
- If everything checks out this far, then make the brake fluid tap at the upper rear master cylinder port. But don't use copper tubing for this. If you do, it will bend and finally break off. Use steel brake tubing.

Driving With a Trailer

Towing a trailer requires a certain amount of experience. Before setting out for the open road, you'll want to get to know your rig. Acquaint yourself with the feel of handling and braking with the added weight of the trailer. And always keep in mind that the vehicle you are driving is now a good deal longer and not nearly so responsive as your vehicle is by itself.

Before you start, check the trailer hitch and platform, safety chains, electrical connector, lights, tires and mirror adjustment. If the trailer has electric brakes, start your vehicle and trailer

moving and then apply the trailer brake controller by hand to be sure the brakes are working. This lets you check your electrical connection at the same time.

During your trip, check occasionally to be sure that the load is secure, and that the lights and any trailer brakes are still working.

Following Distance

Stay at least twice as far behind the vehicle ahead as you would when driving your vehicle without a trailer. This can help you avoid situations that require heavy braking and sudden turns.

Passing

You'll need more passing distance up ahead when you're towing a trailer. And, because you're a good deal longer, you'll need to go much farther beyond the passed vehicle before you can return to your lane.

Backing Up

Hold the bottom of the steering wheel with one hand. Then, to move the trailer to the left, just move that hand to the left. To move the trailer to the right, move your hand to the right. Always back up slowly and, if possible, have someone guide you.

Making Turns

When you're turning with a trailer, make wider turns than normal. Do this so your trailer won't strike soft shoulders, curbs, road signs, trees, or other objects. Avoid jerky or sudden maneuvers. Signal well in advance.

Turn Signals When Towing a Trailer

When you tow a trailer, your vehicle has to have a different turn signal flasher and extra wiring. The green arrows on your instrument panel will flash whenever you signal a turn or lane change. Properly hooked up, the trailer lights will also flash, telling other drivers you're about to turn, change lanes, or stop.

Your Driving and the Road

When towing a trailer, the green arrows on your instrument panel will flash for turns even if the bulbs on the trailer are burned out. Thus, you may think drivers behind you are seeing your signal when they are not. It's important to check occasionally to be sure the trailer bulbs are still working.

Driving on Grades

Reduce speed and shift to a lower gear **before** you start down a long or steep downgrade. If you don't shift down, you might have to use your brakes so much that they would get hot and no longer work well.

On a long uphill grade, shift down and reduce your speed to 45 mph (70 km/h) or less to reduce the possibility of engine and transaxle overheating.

If you are towing a trailer that weighs more than 1,000 pounds (450 kg), and you have an automatic transaxle with Overdrive, you may prefer to drive in **D** instead of Overdrive (or, as you need to, a lower gear). Or, if you have a manual transaxle with fifth gear, it's better not to use fifth gear. Just drive in fourth gear (or, as you need to, a lower gear).

Parking on Hills

You really should not park your vehicle, with a trailer attached, on a hill. If something goes wrong, your rig could start to move. People can be injured, and both your vehicle and the trailer can be damaged.

But if you ever have to park your rig on a hill, here's how to do it:

1. Apply your regular brakes, but don't shift into **P** (Park) yet, or into gear for a manual transaxle.

2. Have someone place chocks under the trailer wheels.
3. When the wheel chocks are in place, release the regular brakes until the chocks absorb the load.
4. Reapply the regular brakes. Then apply your parking brake, and then shift to **P** (Park), or **R** (Reverse) for a manual transaxle.
5. Release the regular brakes.

When You Are Ready to Leave After Parking on a Hill

1. Apply your regular brakes and hold the pedal down while you:
 - Start your engine;
 - Shift into a gear; and
 - Release the parking brake.
2. Let up on the brake pedal.
3. Drive slowly until the trailer is clear of the chocks.
4. Stop and have someone pick up and store the chocks.

Maintenance When Trailer Towing

Your vehicle will need service more often when you're pulling a trailer. See the Maintenance Schedule for more on this. Things that are especially important in trailer operation are automatic transaxle fluid (don't overfill), engine oil, belts, cooling system, and brake adjustment. Each of these is covered in this manual, and the Index will help you find them quickly. If you're trailering, it's a good idea to review these sections before you start your trip.

Check periodically to see that all hitch nuts and bolts are tight.

Notes



Part 5

Problems on the Road

Here you'll find what to do about some problems that can occur on the road.

Hazard Warning Flashers.....	182
Jump Starting	183
Towing Your Vehicle.....	188
Engine Overheating	192
If a Tire Goes Flat	199
If You're Stuck: In Sand, Mud, Ice or Snow	208

Problems on the Road



■ *Hazard Warning Flashers*

Your hazard flashers let you warn others. They also let police know you have a problem. Your front and rear turn signal lights will flash on and off.

Press the button to make your front and rear turn signal lights flash on and off.

Your hazard flashers work no matter what position your key is in, and even if the key isn't in.

To turn off the flashers, push the switch again.

When the flashers are on, your turn signals won't work.

Other Warning Devices

If you carry reflective triangles, you can set one up at the side of the road about 300 feet (100 m) behind your vehicle.

■ *Jump Starting*

If your battery has run down, you may want to use another vehicle and some jumper cables to start your Geo. But please follow the steps below to do it safely.

CAUTION



Batteries can hurt you. They can be dangerous because:

- They contain **acid** that can burn you.
- They contain **gas** that can explode or ignite.
- They contain enough **electricity** to burn you.

If you don't follow these steps exactly, some or all of these things can hurt you.

NOTICE

Ignoring these steps could result in costly damage to your vehicle that wouldn't be covered by your warranty.

Trying to start your Geo by pushing or pulling it could damage your vehicle, even if you have a manual transaxle. And if you have an automatic transaxle, it won't start that way.

Problems on the Road

To Jump Start Your Geo:

1. Check the other vehicle. It must have a 12-volt battery with a negative ground system.

NOTICE

If the other system isn't a 12-volt system with a negative ground, both vehicles can be damaged.

2. Get the vehicles close enough so the jumper cables can reach, but be sure the vehicles aren't touching each other. If they are, it could cause a ground connection you don't want. You wouldn't be able to start your Geo, and the bad grounding could damage the electrical systems.

CAUTION



You could be injured if the vehicles roll. Set the parking brake firmly on each vehicle. Put an automatic transaxle in **P** (Park) or a manual transaxle in **Neutral**.

3. Turn off the ignition on both vehicles. Turn off all lights that aren't needed, and radios. This will avoid sparks and help save both batteries. And it could save your radio!

NOTICE

If you leave a radio on, it could be badly damaged. The repairs wouldn't be covered by your warranty.

4. Open the hoods and locate the batteries.

CAUTION



An electric fan can start up even when the engine is not running and can injure you. Keep hands, clothing and tools away from any underhood electric fan.

Find the positive (+) and negative (-) terminals on each battery.

CAUTION



Using a match near a battery can cause battery gas to explode. People have been hurt doing this, and some have been blinded. Use a flashlight if you need more light.

Be sure the battery has enough water. You don't need to add water to the Delco Freedom® battery installed in every new GM vehicle. But if a battery has filler caps, be sure the right amount of fluid is there. If it is low, add water to take care of that first. If you don't, explosive gas could be present.

Battery fluid contains acid that can burn you. Don't get it on you. If you accidentally get it in your eyes or on your skin, flush the place with water and get medical help immediately.

5. Check that the jumper cables don't have loose or missing insulation. If they do, you could get a shock. The vehicles could be damaged, too.

Before you connect the cables, here are some basic things you should know. Positive (+) will go to positive (+) and negative (-) will go to negative (-) or a metal engine part. Don't connect (+) to (-) or you'll get a short that would damage the battery and maybe other parts, too.

Problems on the Road



CAUTION



Fans or other moving engine parts can injure you badly. Keep your hands away from moving parts once the engines are running.

6. Connect the red positive (+) cable to the positive (+) terminal of the vehicle with the dead battery. Use a remote positive (+) terminal if the vehicle has one.
7. Don't let the other end touch metal. Connect it to the positive (+) terminal of the good battery. Use a remote positive (+) terminal if the vehicle has one.



8. Now connect the black negative (-) cable to the good battery's negative (-) terminal.

Don't let the other end touch anything until the next step. The other end of the negative cable **doesn't** go to the dead battery. It goes to a heavy unpainted metal part on the engine of the vehicle with the dead battery.



9. Attach the cable at least 18 inches (45 cm) away from the dead battery, but not near engine parts that move. The electrical connection is just as good there, but the chance of sparks getting back to the battery is much less.
10. Now start the vehicle with the good battery and run the engine for awhile.
11. Try to start the vehicle with the dead battery.
If it won't start after a few tries, it probably needs service.

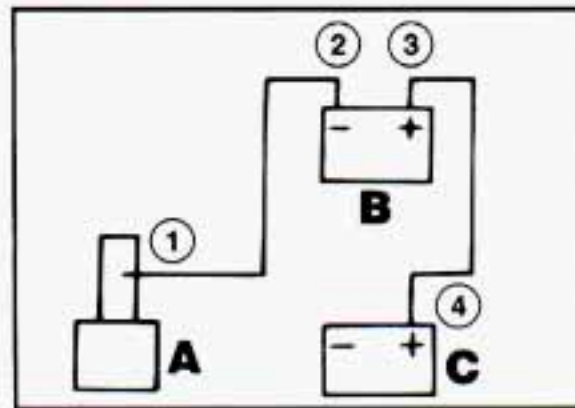

12. Remove the cables in reverse order to prevent electrical shorting. Take care that they don't touch each other or any other metal.
- A. Heavy Metal Engine Part
B. Good Battery
C. Dead Battery

Problems on the Road



■ Towing Your Vehicle

Try to have a GM dealer or a professional towing service tow your Geo. The usual towing equipment is a sling-type (A) or a wheel-lift (B) or car carrier (C) tow truck.

If your vehicle has been changed or modified since it was factory-new by adding aftermarket items like fog lamps, aero skirting, or special tires and wheels, these instructions and illustrations may not be correct.

Before you do anything, turn on the hazard warning flashers.

When you call, tell the towing service:

- That your vehicle cannot be towed from the front or rear with sling-type equipment.

- That your vehicle has front-wheel drive.
- The make, model, and year of your vehicle.
- Whether you can still move the shift lever.
- If there was an accident, what was damaged.

When the towing service arrives, let the tow operator know that this manual contains detailed towing instructions and illustrations. The operator may want to see them.

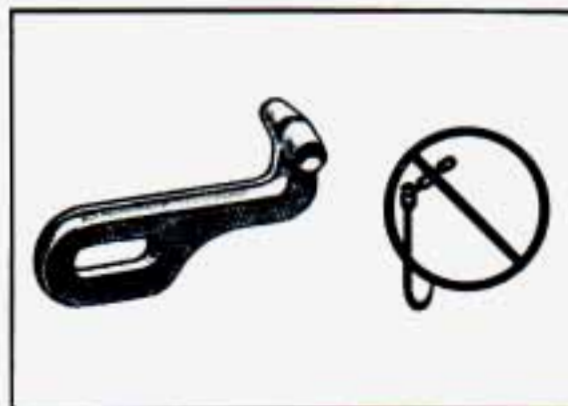

CAUTION



To help avoid injury to you or others:

- Never let passengers ride in a vehicle that is being towed.
- Never tow faster than safe or posted speeds.
- Never tow with damaged parts not fully secured.
- Never get under your vehicle after it has been lifted by the tow truck.
- Always use separate safety chains on each side when towing a vehicle.
- Never use "J" hooks. Use T-hooks instead.

When your vehicle is being towed, have the ignition key off. The steering wheel should be clamped in a straight-ahead position, with a clamping device designed for towing service. Do not use the vehicle's steering column lock for this. The transaxle should be in **Neutral** and the parking brake released.

Don't have your vehicle towed with the front wheels in contact with the ground if it has an automatic transaxle. If a vehicle with an automatic transaxle must be towed from the rear with wheel lift equipment, the front wheels must be supported on a dolly.

If your vehicle has a manual transaxle, don't have it towed on the front wheels unless you must. If a vehicle with a manual transaxle must be towed on the front wheels, don't go more than 35 mph (56 km/h) or farther than 50 miles (80 km) or your transaxle will be damaged. If these limits must be exceeded, then the front wheels have to be supported on a dolly. If you have a manual transaxle and dollies won't be used, turn the ignition key to the **ACC** position and put the transaxle in **Neutral**.

CAUTION



A vehicle can fall from a car carrier if it isn't properly secured. This can cause a collision, serious personal injury and vehicle damage. The vehicle should be tightly secured with chains or steel cables before it is transported.

Don't use substitutes (ropes, leather straps, canvas webbing, etc.) that can be cut by sharp edges underneath the towed vehicle.

Problems on the Road



Front Towing Hook-Ups

Attach T-hook chains to slots in frame brackets just ahead of front wheels on both sides.

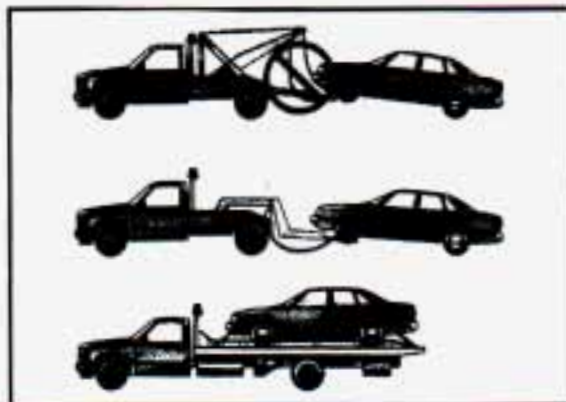

NOTICE

Do not tow with sling-type equipment or fascia damage will occur.

Use wheel lift or car carrier equipment. Additional ramping may be required for car carrier equipment.

Use safety chains and wheel straps.



Attach a separate safety chain around the outboard end of each lower control arm.



Rear Towing Hook-Ups

Attach T-hook chains to slots in the bottom of the floor pan just ahead of the rear wheels on both sides.

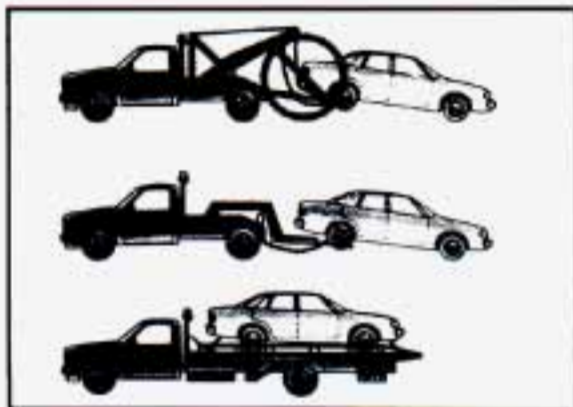

NOTICE

Do not tow with sling-type equipment or rear bumper valance will be damaged.

Use wheel lift or car carrier equipment. Additional ramping may be required for car carrier equipment.

Use safety chains and wheel straps.

Dollies are required under the front wheels or damage will occur.



Attach a separate safety chain around the outboard end of each lower control arm.

Problems on the Road



■ *Engine Overheating*

You will find a coolant temperature gage or the warning light about a hot engine on your Geo instrument panel.

If Steam Is Coming from Your Engine:

CAUTION



Steam from an overheated engine can burn you badly, even if you just open the hood. Stay away from the engine if you see or hear steam coming from it. Just turn it off and get everyone away from the vehicle until it cools down. Wait until there is no sign of steam or coolant before opening the hood.

If you keep driving when your engine is overheated, the liquids in it can catch fire. You or others could be badly burned. Stop your engine if it overheats, and get out of the vehicle until the engine is cool.

NOTICE

If your engine catches fire because you keep driving with no coolant, your vehicle can be badly damaged. The costly repairs would not be covered by your warranty.

If No Steam Is Coming from Your Engine:

If you get the overheat warning but see or hear no steam, the problem may not be too serious. Sometimes the engine can get a little too hot when you:

- Climb a long hill on a hot day.
- Stop after high speed driving.

- Idle for long periods in traffic.
- Tow a trailer.

If you get the overheat warning with no sign of steam, try this for a minute or so:

1. If you have an air conditioner, turn it off.
2. Turn on your heater to full hot at the highest fan speed and open the window as necessary.
3. Try to keep your engine under load (in a drive gear where the engine runs slower).

If you no longer have the overheat warning, you can drive. Just to be safe, drive slower for about ten minutes. If the warning doesn't come back on, you can drive normally.

If the warning continues, pull over, stop, and park your vehicle right away.

If there's still no sign of steam, you can idle the engine for two or three minutes while you're parked, to see if the warning stops. But then, if you still have the warning, **TURN OFF THE ENGINE AND GET EVERYONE OUT OF THE VEHICLE** until it cools down.

You may decide not to lift the hood but to get service help right away.

Problems on the Road

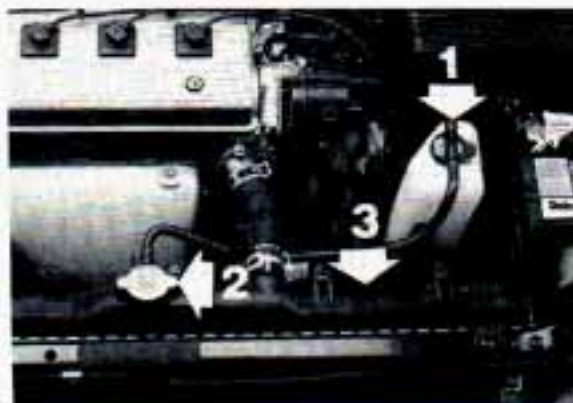

When you decide it's safe to lift the hood, here's what you'll see:

1. Coolant recovery tank
2. Radiator pressure cap
3. Electric engine fan

CAUTION



An electric fan under the hood can start up even when the engine is not running and can injure you. Keep hands, clothing and tools away from any underhood electric fan.



If the coolant inside the coolant recovery tank is boiling, don't do anything else until it cools down.

The coolant level should be at or above **FULL**. If it isn't, you may have a leak in the radiator hoses, heater hoses, radiator, water pump or somewhere else in the cooling system.

CAUTION



Heater and radiator hoses, and other engine parts, can be very hot. Don't touch them. If you do, you can be burned.

Don't run the engine if there is a leak. If you run the engine, it could lose all coolant. That could cause an engine fire, and you could be burned. Get any leak fixed before you drive the vehicle.

NOTICE

Engine damage from running your engine without coolant isn't covered by your warranty.

If there seems to be no leak, check to see if the electric engine fan is running. If the engine is overheating, the fan should be running. If it isn't, your vehicle needs service.

How to Add Coolant to the Coolant Recovery Tank

If you haven't found a problem yet, but the coolant level isn't at or above **FULL**, add a 50/50 mixture of **clean water** (preferably distilled) and a proper antifreeze at the coolant recovery tank. (See "Engine Coolant" in the Index for more information about the proper coolant mix.)

CAUTION



Adding plain water to your cooling system can be **dangerous**. Plain water, or some other liquid like alcohol, can boil before the proper coolant mix will. Your vehicle's coolant warning system is set for the proper coolant mix. With plain water or the wrong mix, your engine could get too hot but you wouldn't get the overheat warning. Your engine could catch fire and you or others could be burned. Use a 50/50 mix of **clean water** and a proper antifreeze.

Problems on the Road



NOTICE

In cold weather, water can freeze and crack the engine, radiator, heater core and other parts. Use the recommended coolant.

CAUTION

 You can be burned if you spill coolant on hot engine parts. Coolant contains ethylene glycol and it will burn if the engine parts are hot enough. Don't spill coolant on a hot engine.

When the coolant in the coolant recovery tank is at or above **FULL**, start your vehicle.

If the overheat warning continues, there's one more thing you can try. You can add the proper coolant mix directly to the radiator, but be sure the cooling system is cool before you do it.

CAUTION

 Steam and scalding liquids from a hot cooling system can blow out and burn you badly. They are under pressure, and if you turn the radiator pressure cap — even a little — they can come out at high speed. Never turn the cap when the cooling system, including the radiator pressure cap, is hot. Wait for the cooling system and radiator pressure cap to cool if you ever have to turn the pressure cap.



How to Add Coolant to the Radiator

1. You can remove the radiator pressure cap when the cooling system, including the radiator pressure cap and upper radiator hose, is no longer hot. Turn the pressure cap slowly to the left until it first stops. (Don't press down while turning the pressure cap.)

If you hear a hiss, wait for that to stop. A hiss means there is still some pressure left.



2. Then keep turning the pressure cap, but now push down as you turn it. Remove the pressure cap.



3. Fill the radiator with the proper mix, up to the base of the filler neck.

Problems on the Road



4. Then fill the coolant recovery tank to **FULL**.

5. Put the cap back on the coolant recovery tank, but leave the radiator pressure cap off.

6. Start the engine and let it run until you can feel the upper radiator hose getting hot. Watch out for the engine fan.

- By this time, the coolant level inside the radiator filler neck may be lower. If the level is lower, add more of the proper mix through the filler neck until the level reaches the base of the filler neck.



7. Then replace the pressure cap. Be sure the arrows on the pressure cap line up like this.

■ *If a Tire Goes Flat*

It's unusual for a tire to "blow out" while you're driving, especially if you maintain your tires properly. If air goes out of a tire, it's much more likely to leak out slowly. But if you should ever have a "blowout," here are a few tips about what to expect and what to do:

If a front tire fails, the flat tire will create a drag that pulls the vehicle toward that side. Take your foot off the accelerator pedal and grip the steering wheel firmly. Steer to maintain lane position, then gently brake to a stop well out of the traffic lane.

A rear blowout, particularly on a curve, acts much like a skid and may require the same correction you'd use in a skid. In any rear blowout, remove your foot from the accelerator pedal. Get the vehicle under control by steering the way you want the vehicle to go. It may be very bumpy and noisy, but you can still steer. Gently brake to a stop, well off the road if possible.

If your tire goes flat, the next section shows how to use your jacking equipment to change a flat tire safely.

Problems on the Road



Changing a Flat Tire

If a tire goes flat, avoid further tire and wheel damage by driving slowly to a level place. Turn on your hazard warning flashers.

CAUTION



Changing a tire can cause an injury. The vehicle can slip off the jack and roll over you or other people. You and they could be badly injured. Find a level place to change your tire. To help prevent the vehicle from moving:

1. Set the parking brake firmly.
2. Put the shift lever in **P** (Park).
3. Shift a manual transaxle to **1** (First) or **R** (Reverse).
4. Turn off the engine.

To be even more certain the vehicle won't move, you can put chocks at the front and rear of the tire farthest away from the one being changed. That would be the tire on the other side of the vehicle, at the opposite end.



The following steps will tell you how to use the jack and change a tire.

The equipment you'll need is in the trunk.

Move the carpet from the top of the spare tire cover. Then remove the cover over the spare tire.

Turn the knob and remove it.

Pull out the spare tire.

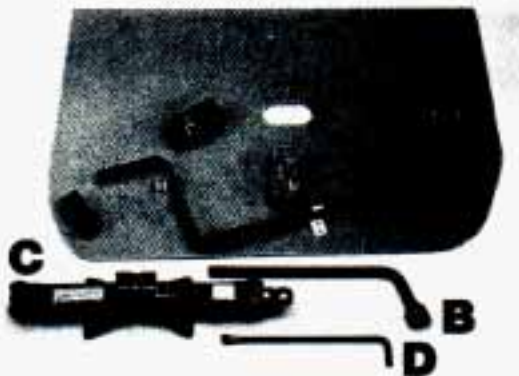

Remove the jack handle (A), wheel wrench (B), jack (C) and wheel cover tool (D) from the trunk.



The jack has a bolt at the end. Attach the jack handle to the jack bolt. Turn the jack handle to the right to raise the lift head.

Problems on the Road



If there is a wheel cover, remove it by using the flat end of the wheel cover tool. Pry along the edge of the wheel cover until it comes off. Be careful; the rim edges may be sharp. Don't try to remove it with your bare hands.



Using the wheel wrench, loosen all the wheel nuts. Don't remove them yet.

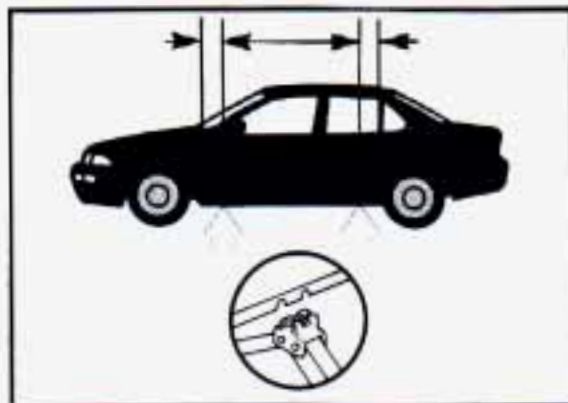

Position the jack under the vehicle. Near each wheel, there are notches in the vehicle's rocker flange. Position the jack and raise the jack lift head until it fits firmly into the notches closest to the flat tire.

CAUTION



Getting under a vehicle when it is jacked up is dangerous. If the vehicle slips off the jack, you could be badly injured or killed. Never get under a vehicle when it is supported only by a jack.

NOTICE

Raising your vehicle with the jack improperly positioned will damage the vehicle or may allow the vehicle to fall off the jack. Be sure to fit the jack lift head into the proper location before raising your vehicle.



Raise the vehicle by rotating the jack handle clockwise. Raise the vehicle far enough off the ground so there is enough room for the spare tire to fit.



Remove all the wheel nuts and take off the flat tire.

Problems on the Road



CAUTION

 Rust or dirt on the wheel, or on the parts to which it is fastened, can make the wheel nuts become loose after a time. The wheel could come off and cause an accident. When you change a wheel, remove any rust or dirt from the places where the wheel attaches to the vehicle. In an emergency, you can use a cloth or a paper towel to do this; but be sure to use a scraper or wire brush later, if you need to, to get all the rust or dirt off.

Remove any rust or dirt from the wheel bolts, mounting surfaces or spare wheel. Place the spare on the wheel mounting surface.

CAUTION

 Never use oil or grease on studs or nuts. If you do, the nuts might come loose. Your wheel could fall off, causing a serious accident.

Replace the wheel nuts with the rounded end of the nuts toward the wheel. Tighten each nut by hand until the wheel is held against the hub.



Lower the vehicle by rotating the jack handle counterclockwise. Lower the jack completely.

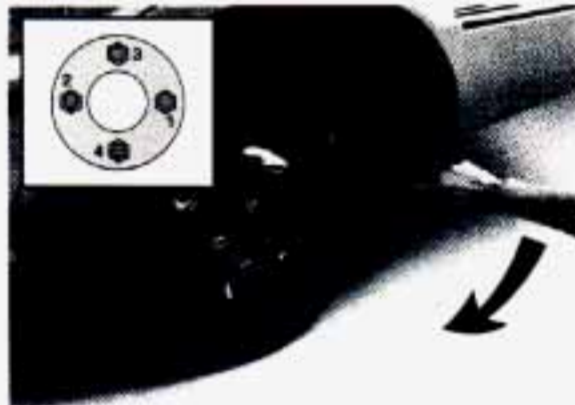

Tighten the wheel nuts firmly in a criss-cross sequence as shown.

CAUTION

 Incorrect wheel nuts or improperly tightened wheel nuts can cause the wheel to become loose and even come off. This could lead to an accident. Be sure to use the correct wheel nuts. If you have to replace them, be sure to get the right kind.

Stop somewhere as soon as you can and have the nuts tightened with a torque wrench to 76 ft. lbs. (103 N•m).

Problems on the Road

STORAGE INSTRUCTIONS

JACK AND
TOOL STORAGE

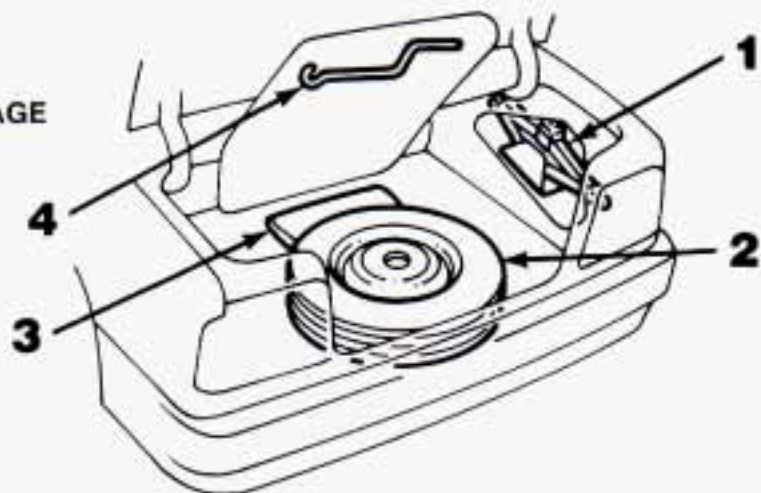

1. Jack
2. Spare Tire
3. Tool Bag
4. Jack Handle

Don't try to put a wheel cover on your compact spare. It won't fit. Store the wheel cover in the trunk until you have the flat tire repaired or replaced.

NOTICE

Wheel covers won't fit on your compact spare. If you try to put a wheel cover on your compact spare, you could damage the cover or the spare.

Replace the jack, jack handle, wheel wrench, wheel cover tool and flat tire.

CAUTION



Storing a jack, a tire or other equipment in the passenger compartment of the vehicle could cause injury. In a sudden stop or collision, loose equipment could strike someone. Store all these in the proper place.

Compact Spare

Although the compact spare was fully inflated when your vehicle was new, it can lose air after a time. Check the inflation pressure regularly. It should be 60 psi (420 kPa). The compact spare is made to go up to 3,000 miles (5 000 km), so you can finish your trip and have your full-size tire repaired or replaced where you want. Of course, it's best to replace your spare with a full-size tire as soon as you can. Your spare will last longer and be in good shape in case you need it again.

Your anti-lock brake system warning light may come on when you are driving with a compact spare. See "Anti-Lock Brake System Warning Light" in the Index.

NOTICE

Don't take your compact spare through an automatic car wash with guide rails. The compact spare can get caught on the rails. That can damage the tire and wheel, and maybe other parts of your vehicle.

Don't use your compact spare on some other vehicle.

And don't mix your compact spare or wheel with other wheels or tires. They won't fit. Keep your spare and its wheel together.

Problems on the Road

NOTICE

Tire chains won't fit your compact spare. Using them will damage your vehicle and destroy the chains too. Don't use tire chains on your compact spare.

■ *If You're Stuck: In Sand, Mud, Ice or Snow*

What you **don't** want to do when your vehicle is stuck is to spin your wheels. The method known as "rocking" can help you get out when you're stuck, but you must use caution.

CAUTION



If you let your tires spin at high speed, they can explode and you or others could be injured. And, the transaxle or other parts of the vehicle can overheat. That could cause an engine compartment fire or other damage. When you're stuck, spin the wheels as little as possible. Don't spin the wheels above 19 mph (30 km/h) as shown on the speedometer.

NOTICE

Spinning your wheels can destroy parts of your vehicle as well as the tires. If you spin the wheels too fast while shifting your transaxle back and forth, you can destroy your transaxle.

Rocking your vehicle to get it out:

First, turn your steering wheel left and right. That will clear the area around your front wheels. Then shift back and forth between **R** (Reverse) and a forward gear (or with a manual transaxle, between First or Second gear and Reverse), spinning the wheels as little as possible. Release the accelerator pedal while you shift, and press lightly

on the accelerator pedal when the transaxle is in gear. If that doesn't get you out after a few tries, you may need to be towed out. If you do need to be towed out, see "Towing Your Vehicle" in the Index.

Notes



Here you will find information about the care of your Geo. This part begins with service and fuel information, and then it shows how to check important fluid and lubricant levels. There is also technical information about your vehicle, and a section devoted to its appearance care.

Part 6

Service & Appearance Care

Service	212
Fuel	213
Checking Things under the Hood	217
Hood Release	217
Engine Oil	220
Air Cleaner	224
Automatic Transaxle Fluid	224
Manual Transaxle Fluid	227
Hydraulic Clutch	228
Engine Coolant	228
Power Steering Fluid	231
Windshield Washer Fluid	232
Brake Master Cylinder	233
Battery	235
Bulb Replacement	236
Loading Your Vehicle	240
Tires	242
Appearance Care	249
Appearance Care and Maintenance Materials	257
Vehicle Identification Number (VIN)	258
Service Parts Identification Label	258
Add-On Electrical Equipment	258
Fuses and Circuit Breakers	259
Replacement Bulbs	262
Capacities and Specifications	263

Service & Appearance Care

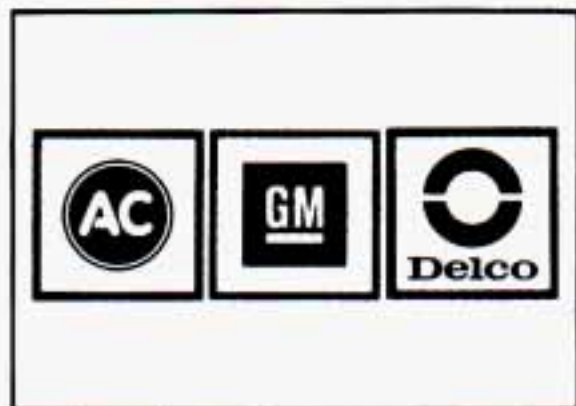

■ Service

Your Geo dealer knows your vehicle best and wants you to be happy with it. We hope you'll go to your dealer for all your service needs. You'll get genuine GM parts and GM-trained and supported service people.

We hope you'll want to keep your GM vehicle all GM. Genuine GM parts have one of these marks.

Doing Your Own Service Work

If you want to do some of your own service work, you'll want to get the proper Geo Service Manual. It tells you much more about how to service your Geo than this manual can. To order the proper service manual, see "Service Publications" in the Index.

You should keep a record of all parts receipts and list the mileage and the date of any service work you perform. See "Maintenance Record" in the Index.

CAUTION



You can be injured if you try to do service work on a vehicle without knowing enough about it.

- Be sure you have sufficient knowledge, experience, and the proper replacement parts and tools before you attempt any vehicle maintenance task.
- Be sure to use the proper nuts, bolts and other fasteners. "English" and "metric" fasteners can be easily confused. If you use the wrong fasteners, parts can later break or fall off. You could be hurt.

NOTICE

If you try to do your own service work without knowing enough about it, your vehicle could be damaged.

■ *Fuel*

The 8th digit of your Vehicle Identification Number (VIN) shows the code letter for your engine. You will find the VIN at the top left of your instrument panel. (See "Vehicle Identification Number" in the Index.)

1.6L LO1 (Engine Code 6)

Use regular unleaded gasoline rated at 87 octane or higher with 1.6L LO1 (Engine Code 6). It should meet specifications ASTM D4814 in the U.S. and CGSB 3.5-92 in Canada. These fuels should have the proper additives, so you should not have to add anything to the fuel.

In the U.S. and Canada, it's easy to be sure you get the right kind of gasoline

(unleaded). You'll see **UNLEADED** right on the pump. And only unleaded nozzles will fit into your vehicle's filler neck.

Be sure the posted octane is at least 87. If the octane is less than 87, you may get a heavy knocking noise when you drive. If it's bad enough, it can damage your engine.

If you're using fuel rated at 87 octane or higher and you still hear heavy knocking, your engine needs service. But don't worry if you hear a little pinging noise when you're accelerating or driving up a hill. That's normal, and you don't have to buy a higher octane fuel to get rid of pinging. It's the heavy,

Service & Appearance Care

constant knock that means you have a problem.

1.8L LV6 (Engine Code 8)

Use premium unleaded gasoline rated at 91 octane or higher with the 1.8L LV6 (Engine Code 8). It should meet specifications ASTM D4814 in the U.S. and CGSB 3.5-92 in Canada. These fuels should have the proper additives, so you should not have to add anything to the fuel.

In the U.S. and Canada, it's easy to be sure you get the right kind of gasoline (unleaded). You'll see **UNLEADED** right on the pump. And only unleaded nozzles will fit into your vehicle's filler neck.

Be sure the posted octane is at least 91. If the octane is less than 91, you may get a heavy knocking noise when you drive. (In an emergency, you may be able to use lower octane — as low as 87 — if heavy knocking does not occur.) If you're using 91 or higher octane unleaded gas and you still get heavy knocking, your engine needs service.

What about gasoline with blending materials that contain oxygen, such as MTBE or alcohol?

MTBE is "methyl tertiary-butyl ether." Fuel that is no more than 15% MTBE is fine for your vehicle.

Ethanol is ethyl or grain alcohol. Properly-blended fuel that is no more

than 10% **ethanol** is fine for your vehicle.

Methanol is methyl or wood alcohol.

NOTICE

Fuel that is more than 5% **methanol** is bad for your vehicle. Don't use it. It can corrode metal parts in your fuel system and also damage plastic and rubber parts. That damage wouldn't be covered under your warranty. And even at 5% or less, there must be "cosolvents" and corrosion preventers in this fuel to help avoid these problems.

Gasolines for Cleaner Air

Your use of gasoline with detergent additives will help prevent deposits from forming in your engine and fuel system. That helps keep your engine in tune and your emission control system working properly. It's good for your vehicle, and you'll be doing your part for cleaner air.

Many gasolines are now blended with materials called oxygenates. General Motors recommends that you use gasolines with these blending materials, such as MTBE and ethanol. By doing so, you can help clean the air, especially in those parts of the country that have high carbon monoxide levels.

In addition, some gasoline suppliers are now producing reformulated gasolines. These gasolines are specially designed to reduce vehicle emissions. General Motors recommends that you use reformulated gasoline. By doing so, you can help clean the air, especially in those parts of the country that have high ozone levels.

You should ask your service station operators if their gasolines contain detergents and oxygenates, and if they have been reformulated to reduce vehicle emissions.

Fuels in Foreign Countries

If you plan on driving in another country outside the U.S. or Canada, unleaded fuel may be hard to find. Do not use leaded gasoline. If you use even one tankful, your emission controls won't work well or at all. With continuous use, spark plugs can get fouled, the exhaust system can corrode, and your engine oil can deteriorate quickly. Your vehicle's oxygen sensor will be damaged. All of that means costly repairs that wouldn't be covered by your warranty.

Service & Appearance Care

To check on fuel availability, ask an auto club, or contact a major oil company that does business in the country where you'll be driving.

You can also write us at the following address for advice. Just tell us where you're going and give your Vehicle Identification Number (VIN).

General Motors of Canada Ltd.
International Export Sales
P.O. Box 828
Oshawa, Ontario L1H 7N1
Canada

Filling Your Tank

CAUTION



Gasoline vapor is highly flammable. It burns violently, and that can cause very bad injuries. Don't smoke if you're near gasoline or refueling your vehicle. Keep sparks, flames, and smoking materials away from gasoline.



The release lever is near the floor to the left of the driver's seat.

The cap is behind a hinged door on the left side of your vehicle.



While refueling, hang the cap inside the fuel door.

To take off the cap, turn it slowly to the left (counterclockwise).

CAUTION



If you get gasoline on you and then something ignites it, you could be badly burned. Gasoline can spray out on you if you open the fuel filler cap too quickly. This spray can happen if your tank is nearly full, and is more likely in hot weather. Open the fuel filler cap slowly and wait for any "hiss" noise to stop. Then unscrew the cap all the way.

When you put the cap back on, turn it to the right until you hear a clicking noise.

NOTICE

If you need a new cap, be sure to get the right type. Your dealer can get one for you. If you get the wrong type, it may not fit or have proper venting, and your fuel tank and emissions system might be damaged.



■ *Checking Things under the Hood*

Hood Release

To open the hood, first pull the handle inside the vehicle.

Service & Appearance Care



Then go to the front of the vehicle and release the secondary hood release.



Lift the hood, release the hood prop from its retainer and put the hood prop into the slot in the hood.

CAUTION



An electric fan under the hood can start up and injure you even when the engine is not running. Keep hands, clothing and tools away from any underhood electric fan.

When you open the hood, you'll see:

1. Windshield Washer Reservoir
2. Oil Fill Cap
3. Engine Oil Dipstick
4. Power Steering Reservoir
5. Brake Fluid Reservoir
6. Air Cleaner
7. Engine Compartment Fuses
8. Battery
9. Engine Coolant Reservoir
10. Automatic Transaxle Dipstick
11. Engine Fan

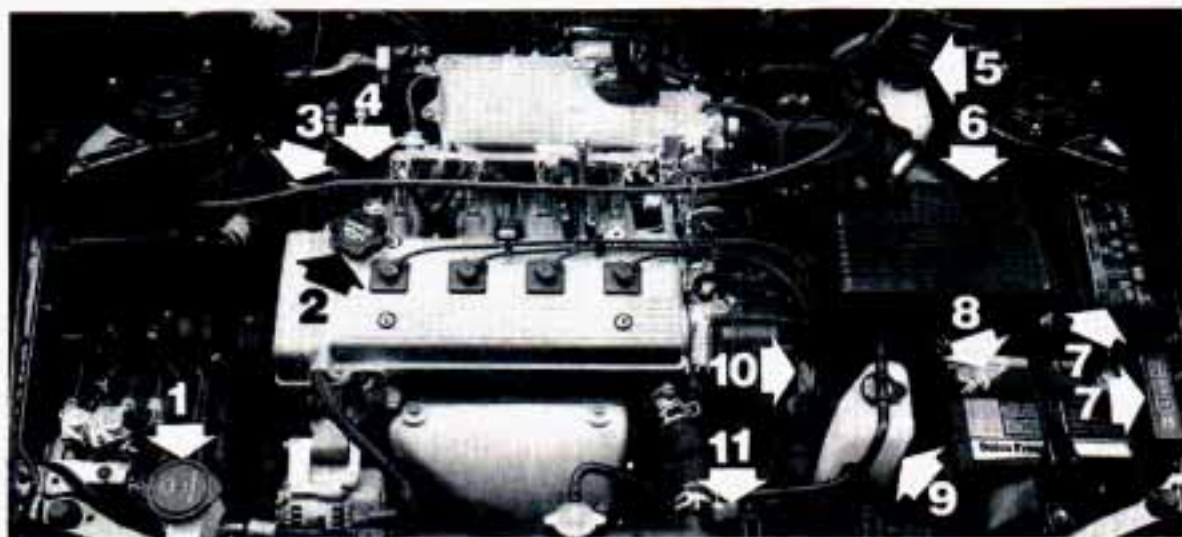

1.6L LO1 (Engine Code 6)

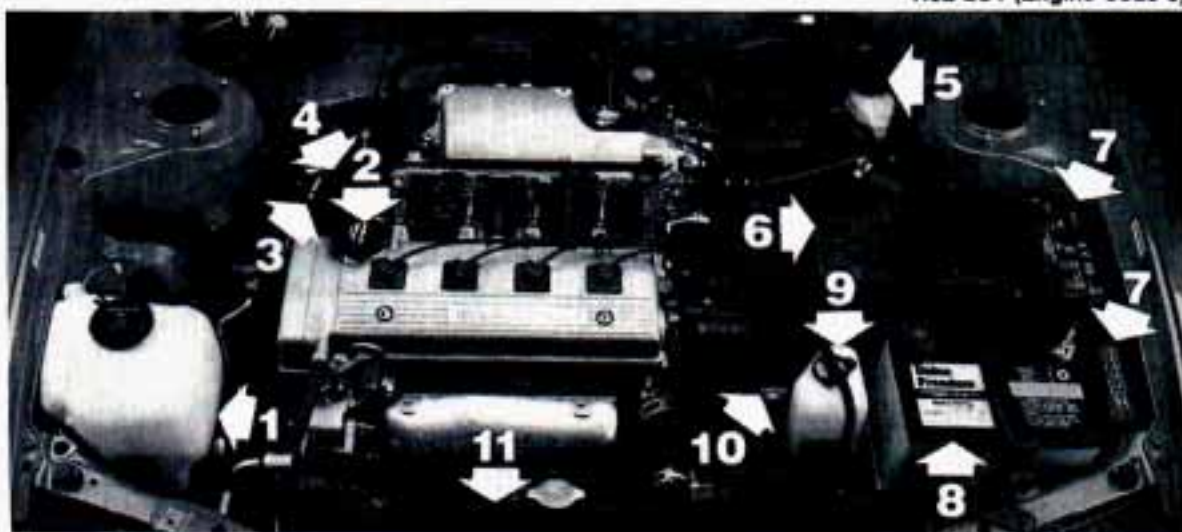

1.8L LV6 (Engine Code 8)

CAUTION



Things that burn can get on hot engine parts and start a fire.

These include liquids like gasoline, oil, coolant, brake fluid, windshield washer and other fluids, and plastic or rubber. You or others could be burned. Be careful not to drop or spill things that will burn onto a hot engine.

Before closing the hood, be sure all the filler caps are on properly.

Then lift the hood to relieve pressure on the hood prop. Remove the hood prop from the slot in the hood and return the prop to its retainer. Then just let the hood down and close it firmly.

Service & Appearance Care



Engine Oil

It's a good idea to check your engine oil level every time you get fuel. In order to get an accurate reading, the oil must be warm and the vehicle must be on level ground.

Turn off the engine and give the oil a few minutes to drain back into the oil pan. If you don't, the oil dipstick might not show the actual level.



To Check Engine Oil:

Pull out the dipstick and clean it with a paper towel or a cloth, then push it back in all the way. Remove it again, keeping the tip lower.



When to Add Oil:

If the oil is at or below the L, you'll need to add some oil. But you must use the right kind. This section explains what kind of oil to use. For crankcase capacity, see "Capacities and Specifications" in the Index.

NOTICE

Don't add too much oil. If your engine has so much oil that the oil level gets above the cross-hatched area that shows the proper operating range, your engine could be damaged.



Just fill it enough to put the level somewhere in the proper operating range. Push the dipstick all the way back in when you're through.

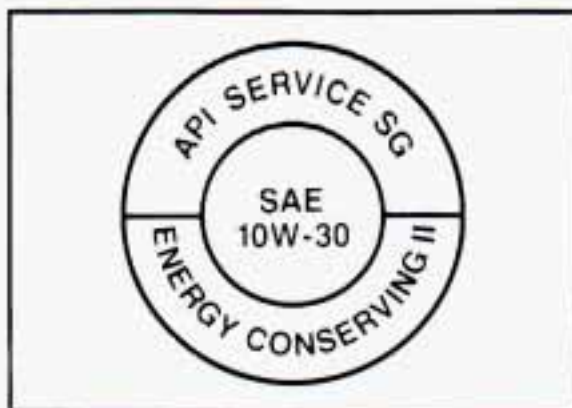

What Kind of Oil to Use:

Look for three things:

- **SG**
SG must be on the oil container, either by itself or combined with other quality designations, such as **SG/CC**, **SG/CD**, **SF**, **SG**, **CC**, etc. These letters show American Petroleum Institute (API) levels of quality.

NOTICE

If you use oils that don't have the **SG** designation, you can cause engine damage which is not covered by your warranty.

Service & Appearance Care

Recommended SAE Viscosity Grade Engine Oils

For best fuel economy and cold starting, select the lowest SAE viscosity grade oil for the expected temperature range.

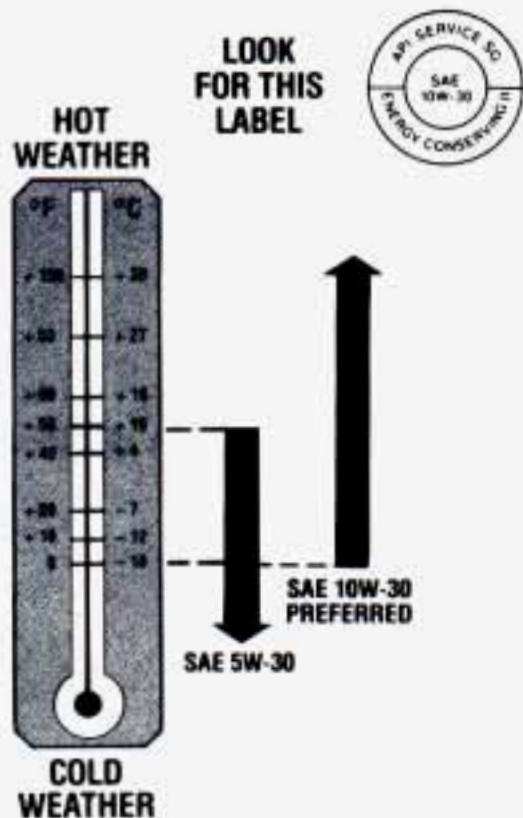

- SAE 10W-30

As shown in the viscosity chart, SAE 10W-30 is best for your vehicle. However you can use SAE 5W-30 if it's going to be colder than 50°F (10°C) before your next oil change. When it's very cold, below 0°F (-18°C), you should use SAE 5W-30.

These numbers on an oil container show its viscosity, or thickness. Do not use other viscosity oils such as SAE 10W-40 or SAE 20W-50.

- Energy Conserving II

Oils with these words on the container will help you save fuel.

This doughnut-shaped logo (symbol) is used on most oil containers to help you select the correct oil.

You should look for this on the oil container, and use **only** those oils that display the logo.

GM Goodwrench® oil (in Canada, GM Engine Oil) meets all the requirements for your vehicle.

Engine Oil Additives:

Don't add anything to your oil. Your Geo dealer is ready to advise if you think something should be added.

When to Change Engine Oil:

See if any one of these is true for you:

- Most trips are less than 4 miles (6 km).
- It's below freezing outside and most trips are less than 10 miles (16 km).
- The engine is at low speed most of the time (as in door-to-door delivery, or in stop-and-go traffic).
- You tow a trailer often.
- Most trips are through dusty places.

If any one of these is true for your vehicle, you need to change your **oil and filter** every 3,750 miles (6 200 km) or 6 months — whichever comes first.

If none of them is true, change oil and filter every 7,500 miles (12 500 km) or 12 months — whichever comes first.

What to Do with Used Oil:

CAUTION



Used engine oil contains things that have caused skin cancer in laboratory animals. Don't let used oil stay on your skin for very long. Clean your skin and nails with soap and water, or a good hand cleaner. Wash or properly throw away clothing or rags containing used engine oil.

Used oil can be a real threat to the environment. If you change your own oil, be sure to drain all free-flowing oil from the filter before disposal. Don't ever dispose of it by pouring it on the ground, into sewers, or into streams or bodies of water. Instead, recycle it by taking it to a place that collects used oil. If you have a problem properly disposing of your used oil, ask your dealer, a service station or a local recycling center for help.

Service & Appearance Care



Air Cleaner

Refer to the Maintenance Schedule to determine when to replace the air filter. See "Scheduled Maintenance Services" in the Index.

CAUTION



Operating the engine with the air cleaner off can cause you or others to be burned. The air cleaner not only cleans the air, it stops flame if the engine backfires. If it isn't there, and the engine backfires, you could be burned. Don't drive with it off, and be careful working on the engine with the air cleaner off.



NOTICE

If the air cleaner is off, a backfire can cause a damaging engine fire. And, dirt can easily get into your engine, which will damage it. Always have the air cleaner in place when you're driving.

Air Filter Replacement

To check or replace the air filter:

1. Release the four clips that hold the cover down.
2. Lift the cover off.
3. Check or replace the air filter.
4. Reverse steps one and two to finish.

Automatic Transaxle Fluid

When to Check and Change:

A good time to check your automatic transaxle fluid level is when the engine oil is changed. Refer to the Maintenance Schedule to determine when to change your fluid. See "Scheduled Maintenance Services" in the Index.

How to Check:

Because this operation can be a little difficult, you may choose to have this done at a Geo dealership Service Department.

If you do it yourself, be sure to follow all the instructions here, or you could get a false reading on the dipstick.

NOTICE

Too much or too little fluid can damage your transaxle. Too much can mean that some of the fluid could come out and fall on hot engine parts, starting a fire. Be sure to get an accurate reading if you check your transaxle fluid.

Wait at least 30 minutes before checking the transaxle fluid level if you have been driving:

- When outside temperatures are above 90°F (32°C).
- At high speed for quite a while.

- In heavy traffic — especially in hot weather.
- While pulling a trailer.

To get the right reading, the fluid should be at normal operating temperature, which is 180°F to 200°F (82°C to 93°C).

Get the vehicle warmed up by driving about 15 miles (24 km) when outside temperatures are above 50°F (10°C). If it's colder than 50°F (10°C), you may have to drive longer.

To check the fluid level:

- Park your vehicle on a level place.
- Place the shift lever in **P** (Park) with the parking brake applied.
- With your foot on the brake pedal, move the shift lever through each gear range, pausing for about three seconds in each range. Then, position the shift lever in **P** (Park).
- Let the engine run at idle for three to five minutes.

Service & Appearance Care

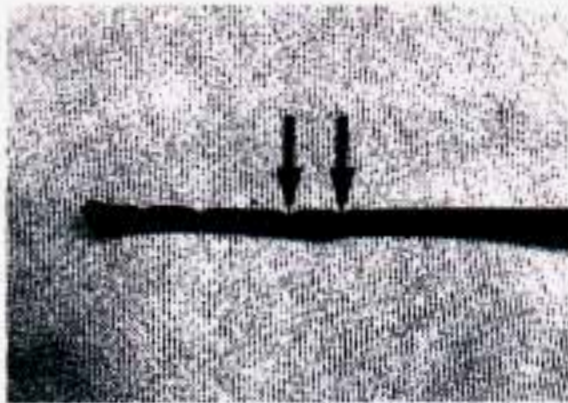

Then, without shutting off the engine, follow these steps:

1. Release the tab and pull out the dipstick and wipe it with a clean rag or paper towel.
2. Push it back in all the way, wait three seconds and then pull it back out again.

3. Check both sides of the dipstick, and read the lower level. The fluid level must be between the two dimples in the hot range.
4. If the fluid level is where it should be, push the dipstick back in all the way.

How to Add Fluid:

Refer to the Maintenance Schedule to determine what kind of transaxle fluid to use. See "Recommended Fluids and Lubricants" in the Index.

If the fluid level is low, add only enough of the proper fluid to bring the fluid level into the area between the dimples on the dipstick. It doesn't take

much fluid, generally less than a pint. Don't overfill. We recommend you use only fluid labeled DEXRON®-II because fluids with that label are made especially for your automatic transaxle. Damage caused by fluid other than DEXRON®-II is not covered by your new vehicle warranty.

- After adding fluid, recheck the fluid level as described under "How to Check."
- When the correct fluid level is obtained, push the dipstick back in all the way.

Manual Transaxle Fluid

When to Check:

A good time to have it checked is when the engine oil is changed. However, the fluid in your manual transaxle doesn't require changing.

How to Check:

Because this operation can be a little difficult, you may choose to have this done at a Geo dealership Service Department.

If you do it yourself, be sure to follow all the instructions here, or you could get a false reading.

NOTICE

Too much or too little fluid can damage your transaxle. Too much can mean that some of the fluid could come out and fall on hot engine parts, starting a fire. Be sure to get an accurate reading if you check your transaxle fluid.

Check the fluid level only when your engine is off, the vehicle is parked on a level place and the transaxle is cool enough for you to rest your fingers on the transaxle case.

Then, follow these steps:

1. Remove the filler plug.
2. Check that the lubricant level is up to the bottom of the filler plug hole.
3. If the fluid level is good, install the plug and be sure it is fully seated. If the fluid level is low, add more fluid as described in the next steps.

Service & Appearance Care



Hydraulic Clutch

The hydraulic clutch in your vehicle is self-adjusting.

When to Check and What to Use:

Refer to your Maintenance Schedule to determine how often you should check the fluid level in your clutch master cylinder reservoir and what to add. See "Owner Checks and Services" and "Recommended Fluids and Lubricants" in the Index.

How to Check:

The proper fluid should be added if the level is at or below the **MIN** mark on the reservoir. See the instructions on the reservoir cap.

How to Add Fluid:

Here's how to add fluid. Refer to the Maintenance Schedule to determine what kind of fluid to use. See "Recommended Fluids and Lubricants" in the Index.

1. Remove the filler plug.
2. Add fluid at the filler plug hole. Add only enough fluid to bring the fluid level up to the bottom of the filler plug hole.
3. Install the filler plug. Be sure the plug is fully seated.

Engine Coolant

The following explains your cooling system and how to add coolant when it is low. If you have a problem with engine overheating, see "Engine Overheating" in the Index.

The proper coolant for your Geo will:

- Give freezing protection down to -34°F (-37°C).
- Give boiling protection up to 262°F (128°C).
- Protect against rust and corrosion.
- Help keep the proper engine temperature.
- Let the warning lights work as they should.

What to Use:

Use a mixture of one-half **clean water** (preferably distilled) and one-half antifreeze that meets "GM Specification 1825M," which won't damage aluminum parts. You can also use a recycled coolant conforming to GM Specification 1825M with a complete coolant flush and refill. Use GM Engine Coolant Supplement (sealer) with any complete coolant change. If you use these, you don't need to add anything else.

CAUTION



Adding only plain water to your cooling system can be dangerous. Plain water, or some other liquid like alcohol, can boil before the proper coolant mix will. Your vehicle's coolant warning system is set for the proper coolant mix. With plain water or the wrong mix, your engine could get too hot but you wouldn't get the overheat warning. Your engine could catch fire and you or others could be burned. Use a 50/50 mix of clean water and a proper antifreeze.

NOTICE

If you use an improper coolant mix, your engine could overheat and be badly damaged. The repair cost wouldn't be covered by your warranty. Too much water in the mix can freeze and crack the engine, radiator, heater core and other parts.

Service & Appearance Care



Adding Coolant

To Check Coolant:

When your engine is cold, the coolant level should be at **LOW**, or a little higher. When your engine is warm, the level should be up to **FULL** or a little higher.

To Add Coolant:

If you need more coolant, add the proper mix **at the coolant recovery tank**.

CAUTION



Turning the radiator pressure cap when the engine and radiator are hot can allow steam and scalding liquids to blow out and burn you badly. With the coolant recovery tank, you will almost never have to add coolant at the radiator. Never turn the radiator pressure cap — even a little — when the engine and radiator are hot.

Add coolant mix at the recovery tank, but be careful not to spill it.

CAUTION



You can be burned if you spill coolant on hot engine parts. Coolant contains ethylene glycol, and it will burn if the engine parts are hot enough. Don't spill coolant on a hot engine.

Radiator Pressure Cap

NOTICE

Your radiator cap is a 15 psi (105 kPa) pressure-type cap and must be tightly installed to prevent coolant loss and possible engine damage from overheating. Be sure the arrows on the cap line up with the overflow tube on the radiator filler neck.

When you replace your radiator pressure cap, an AC® cap is recommended.

Thermostat

Engine coolant temperature is controlled by a thermostat in the engine coolant system. The thermostat stops the flow of coolant through the radiator until the coolant reaches a preset temperature.

When you replace your thermostat, an AC® thermostat is recommended.



Power Steering Fluid

How to Check Power Steering Fluid:

Unscrew the cap and wipe the dipstick with a clean rag. Replace the cap and completely tighten it. Then remove the cap again and look at the fluid level on the dipstick.

Service & Appearance Care



- When the engine compartment is hot, the level should be between the **HOT** marks.
- When the engine compartment is cool, the level should be between the **COLD** marks.

What to Add:

Refer to the Maintenance Schedule to determine what kind of fluid to use. See "Recommended Fluids and Lubricants" in the Index.

NOTICE

When adding power steering fluid or making a complete fluid change, always use the proper fluid. Failure to use the proper fluid can cause leaks and damage hoses and seals.



Windshield Washer Fluid

To Add:

Open the cap labeled **WASHER FLUID ONLY**. Add washer fluid until the bottle is full.

NOTICE

- When using concentrated washer fluid, follow the manufacturer's instructions for adding water.
- Don't mix water with ready-to-use washer fluid. Water can cause the solution to freeze and damage your washer fluid tank and other parts of the washer system. Also, water doesn't clean as well as washer fluid.
- Fill your washer fluid tank only 3/4 full when it's very cold. This allows for expansion, which could damage the tank if it is completely full.
- Don't use radiator antifreeze in your windshield washer. It can damage your paint.



Brake Master Cylinder

Your brake master cylinder is here. It is filled with DOT-3 brake fluid.

There are only two reasons why the brake fluid level in your master cylinder might go down. The first is that the brake fluid goes down to an acceptable level during normal brake lining wear. When new linings are put in, the fluid level goes back up. The other reason is that fluid is leaking out of the brake system. If it is, you should have your brake system fixed, since a leak means that sooner or later your brakes won't work well, or won't work at all.

So, it isn't a good idea to "top off" your brake fluid. Adding brake fluid won't correct a leak. If you add fluid when your linings are worn, then you'll have too much fluid when you get new brake linings. You should add (or remove) brake fluid, as necessary, only when work is done on the brake hydraulic system.

Service & Appearance Care



CAUTION



If you have too much brake fluid, it can spill on the engine. The fluid will burn if the engine is hot enough. You or others could be burned, and your vehicle could be damaged. Add brake fluid only when work is done on the brake hydraulic system.

When your brake fluid falls to a low level, your brake warning light will come on. See "Brake System Warning Light" in the Index.

To Check Brake Fluid:

You can check the brake fluid without taking off the cap. Just look at the windows on the brake fluid reservoir. The fluid levels should be above **MIN**. If they aren't, have your brake system checked to see if there is a leak.

After work is done on the brake hydraulic system, make sure the levels are above **MIN** and below the top of each window.

What to Add:

When you do need brake fluid, use only DOT-3 brake fluid — such as Delco-Supreme 11® (GM Part No. 1052535). Use new brake fluid from a sealed container only.

NOTICE

- DOT-5 silicone brake fluid can damage your vehicle. Don't use it.
- Don't let someone put in the wrong kind of fluid. For example, just a few drops of mineral-based oil, such as engine oil, in your brake system can damage brake system parts so badly that they'll have to be replaced.
- Brake fluid can damage paint, so be careful not to spill brake fluid on your vehicle.

Replacing Brake System Parts

The braking system on a modern vehicle is complex. Its many parts have to be of top quality and work well together if the vehicle is to have really good braking. Vehicles we design and test have top-quality GM brake parts in them, as your Geo does when it is new. When you replace parts of your braking system — for example, when your brake linings wear down and you have to have new ones put in — be sure you get new genuine GM replacement parts. If you don't, your brakes may no longer work properly. For example, if someone puts

in brake linings that are wrong for your vehicle, the balance between your front and rear brakes can change, for the worse. The braking performance you've come to expect can change in many other ways if someone puts in the wrong replacement brake parts.

Battery

Every new Geo has a Delco Freedom® battery. You never have to add water to one of these. When it's time for a new battery, we recommend a Delco Freedom® battery. Get one that has the catalog number shown on the original battery's label.

Vehicle Storage

If you're not going to drive your vehicle for 25 days or more, take off the black, negative (-) cable from the battery. This will help keep your battery from running down.

Service & Appearance Care

CAUTION

 Batteries have acid that can burn you and gas that can explode. You can be badly hurt if you aren't careful. See "Jump Starting" in the Index for tips on working around a battery without getting hurt.

Contact your dealer to learn how to prepare your vehicle for longer storage periods.

■ *Bulb Replacement*

See "Replacement Bulbs" in the Index to check the size and type of bulb you need to use.

Halogen Bulbs

CAUTION

 Halogen bulbs have pressurized gas inside and can burst if you drop or scratch the bulb. You or others could be injured. Take special care when handling and disposing of halogen bulbs.



Headlights

To replace the headlight bulb:

1. Open the hood.
2. Reach behind the headlight assembly and find the lock ring assembly.
3. Turn the lock ring assembly to the left.
4. Pull the connector apart to remove the bulb assembly.
5. Reverse the steps with a new bulb assembly.



Parking Lights

1. Remove the screw.
2. Remove the parking light assembly.
3. Turn the bulb to the left and pull it out.
4. Reverse the steps with a new bulb.



Front Turn Signal Lights

To replace the front turn signal bulbs:

1. Remove the screw in the parking light and remove parking light.
2. Remove the screw from the turn signal assembly and remove assembly.



3. Turn the bulb to the left and pull it out.
4. Reverse the steps with a new bulb.

Service & Appearance Care



Front Sidemarkers Lights

To replace the sidemarkers bulb:

1. Loosen the screw on the sidemarkers lens.
2. Remove the sidemarkers assembly.
3. Turn the bulb to the left and pull it out.
4. Reverse the steps with a new bulb.

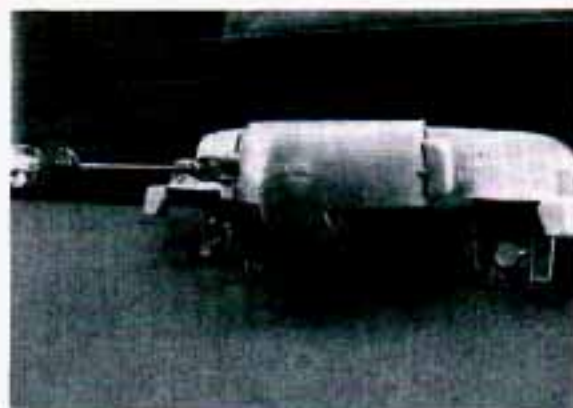

Center High-Mounted Stoplight

To remove the center high-mounted stoplight bulb:

1. Push the buttons in on both sides and remove the cover of the high-mounted stoplight housing.
2. Remove the screw from the stoplight housing.
3. Remove the stoplight housing assembly.



4. Turn the bulb to the left and pull it out.
5. Reverse the steps with a new bulb.



Tail/Stop/Turn Signal Lights

To remove the tail/stop/turn signal bulbs:

1. Open the trunk.
2. Remove the two bolts from the lens assembly.
3. Remove the trunk trim.
4. Remove the nut from the rear combination light assembly.

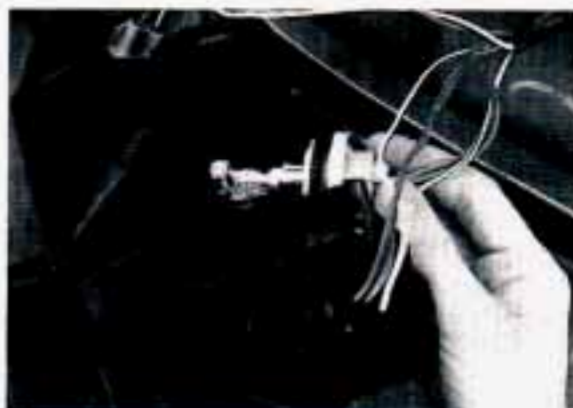

5. Remove the rear combination light assembly.
6. Turn the socket of the tail/stop/turn signal light to the left and pull it out.
7. Turn the bulb to the left and pull it out.
8. Reverse the steps with a new bulb.



License Plate Light

1. Pull the license plate light assembly out from the bumper.
2. Turn the bulb to the left and pull it out from the light assembly.
3. Reverse the steps with a new bulb.

Service & Appearance Care



Back-up Light

1. Open the trunk.
2. Remove the trunk trim (if your vehicle is so equipped).
3. Remove the screw from the back-up light.
4. Remove the bulb housing assembly.
5. Turn the bulb to the left and pull it out.
6. Reverse the steps with a new bulb.

Rear Sidemarker Lights

To replace the rear sidemarker bulb:

1. Open the trunk.
2. With a screwdriver, remove the six plastic studs from the paneling.
3. Turn the socket to the left and pull it out.
4. Pull the bulb out of the socket.
5. Reverse the steps with a new bulb.

GEO PRIZM	
VEHICLE CAPACITY WEIGHT (LBS)	
DESIGNATED SEATING CAPACITY TOTAL	
RECOMMENDED COLD TIRE INFLATION PRESSURE**	
VEHICLE LOAD UP TO VEHICLE CAPACITY*	
RECOMMEND**	
COMPACT RECOMMENDED TIRE SIZE	
RECOMMENDED COLD TIRE INFLATION PRESSURE PSI	
SEE OWNER'S MANUAL FOR ADDITIONAL INFORMATION	

■ Loading Your Vehicle

Two labels on your vehicle show how much weight it may properly carry. The Tire-Loading Information label found in the glove compartment tells you the proper size, speed rating and recommended inflation pressures for the tires on your vehicle. It also gives you important information about the number of people that can be in your vehicle and the total weight that you can carry. This weight is called the Vehicle Capacity Weight and includes the weight of all occupants, cargo, and all nonfactory-installed options.



The other label is the Certification label, found on the rear edge of the driver's door. It tells you the gross weight capacity of your vehicle, called the GVWR (Gross Vehicle Weight Rating). The GVWR includes the weight of the vehicle, all occupants, fuel and cargo. Never exceed the GVWR for your vehicle, or the Gross Axle Weight Rating (GAWR) for either the front or rear axle.

And, if you do have a heavy load, you should spread it out. Don't carry more than 125 pounds (56.7 kilograms) in your trunk.

CAUTION



Do not load your vehicle any heavier than the GVWR or the maximum front and rear GAWRs. If you do, parts on your vehicle can break, or it can change the way your vehicle handles. These could cause you to lose control. Also, overloading can shorten the life of your vehicle.

NOTICE

Your warranty does not cover parts or components that fail because of overloading.

If you put things inside your vehicle — like suitcases, tools, packages, or anything else — they will go as fast as the vehicle goes. If you have to stop or turn quickly, or if there is a crash, they'll keep going.

Service & Appearance Care

CAUTION



Things you put inside your vehicle can strike and injure people in a sudden stop or turn, or in a crash.

- Put things in the trunk of your vehicle. In a trunk, put them as far forward as you can. Try to spread the weight evenly.
- Never stack heavier things, like suitcases, inside the vehicle so that some of them are above the tops of the seats.
- When you carry something inside the vehicle, secure it whenever you can.
- Don't have a seat folded down unless you need to.

■ Tires

We don't make tires. Your new vehicle comes with high quality tires made by a leading tire manufacturer. These tires are warranted by the tire manufacturers and their warranties are delivered with every new Geo. If your spare tire is a different brand than your road tires, you will have a tire warranty folder from each of these manufacturers.

CAUTION



Poorly maintained and improperly used tires are dangerous.

- Overloading your tires can cause overheating as a result of too much friction. You could have an air-out and a serious accident. See "Loading Your Vehicle" in the Index.
- Underinflated tires pose the same danger as overloaded tires. The resulting accident could cause serious injury. Check all tires frequently to maintain the recommended pressure. Tire pressure should be checked when the tires are cold.
- Overinflated tires are more likely to be cut, punctured, or broken by sudden impact, such as when you hit a pothole. Keep tires at the recommended pressure.
- Worn, old tires can cause accidents. If your tread is badly worn, or if your tires have been damaged, replace them.

Inflation — Tire Pressure

The Tire-Loading Information label which is in the glove compartment shows the correct inflation pressures for your tires, when they're cold. "Cold" means your vehicle has been sitting for at least three hours or driven no more than a mile.

NOTICE

Don't let anyone tell you that underinflation or overinflation is all right. It's not. If your tires don't have enough air (underinflation) you can get:

- Too much flexing
- Too much heat
- Tire overloading
- Bad wear
- Bad handling
- Bad fuel economy.

If your tires have too much air (overinflation), you can get:

- Unusual wear
- Bad handling
- Rough ride
- Needless damage from road hazards.

When to Check: Check your tires once a month or more.

Don't forget your compact spare tire. It should be at 60 psi (420 kPa).

How to Check: Use a good quality pocket-type gage to check tire pressure. Simply looking at the tires will not tell you the pressure, especially if you have radial tires — which may look properly inflated even if they're underinflated.

If your tires have valve caps, be sure to put them back on. They help prevent leaks by keeping out dirt and moisture.

Service & Appearance Care

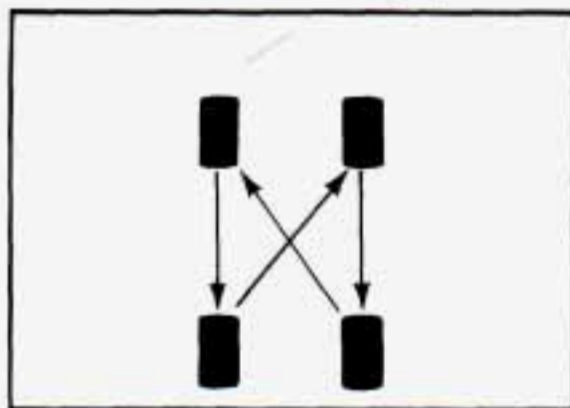

Tire Inspection and Rotation

To make your tires last longer, have them inspected and rotated at the mileages recommended in your Maintenance Schedule. See "Scheduled Maintenance Services" in the Index.

Use this rotation pattern.

After the tires have been rotated, adjust the front and rear inflation pressure as shown on the Tire-Loading Information label. Make certain that all wheel nuts are properly tightened. See "Wheel Nut Torque" in the Index.

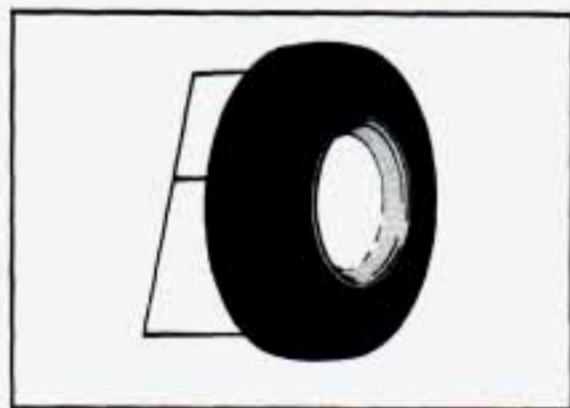

CAUTION

 Rust or dirt on a wheel, or on parts to which it is fastened, can make the wheel nuts become loose after a time. The wheel could come off and cause an accident. When you change a wheel, remove any rust or dirt from places where the wheel attaches to the vehicle. In an emergency, you can use a cloth or a paper towel to do this; but be sure to use a scraper or wire brush later, if you need to, to get all the rust or dirt off. (See "Changing a Flat Tire" in the Index.)

When It's Time for New Tires

One way to tell when it's time for new tires is to check the treadwear indicators, which will appear when your tires have only 2/32 inch (1.6 mm) or less of tread remaining.

You need a new tire if:

- You can see the indicators at three places around the tire.
- You can see cord or fabric showing through the tire's rubber.
- The tread or sidewall is cracked, cut or snagged deep enough to show cord or fabric.

- The tire has a bump, bulge or split.
- The tire has a puncture, cut, or other damage that can't be repaired well because of the size or location of the damage.

Buying New Tires

To find out what kind and size of tires you need, look at the Tire-Loading Information label.

Make sure the replacements are the same size, load range, speed rating and construction type (bias, bias-belted or radial) as your original tires.

CAUTION



Mixing tires could cause you to lose control while driving. If you mix tires of different sizes or types (radial and bias-belted tires), the vehicle may not handle properly, and you could have a crash. Be sure to use the same size and type tires on all wheels. It's all right to drive with your compact spare, though. It was developed for limited use on your vehicle.

Uniform Tire Quality Grading

The following information relates to the system developed by the United States

National Highway Traffic Safety Administration which grades tires by treadwear, traction and temperature performance. (This applies only to vehicles sold in the United States.)

Treadwear

The treadwear grade is a comparative rating based on the wear rate of the tire when tested under controlled conditions on a specified government test course. For example, a tire graded 150 would wear one and a half (1 1/2) times as well on the government course as a tire graded 100. The relative performance of tires depends upon the actual conditions of their use, however, and may depart significantly from the norm due to

Service & Appearance Care

variations in driving habits, service practices and differences in road characteristics and climate.

Traction — A, B, C

The traction grades, from highest to lowest are: A, B, and C. They represent the tire's ability to stop on wet pavement as measured under controlled conditions on specified government test surfaces of asphalt and concrete. A tire marked C may have poor traction performance.

Warning: The traction grade assigned to this tire is based on braking (straight-ahead) traction tests and does not include cornering (turning) traction.

Temperature — A, B, C

The temperature grades are A (the

highest), B, and C, representing the tire's resistance to the generation of heat and its ability to dissipate heat when tested under controlled conditions on a specified indoor laboratory test wheel. Sustained high temperature can cause the material of the tire to degenerate and reduce tire life, and excessive temperature can lead to sudden tire failure. The grade C corresponds to a level of performance which all passenger car tires must meet under the Federal Motor Vehicle Safety Standard No. 109. Grades B and A represent higher levels of performance on the laboratory test wheel than the minimum required by law.

Warning: The temperature grade for this

tire is established for a tire that is properly inflated and not overloaded. Excessive speed, underinflation, or excessive loading, either separately or in combination, can cause heat buildup and possible tire failure.

Those grades are molded on the sidewalls of passenger car tires.

While the tires available as standard or optional equipment on General Motors vehicles may vary with respect to these grades, all such tires meet General Motors performance standards and have been approved for use on General Motors vehicles. All passenger type (P Metric) tires must conform to Federal safety requirements in addition to these grades.

Wheel Alignment and Tire Balance

The wheels on your vehicle were aligned and balanced carefully at the factory to give you the longest tire life and best overall performance.

In most cases, you will not need to have your wheels aligned again. However, if you notice unusual tire wear or your vehicle pulling one way or the other, the alignment may need to be reset. If you notice your vehicle vibrating when driving on a smooth road, your wheels may need to be rebalanced.

Wheel Replacement

Replace any wheel that is bent, cracked or badly rusted. If wheel nuts keep coming loose, the wheel, wheel bolts,

and wheel nuts should be replaced. If the wheel leaks air, replace it (except some aluminum wheels, which can sometimes be repaired). See your Geo dealer if any of these conditions exist.

Your dealer will know the kind of wheel you need.

Each new wheel should have the same load carrying capacity, diameter, width, offset, and be mounted the same way as the one it replaces.

If you need to replace any of your wheels, wheel bolts, or wheel nuts, replace them only with new GM original equipment parts. This way, you will be sure you have the right wheel, wheel

bolts, and wheel nuts for your Geo model.

CAUTION



Using the wrong replacement wheels, wheel bolts, or wheel nuts on your vehicle can be dangerous. It could affect the braking and handling of your vehicle, make your tires lose air and make you lose control. You could have a collision in which you or others could be injured. Always use the correct wheel, wheel bolts, and wheel nuts for replacement.

Service & Appearance Care

NOTICE

The wrong wheel can also cause trouble in bearing life, brake cooling, speedometer/odometer calibration, headlight aim, bumper height, vehicle ground clearance, and tire or tire chain clearance to the body and chassis.

Used Replacement Wheels

CAUTION



Putting a used wheel on your vehicle is dangerous. You can't know how it's been used. It could fail suddenly and cause an accident. If you have to replace a wheel, use a **new GM original equipment wheel**.

Tire Chains

NOTICE

Use tire chains only when you must. Use only SAE Class "S" type chains that are the proper size for your tires. Install them on the front tires and tighten them as tightly as possible with the ends securely fastened. Drive slowly and follow the chain manufacturer's instructions. If you can hear the chains contacting your vehicle, stop and retighten them. If the contact continues, slow down until it stops. Driving too fast with chains on will damage your vehicle.



■ Appearance Care

CAUTION

 Cleaning products can be hazardous. Some are toxic. Others can burst into flame if you strike a match or get them on a hot part of the vehicle. Some are dangerous if you breathe their fumes in a closed space. When you use anything in a container to clean your Geo, be sure to follow the instructions. And always open your doors or windows when you're cleaning the inside.

Never use these to clean your vehicle:

- Gasoline
- Carbon Tetrachloride
- Turpentine
- Benzene
- Acetone
- Lacquer Thinner
- Naphtha
- Paint Thinner
- Nail Polish Remover

They can all be hazardous — some more than others — and they can all damage your vehicle, too.

NOTICE

Don't use any of these unless this manual says you can. In many uses, they will damage your vehicle:

- Laundry Soap
- Bleach
- Reducing Agents

Service & Appearance Care

Cleaning the Inside of Your Geo

Use a vacuum cleaner often to get rid of dust and loose dirt. Wipe vinyl with a clean, damp cloth.

Your Geo dealer has two GM cleaners — a solvent-type spot lifter and a foam-type powdered cleaner. They will clean normal spots and stains very well.

Here are some cleaning tips:

- Always read the instructions on the cleaner label.
- Clean up stains as soon as you can — before they set.
- Use a clean cloth or sponge, and change to a clean area often. A soft brush may be used if stains are stubborn.

- Use solvent-type cleaners in a well-ventilated area only. If you use them, don't saturate the stained area.
- If a ring forms after spot cleaning, clean the entire area immediately or it will set.

Using Foam-Type Cleaner on Fabric

- Vacuum and brush the area to remove any loose dirt.
- Always clean a whole trim panel or section. Mask surrounding trim along stitch or welt lines.
- Mix Multi-Purpose Powdered Cleaner following the directions on the container label.

- Use suds only and apply with a clean sponge.
- Don't saturate the material.
- Don't rub it roughly.
- As soon as you've cleaned the section, use a sponge to remove the suds.
- Rinse the section with a clean, wet sponge.
- Wipe off what's left with a slightly damp paper towel or cloth.
- Then dry it immediately with an air hose, a hair dryer or a heat lamp.

NOTICE

Be careful with a hair dryer or heat lamp. You could scorch the fabric.

- Wipe with a clean cloth.

Using Solvent-Type Cleaner on Fabric

First, see if you have to use solvent-type cleaner at all. Some spots and stains will clean off better with just water and mild soap.

If you need to use it, then:

- Gently scrape excess soil from the trim material with a clean, dull knife or scraper. Use very little cleaner, light pressure and clean cloths (preferably cheesecloth). Cleaning should start at the outside of the stain, "feathering" toward the center. Keep changing to a clean section of the cloth.
- When you clean a stain from fabric, immediately dry the area with an air hose, hair dryer, or heat lamp to help prevent a cleaning ring. (See previous NOTICE.)

Fabric Protection

Your Geo has upholstery that has been treated with Scotchgard™ Fabric Protector, a 3M product. Scotchgard™ protects fabrics by repelling oil and water, which are the carriers of most stains. Even with this protection, you still need to clean your upholstery often to keep it looking new.

Further information on cleaning is available on 1-800-433-3296 (in Minnesota, 1-800-642-6167).

Service & Appearance Care

Special Cleaning Problems

Greasy or oily stains: Like grease, oil, butter, margarine, shoe polish, coffee with cream, chewing gum, cosmetic creams, vegetable oils, wax crayon, tar and asphalt.

- Carefully scrape off excess stain.
- Then follow the solvent-type instructions above.
- Shoe polish, wax crayons, tar and asphalt will stain if left on a vehicle seat fabric. They should be removed as soon as possible. Be careful, because the cleaner will dissolve them and may cause them to bleed.

Non-greasy stains: Like catsup, coffee (black), egg, fruit, fruit juice, milk, soft drinks, wine, vomit, urine and blood.

- Carefully scrape off excess stain, then sponge the soiled area with cool water.
- If a stain remains, follow the foam-type instructions above.
- If an odor lingers after cleaning vomit or urine, treat the area with a water/baking soda solution: 1 teaspoon (5 ml) of baking soda to 1 cup (250 ml) of lukewarm water.
- Finally, if needed, clean lightly with solvent-type cleaner.

Combination stains: Like candy, ice cream, mayonnaise, chili sauce and unknown stains.

- Carefully scrape off excess stain, then clean with cool water and allow to dry.
- If a stain remains, clean it with solvent-type cleaner.

Cleaning Vinyl or Leather

Just use warm water and a clean cloth.

- Rub with a clean, damp cloth to remove dirt. You may have to do it more than once.

- Things like tar, asphalt and shoe polish will stain if you don't get them off quickly. Use a clean cloth and solvent-type vinyl/leather cleaner.

Cleaning the Top of the Instrument Panel

Use only mild soap and water to clean the top surfaces of the instrument panel. Sprays containing silicones or waxes may cause annoying reflections in the windshield and even make it difficult to see through the windshield under certain conditions.

Care of Safety Belts

Keep belts clean and dry.

CAUTION



Do not bleach or dye safety belts. If you do, it may severely weaken them. In a crash they might not be able to provide adequate protection. Clean safety belts only with mild soap and lukewarm water.

Glass

Glass should be cleaned often. GM Glass Cleaner (GM Part No. 1050427) or a liquid household glass cleaner will remove normal tobacco smoke and dust films.

Don't use abrasive cleaners on glass, because they may cause scratches. Avoid placing decals on the inside rear window, since they may have to be scraped off later. If abrasive cleaners are used on the inside of the rear window, an electric defogger element may be damaged. Any temporary license should not be attached across the defogger grid.

Service & Appearance Care

Cleaning the Outside of the Windshield and Wiper Blades

If the windshield is not clear after using the windshield washer, or if the wiper blade chatters when running, wax or other material may be on the blade or windshield.

Clean the outside of the windshield with GM Windshield Cleaner, Bon-Ami Powder* (GM Part No. 1050011). The windshield is clean if beads do not form when you rinse it with water.

Clean the blade by wiping vigorously with a cloth soaked in full strength windshield washer solvent. Then rinse the blade with water.

Wiper blades should be checked on a regular basis and replaced when worn.

Cleaning the Outside of Your Geo

The paint finish on your vehicle provides beauty, depth of color, gloss retention and durability.

Washing Your Vehicle

The best way to preserve your vehicle's finish is to keep it clean by washing it often with lukewarm or cold water.

Don't wash your vehicle in the direct rays of the sun. Don't use strong soaps or chemical detergents. Use liquid hand, dish or car washing (non-detergent) soaps. Don't use cleaning agents that contain acid or abrasives. All cleaning agents should be flushed promptly and not allowed to dry on the surface, or they could stain. Dry the finish with a

soft, clean chamois or a 100% cotton towel to avoid surface scratches and water spotting.

High pressure car washes may cause water to enter your vehicle.

Finish Care

Occasional waxing or mild polishing of your Geo may be necessary to remove residue from the paint finish. You can get GM approved cleaning products from your dealer. (See "Appearance Care and Maintenance Materials" in the Index.)

Your Geo has a "basecoat/clearcoat" paint finish. The clearcoat gives more depth and gloss to the colored basecoat.

NOTICE

Machine compounding or aggressive polishing on a basecoat/clearcoat paint finish may dull the finish or leave swirl marks.

Aluminum Wheels (If So Equipped)

Your aluminum wheels have a protective coating similar to the painted surface of your vehicle. Don't use strong soaps, chemicals, chrome polish or other abrasive cleaners on them because you could damage this coating. After rinsing thoroughly, a wax may be applied.

NOTICE

If you have aluminum wheels, don't use an automatic car wash that has hard silicon carbide cleaning brushes. These brushes can take off the protective coating.

Weatherstrips

These are places where glass or metal meets rubber. Silicone grease there will make them last longer, seal better, and not squeak. Apply silicone grease with a clean cloth at least every six months.

Sheet Metal Damage

If your vehicle is damaged and requires sheet metal repair or replacement, make sure the body repair shop applies anti-corrosion material to the parts repaired or replaced to restore corrosion protection.

Foreign Material

Calcium chloride and other salts, ice melting agents, road oil and tar, tree sap, bird droppings, chemicals from industrial chimneys, and other foreign matter can damage your vehicle's finish if they remain on painted surfaces. Use cleaners that are marked safe for painted surfaces for these stains.

Service & Appearance Care

Finish Damage

Any stone chips, fractures or deep scratches in the finish should be repaired right away. Bare metal will corrode quickly and may develop into a major repair expense.

Minor chips and scratches can be repaired with touch-up materials available from your dealer or other service outlets. Larger areas of finish damage can be corrected in your dealer's body and paint shop.

Underbody Maintenance

Chemicals used for ice and snow removal and dust control can collect on the underbody. If these are not removed, accelerated corrosion (rust) can occur on the underbody parts such as fuel lines, frame, floor pan, and exhaust system even though they have corrosion protection.

At least every spring, flush these materials from the underbody with plain water. Clean any areas where mud and other debris can collect. Dirt packed in closed areas of the frame should be loosened before being flushed. Your dealer or an underbody vehicle washing system can do this for you.

Chemical Paint Spotting

Some weather and atmospheric conditions can create a chemical fallout. Airborne pollutants can fall upon and attack painted surfaces on your vehicle. This damage can take two forms: blotchy, ringlet-shaped discolorations, and small irregular dark spots etched into the paint surface.

Although no defect in the paint job causes this, Geo will repair, at no charge to the owner, the surfaces of new vehicles damaged by this fallout condition within 12 months or 12,000 miles (20 000 km) of purchase, whichever comes first.

■ Appearance Care and Maintenance Materials

PART NUMBER	SIZE	DESCRIPTION	USAGE
1051516	32 oz. (0.946 L)	Washer Solvent and Gas Line De-Icer	Windshield washing system and gas line
1050172	16 oz. (0.473 L)	Tar and Road Oil Remover	Also old waxes, polishes
1050173	16 oz. (0.473 L)	Chrome Cleaner and Polish	Removes rust and corrosion on chrome and steel
1050174	16 oz. (0.473 L)	White Sidewall Tire Cleaner	Cleans white and black tires
1050214	32 oz. (0.946 L)	Vinyl/Leather Cleaner*	Spot and stain removal on leather and vinyl
1050244	16 oz. (0.473 L)	Fabric Cleaner*	Spot and stain removal on cloth and fabric
1050427	24 oz. (0.680 L)	Glass Cleaner	Glass cleaning and spot cleaning on vinyls
1050429	6 lb. (2.72 kg)	Multi-Purpose Powdered Cleaner	Vinyl, cloth, door trims, seats, carpet, tires, mats
1052349	12 oz. (0.340 kg)	Lubriplate	Spray lubricant for hood, trunk, door hinges, latches
1052870	16 oz. (0.473 L)	Wash-Wax (Concentrated)	Exterior wash
12345579	1 oz. (0.028 kg)	Dielectric Silicone Grease	Weatherstrips
1051398	8 oz. (0.237 L)	Spot Lifter*	Spot and stain removal on cloth and fabric
1051515	32 oz. (0.946 L)	GM Optikleen®	Windshield washer solvent and antifreeze
1050201	16 oz. (0.473 L)	Magic Mirror Cleaner-Polish	Exterior cleaner and polish
1051855	32 oz. (0.946 L)	DEXRON®-II	Automatic transaxle and power steering fluid
12345120	9 oz. (0.262 L)	Multi-Purpose Lubricant	Key-lock cylinders
1052753	1 gal. (3.785 L)	Permanent Type Anti-Freeze Coolant	Year-round coolant and antifreeze
1052497	14 oz. (0.397 kg)	Grease	Chassis lubricant
1051344	1 lb. (0.453 kg)	Grease (NLGI Grade 2, Category GC-LB)	Wheel bearings
1052535	16 oz. (0.473 L)	Delco-Supreme 11® Brake Fluid	Brake fluid
1052367	16 oz. (0.473 L)	GM Engine Oil Supplement (E.O.S.)	See your dealer for specific usage
1052271	23 oz. (0.680 L)	Manual Transaxle Fluid	Manual transaxles
1050011	12 oz. (0.340 kg)	Bon-Ami Powder®	Windshield cleaner

*Not recommended for pigskin suede leather.

See your General Motors Dealers for these products. See your Maintenance Schedule for other products.

Service & Appearance Care



■ *Vehicle Identification Number (VIN)*

This is the legal identifier for your Geo. It appears on a plate in the front corner of the instrument panel, on the driver's side. You can see it if you look through the windshield from outside your vehicle. The VIN also appears on the Vehicle Certification and Service Parts labels and the certificates of title and registration.

Engine Identification

The eighth character in your VIN is the engine code for your GM engine. This code will help you identify your engine, specifications; and replacement parts in this section.

■ *Service Parts Identification Label*

You'll find this label on your spare tire cover. It's very helpful if you ever need to order parts. On this label is:

- Your VIN.
- Its model designation.
- Paint information.
- A list of all production options and special equipment.

Be sure that this label is not removed from the vehicle.

■ *Add-On Electrical Equipment*

NOTICE

Don't add anything electrical to your Geo unless you check with your dealer first. Some electrical equipment can damage your vehicle and the damage wouldn't be covered by your warranty. Some of it can just keep other things from working as they should.

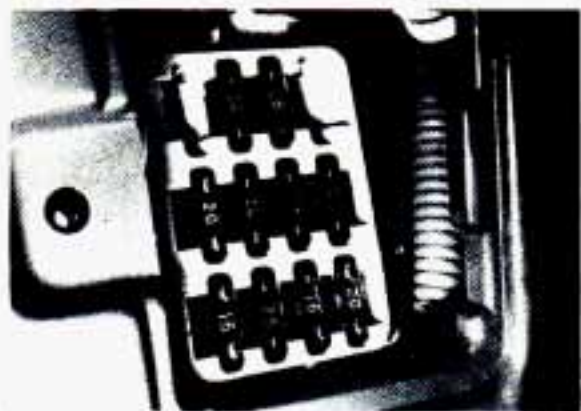

■ *Fuses and Circuit Breakers*

The wiring circuits in your vehicle are protected from short circuits by a combination of fuses, circuit breakers, and fusible thermal links in the wiring itself. This greatly reduces the chance of fires caused by electrical problems.

Your fuse block is beneath the instrument panel near the driver's door. Pull out the panel marked **FUSES** to display the fuse block.

Most of your fuses are in the fuse block. Some are in two electrical centers in your engine compartment. These electrical centers, plus a component

center behind your glove box, also have relays, circuit breakers and other electrical components.

Look at the silver-colored band inside the fuse. If the band is broken or melted, replace the fuse. Be sure you replace a bad fuse with a new one of the correct size.

If you ever have a problem on the road and don't have a spare fuse, you can borrow one. Just pick some feature of your car that you can get along without — like the radio or cigarette lighter — and use its fuse, if it is of the value you need. Replace it as soon as you can.

Headlights

The headlight wiring is protected by a circuit breaker. An electrical overload will cause the lights to go on and off, or in some cases to remain off. If this happens, have your headlight wiring checked right away.

Windshield Wipers

The windshield wiper motor is protected by a circuit breaker and a fuse. If the motor overheats due to heavy snow, etc., the wiper will stop until the motor cools. If the overload is caused by some electrical problem and not snow, etc., be sure to get it fixed.

Service & Appearance Care

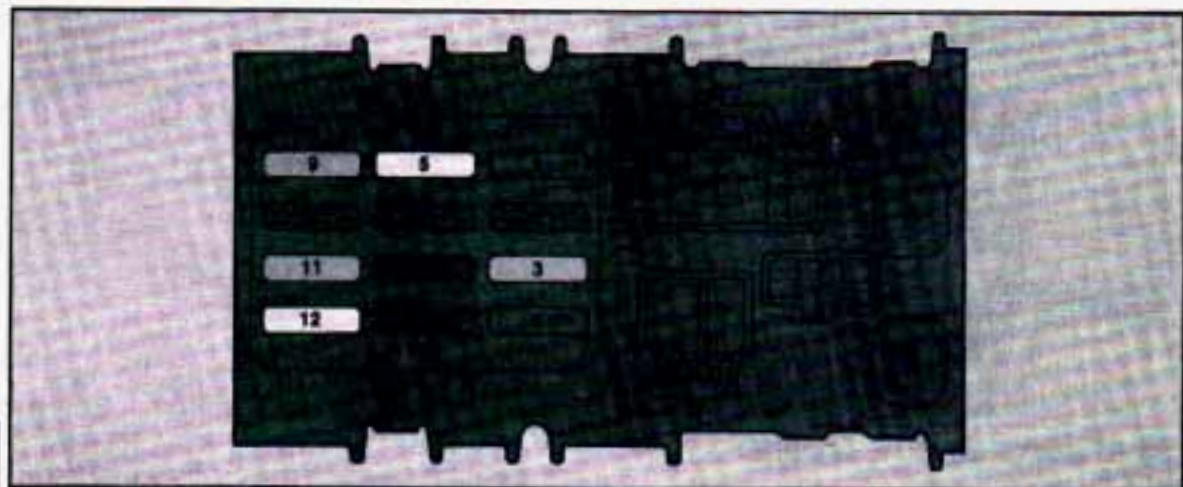

Power Windows and Other Power Options

Circuit breakers protect the power windows and other power accessories. When the current load is too heavy, the circuit breaker opens and closes, protecting the circuit until the problem is fixed or goes away.

Fuse Block

Driver's Side Instrument Panel

- 1—Not Used
- 2—Ignition (10 Amp.)
- 3—Stop (15 Amp.)
- 4—Not Used
- 5—Cigarette Lighter and Radio (20 Amp.)
- 6—ECU-B (10 Amp.)

- 7—Turn Signal (7.5 Amp.)
- 8—Gage (10 Amp.)
- 9—Taillight (15 Amp.)
- 10—Defogger - I/UP (7.5 Amp.)
- 11—ECU-IG (15 Amp.)
- 12—Wiper (20 Amp.)
- A—Power (30 Amp.)
- B—Defroster (30 Amp.)

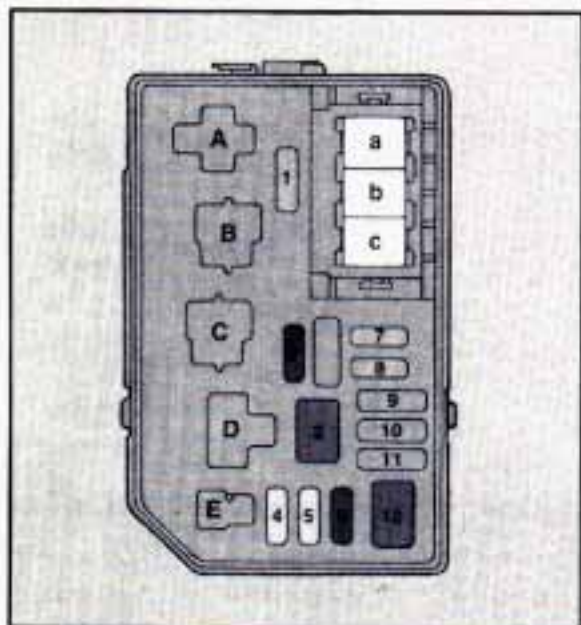

Engine Compartment

- 1—Electronic Fuel Injection (15 Amp.)
- 2—Alternator-S (7.5 Amp.)
- 3—Fan (30 Amp.)
- 4—Dome Light (20 Amp.)
- 5—Hazard Warning Flashers;
Horn (20 Amp.)
- 6—Fan - I/UP (7.5 Amp.)
- 7—Left Head (15 Amp.)
- 8—Right Head (15 Amp.)

- 9—Not Used
- 10—Not Used
- 11—Not Used
- 12—AM2 (30 Amp.)
- a—Anti-Lock Brake System (50 Amp.)
- b—Alternator (100 Amp.)
- c—AM1 (40 Amp.)
- A—Electronic Fuel Injection Relay
- B—Headlight Relay
- C—E/G Main Relay
- D—Fan Relay #1
- E—Horn Relay

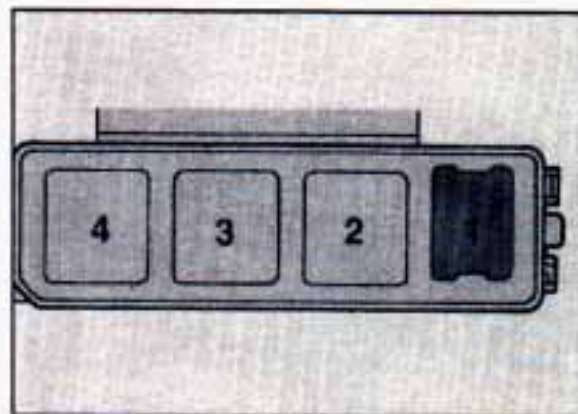

Engine Compartment Relay Block

- 1—CDS (30 Amp.)
- 2—Air Conditioner Fan Relay #2
- 3—Air Conditioner Fan Relay #3
- 4—Air Conditioner MG Relay

Service & Appearance Care

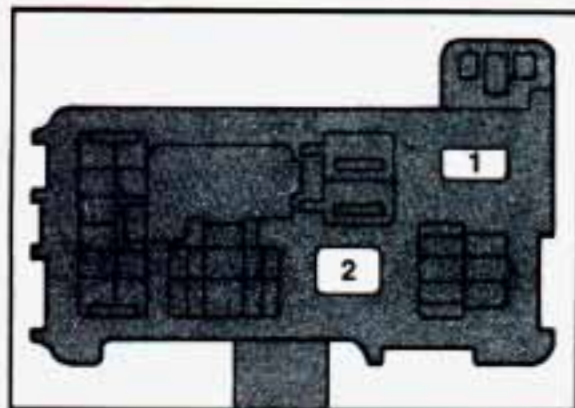

Passenger Side Kick Panel

- 1—Air Conditioner (15 Amp.)
- 2—Heater (40 Amp.)

■ Replacement Bulbs

Automatic Transaxle	158
Back-Up Light	1156
Headlight	
High Beam	9005
Low Beam	9006
Heater or Air Conditioner Control	74
High-Mounted Stoplight	1156
Indicator Lights	
ABS Active	PC745
Air Bag	PC745
Brake	74
Check Engine	74
Cruise	PC745
Fasten Belts	74
Headlight High Beam	74
Oil Pressure	74
Rear Defogger	74
Stop Lamp	74
Turn Signal	74
Volts (Battery)	74
Instrument Cluster	158/74
License Plate Light	—
Parking Light	194
Sidemarker	
Front	194
Rear	168
Taillight/Stoplight	2057
Turn Signal Light	2057

■ Capacities and Specifications

Engine

Type.....	L4
Compression Ratio.....	9.5:1
Firing Order.....	1-3-4-2
Fuel Delivery.....	Fuel Injection
Piston Displacement	
VIN Engine Code 6.....	97 CID (1.6L)
VIN Engine Code 8.....	108 CID (1.8L)
Valve Arrangement.....	Double Overhead Cam
Thermostat Temperature Specification.....	180°F (82°C)

Replacement Parts

Air Cleaner Filter.....	A1164C
Battery.....	22F-60
Engine Oil Filter.....	GM Part No. 94842810
Spark Plug.....	GM Part No. 94853696

Wheel Nuts

Wheel Nut Torque.....	76 pound-feet (103 N·m)
-----------------------	-------------------------

Service & Appearance Care

Capacities (Approximate)

The following approximate capacities are given in U.S. and metric conversions.

Air Conditioning† See the refrigerant information label under hood.

Automatic Transaxle

3-Speed 5.8 qt. (5.5L)**

4-Speed 7.4 qt. (7.0L)**

Cooling System

Manual Transaxle 6.0 qt. (5.6L)

Automatic Transaxle

3-Speed 5.8 qt. (5.5L)

4-Speed 6.1 qt. (5.8L)

Crankcase

VIN Engine Code 6

Oil Change With Filter 3.9 qt. (3.7L)*

Oil Change Without Filter 3.6 qt. (3.4L)*

VIN Engine Code 8

Oil Change With Filter 3.4 qt. (3.2L)*

Oil Change Without Filter 3.2 qt. (3.0L)*

Fuel Tank 13.2 gal. (50.0L)

Manual Transaxle 2.7 qt. (2.6L)**

†Not all air conditioning refrigerants are the same. If the air conditioning system in your vehicle needs refrigerant, be sure the proper refrigerant is used. If you're not sure ask your Geo dealer.

*When changing the oil filter, additional oil may be needed. Recheck the oil level after filling. See "Engine Oil" in the Index.

**Recheck fluid level after filling. See "Automatic Transaxle Fluid" or "Manual Transaxle Fluid" in the Index.

Vehicle Dimensions

Wheelbase97.1" (2 430 mm)
Tread	
Front57.5" (1 460 mm)
Rear57.1" (1 450 mm)
Length173.0" (4 395 mm)
Width66.3" (1 685 mm)
Height54.1" (1 375 mm)

Notes

Maintenance Schedule

**IMPORTANT
KEEP ENGINE OIL
AT THE PROPER
LEVEL AND CHANGE AS
RECOMMENDED**

This part covers the maintenance required for your Geo. Your vehicle needs these services to retain its safety, dependability and emission control performance.

Section

Introduction: A Word about Maintenance	268
Your Vehicle and the Environment	268
How This Part Is Organized	269
A. Scheduled Maintenance Services	271
Using Your Maintenance Schedules	271
Selecting the Right Schedule	271
Schedule I	272
Schedule II	274
Explanation of Scheduled Maintenance Services	276
B. Owner Checks and Services	280
At Each Fuel Fill	280
At Least Once a Month	281
At Least Twice a Year	281
At Least Once a Year	282
C. Periodic Maintenance Inspections	285
Additional Service Center Inspection	287
D. Recommended Fluids and Lubricants	288
E. Maintenance Record	290



**Protection
Plan**

Have you purchased the GM Protection Plan? The Plan supplements your new car warranties. See your GM dealer for details.

Maintenance Schedule

Introduction: A Word about Maintenance

We at General Motors want to help you keep your vehicle in good working condition. But we don't know exactly how you'll drive it. You may drive very short distances only a few times a week. Or you may drive long distances all the time in very hot, dusty weather. You may use your vehicle in making deliveries. Or you may drive it to work, to do errands, or in many other ways.

Because of all the different ways people use their GM vehicles, maintenance needs vary. You may even need more frequent checks and replacements than you will find in the schedules in this part. So please read this part and note how you drive. If you have any questions on how to keep your vehicle in good condition, see your Geo dealer, the place many GM owners choose to have their maintenance work done. Your dealer can be relied upon to use proper parts and practices.

Your Vehicle and the Environment

Proper vehicle maintenance not only helps keep your vehicle in good working condition, but it also helps the environment. All recommended maintenance procedures are important. Improper vehicle maintenance or the removal of important components, can significantly affect the quality of the air we breathe. Improper fluid levels or even the wrong tire inflation can increase the level of emissions from your vehicle. To help protect our environment, and to help keep your vehicle in good condition, please maintain your vehicle properly.

How This Part Is Organized

The remainder of this part is divided into five sections:

“Section A: Scheduled Maintenance Services” shows what to have done, and how often. Some of these services can be complex, so unless you are technically qualified and have the necessary equipment, you should let your dealer’s service department or another qualified service center do these jobs.

CAUTION



Performing maintenance work on a vehicle can be dangerous. In trying to do some jobs, you can be seriously injured. Do your own maintenance work only if you have the required know-how and the proper tools and equipment for the job. If you have any doubt, have a qualified technician do the work.

If you are skilled enough to do some work on your vehicle, you will probably want to get the service information GM publishes. You will find a list of publications and how to get them in this manual. See “Service Publications” in the Index.

“Section B: Owner Checks and Services” tells you what should be checked whenever you stop for fuel. It also explains what you can easily do to help keep your vehicle in good condition.

Maintenance Schedule

Introduction: A Word about Maintenance (Cont.)

“Section C: Periodic Maintenance Inspections” explains important inspections that your Geo dealer’s service department or another qualified service center should perform.

“Section D: Recommended Fluids and Lubricants” lists some products GM recommends to help keep your vehicle properly maintained. These products, or their equivalents, should be used whether you do the work yourself or have it done.

“Section E: Maintenance Record” provides a place for you to record the maintenance performed on your vehicle. Whenever any maintenance is performed, be sure to write it down in this section. This will help you determine when your next maintenance should be done. In addition, it is a good idea to keep your maintenance receipts. They may be needed to qualify your vehicle for warranty repairs.

Maintenance Schedule

Section A: Scheduled Maintenance Services

Using Your Maintenance Schedules

This section tells you the maintenance services you should have done and when you should schedule them. Your Geo dealer knows your vehicle best and wants you to be happy with it. If you go to your dealer for your service needs, you'll know that GM-trained and supported service people will perform the work using genuine GM parts.

These schedules are for vehicles that:

- carry passengers and cargo within recommended limits. You will find these limits on your vehicle's Tire-Loading Information label. See "Loading Your Vehicle" in the Index.
- are driven on reasonable road surfaces within legal driving limits.
- use the recommended unleaded fuel. See "Fuel" in the Index.

Selecting the Right Schedule

First you'll need to decide which of the two schedules is right for your vehicle. Here's how to decide which schedule to follow:

Schedule I

Is any one of these true for your vehicle?

- Most trips are less than 4 miles (6 km).
- Most trips are less than 10 miles (16 km) when outside temperatures are below freezing.
- The engine is at low speed most of the time (as in door-to-door delivery, or in stop-and-go traffic).
- You operate your vehicle in dusty areas.
- You tow a trailer.

If any one (or more) of these is true for your driving, follow Schedule I.

Schedule II

Follow Schedule II **only** if none of the above conditions is true.

Maintenance Schedule

Section A: Scheduled Maintenance Services (Cont.)

Schedule I

Follow Schedule I if your vehicle is **MAINLY** driven under one or more of the following conditions:

- When most trips are less than 4 miles (6 km).
- When most trips are less than 10 miles (16 km) and outside temperatures remain below freezing.
- When most trips include extended idling and/or frequent low-speed operation, as in stop-and-go traffic.
- When towing a trailer.
- When operating in dusty areas.

Schedule I should also be followed if the vehicle is used for delivery service, police, taxi or other commercial applications.

*An Emission Control Service.

‡The U.S. Environmental Protection Agency has determined that the failure to perform this maintenance item will not nullify the emission warranty or limit recall liability prior to the completion of vehicle useful life. General Motors, however, urges that all recommended maintenance services be performed at the indicated intervals and the maintenance be recorded in "Section E: Maintenance Record."

ITEM NO.	TO BE SERVICED <i>See "Explanation of Scheduled Maintenance Services" following Schedules I and II.</i>	WHEN TO PERFORM <i>Miles (kilometers) or Months (whichever occurs first).</i>
1	Engine Oil & Oil Filter Change*	Every 3,750 Miles (6,250 km) or 6 Months.
2	Chassis Lubrication	See "Explanation of Scheduled Maintenance Services" following Schedules I and II.
3	Tire & Wheel Rotation & Inspection	Every 7,500 Miles (12,500 km).
4	Engine Accessory Drive Belts Inspection*	At 60,000 Miles (100,000 km) or 36 Months and then every 7,500 Miles (12,500 km) or 12 Months.
5	Cooling System Service*	At 45,000 Miles (75,000 km) or 36 Months and then every 30,000 Miles (50,000 km) or 24 Months.
6	Transaxle Service	See "Explanation of Scheduled Maintenance Services" following Schedules I and II.
7	Spark Plug Replacement* (Engine VIN Code 6)	Every 30,000 Miles (50,000 km) or 36 Months.
	Spark Plug Replacement* (Engine VIN Code 5)	Every 60,000 Miles (100,000 km) or 72 Months.
8	Air Cleaner Filter Service*	See "Explanation of Scheduled Maintenance Service" following Schedules I and II.
9	Fuel Tank Cap Gasket Replacement*	Every 60,000 Miles (100,000 km) or 72 Months.
10	Fuel Lines & Connection Inspection*‡	Every 30,000 Miles (50,000 km) or 36 Months.
11	Exhaust Pipes System Inspection*	Every 15,000 Miles (25,000 km) or 24 Months.
12	Charcoal Canister Inspection*	Every 60,000 Miles (100,000 km) or 72 Months.
13	Engine Idle Speed Adjustment*	At 7,500 Miles (12,500 km) or 12 Months, 15,000 Miles (25,000 km) or 24 Months, and then every 15,000 Miles (25,000 km) or 24 Months.
14	Valve Clearance Adjustment*	Every 60,000 Miles (100,000 km) or 72 Months.
15	Engine Timing Belt Replacement	See "Explanation of Scheduled Maintenance Services" following Schedules I and II.

The services shown in this schedule up to 60,000 miles (100 000 km) should be performed after 60,000 miles (100 000 km) at the same intervals unless specified otherwise.

MILES

3,750 | 7,500 | 11,250 | 15,000 | 18,750 | 22,500 | 26,250 | 30,000 | 33,750 | 37,500 | 41,250 | 45,000 | 48,750 | 52,500 | 56,250 | 60,000

KILOMETERS

6 250 | 12 500 | 18 750 | 25 000 | 31 250 | 37 500 | 43 750 | 50 000 | 56 250 | 62 500 | 68 750 | 75 000 | 81 250 | 87 500 | 93 750 | 100 000

Maintenance Schedule

Section A: Scheduled Maintenance Services (Cont.)

Schedule II

Follow Schedule II ONLY if none of the driving conditions specified in Schedule I apply.

*An Emission Control Service.

‡The U.S. Environmental Protection Agency has determined that the failure to perform this maintenance item will not nullify the emission warranty or limit recall liability prior to the completion of vehicle useful life. General Motors, however, urges that all recommended maintenance services be performed at the indicated intervals and the maintenance be recorded in "Section E: Maintenance Record".

ITEM NO.	TO BE SERVICED <i>See "Explanation of Scheduled Maintenance Services" following Schedules I and II.</i>	WHEN TO PERFORM <i>Miles (kilometers) or Months (whichever occurs first).</i>
1	Engine Oil & Oil Filter Change*	Every 7,500 Miles (12 500 km) or 12 Months.
2	Chassis Lubrication	See "Explanation of Scheduled Maintenance Services" following Schedules I and II.
3	Tire & Wheel Rotation & Inspection	Every 7,500 Miles (12 500 km).
4	Engine Accessory Drive Belts Inspection*	At 60,000 Miles (100 000 km) or 36 Months and then every 7,500 Miles (12 500 km) or 12 Months.
5	Cooling System Service*	At 45,000 Miles (75 000 km) or 36 Months, and then every 30,000 Miles (50 000 km) or 24 Months.
6	Transaxle Service	See "Explanation of Scheduled Maintenance Services" following Schedules I and II.
7	Spark Plug Replacement* (Engine VIN Code 6)	Every 30,000 Miles (50 000 km) or 36 Months.
	Spark Plug Replacement* (Engine VIN Code 5)	Every 60,000 Miles (100 000 km) or 72 Months.
8	Air Cleaner Filter Service*	See "Explanation of Scheduled Maintenance Services" following Schedules I and II.
9	Fuel Tank Cap Gasket Replacement*	Every 60,000 Miles (100 000 km) or 72 Months.
10	Fuel Lines & Connection Inspection*‡	Every 30,000 Miles (50 000 km) or 36 Months.
11	Exhaust Pipes System Inspection*	
12	Charcoal Canister Inspection*	Every 60,000 Miles (100 000 km) or 72 Months.
13	Engine Idle Speed Adjustment*	At 7,500 Miles (12 500 km) or 12 Months, 15,000 Miles (25 000 km) or 24 Months, and then every 15,000 Miles (25 000 km) or 24 Months.
14	Valve Clearance Adjustment*	Every 60,000 Miles (100 000 km) or 72 Months.

The services shown in this schedule up to 75,000 miles (125 000 km) should be performed after 75,000 miles (125 000 km) at the same intervals unless specified otherwise.

MILES

7,500	15,000	22,500	30,000	37,500	45,000	52,500	60,000	67,500	75,000
KILOMETERS									
12 500	25 000	37 500	50 000	62 500	75 000	87 500	100 000	112 500	125 000
.
.
							.	.	.
					.				.
			.				.		
							.		
			.				.		
			.				.		
			.				.		
.
							.		

Maintenance Schedule

Section A: Scheduled Maintenance Services (Cont.)

Explanation of Scheduled Maintenance Services

Below are explanations of the services listed in Schedule I and Schedule II.

The proper fluids and lubricants to use are listed in Section D. Make sure whoever services your vehicle uses these. All

parts should be replaced and all necessary repairs done before you or anyone else drives the vehicle.

NOTE: To determine your engine's displacement and code, see "Engine Identification" in the Index.

ITEM NO. SERVICE

- 1 Engine Oil and Oil Filter Change*** — Always use SG Energy Conserving II Oils of proper viscosity. The SG designation may be shown alone or in combination with others, such as SG/CC, SG/CD, or SF, SG, CC, etc. To determine the preferred viscosity for your vehicle's engine (e.g., SAE 5W-30 or 10W-30) see "Engine Oil" in the Index.
- 2 Chassis Lubrication** — Lubricate the transaxle shift linkage, parking brake cable guides, underbody contact points and linkage. Every 7,500 miles (12 500 km) for Schedule I or 15,000 miles (25 000 km) for Schedule II conditions, inspect brake linings, drums, discs and pads for scoring, burning, runout and excessive wear. With the vehicle stopped, check for excessive free play in the steering wheel. Check for looseness or bends in the

ITEM NO. SERVICE

steering linkage or damage to the steering linkage ball joints. Check all dust boots and covers for deterioration, cracks, grease leaks or damage, including drive shaft boots. Check for any leaking fluids. Replace all damaged parts and, if necessary, repack the grease. Where necessary, retighten any loose chassis or body nuts and bolts to the specified torque.

Every 15,000 miles (25 000 km) inspect brake lines and hoses for proper installation, chafing, cracks, deterioration or leaks. Replace any deteriorated or damaged parts immediately. Inspect the transaxle, differential and steering gear for leaks. Repair all leaks. Add fluid as required to the proper level. See "Brake Fluid" in the Index.

*An Emission Control Service.

**ITEM
NO. SERVICE**

- 3 Tire and Wheel Rotation and Inspection** — For proper wear and maximum tire life, rotate your tires following the instructions in this manual. See “Tires, Inspection and Rotation” in the Index. Check the tires for uneven wear or damage. If you see irregular or premature wear, check the wheel alignment. Check for damaged wheels also.
- 4 Engine Accessory Drive Belts Inspection*** — Inspect the drive belts for cracks, excessive wear or oiliness. Replace any damaged belts. Check the belt tension and adjust as necessary.
- 5 Cooling System Service*** — Drain, flush and refill the system with new or approved recycled coolant conforming to GM Specification 1825M. Keep coolant at the proper mixture as specified. See “Coolant” in the Index. This provides proper freeze

**An Emission Control Service.*

**ITEM
NO. SERVICE**

- protection, corrosion inhibitor level and engine operating temperature.
- Inspect hoses and replace if they are cracked, swollen or deteriorated. Tighten screw-type hose clamps. Clean the outside of the radiator and air conditioning condenser. Wash the pressure cap and neck.
- To help ensure proper operation, we recommend a pressure test of both the cooling system and the pressure cap.
- 6 Transaxle Service** — For manual transaxles, the fluid doesn't require changing.
- For automatic transaxles, change the fluid in the transaxle and differential (3-speed automatic only) every 15,000 miles (25 000 km) if the vehicle is

Maintenance Schedule

Section A: Scheduled Maintenance Services (Cont.)

ITEM NO. SERVICE

is mainly driven under one or more of these conditions:

- In heavy city traffic where the outside temperature regularly reaches 90°F (32°C) or higher.
- In hilly or mountainous terrain.
- When doing frequent trailer towing.
- Uses such as found in taxi, police car, or delivery service.

If you do not use your vehicle under any of these conditions, change the fluid every 100,000 miles (160 000 km).

**An Emission Control Service.*

ITEM NO. SERVICE

- 7 Spark Plug Replacement*** — Replace spark plugs with the proper type. See "Replacement Parts" in the Index.
- 8 Air Cleaner Filter Service*** — Replace every 30,000 miles (50 000 km) or more often under dusty conditions. Ask your dealer for the proper replacement intervals for your driving conditions.
- 9 Fuel Tank Cap Gasket Replacement*** — Replace the gasket. Make sure the new gasket is correctly installed.

**ITEM
NO. SERVICE**

- 10 Fuel Lines and Connection Inspection*‡** — Inspect fuel lines, connections and tank band for corrosion, damage, cracks or loose or leaking connections. Tighten the connections or replace the parts as necessary. Periodic replacement of the fuel filter is not required.
- 11 Exhaust Pipes System Inspection*** — Inspect the exhaust pipes, muffler and hangers for cracks, deterioration or damage. Start the engine and listen carefully for any exhaust gas leakage. Tighten the connections or replace the parts as necessary.
- 12 Charcoal Canister Inspection*** — Inspect for internal damage or clogging. Clean with compressed air or replace if necessary.

**An Emission Control Service.*

‡The U.S. Environmental Protection Agency has determined that the failure to perform this maintenance item will not nullify the emission warranty or limit recall liability prior to the completion of vehicle useful life. General Motors, however, urges that all recommended maintenance services be performed at the indicated intervals and the maintenance be recorded in your Maintenance Record (Section E).

**ITEM
NO. SERVICE**

- 13 Engine Idle Speed Adjustment*** — Adjust the idle speed to factory specifications.
- 14 Valve Clearance Adjustment*** — The valve clearance should be adjusted to factory specifications.
- 15 Engine Timing Belt Replacement** — Replace at 60,000 miles (100 000 km) for vehicles frequently idled for extensive periods and/or driven for long distances at low speed, such as found in police, taxi, or door-to-door delivery service.

Maintenance Schedule

Section B: Owner Checks and Services

Listed below are owner checks and services which should be made at the intervals specified to help ensure the safety, dependability and emission control performance of your vehicle.

Be sure any necessary repairs are completed at once. Whenever any fluids or lubricants are added to your vehicle, make sure they are the proper ones, as shown in Section D.

At Each Fuel Fill *(It is important for you or a service station attendant to perform these underhood checks at each fuel fill.)*

CHECK OR SERVICE	WHAT TO DO
Engine Oil Level	Check the engine oil level and add the proper oil if necessary. See "Engine Oil" in the Index for further details.
Engine Coolant Level	Check the engine coolant level in the coolant recovery tank and add the proper coolant mix if necessary. See "Coolant" in the Index for further details.
Windshield Washer Fluid Level	Check the windshield washer fluid level in the windshield washer tank and add the proper fluid if necessary. See "Windshield Washer Fluid" in the Index for further details.
Hood Latch Operation	Pull the primary hood latch release handle inside the vehicle. The secondary latch should keep the hood from opening all the way when the primary latch is released. Make sure the hood closes firmly. See "Hood Release" in the Index for further details.

At Least Once a Month

CHECK OR SERVICE	WHAT TO DO
Tire Inflation	Check tire inflation. Make sure they are inflated to the pressures specified on the Tire-Loading Information label located on the inside of the glove box door. See "Tires" in the Index for further details.

At Least Twice a Year

CHECK OR SERVICE	WHAT TO DO
Fluid Level Check	Check the power steering pump, hydraulic clutch and automatic or manual transaxle fluid levels and add as needed. See "Power Steering," "Hydraulic Clutch" and "Automatic Transaxle" or "Manual Transaxle" in the Index. A fluid loss in these systems could indicate a problem. Have the system inspected and repaired at once.

Maintenance Schedule

Section B: Owner Checks and Services (Cont.)

At Least Once a Year

CHECK OR SERVICE	WHAT TO DO
Key Lock Cylinders	Lubricate the key lock cylinders with the lubricant specified in Section D.
Seat Operation	Make sure the head restraints stay in position and all seat latches lock. Check that the recliner holds by pushing and pulling the seatback while it is reclined.
Starter Switch	CAUTION
	 When you are doing this check, the vehicle could move suddenly. If it does, you or others could be injured. Follow the steps below.
	<ol style="list-style-type: none">1. Before you start, be sure you have enough room around the vehicle.2. Firmly apply both the parking brake (see "Parking Brake" in the Index if necessary) and the regular brake. <p>Note: Do not use the accelerator pedal, and be ready to turn off the engine immediately if it starts.</p> <ol style="list-style-type: none">3. On automatic transaxle vehicles, try to start the engine in each gear. The starter should work only in P (Park) or N (Neutral). If the starter works in any other position, your vehicle needs service. On manual transaxle vehicles, put the shift lever in Neutral, push the clutch down halfway, and try to start the engine. The starter should work only when the clutch is pushed down all the way to the floor. If the starter works when the clutch isn't pushed all the way down, your vehicle needs service.

At Least Once a Year (CONT.)

CHECK OR SERVICE	WHAT TO DO
Brake-Transaxle Shift Interlock—BTSI (Automatic Transaxle)	CAUTION
	 When you are doing this check, the vehicle could move suddenly. If it does, you or others could be injured. Follow the steps below. <ol style="list-style-type: none">1. Before you start, be sure you have enough room around the vehicle. It should be parked on a level surface.2. Firmly apply the parking brake (see “Parking Brake” in the Index if necessary). <p>Note: Be ready to apply the regular brake immediately if the vehicle begins to move.</p> <ol style="list-style-type: none">3. With the engine off, turn the key to the ON position, but don't start the engine. Without applying the regular brake, try to move the shift lever out of P (Park) with normal effort. If the shift lever moves out of P (Park), your vehicle's BTSI needs service.
Steering Column Lock	While parked, and with the parking brake set, try to turn the key to LOCK in each shift lever position. <ul style="list-style-type: none">• With an automatic transaxle, the key should turn to LOCK only when the shift lever is in P (Park).• With a manual transaxle, the key should turn to LOCK only if you push the key in farther, while turning it towards LOCK. On all vehicles, the key should come out only in LOCK .

Maintenance Schedule

Section B: Owner Checks and Services (Cont.)

At Least Once a Year (CONT.)

CHECK OR SERVICE	WHAT TO DO
Parking Brake and Automatic Transaxle P (Park) Mechanism	CAUTION  When you are doing this check, your vehicle could begin to move. You or others could be injured and property could be damaged. Make sure there is room in front of your vehicle in case it begins to roll. Be ready to apply the regular brake at once should the vehicle begin to move.
	Park on a fairly steep hill, with the vehicle facing downhill. Keeping your foot on the regular brake, set the parking brake. <ul style="list-style-type: none">● To check the parking brake: With the engine running and transaxle in N (Neutral), slowly remove foot pressure from the regular brake pedal. Do this until the vehicle is held by the parking brake only.● To check the P (Park) mechanism's holding ability: Shift to P (Park). Then release all brakes.
Underbody Flushing	At least every spring, use plain water to flush any corrosive materials from the underbody. Take care to clean thoroughly any areas where mud and other debris can collect.

Maintenance Schedule

Section C: Periodic Maintenance Inspections

Listed below are inspections and services which should be performed at least twice a year (for instance, each spring and fall). You should let your GM dealer's service

department or other qualified service center do these jobs. Make sure any necessary repairs are completed at once.

INSPECTION OR SERVICE	WHAT SHOULD BE DONE
Steering, Suspension, and Front-Wheel-Drive Axle Boot and Seal Inspection	Inspect the front and rear suspension and steering system for damaged, loose or missing parts, signs of wear, or lack of lubrication. On vehicles equipped with power steering, inspect the power steering lines and hoses for proper hookup, binding, leaks, cracks, chafing, etc. On vehicles with manual steering, check for seal leakage. Clean and then inspect the drive axle boot seals for damage, tears or leakage. Replace seals if necessary.
Exhaust System Inspection	Inspect the complete exhaust system. Inspect the body near the exhaust system. Look for broken, damaged, missing, or out-of-position parts as well as open seams, holes, loose connections, or other conditions which could cause a heat build-up in the floor pan or could let exhaust fumes into the vehicle. See "Engine Exhaust" in the Index.
Throttle Linkage Inspection	Inspect the throttle linkage for interference or binding, and for damaged or missing parts. Replace parts as needed. Check the accelerator pedal for smooth operation and even pedal effort.

Maintenance Schedule

Section C: Periodic Maintenance Inspections (Cont.)

INSPECTION OR SERVICE	WHAT SHOULD BE DONE
Brake System Inspection	<p>Inspect the complete system. Inspect brake lines and hoses for proper hookup, binding, leaks, cracks, chafing, etc. Inspect disc brake pads for wear and rotors for surface condition. Also inspect brake drum linings for wear and cracks. Inspect other brake parts, including drums, wheel cylinders, calipers, parking brake, etc. Check parking brake adjustment. You may need to have your brakes inspected more often if your driving habits or conditions result in frequent braking.</p> <p>Note: A low brake fluid level can indicate worn disc brake pads which may need to be serviced. Also, if the brake system warning light stays on or comes on, something may be wrong with the brake system. See "Brake System Warning Light" in the Index. If your vehicle is equipped with anti-lock brakes and the anti-lock brake system warning light stays on, comes on or flashes, something may be wrong with the anti-lock brake system. See "Anti-Lock Brake System Warning Light" in the Index.</p>

Additional Service Center Inspection

The inspection listed below should be performed by your Geo dealer's service department or some other qualified

service center. Make sure any necessary repairs are completed at once.

INSPECTION OR SERVICE	WHAT SHOULD BE DONE
Air Bag System Inspection	The air bag system should be inspected by a qualified technician at 120 months. After 120 months, have the system inspected every 24 months.

Maintenance Schedule

Section D: Recommended Fluids and Lubricants

Note: Fluids and lubricants identified below by name, part number or specification may be obtained from your GM dealer.

USAGE	FLUID/LUBRICANT
Engine Oil	GM Goodwrench Motor Oil or equivalent for API service SG Energy Conserving II oils of the recommended viscosity. The SG designation may be shown alone or in combination with others, such as SG/CC, SG/CD, or SF, SG, CC, etc. To determine the preferred viscosity for your vehicle's engine, see "Engine Oil" in the Index.
Engine Coolant	50/50 mixture of water (preferably distilled) and good quality ethylene glycol base antifreeze (GM Part No. 1052753 or equivalent) conforming to GM Specification 1825M or approved recycled coolant conforming to GM Specification 1825M.
Hydraulic Brake System	Delco-Supreme 11 [®] Brake Fluid (GM Part No. 1052535) or equivalent DOT-3 brake fluid.
Hydraulic Clutch System	Hydraulic Clutch Fluid (GM Part No. 12345347) or equivalent.
Power Steering System	DEXRON [®] -II Automatic Transmission Fluid (GM Part No. 1051855) or equivalent.
Manual Transaxle	SAE 75W-90 GL-4 (GM Part No. 12346074 Castrol [®] Syntorq GL-4 or equivalent) or SAE 75W-90 GL-5 Gear Lubricant.
Automatic Transaxle	DEXRON [®] -II Automatic Transmission Fluid (GM Part No. 1051855) or equivalent.
Key Lock Cylinders	Lubricate with Multi-Purpose Lubricant (GM Part No. 12345120), synthetic SAE 5W-30 engine oil or silicone lubricant (GM Part No. 1052276 or 1052277).
Manual Transaxle Shift Linkage	Chassis lubricant meeting requirements of NLGI Grade 2, Category LB or GC-LB (GM Part No. 1052497 or equivalent).

USAGE	FLUID/LUBRICANT
Automatic Transaxle Shift Linkage	Engine oil.
Clutch Linkage Pivot Points	Lithium base grease.
Floor Shift Linkage	Engine oil.
Wheel Bearings	Wheel bearing grease meeting requirements of NLGI Grade 2, Category GC or GC-LB (GM Part No. 1051344).
Chassis Lubrication	Chassis lubricant meeting requirements of NLGI Grade 2, Category LB or GC-LB (GM Part No. 1052497 or equivalent).
Windshield Washer Solvent	GM Optikleen® Washer Solvent (GM Part No. 1051515) or equivalent.
Hood Latch Assembly a. Pivots and Spring Anchor b. Release Pawl	a. Engine oil or Lubriplate Lubricant (GM Part No. 1050109). b. Chassis lubricant meeting requirements of NLGI Grade 2, Category LB or GC-LB (GM Part No. 1052497 or equivalent).
Hood and Door Hinges, Fuel Door Hinge, Rear Compartment Lid Hinges	Engine oil or Lubriplate Lubricant (GM Part No. 1050109).
Weatherstrips	Dielectric Silicone Grease (GM Part No. 12345579 or equivalent).

See "Replacement Parts" in the Index for recommended replacement filters, valves and spark plugs.

Maintenance Schedule

Section E: Maintenance Record

After the scheduled services are performed, record the date, odometer reading, and who performed the service in the columns indicated. When completing the Maintenance Performed column, insert the numbers from the Schedule I

or Schedule II maintenance charts which correspond to the maintenance performed. Also, you should retain all maintenance receipts. Your owner information portfolio is a convenient place to store them.

DATE	ODOMETER READING	SERVICED BY	MAINTENANCE PERFORMED

DATE	ODOMETER READING	SERVICED BY	MAINTENANCE PERFORMED

Maintenance Schedule

Section E: Maintenance Record (Cont.)

DATE	ODOMETER READING	SERVICED BY	MAINTENANCE PERFORMED



Part 8

Customer Assistance Information

Here you will find out how to contact Chevrolet/Geo if you need assistance. This part also tells you how to obtain service publications and how to report any safety defects.

Customer Satisfaction Procedure	294
GM Participation in Better Business Bureau Mediation/Arbitration Program	296
Reporting Safety Defects to the United States Government	298
Reporting Safety Defects to the Canadian Government	299
Reporting Safety Defects to General Motors	299
Chevrolet/Geo Roadside Assistance Program	300
Service Publications	301

Customer Assistance Information

■ *Customer Satisfaction Procedure*

Your satisfaction and goodwill are important to your dealer and Chevrolet/Geo. Normally, any problems with the sales transaction or the operation of your vehicle will be resolved by your dealer's Sales or Service Departments. Sometimes, however, despite the best intentions of all concerned, misunderstandings can occur. If your concern has not been resolved to your satisfaction, the following steps should be taken:

STEP ONE — Discuss your problem with a member of dealership management. Complaints can often be quickly resolved at that level. If the

matter has already been reviewed with the Sales, Service, or Parts Manager, contact the owner of the dealership or the General Manager.

STEP TWO — If after contacting a member of Dealership Management, it appears your problem cannot be resolved by the dealership without further help, contact the Chevrolet/Geo Motor Division Customer Assistance Center by calling 1-800-222-1020. In Canada, contact GM of Canada Customer Assistance Center in Oshawa by calling 1-800-263-3777 (English) or 1-800-263-7854 (French).

In Mexico, call 254-17-86. In Puerto Rico or U.S. Virgin Islands, call 1-809-763-1315. In all other overseas locations, contact GM International Export Sales in Canada by calling 1-416-644-4112.

For prompt assistance, please have the following information available to give the Customer Assistance Representative:

- Your name, address, telephone number
- Vehicle Identification Number (This is available from the vehicle registration or title, or the plate attached to the left top of the instrument panel and visible through the windshield.)

- Dealership name and location
- Vehicle delivery date and present mileage
- Nature of problem

In order to give your inquiry prompt attention, please call the toll-free number listed above. However, if you wish to write Chevrolet/Geo, write to:

Chevrolet/Geo
Customer Assistance Center
P.O. Box 7047
Troy, MI 48007-7047

A listing of all Chevrolet/Geo Branch Offices and offices outside the U.S. which can assist you can be found in the warranty booklet.

When contacting Chevrolet/Geo, please remember that your problem will likely be resolved in the dealership, using the dealership's facilities, equipment and personnel. That is why we suggest you follow Step One first if you have a problem.

Customer Assistance for the Hearing or Speech Impaired

To assist owners who have hearing difficulties, Chevrolet/Geo has installed special TDD (Telecommunication Devices for the Deaf) equipment in its Customer Assistance Center. Any hearing or speech impaired customer who has access to a TDD or a conventional teletypewriter (TTY) can communicate with Chevrolet/Geo by dialing: 1-800-TDD-CHEV (TDD users in Canada can dial 1-800-263-3830.)

Customer Assistance Information

■ *GM Participation in Better Business Bureau Mediation/Arbitration Program**

General Motors reserves the right to change eligibility limitations and/or to discontinue its participation in this program.

Our experience has shown that the Customer Satisfaction Procedure described earlier in this part has been very successful in achieving customer satisfaction. However, if you have not been substantially satisfied, Chevrolet/Geo wants you to be aware of GM's voluntary participation in a no-charge mediation/arbitration program

called BBB AUTO LINE. This program is administered by the Council of Better Business Bureaus through local Better Business Bureaus. The program can resolve individual disputes involving vehicle repairs and the interpretation of your New Vehicle Limited Warranty.

We prefer that you not resort to BBB AUTO LINE until after a final decision is made under the Customer Satisfaction Procedure. However, you may file a claim at any time by contacting your local Better Business Bureau (BBB) at the following toll-free number: 1-800-955-5100. For further information about filing a claim, you may also write to:

BBB AUTO LINE
Council of Better Business Bureaus
4200 Wilson Boulevard
Suite 800
Arlington, VA 22203

In order to file a claim, you will have to provide your name and address, the vehicle identification number (VIN) of your vehicle, and a statement of the nature of your complaint. BBB staff may try to help resolve your dispute through mediation. If mediation is not successful, or if you do not wish to participate in mediation, eligible customers may present their case to an impartial third-party arbitrator at an informal hearing. The arbitrator will render a decision in your case, which you may accept or reject. If you accept a valid arbitrator decision, GM will be bound by that decision. The entire dispute settlement process should

ordinarily take about 40 days from the time you file your complaint to the time a decision is rendered (or 47 days if you did not first contact your dealer or Chevrolet/Geo).

We encourage you to use this program before or instead of resorting to the courts. We believe it offers advantages over courts in most jurisdictions because it is fast, free of charge, and informal (lawyers are not usually present, although you may retain one at your expense if you choose). Arbitrators make decisions based on the principles of fairness and equity, and are not

required to duplicate the functions of courts by strictly applying state or federal law. If you wish to go to court, however, we do not require that you first file a claim with BBB AUTO LINE** unless state law provides otherwise. Whatever your preference may be, remember that if you are unhappy with the results of BBB AUTO LINE, you can still go to court because an arbitrator's decision is binding on GM but not on you, unless you accept it.

Customer Assistance Information

Eligibility is limited by vehicle age/mileage and other factors. For further information concerning the program, call the BBB at 1-800-955-5100. You may also contact the Chevrolet/Geo Customer Assistance Center by calling 1-800-222-1020.

*This program may not be available in all states, depending on state law. Canadian owners refer to your warranty booklet.

**Some states may require that you file a claim with BBB AUTO LINE before resorting to state-operating procedures (including court).

■ *Reporting Safety Defects to the United States Government*

If you believe that your vehicle has a defect which could cause a crash or could cause injury or death, you should immediately inform the National Highway Traffic Safety Administration (NHTSA), in addition to notifying General Motors.

If NHTSA receives similar complaints, it may open an investigation, and if it finds that a safety defect exists in a group of vehicles, it may order a recall and remedy campaign. However, NHTSA cannot become involved in individual problems between you, your dealer, or General Motors.

To contact NHTSA, you may either call the Auto Safety Hotline toll-free at 1-800-424-9393 (or 366-0123 in the Washington, D.C. area) or write to:

NHTSA
U.S. Department of Transportation
Washington D.C. 20590

You can also obtain other information about motor vehicle safety from the Hotline.

■ ***Reporting Safety Defects
to the Canadian
Government***

If you live in Canada, and you believe that your vehicle has a safety defect, you should immediately notify Transport Canada, in addition to notifying General Motors of Canada Limited. You may write to:

Transport Canada
Box 8880
Ottawa, Ontario K1G 3J2

■ ***Reporting Safety Defects
to General Motors***

In addition to notifying NHTSA (or Transport Canada) in a situation like this, we certainly hope you'll notify us. Please call us at 1-800-222-1020, or write:

Chevrolet/Geo
Customer Assistance Center
P.O. Box 7047
Troy, Michigan 48007-7047

In Canada, please call us at 1-800-263-3777 (English) or 1-800-263-7854 (French). Or, write:

General Motors of Canada Limited
Customer Assistance Center
1908 Colonel Sam Drive
Oshawa, Ontario L1H 8P7

Customer Assistance Information



■ *Chevrolet/Geo Roadside Assistance Program*

To enhance Chevrolet's strong commitment to customer satisfaction, Chevrolet is excited to announce the establishment of the Chevrolet/Geo Roadside Assistance Center. As the owner of a 1993 Chevrolet/Geo, membership in Roadside Assistance is free.

Roadside Assistance is available 24 hours a day, 365 days a year, by calling 1-800-CHEV USA (1-800-243-8872). This toll-free number will provide you over-the-phone roadside assistance with minor mechanical problems. If your

problem cannot be resolved over the phone, our advisors have access to a nationwide network of dealer recommended service providers. The following services are available:

- Towing
- Locksmith
- Tire Repair
- Glass Replacement
- Rental car or taxi
- Additional services as necessary

The Roadside Assistance Center uses companies that will provide you with quality and priority service. When roadside services are required, our advisors will explain any payment obligations that may be incurred for utilizing outside services.

For prompt assistance when calling, please have the following available to give to the advisor:

- Vehicle Identification Number
- License plate number
- Vehicle color
- Vehicle location
- Telephone number where you can be reached
- Vehicle mileage
- Description of problem

Please refer to the Roadside Assistance brochure inside your portfolio for full program details.

In Canada please consult your GM Dealer regarding availability of Roadside Assistance.

■ *Service Publications*

Information on how to obtain Product Service Publications and Indexes as described below is applicable only in the fifty U.S. states (and the District of Columbia) and only for cars and light trucks with GVWR less than 10,000 pounds (4 536 kg).

In Canada, information pertaining to Product Service Bulletins and Indexes can be obtained by writing to:

General Motors of Canada Limited
Service Publications Department
1908 Colonel Sam Dr.
Oshawa, Ontario L1H 8P7

Customer Assistance Information

Chevrolet/Geo regularly sends its dealers useful service bulletins about Chevrolet/Geo products. Chevrolet/Geo monitors product performance in the field. We then prepare bulletins for servicing our products better. Now, you can get these bulletins too.

Bulletins cover various subjects. Some pertain to the proper use and care of your vehicle. Some describe costly repairs. Others describe inexpensive repairs which, if done on time with the latest parts, may avoid future costly repairs. Some bulletins tell a technician how to repair a new or unexpected condition. Others describe a quicker way

to fix your vehicle. They can help a technician service your vehicle better.

Most bulletins apply to conditions affecting a small number of cars or trucks. Your Chevrolet/Geo dealer or a qualified technician may have to determine if a specific bulletin applies to your vehicle.

Individual PSP's

If you don't want to buy all the PSP's issued by Chevrolet/Geo for all car or truck models in the model year, you can buy individual PSP's, such as those which may pertain to a particular model. To do this, you will first need to see our index of PSP's. It provides a variety of information. Here's what you'll find in the index and how you can get one:

What You'll Find in the Index:

- A list of all PSP's published by Chevrolet/Geo in a model year (1990 or later). PSP's covering all models of Chevrolet/Geo cars or light trucks (less than 10,000 lbs. (4 536 kg) GVWR) are listed in the same index.
- Ordering information so you can buy the specific PSP's you may want.
- Price information for the PSP's you may want to buy.

How You Can Get an Index:

Indexes are published periodically. Most of the PSP's which could potentially apply to the most recent Chevrolet/Geo models will be listed in the most recent publication for that model year. This means you may want to wait until the end of the model year before ordering an index, if you are interested in buying PSP's pertaining to a current model year car or truck.

Some PSP's pertaining to a particular model year vehicle may be published in later years, and these would be listed in the later year's index. When you order an index for a model year that is not over yet, we'll send you the most recently published issue. Check the ordering form for indexes for earlier model years.

Cut out the ordering form, fill it out, and mail it in. We will then see to it that an index is mailed to you. There is no charge for indexes for the 1990-1993 model years.

Customer Assistance Information

Toll-Free Telephone Number

If you want an additional ordering form for an index or a subscription, just call toll-free and we'll be happy to send you one. Automated recording equipment will take your name and mailing address. The number to call is 1-800-551-4123.

A VERY IMPORTANT REMINDER: These PSP's are meant for technicians. They are not meant for the "do-it-yourselfer." Technicians have the equipment, tools, safety instructions, and know-how to do a job quickly and safely.

Chevrolet/Geo Service Publications

You can get these by using the order form.

1993 CHEVROLET/GEO SERVICE PUBLICATIONS ORDERING INFORMATION

The following publications covering the operation and servicing of your vehicle can be purchased by filling out the Service Publications Order Form in this book and mailing it with your check, money order or credit card information to Helm, Incorporated (address listed below).

CURRENT PUBLICATIONS FOR 1993 GEO PRIZM

PRODUCT SERVICE PUBLICATIONS

Product Service Publications (PSP's), are bulletins, letters and articles published for trained dealer service personnel. See Service Publications listed previously in this section.

A cumulative index is published quarterly during the current model year. The indexes list all PSP's published by Chevrolet in the model year.

PSP Index and Summaries

Year	Form Number	Price
1992	PSPI-92	Free
1991	PSPI-91	Free
1990	PSPI-90	Free

NOTE: Form Numbers for individual Product Service Publications may be found in the PSP Index. Prices are \$4.00 for the first PSP and \$2.00 for each additional PSP on the same order.

PSP Bound Bulletin Book (Complete Year Bulletins)

Year	Description	Form Number	Price
1991	All PSP's	PSP-91-4	40.00
1990	All PSP's	PSP-90-4	40.00

For subscription information call Helm, Incorporated.

SERVICE MANUALS (Available 4/93)

Service Manuals have the diagnosis, repair and overhaul information on engines, transmission, axle, suspension, brakes, electrical, steering, body, etc.

Model	Form Number	Price
1993 Geo Prizm	ST-373-93	\$43.00

*Please specify special body or engine types on order form. Write information in the Form Number column. For example; Turbo, Convertible.

OWNER'S INFORMATION

Owner publications are written directly for owners and intended to provide basic operational information about the vehicle. The Owner's Manual includes the Maintenance Schedule for all models.

1993 Geo Prizm Owner's Manual

In Portfolio: Includes Portfolio, Owner's Manual and Warranty Booklet.		
1993	Geo Prizm In-Portfolio	10213039 \$15.00
Without Portfolio: Includes Owner's Manual.		
1993	Geo Prizm Without Portfolio	10193597 \$11.00

CURRENT & PAST MODEL ORDER FORMS

Service Publications are available for current and past model Chevrolet/Geo vehicles. To request an order form, please specify year and model name of vehicle.

Address all inquiries to: HELM, INCORPORATED
P.O. Box 07130
Detroit, MI 48207

Credit Card Orders ONLY: 1-800-782-4356

For information and inquiries call: (313) 883-1430

Notes

CHEVROLET/GEO SERVICE PUBLICATIONS ORDER FORM

NOTE: Please complete form below (Print or Type) and MAIL TO:

HELM

Post Office Box 07130, Detroit, Michigan 48207

ORDER TOLL FREE (NOTE: For Credit Card Holder Orders Only) 1-800-782-4356 (Monday-Friday 8:30 A.M.-6:00 P.M. EST)	•Minimum Credit Card Order \$10.00 If further information is needed, write Helm or call (313) 883-1430. ORDER INFORMATION NOT AVAILABLE THROUGH THE TOLL FREE NUMBER.
--	--

PUBLICATION FORM NUMBER **	ITEM DESCRIPTION	VEHICLE MODEL		QTY.	PRICE EACH*	TOTAL PRICE
		NAME	YEAR			
ST-373-93	Service Manual	Geo Prizm	1993		\$43.00	
10213039	Owner's Manual In-Portfolio	Geo Prizm	1993		\$15.00	
10193597	Owner's Manual Without-Portfolio	Geo Prizm	1993		\$11.00	

SHIP TO

NOTE: Dealers and Companies please provide dealer or company name, and also the name of the person to whose attention the shipment should be sent. For purchases outside U.S.A. please write to the above address for quotation.

(CUSTOMER NAME) (ATTENTION)

(STREET ADDRESS—NO P.O. BOX NUMBERS) (APT. NO.)

(CITY) (STATE) (ZIP CODE)

DAYTIME TELEPHONE NO. AREA CODE () _____

PAYMENT

Check or Money Order payable to Helm, Inc. (USA funds only — do not send cash.)

MasterCard

VISA

Account Number: _____

Expiration Date mo/yr: _____

Check here if your billing address is different from your shipping address shown.

(CUSTOMER SIGNATURE)

TOTAL MATERIAL	
Michigan Purchasers add 4% sales tax	
Handling Charge	\$3.50
Canadian Postage/Handling (U.S. Funds)	\$6.50
GRAND TOTAL	

* Prices are subject to change without notice and without incurring obligation.
 ** Orders for Individual Product Service Publications cannot be filled without the appropriate bulletin numbers. These numbers may be found in the PSP Index. Your first Product Service Publication costs \$4.00; each additional PSP costs \$2.00

NOTE: All listed prices are quoted in U.S. funds. Canadian residents are to make checks payable in U.S. funds and are to include \$6.50 for additional postage and handling. Requests for manuals printed in French should be directed to Canadian General Motors dealerships.
Please allow adequate time for postal service.

CHEVROLET/GEO SERVICE PUBLICATIONS ORDER FORM

NOTE: Please complete form below (Print or Type) and MAIL TO:



Post Office Box 07130, Detroit, Michigan 48207

<p>ORDER TOLL FREE (NOTE: For Credit Card Holder Orders Only) 1-800-782-4356 (Monday-Friday 8:30 A.M.-6:00 P.M. EST)</p>	<p>•Minimum Credit Card Order \$10.00</p> <p>If further information is needed, write Helm or call (313) 883-1430.</p> <p>ORDER INFORMATION NOT AVAILABLE THROUGH THE TOLL FREE NUMBER.</p>
---	---

PUBLICATION FORM NUMBER**	ITEM DESCRIPTION	VEHICLE MODEL		QTY.	PRICE EACH*	TOTAL PRICE
		NAME	YEAR			
ST-373-93	Service Manual	Geo Prizm	1993		\$43.00	
10213039	Owner's Manual In-Portfolio	Geo Prizm	1993		\$15.00	
10193597	Owner's Manual Without-Portfolio	Geo Prizm	1993		\$11.00	

S-I-S
P
T
O

NOTE: Dealers and Companies please provide dealer or company name, and also the name of the person to whose attention the shipment should be sent. For purchases outside U.S.A. please write to the above address for quotation.

(CUSTOMER NAME) _____ (ATTENTION) _____

(STREET ADDRESS—NO P.O. BOX NUMBERS) _____ (APT. NO.) _____

(CITY) _____ (STATE) _____ (ZIP CODE) _____

DAYTIME TELEPHONE NO. AREA CODE () _____

P
A
Y
M
E
N
T

Check or Money Order payable to Helm, Inc. (USA funds only — do not send cash.)

MasterCard

VISA

Account Number:

Expiration Date mo/yr: Check here if your billing address is different from your shipping address shown.

TOTAL MATERIAL	
Michigan Purchasers add 4% sales tax	
Handling Charge	\$3.50
Canadian Postage/Handling (U.S. Funds)	\$6.50
GRAND TOTAL	

(CUSTOMER SIGNATURE)

* Prices are subject to change without notice and without incurring obligation.
 ** Orders for Individual Product Service Publications cannot be filled without the appropriate bulletin numbers. These numbers may be found in the PSP Index. Your first Product Service Publication costs \$4.00; each additional PSP costs \$2.00.

NOTE: All listed prices are quoted in U.S. funds. Canadian residents are to make checks payable in U.S. funds and are to include \$6.50 for additional postage and handling. Requests for manuals printed in French should be directed to Canadian General Motors dealerships.
Please allow adequate time for postal service.

Index

- A**BS Active Light 95
Add-On Electrical Equipment 258
Air Bag 25
 How It Works 26
 Servicing Your Geo
 with the System 29
 System Light 26
Air Cleaner 224
Air Conditioner Controls 103
Air Filter Replacement 224
Alignment, Wheel 247
Aluminum Wheel Cleaning 255
AM/FM Stereo 107
AM/FM Stereo with Cassette Tape
and Compact Disc Player 116
AM/FM Stereo with Cassette
Tape Player 109
Antenna 125
Anti-Lock Brake System 139
Anti-Lock Brake System Warning
Light 94
Appearance Care 249
Appearance Care and Maintenance
Materials 257
Appearance Care, Service and 211
Ashtray, Front 87
Ashtray, Rear 87
Ashtrays and Lighter 86
Assist Grips, Passenger 86
Audio Systems 105
Automatic Transaxle 58
Automatic Transaxle Fluid 224
Balance, Tire 247
Battery 235
Bi-Level Heating 101
Blizzard, If You're Caught in a 170
Brakes
 Anti-Lock 139
 Anti-Lock System Warning Light .. 94
 Brake Transaxle Shift
 Interlock (BTSI) 67
 Disc, Wear Indicators 141
 Fluid 234
 Master Cylinder 233
 Parking 64
 Pedal Travel 126
 Rear Drum 142
 System Parts, Replacing 235
 System Warning Light 93
Braking 137
Braking in Emergencies 142
"Break-In," New Vehicle 54
Brightness Control 75
Bulb Replacement 236
 Backup Lights 240
 Center High-Mounted Stoplight .. 238
 Front Sidemarket Lights 238
 Front Turn Signal Lights 237
 Headlights 236
 License Plate Light 239
 Parking Lights 237
 Rear Sidemarket Lights 240
 Tail/Stop/Turn Signal Lights 239
Bulbs, Halogen 236
Bulbs, Replacement 262
Capacities and Specifications 263
Carbon Monoxide 170
Cassette Tape Player, Care of Your .. 124
Cassette Tape, To Play a
 AM/FM Stereo with Cassette Tape
 and Compact Disc Player 118
 AM/FM Stereo with Cassette
 Tape Player 111

Index

Certification Label	241
Chains, Tire	248
Changing a Flat Tire	200
Charging System Light	97
Check Engine Light (Malfunction Indicator Lamp)	97
Checking Things under the Hood	217
Checking Your Restraint Systems	44
Chevrolet/Geo Roadside Assistance	300
Child Restraints	35
Securing in a Rear Outside Position	36
Securing in the Center Rear Seat Position	39
Securing in the Right Front Seat	40
Top Strap	36
Children (Safety Belts)	34
Children, Larger (Safety Belts)	42
Cigarette Lighter	86
Circuit Breakers, Fuses and	259
City Driving	157

Cleaning	
Fabric, Using Foam-Type Cleaner on	250
Fabric, Using Solvent-Type Cleaner on	251
Geo, the Inside of Your	250
Geo, the Outside of Your	254
Glass	253
Instrument Panel, the Top of the	253
Vinyl or Leather	252
Windshield, the Outside of Your	254
Clock, Setting the	106
Clusters, Instrument Panel and	90
Clutch, Hydraulic	228
Comfort Controls and Audio Systems	99
Compact Disc, Care of	125
Compact Disc Player, AM/FM Stereo with Cassette Tape and	116
Compact Disc, To Play a	119
Compact Spare	207
Compartments, Storage and	84

Controls	
Air Conditioner	103
Brightness	75
Comfort	100
Cruise	77
Heater	100
Seats and Seat	12
Coolant	
Engine	228
Radiator, How to Add to the	197
Recovery Tank, How to Add Coolant to	195
Temperature Gage, Engine	95
Cooling (Air Conditioning)	103
Cruise Control	77
To Erase Speed Memory	81
To Get Out of	81
To Increase Speed	80
To Reduce Speed	80
To Resume a Set Speed	79
To Set	78
Using on Hills	81

Cupholder	84
Customer Assistance for the Hearing or Speech Impaired	295
Customer Assistance Information	293
Customer Satisfaction Procedure	294
D efensive Driving	132
Defogger Light, Rear Window	98
Defogger, Rear Window	104
Defogging and Defrosting Windows	102
Dehumidifying (Air Conditioning)	103
Disc Brake Wear Indicators	141
Dome Light	73
Door	
Locks	49
Locks, Power	50
Security Lock, Rear	50
Storage Compartments	85

Driver Position (Safety Belt)	20
Driving	
A Long Distance	161
And the Road, Your	127
At Night	150
City	157
Defensive	132
Drunken	132
Freeway	158
In Fog, Mist and Haze	155
In Fog, Tips on	156
In the Rain	153
On Curves	143
On Snow or Ice	168
On the Freeway	159
Through Deep Standing Water	58
Winter	167
With a Trailer	176
Drunken Driving	133

E lectrical Equipment, Add-On	258
Engine	
Coolant	228
Coolant Temperature Gage	95
Exhaust	68
Identification	258
Oil	220
Oil Pressure Light	96
Overheating	192
Starting Your	55
Exhaust, Engine	68
Extender, Safety Belt	44
F abric Protection	251
Features and Controls	47
Filling Your Tank	216
Five-Speed Manual Transaxle	62
Flash-to-Pass	74
Flashers, Hazard Warning	182
Flat Tire, Changing a	200
Flat, If a Tire Goes	199
Flow-Through Ventilation System	104
Fluids and Lubricants, Recommended	288

Index

Fog, Mist and Haze, Driving in	155
Fog, Tips on Driving in	156
Folding Seatback, Rear	14
Freeway	
Driving	158
Driving on the	159
Entering the	159
Leaving the	160
Fuel	213
Gage	93
In Foreign Countries	215
Filling Your Tank	216
Fuse Block, Engine Compartment	261
Fuse Block, Instrument Panel	260
Fuses and Circuit Breakers	259
G ages	
Engine Coolant Temperature	95
Fuel	93
Warning Lights, Indicators and	92
Glove Box	85
GM Participation in Better Business	
Bureau Mediation/Arbitration	
Program	296
H alogen Bulbs	236
Hazard Warning Flashers	182
Head Restraints	14

Headlight	
Bulb Replacement	236
High/Low Beam	73
Lever, Turn Signal	71
Lights On Reminder	74
Heater Controls	100
Heating	101
Heating, Bi-Level	101
High/Low Beam, Headlight	73
Hill and Mountain Roads	163
Hills, Parking on	165
Hitches (Trailer)	175
Hood Release	217
Horn	71
Hydraulic Clutch	228
Hydroplaning	154
I dentification	
Engine	258
Label, Service Parts	258
Number, Vehicle	258
If You're Stuck: In Sand	
Mud, Ice or Snow	208
Ignition Switch	54
Inflation — Tire Pressure	224
Inside Day/Night Rearview Mirror . . .	81
Instrument Panel and Clusters	90
Interior Lights	74

J ump Starting	183
K eys	48
L ane Change Indicator, Turn	
Signal and	72
Lap-Shoulder Belt	21
Lighter, Ashtrays and	86
Lights	
ABS Active	95
Air Bag System	26
Anti-Lock System Warning	94
Brake System Warning	93
Charging System	97
Dome	73
Door Warning	98
Engine Oil Pressure	96
Flash-to-Pass	74
Interior	74
Lights On Reminder	74
Malfunction Indicator Lamp	
(Check Engine)	97
Operation	72
Overdrive Off	98
Rear Window Defogger	98
Safety Belt Reminder	20
Traffic	130
Warnings, Gages and Indicators . . .	92

Loading Your Vehicle	240
Lock, Rear Door Security	50
Locks, Door	49

Maintenance

Inspections, Periodic	285
Materials, Appearance	
Care and	257
Record	290
Schedule	267
Services, Explanation of	
Scheduled	276
Services, Scheduled	271
When Trailer Towing	179
Malfunction Indicator Lamp	97
Manual Front Seat	12
Manual Transaxle	
Five-Speed	62
Fluid	227
Shift Speeds	63
Manual Windows	70
Mirrors	82
Electric Control	83
Inside Day/Night Rearview	82
Manual Remote Control	82
Outside, Convex	82
Visor Vanity	86

N ew Vehicle "Break-In"	54
--------------------------------------	----

O dometer, Speedometer and	90
Odometer, Trip	91
Off-Road Recovery	146
Oil Pressure Light, Engine	96
Oil, Engine	220
Operation of Lights	72
Overdrive	62
Overdrive Off Light	98
Overheating, Engine	192
Owner Checks and Services	280

P (Park), Shifting into	65
P (Park), Shifting out of	67

Paint

Chemical Spotting	256
Finish Care	254
Finish Damage	256
Foreign Material	255

Parking

Brake	64
Downhill	166
Manual Transaxle	67
On Hills	165
On Hills (With a Trailer)	178
Over Things That Burn	68
Uphill	166

Parts, Replacement	263
--------------------------	-----

Passenger

Assist Grips	86
Center Position (Safety Belt)	33
Positions (Safety Belt)	31
Rear Seat (Safety Belt)	31
Rear Seat Outside (Safety Belt)	31
Right Front Position	
(Safety Belt)	31
Passing	146
Pavement Markings	131
Power	
Door Locks	50
Steering	143
Steering Fluid	231
Windows	70
Pregnancy, Safety Belt Use during	31
Problems on the Road	181
Publications, Service	301

R adiator Pressure Cap	231
-------------------------------------	-----

Radiator, How to Add Coolant

to the	197
Radio Reception, Understanding	124
Radio, To Play the	
AM/FM Stereo	107
AM/FM Stereo with Cassette Tape	
and Compact Disc Player	116
AM/FM Stereo with Cassette	
Tape Player	109

Index

- | | | | | | |
|---|-----|--|-----|--|-----|
| Rear Drum Brakes | 142 | Rocking Your Vehicle
to Get It Out | 209 | Safety Defects
Reporting to General Motors | 299 |
| Rear Window Defogger | 104 | Running Your Engine While You're
Parked (Automatic Transaxle) | 69 | Reporting to the Canadian
Government | 299 |
| Rear Window Defogger Light | 98 | S afety Belts
Care of | 253 | Reporting to the United States
Government | 298 |
| Reclining Front Seatbacks | 13 | Center Passenger Position | 33 | Safety Warnings | 5 |
| Recommended Fluids and
Lubricants | 288 | Children | 34 | Sand, Mud, Ice or Snow, If You're
Stuck in | 208 |
| Remote Trunk Lock Release | 52 | Driver Position | 20 | Scheduled Maintenance
Services | 271 |
| Replacement, Bulb | 236 | Extender | 44 | Seat, Manual Front | 12 |
| Replacement Bulbs | 262 | How to Wear Properly | 20 | Seatback, Rear Folding | 13 |
| Replacement Parts | 263 | Lap-Shoulder Belt | 21 | Seatback, Reclining Front | 14 |
| Replacing Safety Belts after a
Crash | 45 | Larger Children | 42 | Seats | 12 |
| Reporting Safety Defects
To General Motors | 299 | Outside Positions | 31 | Seats and Safety Belts | 11 |
| To the Canadian Government | 299 | Passenger Positions | 31 | Seats and Seat Controls | 12 |
| To the United States
Government | 298 | Questions People Ask | 19 | Securing a Child Restraint
In a Rear Outside Position | 36 |
| Restraint Systems, Checking Your | 44 | Rear Seat Passengers | 31 | In the Center Rear Seat Position | 39 |
| Restraint System, Supplemental | 25 | Reminder Light | 20 | In the Right Front Seat | 40 |
| Restraint, Where to Put the Child | 35 | Replacing after a Crash | 45 | Security Lock, Rear Door | 50 |
| Restraints, Child | 35 | Right Front Passenger Position | 40 | Service | 212 |
| Restraints, Head | 14 | Seats and | 11 | Service and Appearance Care | 211 |
| Road Signs | 128 | Shoulder Belt Height Adjuster | 22 | Service Parts Identification Label | 258 |
| Color of | 128 | Smaller Children and Babies | 34 | | |
| Shape of | 129 | They're for Everyone | 15 | | |
| Symbols on | 130 | Use during Pregnancy | 31 | | |
| | | Why They Work | 16 | | |
| | | Safety Chains (Trailer) | 175 | | |

Service Publications	301	Specifications, Capacities and	263	Tilt Wheel	71
Service Work, Doing Your Own	212	Speedometer and Odometer	90	Tires	242
Shift Speeds — Manual Transaxle	63	Starting Your Engine	55	Balance	247
Shifting into P (Park)	65	Steering	143	Chains	248
Shifting out of P (Park)	67	Fluid, Power	231	Changing a Flat	200
Shoulder Belt Adjuster (Safety Belt)	22	In Emergencies	145	Compact Spare	207
Sidemarkers Light Bulb Replacement, Front	238	Power	143	Inflation Pressure	243
Rear	240	Tips	143	Inspection	244
Skidding	148	Wheel, Tilt	71	Loading	240
Smaller Children and Babies (Safety Belts)	34	Stoplight Bulb Replacement, Center High-Mounted	238	New	245
Snow or Ice, Driving on	168	Storage and Compartments	84	Rotation	244
Snow, If You're Stuck in Deep	171	Sun Visors	85	Temperature Grades	246
Spare, Compact	207	Sunroof	83	Traction Grades	246
Speakers, Adjusting the AM/FM Stereo	108	Supplemental Restraint System (Air Bag)	25	Treadwear	245
AM/FM Stereo with Cassette Tape and Compact Disc Player	117	T achometer	91	Uniform Quality Grading	245
AM/FM Stereo with Cassette Tape Player	110	Tail/Stop/Turn Signal Light Bulb Replacement	239	Tone, Setting the AM/FM Stereo	108
		Theft	53	AM/FM Stereo with Cassette Tape and Compact Disc Player	117
		Theft-Deterrent Feature AM/FM Stereo with Cassette Tape and Compact Disc Player	121	AM/FM Stereo with Cassette Tape Player	110
		AM/FM Stereo with Cassette Tape Player	114	Top Strap (Child Restraint)	36
		Thermostat	231	Towing a Trailer	171
				Towing Hook-Ups, Front	190
				Towing Hook-Ups, Rear	191

Index

- | | | | | | |
|--|-----|---|-----|---|-----|
| Towing Your Vehicle | 188 | Transaxle Fluid, Automatic | 224 | Ventilation | 102 |
| Traffic Lights | 130 | Transaxle Fluid, Manual | 227 | Ventilation System,
Flow-Through | 104 |
| Traffic Officer | 132 | Transaxle, Automatic | 58 | Ventilation Tips | 105 |
| Trailer | | Transaxle, Five-Speed Manual | 62 | Visor Vanity Mirrors | 86 |
| Backing Up with a | 177 | Trip Odometer | 91 | Visors, Sun | 85 |
| Brakes | 176 | Trunk Lock Release | 52 | W arning Flashers, Hazard | 181 |
| Driving on Grades with a | 178 | Turn Signal and Lane Change
Indicator | 72 | Warning Light, Door | 98 |
| Driving with a | 176 | Turn Signal/Lights Control/
Headlight Beam Lever | 71 | Warning Lights, Gages
and Indicators | 92 |
| Following Distance | 177 | Turn Signal Light Bulb
Replacement, Front | 237 | Washer Fluid, Windshield | 232 |
| Hitches | 175 | U nderbody Maintenance | 256 | Washers (Windshield) | 76 |
| If You Do Decide to Pull a | 172 | Used Oil, What to do with | 223 | Washing Your Vehicle | 254 |
| Making Turns with a | 177 | V ehicle | | Weatherstrips | 255 |
| Parking on Hills with a | 178 | Control of a | 137 | Weight | |
| Passing with a | 177 | Damage Warnings | 6 | Total on Your Vehicle's Tires | 174 |
| Safety Chains | 175 | Dimensions | 265 | Trailer | 173 |
| Tongue, Weight of the | 174 | Identification Number | 258 | Trailer Tongue | 174 |
| Towing a | 171 | Loading | 240 | | |
| Towing, Maintenance When | 179 | Storage | 235 | | |
| Turn Signals When Towing a | 177 | Symbols | 7 | | |
| Weight of the | 173 | | | | |
| When You Are Ready to Leave
After Parking on a Hill | 179 | | | | |

Wheel	
Alignment	247
Cleaning Aluminum	255
Nut Torque	205
Replacement	247
Used Replacement	248
Windshield	
Cleaning	254
Washers	76
Washer Fluid	232
Wiper/Washer Lever	75
Windows	70
Defogging and Defrosting	102
Manual	70
Power	70
Winter Driving	167

Service Station Information

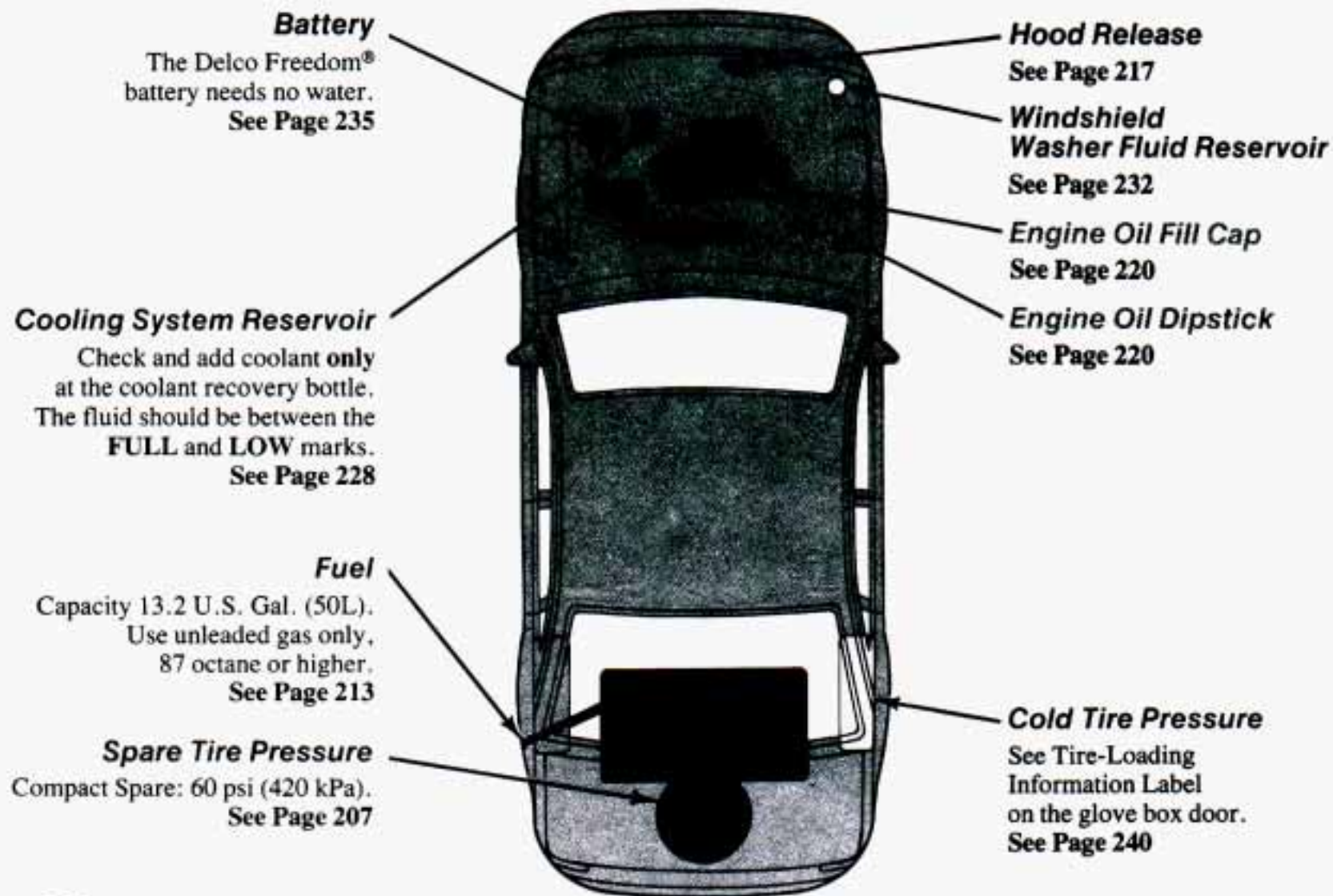



WE SUPPORT
VOLUNTARY TECHNICIAN
CERTIFICATION THROUGH

National Institute for
**AUTOMOTIVE
SERVICE
EXCELLENCE**



CHEVROLET
Geo



GM