

C H E V R O L E T   C A M A R O



1 9 9 3   O W N E R ' S   M A N U A L





## Camaro

# 1993 Owner's Manual Table of Contents

Introduction	<b>How to Use This Manual . . . . .</b>	<b>6</b>
<b>Part 1</b>	<b>Seats &amp; Safety Belts . . . . .</b>	<b>11</b>
<b>Part 2</b>	<b>Features &amp; Controls . . . . .</b>	<b>47</b>
<b>Part 3</b>	<b>Comfort Controls &amp; Audio Systems . . .</b>	<b>109</b>
<b>Part 4</b>	<b>Your Driving and the Road . . . . .</b>	<b>131</b>
<b>Part 5</b>	<b>Problems on the Road . . . . .</b>	<b>183</b>
<b>Part 6</b>	<b>Service &amp; Appearance Care . . . . .</b>	<b>217</b>
<b>Part 7</b>	<b>Maintenance Schedule . . . . .</b>	<b>285</b>
<b>Part 8</b>	<b>Customer Assistance Information . . .</b>	<b>313</b>
	Including "Reporting Safety Defects" on page 318.	
<b>Part 9</b>	<b>Index . . . . .</b>	<b>329</b>
	<b>Service Station Information . . . .</b>	<b>Last Page</b>

Please keep this manual in your Chevrolet, so it will be there if you ever need it when you're on the road. If you sell the vehicle, please leave this manual in it so the new owner can use it.

This manual includes the latest information at the time it was printed. We reserve the right to make changes in the product after that time without further notice. For vehicles first sold in Canada, substitute the name "General Motors of Canada Limited" for Chevrolet Motor Division whenever it appears in this manual.

**For Canadian Owners Who Prefer a French Language Manual**

**Aux propriétaires canadiens:** Vous pouvez vous procurer un exemplaire de ce guide en français chez votre concessionnaire ou au DGN Marketing Services Ltd., 1500 Bonhill Rd., Mississauga, Ontario L5T 1C7.

Published by **Chevrolet Motor Division**  
**General Motors Corporation**

**General Motors, GM** and the GM emblem, **Chevrolet** and the Chevrolet emblem, and **Camaro** and the Camaro emblem are registered trademarks of General Motors Corporation.

© Copyright 1992 General Motors Corporation, Chevrolet Motor Division. All Rights Reserved.

# The Heritage of Chevrolet



*The dynamic William C. "Billy" Durant shifted gears from making carriages to making cars, forming half the team that gave birth to Chevrolet.*

**W**elcome to the largest automotive family in the world — the family of Chevrolet owners. You have selected a vehicle designed, engineered and crafted by teamwork, a vehicle backed by a proud history

of performance and value. Since the first "Classic Six" rolled off the line in 1912, more than 110 million Chevrolet cars and trucks have worn the Chevrolet marque. That kind of reception from auto owners is

unmatched by any other car manufacturer in the world.

The Chevrolet blend of value and performance has become an American tradition—whether bred for the racetrack like the legendary

*Louis Chevrolet, the other half of the team, at the wheel of his experimental "Classic Six," which entered production in 1912—producing 2999 vehicles.*





*In January 1942, Chevrolet factories were converted to military production in an all-out effort to achieve victory in Europe and the Pacific . . . but millions of Americans already owned a "Chevy."*

Corvette and Camaro, or created for the pleasure of the open road.

Every decade, Chevrolet has reinforced its heritage of affordable

performance with quality and value crafted into every vehicle. It's not surprising that for eighty years Chevrolet has been America's

automobile . . . truly

"The Heartbeat of America."

We're proud to continue that heritage in your Chevrolet, and we

*In 1932 Chevrolet introduced the Synchronmesh transmission and offered a host of accessories—including such niceties as a clock!*



*The legacy of America's favorite sportscar began in 1953, when 319 hand-assembled white Corvettes launched the first use of a fiberglass body in a production car.*





*The 1957 Chevy started a romance with the American public—and was powered by an available fuel-injected V8.*

are pledged to make ownership of your Chevrolet an enjoyable and rewarding experience.

**Jim Perkins,  
General Manager**

*60's automotive excitement included Chevrolet landmarks like the Corvette Sting Ray, the sporty Camaro, and power-plants like the legendary 327 V8.*

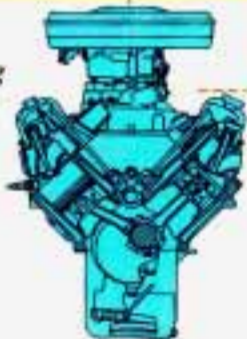

*Your new Chevrolet continues a tradition of quality and value.*

# How to Use This Manual



## ■ *How to Use This Manual*

Many people read their owner's manual from beginning to end when they first receive their new vehicle. This will help you learn about the features and controls for your vehicle. In this manual, you'll find that pictures and words work together to explain things quickly.

**Index:** A good place to look for what you need is the Index in back of the manual. It's an alphabetical list of all that's in the manual, and the page number where you'll find it.

**Parts 1-8:** Each part of this manual begins with a brief list of its contents, so you can often find at a glance if a part contains the information you want.

## How to Use This Manual

This part tells you how to use your manual and includes safety and vehicle damage warnings and symbols.

### **Part 1: Seats & Safety Belts**

This part tells you how to use your seats and safety belts properly.

### **Part 2: Features & Controls**

This part explains how to start and operate your Chevrolet.

### **Part 3: Comfort Controls & Audio Systems**

This part tells you how to adjust the ventilation and comfort controls and how to operate your sound system.

### **Part 4: Your Driving and the Road**

Here you'll find helpful information and tips about the road and how to drive under different conditions.

### **Part 5: Problems on the Road**

This part tells you what to do if you have a problem while driving, such as a flat tire or engine overheating.

### **Part 6: Service & Appearance Care**

Here the manual tells you how to keep your Chevrolet running properly and looking good.

### **Part 7: Maintenance Schedule**

This part tells when to perform vehicle maintenance and what fluids and lubricants to use.



### **Part 8: Customer Assistance Information**

This part includes important information about reporting safety defects and gives you details about the "Roadside Assistance" program. You will also find customer satisfaction phone numbers (including customer satisfaction numbers for the hearing and speech impaired), as well as the mediation/arbitration procedure. We've also included ordering information for service publications in this part.

### **Service Station Information**

This is a quick reference of service information. You can find it on the last page of this manual.

## **CAUTION**



These mean there is something that could hurt you or other people.

### ***Safety Warnings and Symbols***

You will find a number of safety cautions in this book. We use yellow and the word **CAUTION** to tell you about things that could hurt you if you were to ignore the warning.

In the yellow caution area, we tell you what the hazard is. Then we tell you what to do to help avoid or reduce the hazard. Please read these cautions. If you don't, you or others could be hurt.

## How to Use This Manual



You will also find a red circle with a slash through it in this book. This safety symbol means “Don’t,” “Don’t do this,” or “Don’t let this happen.”

### **NOTICE**

These mean there is something that could damage your vehicle.

### ***Vehicle Damage Warnings***

Also, in this book you will find these blue notices.

In the blue notice area, we tell you about something that can damage your vehicle. Many times, this damage would not be covered by your warranty, and it could be costly. But the notice will tell you what to do to help avoid the damage.

When you read other manuals, you might see CAUTION and NOTICE warnings in different colors or in different words. In this manual, we’ve used the familiar words and colors that Chevrolet has used for years.

You’ll also see warning labels on your vehicle. They use the same colors, and the words CAUTION or NOTICE.

## Vehicle Symbols

These are some of the symbols you will find on your vehicle. For example, these symbols are used on an original battery:

These symbols are important for you and your passengers whenever your vehicle is driven:

*Caution Possible Injury*



*Protect Eyes by Shielding*



*Caustic Battery Acid  
Could Cause Burns*



*Avoid Sparks or Flames*



*Sparks or Flame Could  
Explode Battery*



*Fasten Safety Belts*



*Door Lock/Unlock*



These symbols have to do with your lights:

*Master Lighting Switch*



*Turn Signal Direction*

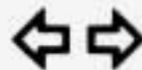

*Hazard Warning Flasher*



*Headlight High Beam*



*Parking Lights*



*Courtesy Lights*



*Fog Lights*



# How to Use This Manual

These symbols are on some of your controls:

*Windshield Wiper*



*Windshield Washer*



*Windshield Defroster*



*Rear Window Defogger*



*Ventilating Fan*



These symbols are used on warning and indicator lights:

*Engine Coolant Temperature*



*Battery Charging System*



*Engine Oil Pressure*



*Brake (Canada)*



*Anti-Lock Brake System (Canada)*



*Low Coolant*



Here are some other symbols you may see:

*Fuel*



*Hood Release*



*Hatchback Release*



*Lighter*



*Horn*



*Speaker*



C H E V R O L E T   C A M A R O



1 9 9 3   O W N E R ' S   M A N U A L

# How to Use This Manual

These symbols are on some of your controls:

*Windshield Wiper*



*Windshield Washer*



*Windshield Defroster*



*Rear Window Defogger*



*Ventilating Fan*



These symbols are used on warning and indicator lights:

*Engine Coolant Temperature*



*Battery Charging System*



*Engine Oil Pressure*



*Brake (Canada)*



*Anti-Lock Brake System (Canada)*



*Low Coolant*



Here are some other symbols you may see:

*Fuel*



*Hood Release*



*Hatchback Release*



*Lighter*



*Horn*



*Speaker*





# Part 1

## Seats & Safety Belts

**H**ere you'll find information about the seats in your Chevrolet and how to use your safety belts properly. You can also learn about some things you should **not** do with safety belts.

Seats and Seat Controls .....	12
Safety Belts: They're for Everyone .....	15
Why Safety Belts Work .....	17
Here Are Questions Many People Ask about Safety Belts — and the Answers ...	19
Safety Belt Reminder Light .....	20
How to Wear Safety Belts Properly .....	21
Children .....	34
Child Restraints .....	36
Larger Children .....	43
Safety Belt Extender .....	44
Checking Your Restraint Systems .....	45
Replacing Safety Belts after a Crash .....	45

# Seats & Safety Belts



## ■ *Seats and Seat Controls*

This section tells you about the seats — how to adjust them, and also about reclining front seatbacks, seatback latches and the folding rear seatback.

### ***Manual Front Seat***

Move the lever under the passenger's front seat to unlock it. Slide the seat to where you want it. Then release the lever and try to move the seat with your body, to make sure the seat is locked into place.

### ***Four-Way Manual Seat***

To move the driver's seat forward or backward, lift the lever under the left front of the seat. To tilt the entire seat, lift the lever under the right front of the seat.



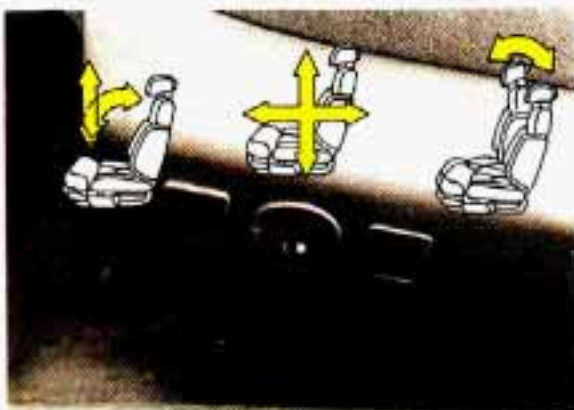

## **CAUTION:**

 You can lose control of the vehicle if you try to adjust a manual driver's seat while the vehicle is moving. The sudden movement could startle and confuse you, or make you push a pedal when you don't want to. Adjust the driver's seat only when the vehicle is not moving.

### ***Six-Way Power Seat (OPTION)***

The driver's seat has three controls on the left side.

The front control makes the front of the seat go up and down.

The back control makes the back of the seat go up and down.

The center control makes the whole seat go up and down or forward and backward.

### ***Reclining Front Seatbacks***

To adjust the seatback, lift the lever on the outer side of the seat. Release the lever to lock the seatback where you want it. Pull up on the lever, and the seat will go to its original upright position. But don't have the seatback reclined if your vehicle is moving.

## Seats & Safety Belts



### **CAUTION:**



Sitting in a reclined position when your vehicle is in motion can be dangerous. Even if you buckle up, your safety belts can't do their job when you're reclined like this.

The shoulder belt can't do its job because it won't be against your body. Instead, it will be in front of you. In a crash you could go into it, receiving neck or other injuries.

The lap belt can't do its job either. In a crash the belt could go up over your abdomen. The belt forces would be there, not at your pelvic bones. This could cause serious internal injuries.

For proper protection when the vehicle is in motion, have the seatback upright. Then sit well back in the seat and wear your safety belt properly.



### ***Front Seatback Latches***

The front seatbacks fold forward to let people get into the back seat. To fold a seatback forward, push the seatback toward the rear as you lift this latch. Then the seatback will fold forward.



### ***Folding Rear Seatback***

The rear seatback in your Chevrolet folds down to provide more storage space.

To fold the seatback down:

1. Pull forward on both levers.
2. Fold the seatback down.

To raise the seatback:

1. Pull it up to the locked, upright position.
2. Be sure both latches hold the seatback in place. Have them fixed if they don't.

When you return the seatback to its original position, make sure the seatback is locked. The latch must be down for the seat to work properly.

#### ***CAUTION:***



If the seatback isn't locked, it could move forward in a sudden stop or crash. That could cause injury to the person sitting there. Always press rearward on the seatback to be sure it is locked.

### **■ *Safety Belts: They're for Everyone***

This part of the manual tells you how to use safety belts properly. It also tells you some things you should not do with safety belts. And it explains the Supplemental Inflatable Restraint, or "air bag" system.

## Seats & Safety Belts



### CAUTION:



Don't let anyone ride where they can't wear a safety belt properly. If you are in a crash and you're not wearing a safety belt, your injuries can be **much** worse. You can hit things inside the vehicle or be ejected from it. You can be seriously injured or killed. In the same crash, you might not be if you are buckled up. Always fasten your safety belt, and check that your passengers' belts are fastened properly too.

This figure lights up when you turn the key to **Run** or **Start** when your safety belt isn't buckled, and you'll hear a chime, too. It's the reminder to buckle up.

In many states and Canadian provinces, the law says to wear safety belts. Here's why: **They work.**

You never know if you'll be in a crash. If you do have a crash, you don't know if it will be a bad one.

A few crashes are very mild. In them, you won't get hurt even if you're not buckled up. And some crashes can be so serious, like being hit by a train, that even buckled up a person wouldn't survive. But most crashes are in between. In many of them, people who buckle up can survive and sometimes walk away. Without belts they could be badly hurt or killed.

After 25 years of safety belts in vehicles, the facts are clear. In most crashes buckling up does matter ... a lot!



### ■ *Why Safety Belts Work*

When you ride in or on anything, you go as fast as it goes.

For example, if the bike is going 10 mph (16 km/h), so is the child.



When the bike hits the block, it stops. But the child keeps going!

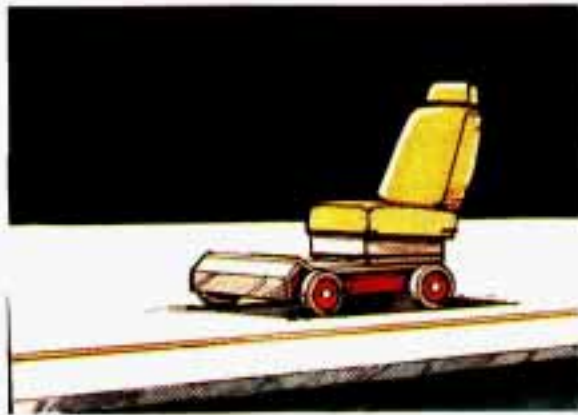

Take the simplest "car." Suppose it's just a seat on wheels.

## Seats & Safety Belts



Put someone on it.



Get it up to speed. Then stop the "car."  
The rider doesn't stop.



The person keeps going until stopped by something.

In a real vehicle, it could be the windshield ...



or the instrument panel ...



or the safety belts!

With safety belts, you slow down as the vehicle does. You get more time to stop. You stop over more distance, and your strongest bones take the forces. That's why safety belts make such good sense.

## ■ *Here Are Questions Many People Ask about Safety Belts — and the Answers*

- Q:** Won't I be trapped in the vehicle after an accident if I'm wearing a safety belt?
- A:** You **could** be — whether you're wearing a safety belt or not. But you can easily unbuckle a safety belt, even if you're upside down. And your chance of being conscious during and after an accident, so you **can** unbuckle and get out, is **much** greater if you are belted.

# Seats & Safety Belts

**Q:** Why don't they just put in air bags so people won't have to wear safety belts?

**A:** "Air bags," or Supplemental Inflatable Restraint systems, are in some vehicles today and will be in more of them in the future. But they are supplemental systems only — so they work **with** safety belts, not instead of them. Every "air bag" system ever offered for sale has required the use of safety belts. Even if you're in a vehicle that has "air bags," you still have to buckle up to get the most protection. That's true not only in frontal collisions, but especially in side and other collisions.

**Q:** If I'm a good driver, and I never drive far from home, why should I wear safety belts?

**A:** You may be an excellent driver, but if you're in an accident — even one that isn't your fault — you and your passengers can be hurt. Being a good driver doesn't protect you from things beyond your control, such as bad drivers.

Most accidents occur within 25 miles (40 km) of home. And the greatest number of serious injuries and deaths occur at speeds of less than 40 mph (65 km/h).

Safety belts are for everyone.



## ■ *Safety Belt Reminder Light*

When the key is turned to **Run** or **Start**, a light will come on for about eight seconds to remind people to fasten their safety belts. Unless the driver's safety belt is buckled, a chime will also sound.



## ■ *How to Wear Safety Belts Properly*

### **Adults**

This section is only for people of adult size.

### **CAUTION:**



There are special things to know about safety belts and children. And there are different rules for babies and smaller children. If a child will be riding in your Chevrolet, see the section after this one, called "Children." Follow those rules for everyone's protection.

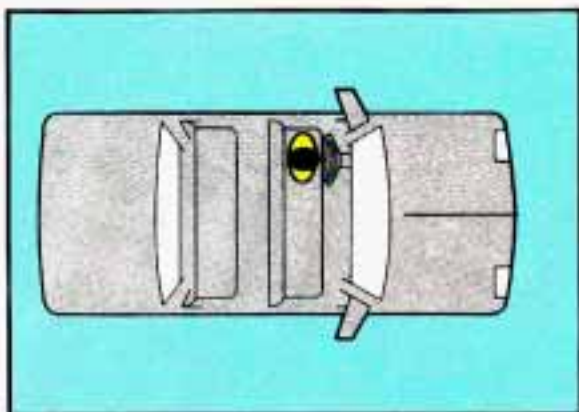

First, you'll want to know which restraint systems your vehicle has.

We'll start with the driver position.

### ***Driver Position***

This section describes the driver's restraint system.



### **Lap-Shoulder Belt**

The driver has a lap-shoulder belt. Here's how to wear it properly.

1. Close and lock the door.
2. Adjust the seat (to see how, see "Seats" in the Index) so you can sit up straight.

## Seats & Safety Belts



3. Pick up the latch plate and pull the belt across you. Don't let it get twisted.
4. Push the latch plate into the buckle until it clicks.

If the belt isn't long enough, see "Safety Belt Extender" at the end of this section.

Make sure the release button on the buckle faces upward or outward so you would be able to unbuckle it quickly if you ever had to.

5. To make the lap part tight, pull down on the buckle end of the belt as you pull up on the shoulder belt.

If the shoulder belt is too tight, move the shoulder belt to the upper or lower guide loop. Choose the one that makes the shoulder belt more comfortable.



The lap part of the belt should be worn low and snug on the hips, just touching the thighs. In a crash, this applies force to the strong pelvic bones. And you'd be less likely to slide under the lap belt. If you slid under it, the belt would apply force at your abdomen. This could cause serious or even fatal injuries. The shoulder belt should go over the shoulder and across the chest. These parts of the body are best able to take belt restraining forces.

The safety belt locks if there's a sudden stop or crash.



**Q: What's wrong with this?**

**A:** The shoulder belt is too loose. It won't give nearly as much protection this way.

### **CAUTION:**



You can be seriously hurt if your shoulder belt is too loose. In a crash you would move forward too much, which could increase injury. The shoulder belt should fit against your body.

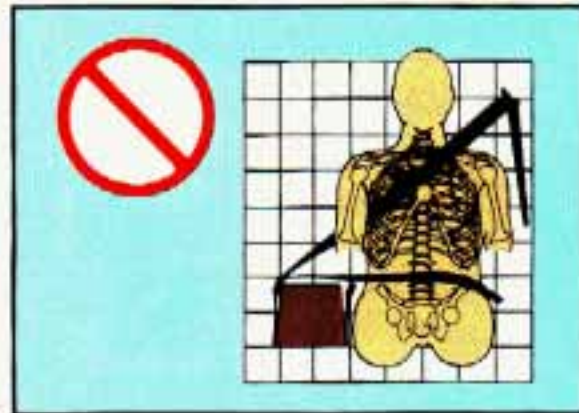

**Q: What's wrong with this?**

**A:** The belt is buckled in the wrong place.

### **CAUTION:**



You can be seriously injured if your belt is buckled in the wrong place like this. In a crash, the belt would go up over your abdomen. The belt forces would be there, not at the pelvic bones. This could cause serious internal injuries. Always buckle your belt into the buckle nearest you.

## Seats & Safety Belts

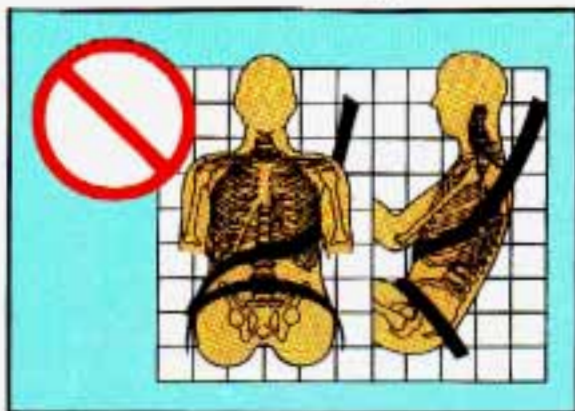

**Q:** What's wrong with this?

**A:** The shoulder belt is worn under the arm. It should be worn over the shoulder at all times.

### **CAUTION:**

 You can be seriously injured if you wear the shoulder belt under your arm. In a crash, your body would move too far forward, which would increase the chance of head and neck injury. Also, the belt would apply too much force to the ribs, which aren't as strong as shoulder bones. You could also severely injure internal organs like your liver or spleen.

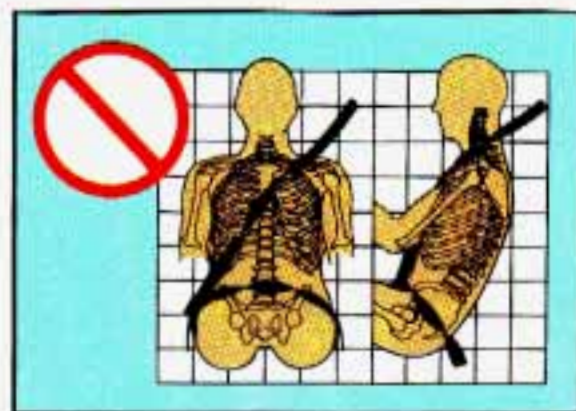

**Q:** What's wrong with this?

**A:** The belt is twisted across the body.

### **CAUTION:**

 You can be seriously injured by a twisted belt. In a crash, you wouldn't have the full width of the belt to spread impact forces. If a belt is twisted, make it straight so it can work properly, or ask your dealer to fix it.



To unlatch the belt, just push the button on the buckle. The belt should go back out of the way.

Before you close the door, be sure the belt is out of the way. If you slam the door on it, you can damage both the belt and your vehicle.

This vehicle has **AIR BAGS** for front occupants.



**CAUTION: YOU NEED YOUR SAFETY BELT, EVEN WITH AN AIR BAG. AND HERE'S WHY:**

- Air bags are not designed to inflate in rollovers or in rear, side or low-speed frontal crashes.
- Air bags inflate with great force—faster than the blink of an eye. If you're too close to an inflating air bag, it could seriously injure you. Safety belts help keep you in position for air bag inflation in a crash.
- An inflating air bag can seriously injure small children. Follow the instructions on the passenger safety belt Caution label.

**REGULAR MAINTENANCE OF THE AIR BAG SYSTEM IS NOT REQUIRED.** If the air bag readiness light comes on while you are driving, or doesn't come on when you first start your vehicle, see your dealer for service.

PRINTED IN U.S.A.

See your Owner's Manual for more information.

PART NO. C20-30-356

### ***Supplemental Inflatable Restraint System (Air Bags)***

This section explains the Supplemental Inflatable Restraint (SIR), or "air bag," system. Your Chevrolet has an air bag for both the driver and the right-front passenger.

Here's the most important thing to know:

#### **CAUTION:**



Even with an air bag, if you're not wearing a safety belt and you're in a crash, your injuries may be much worse. Air bags are not designed to inflate in rollovers or in rear, side or low-speed frontal crashes. You need to wear your safety belt to reduce the chance of hitting things inside the vehicle or being ejected from it. Always wear your safety belt, even with an air bag.

# Seats & Safety Belts



## **CAUTION:**

 Air bags inflate with great force, faster than the blink of an eye. If you're too close to an inflating air bag, it could seriously injure you. Safety belts help keep you in position for an air bag inflation in a crash. Always wear your safety belt, even with an air bag, and the driver should sit as far back as possible while still maintaining control of the vehicle.

## **CAUTION:**

 An inflating air bag can seriously injure small children. Always secure children properly in your vehicle. To read how, see the "Children and Safety Belts" section of this manual, and read the caution label on the front-passenger's safety belt.

## **Air Bag System Light**

There is an air bag readiness light on the instrument panel, which has **AIR BAG** on it. The system checks itself and the light tells you if there is a problem.

You will see this light flash for a few seconds when you turn your ignition to **Run** or **Start**. Then the light should go out, which means the system is ready.



### **CAUTION:**



If the air bag readiness light doesn't come on when you start your vehicle, or stays on, or comes on when you are driving, your air bag system may not work properly. Have your vehicle serviced right away.

### **How the Air Bag System Works**

#### **Where is the air bag?**

The driver's air bag is in the middle of the steering wheel.

The right-front passenger's air bag is located in the instrument panel on the passenger's side.

# Seats & Safety Belts

## **When is an air bag expected to inflate?**

The air bag is designed to inflate in moderate to severe frontal or near-frontal crashes. The air bag will only inflate if the velocity of the impact is above the designed threshold level. When impacting straight into a wall that does not move or deform, the threshold level for most GM vehicles is between 9 and 14 mph (14 and 23 km/h). However, this velocity threshold depends on the vehicle design and may be several miles-per-hour faster or slower. In addition, this threshold velocity will be considerably higher if the vehicle strikes an object such as a parked car which will move and deform on impact. The air bag is also not designed to

inflate in rollovers, side impacts, or rear impacts where the inflation would provide no occupant protection benefit.

In any particular crash, the determination of whether the air bag should have inflated cannot be based solely on the level of damage on the vehicle(s). Inflation is determined by the angle of the impact and the vehicle's deceleration, of which vehicle damage is only one indication. Repair cost is not a good indicator of whether an air bag should have deployed.

## **What makes an air bag inflate?**

In a frontal or near-frontal impact of sufficient severity, sensors strategically located on the vehicle detect that the vehicle is suddenly stopping as a result of a crash. These sensors complete an electrical circuit, triggering a chemical reaction of the sodium azide sealed in the inflator. The reaction produces nitrogen gas, which inflates a cloth bag. The inflator, cloth bag, and related hardware are all part of the air bag inflator modules packed inside the steering wheel and in the instrument panel in front of the passenger.



### **How does an air bag restrain?**

In moderate to severe frontal or near-frontal collisions, even belted occupants can contact the steering wheel or the instrument panel. The air bag supplements the protection provided by safety belts. Air bags distribute the force of the impact more evenly over the occupant's upper body, stopping the occupant more gradually. But air bags would not provide protection in many types of collisions, including rollovers and rear and side impacts, primarily because an occupant's motion is not toward the air bag. Air bags should never be regarded as anything more than a supplement to safety belt protection in

moderate to severe frontal and near-frontal collisions.

### **What will you see after an air bag inflation?**

After the air bag has inflated, it will then quickly deflate. This occurs so quickly that some people may not even realize that the air bag inflated. The air bag will **not** impede the driver's vision or ability to steer the vehicle, nor will it hinder the occupants from exiting the vehicle. There will be small amounts of smoke coming from vents in the deflated air bags. Some components of the air bag module in the steering wheel hub for the driver's air bag or the instrument panel for the passenger's bag may be hot for a short

time, but the portion of the bag that comes into contact with you will not be hot to the touch. The nitrogen gas used to inflate the air bag will have vented into the passenger compartment, and the bag will be deflated within seconds after the collision. Nitrogen makes up about 80% of the air we breathe and is not hazardous. As the nitrogen vents from the bag, small particles are also vented into the passenger compartment.

In many crashes severe enough to inflate an air bag, windshields are broken by vehicle deformation. Additional windshield breakage may occur in vehicles with passenger air bags because the windshield acts as a reaction surface for the inflating air bag.

# Seats & Safety Belts

## CAUTION:



- Don't attach anything to the steering wheel pad. It might injure the driver if the air bag inflates.
- Don't set anything on or attach anything to the instrument panel. It might injure the passenger if the air bag inflates.
- The air bags are designed to inflate only once. After they inflate, you'll need some new parts for your air bag system. If you don't get them, the air bag system won't be there to help protect you in another crash. A new system will include air bag modules and possibly other parts.
- Let only qualified technicians work on your air bag system. Improper service can mean that your air bag system won't work properly. See your dealer for service.

## NOTICE:

If you damage the cover for the right-front passenger's air bag, it may not work properly. You may have to replace both the air bag and the instrument panel. Don't open or break the air bag cover.

### Servicing Your Chevrolet with the Air Bag System

Please tell or remind anyone who works on your Chevrolet that it has the air bag system. There are parts of the air bag system in several places around your vehicle. You don't want the system to inflate while someone is working on your vehicle. The air bag system does not need

regular maintenance. Your Chevrolet dealer and the 1993 Camaro Service Manual have information about the air bag system, including repair or disposal.

## CAUTION:



For up to 2 minutes after the ignition key is turned off and the battery disconnected, an air bag can still inflate during improper service. You can be injured if you are close to an air bag when it inflates. Be sure to follow the proper service procedures.

When electrical work is done under the hood or inside your vehicle, the ignition should be in **LOCK** if possible. Avoid wires wrapped with yellow tape, or yellow connectors. They are probably part of the air bag system.

Your vehicle has a driver's air bag and a right-front passenger's air bag. Both bags must be disconnected if the ignition has to be on for electrical work or if the steering column is to be disassembled. First, disconnect the driver's air bag like this:

1. Turn off the ignition.
2. Remove the SIR (air bag) fuse. (See "Fuses and Circuit Breakers" in the Index.)
3. Disconnect the yellow connector at the base of the steering column.

After you follow this procedure for the driver's air bag, then disconnect the right-front passenger's air bag like this:

1. Remove the cover under the instrument panel.
2. Disconnect the small yellow connector below the glove box.

When the work is complete, if the air bag system was disconnected, be sure to reattach everything and replace the fuse before turning the ignition on. When you turn the ignition key on, be sure you see the air bag readiness light on the instrument panel. If you don't see this light flash and then go out as usual, have your air bag system repaired.



### ***Safety Belt Use during Pregnancy***

Safety belts work for everyone, including pregnant women. Like all occupants, they are more likely to be seriously injured if they don't wear safety belts.

A pregnant woman should wear a lap-shoulder belt, and the lap portion should be worn as low as possible throughout the pregnancy.

The best way to protect the fetus is to protect the mother. When a safety belt is worn properly, it's more likely that the fetus won't be hurt in a crash. For pregnant women, as for anyone, the key to making safety belts effective is wearing them properly.

# Seats & Safety Belts

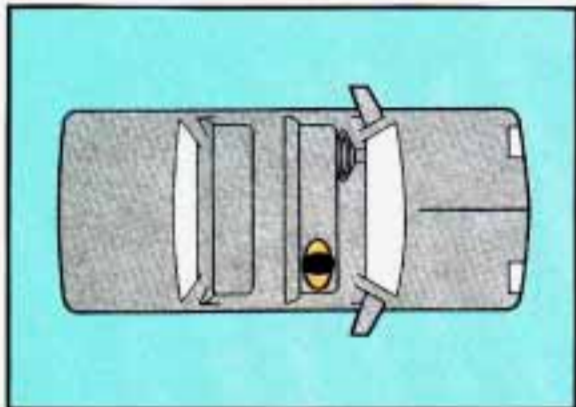

## *Passenger Positions*

### **Right Front Passenger Position**

The right front passenger's safety belt works the same way as the driver's safety belt. See "Driver Position," earlier in this part.

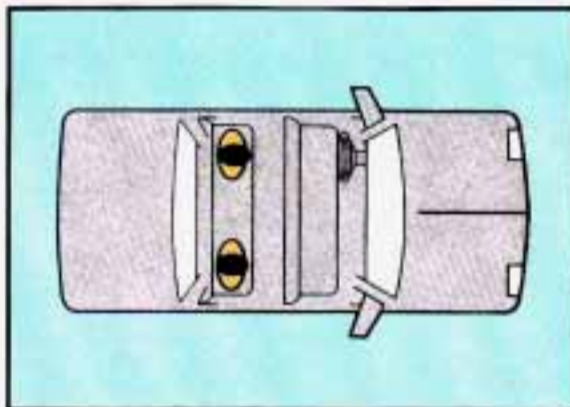

### **Rear Seat Passengers**

It's very important for rear seat passengers to buckle up! Accident statistics show that unbelted people in the rear seat are hurt more often in crashes than those who are wearing safety belts.

Rear passengers who aren't safety belted can be thrown out of the vehicle in a crash. And they can strike others in the vehicle who are wearing safety belts.

The rear seats have lap-shoulder belts. Here's how to wear one properly.



1. Pick up the latch plate and pull the belt across you. Don't let it get twisted.
2. Push the latch plate into the buckle until it clicks.



If the belt stops before it reaches the buckle, tilt the latch plate and keep pulling until you can buckle it.

If the belt is not long enough, see "Safety Belt Extender" at the end of this section.

Make sure the release button on the buckle faces upward or outward so you would be able to unbuckle it quickly if you ever had to.



3. To make the lap part tight, pull down on the buckle end of the belt as you pull up on the shoulder part.

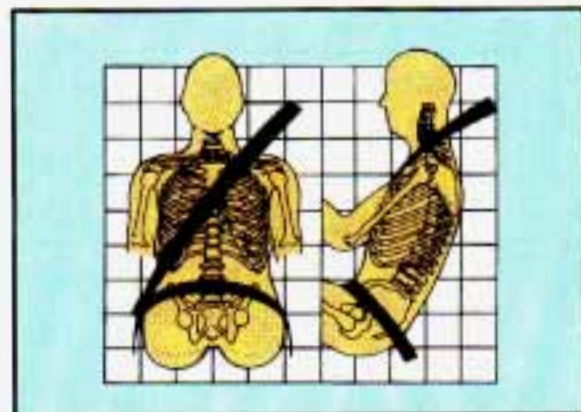

The lap part of the belt should be worn low and snug on the hips, just touching the thighs. In a crash, this applies force to the strong pelvic bones. And you'd be less likely to slide under the lap belt. If you slid under it, the belt would apply force at your abdomen. This could cause serious or even fatal injuries. The shoulder belt should go over the shoulder and across the chest. These parts of the body are best able to take belt restraining forces.

# Seats & Safety Belts



The safety belt locks if there's a sudden stop or a crash.

## **CAUTION:**



You can be seriously hurt if your shoulder belt is too loose. In a crash you would move forward too much, which could increase injury. The shoulder belt should fit against your body.

- To unlatch the belt, just push the button on the buckle.

## ■ *Children*

Everyone in a vehicle needs protection! That includes infants and all children smaller than adult size. In fact, the law in every state and Canadian province says children up to some age must be restrained while in a vehicle.

### Smaller Children and Babies



#### **CAUTION:**



Smaller children and babies should always be restrained in a child or infant restraint. The instructions for the restraint will say whether it is the right type and size for your child. A very young child's hip bones are so small that a regular belt might not stay low on the hips, as it should. Instead, the belt will likely be over the child's abdomen. In a crash the belt would apply force right on the child's abdomen, which could cause serious or fatal injuries. So, be sure that any child small enough for one is always properly restrained in a child or infant restraint.

#### **CAUTION:**



Never hold a baby in your arms while riding in a vehicle. A baby doesn't weigh much — until a crash. During a crash a baby will become so heavy you can't hold it. For example, in a crash at only 25 mph (40 km/h), a 12-pound (5.5 kg) baby will suddenly become a 240-pound (110 kg) force on your arms. The baby would be almost impossible to hold.  
Secure the baby in an infant restraint.

# Seats & Safety Belts

## ■ *Child Restraints*

Be sure to follow the instructions for the restraint. You may find these instructions on the restraint itself or in a booklet, or both. These restraints use the belt system in your vehicle, but the child also has to be secured within the restraint to help reduce the chance of personal injury. The instructions that come with the infant or child restraint will show you how to do that.

### **Where to Put the Restraint**

Accident statistics show that children are safer if they are restrained in the rear rather than the front seat. We at General Motors therefore recommend that you put your child restraint in the rear seat. If you are using a rear-facing child restraint, don't put it in the front seat. Here's why:

### **CAUTION:**



A child in a rear-facing child restraint can be seriously injured if the right-front passenger's air bag inflates. This is because the back of a rear-facing child restraint would be very close to the inflating air bag. If your vehicle has a right-front passenger's air bag, always secure a rear-facing child restraint in the rear seat.

You may secure a forward-facing child restraint in the right-front seat. However, before securing a forward-facing child restraint, **ALWAYS** move the front passenger seat as far back as it will go. Or, secure the child restraint in the rear seat.





Wherever you install it, be sure to secure the child restraint properly.

**CAUTION:**



An unsecured child restraint can move around in a collision or sudden stop and injure people in the vehicle. Be sure to properly secure any child restraint in your vehicle — even when no child is in it.

**Top Strap**

If your child restraint has a top strap, it should be anchored.

If you need to have an anchor installed, you can ask your Chevrolet dealer to put it in for you. If you want to install an anchor yourself, your dealer can tell you how to do it.

**CAUTION:**



The place where the anchor has to go is quite close to your fuel tank. If the anchor isn't put in correctly, it can make a hole in the fuel tank — either then, or in a later collision. Gasoline could leak out and be ignited, and people in the vehicle or outside it could be badly burned. Don't put in the anchor yourself unless you know you can do it correctly.

## Seats & Safety Belts

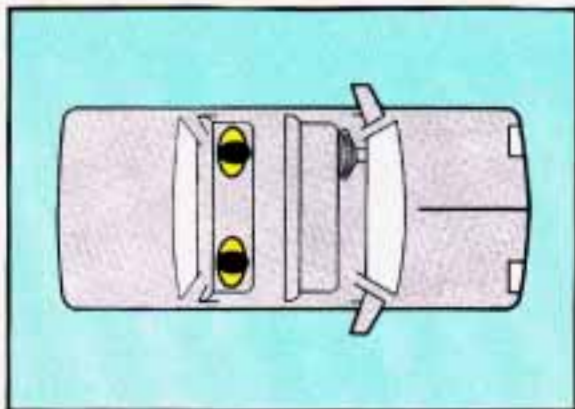

Vehicles first sold in Canada have child restraint anchor bracket hardware in the glove box, along with instructions for installing it. This should be used only with a child restraint, and only to secure a child restraint at a rear seating position. An additional anchor bracket for a child restraint at the other rear seating position is available at Chevrolet dealerships in Canada.

### Securing a Child Restraint in the Rear Seat

You'll be using the lap-shoulder belt. See the earlier section about the top strap if the child restraint has one.

1. Put the restraint on the seat. Follow the instructions for the child restraint.
2. Secure the child in the child restraint as the instructions say.

3. Pull out the vehicle's safety belt and run the lap part through or around the restraint. The child restraint instructions will show you how. Tilt the latch plate to adjust the belt if needed.

See if the shoulder belt would go in front of the child's face or neck. If so, put it behind the child restraint.



4. Buckle the belt. Make sure the release button faces upward or outward, so you'll be able to unbuckle it quickly if you ever need to.



5. To tighten the belt, pull up on the shoulder belt while you push down on the child restraint.



6. Push and pull the child restraint in different directions to be sure it is secure.

To remove the child restraint, just unbuckle the vehicle's safety belt and let it go back all the way. The safety belt will move freely again and be ready to work for an adult or larger child passenger.

## Seats & Safety Belts

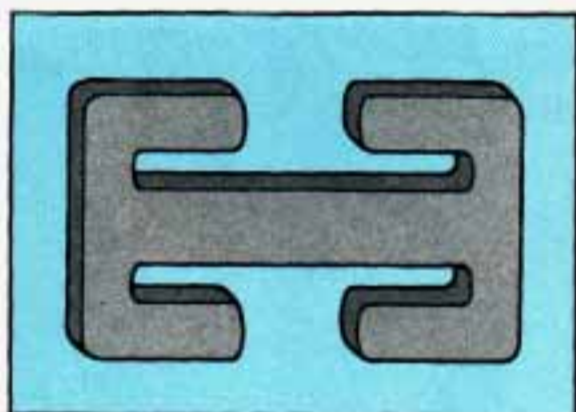
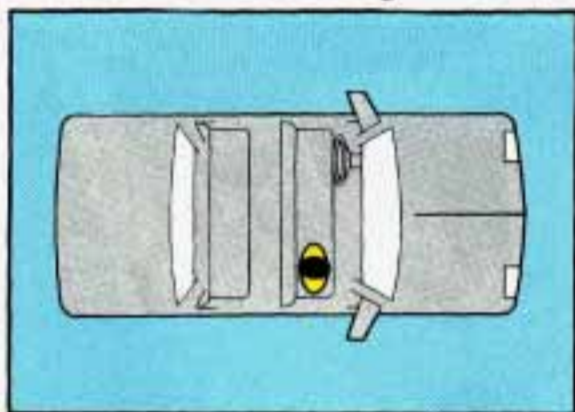

### Securing a Child Restraint in the Right Front Seat

Your vehicle has a right-front passenger's air bag. NEVER put a rear-facing child restraint in this position. Here's why:

#### **CAUTION:**

 A rear-facing child restraint in the front seat could be pushed into the seatback by the right-front passenger's air bag if it inflates. A child in a rear-facing child restraint can be seriously injured if this happens. Always secure a rear-facing child restraint in the rear seat.

You'll be using the lap-shoulder belt. See the earlier section about the top strap if the child restraint has one.

You'll need a safety locking clip to properly secure a child restraint in this position. You can get a locking clip where child restraints are sold, or from your Chevrolet dealer (GM Part No. 94844571). The locking clip must be the same as the one shown here.

Until you have this clip, secure a child restraint only in the rear seat. See the earlier section about securing a child restraint in the rear seat. Once you have the clip, follow these instructions:

1. Move the seat as far back as it will go before securing a front-facing child restraint.
2. Put the restraint on the seat. Follow the instructions for the child restraint.

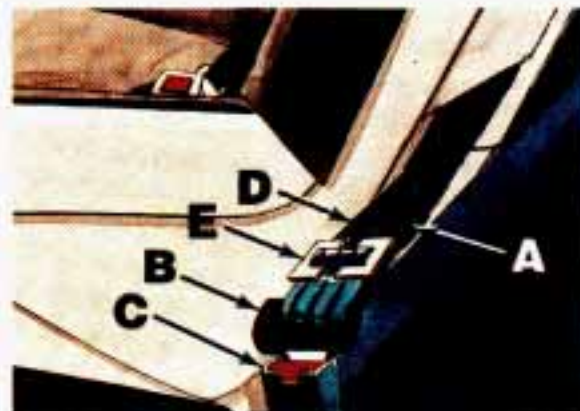

3. Secure the child in the child restraint as the instructions say.
4. Pull out the vehicle's safety belt and run the lap part through or around the restraint. The child restraint instructions will show you how.  
See if the shoulder belt would go in front of the child's face or neck. If so, put it behind the child restraint.

5. Buckle the belt.  
Make sure the release button faces upward or outward, so you'll be able to unbuckle it quickly if you ever need to.

- A. Lap Belt Portion
  - B. Latch Plate
  - C. Buckle
  - D. Shoulder Belt Portion
  - E. Locking Clip
6. Then thread both lap and shoulder belt portions through the locking clip.

## Seats & Safety Belts



### **CAUTION:**

 If a locking clip is not used or is not installed properly, the child restraint may move or tip over when your vehicle turns or stops quickly. The child or others could be injured. When you secure a child restraint with a lap-shoulder belt, always thread both the lap and shoulder belt portions through a locking clip.

7. Push and pull the child restraint in different directions to be sure it is secure.

To remove the child restraint, just unbuckle the vehicle's safety belt and remove the locking clip. Let the safety belt go back all the way.

### **CAUTION:**

 When not used with a child restraint seat, a safety belt with a child restraint locking clip still attached can cause serious injury in a crash. Always remove the clip when you are not using it with a child restraint.

The safety belt will move freely again and be ready to work for an adult or larger child passenger.



## ■ *Larger Children*

Children who have outgrown child restraints should wear the vehicle's safety belts.

Accident statistics show that children are safer if they are restrained in the rear seat. But they need to use the safety belts properly.

- Children who aren't buckled up can be thrown out in a crash.

- Children who aren't buckled up can strike other people who are.

### **CAUTION:**



Never do this.

Here two children are wearing the same belt. The belt can't properly spread the impact forces. In a crash, the two children can be crushed together and seriously injured. A belt must be used by only one person at a time.

# Seats & Safety Belts



**Q.** What if a child is wearing a lap-shoulder belt, but the child is so small that the shoulder belt is very close to the child's face or neck?

**A:** Move the child toward the center of the vehicle, but be sure that the shoulder belt still is on the child's shoulder, so that in a crash the child's upper body would have the restraint that belts provide.

## **CAUTION:**



Never do this. Here a child is sitting in a seat that has a lap-shoulder belt, but the shoulder part is behind the child. If the child wears the belt in this way, in a crash the child might slide under the belt. The belt's force would then be applied right on the child's abdomen. That could cause serious or fatal injuries.

Wherever the child sits, the lap portion of the belt should be worn low and snug on the hips, just touching the child's thighs. This applies belt force to the child's pelvic bones in a crash.

## ■ *Safety Belt Extender*

If the vehicle's safety belt will fasten around you, you should use it.

But if a safety belt isn't long enough to fasten, your dealer will order you an extender. It's free. When you go in to order it, take the heaviest coat you will wear, so the extender will be long enough for you. The extender will be just for you, and just for the seat in your vehicle that you choose. Don't let someone else use it, and use it only for the seat it is made to fit. To wear it, just attach it to the regular safety belt.



## ■ *Checking Your Restraint Systems*

Now and then, make sure all your belts, buckles, latch plates, retractors, anchorages and reminder systems are working properly. Look for any loose parts or damage. If you see anything that might keep a restraint system from doing its job, have it repaired.

## ■ *Replacing Safety Belts after a Crash*

If you've had a crash, do you need new belts?

After a very minor collision, nothing may be necessary. But if the belts were stretched, as they would be if worn during a more severe crash, then you need new belts.

If belts are cut or damaged, replace them. Collision damage also may mean you will have to have safety belt parts, like the retractor, replaced or anchorage locations repaired — even if the belt wasn't being used at the time of the collision.



**Q:** What's wrong with this?

**A:** The belt is torn.

### **CAUTION:**



Torn or frayed belts may not protect you in a crash. They can rip apart under impact forces. If a belt is torn or frayed, get a new one right away.

The model number on the replacement belt must be listed on the safety belt you want to replace.

# Notes



**H**ere you can learn about the many standard and optional features on your Chevrolet, and information on starting, shifting and braking. Also explained are the instrument panel and the warning systems that tell you if everything is working properly — and what to do if you have a problem.

## Part 2 Features & Controls

Keys .....	48
Door Locks .....	50
Theft .....	52
PASS-Key II® .....	53
New Vehicle "Break-In" .....	55
Ignition Switch .....	55
Starting Your Engine .....	57
Driving through Deep Standing Water .....	61
Engine Block Heater .....	61
Automatic Transmission .....	62
Manual Transmission .....	66
Limited-Slip Rear Axle .....	70
Parking .....	70
Engine Exhaust .....	74
Windows .....	75
Horn .....	76
Tilt Wheel .....	76
The Turn Signal/Headlight Beam Lever .....	77
Operation of Lights .....	84
Interior Lights .....	86
Mirrors .....	87
Twin Lift-Off Roof Panels .....	88
Storage and Compartments .....	92
Sun Visors .....	94
Ashtray and Lighter .....	94
Floor Mats .....	95
Instrument Panel and Cluster .....	98
Warning Lights, Gages and Indicators .....	99

## Features & Controls



### ■ Keys

#### **CAUTION:**



Leaving young children in a vehicle with the ignition key is dangerous for many reasons. A child or others could be badly injured or even killed.

They could operate power windows or other controls or even make the vehicle move. Don't leave the keys in a vehicle with young children.

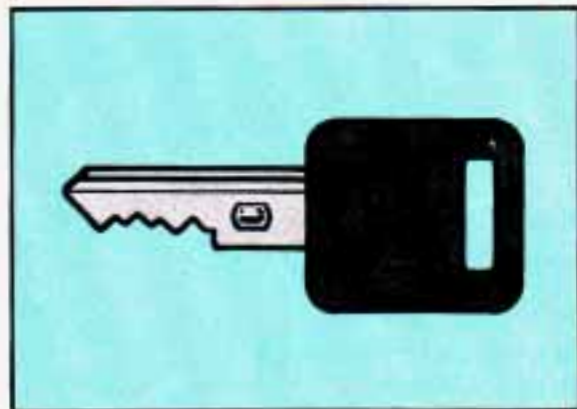

The ignition keys are for the ignition only.



The door keys are for the doors and all other locks.

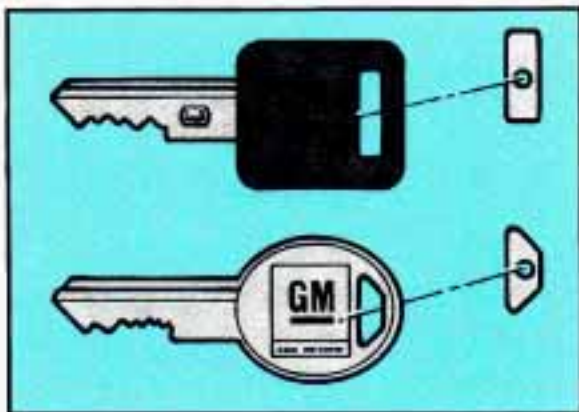

When a new Camaro is delivered, the dealer removes the plugs from the keys, and gives them to the first owner. However, the ignition key may not have a plug.

If the ignition key doesn't have a plug, there will be a bar-coded key tag instead. Each plug or tag has a code on it that tells your dealer or a qualified locksmith how to make extra keys. Keep the plugs in a safe place. If you lose your keys, you'll be able to have new ones made easily using these plugs. If your ignition keys don't have plugs, go to your Chevrolet dealer for the correct key code if you need a new ignition key.

### **NOTICE:**

Your Chevrolet has a number of new features that can help prevent theft. But you can have a lot of trouble getting into your vehicle if you ever lock your keys inside. You may even have to damage your vehicle to get in. So be sure you have extra keys.

# Features & Controls

## ■ *Door Locks*

### **CAUTION:**

 Unlocked doors can be dangerous.

Passengers — especially children — can easily open the doors and fall out. When a door is locked, the inside handle won't open it.

Outsiders can easily enter through an unlocked door when you slow down or stop your vehicle.

This may not be so obvious: You increase the chance of being thrown out of the vehicle in a crash if the doors aren't locked. Wear safety belts properly, lock your doors, and you will be far better off whenever you drive your vehicle.



There are several ways to lock and unlock your vehicle:

From the outside: Use your door key.



From the inside: To lock the door, move the lock control on the door back.

To unlock the door, move the lock control on the door forward.



#### **Power Door Locks (Option)**

Push the power door lock switch to lock or unlock both doors at once.

The switch only works when the ignition switch is in **Run** or **Acc**, or when RAP is present. (See "Retained Accessory Power" in the Index.)

#### **Leaving Your Vehicle**

If you are leaving the vehicle, take your keys, open your door and set the locks from inside. Then get out and close the door.



#### **Hatch Release**

Your door key opens the hatch.



#### **Remote Hatch Release (Option)**

Press the switch in your glove box to unlock the hatch from inside your vehicle. If you have an automatic transmission, your shift lever must be in **P** (Park) or **N** (Neutral) to use the switch. If you have a manual transmission and the ignition switch is in **Run**, you must set the parking brake before you can use the switch.

The switch only works when the ignition switch is in **Run** or **Acc**, or when RAP is present. (See "Retained Accessory Power" in the Index.)

# Features & Controls

## NOTICE:

If you put things in the hatchback area, be sure they won't break the glass when you close it. Never slam the hatch down. You could break the glass or damage the defogger grid (if equipped).

## CAUTION:



It can be dangerous to drive with the hatch open. Carbon monoxide (CO) gas can come into your vehicle. You can't see or smell CO. It can cause unconsciousness and even death.

If you must drive with the hatch open:

- Make sure all other windows are shut.
- Turn the fan on your heating or cooling system to its highest speed with the setting on . That will force outside air into your vehicle. See "Comfort Controls" in the Index.
- If you have air vents on or under the instrument panel, open them all the way.

## ■ Theft

Vehicle theft is big business, especially in some cities. Although your Chevrolet has a number of theft-deterrent features, we know that nothing we put on it can make it impossible to steal. However, there are ways you can help.

**Key in the ignition:** If you walk away from your vehicle with the keys inside, it's an easy target for joy riders or professional thieves — so don't do it.



When you park your Chevrolet and open the driver's door, you'll hear a tone reminding you to remove your key from the ignition and take it with you. Always do this. Your steering wheel will be locked, and so will your ignition. If you have an automatic transmission, taking your key out also locks your transmission. And remember to lock the doors.

**Parking at Night:** Park in a lighted spot, close all windows and lock your vehicle. Remember to keep your valuables out of sight. Put them in a storage area, or take them with you.

**Parking Lots:** If you park in a lot where someone will be watching your vehicle, it's best to lock it up and take your keys. But what if you have to leave your ignition key? What if you have to leave something valuable in your vehicle?

- Put your valuables in a storage area, like your glove box.
- Lock the glove box.
- Lock all the doors except the driver's.
- Then take the door key with you.

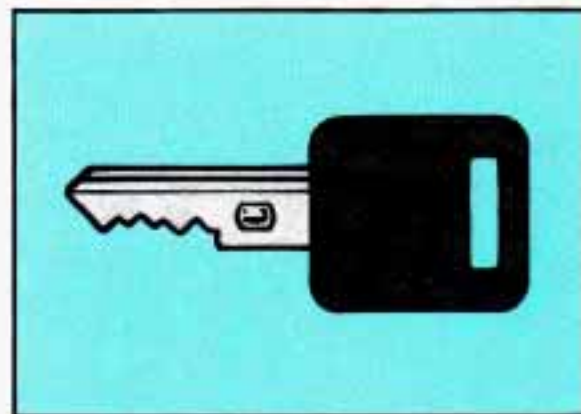

### ■ *PASS-Key II*<sup>®</sup>

Your vehicle is equipped with the PASS-Key II<sup>®</sup> (Personalized Automotive Security System) theft-deterrent system. PASS-Key II<sup>®</sup> is a passive theft-deterrent system. This means you don't have to do anything different to arm or disarm the system. It works when you insert or remove the key from the ignition. PASS-Key II<sup>®</sup> uses a resistor pellet in the ignition key that matches a decoder in your vehicle.

When the PASS-Key II<sup>®</sup> system senses that someone is using the wrong key, it shuts down the vehicle's starter and fuel systems. For about three minutes, the starter won't work and fuel won't go to

## Features & Controls

### SECURITY

the engine. If someone tries to start your vehicle again or uses another key during this time, the vehicle will not start. This discourages someone from randomly trying different keys with different resistor pellets in an attempt to make a match.

The ignition key must be clean and dry before it's inserted in the ignition or the engine may not start. If the engine does not start and the **SECURITY** light stays on when you try to start the vehicle, the key may be dirty or wet. Turn the ignition off.

Clean and dry the key. Wait about three minutes and try again. The **SECURITY** light will remain on during this time. If

the starter still won't work, and the key appears to be clean and dry, wait about three minutes and try the other ignition key. At this time, you may also want to check the fuses (see "Fuses and Circuit Breakers" in the Index). If the starter won't work with the other key, your vehicle needs service. If your vehicle does start, the first ignition key may be faulty. See your Chevrolet dealer or a locksmith who can service the PASS-Key II®.

If you accidentally use a key that has a damaged or missing resistor pellet, the starter won't work and the security light will flash. But you don't have to wait three minutes before trying one of the other ignition keys.

See your Chevrolet dealer or a locksmith who can service the PASS-Key II® to have a new key made.

If you're ever driving and the **SECURITY** light comes on and stays on, you will be able to restart your engine if you turn it off. Your PASS-Key II® system, however, is not working properly and must be serviced by your Chevrolet dealer. Your vehicle is not protected by the PASS-Key II® system.

If you lose or damage a PASS-Key II® ignition key, see your Chevrolet dealer or a locksmith who can service PASS-Key II® to have a new key made.

## ■ *New Vehicle “Break-In”*

### **NOTICE:**

Your modern Chevrolet doesn't need an elaborate “break-in.” But it will perform better in the long run if you follow these guidelines:

- Keep your speed at 55 mph (88 km/h) or less for the first 500 miles (804 km).
- Don't drive at any one speed — fast or slow — for the first 500 miles (804 km). Don't make full-throttle starts.
- Avoid making hard stops for the first 200 miles (322 km) or so. During this time your new brake linings aren't yet broken in. Hard stops with new linings can mean premature wear and earlier replacement. Follow this “breaking-in” guideline every time you get new brake linings.

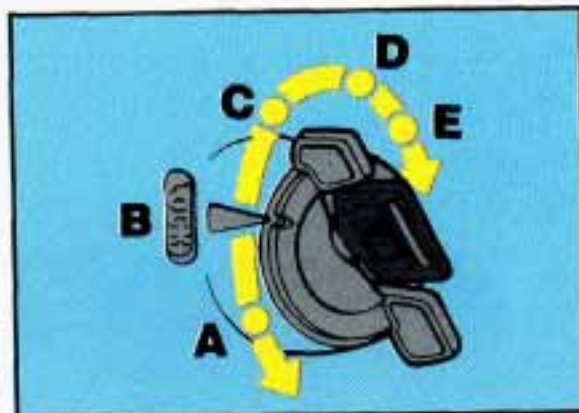

### ■ *Ignition Switch*

With the ignition key in the ignition switch, you can turn the switch to five positions:

**Acc (A):** Position in which you can operate your electrical power accessories. Press in the ignition switch as you turn the top of it toward you.

**LOCK (B):** The only position in which you can remove the key. This locks your steering wheel, ignition and automatic transmission.

If you have an automatic transmission, the ignition switch can't be turned to **LOCK** unless the shift lever is in the **P** (Park) position.

**Off (C):** Unlocks the steering wheel, ignition and automatic transmission, but does not send electrical power to any accessories. Use this position if your vehicle must be pushed or towed. A warning tone will sound if you open the driver's door when the ignition is in **Off** and the key is in the ignition.

**Run (D):** Position to which the switch returns after you start your engine and release the switch. The switch stays in the **Run** position when the engine is running. But even when the engine is not running, you can use **Run** to operate your electrical power accessories and to display some instrument panel warning and indicator lights.

## Features & Controls



**Start (E):** Starts the engine. When the engine starts, release the key. The ignition switch will return to **Run** for normal driving.

Note that even if the engine is not running, **Acc** and **Run** allow you to operate your electrical accessories, such as the radio and ventilation fan.

**Key Release Button:** If you have a manual transmission, your ignition lock has a key release button. You must press the button before you can take your key out of the ignition lock.

### **CAUTION:**

 On manual transmission vehicles, turning the key to **LOCK** will lock the steering column and result in a loss of ability to steer the vehicle. This could cause a collision. If you need to turn the engine off while the vehicle is moving, turn the key only to **Off**. Don't press the key release button while the vehicle is moving.

## **NOTICE:**

If your key seems stuck in **LOCK** and you can't turn it, be sure it is all the way in. If it is, then turn the steering wheel left and right while you turn the key hard. But turn the key only with your hand. Using a tool to force it could break the key or the ignition switch. If none of this works, then your vehicle needs service.

### **Retained Accessory Power (RAP)**

If you have power door locks, your vehicle has a feature called Retained Accessory Power (RAP). With RAP your

power door locks, electric mirrors, power windows, audio system and remote hatch release will continue to work up to 10 minutes after the ignition key is turned to **Off** and neither door is opened.

If a door is opened, the audio system and power windows will shut off. The power door locks, electric mirrors and remote hatch release will work until you shut the door. Once you have shut the door, these accessories will continue to work for approximately 35 seconds. After this time you will not be able to use these accessories until the next time you open a door or turn on the ignition.

## ■ **Starting Your Engine**

**Automatic Transmission:** Move your shift lever to **P** (Park) or **N** (Neutral). Your engine won't start in any other position — that's a safety feature. To restart when you're already moving, use **N** (Neutral) only.

## **NOTICE:**

Don't try to shift to **P** (Park) if your Chevrolet is moving. If you do, you could damage the transmission. Shift to **P** (Park) only when your vehicle is stopped.

# Features & Controls

**Manual Transmission:** Shift your gear selector to neutral and hold the clutch pedal to the floor while starting the engine. Your vehicle won't start if the clutch pedal is not all the way down — that's a safety feature.

## To start your V6 engine:

1. Don't push the accelerator pedal before starting your engine. In some other vehicles you might need to do this, but because of your vehicle's computer systems, you don't.
2. Turn your ignition key to **Start**. When the engine starts, let go of the key. The idle speed will go down as your engine gets warm.

## **NOTICE:**

Holding your key in **Start** for longer than 15 seconds at a time will cause your battery to be drained much sooner. And the excessive heat can damage your starter motor.

3. If your engine won't start (or starts but then stops), it could be flooded with too much gasoline. Try pushing your accelerator pedal all the way to the floor and holding it there as you hold the key in **Start** for about three seconds. If the vehicle starts briefly but then stops again, do the same thing, but this time keep the pedal down for five or six seconds. This clears the extra gasoline from the engine.

## **NOTICE:**

Your engine is designed to work with the electronics in your vehicle. If you add electrical parts or accessories, you could change the way the fuel injection system operates. Before adding electrical equipment, check with your dealer. If you don't, your engine might not perform properly.

If you ever have to have your vehicle towed, see the part of this Manual that tells how to do it without damaging your vehicle. See "Towing Your Vehicle" in the Index.

### **To start your V8 engine:**

1. Don't push the accelerator pedal before starting your engine. In some other vehicles you might need to do this, but because of your vehicle's computer systems, you don't.
2. Turn the ignition key to **Start**. When the engine starts, let go of the key. The idle speed will go down as your engine gets warm.

3. If it doesn't start within 10 seconds, push the accelerator pedal all the way to the floor, while you hold the ignition key in **Start**. When the engine starts, let go of the key and let up on the accelerator pedal. Wait about 15 seconds between each try to help avoid draining your battery.

## **NOTICE:**

Holding your key in **Start** for longer than 15 seconds at a time will cause your battery to be drained much sooner. And the excessive heat can damage your starter motor.

# Features & Controls

When starting your engine in very cold weather (below 0°F or -18°C), do this:

1. With your foot off the accelerator pedal, turn the ignition key to **Start** and hold it there. When the engine starts, let go of the key. Use the accelerator pedal to maintain engine speed, if you have to, until your engine has run for a while.
2. If your engine still won't start (or starts but then stops), it could be flooded with too much gasoline. Try pushing your accelerator pedal all the way to the floor and holding it there as you hold the key in **Start** for about three seconds. If the vehicle starts briefly but then stops again, do the same thing, but this time keep the pedal down for five or six seconds. This clears the extra gasoline from the engine.

## **NOTICE:**

Your engine is designed to work with the electronics in your vehicle. If you add electrical parts or accessories, you could change the way the fuel injection system operates. Before adding electrical equipment, check with your dealer. If you don't, your engine might not perform properly.

If you ever have to have your vehicle towed, see the part of this Manual that tells how to do it without damaging your vehicle. See "Towing Your Vehicle" in the Index.



## ■ *Driving through Deep Standing Water*

### **NOTICE:**

If you drive too quickly through deep puddles or standing water, water can come in through your engine's air intake and badly damage your engine. If you can't avoid deep puddles or standing water, drive through them very slowly.

## ■ *Engine Block Heater* (OPTION)

In very cold weather, 0°F (-18°C) or colder, the engine block heater can help. You'll get easier starting and better fuel economy during engine warm-up.

### **To use the block heater:**

1. Turn off the engine.
2. Open the hood and unwrap the electrical cord.



3. Plug it into a normal, grounded 110-volt outlet.

### **CAUTION:**



Plugging the cord into an ungrounded outlet could cause an electrical shock. Also, the wrong kind of extension cord could overheat and cause a fire. You could be seriously injured. Plug the cord into a properly grounded three-prong 110-volt outlet. If the cord won't reach, use a heavy-duty three-prong extension cord rated for at least 15 amps.

# Features & Controls



## NOTICE:

After you've used the block heater, be sure to store the cord as it was before, to keep it away from moving engine parts. If you don't, it could be damaged.

How long should you keep the block heater plugged in? The answer depends on the weather, the kind of oil you have, and some other things. Instead of trying to list everything here, we ask that you contact a Chevrolet dealer in the area where you'll be parking your vehicle. The dealer can give you the best advice for that particular area.

## ■ Automatic Transmission

There are several different positions for your shift lever.

### ● P (Park)

This locks your rear wheels. It's the best position to use when you start your engine because your vehicle can't move easily.

## CAUTION:



It is dangerous to get out of your vehicle if the shift lever is not fully in **P** (Park) with the parking brake firmly set. Your vehicle can roll.

Don't leave your vehicle when the engine is running unless you have to. If you have left the engine running, the vehicle can move suddenly. You or others could be injured. To be sure your vehicle won't move, when you're on fairly level ground, always set your parking brake and move the shift lever to **P** (Park).

See "Shifting into **P** (Park)" in the Index. If you are parking on a hill, or if you're pulling a trailer, also see "Parking on Hills" or "Towing a Trailer" in the Index.

Ensure the shift lever is fully in **P** (Park) range before starting the engine. Your Chevrolet has a brake-transmission shift interlock. You have to fully **apply** your regular brakes **before** you can shift from **P** (Park) when the ignition key is in the **Run** position. If you cannot shift out of **P** (Park), ease pressure on the shift lever — push the shift lever all the way into **P** (Park) and also release the shift lever button on floor shift console models as you maintain brake application. Then move the shift lever into the gear you wish. (Press the shift lever button before moving the shift lever on floor shift console models.) See “Shifting out of **P** (Park)” in this part.

- **R (Reverse)**

Use this gear to back up.

**NOTICE:**

Shifting to **R** (Reverse) while your vehicle is moving forward could damage your transmission. Shift to **R** only after your vehicle is stopped.

To rock your vehicle back and forth to get out of snow, ice or sand without damaging your transmission, see “Stuck: In Sand, Mud, Ice or Snow, If You’re” in the Index.

- **N (Neutral)**

In this position, your engine doesn’t connect with the wheels. To restart when you’re already moving, use **N** (Neutral) only. Also, use **N** when your vehicle is being towed.

# Features & Controls

## CAUTION:



Shifting out of **P** (Park) or **N** (Neutral) while your engine is “racing” (running at high speed) is dangerous. Unless your foot is firmly on the brake pedal, your vehicle could move very rapidly. You could lose control and hit people or objects. Don't shift out of **P** (Park) or **N** (Neutral) while your engine is racing.

## NOTICE:

Damage to your transmission caused by shifting out of **P** (Park) or **N** (Neutral) with the engine racing isn't covered by your warranty.

### ● **Ⓧ** Automatic Overdrive

This position is for normal driving. If you need more power for passing, and you're:

- Going less than about 35 mph (56 km/h), push your accelerator pedal about halfway down.
- Going about 35 mph (56 km/h) or more, push the accelerator all the way down.

You'll shift down to the next gear and have more power.

### ● **D** (Third Gear)

This is like **Ⓧ**, but you never go into Overdrive.

Here are some times you might choose **D** instead of **Ⓧ**:

- When driving on hilly, winding roads
- When towing a trailer, so there is less shifting between gears
- When going down a steep hill

- **2 (Second Gear)**

This position gives you more power but lower fuel economy. You can use **2** on hills. It can help control your speed as you go down steep mountain roads, but then you would also want to use your brakes off and on.

**NOTICE:**

Don't drive in **2 (Second Gear)** for more than 5 miles (8 km), or at speeds over 55 mph (88 km/h), or you can damage your transmission. Use **Ⓢ** or **D** as much as possible.

Don't shift into **2** unless you are going slower than 65 mph (105 km/h), or you can damage your engine.

- **1 (First Gear) (V6 Engine)**

This position gives you even more power (but lower fuel economy) than **2**. You can use it on very steep hills, or in deep snow or mud. If the selector lever is put in **1**, the transmission won't shift into first gear until the vehicle is going slowly enough.

# Features & Controls

## NOTICE:

If your rear wheels can't rotate, don't try to drive. This might happen if you were stuck in very deep sand or mud or were up against a solid object. You could damage your transmission.

Also, if you stop when going uphill, don't hold your vehicle there with only the accelerator pedal. This could overheat and damage the transmission. Use your brakes or shift into **P** (Park) to hold your vehicle in position on a hill.

Maximum engine speed is limited to protect driveline components from improper operation.

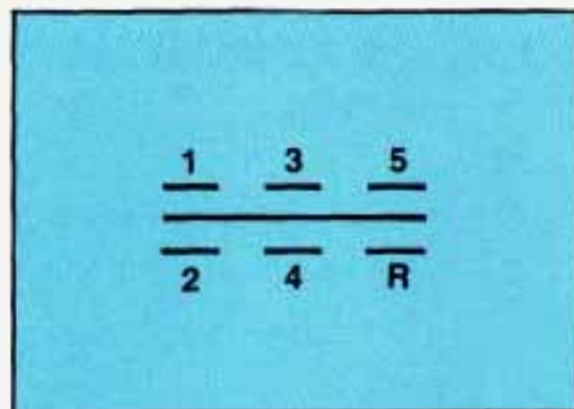

## ■ *Manual Transmission* *Five-Speed*

This is your shift pattern. Here's how to operate your transmission:

- **1 (First Gear)** — Press the clutch pedal and shift into **1**. Then, slowly let up on the clutch pedal as you press the accelerator pedal.

You can shift into **1** when you're going less than 20 mph (32 km/h). If you've come to a complete stop and it's hard to shift into **1**, put the shift lever in **Neutral** and let up on the clutch. Press the clutch pedal back down. Then shift into **1**.

- **2 (Second Gear)** — Press the clutch pedal as you let up on the accelerator pedal and shift into **2**. Then, slowly let up on the clutch pedal as you press the accelerator pedal.
- **3, 4 and 5 (Third, Fourth and Fifth Gears)** — Shift into **3**, **4** and **5** the same way you do for **2**. Slowly let up on the clutch pedal as you press the accelerator pedal.
- **To Stop** — Let up on the accelerator pedal and press the brake pedal. Just before the vehicle stops, press the clutch pedal and the brake pedal, and shift to **Neutral**.

- **Neutral** — Use this position when you start or idle your engine.
- **R (Reverse)** — To back up, press down the clutch pedal and shift into **R**. Let up on the clutch pedal slowly while pressing the accelerator pedal.

### **NOTICE:**

Shift to **R (Reverse)** only after your vehicle is stopped. Shifting to **R (Reverse)** while your vehicle is moving could damage your transmission.

Also, use Reverse, along with the parking brake, for parking your vehicle.

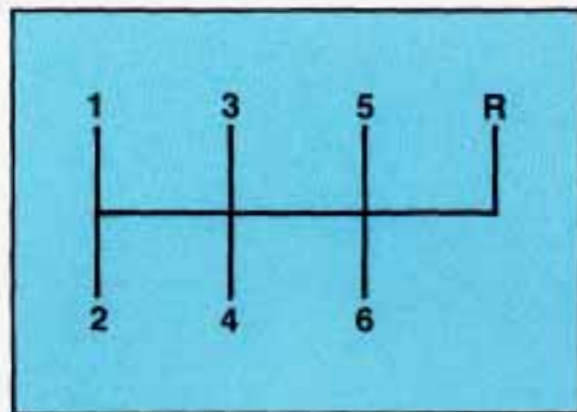

### **Six-Speed**

This is your shift pattern. Here's how to operate your transmission:

- **1 (First Gear)** — Press the clutch pedal and shift into **1**. Then, slowly let up on the clutch pedal as you press the accelerator pedal.

You can shift into **1** when you're going less than 20 mph (30 km/h). If you've come to a complete stop and it's hard to shift into **1**, put the shift lever in **Neutral** and let up on the clutch. Press the clutch pedal back down. Then shift into **1**.

## Features & Controls

- **2 (Second Gear)** — Press the clutch pedal as you let up on the accelerator pedal and shift into **2**. Then, slowly let up on the clutch pedal as you press the accelerator pedal.
- **3, 4, 5 and 6 (Third, Fourth, Fifth and Sixth Gears)** — Shift into **3, 4, 5 and 6** the same way you do for **2**. Slowly let up on the clutch pedal as you press the accelerator pedal.
- **To Stop** — Let up on the accelerator pedal and press the brake pedal. Just before the vehicle stops, press the clutch pedal and the brake pedal, and shift to **Neutral**.

- **Neutral** — Use this position when you start or idle your engine.
- **R (Reverse)** — To back up, press down the clutch pedal and shift into **R**. Let up on the clutch pedal slowly while pressing the accelerator pedal. If you shift from **6** into **R**, the shift lever must be first placed in the **Neutral** position centered between **2** and **3** prior to shifting into **R**.

Your six-speed manual transmission has a feature that allows you to safely shift into **R (Reverse)** while the vehicle is rolling (at less than 5 mph). You will be “locked-out” if you try to shift into **R (Reverse)** while your vehicle is moving faster than 5 mph.

If you have turned your ignition off and wish to park your vehicle in Reverse, you will have to move the shift lever quickly to the right, “crashing” through the high load spring and then into gear.



### **Shift Speeds (MANUAL TRANSMISSION)**

This chart shows when to shift to the next higher gear for best fuel economy.

**MANUAL TRANSMISSION RECOMMENDED SHIFT SPEEDS, IN MPH (km/h)**

Engine	Acceleration Shift Speed				
	1 to 2	2 to 3	3 to 4	4 to 5	5 to 6
3.4L L32 (Code S)	13–16 (21–25)	21–28 (34–35)	32–37 (51–59)	45–47 (72–75)	N/A
5.7L LT1 (Code P)	15 (24)	25 (40)	40 (64)	45 (72)	50 (80)

If your speed drops below 20 mph (30 km/h), or if the engine is not running smoothly, you should downshift to the next lower gear. You may have to downshift two or more gears to keep the engine running smoothly or for good performance.

### **CAUTION:**



If you skip more than one gear when you downshift, you could lose control of your vehicle. And you could injure yourself or others. Don't shift from 6 to 3, 5 to 2 or 4 to 1.

### **NOTICE:**

If you skip more than one gear when you downshift, or if you race the engine when you downshift, you can damage the clutch or transmission.

## Features & Controls

### ■ *Limited-Slip Rear Axle*

If you have this feature, your rear axle can give you additional traction on snow, mud, ice, sand or gravel. It works like a standard axle most of the time, but when one of the rear wheels has no traction and the other does, the limited-slip feature will allow the wheel with traction to move the vehicle.



### ■ *Parking*

#### *Parking Brake*

The parking brake uses the brakes on the rear wheels

**To set the parking brake:** Hold the brake pedal down and pull up on the parking brake lever. If the ignition is on, the brake system warning light will come on.

**To release the parking brake:** Hold the brake pedal down. Pull the parking brake lever up until you can push in the release button. Hold the release button in as you move the brake lever all the way down.

#### **NOTICE:**

Driving with the parking brake on can cause your rear brakes to overheat. You may have to replace them, and you could also damage other parts of your vehicle.

**If you are on a hill:** See “Parking on Hills” in the Index. That section shows how to turn your front wheels.

**If you are towing a trailer and are parking on any hill:** See “Towing a Trailer” in the Index. That section shows what to do first to keep the trailer from moving.

### ***Shifting into P (Park)*** ***(AUTOMATIC TRANSMISSION)***

#### **CAUTION:**



It can be dangerous to get out of your vehicle if the shift lever is not fully in **P (Park)** with the parking brake firmly set. Your vehicle can roll.

If you have left the engine running, the vehicle can move suddenly. You or others could be injured. To be sure your vehicle won't move, when you're on fairly level ground, use the steps that follow. If you are parking on a hill, or if you're pulling a trailer, also see “Parking on Hills” or “Towing a Trailer” in the Index.



1. Hold the brake pedal down with your right foot and set the parking brake.
2. Move the shift lever into **P (Park)** position like this:
  - Hold in the button on the lever, and push the lever all the way toward the front of your vehicle.
3. Move the ignition key to **LOCK**.
4. Remove the key and take it with you. If you can walk away from your vehicle with the ignition key in your hand, your vehicle is in **P (Park)**.

# Features & Controls

## *Leaving Your Vehicle with the Engine Running* (AUTOMATIC TRANSMISSION)

### **CAUTION:**



It can be dangerous to leave your vehicle with the engine running. Your vehicle could move suddenly if the shift lever is not fully in **P** (Park) with the parking brake firmly set. And, if you leave the vehicle with the engine running, it could overheat and even catch fire. You or others could be injured. Don't leave your vehicle with the engine running unless you have to.

If you have to leave your vehicle with the engine running, be sure your vehicle is in **P** (Park) and your parking brake is firmly set before you leave it. After you've moved the shift lever into the **P** (Park) position, hold the regular brake pedal down. Then, see if you can move the shift lever away from **P** (Park) without first pushing the button. If you can, it means that the shift lever wasn't fully locked into **P** (Park).

## *Shifting out of P (Park)* (AUTOMATIC TRANSMISSION)

Your Chevrolet has a brake-transmission shift interlock. You have to fully **apply** your regular brake **before** you can shift from **P** (Park) when the ignition is in the **Run** position. See "Automatic Transmission" in the Index.

If you cannot shift out of **P** (Park), ease pressure on the shift lever — push the shift lever all the way into **P** (Park) and also release the shift lever button on floor shift console models as you maintain brake application. Then move the shift lever into the gear you wish. (Press the shift lever button before moving the shift lever.)

If you ever hold the brake pedal down but still can't shift out of **P** (Park), try this:

1. Turn the key to **Off**.
2. Apply and hold the brake until the end of Step 4.
3. Shift to **N** (Neutral).
4. Start the vehicle and then shift to the drive gear you want.
5. Have the vehicle fixed as soon as you can.

### ***Parking Your Vehicle (MANUAL TRANSMISSION)***

Before you get out of your vehicle, put your manual transmission in **R** (Reverse) and firmly apply the parking brake.

If you are parking on a hill, or if your vehicle is equipped to tow a trailer, see “Parking on Hills” or “Towing a Trailer” in the Index.

## Features & Controls



### *Parking over Things That Burn*

#### **CAUTION:**



Things that can burn could touch hot exhaust parts under your vehicle and ignite. Don't park over papers, leaves, dry grass or other things that can burn.

### ■ *Engine Exhaust*

#### **CAUTION:**



Engine exhaust can kill. It contains the gas carbon monoxide (CO), which you can't see or smell. It can cause unconsciousness and death.

You might have exhaust coming in if:

- Your exhaust system sounds strange or different.
- Your vehicle gets rusty underneath.
- Your vehicle was damaged in a collision.
- Your vehicle was damaged when driving over high points on the road or over road debris.
- Repairs weren't done correctly.
- Your vehicle or exhaust system had been modified improperly.

If you **ever** suspect exhaust is coming into your vehicle:

- Drive it only with all the windows down to blow out any CO; and
- Have it fixed **immediately**.

## ***Running Your Engine While You're Parked (AUTOMATIC TRANSMISSION)***

It's better not to park with the engine running. But if you ever have to, here are some things to know.

### **CAUTION:**



Idling the engine with the air system control off could allow dangerous exhaust into your vehicle (see the earlier Caution under "Engine Exhaust").

Also, idling in a closed-in place can let deadly carbon monoxide (CO) into your vehicle even if the fan switch is at the highest setting. One place this can happen is a garage. Exhaust — with CO — can come in easily. NEVER park in a garage with the engine running.

Another closed-in place can be a blizzard. (See "Blizzard" in the Index.)

### **CAUTION:**



It can be dangerous to get out of your vehicle if the shift lever is not fully in **P** (Park) with the parking brake firmly set. Your vehicle can roll. Don't leave your vehicle when the engine is running unless you have to. If you've left the engine running, the vehicle can move suddenly. You or others could be injured. To be sure your vehicle won't move, even when you're on fairly level ground, always set your parking brake and move the shift lever to **P** (Park).

If you are parking on a hill, or if you're pulling a trailer, also see "Parking on Hills" or "Towing a Trailer" in the Index.

## ■ ***Windows***

### **Manual Windows**

Use the window crank to open and close each door window.

## Features & Controls



### Power Windows (Option)

With power windows, switches on the door control each window when the ignition is on or when RAP is present. (See "Retained Accessory Power" in the Index.)

The switch for the driver's window has an Express Down feature. Quickly press and release the switch for the driver's window and the window will lower completely.

You can also open this window any amount by pressing the switch and releasing it when the window has lowered to the position you want.



### ■ *Horn*

To sound the horn, press either horn symbol on your steering wheel.



### ■ *Tilt Wheel*

A tilt steering wheel allows you to adjust the steering wheel before you drive.

You can also raise it to the highest level to give your legs more room when you exit and enter the vehicle.

To tilt the wheel, hold the steering wheel and pull the lever. Move the steering wheel to a comfortable level, then release the lever to lock the wheel in place.



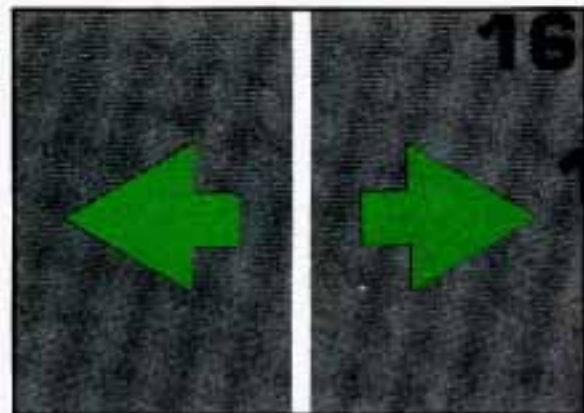

## ■ *The Turn Signal/Headlight Beam Lever*

The lever on the left side of the steering column includes your:

- Turn Signal and Lane Change Indicator
- Headlight High/Low Beam and Passing Signal
- Windshield Wipers
- Windshield Washer
- Cruise Control (Option)

## *Turn Signal and Lane Change Indicator*

The turn signal has two upward (for Right) and two downward (for Left) positions. These positions allow you to signal a turn or a lane change.

To signal a turn, move the lever all the way up or down. When the turn is finished, the lever will return automatically.

A green arrow on the instrument panel will flash in the direction of the turn or lane change.

To signal a lane change, just raise or lower the lever until the green arrow starts to flash. Hold it there until you complete your lane change. The lever will return by itself when you release it.

As you signal a turn or a lane change, if the arrows don't flash but just stay on, a signal bulb may be burned out and other drivers won't see your turn signal.

If a bulb is burned out, replace it to help avoid an accident. If the green arrows don't go on at all when you signal a turn, check the fuse (see "Fuses" in the Index) and for burned-out bulbs.

## Features & Controls

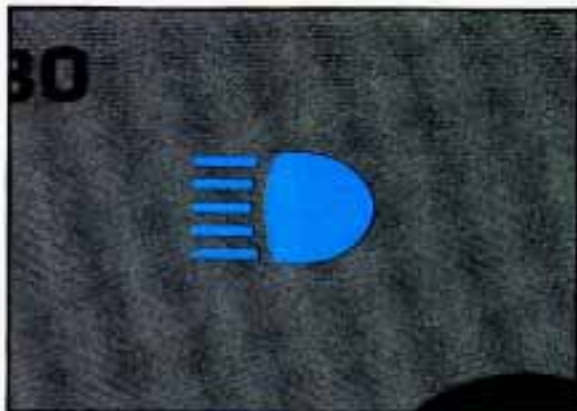

### *Headlight High/Low Beam*

To change the headlights from low beam to high or high to low, pull the turn signal lever all the way toward you. Then release it. When the high beams are on, this blue light on the instrument panel also will be on.



### *Windshield Wipers*

You control the windshield wipers by turning the band with the wiper symbol on it.

For a single wiping cycle, turn the band to **MIST**. Hold it there until the wipers start, then let go. The wipers will stop after one cycle. If you want more cycles, hold the band on **MIST** longer.

You can set the wiper speed for a long or short delay between wipes. This can be very useful in light rain or snow. Turn the band to choose the delay time. The closer to **LO**, the shorter the delay.

For steady wiping at low speed, turn the band away from you to the **LO** position. For high speed wiping, turn the band further, to **HI**. To stop the wipers, move the band to **OFF**.



### **Windshield Washer**

At the top of the turn signal lever there's a paddle with the word **PUSH** on it. To spray washer fluid on the windshield, just push the paddle. The washer will continue to spray until you release the paddle. The wipers will clear the window and wipe a few more times before stopping or returning to the previous setting.

#### **CAUTION:**



Damaged wiper blades may prevent you from seeing well enough to drive safely. To avoid damage, be sure to clear ice and snow from the wiper blades before using them. If they're frozen to the windshield, carefully loosen or thaw them. If your blades do become damaged, get new blades or blade inserts.

Heavy snow or ice can overload your wipers. A circuit breaker will stop them until the motor cools. Clear away snow or ice to prevent an overload.

#### **CAUTION:**



- Driving without washer fluid can be dangerous. A bad mud splash can block your vision. You could hit another vehicle or go off the road. Check your washer fluid level often.
- In freezing weather, don't use your washer until the windshield is warmed. Otherwise the washer fluid can form ice on the windshield, blocking your vision.

# Features & Controls

## NOTICE:

- When using concentrated washer fluid, follow the manufacturer's instructions for adding water.
- Don't mix water with ready-to-use washer fluid. Water can cause the solution to freeze and damage your washer fluid tank and other parts of the washer system. Also, water doesn't clean as well as washer fluid.
- Fill your washer fluid tank only 3/4 full when it's very cold. This allows for expansion, which could damage the tank if it is completely full.
- Don't use radiator antifreeze in your windshield washer. It can damage your washer system and paint.



## Cruise Control (OPTION)

With Cruise Control, you can maintain a speed of about 25 mph (40 km/h) or more without keeping your foot on the accelerator. This can really help on long trips. Cruise Control does not work at speeds below about 25 mph (40 km/h).

When you apply your brakes, or push the clutch pedal, if you have a manual transmission, the Cruise Control shuts off.

## CAUTION:



- Cruise Control can be dangerous where you can't drive safely at a steady speed. So, don't use your Cruise Control on winding roads or in heavy traffic.
- Cruise Control can be dangerous on slippery roads. On such roads, fast changes in tire traction can cause needless wheel spinning, and you could lose control. Don't use Cruise Control on slippery roads.

### To Set Cruise Control

1. Move the Cruise Control switch to **ON**.

#### **CAUTION:**

 If you leave your Cruise Control switch on when you're not using Cruise, you might hit a button and go into Cruise when you don't want to. You could be startled and even lose control. Keep the Cruise Control switch **OFF** until you want to use it.



2. Get up to the speed you want.
3. Push in the set button at the end of the lever and release it.
4. Take your foot off the accelerator pedal.



### To Resume a Set Speed

Suppose you set your Cruise Control at a desired speed and then you apply the brake. This, of course, shuts off the Cruise Control. But you don't need to reset it. Once you're going about 25 mph (40 km/h) or more, you can move the Cruise Control switch from **ON** to **R/A** (Resume/Accelerate) for about half a second.

You'll go right back up to your chosen speed and stay there.

## Features & Controls



### CAUTION:



If you hold the switch at **R/A** longer than half a second, the vehicle will keep going faster until you release the switch or apply the brake. You could be startled and even lose control. So unless you want to go faster, don't hold the switch at **R/A**.

### To Increase Speed While Using Cruise Control

There are two ways to go to a higher speed. Here's the first:

1. Use the accelerator pedal to get to the higher speed.
2. Push the button at the end of the lever, then release the button and the accelerator pedal. You'll now cruise at the higher speed.

Here's the second way to go to a higher speed:

1. Move the Cruise switch from **ON** to **R/A**. Hold it there until you get up to the speed you want, and then release the switch.
- To increase your speed in very small amounts, move the switch to **R/A** for less than half a second and then release it. Each time you do this, your vehicle will go about 1 mph (1.6 km/h) faster.



### **To Reduce Speed While Using Cruise Control**

There are two ways to reduce your speed while using cruise control:

1. Push in the button at the end of the lever until you reach the lower speed you want, then release it.
2. To slow down in very small amounts, push the button for less than half a second. Each time you do this, you'll go 1 mph (1.6 km/h) slower.

### **Passing Another Vehicle While Using Cruise Control**

Use the accelerator pedal to increase your speed. When you take your foot off the pedal, your vehicle will slow down to the Cruise Control speed you set earlier.

### **Using Cruise Control on Hills**

How well your Cruise Control will work on hills depends upon your speed, load, and the steepness of the hills. When going up steep hills, you may have to step on the accelerator pedal to maintain your speed. When going downhill, you may have to brake or shift to a lower gear to keep your speed down. Of course, applying the brake takes you out of Cruise Control. Many drivers find this to be too much trouble and don't use Cruise Control on steep hills.

## Features & Controls



### To Get Out of Cruise Control

There are several ways to turn off the Cruise Control:

1. Step lightly on the brake pedal or push the clutch pedal, if you have a manual transmission; **OR**



2. Move the Cruise switch to **OFF**.

### To Erase Speed Memory

When you turn off the Cruise Control or the ignition, your Cruise Control set speed memory is erased.

## ■ Operation of Lights

Although your vehicle's lighting system (headlights, parking lights, fog lamps, side marker lights and taillights) meet all applicable federal lighting requirements, certain states and provinces may apply their own lighting regulations that may require special attention before you operate these lights. For example, some jurisdictions may require that you operate your lower beam lights with fog lamps at all times, or that headlights be turned on whenever you must use your windshield wipers. In addition, most jurisdictions prohibit driving solely with parking lights, especially at dawn or dusk. It is recommended that you check with your own state or provincial highway authority for applicable lighting regulations.





### Main Light Control

The main light control is a knob that works these lights:

- Headlights
- Taillights
- Parking lights
- License lights
- Sidemarkers lights
- Instrument panel lights

Turn the knob to ☀ to turn on your headlights and other operating lights.

Turn the knob to P☀ to turn on your parking lights without your headlights.

Turn the knob to OFF to turn off the lights.



### Brightness Control

This switch controls the brightness of your instrument panel lights. Turn the switch to brighten or dim the lights. If you turn the switch all the way up to ☀, your courtesy lights will come on.

### Lights On Reminder

If you turn the ignition **Off** and leave the lights on, you will hear a tone when you open the driver's door.

### Daytime Running Lights (Canada)

The Canadian Federal Government has decided that "Daytime Running Lights" (DRL) are a useful feature, in that DRL can make your vehicle more visible to pedestrians and other drivers during daylight hours. DRL are required on new vehicles sold in Canada.

Your DRL work with a light sensor on top of the instrument panel. Don't cover it up.

The front turn signal lights will come on in daylight when:

- The ignition is on
- The headlight switch is off, and
- The parking brake is released.

## Features & Controls



At dusk, the exterior lights will come on automatically and the front turn signal lights will go out. At dawn, the exterior lights will go out and the front turn signal lights will come on (if the headlight switch is off).

Of course, you may still turn on the headlights any time you need to.

To idle your vehicle with the DRL off, set the parking brake while the ignition is in the **Off** or **LOCK** position. Then start the vehicle. The DRL will stay off until you release the parking brake.

### Fog Lights (Option)

Use your fog lights for better vision in foggy or misty conditions. Your parking lights must be on or your fog lights won't work.

To turn the fog lights on, push the switch above . Push the bottom of the switch to turn the fog lights off. A light on the switch will come on when the fog lights are on.

Fog lights will go off whenever your high beams come on. When the high beams go off, the fog lights will come on again.



### ■ Interior Lights

#### Courtesy Lights

When any door is opened, several interior lights go on. These lights are courtesy lights. They make it easier for you to enter and leave your vehicle.

Courtesy lights include the dome light and other lights throughout the interior of your vehicle.



### Front Map Lights

Your inside rearview mirror includes two map lights. Each light has its own switch. Use the switch closest to the light to turn it on. The lights will also go on when a door is opened.

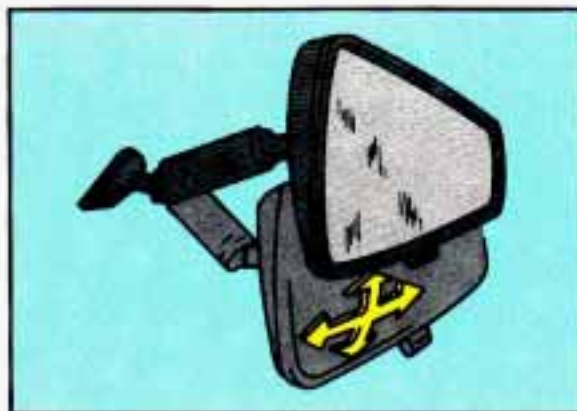

## ■ Mirrors

### Inside Day/Night Rearview Mirror

An inside rearview mirror is attached to your windshield. The mirror has pivots so that you can adjust it up and down or side to side.

You can adjust the mirror for day or night driving. Pull the tab for night driving to reduce glare. Push the tab for daytime driving.

### Manual Adjust Mirror

Adjust the passenger side outside mirror by hand so that you can just see the side of your vehicle when you are sitting in a comfortable driving position.

### Convex Outside Mirror

Your right side mirror is convex.

A convex mirror's surface is curved so you can see more from the driver's seat.

## CAUTION:



If you aren't used to a convex mirror, you can hit another vehicle. A convex mirror can make things (like other vehicles) look farther away than they really are. If you cut too sharply into the right lane, you could hit a vehicle on your right. Check your inside mirror or glance over your shoulder before changing lanes.

## Features & Controls



### Manual Remote Control Mirror

Adjust the driver side outside mirror with the lever on the door. Adjust the mirror so that you can just see the side of your vehicle when you are sitting in a comfortable driving position.

### Electric Mirror Control (Option)

The electric mirror control is on the driver's door. To adjust either mirror, turn the switch to **LEFT** or **RIGHT**. Then use the joystick to adjust the mirror.

The control only works when the ignition switch is in **Run** or **Acc**, or when RAP is present. (See "Retained Accessory Power" in the Index.)

### ■ *Twin Lift-Off Roof Panels (OPTION)*

If you have this option, you can remove one or both lift-off roof panels.

#### **CAUTION:**

 Don't try to remove the T-top panels while the vehicle is moving. Trying to remove a T-top panel while the vehicle is moving could cause an accident. The panel could fall into the vehicle and cause you to lose control, or it could fly off and strike another vehicle. You or others could be injured. Remove a T-top panel only when the vehicle is parked.



The door key unlocks the panels. Turn the key to the left to unlock the panel.



Then pull on the release handle to unlatch the panel. Lift the outer edge of the panel and pull it toward you.

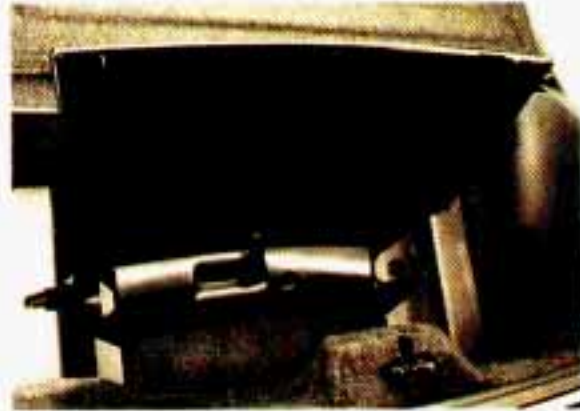

Open the close-out panel completely. Place the panel in the correct slot (**DRIVER** or **PASSENGER**) in the rear area of your vehicle. Make sure the handle is open and facing you when you put it in the storage slot.

### **CAUTION:**



If a T-top panel is not stored properly, it could be thrown about the vehicle in a crash or sudden maneuver. People in the vehicle could be injured. Whenever you store a T-top panel in the vehicle, always be sure that it is stored securely in the correct storage slot with the T-top handle closed.

## Features & Controls



Push the handle closed to secure the panel in the slot. To lock each panel in the storage area, use your door key.

### CAUTION:



An improperly installed T-top panel may fall into or fly off the vehicle. You or others could be injured. After installing a T-top panel, always check that it is firmly attached by pushing up on the underside of the panel.

Reverse the steps above to install the T-top panels.

When installing panels, be sure to align weatherstrips properly. Panels incorrectly installed may leak.

### NOTICE:

High pressure car washes may cause water to enter your vehicle. Never spray water directly at the roof panel joints. This will cause leaks.



### T-Top Sunshades

1. Start with the panel marked **DRIVER FRONT**. Unlatch the driver-side T-top, raise it halfway and close the latch handle.
2. With the top raised and resting on the center roof rail, slide the flat edge of the sunshade panel (with the vinyl side to the glass) between the glass and plastic trim, making sure the edge marked **DRIVER FRONT** is pointing to the front of the vehicle.



3. Open the latch and close the T-top. Check to see if there are any gaps showing. Unlatch the T-top and adjust the sunshade as required.

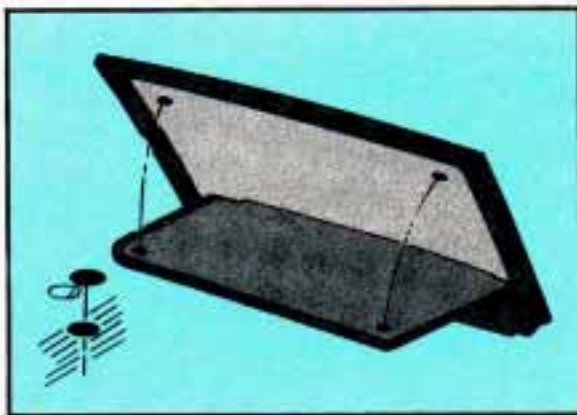

4. Once the sunshade is installed properly, you can stick the velcro® buttons on the glass for a proper fit every time you install the sunshades. To do this, first remove the T-top with the sunshade installed and place it upside down on a table or bench. Take care not to scratch the glass.
5. Pull the sunshade back a little and remove the backing paper from the velcro® buttons. Push the sunshade back into place sticking the velcro® to the glass.
6. Install the T-top, close the latch and lock the T-top. Repeat the above steps for the passenger-side sunshade.



You can store the sunshades in their storage area in the rear of your vehicle. You can also leave them attached to the T-tops. The T-tops can still be removed and placed in their storage slots when the sunshades are attached.

## Features & Controls

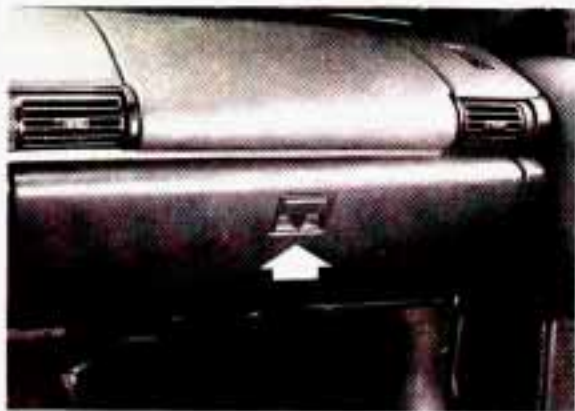

### ■ *Storage and Compartments*

#### **Glove Box**

To open the glove box, lift up on the lever. Use your door key to lock and unlock it. The glove box has a light inside.



#### **Map Pocket**

Each door has a map pocket.



#### **Front Console**

To use the storage area, pull up on the front end of the console. There is a cupholder and light and may be a coinholder in the console.





### **Cassette and Compact Disc Storage**

You have a storage area for cassette tapes.



If you have a compact disc player, you will have a storage area for compact discs in your console.



### **Close-Out Panel**

The close-out panel can be closed for hidden storage in the rear area of your vehicle.

#### **To remove the close-out panel:**

1. Close the panel. If the close-out panel is not closed and resting on the trim panel, it cannot be removed.
2. Pull the panel toward you to unsnap it. Then slide the close-out panel along the groove in the trim panel.

Reverse the steps to install the panel.

## Features & Controls



When carrying large or heavy items, it is a good idea to open the panel and place the items in the rear area.

### **CAUTION:**



An improperly stored close-out panel could be thrown about the vehicle during a collision or sudden maneuver. You or others could be injured. If you remove the cover, don't store it in your vehicle. When you put it back, always be sure that it is securely attached with both sides snapped in place.



### ■ *Sun Visors*

To block out glare, you can swing down the visors. You can also swing them to the side.

#### **Covered Visor Vanity Mirror**

Pull down the sun visor and lift the cover to expose the vanity mirror.



### ■ *Ashtray and Lighter*

#### **Front Ashtray**

Lift up the cover to open the ashtray. To remove it, lift up on the right side of the ashtray. If you have an automatic transmission, the ashtray is near the front of your console. If you have a manual transmission, the ashtray is near your cupholder.

### **NOTICE:**

Don't put papers and other things that burn into your ashtray. If you do, cigarettes or other smoking materials could set them on fire, causing damage.



### Cigarette Lighter

To use the lighter, push it in all the way and let go. When it's ready, it will pop back by itself.

### **NOTICE:**

Don't hold a cigarette lighter in with your hand while it is heating. If you do, it won't be able to back away from the heating element when it's ready. That can make it overheat, damaging the lighter and the heating element.

### ■ *Floor Mats*

Your Chevrolet's floor mats are custom-fitted to the foot wells. Be sure the driver's floor mat is in place. If it isn't, it could interfere with the accelerator or brake pedals.

# Features & Controls

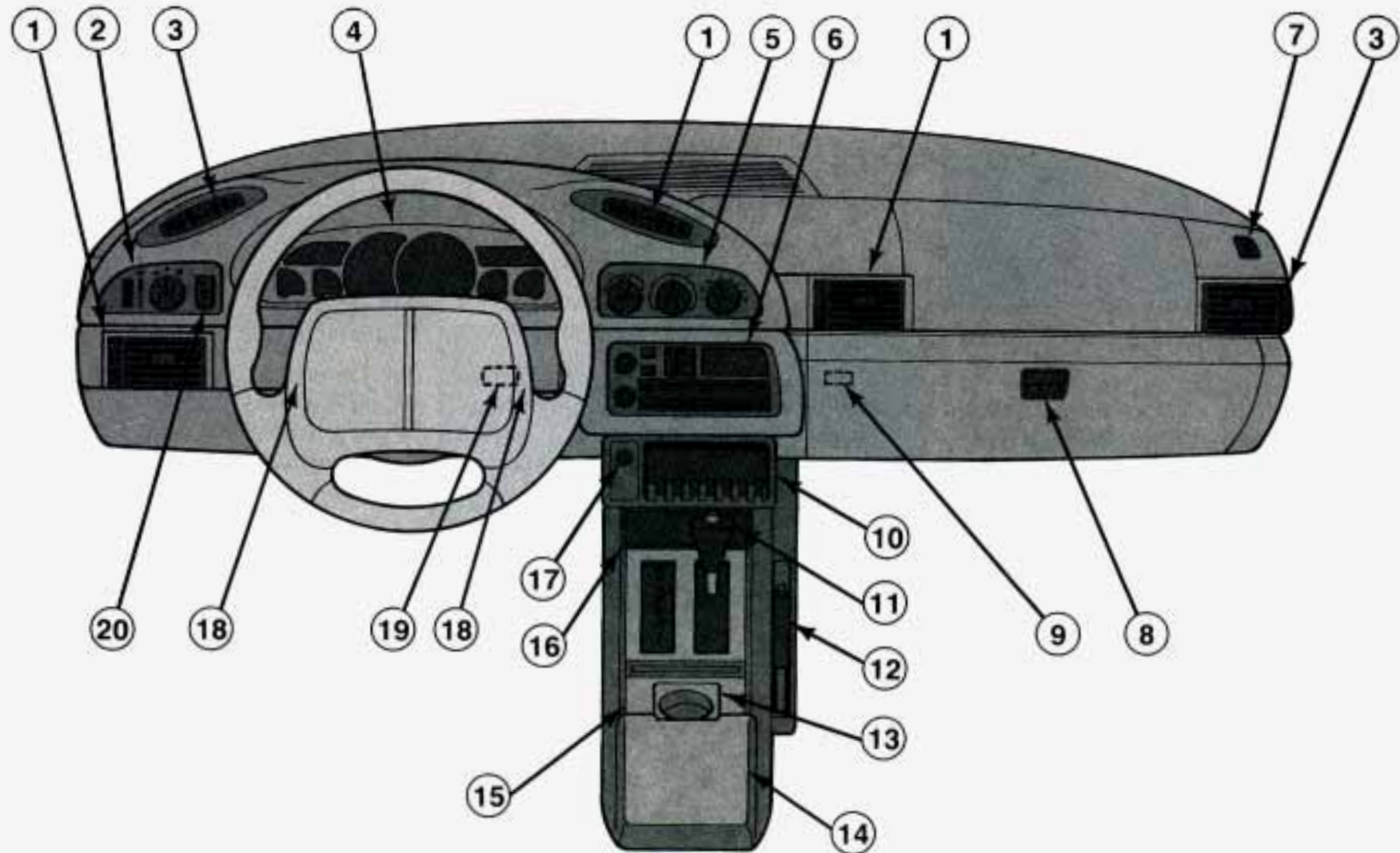

### ***Instrument Panel***

1. Upper Air Vent
2. Main Light Control
3. Side Upper Air Vent
4. Instrument Cluster
5. Comfort Controls
6. Audio System
7. Side Window Defogger Vent
8. Glove Box
9. Remote Hatch Release
10. Cassette Tape Storage
11. Shift Lever
12. Parking Brake Lever
13. Cupholder
14. Storage Console and Compact Disc Storage (if equipped)
15. Cigarette Lighter  
(Manual Transmission)
16. Ashtray and Coinholder with Mat  
(Automatic Transmission)
17. Cigarette Lighter
18. Horn
19. Rear Window Defogger Switch
20. Fog Lamp Switch (if equipped)

# Features & Controls



## ■ *Instrument Panel and Cluster*

Your instrument cluster is designed to let you know at a glance how your vehicle is running. You'll know how fast you're going, about how much fuel you have left and many other things you'll need to know to drive safely and economically.

### **Speedometer and Odometer**

Your speedometer lets you see your speed in both miles per hour (mph) and kilometers per hour (km/h). Your odometer shows how far your vehicle has been driven, in either miles (used in the U.S.) or kilometers (used in Canada).

Your Chevrolet's odometer is tamper-resistant. If you can see silver lines between the numbers, probably someone has tried to turn it back. The numbers may not be true.

U.S. shown, Canada similar

You may wonder what happens if your Chevrolet needs a new odometer installed. If possible, the new one has to be set to the same reading the old one had. If it can't be, then it's set at zero, but a label on the driver's door must show the old reading and when the new one was installed.

### Trip Odometer

The trip odometer can tell you how far your vehicle has been driven since you last set the trip odometer to zero.

To set the trip odometer to zero, press the knob.

### Tachometer

The tachometer displays the engine speed in thousands of revolutions per minute (rpm).

#### **NOTICE:**

Do not operate the engine with the tachometer in the red area, or engine damage may occur.

## ■ *Warning Lights, Gages and Indicators*

This section describes the warning lights and gages that are on your vehicle. The pictures will help you locate them.

Warning lights and gages can signal that something is wrong before it becomes serious enough to cause an expensive repair or replacement. Paying attention to your warning lights and gages could also save you or others from injury.

Warning lights go on when there may be or is a problem with one of your vehicle's functions. As you will see in the details on the next few pages, some warning lights come on briefly when you turn the ignition key just to let you know they're

working. If you are familiar with this section, you should not be alarmed when this happens.

Gages can indicate when there may be or is a problem with one of your vehicle's functions. Often gages and warning lights work together to let you know when there's a problem with your vehicle.

When one of the warning lights comes on and stays on when you are driving, or when one of the gages shows there may be a problem, check the section that tells you what to do about it. Please follow the manual's advice. Waiting to do repairs can be costly — and even dangerous. So please get to know your warning lights and gages. They're a big help.

## Features & Controls



### Fuel Gage

Your fuel gage shows about how much fuel is in your tank. The fuel gage works only when the ignition switch is in the **Run** position. When the gage pointer first indicates **E**, you still have a little fuel left (about one to two gallons), but you need to get more right away.

Here are four concerns some owners have had about the fuel gage. All these situations are normal and do not indicate that anything is wrong with the fuel gage.

- At the gas station, the gas pump shuts off before the gage reads **F**.
- It takes more (or less) gas to fill up than the gage reads. For example, the gage reads 1/2 full, but it took more (or less) than half of the tank's capacity to fill it.
- The gage moves a little when you turn, stop or speed up.
- When you turn the engine off, the gage doesn't go back to **E**.



### Brake System Warning Light

Your Chevrolet's hydraulic brake system is divided into two parts. If one part isn't working, the other part can still work and stop you. For good braking, though, you need both parts working well.

If the warning light goes on, there could be a brake problem. Have your brake system inspected right away.

This light should come on as you start the vehicle. If it doesn't come on then, have it fixed so it will be ready to warn you if there's a problem.



This light will also come on when you set your parking brake, and will stay on if your parking brake doesn't release fully. If it stays on after your parking brake is fully released, it means you have a brake problem.

If the light comes on while driving, pull off the road and stop carefully. You may notice that the pedal is harder to push. Or, the pedal may go closer to the floor. It may take longer to stop. If the light is still on, have the vehicle towed for service. (See "Towing Your Vehicle" in the Index.)

### **CAUTION:**



Your brake system may not be working properly if the brake warning light is on. Driving with the brake warning light on can lead to an accident. If the light is still on after you've pulled off the road and stopped carefully, have the vehicle towed for service.

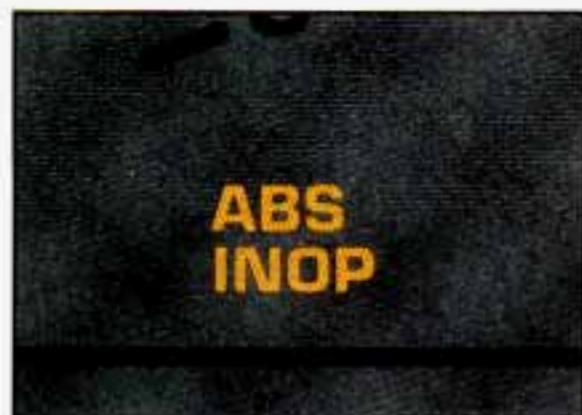

### **Anti-Lock Brake System Warning Light**

With anti-lock, this light will go on when you start your engine and it will stay on for three seconds. If the light doesn't come on, have it fixed so it will be ready to warn you if there is a problem.

## Features & Controls



If the light stays on or comes on when you're driving, stop as soon as possible and turn the key off. Then start the engine to reset the system. If the light still stays on, or comes on again while you're driving, your Chevrolet needs service. Unless the regular brake system warning light is also on, you will still have brakes, but not anti-lock brakes. If the regular brake system warning light is also on, see "Brake System Warning Light" earlier in this part.

When your anti-lock system is working, the message **LOW TRAC** will appear on your instrument cluster. This means that slippery road conditions may exist. Adjust your driving accordingly. The light will stay on for about four seconds after the ABS stops working. The **LOW TRAC** light also comes on during engine starting as a bulb check.



### Engine Coolant Temperature Gage

This gage shows the engine coolant temperature. If the gage pointer moves into the red area, your engine is too hot! It means that your engine coolant has overheated. If you have been operating your vehicle under normal driving conditions, you should pull off the road, stop your vehicle and turn off the engine as soon as possible.

### **HOT COOLANT CAN BURN YOU BADLY!**

In "Problems on the Road," this manual shows what to do. See "Engine Overheating" in the Index.



### Voltmeter

You can read battery voltage on your voltmeter. If it reads less than 11 volts or more than 16 volts while your engine is running, and it stays there, you may have a problem with the electrical charging system. Have it checked right away. Driving with the voltmeter reading in a warning zone could drain your battery.

If you idle your engine for a while, the voltmeter reading might move into the yellow zone. If the reading stays in the yellow zone while you are driving, you may have a problem with the electrical charging system. Have it checked. While the voltmeter reads in the yellow zone, your battery may not be able to power certain electrical accessories, like ABS. (If this happens, your **ABS INOP** light will come on. See "Anti-Lock Brake System Warning Light" in this part.)

If you must drive a short distance with the voltmeter reading in a warning zone, turn off all your accessories, including your comfort control and audio systems.



### Malfunction Indicator Lamp (Service Engine Soon Light)

A computer monitors operation of your fuel, ignition and emission control systems. This light should come on when the ignition is on, but the engine is not running, as a check to show you it is working. If it does not come on at all, have it fixed right away. If it stays on, or it comes on while you are driving, the computer is indicating that you have a problem. You should take your vehicle in for service soon.

## Features & Controls



### **NOTICE:**

If you keep driving your vehicle with this light on, after a while the emission controls won't work as well, your fuel economy won't be as good and your engine may not run as smoothly. This could lead to costly repairs not covered by your warranty.

### **Engine Oil Pressure Gage**

This gage tells you if there could be a problem with your engine oil pressure.

The engine oil pressure gage shows the engine oil pressure in psi (pounds per square inch) in the U.S., or kPa (kilopascals) in Canada, when the engine is running. Oil pressure should be 20 to 80 psi (140 to 550 kPa). It may vary with engine speed, outside temperature and oil viscosity, but readings above the red area show the normal operating range. Readings in the red area tell you that the engine is low on oil, or that you might have some other oil problem. See "Engine Oil" in the Index.

### **CAUTION:**



Don't keep driving if the oil pressure is low. If you do, your engine can become so hot that it catches fire. You or others could be burned. Check your oil as soon as possible and have your vehicle serviced.

### **NOTICE:**

Damage to your engine from neglected oil problems can be costly and is not covered by your warranty.

## CHECK GAUGES

### Check Gages Light

This light will come on briefly when you are starting the engine. If the light comes on and stays on while you are driving, check your gages to see if they are in the warning areas.

## LOW OIL

### Low Oil Light

This light should come on while you are starting your engine. If the light doesn't come on, have it repaired. If the light comes on while starting your engine and stays on, your engine oil level may be too low. You may need to add oil. See the Index under "Engine Oil."



### Low Coolant Light (V8 Engine)

This light should come on while you are starting your engine. If the light doesn't come on, have it repaired. The light also comes on when the coolant in your radiator is low. You may need to add coolant. See the Index under "Engine Coolant."

### **NOTICE:**

Driving with the **LOW COOLANT** light on could cause your Chevrolet to overheat. See "Engine Overheating" in the Index. Your Chevrolet could be damaged, and it wouldn't be covered by your warranty.

# Notes

## Notes

# Notes





## Part 3

# Comfort Controls & Audio Systems

In this part you'll find out how to operate the comfort control systems and audio systems offered with your Chevrolet. Be sure to read about the particular system supplied with your vehicle.

Comfort Controls .....	110
Heater Controls .....	110
Heating .....	111
Bi-Level Heating .....	111
Ventilation .....	112
Defogging and Defrosting Windows .....	112
Air Conditioner Controls .....	112
Cooling .....	113
Rear Window Defogger .....	114
Flow-Through Ventilation System .....	114
Audio Systems .....	115
Setting the Clock .....	116
AM/FM Stereo with Cassette Tape Player .....	117
Delco/Bose AM/FM Stereo with Compact Disc Player .....	121
Understanding Radio Reception .....	127
Care of Your Cassette Tape Player .....	128
Care of Your Compact Discs .....	129
Fixed Mast Antenna .....	129

# Comfort Controls & Audio Systems



## ■ *Comfort Controls*

With this system, you can control the heating and ventilation in your Chevrolet. If you have the air conditioning option, you can also control cooling.

Your vehicle also has the flow-through ventilation system described later in this section.

## *Heater Controls*

### Fan Control Knob

 : Turn this knob to select the force of air you want.

### Temperature Control Knob

Turn the knob to change the temperature of the air flowing from the heating system. Turn it to the right for warmer air and to the left for cooler air. The temperature of the air can not be less than the temperature of the outside air.

### Air Control Knob

OFF: The system is off.

 : Air flows through the upper air vents.

 : Air is directed through the upper air vents and the heater ducts.

 : This setting directs most of the air through the heater ducts and some of the air through the windshield defroster vents.

 : Air is directed through the windshield defroster vents and the heater ducts.

 : This setting directs most of the air through the windshield defroster vents and some of the air through the heater ducts.

## **Heating**

The heater works best if you keep your windows closed while using it.

1. Turn the air control knob to .
2. Turn the fan control knob to the right.
3. Turn the temperature control knob to a comfortable setting.

During initial start-up only, if your vehicle is equipped with an optional engine block heater, you can use it in cold weather (around +20°F/-8°C or lower) to heat the passenger area better than without it. Because an engine block heater warms the engine coolant, your vehicle's heating system can more efficiently provide heat for the passenger area of your vehicle. See "Engine Block Heater" in the Index.

## **Bi-Level Heating**

You may want to use bi-level heating on cool, but sunny days. This setting directs cool air toward your body and warmer air toward your feet.

1. Turn the air control knob to .
2. Turn the temperature control knob to a comfortable setting.
3. Turn the fan control knob to the right.

# Comfort Controls & Audio Systems



## ***Ventilation***

For mild outside temperatures when little heating or cooling is needed, you can still direct outside air through your vehicle.

1. Turn the air control knob to .
2. Turn the temperature control knob to a comfortable setting.
3. Turn the fan control knob to the right.

## ***Defogging and Defrosting Windows***

1. Turn the air control knob to .
2. Turn the temperature control knob all the way to the right.
3. Turn the fan control knob to the right.

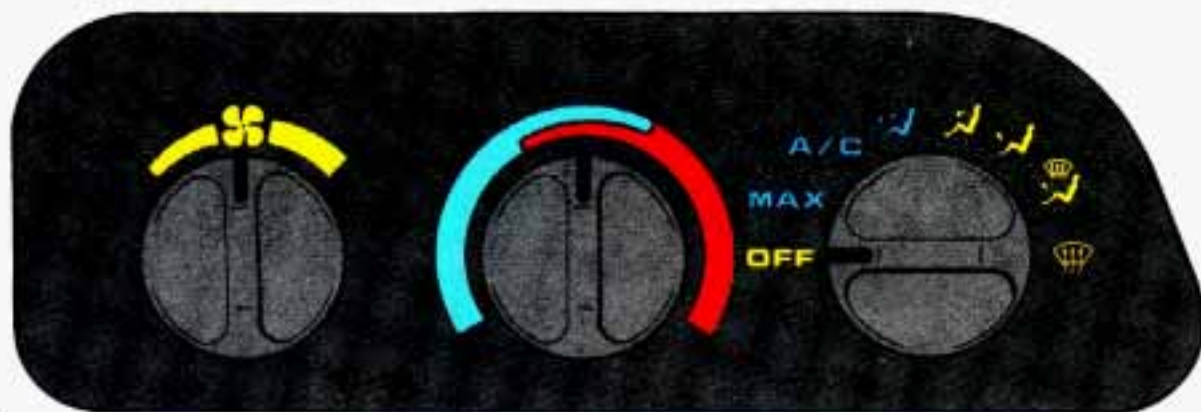

## ***Air Conditioner Controls (OPTION)***

The air conditioning system uses the same controls as the heating system, except that the air control knob has two extra settings, described below. For an explanation of all the controls, see "Heater Controls" earlier in this part.



**MAX:** Provides maximum cooling or quick cool-down on very hot days. This setting recirculates most of the air inside your vehicle. If it is used for long periods of time, the air may become dry. This setting directs air through the upper air vents.

**A/C:** Use for normal cooling on hot days. This setting cools outside air and directs it through the upper air vents.

The air conditioner compressor operates in **MAX**, **A/C** and in ,  and  when the outside temperature is above freezing. When the air conditioner is on, you may sometimes notice slight changes in your vehicle's engine speed and power. This is normal because the system is designed to cycle the compressor on and off to keep the desired cooling and help fuel economy.

## Cooling

The air conditioner works best if you keep your windows closed. On very hot days, open the windows just long enough for the hot air to escape.

1. Turn the air control knob to **A/C** for normal cooling. For faster cooling move the knob to **MAX**.
2. Turn the temperature control knob to a comfortable setting.
3. Turn the fan control knob to the right.

## Comfort Controls & Audio Systems



### **Rear Window Defogger** **(OPTION)**

The rear window defogger uses a warming grid to remove fog from the rear window.

Press the right side of the switch to turn on the defogger. An indicator light will come on to remind you that the defogger is on. The defogger will turn off automatically after about ten minutes of use. If you turn it on again, the defogger will operate for about five minutes only. You can also turn the defogger off by pressing the left side of the switch.

Do not attach anything like a temporary vehicle license or a decal across the defogger grid on the rear window.

### **NOTICE:**

Don't use a razor blade or something else sharp on the inside of the rear window. If you do, you could cut or damage the warming grid, and the repairs wouldn't be covered by your warranty.

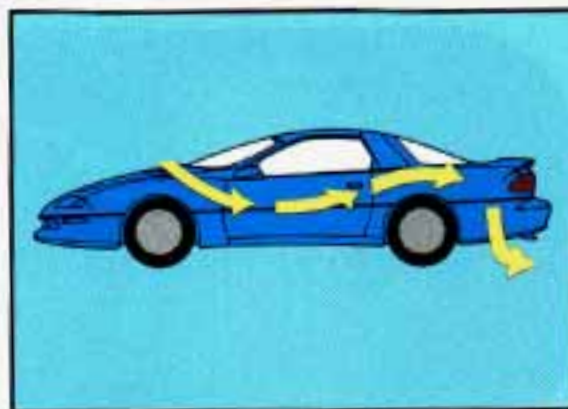

### **Flow-Through Ventilation** **System**

Your Chevrolet's flow-through ventilation system supplies outside air into the vehicle when it is moving. Outside air will also enter the vehicle when the heater or the air conditioning fan is running.



#### Ventilation Tips

- Keep the hood and front air inlet free of ice, snow, or any other obstruction (such as leaves). The heater and defroster will work far better, reducing the chance of fogging the inside of your windows.
  - When you enter a vehicle in cold weather, turn the fan control knob to the right for a few moments before driving off. This helps clear the intake ducts of snow and moisture, and reduces the chance of fogging the inside of your windows.
- Keep the air path under the front seats clear of objects. This helps air to circulate throughout your vehicle.

#### ■ *Audio Systems*

Your Delco<sup>®</sup> audio system has been designed to operate easily and give years of listening pleasure. But you will get the most enjoyment out of it if you acquaint yourself with it first. Find out what your Delco<sup>®</sup> system can do and how to operate all its controls, to be sure you're getting the most out of the advanced engineering that went into it.

# Comfort Controls & Audio Systems

## CAUTION:



Hearing damage from loud noise is almost undetectable until it is too late. Your hearing can adapt to higher volumes of sound. Sound that seems normal can be loud and harmful to your hearing. Take precautions by adjusting the volume control on your radio to a safe sound level before your hearing adapts to it.

To help avoid hearing loss or damage:

- Adjust the volume control to the lowest setting.
- Increase volume slowly until you hear comfortably and clearly.

## NOTICE:

Before you add any sound equipment to your vehicle — like a tape player, CB radio, mobile telephone or two-way radio — be sure you can add what you want. If you can, it's very important to do it properly. Added sound equipment may interfere with the operation of your vehicle's engine, Delco® radio or other systems, and even damage them. And, your vehicle's systems may interfere with the operation of sound equipment that has been added improperly.

So, before adding sound equipment, check with your dealer and be sure to check Federal rules covering mobile radio and telephone units.

## Setting the Clock

### AM/FM Stereo with Cassette Tape Player

1. Press SET.
2. Within five seconds, press and hold **SEEK ▼** until the correct hour appears.
3. Press and hold **SEEK ▲** until the correct minute appears.

### Delco/Bose AM/FM Stereo with Compact Disc Player

1. Press SET.
2. Within five seconds, press and hold **SEEK ◀** until the correct hour appears.
3. Press and hold **SEEK ▶** until the correct minute appears.





## ***AM/FM Stereo with Cassette Tape Player***

### **To Play the Radio**

Turn the upper knob to turn the system on or off.

### **Volume**

Turn the upper knob to adjust the volume.

### **AM-FM**

Press the lower knob to get AM or FM. The lighted display shows your selection.

### **Tune**

Turn the lower knob to choose radio stations.

### **Recall**

Press the upper knob to recall the station being played or the clock display.

### **Seek**

Press **SEEK ▼** or **▲** and the radio will tune to the next lower or higher station and stay there.

### **Scan**

The scan function uses the same two buttons as the seek function.

To go to the next higher station and stay there for a few seconds, press and hold **SEEK ▲** and then press **SEEK ▼** for an instant.

To go to the next lower station and stay there for a few seconds, press and hold **SEEK ▼** and then press **SEEK ▲** for an instant.

To stop the scan function, press either **SEEK ▲** or **▼**.

# Comfort Controls & Audio Systems



## Pushbuttons

The four pushbuttons let you return to your favorite stations. You can preset up to 14 stations (7 AM and 7 FM).

To set the pushbuttons for up to eight stations (four AM and four FM), just:

1. Tune in the station.
2. Press **SET**. ("SET" will appear on the display for about five seconds.)
3. Within five seconds, press one of the four pushbuttons. Whenever you press that button, the preset station will return.

Repeat these steps for each pushbutton.

You can preset three more stations on each band by pressing a pair of buttons next to each other at the same time. Just:

1. Tune in the station.
2. Press **SET**. ("SET" will appear on the display for about five seconds.)
3. Within five seconds, press two pushbuttons next to each other at the same time. Whenever you press that pair of buttons, the preset station will return.

Repeat these steps for each pair of pushbuttons.

## Setting the Tone

**Bass:** Slide the **BASS** lever up to hear more bass.

**Treble:** Slide the **TREB** lever up to hear more treble.

If a station is weak and noisy, move **TREB** down to reduce the noise.

### Adjusting the Speakers

**Balance:** Turn the balance control behind the upper knob to move the sound between the right and left speakers if you do not have the Delco/Bose system. With the Delco/Bose system, your speakers are electronically balanced.

**Fade:** Turn the fade control behind the lower knob to move the sound between the front and rear speakers.

### To Play a Cassette Tape

Your tape player is built to work best with tapes that are 30 to 45 minutes long on each side. Tapes longer than that are so thin they may not work well in this player.

The longer side with the tape visible goes in first. If you hear nothing or hear just a garbled sound, it may not be in squarely. Press **STOP-EJECT** to remove the tape and start over.

Once the tape is playing, use the upper and lower knobs for volume and balance, just as you do for radio. The arrows show which side of the tape is playing.

Press ◀ or ▶ to rapidly rewind or advance the tape. Press **STOP-EJECT** to stop the tape.

# Comfort Controls & Audio Systems

## Automatic Program Search

When you push **APS** you can go to the beginning of a new selection.

- To go forward to the beginning of the next selection, press ►.
- To go back to the beginning of the current selection press ◀. Push ◀ again to go to the beginning of the previous selection.

## Program

Press the upper knob on your system to switch from one side of the tape to the other.

Your cassette tape player can play continuously because the player has an auto-reverse feature.

## Eject

Press **STOP-EJECT** to remove the tape or stop the tape and switch to the radio.

## CrO<sub>2</sub> (Delco/Bose System)

The **CrO<sub>2</sub>** button lets you set the system for the type of cassette being used. If you are using chrome or metal tapes, push **CrO<sub>2</sub>** in. If you are using standard tapes, make sure **CrO<sub>2</sub>** is out.

## Noise Reduction (Delco/Bose System)

Your sound system has the Dolby<sup>®</sup> automatic noise reduction feature.

Dolby<sup>®</sup> Noise Reduction is manufactured under license from Dolby Laboratories Licensing Corporation. **Dolby** and the double-D symbol are trademarks of Dolby Laboratories Licensing Corporation.



## ***Delco/Bose AM/FM Stereo with Compact Disc Player***

### **To Play the Radio**

Turn the upper knob to turn the system on or off.

### **Volume**

Turn the upper knob to adjust the volume.

### **AM-FM**

Press the lower knob to get AM, FM1 or FM2.

### **Tune**

Turn the lower knob to choose radio stations.

### **Seek**

Press **SEEK** ◀ or ▶ to go to the next lower or higher station and stay there.

### **Scan**

Press **SCAN** to hear each station for a few seconds. When you want to stop scanning, press **SCAN** again or the upper knob.

### **Pushbuttons**

The five pushbuttons let you return to your favorite stations. To set the pushbuttons for up to 15 stations (5 AM, 5 FM1 and 5 FM2), just:

1. Press the lower knob to choose AM, FM1 or FM2.
  2. Tune in the station.
  3. Press **SET**. ("SET" will appear on the display for about five seconds.)
  4. Within five seconds, press one of the pushbuttons. Whenever you press that button, the preset station will return.
- Repeat these steps for each pushbutton.

# Comfort Controls & Audio Systems

## Setting the Tone

**Bass:** Press **BASS ▲** or **BASS ▼** to hear more or less bass.

**Treble:** Press **TREB ▲** or **TREB ▼** to hear more or less treble.

For the clearest sound, keep both of these adjusted all the way up. If a station is weak and noisy, press **TREB ▼** to reduce the noise.

## Adjusting the Speakers

**Balance:** Turn the balance control behind the upper knob to move the sound between the right and left speakers.

**Fade:** Turn the fade control behind the lower knob to move the sound between the front and rear speakers.

## To Play a Compact Disc

Before you begin, please note: don't use the mini-discs that are called "singles." They won't eject. Use full-size compact discs.

With the audio system on, insert a disc into the slot with the label side up. "CD" will appear on the display and track 1 will begin to play.

If the disc comes back out and "ERR" appears on the display, it could be that:

- The disc is upside down.
- It is dirty, scratched, or wet.
- There's too much moisture in the air.
- You are driving on a very rough road.
- The temperature is too hot or too cold.

### **Recall**

Press **RCL** to see what track is playing. Press it again within five seconds to see how long it has been playing.

The track number also appears when the disc is inserted.

### **To Play the Next Selection**

Press **NEXT** to hear the next track now (instead of waiting until the present track is finished).

If you press and hold this button or press it more than once, the disc will advance further.

### **To Replay the Current Selection**

Press **PREV** to hear a track again.

If you press and hold this button, or press it more than once, the disc will return to previous tracks.

### **Reverse**

Press and hold **REV** to rapidly return to a favorite passage. Release it to play the passage.

### **Fast Forward**

Press and hold **FWD** to quickly advance within a track. Release it to resume playing.

### **Scan**

Press **SCAN** to listen to each track for about 10 seconds. Press **RDM** or **SCAN** to stop the scanning.

### **Compression**

Press **COMP** to make loud and soft passages more nearly equal in volume.

### **Random**

Press **RDM** to hear a random selection of tracks.

# Comfort Controls & Audio Systems

## To Stop the Disc Player

- Turn the power off or turn the ignition key off. The disc stays in the player and will resume playing at the point where it stopped.
- Press **ST-PL** to stop playing the disc and switch to radio. Press **ST-PL** to restart the disc at the point where it stopped.
- Press **EJCT** to eject the disc and the radio will play. The disc will start playing at track 1 when you reinsert it.

## Theft-Deterrent Feature

Delco-Loc II is a security feature for the compact disc player. It can be used or ignored. If ignored, the system functions normally. If it is used, your system won't be usable if it's ever stolen.

## Setting Your Security Code

The instructions below tell you how to enter a security code into the system. If your vehicle loses battery power **for any reason**, you must enter the security code again before the system will turn on.

1. Write down any six digit number and keep it in a safe place.
2. Turn the ignition switch to the **Acc** or **Run** position.
3. Turn the audio system off.
4. Press and hold **1** and **4** together until "----" shows on the display.



You are now ready to enter your security code. Don't wait more than 15 seconds between steps.

5. Press **SET** and "000" will appear on the display.
6. Press **SCAN** and hold until the first digit of your code appears. Release the button.
7. Press **SEEK** ◀ or ▶ and hold until the second and third digits of your code appear. Release the button.
8. Press the lower knob and "000" will appear. Now you are ready to enter the last three digits of your code.
9. Press **SCAN** and hold until the fourth digit of your code appears. Release the button.
10. Press **SEEK** ◀ or ▶ and hold until the fifth and sixth digits of your code appear. Release the button.
11. Press the lower knob. "rEP" will appear for five seconds, and then "000" will appear.
12. Repeat steps 6 through 11. "SEC" will appear. This means that your audio system is secured.

### **Shutting Off the Theft-Deterrent Feature**

If your audio system is secured ("SEC" shows on display) and you wish to disable it, enter your security code as follows, pausing no more than 15 seconds between steps:

1. Turn the ignition on. Make sure the audio system is off. The time will show on the display.
2. Press **1** and **4** together for five seconds. "SEC" will show on the display.
3. Press **SET**. "000" will appear on the display.

# Comfort Controls & Audio Systems

4. Press **SCAN** and hold until the first digit of your code appears. Release the button.
5. Press **SEEK** ◀ or ▶ and hold until the second and third digits appear. Release the button.
6. Press the lower knob. "000" will appear on the display.
7. Press **SCAN** and hold until the fourth digit of your security code appears. Release the button.

8. Press **SEEK** ◀ or ▶ and hold until the fifth and sixth digits of your code appear. Release the button.
9. Press the lower knob. If "---" shows, you have shut off the theft-deterrent feature. If "SEC" shows, your audio system is still secured.

**NOTE:** If you lose or forget your security code, see your dealer for assistance.

## **Unlocking the Audio System after a Power Failure**

If power is disrupted to the audio system while in the "SEC" mode, the unit will not work and "LOC" will show on the display whenever the ignition is on. To unlock the unit:

1. Press **SET**. "000" will appear on the display.
2. Press **SCAN** and hold until the first digit of your code appears. Release the button.
3. Press **SEEK** ◀ or ▶ and hold until the second and third digits appear. Release the button.

4. Press the lower knob. "000" will appear on the display.
5. Press **SCAN** and hold until the fourth digit of your code appears. Release the button.
6. Press **SEEK** ◀ or ▶ and hold until the fifth and sixth digits of your code appear. Release the button.
7. Press the lower knob. "SEC" will appear and the unit will work. If "LOC" shows, the numbers did not match and the unit is still locked.

#### **How to Change Your Security Code**

You can change your security code by following these steps:

1. Using your old code, follow the directions given under "Shutting Off the Theft-Deterrent Feature."
2. Repeat directions of "Setting Your Security Code" with your new security code.

### ***Understanding Radio Reception***

#### **FM Stereo**

FM stereo will give you the best sound. But FM signals will reach only about 10 to 40 miles (16 to 65 km). And, tall buildings or hills can interfere with FM signals, causing the sound to come and go.

#### **AM**

The range for most AM stations is greater than for FM, especially at night. The longer range, however, can cause stations to interfere with each other. AM can pick up noise from things like storms and power lines. Try reducing the treble to reduce this noise if you ever get it.

## Comfort Controls & Audio Systems



### AM Stereo

This means the Delco<sup>®</sup> system can receive C-QUAM<sup>®</sup> stereo broadcasts. Many AM stations around the country use C-QUAM<sup>®</sup> to produce stereo, though some do not. (C-QUAM<sup>®</sup> is a registered trademark of Motorola, Inc.) If your Delco<sup>®</sup> system can get C-QUAM<sup>®</sup>, your "STEREO" light will come on when you're receiving it.

### *Care of Your Cassette Tape Player*

A tape player that is not cleaned regularly can cause reduced sound quality, ruined cassettes, or a damaged mechanism. Cassette tapes should be stored in their cases away from contaminants, direct sunlight, and extreme heat. If they aren't, they may not operate properly or cause failure of the tape player.

Your tape player should be cleaned regularly each month or after every 15 hours of use. If you notice a reduction in sound quality, try a known good cassette to see if the tape or the tape player is at fault. If this other cassette has no improvement in sound quality, clean the tape player.

Clean your tape player with a wiping-action, non-abrasive cleaning cassette, and follow the directions provided with it.

Cassettes are subject to wear and the sound quality may degrade over time. Always make sure that the cassette tape is in good condition before you have your tape player serviced.



### ***Care of Your Compact Discs***

Handle discs carefully. Store them in their original cases or other protective cases and away from direct sunlight and dust. If the surface of a disc is soiled, dampen a clean, soft cloth in a mild, neutral detergent solution and clean it, wiping from the center to the edge.

Be sure never to touch the signal surface when handling discs. Pick up discs by grasping the outer edges or the edge of the hole and the outer edge.

### ***Fixed Mast Antenna***

The fixed mast antenna can withstand most car washes without being damaged. If the mast should ever become slightly bent, you can straighten it out by hand. If the mast is badly bent, as it might be by vandals, you should replace it.

Check every once in a while to be sure the mast is still tightened to the fender.

# Notes



## Part 4

# Your Driving and the Road

**H**ere you'll find information about driving on different kinds of roads and in varying weather conditions. We've also included many other useful tips on driving.

Road Signs . . . . .	132
Defensive Driving . . . . .	136
Drunken Driving . . . . .	137
Control of a Vehicle . . . . .	140
Driving at Night . . . . .	153
Driving in the Rain . . . . .	155
Driving in Fog, Mist and Haze . . . . .	158
City Driving . . . . .	160
Freeway Driving . . . . .	161
Driving a Long Distance . . . . .	163
Hill and Mountain Roads . . . . .	165
Parking on Hills . . . . .	168
Winter Driving . . . . .	170
Towing a Trailer . . . . .	173

# Your Driving and the Road

## ■ Road Signs

The road signs you see everywhere are coded by color, shape and symbols. It's a good idea to know these codes so that you can quickly grasp the basic meaning or intent of the sign even before you have a chance to read it.



LOW SHOULDER



FLAGGER AHEAD



WORKERS AHEAD

### Color of Road Signs

**RED** means STOP. It may also indicate that some movement is not allowed. Examples are DO NOT ENTER and WRONG WAY.



RAILROAD ADVANCE CROSSING



NARROW BRIDGE

**YELLOW** indicates a general warning. Slow down and be careful when you see a yellow sign. It may signal a railroad crossing ahead, a no-passing zone, or some other potentially dangerous situation. Likewise, a yellow solid line painted on the road means "Don't Cross."

**ORANGE** indicates road construction or maintenance. You'll want to slow down when you see an orange sign, as part of the road may be closed off or torn up. And there may be workers and maintenance vehicles around, too.



**GREEN** is used to guide the driver. Green signs may indicate upcoming freeway exits or show the direction you should turn to reach a particular place.





HOSPITAL



INFORMATION

**BLUE** signs with white letters show motorists' services.



CANOEING



SWIMMING

**BROWN** signs point out recreation areas or points of historic or cultural interest.



### Shape of Road Signs

The shape of the sign will tell you something, too.

An **OCTAGONAL** (eight-sided) sign means **STOP**. It is always red with white letters.



END DIVIDED HIGHWAY

A **DIAMOND**-shaped sign is a warning of something ahead — for example, the end of a divided highway, a curve, steep hill, soft shoulder, or a narrow bridge.



A **TRIANGLE**, pointed downward, indicates **YIELD**. It assigns the right-of-way to traffic on certain approaches to an intersection.



A **TRIANGULAR** sign also is used on two-lane roads to indicate a **NO PASSING ZONE**. This sign will be on the left side of the roadway.

# Your Driving and the Road



RECTANGULAR (square or oblong) signs show speed limits, parking regulations, give directions, and such information as distances to cities.



## Symbols on Road Signs

There are many international road signs in use today.



The basic message of many of these signs is in pictures or graphic symbols. A picture within a circle with a diagonal line across it shows what **not** to do.



## Traffic Lights

We're all familiar with traffic lights or stop lights. Often green arrows are being used in the lights for improved traffic control. On some multilane roads, green arrows light up, indicating that traffic in one or more lanes can move or make a turn. Green arrows don't mean "go no matter what." You'll still need to proceed with caution, yielding the right of way to pedestrians and sometimes to other vehicles.

Some traffic lights also use red arrows to signify that you must stop before turning on red.

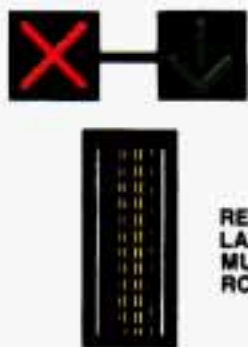

REVERSIBLE  
LANE ON  
MULTI-LANE  
ROADWAY

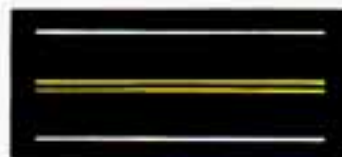

NO PASSING ZONE

Many city roads and expressways, and even bridges, use reversible-lane traffic control during rush hours. A red X light above a lane means no driving in that lane at that time. A green arrow means you may drive in that lane. Look for the signs posted to warn drivers what hours and days these systems are in effect.

### Pavement Markings

Pavement markings add to traffic signs and signals. They give information to drivers without taking attention from the roadway. A solid yellow line on your side of the road or lane means “don’t cross.”

### Your Own Signals

Drivers signal to others, too. It’s not only more polite, it’s safer to let other drivers know what you are doing. And in some places the law requires driver signals.

**Turn and lane change signals:** Always signal when you plan to turn or change lanes.

If necessary, you can use hand signals out the window: Left arm straight out for a left turn, down for slow or about-to-stop, and up for a right turn.

# Your Driving and the Road

**Slowing down:** If time allows, tap the brake pedal once or twice in advance of slowing or stopping. This warns the driver behind you.

**Disabled:** Your four-way flashers signal that your vehicle is disabled or is a hazard. See "Hazard Warning Flashers" in the Index.

## Traffic Officer

The traffic police officer is also a source of important information. The officer's signals govern, no matter what the traffic lights or other signs say.

The next section discusses some of the road conditions you may encounter.

## ■ *Defensive Driving*

The best advice anyone can give about driving is: Drive defensively.

Please start with a very important safety device in your Chevrolet: Buckle up. (See "Safety Belts" in the Index.)

Defensive driving really means "be ready for anything." On city streets, rural roads, or freeways, it means "always expect the unexpected."

Assume that pedestrians or other drivers are going to be careless and make mistakes. Anticipate what they might do. Be ready for their mistakes.

Expect children to dash out from behind parked cars, often followed by other children. Expect occupants in parked cars to open doors into traffic. Watch for

movement in parked cars — someone may be about to open a door.

Expect other drivers to run stop signs when you are on a through street. Be ready to brake if necessary as you go through intersections. You may not have to use the brake, but if you do, you will be ready.

If you're driving through a shopping center parking lot where there are well-marked lanes, directional arrows, and designated parking areas, expect some drivers to ignore all these markings and dash straight toward one part of the lot.

Pedestrians can be careless. Watch for them. In general, you must give way to pedestrians even if you know you have the right of way.

Rear-end collisions are about the most preventable of accidents. Yet they are common. Allow enough following distance. It's the best defensive driving maneuver, in both city and rural driving. You never know when the vehicle in front of you is going to brake or turn suddenly.

Here's a final bit of information about defensive driving. The most dangerous time for driving in the U.S. is very early on Sunday morning. In fact, GM Research studies show that the most and the least dangerous times for driving, every week, fall on the same day. That day is Sunday. The most dangerous time is Sunday from 3 a.m. to 4 a.m. The safest time is Sunday from 10 a.m. to 11 a.m. Driving the same distance on a Sunday at 3 a.m. isn't just a little more dangerous than it is at 10 a.m. It's about 134 times more dangerous!

That leads to the next section.

## ■ *Drunken Driving*

Death and injury associated with drinking and driving is a national tragedy. It's the number one contributor to the highway death toll, claiming thousands of victims every year. Alcohol takes away three things that anyone needs to drive a vehicle:

- Judgment
- Muscular Coordination
- Vision

Police records show that half of all motor vehicle-related deaths involve alcohol — a driver, a passenger or someone else, such as a pedestrian, had been drinking.

# Your Driving and the Road

In most cases, these deaths are the result of someone who was drinking and driving. Over 25,000 motor vehicle-related deaths occur each year because of alcohol, and thousands of people are injured.

Just how much alcohol is too much if a person plans to drive? Ideally, no one should drink alcohol and then drive. But if one does, then what's "too much"? It can be a lot less than many might think. Although it depends on each person and situation, here is some general information on the problem.

The Blood Alcohol Content (BAC) of someone who is drinking depends upon four things:

- How much alcohol is in the drink.
- The drinker's body weight.
- The amount of food that is consumed before and during drinking.
- The length of time it has taken the drinker to consume the alcohol.



According to the American Medical Association, a 180-pound (82 kg) person who drinks three 12-ounce (355 ml) bottles of beer in an hour will end up with a BAC of about 0.06 percent. The person would reach the same BAC by drinking three 4-ounce (120 ml) glasses of wine or three mixed drinks if each had 1-1/2 ounces (45 ml) of a liquor like whiskey, gin or vodka.

It's the amount of alcohol that counts. For example, if the same person drank three double martinis (3 ounces or 90 ml of liquor each) within an hour, the person's BAC would be close to 0.12 percent. A person who consumes food just before or during drinking will have a slightly lower BAC level.

**DRINKING THAT WILL  
RESULT IN A BAC OF .05%  
IN THE TIME SHOWN**

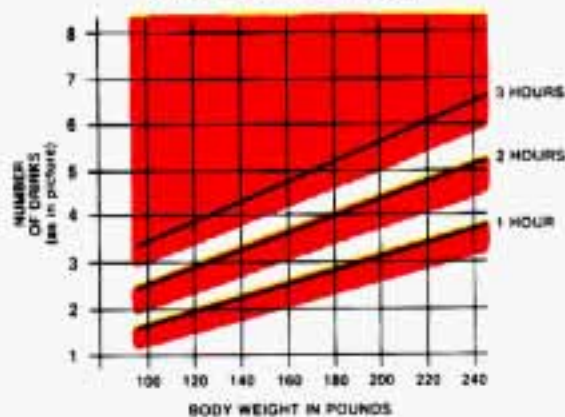

The law in most U.S. states sets the legal limit at a BAC of 0.10 percent. In Canada the limit is 0.08 percent, and in some other countries it's lower than that. The BAC will be over 0.10 percent after three to six drinks (in one hour). Of course, as we've seen, it depends on how much alcohol is in the drinks, and how quickly the person drinks them.

But it's very important to keep in mind that the ability to drive is affected well below a BAC of 0.10 percent. Research shows that the driving skills of many people are impaired at a BAC approaching 0.05 percent, and that the effects are worse at night. All drivers are impaired at BAC levels above 0.05 percent. Statistics show that the chance of being in an accident increases sharply for drivers who have a BAC of 0.05 percent or above. A driver with a BAC level of 0.06 percent (three beers in one hour for a 180-pound or 82 kg person) has doubled his or her chance of having an accident.

At a BAC level of 0.10 percent, the chance of that driver having an accident is six times greater; at a level of 0.15 percent, the chances are twenty-five times greater! And, the body takes about an hour to rid itself of the alcohol in one drink. No amount of coffee or number of cold showers will speed that up.

"I'll be careful" isn't the right answer. What if there's an emergency, a need to take sudden action, as when a child darts into the street? A person with a higher BAC might not be able to react quickly enough to avoid the collision.

# Your Driving and the Road

There's something else about drinking and driving that many people don't know. Medical research shows that alcohol in a person's system can make crash injuries worse. That's especially true for brain, spinal cord and heart injuries. That means that if anyone who has been drinking — driver or passenger — is in a crash, the chance of being killed or permanently disabled is higher than if that person had not been drinking. And we've already seen that the chance of a crash itself is higher for drinking drivers.

## **CAUTION:**



Drinking and then driving is very dangerous. Your reflexes, perceptions, and judgment will be affected by even a small amount of alcohol. You could have a serious — or even fatal — accident if you drive after drinking. Please don't drink and drive or ride with a driver who has been drinking. Ride home in a cab; or if you're with a group, designate a driver who will not drink.



## ■ *Control of a Vehicle*

You have three systems that make your vehicle go where you want it to go. They are the brakes, the steering and the accelerator. All three systems have to do their work at the places where the tires meet the road.

Sometimes, as when you're driving on snow or ice, it's easy to ask more of those control systems than the tires and road can provide. That means you can lose control of your vehicle.



## ***Braking***

Braking action involves **perception time** and **reaction time**.

First, you have to decide to push on the brake pedal. That's **perception time**. Then you have to bring up your foot and do it. That's **reaction time**.

Average **reaction time** is about 3/4 of a second. But that's only an average. It might be less with one driver and as long as two or three seconds or more with another. Age, physical condition, alertness, coordination, and eyesight all play a part. So do alcohol, drugs and frustration. But even in 3/4 of a second, a vehicle moving at 60 mph (100 km/h) travels 66 feet (20 m). That could be a lot of distance in an emergency, so keeping

enough space between your vehicle and others is important.

And, of course, actual stopping distances vary greatly with the surface of the road (whether it's pavement or gravel); the condition of the road (wet, dry, icy); tire tread; and the condition of your brakes.

Most drivers treat their brakes with care. Some, however, overwork the braking system with poor driving habits.

- Avoid needless heavy braking. Some people drive in spurts — heavy acceleration followed by heavy braking — rather than keeping pace with traffic. This is a mistake. Your brakes may not have time to cool between hard stops. Your brakes will wear out much faster if you do a lot of heavy braking.
- Don't "ride" the brakes by letting your left foot rest lightly on the brake pedal while driving.

## Your Driving and the Road



### **CAUTION:**



"Riding" your brakes can cause them to overheat to the point that they won't work well. You might not be able to stop your vehicle in time to avoid an accident. If you "ride" your brakes, they will get so hot they will require a lot of pedal force to slow you down. Avoid "riding" the brakes.

### **NOTICE:**

"Riding" the brakes wears them out much faster. You would need costly brake replacement much sooner than normal, and it also reduces fuel economy.

If you keep pace with the traffic and allow realistic following distances, you will eliminate a lot of unnecessary braking. That means better braking and longer brake life.

- If your engine ever stops while you're driving, brake normally but don't pump your brakes. If you do, the pedal may get harder to push down. If your engine stops, you will still have some power brake assist. But you will use it when you brake. Once the power assist is used up, it may take longer to stop and the brake pedal will be harder to push.



### Anti-Lock Brakes (ABS)

Your Chevrolet has an advanced electronic braking system that will help prevent skidding.

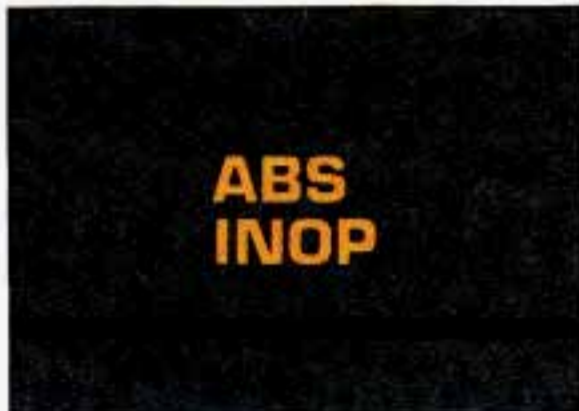

This light on the instrument panel will go on when you start your vehicle.

When you start your vehicle, you may hear a momentary motor or clicking noise. And you may even notice that your brake pedal moves a little while this is going on. This is the ABS system testing itself. If you have your foot on the brake pedal, this check won't happen until the vehicle goes about 3 mph (5 km/h) or until you take your foot off the brake pedal.

If there's a problem with the anti-lock brake system, the **ABS INOP** warning light will stay on or flash.

See "Anti-Lock Brake System Warning Light" in the Index.

## Your Driving and the Road



Here's how anti-lock works. Let's say the road is wet. You're driving safely. Suddenly an animal jumps out in front of you.

You slam on the brakes. Here's what happens with ABS.

A computer senses that wheels are slowing down. The computer separately works the brakes at each front wheel and at the rear wheels.

The anti-lock system can change the brake pressure faster than any driver could. The computer is programmed to make the most of available tire and road conditions.



You can steer around the obstacle while braking hard.

As you brake, your computer keeps receiving updates on wheel speed and controls braking pressure accordingly.

### **CAUTION:**



Anti-lock doesn't change the time you need to get your foot up to the brake pedal. If you get too close to the vehicle in front of you, you won't have time to apply your brakes if that vehicle suddenly slows or stops. Always leave enough room up ahead to stop, even though you have anti-lock brakes.

### **To Use Anti-Lock:**

Don't pump the brakes. Just hold the brake pedal down and let anti-lock work for you. When the ABS is active, the **LOW TRAC** light comes on to indicate low traction conditions. Adjust your driving accordingly. The light will stay on for about four seconds after the ABS stops being active.

### Disc Brake Wear Indicators

Unless you have the four-wheel disc brake option, your Chevrolet has front disc brakes and rear drum brakes.

Disc brake pads have built-in wear indicators that make a high-pitched warning sound when the brake pads are worn and new pads are needed. The sound may come and go or be heard all the time your vehicle is moving (except when you are pushing on the brake pedal firmly).

### **CAUTION:**



The brake wear warning sound means that sooner or later your brakes won't work well. That could lead to an accident. When you hear the brake wear warning sound, have your vehicle serviced.

### **NOTICE:**

Continuing to drive with worn-out brake pads could result in costly brake repair.

Some driving conditions or climates may cause a brake squeal when the brakes are first applied or lightly applied. This does not mean something is wrong with your brakes.

### Rear Drum Brakes

If you have rear drum brakes, they don't have wear indicators, but if you ever hear a rear brake rubbing noise, have the rear brake linings inspected. Also, the rear brake drums should be removed and inspected each time the tires are removed for rotation or changing. When you have the front brakes replaced, have the rear brakes inspected, too.

Brake linings should always be replaced as complete axle sets.

# Your Driving and the Road

## **Brake Pedal Travel**

See your dealer if the brake pedal does not return to normal height, or if there is a rapid increase in pedal travel. This could be a sign of brake trouble.

## **Brake Adjustment**

Every time you make a moderate brake stop, your disc brakes adjust for wear. If you rarely make a moderate or heavier stop, then your brakes might not adjust correctly. If you drive in that way, then — very carefully — make a few moderate brake stops about every 1000 miles (1 600 km), so your brakes will adjust properly.

If your brake pedal goes down farther than normal, your rear drum brakes may need adjustment. Adjust them by backing up and firmly applying the brakes a few times.

## **Braking in Emergencies**

Use your anti-lock braking system when you need to. With anti-lock, you can steer and brake at the same time. In many emergencies, steering can help you more than even the very best braking.

## ***Steering***

### **Power Steering**

If you lose power steering assist because the engine stops or the system fails to function, you can steer but it will take much more effort.

### **Steering Tips**

#### **Driving on Curves**

It's important to take curves at a reasonable speed.

A lot of the "driver lost control" accidents mentioned on the news happen on curves. Here's why:

Experienced driver or beginner, each of us is subject to the same laws of physics when driving on curves. The traction of

the tires against the road surface makes it possible for the vehicle to change its path when you turn the front wheels. If there's no traction, inertia will keep the vehicle going in the same direction. If you've ever tried to steer a vehicle on wet ice, you'll understand this.

The traction you can get in a curve depends on the condition of your tires and the road surface, the angle at which the curve is banked, and your speed. While you're in a curve, speed is the one factor you can control.

Suppose you're steering through a sharp curve. Then you suddenly accelerate. Those two control systems — steering and acceleration — can overwhelm those places where the tires meet the road and make you lose control.

What should you do if this ever happens? Let up on the accelerator pedal, steer the vehicle the way you want it to go, and slow down.

Speed limit signs near curves warn that you should adjust your speed. Of course, the posted speeds are based on good weather and road conditions. Under less favorable conditions you'll want to go slower.

If you need to reduce your speed as you approach a curve, do it before you enter the curve, while your front wheels are straight ahead.

Try to adjust your speed so you can "drive" through the curve. Maintain a reasonable, steady speed. Wait to accelerate until you are out of the curve, and then accelerate gently into the straightaway.

When you drive into a curve at night, it's harder to see the road ahead of you because it bends away from the straight beams of your lights. This is one good reason to drive slower.

# Your Driving and the Road



## Steering in Emergencies

There are times when steering can be more effective than braking. For example, you come over a hill and find a truck stopped in your lane, or a car suddenly pulls out from nowhere, or a child darts out from between parked cars and stops right in front of you. You can avoid these problems by braking — if you can stop in time. But sometimes you can't; there isn't room. That's the time for evasive action — steering around the problem.

Your Chevrolet can perform very well in emergencies like these. First apply your brakes. It is better to remove as much speed as you can from a possible collision. Then steer around the problem, to the left or right depending on the space available.

An emergency like this requires close attention and a quick decision. If you are holding the steering wheel at the recommended 9 and 3 o'clock positions, you can turn it a full 180 degrees very quickly without removing either hand.

But you have to act fast, steer quickly, and just as quickly straighten the wheel once you have avoided the object. You must then be prepared to steer back to your original lane and then brake to a controlled stop.

Depending on your speed, this can be rather violent for an unprepared driver. This is one of the reasons driving experts recommend that you use your safety belts and keep both hands on the steering wheel.

The fact that such emergency situations are always possible is a good reason to practice defensive driving at all times.



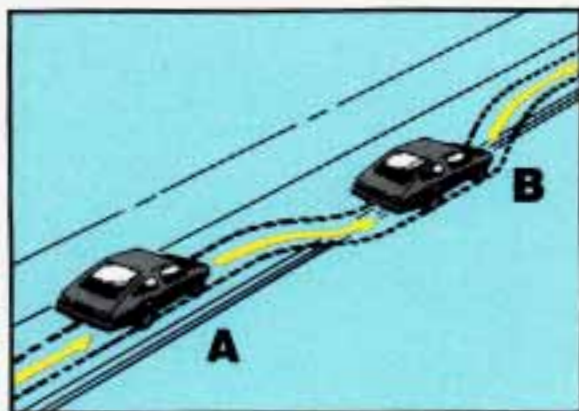

### Off-Road Recovery

You may find sometime that your right wheels have dropped off the edge of a road onto the shoulder (A) while you're driving.

If the level of the shoulder is only slightly below the pavement, recovery should be fairly easy. Ease off the accelerator and then, if there is nothing in the way, steer so that your vehicle straddles the edge of the pavement. You can turn the steering wheel up to 1/4 turn (B) until the right front tire contacts the pavement edge. Then turn your steering wheel to go straight down the roadway.

If the shoulder appears to be about four inches (100 mm) or more below the pavement, this difference can cause problems. If there is not enough room to pull entirely onto the shoulder and stop, then follow the same procedures. But if the right front tire scrubs against the side of the pavement, do NOT steer more sharply. With too much steering angle, the vehicle may jump back onto the road with so much steering input that it crosses over into the oncoming traffic before you can bring it back under control. Instead, ease off again on the accelerator and steering input, straddle the pavement once more, then try again.

### Passing

The driver of a vehicle about to pass another on a two-lane highway waits for just the right moment, accelerates, moves around the vehicle ahead, then goes back into the right lane again. A simple maneuver?

Not necessarily! Passing another vehicle on a two-lane highway is a potentially dangerous move, since the passing vehicle occupies the same lane as oncoming traffic for several seconds. A miscalculation, an error in judgment, or a brief surrender to frustration or anger can suddenly put the passing driver face to face with the worst of all traffic accidents — the head-on collision.

# Your Driving and the Road

So here are some tips for passing:

- “Drive ahead.” Look down the road, to the sides, and to crossroads for situations that might affect your passing patterns. If you have any doubt whatsoever about making a successful pass, wait for a better time.
- Watch for traffic signs, pavement markings, and lines. If you can see a sign up ahead that might indicate a turn or an intersection, delay your pass. A broken center line usually indicates it’s all right to pass (providing the road ahead is clear).

Never cross a solid line on your side of the lane or a double solid line, even if the road seems empty of approaching traffic.

- If you suspect that the driver of the vehicle you want to pass isn’t aware of your presence, tap the horn a couple of times before passing.
- Do not get too close to the vehicle you want to pass while you’re awaiting an opportunity. For one thing, following too closely reduces your area of vision, especially if you’re following a larger vehicle. Also, you won’t have adequate space if the vehicle ahead suddenly slows or stops. Keep back a reasonable distance.

- When it looks like a chance to pass is coming up, start to accelerate but stay in the right lane and don’t get too close. Time your move so you will be increasing speed as the time comes to move into the other lane. If the way is clear to pass, you will have a “running start” that more than makes up for the distance you would lose by dropping back. And if something happens to cause you to cancel your pass, you need only slow down and drop back again and wait for another opportunity.

- If other cars are lined up to pass a slow vehicle, wait your turn. But take care that someone isn't trying to pass you as you pull out to pass the slow vehicle. Remember to glance over your shoulder and check the blind spot.
- Check your mirrors, glance over your shoulder, and start your left lane change signal before moving out of the right lane to pass. When you are far enough ahead of the passed vehicle to see its front in your inside mirror, activate your right lane change signal and move back into the right lane.

(Remember that your right outside mirror is convex. The vehicle you just passed may seem to be farther away from you than it really is.)

- Try not to pass more than one vehicle at a time on two-lane roads. Reconsider before passing the next vehicle.
- Don't overtake a slowly moving vehicle too rapidly. Even though the brake lights are not flashing, it may be slowing down or starting to turn.
- If you're being passed, make it easy for the following driver to get ahead of you. Perhaps you can ease a little to the right.

## ***Loss of Control***

Let's review what driving experts say about what happens when the three control systems (brakes, steering and acceleration) don't have enough friction where the tires meet the road to do what the driver has asked.

In any emergency, don't give up. Keep trying to steer and constantly seek an escape route or area of less danger.

### **Skidding**

In a skid, a driver can lose control of the vehicle. Defensive drivers avoid most skids by taking reasonable care suited to existing conditions, and by not "overdriving" those conditions. But skids are always possible.

## Your Driving and the Road

The three types of skids correspond to your Chevrolet's three control systems. In the braking skid your wheels aren't rolling. In the steering or cornering skid, too much speed or steering in a curve causes tires to slip and lose cornering force. And in the acceleration skid too much throttle causes the driving wheels to spin.

A cornering skid and an acceleration skid are best handled by easing your foot off the accelerator pedal. If your vehicle starts to slide (as when you turn a corner on a wet, snow- or ice-covered road), ease your foot off the accelerator pedal as soon as you feel the vehicle start to slide. Quickly steer the way you want the

vehicle to go. If you start steering quickly enough, your vehicle will straighten out. As it does, straighten the front wheels.

Of course, traction is reduced when water, snow, ice, gravel, or other material is on the road. For safety, you'll want to slow down and adjust your driving to these conditions. It is important to slow down on slippery surfaces because stopping distance will be longer and vehicle control more limited.

While driving on a surface with reduced traction, try your best to avoid sudden steering, acceleration, or braking (including engine braking by shifting to a lower gear). Any sudden changes could cause the tires to slide. You may not realize the surface is slippery until your vehicle is skidding. Learn to recognize warning clues — such as enough water, ice or packed snow on the road to make a "mirrored surface" — and slow down when you have any doubt.

Remember: Any anti-lock braking system (ABS) helps avoid only the braking skid. Steer the way you want to go.



## ■ *Driving at Night*

Night driving is more dangerous than day driving. One reason is that some drivers are likely to be impaired — by alcohol or drugs, with night vision problems, or by fatigue.

Here are some tips on night driving.

- Drive defensively. Remember, this is the most dangerous time.
- Don't drink and drive. (See "Drunken Driving" in the Index for more on this problem.)
- Adjust your inside rearview mirror to reduce the glare from headlights behind you.

- Since you can't see as well, you may need to slow down and keep more space between you and other vehicles. It's hard to tell how fast the vehicle ahead is going just by looking at its taillights.
- Slow down, especially on higher speed roads. Your headlights can light up only so much road ahead.
- In remote areas, watch for animals.
- If you're tired, pull off the road in a safe place and rest.

## **Night Vision**

No one can see as well at night as in the daytime. But as we get older these differences increase. A 50-year-old driver may require at least twice as much light to see the same thing at night as a 20-year-old.

What you do in the daytime can also affect your night vision. For example, if you spend the day in bright sunshine you are wise to wear sunglasses. Your eyes will have less trouble adjusting to night.

# Your Driving and the Road

But if you're driving, don't wear sunglasses at night. They may cut down on glare from headlights, but they also make a lot of things invisible that should remain visible — such as parked cars, obstacles, pedestrians, or even trains blocking railway crossings. You may want to put on your sunglasses after you have pulled into a brightly-lighted service or refreshment area. Eyes shielded from that glare may adjust more quickly to darkness back on the road. But be sure to remove your sunglasses before you leave the service area.

You can be temporarily blinded by approaching lights. It can take a second or two, or even several seconds, for your eyes to readjust to the dark. When you are faced with severe glare (as from a driver who doesn't lower the high beams, or a vehicle with misaimed headlights), slow down a little. Avoid staring directly into the approaching lights. If there is a line of opposing traffic, make occasional glances over the line of headlights to make certain that one of the vehicles isn't starting to move into your lane. Once you are past the bright lights, give your eyes time to readjust before resuming speed.

## High Beams

If the vehicle approaching you has its high beams on, signal by flicking yours to high and then back to low beam. This is the usual signal to lower the headlight beams. If the other driver still doesn't lower the beams, resist the temptation to put your high beams on. This only makes two half-blinded drivers.

On a freeway, use your high beams only in remote areas where you won't impair approaching drivers. In some places, like cities, using high beams is illegal.



### ■ *Driving in the Rain*

Rain and wet roads can mean driving trouble. On a wet road you can't stop, accelerate or turn as well because your tire-to-road traction isn't as good as on dry roads. And, if your tires don't have much tread left, you'll get even less traction.

It's always wise to go slower and be cautious if rain starts to fall while you are driving. The surface may get wet suddenly when your reflexes are tuned for driving on dry pavement.

When you follow another vehicle on a freeway or highway, use low beams. True, most vehicles now have day/night mirrors that enable the driver to reduce glare. But outside mirrors are not of this type and high beams from behind can bother the driver ahead.

#### **A Few More Night Driving Suggestions**

Keep your windshield and all the glass on your vehicle clean — inside and out. Glare at night is made much worse by dirt on the glass. Even the inside of the glass can build up a film caused by dust. Tobacco smoke also makes inside glass surfaces very filmy and can be a vision hazard if it's left there.

Dirty glass makes lights dazzle and flash more than clean glass would, making the pupils of your eyes contract repeatedly. You might even want to keep a cloth and some glass cleaner in your vehicle if you need to clean your glass frequently.

Remember that your headlights light up far less of a roadway when you are in a turn or curve.

Keep your eyes moving; that way, it's easier to pick out dimly lighted objects.

Just as your headlights should be checked regularly for proper aim, so should your eyes be examined regularly. Some drivers suffer from night blindness — the inability to see in dim light — and aren't even aware of it.

## Your Driving and the Road



The heavier the rain, the harder it is to see. Even if your windshield wiper blades are in good shape, a heavy rain can make it harder to see road signs and traffic signals, pavement markings, the edge of the road, and even people walking. Road spray can often be worse for vision than rain, especially if it comes from a dirty road.

So it is wise to keep your wiping equipment in good shape and keep your windshield washer tank filled. Replace your windshield wiper inserts when they show signs of streaking or missing areas on the windshield, or when strips of rubber start to separate from the inserts.

Driving too fast through large water puddles or even going through some car washes can cause problems, too. The water may affect your brakes. Try to avoid puddles. But if you can't, try to slow down before you hit them.

### **CAUTION:**



Wet brakes can cause accidents. They won't work well in a quick stop and may cause pulling to one side. You could lose control of the vehicle.

After driving through a large puddle of water or a car wash, apply your brake pedal lightly until your brakes work normally.



### **Hydroplaning**

Hydroplaning is dangerous. So much water can build up under your tires that they can actually ride on the water. This can happen if the road is wet enough and you're going fast enough. When your vehicle is hydroplaning, it has little or no contact with the road.

You might not be aware of hydroplaning. You could drive along for some time without realizing your tires aren't in constant contact with the road. You could find out the hard way: when you have to slow, turn, move out to pass — or if you get hit by a gust of wind. You could suddenly find yourself out of control.

Hydroplaning doesn't happen often. But it can if your tires haven't much tread or if the pressure in one or more is low. It can happen if a lot of water is standing on the road. If you can see reflections from trees, telephone poles, or other vehicles, and raindrops "dimple" the water's surface, there could be hydroplaning.

Hydroplaning usually happens at higher speeds. There just isn't a hard and fast rule about hydroplaning. The best advice is to slow down when it is raining, and be careful.

### **Some Other Rainy Weather Tips**

- Turn on your headlights — not just your parking lights — to help make you more visible to others.
- Look for hard-to-see vehicles coming from behind. You may want to use your headlights even in daytime if it's raining hard.

# Your Driving and the Road



- Besides slowing down, allow some extra following distance. And be especially careful when you pass another vehicle. Allow yourself more clear room ahead, and be prepared to have your view restricted by road spray. If the road spray is so heavy you are actually blinded, drop back. Don't pass until conditions improve. Going more slowly is better than having an accident.
- Use your defogger if it helps.
- Have good tires with proper tread depth. (See "Tires" in the Index.)

## ■ *Driving in Fog, Mist and Haze*

Fog can occur with high humidity or heavy frost. It can be so mild that you can see through it for several hundred feet (meters). Or it might be so thick that you can see only a few feet (meters) ahead. It may come suddenly to an otherwise clear road. And it can be a major hazard.

When you drive into a fog patch, your visibility will be reduced quickly. The biggest dangers are striking the vehicle ahead or being struck by the one behind. Try to "read" the fog density down the road. If the vehicle ahead starts to become less clear or, at night, if the taillights are harder to see, the fog is probably thickening. Slow down to give traffic

behind you a chance to slow down. Everybody then has a better chance to avoid hitting the vehicle ahead.

A patch of dense fog may extend only for a few feet (meters) or for miles (kilometers); you can't really tell while you're in it. You can only treat the situation with extreme care.

One common fog condition — sometimes called mist or ground fog — can happen in weather that seems perfect, especially at night or in the early morning in valley and low, marshy areas. You can be suddenly enveloped in thick, wet haze that may even coat your windshield. You can often spot these fog patches or mist layers with your headlights. But

sometimes they can be waiting for you as you come over a hill or dip into a shallow valley. Start your windshield wipers and washer, to help clear accumulated road dirt. Slow down carefully.

#### **Tips on Driving in Fog**

If you get caught in fog, turn your headlights on low beam, even in daytime. You'll see — and be seen — better. Use your fog lights if your vehicle has them.

Don't use your high beams. The light will bounce off the water droplets that make up fog and reflect back at you.

Use your defogger. In high humidity, even a light buildup of moisture on the inside of the glass will cut down on your already limited visibility. Run your windshield wipers and washer occasionally. Moisture can build up on the outside glass, and what seems to be fog may actually be moisture on the outside of your windshield.

Treat dense fog as an emergency. Try to find a place to pull off the road. Of course you want to respect another's property, but you might need to put something between you and moving vehicles — space, trees, telephone poles, a private driveway, anything that removes you from other traffic.

If visibility is near zero and you must stop but are unsure whether you are away from the road, turn your lights on, start your hazard warning flashers, and sound your horn at intervals or when you hear approaching traffic.

Pass other vehicles in fog only if you can see far enough ahead to pass safely. Even then, be prepared to delay your pass if you suspect the fog is worse up ahead. If other vehicles try to pass you, make it easy for them.

# Your Driving and the Road



## ■ *City Driving*

One of the biggest problems with city streets is the amount of traffic on them. You'll want to watch out for what the other drivers are doing and pay attention to traffic signals.

Here are ways to increase your safety in city driving:

- Know the best way to get to where you are going. Try not to drive around trying to pick out a familiar street or landmark. Get a city map and plan your trip into an unknown part of the city just as you would for a cross-country trip.
- Try to use the freeways that rim and crisscross most large cities. You'll save time and energy. (See the next section, "Freeway Driving.")
- Treat a green light as a warning signal. A traffic light is there because the corner is busy enough to need it. When a light turns green, and just before you start to move, check both ways for vehicles that have not cleared the intersection or may be running the red light.
- Obey all posted speed limits. But remember that they are for ideal road, weather and visibility conditions. You may need to drive below the posted limit in bad weather or when visibility is especially poor.
- Pull to the right (with care) and stop clear of intersections when you see or hear emergency vehicles.



## ■ *Freeway Driving*

Mile for mile, freeways (also called thruways, parkways, expressways, turnpikes, or superhighways) are the safest of all roads. But they have their own special rules.

The most important advice on freeway driving is: Keep up with traffic and keep to the right. Drive at the same speed most of the other drivers are driving. Too-fast or too-slow driving breaks a smooth traffic flow. Treat the left lane on a freeway as a passing lane.

### **Entering the Freeway**

At the entrance there is usually a ramp that leads to the freeway. If you have a clear view of the freeway as you drive along the entrance ramp, you should begin to check traffic. Try to determine where you expect to blend with the flow. If traffic is light, you may have no problem. But if it is heavy, find a gap as you move along the entering lane and time your approach. Try to merge into the gap at close to the prevailing speed. Switch on your turn signal, check your rearview mirrors as you move along, and glance over your shoulder as often as necessary. Try to blend smoothly with the traffic flow.

### **Driving on the Freeway**

Once you are on the freeway, adjust your speed to the posted limit or to the prevailing rate if it's slower. Stay in the right lane unless you want to pass. If you are on a two-lane freeway, treat the right lane as the slow lane and the left lane as the passing lane.

If you are on a three-lane freeway, treat the right lane as the slower-speed through lane, the middle lane as the higher-speed through lane, and the left lane as the passing lane.

Before changing lanes, check your rearview mirrors. Then use your turn signal.

# Your Driving and the Road

Just before you leave the lane, glance quickly over your shoulder to make sure there isn't another vehicle in your "blind" spot.

If you are moving from an outside to a center lane on a freeway having more than two lanes, make sure another vehicle isn't about to move into the same spot. Look at the vehicles two lanes over and watch for telltale signs: turn signals flashing, an increase in speed, or moving toward the edge of the lane. Be prepared to delay your move.

Once you are moving on the freeway, make certain you allow a reasonable following distance. Expect to move slightly slower at night.

## Leaving the Freeway

When you want to leave the freeway, move to the proper lane well in advance. Dashing across lanes at the last minute is dangerous. If you miss your exit do not, under any circumstances, stop and back up. Drive on to the next exit.

At each exit point is a deceleration lane. Ideally it should be long enough for you to enter it at freeway speed (after signaling, of course) and then do your braking before moving onto the exit ramp. Unfortunately, not all deceleration lanes are long enough — some are too short for all the braking. Decide when to start braking. If you must brake on the through lane, and if there is traffic close

behind you, you can allow a little extra time and flash your brake lights (in addition to your turn signal) as extra warning that you are about to slow down and exit.

The exit ramp can be curved, sometimes quite sharply.

The exit speed is usually posted. Reduce your speed according to your speedometer, not to your sense of motion. After driving for any distance at higher speeds, you may tend to think you are going slower than you actually are. For example, 40 mph (65 km/h) might seem like only 20 mph (30 km/h). Obviously, this could lead to serious trouble on a ramp designed for 20 mph (30 km/h)!

## ■ *Driving a Long Distance*

Although most long trips today are made on freeways, there are still many made on regular highways.

Long-distance driving on freeways and regular highways is the same in some ways. The trip has to be planned and the vehicle prepared, you drive at higher-than-city speeds, and there are longer turns behind the wheel. You'll enjoy your trip more if you and your vehicle are in good shape. Here are some tips for a successful long trip.

### **Before Leaving on a Long Trip**

Make sure you're ready. Try to be well rested. If you must start when you're not fresh — such as after a day's work — don't plan to make too many miles that first part of the journey. Wear comfortable clothing and shoes you can easily drive in.

Is your vehicle ready for a long trip? If you keep it serviced and maintained, it's ready to go. If it needs service, have it done before starting out. Of course, you'll find experienced and able service experts in Chevrolet dealerships all across North America. They'll be ready and willing to help if you need it.

Here are some things you can check before a trip:

- **Windshield Washer Fluid:** Is the reservoir full? Are all windows clean inside and outside?
- **Wiper Blades:** Are they in good shape?
- **Fuel, Engine Oil, Other Fluids:** Have you checked all levels?
- **Lights:** Are they all working? Are the lenses clean?
- **Tires:** They are vitally important to a safe, trouble-free trip. Is the tread good enough for long-distance driving? Are the tires all inflated to the recommended pressure?

# Your Driving and the Road

- **Weather Forecasts:** What's the weather outlook along your route? Should you delay your trip a short time to avoid a major storm system?
- **Maps:** Do you have up-to-date maps?

## On the Road

Unless you are the only driver, it is good to share the driving task with others. Limit turns behind the wheel to about 100 miles (160 km) or two hours at a sitting. Then, either change drivers or stop for some refreshment like coffee, tea or soft drinks and some limbering up. But do stop and move around. Eat lightly along the way. Heavier meals tend to make some people sleepy.

On two-lane highways or undivided multilane highways that do not have controlled access, you'll want to watch for some situations not usually found on freeways. Examples are: stop signs and signals, shopping centers with direct access to the highway, no passing zones and school zones, vehicles turning left and right off the road, pedestrians, cyclists, parked vehicles, and even animals.

## Highway Hypnosis

Is there actually such a condition as "highway hypnosis"? Or is it just plain falling asleep at the wheel? Call it highway hypnosis, lack of awareness, or whatever.

There is something about an easy stretch of road with the same scenery, along with the hum of the tires on the road, the drone of the engine, and the rush of the wind against the vehicle that can make you sleepy. Don't let it happen to you! If it does, your vehicle can leave the road in **less than a second**, and you could crash and be injured.



What can you do about highway hypnosis? First, be aware that it can happen.

Then here are some tips:

- Make sure your vehicle is well ventilated, with a comfortably cool interior.
- Keep your eyes moving. Scan the road ahead and to the sides. Check your rearview mirrors frequently and your instruments from time to time. This can help you avoid a fixed stare.

- Wear good sunglasses in bright light. Glare can cause drowsiness. But don't wear sunglasses at night. They will drastically reduce your overall vision at the very time you need all the seeing power you have.
- If you get sleepy, pull off the road into a rest, service, or parking area and take a nap, get some exercise, or both. For safety, treat drowsiness on the highway as an emergency.

As in any driving situation, keep pace with traffic and allow adequate following distances.



## ■ *Hill and Mountain Roads*

Driving on steep hills or mountains is different from driving in flat or rolling terrain. If you drive regularly in steep country, or if you're planning to visit there, here are some tips that can make your trips safer and more enjoyable.

- Keep your vehicle in good shape. Check all fluid levels and also the brakes, tires, cooling system and transmission. These parts can work hard on mountain roads.

## Your Driving and the Road

- Know how to go down hills. The most important thing to know is this: let your engine do some of the slowing down. Don't make your brakes do it all. Shift to a lower gear when you go down a steep or long hill. That way, you will slow down without excessive use of your brakes.

### **CAUTION:**



If you don't shift down, your brakes could get so hot that they wouldn't work well. You would then have poor braking or even none going down a hill. You could crash. Shift down to let your engine assist your brakes on a steep downhill slope.

### **CAUTION:**



Coasting downhill in N (Neutral) or with the ignition off is dangerous. Your brakes will have to do all the work of slowing down. They could get so hot that they wouldn't work well. You could crash. Always have your engine running and your vehicle in gear when you go downhill.

- Know how to go uphill. You may want to shift down to a lower gear. The lower gears help cool your engine and transmission, and you can climb the hill better.
- Stay in your own lane when driving on two-lane roads in hills or mountains. Don't swing wide or cut across the center of the road. Drive at speeds that let you stay in your own lane. That way, you won't be surprised by a vehicle coming toward you in the same lane.

- It takes longer to pass another vehicle when you're going uphill. You'll want to leave extra room to pass. If a vehicle is passing you and doesn't have enough room, slow down to make it easier for the other vehicle to get by.
- As you go over the top of a hill, be alert. There could be something in your lane, like a stalled car or an accident.

- You may see highway signs on mountains that warn of special problems. Examples are long grades, passing or no-passing zones, a falling rocks area, or winding roads. Be alert to these and take appropriate action.
- Winter driving can present special problems. See "Winter Driving" in the Index.

# Your Driving and the Road



## ■ *Parking on Hills*

Hills and mountains mean spectacular scenery. But please be careful where you stop if you decide to look at the view or take pictures. Look for pull-offs or parking areas provided for scenic viewing.

Another part of this manual tells how to use your parking brake (see "Parking Brake" in the Index). But on a mountain or steep hill, you can do one more thing. You can turn your front wheels to keep your vehicle from rolling downhill or out into traffic.

Here's how:

### **Parking Downhill**

Turn your wheels to the right.

You don't have to jam your tires against the curb, if there is a curb. A gentle contact is all you need.

### **Parking Uphill**

If there is a curb, turn your wheels to the left if the curb is at the right side of your vehicle.



If you're going uphill on a one-way street and you're parking on the left side, your wheels should point to the right.



If there is no curb when you're parking uphill, turn the wheels to the right.

If there is no curb when you're parking uphill on the left side of a one-way street, your wheels should be turned to the left.

#### **Torque Lock (Automatic Transmission)**

If you are parking on a hill and you don't shift your transmission into **P** (Park) properly, the weight of the vehicle may put too much force on the parking pawl in the transmission. You may find it difficult to pull the shift lever out of **P** (Park). This is called "torque lock." To prevent torque lock, always be sure to shift into **P** (Park)

properly before you leave the driver's seat. To find out how, see "Shifting into **P** (Park)" in the Index.

When you are ready to drive, move the shift lever out of **P** (Park) **BEFORE** you release the parking brake.

If "torque lock" does occur, you may need to have another vehicle push yours a little uphill to take some of the pressure from the transmission, so you can pull the shift lever out of **P** (Park).

# Your Driving and the Road



## ■ *Winter Driving*

Here are some tips for winter driving:

- Have your Chevrolet in good shape for winter. Be sure your engine coolant mix is correct.
- Snow tires can help in loose snow, but they may give you less traction on ice than regular tires. If you do not expect to be driving in deep snow, but may have to travel over ice, you may not want to switch to snow tires at all.

- You may want to put winter emergency supplies in your vehicle. Include an ice scraper, a small brush or broom, a supply of windshield washer fluid, a rag, some winter outer clothing, a small shovel, a flashlight, a red cloth, and a couple of reflective warning triangles. And, if you will be driving under severe conditions, include a small bag of sand, a piece of old carpet or a couple of burlap bags to help provide traction. Be sure you properly secure these items in your vehicle.

## **Driving on Snow or Ice**

Most of the time, those places where your tires meet the road probably have good traction.

However, if there is snow or ice between your tires and the road, you can have a very slippery situation. You'll have a lot less traction or "grip" and will need to be very careful.



What's the worst time for this? "Wet ice." Very cold snow or ice can be slick and hard to drive on. But wet ice can be even more trouble because it may offer the least traction of all. You can get "wet ice" when it's about freezing (32°F; 0°C) and freezing rain begins to fall. Try to avoid driving on wet ice until salt and sand crews can get there.

Whatever the condition — smooth ice, packed, blowing or loose snow — drive with caution. Accelerate gently. Try not to break the fragile traction. If you accelerate too fast, the drive wheels will spin and polish the surface under the tires even more.

Your anti-lock brakes improve your ability to make a hard stop on a slippery road. Even though you have the anti-lock braking system, you'll want to begin stopping sooner than you would on dry pavement. See "Anti-Lock" in the Index.

- Allow greater following distance on any slippery road.
- Watch for slippery spots. The road might be fine until you hit a spot that's covered with ice. On an otherwise clear road, ice patches may appear in shaded areas where the sun can't reach: around clumps of trees, behind buildings, or under bridges. Sometimes the surface of a curve or an overpass may remain icy when the surrounding roads are clear. If you see a patch of ice ahead of you, brake before you are on it. Try not to brake while you're actually on the ice, and avoid sudden steering maneuvers.

# Your Driving and the Road



## If You're Caught in a Blizzard

If you are stopped by heavy snow, you could be in a serious situation. You should probably stay with your vehicle unless you know for sure that you are near help and you can hike through the snow. Here are some things to do to summon help and keep yourself and your passengers safe: Turn on your hazard flashers. Tie a red cloth to your vehicle to alert police that you've been stopped by the snow. Put on extra clothing or wrap a blanket around you. If you have no blankets or extra clothing, make body insulators from

newspapers, burlap bags, rags, floor mats — anything you can wrap around yourself or tuck under your clothing to keep warm. You can run the engine to keep warm, but be careful.

## CAUTION:

 Snow can trap exhaust gases under your vehicle. This can cause deadly CO (carbon monoxide) gas to get inside. CO could overcome you and kill you. You can't see it or smell it, so you might not know it is in your vehicle. Clear away snow from around the base of your vehicle, especially any that is blocking your exhaust pipe. And check around again from time to time to be sure snow doesn't collect there.

Open a window just a little on the side of the vehicle that's away from the wind. This will help keep CO out.





Run your engine only as long as you must. This saves fuel. When you run the engine, make it go a little faster than just idle. That is, push the accelerator slightly. This uses less fuel for the heat that you get and it keeps the battery charged. You will need a well-charged battery to restart the vehicle, and possibly for signaling later on with your headlights. Let the heater run for awhile.

Then, shut the engine off and close the window almost all the way to preserve the heat. Start the engine again and repeat this only when you feel really uncomfortable from the cold. But do it as little as possible. Preserve the fuel as long as you can. To help keep warm, you can get out

of the vehicle and do some fairly vigorous exercises every half hour or so until help comes.

#### **If You're Stuck in Deep Snow**

This manual explains how to get the vehicle out of deep snow without damaging it. See "Rocking Your Vehicle" in the Index.

## ■ *Towing a Trailer*

### **CAUTION:**



If you don't use the correct equipment and drive properly, you can lose control when you pull a trailer. For example, if the trailer is too heavy, the brakes may not work well — or even at all. You and your passengers could be seriously injured. Pull a trailer only if you have followed all the steps in this section.

# Your Driving and the Road

## **NOTICE:**

Pulling a trailer improperly can damage your vehicle and result in costly repairs not covered by your warranty. To pull a trailer correctly, follow the advice in this section.

Your vehicle can tow a trailer if it is equipped with the proper trailer towing equipment. To identify what the vehicle trailering capacity is for your vehicle, you should read the information in "Weight of the Trailer" that appears later in this section. But trailering is different than just driving your vehicle by itself. Trailering means changes in handling, durability,

and fuel economy. Successful, safe trailering takes correct equipment, and it has to be used properly.

That's the reason for this section. In it are many time-tested, important trailering tips and safety rules. Many of these are important for your safety and that of your passengers. So please read this section carefully before you pull a trailer.

Load-pulling components such as the engine, transmission, wheel assemblies, and tires are forced to work harder against the drag of the added weight. The engine is required to operate at relatively higher speeds and under greater loads,

generating extra heat. What's more, the trailer adds considerably to wind resistance, increasing the pulling requirements.

## **If You Do Decide to Pull a Trailer**

If you do, here are some important points.

- There are many different laws having to do with trailering. Make sure your rig will be legal, not only where you live but also where you'll be driving. A good source for this information can be state or provincial police.

- Consider using a sway control. You can ask a hitch dealer about sway controls.
- Don't tow a trailer at all during the first 500 miles (800 km) your new vehicle is driven. Your engine, axle or other parts could be damaged.
- Then, during the first 500 miles (800 km) that you tow a trailer, don't drive over 50 mph (80 km/h) and don't make starts at full throttle. This helps your engine and other parts of your vehicle wear in at the heavier loads.

Three important considerations have to do with weight:

#### **Weight of the Trailer**

How heavy can a trailer safely be?

It should never weigh more than 1,500 pounds (680 kg) under normal driving conditions. It should never weigh more than 1,000 pounds (450 kg) when driven on long grades at high ambient temperatures. But even that can be too heavy.

It depends on how you plan to use your rig. For example, speed, altitude, road grades, outside temperature and how much your vehicle is used to pull

a trailer are all important. And, it can also depend on any special equipment that you have on your vehicle.

You can ask your dealer for our trailering information or advice, or you can write us at:

Chevrolet Motor Division  
Customer Assistance Department  
P.O. Box 7047  
Troy, MI 48007-7047

In Canada, write to:  
General Motors of Canada Limited  
Customer Assistance Center  
1908 Colonel Sam Drive  
Oshawa, Ontario L1H 8P7

# Your Driving and the Road

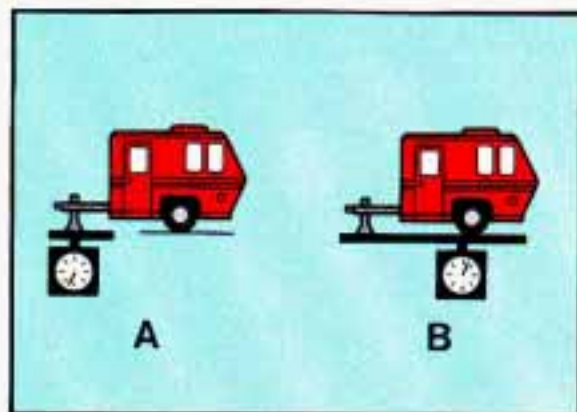

## Weight of the Trailer Tongue

The tongue load (A) of any trailer is an important weight to measure because it affects the total capacity weight of your vehicle. The capacity weight includes the curb weight of the vehicle, any cargo you may carry in it, and the people who will be riding in the vehicle. And if you will tow a trailer, you must subtract the tongue load from your vehicle's capacity weight because your vehicle will be carrying that weight, too. See "Loading Your Vehicle" in the Index for more information about your vehicle's maximum load capacity.

The trailer tongue (A) should weigh 10% of the total loaded trailer weight (B).

After you've loaded your trailer, weigh the trailer and then the tongue, separately, to see if the weights are proper. If they aren't, you may be able to get them right simply by moving some items around in the trailer.

## Total Weight on Your Vehicle's Tires

Be sure your vehicle's tires are inflated to the limit for cold tires. You'll find these numbers on the Certification label at the rear edge of the driver's door (or see "Tire Loading" in the Index). Then be sure you don't go over the GVW limit for your vehicle.

## Hitches

It's important to have the correct hitch equipment. Crosswinds, large trucks going by, and rough roads are a few reasons why you'll need the right hitch.

Here are some rules to follow:

- Will you have to make any holes in the body of your vehicle when you install a trailer hitch? If you do, then be sure to seal the holes later when you remove the hitch. If you don't seal them, deadly carbon monoxide (CO) from your exhaust can get into your vehicle (see "Carbon Monoxide" in the Index). Dirt and water can, too.
- The bumpers on your vehicle are not intended for hitches. Do not attach rental hitches or other bumper-type hitches to them. Use only a frame-mounted hitch that does not attach to the bumper.

### **Safety Chains**

You should always attach chains between your vehicle and your trailer. Cross the safety chains under the tongue of the trailer so that the tongue will not drop to the road if it becomes separated from the hitch. Instructions about safety chains may be provided by the hitch manufacturer or by the trailer manufacturer. Follow the manufacturer's recommendation for attaching safety chains. Always leave just enough slack so you can turn with your rig. And, never allow safety chains to drag on the ground.

### **Trailer Brakes**

If your trailer weighs more than 1,000 pounds (450 kg) loaded, then it needs its own brakes — and they must be adequate. Be sure to read and follow the instructions for the trailer brakes so you'll be able to install, adjust and maintain them properly. Because you have anti-lock brakes, do not try to tap into your vehicle's brake system. If you do, both brake systems won't work well, or at all.

### **Driving with a Trailer**

Towing a trailer requires a certain amount of experience. Before setting out for the open road, you'll want to get to know your rig. Acquaint yourself with the feel of handling and braking with the added

# Your Driving and the Road

weight of the trailer. And always keep in mind that the vehicle you are driving is now a good deal longer and not nearly so responsive as your vehicle is by itself.

Before you start, check the trailer hitch and platform, safety chains, electrical connector, lights, tires and mirror adjustment. If the trailer has electric brakes, start your vehicle and trailer moving and then apply the trailer brake controller by hand to be sure the brakes are working. This lets you check your electrical connection at the same time.

During your trip, check occasionally to be sure that the load is secure, and that the lights and any trailer brakes are still working.

## **Following Distance**

Stay at least twice as far behind the vehicle ahead as you would when driving your vehicle without a trailer. This can help you avoid situations that require heavy braking and sudden turns.

## **Passing**

You'll need more passing distance up ahead when you're towing a trailer. And, because you're a good deal longer, you'll need to go much farther beyond the passed vehicle before you can return to your lane.

## **Backing Up**

Hold the bottom of the steering wheel with one hand. Then, to move the trailer to the left, just move that hand to the left. To move the trailer to the right, move your hand to the right. Always back up slowly and, if possible, have someone guide you.

## **Making Turns**

When you're turning with a trailer, make wider turns than normal. Do this so your trailer won't strike soft shoulders, curbs, road signs, trees, or other objects. Avoid jerky or sudden maneuvers. Signal well in advance.

### Turn Signals When Towing a Trailer

When you tow a trailer, your vehicle has to have a different turn signal flasher and extra wiring. The green arrows on your instrument panel will flash whenever you signal a turn or lane change. Properly hooked up, the trailer lights will also flash, telling other drivers you're about to turn, change lanes or stop.

When towing a trailer, the green arrows on your instrument panel will flash for turns even if the bulbs on the trailer are burned out. Thus, you may think drivers behind you are seeing your signal when they are not. It's important to check occasionally to be sure the trailer bulbs are still working.

### Driving on Grades

Reduce speed and shift to a lower gear **before** you start down a long or steep downgrade. If you don't shift down, you might have to use your brakes so much that they would get hot and no longer work well.

On a long uphill grade, shift down and reduce your speed to around 45 mph (70 km/h) to reduce the possibility of engine and transmission overheating.

If you are towing a trailer and you have an automatic transmission with Overdrive, you may prefer to drive in **D** instead of Overdrive (or, as you need to, a lower gear). Or, if you have a manual transmission with fifth (or sixth) gear and you are towing a trailer, it's better not to use fifth (or sixth) gear. Just drive in fourth gear (fifth gear if you have a six-speed manual transmission) (or, as you need to, a lower gear).

# Your Driving and the Road

## Parking on Hills

You really should not park your vehicle, with a trailer attached, on a hill. If something goes wrong, your rig could start to move. People can be injured, and both your vehicle and the trailer can be damaged.

But if you ever have to park your rig on a hill, here's how to do it:

1. Apply your regular brakes, but don't shift into **P** (Park) yet, or into gear for a manual transmission.
2. Have someone place chocks under the trailer wheels.
3. When the wheel chocks are in place, release the regular brakes until the chocks absorb the load.
4. Reapply the regular brakes. Then apply your parking brake, and then shift to **P** (Park), or **R** (Reverse) for a manual transmission.
5. Release the regular brakes.

## When You Are Ready to Leave after Parking on a Hill

1. Apply your regular brakes and hold the pedal down while you:
  - Start your engine;
  - Shift into a gear; and
  - Release the parking brake.
2. Let up on the brake pedal.
3. Drive slowly until the trailer is clear of the chocks.
4. Stop and have someone pick up and store the chocks.



### **Maintenance When Trailer Towing**

Your vehicle will need service more often when you're pulling a trailer. See the Maintenance Schedule for more on this. Things that are especially important in trailer operation are automatic transmission fluid (don't overfill), engine oil, axle lubricant, belts, cooling system, and brake adjustment. Each of these is covered in this manual, and the Index will help you find them quickly. If you're trailering, it's a good idea to review these sections before you start your trip.

Check periodically to see that all hitch nuts and bolts are tight.

# Notes

# Part 5

## Problems on the Road



**H**ere you'll find what to do about some problems that can occur on the road.

Hazard Warning Flashers .....	184
Jump Starting .....	185
Towing Your Vehicle .....	190
Engine Overheating .....	193
If a Tire Goes Flat .....	204
If You're Stuck: In Sand, Mud, Ice or Snow .....	215

## Problems on the Road



### ■ *Hazard Warning Flashers*

Your hazard warning flashers let you warn others. They also let police know you have a problem. Your front and rear turn signal lights will flash on and off.

Press the button in to make your front and rear turn signal lights flash on and off.

Your hazard warning flashers work no matter what position your key is in, and even if the key isn't in.

To turn off the flashers, pull out on the collar.

When the hazard warning flashers are on, your turn signals won't work.

### **Other Warning Devices**

If you carry reflective triangles, you can set one up at the side of the road about 300 feet (100 m) behind your vehicle.

## ■ *Jump Starting*

If your battery has run down, you may want to use another vehicle and some jumper cables to start your Chevrolet. But please follow the steps below to do it safely.

### **CAUTION:**



Batteries can hurt you. They can be dangerous because:

- They contain **acid** that can burn you.
- They contain **gas** that can explode or ignite.
- They contain enough **electricity** to burn you.

If you don't follow these steps exactly, some or all of these things can hurt you.

### **NOTICE:**

Ignoring these steps could result in costly damage to your vehicle that wouldn't be covered by your warranty.

Trying to start your Chevrolet by pushing or pulling it could damage your vehicle, even if you have a manual transmission. And if you have an automatic transmission, it won't start that way.

# Problems on the Road

## To Jump Start Your Chevrolet:

1. Check the other vehicle. It must have a 12-volt battery with a negative ground system.

### **NOTICE:**

If the other system isn't a 12-volt system with a negative ground, both vehicles can be damaged.

2. Get the vehicles close enough so the jumper cables can reach, but be sure the vehicles aren't touching each other. If they are, it could cause a ground connection you don't want. You wouldn't be able to start your Chevrolet, and the bad grounding could damage the electrical systems.

### **CAUTION:**



You could be injured if the vehicles roll. Set the parking brake firmly on each vehicle. Put an automatic transmission in P (Park) or a manual transmission in **Neutral**.

3. Turn off the ignition on both vehicles. Turn off all lights that aren't needed, and radios. This will avoid sparks and help save both batteries. And it could save your radio!

### **NOTICE:**

If you leave your radio on, it could be badly damaged. The repairs wouldn't be covered by your warranty.

4. Open the hoods and locate the batteries.

### CAUTION:



An electric fan can start up even when the engine is not running and can injure you. Keep hands, clothing and tools away from any underhood electric fan.

Find the positive (+) and negative (-) terminals on each battery.

### CAUTION:



Using a match near a battery can cause battery gas to explode. People have been hurt doing this, and some have been blinded. Use a flashlight if you need more light.

Be sure the battery has enough water. You don't need to add water to the Delco Freedom<sup>®</sup> battery installed in every new GM vehicle. But if a battery has filler caps, be sure the right amount of fluid is there. If it is low, add water to take care of that first. If you don't, explosive gas could be present.

Battery fluid contains acid that can burn you. Don't get it on you. If you accidentally get it in your eyes or on your skin, flush the place with water and get medical help immediately.

5. Check that the jumper cables don't have loose or missing insulation. If they do, you could get a shock. The vehicles could be damaged, too.

Before you connect the cables, here are some basic things you should know. Positive (+) will go to positive (+) and negative (-) will go to negative (-) or a metal engine part. Don't connect (+) to (-) or you'll get a short that would damage the battery and maybe other parts, too.

## Problems on the Road



### **CAUTION:**



Fans or other moving engine parts can injure you badly. Keep your hands away from moving parts once the engines are running.

6. Connect the red positive (+) cable to the positive (+) terminal of the vehicle with the dead battery. Use a remote positive (+) terminal if the vehicle has one.
7. Don't let the other end touch metal. Connect it to the positive (+) terminal of the good battery. Use a remote positive (+) terminal if the vehicle has one. But don't use the junction block on your Chevrolet.





8. Now connect the black negative (-) cable to the good battery's negative (-) terminal.

Don't let the other end touch anything until the next step. The other end of the negative cable **doesn't** go to the dead battery. It goes to a heavy unpainted metal part on the engine of the vehicle with the dead battery.



9. Attach the cable at least 18 inches (45 cm) away from the dead battery, but not near engine parts that move. The electrical connection is just as good there, but the chance of sparks getting back to the battery is much less.
10. Now start the vehicle with the good battery and run the engine for a while.
11. Try to start the vehicle with the dead battery.  
If it won't start after a few tries, it probably needs service.

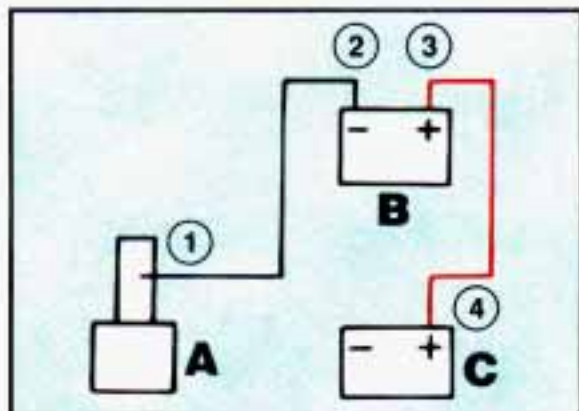

12. Remove the cables in reverse order to prevent electrical shorting. Take care that they don't touch each other or any other metal.
- A. Heavy Metal Engine Part  
B. Good Battery  
C. Dead Battery

# Problems on the Road

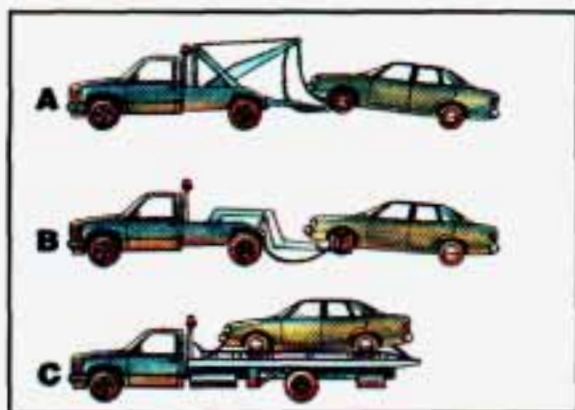

## ■ *Towing Your Vehicle*

Try to have a GM dealer or a professional towing service tow your Chevrolet. The usual towing equipment is a sling-type (A) or a wheel-lift (B) or car carrier (C) tow truck.

If your vehicle has been changed or modified since it was factory-new by adding aftermarket items like fog lamps, aero skirting, or special tires and wheels, these instructions and illustrations may not be correct.

Before you do anything, turn on the hazard warning flashers.

When you call, tell the towing service:

- That your vehicle cannot be towed from the front or rear with sling-type equipment.
- That your vehicle has rear-wheel drive.
- The make, model, and year of your vehicle.
- Whether you can still move the shift lever.
- If there was an accident, what was damaged.

When the towing service arrives, let the tow operator know that this manual contains detailed towing instructions and illustrations. The operator may want to see them.



## **CAUTION:**



To help avoid injury to you or others:

- Never let passengers ride in a vehicle that is being towed.
- Never tow faster than safe or posted speeds.
- Never tow with damaged parts not fully secured.
- Never get under your vehicle after it has been lifted by the tow truck.
- Always use separate safety chains on each side when towing a vehicle.
- Never use "J" hooks. Use T-hooks instead.

When your vehicle is being towed, have the ignition key off. The steering wheel should be clamped in a straight-ahead position, with a clamping device designed for towing service. Do not use the vehicle's steering column lock for this. The transmission should be in **Neutral** and the parking brake released.

Don't have your vehicle towed on the rear wheels, unless you must. If the vehicle must be towed on the rear wheels, don't go more than 35 mph (55 km/h) or farther than 50 miles (80 km) or your transmission will be damaged. If these limits must be exceeded, then the rear wheels have to be supported on a dolly.

### **CAUTION:**



A vehicle can fall from a car carrier if it isn't properly secured. This can cause a collision, serious personal injury and vehicle damage. The vehicle should be tightly secured with chains or steel cables before it is transported.

Don't use substitutes (ropes, leather straps, canvas webbing, etc.) that can be cut by sharp edges underneath the towed vehicle.



### **Front Towing Hook-Ups**

Attach T-hook chains to slots in frame rearward of front wheels on both sides.

### **NOTICE:**

Do not attach winch cables or "J" hooks to suspension components when using car carrier equipment. Always use T-hooks inserted in the T-hook slots.

## Problems on the Road

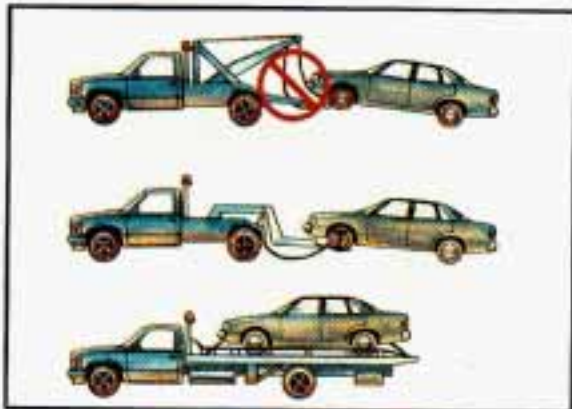

### **NOTICE:**

Do not tow with sling-type equipment or fascia/fog light damage will occur.

Use wheel lift or car carrier equipment. Additional ramping may be required for car carrier equipment. Use safety chains and wheel straps.



Attach a separate safety chain around outboard end of each lower control arm.

### **NOTICE:**

Take care not to damage the brake pipes and hoses or the ABS sensor and wiring.

### **NOTICE:**

Towing a vehicle over rough surfaces could damage a vehicle. Damage can occur from both vehicle-to-ground or vehicle-to-wheel-lift-equipment contact. To help avoid damage, install a towing dolly and raise vehicle until proper clearance is obtained between the ground and/or wheel-lift equipment.

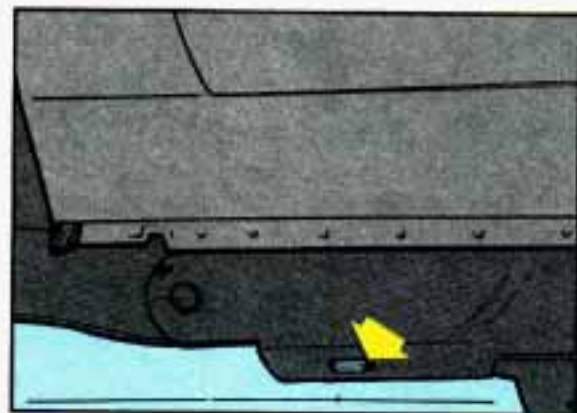

### **Rear Towing Hook-Ups**

Attach T-hook chains in front of rear wheels in bottom of frame rail on both sides.

### **NOTICE:**

Do not attach winch cables or "J" hooks to suspension components when using car carrier equipment. Always use T-hooks inserted in the T-hook slots.

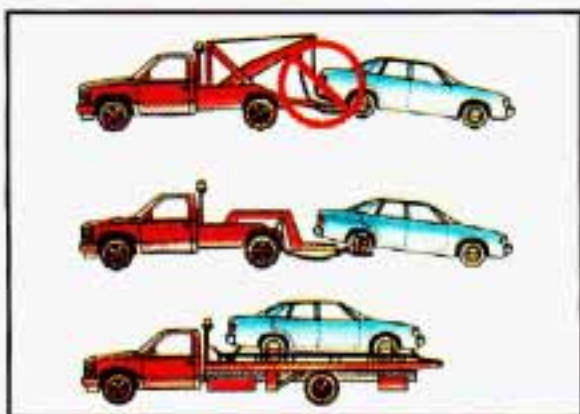

### **NOTICE:**

Do not tow with sling-type equipment or rear bumper valance will be damaged.

Use wheel lift or car carrier equipment. Additional ramping may be required for car carrier equipment.

Use safety chains and wheel straps.



Attach a separate safety chain around outboard end of the rear axle.

### **NOTICE:**

Take care not to damage the brake pipes and cables.

### **NOTICE:**

Towing a vehicle over rough surfaces could damage a vehicle. Damage can occur from both vehicle-to-ground or vehicle-to-wheel-lift-equipment contact. To help avoid damage, install a towing dolly and raise vehicle until proper clearance is obtained between the ground and/or wheel-lift equipment.

### ■ **Engine Overheating**

You will find a coolant temperature gage on your Chevrolet's instrument panel.

You may also find a low coolant warning light on your Chevrolet instrument panel.

## Problems on the Road



If Steam Is Coming from Your Engine:

### CAUTION:

 Steam from an overheated engine can burn you badly, even if you just open the hood. Stay away from the engine if you see or hear steam coming from it. Just turn it off and get everyone away from the vehicle until it cools down. Wait until there is no sign of steam or coolant before opening the hood.

If you keep driving when your engine is overheated, the liquids in it can catch fire. You or others could be badly burned. Stop your engine if it overheats, and get out of the vehicle until the engine is cool.

### NOTICE:

If your engine catches fire because you keep driving with no coolant, your vehicle can be badly damaged. The costly repairs would not be covered by your warranty.

If No Steam Is Coming from Your Engine:

If you get the overheat warning but see or hear no steam, the problem may not be too serious. Sometimes the engine can get a little too hot when you:

- Climb a long hill on a hot day.
- Stop after high speed driving.
- Idle for long periods in traffic.
- Tow a trailer.

If you get the overheat warning with no sign of steam, try this for a minute or so:

1. If you have an air conditioner, turn it off.
2. Turn on your heater to full hot at the highest fan speed and open the window as necessary.
3. Try to keep your engine under load (in a drive gear where the engine runs slower).

If you no longer have the overheat warning, you can drive. Just to be safe, drive slower for about ten minutes. If the warning doesn't come back on, you can drive normally.

If the warning continues, pull over, stop, and park your vehicle right away.

If there's still no sign of steam, you can idle the engine for two or three minutes while you're parked, to see if the warning stops. But then, if you still have the warning, **TURN OFF THE ENGINE AND GET EVERYONE OUT OF THE VEHICLE** until it cools down.

You may decide not to lift the hood but to get service help right away.



### Cooling System

When you decide it's safe to lift the hood, here's what you'll see on the V6 engine:

1. Coolant recovery tank
2. Radiator pressure cap
3. Electric engine fan

## Problems on the Road

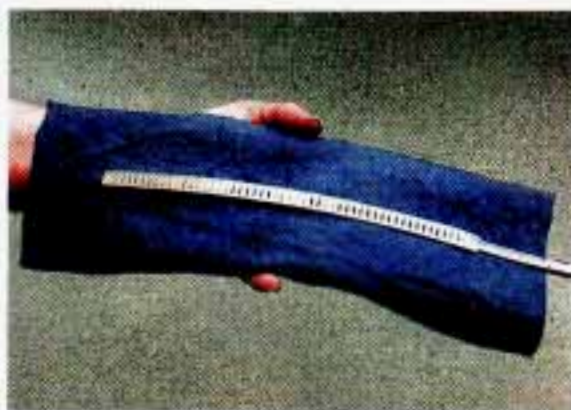

On the V8 engine you'll see this:

1. Coolant recovery tank
2. Radiator pressure cap
3. Electric engine fans

### CAUTION:

 An electric fan under the hood can start up even when the engine is not running and can injure you. Keep hands, clothing and tools away from any underhood electric fan.

If the coolant inside the coolant recovery tank is boiling, don't do anything else until it cools down.

When it is cool, remove the coolant recovery tank cap and look at the dipstick. The coolant level should be at or above **FULL COLD**. If it isn't, you may have a leak in the radiator hoses, heater hoses, radiator, water pump or somewhere else in the cooling system.

### CAUTION:

 Heater and radiator hoses, and other engine parts, can be very hot. Don't touch them. If you do, you can be burned.

Don't run the engine if there is a leak. If you run the engine, it could lose all coolant. That could cause an engine fire, and you could be burned. Get any leak fixed before you drive the vehicle.





### **NOTICE:**

Engine damage from running your engine without coolant isn't covered by your warranty.

If there seems to be no leak, check to see if the electric engine fan is running. If the engine is overheating, the fan should be running. If it isn't, your vehicle needs service.

### **How to Add Coolant to the Coolant Recovery Tank**

If you haven't found a problem yet, but the coolant level isn't at or above **FULL COLD**, add a 50/50 mixture of **clean water** (preferably distilled) and a proper antifreeze at the coolant recovery tank. (See "Engine Coolant" in the Index for more information about the proper coolant mix.)

### **CAUTION:**



Adding only plain water to your cooling system can be dangerous. Plain water, or some other liquid like alcohol, can boil before the proper coolant mix will. Your vehicle's coolant warning system is set for the proper coolant mix. With plain water or the wrong mix, your engine could get too hot but you wouldn't get the overheat warning. Your engine could catch fire and you or others could be burned. Use a 50/50 mix of **clean water** and a proper antifreeze.

# Problems on the Road

## NOTICE:

In cold weather, water can freeze and crack the engine, radiator, heater core and other parts. Use the recommended coolant.

## CAUTION:



You can be burned if you spill coolant on hot engine parts. Coolant contains ethylene glycol and it will burn if the engine parts are hot enough. Don't spill coolant on a hot engine.

When the coolant in the coolant recovery tank is at or above **FULL COLD**, start your vehicle.

If the overheat warning continues, there's one more thing you can try. You can add the proper coolant mix directly to the radiator, but be sure the cooling system is cool before you do it.



## CAUTION:



Steam and scalding liquids from a hot cooling system can blow out and burn you badly. They are under pressure, and if you turn the radiator pressure cap — even a little — they can come out at high speed. Never turn the cap when the cooling system, including the radiator pressure cap, is hot. Wait for the cooling system and radiator pressure cap to cool if you ever have to turn the pressure cap.



### How to Add Coolant to the Radiator (3.4L L32 (Code S) Engine)

1. You can remove the radiator pressure cap when the cooling system, including the radiator pressure cap and upper radiator hose, is no longer hot. Turn the pressure cap slowly to the left until it first stops. (Don't press down while turning the pressure cap.) If you hear a hiss, wait for that to stop. A hiss means there is still some pressure left.



2. Then keep turning the pressure cap, but now push down as you turn it. Remove the pressure cap.



3. Fill the radiator with the proper mix, up to the base of the filler neck.

## Problems on the Road



4. Then fill the coolant recovery tank to **FULL COLD**.

5. Put the cap back on the coolant recovery tank, but leave the radiator pressure cap off.

6. Start the engine and let it run until you can feel the upper radiator hose getting hot. Watch out for the engine fan(s).
- By this time the coolant level inside the radiator filler neck may be lower. If the level is lower, add more of the proper mix through the filler neck until the level reaches the base of the filler neck.



7. Then replace the pressure cap. Be sure the arrows on the pressure cap line up like this.

#### How to Add Coolant to the Radiator (5.7L LT1 (Code P) Engine)

#### **NOTICE:**

The LT1 engine (Code P) has a specific radiator fill procedure. Failure to follow this procedure could cause your engine to overheat and be severely damaged.



1. You can remove the radiator pressure cap when the cooling system, including the radiator pressure cap and upper radiator hose, is no longer hot. Turn the pressure cap slowly to the left until it first stops. (Don't press down while turning the pressure cap.) If you hear a hiss, wait for that to stop. A hiss means there is still some pressure left.

## Problems on the Road



2. Then keep turning the pressure cap, but now push down as you turn it. Remove the pressure cap.



### **CAUTION:**



You can be burned if you spill coolant on hot engine parts. Coolant contains ethylene glycol and it will burn if the engine parts are hot enough. Don't spill coolant on a hot engine.

3. After the engine cools, open the air bleed valves on the heater return hose and water pump inlet.

4. Fill with the proper mix. Add coolant until you see a steady stream of coolant coming from the bleed valves.
5. Close the bleed valves.



**6.** Continue to fill the radiator up to the base of the filler neck.



**7.** Rinse or wipe the spilled coolant from the engine and compartment.

**8.** Start the engine and allow it to run in idle for approximately four minutes. By this time, the coolant level inside the radiator will be lower. Add more of the proper mix through the filler neck until the level reaches the base of the filler neck.

## Problems on the Road



9. Shut the engine off and replace the pressure cap. Be sure the arrows on the cap line up like this.



10. Then fill the coolant recovery tank to the proper level.

For a complete drain, flush and refill, see your Chevrolet dealer or a Chevrolet Camaro Service Manual. To purchase a service manual, see "Service Publications" in the Index.

### ■ *If a Tire Goes Flat*

It's unusual for a tire to "blow out" while you're driving, especially if you maintain your tires properly. If air goes out of a tire, it's much more likely to leak out slowly. But if you should ever have a "blowout," here are a few tips about what to expect and what to do:

If a front tire fails, the flat tire will create a drag that pulls the vehicle toward that side. Take your foot off the accelerator pedal and grip the steering wheel firmly. Steer to maintain lane position, then gently brake to a stop well out of the traffic lane.





A rear blowout, particularly on a curve, acts much like a skid and may require the same correction you'd use in a skid. In any rear blowout, remove your foot from the accelerator pedal. Get the vehicle under control by steering the way you want the vehicle to go. It may be very bumpy and noisy, but you can still steer. Gently brake to a stop, well off the road if possible.

If your tire goes flat, the next section shows how to use your jacking equipment to change a flat tire safely.

### ***Changing a Flat Tire***

If a tire goes flat, avoid further tire and wheel damage by driving slowly to a level place. Turn on your hazard warning flashers.

#### **CAUTION:**



Changing a tire can cause an injury. The vehicle can slip off the jack and roll over you or other people. You and they could be badly injured. Find a level place to change your tire. To help prevent the vehicle from moving:

1. Set the parking brake firmly.
2. Put the shift lever in **P** (Park).
3. Shift a manual transmission to **1** (First) or **R** (Reverse).
4. Turn off the engine.

To be even more certain the vehicle won't move, you can put chocks at the front and rear of the tire farthest away from the one being changed. That would be the tire on the other side of the vehicle, at the opposite end.

## Problems on the Road



The following steps will tell you how to use the jack and change a tire.

The equipment you'll need is in the rear area.

Find the plastic screw heads in the trim panel over the spare tire. Use a coin or a key to turn the screw heads until the slots point front and back. Lift the trim panel and move it out of the way.



If you have speakers in the trim panel, the speaker wire should be long enough to remove the trim panel without disconnecting the wire.

To remove the jack and wheel wrench, loosen and remove the bolt and remove the plastic cover.



Remove the wing nut and adapter and pull out the spare.



Start with the jack (A) and wheel wrench (B).

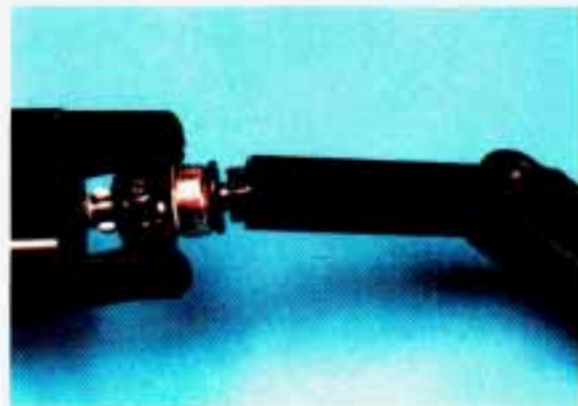

The jack has a bolt at the end. Attach the wheel wrench to the jack bolt. Turn the wheel wrench to the right to raise the lift head a little.

## Problems on the Road



If your wheel has a center cap, pry it off using the wheel wrench.



If your vehicle has a bolt-on wheel cover, loosen the plastic caps using the wheel wrench and remove the wheel cover.



If your vehicle has optional alloy wheels, each wheel may have one locknut in place of the standard wheel nut. A special wheel lock key (removal tool) and instructions are located in the center console. Attach the wheel lock key to the socket of the wheel wrench. Remove the locking wheel nut by turning counterclockwise.



Using the wheel wrench, loosen all the wheel nuts. Don't remove them yet.

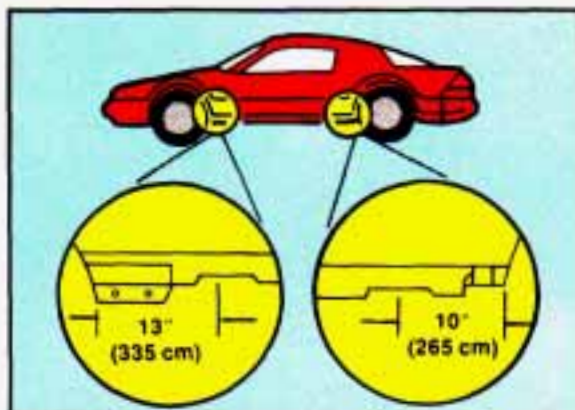

Position the jack under the vehicle. There is a notch in the vehicle's rocker flange. Raise the jack head until it fits firmly into the notch nearest the flat tire.



Stay away from the moldings or fender flanges to avoid damaging them.

### **CAUTION:**



Getting under a vehicle when it is jacked up is dangerous. If the vehicle slips off the jack, you could be badly injured or killed. Never get under a vehicle when it is supported only by a jack.

## Problems on the Road



### **NOTICE:**

Raising your vehicle with the jack improperly positioned will damage the vehicle or may allow the vehicle to fall off the jack. Be sure to fit the jack lift head into the proper location before raising your vehicle.

Raise the vehicle by rotating the wheel wrench clockwise. Raise the vehicle far enough off the ground so there is enough room for the spare tire to fit.

Remove all the wheel nuts and take off the flat tire.



### **CAUTION:**

 Rust or dirt on the wheel, or on the parts to which it is fastened, can make the wheel nuts become loose after a time. The wheel could come off and cause an accident. When you change a wheel, remove any rust or dirt from the places where the wheel attaches to the vehicle. In an emergency, you can use a cloth or a paper towel to do this; but be sure to use a scraper or wire brush later, if you need to, to get all the rust or dirt off.

Remove any rust or dirt from the wheel bolts, mounting surfaces or spare wheel. Place the spare on the wheel mounting surface.

### **CAUTION:**

 Never use oil or grease on studs or nuts. If you do, the nuts might come loose. Your wheel could fall off, causing a serious accident.



Replace the wheel nuts with the rounded end of the nuts toward the wheel. Tighten each nut by hand until the wheel is held against the hub.

## Problems on the Road



Lower the vehicle by rotating the wheel wrench counterclockwise. Lower the jack completely.



Tighten the wheel nuts firmly in a criss-cross sequence as shown.

### **CAUTION:**



Incorrect wheel nuts or improperly tightened wheel nuts can cause the wheel to become loose and even come off. This could lead to an accident. Be sure to use the correct wheel nuts. If you have to replace them, be sure to get the right kind.

Stop somewhere as soon as you can and have the nuts tightened with a torque wrench to 100 pound-feet (140 N•m).

Don't try to put a wheel cover on your compact spare tire. It won't fit. Store the wheel cover in the rear area until you have the flat tire repaired or replaced.

### **NOTICE:**

Wheel covers won't fit on your compact spare. If you try to put a wheel cover on your compact spare, you could damage the cover or the spare.



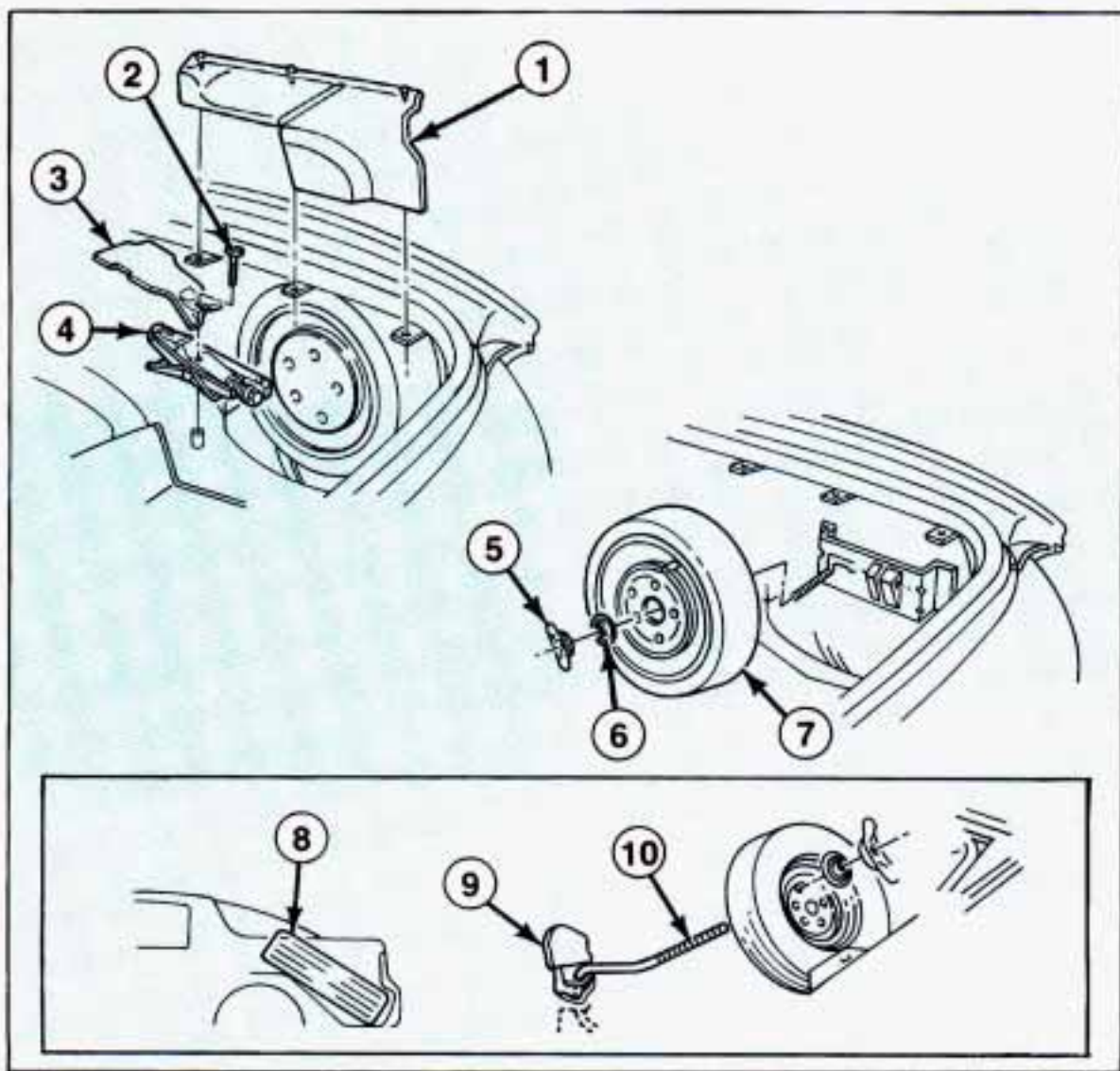

Replace the jack, wheel wrench and flat tire using the storage instructions. When you replace the trim panel, be sure to tuck it under the weatherstrip.

1. Trim Panel
2. Bolt
3. Cover
4. Jack
5. Wing Nut
6. Adapter
7. Compact Spare Tire
8. Full-Size Tire
9. Carpet Flap
10. Tire Storage Bolt

# Problems on the Road

## **CAUTION:**



Storing a jack, a tire or other equipment in the passenger compartment of the vehicle could cause injury. In a sudden stop or collision, loose equipment could strike someone. Store all these in the proper place.

## **Compact Spare**

Although the compact spare was fully inflated when your vehicle was new, it can lose air after a time. Check the inflation pressure regularly. It should be 60 psi (420 kPa). The compact spare is made to go up to 3,000 miles (5 000 km), so you can finish your trip and have your full-size tire repaired or replaced where you want. Of course, it's best to replace your spare with a full-size tire as soon as you can. Your spare will last longer and be in good shape in case you need it again.

## **NOTICE:**

If the compact spare is used as a rear tire, do not drive faster than 50 mph (80 km/h). Damage to the rear axle may occur if the compact spare is driven faster than 50 mph (80 km/h). This speed limitation does not apply when the compact spare is used as a front tire.

### **NOTICE:**

Don't take your compact spare through an automatic car wash with guide rails. The compact spare can get caught on the rails. That can damage the tire and wheel, and maybe other parts of your vehicle.

Don't use your compact spare on some other vehicle.

And don't mix your compact spare or wheel with other wheels or tires. They won't fit. Keep your spare and its wheel together.

### **NOTICE:**

Tire chains won't fit your compact spare. Using them will damage your vehicle and destroy the chains too. Don't use tire chains on your compact spare.

### ■ *If You're Stuck: In Sand, Mud, Ice or Snow*

What you **don't** want to do when your vehicle is stuck is to spin your wheels. The method known as "rocking" can help you get out when you're stuck, but you must use caution.

# Problems on the Road

## CAUTION:



If you let your tires spin at high speed, they can explode and you or others could be injured. And, the transmission or other parts of the vehicle can overheat. That could cause an engine compartment fire or other damage. When you're stuck, spin the wheels as little as possible. Don't spin the wheels above 35 mph (55 km/h) as shown on the speedometer.

## NOTICE:

Spinning your wheels can destroy parts of your vehicle as well as the tires. If you spin the wheels too fast while shifting your transmission back and forth, you can destroy your transmission.

## Rocking your vehicle to get it out:

First, turn your steering wheel left and right. That will clear the area around your front wheels. Then shift back and forth between **R** (Reverse) and a forward gear (or with a manual transmission, between First or Second gear and Reverse), spinning the wheels as little as possible. Release the accelerator pedal while you shift, and press lightly on the accelerator pedal when the transmission is in gear. If that doesn't get you out after a few tries, you may need to be towed out. If you do need to be towed out, see "Towing Your Vehicle" in the Index.



## Part 6

# Service & Appearance Care

**H**ere you will find information about the care of your Chevrolet. This part begins with service and fuel information, and then it shows how to check important fluid and lubricant levels. There is also technical information about your vehicle, and a section devoted to its appearance care.

Service .....	218
Fuel .....	219
Checking Things under the Hood .....	223
Hood Release .....	223
Engine Oil .....	226
Air Cleaner .....	230
Automatic Transmission Fluid .....	233
Manual Transmission Fluid .....	235
Hydraulic Clutch .....	237
Rear Axle .....	237
Engine Coolant .....	238
Power Steering Fluid .....	242
Windshield Washer Fluid .....	243
Brake Master Cylinder .....	244
Battery .....	246
Bulb Replacement .....	247
Loading Your Vehicle .....	255
Tires .....	256
Appearance Care .....	265
Appearance Care and Maintenance Materials .....	274
Vehicle Identification Number (VIN) .....	275
Service Parts Identification Label .....	275
Add-On Electrical Equipment .....	275
Fuses and Circuit Breakers .....	276
Replacement Bulbs .....	279
Capacities and Specifications .....	280

## Service & Appearance Care



### ■ *Service*

Your Chevrolet dealer knows your vehicle best and wants you to be happy with it. We hope you'll go to your dealer for all your service needs. You'll get genuine GM parts and GM-trained and supported service people.

We hope you'll want to keep your GM vehicle all GM. Genuine GM parts have one of these marks.

### **Doing Your Own Service Work**

If you want to do some of your own service work, you'll want to get the proper Chevrolet Service Manual. It tells you much more about how to service your Chevrolet than this manual can. To order the proper service manual, see "Service Publications" in the Index.

You should keep a record with all parts receipts and list the mileage and the date of any service work you perform. See "Maintenance Record" in the Index.

### **CAUTION:**



You can be injured if you try to do service work on a vehicle without knowing enough about it.

- Be sure you have sufficient knowledge, experience, and the proper replacement parts and tools before you attempt any vehicle maintenance task.
- Be sure to use the proper nuts, bolts and other fasteners. "English" and "metric" fasteners can be easily confused. If you use the wrong fasteners, parts can later break or fall off. You could be hurt.

## **NOTICE:**

If you try to do your own service work without knowing enough about it, your vehicle could be damaged.

### ■ *Fuel*

The 8th digit of your Vehicle Identification Number (VIN) shows the code letter for your engine. You will find the VIN at the top left of your instrument panel. (See “Vehicle Identification Number” in the Index.)

#### **3.4L L32 (Code S)**

Use regular unleaded gasoline rated at 87 octane or higher. It should meet specifications ASTM D4814 in the U.S. and CGSB 3.5-92 in Canada. These fuels should have the proper additives, so you should not have to add anything to the fuel.

In the U.S. and Canada, it's easy to be sure you get the right kind of gasoline (unleaded). You'll see **UNLEADED** right

on the pump. And only unleaded nozzles will fit into your vehicle's filler neck.

Be sure the posted octane is at least 87. If the octane is less than 87, you may get a heavy knocking noise when you drive. If it's bad enough, it can damage your engine.

If you're using fuel rated at 87 octane or higher and you still hear heavy knocking, your engine needs service. But don't worry if you hear a little pinging noise when you're accelerating or driving up a hill. That's normal, and you don't have to buy a higher octane fuel to get rid of pinging. It's the heavy, constant knock that means you have a problem.

# Service & Appearance Care

## 5.7L LT1 (Code P)

Use premium unleaded gasoline rated at 91 octane or higher. You may use middle grade or regular unleaded gasolines, but your vehicle may not accelerate as well. The gasoline you use should meet specifications ASTM D4814 in the U.S. and CGSB 3.5-92 in Canada. These fuels should have the proper additives, so you should not have to add anything to the fuel.

In the U.S. and Canada, it's easy to be sure you get the right kind of gasoline (unleaded). You'll see **UNLEADED** right on the pump. And only unleaded nozzles will fit into your vehicle's filler neck.

Be sure the posted octane for premium is at least 91 (at least 89 for middle grade and 87 for regular). If the octane is less than 87, you may get a heavy knocking noise when you drive. If it's bad enough, it can damage your engine.

If you're using fuel rated at 91 octane or higher and you still hear heavy knocking, your engine needs service. But don't worry if you hear a little pinging noise when you're accelerating or driving up a hill. That's normal and you don't have to buy a higher octane fuel to get rid of pinging. It's the heavy, constant knock that means you have a problem.

## All Engines

What about gasoline with blending materials that contain oxygen, such as MTBE or alcohol?

**MTBE** is "methyl tertiary-butyl ether." Fuel that is no more than 15% MTBE is fine for your vehicle.

**Ethanol** is ethyl or grain alcohol. Properly-blended fuel that is no more than 10% **ethanol** is fine for your vehicle.



**Methanol** is methyl or wood alcohol.

**NOTICE:**

Fuel that is more than 5% **methanol** is bad for your vehicle. Don't use it. It can corrode metal parts in your fuel system and also damage plastic and rubber parts. That damage wouldn't be covered under your warranty. And even at 5% or less, there must be "cosolvents" and corrosion preventers in this fuel to help avoid these problems.

**Gasolines for Cleaner Air**

Your use of gasoline with detergent additives will help prevent deposits from forming in your engine and fuel system. That helps keep your engine in tune and your emission control system working properly. It's good for your vehicle, and you'll be doing your part for cleaner air.

Many gasolines are now blended with materials called oxygenates. General Motors recommends that you use gasolines with these blending materials, such as MTBE and ethanol. By doing so, you can help clean the air, especially in those parts of the country that have high carbon monoxide levels.

In addition, some gasoline suppliers are now producing reformulated gasolines. These gasolines are specially designed to reduce vehicle emissions. General Motors recommends that you use reformulated gasoline. By doing so, you can help clean the air, especially in those parts of the country that have high ozone levels.

You should ask your service station operators if their gasolines contain detergents and oxygenates, and if they have been reformulated to reduce vehicle emissions.

# Service & Appearance Care

## Fuels in Foreign Countries

If you plan on driving in another country outside the U.S. or Canada, unleaded fuel may be hard to find. Do not use leaded gasoline. If you use even one tankful, your emission controls won't work well or at all. With continuous use, spark plugs can get fouled, the exhaust system can corrode, and your engine oil can deteriorate quickly. Your vehicle's oxygen sensor will be damaged. All of that means costly repairs that wouldn't be covered by your warranty.

To check on fuel availability, ask an auto club, or contact a major oil company that does business in the country where you'll be driving.

You can also write us at the following address for advice. Just tell us where you're going and give your Vehicle Identification Number (VIN).

General Motors of Canada Ltd.  
International Export Sales  
P.O. Box 828  
Oshawa, Ontario L1H 7N1  
Canada



## Filling Your Tank

### **CAUTION:**

 Gasoline vapor is highly flammable. It burns violently, and that can cause very bad injuries. Don't smoke if you're near gasoline or refueling your vehicle. Keep sparks, flames, and smoking materials away from gasoline.

The cap is behind a hinged door on the left side of your vehicle.

To take off the cap, turn it slowly to the left (counterclockwise).

### **CAUTION:**



If you get gasoline on you and then something ignites it, you could be badly burned. Gasoline can spray out on you if you open the fuel filler cap too quickly. This spray can happen if your tank is nearly full, and is more likely in hot weather. Open the fuel filler cap slowly and wait for any "hiss" noise to stop. Then unscrew the cap all the way.

When you put the cap back on, turn it to the right until you hear a clicking noise.

### **NOTICE:**

If you need a new cap, be sure to get the right type. Your dealer can get one for you. If you get the wrong type, it may not fit and your fuel tank and emissions system might be damaged.



## ■ *Checking Things under the Hood*

### **Hood Release**

To open the hood, first pull the handle inside the vehicle.

## Service & Appearance Care

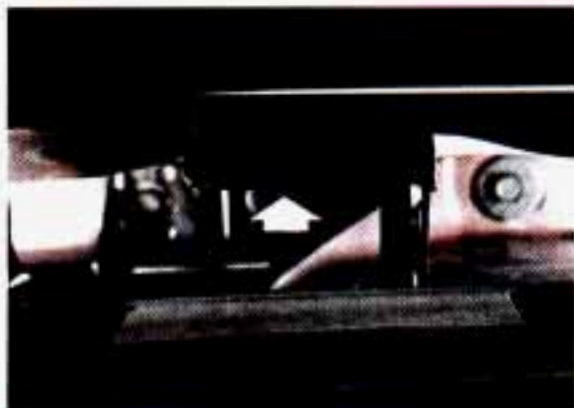

Then go to the front of the vehicle and pull up on the hood release.

Lift the hood.

### **CAUTION:**



An electric fan under the hood can start up and injure you even when the engine is not running. Keep hands, clothing and tools away from any underhood electric fan.

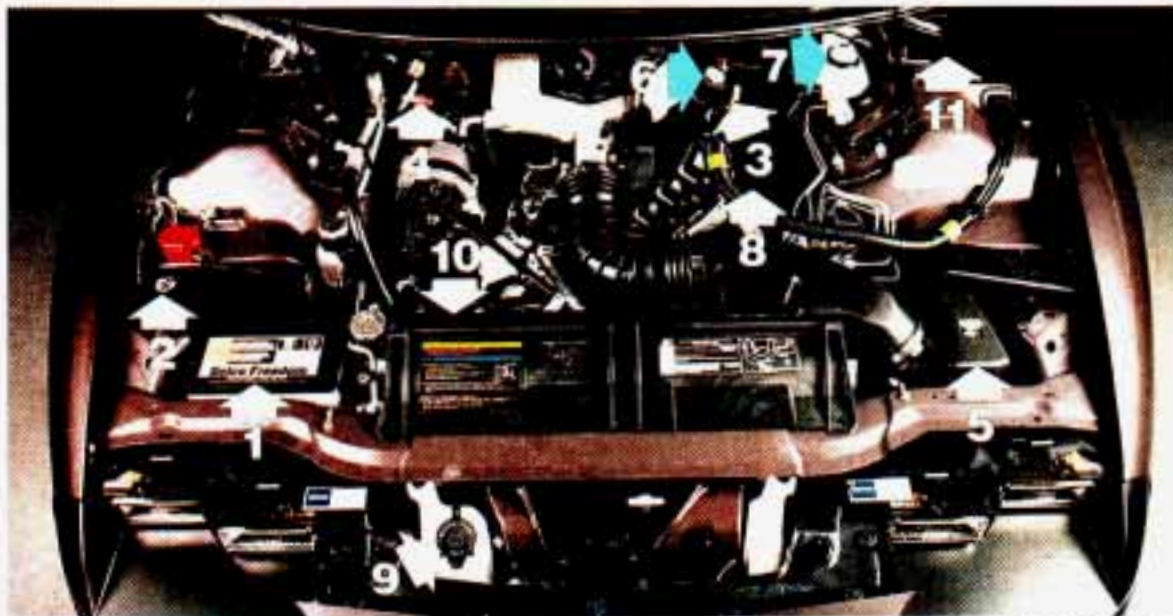

3.4L L32 (Code S)

When you open the hood you'll see.

1. Battery
2. Engine Coolant Reservoir
3. Engine Oil Dipstick
4. Automatic Transmission Dipstick (if equipped)
5. Air Cleaner
6. Oil Fill Cap
7. Brake Fluid Reservoir
8. Power Steering Reservoir
9. Windshield Washer Reservoir
10. Engine Fan
11. Clutch Fluid Reservoir (if equipped)

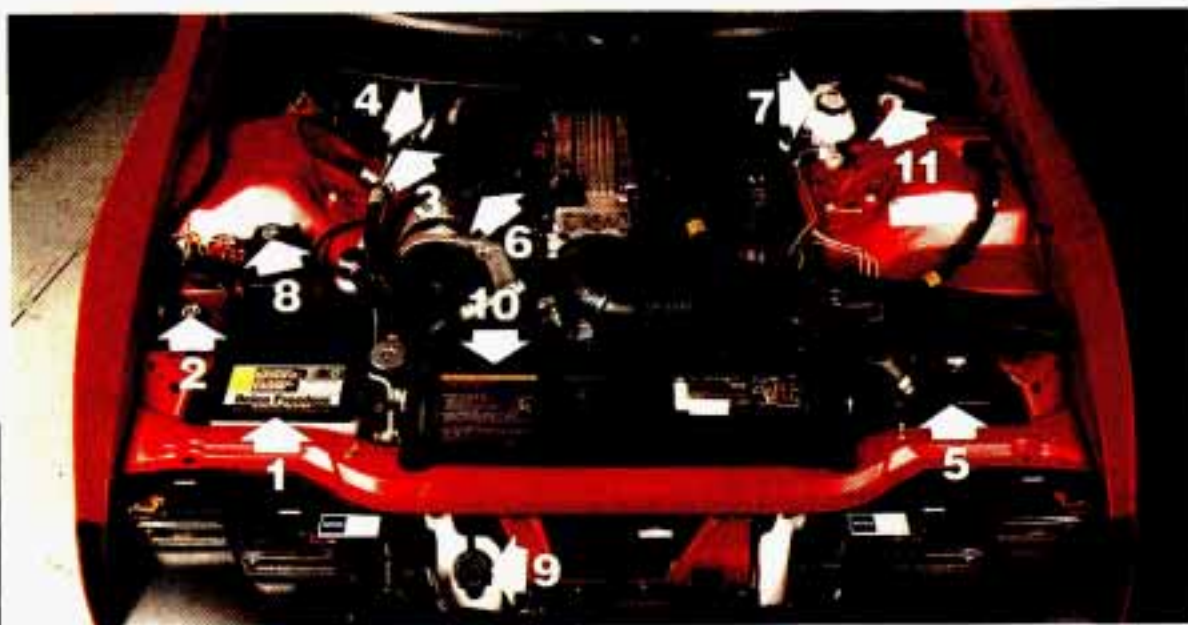

5.7L I.T1 (Code P)

When you open the hood you'll see:

1. Battery
2. Engine Coolant Reservoir
3. Engine Oil Dipstick
4. Automatic Transmission Dipstick (if equipped)
5. Air Cleaner
6. Oil Fill Cap
7. Brake Fluid Reservoir
8. Power Steering Reservoir
9. Windshield Washer Reservoir
10. Engine Fans
11. Clutch Fluid Reservoir (if equipped)

### CAUTION:



Things that burn can get on hot engine parts and start a fire. These include liquids like gasoline, oil, coolant, brake fluid, windshield washer and other fluids, and plastic or rubber. You or others could be burned. Be careful not to drop or spill things that will burn onto a hot engine.

Before closing the hood, be sure all the filler caps are on.

Then just pull the hood down and close it firmly.

## Service & Appearance Care



3.4L L32 (Code S)

### **Engine Oil**

It's a good idea to check your engine oil every time you get fuel. In order to get an accurate reading, the oil must be warm and the vehicle must be on level ground.



5.7L LT1 (Code P)

Turn off the engine and give the oil a few minutes to drain back into the oil pan. If you don't, the oil dipstick might not show the actual level.



### **To Check Engine Oil (3.4L L32 (Code S) Engine)**

Pull out the dipstick and clean it with a paper towel or cloth, then push it back in all the way. Remove it again, keeping the tip lower.

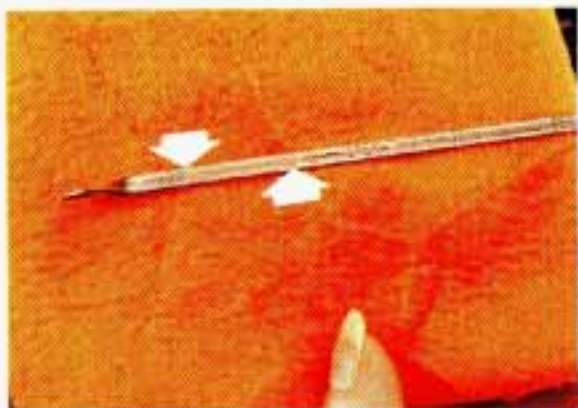

### To Check Engine Oil (5.7L LT1 (Code P) Engine)

Pull out the dipstick slightly. Pinch the end of the dipstick tube as you remove the dipstick to wipe the oil from it. Then push it all the way back in. Now remove it without pinching the tube, keeping the tip lower.



3.4L L32 (Code S)

### When to Add Oil:

If the oil is at or below the ADD line, then you'll need to add some oil. But you must use the right kind. This section explains what kind of oil to use. For crankcase capacity, see "Capacities and Specifications" in the Index.

### **NOTICE:**

Don't add too much oil. If your engine has so much oil that the oil level gets above the cross-hatched area that shows the proper operating range, your engine could be damaged.



5.7L LT1 (Code P)

Just fill it enough to put the level somewhere in the proper operating range. Push the dipstick all the way back in when you're through.

# Service & Appearance Care

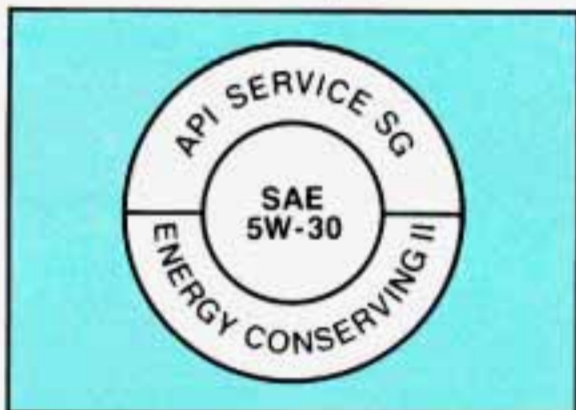

## Recommended SAE Viscosity Grade Engine Oils

For best fuel economy and cold starting, select the lowest SAE viscosity grade oil for the expected temperature range.

**HOT WEATHER**



**LOOK FOR THIS LABEL**

SAE 10W-30

SAE 5W-30 PREFERRED

**COLD WEATHER**

IF NEITHER SAE 5W-30 NOR SAE 10W-30 GRADE OILS ARE AVAILABLE, SAE 30 GRADE MAY BE USED AT TEMPERATURES ABOVE 40 DEGREES F (4 DEGREES C).

DO NOT USE SAE 10W-40, SAE 20W-50 OR ANY OTHER GRADE OIL NOT RECOMMENDED.

### What Kind of Oil to Use:

Look for three things:

- SG  
SG must be on the oil container, either by itself or combined with other quality designations, such as SG/CC, SG/CD, SF, SG, CC, etc. These letters show American Petroleum Institute (API) levels of quality.

### NOTICE:

If you use oils that don't have the SG designation, you can cause engine damage not covered by your warranty.

- SAE 5W-30

As shown in the viscosity chart, SAE 5W-30 is best for your vehicle. However, you can use SAE 10W-30 if it's going to be 0°F (-18°C) or above. These numbers on an oil container show its viscosity, or thickness. Do not use other viscosity oils such as SAE 10W-40 or SAE 20W-50.

- Energy Conserving II

Oils with these words on the container will help you save fuel.

This doughnut-shaped logo (symbol) is used on most oil containers to help you select the correct oil.



You should look for this on the oil container, and use **only** those oils that display the logo.

GM Goodwrench<sup>®</sup> oil (in Canada, GM Engine Oil) meets all the requirements for your vehicle.

#### **Engine Oil Additives:**

Don't add anything to your oil. Your Chevrolet dealer is ready to advise if you think something should be added.

#### **When to Change Engine Oil:**

See if any one of these is true for you:

- Most trips are less than 4 miles (6 km).
- It's below freezing outside and most trips are less than 10 miles (16 km).
- The engine is at low speed most of the time (as in door-to-door delivery, or in stop-and-go traffic).
- You tow a trailer often.
- Most trips are through dusty places.

If any one of these is true for your vehicle, then you need to change your **oil and filter** every 3,000 miles (5 000 km) or 3 months — whichever comes first.

If none of them is true, change the oil every 7,500 miles (12 500 km) or 12 months — whichever comes first. Change the filter at the first oil change and at every other oil change after that.

#### **Engine Block Heater:**

An engine block heater can be a big help if you have to park outside in very cold weather, 0°F (-18°C) or colder. If your vehicle has this option, see "Engine Block Heater" in the Index.

# Service & Appearance Care

## What to Do with Used Oil:

### **CAUTION:**



Used engine oil contains things that have caused skin cancer in laboratory animals. Don't let used oil stay on your skin for very long. Clean your skin and nails with soap and water, or a good hand cleaner. Wash or properly throw away clothing or rags containing used engine oil.

Used oil can be a real threat to the environment. If you change your own oil, be sure to drain all free-flowing oil from the filter before disposal. Don't ever dispose of oil by putting it in the trash, pouring it on the ground, into sewers, or into streams or bodies of water. Instead, recycle it by taking it to a place that collects used oil. If you have a problem properly disposing of your used oil, ask your dealer, a service station or a local recycling center for help.



## *Air Cleaner*

3.4L L32 (Code S)

Refer to the Maintenance Schedule to determine when to replace the air filter. See "Scheduled Maintenance Services" in the Index.



5.7L LT1 (Code P)

### **CAUTION:**



Operating the engine with the air cleaner off can cause you or others to be burned. The air cleaner not only cleans the air, it stops flame if the engine backfires. If it isn't there, and the engine backfires, you could be burned. Don't drive with it off, and be careful working on the engine with the air cleaner off.

### **NOTICE:**

If the air cleaner is off, a backfire can cause a damaging engine fire. And, dirt can easily get into your engine, which will damage it. Always have the air cleaner in place when you're driving.



### **Air Filter Replacement**

To remove the air filter:

1. Remove the two plastic pins by pulling them straight up.

## Service & Appearance Care



2. Disconnect the plastic clamp on the duct. Pull apart the connection.



3. Pull the air cleaner straight up. Unclamp the metal clips.



4. Open the air cleaner and remove the filter.

## **Automatic Transmission Fluid**

### **When to Check and Change:**

A good time to check your automatic transmission fluid level is when the engine oil is changed. Refer to the Maintenance Schedule to determine when to change your fluid. See "Scheduled Maintenance Services" in the Index.

### **How to Check:**

Because this operation can be a little difficult, you may choose to have this done at a Chevrolet dealership Service Department.

If you do it yourself, be sure to follow all the instructions here, or you could get a false reading on the dipstick.

## **NOTICE:**

Too much or too little fluid can damage your transmission. Too much can mean that some of the fluid could come out and fall on hot engine parts, starting a fire. Be sure to get an accurate reading if you check your transmission fluid.

Wait at least 30 minutes before checking the transmission fluid level if you have been driving:

- When outside temperatures are above 90°F (32°C).
- At high speed for quite a while.
- In heavy traffic — especially in hot weather.
- While pulling a trailer.

To get the right reading, the fluid should be at normal operating temperature, which is 180°F to 200°F (82°C to 93°C).

**To check transmission fluid hot:** Get the vehicle warmed up by driving about 15 miles (24 km) when outside temperatures are above 50°F (10°C). If it's colder than 50°F (10°C), drive the vehicle in **D** (Third Gear) until the engine temperature gage moves and then remains steady for ten minutes. Then follow the hot check procedures.

**To check transmission fluid cold:** A cold check is made after the vehicle has been sitting for eight hours or more with the engine off and is used only as a reference. Let the engine run at idle for five minutes

# Service & Appearance Care



3.4L I32 (Code S)



5.7L LTI (Code P)

if outside temperatures are 50°F (10°C) or more. If it's colder than 50°F (10°C), you may have to idle the engine longer. A hot check must follow when fluid is added during a cold check.

## To check the fluid hot or cold:

- Park your vehicle on a level place.
- Place the shift lever in **P** (Park) with the parking brake applied.
- With your foot on the brake pedal, move the shift lever through each gear range, pausing for about three seconds in each range. Then, position the shift lever in **P** (Park).
- Let the engine run at idle for three minutes or more.

**Then, without shutting off the engine, follow these steps:**

1. Pull out the dipstick and wipe it with a clean rag or paper towel.

2. Push it back in all the way, wait three seconds and then pull it back out again.



3. Check both sides of the dipstick, and read the lower level. The fluid level must be in the **COLD** area for a cold check or in the **HOT** area or cross-hatched area for a hot check.
4. If the fluid level is where it should be, push the dipstick back in all the way.

#### **How to Add Fluid:**

Refer to the Maintenance Schedule to determine what kind of transmission fluid to use. See "Recommended Fluids and Lubricants" in the Index.

If the fluid level is low, add only enough of the proper fluid to bring the level up to the **COLD** area for a cold check or the **HOT** area for a hot check. It doesn't take much fluid, generally less than a pint. Don't overfill. We recommend you use only fluid labeled DEXRON<sup>®</sup>-III, because fluids with that label are made especially for your automatic transmission. Damage caused by fluid other than DEXRON<sup>®</sup>-III is not covered by your new vehicle warranty.

- After adding fluid, recheck the fluid level as described under "How to Check."
- When the correct fluid level is obtained, push the dipstick back in all the way.

## ***Manual Transmission Fluid***

### **When to Check:**

A good time to have it checked is when the engine oil is changed. However, the fluid in your manual transmission doesn't require changing.

### **How to Check:**

Because this operation can be a little difficult, you may choose to have this done at a Chevrolet dealership Service Department.

If you do it yourself, be sure to follow all the instructions here, or you could get a false reading.

# Service & Appearance Care

## **NOTICE:**

Too much or too little fluid can damage your transmission. Too much can mean that some of the fluid could come out and fall on hot engine parts, starting a fire. Be sure to get an accurate reading if you check your transmission fluid.

Check the fluid level only when your engine is off, the vehicle is parked on a level place and the transmission is cool enough for you to rest your fingers on the transmission case.

Then, follow these steps:

1. Remove the filler plug.
2. Check that the lubricant level is up to the bottom of the filler plug hole.
3. If the fluid level is good, install the plug and be sure it is fully seated. If the fluid level is low, add more fluid as described in the next steps.

**How to Add Fluid:**

Here's how to add fluid. Refer to the Maintenance Schedule to determine what kind of fluid to use. See "Recommended Fluids and Lubricants" in the Index.

1. Remove the filler plug.
2. Add fluid at the filler plug hole. Add only enough fluid to bring the fluid level up to the bottom of the filler plug hole.
3. Install the filler plug. Be sure the plug is fully seated.





### ***Hydraulic Clutch***

The hydraulic clutch in your vehicle is self-adjusting.

#### **When to Check and What to Use:**

Refer to the Maintenance Schedule to determine how often you should check the fluid level in your clutch master cylinder reservoir and what to add. See "Owner Checks and Services" and "Recommended Fluids and Lubricants" in the Index.

#### **How to Check:**

The proper fluid should be added if the level is below the **STEP** mark on the reservoir. See the instructions on the reservoir cap.

### ***Rear Axle***

#### **When to Check and Change Lubricant:**

Refer to the Maintenance Schedule to determine how often to check the lubricant and when to change it. See "Periodic Maintenance Inspections" in the Index.

#### **How to Check Lubricant:**

If the level is below the bottom of the filler plug hole, you'll need to add some lubricant. Add enough lubricant to raise the level to the bottom of the filler plug hole.

# Service & Appearance Care

## What to Use:

### Standard and Limited-Slip Differential

Use Axle Lubricant (GM Part No. 1052271) or SAE 80W-90 GL-5 gear lubricant.

## *Engine Coolant*

The following explains your cooling system and how to add coolant when it is low. If you have a problem with engine overheating or if you need to add coolant to your radiator, see "Engine Overheating" in the Index.

The proper coolant for your Chevrolet will:

- Give freezing protection down to  $-34^{\circ}\text{F}$  ( $-37^{\circ}\text{C}$ ).
- Give boiling protection up to  $262^{\circ}\text{F}$  ( $128^{\circ}\text{C}$ ).
- Protect against rust and corrosion.
- Help keep the proper engine temperature.
- Let the warning lights work as they should.

#### **What to Use:**

Use a mixture of one-half **clean water** (preferably distilled) and one-half antifreeze that meets "GM Specification 1825M," which won't damage aluminum parts. You can also use a recycled coolant conforming to GM Specification 1825M with a complete coolant flush and refill. If you use this mixture, you don't need to add anything else.

#### **CAUTION:**



Adding only plain water to your cooling system can be dangerous. Plain water, or some other liquid like alcohol, can boil before the proper coolant mix will. Your vehicle's coolant warning system is set for the proper coolant mix. With plain water or the wrong mix, your engine could get too hot but you wouldn't get the overheat warning. Your engine could catch fire and you or others could be burned. Use a 50/50 mix of clean water and a proper antifreeze.

#### **NOTICE:**

If you use an improper coolant mix, your engine could overheat and be badly damaged. The repair cost wouldn't be covered by your warranty. Too much water in the mix can freeze and crack the engine, radiator, heater core and other parts.

## Service & Appearance Care



### Adding Coolant

**To Check Coolant:** When your engine is cold, check the dipstick on the cap of the coolant recovery tank. The coolant level should be at **FULL COLD**, or a little higher. When your engine is warm, the level on the dipstick should be up to **FULL HOT**, or a little higher.



If you have the 5.7L LT1 (Code P) engine and this light comes on, it means you're low on engine coolant.



**To Add Coolant to the Recovery Tank:** If you need more coolant, add the proper mix **at the coolant recovery tank**, but only when your engine is cool. If the tank is very low or empty, also add coolant to the radiator. See "Engine Overheating" in the Index.

### **CAUTION:**



Turning the radiator pressure cap when the engine and radiator are hot can allow steam and scalding liquids to blow out and burn you badly. Never turn the pressure cap — even a little — when the engine and radiator are hot.

Add coolant mix at the recovery tank, but be careful not to spill it.

### **CAUTION:**



You can be burned if you spill coolant on hot engine parts. Coolant contains ethylene glycol, and it will burn if the engine parts are hot enough. Don't spill coolant on a hot engine.

### **Radiator Pressure Cap (All Engines)**

### **NOTICE:**

Your radiator cap is a 18 psi (124 kPa) pressure-type cap and must be tightly installed to prevent coolant loss and possible engine damage from overheating. Be sure the arrows on the cap line up with the overflow tube on the radiator filler neck.

# Service & Appearance Care

When you replace your radiator pressure cap, an AC<sup>®</sup> cap is recommended.

## Thermostat

Engine coolant temperature is controlled by a thermostat in the engine coolant system. The thermostat stops the flow of coolant through the radiator until the coolant reaches a preset temperature.

When you replace your thermostat, an AC<sup>®</sup> thermostat is recommended.



3.4L L32 (Code S)

## *Power Steering Fluid*

### **How to Check Power Steering Fluid:**

Unscrew the cap and wipe the dipstick with a clean rag. Replace the cap and completely tighten it. Then remove the cap again and look at the fluid level on the dipstick.



5.7L LT1 (Code P)

- When the engine compartment is hot, the level should be at the **H** mark.
- When the engine compartment is cool, the level should be at the **C** mark.



#### What to Add:

Refer to the Maintenance Schedule to determine what kind of fluid to use. See "Recommended Fluids and Lubricants" in the Index.

#### **NOTICE:**

When adding power steering fluid or making a complete fluid change, always use the proper fluid. Failure to use the proper fluid can cause leaks and damage hoses and seals.



#### *Windshield Washer Fluid*

#### To Add:

Open the cap labeled **WASHER FLUID ONLY**. Add washer fluid until the bottle is full.

# Service & Appearance Care

## NOTICE:

- When using concentrated washer fluid, follow the manufacturer's instructions for adding water.
- Don't mix water with ready-to-use washer fluid. Water can cause the solution to freeze and damage your washer fluid tank and other parts of the washer system. Also, water doesn't clean as well as washer fluid.
- Fill your washer fluid tank only 3/4 full when it's very cold. This allows for expansion, which could damage the tank if it is completely full.
- Don't use radiator antifreeze in your windshield washer. It can damage your washer system and paint.



## *Brake Master Cylinder*

Your brake master cylinder is here. It is filled with DOT-3 brake fluid.

There are only two reasons why the brake fluid level in your master cylinder might go down. The first is that the brake fluid goes down to an acceptable level during normal brake lining wear. When new linings are put in, the fluid level goes back up. The other reason is that fluid is leaking out of the brake system. If it is, you should have your brake system fixed, since a leak means that sooner or later your brakes won't work well, or won't work at all.

So, it isn't a good idea to "top off" your brake fluid. Adding brake fluid won't correct a leak. If you add fluid when your linings are worn, then you'll have too much fluid when you get new brake linings. You should add (or remove) brake fluid, as necessary, only when work is done on the brake hydraulic system.





### **CAUTION:**



If you have too much brake fluid, it can spill on the engine. The fluid will burn if the engine is hot enough. You or others could be burned, and your vehicle could be damaged. Add brake fluid only when work is done on the brake hydraulic system.

Refer to the Maintenance Schedule to determine when to check your brake fluid. See "Periodic Maintenance Inspections" in the Index.

### **To Check Brake Fluid:**

You can check the brake fluid without taking off the cap. Just look at the brake fluid reservoir. The fluid level should be above the plastic seam in the reservoir. If it isn't, have your brake system checked to see if there is a leak.

After work is done on the brake hydraulic system, make sure the level is above the plastic seam, near the base of the filler neck.

### **What to Add:**

When you do need brake fluid, use only DOT-3 brake fluid — such as Delco-Supreme 11® (GM Part No. 1052535). Use new brake fluid from a sealed container only.

### **NOTICE:**

- DOT-5 silicone brake fluid can damage your vehicle. Don't use it.
- Don't let someone put in the wrong kind of fluid. For example, just a few drops of mineral-based oil, such as engine oil, in your brake system can damage brake system parts so badly that they'll have to be replaced.
- Brake fluid can damage paint, so be careful not to spill brake fluid on your vehicle.

# Service & Appearance Care

## **Replacing Brake System Parts**

The braking system on a modern vehicle is complex. Its many parts have to be of top quality and work well together if the vehicle is to have really good braking.

Vehicles we design and test have top-quality GM brake parts in them, as your Chevrolet does when it is new.

When you replace parts of your braking system — for example, when your brake linings wear down and you have to have new ones put in — be sure you get new genuine GM replacement parts. If you don't, your brakes may no longer work properly. For example, if someone puts in

brake linings that are wrong for your vehicle, the balance between your front and rear brakes can change, for the worse. The braking performance you've come to expect can change in many other ways if someone puts in the wrong replacement brake parts.

## ***Battery***

Every new Chevrolet has a Delco Freedom® battery. You never have to add water to one of these. When it's time for a new battery, we recommend a Delco Freedom® battery. Get one that has the catalog number shown on the original battery's label.

### Vehicle Storage

If you're not going to drive your vehicle for 25 days or more, take off the black, negative (-) cable from the battery. This will help keep your battery from running down.

#### **CAUTION:**



Batteries have acid that can burn you and gas that can explode. You can be badly hurt if you aren't careful. See "Jump Starting" in the Index for tips on working around a battery without getting hurt.

Contact your dealer to learn how to prepare your vehicle for longer storage periods.

### ■ *Bulb Replacement*

For the proper type of replacement bulb, see "Replacement Bulbs" in the Index.

#### Halogen Bulbs

#### **CAUTION:**



Halogen bulbs have pressurized gas inside and can burst if you drop or scratch the bulb. You or others could be injured. Take special care when handling and disposing of halogen bulbs.

# Service & Appearance Care



## Headlights

### Headlight Aiming

Your vehicle has a mini-quad headlight system. These headlights have vertical and horizontal indicators. When the headlights are properly installed and adjusted, and the vehicle is on level ground, both indicators will read in the center of the gage. If they do not, you can adjust the aim.

To adjust the aim of your headlights:

1. Move your vehicle to a level surface. Use a spirit level to be sure. Be sure to remove any items that are not part of your original equipment from the trunk and passenger areas. No one should be seated in the vehicle and your fuel tank should be about half full. Check to be sure your tires are at the correct pressure.

There are four headlights. Each one has its own vertical and horizontal aim position indicator. Each indicator has its own aiming screw.

- A. Vertical Indicator
- B. Horizontal Indicator
- C. Vertical Aiming Screw
- D. Horizontal Aiming Screw



2. Start with the vertical (up and down) headlight aim. Don't try to adjust the horizontal (left and right) aim first.
3. Check the vertical aim for each headlight and adjust it as necessary.
4. Turn the vertical aiming screw until the bubble comes to the center of the gage.



5. Now adjust the horizontal aim. Check the horizontal aim for each headlight and adjust it as necessary.
6. Turn the horizontal aiming screw until the line comes to the center of the gage.
7. If the gage readings are not centered, repeat steps 2 and 3.

Try not to touch threaded parts other than the vertical and horizontal aiming screws.

If the vehicle body has been damaged in an accident or something, the headlight should be aimed after repairing the body.

To replace a headlight:

Before replacing a headlight that does not light, check to make sure that the wiring connector is securely fastened to it.

See "Replacement Bulbs" in the Index to check the size and type of headlight you need to use before you begin to replace the headlight. You must replace a headlight with one that is exactly the same.

## Service & Appearance Care



Be careful not to move the aiming screws when you replace the headlight. If the headlight being replaced was properly aimed, the new one will be also if it is properly installed.

**1.** Remove the Torx® head screws at the end of the aiming ring.

**2.** The aiming ring will swing open like a gate. Remove the aiming ring from the assembly. Place it face down, with the aim indicator up. Be careful not to damage the aiming bubble.



3. Pull the headlight out of the assembly. Remove the wiring connector from the headlight socket by lifting the plastic locking tabs on the connector and pulling it from the socket.
4. Check the new headlight again. The number on the light must match the number on the headlight being replaced. The letter, "U" or "L," must also match.
5. Plug the wiring connector into the headlight socket. Snap the locking tabs onto the socket.

6. Place the new headlight in the headlight assembly. The socket must be pointing in the same direction the socket on the burned out bulb was.
7. Insert the tabs on the aiming ring into the slots in the headlight assembly.
8. Hold the aiming ring closed, insert the screws at the end of the ring. Tighten the screws until the aiming ring touches the plastic nuts on both the top and bottom. Do not overtighten. Do not damage the vertical aiming bubble.



9. Check the headlight aim indicators. The horizontal indicator (A) should be on 0 (zero). If the vehicle is level, the vertical indicator (B) should also be on 0 (zero). If the vehicle isn't level, check the vertical aim on a level surface as soon as you can. If either indicator doesn't read "0," adjust the headlight aim. See "Adjusting Headlight Aim" in the Index.

If your vehicle is damaged in an accident and the headlight aim seems to be affected, see your Chevrolet dealer. Headlights on damaged vehicles may require recalibration of the horizontal aim by your Chevrolet dealer.

## Service Station Information



### Center High-Mounted Stoplight

To replace the bulb:

1. Remove the two screws in the stoplight lens.



2. Gently pull the assembly out and remove the bulb from the back of the assembly.
3. Reverse the steps with a new bulb.



### Front Turn Signal

1. Using a screwdriver, remove the plastic screws from the deflector under the vehicle. Move the deflector out of the way.



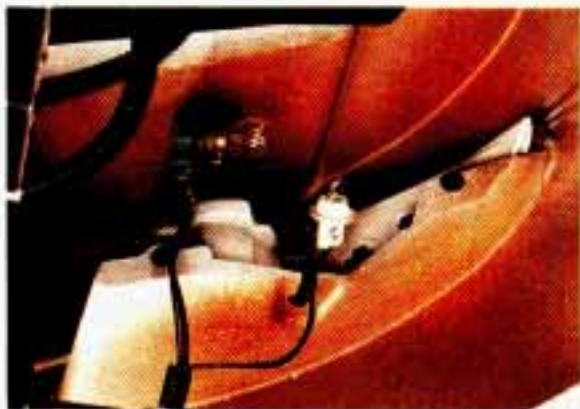

2. Turn and pull out the socket and the bulb.
3. Pull out the bulb.
4. Reverse the steps with a new bulb.

### Rear Lights

To change any rear bulb, you have to remove the entire housing.

1. Remove the trim panel from the side that you are replacing the bulb.
2. Pull back the carpet.



3. Remove the wing nuts.

## Service Station Information



4. Pull the assembly off from the outside.
5. To remove a socket with a tab, press the tab and turn the socket counterclockwise. To remove a socket without a tab, turn the socket counterclockwise.
6. To remove the bulb, push in and turn it counterclockwise, then pull it out.
7. Reverse the steps with a new bulb.



### Rear Sidemarker

To replace a rear sidemarker bulb:

1. Remove the screw from the sidemarker assembly.
2. To pull out the bulb housing, tilt the housing to remove the tabbed end.



3. Turn counterclockwise and pull out the socket and the bulb.
4. Pull out the bulb.
5. Reverse the steps with a new bulb.

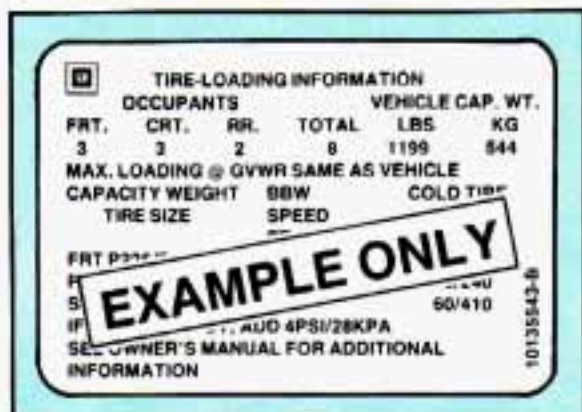

## ■ *Loading Your Vehicle*

Two labels on your vehicle show how much weight it may properly carry. The Tire-Loading Information label found on the driver's door tells you the proper size, speed rating and recommended inflation pressures for the tires on your vehicle. It also gives you important information about the number of people that can be in your vehicle and the total weight that you can carry. This weight is called the Vehicle Capacity Weight and includes the weight of all occupants, cargo, and all nonfactory-installed options.

The other label is the Certification label, found on the rear edge of the driver's door. It tells you the gross weight capacity of your vehicle, called the GVWR (Gross Vehicle Weight Rating). The GVWR includes the weight of the vehicle, all occupants, fuel and cargo. Never exceed the GVWR for your vehicle, or the Gross Axle Weight Rating (GAWR) for either the front or rear axle.

And, if you do have a heavy load, you should spread it out. Don't carry more than 100 pounds (45 kg) in your rear area.

## **CAUTION:**



Do not load your vehicle any heavier than the GVWR or the maximum front and rear GAWRs. If you do, parts on your vehicle can break, or it can change the way your vehicle handles. These could cause you to lose control. Also, overloading can shorten the life of your vehicle.

# Service & Appearance Care

## **NOTICE:**

Your warranty does not cover parts or components that fail because of overloading.

If you put things inside your vehicle — like suitcases, tools, packages, or anything else — they will go as fast as the vehicle goes. If you have to stop or turn quickly, or if there is a crash, they'll keep going.

## **CAUTION:**



Things you put inside your vehicle can strike and injure people in a sudden stop or turn, or in a crash.

- Put things in the rear area of your vehicle. Try to spread the weight evenly.
- Never stack heavier things, like suitcases, inside the vehicle so that some of them are above the tops of the seats.
- When you carry something inside the vehicle, secure it whenever you can.
- Don't leave a seat folded down unless you need to.

## ■ *Tires*

We don't make tires. Your new vehicle comes with high quality tires made by a leading tire manufacturer. These tires are warranted by the tire manufacturers and their warranties are delivered with every new Chevrolet. If your spare tire is a different brand than your road tires, you will have a tire warranty folder from each of these manufacturers.

## CAUTION:



Poorly maintained and improperly used tires are dangerous.

- Overloading your tires can cause overheating as a result of too much friction. You could have an air-out and a serious accident. See "Loading Your Vehicle" in the Index.
- Underinflated tires pose the same danger as overloaded tires. The resulting accident could cause serious injury. Check all tires frequently to maintain the recommended pressure. Tire pressure should be checked when your tires are cold.
- Overinflated tires are more likely to be cut, punctured, or broken by a sudden impact, such as when you hit a pothole. Keep tires at the recommended pressure.
- Worn, old tires can cause accidents. If your tread is badly worn, or if your tires have been damaged, replace them.

### Inflation — Tire Pressure

The Tire-Loading Information label which is on the driver's door shows the correct inflation pressures for your tires, when they're cold. "Cold" means your vehicle has been sitting for at least three hours or driven no more than a mile.

If your vehicle is equipped with P245/50ZR16 tires and you'll be driving at speeds higher than 100 mph (160 km/h) where it is legal, raise the "cold" inflation pressure of each tire to 35 psi (240 kPa). When you end this very high speed driving, reduce the "cold" inflation pressures to those listed on the Tire Loading Information label. Never inflate the tires higher than the maximum "cold" inflation pressures stated on the sidewall of the tires.

## NOTICE:

Don't let anyone tell you that underinflation or overinflation is all right. It's not. If your tires don't have enough air (underinflation) you can get:

- Too much flexing
- Too much heat
- Tire overloading
- Bad wear
- Bad handling
- Bad fuel economy.

If your tires have too much air (overinflation), you can get:

- Unusual wear
- Bad handling
- Rough ride
- Needless damage from road hazards.

## Service & Appearance Care

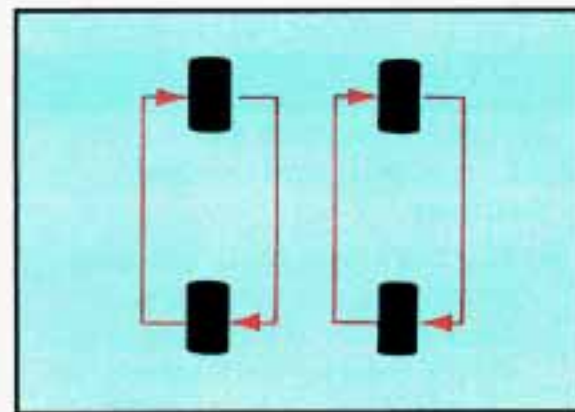
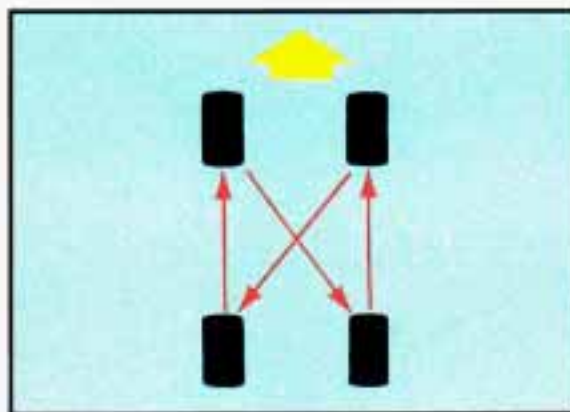

**When to Check:** Check your tires once a month or more. Don't forget your compact spare tire. It should be at 60 psi (420 kPa).

**How to Check:** Use a good quality pocket-type gage to check tire pressure. Simply looking at the tires will not tell you the pressure, especially if you have radial tires — which may look properly inflated even if they're underinflated.

If your tires have valve caps, be sure to put them back on. They help prevent leaks by keeping out dirt and moisture.

### Tire Inspection and Rotation

To make your tires last longer, have them inspected and rotated at the mileages recommended in the Maintenance Schedule. See "Scheduled Maintenance Services" in the Index.

If you don't have P245/50ZR16 size tires, use the rotation pattern shown above for your size tires.

If you have P245/50ZR16 size tires, they must roll in a certain direction for the best overall performance. The direction is shown by an arrow on both sidewalls. Because these tires are directional, they should be rotated as shown in the example above. These tires should only be moved from front to rear and rear to front on the same side of the vehicle.

After the tires have been rotated, adjust the front and rear inflation pressure as shown on the Tire-Loading Information label. Make certain that all wheel nuts are properly tightened. See "Wheel Nut Torque" in the Index.

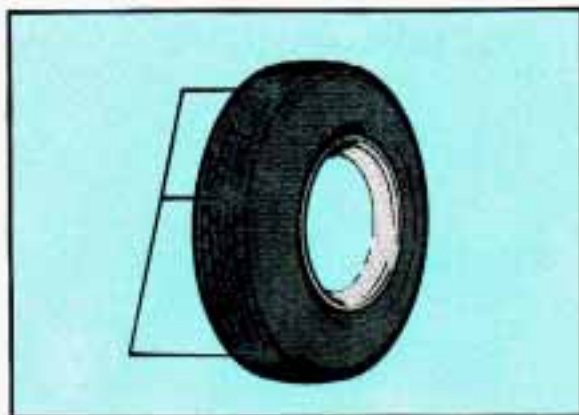

## CAUTION:



Rust or dirt on a wheel, or on the parts to which it is fastened, can make wheel nuts become loose after a time. The wheel could come off and cause an accident. When you change a wheel, remove any rust or dirt from places where the wheel attaches to the vehicle. In an emergency, you can use a cloth or a paper towel to do this; but be sure to use a scraper or wire brush later, if you need to, to get all the rust or dirt off. (See "Changing a Flat Tire" in the Index.)

### When It's Time for New Tires

One way to tell when it's time for new tires is to check the treadwear indicators, which will appear when your tires have only  $2/32$  inch (1.6 mm) or less of tread remaining.

You need a new tire if:

- You can see the indicators at three places around the tire.
- You can see cord or fabric showing through the tire's rubber.
- The tread or sidewall is cracked, cut or snagged deep enough to show cord or fabric.
- The tire has a bump, bulge or split.

- The tire has a puncture, cut, or other damage that can't be repaired well because of the size or location of the damage.

### Buying New Tires

To find out what kind and size of tires you need, look at the Tire-Loading Information label.

The tires installed on your vehicle when it was new had a Tire Performance Criteria Specification (TPC Spec) number on each tire's sidewall. When you get new tires, get ones with that same TPC Spec number. That way, your vehicle will continue to have tires that are designed to give proper endurance, handling, speed

## Service & Appearance Care

rating, traction, ride and other things during normal service on your vehicle. If your tires have an all-season tread design, the TPC number will be followed by a "MS" (for mud and snow).

If you ever replace your tires with those not having a TPC Spec number, make sure they are the same size, load range, speed rating and construction type (bias, bias-belted or radial) as your original tires.

### **CAUTION:**



Mixing tires could cause you to lose control while driving. If you mix tires of different sizes or types (radial and bias-belted tires), the vehicle may not handle properly, and you could have a crash. Be sure to use the same size and type tires on all wheels.

It's all right to drive with your compact spare, though. It was developed for limited use on your vehicle.

### **Uniform Tire Quality Grading**

The following information relates to the system developed by the United States National Highway Traffic Safety Administration which grades tires by treadwear, traction and temperature performance. (This applies only to vehicles sold in the United States.)



### **Treadwear**

The treadwear grade is a comparative rating based on the wear rate of the tire when tested under controlled conditions on a specified government test course. For example, a tire graded 150 would wear one and a half (1 1/2) times as well on the government course as a tire graded 100. The relative performance of tires depends upon the actual conditions of their use, however, and may depart significantly from the norm due to variations in driving habits, service practices and differences in road characteristics and climate.

### **Traction — A, B, C**

The traction grades, from highest to lowest are: A, B, and C. They represent the tire's ability to stop on wet pavement as measured under controlled conditions on specified government test surfaces of asphalt and concrete. A tire marked C may have poor traction performance.

Warning: The traction grade assigned to this tire is based on braking (straight-ahead) traction tests and does not include cornering (turning) traction.

### **Temperature — A, B, C**

The temperature grades are A (the highest), B, and C, representing the tire's resistance to the generation of heat and its ability to dissipate heat when tested under controlled conditions on a specified indoor laboratory test wheel. Sustained high temperature can cause the material of the tire to degenerate and reduce tire life, and excessive temperature can lead to sudden tire failure. The grade C corresponds to a level of performance which all passenger car tires must meet under the Federal Motor Vehicle Safety Standard No. 109. Grades B and A

## Service & Appearance Care

represent higher levels of performance on the laboratory test wheel than the minimum required by law.

**Warning:** The temperature grade for this tire is established for a tire that is properly inflated and not overloaded. Excessive speed, underinflation, or excessive loading, either separately or in combination, can cause heat buildup and possible tire failure.

Those grades are molded on the sidewalls of passenger car tires.

While the tires available as standard or optional equipment on General Motors vehicles may vary with respect to these grades, all such tires meet General Motors performance standards and have been approved for use on General Motors vehicles. All passenger type (P Metric) tires must conform to Federal safety requirements in addition to these grades.

### **Wheel Alignment and Tire Balance**

The wheels on your vehicle were aligned and balanced carefully at the factory to give you the longest tire life and best overall performance.

In most cases, you will not need to have your wheels aligned again. However, if you notice unusual tire wear or your vehicle pulling one way or the other, the alignment may need to be reset. If you notice your vehicle vibrating when driving on a smooth road, your wheels may need to be rebalanced.

### Wheel Replacement

Replace any wheel that is bent, cracked or badly rusted. If wheel nuts keep coming loose, the wheel, wheel bolts, and wheel nuts should be replaced. If the wheel leaks air out, replace it (except some aluminum wheels, which can sometimes be repaired). See your Chevrolet dealer if any of these conditions exist.

Your dealer will know the kind of wheel you need.

Each new wheel should have the same load carrying capacity, diameter, width, offset, and be mounted the same way as the one it replaces.

If you need to replace any of your wheels, wheel bolts, or wheel nuts, replace them only with new GM original equipment parts. This way, you will be sure to have the right wheel, wheel bolts, and wheel nuts for your Chevrolet model.

### CAUTION:



Using the wrong replacement wheels, wheel bolts, or wheel nuts on your vehicle can be dangerous. It could affect the braking and handling of your vehicle, make your tires lose air and make you lose control. You could have a collision in which you or others could be injured. Always use the correct wheel, wheel bolts, and wheel nuts for replacement.

# Service & Appearance Care

## **NOTICE:**

The wrong wheel can also cause problems with bearing life, brake cooling, speedometer/odometer calibration, headlight aim, bumper height, vehicle ground clearance, and tire or tire chain clearance to the body and chassis.

## Used Replacement Wheels

### **CAUTION:**



Putting a used wheel on your vehicle is dangerous. You can't know how it's been used or how many miles it's been driven. It could fail suddenly and cause an accident. If you have to replace a wheel use a new GM original equipment wheel.

## Tire Chains

### **NOTICE:**

If your Chevrolet has P235/55R16 or P245/50ZR16 size tires, don't use tire chains; they can damage your vehicle.

If you have other tires, use tire chains only when you must. Use only SAE Class "S" type chains that are the proper size for your tires. Install them on the rear tires and tighten them as tightly as possible with the ends securely fastened. Drive slowly and follow the chain manufacturer's instructions. If you can hear the chains contacting your vehicle, stop and retighten them. If the contact continues, slow down until it stops. Driving too fast with chains on will damage your vehicle.



## ■ Appearance Care

### CAUTION:



Cleaning products can be hazardous. Some are toxic. Others can burst into flame if you strike a match or get them on a hot part of the vehicle. Some are dangerous if you breathe their fumes in a closed space. When you use anything in a container to clean your Chevrolet, be sure to follow the instructions. And always open your doors or windows when you're cleaning the inside.

Never use these to clean your vehicle:

- Gasoline
- Benzene
- Naphtha
- Carbon Tetrachloride
- Acetone
- Paint Thinner
- Turpentine
- Lacquer Thinner
- Nail Polish Remover

They can all be hazardous — some more than others — and they can all damage your vehicle, too.

### NOTICE:

Don't use any of these unless this manual says you can. In many uses, they will damage your vehicle:

- Laundry Soap
- Bleach
- Reducing Agents

# Service & Appearance Care

## ***Cleaning the Inside of Your Chevrolet***

Use a vacuum cleaner often to get rid of dust and loose dirt. Wipe vinyl with a clean, damp cloth.

Your Chevrolet dealer has two GM cleaners — a solvent-type spot lifter and a foam-type powdered cleaner. They will clean normal spots and stains very well.

Here are some cleaning tips:

- Always read the instructions on the cleaner label.
- Clean up stains as soon as you can — before they set.
- Use a clean cloth or sponge, and change to a clean area often. A soft brush may be used if stains are stubborn.
- Use solvent-type cleaners in a well-ventilated area only. If you use them, don't saturate the stained area.
- If a ring forms after spot cleaning, clean the entire area immediately or it will set.

## **Using Foam-Type Cleaner on Fabric**

- Vacuum and brush the area to remove any loose dirt.
- Always clean a whole trim panel or section. Mask surrounding trim along stitch or welt lines.
- Mix Multi-Purpose Powdered Cleaner following the directions on the container label.
- Use suds only and apply with a clean sponge.
- Don't saturate the material.
- Don't rub it roughly.

- As soon as you've cleaned the section, use a sponge to remove the suds.
- Rinse the section with a clean, wet sponge.
- Wipe off what's left with a slightly damp paper towel or cloth.
- Then dry it immediately with an air hose, a hair dryer or a heat lamp.

### **NOTICE:**

Be careful with a hair dryer or heat lamp. You could scorch the fabric.

- Wipe with a clean cloth.

### **Using Solvent-Type Cleaner on Fabric**

First, see if you have to use solvent-type cleaner at all. Some spots and stains will clean off better with just water and mild soap.

If you need to use it, then:

- Gently scrape excess soil from the trim material with a clean, dull knife or scraper. Use very little cleaner, light pressure and clean cloths (preferably cheesecloth). Cleaning should start at the outside of the stain, "feathering" toward the center. Keep changing to a clean section of the cloth.

- When you clean a stain from fabric, immediately dry the area with an air hose, hair dryer, or heat lamp to help prevent a cleaning ring. (See the previous NOTICE.)

### **Fabric Protection**

Your Chevrolet has upholstery and carpet that has been treated with Scotchgard™ Fabric Protector, a 3M product. Scotchgard™ protects fabrics by repelling oil and water, which are the carriers of most stains. Even with this protection, you still need to clean your upholstery often to keep it looking new.

Further information on cleaning is available by calling 1-800-433-3296 (in Minnesota, 1-800-642-6167).

# Service & Appearance Care

## Special Cleaning Problems

**Greasy or oily stains:** Like grease, oil, butter, margarine, shoe polish, coffee with cream, chewing gum, cosmetic creams, vegetable oils, wax crayon, tar and asphalt.

- Carefully scrape off excess stain.
- Then follow the solvent-type instructions above.
- Shoe polish, wax crayon, tar and asphalt will stain if left on a vehicle seat fabric. They should be removed as soon as possible. Be careful, because the cleaner will dissolve them and may cause them to bleed.

**Non-greasy stains:** Like catsup, coffee (black), egg, fruit, fruit juice, milk, soft drinks, wine, vomit, urine and blood.

- Carefully scrape off excess stain, then sponge the soiled area with cool water.
- If a stain remains, follow the foam-type instructions above.
- If an odor lingers after cleaning vomit or urine, treat the area with a water/baking soda solution: 1 teaspoon (5 ml) of baking soda to 1 cup (250 ml) of lukewarm water.
- Finally, if needed, clean lightly with solvent-type cleaner.

**Combination stains:** Like candy, ice cream, mayonnaise, chili sauce and unknown stains.

- Carefully scrape off excess stain, then clean with cool water and allow to dry.
- If a stain remains, clean it with solvent-type cleaner.



### **Cleaning Vinyl or Leather**

Just use warm water and a clean cloth.

- Rub with a clean, damp cloth to remove dirt. You may have to do it more than once.
- Things like tar, asphalt and shoe polish will stain if you don't get them off quickly. Use a clean cloth and solvent-type vinyl/leather cleaner.

### **Cleaning the Top of the Instrument Panel**

Use only mild soap and water to clean the top surfaces of the instrument panel. Sprays containing silicones or waxes may

cause annoying reflections in the windshield and even make it difficult to see through the windshield under certain conditions.

### **Care of Safety Belts**

Keep belts clean and dry.

#### **CAUTION:**



Do not bleach or dye safety belts. If you do, it may severely weaken them. In a crash they might not be able to provide adequate protection. Clean safety belts only with mild soap and lukewarm water.

### **Glass**

Glass should be cleaned often. GM Glass Cleaner (GM Part No. 1050427) or a liquid household glass cleaner will remove normal tobacco smoke and dust films.

Don't use abrasive cleaners on glass, because they may cause scratches. Avoid placing decals on the inside rear window, since they may have to be scraped off later. If abrasive cleaners are used on the inside of the rear window, an electric defogger element may be damaged. Any temporary license should not be attached across the defogger grid.

# Service & Appearance Care

## **Cleaning the Outside of the Windshield and Wiper Blades**

If the windshield is not clear after using the windshield washer, or if the wiper blade chatters when running, wax or other material may be on the blade or windshield.

Clean the outside of the windshield with GM Windshield Cleaner, Bon-Ami Powder<sup>®</sup> (GM Part No. 1050011). The windshield is clean if beads do not form when you rinse it with water.

Clean the blade by wiping vigorously with a cloth soaked in full strength windshield washer solvent. Then rinse the blade with water.

Wiper blades should be checked on a regular basis and replaced when worn.

## **Cleaning Twin Lift-Off Roof Panels**

Special care is necessary when cleaning, removing and/or storing the roof panels.

- Flush off dust and dirt with water, then dry the panels.
- Clean the panels with GM Glass Cleaner. Leave the cleaner on the panel for one minute, then wipe the panel with a soft, lint-free cloth.
- Don't use abrasive cleaning materials.

## ***Cleaning the Outside of Your Chevrolet***

The paint finish on your vehicle provides beauty, depth of color, gloss retention and durability.

### **Washing Your Vehicle**

The best way to preserve your vehicle's finish is to keep it clean by washing it often with lukewarm or cold water.

Don't wash your vehicle in the direct rays of the sun. Don't use strong soaps or chemical detergents. Use liquid hand, dish or car washing (non-detergent) soaps. Don't use cleaning agents that contain acid or abrasives. All cleaning agents should be flushed promptly and not allowed to dry on the surface, or they could stain. Dry the finish with a soft, clean chamois or a 100% cotton towel to avoid surface scratches and water spotting.

High pressure car washes may cause water to enter your vehicle.

### **Finish Care**

Occasional waxing or mild polishing of your Chevrolet may be necessary to remove residue from the paint finish. You can get GM approved cleaning products from your dealer. (See "Appearance Care and Maintenance Materials" in the Index.) Your Chevrolet has a "basecoat/clearcoat" paint finish. The clearcoat gives more depth and gloss to the colored basecoat.

#### **NOTICE:**

Machine compounding or aggressive polishing on a basecoat/clearcoat paint finish may dull the finish or leave swirl marks.

### **Aluminum Wheels (If So Equipped)**

Your aluminum wheels have a protective coating similar to the painted surface of your vehicle. Don't use strong soaps, chemicals, chrome polish, or other abrasive cleaners on them because you could damage this coating. After rinsing thoroughly, a wax may be applied.

#### **NOTICE:**

If you have aluminum wheels, don't use an automatic car wash that has hard silicon carbide cleaning brushes. These brushes can take off the protective coating.

# Service & Appearance Care

## White Sidewall Tires

Your Chevrolet dealer has a GM White Sidewall Tire Cleaner. You can use a stiff brush with it.

## Weatherstrips

These are places where glass or metal meets rubber. Silicone grease there will make them last longer, seal better, and not stick or squeak. Apply silicone grease with a clean cloth at least every six months.

## Sheet Metal Damage

If your vehicle is damaged and requires sheet metal repair or replacement, make sure the body repair shop applies anti-corrosion material to the parts repaired or replaced to restore corrosion protection.

## Foreign Material

Calcium chloride and other salts, ice melting agents, road oil and tar, tree sap, bird droppings, chemicals from industrial chimneys, and other foreign matter can damage your vehicle's finish if they remain on painted surfaces. Use cleaners that are marked safe for painted surfaces for these stains.

### **Finish Damage**

Any stone chips, fractures or deep scratches in the finish should be repaired right away. Bare metal will corrode quickly and may develop into a major repair expense.

Minor chips and scratches can be repaired with touch-up materials available from your dealer or other service outlets. Larger areas of finish damage can be corrected in your dealer's body and paint shop.

### **Underbody Maintenance**

Chemicals used for ice and snow removal and dust control can collect on the underbody. If these are not removed, accelerated corrosion (rust) can occur on the underbody parts such as fuel lines, frame, floor pan, and exhaust system even though they have corrosion protection.

At least every spring, flush these materials from the underbody with plain water. Clean any areas where mud and other debris can collect. Dirt packed in closed areas of the frame should be loosened before being flushed. Your dealer or an underbody vehicle washing system can do this for you.

### **Chemical Paint Spotting**

Some weather and atmospheric conditions can create a chemical fallout. Airborne pollutants can fall upon and attack painted surfaces on your vehicle. This damage can take two forms: blotchy, ringlet-shaped discolorations, and small irregular dark spots etched into the paint surface.

Although no defect in the paint job causes this, Chevrolet will repair, at no charge to the owner, the surfaces of new vehicles damaged by this fallout condition within 12 months or 12,000 miles (20 000 km) of purchase, whichever comes first.

# Service Station Information

## ■ Appearance Care and Maintenance Materials

PART NUMBER	SIZE	DESCRIPTION	USAGE
1051516	32 oz. (0.946 L)	Washer Solvent and Gas Line De-Icer	Windshield washing system and gas line
1050172	16 oz. (0.473 L)	Tar and Road Oil Remover	Also old waxes, polishes
1050173	16 oz. (0.473 L)	Chrome Cleaner and Polish	Removes rust and corrosion on chrome and steel
1050174	16 oz. (0.473 L)	White Sidewall Tire Cleaner	Cleans white and black tires
1050214	32 oz. (0.946 L)	Vinyl/Leather Cleaner*	Spot and stain removal on leather and vinyl
1050244	16 oz. (0.473 L)	Fabric Cleaner*	Spot and stain removal on cloth and fabric
1052884	16 oz. (0.473 L)	Power Steering Fluid	Power steering
1050427	24 oz. (0.680 L)	Glass Cleaner	Glass cleaning and spot cleaning on vinyls
1050429	6 lb. (2.72 kg)	Multi-Purpose Powdered Cleaner	Vinyl, cloth, door trims, seats, carpet, tires, mats
1050109	12 oz. (0.340 kg)	Lubriplate	Spray lubricant for hood, hatchback, door hinges, latches
1052870	16 oz. (0.473 L)	Wash-Wax (Concentrated)	Exterior wash
12345579	1 oz. (0.028 kg)	Dielectric Silicone Grease	Weatherstrips
1051398	8 oz. (0.237 L)	Spot Lifter*	Spot and stain removal on cloth and fabric
1051515	32 oz. (0.946 L)	GM Optikleem <sup>®</sup>	Windshield washer solvent and antifreeze
1050201	16 oz. (0.473 L)	Magic Mirror Cleaner-Polish	Exterior cleaner and polish
12345881	32 oz. (0.946 L)	DEXRON <sup>®</sup> -III	Automatic and manual transmission fluid
12345120	9 oz. (0.262 L)	Multi-Purpose Lubricant	Key-lock cylinders
1052753	1 gal. (3.785 L)	Permanent Type Anti-Freeze Coolant	Year-round coolant and antifreeze
1052497	14 oz. (0.397 kg)	Lubricant	Chassis
1052535	16 oz. (0.473 L)	Delco-Supreme 11 <sup>®</sup> Brake Fluid	Brake fluid
1050011	12 oz. (0.340 kg)	Bon-Ami Powder <sup>®</sup>	Windshield cleaner
12345347	16 oz. (0.473 L)	Hydraulic Clutch Fluid	Hydraulic clutch system
1052271	24 oz. (0.680 L)	SAE 80W-90-GL-5	Rear axle

\*Not recommended for pigskin suede leather.

See your General Motors Dealers for these products. See your Maintenance Schedule for other products.

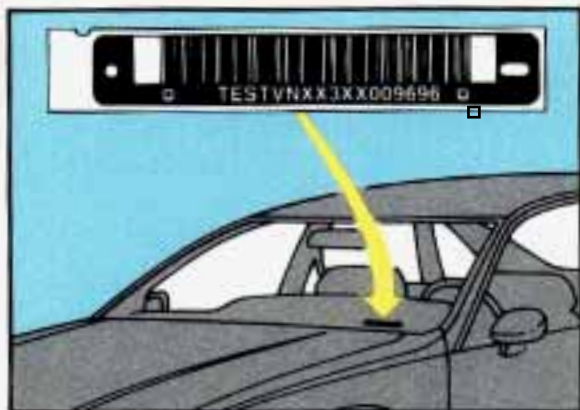

## ■ *Vehicle Identification Number (VIN)*

This is the legal identifier for your Chevrolet. It appears on a plate in the front corner of the instrument panel, on the driver's side. You can see it if you look through the windshield from outside your vehicle. The VIN also appears on the Vehicle Certification and Service Parts labels and the certificates of title and registration.

### **Engine Identification**

The eighth character in your VIN is the engine code for your 1993 GM engine. This code will help you identify your engine, specifications, and replacement parts in this section.

## ■ *Service Parts Identification Label*

You'll find this label inside your console storage compartment. It's very helpful if you ever need to order parts. On this label is:

- Your VIN.
- Its model designation.
- Paint information.
- A list of all production options and special equipment.

Be sure that this label is not removed from the vehicle.

## ■ *Add-On Electrical Equipment*

### **NOTICE:**

Don't add anything electrical to your Chevrolet unless you check with your dealer first. Some electrical equipment can damage your vehicle and the damage wouldn't be covered by your warranty. Some of it can just keep other things from working as they should.

## Service & Appearance Care



### ■ *Fuses and Circuit Breakers*

The wiring circuits in your vehicle are protected from short circuits by a combination of fuses, circuit breakers, and fusible thermal links in the wiring itself. This greatly reduces the chance of fires caused by electrical problems.

There are two fuse centers on your vehicle. One is in the left side of your instrument panel.

The other is in the engine compartment. Open the cover on either of the boxes to expose the fuses.

Look at the silver-colored band inside the fuse. If the band is broken or melted, replace the fuse. Be sure you replace a bad fuse with a new one of the correct size.

If you ever have a problem on the road and don't have a spare fuse, you can borrow one of the correct value. Just pick some feature of your vehicle that you can get along without — like the radio or cigarette lighter — and use its fuse, if it is the size you need. Replace it as soon as you can.

### **Headlights**

The headlight wiring is protected by a circuit breaker. An electrical overload will cause the lights to go on and off, or in some cases to remain off. If this happens, have your headlight wiring checked right away.

### **Windshield Wipers**

The windshield wiper motor is protected by a circuit breaker and a fuse. If the motor overheats due to heavy snow, etc., the wiper will stop until the motor cools. If the overload is caused by some electrical problem and not snow, etc., be sure to get it fixed.



### Power Windows and Other Power Options

Circuit breakers protect the power windows and other power accessories. When the current load is too heavy, the circuit breaker opens and closes, protecting the circuit until the problem is fixed or goes away.

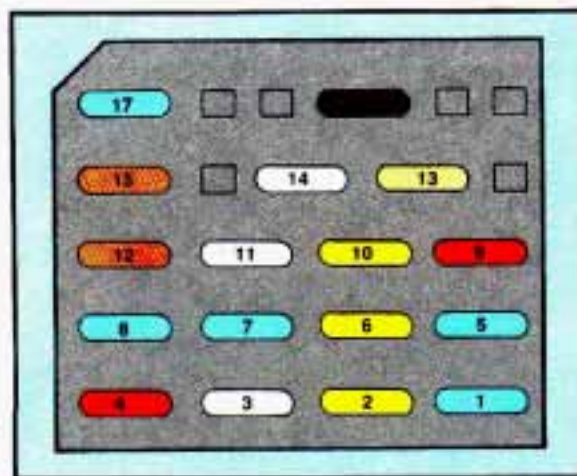

### Main Fuse Block

- 1 — Air Bag: SIR Components (15 Amp.)
- 2 — Backup Lights; Daytime Running Lights Module (Canada); Turn Flasher (20 Amp.)
- 3 — HVAC Selector Switch (Heater/Air Conditioner); Rear Defogger (25 Amp.)
- 4 — Engine Control Module; Instrument Cluster; PASS-Key II® Decoder Module (10 Amp.)
- 5 — Engine Control Module; PASS-Key II® Decoder Module; Fuel Pump Relay (15 Amp.)
- 6 — Brake Light/Cruise Release Switch; Hazard Flasher (20 Amp.)
- 7 — Power Door Locks; Power Mirrors; Hatch Release (15 Amp.)
- 8 — Audio Alarm Module; Bose® Relay; Courtesy Lights: Console Compartment, Glove Box, Dome, Rearview Mirror and Radio (15 Amp.)
- 9 — Audio Alarm Module; Daytime Running Lights Module (Canada); Diagnostic Energy Reserve Module; Instrument Cluster (10 Amp.)
- 10 — Exterior Lighting (20 Amp.)
- 11 — Cigarette Lighter; Horn Relay (25 Amp.)
- 12 — Power Seats; Rear Defogger (35 Amp. Circuit Breaker)
- 13 — Brightness Control (5 Amp.)
- 14 — Windshield Wiper/Washer (25 Amp.)
- 15 — Power Windows (35 Amp. Circuit Breaker)
- 16 — Diagnostic Energy Reserve Module (3 Amp.)
- 17 — Radio (15 Amp.)

# Service & Appearance Care

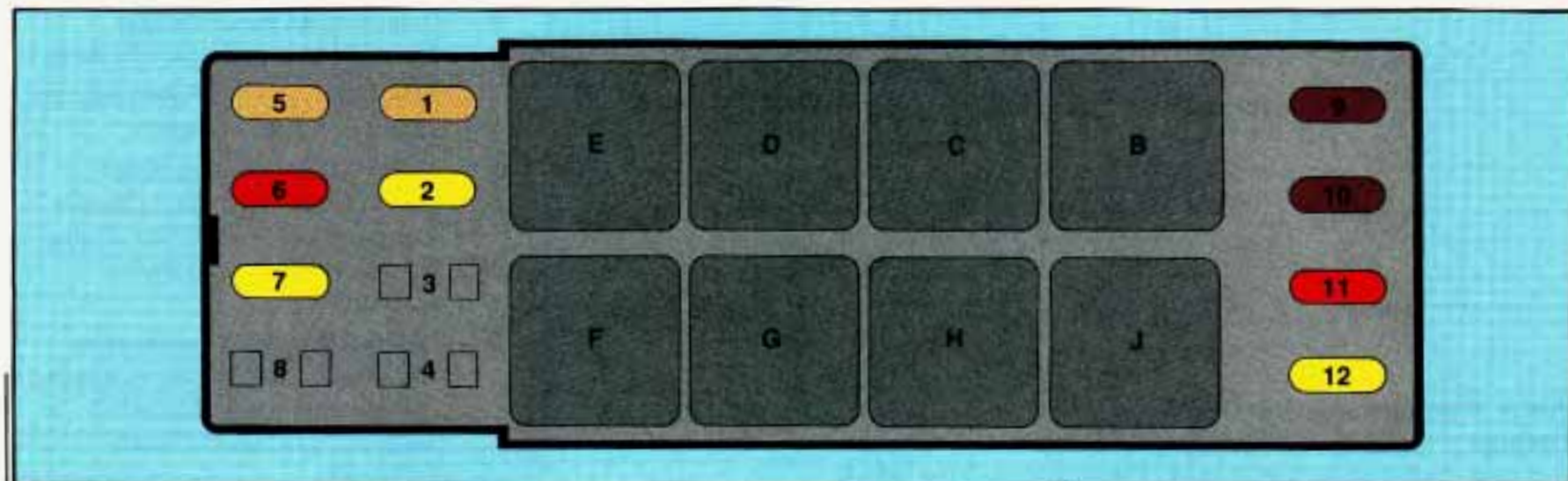

## Underhood Electrical Center

### Fuses

- 1 — Electronic Brake Control Module (5 Amp.)
- 2 — Fog Lamps (20 Amp.)
- 3 — Not Used
- 4 — Not Used
- 5 — Anti-Lock Brake System (5 Amp.)
- 6 — Coolant Fan Relays; EVAP Canister Purge Solenoid; Exhaust Gas Recirculation; Low Coolant Relay; Reverse Lockout Solenoid (10 Amp.)

7 — Air Injection Pump Assembly; Air Pump Relay (20 Amp.)

8 — Not Used

9 — Fuel Injectors (7.5 Amp.)

10 — Fuel Injectors (7.5 Amp.)

11 — VIN Engine Code S: Camshaft Position Sensor; Crankshaft Position Sensor; Electronic Ignition Module (10 Amp.)  
VIN Engine Code P: Ignition Coil; Ignition Coil Driver (10 Amp.)

12 — Air Conditioning Compressor Relay; Cruise Control Switches and Module (20 Amp.)

### Relays

- B — Air Conditioning Compressor
- C — Anti-Lock Brake System
- D — Primary Coolant Fan (Driver Side)
- E — Air Pump
- F — Secondary Coolant Fan (Passenger Side)
- G — Low Coolant
- H — Fog Lamps
- J — High Blower

## ■ *Replacement Bulbs*

Ashtray*	194
Automatic Transmission Indicator	73
Backup	1141
Center High-Mounted Stoplight	921
Cluster	161
Console	194
Dome	561
Door Courtesy	70
Fog	885
Front Parking and Turn Signal	2397
Glove Box	194
Headlight (Low Beam)	H-4351
Headlight (High Beam)	H-4352
Heater and A/C Control	37
High Beam Indicator	161
Indicator Lights	161
License	194
Reading	212-2
Sidemarkers	194
Tail Only	194
Tail/Stop/Turn	2057
Turn Signal Indicators	161

\*Manual transmission only.

# Service & Appearance Care

## ■ *Capacities and Specifications*

### Engine

#### Type

VIN Engine Code S ..... V6

VIN Engine Code P ..... V8

Fuel Delivery ..... Fuel Injection

Valve Arrangement ..... In-Head

#### Piston Displacement

VIN Engine Code S ..... 207 CID (3.4L)

VIN Engine Code P ..... 350 CID (5.7L)

#### Compression Ratio

VIN Engine Code S ..... 9.0:1

VIN Engine Code P ..... 10.5:1

#### Firing Order

VIN Engine Code S ..... 1-2-3-4-5-6

VIN Engine Code P ..... 1-8-4-3-6-5-7-2

## Replacement Parts

Air Cleaner Filter .....	A1163C
Battery .....	75-60
Engine Oil Filter	
VIN Engine Code S .....	PF47
VIN Engine Code P .....	PF25
Fuel Filter .....	GF578
PCV Valve	
VIN Endinge Code S .....	CV789C
VIN Engine Code P .....	CV895C
Radiator Cap .....	RC24
Spark Plug	
VIN Engine Code S .....	•R43TSK (0.045" Gap)
VIN Engine Code P .....	•R45LTSP (0.050" Gap)
Thermostat Temperature Specification .....	180°F (82°C)

## Wheel Nuts

Wheel Nut Torque .....	100 lb. ft. (140 N•m)
------------------------	-----------------------

# Service & Appearance Care

## Capacities (Approximate)

The following approximate capacities are given in U.S. and metric conversions.

Air Conditioning†	.....	See the refrigerant information label under the hood.
Automatic Transmission		
Drain and Refill	.....	10 pt. (4.7 L)*
Overhaul		
VIN Engine Code S	.....	16.7 pt. (7.9 L)*
VIN Engine Code P	.....	22.4 pt. (10.6 L)*
Cooling System		
VIN Engine Code S		
With Manual Transmission	.....	12.5 qt. (11.8 L)
With Automatic Transmission	.....	12.3 qt. (11.6 L)
VIN Engine Code P		
With Manual Transmission	.....	15.3 qt. (14.5 L)
With Automatic Transmission	.....	15.1 qt. (14.3 L)

†Not all air conditioning refrigerants are the same. If the air conditioning system in your vehicle needs refrigerant, be sure the proper refrigerant is used. If you're not sure, ask your Chevrolet dealer.

\*Recheck fluid level after filling. See "Automatic Transmission Fluid" or "Manual Transmission Fluid" in the Index.

#### Crankcase

VIN Engine Code S .....	4.0 qt. (3.8 L)**
VIN Engine Code P	
Without Filter Change .....	4.0 qt. (3.8 L)**
With Filter Change .....	4.5 qt. (4.3 L)**
Fuel Tank .....	15.5 gal. (58.7 L)
Manual Transmission	
Five-Speed .....	5.9 pt. (2.8 L)*
Six-Speed .....	8.0 pt. (3.8 L)*
Rear Axle Lubricant .....	4 fl. oz. (118 ml)

#### Vehicle Dimensions

Wheelbase .....	101.1" (2 566 mm)
Tread	
Front .....	60.7" (1 542 mm)
Rear .....	60.6" (1 540 mm)
Length .....	193.2" (4 908 mm)
Width .....	74.1" (1 883 mm)
Height .....	51.3" (1 303 mm)

\*Recheck fluid level after filling. See "Automatic Transmission Fluid" or "Manual Transmission Fluid" in the Index.

\*\*Recheck the oil level after filling. See "Engine Oil" in the Index.

# Notes



**IMPORTANT:  
KEEP ENGINE OIL  
AT THE PROPER  
LEVEL AND CHANGE AS  
RECOMMENDED**

**T**his part covers the maintenance required for your Chevrolet. Your vehicle needs these services to retain its safety, dependability and emission control performance.

## Part 7

# Maintenance Schedule

### Section

<b>Introduction: A Word about Maintenance</b> .....	286
Your Vehicle and the Environment .....	286
How This Part Is Organized .....	287
<b>A. Scheduled Maintenance Services</b> .....	289
Using Your Maintenance Schedules .....	289
Selecting the Right Schedule .....	289
Schedule I .....	290
Schedule II .....	292
Explanation of Scheduled Maintenance Services .....	294
<b>B. Owner Checks and Services</b> .....	298
At Each Fuel Fill .....	298
At Least Once a Month .....	299
At Least Twice a Year .....	299
At Least Once a Year .....	300
<b>C. Periodic Maintenance Inspections</b> .....	303
<b>D. Recommended Fluids and Lubricants</b> .....	305
<b>E. Maintenance Record</b> .....	308



**Protection  
Plan**

*Have you purchased the GM Protection Plan? The Plan  
supplements your new car warranties.  
See your GM dealer for details.*

# Maintenance Schedule

## Introduction: A Word about Maintenance

We at General Motors want to help you keep your vehicle in good working condition. But we don't know exactly how you'll drive it. You may drive very short distances only a few times a week. Or you may drive long distances all the time in very hot, dusty weather. You may use your vehicle in making deliveries. Or you may drive it to work, to do errands, or in many other ways.

Because of all the different ways people use their GM vehicles, maintenance needs vary. You may even need more frequent checks and replacements than you will find in the schedules in this part. So please read this part and note how you drive. If you have any questions on how to keep your vehicle in good condition, see your Chevrolet dealer, the place many GM owners choose to have their maintenance work done. Your dealer can be relied upon to use proper parts and practices.

### ***Your Vehicle and the Environment***

Proper vehicle maintenance not only helps keep your vehicle in good working condition, but it also helps the environment. All recommended maintenance procedures are important. Improper vehicle maintenance or the removal of important components can significantly affect the quality of the air we breathe. Improper fluid levels or even the wrong tire inflation can increase the level of emissions from your vehicle. To help protect our environment, and to help keep your vehicle in good condition, please maintain your vehicle properly.

## ***How This Part Is Organized***

The remainder of this part is divided into five sections:

“Section A: Scheduled Maintenance Services” shows what to have done, and how often. Some of these services can be complex, so unless you are technically qualified and have the necessary equipment, you should let your dealer’s service department or another qualified service center do these jobs.

### **CAUTION:**



Performing maintenance work on a vehicle can be dangerous. In trying to do some jobs, you can be seriously injured. Do your own maintenance work only if you have the required know-how and the proper tools and equipment for the job. If you have any doubt, have a qualified technician do the work.

If you are skilled enough to do some work on your vehicle, you will probably want to get the service information GM publishes. You will find a list of publications and how to get them later in this manual. See “Service Publications” in the Index.

“Section B: Owner Checks and Services” tells you what should be checked whenever you stop for fuel. It also explains what you can easily do to help keep your vehicle in good condition.

“Section C: Periodic Maintenance Inspections” explains important inspections that your Chevrolet dealer’s service department or another qualified service center should perform.

# Maintenance Schedule

## Introduction: A Word about Maintenance (Cont.)

“Section D: Recommended Fluids and Lubricants” lists some products GM recommends to help keep your vehicle properly maintained. These products, or their equivalents, should be used whether you do the work yourself or have it done.

“Section E: Maintenance Record” provides a place for you to record the maintenance performed on your vehicle. Whenever any maintenance is performed, be sure to write it down in this section. This will help you determine when your next maintenance should be done. In addition, it is a good idea to keep your maintenance receipts. They may be needed to qualify your vehicle for warranty repairs.

# Maintenance Schedule

## Section A: Scheduled Maintenance Services

### ***Using Your Maintenance Schedules***

This section tells you the maintenance services you should have done and when you should schedule them. Your Chevrolet dealer knows your vehicle best and wants you to be happy with it. If you go to your dealer for your service needs, you'll know that GM-trained and supported service people will perform the work using genuine GM parts.

These schedules are for vehicles that:

- carry passengers and cargo within recommended limits. You will find these limits on your vehicle's Tire-Loading Information label. See "Loading Your Vehicle" in the Index.
- are driven on reasonable road surfaces within legal driving limits.
- use the recommended unleaded fuel. See "Fuel" in the Index.

### ***Selecting the Right Schedule***

First you'll need to decide which of the two schedules is right for your vehicle. Here's how to decide which schedule to follow:

#### **Schedule I**

Is any one of these true for your vehicle?

- Most trips are less than 4 miles (6 km).
- Most trips are less than 10 miles (16 km) when outside temperatures are below freezing.
- The engine is at low speed most of the time (as in door-to-door delivery, or in stop-and-go traffic).
- You operate your vehicle in dusty areas.
- You tow a trailer.

If any one (or more) of these is true for your driving, follow Schedule I.

#### **Schedule II**

Follow Schedule II **only** if none of the above conditions is true.

# Maintenance Schedule

## Section A: Scheduled Maintenance Services (Cont.)

### Schedule I

Follow Schedule I if your vehicle is **MAINLY** driven under one or more of the following conditions:

- When most trips are less than 4 miles (6 km).
- When most trips are less than 10 miles (16 km) and outside temperatures remain below freezing.
- When most trips include extended idling and/or frequent low-speed operation, as in stop-and-go traffic.
- When towing a trailer.
- When operating in dusty areas.

**Schedule I should also be followed if the vehicle is used for delivery service, police, taxi or other commercial applications.**

*\*An Emission Control Service.*

☆ *The U.S. Environmental Protection Agency has determined that the failure to perform this maintenance item will not nullify the emission warranty or limit recall liability prior to the completion of vehicle useful life. General Motors, however, urges that all recommended maintenance services be performed at the indicated intervals and the maintenance be recorded in "Section E: Maintenance Record."*

ITEM NO.	WHAT TO SERVICE <i>See "Explanation of Scheduled Maintenance Services" following Schedules I and II.</i>	WHEN TO PERFORM <i>Miles (kilometers) or Months (whichever occurs first).</i>
1	Engine Oil & Oil Filter Change*	Every 3,000 Miles (5 000 km) or 3 Months.
2	Chassis Lubrication	Every other oil change.
3	Tire and Wheel Rotation & Inspection	At 6,000 Miles (10 000 km) and every 15,000 Miles (25 000 km) or as necessary.
4	Engine Accessory Drive Belt Inspection*	Every 30,000 Miles (50 000 km) or 24 Months.
5	Cooling System Service*	
6	Transmission Service	See "Explanation of Scheduled Maintenance Services" following Schedules I and II.
7	Spark Plug Replacement (3.4L L32 (Code S) Engine)*	Every 30,000 Miles (50 000 km).
	Spark Plug Replacement (5.7L LT1 (Code P) Engine)*	Every 100,000 Miles (160 000 km).
8	Spark Plug Wire Inspection* ☆	Every 30,000 Miles (50 000 km).
9	Air Cleaner Filter and Crankcase Ventilation Filter Replacement*	
10	Fuel Tank, Cap & Lines Inspection* ☆	

The services shown in this schedule up to 48,000 miles (80 000 km) should be performed after 48,000 miles at the same intervals.

**MILES (000)**

3	6	9	12	15	18	21	24	27	30	33	36	39	42	45	48
---	---	---	----	----	----	----	----	----	----	----	----	----	----	----	----

**KILOMETERS (000)**

5	10	15	20	25	30	35	40	45	50	55	60	65	70	75	80
---	----	----	----	----	----	----	----	----	----	----	----	----	----	----	----

.	.	.	.	.	.	.	.	.	.	.	.	.	.	.	.
	.		.		.		.		.		.		.		.
	.					.					.				
									.						
									.						
									.						
									.						
									.						
									.						
									.						

# Maintenance Schedule

## Section A: Scheduled Maintenance Services (Cont.)

### Schedule II

Follow Schedule II ONLY if none of the driving conditions specified in Schedule I apply.

\*An Emission Control Service.

☆The U.S. Environmental Protection Agency has determined that the failure to perform this maintenance item will not nullify the emission warranty or limit recall liability prior to the completion of vehicle useful life. General Motors, however, urges that all recommended maintenance services be performed at the indicated intervals and the maintenance be recorded in "Section E: Maintenance Record."

ITEM NO.	WHAT TO SERVICE <i>See "Explanation of Scheduled Maintenance Services" following Schedules I and II.</i>	WHEN TO PERFORM <i>Miles (kilometers) or Months (whichever occurs first).</i>
1	Engine Oil Change*	Every 7,500 Miles (12 500 km) or 12 Months.
	Oil Filter Change*	At first and every other oil change.
2	Chassis Lubrication	Every 7,500 Miles (12 500 km) or 12 Months.
3	Tire and Wheel Rotation & Inspection	At 7,500 Miles (12 500 km) and then every 15,000 Miles (25 000 km) or as necessary.
4	Engine Accessory Drive Belt Inspection*	Every 30,000 Miles (50 000 km) or 24 Months.
5	Cooling System Service*	
6	Transmission Service	See "Explanation of Scheduled Maintenance Services" following Schedules I and II.
7	Spark Plug Replacement (3.4L L32 (Code S) Engine)*	Every 30,000 Miles (50 000 km).
	Spark Plug Replacement (5.7L LT1 (Code P) Engine)*	Every 100,000 Miles (160 000 km).
8	Spark Plug Wire Inspection* ☆	Every 30,000 Miles (50 000 km).
9	Air Cleaner Filter and Crankcase Ventilation Filter Replacement*	
10	Fuel Tank, Cap & Lines Inspection* ☆	



The services shown in this schedule up to 45,000 miles (75 000 km) should be performed after 45,000 miles at the same intervals.

**MILES (000)**

7.5	15	22.5	30	37.5	45
-----	----	------	----	------	----

**KILOMETERS (000)**

12.5	25	37.5	50	62.5	75
------	----	------	----	------	----

•	•	•	•	•	•
•		•		•	
•	•	•	•	•	•
•		•		•	
			•		
			•		
			•		
			•		
			•		
			•		

# Maintenance Schedule

## Section A: Scheduled Maintenance Services (Cont.)

### ***Explanation of Scheduled Maintenance Services***

Below are explanations of the services listed in Schedule I and Schedule II.

The proper fluids and lubricants to use are listed in Section D. Make sure whoever services your vehicle uses these. All

parts should be replaced and all necessary repairs done before you or anyone else drives the vehicle.

NOTE: To determine your engine's displacement and code, see "Engine Identification" in the Index.

#### **ITEM**

##### **NO. SERVICE**

- 1 Engine Oil and Filter Change\*** — Always use SG Energy Conserving II oils of proper viscosity. The SG designation may be shown alone or in combination with others, such as SG/CC, SG/CD, or SF, SG, CC, etc. To determine the preferred viscosity for your vehicle's engine (e.g., SAE 5W-30 or 10W-30), see "Engine Oil" in the Index.
- 2 Chassis Lubrication** — If your vehicle is equipped with grease fittings, lubricate the suspension and steering linkage. Lubricate the transmission shift linkage.

#### **ITEM**

##### **NO. SERVICE**

- 3 Tire and Wheel Rotation and Inspection** — For proper wear and maximum tire life, rotate your tires following the instructions in this manual. See "Tires, Inspection and Rotation" in the Index. Check the tires for uneven wear or damage. If you see irregular or premature wear, check the wheel alignment. Check for damaged wheels also.
- 4 Engine Accessory Drive Belt Inspection\*** — Inspect the belt for cracks, fraying, wear and proper tension. Replace as needed.

\*An Emission Control Service.

**ITEM****NO. SERVICE**

- 5 Cooling System Service\*** — Drain, flush and refill the system with new or approved recycled coolant conforming to GM Specification 1825M. Keep coolant at the proper mixture as specified. See "Coolant" in the Index. This provides proper freeze protection, corrosion inhibitor level and engine operating temperature.

**ITEM****NO. SERVICE**

- Inspect hoses and replace if they are cracked, swollen or deteriorated. Tighten screw-type hose clamps. Clean the outside of the radiator and air conditioning condenser. Wash the pressure cap and neck.
- To help ensure proper operation, we recommend a pressure test of both the cooling system and the pressure cap.

*\*An Emission Control Service.*

# Maintenance Schedule

## Section A: Scheduled Maintenance Services (Cont.)

### ITEM NO. SERVICE

**6 Transmission Service** — For manual transmissions, fluid doesn't require changing.

For automatic transmissions, change both the fluid and filter every 15,000 miles (25 000 km) if the vehicle is mainly driven under one or more of these conditions:

- In heavy city traffic where the outside temperature regularly reaches 90°F (32°C) or higher.
- In hilly or mountainous terrain.
- When doing frequent trailer towing.
- Uses such as found in taxi, police car or delivery service.

*\*An Emission Control Service.*

*☆The U.S. Environmental Protection Agency has determined that the failure to perform this maintenance item will not nullify the emission warranty or limit recall liability prior to the completion of vehicle useful life. General Motors, however, urges that all recommended maintenance services be performed at the indicated intervals and the maintenance be recorded in "Section E: Maintenance Record."*

### ITEM NO. SERVICE

If you do not use your vehicle under any of these conditions, change both the fluid and filter every 100,000 miles (160 000 km).

**7 Spark Plug Replacement\*** — Replace spark plugs with the proper type. See "Replacement Parts" in the Index.

**8 Spark Plug Wire Inspection\*☆** — Inspect for burns, cracks or other damage. Check the boot fit at the distributor and at the spark plugs. Replace wires as needed.

**ITEM****NO. SERVICE**

- 9 Air Cleaner Filter and Crankcase Ventilation Filter Replacement\*** — Replace every 30,000 miles (50 000 km) or more often under dusty conditions. Ask your dealer for the proper replacement intervals for your driving conditions.

**ITEM****NO. SERVICE**

- 10 Fuel Tank, Cap and Lines Inspections\*☆** — Inspect fuel tank, cap and lines (including fuel rails and injection assembly, if equipped) for damage or leaks. Inspect fuel cap gasket for an even filler neck imprint or any damage. Replace parts as needed. Periodic replacement of the fuel filter is not required.

*\*An Emission Control Service.*

*☆The U.S. Environmental Protection Agency has determined that the failure to perform this maintenance item will not nullify the emission warranty or limit recall liability prior to the completion of vehicle useful life. General Motors, however, urges that all recommended maintenance services be performed at the indicated intervals and the maintenance be recorded in "Section E: Maintenance Record."*

# Maintenance Schedule

## Section B: Owner Checks and Services

Listed below are owner checks and services which should be performed at the intervals specified to help ensure the safety, dependability and emission control performance of your vehicle.

Be sure any necessary repairs are completed at once. Whenever any fluids or lubricants are added to your vehicle, make sure they are the proper ones, as shown in Section D.

### ***At Each Fuel Fill*** *(It is important for you or a service station attendant to perform these underhood checks at each fuel fill.)*

<b>CHECK OR SERVICE</b>	<b>WHAT TO DO</b>
Engine Oil Level	Check the engine oil level and add the proper oil if necessary. See "Engine Oil" in the Index for further details.
Engine Coolant Level	Check the engine coolant level in the coolant recovery tank and add the proper coolant mix if necessary. See "Coolant" in the Index for further details.
Windshield Washer Fluid Level	Check the windshield washer fluid level in the windshield washer tank and add the proper fluid if necessary. See "Windshield Washer Fluid" in the Index for further details.

### ***At Least Once a Month***

<b>CHECK OR SERVICE</b>	<b>WHAT TO DO</b>
Tire Inflation	Check tire inflation. Make sure they are inflated to the pressures specified on the Tire-Loading Information label located on the rear edge of the driver's door. See "Tires" in the Index for further details.

### ***At Least Twice a Year***

<b>CHECK OR SERVICE</b>	<b>WHAT TO DO</b>
Hydraulic Clutch System Inspection	Check the fluid level in the clutch reservoir. See "Hydraulic Clutch Fluid" in the Index. A fluid loss in this system could indicate a problem. Have the system inspected and repaired at once.

# Maintenance Schedule

## Section B: Owner Checks and Services (Cont.)

### At Least Once a Year

CHECK OR SERVICE	WHAT TO DO
Key Lock Cylinders	Lubricate the key lock cylinders with the lubricant specified in Section D.
Body Lubrication	Lubricate all body door hinges, including the hatchback lid. Also lubricate all hinges and latches, including those for the hood, rear compartment, console doors and any folding seat hardware. Section D tells you what to use.
Starter Switch	<b>CAUTION:</b>
	 When you are doing this check, the vehicle could move suddenly. If it does, you or others could be injured. Follow the steps below. <ol style="list-style-type: none"><li>1. Before you start, be sure you have enough room around the vehicle.</li><li>2. Firmly apply both the parking brake (see "Parking Brake" in the Index if necessary) and the regular brake.</li></ol> <b>NOTE:</b> Do not use the accelerator pedal, and be ready to turn off the engine immediately if it starts. <ol style="list-style-type: none"><li>3. On automatic transmission vehicles, try to start the engine in each gear. The starter should work only in <b>P</b> (Park) or <b>N</b> (Neutral). If the starter works in any other position, your vehicle needs service. On manual transmission vehicles, put the shift lever in <b>Neutral</b>, push the clutch down halfway and try to start the engine. The starter should work only when the clutch is pushed down all the way to the floor. If the starter works when the clutch isn't pushed all the way down, your vehicle needs service.</li></ol>



### At Least Once a Year (CONT.)

CHECK OR SERVICE	WHAT TO DO
Brake Transmission Shift Interlock—BTSI	<p data-bbox="472 482 1875 538"><b>CAUTION:</b></p> <p data-bbox="472 542 1875 626"> When you are doing this check, the vehicle could move suddenly. If it does, you or others could be injured. Follow the steps below.</p> <ol data-bbox="491 635 1875 901" style="list-style-type: none"><li>1. Before you start, be sure you have enough room around the vehicle. It should be parked on a level surface.</li><li>2. Firmly apply the parking brake (see “Parking Brake” in the Index if necessary). <b>NOTE:</b> Be ready to apply the regular brake immediately if the vehicle begins to move.</li><li>3. With the engine off, turn the key to the <b>Run</b> position, but don't start the engine. Without applying the regular brake, try to move the shift lever out of <b>P</b> (Park) with normal effort. If the shift lever moves out of <b>P</b> (Park), your vehicle's BTSI needs service.</li></ol>
Steering Column Lock	<p data-bbox="472 905 1875 989">While parked, and with the parking brake set, try to turn the key to <b>LOCK</b> in each shift lever position.</p> <ul data-bbox="472 998 1875 1150" style="list-style-type: none"><li>• With an automatic transmission, the key should turn to <b>LOCK</b> only when the shift lever is in <b>P</b> (Park).</li><li>• With a manual transmission, the key should turn to <b>LOCK</b> only when you press the key release button.</li></ul> <p data-bbox="472 1159 1875 1278">On vehicles with a key release button, try to turn the key to <b>LOCK</b> without pressing the button. The key should turn to <b>LOCK</b> only with the key button depressed. On all vehicles, the key should come out only in <b>LOCK</b>.</p>

# Maintenance Schedule

## Section B: Owner Checks and Services (Cont.)

### At Least Once a Year (CONT.)

CHECK OR SERVICE	WHAT TO DO
Parking Brake and Automatic Transmission P (Park) Mechanism Check	<b>CAUTION:</b>  When you are doing this check, your vehicle could begin to move. You or others could be injured and property could be damaged. Make sure there is room in front of your vehicle in case it begins to roll. Be ready to apply the regular brake at once should the vehicle begin to move.
	Park on a fairly steep hill, with the vehicle facing downhill. Keeping your foot on the regular brake, set the parking brake. <ul style="list-style-type: none"><li>• To check the parking brake: With the engine running and transmission in <b>N</b> (Neutral), slowly remove foot pressure from the regular brake pedal. Do this until the vehicle is held by the parking brake only.</li><li>• To check the <b>P</b> (Park) mechanism's holding ability: Shift to <b>P</b> (Park). Then release all brakes.</li></ul>
Underbody Flushing	At least every spring, use plain water to flush any corrosive materials from the underbody. Take care to clean thoroughly any areas where mud and other debris can collect.

# Maintenance Schedule

## Section C: Periodic Maintenance Inspections

Listed below are inspections and services which should be performed at least twice a year (for instance, each spring and fall). You should let your GM dealer's service

department or other qualified service center do these jobs. Make sure any necessary repairs are completed at once.

INSPECTION OR SERVICE	WHAT SHOULD BE DONE
Steering and Suspension Inspection	Inspect the front and rear suspension and steering system for damaged, loose or missing parts, signs of wear, or lack of lubrication. Inspect the power steering lines and hoses for proper hookup, binding, leaks, cracks, chafing, etc.
Exhaust System Inspection	Inspect the complete exhaust system. Inspect the body near the exhaust system. Look for broken, damaged, missing or out-of-position parts as well as open seams, holes, loose connections, or other conditions which could cause a heat build-up in the floor pan or could let exhaust fumes into the vehicle. See "Engine Exhaust" in the Index.
Throttle Linkage Inspection	Inspect the throttle linkage for interference or binding, and for damaged or missing parts. Replace parts as needed.

# Maintenance Schedule

## Section C: Periodic Maintenance Inspections (Cont.)

INSPECTION OR SERVICE	WHAT SHOULD BE DONE
Rear Axle Service	Check the gear lubricant level in the rear axle and add if needed. See "Rear Axle" in the Index. A fluid loss in this system may indicate a problem. Check the system and repair it if needed. <b>If your vehicle is used to pull a trailer, change the gear lubricant every 7,500 miles (12 500 km).</b>
Brake System Inspection	<p>Inspect the complete system. Inspect brake lines and hoses for proper hookup, binding, leaks, cracks, chafing, etc. Inspect disc brake pads for wear and rotors for surface condition. Also inspect drum brake linings for wear and cracks. Inspect other brake parts, including drums, wheel cylinders, calipers, parking brake, etc. The parking brake is self-adjusting and no manual adjustment is required. You may need to have your brakes inspected more often if your driving habits or conditions result in frequent braking.</p> <p><b>NOTE:</b> A low brake fluid level can indicate worn disc brake pads which may need to be serviced. Also, if the brake system warning light stays on or comes on, something may be wrong with the brake system. See "Brake System Warning Light" in the Index. If your anti-lock brake system warning light stays on, comes on or flashes, something may be wrong with the anti-lock brake system. See "Anti-Lock Brake System Warning Light" in the Index.</p>

# Maintenance Schedule

## Section D: Recommended Fluids & Lubricants

**NOTE:** Fluids and lubricants identified below by name, part number or specification may be obtained from your GM dealer.

USAGE	FLUID/LUBRICANT
Engine Oil	GM Goodwrench Motor Oil or equivalent for API service SG Energy Conserving II oils of the proper viscosity. The SG designation may be shown alone or in combination with others, such as SG/CC, SG/CD, or SF, SG, CC, etc. To determine the preferred viscosity for your vehicle's engine, see "Engine Oil" in the Index.
Engine Coolant	50/50 mixture of water (preferably distilled) and good quality ethylene glycol base antifreeze (GM Part No. 1052753) conforming to GM Specification 1825M or approved recycled coolant conforming to GM Specification 1825M.
Hydraulic Brake System	Delco-Supreme 11 <sup>®</sup> Brake Fluid (GM Part No. 1052535) or equivalent DOT-3 Brake Fluid.
Hydraulic Clutch System	Hydraulic Clutch Fluid (GM Part No. 12345347) or equivalent.
Power Steering System	GM Hydraulic Power Steering Fluid (GM Part No. 1052884) or equivalent.
Manual Transmission	DEXRON <sup>®</sup> -III Automatic Transmission Fluid (GM Part No. 12345881).
Automatic Transmission	DEXRON <sup>®</sup> -III Automatic Transmission Fluid (GM Part No. 12345881).

# Maintenance Schedule

## Section D: Recommended Fluids & Lubricants (Cont.)

USAGE	FLUID/LUBRICANT
Key Lock Cylinders	Lubricate with Multi-Purpose Lubricant (GM Part No. 12345120) or synthetic SAE 5W-30 engine oil or silicone lubricant (GM Part No. 1052276 or 1052277).
Automatic Transmission Shift Linkage	Engine Oil.
Clutch Linkage Pivot Points	Engine Oil.
Floor Shift Linkage	Engine Oil.
Chassis Lubrication	Chassis lubricant meeting requirements of NLGI Grade 2, Category LB or GC-LB (GM Part No. 1052497) or equivalent.
Windshield Washer Solvent	GM Optikleen® Washer Solvent (GM Part No. 1051515) or equivalent.
Windshield & Wiper Blades	Clean with Bon-Ami Powder® (GM Part No. 1050011).

USAGE	FLUID/LUBRICANT
Rear Axle (Standard and Limited-Slip Differential)	Axle Lubricant (GM Part No. 1052271) or SAE 80W-90 GL-5 Gear Lubricant.
Hood Latch Assembly a. Pivots and Spring Anchor b. Release Pawl	a. Engine oil. b. Chassis lubricant meeting requirements of NLGI Grade 2, Category LB or GC-LB (GM Part No. 1052497) or equivalent.
Hood and door hinges, rear folding seat, fuel door hinge, rear compartment lid hinges	Engine oil or Lubriplate Lubricant (GM Part No. 1050109).
Weatherstrips	Dielectric Silicone Grease (GM Part No. 12345579) or equivalent.

See "Replacement Parts" in the Index for recommended replacement filters, valves and spark plugs.

# Maintenance Schedule

## Section E: Maintenance Record

After the scheduled services are performed, record the date, odometer reading and who performed the service in the columns indicated. When completing the Maintenance Performed column, insert the numbers from the Schedule I

or Schedule II maintenance charts which correspond to the maintenance performed. Also, you should retain all maintenance receipts. Your owner information portfolio is a convenient place to store them.

DATE	ODOMETER READING	SERVICED BY	MAINTENANCE PERFORMED



DATE	ODOMETER READING	SERVICED BY	MAINTENANCE PERFORMED

# Maintenance Schedule

## Section E: Maintenance Record (Cont.)

DATE	ODOMETER READING	SERVICED BY	MAINTENANCE PERFORMED

<b>DATE</b>	<b>ODOMETER READING</b>	<b>SERVICED BY</b>	<b>MAINTENANCE PERFORMED</b>

# Maintenance Schedule

## Section E: Maintenance Record (Cont.)

DATE	ODOMETER READING	SERVICED BY	MAINTENANCE PERFORMED

## Customer Assistance Information



**H**ere you will find out how to contact Chevrolet if you need assistance. This part also tells you how to obtain service publications and how to report any safety defects.

Customer Satisfaction Procedure .....	314
GM Participation in Better Business Bureau Mediation/Arbitration Program .....	316
Reporting Safety Defects to the United States Government .....	318
Reporting Safety Defects to the Canadian Government .....	318
Reporting Safety Defects to General Motors .....	319
Chevrolet Roadside Assistance .....	319
Service Publications. ....	320

# Customer Assistance Information

## ■ *Customer Satisfaction Procedure*

Your satisfaction and goodwill are important to your dealer and Chevrolet. Normally, any concerns with the sales transaction or the operation of your vehicle will be resolved by your dealer's Sales or Service Departments.

Sometimes, however, despite the best intentions of all concerned, misunderstandings can occur. If your concern has not been resolved to your satisfaction, the following steps should be taken:

**STEP ONE:** Discuss your concern with a member of dealership management. Complaints can often be quickly resolved

at that level. If the matter has already been reviewed with the Sales, Service, or Parts Manager, contact the owner of the dealership or the General Manager.

**STEP TWO:** If after contacting a member of Dealership Management, it appears your concern cannot be resolved by the dealership without further help, contact the Chevrolet Customer Assistance Center by calling 1-800-222-1020. In Canada, contact GM of Canada Customer Assistance Center in Oshawa by calling 1-800-263-3777 (English) or 1-800-263-7854 (French). In Mexico,

call (525) 254-3777. In Puerto Rico or U.S. Virgin Islands, call 1-809-763-1315. In all other overseas locations, contact GM International Export Sales in Canada by calling 1-416-644-4112.

For prompt assistance, please have the following information available to give the Customer Assistance Representative:

- Your name, address, telephone number
- Vehicle Identification Number (This is available from the vehicle registration or title, or the plate attached to the left top of the instrument panel and visible through the windshield.)
- Dealership name and location

- Vehicle delivery date and present mileage
- Nature of concern

We encourage you to call the toll-free number listed previously in order to give your inquiry prompt attention. However, if you wish to write Chevrolet, write to:

Chevrolet Customer Assistance Center  
P.O. Box 7047  
Troy, MI 48007-7047

A listing of all Chevrolet Branch Offices and offices outside the U.S. which can assist you can also be found in the warranty booklet.

When contacting Chevrolet, please remember that your concern will likely be resolved in the dealership, using the dealership's facilities, equipment and personnel. That is why we suggest you follow Step One first if you have a concern.

#### **Customer Assistance for the Hearing or Speech Impaired (TDD)**

To assist owners who have hearing difficulties, Chevrolet has installed special TDD (Telecommunication Devices for the Deaf) equipment at its Customer Assistance Center. Any hearing or speech impaired customer who has access to a TDD or a conventional teletypewriter (TTY) can communicate with Chevrolet by dialing:

1-800-TDD-CHEV (TDD users in Canada can dial 1-800-263-3830.)

# Customer Assistance Information

## ■ *GM Participation in Better Business Bureau Mediation/Arbitration Program\**

General Motors reserves the right to change eligibility limitations and/or to discontinue its participation in this program.

Our experience has shown that the Customer Satisfaction Procedure described earlier in this part has been very successful in achieving customer satisfaction. However, if you have not been substantially satisfied, Chevrolet wants you to be aware of GM's voluntary participation in a no-charge

mediation/arbitration program called BBB AUTO LINE. This program is administered by the Council of Better Business Bureaus through local Better Business Bureaus. The program can resolve individual disputes involving vehicle repairs and the interpretation of your New Vehicle Limited Warranty. We prefer that you not resort to BBB AUTO LINE until after a final decision is made under the Customer Satisfaction Procedure. However, you may file a claim at any time by contacting your local Better Business Bureau (BBB) at the following toll-free number: 1-800-955-5100. For further information

about filing a claim, you may also write to:

BBB AUTO LINE  
Council of Better Business Bureaus  
4200 Wilson Boulevard  
Suite 800  
Arlington, VA 22203

In order to file a claim, you will have to provide your name and address, the vehicle identification number (VIN) of your vehicle, and a statement of the nature of your complaint. BBB staff may try to help resolve your dispute through mediation. If mediation is not successful, or if you do not wish to participate in



mediation, eligible customers may present their case to an impartial third-party arbitrator at an informal hearing. The arbitrator will render a decision in your case, which you may accept or reject. If you accept a valid arbitrator decision, GM will be bound by that decision. The entire dispute settlement process should ordinarily take about 40 days from the time you file your complaint to the time a decision is rendered (or 47 days if you did not first contact your dealer or Chevrolet).

We encourage you to use this program before or instead of resorting to the courts. We believe it offers advantages over courts in most jurisdictions because it is fast, free of charge, and informal

(lawyers are not usually present, although you may retain one at your expense if you choose). Arbitrators make decisions based on the principles of fairness and equity, and are not required to duplicate the functions of courts by strictly applying state or federal law. If you wish to go to court, however, we do not require that you first file a claim with BBB AUTO LINE\*\* unless state law provides otherwise. Whatever your preference may be, remember that if you are unhappy with the results of BBB AUTO LINE, you can still go to court because an arbitrator's decision is binding on GM but not on you, unless you accept it.

Eligibility is limited by vehicle age/mileage and other factors. For further information concerning the program, call the BBB at 1-800-955-5100. You may also call the Chevrolet Customer Assistance Center.

\*This program may not be available in all states, depending on state law. Canadian owners refer to your warranty booklet.

\*\*Some states may require that you file a claim with BBB AUTO LINE before resorting to state-operated procedures (including court).

# Customer Assistance Information

## ■ *Reporting Safety Defects to the United States Government*

If you believe that your vehicle has a defect which could cause a crash or could cause injury or death, you should immediately inform the National Highway Traffic Safety Administration (NHTSA), in addition to notifying General Motors.

If NHTSA receives similar complaints, it may open an investigation, and if it finds that a safety defect exists in a group of vehicles, it may order a recall and remedy campaign. However, NHTSA cannot

become involved in individual problems between you, your dealer, or General Motors.

To contact NHTSA, you may either call the Auto Safety Hotline toll-free at 1-800-424-9393 (or 366-0123 in the Washington, D.C. area) or write to:

NHTSA  
U.S. Department of Transportation  
Washington, D.C. 20590

You can also obtain other information about motor vehicle safety from the Hotline.

## ■ *Reporting Safety Defects to the Canadian Government*

If you live in Canada, and you believe that your vehicle has a safety defect, you should immediately notify Transport Canada, in addition to notifying General Motors of Canada Limited. You may write to:

Transport Canada  
Box 8880  
Ottawa, Ontario K1G 3J2



### ■ *Reporting Safety Defects to General Motors*

In addition to notifying NHTSA (or Transport Canada) in a situation like this, we certainly hope you'll notify us. Please call us at 1-800-222-1020, or write:

Chevrolet Customer Assistance Center  
P.O. Box 7047  
Troy, MI 48007-7047

In Canada, please call us at 1-800-263-3777 (English) or 1-800-263-7854 (French). Or, write:

General Motors of Canada Limited  
Customer Assistance Center  
1908 Colonel Sam Drive  
Oshawa, Ontario L1H 8P7

### ■ *Chevrolet Roadside Assistance*

To enhance Chevrolet's strong commitment to customer satisfaction, Chevrolet is excited to announce the establishment of the Chevrolet Roadside Assistance Center. As the owner of a 1993 Chevrolet, membership in Roadside Assistance is free.

Roadside Assistance is available 24 hours a day, 365 days a year, by calling 1-800-CHEV USA (1-800-243-8872). This toll-free number will provide you over-the-phone roadside assistance with minor mechanical problems. If your problem cannot be resolved over the phone, our advisors have access to a

nationwide network of dealer recommended service providers. The following services are available:

- Towing
- Locksmith
- Tire Repair
- Glass Replacement
- Rental car or taxi
- Additional services as necessary

# Customer Assistance Information

The Roadside Assistance Center uses companies that will provide you with quality and priority service. When roadside services are required, our advisors will explain any payment obligations that may be incurred for utilizing outside services.

For prompt assistance when calling, please have the following available to give to the advisor:

- Vehicle Identification Number
- License plate number
- Vehicle color

- Vehicle location
- Telephone number where you can be reached
- Vehicle mileage
- Description of problem

Please refer to the Roadside Assistance brochure inside your portfolio for full program details.

**In Canada, call 1-800-268-6800 for details on Roadside Assistance.**

## ■ *Service Publications*

Information on how to obtain Product Service Publications and Indexes as described below is applicable only in the fifty U.S. states (and the District of Columbia) and only for cars and light trucks with GVWR less than 10,000 pounds (4 536 kg).

In Canada, information pertaining to Product Service Bulletins and Indexes can be obtained by writing to:

General Motors of Canada Limited  
Service Publications Department  
1908 Colonel Sam Dr.  
Oshawa, Ontario L1H 8P7

Chevrolet regularly sends its dealers useful service bulletins about Chevrolet products. Chevrolet monitors product

performance in the field. We then prepare bulletins for servicing our products better. Now, you can get these bulletins too.

Bulletins cover various subjects. Some pertain to the proper use and care of your vehicle. Some describe costly repairs. Others describe inexpensive repairs which, if done on time with the latest parts, may avoid future costly repairs. Some bulletins tell a technician how to repair a new or unexpected condition. Others describe a quicker way to fix your vehicle. They can help a technician service your vehicle better.

Most bulletins apply to conditions affecting a small number of cars or trucks.

Your Chevrolet dealer or a qualified technician may have to determine if a specific bulletin applies to your vehicle.

#### **Individual PSP's**

If you don't want to buy all the PSP's issued by Chevrolet for all car or truck models in the model year, you can buy individual PSP's, such as those which may pertain to a particular model. To do this, you will first need to see our index of PSP's. It provides a variety of information. Here's what you'll find in the index and how you can get one:

#### **What You'll Find in the Index:**

- A list of all PSP's published by Chevrolet in a model year (1989 or later). PSP's covering all models of Chevrolet cars or light trucks (less than 10,000 pounds (4 536 kg) GVWR) are listed in the same index.
- Ordering information so you can buy the specific PSP's you may want.
- Price information for the PSP's you may want to buy.

#### **How You Can Get an Index:**

Indexes are published periodically. Most of the PSP's which could potentially apply to the most recent Chevrolet models

# Customer Assistance Information

will be listed in the most recent publication for that model year. This means you may want to wait until the end of the model year before ordering an index, if you are interested in buying PSP's pertaining to a current model year car or truck.

Some PSP's pertaining to a particular model year vehicle may be published in later years, and these would be listed in the later year's index. When you order an index for a model year that is not over yet, we'll send you the most recently published issue. Check the ordering form for indexes for earlier model years.

Cut out the ordering form, fill it out, and mail it in. We will then see to it that an index is mailed to you. There is no charge for indexes for the 1989-1993 model years.

## **Toll-Free Telephone Number**

If you want an additional ordering form for an index, just call toll-free and we'll be happy to send you one. Automated recording equipment will take your name and mailing address. The number to call is 1-800-551-4123.

## **A VERY IMPORTANT REMINDER:**

These PSP's are meant for technicians. They are not meant for the "do-it-yourselfer." Technicians have the equipment, tools, safety instructions, and know-how to do a job quickly and safely.

## **Chevrolet Service Publications**

You can get these by using the order form:

## 1993 CHEVROLET SERVICE PUBLICATIONS ORDERING INFORMATION

The following publications covering the operation and servicing of your vehicle can be purchased by filling out the Service Publications Order Form in this book and mailing it with your check, money order or credit card information to Helm, Incorporated (address listed below).

### CURRENT PUBLICATIONS FOR 1993 CHEVROLET CAMARO

#### PRODUCT SERVICE PUBLICATIONS

Product Service Publications (PSP's), are bulletins, letters and articles published for trained dealer service personnel. See Service Publications listed previously in this section.

A cumulative index is published quarterly during the current model year. The indexes list all PSP's published by Chevrolet in the model year.

#### PSP Index and Summaries

Year	Form Number	Price
1992	PSPI-92 .....	Free
1991	PSPI-91 .....	Free
1990	PSPI-90 .....	Free
1989	PSPI-89 .....	Free

**NOTE:** Form Numbers for individual Product Service Publications may be found in the PSP Index. Prices are \$4.00 for the first PSP and \$2.00 for each additional PSP on the same order.

#### PSP Bound Bulletin Book (Complete Year Bulletins)

Year	Description	Form Number	Price
1991	All PSP's .....	PSP-91-4	40.00
1990	All PSP's .....	PSP-90-4	40.00

For subscription information call Helm, Incorporated.

#### CURRENT & PAST MODEL ORDER FORMS

Service Publications are available for current and past model Chevrolet vehicles. To request an order form, please specify year and model name of vehicle.

#### SERVICE MANUALS

Service Manuals have the diagnosis, repair and overhaul information on engines, transmission, axle, suspension, brakes, electrical, steering, body, etc.

Model	Form Number	Price
1993 Chevrolet Camaro .....	ST-368-93	\$43.00

\*Please specify special body or engine types on order form. Write information in the Form Number column. For example: Turbo, Convertible.

#### OWNER'S INFORMATION

Owner publications are written directly for owners and intended to provide basic operational information about the vehicle. The Owner's Manual includes the Maintenance Schedule for all models.

#### 1993 Chevrolet Camaro Owner's Manual

<b>In Portfolio:</b> <i>Includes Portfolio, Owner's Manual and Warranty Booklet.</i>		
1993	Chevrolet Camaro In-Portfolio .....	10201494 \$15.00
<b>Without Portfolio:</b> <i>Includes Owner's Manual.</i>		
1993	Chevrolet Camaro Without Portfolio ..	10193571 \$11.00

Address all inquiries to: HELM, INCORPORATED  
P.O. Box 07130  
Detroit, MI 48207

Credit Card Orders ONLY: 1-800-782-4356  
For information and inquiries call: (313) 883-1430

# Notes



# CHEVROLET SERVICE PUBLICATIONS ORDER FORM

**NOTE: Please complete form below (Print or Type) and MAIL TO:**

## HELM

Post Office Box 07130, Detroit, Michigan 48207

<p style="text-align: center;"><b>ORDER TOLL FREE</b>                  (NOTE: For Credit Card Holder Orders Only)  <b>1-800-782-4356</b>                  (Monday-Friday 8:30 A.M.-6:00 P.M. EST)</p>	<p>•Minimum Credit Card Order \$10.00</p> <p>If further information is needed, write Helm or call (313) 883-1430.</p> <p><b>ORDER INFORMATION NOT AVAILABLE THROUGH THE TOLL FREE NUMBER.</b></p>
---	---

PUBLICATION FORM NUMBER **	ITEM DESCRIPTION	VEHICLE MODEL		QTY.	PRICE EACH *	TOTAL PRICE
		NAME	YEAR			
ST-368-93	Service Manual	Chevrolet Camaro	1993		\$43.00	
10201494	Owner's Manual In-Portfolio	Chevrolet Camaro	1993		\$15.00	
10193571	Owner's Manual Without-Portfolio	Chevrolet Camaro	1993		\$11.00	

S H I P T O	<b>NOTE:</b> Dealers and Companies please provide dealer or company name, and also the name of the person to whose attention the shipment should be sent. For purchases outside U.S.A. please write to the above address for quotation.	
	(CUSTOMER NAME) _____	(ATTENTION) _____
	(STREET ADDRESS—NO P.O. BOX NUMBERS) _____	(APT. NO.) _____
	(CITY) _____	(STATE) _____ (ZIP CODE) _____
	DAYTIME TELEPHONE NO. _____ AREA CODE (      ) _____	

P A Y M E N T	<input type="checkbox"/> Check or Money Order payable to Helm, Inc. (USA funds only — do not send cash.)	<table border="1" style="width: 100%; border-collapse: collapse;"> <tr> <td colspan="2" style="text-align: center;">TOTAL MATERIAL</td> </tr> <tr> <td style="width: 70%;">Michigan Purchasers add 4% sales tax</td> <td></td> </tr> <tr> <td>Handling Charge</td> <td style="text-align: right;">\$3.50</td> </tr> <tr> <td>Canadian Postage/Handling (U.S. Funds)</td> <td style="text-align: right;">\$6.50</td> </tr> <tr> <td><b>GRAND TOTAL</b></td> <td></td> </tr> </table>	TOTAL MATERIAL		Michigan Purchasers add 4% sales tax		Handling Charge	\$3.50	Canadian Postage/Handling (U.S. Funds)	\$6.50	<b>GRAND TOTAL</b>	
	TOTAL MATERIAL											
	Michigan Purchasers add 4% sales tax											
	Handling Charge	\$3.50										
	Canadian Postage/Handling (U.S. Funds)	\$6.50										
<b>GRAND TOTAL</b>												
<input type="checkbox"/> MasterCard												
<input type="checkbox"/> VISA												
Account Number: <input style="width: 20px; height: 20px;" type="text"/> <input style="width: 20px; height: 20px;" type="text"/> <input style="width: 20px; height: 20px;" type="text"/> <input style="width: 20px; height: 20px;" type="text"/> <input style="width: 20px; height: 20px;" type="text"/> <input style="width: 20px; height: 20px;" type="text"/> <input style="width: 20px; height: 20px;" type="text"/> <input style="width: 20px; height: 20px;" type="text"/> <input style="width: 20px; height: 20px;" type="text"/> <input style="width: 20px; height: 20px;" type="text"/>												
Expiration Date mo/yr: <input style="width: 20px; height: 20px;" type="text"/> <input style="width: 20px; height: 20px;" type="text"/> <input style="width: 20px; height: 20px;" type="text"/> <input style="width: 20px; height: 20px;" type="text"/>	Check here if your billing address is different from your shipping address shown. <input type="checkbox"/>											
_____ (CUSTOMER SIGNATURE)												

\* Prices are subject to change without notice and without incurring obligation. Orders for Individual Product Service Publications cannot be filled without the appropriate bulletin numbers. These numbers may be found in the PSP Index. Your first Product Service Publication costs \$4.00; each additional PSP costs \$2.00.

NOTE: All listed prices are quoted in U.S. funds. Canadian residents are to make checks payable in U.S. funds and are to include \$6.50 for additional postage and handling. Requests for manuals printed in French should be directed to Canadian General Motors dealerships. Please allow adequate time for postal service.

GENERAL INSTRUCTIONS FOR THE STUDENT

These instructions are intended to help you understand the purpose and objectives of the course.

OBJECTIVES

By the end of the course, you should be able to:

1. Understand the basic principles of the course.

2. Apply the principles to solve problems.

3. Analyze and synthesize information.

4. Evaluate the results of your work.

5. Communicate your findings effectively.

6. Work independently and in groups.

7. Use the resources available to you.

8. Follow the rules and regulations of the institution.

9. Be punctual and regular in attendance.

10. Be honest and ethical in your work.

11. Be respectful and courteous to others.

12. Be responsible for your own learning.

13. Be open to new ideas and perspectives.

14. Be able to work under pressure.

15. Be able to manage your time effectively.

16. Be able to work with diverse people.

17. Be able to learn from your mistakes.

18. Be able to set and achieve your goals.

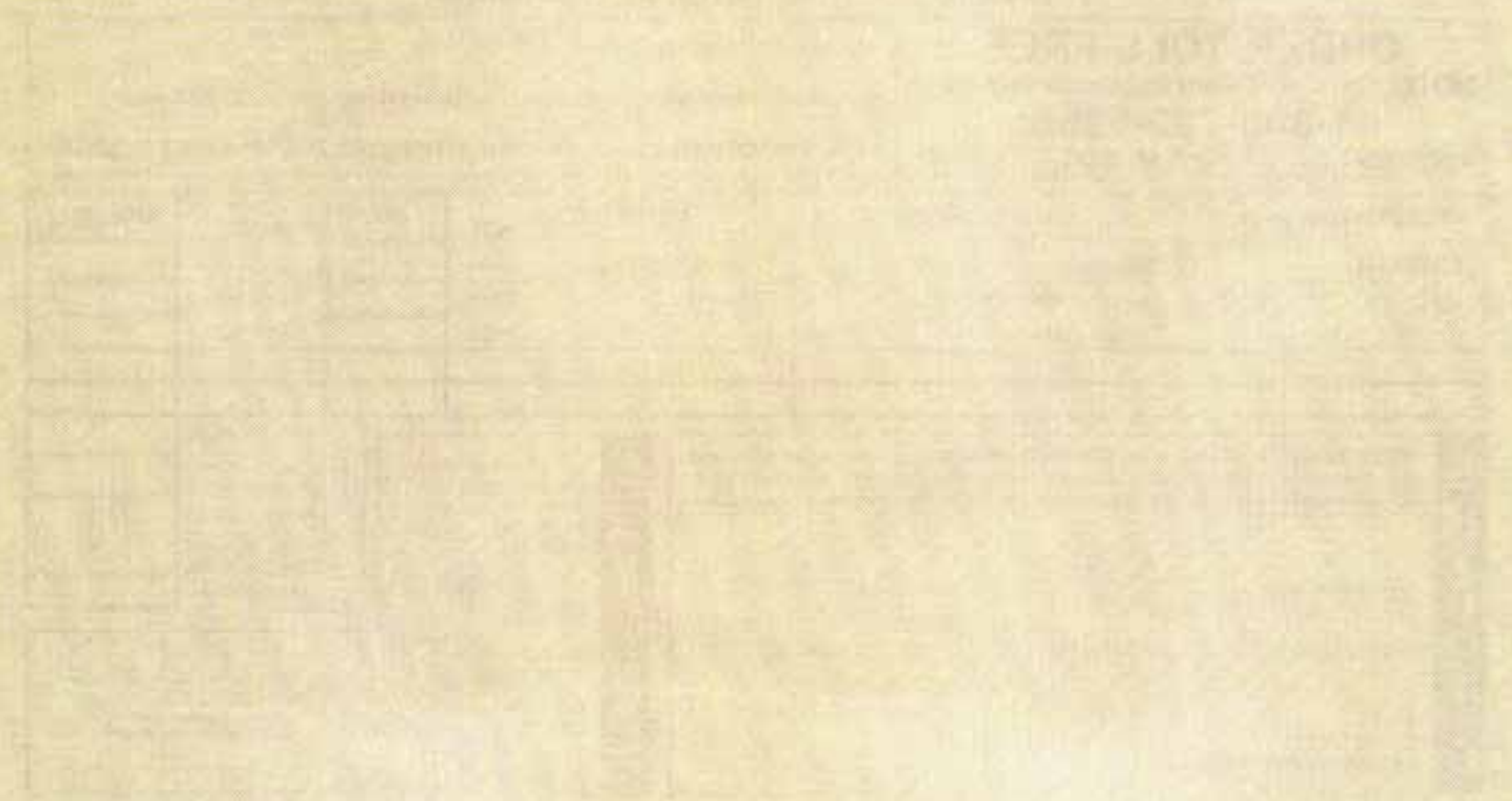

# CHEVROLET SERVICE PUBLICATIONS ORDER FORM

**NOTE: Please complete form below (Print or Type) and MAIL TO:**



Post Office Box 07130, Detroit, Michigan 48207

<p style="text-align: center;"><b>ORDER TOLL FREE</b>                  (NOTE: For Credit Card Holder Orders Only)  <b>1-800-782-4356</b>                  (Monday-Friday 8:30 A.M.-6:00 P.M. EST)</p>	<p>•Minimum Credit Card Order \$10.00</p> <p>If further information is needed, write Helm or call (313) 883-1430.</p> <p><b>ORDER INFORMATION NOT AVAILABLE THROUGH THE TOLL FREE NUMBER.</b></p>
---	---

PUBLICATION FORM NUMBER **	ITEM DESCRIPTION	VEHICLE MODEL		QTY.	PRICE EACH*	TOTAL PRICE
		NAME	YEAR			
ST-368-93	Service Manual	Chevrolet Camaro	1993		\$43.00	
10201494	Owner's Manual In-Portfolio	Chevrolet Camaro	1993		\$15.00	
10193571	Owner's Manual Without-Portfolio	Chevrolet Camaro	1993		\$11.00	

S  
H  
I  
P  
T  
O

**NOTE: Dealers and Companies please provide dealer or company name, and also the name of the person to whose attention the shipment should be sent. For purchases outside U.S.A. please write to the above address for quotation.**

(CUSTOMER NAME) \_\_\_\_\_ (ATTENTION) \_\_\_\_\_

(STREET ADDRESS—NO P.O. BOX NUMBERS) \_\_\_\_\_ (APT. NO.) \_\_\_\_\_

(CITY) \_\_\_\_\_ (STATE) \_\_\_\_\_ (ZIP CODE) \_\_\_\_\_

DAYTIME TELEPHONE NO. \_\_\_\_\_ AREA CODE (      ) \_\_\_\_\_

P  
A  
Y  
M  
E  
N  
T

Check or Money Order payable to Helm, Inc. (USA funds only — do not send cash.)

MasterCard

VISA

Account Number:

Expiration Date mo/yr:      Check here if your billing address is different from your shipping address shown.

\_\_\_\_\_  
(CUSTOMER SIGNATURE)

TOTAL MATERIAL

Michigan Purchasers add 4% sales tax	
Handling Charge	\$3.50
Canadian Postage/Handling (U.S. Funds)	\$6.50
GRAND TOTAL	

\* Prices are subject to change without notice and without incurring obligation.  
 \*\* Orders for Individual Product Service Publications cannot be filled without the appropriate bulletin numbers. These numbers may be found in the PSP Index. Your first Product Service Publication costs \$4.00; each additional PSP costs \$2.00.

NOTE: All listed prices are quoted in U.S. funds. Canadian residents are to make checks payable in U.S. funds and are to include \$6.50 for additional postage and handling. Requests for manuals printed in French should be directed to Canadian General Motors dealerships. Please allow adequate time for postal service.

THE UNIVERSITY OF CHICAGO

PHYSICS DEPARTMENT

1950

PHYSICS 101

LECTURE 1

MECHANICS

1. Kinematics

2. Dynamics

3. Energy

4. Momentum

5. Rotational Motion

6. Oscillations

7. Waves

8. Optics

9. Modern Physics

10. Relativity

- |                                   |     |                                  |     |   |     |
|-----------------------------------|-----|----------------------------------|-----|---|-----|
| <b>A</b> dding Coolant .....      | 240 | AM/FM Stereo                     |     | Automatic Transmission .....              | 62  |
| Add-On Electrical Equipment ..... | 275 | With Cassette Tape Player .....  | 117 | Automatic Transmission Fluid .....        | 233 |
| Air Bags .....                    | 25  | With Compact Disc Player,        |     | Axle, Limited-Slip Rear .....             | 70  |
| How the System Works .....        | 27  | Delco-Bose® .....                | 121 | Axle, Rear .....                          | 237 |
| Servicing Your Chevrolet with     |     | AM Stereo .....                  | 128 |   |     |
| the System .....                  | 30  | Antenna, Fixed Mast .....        | 129 | <b>B</b> acking Up (with a Trailer) ..... | 178 |
| System Light .....                | 26  | Anti-lock Brakes (ABS) .....     | 143 | Balance, Wheel Alignment                  |     |
| Air Cleaner .....                 | 230 | System Warning Light .....       | 101 | and Tire .....                            | 262 |
| Air Conditioner Controls .....    | 112 | To Use .....                     | 144 | Battery .....                             | 246 |
| Air Control Knob .....            | 110 | Appearance Care .....            | 265 | Beams, High .....                         | 154 |
| Air Filter Replacement .....      | 231 | Appearance Care and              |     | Before Leaving on a Long Trip ...         | 163 |
| Alignment and Tire Balance,       |     | Maintenance Materials .....      | 274 | Belt, Lap-Shoulder .....                  | 21  |
| Wheel .....                       | 262 | Appearance Care, Service and ... | 217 | Better Business Bureau                    |     |
| Aluminum Wheels .....             | 271 | Ashtray and Lighter .....        | 94  | Mediation/Arbitration Program             |     |
| AM .....                          | 127 | Ashtray, Front .....             | 94  | GM Participation in .....                 | 316 |
|                                   |     | Audio Systems .....              | 115 | Bi-Level Heating .....                    | 111 |
|                                   |     | Audio Systems, Comfort           |     | Blizzard, If You're Caught in a ...       | 172 |
|                                   |     | Controls and .....               | 109 | Box, Glove .....                          | 92  |

# Index

- |                                |     |                                       |     |
|--------------------------------|-----|---------------------------------------|-----|
| Brakes                         |     |                                       |     |
| Adjustment                     | 146 | Bulb Replacement                      | 247 |
| Anti-lock (ABS)                | 143 | Headlight Aiming                      | 248 |
| Fluid                          | 245 | Headlights                            | 248 |
| Master Cylinder                | 244 | Center High-Mounted                   |     |
| Parking                        | 70  | Stoplight                             | 252 |
| Pedal Travel                   | 146 | Front Turn Signal                     | 252 |
| Rear Drum                      | 145 | Rear Lights                           | 253 |
| System Parts, Replacing        | 246 | Rear Sidemarker                       | 254 |
| System Warning Light           | 100 | Bulbs, Halogen                        | 247 |
| Trailer                        | 177 | Bulbs, Replacement                    | 279 |
| Wear Indicators, Disc          | 145 | <b>C</b> apacities and Specifications | 280 |
| Braking (Control of a Vehicle) | 141 | Carbon Monoxide                       | 75  |
| Braking in Emergencies         | 146 | Care of Safety Belts                  | 269 |
| “Break-In,” New Vehicle        | 55  | Cassette and Compact Disc             |     |
| Brightness Control             | 85  | Storage                               | 93  |
|                                |     | Cassette Tape Player,                 |     |
|                                |     | AM/FM Stereo with                     | 117 |
|                                |     | Cassette Tape Player, Care            |     |
|                                |     | of Your                               | 128 |
|                                |     | Cassette Tape, To Play a              |     |
|                                |     | AM/FM Stereo with Cassette            |     |
|                                |     | Tape Player                           | 119 |
|                                |     | Chains, Safety                        | 177 |
|                                |     | Chains, Tire                          | 264 |
|                                |     | Changing a Flat Tire                  | 205 |
|                                |     | Check Gages Light                     | 105 |
|                                |     | Checking Things under the             |     |
|                                |     | Hood                                  | 223 |
|                                |     | Checking Your Restraint System        | 45  |
|                                |     | Chemical Paint Spotting               | 273 |
|                                |     | Chevrolet Roadside Assistance         | 319 |
|                                |     | Chevrolet Service Publications        |     |
|                                |     | (Ordering Information)                | 323 |

Child Restraints .....	36
Rear Seat .....	38
Right Front Seat .....	40
Top Strap .....	37
Where to Put the .....	36
Children (Safety Belts) .....	34
Children Larger (Safety Belts) .....	43
Cigarette Lighter .....	95
Circuit Breakers, Fuses and .....	276
City Driving .....	160
Cleaner, Air .....	230
Cleaning	
Fabric, Using Foam-Type	
Cleaner on .....	266
Fabric, Using Solvent-Type	
Cleaner on .....	267
Glass .....	269

Problems, Special .....	268
The Inside of Your Chevrolet ...	266
The Outside of the Windshield	
and Wiper Blades .....	270
The Outside of Your	
Chevrolet .....	270
The Top of the Instrument	
Panel .....	269
Twin Lift-Off	
Roof Panels .....	270
Vinyl or Leather .....	269
Clock, Setting the .....	116
Close-Out Panel .....	93
Clutch, Hydraulic .....	237
Color of Road Signs .....	132
Comfort Controls .....	110

Comfort Controls and Audio	
Systems .....	109
Compact Disc Player, Delco-Bose®	
AM/FM Stereo with .....	121
Compact Disc, Care of Your .....	129
Compact Disc Storage,	
Cassette and .....	93
Compact Disc, To Play a .....	122
Compact Spare .....	214
Compartments, Storage and .....	92
Console Storage, Front .....	92
Control of a Vehicle .....	140
Control, Loss of .....	151

# Index

- |                           |          |                                 |     |
|---------------------------|----------|---------------------------------|-----|
| Controls                  |          |                                 |     |
| Air Conditioner           | 112      | Cooling                         | 113 |
| Brightness                | 85       | Cooling System                  | 195 |
| Comfort                   | 110      | Courtesy Lights                 | 86  |
| Cruise                    | 80       | Cruise Control                  | 80  |
| Features and              | 47       | Passing Another Vehicle         |     |
| Heater                    | 110      | While Using                     | 83  |
| Main Light                | 85       | To Erase Speed Memory           | 84  |
| Seats and Seat            | 12       | To Get Out of                   | 84  |
| Coolant                   |          | To Increase Speed While         |     |
| Adding                    | 240      | Using                           | 82  |
| Engine                    | 238      | To Reduce Speed While           |     |
| How to Add to the Coolant |          | Using                           | 83  |
| Recovery Tank             | 197      | To Resume a Set Speed           | 81  |
| How to Add to the         |          | To Set                          | 81  |
| Radiator                  | 199, 201 | Using on Hills                  | 83  |
| Temperature Gage, Engine  | 102      | Curves, Driving on              | 146 |
|                           |          | Customer Assistance             |     |
|                           |          | Information                     | 313 |
|                           |          | Customer Satisfaction Procedure | 314 |
|                           |          | <b>D</b> aytime Running Lights  | 85  |
|                           |          | Deep Snow, If You're            |     |
|                           |          | Stuck in                        | 173 |
|                           |          | Deep Standing Water,            |     |
|                           |          | Driving through                 | 61  |
|                           |          | Defects, Safety                 |     |
|                           |          | Reporting to General Motors     | 319 |
|                           |          | Reporting to the Canadian       |     |
|                           |          | Government                      | 318 |
|                           |          | Reporting to the United         |     |
|                           |          | States Government               | 318 |
|                           |          | Defensive Driving               | 136 |
|                           |          | Defogger, Rear Window           | 114 |



Defogging and Defrosting	
Windows	112
Delco-Bose® AM/FM Stereo	
with Compact Disc Player	121
Delco-Loc II/Theft-Deterrent	
Feature	124
Disc Brake Wear Indicators	145
Doing Your Own Service Work	218
Door Locks	50
Door Locks, Power	51
Downhill, Parking	168
Driver Position (Safety Belt)	21

Driving	
A Long Distance	163
At Night	153
City	160
Defensive	136
Drunken	137
Freeway	161
In Fog, Mist and Haze	158
In the Rain	155
On Curves	146
On Grades (with a Trailer)	179
On Snow or Ice	170
Through Deep Standing Water	61
Winter	170
With a Trailer	177
Drunken Driving	137

<b>E</b> lectric Mirror Control	88
Electrical Center, Underhood	278
Electrical Equipment, Add-On	275
Emergencies, Braking in	146
Emergencies, Steering in	148
Engine	
Block Heater	61
Coolant	238
Coolant Temperature Gage	102
Exhaust	74
Identification	275
Oil	226
Oil Pressure Gage	104
Overheating	193
Starting Your	57
Entering the Freeway	161
Environment, Your Vehicle	
and the	286

# Index

- |                                   |     |                                   |     |                                  |     |
|-----------------------------------|-----|-----------------------------------|-----|----------------------------------|-----|
| Exhaust, Engine .....             | 74  | Fluid, Windshield Washer .....    | 243 | Front                            |     |
| Extender, Safety Belt .....       | 44  | Fluids and Lubricants,            |     | Ashtray .....                    | 94  |
| <b>F</b> abric Protection .....   | 267 | Recommended .....                 | 305 | Console Storage .....            | 92  |
| Fan Control Knob .....            | 110 | FM Stereo .....                   | 127 | Map Lights .....                 | 87  |
| Features and Controls .....       | 47  | Fog Lights .....                  | 86  | Seat, Manual .....               | 12  |
| Filling Your Tank .....           | 222 | Fog, Mist and Haze,               |     | Seatbacks, Reclining .....       | 13  |
| Finish Care (Paint) .....         | 271 | Driving in .....                  | 158 | Towing Hook-ups .....            | 191 |
| Finish Damage (Paint) .....       | 273 | Fog, Tips on Driving in .....     | 159 | Fuel .....                       | 219 |
| Fixed Mast Antenna .....          | 129 | Following Distance (with a        |     | Fuel Gage .....                  | 100 |
| Flashers, Hazard Warning .....    | 184 | Trailer) .....                    | 178 | Fuels in Foreign Countries ..... | 222 |
| Flat Tire, Changing a .....       | 205 | Foreign Countries, Fuels in ..... | 222 | Fuse Block, Main .....           | 277 |
| Flat, If a Tire Goes .....        | 204 | Foreign Material Paint Damage ... | 272 | Fuses and Circuit Breakers ..... | 276 |
| Floor Mats .....                  | 95  | Freeway                           |     |                                  |     |
| Fluid, Automatic Transmission ... | 233 | Driving on the .....              | 161 |                                  |     |
| Fluid, Manual Transmission .....  | 235 | Entering the .....                | 161 |                                  |     |
| Fluid, Power Steering .....       | 242 | Leaving the .....                 | 162 |                                  |     |

## **G**ages

Engine Coolant Temperature . . .	102
Engine Oil Pressure . . . . .	104
Fuel . . . . .	100
Warning Lights and Indicators . . .	99
Gasolines for Cleaner Air . . . . .	221
Glass . . . . .	269
Glove Box . . . . .	92
GM Participation in Better Business Bureau Mediation/ Arbitration Program . . . . .	316

<b>H</b> alogen Bulbs . . . . .	247
Hatch Release . . . . .	51
Hatch Release, Remote . . . . .	51
Hazard Warning Flashers . . . . .	184
Head Restraints . . . . .	14

Headlight Aiming . . . . .	248
Headlight High/Low Beam . . . . .	78
Heater Controls . . . . .	110
Heater, Engine Block . . . . .	61
Heating . . . . .	111
Heating, Bi-Level . . . . .	111
High Beams . . . . .	154
Highway Hypnosis . . . . .	164
Hill and Mountain Roads . . . . .	165
Hills, Parking on . . . . .	168
Hitches . . . . .	176
Hood Release . . . . .	223
Hood, Checking Things under the . . . . .	223
Hook-Ups Front Towing . . . . .	191
Hook-Ups, Rear Towing . . . . .	192
Horn . . . . .	76

How to Add Coolant to the Coolant Recovery Tank . . . . .	197
How to Add Coolant to the Radiator . . . . .	199, 201
Hydraulic Clutch . . . . .	237
Hydroplaning . . . . .	157
Hypnosis, Highway . . . . .	164

<b>I</b> dentification Number, Vehicle . . . . .	275
If a Tire Goes Flat . . . . .	204
If You're Stuck in Deep Snow . . . . .	173
If You're Stuck: In Sand, Mud, Ice or Snow . . . . .	215
Ignition Switch . . . . .	55
Inflatable Restraint, Supplemental . .	25

# Index

Inflation – Tire Pressure .....	257
Instrument Panel .....	96
Instrument Panel and Clusters .....	98
Instrument Panel, Cleaning the Top of .....	269
Interior Lights .....	86
<b>J</b> ump Starting .....	185
<b>K</b> eys .....	48
<b>L</b> ane Change Indicator, Turn Signal and .....	77
Lap-Shoulder Belt (Safety Belts) .....	21
Larger Children (Seats and Safety Belts) .....	43
Latches, Front Seatback .....	14

Leaving the Freeway .....	162
Leaving Your Vehicle with the Engine Running .....	72
Lighter, Ashtray and .....	94
<b>L</b> ights	
Air Bag System .....	26
Anti-lock Brake System Warning .....	101
Brake System Warning .....	100
Bulb Replacement .....	279
Check Gages .....	105
Courtesy .....	86
Daytime Running .....	85
Fog .....	86
Front Map .....	87
Gages and Indicators, Warning ..	99
Interior .....	86

Low Coolant .....	105
Low Oil .....	105
Main Control .....	85
Malfunction Indicator Lamp ...	103
Operation of .....	84
Safety Belt Reminder .....	20
Service Engine Soon .....	103
Traffic .....	134
Lights On Reminder .....	85
Limited-Slip Rear Axle .....	70
Loading Your Vehicle .....	255
<b>L</b> ocks	
Door .....	50
Power Door .....	51
Long Distance, Driving a .....	163
Loss of Control .....	151
Low Coolant Light .....	105
Low Oil Light .....	105

<b>M</b> ain Fuse Block .....	277
Main Light Control .....	85
Maintenance	
Inspections, Periodic .....	303
Materials, Appearance	
Care and .....	274
Record .....	308
Schedule .....	285
Services, Scheduled .....	289
When Trailer Towing .....	181
Making Turns (With a Trailer) .....	178
Malfunction Indicator Lamp .....	103
Manual	
Four-Way Seat .....	12
Front Seat .....	12
Remote Control Mirror .....	88

Transmission (Five-Speed) .....	66
Transmission (Six-Speed) .....	67
Transmission Fluid .....	235
Windows .....	75
Map Lights, Front .....	87
Map Pocket .....	92
Markings, Pavement .....	135
Master Cylinder, Brake .....	244
Mirrors .....	87
Convex Outside .....	87
Electric Control .....	88
Inside Day/Night Rearview .....	87
Manual Adjust .....	87
Manual Remote Control .....	88
Visor Vanity, Covered .....	94

<b>N</b> ew Vehicle "Break-In" .....	55
Night	
Driving at .....	153
Driving Suggestions, A Few	
More .....	155
Vision .....	153
<b>O</b> dometer, Speedometer and .....	98
Odometer, Trip .....	99
Off-Road Recovery .....	149
Officer, Traffic .....	136
Oil, Engine .....	226
Operation of Lights .....	84
Overheating, Engine .....	193
Owner Checks and Services .....	298

# Index

- P** (Park) Shifting into . . . . . 71  
P (Park), Shifting out of . . . . . 72  
Paint  
    Chemical Spotting . . . . . 273  
    Finish Care . . . . . 271  
    Finish Damage . . . . . 273  
    Foreign Material . . . . . 272  
Parking  
    Brake . . . . . 70  
    Downhill . . . . . 168  
    On Hills . . . . . 168  
    On Hills (with a Trailer) . . . . . 180  
    Over Things That Burn . . . . . 74  
    Uphill . . . . . 168  
    Your Vehicle . . . . . 73  
PASS-Key II® . . . . . 53  
Passenger Position (Safety Belts) . . 32  
    Rear Seat . . . . . 32  
    Right Front . . . . . 32  
Passing . . . . . 149  
Passing (with a Trailer) . . . . . 178  
Pavement Markings . . . . . 135  
Pedal Travel, Brake . . . . . 146  
Periodic Maintenance  
    Inspections . . . . . 303  
Power  
    Door Locks . . . . . 51  
    Seat, Six-way . . . . . 13  
    Steering . . . . . 146  
    Steering Fluid . . . . . 242  
    Windows . . . . . 76  
Pregnancy, Safety Belt Use  
    during . . . . . 31  
Problems on the Road . . . . . 183  
Publications, Service . . . . . 320  
**Q**uestions Many People Ask about  
    Safety Belts – and the Answers,  
    Here are . . . . . 19  
**R**adiator Pressure Cap . . . . . 241  
Radio Reception Understanding . . 127  
Radio, To Play the  
    AM/FM Stereo with Cassette  
    Tape Player . . . . . 117  
    Delco-Bose® AM/FM Stereo  
    with Compact Disc Player . . . . . 121  
Rain, Driving in the . . . . . 155

Rainy Weather Tips, Some Other .....	157
Rear Axle .....	237
Rear Axle, Limited-Slip .....	70
Rear Drum Brakes .....	145
Rear Seat Passengers (Safety Belts) .....	32
Rear Seatback, Folding .....	15
Rear Towing Hook-Ups .....	192
Rear Window Defogger .....	114
Reclining Front Seatbacks .....	13
Recommended Fluids and Lubricants .....	305
Recovery, Off-Road .....	149

Release Hatch .....	51
Hood .....	223
Remote Hatch .....	51
Reminder Light, Safety Belt .....	20
Reminder, Lights On .....	85
Remote Hatch Release .....	51
Replacement Bulbs (Part Numbers) .....	279
Replacement Air Filter .....	231
Bulb (Service) .....	247
Parts .....	281
Wheel .....	263
Wheels, Used .....	264
Replacing Brake System Parts ....	246

Replacing Safety Belts after a Crash .....	45
Reporting Safety Defects To General Motors .....	319
To the Canadian Government ..	318
To the United States Government .....	318
Restraints Checking Your System .....	45
Child .....	36
Head .....	14
Where to Put the .....	36
Road Signs .....	132
Color of .....	132
Shape of .....	133
Symbols on .....	134
Road, Problems on the .....	183

# Index

- |                                      |     |                                     |     |                                       |     |
|--------------------------------------|-----|-------------------------------------|-----|---------------------------------------|-----|
| Road, Your Driving and the . . . . . | 131 | Lap-Shoulder . . . . .              | 21  | Safety Warnings and Symbols . . . . . | 7   |
| Roads, Hill and Mountain . . . . .   | 165 | Larger Children . . . . .           | 43  | Schedule, Maintenance . . . . .       | 285 |
| Roadside Assistance, Chevrolet . . . | 319 | Questions People Ask . . . . .      | 19  | Scheduled Maintenance Services . .    | 289 |
| Rocking Your Vehicle to              |     | Reminder Light . . . . .            | 20  | Seats                                 |     |
| Get it Out . . . . .                 | 216 | Replacing after a Crash . . . . .   | 45  | And Safety Belts . . . . .            | 11  |
| Roof Panels, Twin Lift-Off . . . . . | 88  | Seats and . . . . .                 | 11  | And Seat Controls . . . . .           | 12  |
| Running Lights, Daytime . . . . .    | 85  | Smaller Children and Babies . . . . | 35  | Manual Front . . . . .                | 12  |
| Running Your Engine while            |     | They're for Everyone . . . . .      | 15  | Manual, Four-Way . . . . .            | 12  |
| You're Parked . . . . .              | 75  | Use during Pregnancy . . . . .      | 31  | Power, Six-Way . . . . .              | 13  |
| <b>S</b> afety Belts                 |     | Why They Work . . . . .             | 17  | Seatback                              |     |
| Adults . . . . .                     | 21  | Safety Chains . . . . .             | 177 | Folding Rear . . . . .                | 15  |
| Air bags . . . . .                   | 25  | Safety Defects                      |     | Latches, Front . . . . .              | 14  |
| Care of . . . . .                    | 269 | Reporting to General Motors . . .   | 319 | Reclining Front . . . . .             | 13  |
| Children . . . . .                   | 34  | Reporting to the Canadian           |     | Securing a Child Restraint            |     |
| Extender . . . . .                   | 44  | Government . . . . .                | 318 | Rear Seat . . . . .                   | 38  |
| How to Wear Properly . . . . .       | 21  | Reporting to the United             |     | Right Front Seat . . . . .            | 40  |
|                                      |     | States Government . . . . .         | 318 |                                       |     |



Service .....	218
and Appearance Care .....	217
Engine Soon Light .....	103
Parts Identification Label .....	275
Publications .....	320
Publications Ordering	
Information, Chevrolet .....	323
Work, Doing Your Own .....	218
Setting the Clock .....	116
Shape of Road Signs .....	133
Sheet Metal Damage .....	272
Shift Speeds .....	69
Shifting into P (Park) .....	71
Shifting out of P (Park) .....	72
Signals, Your Own .....	135
Signs, Road .....	132
Skidding .....	151

Smaller Children and Babies	
(Safety Belts) .....	35
Snow or Ice, Driving on .....	170
Spare, Compact .....	214
Speakers, Adjusting the	
AM/FM Stereo with Cassette	
Tape Player .....	119
Delco-Bose <sup>®</sup> AM/FM Stereo with	
Compact Disc Player .....	122
Specifications, Capacities and ....	280
Speedometer and Odometer .....	98
Starting Your Engine .....	57
Starting, Jump .....	185
Steam Coming from Your	
Engine, If There Is .....	194
Steam, If There Is No .....	194

Steering .....	146
Fluid, Power .....	242
In Emergencies .....	148
Power .....	146
Tips .....	146
Storage and Compartments .....	92
Storage, Vehicle .....	247
Stuck: In Sand, Mud, Ice or	
Snow, If You're .....	215
Sunshades, T-Top .....	90
Sun Visors .....	94
Supplemental Inflatable	
Restraint System (Air Bag) .....	25
Switch, Ignition .....	55
Symbols on Road Signs .....	134
Symbols, Safety Warnings and ....	7
Symbols, Vehicle .....	9

# Index

<b>T</b> -Top Sunshades . . . . .	90	Tips, Ventilation . . . . .	114	Tone, Setting the	
Tachometer . . . . .	99	Tire Loading . . . . .	255	AM/FM Stereo with Cassette	
Tank, Filling Your . . . . .	222	Tires . . . . .	256	Tape Player . . . . .	118
Temperature Control Knob . . . . .	110	Balance, Wheel		Delco-Bose® AM/FM Stereo	
Theft . . . . .	52	Alignment and . . . . .	262	with Compact Disc Player . . .	122
Theft Deterrent Feature/		Buying New . . . . .	259	Top Strap (Child Restraints) . . . . .	37
Delco-Loc II . . . . .	124	Chains . . . . .	264	Torque Lock (Automatic	
How to Change Your Security		Changing a Flat . . . . .	205	Transmission) . . . . .	169
Code . . . . .	127	Inflation Pressure . . . . .	257	Towing	
Setting Your Security		Inspection and Rotation . . . . .	258	A Trailer . . . . .	173
Code . . . . .	124	Temperature Grades . . . . .	261	Front Hook-Ups . . . . .	191
Shutting off the . . . . .	125	Total Weight on Your		Rear Hook-Ups . . . . .	192
Unlocking the Audio System		Vehicle's . . . . .	176	Your Vehicle . . . . .	190
after a Power Failure . . . . .	126	Traction Grades . . . . .	261	Traffic Lights . . . . .	134
Thermostat . . . . .	242	Treadwear . . . . .	261	Traffic Officer . . . . .	136
Tilt Wheel . . . . .	76	Uniform Quality Grading . . . . .	260		
Tips, Steering . . . . .	146	When It's Time for New . . . . .	259		
		White Sidewall . . . . .	272		

<b>Trailer</b>	
Backing Up with a	178
Brakes	177
Driving on Grades with a	179
Driving with a	177
Following Distance with a	178
If You Do Decide to Pull a	174
Making Turns with a	178
Parking on Hills with a	180
Passing with a	178
Tongue, Weight of the	176
Towing a	173
Towing, Maintenance When	181
Turn Signals When	
Towing a	179
Weight of the	175
When You Are Ready to Leave after Parking on a Hill	180

<b>Transmission</b>	
Automatic	62
Fluid, Automatic	233
Fluid, Manual	235
Manual (Five-Speed)	66
Manual (Six-Speed)	67
Trip Odometer	99
Turn Signal and Lane Change Indicator	77
Turn Signal/Headlight Beam Lever, the	77
Turn Signals When Towing a Trailer	179
Twin Lift-Off Roof Panels	88

<b>U</b> nderbody Maintenance	273
Underhood Electrical Center	278
Uphill, Parking	168
Used Replacement Wheels	264
<b>V</b> ehicle	
Control of a	140
Damage Warnings	8
Dimensions	283
Environment and Your	288
Identification Number (VIN)	275
Loading Your	255
Parking Your	73
Storage	247
Symbols	9
Towing Your	190
Washing Your	270

# Index

Ventilation .....	112
Ventilation System, Flow-Through .	114
Ventilation Tips .....	114
Vision, Night .....	153
Visor Vanity Mirror, Covered .....	94
Visors, Sun .....	94
Voltmeter .....	103
<b>W</b> arning	
Devices, Other .....	184
Hazard Flashers .....	184
Lights, Gages and Indicators ....	99
Safety .....	7
Vehicle Damage .....	8
Washer Fluid, Windshield .....	243
Washer, Windshield .....	79
Washing Your Vehicle .....	270

Weatherstrips .....	272
Weight of the Trailer .....	175
Weight of the Trailer Tongue .....	176
Weight, Total on Your Vehicle's Tires .....	176
Wheel Nut Torque .....	281
<b>W</b> heels	
Alignment and Tire Balance ...	262
Aluminum .....	271
Replacement .....	263
Tilt .....	76
Used Replacement .....	264
<b>W</b> here to Put the Restraint (Children and Safety Belts) .....	36
<b>W</b> hy Safety Belts Work .....	17

<b>W</b> indows .....	75
Defogging and Defrosting .....	112
Manual .....	75
Power .....	76
Rear Defogger .....	114
<b>W</b> indshield	
And Wiper Blades, Cleaning the Outside of the ..	270
Washer .....	79
Washer Fluid .....	243
Wipers .....	78
<b>W</b> inter Driving .....	170
<b>W</b> ipers, Windshield .....	78
<b>Y</b> our Driving and the Road .....	131
<b>Y</b> our Own Signals .....	135

## Notes

## Notes

## Notes

# Notes



## Notes

## Notes

# Notes

# Service Station Information

## Hood Release

See Page 223.

## Windshield Washer Fluid Reservoir

See Page 243.

## Battery

The Delco Freedom® battery needs no water.  
See Page 246.

## Cooling System Reservoir

Check coolant at the coolant recovery tank by using the dipstick. Add coolant at the coolant recovery tank. The fluid should be at or a little above the **FULL HOT** mark on the dipstick when the engine is warm. If the engine is cool, the level should be at **FULL COLD** on the dipstick.  
See Page 238.

## Engine Oil Dipstick and Fill Cap

(3.4L L32 (Code S) Engine)  
See Page 226.

## Engine Oil Dipstick and Fill Cap

(5.7L LT1 (Code P) Engine)  
See Page 226.

## Cold Tire Pressure

See Tire-Loading Information label on the inside of the rear edge of the driver's door.  
See Page 255.

## Fuel Cap

Capacity 15.5 U.S. gallons (58.7L).  
Use unleaded gas only, 87 octane or higher for the 3.4L L32 (Code S) engine, 91 octane or higher for the 5.7L LT1 (Code P) engine.  
See Page 219.

## Spare Tire Pressure

Compact spare: 60 psi (420 kPa).  
See Page 214.

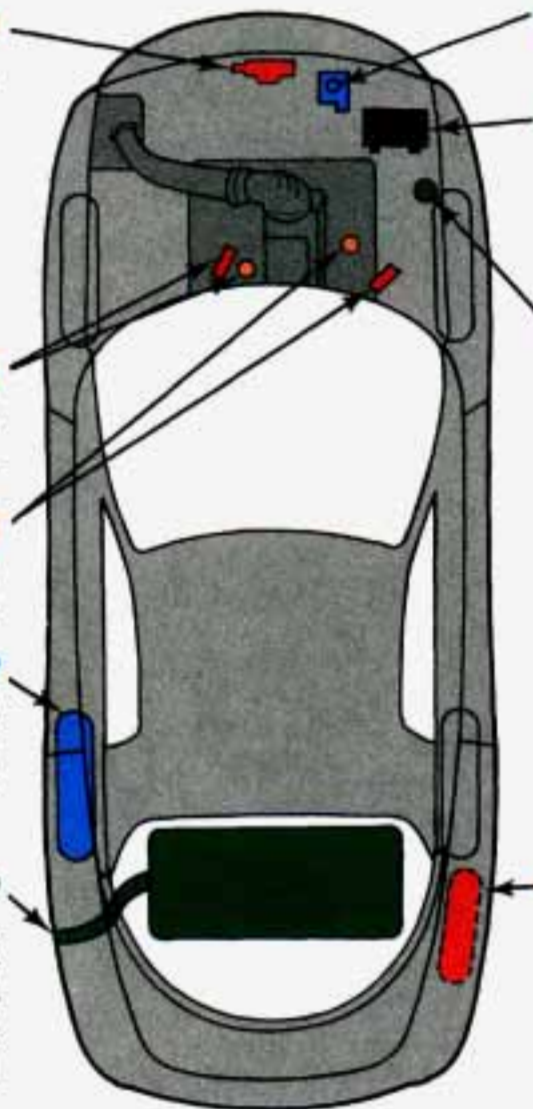





WE SUPPORT  
VOLUNTARY TECHNICIAN  
CERTIFICATION THROUGH  
National Institute for  
**AUTOMOTIVE  
SERVICE  
EXCELLENCE**



CHEVROLET

The GM logo, consisting of the letters "GM" in a bold, sans-serif font, is centered within a dark blue square box.

GM