



# 1993 *Cadillac*

SEVILLE

**OWNER'S LITERATURE**

*\*THIS MANUAL IS A REPLICATION.  
IT IS NOT AN ORIGINAL.*

**H3026**

# The PENALTY OF LEADERSHIP

IN every field of human endeavor, he that is first must perpetually live in the white light of publicity. ¶Whether the leadership be vested in a man or in a manufactured product, emulation and envy are ever at work. ¶In art, in literature, in music, in industry, the reward and the punishment are always the same. ¶The reward is widespread recognition; the punishment, fierce denial and detraction. ¶When a man's work becomes a standard for the whole world, it also becomes a target for the shafts of the envious few. ¶If his work be merely mediocre, he will be left severely alone — if he achieve a masterpiece, it will set a million tongues a-wagging. ¶Jealousy does not protrude its forked tongue at the artist who produces a commonplace painting. ¶Whatever you write, or paint, or play, or sing, or build, no one will strive to surpass, or to slander you, unless your work be stamped with the seal of genius. ¶Long, long after a great work or a good work has been done, those who are disappointed or envious continue to cry out that it can not be done. ¶Spiteful little voices in the domain of art were raised against our own Whistler as a mountebank, long after the big world had acclaimed him its greatest artistic genius. ¶Multitudes flocked to Bayreuth to worship at the musical shrine of Wagner, while the little group of those whom he had dethroned and displaced argued angrily that he was no musician at all. ¶The little world continued to protest that Fulton could never build a steamboat, while the big world flocked to the river banks to see his boat steam by. ¶The leader is assailed because he is a leader, and the effort to equal him is merely added proof of that leadership. ¶Failing to equal or to excel, the follower seeks to depreciate and to destroy — but only confirms once more the superiority of that which he strives to supplant. ¶There is nothing new in this. ¶It is as old as the world and as old as the human passions — envy, fear, greed, ambition, and the desire to surpass. ¶And it all avails nothing. ¶If the leader truly leads, he remains — the leader. ¶Master-poet, master-painter, master-workman, each in his turn is assailed, and each holds his laurels through the ages. ¶That which is good or great makes itself known, no matter how loud the clamor of denial. ¶That which deserves to live — lives.

Cadillac Motor Car Co. Detroit, Mich.



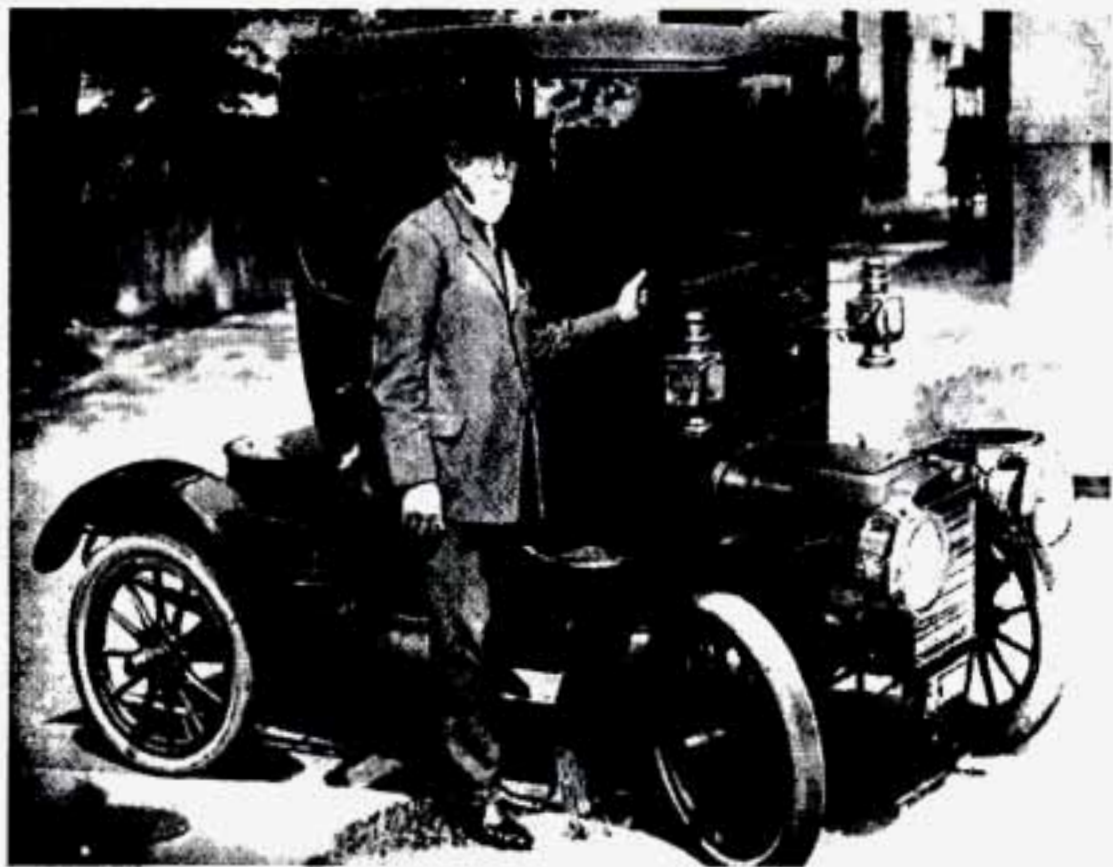

*Henry M. Leland, founder of Cadillac, stands beside the 1905 "Osceola" which was built to evaluate the feasibility of a closed bodied car.*



Few automobiles are fortunate enough to have the rich heritage that is Cadillac. The name Cadillac is appropriately that of Antoine de La Mothe Cadillac, the French military commander who founded the city of Detroit in 1701. What better name for the oldest automobile manufacturer in Detroit.

Henry M. Leland, known as the master of precision, initiated his precision manufacturing techniques at the founding of Cadillac in 1902. His exacting standards prompted the motto by which Cadillac has been guided over the years – "Craftsmanship A Creed – Accuracy A Law."

The introduction of the first four cylinder engine in 1905 led the industry and enabled Cadillacs to travel at speeds up to 50 mph.

For attention to quality and innovation, the Royal Automobile

Club of England awarded the prestigious **Dewar Trophy** to Cadillac twice . . .



first in 1908 for achieving perfect interchangeability of parts and again in 1912 for introducing the electric self starter, electric lighting and ignition system.

Cadillac is the only American manufacturer to win this honor and the only manufacturer in the world to win it twice. As commonplace as standardized parts are today, in 1908 parts were still individually hand fitted both in production and service.

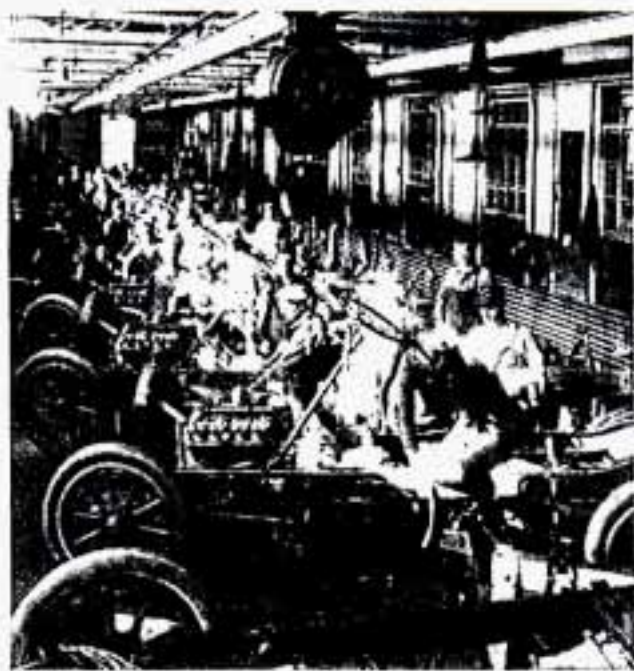

Standardization opened the eyes of the industrial world and was the corner-stone of modern **assembly line** production. From this achievement evolved the reference to Cadillac as "Standard of the World."

In 1909 Cadillac was purchased by the then new General Motors Corporation. Convenience, cleanliness and all-weather comfort were greatly enhanced in 1910 when Cadillac became the first manufacturer to offer closed bodies as standard equipment.

"The Penalty of Leadership" first appeared in the January 2, 1915 issue of The Saturday Evening Post as an expression of the Cadillac commitment to leadership, quality, and innovation. It is widely regarded as one of the finest documents ever written and was published following the introduction of the first production V8 engine. The V8 was standard on all 1915+ Cadillac models.

"The Penalty of Leadership" is a classic example of the quality and innovation that have made Cadillac a leader in the automotive industry for over a century.

© 1999 GM Corp.

10-10-99

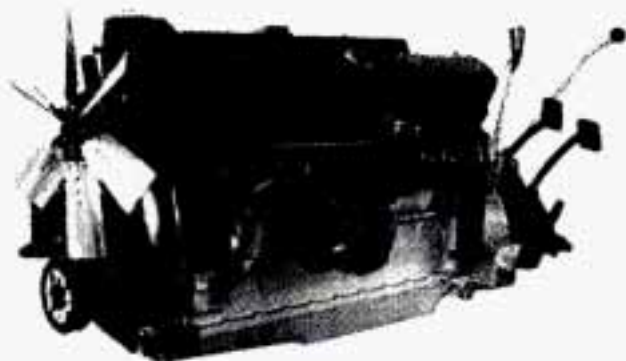

**45° V-16 Engine**

service policy, security plate glass, chrome plating and the first car to be designed by a stylist (1927 LaSalle/Harley Earl). The '30s witnessed production of the smooth and quiet V12 and **V 16 engines.**

The crisp, contemporary lines of the 1938 60 Special series ushered in a new era in styling.

During World War II, shortly after Pearl Harbor, Cadillac discontinued car production for the first time since 1902 in order to construct light tanks, combat vehicles and aerial parts for Allison V1710 engines. Two Cadillac V8 engines and Hurst-Matic transmissions were used in each tank.



**1931 V-16 Sport Phaeton**

# Cadillac

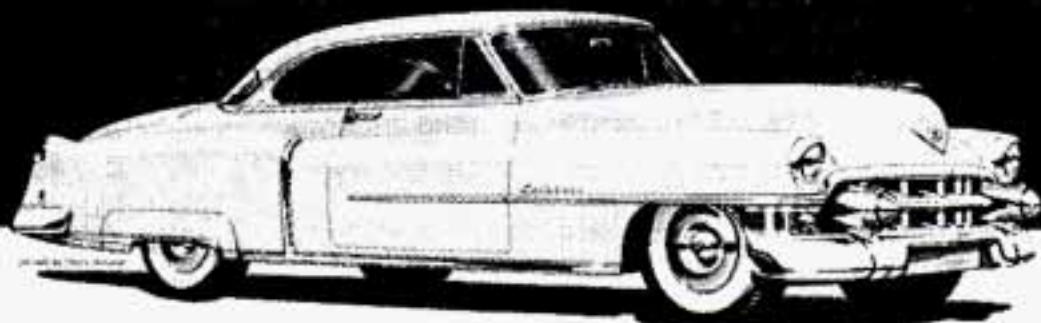

## It Will Add to Your Happiness!

There is a great joy in the quietness of a Cadillac. With its quiet, smooth, unobtrusive motion, it is just as peaceful as a feather. With a grace and ease of movement that is almost magical, it is just as perfect as a diamond. It is the joy of a Cadillac that will add to your happiness.

It is the joy of a Cadillac that will add to your happiness. It is the joy of a Cadillac that will add to your happiness. It is the joy of a Cadillac that will add to your happiness. It is the joy of a Cadillac that will add to your happiness.

It is the joy of a Cadillac that will add to your happiness. It is the joy of a Cadillac that will add to your happiness. It is the joy of a Cadillac that will add to your happiness. It is the joy of a Cadillac that will add to your happiness.

CADILLAC DIVISION • GENERAL MOTORS CORPORATION



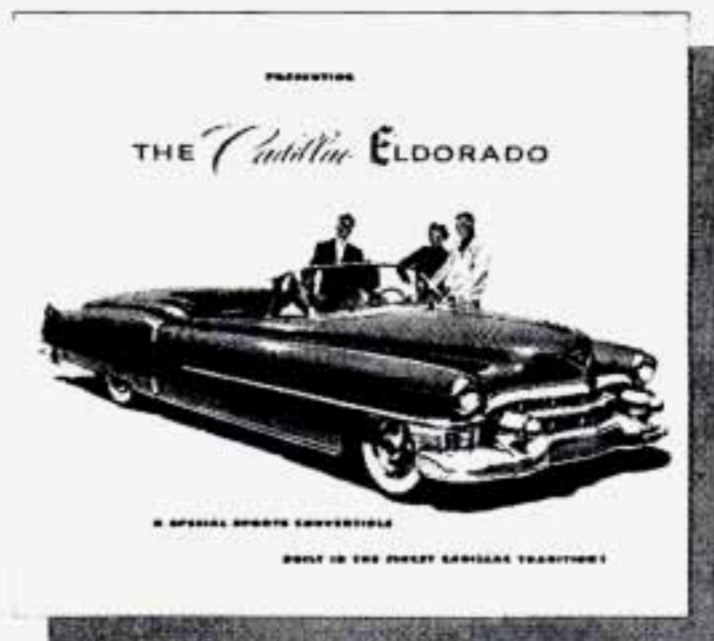

For the 1948 model, Cadillac introduced the **legendary tail fin** which set the trend in automotive styling for nearly two decades. This was followed by the 1949 model with the two door hardtop Coupe DeVille and the modern overhead valve, high compression V8 engine.

Engineering innovations, conveniences and styling dominated the '50s and '60s. Cruise control, automatic climate control, tilt and telescoping steering wheels, twilight sentinel and four door hard tops all debuted in these years. In 1957 the Eldorado Brougham featured advances such as air suspension, memory seat, automatic electric door locks, transistor radio, a brushed

stainless steel roof and low profile tires.

**The Eldorado,** introduced in 1953, was redesigned for 1967 as the first front wheel drive personal luxury car. The 472 cu. in. V8 engine used in all Cadillacs in 1968 and 1969 was enlarged to 500 cu. in. for all 1970 Eldorados.

An Air Cushion Restraint System (airbag) was available for 1974, 1975 and 1976 Cadillacs.

Analog Electronic Fuel Injection was available, on 1975 Cadillacs and was standard on the new international size 1976 Seville. In 1978, the Trip Computer option incorporated an on-board microprocessor.

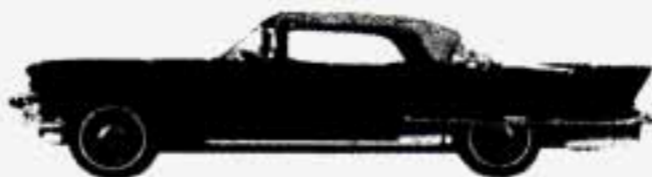

1957 Eldorado Brougham

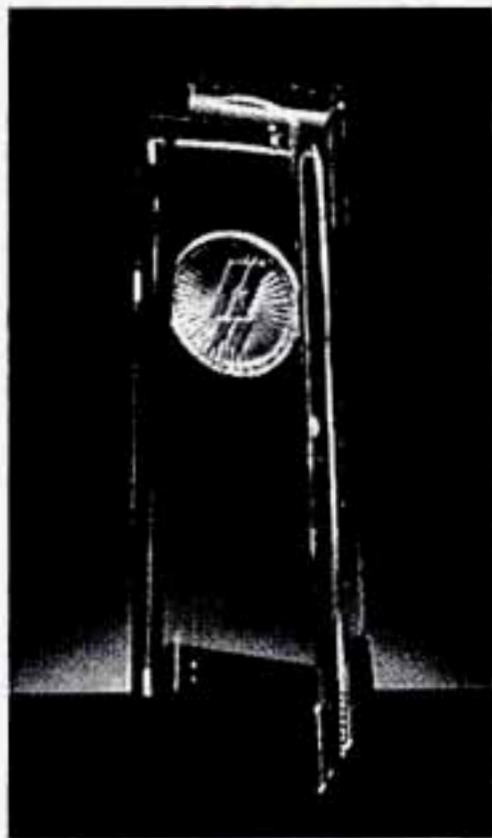

This rich tradition continues into the '90s as Cadillac became the first automobile manufacturer to be awarded the prestigious Malcolm Baldrige National Quality Award.

The 1992 Seville STS is the first car ever to win all three major automotive awards: Car of the Year, Motor Trend; Ten Best List, Car & Driver; Car of the Year, Automobile Magazine.



A 1993 Cadillac Allanté in stock technical configuration, was selected as the pace car for the 76th Indianapolis 500. The demanding pace car performance and handling requirements were met because of such advanced systems as the 32 valve, dual overhead camshaft, Northstar 4.6 liter V8 engine, 4t80 E electronically controlled automatic transaxle, road sensing suspension, speed sensitive steering, antilock brakes and traction control.

For more than nine decades Cadillac has been a leader in quality and technical innovation. Now more than ever, substance takes shape

**... Cadillac Style**



*1993 Allanté pace car*

INDIANAPOLIS '500' PACEMAKERS

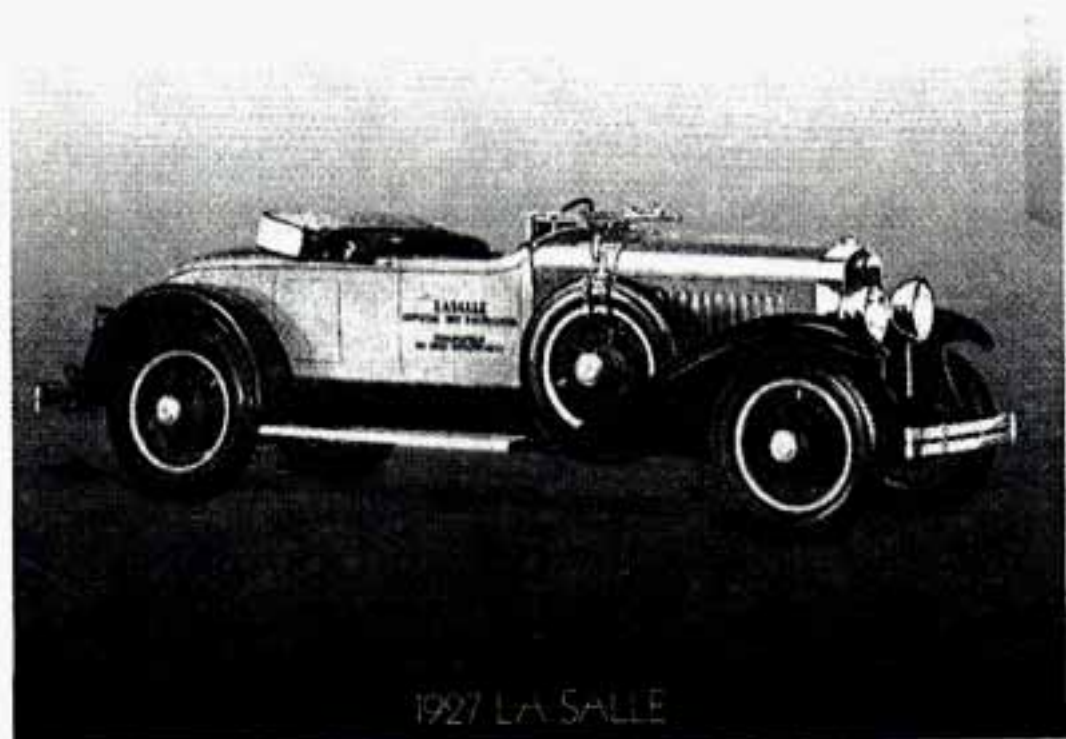

INDIANAPOLIS 500<sup>®</sup> PACEMAKERS





# TABLE OF CONTENTS

This Cadillac Manual is divided into major sections.

<b>Introduction – How to use this Manual</b> .....	<b>1</b>
This section tells you how to use your Manual and includes Safety and Vehicle Damage Warnings and Symbols	
<b>Section 1 – Seats and Safety Belts</b> .....	<b>6</b>
This section tells you how to use your seats and safety belts properly.	
<b>Section 2 – Features and Controls</b> .....	<b>63</b>
This section explains how to start and operate your Cadillac.	
<b>Section 3 – Comfort Controls and Audio Systems</b> .....	<b>146</b>
This section tells you how to adjust the ventilation and comfort controls and how to operate your Sound System.	
<b>Section 4 – Your Driving and the Road</b> .....	<b>165</b>
Here you'll find helpful information and tips about the road and how to drive under different conditions.	
<b>Section 5 – Problems on the Road</b> .....	<b>220</b>
This section tells you what to do if you have a problem while driving, such as a flat tire, or engine overheating.	
<b>Section 6 – Service and Appearance Care</b> .....	<b>261</b>
Here the manual tells you how to keep your Cadillac running properly and looking good.	

**For more information on “Reporting Safety Defects”, see Owner Assistance, Page 7.**



## THE 1993 SEVILLE AND STS LITERATURE



Please keep this literature in your Cadillac, so it will be there if you ever need it when you're on the road. If you sell the vehicle, please leave this book in it so the new owner can use it.

### ***FOR CANADIAN OWNERS WHO PREFER A FRENCH LANGUAGE MANUAL:***

Aux propriétaires canadiens: Vous pouvez vous procurer un exemplaire de ce guide en français chez votre concessionnaire ou au DGN Marketing Services Ltd., 1500 Bonhill Rd., Mississauga, Ontario L5T 1C7.

This literature includes the latest information at the time it was printed. We reserve the right to make changes in the product after that time without further notice. For vehicles first sold in Canada, substitute the name "General Motors of Canada Limited" for Cadillac Motor Car Division whenever it appears in this literature.

GENERAL MOTORS, GM and the GM Emblem, CADILLAC, and the CADILLAC Emblem are registered trademarks of General Motors Corporation.



## HOW TO USE THIS MANUAL

Many people read their owner's manual from beginning to end when they first receive their new vehicle. This will help you learn about the features and controls for your vehicle. In this manual, you'll find that pictures and words work together to explain things quickly.

**INDEX:** A good place to look for what you need is the Index in back of the manual. It's an alphabetical list of all that's in the manual, and the page number where you'll find it.

## *SAFETY WARNINGS AND SYMBOLS*

You will find a number of safety cautions in this book. We use yellow and the word **CAUTION** to tell you about things that could hurt you if you were to ignore the warning.



### **CAUTION:**

**These mean there is something that could hurt you or other people.**

In the yellow caution area, we tell you what the hazard is. Then we tell you what to do to help avoid or reduce the hazard. Please read these cautions. If you don't, you or others could be hurt.

You will also find a red circle with a slash through it in this book. This safety symbol means "Don't," "Don't do this," or "Don't let this happen."



## *Vehicle Damage Warnings*

Also, in this book you will find these blue notices:

### **NOTICE:**

**These mean there is something that could damage your vehicle.**

In the blue notice area, we tell you about something that can damage your vehicle. Many times, this damage would not be covered by your warranty, and it could be costly. But the notice will tell you what to do to help avoid the damage.

When you read other manuals, you might see CAUTION and NOTICE warnings in different colors or in different words. In this manual, we've used the familiar words and colors that Cadillac has used for years.

You'll also see warning labels on your vehicle. They use the same colors, and the words CAUTION or NOTICE.



## Vehicle Symbols

These are some of the symbols you will find on your vehicle. For example, these symbols are used on an original battery:

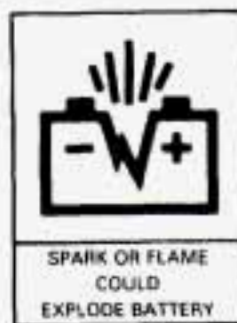

These symbols are important for you and your passengers whenever your vehicle is driven:



These symbols have to do with your lights:

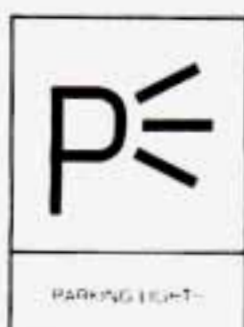
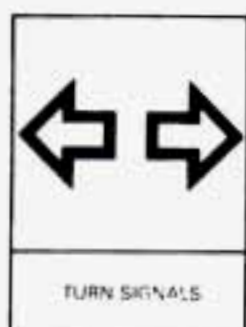
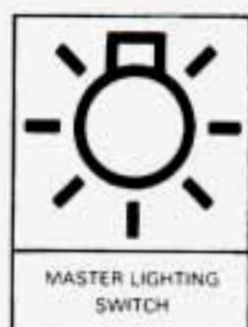

These symbols are on some of your controls:

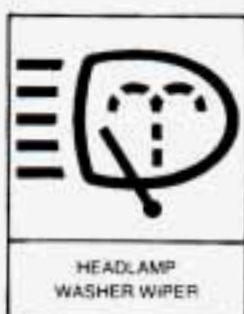
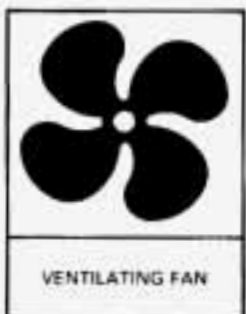
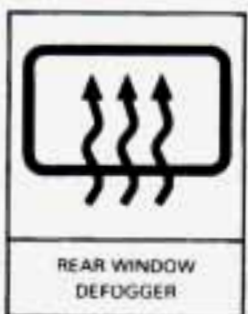
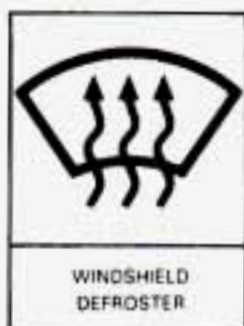
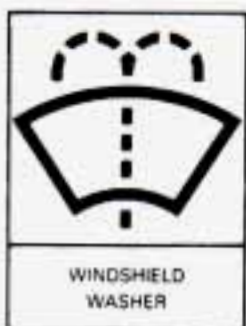
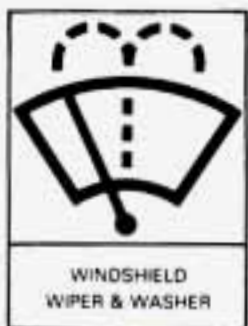

These symbols are used on warning and indicator lights:

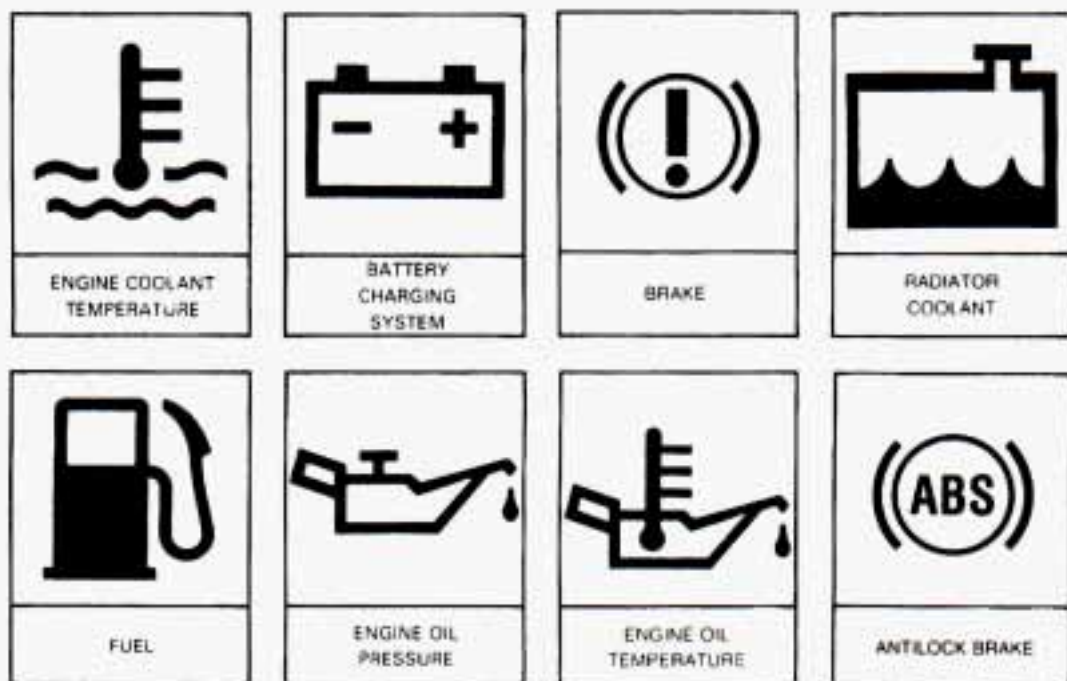

Here are some other symbols you may see:

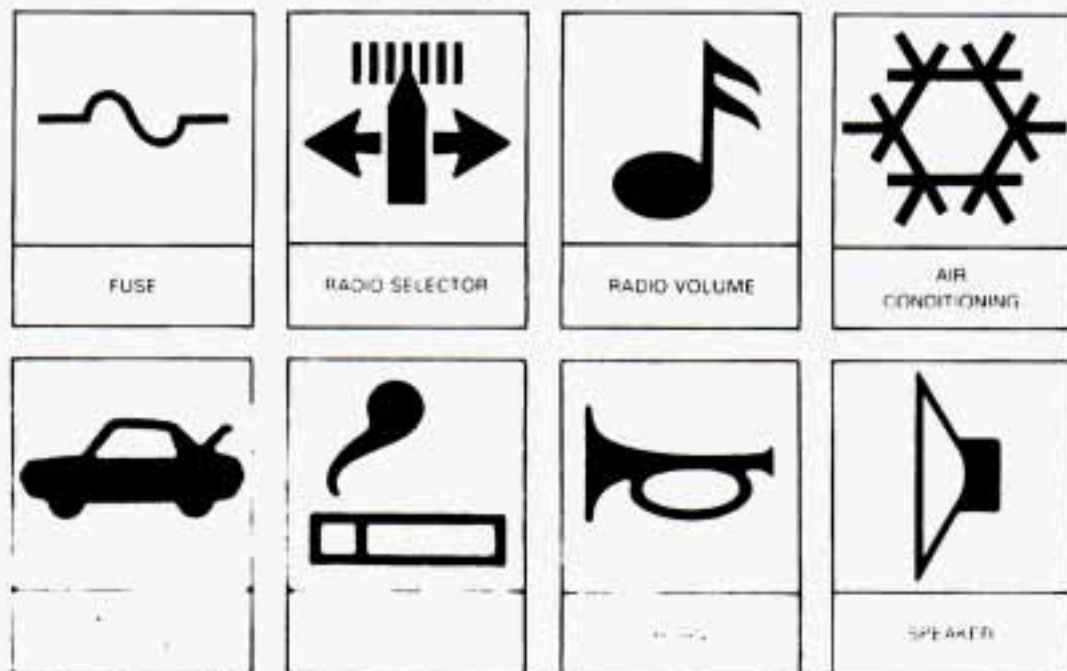



## SECTION 1

### SEATS AND SAFETY BELTS

Here you'll find information about the seats in your Cadillac, your Supplemental Inflatable Restraint ("air bag") system and how to use your safety belts properly. You can also learn about some things you should not do with safety belts.

### *SEATS AND SEAT CONTROLS*

This section tells you about the seats -- how to adjust them, and also about reclining front seatbacks, lumbar adjustments, heated seats, and head restraints.

#### *Power Seat Control*

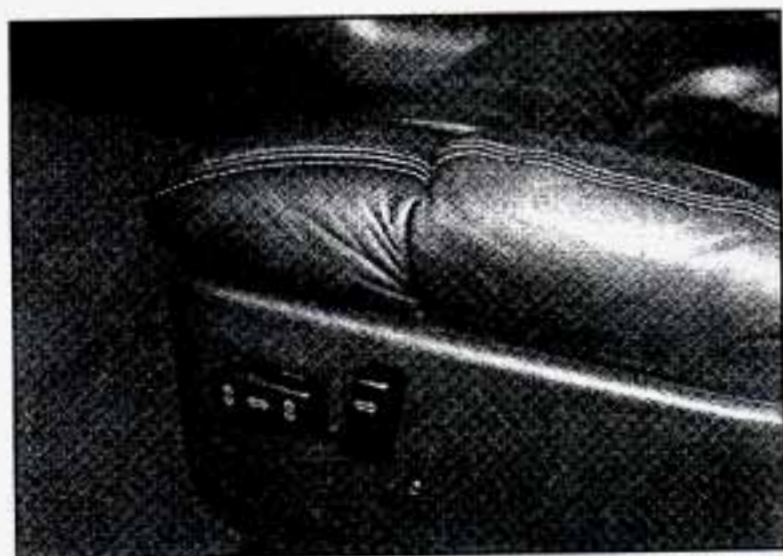

The power seat control switch is located on the outboard side of the seat cushion.

The power control switch moves the seat forward and backward, up and down, and adjusts the angle of the seat.

## *Power Seat*

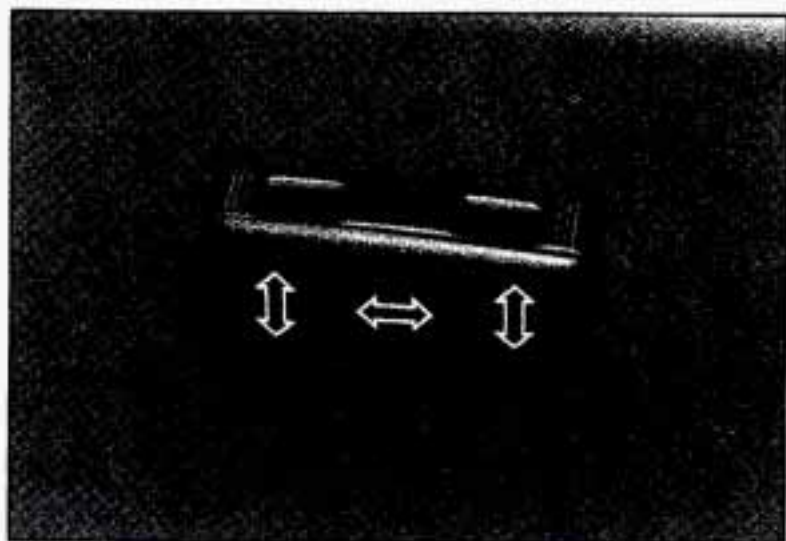

- Move the front of the switch in the direction of the arrows to make the front part of the cushion move up or down.
- Move the rear of the switch in the direction of the arrows to make the rear part of the cushion move up or down.

- Move the whole switch in the direction of both arrows to move the seat up or down.
- Move the switch forward or backward to move the whole seat forward or backward.

## *Power Seatback Recliner*

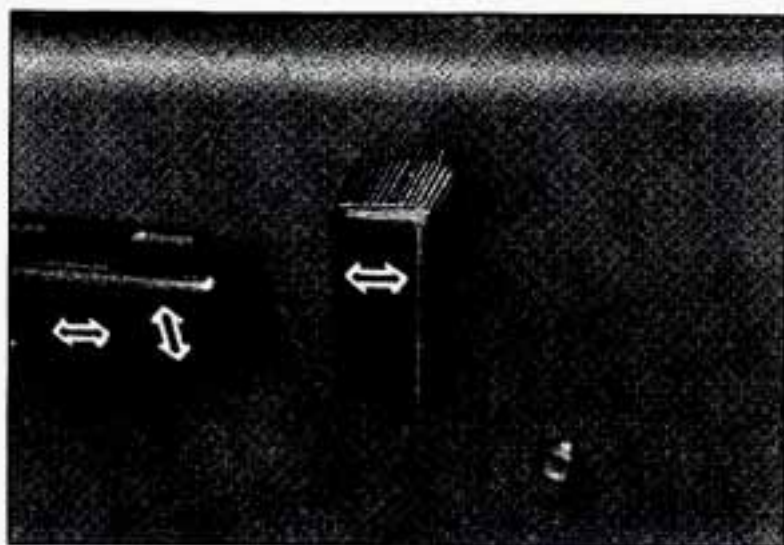

Move the switch in the direction of the arrow to move the seatback forward or backward.

But don't have a seatback reclined if your vehicle is moving.

 **CAUTION:**

**Sitting in a reclined position when your vehicle is in motion can be dangerous. Even if you buckle up, your safety belts can't do their job when you're reclined like this.**



**The shoulder belt can't do its job because it won't be against your body. Instead, it will be in front of you. In a crash you could go into it, receiving neck or other injuries.**

**The lap belt can't do its job either. In a crash the belt could go up over your abdomen. The belt forces would be there, not at your pelvic bones. This could cause serious internal injuries.**

**For proper protection when the vehicle is in motion, have the seatback upright. Then sit well back in the seat and wear your safety belt properly.**

## *Lumbar/Heated Seats*

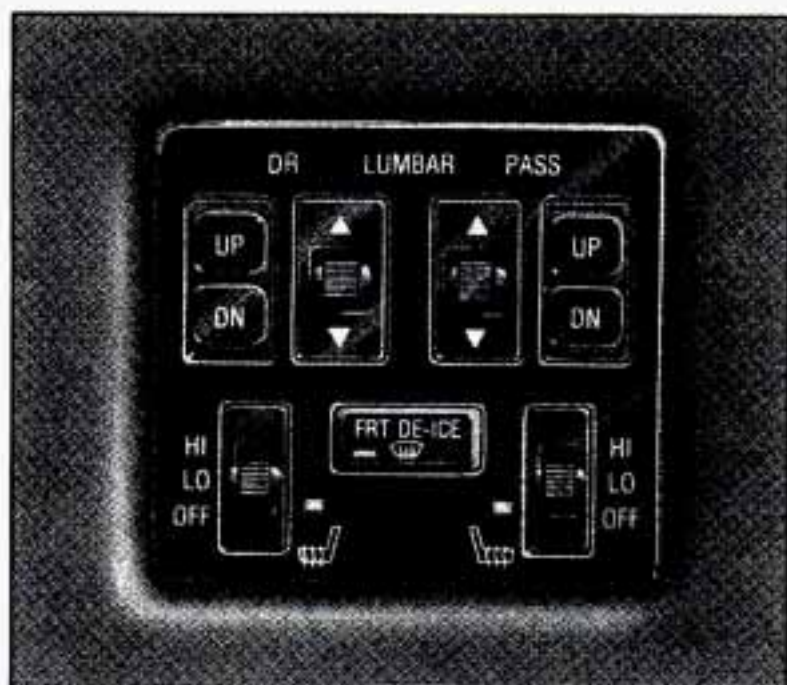

### **Lumbar Control Option**

If you have this feature, you can change the shape of the driver and passenger seats. It works independently of the other seat controls. Use the power seat control first to get the proper position. Then proceed with the lumbar adjustment.

The LUMBAR control switches are located on the center console. You can control either the DR (Driver) or PASS (Passenger) seat.

- Move the switch ▲ to increase support or ▼ to decrease support to reshape the lower seatback.
- Push the switch UP or DN (down) to raise or lower the support mechanism to suit your preference.

### **Heated Seat Option**

Move the switch to either LO or HI to turn on the heating element in the seat.

Designed primarily for use on damp and chilly days, the LO setting warms the seatback and cushion until the seat approximates body temperature. On colder days, the HI setting heats the seats to an even

higher temperature. To prevent uncomfortable overheating of the seats, the heating elements are thermostatically regulated to automatically maintain the temperature at the selected setting. A telltale light in the control switch reminds you that the heating system is in use. To preserve the battery, the heated seats can only be used when the ignition is turned on, and are deactivated when the ignition is turned off.

### ***Head Restraints***



Slide the head restraint up or down so that the top of the restraint is closest to the top of your ears.

This position reduces the chance of a neck injury in a crash. The head restraints tilt forward and rearward also.

### ***SAFETY BELTS: THEY'RE FOR EVERYONE***

This part of the manual tells you how to use safety belts properly. It also tells you some things you should not do with safety belts.

And it explains the Supplemental Inflatable Restraint, or "air bag" system.



**⚠ CAUTION:**

**Don't let anyone ride where they can't wear a safety belt properly. If you are in a crash and you're not wearing a safety belt, your injuries can be much worse. You can hit things inside the vehicle or be ejected from it. You can be seriously injured or killed. In the same crash, you might not be if you are buckled up. Always fasten your safety belt, and check that your passengers' belts are fastened properly too.**



This figure lights up when you turn the key to “Run” or “Start” when your safety belt isn't buckled, and you'll hear a chime, too. It's the reminder to buckle up.

In many states and Canadian provinces, the law says to wear safety belts. Here's why: They work.

You never know if you'll be in a crash. If you do have a crash, you don't know if it will be a bad one.

A few crashes are very mild. In them, you won't get hurt even if you're not buckled up. And some crashes can be so serious, like being hit by a train, that even buckled up a person wouldn't survive. But most crashes are in between. In many of them, people who buckle up can survive and sometimes walk away. Without belts they could be badly hurt or killed.

After 25 years of safety belts in vehicles, the facts are clear. In most crashes buckling up does matter ... a lot!



## *Why Safety Belts Work*

When you ride in or on anything, you go as fast as it goes.

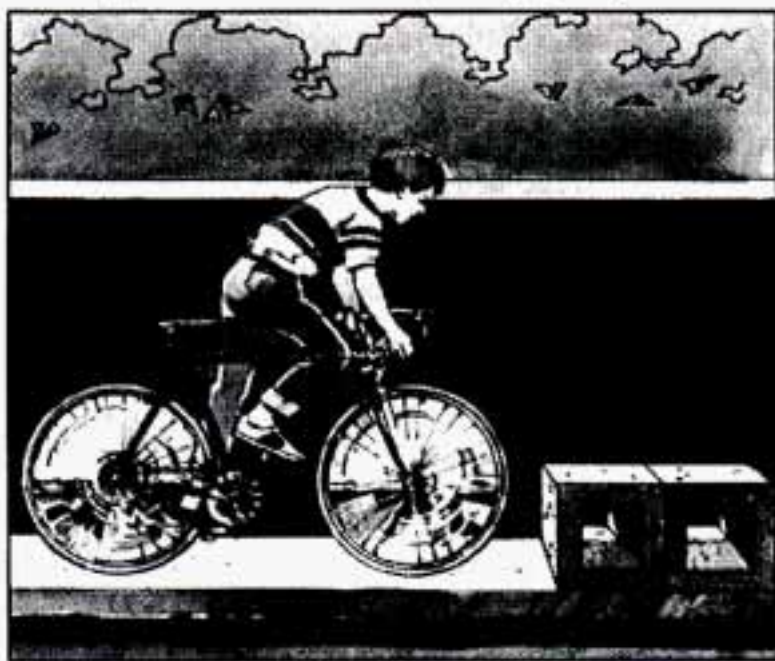

For example, if the bike is going 10 mph (16 km/h), so is the child.

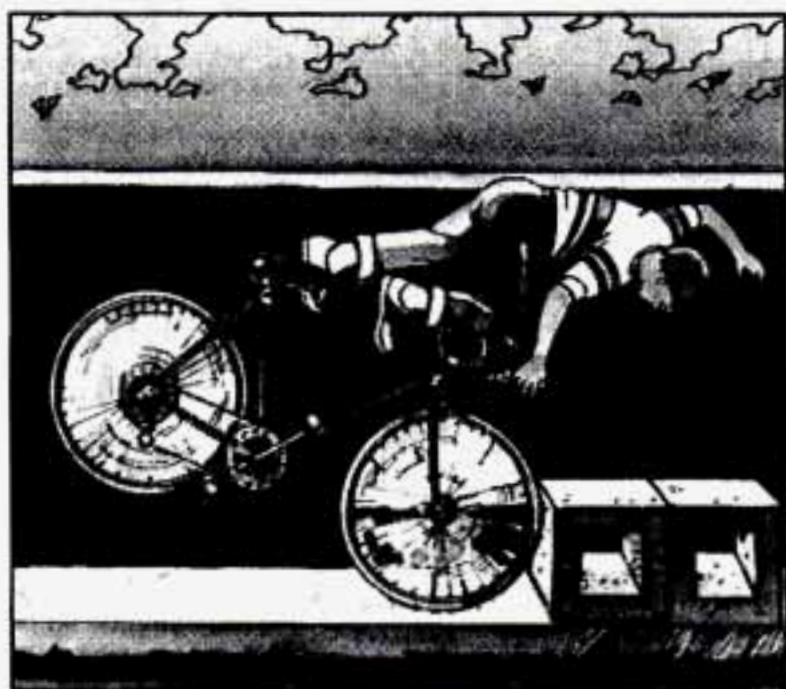

When the bike hits the block, it stops. But the child keeps going!

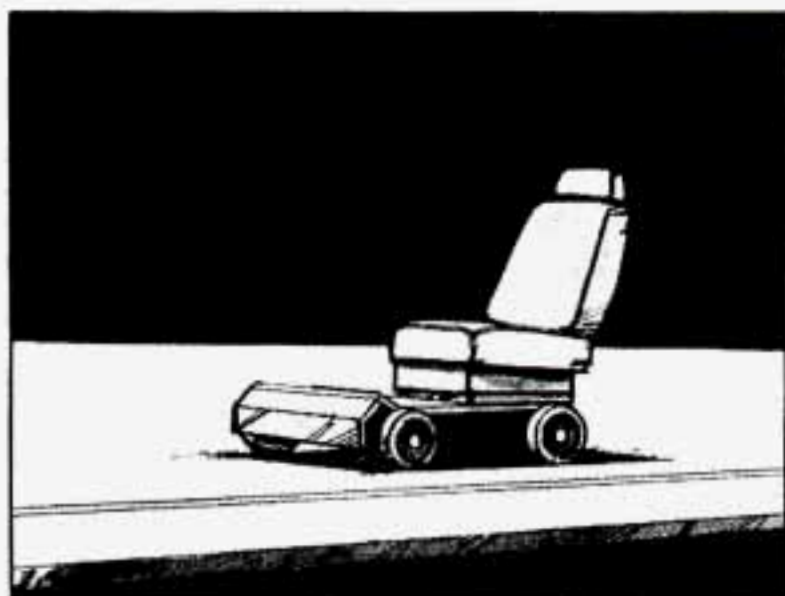

Take the simplest "vehicle." Suppose it's just a seat on wheels.

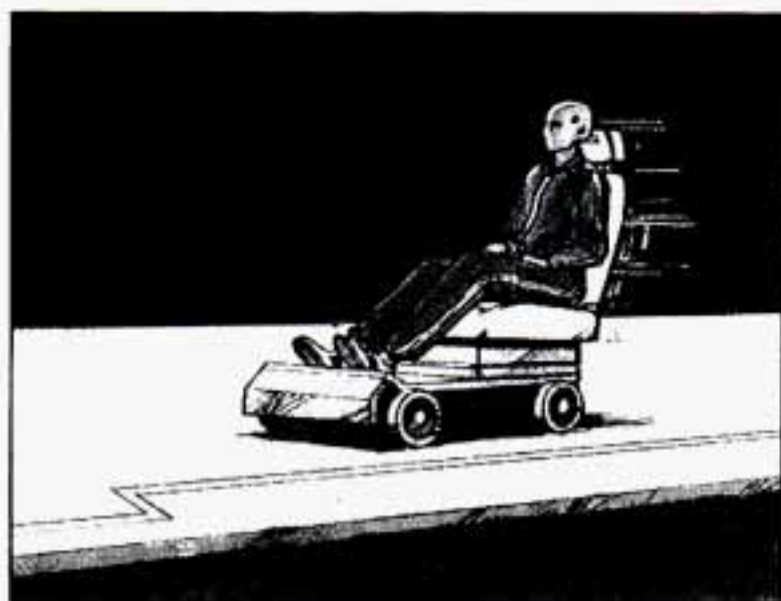

Put someone on it.



Get it up to speed.  
Then stop the "car."  
The rider doesn't stop.



The person keeps going until stopped by something.

In a real vehicle, it could be the windshield ...

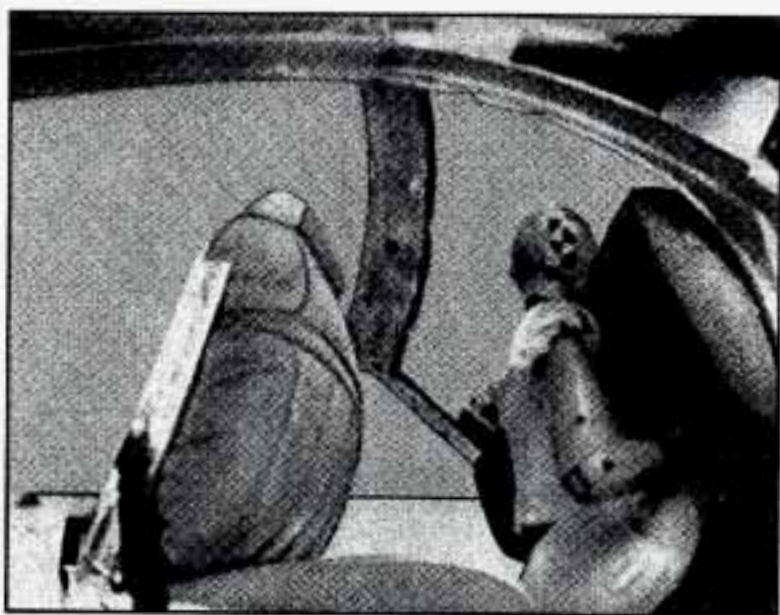

or the instrument panel ...



or the safety belts!

With safety belts, you slow down as the vehicle does. You get more time to stop. You stop over more distance, and your strongest bones take the forces. That's why safety belts make such good sense.

## ***HERE ARE QUESTIONS MANY PEOPLE ASK ABOUT SAFETY BELTS -- AND THE ANSWERS***

**Q:** *Won't I be trapped in the vehicle after an accident if I'm wearing a safety belt?*

**A:** You could be -- whether you're wearing a safety belt or not. But you can easily unbuckle a safety belt, even if you're upside down. And your chance of being conscious during and after an accident, so you can unbuckle and get out, is much greater if you are belted.

**Q:** *Why don't they just put in air bags so people won't have to wear safety belts?*

**A:** "Air bags," or Supplemental Inflatable Restraint systems, are in some vehicles today and will be in more of them in the future. But they are supplemental systems only -- so they work with safety belts, not instead of them. Every "air bag" system ever offered for sale has

required the use of safety belts. Even if you're in a vehicle that has "air bags," you still have to buckle up to get the most protection. That's true not only in frontal collisions, but especially in side and other collisions.

**Q:** *If I'm a good driver, and I never drive far from home, why should I wear safety belts?*

**A:** You may be an excellent driver, but if you're in an accident -- even one that isn't your fault -- you and your passengers can be hurt. Being a good driver doesn't protect you from things beyond your control, such as bad drivers.

Most accidents occur within 25 miles (40 km) of home. And the greatest number of serious injuries and deaths occur at speeds of less than 40 mph (65 km/h).

Safety belts are for everyone.

### ***Safety Belt Reminder Light***



When the key is turned to "Run" or "Start," a light will come on for about eight seconds to remind people to fasten their safety belts. Unless the driver's safety belt is buckled, a chime will also sound.

# ***HOW TO WEAR SAFETY BELTS PROPERLY***

## ***Adults***

This section is only for people of adult size.



### **CAUTION:**

**There are special things to know about safety belts and children. And there are different rules for babies and smaller children. If a child will be riding in your Cadillac, see the section after this one, called "Children." Follow those rules for everyone's protection.**

First, you'll want to know which restraint systems your vehicle has.

We'll start with the driver position.

## ***DRIVER POSITION***

This section describes the driver's restraint system.

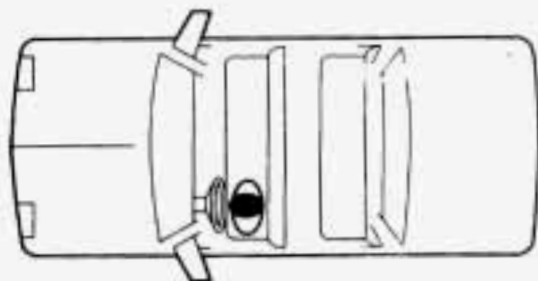



## *Lap-Shoulder Belt*



The driver has a lap-shoulder belt. Here's how to wear it properly.

1. Close and lock the door.
2. Adjust the seat (to see how, see "Seats" in the Index) so you can sit up straight.



3. Pick up the latch plate and pull the belt across you. Don't let it get twisted.

4. Push the latch plate into the buckle until it clicks.

If the belt isn't long enough, see "Safety Belt Extender" at the end of this section.

Make sure the release button on the buckle faces upward or outward so you would be able to unbuckle it quickly if you ever had to.

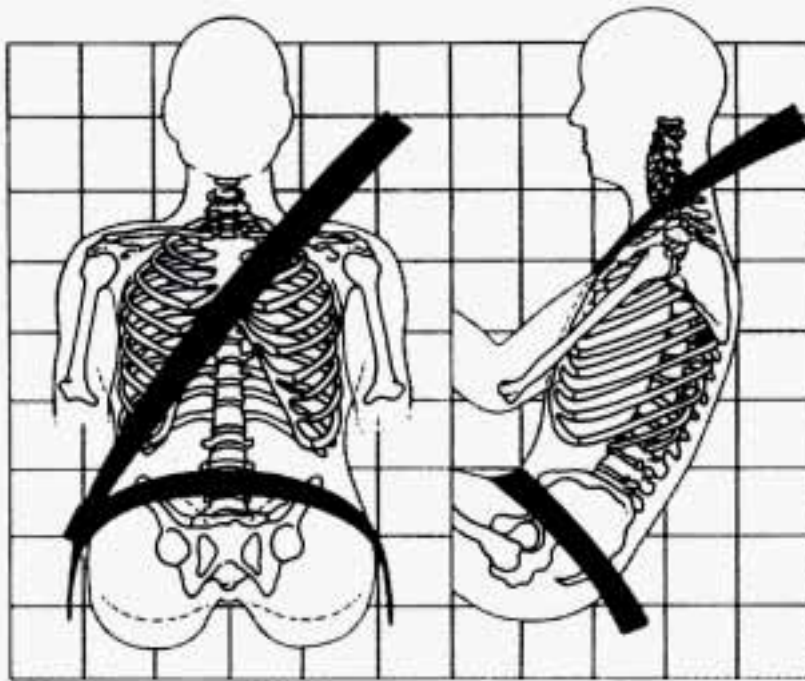

The lap part of the belt should be worn low and snug on the hips, just touching the thighs. In a crash, this applies force to the strong pelvic bones. And you'd be less likely to slide under the lap belt. If you slid under it, the belt would apply force at your abdomen. This could cause serious or even fatal injuries. The shoulder belt should go over the shoulder and across the chest. These parts of the body are best able to take belt restraining forces.

The safety belt locks if there's a sudden stop or crash.

## *Shoulder Belt Height Adjuster*

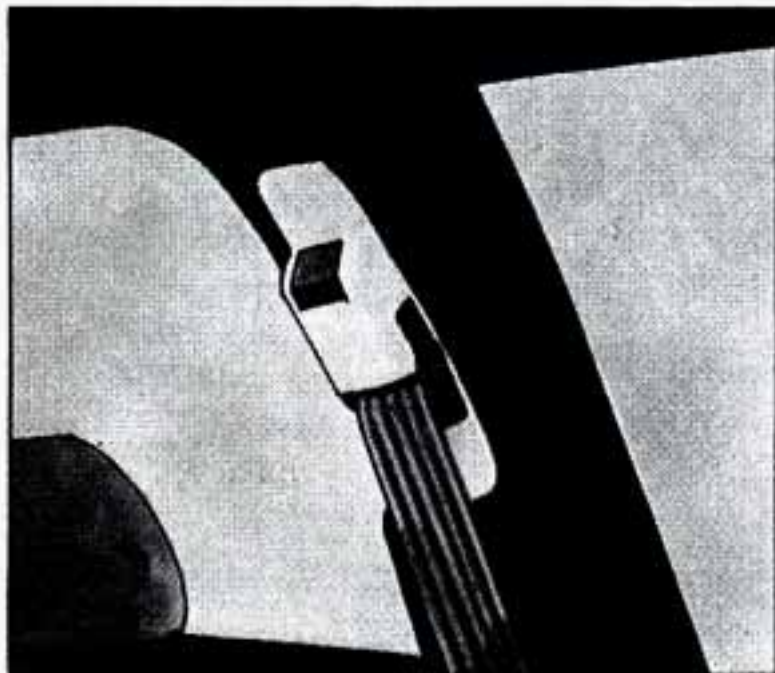

You can move the shoulder belt adjuster to the height that is right for you.



To move it up or down, squeeze the release handle. When you release the handle, try to move it down a little to make sure it has locked into position.

You can move the adjuster up from a lower position by pushing the bottom of the release handle.



Adjust the height so that the shoulder portion of the belt is properly positioned on your shoulder, away from your face and neck.

To help you find a height that is right for you, follow these guidelines:

For a tall person: Use the upper or upper-middle position.

For a person of average height: Use a position somewhere in the middle.

For a short person: Use the lower or lower-middle position.

## *Shoulder Belt Tightness Adjustment*

Your Seville has a shoulder belt tightness adjustment feature. If the shoulder belt seems too tight, you can adjust it like this:

1. Sit well back in the seat.



2. Start pulling the shoulder belt out.



3. Just before it reaches the end, give it a quick pull.

4. Let the belt go back all the way. You should hear a slight clicking sound. If you don't, the adjustment feature won't set, and you'll have to start again.



5. Now you can add a small amount of slack. Lean forward slightly, then sit back. If you've added more than 1 inch (25 mm) of slack, pull the shoulder belt out as you did before and start again.

If you move around in the vehicle enough, or if you pull out the shoulder belt, the belt will become tight again. If this happens, you can reset it.

**Q:** What's wrong with this?

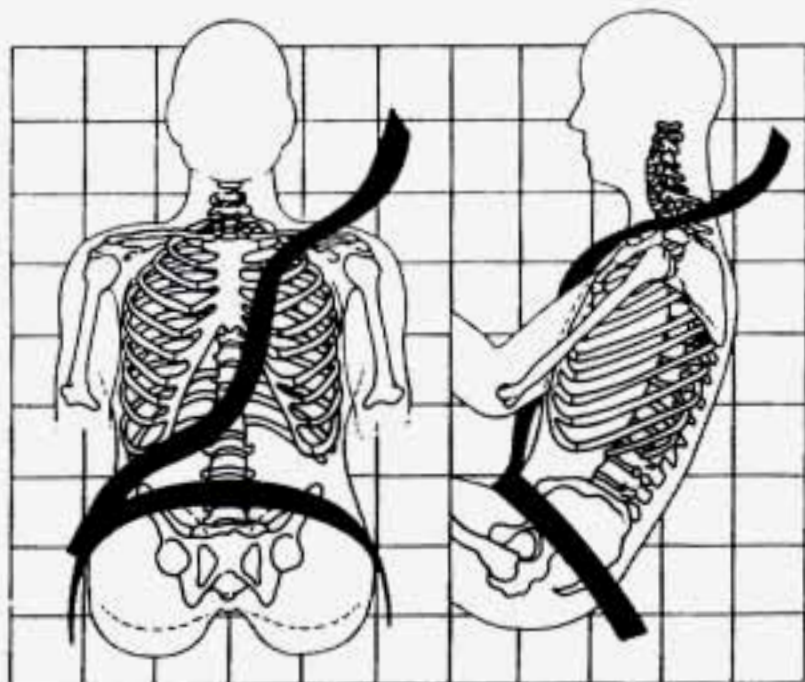

**A:** The shoulder belt is too loose. It won't give nearly as much protection this way.

**⚠ CAUTION:**

You can be seriously hurt if your shoulder belt is too loose. In a crash you would move forward too much, which could increase injury. The shoulder belt should fit against your body. Don't allow more than 1 inch (25 mm) of slack in Seville models.



**Q:** What's wrong with this?

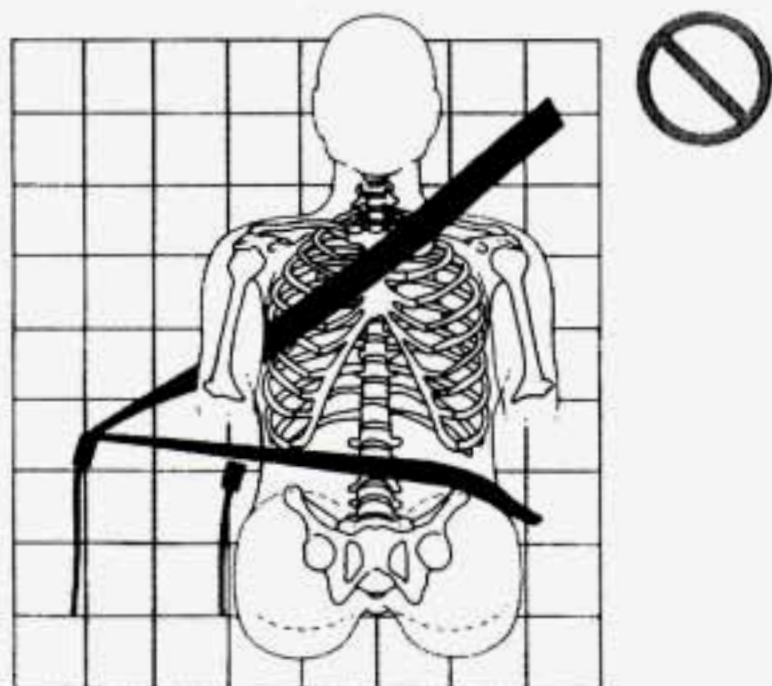

**A:** The belt is buckled in the wrong place.

**⚠ CAUTION:**

**You can be seriously injured if your belt is buckled in the wrong place like this. In a crash, the belt would go up over your abdomen. The belt forces would be there, not at the pelvic bones. This could cause serious internal injuries. Always buckle your belt into the buckle nearest you.**

**Q:** What's wrong with this?

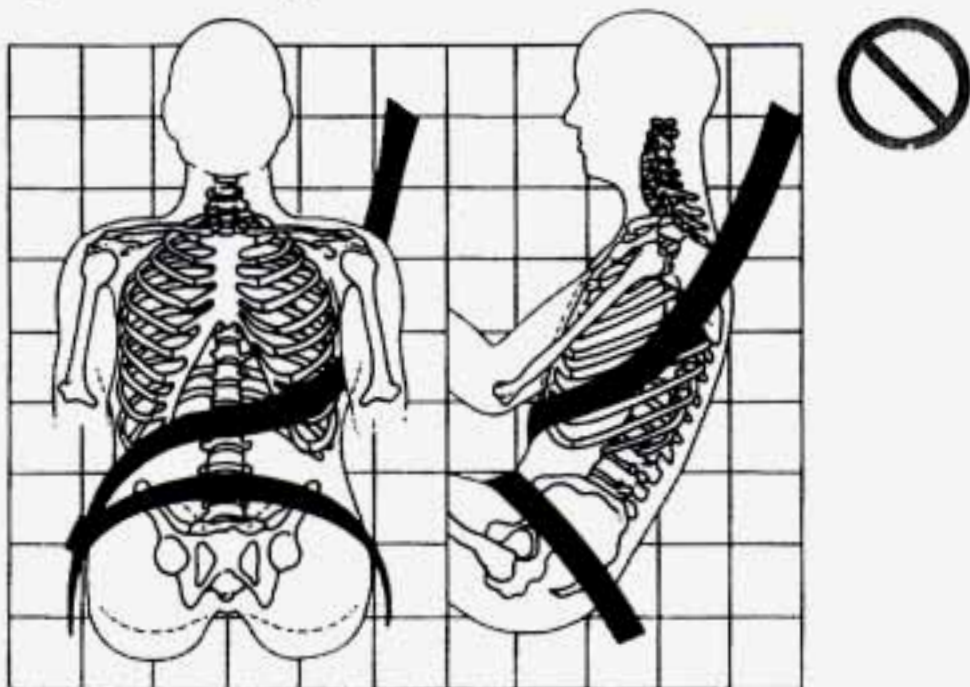

**A:** The shoulder belt is worn under the arm. It should be worn over the shoulder at all times.

**⚠ CAUTION:**

You can be seriously injured if you wear the shoulder belt under your arm. In a crash, your body would move too far forward, which would increase the chance of head and neck injury. Also, the belt would apply too much force to the ribs, which aren't as strong as shoulder bones. You could also severely injure internal organs like your liver or spleen.

**Q:** What's wrong with this?

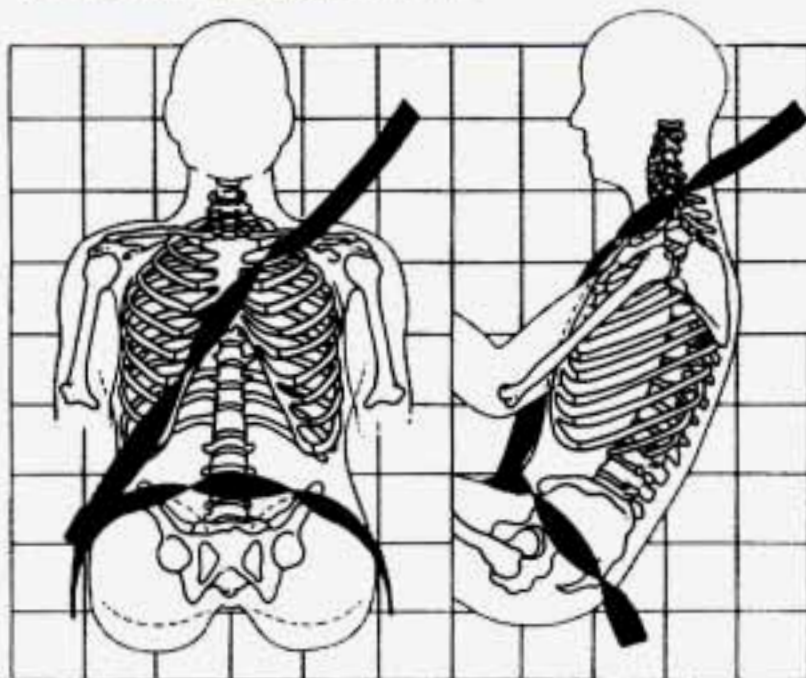

**A:** The belt is twisted across the body.

**⚠ CAUTION:**

You can be seriously injured by a twisted belt. In a crash, you wouldn't have the full width of the belt to spread impact forces. If a belt is twisted, make it straight so it can work properly, or ask your dealer to fix it.



To unlatch the belt, just push the button on the buckle. The belt should go back out of the way.

Before you close the door, be sure the belt is out of the way. If you slam the door on it, you can damage both the belt and your vehicle.

## ***SUPPLEMENTAL INFLATABLE RESTRAINT SYSTEM (AIR BAGS)***

This section explains the Supplemental Inflatable Restraint (SIR), or “air bag,” system. Your Cadillac has an air bag for the driver and for the right-front passenger.

Here's the most important thing to know:

### **⚠ CAUTION:**

Even with an air bag, if you're not wearing a safety belt and you're in a crash, your injuries may be much worse. Air bags are not designed to inflate in rollovers or in rear, side or low-speed frontal crashes. You need to wear your safety belt to reduce the chance of hitting things inside the vehicle or being ejected from it. Always wear your safety belt, even with an air bag.

CAUTION: (Continued)

**CAUTION:** (Continued)

**Air bags inflate with great force, faster than the blink of an eye. If you're too close to an inflating air bag, it could seriously injure you. Safety belts help keep you in position for an air bag inflation in a crash. Always wear your safety belt, even with an air bag, and the driver should sit as far back as possible while still maintaining control of the vehicle.**



**CAUTION:**

**An inflating air bag can seriously injure small children. Always secure children properly in your vehicle. To read how, see the "Children and Safety Belts" section of this manual, and read the caution label on the front-passenger's safety belt.**

### ***Air Bag System Light***

There is an air bag readiness light on the instrument panel. The system checks itself and the light tells you if there is a problem.

**INFL.  
REST.**

**INFLATABLE  
RESTRAINT**

You will see this light flash for a few seconds when you turn your ignition to "Run" or "Start." Then the light should go out, which means the system is ready.

**⚠ CAUTION:**

If the air bag readiness light doesn't come on when you start your vehicle, or stays on, or comes on when you are driving, your air bag system may not work properly. Have your vehicle serviced right away.

### *How The Air Bag System Works*



#### **Where is the air bag?**

The driver's air bag is in the middle of the steering wheel. If your vehicle has a right-front passenger air bag, it is located in the instrument panel on the passenger's side.

#### **When is an air bag expected to inflate?**

The air bag is designed to inflate in moderate to severe frontal or near-frontal crashes. The air bag will only inflate if the velocity of the impact is above the designed threshold level. When impacting straight into a wall that does not move or deform, the threshold level for most

GM vehicles is between 9 and 14 mph. However, this velocity threshold depends on the vehicle design and may be several miles-per-hour faster or slower. In addition, this threshold velocity will be considerably higher if the vehicle strikes an object such as a parked car which will move and deform on impact. The air bag is also not designed to inflate in rollovers, side impacts, or rear impacts where the inflation would provide no occupant protection benefit.

In any particular crash, the determination of whether the air bag should have inflated cannot be based solely on the level of damage on the vehicle(s). Inflation is determined by the angle of the impact and the vehicle's deceleration, of which vehicle damage is only one indication. Repair cost is not a good indicator of whether an air bag should have deployed.

### **What makes an air bag inflate?**

In a frontal or near-frontal impact of sufficient severity, sensors strategically located on the vehicle detect that the vehicle is suddenly stopping as a result of a crash. These sensors complete an electrical circuit, triggering a chemical reaction of the sodium azide sealed in the inflator. The reaction produces nitrogen gas, which inflates a cloth bag. The inflator, cloth bag, and related hardware are all part of the air bag inflator modules packed inside the steering wheel and in the instrument panel in front of the passenger if there is a passenger air bag.

### **How does an air bag restrain?**

In moderate to severe frontal or near-frontal collisions, even belted occupants can contact the steering wheel or the instrument panel. The air bag supplements the protection provided by safety belts. Air bags distribute the force of the impact more evenly over the occupant's upper body, stopping the occupant more gradually. But air bags would not provide protection in many types of collisions, including rollovers and rear and side impacts, primarily because an occupant's motion is not toward the air bag. Air bags should never be regarded as anything more than a supplement to safety belt protection in moderate to severe frontal and near-frontal collisions.

### **What will you see after an air bag inflation?**

After the air bag has inflated, it will then quickly deflate. This occurs so quickly that some people may not even realize that the air bag inflated. The air bag will not impede the driver's vision or ability to steer the vehicle, nor will it hinder the occupants from exiting the vehicle. There will be small amounts of smoke coming from vents in the deflated air bags. Some components of the air bag module in the steering wheel hub for the driver's air bag or the instrument panel for the passenger's bag may be hot for a short time, but the portion of the bag that comes into contact with you will not be hot to the touch. The nitrogen gas used to inflate the air bag will have vented into the passenger compartment, and the bag will be deflated within seconds after the collision. Nitrogen makes up about 80% of the air we breathe and is not hazardous. As the nitrogen vents from the bag, small particles are also vented into the passenger compartment.

In many crashes severe enough to inflate an air bag, windshields are broken by vehicle deformation. Additional windshield breakage may occur in vehicles with passenger air bags because the windshield acts as a reaction surface for the inflating air bag.

#### **CAUTION:**

- **Don't attach anything to the steering wheel pad. It might injure the driver if the air bag inflates.**
- **Don't set anything on or attach anything to the instrument panel. It might injure the passenger if the air bag inflates.**
- **The air bags are designed to inflate only once. After they inflate, you'll need some new parts for your air bag system. If you don't get them, the air bag system won't be there to help protect you in another crash. A new system will include air bag modules and possibly other parts**
- **Let only qualified technicians work on your air bag system. Improper service can mean that your air bag system won't work properly. See your dealer for service.**



## **NOTICE:**

**If you damage the cover for the right-front passenger's air bag, it may not work properly. You may have to replace both the air bag and the instrument panel. Don't open or break the air bag cover.**

## ***Servicing Your Cadillac with the Air Bag System***

Please tell or remind anyone who works on your Cadillac that it has the air bag system. There are parts of the air bag system in several places around your vehicle. You don't want the system to inflate while someone is working on your vehicle. The air bag system does not need regular maintenance. Your Cadillac dealer and the 1993 Cadillac Service Manual have information about the air bag system, including repair or disposal.



## **CAUTION:**

**For up to 10 minutes after the ignition key is turned off and the battery disconnected, an air bag can still inflate during improper service. You can be injured if you are close to an air bag when it inflates. Be sure to follow the proper service procedures.**

When electrical work is done under the hood or inside your vehicle, the ignition should be in "Lock" if possible. Avoid wires wrapped with yellow tape, or yellow connectors. They are probably part of the air bag system.

Your vehicle has the driver's air bag only. The driver's air bag must be disconnected if the ignition has to be on for electrical work or if the steering column is to be disassembled. Disconnect the driver's air bag like this:

- Turn off the ignition.

- Remove the SIR (air bag) fuse (see “Fuses and Circuit Breakers” in the Index).
- Disconnect the yellow connector at the base of the steering column.

Your vehicle also has the right-front passenger’s air bag, both the driver’s air bag and the right-front passenger’s air bag must be disconnected if the ignition has to be on for electrical work, or if the steering column or instrument panel is to be disassembled.

Your vehicle with both a driver’s air bag and a right-front passenger’s air bag, you must disconnect both air bags. Follow the procedure above for the driver’s air bag, then disconnect the right-front passenger’s air bag like this:

- Turn off ignition.
- Remove the SIR (air bag) fuse (see “Fuses and Circuit Breakers” in the Index).
- Remove the trap door located inside the glove box.
- Disconnect the yellow connector.

When the work is complete, if the air bag system was disconnected, be sure to reattach everything and replace the fuse before turning the ignition on. When you turn the ignition key on, be sure you see the inflatable restraint light on the instrument panel. If you don’t see this light flash and then go out as usual, have your air bag system repaired.

## ***SAFETY BELT USE DURING PREGNANCY***

Safety belts work for everyone, including pregnant women. Like all occupants, they are more likely to be seriously injured if they don’t wear safety belts.

A pregnant woman should wear a lap-shoulder belt, and the lap portion should be worn as low as possible throughout the pregnancy.



The best way to protect the fetus is to protect the mother. When a safety belt is worn properly, it's more likely that the fetus won't be hurt in a crash. For pregnant women, as for anyone, the key to making safety belts effective is wearing them properly.

## ***RIGHT FRONT PASSENGER POSITION***

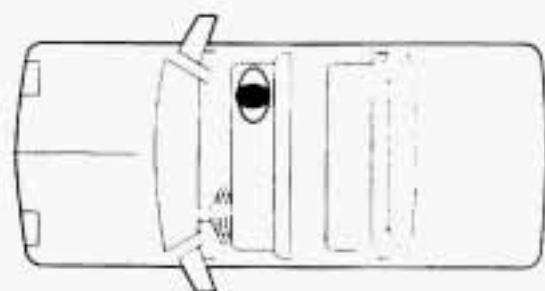

The right front passenger's safety belt works the same way as the driver's safety belt. See "Driver Position," earlier in this part.

When the lap portion of the belt is pulled out all the way, it will lock. If it does, let it go back all the way and start again.

## ***REAR SEAT PASSENGERS***

It's very important for rear seat passengers to buckle up! Accident statistics show that unbelted people in the rear seat are hurt more often in crashes than those who are wearing safety belts.

Rear passengers who aren't safety belted can be thrown out of the vehicle in a crash. And they can strike others in the vehicle who are wearing safety belts.

### ***Rear Seat Outside Passenger Positions***

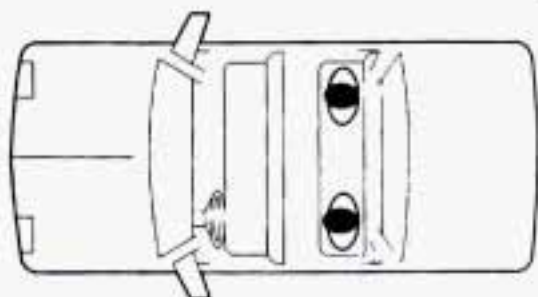

The positions next to the windows have lap-shoulder belts. Here's how to wear one properly.



1. Pick up the latch plate and pull the belt across you. Don't let it get twisted.

2. Push the latch plate into the buckle until it clicks.



If the belt stops before it reaches the buckle, tilt the latch plate and keep pulling until you can buckle it.

If the belt is not long enough, see “Safety Belt Extender” at the end of this section. Make sure the release button on the buckle faces upward or outward so you would be able to unbuckle it quickly if you ever had to.



3. To make the lap part tight, pull down on the buckle end of the belt as you pull up on the shoulder part.

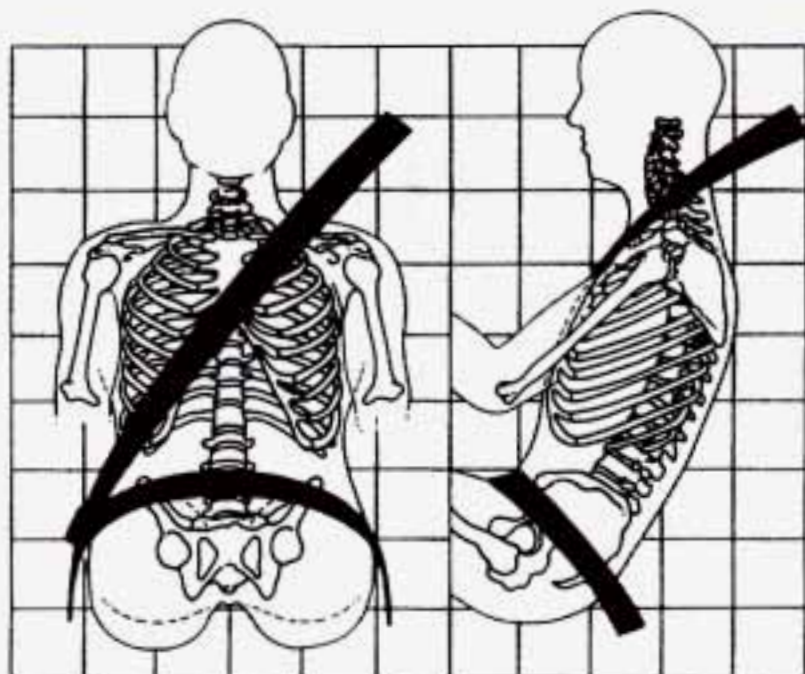

The lap part of the belt should be worn low and snug on the hips, just touching the thighs. In a crash, this applies force to the strong pelvic bones. And you'd be less likely to slide under the lap belt. If you slid under it, the belt would apply force at your abdomen. This could cause serious or even fatal injuries. The shoulder belt should go over the shoulder and across the chest. These parts of the body are best able to take belt restraining forces.

The safety belt locks if there's a sudden stop or a crash.

**⚠ CAUTION:**

**You can be seriously hurt if your shoulder belt is too loose. In a crash you would move forward too much, which could increase injury. The shoulder belt should fit against your body.**



- To unlatch the belt, just push the button on the buckle.

## ***CENTER PASSENGER POSITION***

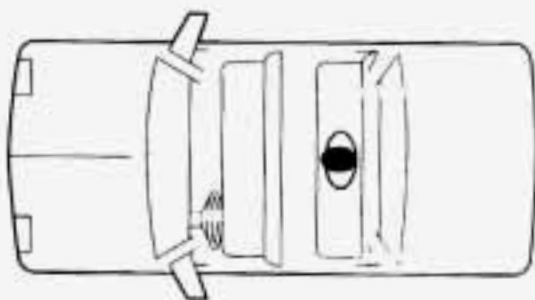

Your vehicle has a rear bench seat. Someone can sit in the center position.

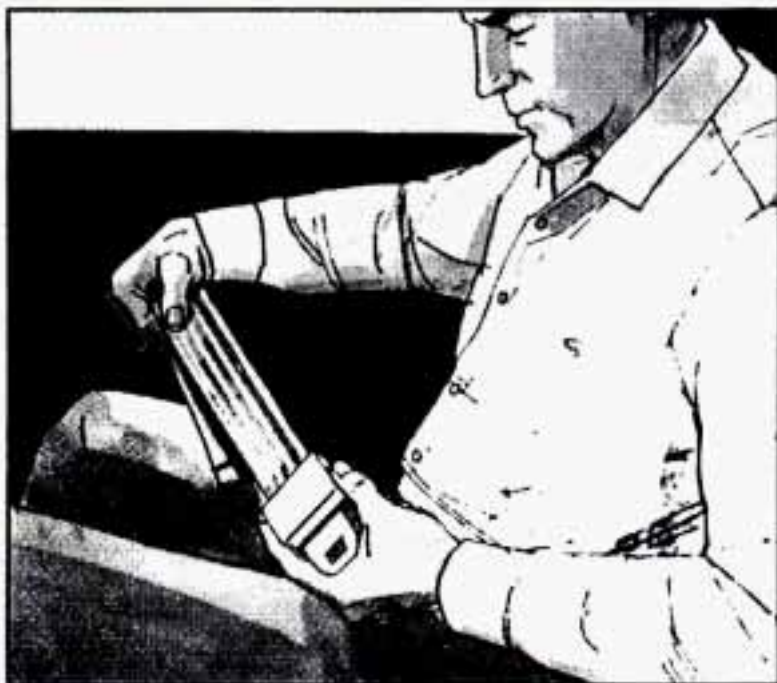

When you sit in a center seating position, you have a lap safety belt, which has no retractor. To make the belt longer, tilt the latch plate and pull it along the belt.



To make the belt shorter, pull its free end as shown until the belt is snug.

Buckle, position and release it the same way as the lap part of a lap-shoulder belt. If the belt isn't long enough, see "Safety Belt Extender" at the end of this section.



Make sure the release button on the buckle faces upward or outward so you would be able to unbuckle it quickly if you ever had to.

## ***CHILDREN***



Everyone in a vehicle needs protection! That includes infants and all children smaller than adult size. In fact, the law in every state and Canadian province says children up to some age must be restrained while in a vehicle.

## *Smaller Children and Babies*

### **CAUTION:**

Smaller children and babies should always be restrained in a child or infant restraint. The instructions for the restraint will say whether it is the right type and size for your child. A very young child's hip bones are so small that a regular belt might not stay low on the hips, as it should. Instead, the belt will likely be over the child's abdomen. In a crash the belt would apply force right on the child's abdomen, which could cause serious or fatal injuries. So, be sure that any child small enough for one is always properly restrained in a child or infant restraint.

### **CAUTION:**

Never hold a baby in your arms while riding in a vehicle. A baby doesn't weigh much -- until a crash. During a crash a baby will become so heavy you can't hold it. For example, in a crash at only 25 mph (40 km/h), a 12-pound (5.5 kg) baby will suddenly become a 240-pound (110 kg) force on your arms. The baby would be almost impossible to hold.

CAUTION: (Continued)

**CAUTION:** (Continued)



**Secure the baby in an infant restraint.**



## ***CHILD RESTRAINTS***

Be sure to follow the instructions for the restraint. You may find these instructions on the restraint itself or in a booklet, or both. These restraints use the belt system in your vehicle, but the child also has to be secured within the restraint to help reduce the chance of personal injury. The instructions that come with the infant or child restraint will show you how to do that.

### ***Where to Put the Restraint***

Accident statistics show that children are safer if they are restrained in the rear rather than the front seat. We at General Motors therefore recommend that you put your child restraint in the rear seat. **NEVER** put a rear-facing child restraint in the front passenger seat. Here's why:

#### **CAUTION:**

**A child in a rear-facing child restraint can be seriously injured if the right-front passenger's air bag inflates. This is because the back of a rear-facing child restraint would be very close to the inflating air bag. If your vehicle has a right-front passenger's air bag, always secure a rear-facing child restraint in the rear seat.**

**You may secure a forward-facing child restraint in the right front seat. However, before securing a forward-facing child restraint, ALWAYS move the front passenger seat as far back as it will go. Or, secure the child restraint in the rear seat.**

#### **CAUTION:**

**A child in a child restraint in the front-center seat can be badly injured by the passenger air bag if it inflates. NEVER use a child restraint in the front-center seat. It's always better to secure a child restraint in the rear seat. You may, however, secure a forward-facing child restraint in the right-front passenger seat only with the seat moved all the way back.**

Wherever you install it, be sure to secure the child restraint properly.

**⚠ CAUTION:**

**An unsecured child restraint can move around in a collision or sudden stop and injure people in the vehicle. Be sure to properly secure any child restraint in your vehicle -- even when no child is in it.**

### *Top Strap*

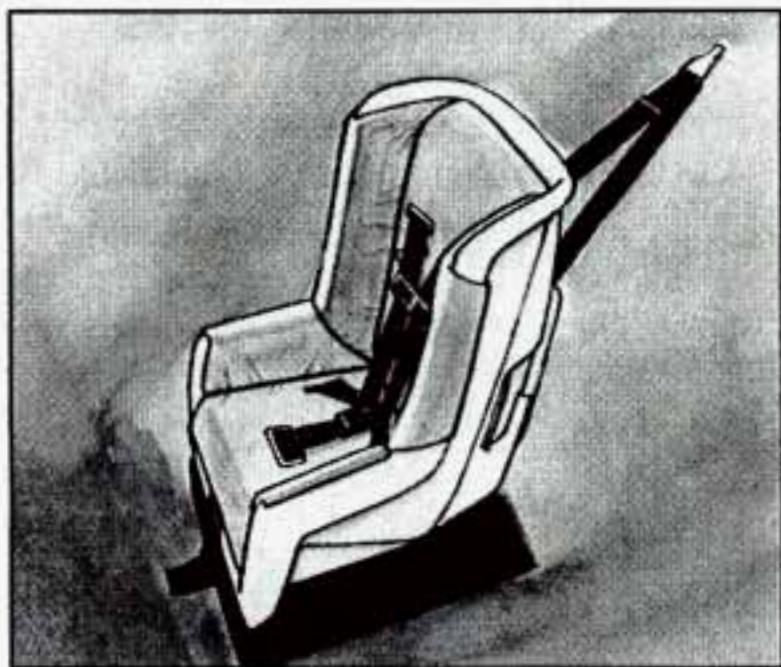

If your child restraint has a top strap, it should be anchored.

If you need to have an anchor installed, you can ask your Cadillac dealer to put it in for you. If you want to install an anchor yourself, your dealer can tell you how to do it.

Vehicles first sold in Canada have child restraint anchor bracket hardware in the glove box, along with instructions for installing it. This should be used only with a child restraint, and only to secure a child restraint at the center rear seating position. Additional anchor brackets for child restraints at one or both of the rear outside seating positions are available at Cadillac dealerships in Canada.

## ***Securing a Child Restraint in a Rear Outside Position***

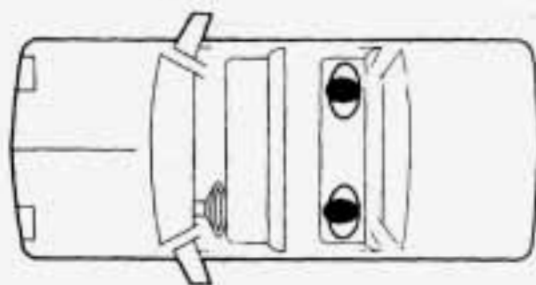

You'll be using the lap-shoulder belt. See the earlier section about the top strap if the child restraint has one.

1. Put the restraint on the seat. Follow the instructions for the child restraint.
2. Secure the child in the child restraint as the instructions say.
3. Pull out the vehicle's safety belt and run the lap part through or around the restraint. The child restraint instructions will show you how. Tilt the latch plate to adjust the belt if needed.

See if the shoulder belt would go in front of the child's face or neck. If so, put it behind the child restraint.



4. Buckle the belt. Make sure the release button faces upward or outward, so you'll be able to unbuckle it quickly if you ever need to.



5. To tighten the belt, pull up on the shoulder belt while you push down on the child restraint.



6. Push and pull the child restraint in different directions to be sure it is secure.

To remove the child restraint, just unbuckle the vehicle's safety belt and let it go back all the way. The safety belt will move freely again and be ready to work for an adult or larger child passenger.

### ***Securing a Child Restraint in the Center Rear Seat Position***

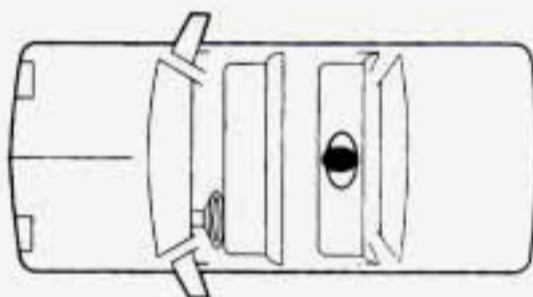

When you secure a child restraint in a center seating position, you'll be using the lap belt.

See the earlier section about the top strap if the child restraint has one.





1. Make the belt as long as possible by tilting the latch plate and pulling it along the belt.

2. Put the restraint on the seat. Follow the instructions for the child restraint.
3. Secure the child in the child restraint as the instructions say.
4. Run the vehicle's safety belt through or around the restraint. The child restraint instructions will show you how.



5. Buckle the belt. Make sure the release button faces upward or outward, so you'll be able to unbuckle it quickly if you ever need to.

6. To tighten the belt, pull its free end while you push down on the child restraint.
7. Push and pull the child restraint in different directions to be sure it is secure. If the child restraint isn't secure, turn the latch plate over and buckle it again. Then see if it is secure. If it isn't, secure the restraint in a different place in the vehicle and contact the child restraint maker for their advice.

To remove the child restraint, just unbuckle the vehicle's safety belt. It will be ready to work for an adult or larger child passenger.

## *Securing a Child Restraint in the Right Front Seat*

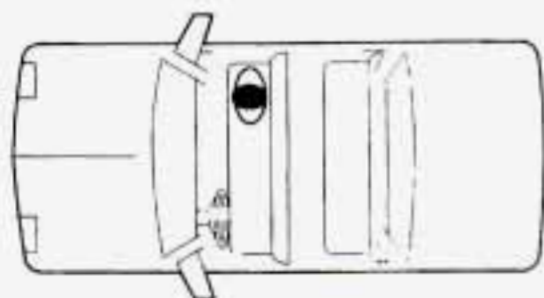

Your vehicle has a right-front passenger's air bag. **NEVER** put a rear-facing child restraint in this position. Here's why:

### **CAUTION:**

**A rear-facing child restraint in the front seat could be pushed into the seatback by the right front passenger's air bag if it inflates. A child in a rear-facing child restraint can be seriously injured if this happens. Always secure a rear-facing child restraint in the rear seat.**

You'll be using the lap-shoulder belt. See the earlier section about the top strap if the child restraint has one.

1. Always move the seat as far back as it will go before securing a front-facing child restraint.
2. Put the restraint on the seat. Follow the instructions for the child restraint.
3. Secure the child in the child restraint as the instructions say.



4. Pull out the vehicle's safety belt and run the lap part through or around the restraint. The child restraint instructions will show you how.

See if the shoulder belt would go in front of the child's face or neck. If so, put it behind the child restraint.

5. Buckle the belt.

Make sure the release button faces upward or outward, so you'll be able to unbuckle it quickly if you ever need to.



6. Pull the rest of the lap belt all the way out of the retractor to set the lock.



7. To tighten the belt, feed the lap belt back into the retractor while you push down on the child restraint.



8. Push and pull the child restraint in different directions to be sure it is secure.

To remove the child restraint, just unbuckle the vehicle's safety belt and let it go back all the way.

The safety belt will move freely again and be ready to work for an adult or larger child passenger.

## *Larger Children*



Children who have outgrown child restraints should wear the vehicle's safety belts.

If you have the choice, a child should sit next to a window so the child can wear a lap-shoulder belt and get the additional restraint a shoulder belt can provide.

Accident statistics show that children are safer if they are restrained in the rear seat. But they need to use the safety belts properly.

- Children who aren't buckled up can be thrown out in a crash.



- Children who aren't buckled up can strike other people who are.





 **CAUTION:**

Never do this.



Here two children are wearing the same belt. The belt can't properly spread the impact forces. In a crash, the two children can be crushed together and seriously injured. A belt must be used by only one person at a time.

**Q:** What if a child is wearing a lap-shoulder belt, but the child is so small that the shoulder belt is very close to the child's face or neck?

**A:** Move the child toward the center of the vehicle, but be sure that the shoulder belt still is on the child's shoulder, so that in a crash the child's upper body would have the restraint that belts provide. If the child is so small that the shoulder belt is still very close to the child's face or neck, you might want to place the child in the center seat position, the one that has only a lap belt.

**⚠ CAUTION:**

**Never do this.**



**Here a child is sitting in a seat that has a lap-shoulder belt, but the shoulder part is behind the child. If the child wears the belt in this way, in a crash the child might slide under the belt. The belt's force would then be applied right on the child's abdomen. That could cause serious or fatal injuries.**

Wherever the child sits, the lap portion of the belt should be worn low, snug below the hips, and just touching the child's thighs. This applies belt force to the child's pelvic bones in a crash.

## ***SAFETY BELT EXTENDER***

If the vehicle's safety belt will fasten around you, you should use it.

But if a safety belt isn't long enough to fasten, your dealer will order you an extender. It's free. When you go in to order it, take the heaviest coat you will wear, so the extender will be long enough for you. The extender will be just for you, and just for the seat in your vehicle that you choose. Don't let someone else use it, and use it only for the seat it is made to fit. To wear it, just attach it to the regular safety belt.

## ***CHECKING YOUR RESTRAINT SYSTEMS***

Now and then, make sure all your belts, buckles, latch plates, retractors, anchorages and reminder systems are working properly. Look for any loose parts or damage. If you see anything that might keep a restraint system from doing its job, have it repaired.

## ***REPLACING SAFETY BELTS AFTER A CRASH***

If you've had a crash, do you need new belts?

After a very minor collision, nothing may be necessary. But if the belts were stretched, as they would be if worn during a more severe crash, then you need new belts.

If belts are cut or damaged, replace them. Collision damage also may mean you will have to have safety belt parts, like the retractor, replaced or anchorage locations repaired -- even if the belt wasn't being used at the time of the collision.

**Q:** What's wrong with this?

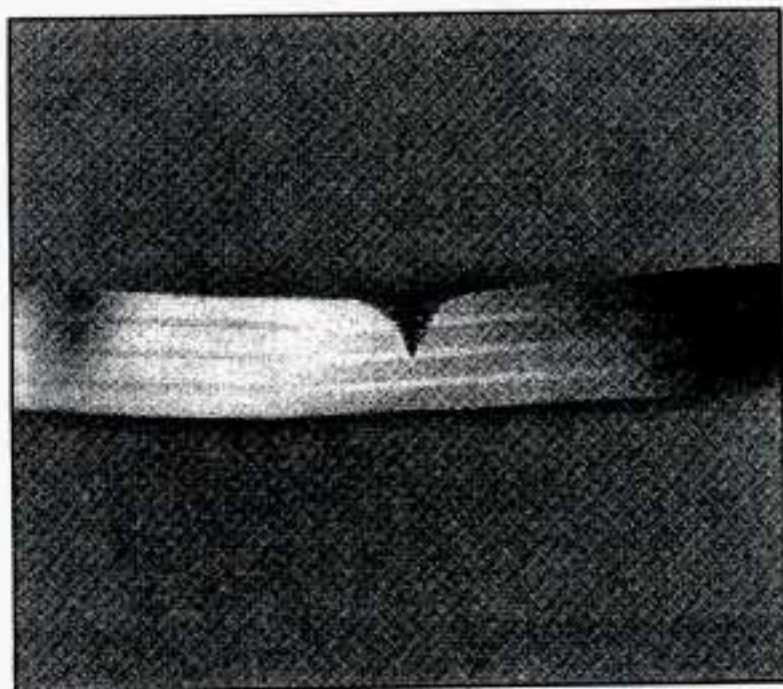

**A:** The belt is torn.

**⚠ CAUTION:**

**Torn or frayed belts may not protect you in a crash. They can rip apart under impact forces. If a belt is torn or frayed, get a new one right away.**



## SECTION 2

### FEATURES AND CONTROLS

Here you can learn about the many standard and optional features on your Cadillac, and information on starting, shifting and braking. Also explained are the instrument panel and the warning systems that tell you if everything is working properly -- and what to do if you have a problem.

### *KEYS*

#### CAUTION:

**Leaving young children in a vehicle with the ignition key is dangerous for many reasons. A child or others could be badly injured or even killed.**

**They could operate power windows or other controls or even make the vehicle move. If they turned the ignition to "ON" and moved the shift lever out of "P" (Park), that would release the parking brake. Don't leave the keys in a vehicle with young children.**





The square keys are for the ignition only. The round keys are for the doors and all other locks.



When a new Cadillac is delivered, the dealer removes the plugs from the keys, and gives them to the first owner.

Each plug has a code on it that tells your dealer or a qualified locksmith how to make extra keys. Keep the plugs in a safe place. If you lose your keys, you'll be able to have new ones made easily using these plugs.

## **NOTICE:**

**Your Cadillac has a number of new features that can help prevent theft. But you can have a lot of trouble getting into your vehicle if you ever lock your keys inside. You may even have to damage your vehicle to get in. So be sure you have extra keys.**

## ***DOOR LOCKS***

### **⚠ CAUTION:**

**Unlocked doors can be dangerous.**

**Passengers -- especially children -- can easily open the doors and fall out. When a door is locked, the inside handle won't open it.**

**Outsiders can easily enter through an unlocked door when you slow down or stop your vehicle.**

**This may not be so obvious: You are more likely to be thrown out of the vehicle in a crash if the doors aren't locked. Wear safety belts properly, lock your doors, and you will be far better off whenever you drive your vehicle.**

There are several ways to lock and unlock your vehicle:



From the outside: Use your door key.

If your vehicle has a theft deterrent system and it is armed, unlock the doors only with the key or Keyless Entry System. This will avoid setting off the alarm.

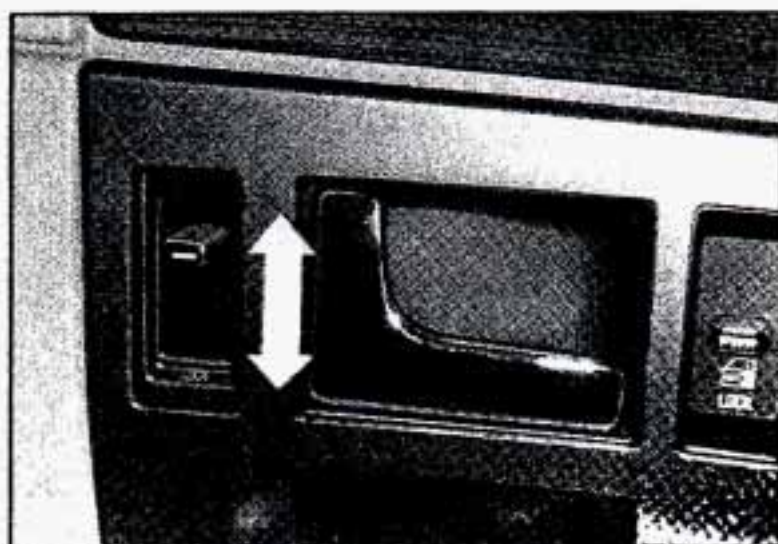

From the inside: To lock the door, slide the lock lever down to manually lock the door.

To unlock the door, slide the lock lever up.

### *Power Door Locks*

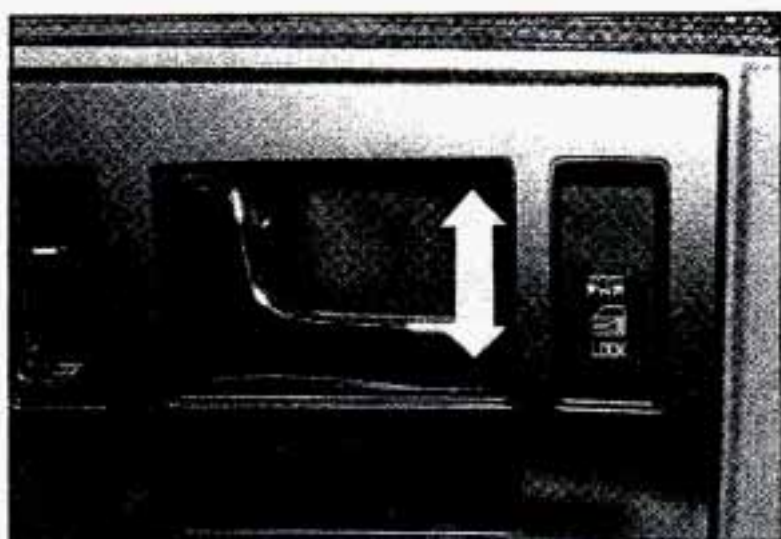

Push the power door lock switch to lock or unlock all the doors at once. The rear power door lock switches won't unlock any of the doors -- that's a safety feature.



## *Rear Door Security Lock*

Your Cadillac is equipped with rear door security locks that help prevent passengers from opening the rear doors of your car from the inside. To use this lock,



1. Move the lever on the door all the way up to the ENGAGED position.
2. Close the door.
3. Do the same thing to the other rear door lock.

The rear doors of your vehicle cannot be opened from the inside when this feature is in use.

When you want to open a rear door when the security lock is on:

1. Unlock the door from the inside.
2. Then open the door from the outside.

To cancel the rear door lock:

1. Unlock the door from the inside and open the door from the outside.
2. Move the lever all the way down.
3. Do the same for the other rear door.

The rear door locks will now work normally.

## ***Automatic Door Locks (Option)***

Just close your doors, turn on the ignition and make sure the interior courtesy lights are switched off. Every time you move your shift lever out of “P” (Park) all of the doors will lock. And, every time you stop and move your shift lever into “P” (Park), your doors will unlock. If someone needs to get out while you’re not in “P” (Park), have that person use the manual or power lock. When the door is closed again, it will not lock automatically. Just use the manual or power lock to lock the door again.

## ***Leaving Your Vehicle***

If you are leaving the vehicle, set the locks from inside, get out and close the door.

## ***Central Door Unlocking System (Option)***

Your vehicle may be equipped with this feature. When unlocking either door, you can unlock the other doors by holding the key in the turned position for a few seconds.

## ***Illuminated Entry System***

Your illuminated entry system turns on all the courtesy lights when either door is opened. When the door is closed, the courtesy lights will stay on for approximately 20 seconds or until the ignition is turned on.

## ***REMOTE KEYLESS ENTRY SYSTEM***

If your Cadillac has this option, you can lock and unlock your doors or unlock your trunk from up to 15 feet (4.5 m) using the key chain transmitter supplied with your vehicle.

Your Remote Keyless Entry System is intended to be used as a supplementary vehicle entry device. It is not intended to replace, but rather should be used in conjunction with a door lock key. It operates on a radio frequency subject to Federal Communications Commission (FCC) Rules.

This device complies with Part 15 of the FCC Rules. Operation is subject to the following two conditions: (1) This device may not cause harmful

interference, and (2) This device must accept any interference received, including interference that may cause undesired operation.

Should interference to this system occur, try this:

- Check to determine if battery replacement is necessary. See the instructions on battery replacement.
- Check the distance. You may be too far from your vehicle. This product has a maximum range.
- Check the location. Other vehicles or objects may be blocking the signal.
- See your Cadillac dealer or a qualified technician for service.

Changes or modifications to this system by other than an authorized service facility could void authorization to use this equipment.

## *Operation*



- Press this symbol to unlock the driver's door. Press it again within 4 seconds to unlock the other doors. Pressing this button will also disarm the Theft Deterrent System and turn on the interior lights.



- Press this symbol to lock your doors. This also arms the Theft Deterrent System.



- Press this symbol to open the trunk.



- Press this button to turn on the interior lights and door lock cylinder illumination.

### ***Matching Transmitter(s) To Your Vehicle***

Each key chain transmitter is coded to prevent another transmitter from unlocking your vehicle. If a transmitter is lost or stolen, a replacement can be purchased through your dealer. Remember to bring the remaining transmitter with you when you go to your dealer. When the dealer matches the replacement transmitter to your vehicle, the remaining transmitter must also be matched. Once the new transmitter is coded, the lost transmitter will not unlock your vehicle.

You can match a transmitter to as many different vehicles as you own, provided they are equipped with exactly the same model system. (General Motors offers several different models of these systems on their vehicles.) Each vehicle can have only 2 transmitters matched to it.

See your dealer to match transmitters to another vehicle.

### ***Battery Replacement***

Under normal use, the batteries in your key chain transmitter should last about two years.

You can tell the batteries are weak if the transmitter won't work at the normal range in any location. If you have to get close to your vehicle before the transmitter works, it's probably time to change the batteries.



1. Use round end of the door key, or a quarter to rotate cover counterclockwise 1/16 of a turn.



2. Remove battery and replace with CR2025 or equivalent. Using the wrong size battery can damage the transmitter.



3. Make sure battery is positioned with "+" facing cover.



4. Align notches on cover and transmitter and rotate clockwise to reinstall.

## ***CENTER CONSOLE***

Your vehicle is equipped with either the Mini Console or optional Full Console.

The mini console comes with a storage tray and a flip up arm rest door with dual cup holder, that opens to a storage compartment.

The full console includes a floor shift lever along with a flip up arm rest door with a dual cup holder, that opens to a storage compartment.

## ***GLOVE BOX***

The glove box is directly in front of the front passenger seat. To unlock the door, insert the oval key into the lock cylinder and turn it to the left. An additional quarter turn will open the door. To lock the door, turn the key to the right and remove the key. The key may be removed in the locked or unlocked position.

## ***REMOTE TRUNK RELEASE***

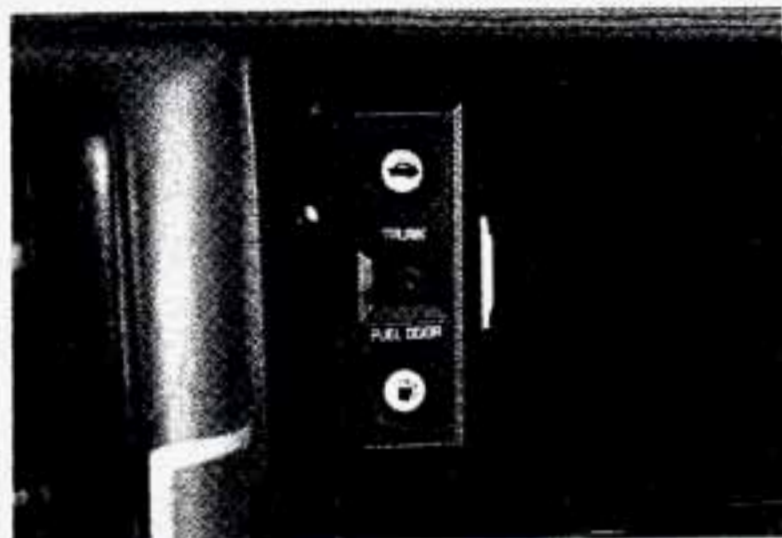

You'll find the button here in the glove box.

## ***AUTOMATIC PULL-DOWN FEATURE***

### **⚠ CAUTION:**

Your car has an automatic pull-down feature that helps close the trunk electronically. Your fingers can be trapped under the trunk lid as it goes down. Your fingers could be injured, and you would need someone to help you free them. Keep your fingers away from the trunk lid as you close it and as it is going down.

### **NOTICE:**

Don't slam your trunk lid down. If you slam it, you can damage the Pull Down system.



## ***THEFT***

Vehicle theft is big business, especially in some cities. Although your Cadillac has a number of theft deterrent features, we know that nothing we put on it can make it impossible to steal. However, there are ways you can help.

**Key in the ignition:** If you walk away from your vehicle with the keys inside, it's an easy target for joy riders or professional thieves -- so don't do it.

When you park your Cadillac and open the driver's door, you'll hear a chime reminding you to remove your key from the ignition and take it with you. Always do this. Your steering wheel will be locked, and so will your ignition and transaxle. And remember to lock the doors.

**Parking at Night:** Park in a lighted spot, close all windows and lock your vehicle. Remember to keep your valuables out of sight. Put them in a storage area, or take them with you.

**Parking Lots:** If you park in a lot where someone will be watching your vehicle, it's best to lock it up and take your keys. But what if you have to leave your ignition key? What if you have to leave something valuable in your vehicle?

- Put your valuables in a storage area, like your trunk or glove box.
- Lock the glove box.
- Lock all the doors except the driver's.
- Then take the door key with you.

## ***THEFT DETERRENT (OPTION)***



**SECURITY**

If your Cadillac has this option, it has a Theft Deterrent Alarm System. With this system, the “SECURITY” light will flash as you open the door (if your ignition is off).

This light reminds you to arm the theft deterrent system. Here’s how to do it:

1. Open the door.
2. Lock the door with the power door lock switch or Keyless Entry System. The “SECURITY” light should come on and stay on.
3. Close all doors. The “SECURITY” light should go off.

If a door or the trunk is opened without the key or Keyless Entry System, the alarm will go off. It will also go off if the trunk lock is damaged. Your vehicle’s lights will flash and the horn will sound for 3 minutes, then will go off to save battery power.

Remember, the theft deterrent system won’t arm if you lock the doors with a key or manual door lock. It arms only if you use a power door lock switch or Keyless Entry System.

Here’s how to avoid setting off the alarm by accident:

- If you don’t want to arm the theft deterrent system, the vehicle should be locked with the door key after the doors are closed.
- Always unlock a door with a key, or use the Keyless Entry System. Unlocking a door any other way will set off the alarm.

If you set off the alarm by accident, unlock any door with your key. You can also turn off the alarm by using the Keyless Entry System, if you have it. The alarm won't stop if you try to unlock a door any other way.

### ***How to Test The Alarm***

- Roll down your window and lock your vehicle using the power door lock or the Keyless Entry System.
- Reach in and unlock the door using the manual lock, and open the door. The horn will sound and your headlights will flash.

If the alarm does not sound when it should, check to see if the horn works. The horn fuse may be blown. To replace the fuse, see "Fuses and Circuit Breakers" in the Index.

To reduce the possibility of theft, always arm the theft deterrent system when leaving your vehicle.

### ***PASS-KEY II™***

Your vehicle is equipped with the PASS-Key II™ (Personalized Automotive Security System) theft deterrent system. PASS-Key II™ is a passive theft deterrent system. This means you don't have to do anything different to arm or disarm the system. It works when you insert or remove the key from the ignition. PASS-Key™ uses a resistor pellet in the ignition key that matches a decoder in your vehicle.

When the PASS-Key II™ system senses that someone is using the wrong key, it shuts down the vehicle's starter and fuel systems. For about three minutes, the starter won't work and fuel won't go to the engine. If someone tries to start your vehicle again or uses another key during this time, the vehicle will not start. This discourages someone from randomly trying different keys with different resistor pellets in an attempt to make a match.

The ignition key must be clean and dry before it's inserted in the ignition or the engine may not start. If the "SECURITY" light comes on, the key may be dirty or wet.

If this happens and the starter won't work, turn the ignition off. Clean and dry the key. Wait about three minutes and try again. The security light will remain on during this time. If the starter still won't work, and

the key appears to be clean and dry, wait about three minutes and try the other ignition key. At this time, you may also want to check the fuse (see "Fuses and Circuit Breakers" in the Index). If the starter won't work with the other key, your vehicle needs service. If your vehicle does start, the first ignition key may be faulty. See your Cadillac dealer or a locksmith who can service the PASS-Key II™.

However, if you accidentally use a key that has a damaged or missing resistor pellet, the starter won't work, the security light will flash. But you don't have to wait three minutes before trying one of the ignition keys.

If the resistor pellet is damaged or missing, the starter won't work. Use the other ignition key, and see your Cadillac dealer or a locksmith who can service the Pass-Key II™ to have a new key made.

If you're ever driving and the "SECURITY" light comes on and continues to flash, you get the PASS-KEY MALFUNCTION message, and the "STARTING DISABLED" message appears, you will be able to restart your engine if you turn it off. Your PASS-Key II™ system, however, is not working properly and must be serviced by your Cadillac dealer. Your vehicle is not protected by the PASS-Key II™ system.

If you lose or damage a PASS-Key II™ ignition key, see your Cadillac dealer or a locksmith who can service PASS-Key II™ to have a new key made.

## ***NEW VEHICLE “BREAK-IN”***

### **NOTICE:**

Your modern Cadillac doesn't need an elaborate “break-in.” But it will perform better in the long run if you follow these guidelines:

- Don't drive at any one speed -- fast or slow -- for the first 500 miles (804 km). Don't make full-throttle starts.
- Avoid making hard stops for the first 200 miles (322 km) or so. During this time your new brake linings aren't yet broken in. Hard stops with new linings can mean premature wear and earlier replacement. Follow this “breaking-in” guideline every time you get new brake linings.

## ***IGNITION KEY POSITIONS***

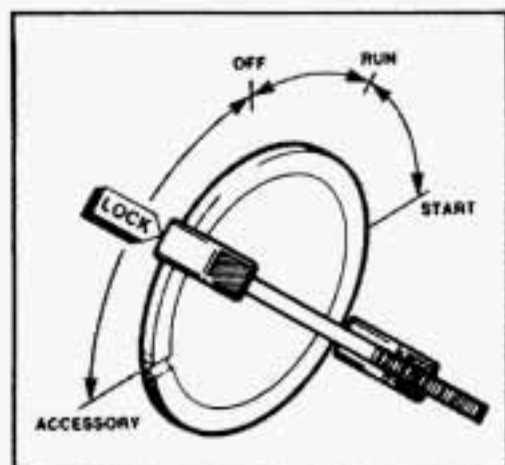

This lock gives you five different positions.

Before you put the key in, your ignition will be in the “LOCK” position. This position locks your ignition, steering wheel and transaxle. It's an anti-theft feature.

The other positions let you perform these functions:

**ACC:** Accessory lets you use things like the radio and the windshield wipers when the engine is off. To get into "Acc", push in the key and turn it toward you. Your steering wheel will remain locked, just as it was before you inserted the key.

**OFF:** This position lets you turn off the engine but still turn the steering wheel. It doesn't lock the steering wheel like "Lock." Use "Off" if you must have your car in motion while the engine is off (for example, if your car is being pushed).

**RUN:** This is the position for driving.

**START:** This starts your engine.

### **NOTICE:**

**If your key seems stuck in "Lock" and you can't turn it, be sure it is all the way in. If it is, then turn the steering wheel left and right while you turn the key hard. But turn the key only with your hand. Using a tool to force it could break the key or the ignition switch. If none of this works, then your vehicle needs service.**

## ***STARTING YOUR ENGINE***

Engines start differently. The 8th digit of your Vehicle Identification Number (VIN) shows the code letter or number for your engine. You will find the VIN at the top left of your instrument panel. (See "Vehicle Identification Number" in the Index.) Follow the proper steps to start the engine.

Move your shift lever to "P" (Park) or "N" (Neutral). Your engine won't start in any other position -- that's a safety feature. To restart when you're already moving, use "N" (Neutral) only.

## **NOTICE:**

**Don't try to shift to "P" (Park) if your Cadillac is moving. If you do, you could damage the transaxle. Shift to "P" (Park) only when your vehicle is stopped.**

1. Don't push the accelerator pedal before starting your engine. In some other vehicles you might need to do this, but because of your vehicle's computer systems, you don't.
2. Turn your ignition key to "Start." When the engine starts, let go of the key. The idle speed will go down as your engine gets warm.
3. If it doesn't start right away, hold your key in "Start " for about three seconds at a time until your engine starts. Wait about 15 seconds between each try to help avoid draining your battery.

## **NOTICE:**

**Holding your key in "Start" for longer than 15 seconds at a time will cause your battery to be drained much sooner. And the excessive heat can damage your starter motor.**

4. If your engine still won't start (or starts but then stops), it could be flooded with too much gasoline. Try pushing your accelerator pedal all the way to the floor and holding it there as you hold the key in "Start" for about three seconds. If the vehicle starts briefly but then stops again, do the same thing, but this time keep the pedal down for five or six seconds. This clears the extra gasoline from the engine.

## **NOTICE:**

**Your engine is designed to work with the electronics in your vehicle. If you add electrical parts or accessories, you could change the way the fuel injection system operates. Before adding electrical equipment, check with your dealer. If you don't, your engine might not perform properly.**

**If you ever have to have your vehicle towed, see the part of this Manual that tells how to do it without damaging your vehicle. See "Towing Your Vehicle" in the Index.**

## ***ENGINE BLOCK HEATER (OPTION)***

In very cold weather, 0°F (-18°C) or colder, the engine block heater can help. You'll get easier starting and better fuel economy during engine warm-up.

### To use the block heater:

1. Turn off the engine.
2. Open the hood and unwrap the electrical cord.
3. Plug it into a normal, grounded 110-volt outlet.



## **CAUTION:**

**Plugging the cord into an ungrounded outlet could cause an electrical shock. Also, the wrong kind of extension cord could overheat and cause a fire. You could be seriously injured. Plug the cord into a properly grounded three-prong 110-volt outlet. If the cord won't reach, use a heavy-duty three-prong extension cord rated for at least 15 amps.**



## **NOTICE:**

**After you've used the block heater, be sure to store the cord as it was before, to keep it away from moving engine parts. If you don't, it could be damaged.**

How long should you keep the block heater plugged in? The answer depends on the weather, the kind of oil you have, and some other things. Instead of trying to list everything here, we ask that you contact a Cadillac dealer in the area where you'll be parking your vehicle. The dealer can give you the best advice for that particular area.

## ***DRIVING THROUGH DEEP STANDING WATER***

### **NOTICE:**

**If you drive too quickly through deep puddles or standing water, water can come in through your engine's air intake and badly damage your engine. If you can't avoid deep puddles or standing water, drive through them very slowly.**

## ***AUTOMATIC TRANSAXLE***

Your automatic transaxle may have either a shift lever located on the steering column or on the console between the seats.

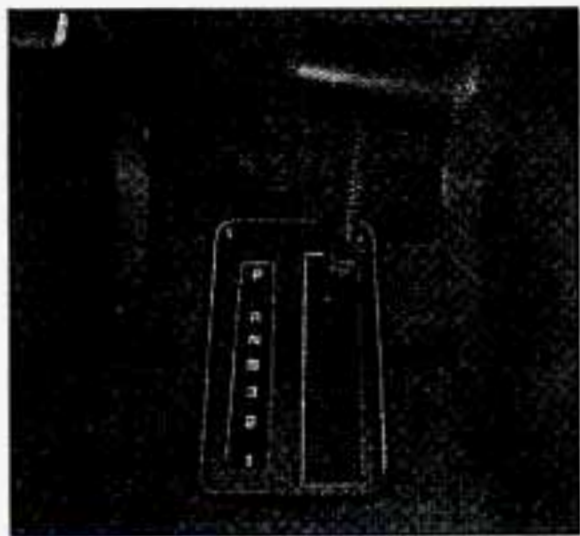
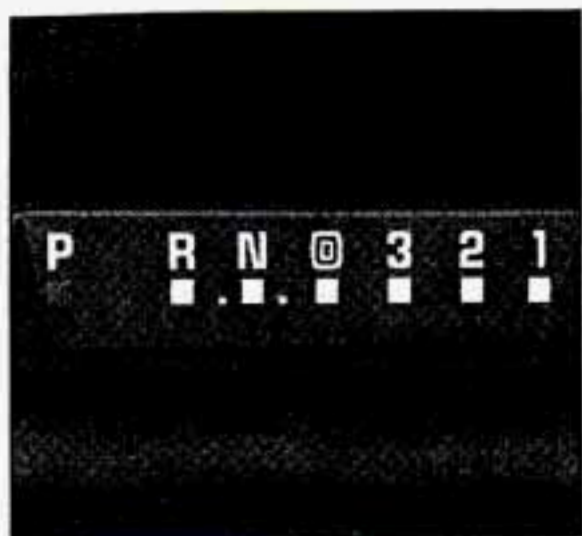

There are several different positions for your shift lever.

P	.....	Park
R	.....	Reverse
N	.....	Neutral
⓪	.....	Overdrive
3	.....	Third Gear (Drive)
2	.....	Second Gear
1	.....	First Gear

● **P (Park)**

This locks your front wheels. It's the best position to use when you start your engine because your vehicle can't move easily.



**CAUTION:**

**It can be dangerous to get out of your vehicle if the shift lever is not fully in "P" (Park) with the parking brake firmly set. Your vehicle can roll.**

CAUTION: (Continued)

**CAUTION:** (Continued)

**Don't leave your vehicle when the engine is running unless you have to. If you have left the engine running, the vehicle can move suddenly. You or others could be injured. To be sure your vehicle won't move, when you're on fairly level ground, always set your parking brake and move the shift lever to "P" (Park).**

**See "Shifting Into "P" (Park)" in the Index. If you are parking on a hill, or if you're pulling a trailer, also see "Parking on Hills" or "Towing a Trailer" in the Index.**

Ensure the shift lever is fully in "P" (Park) range before starting the engine. Your Cadillac has a brake-transaxle shift interlock. You have to fully apply your regular brakes before you can shift from "P" (Park) when the ignition key is in the "Run" position. If you cannot shift out of "P" (Park), ease pressure on the shift lever - push the shift lever all the way into "P" (Park) and also release the shift lever button on floor shift console models as you maintain brake application. Then move the shift lever into the gear you wish. (Press the shift lever button before moving the shift lever on floor shift console models.) See "Shifting Out of 'P' (Park)" in this section.

- **R (Reverse)**

Use this gear to back up.

**NOTICE:**

**Shifting to "R" (Reverse) while your vehicle is moving forward could damage your transaxle. Shift to "R" only after your vehicle is stopped.**

To rock your vehicle back and forth to get out of snow, ice or sand without damaging your transaxle, see "If You're Stuck in Sand, Mud, Ice or Snow" in the Index.

- **N (Neutral)**

In this position, your engine doesn't connect with the wheels. To restart when you're already moving, use "N" (Neutral) only. Also, use "N" when your vehicle is being towed.



**CAUTION:**

Shifting out of "P" (Park) or "N" (Neutral) while your engine is "racing" (running at high speed) is dangerous. Unless your foot is firmly on the brake pedal, your vehicle could move very rapidly. You could lose control and hit people or objects. Don't shift out of "P" (Park) or "N" (Neutral) while your engine is racing.

**NOTICE:**

Damage to your transaxle caused by shifting out of "P" (Park) or "N" (Neutral) with the engine racing isn't covered by your warranty.

- **ⓓ Automatic Overdrive**

This position is for normal driving. If you need more power for passing, and you're:

- Going less than about 35 mph (56 km/h), push your accelerator pedal about halfway down.
- Going about 35 mph (56 km/h) or more, push the accelerator all the way down.

You'll shift down to the next gear and have more power.

## **NOTICE:**

**If your vehicle seems to start up rather slowly, or if it seems not to shift gears as you go faster, something may be wrong with a transaxle system sensor. If you drive very far that way, your vehicle can be damaged. So, if this happens, have your vehicle serviced right away. Until then, you can use “2” (Second Gear) when you are driving less than 35 mph (56 km/h) and Ⓣ (Overdrive) for higher speeds.**

### ● 3 (Third Gear)

This is like Ⓣ, but you never go into Overdrive.

Here are some times you might choose “3” instead of Ⓣ:

- When driving on hilly, winding roads
- When towing a trailer, so there is less shifting between gears
- When going down a steep hill

### ● 2 (Second Gear)

This position gives you more power but lower fuel economy. You can use “2” on hills. It can help control your speed as you go down steep mountain roads, but then you would also want to use your brakes off and on.

## **NOTICE:**

**Don't drive in “2” (Second Gear) for more than 5 miles (8 km), or at speeds over 55 mph (88 km/h), or you can damage your transaxle. Use “Ⓣ” or “3” as much as possible.**

**Don't shift into “2” unless you are going slower than 65 mph (105 km/h), or you can damage your engine.**

- **1 (First Gear)**

This position gives you even more power (but lower fuel economy) than "2." You can use it on very steep hills, or in deep snow or mud. If the selector lever is put in "1," the transaxle won't shift into first gear until the vehicle is going slowly enough.

**NOTICE:**

**If your front wheels can't rotate, don't try to drive. This might happen if you were stuck in very deep sand or mud or were up against a solid object. You could damage your transaxle.**

**Also, if you stop when going uphill, don't hold your vehicle there with only the accelerator pedal. This could overheat and damage the transaxle. Use your brakes to hold your vehicle in position on a hill.**

## ***PARKING BRAKE***



**To set the parking brake:**

Hold the regular brake pedal down with your right foot. Push down the parking brake pedal with your left foot. If the ignition is on, the brake system warning light will come on.



When you move out of “P” (Park) or “N” (Neutral), if your engine is running, your parking brake should go off. If it doesn’t, you have a parking brake problem and should have it fixed. In the meantime, you can still release your parking brake. Just pull on the manual release lever, as shown.

 **CAUTION:**

**If your hand or arm is in the way of the pedal, you could be hurt. The pedal springs back quickly. Keep your hand and arm away when you use the manual release lever.**

**NOTICE:**

**Driving with the parking brake on can cause your rear brakes to overheat. You may have to replace them, and you could also damage other parts of your vehicle.**

If you are on a hill: See “Parking on Hills” in the Index. That section shows how to turn your front wheels.

If you are towing a trailer and are parking on any hill: See “Towing a Trailer” in the Index. That section shows what to do first to keep the trailer from moving.

## ***SHIFTING INTO “P” (PARK)***

### **⚠ CAUTION:**

It can be dangerous to get out of your vehicle if the shift lever is not fully in “P” (Park) with the parking brake firmly set. Your vehicle can roll.

If you have left the engine running, the vehicle can move suddenly. You or others could be injured. To be sure your vehicle won't move, when you're on fairly level ground, use the steps that follow. If you are parking on a hill, or if you're pulling a trailer, also see “Parking On Hills” or “Towing a Trailer” in the Index.

### ***Steering Column Shift Lever***

1. Hold the brake pedal down with your right foot.
2. Move the shift lever into “P” (Park) position like this:



- Pull the lever toward you.



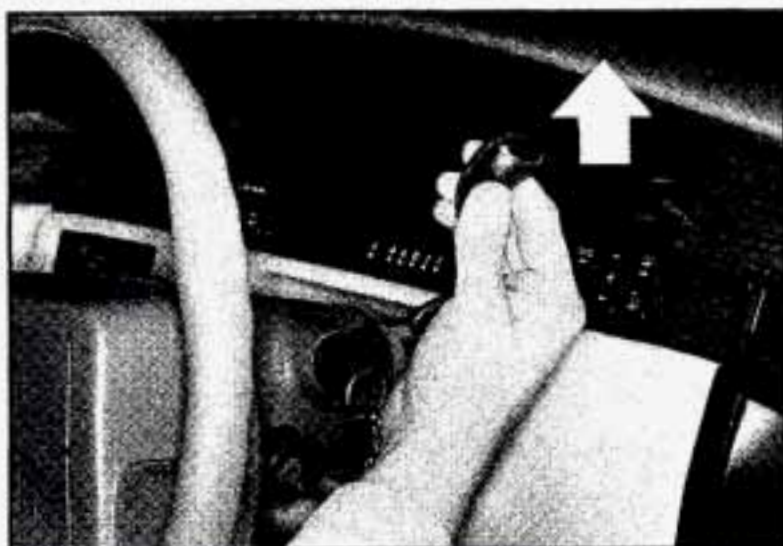

- Move the lever up as far as it will go.

3. With your right foot still holding the brake pedal down, set the parking brake.
4. Move the ignition key to "Lock."
5. Remove the key and take it with you. If you can walk away from your vehicle with the ignition key in your hand, your vehicle is in "P" (Park).

### ***Console Shift Lever***

1. Hold the brake pedal down with your right foot.

2. Move the shift lever into "P" (Park) position like this:



- Hold in the button on the lever, and push the lever all the way toward the front of your vehicle.

3. With your right foot still holding the brake pedal down, set the parking brake.
4. Move the ignition key to "Lock."
5. Remove the key and take it with you. If you can walk away from your vehicle with the ignition key in your hand, your vehicle is in "P" (Park).

### *Leaving Your Vehicle With the Engine Running*

#### **CAUTION:**

**It can be dangerous to leave your vehicle with the engine running. Your vehicle could move suddenly if the shift lever is not fully in "P" (Park) with the parking brake firmly set. And, if you leave the vehicle with the engine running, it could overheat and even catch fire. You or others could be injured. Don't leave your vehicle with the engine running unless you have to.**

If you have to leave your vehicle with the engine running, be sure your vehicle is in "P" (Park) and your parking brake is firmly set before you

leave it. After you've moved the shift lever into the "P" (Park) position, hold the regular brake pedal down. Then, see if you can move the shift lever away from "P" (Park) without first pulling it toward you (or, if you have the console shift lever, without first pushing the button). If you can, it means that the shift lever wasn't fully locked into "P" (Park).

## ***SHIFTING OUT OF "P" (PARK)***

Your Cadillac has a brake-transaxle shift interlock. You have to fully apply your regular brake before you can shift from "P" (Park) when the ignition is in the "Run" position. See "Automatic Transaxle" in the Index.

If you cannot shift out of "P" (Park), ease pressure on the shift lever -- push the shift lever all the way into "P" (Park) and also release the shift lever button on floor shift console models as you maintain brake application. Then move the shift lever into the gear you wish. (Press the shift lever button before moving the shift lever.) If you ever hold the brake pedal down but still can't shift out of "P" (Park), try this:

1. Turn the key to "Off." Open and close the driver's door to turn off the Retained Accessory Power feature.
2. Apply and hold the brake until the end of Step 4.
3. Shift to "N" (Neutral).
4. Start the vehicle and then shift to the drive gear you want.
5. Have the vehicle fixed as soon as you can.

## ***PARKING OVER THINGS THAT BURN***



 **CAUTION:**

Things that can burn could touch hot exhaust parts under your vehicle and ignite. Don't park over papers, leaves, dry grass or other things that can burn.

## ***ENGINE EXHAUST***

### **CAUTION:**

Engine exhaust can kill. It contains the gas carbon monoxide (CO), which you can't see or smell. It can cause unconsciousness and death.

You might have exhaust coming in if:

- Your exhaust system sounds strange or different.
- Your vehicle gets rusty underneath.
- Your vehicle was damaged in a collision.
- Your vehicle was damaged when driving over high points on the road or over road debris.
- Repairs weren't done correctly.
- Your vehicle or exhaust system had been modified improperly.

If you ever suspect exhaust is coming into your vehicle:

- Drive it only with all the windows down to blow out any CO; and
- Have it fixed immediately.

## ***RUNNING YOUR ENGINE WHILE YOU'RE PARKED***

It's better not to park with the engine running. But if you ever have to, here are some things to know.

### **CAUTION:**

Idling the engine with the air system control off could allow dangerous exhaust into your vehicle (see the earlier Caution under "Engine Exhaust").

Also, idling in a closed-in place can let deadly carbon monoxide (CO) into your vehicle even if the fan switch is at the highest setting. One place this can happen is a garage. Exhaust -- with CO -- can come in easily. NEVER park in a garage with the engine running.

Another closed-in place can be a blizzard. (See "Blizzard" in the Index.)

It can be dangerous to get out of your vehicle if the shift lever is not fully in "P" (Park) with the parking brake firmly set. Your vehicle can roll. Don't leave your vehicle when the engine is running unless you have to. If you've left the engine running, the vehicle can move suddenly. You or others could be injured. To be sure your vehicle won't move, even when you're on fairly level ground, always set your parking brake and after you move the shift lever to "P" (Park).

If you are parking on a hill, or if you're pulling a trailer, also see "Parking on Hills" or "Towing a Trailer" in the Index.

## ***POWER WINDOWS***

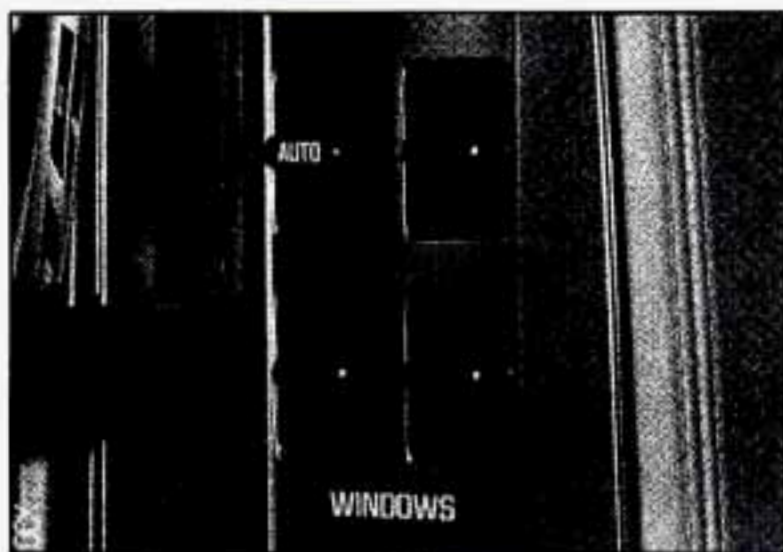

The controls are near each window. Here's how the master control works.

Your vehicle has Retained Accessory Power (RAP). When you stop your vehicle and turn the ignition key to "Off", you can still use your power windows. The electrical power to operate the windows will not shut off until you open a door or 10 minutes has passed. If you want this power for another 10 minutes, just turn the key to "Run" and back to "Off".

### ***Express Down Window***

The driver's power window has this feature. Just press the switch once -- for half a second or more -- and then let go. The window will go all the way down. If you want to stop the window as it is going down, press the switch again.

## ***HORN***

To sound the horn, just press the center of the steering wheel.

## *TILT WHEEL*



A tilt steering wheel allows you to adjust the steering wheel before you drive.

You can also raise it to the highest level to give your legs more room when you exit and enter the vehicle.

To tilt the wheel, hold the steering wheel and pull the lever. Move the steering wheel to a comfortable level, then release the lever to lock the wheel in place.



## ***THE TURN SIGNAL/MULTIFUNCTION LEVER***



The lever on the left side of the steering column includes your:

- Turn Signal and Lane Change Indicator
- Headlight High-Low Beam
- Flash-To-Pass Feature
- Headlamp Washers (Export Only)
- Windshield Wipers
- Windshield Washer
- Cruise Control

## Turn Signal and Lane Change Indicator

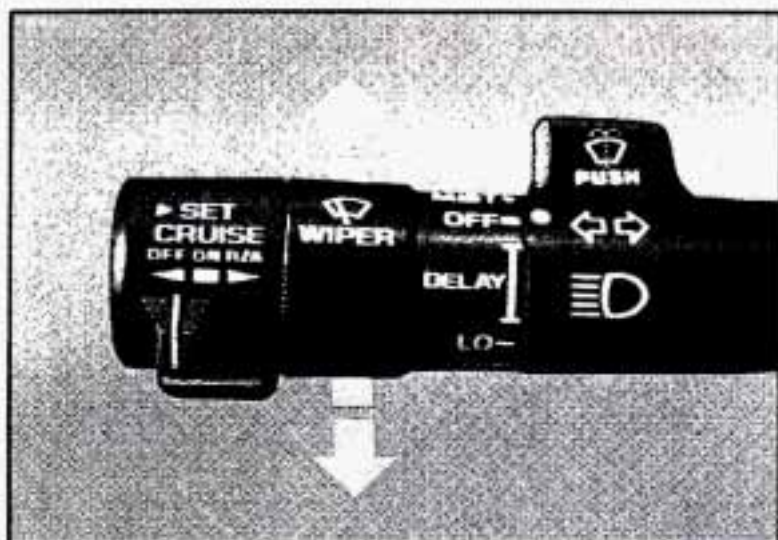

The turn signal has two upward (for Right) and two downward (for Left) positions. These positions allow you to signal a turn or a lane change.

To signal a turn, move the lever all the way up or down. When the turn is finished, the lever will return automatically.



A green arrow on the instrument panel will flash in the direction of the turn or lane change.

To signal a lane change, just raise or lower the lever until the green arrow starts to flash. Hold it there until you complete your lane change. The lever will return by itself when you release it.

If for some reason your turn signal is left on, the Driver Information Center will display "TURN SIGNAL ON" (after driving about a mile) to remind you to turn it off.

As you signal a turn or a lane change, if the arrows don't flash but just stay on, a signal bulb may be burned out and other drivers won't see your turn signal.

If a bulb is burned out, replace it to help avoid an accident. If the green arrows don't go on at all when you signal a turn, check the fuse (see "Fuses" in the Index) and for burned-out bulbs.

## ***Headlight High-Low Beam***



To change the headlights from low beam to high or high to low, pull the turn signal lever all the way toward you. Then release it. When the high beams are on, a blue light on the instrument panel also will be on.

## ***Flash-To-Pass Feature***

This lets you use your high beam headlights to signal a driver in front of you that you want to pass. It works even if your headlights are off.

To use it, pull the multifunction lever toward you. When you do:

**If your headlights are off:** Your high beam headlights will turn on. They'll stay on as long as you hold the lever there. Release the lever to turn them off.

**If your headlights are on, but on low beam:** The system works normally. Just pull the lever. Your headlights will shift to high beam and stay there. To return to low beam, just pull the lever toward you.

**If your headlights are on, and on high beam:** Your headlights will switch to low beam. To get back to high beam, pull the lever toward you.

## Windshield Wipers

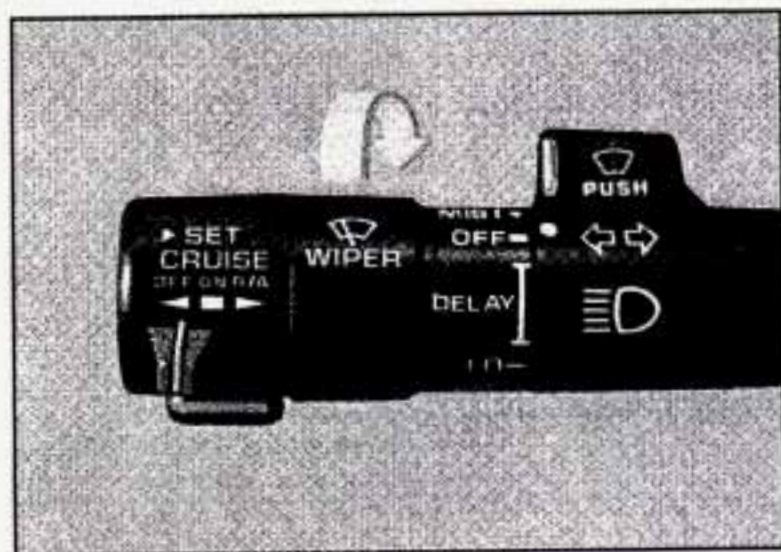

**WIPER:** To control the wipers, turn the band on the multifunction lever.

**MIST:** Turn the band away from you and then release it for a single wipe cycle. For more cycles, hold the band on MIST longer.

**LO or HI:** Turn the band toward you to either LO (low speed) or to HI (high speed), depending on the wiper speed you want.

**DELAY:** With this you can set the wiper speed for a long or short delay between wipes. Move the band to ON for long delays and the closer you get to LO the shorter the delay.

**OFF:** To turn the wipers off, turn the band to OFF.

### **CAUTION:**

Damaged wiper blades may prevent you from seeing well enough to drive safely. To avoid damage, be sure to clear ice and snow from the wiper blades before using them. If they're frozen to the windshield, carefully loosen or thaw them. If your blades do become damaged, get new blades or blade inserts.

Heavy snow or ice can overload your wipers. A circuit breaker will stop them until the motor cools. Clear away snow or ice to prevent an overload.

## *Windshield Washer*

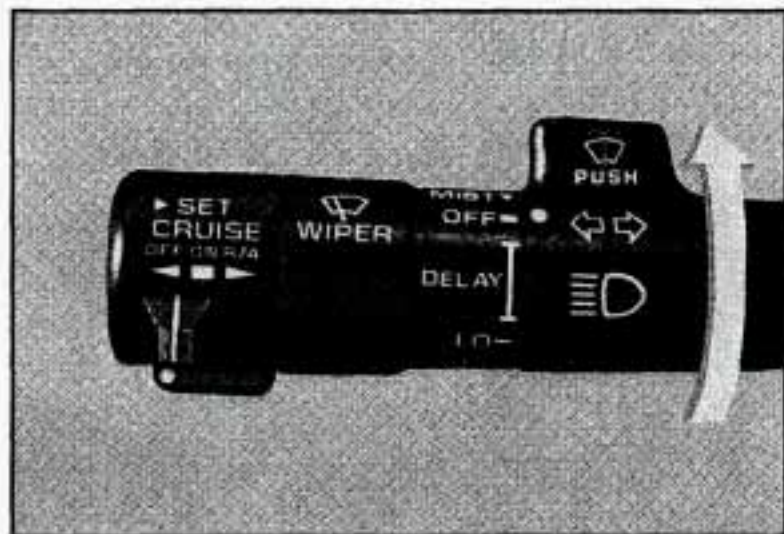

To wash your windshield push the paddle labeled **PUSH**, then release it. After washing the windshield the wipers will stop, unless you were using your wipers. If you were, the wipers will resume the wiper speed you were using. For more washer cycles push and hold the paddle.

When the washer fluid reaches a low level, “**LOW WASHER FLUID**” will be displayed in the Driver Information Center.

### **CAUTION:**

- **Driving without washer fluid can be dangerous. A bad mud splash can block your vision. You could hit another vehicle or go off the road. Check your washer fluid level often.**
- **In freezing weather, don't use your washer until the windshield is warmed. Otherwise the washer fluid can form ice on the windshield, blocking your vision.**

## **NOTICE:**

- **When using concentrated washer fluid, follow the manufacturer's instructions for adding water.**
- **Don't mix water with ready-to-use washer fluid. Water can cause the solution to freeze and damage your washer fluid tank and other parts of the washer system. Also, water doesn't clean as well as washer fluid.**
- **Fill your washer fluid tank only 3/4 full when it's very cold. This allows for expansion, which could damage the tank if it is completely full.**
- **Don't use radiator antifreeze in your windshield washer. It can damage your paint.**

### ***Headlight Washer (Export Only)***

If you have this feature, you will wash your headlights while washing your windshield at the same time in bad weather. Just press the PUSH paddle on the multifunction lever.

## ***CRUISE CONTROL***

With Cruise Control, you can maintain a speed of about 25 mph (40 km/h) or more without keeping your foot on the accelerator. This can really help on long trips. Cruise Control does not work at speeds below about 25 mph (40 km/h).

When you apply your brakes, the Cruise Control shuts off.

**⚠ CAUTION:**

- **Cruise Control can be dangerous where you can't drive safely at a steady speed. So, don't use your Cruise Control on winding roads or in heavy traffic.**
- **Cruise Control can be dangerous on slippery roads. On such roads, fast changes in tire traction can cause needless wheel spinning, and you could lose control. Don't use Cruise Control on slippery roads.**

*To Set Cruise Control*

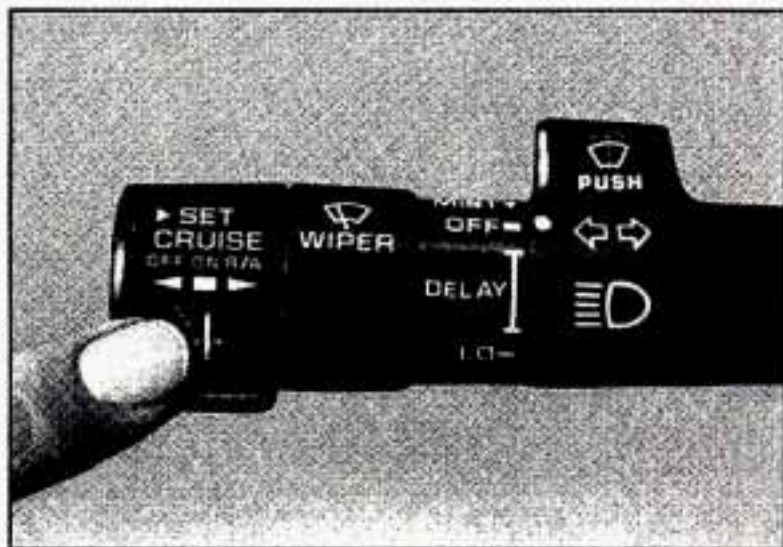

1. Move the Cruise Control switch to "ON."

**⚠ CAUTION:**

**If you leave your Cruise Control switch on when you're not using Cruise, you might hit a button and go into Cruise when you don't want to. You could be startled and even lose control. Keep the Cruise Control switch "OFF" until you want to use it.**

2. Get up to the speed you want.

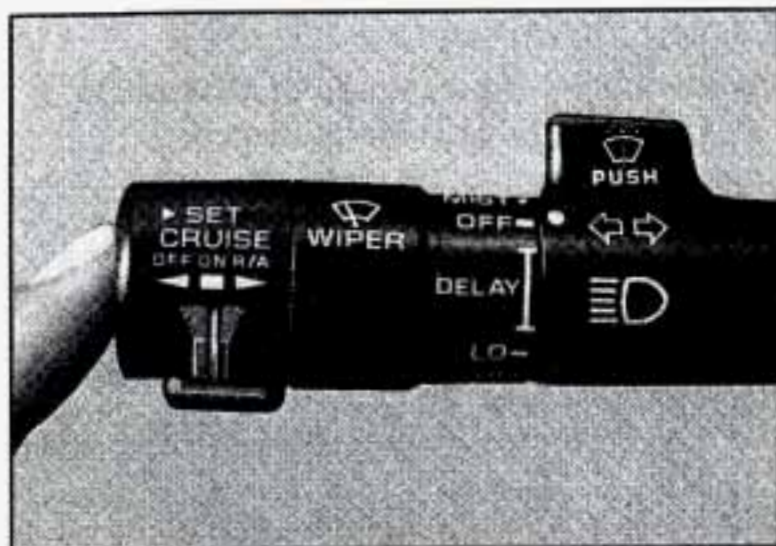

3. Push in the button at the end of the lever and release it.



4. The digital instrument panel cluster has a "CRUISE ENGAGED" light that will come on. There is no light on the analog cluster.

5. Take your foot off the accelerator pedal.

### *To Resume a Set Speed*

Suppose you set your Cruise Control at a desired speed and then you apply the brake. This, of course, shuts off the Cruise Control. But you don't need to reset it. Once you're going about 25 mph (40 km/h) or more, you can move the Cruise Control switch from "ON" to "R/A" for about half a second.



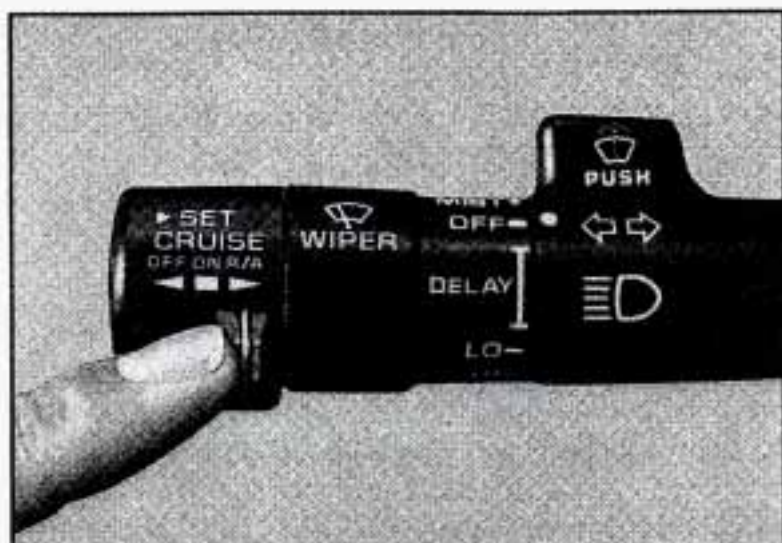

You'll go right back up to your chosen speed and stay there.

**⚠ CAUTION:**

If you hold the switch at "R/A" longer than half a second, the vehicle will keep going faster until you release the switch or apply the brake. You could be startled and even lose control. So unless you want to go faster, don't hold the switch at "R/A."

### *To Increase Speed While Using Cruise Control*

There are two ways to go to a higher speed. Here's the first:

1. Use the accelerator pedal to get to the higher speed.
2. Push the button at the end of the lever, then release the button and the accelerator pedal. You'll now cruise at the higher speed.

Here's the second way to go to a higher speed:

1. Move the Cruise switch from "ON" to "R/A." Hold it there until you get up to the speed you want, and then release the switch.
2. To increase your speed in very small amounts, move the switch to "R/A". Each time you do this, your vehicle will go about 1 mph (1.6 km/h) faster.

## ***4.6 Liter (Northstar)***

The accelerate feature will only work after you have set the Cruise Control speed by pushing the “SET CRUISE” button.

### ***To Reduce Speed While Using Cruise Control***

1. Push in the button at the end of the lever until you reach the lower speed you want, then release it.
2. To slow down in very small amounts, push the button for less than half a second. Each time you do this, you'll go 1 mph (1.6 km/h) slower.

### ***Passing Another Vehicle While Using Cruise Control***

Use the accelerator pedal to increase your speed. When you take your foot off the pedal, your vehicle will slow down to the Cruise Control speed you set earlier.

### ***Using Cruise Control on Hills***

How well your Cruise Control will work on hills depends upon your speed, load, and the steepness of the hills. When going up steep hills, you may have to step on the accelerator pedal to maintain your speed. When going downhill, you may have to brake or shift to a lower gear to keep your speed down. Of course, applying the brake takes you out of Cruise Control. Many drivers find this to be too much trouble and don't use Cruise Control on steep hills.

## *To Get Out of Cruise Control*

There are two ways to turn off the Cruise Control:



1. Step lightly on the brake pedal; OR

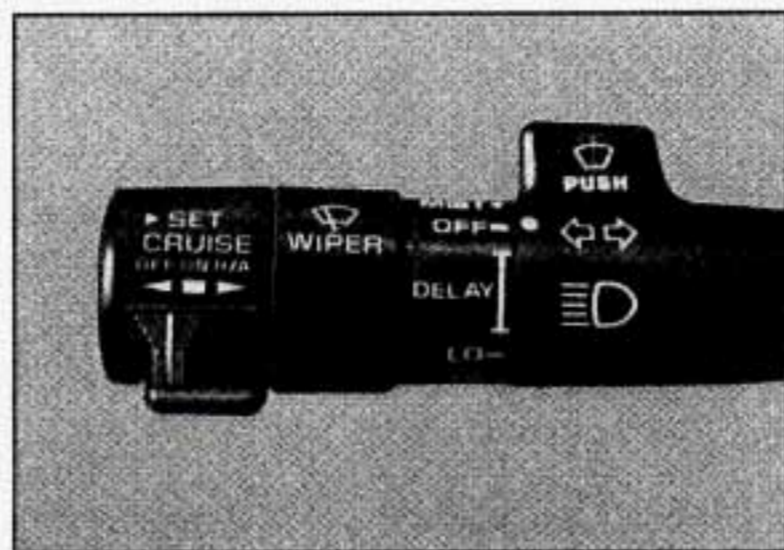

2. Move the Cruise switch to "OFF."  
(The "CRUISE" light will go out.)

## *To Erase Speed Memory*

When you turn off the Cruise Control or the ignition, your Cruise Control set speed memory is erased.

# LIGHTS

You'll find the control on the left side of the instrument panel.

It controls these light systems:

- Headlights
- Taillights
- Parking Lights
- Underhood Light
- Instrument Panel Lights
- License Plate Lights
- Interior Courtesy Lights
- Fog Lights
- Rear Fog Lights (Export Only)

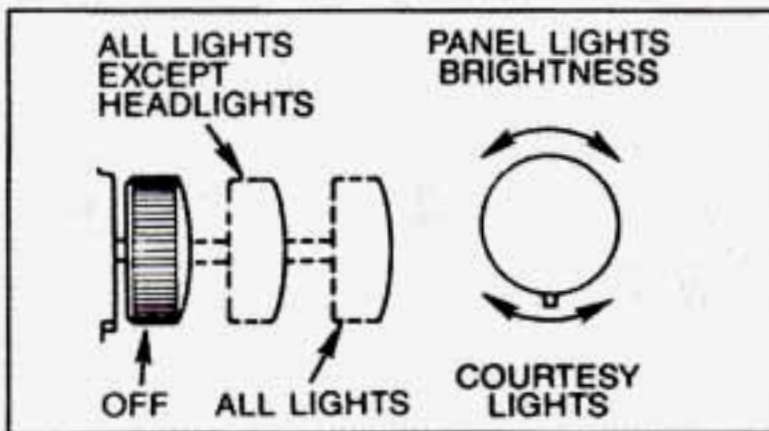

Here's how to manually work your light system.

## Lights On Reminder

If you open the door while leaving the lights on, you will hear a warning tone.

## *Twilight Sentinel*

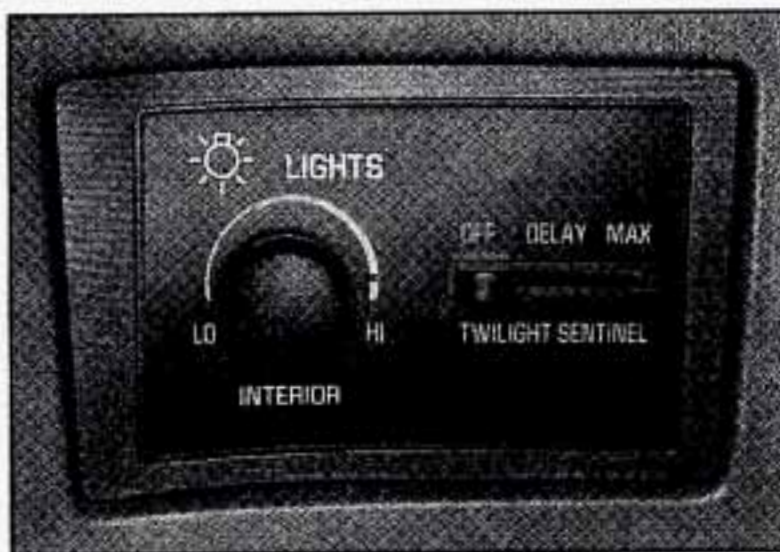

The control is next to the headlight switch. It switches your lights on and off by sensing how dark it is outside. To operate it, leave the light switch off and move the control to any position but off.

If you move the control all the way to **MAX**, your lights will remain on for 90 seconds after you turn your engine off. If you move the control almost all the way in the other direction, so it is just on, the lights will go off quickly when you turn off your engine. You can change this delay time from only a few seconds to 90 seconds.

### *Operation of Lights*

Although your vehicle's lighting system (headlamps, parking lamps, fog lamps, side marker lamps and tail lamps) meet all applicable Federal lighting requirements, certain States and Provinces may apply their own lighting regulations that may require special attention before you operate these lamps. For example, some jurisdictions may require that you operate your lower beam lamps with fog lamps at all times, or that headlamps be turned on whenever you must use your windshield wipers. In addition, most jurisdictions prohibit driving solely with parking lamps, especially at dawn or dusk. It is recommended that you check with your own State or Provincial highway authority for applicable lighting regulations.

## *Light Sensor*

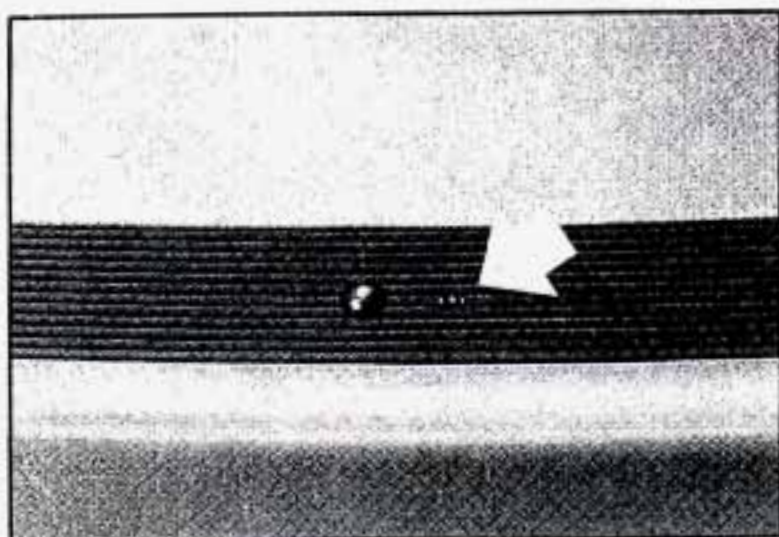

The light sensor for the twilight sentinel is located in the center of the front defogger grille. If you cover the sensor, it will read "dark" and your lights will come on.

## *Interior Lights*

Turn the headlight switch past HI to turn on the interior lights.

## *Fog Lights (STS)*



Use your fog lights for better vision in foggy or misty conditions. When you press the upper fog light switch, a small indicator light will glow to tell you the fog lights are on. To turn them off, press the switch again.

If you switch on your high beam headlights, your fog lights will turn off. They'll turn back on again when you switch to low beam headlights.

When the twilight sentinel is on, only the headlights will turn off automatically. Your fog and parking lights will remain on.

### ***Rear Fog Lights (Export Only)***

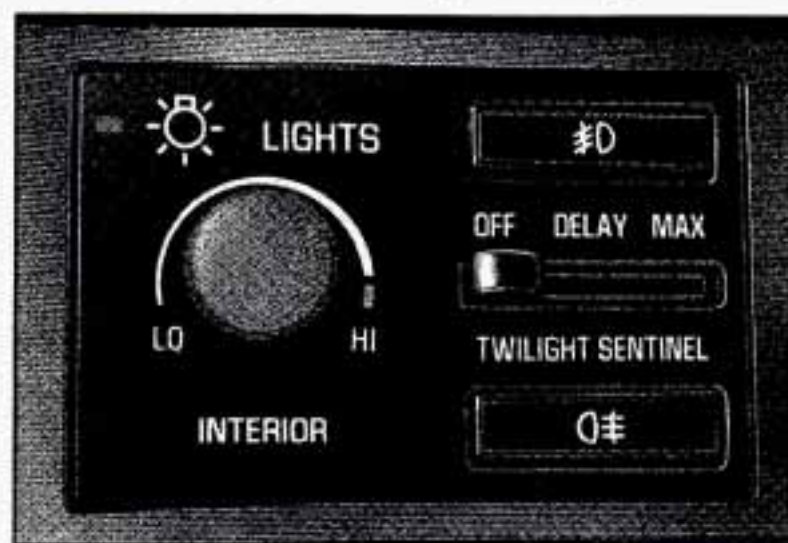

To operate the rear fog lights, first turn on the front fog lights, then push the lower switch. A small indicator light will glow to tell you they are on. To turn them off, press the switch again.

### ***Cornering Lights***

The cornering lights come on when you signal a turn when the headlights or parking lights are on. This will provide more light for cornering.

### ***Underhood Light***

To operate, turn on your parking lights, then the underhood light will illuminate when the hood is open.

### ***Daytime Running Lights (Canada Only)***

The Canadian Federal Government has decided that “Daytime Running Lights” (DRL) are a useful feature, in that DRL can make your vehicle more visible to pedestrians and other drivers during daylight hours. DRL are required on new vehicles sold in Canada.

Your DRL work with a light sensor on top of the instrument panel. Don't cover it up.

The low beam headlights will come on at reduced brightness in daylight when:

- The ignition is on
- The headlight switch is off, and
- The transaxle is not in “P” (Park).

At dusk, if the Twilight Sentinel feature is turned on, the exterior lights will come on automatically and the low beams will change to full brightness. At dawn, the exterior lights will go out and the low beams will change to the reduced brightness of DRL (if the headlight switch is off).

Of course, you may still turn on the headlights any time you need to.

To idle your vehicle with the DRL off, shift the transaxle into “P” (Park). The DRL will stay off until you shift out of “P” (Park).

## ***Reading Lights***

You have reading lights located in the roof. These lights and the interior courtesy lights will come on when you open a door.

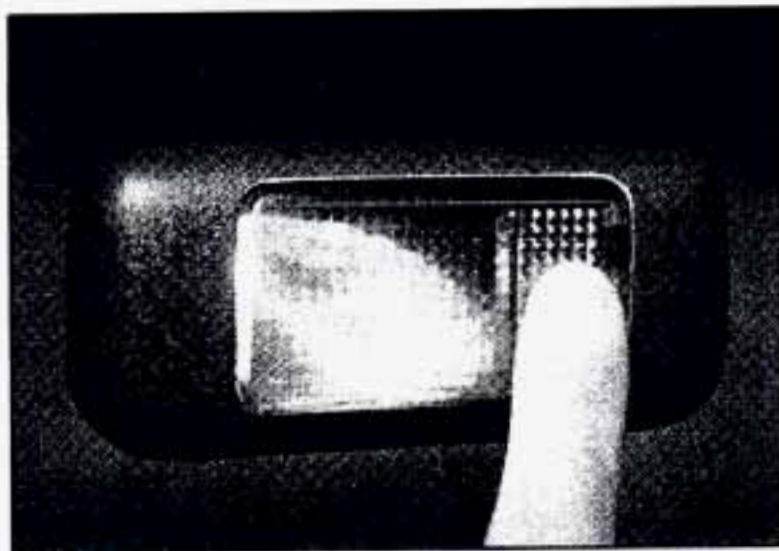

Push the button to turn them on. Push it again to turn them off.



## ***MIRRORS***

### ***Inside Day/Night Rearview Mirror***

To reduce glare from lights behind you, move the lever like this:

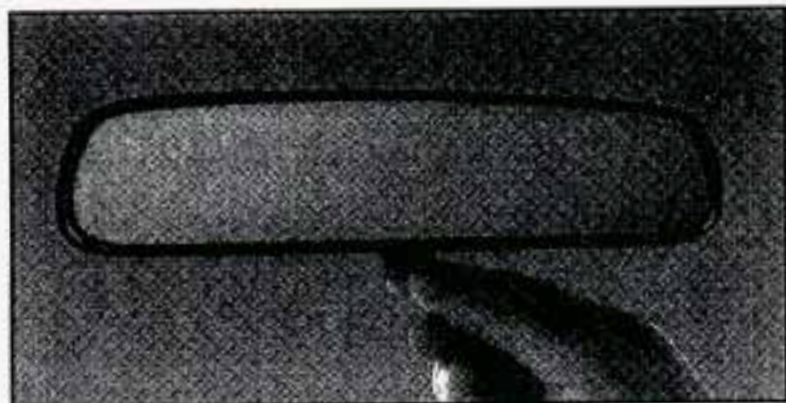

### ***Automatic Inside Rearview Mirror***

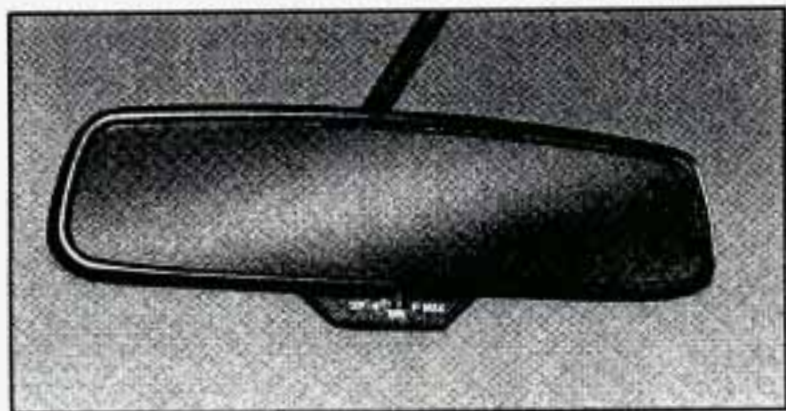

Your Cadillac may have the optional automatic electrochromic rearview mirror.

During the daylight it's like the standard mirror. But at night the system goes to work.

During the day the mirror reflects all the light from behind your car. At night, when the glare is too high, it darkens to reflect only part of the light behind you. When the mirror darkens, it holds that position until the glare is no longer present.

## *Settings*

Your automatic rearview mirror has different positions for light sensitivity. At the "MAX" setting, bright headlights far away will cause the mirror to gradually darken. This is a good setting for rural driving. At the "MIN" setting, bright headlights have to be rather close for the mirror to darken. This is a good setting for city driving.

## *Reverse Gear Day Mode*

The reverse mode is another important feature of the automatic mirror. When the shift lever is placed in "R" (Reverse), the mirror changes to the daytime mode for a bright image in the mirror as you back up.

## *Off*

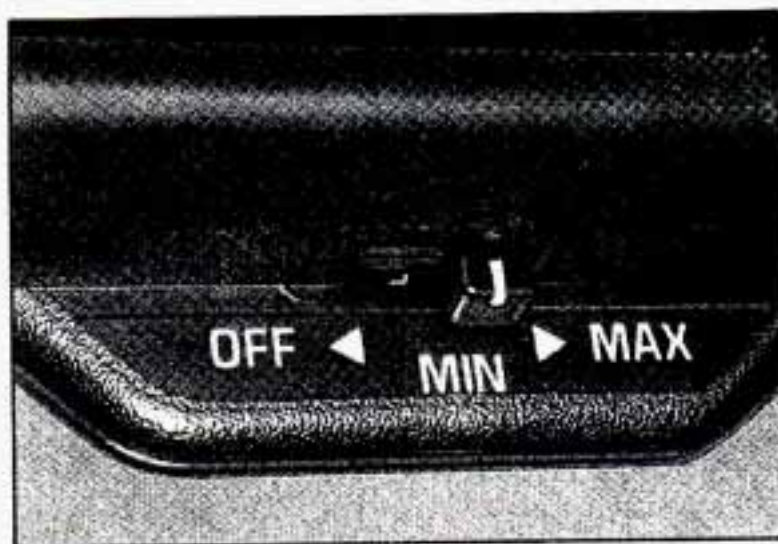

Turn the switch to "OFF" when you want the mirror to stay in the day mode.

## *Cleaning Photocells*

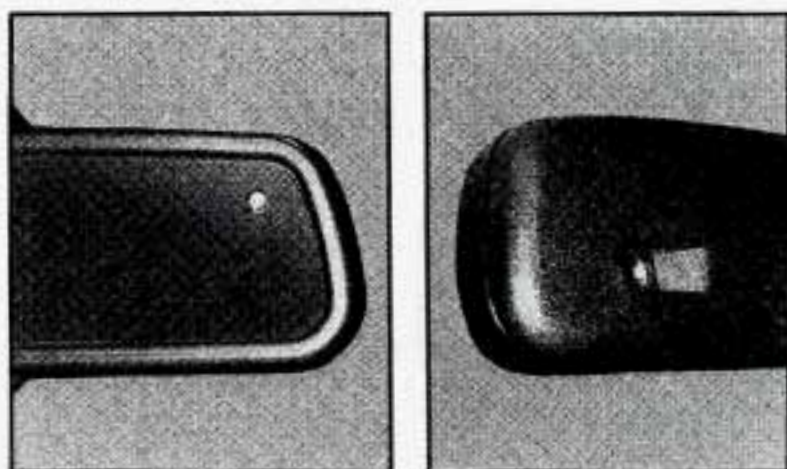

Use a cotton swab and glass cleaner to clean the front and rear photocells that make the mirror work.

## *Front Seat Vanity Mirrors*

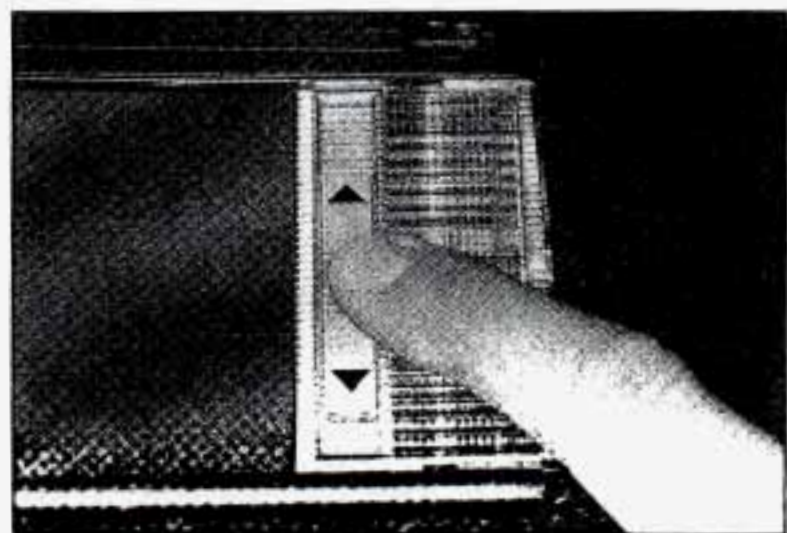

To use one, turn the sunshade down. Then lift the cover up to see the mirror. The switch makes the light brighter.

Driver side lighted vanity mirror is optional.

## *Power Remote Control Mirrors*



The control on the driver's door armrest operates both outside rearview mirrors. Move the center switch to the left to select the driver side mirror, or to the right to select the passenger side mirror. Then press the control pad to adjust each mirror so that you can just see the side of your vehicle.

To lock the controls leave the selector switch in the middle position.

When you operate the rear window defogger, it also warms both outside mirrors to help clear them of fog or ice.

## ***CONVEX OUTSIDE MIRROR***

Your right side mirror is convex.

A convex mirror's surface is curved so you can see more from the driver's seat.

**⚠ CAUTION:**

If you aren't used to a convex mirror, you can hit another vehicle. A convex mirror can make things (like other vehicles) look farther away than they really are. If you cut too sharply into the right lane, you could hit a vehicle on your right. Check your inside mirror or glance over your shoulder before changing lanes.

### ***BREAK-AWAY OUTSIDE MIRROR (EXPORT)***

The mirrors will collapse in either the forward or rearward direction, and then return to the normal position.

### ***ASTROROOF – EXPRESS OPEN***

If you have this option, the switch is here:

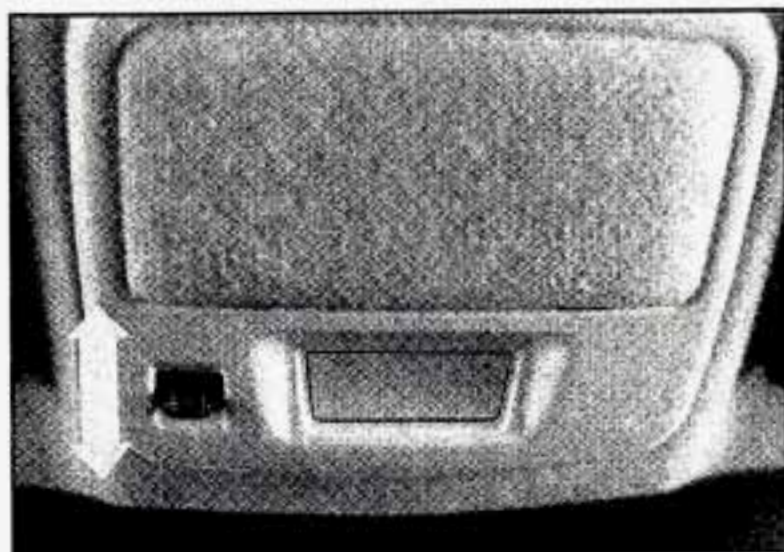

The astrorooftop includes a sliding glass panel and a sliding sunshade. The control switch only works with the ignition on or in Retained Accessory Power (RAP) mode.

**To Open:** Press the switch rearward to open the glass panel and sunshade. The sunshade can also be opened by hand. If you want to stop the roof in a partially open position, press the switch in either direction to stop it. Press the switch again to open it fully.

**To Close:** Press and hold the switch forward to close the glass panel. The sunshade can only be closed by hand.

**To Vent:** Press the switch forward when the glass panel is closed. Open the sunshade by hand. To close the vent press the switch rearward.

## ***SUNGLASS COMPARTMENT***

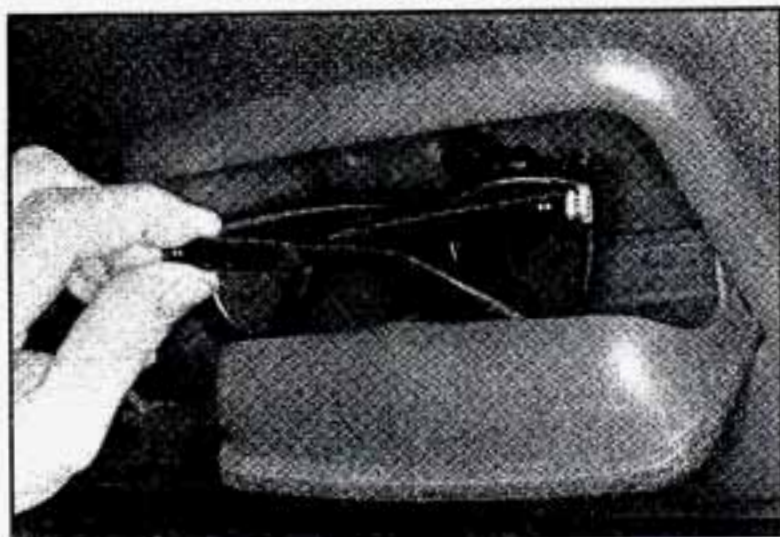

If you have the optional Astroroof you will not have this feature. To gain access to this feature located directly above the inside rearview mirror in the headliner, just push up and the compartment will open.

## *ASHTRAYS AND LIGHTERS*

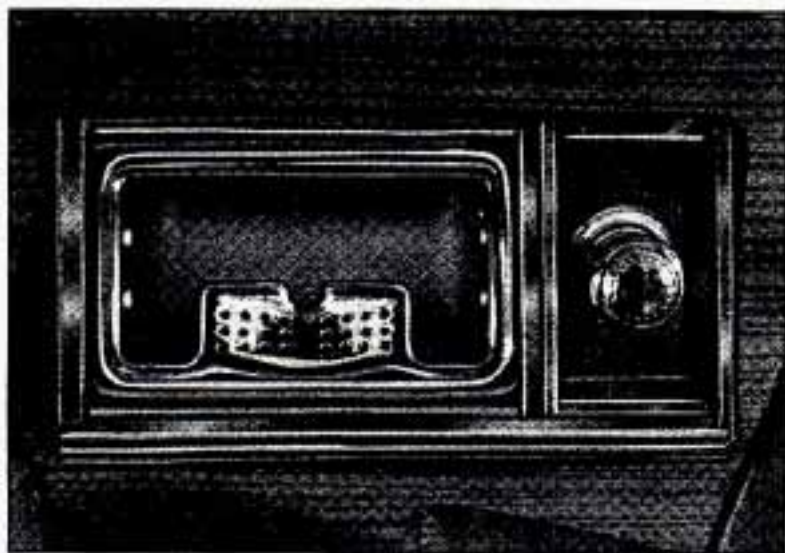

If you have the full console, push on the cover to reveal the ashtray and lighter.

OR

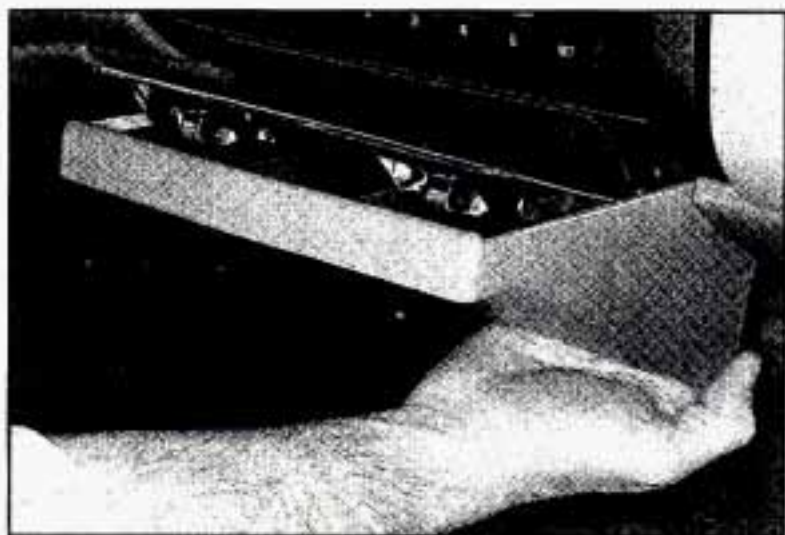

If you don't have a center console just pull the ashtray out to reveal the ashtray and lighter.

To clean the ashtray, lift it out by pulling on the snuffer.

If you don't have a console, and the ashtray will not come out by pulling on the snuffer, try this: Reach under the ashtray and gently push up on the ashtray bowl and remove it.

## *Rear Ashtray*

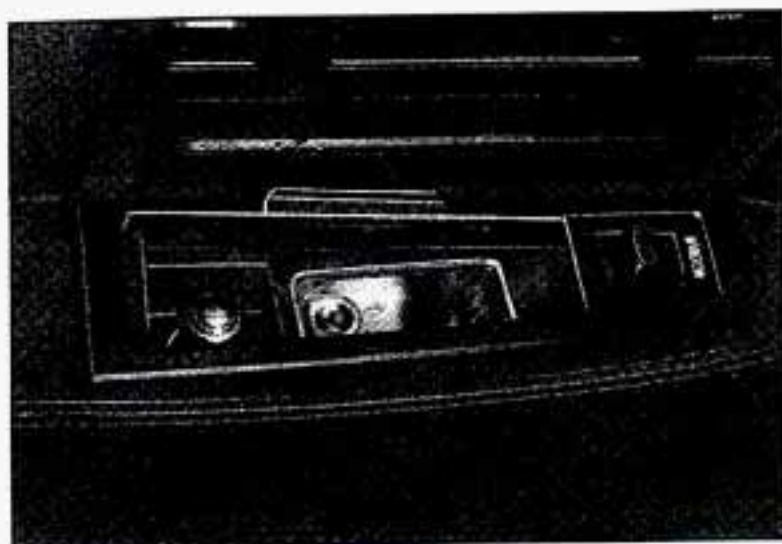

To open the rear ashtrays lift the lid.

### **NOTICE:**

**Don't put papers or other flammable things into your ashtrays. Hot cigarettes or other smoking materials could ignite them, causing a damaging fire.**

## *Cigarette Lighter*

It's near the ashtray. To use the lighter just push it all the way and let go. When it's ready, it will pop back by itself.

### **NOTICE:**

**Don't hold a cigarette lighter in with your hand while it is heating. If you do, it won't be able to back away from the heating element when it's ready. That can make it overheat, damaging the lighter and the heating element.**



## ***GARAGE DOOR OPENER (OPTION)***

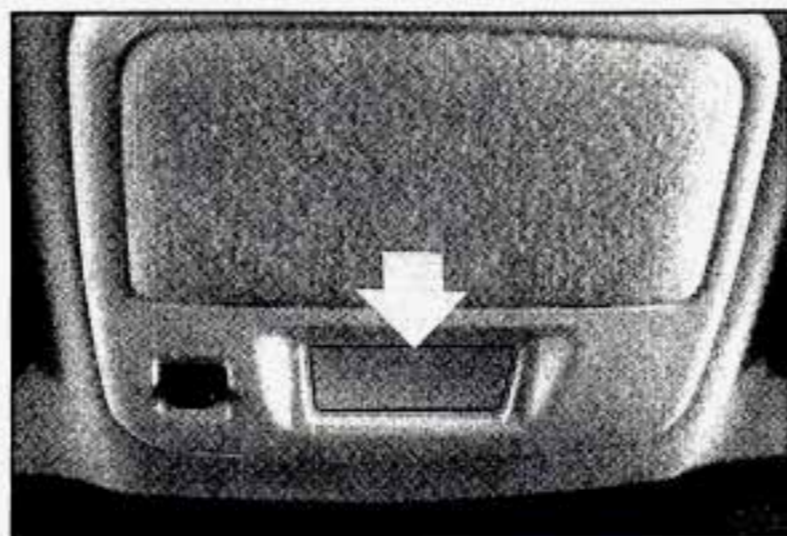

This option allows you to open up to three garage doors. The transmitter unit fits the overhead panel.

Your Cadillac dealer can tell you about the hand held power pack unit and the installation you'll need at home to make this work. If your Cadillac is equipped with an Electriclear® heated windshield, you'll have to be closer to the garage door for the transmitter unit to work.

## ***FLOOR MATS***

If your Cadillac is equipped with rubber-backed front and rear floor mats, keep them clean by vacuuming and using a spot cleaner, if necessary. Do not machine wash.

## ***TRACTION CONTROL SYSTEM (STS)***

Your traction control system operates only when the system senses that one or both of the front wheels is spinning or beginning to lose traction while driving. This is especially useful in slippery road conditions. The traction control system works at all speeds. It limits wheel spin by using the antilock and brake systems to apply the front brakes and by shutting off fuel injectors to reduce engine torque.

You may be able to spin the tires when accelerating from a standstill on dry pavement. This is normal. The "Traction Active" message will display on the driver's information center when the traction control system is operating.

You may feel the system working through slight movement of the accelerator pedal, or you may notice some noise, but this is normal.

Your driver information center is an important source of information about your traction control system. See "Driver Information Center" in the Index.

## ***THE INSTRUMENT PANEL: YOUR INFORMATION SYSTEM***

Your instrument panel is designed to let you know at a glance how your Cadillac is running. You'll know how fast you're going, how much fuel you're using, and many of the other things you'll need to know to drive safely and economically.

### ***Digital Cluster (4.9 L)***



### ***Analog Cluster (4.9 L)***

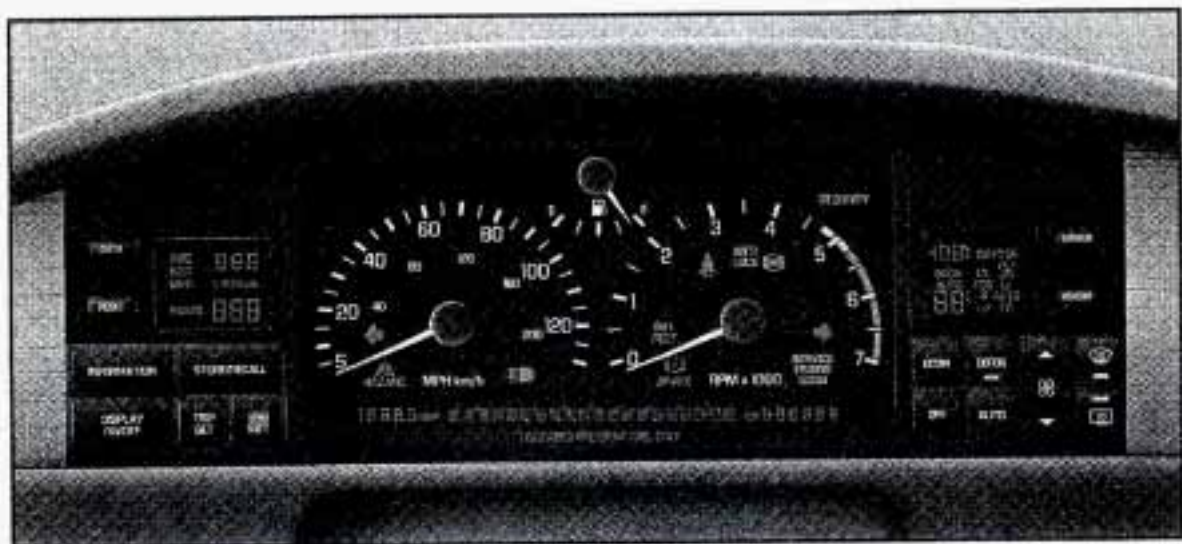

### *Canadian Analog Cluster (4.9 L)*

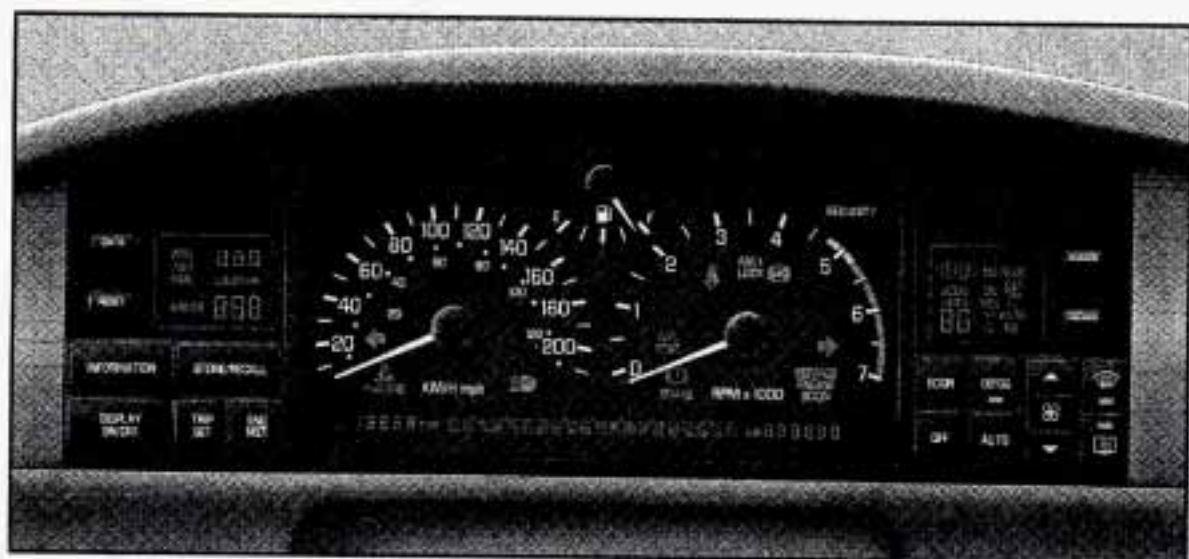

### *Export Cluster (4.9 L)*

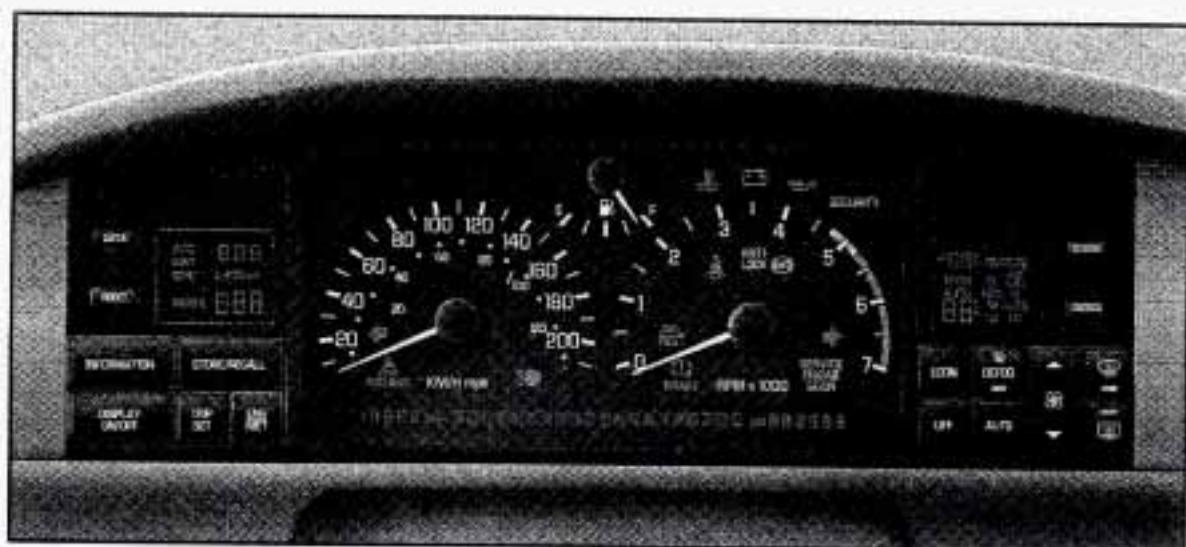

If you have the 4.6 L Northstar your tachometer and speedometer will have a different calibration.

### *Speedometer and Odometer*

Your speedometer lets you see your speed in both miles per hour (mph) and kilometers per hour (km/h). Your odometer shows how far your vehicle has been driven, in either miles (used in the U.S.) or kilometers (used in Canada).

## ***English/Metric Button***



You can go back and forth from English (miles) to metric (kilometers) by pushing this button.

The same button also makes other readings (like temperature, fuel and odometer) go between English and metric.

## ***Trip Odometer***



You can tell how far you've gone since you last set it back to zero. To reset, push and hold the button until it zeros.

If your vehicle is domestic, the trip odometer will return to zero after 999.9 miles (1609 km). If your vehicle is Canadian or Export, the trip odometer will return to zero after 1999.9 km (1242 miles).

## *Odometer*

You may wonder what happens if a car has to have a new odometer installed. The new one may read the correct mileage. This is because your car's computer has stored the mileage in memory. If it isn't stored, then this odometer is set at zero, but a label on the driver's door must show the old reading and when the new one was installed.

## ***WARNING LIGHTS***

This section describes the warning lights that may be on your vehicle. The pictures will help you locate them.

Warning lights can signal that something is wrong before it becomes serious enough to cause an expensive repair or replacement. Paying attention to your warning lights could also save you or others from injury.

Warning lights go on when there may be or is a problem with one of your vehicle's functions. As you will see in the details on the next few pages, some warning lights come on briefly when you turn the ignition key just to let you know they're working. If you are familiar with this section, you should not be alarmed when this happens.

When one of the warning lights comes on and stays on when you are driving, check the section that tells you what to do about it. Please follow the manual's advice. Waiting to do repairs can be costly -- and even dangerous. So please get to know your warning lights. They're a big help.

Your vehicle may also have a driver information system that works along with the warning lights. See "Driver Information System" in the Index.

## ***Brake System Warning Light***

Your Cadillac hydraulic brake system is divided into two parts. If one part isn't working, the other part can still work and stop you. For good braking, though, you need both parts working well.

If the warning light goes on, there could be a brake problem. Have your brake system inspected right away.



This light should come on as you start the vehicle. If it doesn't come on then, have it fixed so it will be ready to warn you if there's a problem.

This light will also come on when you set your parking brake, and will stay on if your parking brake doesn't release fully. If it stays on after your parking brake is fully released, it means you have a brake problem. If the light comes on while driving, pull off the road and stop carefully. You may notice that the pedal is harder to push. Or, the pedal may go closer to the floor. It may take longer to stop. If the light is still on, have the vehicle towed for service. (See "Towing Your Vehicle" in the Index.)

### **⚠ CAUTION:**

**Your brake system may not be working properly if the brake warning light is on. Driving with the brake warning light on can lead to an accident. If the light is still on after you've pulled off the road and stopped carefully, have the vehicle towed for service.**

## *Anti-Lock Brake System Warning Light*

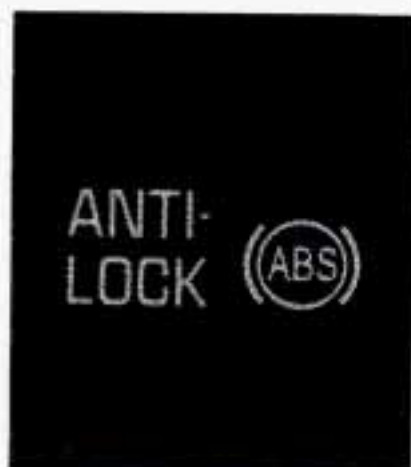

With anti-lock, this light will go on when you start your engine and may stay on for several seconds or so. That's normal. If the light doesn't come on, have it fixed so it will be ready to warn you if there is a problem.

If the light stays on or comes on when you're driving, stop as soon as possible and turn the key off. Then start the engine to reset the system. If the light still stays on, or comes on again while you're driving, your Cadillac needs service. Unless the regular brake system warning light is also on, you will still have brakes, but not anti-lock brakes. If the regular brake system warning light is also on, see "Brake System Warning Light" earlier in this part.

The anti-lock brake system warning light may also come on when you are driving with a compact spare tire. If this happens, the light means you won't have anti-lock until you replace the compact spare with a full-size tire. If the warning light stays on after you replace the compact spare with a full-size tire, or if it comes on again when you're driving, your Cadillac needs service.

## ***Engine Temperature Warning Light (Export Only)***

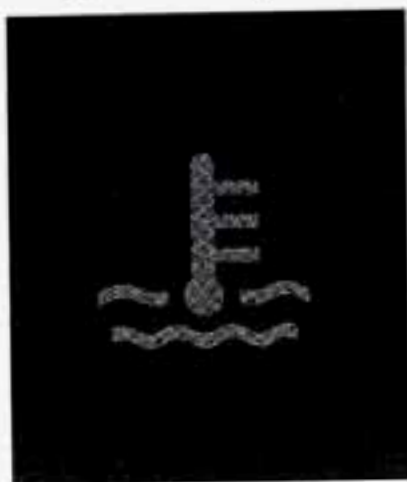

This light tells you that your engine has overheated. You should stop the car and turn the engine off as soon as possible. A warning chime should also sound if this light comes on. As a check, the light should come on for a few seconds when you start your engine.

### **HOT COOLANT CAN BURN YOU BADLY!**

In "Problems on the Road," this manual shows what to do. See "Engine Overheating" in the Index.

## ***Service Engine Soon Light***



A computer monitors operation of your fuel, ignition and emission control systems. This light should come on when the ignition is on, but the engine is not running, as a check to show you it is working. If it does not come on at all, have it fixed right away. If it stays on, or it comes on



while you are driving, the computer is indicating that you have a problem. You should take your vehicle in for service soon.

## **NOTICE:**

**If you keep driving your vehicle with this light on, after a while the emission controls won't work as well, your fuel economy won't be as good and your engine may not run as smoothly. This could lead to costly repairs not covered by your warranty.**

### ***Battery Charge Light (Export Only)***

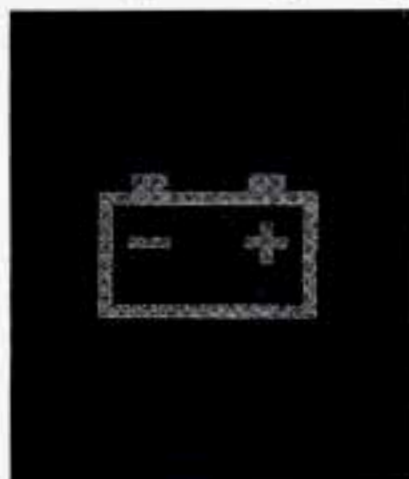

When you turn the key to "Run" or "START", this light will come on briefly, to show that your alternator and battery charging systems are working.

If a light stays on, you need service, and you should take your Cadillac to the dealer at once. To save your battery until you get there, turn off all accessories.

## *Engine Oil Light (Export Only)*



This light tells you if there could be a problem with your engine oil pressure.

The light goes on when you turn your key to “Run” or “Start.” It goes off once you start your engine. That’s just a check to be sure the light works. If it doesn’t, be sure to have it fixed so it will be there to warn you if something goes wrong.

When the light comes on and stays on, it means oil isn’t going through your engine properly. You could be low on oil, or you might have some other oil problem.



### **CAUTION:**

**Don’t keep driving if the oil pressure is low. If you do, your engine can become so hot that it catches fire. You or others could be burned. Check your oil as soon as possible and have your vehicle serviced.**

### **NOTICE:**

**Damage to your engine from neglected oil problems can be costly and is not covered by your warranty.**

## *Tachometer - Analog Cluster*



This gage indicates the engine speed in Revolutions Per Minute (RPM).

### **NOTICE:**

**Do not operate the engine with the tachometer in the red area, or engine damage may occur.**

## *Engine Speed Limiter (Northstar)*

If you have the 4.6 L Northstar engine, you have an Engine Speed Limiter. This feature prevents the engine from operating at too many revolutions per minute (RPM). When your engine RPM's are critically high the fuel supply to the engine is shut off. When the engine speed slows, the fuel supply will come on again. This helps prevent damage to the engine.

## Fuel Gage



Your fuel gage shows about how much fuel is in your tank. It works only when the ignition is in the "RUN" position.

### Digital Gage

If the fuel level is within approximately one gallon (3.9 liters) of being full the letter "F" is shown.

If the fuel level is between 1 and 2 gallons (3.9 and 7.6 liters) from being empty the letter "E" is shown. If the fuel supply gets down to approximately 1 gallon (3.9 liter) the "E" will flash, and the "FUEL LEVEL VERY LOW" message will appear in the Driver Information Center (DIC). (On the analog fuel gage, the "FUEL LEVEL VERY LOW" message will also appear.)

Here are a few concerns some owners have had about the fuel gage. All these situations are normal and indicate nothing wrong with the fuel gage.

- At the gas station, the gas pump shuts off before the gage reads "F".
- It takes more (or less) gas to fill up than the gage said. For example, the gage said "8 Gallons", but it took more -- or less -- than the tank's remaining capacity to fill it.
- The gage changes when you turn (or stop, or speed up).

## *Fuel Data Panel*

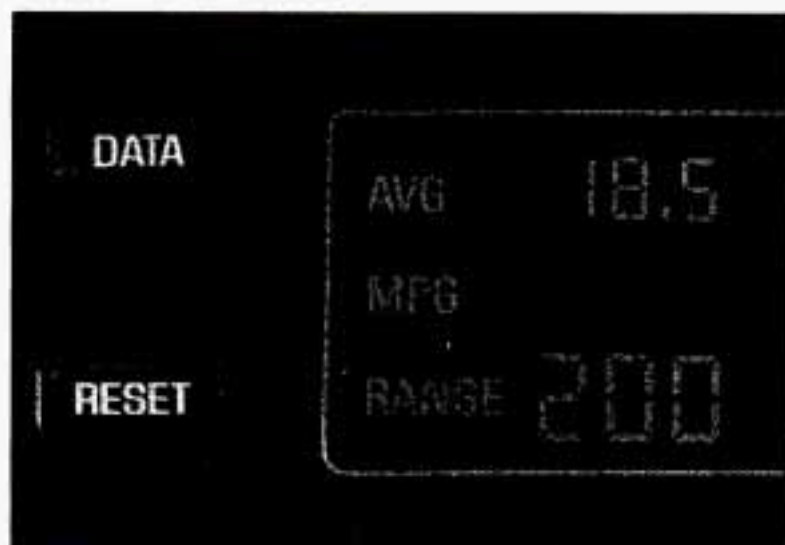

Your Fuel Data Panel tells you all you want to know about your fuel economy and how far you can travel with the fuel remaining. Here's how it works.

**DATA:** Push this button to toggle between “INST MPG” (instantaneous miles per gallon) or the “AVG MPG” (average mile per gallon) displays. You can also display it in metric units by pressing the “ENG MET” button.

**RESET:** Push this button to reset the “AVG MPG” to zero.

**AVG MPG (Average Fuel Economy):** When “AVG MPG” is selected, the total distance is divided by the total fuel used.

**INST (Instantaneous Fuel Economy):** When “INST MPG” is selected, you will see what your fuel economy is at that instant. The computer takes a new reading twice every second. It will show economy up to 70 miles per gallon (or 2 liters per 100 Kilometers).

**RANGE:** This display shows how far the computer thinks you can go with the fuel that is in your tank. The computer does not know what driving conditions will be like for the rest of your trip, so the range is estimated based on your previous fuel economy. Therefore, your range reading may change as your driving habits change (going from city to highway driving may increase the range reading).

When you get down to 40 miles to go (or, in metric 64 km) the range display will show “Lo”.

Your computer needs enough data for the “RANGE” reading to work, however, so it will read “Lo” for a while when your vehicle is brand new (under 25 miles). Also, it will show “Lo” for a while if your battery has been disconnected.

## *Driver Information Center*



Your Driver Information Center (DIC) display gives you the status of many of your vehicle systems. The DIC is used to display driver selectable information and warning/status messages.

If more than one problem is detected, messages will automatically appear in priority succession with the higher priority messages displayed first.

### *Driver Information Center Control Buttons*

#### **INFORMATION**

Pressing this button successively will display the ENGINE RPM (Digital Cluster only), ENGINE COOLANT TEMP, BATTERY VOLTAGE, OIL LIFE INDEX and FUEL USED.

#### **STORE/RECALL**

Pressing this button will store any currently displayed message that is indicating a system problem. Once a message has been stored the next message of normal information is displayed.

When a message is stored it is saved in the computer, but once the ignition is turned off the message is lost. All messages stored when your engine is running can be viewed one at a time by pressing "STORE/RECALL" button.

#### **FUEL USED RESET**

Display the fuel used, then press and hold the STORE/RECALL button until 0 is displayed.

## **DISPLAY ON/OFF**

Pressing this button will turn off the Driver Information Center, Electronic Climate Control and Fuel Data Center displays. While displays are off, pressing the "INFORMATION" button will turn on only the Driver Information Center. If any other button is pressed or a driving warning message needs to be displayed, or fuel level falls below 4 gallons, all the displays will come back on.

## **TRIP SET**

Press and hold this button to set the Trip Odometer back to zero.

## **ENG/MET (English/Metric)**

Press this button to switch from English (miles) to metric (kilometers).

## ***Driver Information Center Messages***

These messages will appear if there is a problem sensed in one of your vehicle's systems. Vehicles that are first sold in Canada or are export vehicles will have a number after each message. This number helps to identify that message, which is only displayed in English.

### **APPLY BRAKE TO SHIFT**

This message will appear if your vehicle is in "P" (Park) for about 5 seconds and the brake is not depressed. If you do not want this message to appear, you can cancel this message by pressing the OFF and the Blue (cooler) button on the Electronic Climate control panel. Push the same 2 buttons again to have this message displayed again.

### **A/C OVERHEATED - A/C COMPRESSOR OFF**

If the refrigerant system ever reaches an over-pressure condition, this message will appear to tell you that the air conditioning compressor has been turned off. Air conditioned air will not be delivered to cool your vehicle. If the pressure returns to a normal operating range, you must select "AUTO", "DEFOG", or Defrost to start the compressor. If this message continues to appear, have the system repaired as soon as possible to avoid compressor damage.

### **BATTERY NO CHARGE**

This message will appear if your battery is not being charged. Have your electrical system checked by your Cadillac dealership at your earliest convenience.

## **BATTERY VOLTS HIGH**

This message shows that the electrical charging system is overcharging, (more than 16 volts). To avoid being stranded have the electrical system checked by your Cadillac dealership at your earliest convenience. You can reduce the charging overload by using the accessories. Turn on the lights, radio, set the Climate Control on "AUTO" and the fan speed on "HI" and turn the rear window defogger on. You can monitor battery voltage on the Driver Information Center by toggling the "INFORMATION" button. When the engine is running, the normal range is 11.5 to 15.5 volts.

## **BATTERY VOLTS LOW**

This message will appear when the electrical system is charging less than 10 volts, or if the battery has been drained. If this message appears immediately after starting it is possible that the generator can still recharge the battery. The battery should recharge after driving a few miles and the message should go out. If this message appears while driving or after starting your vehicle and stays on, have it checked immediately to determine the cause of this problem. To help the generator recharge the battery quickly, you can reduce the load on the electrical system by turning off your accessories. You can monitor battery voltage on the Driver Information Center by toggling the "INFORMATION" button. The normal range is 11.5 to 15.5 volts.

## **CHANGE TRANS FLUID (Northstar Only)**

This message will appear when it is time to replace the transaxle fluid. See your maintenance booklet for the proper fluid and change intervals.

## **CHECK BRAKE FLUID**

This message is displayed to inform the driver that the brake reservoir fluid level is low. Check the brake reservoir level and add as needed. Have the brake system serviced by a Cadillac technician as soon as possible. If the brake warning light is on, follow the directions in that section.

## **CHECK COOLANT LEVEL (Northstar Only)**

This message will appear when there is a low level of engine coolant. Have the cooling system serviced by a Cadillac technician as soon as possible.



### **CHECK FUEL GAGE**

This message will appear when your fuel supply is less than 4 gallons and your display is turned off.

### **CHECK OIL LEVEL (Northstar Only)**

This message will appear when your engine oil is approximately a quart low. If this message is displayed, check the oil and add as needed.

### **CHANGE OIL SOON**

This message will appear when your engine oil is less than 10 percent or the mileage since the last oil change is more than 6750 miles.

### **CHANGE ENGINE OIL**

This means that the life of your engine oil has expired and it should be changed immediately. See engine oil and filter recommendations in the Maintenance Schedule. After an oil change, the Oil Life Index must be reset. See "Oil Life Indicator" in the index on how to reset it.

### **ENGINE COOLANT HOT IDLE ENGINE**

This message will appear when your engine coolant temperature is over 126°C (248°F). To avoid added strain on a hot engine, turn off your Climate Control system and stop and allow your vehicle to idle until it cools down or the message is removed. If it does not cool down, turn off your engine and have it serviced before driving it again. Severe engine damage can result from an overheated engine. See "Engine Overheating" in the Index.

### **ENGINE HOT - A/C COMPRESSOR OFF**

This message will appear when the Climate Control is in "Auto" or Defrost and the engine coolant is hotter than the normal operating temperature. To avoid added strain on a hot engine the air conditioning compressor is automatically turned off. When that happens, air conditioned air is not delivered. If the coolant temperature returns to normal, you must select "AUTO", "DEFOG" or Defrost to return to a normal A/C compressor operation.

### **FUEL LEVEL VERY LOW**

This message serves as a warning that the fuel level in your tank is critically low. It means you should stop for fuel immediately.

### **LOW A/C REFRIGERANT - SERVICE A/C SOON**

This message will appear when the A/C refrigerant is so low that it no longer can cool well. This message shows that some of the refrigerant has leaked out of the system, and that the A/C needs recharging. If you do not have it recharged, the system may not cool at all.

### **CHECK WASHER FLUID**

This message shows that the washer fluid reservoir is nearly empty.

### **REDUCE ENGINE POWER (Northstar Only)**

This message will appear if the engine starts to cut cylinders to reduce power. If this message is ever displayed, have your vehicle serviced as soon as possible.

### **SERVICE A/C SYSTEM A/C COMPRESSOR OFF**

This message appears when the electronic sensors that control the A/C and heating system are no longer working. You may notice a drop in heating and A/C efficiency when this message appears. Have your Climate Control system serviced if this message appears.

### **STARTING DISABLED DUE TO THEFT SYSTEM REMOVE IGNITION KEY**

This message will appear when the Personalized Automotive Security System (PASS Key II™) senses that an improper ignition key is being used to try to start the vehicle. Check the ignition key for damage. If it is damaged, it may need to be replaced. If you see no damage, clean the pellet contacts with a soft cloth or napkin. Remove the ignition key and wait for the Driver Information Center to display "WAIT 3 MINUTES". The Instrument Panel Cluster will then run a timer and change the messages to "WAIT 2 MINUTES", "WAIT 1 MINUTE", and then "START CAR". When the "START CAR" message is displayed, try again to start the engine.

### **SERVICE NOW - REFER TO OWNERS MANUAL**

This message appears if you have a problem with the Electronic Control Module (ECM). To correct this problem have your vehicle serviced at your Cadillac dealership.

## **SERVICE RIDE CONTROL**

This message is displayed to indicate that the Suspension System is not operating properly. To correct this problem have your vehicle serviced at your Cadillac dealership at your earliest convenience.

## **STOP ENGINE ENGINE OVERHEATING**

This message will appear when your engine has overheated. Stop and turn your engine off immediately to avoid severe engine damage. See "Engine Overheating" in the Index.

## **SERVICE VEHICLE SOON**

This message will appear if there is a problem with your Emission Control System. If the "SERVICE ENGINE SOON" light on the instrument panel and this message appear and then turns off, it is an indication that a temporary problem has cleared itself. Have your vehicle checked at your earliest convenience.

## **STOP ENGINE LOW OIL PRESSURE**

If this message appears while the engine is running, stop the engine and do not operate it until the cause of low oil pressure is corrected. Severe damage to the engine can result.

## **SERVICE SUPPLEMENTAL INFLATABLE RESTRAINT**

If this message appears, there is a problem with your Supplemental Inflatable Restraint (Air Bag) system. Let only a qualified technician work on your vehicle. See your Cadillac dealer for service at once.

## **THEFT SYSTEM PROBLEM/CAR MAY NOT RESTART**

This message means there is a problem in the Personalized Automotive Security System (PASS Key II™). PASS Key II™ will prevent the vehicle from restarting if it is turned off, so you should take the vehicle to a proper service center before turning the engine off. Never leave an unattended vehicle with the engine running. Once you are where you can get service, turn the engine off and then try to restart it. If the vehicle does not restart, the PASS Key II™ system will need servicing.

## **TRACTION ACTIVE**

If your vehicle is equipped with Traction Control, this message will be displayed if Traction Control is being used to reduce wheel slippage.

## **TRACTION DISABLED**

If your vehicle is equipped with Traction Control, this message will be displayed if a problem is noted in the Traction Control System. Have your vehicle serviced as soon as possible.

## **TRANS FLUID RESET (Northstar Only)**

With the engine not running and the ignition ON, press and hold the OFF and REAR DEFOG buttons until the TRANS FLUID RESET message appears in the Information Center (between 5 and 20 seconds).

## **TRANS OVERHEATED (Northstar Only)**

This message indicates that your transaxle is running too hot. You should stop and turn your engine off as soon as possible. Let the engine and transaxle cool and have the problem corrected. Severe transaxle damage can result from an overheated transaxle.

## **TURN SIGNAL ON**

This message is a reminder, after driving about a mile that you have your turn signal on.

## **TRUNK OPEN**

This message indicates that your trunk is open when the Ignition is ON.

## **VERY LOW REFRIGERANT**

This message means that the Air Conditioning system detects a refrigerant level that is low enough to cause damage to the A/C compressor. To avoid damage, the A/C compressor automatically turns off and the Electronic Climate Control will automatically switch from "AUTO" to "ECON" and remain there. Have your A/C system serviced if this message appears.

## ***Speed Sensitive Steering (SSS)***

This system varies the amount of steering effort proportionate to your vehicle speed. Steering is easier at a lower speed for increased maneuverability and parking ease. As your vehicle speed increases, the steering effort is also increased proportionately. At highway speeds the amount of steering effort is greatly increased to provide a manual like steering feel for maximum control and enhanced vehicle stability.

## ***Road Sensing Suspension (Northstar Only)***

The Road Sensing Suspension automatically controls the ride of your vehicle. The system controls damping forces in the shock absorbers and struts in response to various road and driving conditions. The system is capable of making these changes within milli-seconds.

The Road Sensing Suspension controller is a computer used to control and monitor the system. The computer receives inputs from vertical acceleration sensors, wheel to body position sensors, vehicle speed sensor, lift and dive signals, and determines optimum strut valving or (suspension stiffness) for your current operating conditions. The computer also receives feedback from the various components to determine proper system operation. If the computer receives an incorrect feedback from the system, an error code will be set in memory and a **SERVICE RIDE CONTROL** message will display on the Driver Information Center. If this message should appear, have your vehicle serviced at your Cadillac dealer at your earliest convenience.

## ***Oil Life Indicator***

Your Cadillac has a Driver Information Center with an Oil Change Indicator feature. This tells you when you need to change your engine oil. It's based upon the engine oil temperatures and your driving patterns.



To see the display, press the Information button several times until "OIL LIFE INDEX" appears.

You'll see how much oil life you have left, as a percentage. So, if you see "95 OIL LIFE INDEX," for example, that means that the way you're driving your car, 95% of your current oil life is still left.

The "OIL LIFE INDEX" may say to change the oil sooner than your maintenance schedule. This can happen if driving conditions, such as short trips in cold weather, cause shorter oil life. Always keep a written record of the mileage and date when you last changed your oil. For more information on when to change your oil, see the "Maintenance Schedule."

If you see "CHANGE OIL SOON," it means that you have less than 10% of your oil life left, and you should consider changing your engine oil.

If you see "CHANGE ENGINE OIL," it means the oil life is gone and you should change the oil right away (certainly within 200 more miles [320 km]).

The system probably will say to change the oil between 3000 miles (5000 km) and 7500 miles (12500 km), but it may even say to change it before 3000 under very severe conditions. It all depends on your driving patterns. If it's been 7500 miles (12500 km) it will say to change oil.

There are two things the system doesn't do:

- It can't sense heavy dust in the places where you drive. If you drive in a dusty area, you should change your oil every 3000 miles (5000 km) or 3 months (whichever comes first), unless the display says to change it even sooner than that.
- It doesn't check how much oil you have, so you'll still have to check for that. To see how, see Index under "Engine Oil."

Also, for the system to work right, it is important that you use SG oil, as discussed earlier.

### ***When You've Changed the Oil***

When new oil is put in, you'll need to reset your system. To do it, display the "OIL LIFE INDEX" by pressing the "Information" button. Then press and hold the "STORE/RECALL" buttons until the display shows "100."

## ***Speed Sensitive Suspension***

The Speed Sensitive Suspension automatically controls the firmness of your Cadillac's ride. An actuator in each of the four struts will change ride firmness depending on vehicle speed and other driving conditions. As the vehicle speed increases, the firmness of the suspension changes to one or three damping modes "Comfort", for speeds less than 40 mph, "Normal" for speeds between 40 and 60 mph, and "Firm" for speeds greater than 60 mph. The system also stiffens damping during hard acceleration, braking and cornering for increased control.

A computer is used to control and monitor the system. The computer receives speed, acceleration and determines optimum mode strut valving (or suspension stiffness) for your current operating conditions. The computer also receives feedback from the struts to determine proper system operation. If the computer receives an incorrect feedback from the system, an error code will be set in memory and a message "SERVICE RIDE CONTROL" will be displayed until the problem is corrected. If this message should appear, have your vehicle serviced at your Cadillac dealer at your earliest convenience.

## ***Electronic Level Control***

This keeps your car level.

The ignition has to be "ON" for the level control to work. When you turn the ignition off, you may hear the level control exhausting. The system consists of an electronic height sensor, a small electric air compressor, and air adjustable shock absorbers mounted on the rear of the vehicle.

If the system has a slight leak, the air compressor will run frequently for a few seconds each time.

For a massive air leak, the air compressor will stay on for approximately 7 minutes. You should see your dealer for service, but you can keep driving your Cadillac, though.



## SECTION 3

### COMFORT CONTROLS AND AUDIO SYSTEMS

In this section you'll find out how to operate the comfort control systems and audio systems offered with your Cadillac. Be sure to read about the particular system supplied with your vehicle.

### *YOUR CADILLAC AIR SYSTEM*

#### *Outside Air*

The outside air always flows through your Cadillac when it is moving. It enters your vehicle through an inlet at the base of the windshield. Keep this area clear a debris. Even if the vehicle is not moving, you can always get outside air . If you are traveling in the 60°F (16°C ) AUTO setting, a door will close to stop the flow of outside air, recirculating only the interior air to cool your vehicle.

#### *Air Outlets*



The air outlets are located in the center and each side of the instrument panel. You can adjust the direction of air flow by moving the control levers or even turn off the air flow by rotating the lever located on each side of the outlets.



## *Electronic Climate Control (ECC)*



Your vehicle has strategically placed electronic sensors, that feed information to the vehicle's computer systems. Your vehicle can control the ventilation, heating, and air conditioning automatically year round. The outside temperature, inside temperature setting, fan speeds, and the ECC selection are displayed on a digital screen.

**OFF:** Nothing is on, but air will flow through your vehicle if you're moving. The system will try to keep the air at the selected temperature, but it might not be able to maintain it if it's hot, or cold, outside.

**"OUTSIDE" Temperature:** The outside temperature is always displayed when your vehicle is running. You can change it from Celsius to Fahrenheit by pushing the ENG/MET(English/Metric) button.

## Temperature

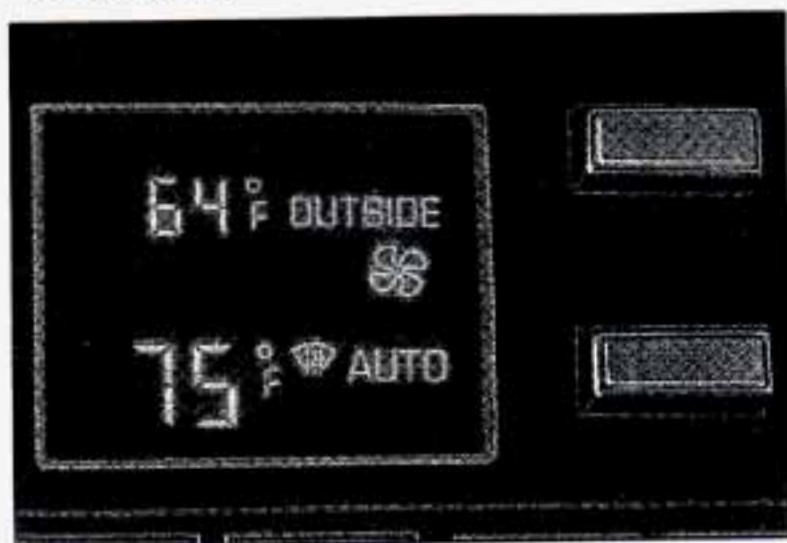

To select the temperature you want, push the blue button for a cooler setting and the red button for a warmer setting. The temperature setting will be displayed on the digital screen.

You can select temperatures from 65° F (18° C) to 85° F (69° C). And, at each end, you may choose 60° F (16° C), for maximum cooling, and 90° F (33° C), for maximum heating. We recommend when first getting familiar with your vehicle, select 75° F (24° C). You may find that your own personal comfort requires a slightly higher or lower setting. Once you set the temperature, the system will automatically maintain the set temperature.

### ECON

With this setting it's all automatic, but the air conditioning compressor does not operate and it won't remove humidity from the air. However, the system will try to keep the air at the selected temperature. Use this setting in cold or cool weather to save fuel.

If it's warm outside and you need to cool the air, use the next choice.

### AUTO

With this setting, the air conditioning compressor runs and it's all automatic. In cold weather when the system senses the need for heat, the air flow will be directed out the floor ducts. As the interior temperature approaches the desired setting, the blower speed will decrease and the air flow could be directed through the defroster and floor ducts. To maintain interior comfort, the air flow may move to the air outlets and floor ducts (Bi-level). On bright sunny days in cold weather, the air flow could even come out the A/C outlets to maintain comfort.

## **Electronic Climate Control Features**

### **A/C Purge**

If your vehicle is sitting out on a hot day and you have it set on AUTO, the air will first flow out the floor air ducts for a few seconds. That is normal. This is to expel hot air in the air ducts. As the air is cooled, the flow will move through the A/C outlets.

### **Cold Weather Purge**

On cold days when your system is first turned on, at any setting other than Defroster, DEFOG or OFF a small amount of air will flow through the defroster duct preventing your windshield from fogging.

### **Automatic Defog**

When using your wipers or rear window defogger for several minutes, the system senses that a humid condition exists. When this happens, air flow will be directed to the windshield and floor ducts to keep your side glass and windshield clear.

### **Manually Recirculate Inside Air**

There may be times, when you don't want air from the outside. To recirculate the air from the inside only, just set the temperature to 60°F (16°C) and adjust your fan speed.

### **DEFOG**

Push this button to divide the air between the windshield and the heater ducts. This is useful when fog appears on the windshield or side glass due to a sudden rain.

## Fan Speeds



Push the (symbol) button until "AUTO" is displayed on the screen. At this setting, the fan speed is controlled automatically. If it is cold outside, the blower may not run in the maximum high fan speed. That is normal.

If you want the blower fan to run only at a fixed high speed, push the (upper) button until you see "HI" on the display.

If you want the fan speed to be automatic, but you like the fan speed to be higher than the AUTO setting, just push the buttons until "HI/AUTO" is shown on the display.

If you want the blower to run only at a fixed low speed, push the (low) button until "LO" is shown on the display.

If you want the fan speed to run lower than the "AUTO" setting, push the button until "AUTO LO" is shown on the display.

## DEFROSTER



Push this button to remove fog or ice from the windshield.

The fan speed will work automatically or you can choose another fan speed if you want.

It will help a lot if you first clear any ice and snow from the hood and the air inlet (it's between the hood and the windshield).

## REAR DEFOGGER

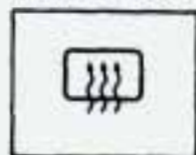

Push this button to turn on the rear defogger.

With it, your rear window and both outside rearview mirrors are heated.

The system will automatically shut off after 10 minutes. If further defrosting is desired, simply push the button again.

### **NOTICE:**

**Scraping the inside of your rear window could cut and damage the heating grids. Your warranty would not cover this damage. And don't put decals there; you might have to scrape them off.**

### *Electronic Solar Sensor*

The Electronic Solar Sensor is part of the Electronic Climate Control System.

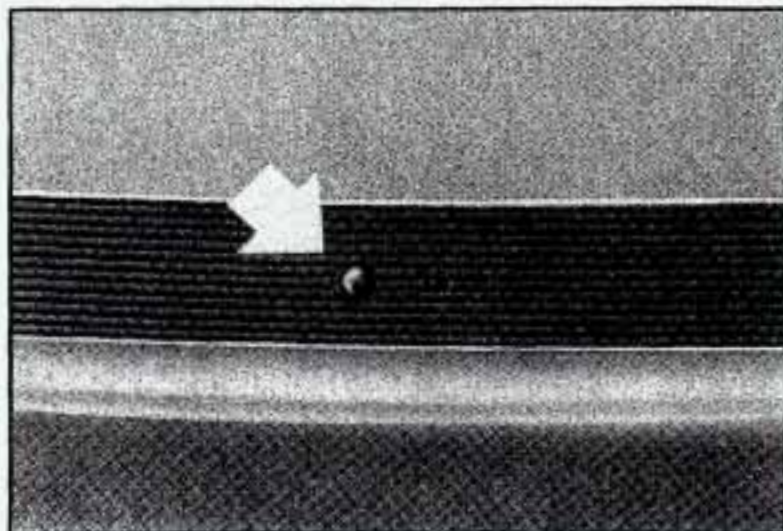

The sensor monitors the sun's solar radiation by telling the Electronic Climate Control system at what angle and intensity the sun is. The Electronic Climate Control uses this information to automatically make the necessary temperature and air flow adjustments.

## *Rear Seat Air Outlet*

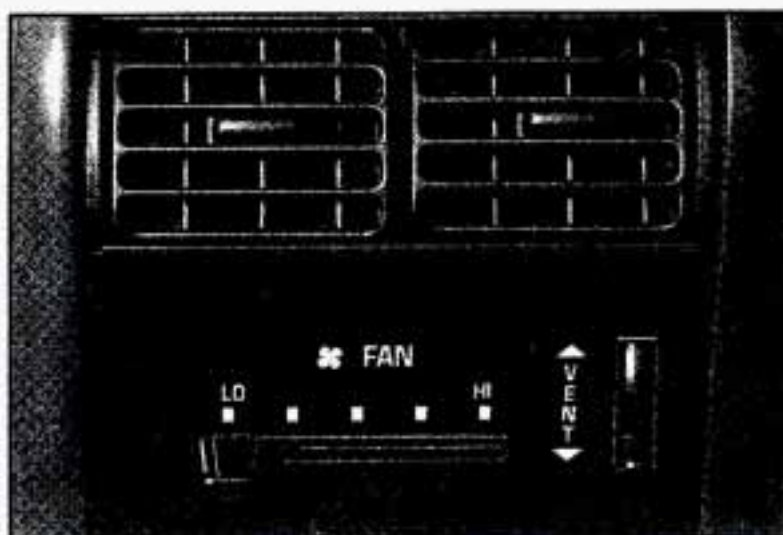

Move the switch to adjust the blower speed from "LO" to "HI."

Move the "VENT" lever to direct air flow from either the upper or floor outlets.

## *Heated Windshield (Option)*

### **Front De-Ice**

Here's how to use your heated windshield in cold weather to remove ice or frost quickly:

1. If any snow is piled up on the windshield, brush it away.
2. Start your Cadillac and leave it in P ("Park").



3. Push the switch. A light will come on to tell you it is working.

4. Try not to use other electrical equipment while the system is working.

The system will go off after a four minute heating cycle. If you shift out of "P" (Park), the system will only cycle for two minutes. If you want it to cycle again, push the switch. It will go on for two minute cycles after that. If it has cleared your windshield before the cycle is over, you can turn it off by just pushing the switch again.

Use the defroster to clear the windshield. In warm weather the heated windshield system helps keep the vehicle's interior cool by blocking much of the sun's heat producing radiation. The system's solar control properties also help reduce interior fading.

There is a metal film in the windshield which will block out some radio or microwave signals. Therefore, the heated windshield will reduce the useful range of devices such as garage door openers and radar detectors. (In certain states radar detectors are legal.)

## ***SOUND SYSTEMS***

Your Delco® sound system has been designed to operate easily and give years of listening pleasure. But you will get the most enjoyment out of it if you acquaint yourself with it first. Find out what your Delco® system can do and how to operate all its controls, to be sure you're getting the most out of the advanced engineering that went into it.

### ***FM Stereo***

FM stereo will give you the best sound. But FM signals will reach only about 10 to 40 miles (16 to 65 km). And, tall buildings or hills can interfere with FM signals, causing the sound to come and go.

### ***AM***

The range for most AM stations is greater than for FM, especially at night. The longer range, however, can cause stations to interfere with each other. AM can pick up noise from things like storms and power lines. Try reducing the treble to reduce this noise if you ever get it.

## **AMAX®**

This means your radio can produce quality AM sound comparable to FM stereo. AMAX® reduces noise without reducing the high frequencies you need for the best sound. In addition to improved sound quality, AMAX® includes more station on the AM band. You don't have to do anything in your radio because AMAX® is automatic.

## **AM Stereo**

This means the Delco® system can receive C-QUAM<sup>®</sup> stereo broadcasts. Many AM stations around the country use C-QUAM<sup>®</sup> to produce stereo, though some do not. (C-QUAM<sup>®</sup> is a registered trademark of Motorola, Inc.) If your Delco® system can get C-QUAM<sup>®</sup>, your "SI" stereo light will come on when you're receiving it.



### **CAUTION:**

**Hearing damage from loud noise is almost undetectable until it is too late. Your hearing can adapt to higher volumes of sound. Sound that seems normal can be loud and harmful to your hearing. Take precautions by adjusting the volume control on your radio to a safe sound level before your hearing adapts to it.**

**To help avoid hearing loss or damage:**

- **Adjust the volume control to the lowest setting.**
- **Increase volume slowly until you hear comfortably and clearly.**



## **NOTICE:**

**Before you add any sound equipment to your vehicle -- like a tape player, CB radio, mobile telephone or two-way radio -- be sure you can add what you want. If you can, it's very important to do it properly. Added sound equipment may interfere with the operation of your vehicle's engine, Delco® radio or other systems, and even damage them. And, your vehicle's systems may interfere with the operation of sound equipment that has been added improperly.**

**So, before adding sound equipment, check with your dealer and be sure to check Federal rules covering mobile radio and telephone units.**

## *How To Operate Your Sound System*

Your Cadillac will have one of these Delco Radio Systems.





Please read the following to operate the radio portion of your Delco radio system.

### *The Upper Knob*

The upper knob does these five things:

- It turns the radio on and off.
- It controls the volume.

- It lets you see what station you have. (When the radio is on, push the knob to display the station).
- It tells you the time. (When the ignition is off, push the upper knob to display the time.)
- Push the knob to change direction of tape play.

Behind the upper knob is a balance control. It moves the sound between the left and right speakers. If you have the Delco Bose System you do not have this balance control.

### ***The Lower Knob***

Turn the lower knob to choose radio stations. Push the knob to switch from AM or FM.

If you have the Delco Bose Gold Series Music System, it lets you switch from CD (Compact Disc) to TP (Tape player).

The control behind the lower knob moves the sound between your front and rear speakers.

### ***SCAN***

When you push this button either up or down, the SCAN indicator in the display will light and the radio will find the next station and stay there about 5 seconds. Then it will go to the next station and pause, and keep doing that until you push either the SCAN or upper knob.

### ***SEEK***

This button selects stations, but it doesn't keep moving as SCAN does. When you push SEEK up or down, the radio will automatically go to the next strongest station and stay there.

### ***Export Radio Only***

The SCAN and SEEK function selects station only in one direction.

## ***Push Buttons***

You can set the push buttons to get up to ten favorite stations (Five on AM and five more on FM). Just:

- Choose either AM or FM
- Tune in the station.
- Push the SET button.
- Within 5 seconds, push one of the five push buttons.
- Repeat these steps for each of the five push buttons.

## ***BASS***

The slide control increases or decreases the bass response tone. Moving the control to the right increases bass while moving it to the left decreases it.

## ***TREBLE***

The slide control increases or decreases the treble response tone. Moving the control to the right increases the treble while moving it to the left decreases it.

## ***Your Cassette Tape Player***

Your cassette tape player works best with tapes that are 30 to 45 minutes long on each side. Tapes longer than that are so thin that they may not work well in this player.

If you look at the tape, or on its label or box, it should say whether its bias, ("equalization" is 70 microseconds ( $70 \mu$ ) or 120 microseconds ( $120 \mu$ ). Chrome and metal tapes are  $70 \mu$  sec and standard iron tapes are  $120 \mu$  sec. Your tape player will adjust automatically for either type of cassette tape.

## ***To Play A Cassette Tape***

- Turn the radio on.
- Insert the cassette through the tape door. (The "TAPE" indicator in the display will light.)

If you hear nothing or hear just a garbled sound, the cassette may not be in squarely. Push the EJCT button to remove the tape and start over. The tape equalization is automatically sensed and set. Inserting the cassette also automatically disables DNR®\* and activates DOLBY® noise reduction.

DNR® is the Dynamic Noise Reduction. It helps remove background hiss noise from the radio.

- Once the tape is playing, use the upper and lower knobs to adjust the volume and balance, just as you do for the radio. Push the upper knob to change tape direction. The arrow in the display show which direction the tape is being played.

## ***FWD (Forward)***

Push the FWD button to move forward rapidly to another part of the tape. The radio will play during fast forward. To stop the tape push the same button and the tape will start to play again.

## ***REV (Reverse)***

Push the REV button to move the tape rapidly backward. To stop the tape, push the same button lightly or any of the other buttons. The radio will play during this reverse function.

To go from one side of the tape to the other, push in the upper knob on your radio. To remove the tape, push EJCT. The tape can be ejected when the ignition is turned off.

\*DNR® is a registered trademark of National Semiconductor Corporation.

## ***NEXT***

Push the NEXT button up to jump quickly to the next selection. If the selection is at the end of the tape, the tape will reverse directions and begin playing at a normal speed.

## ***PREV***

Push the PREV button up to quickly go to the beginning of the last selection.

If the player has played less than 10 seconds into the current selection, depressing the PREV button will cause the player to find the beginning of the previous selection and resume play from that point. If the player is more than 10 seconds into the current selection, pressing PREV button will cause the player to find the beginning of the current selection and resume play from that point. If PREV is issued while the first selection on the tape is being played, the player will return to the beginning of that side of the tape.

## ***ST/PL (Stop-Play)***

Press ST/PL to switch back to the radio without ejecting the tape. Press it a second time to start playing it again.

## ***EJCT (Eject Tape)***

Press this button to remove the tape.

## ***The Delco Bose Gold Series Music System***

This optional sound system combines an AM/FM stereo radio with a cassette tape player and a compact disc player in a single unit.

To operate the radio and cassette tape player portion of this music system, please read the beginning of this section. "How To Operate Your Sound System" and "Your Cassette Tape Player."

## ***To Play the Disc Player***

Before you begin, please note: don't use the mini-discs that are called "singles" (even with an adapter). They won't eject. Use full-size compact discs only.

- Turn the radio on.
- Insert a disc (label side up) partway into the slot. The player will pull it in. Wait a few seconds and the disc will play. Then only the time of day and "CD" will display.

If the disc comes back out, check to see if:

- The disc is upside down.
- The disc is dirty, scratched, or wet.
- There's too much moisture in the air. (If there is, wait about one hour and try again).

## ***"Err" (Error Detection)***

If this message is displayed, you have a condition of either extreme temperature, moisture, or an incorrect disc. The disc will automatically be ejected. When conditions are back to normal, the disc should play again.

## ***RCL/PROG (Recall/Program)***

- Press once to see what track is being played.
- Within 5 seconds press it a second time to see how long the disc has been playing.
- Press it a third time to see the time of day.

## ***Rev (Reverse)***

Push and hold REV to return rapidly within a track. Release it to play the passage. The elapsed time will be displayed to show the reverse progress of the CD.

## ***FWD (Fast Forward)***

Press and hold FWD to advance quickly within a track. Release it to resume playing. Elapsed time will be displayed to show the forward progress of the CD.

### ***Prev (Previous)***

Push this button to go back to the beginning of the track or push it again to a favorite track.

### ***Next***

Push this button to advance to the next track.

### ***ST/PL (Stop/Play)***

Press this button and the disc or tape will stop without ejecting it and the radio will start to play. Press it again and the disc or tape will start to play again.

### ***EJCT (Eject)***

Press this button to eject the disc or tape. If you have both a CD and a tape in the player, then the other playback media will start to play. Press it again and the other media will eject.

### ***Comp (Compression)***

Pressing COMP makes soft and loud passages more nearly equal in volume. For example, playing classical or jazz music with very quiet and very loud passages in the same tune. The COMP display will light as long as COMP is on.

### ***Setting The Clock***

Turn the ignition on. Then:

To Set the Hour:

- Press SET, and within 5 seconds,
- Press and hold SEEK. When the clock gets to the correct hour, let go.

To Set the Minutes:

- Press SET, and within 5 seconds,
- Press and hold SCAN. When the clock gets to the correct minute, let go.

Your clock is set.



## ***Care of Your Cassette Tape Player***

A tape player that is not cleaned regularly can cause reduced sound quality, ruined cassettes, or a damaged mechanism. Cassette tapes should be stored in their cases away from contaminants, direct sunlight, and extreme heat. If they aren't, they may not operate properly or cause failure of the tape player.

Your tape player should be cleaned regularly each month or after every 15 hours of use. If you notice a reduction in sound quality, try a known good cassette to see if the tape or the tape player is at fault. If this other cassette has no improvement in sound quality, clean the tape player.

Clean your tape player with a wiping-action, non-abrasive cleaning cassette, and follow the directions provided with it.

Cassettes are subject to wear and the sound quality may degrade over time. Always make sure that the cassette tape is in good condition before you have your tape player serviced.

## ***Care of Your Compact Discs***

Handle discs carefully. Store them in their original cases or other protective cases and away from direct sunlight and dust. If the surface of a disc is soiled, dampen a clean, soft cloth in a mild, neutral detergent solution and clean it, wiping from the center to the edge.



Be sure never to touch the signal surface when handling discs. Pick up discs by grasping the outer edges or the edge of the hole and the outer edge.

## ***Power Antenna Mast Care***

Your power antenna will look its best and work well if it's cleaned from time to time.

### **To Clean the Antenna Mast:**

1. Turn on the ignition and radio to raise the antenna to full mast extension.
2. Dampen a clean cloth with mineral spirits or equivalent solvent.
3. Wipe cloth over the mast sections, removing any dirt.
4. Wipe dry with clean cloth before retracting.
5. Make the antenna go up and down by turning the radio or ignition on and off.
6. Then repeat if necessary.

### **NOTICE:**

**Don't lubricate the power antenna. Lubrication could damage it.**

### **NOTICE:**

**Before entering an automatic car wash, turn off your radio to make the power antenna go down. This will prevent the mast from possibly getting damaged. If the antenna does not go down when you turn the radio off, it may be damaged or need to be cleaned. In either case, lower the antenna by hand by carefully pressing the antenna down.**



## SECTION 4

### YOUR DRIVING AND THE ROAD



Here you'll find information about driving on different kinds of roads and in varying weather conditions. We've also included many other useful tips on driving.

### ***ROAD SIGNS***

The road signs you see everywhere are coded by color, shape and symbols. It's a good idea to know these codes so that you can quickly grasp the basic meaning or intent of the sign even before you have a chance to read it.

## *Color of Road Signs*



**RED** means **STOP**. It may also indicate that some movement is not allowed. Examples are **DO NOT ENTER** and **WRONG WAY**



**RAILROAD  
ADVANCE  
CROSSING**



**NO PASSING  
ZONE**



**NARROW  
BRIDGE**

**YELLOW** indicates a general warning. Slow down and be careful when you see a yellow sign. It may signal a railroad crossing ahead, a no passing

zone, or some other potentially dangerous situation. Likewise, a yellow solid line painted on the road means “Don’t Cross.”



**LOW  
SHOULDER**



**WORKERS  
AHEAD**



**FLAGGER  
AHEAD**

**ORANGE** indicates road construction or maintenance. You’ll want to slow down when you see an orange sign, as part of the road may be closed off or torn up. And there may be workers and maintenance vehicles around, too.



**GREEN** is used to guide the driver. Green signs may indicate upcoming freeway exits or show the direction you should turn to reach a particular place.



**HOSPITAL**



**INFORMATION**

**BLUE** signs with white letters show motorists' services.



**CANOEING**



**SWIMMING**

**BROWN** signs point out recreation areas or points of historic or cultural interest.

### ***Shape of Road Signs***

The shape of the sign will tell you something, too.



An **OCTAGONAL** (eight-sided) sign means **STOP**. It is always red with white letters.



A **DIAMOND**-shaped sign is a warning of something ahead — for example, a curve, steep hill, soft shoulder, or a narrow bridge.



A **TRIANGLE**, pointed downward, indicates **YIELD**. It assigns the right-of-way to traffic on certain approaches to an intersection.



A TRIANGULAR sign also is used on two-lane roads to indicate a NO PASSING ZONE. This sign will be on the left side of the roadway.



**KEEP  
RIGHT**



**LEFT OR  
THROUGH**



**RIGHT TURN  
ONLY**

RECTANGULAR (square or oblong) signs show speed limits, parking regulations, give directions, and such information as distances to cities.



## *Symbols on Road Signs*



There are many international road signs in use today.

The basic message of many of these signs is in pictures or graphic symbols. A picture within a circle with a diagonal line across it shows what not to do.



## ***TRAFFIC LIGHTS***

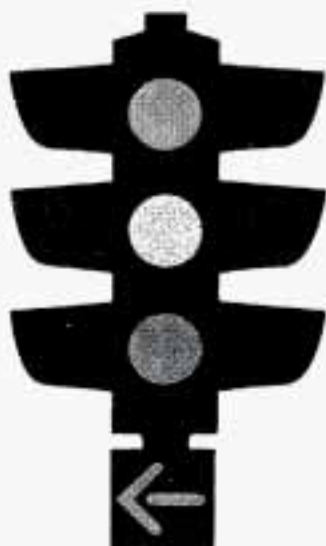

We're all familiar with traffic lights or stop lights. Often green arrows are being used in the lights for improved traffic control. On some multilane roads, green arrows light up, indicating that traffic in one or more lanes can move or make a turn. Green arrows don't mean "go no matter what." You'll still need to proceed with caution, yielding the right of way to pedestrians and sometimes to other vehicles.

Some traffic lights also use red arrows to signify that you must stop before turning on red.

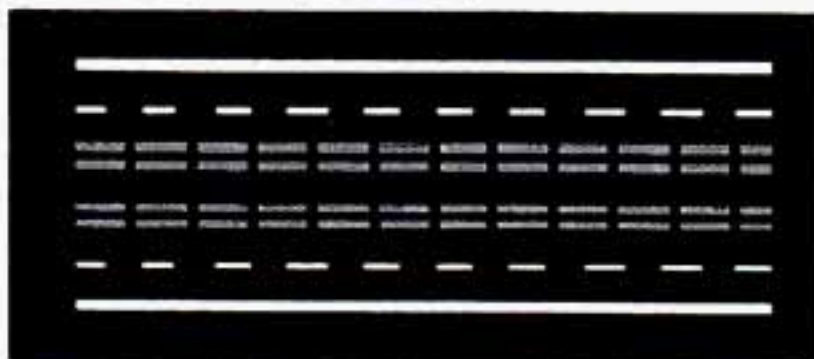
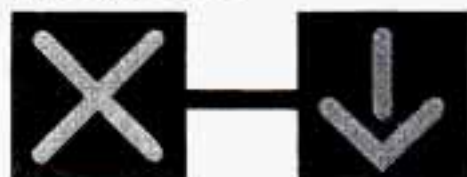

**REVERSIBLE  
LANE ON  
MULTI-  
LANE  
ROADWAY**

Many city roads and expressways, and even bridges, use reversible-lane traffic control during rush hours. A red X light above a lane means no driving in that lane at that time. A green arrow means you may drive in that lane. Look for the signs posted to warn drivers what hours and days these systems are in effect.

## ***PAVEMENT MARKINGS***



**NO  
PASSING  
ZONE**

Pavement markings add to traffic signs and signals. They give information to drivers without taking attention from the roadway. A solid yellow line on your side of the road or lane means “don’t cross.”

## ***YOUR OWN SIGNALS***

Drivers signal to others, too. It’s not only more polite, it’s safer to let other drivers know what you are doing. And in some places the law requires driver signals.

Turn and lane change signals. Always signal when you plan to turn or change lanes.

If necessary, you can use hand signals out the window: Left arm straight out for a left turn, down for slow or about-to-stop, and up for a right turn.

Slowing down. If time allows, tap the brake pedal once or twice in advance of slowing or stopping. This warns the driver behind you.

Disabled. Your four-way flashers signal that your vehicle is disabled or is a hazard. See “Hazard Warning Flasher” in the Index.

## ***TRAFFIC OFFICER***

The traffic police officer is also a source of important information. The officer's signals govern, no matter what the traffic lights or other signs say.

The next section discusses some of the road conditions you may encounter.

## ***DEFENSIVE DRIVING***

The best advice anyone can give about driving is: Drive defensively.

Please start with a very important safety device in your Cadillac: Buckle up. (See "Safety Belts" in the Index.)

Defensive driving really means "be ready for anything." On city streets, rural roads, or freeways, it means "always expect the unexpected."

Assume that pedestrians or other drivers are going to be careless and make mistakes. Anticipate what they might do. Be ready for their mistakes.

Expect children to dash out from behind parked cars, often followed by other children. Expect occupants in parked cars to open doors into traffic. Watch for movement in parked cars -- someone may be about to open a door.

Expect other drivers to run stop signs when you are on a through street. Be ready to brake if necessary as you go through intersections. You may not have to use the brake, but if you do, you will be ready.

If you're driving through a shopping center parking lot where there are well-marked lanes, directional arrows, and designated parking areas, expect some drivers to ignore all these markings and dash straight toward one part of the lot.

Pedestrians can be careless. Watch for them. In general, you must give way to pedestrians even if you know you have the right of way.

Rear-end collisions are about the most preventable of accidents. Yet they are common. Allow enough following distance. It's the best defensive driving maneuver, in both city and rural driving. You never know when the vehicle in front of you is going to brake or turn suddenly.

Here's a final bit of information about defensive driving. The most dangerous time for driving in the U.S. is very early on Sunday morning. In fact, GM Research studies show that the most and the least dangerous times for driving, every week, fall on the same day. That day is Sunday. The most dangerous time is Sunday from 3 a.m. to 4 a.m. The safest time is Sunday from 10 a.m. to 11 a.m. Driving the same distance on a Sunday at 3 a.m. isn't just a little more dangerous than it is at 10 a.m. It's about 134 times more dangerous!

That leads to the next section.

## ***DRUNKEN DRIVING***

Death and injury associated with drinking and driving is a national tragedy. It's the number one contributor to the highway death toll, claiming thousands of victims every year. Alcohol takes away three things that anyone needs to drive a vehicle:

- Judgment
- Muscular Coordination
- Vision

Police records show that half of all motor vehicle-related deaths involve alcohol — a driver, a passenger or someone else, such as a pedestrian, had been drinking. In most cases, these deaths are the result of someone who was drinking and driving. Over 25,000 motor vehicle-related deaths occur each year because of alcohol, and thousands of people are injured.

Just how much alcohol is too much if a person plans to drive? Ideally, no one should drink alcohol and then drive. But if one does, then what's "too much"? It can be a lot less than many might think. Although it depends on each person and situation, here is some general information on the problem.

The Blood Alcohol Content (BAC) of someone who is drinking depends upon four things:

- How much alcohol is in the drink.
- The drinker's body weight.
- The amount of food that is consumed before and during drinking.
- The length of time it has taken the drinker to consume the alcohol.

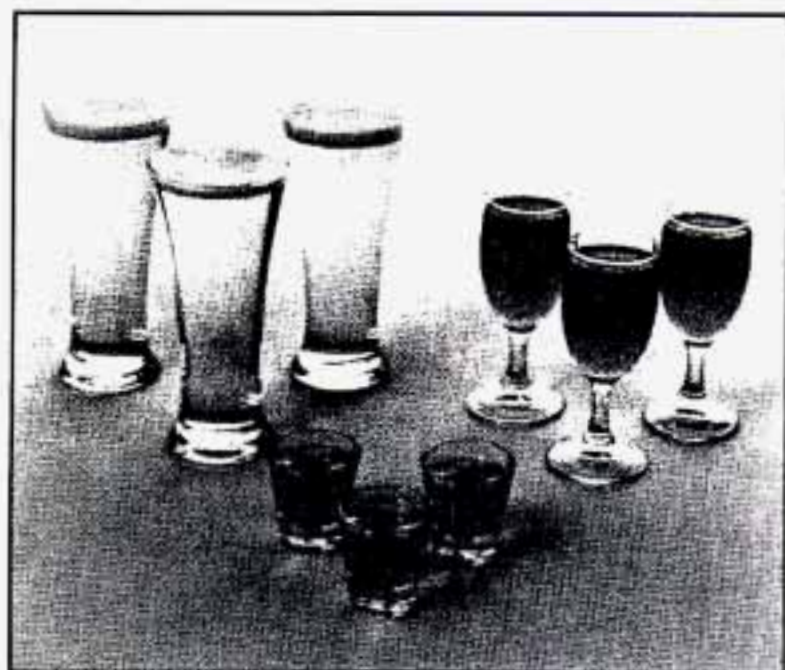

According to the American Medical Association, a 180-pound (82 kg) person who drinks three 12-ounce (355 ml) bottles of beer in an hour will end up with a BAC of about 0.06 percent. The person would reach the same BAC by drinking three 4-ounce (120 ml) glasses of wine or three mixed drinks if each had 1-1/2 ounces (45 ml) of a liquor like whiskey, gin or vodka.

It's the amount of alcohol that counts. For example, if the same person drank three double martinis (3 ounces or 90 ml of liquor each) within an hour, the person's BAC would be close to 0.12 percent. A person who consumes food just before or during drinking will have a slightly lower BAC level.

### DRINKING THAT WILL RESULT IN A BAC OF .05% IN THE TIME SHOWN

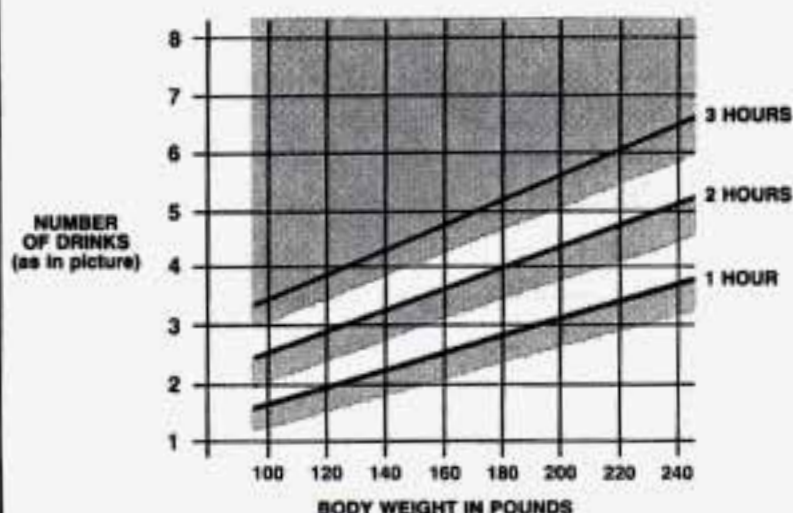

The law in most U.S. states sets the legal limit at a BAC of 0.10 percent. In Canada the limit is 0.08 percent, and in some other countries it's lower than that. The BAC will be over 0.10 percent after three to six drinks (in one hour). Of course, as we've seen, it depends on how much alcohol is in the drinks, and how quickly the person drinks them.

But it's very important to keep in mind that the ability to drive is affected well below a BAC of 0.10 percent. Research shows that the driving skills of many people are impaired at a BAC approaching 0.05 percent, and that the effects are worse at night. All drivers are impaired at BAC levels above 0.05 percent. Statistics show that the chance of being in an accident increases sharply for drivers who have a BAC of 0.05 percent or above. A driver with a BAC level of 0.06 percent (three beers in one hour for a 180-pound or 82 kg person) has doubled his or her chance of having an accident. At a BAC level of 0.10 percent, the chance of that driver having an accident is six times greater; at a level of 0.15 percent, the chances are twenty-five times greater! And, the body takes about an hour to rid itself of the alcohol in one drink. No amount of coffee or number of cold showers will speed that up.

"I'll be careful" isn't the right answer. What if there's an emergency, a need to take sudden action, as when a child darts into the street? A

person with a higher BAC might not be able to react quickly enough to avoid the collision.

There's something else about drinking and driving that many people don't know. Medical research shows that alcohol in a person's system can make crash injuries worse. That's especially true for brain, spinal cord and heart injuries. That means that if anyone who has been drinking -- driver or passenger -- is in a crash, the chance of being killed or permanently disabled is higher than if that person had not been drinking. And we've already seen that the chance of a crash itself is higher for drinking drivers.



### **CAUTION:**

**Drinking and then driving is very dangerous. Your reflexes, perceptions, and judgment will be affected by even a small amount of alcohol. You could have a serious -- or even fatal -- accident if you drive after drinking. Please don't drink and drive or ride with a driver who has been drinking. Ride home in a cab; or if you're with a group, designate a driver who will not drink.**

## ***CONTROL OF A VEHICLE***

You have three systems that make your vehicle go where you want it to go. They are the brakes, the steering and the accelerator. All three systems have to do their work at the places where the tires meet the road.



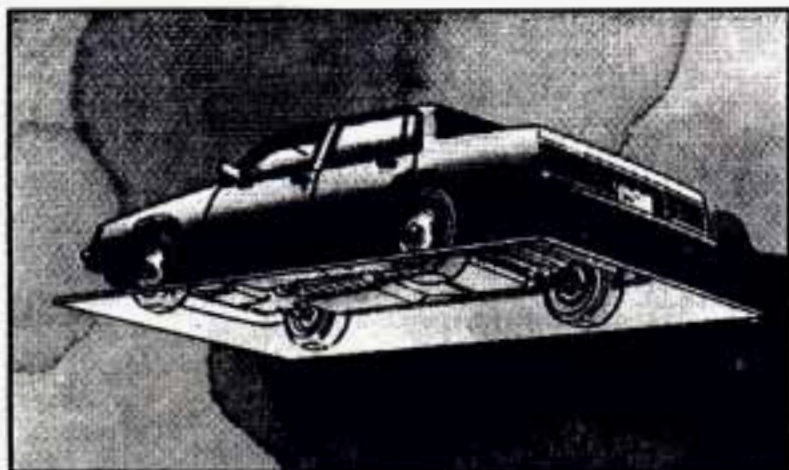

Sometimes, as when you're driving on snow or ice, it's easy to ask more of those control systems than the tires and road can provide. That means you can lose control of your vehicle.

## ***BRAKING***

Braking action involves perception time and reaction time.

First, you have to decide to push on the brake pedal. That's perception time. Then you have to bring up your foot and do it. That's reaction time.

Average reaction time is about 3/4 of a second. But that's only an average. It might be less with one driver and as long as two or three seconds or more with another. Age, physical condition, alertness, coordination, and eyesight all play a part. So do alcohol, drugs and frustration. But even in 3/4 of a second, a vehicle moving at 60 mph (100 km/h) travels 66 feet (20 m). That could be a lot of distance in an emergency, so keeping enough space between your vehicle and others is important.

And, of course, actual stopping distances vary greatly with the surface of the road (whether it's pavement or gravel); the condition of the road (wet, dry, icy); tire tread, and the condition of your brakes.

Most drivers treat their brakes with care. Some, however, overwork the braking system with poor driving habits.

- Avoid needless heavy braking. Some people drive in spurts -- heavy acceleration followed by heavy braking -- rather than keeping pace with traffic. This is a mistake. Your brakes may not have time to cool

between hard stops. Your brakes will wear out much faster if you do a lot of heavy braking.

- Don't "ride" the brakes by letting your left foot rest lightly on the brake pedal while driving.



 **CAUTION:**

**"Riding" your brakes can cause them to overheat to the point that they won't work well. You might not be able to stop your vehicle in time to avoid an accident. If you "ride" your brakes, they will get so hot they will require a lot of pedal force to slow you down. Avoid "riding" the brakes.**

**NOTICE:**

**"Riding" the brakes wears them out much faster. You would need costly brake replacement much sooner than normal, and it also reduces fuel economy.**

If you keep pace with the traffic and allow realistic following distances, you will eliminate a lot of unnecessary braking. That means better braking and longer brake life.

- If your engine ever stops while you're driving, brake normally but don't pump your brakes. If you do, the pedal may get harder to push down. If your engine stops, you will still have some power brake assist. But you will use it when you brake. Once the power assist is used up, it may take longer to stop and the brake pedal will be harder to push.

### ***Anti-Lock Brakes (ABS)***

Your Cadillac has an advanced electronic braking system that will help prevent skidding.

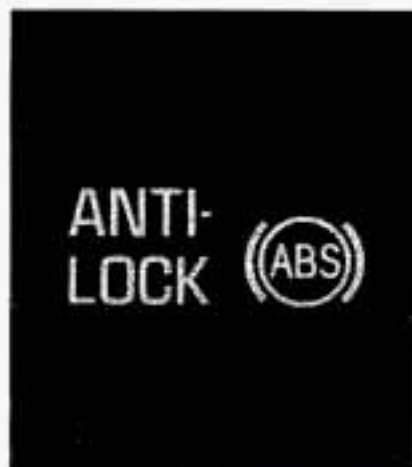

This light on the instrument panel will go on when you start your vehicle.

Once the vehicle speed reaches about 5 mph (8 km/h), you may hear a momentary motor or clicking noise and you may even notice that your brake pedal moves a little while this is going on. This is the ABS system testing itself. If there's a problem with the anti-lock brake system, the anti-lock brake system warning light will stay on. See "Anti-lock Brake System Warning Light" in the Index.



Here's how anti-lock works. Let's say the road is wet. You're driving safely. Suddenly an animal jumps out in front of you.

You slam on the brakes. Here's what happens with ABS.

A computer senses that wheels are slowing down. The computer separately works the brakes at each front wheel and at the rear wheels.

The anti-lock system can change the brake pressure faster than any driver could. The computer is programmed to make the most of available tire and road conditions.



You can steer around the obstacle while braking hard.

As you brake, your computer keeps receiving updates on wheel speed and controls braking pressure accordingly.

 **CAUTION:**

**Anti-lock doesn't change the time you need to get your foot up to the brake pedal. If you get too close to the vehicle in front of you, you won't have time to apply your brakes if that vehicle suddenly slows or stops. Always leave enough room up ahead to stop, even though you have anti-lock brakes.**

***To Use Anti-Lock:***

Don't pump the brakes. Just hold the brake pedal down and let anti-lock work for you. You may hear the anti-lock pump or motor operate, and feel the brake pedal pulsate, but this is normal.

***Disc Brake Wear Indicators***

Your Cadillac has four-wheel disc brakes.

Disc brake pads have built-in wear indicators that make a high-pitched warning sound when the brake pads are worn and new pads are needed. The sound may come and go or be heard all the time your vehicle is moving (except when you are pushing on the brake pedal firmly).

 **CAUTION:**

**The brake wear warning sound means that sooner or later your brakes won't work well. That could lead to an accident. When you hear the brake wear warning sound, have your vehicle serviced.**

**NOTICE:**

**Continuing to drive with worn-out brake pads could result in costly brake repair.**

Some driving conditions or climates may cause a brake squeal when the brakes are first applied or lightly applied. This does not mean something is wrong with your brakes.

Brake linings should always be replaced as complete axle sets.

### ***Brake Pedal Travel***

See your dealer if the brake pedal does not return to normal height, or if there is a rapid increase in pedal travel. This could be a sign of brake trouble.

### ***Brake Adjustment***

Every time you make a moderate brake stop, your disc brakes adjust for wear.

If you rarely make a moderate or heavier stop, then your brakes might not adjust correctly. If you drive in that way, then -- very carefully -- make a few moderate brake stops about every 1000 miles (1600 km), so your brakes will adjust properly.

### ***Braking in Emergencies***

Use your anti-lock braking system when you need to. With anti-lock, you can steer and brake at the same time. In many emergencies, steering can help you more than even the very best braking.

## ***STEERING***

### ***Power Steering***

If you lose power steering assist because the engine stops or the system fails to function, you can steer but it will take much more effort.

### ***Steering Tips***

#### ***Driving on Curves***

It's important to take curves at a reasonable speed.

A lot of the “driver lost control” accidents mentioned on the news happen on curves. Here’s why:

Experienced driver or beginner, each of us is subject to the same laws of physics when driving on curves. The traction of the tires against the road surface makes it possible for the vehicle to change its path when you turn the front wheels. If there’s no traction, inertia will keep the vehicle going in the same direction. If you’ve ever tried to steer a vehicle on wet ice, you’ll understand this.

The traction you can get in a curve depends on the condition of your tires and the road surface, the angle at which the curve is banked, and your speed. While you’re in a curve, speed is the one factor you can control.

Suppose you’re steering through a sharp curve. Then you suddenly accelerate.

Those two control systems -- steering and acceleration -- can overwhelm those places where the tires meet the road and make you lose control.

What should you do if this ever happens? Let up on the accelerator pedal, steer the vehicle the way you want it to go, and slow down.

Speed limit signs near curves warn that you should adjust your speed. Of course, the posted speeds are based on good weather and road conditions. Under less favorable conditions you’ll want to go slower.

If you need to reduce your speed as you approach a curve, do it before you enter the curve, while your front wheels are straight ahead.

Try to adjust your speed so you can “drive” through the curve. Maintain a reasonable, steady speed. Wait to accelerate until you are out of the curve, and then accelerate gently into the straightaway.

When you drive into a curve at night, it’s harder to see the road ahead of you because it bends away from the straight beams of your lights. This is one good reason to drive slower.

## ***Steering in Emergencies***

There are times when steering can be more effective than braking. For example, you come over a hill and find a truck stopped in your lane, or a car suddenly pulls out from nowhere, or a child darts out from between parked cars and stops right in front of you. You can avoid these problems

by braking -- if you can stop in time. But sometimes you can't; there isn't room. That's the time for evasive action -- steering around the problem.

Your Cadillac can perform very well in emergencies like these. First apply your brakes. It is better to remove as much speed as you can from a possible collision. Then steer around the problem, to the left or right depending on the space available.

An emergency like this requires close attention and a quick decision. If you are holding the steering wheel at the recommended 9 and 3 o'clock positions, you can turn it a full 180 degrees very quickly without removing either hand. But you have to act fast, steer quickly, and just as quickly straighten the wheel once you have avoided the object. You must then be prepared to steer back to your original lane and then brake to a controlled stop.

Depending on your speed, this can be rather violent for an unprepared driver. This is one of the reasons driving experts recommend that you use your safety belts and keep both hands on the steering wheel.

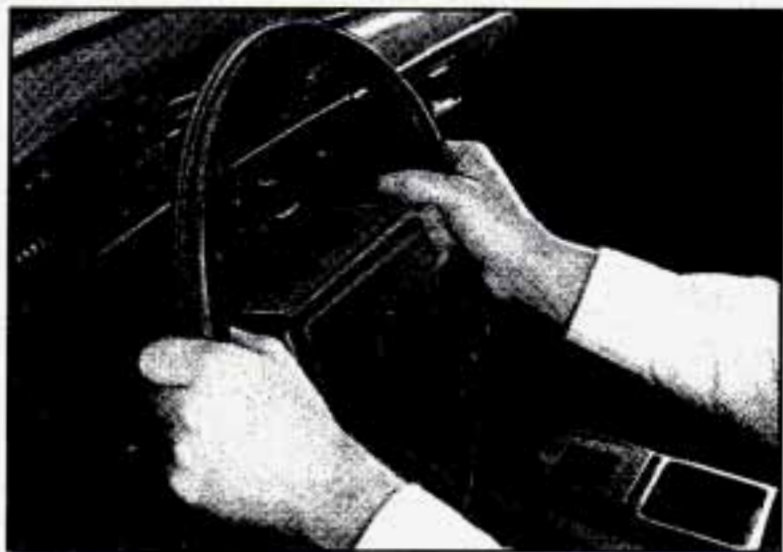

The fact that such emergency situations are always possible is a good reason to practice defensive driving at all times.

## ***OFF-ROAD RECOVERY***

You may find sometime that your right wheels have dropped off the edge of a road onto the shoulder while you're driving.



If the level of the shoulder is only slightly below the pavement, recovery should be fairly easy. Ease off the accelerator and then, if there is nothing in the way, steer so that your vehicle straddles the edge of the pavement. You can turn the steering wheel up to 1/4 turn until the right front tire contacts the pavement edge. Then turn your steering wheel to go straight down the roadway.

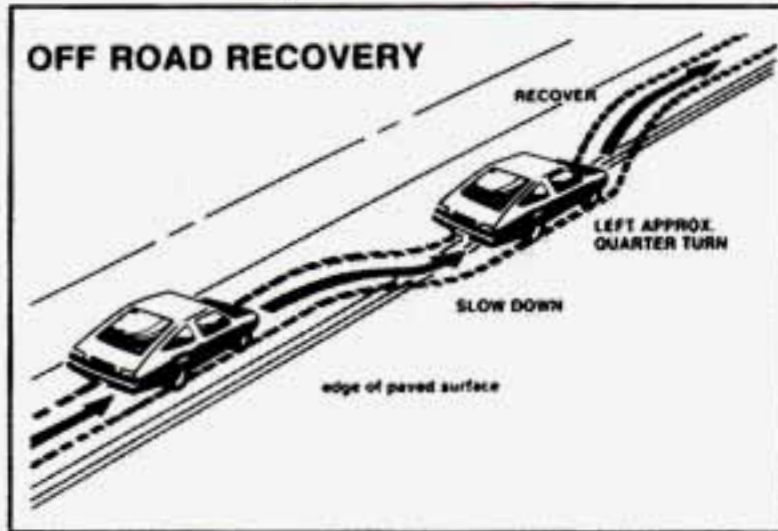

If the shoulder appears to be about four inches (100 mm) or more below the pavement, this difference can cause problems. If there is not enough room to pull entirely onto the shoulder and stop, then follow the same procedures. But if the right front tire scrubs against the side of the pavement, do NOT steer more sharply. With too much steering angle, the vehicle may jump back onto the road with so much steering input that it crosses over into the oncoming traffic before you can bring it back under control.

Instead, ease off again on the accelerator and steering input, straddle the pavement once more, then try again.

## ***PASSING***

The driver of a vehicle about to pass another on a two-lane highway waits for just the right moment, accelerates, moves around the vehicle ahead, then goes back into the right lane again. A simple maneuver?

Not necessarily! Passing another vehicle on a two-lane highway is a potentially dangerous move, since the passing vehicle occupies the same

lane as oncoming traffic for several seconds. A miscalculation, an error in judgment, or a brief surrender to frustration or anger can suddenly put the passing driver face to face with the worst of all traffic accidents -- the head-on collision.

So here are some tips for passing:

- “Drive ahead.” Look down the road, to the sides, and to crossroads for situations that might affect your passing patterns. If you have any doubt whatsoever about making a successful pass, wait for a better time.
- Watch for traffic signs, pavement markings, and lines. If you can see a sign up ahead that might indicate a turn or an intersection, delay your pass. A broken center line usually indicates it’s all right to pass (providing the road ahead is clear). Never cross a solid line on your side of the lane or a double solid line, even if the road seems empty of approaching traffic.
- If you suspect that the driver of the vehicle you want to pass isn’t aware of your presence, tap the horn a couple of times before passing.
- Do not get too close to the vehicle you want to pass while you’re awaiting an opportunity. For one thing, following too closely reduces your area of vision, especially if you’re following a larger vehicle. Also, you won’t have adequate space if the vehicle ahead suddenly slows or stops. Keep back a reasonable distance.
- When it looks like a chance to pass is coming up, start to accelerate but stay in the right lane and don’t get too close. Time your move so you will be increasing speed as the time comes to move into the other lane. If the way is clear to pass, you will have a “running start” that more than makes up for the distance you would lose by dropping back. And if something happens to cause you to cancel your pass, you need only slow down and drop back again and wait for another opportunity.
- If other cars are lined up to pass a slow vehicle, wait your turn. But take care that someone isn’t trying to pass you as you pull out to pass the slow vehicle. Remember to glance over your shoulder and check the blind spot.
- Check your mirrors , glance over your shoulder, and start your left lane change signal before moving out of the right lane to pass. When you are far enough ahead of the passed vehicle to see its front in your

inside mirror, activate your right lane change signal and move back into the right lane. (Remember that your right outside mirror is convex. The vehicle you just passed may seem to be farther away from you than it really is.)

- Try not to pass more than one vehicle at a time on two-lane roads. Reconsider before passing the next vehicle.
- Don't overtake a slowly moving vehicle too rapidly. Even though the brake lights are not flashing, it may be slowing down or starting to turn.
- If you're being passed, make it easy for the following driver to get ahead of you. Perhaps you can ease a little to the right.

## ***LOSS OF CONTROL***

Let's review what driving experts say about what happens when the three control systems (brakes, steering and acceleration) don't have enough friction where the tires meet the road to do what the driver has asked.

In any emergency, don't give up. Keep trying to steer and constantly seek an escape route or area of less danger.

### ***Skidding***

In a skid, a driver can lose control of the vehicle. Defensive drivers avoid most skids by taking reasonable care suited to existing conditions, and by not "overdriving" those conditions. But skids are always possible.

The three types of skids correspond to your Cadillac's three control systems. In the braking skid your wheels aren't rolling. In the steering or cornering skid, too much speed or steering in a curve causes tires to slip and lose cornering force. And in the acceleration skid too much throttle causes the driving wheels to spin.

A cornering skid and an acceleration skid are best handled by easing your foot off the accelerator pedal.

If your vehicle starts to slide (as when you turn a corner on a wet, snow- or ice-covered road), ease your foot off the accelerator pedal as soon as you feel the vehicle start to slide. Quickly steer the way you want to go. If you start steering quickly enough, your vehicle will straighten out. As it does, straighten the front wheels.

Of course, traction is reduced when water, snow, ice, gravel, or other material is on the road. For safety, you'll want to slow down and adjust your driving to these conditions. It is important to slow down on slippery surfaces because stopping distance will be longer and vehicle control more limited.

While driving on a surface with reduced traction, try your best to avoid sudden steering, acceleration, or braking (including engine braking by shifting to a lower gear). Any sudden changes could cause the tires to slide. You may not realize the surface is slippery until your vehicle is skidding. Learn to recognize warning clues -- such as enough water, ice or packed snow on the road to make a "mirrored surface" -- and slow down when you have any doubt.

Remember: Any anti-lock braking system (ABS) helps avoid only the braking skid. Steer the way you want to go.

## ***DRIVING AT NIGHT***



Night driving is more dangerous than day driving. One reason is that some drivers are likely to be impaired -- by alcohol or drugs, with night vision problems, or by fatigue.

Here are some tips on night driving.

- Drive defensively. Remember, this is the most dangerous time.

- Don't drink and drive. (See "Drunken Driving" in the Index for more on this problem.)
- Adjust your inside rearview mirror to reduce the glare from headlights behind you.
- Since you can't see as well, you may need to slow down and keep more space between you and other vehicles. It's hard to tell how fast the vehicle ahead is going just by looking at its taillights.
- Slow down, especially on higher speed roads. Your headlights can light up only so much road ahead.
- In remote areas, watch for animals.
- If you're tired, pull off the road in a safe place and rest.

## *Night Vision*

No one can see as well at night as in the daytime. But as we get older these differences increase. A 50-year-old driver may require at least twice as much light to see the same thing at night as a 20-year-old.

What you do in the daytime can also affect your night vision. For example, if you spend the day in bright sunshine you are wise to wear sunglasses. Your eyes will have less trouble adjusting to night.

But if you're driving, don't wear sunglasses at night. They may cut down on glare from headlights, but they also make a lot of things invisible that should remain visible — such as parked cars, obstacles, pedestrians, or even trains blocking railway crossings. You may want to put on your sunglasses after you have pulled into a brightly-lighted service or refreshment area. Eyes shielded from that glare may adjust more quickly to darkness back on the road. But be sure to remove your sunglasses before you leave the service area.

You can be temporarily blinded by approaching lights. It can take a second or two, or even several seconds, for your eyes to readjust to the dark. When you are faced with severe glare (as from a driver who doesn't lower the high beams, or a vehicle with misaimed headlights), slow down a little. Avoid staring directly into the approaching lights. If there is a line of opposing traffic, make occasional glances over the line of headlights to make certain that one of the vehicles isn't starting to move into your lane.

Once you are past the bright lights, give your eyes time to readjust before resuming speed.

## ***High Beams***

If the vehicle approaching you has its high beams on, signal by flicking yours to high and then back to low beam. This is the usual signal to lower the headlight beams. If the other driver still doesn't lower the beams, resist the temptation to put your high beams on. This only makes two half-blinded drivers.

On a freeway, use your high beams only in remote areas where you won't impair approaching drivers. In some places, like cities, using high beams is illegal.

When you follow another vehicle on a freeway or highway, use low beams. True, most vehicles now have day-night mirrors that enable the driver to reduce glare. But outside mirrors are not of this type and high beams from behind can bother the driver ahead.

## ***A Few More Night Driving Suggestions***

Keep your windshield and all the glass on your vehicle clean -- inside and out. Glare at night is made much worse by dirt on the glass. Even the inside of the glass can build up a film caused by dust. Tobacco smoke also makes inside glass surfaces very filmy and can be a vision hazard if it's left there.

Dirty glass makes lights dazzle and flash more than clean glass would, making the pupils of your eyes contract repeatedly. You might even want to keep a cloth and some glass cleaner in your vehicle if you need to clean your glass frequently.

Remember that your headlights light up far less of a roadway when you are in a turn or curve.

Keep your eyes moving; that way, it's easier to pick out dimly lighted objects.

Just as your headlights should be checked regularly for proper aim, so should your eyes be examined regularly. Some drivers suffer from night blindness -- the inability to see in dim light -- and aren't even aware of it.

## ***DRIVING IN THE RAIN***



Rain and wet roads can mean driving trouble. On a wet road you can't stop, accelerate or turn as well because your tire-to-road traction isn't as good as on dry roads. And, if your tires don't have much tread left, you'll get even less traction.

It's always wise to go slower and be cautious if rain starts to fall while you are driving. The surface may get wet suddenly when your reflexes are tuned for driving on dry pavement.

The heavier the rain, the harder it is to see. Even if your windshield wiper blades are in good shape, a heavy rain can make it harder to see road signs and traffic signals, pavement markings, the edge of the road, and even people walking. Road spray can often be worse for vision than rain, especially if it comes from a dirty road.

So it is wise to keep your wiping equipment in good shape and keep your windshield washer tank filled. Replace your windshield wiper inserts when they show signs of streaking or missing areas on the windshield, or when strips of rubber start to separate from the inserts.



Driving too fast through large water puddles or even going through some car washes can cause problems, too. The water may affect your brakes. Try to avoid puddles. But if you can't, try to slow down before you hit them.

 **CAUTION:**

**Wet brakes can cause accidents. They won't work well in a quick stop and may cause pulling to one side. You could lose control of the vehicle.**

**After driving through a large puddle of water or a car wash, apply your brake pedal lightly until your brakes work normally.**

## *Hydroplaning*

Hydroplaning is dangerous. So much water can build up under your tires that they can actually ride on the water. This can happen if the road is wet enough and you're going fast enough. When your vehicle is hydroplaning, it has little or no contact with the road.

You might not be aware of hydroplaning. You could drive along for some time without realizing your tires aren't in constant contact with the road. You could find out the hard way: when you have to slow, turn, move out



to pass -- or if you get hit by a gust of wind. You could suddenly find yourself out of control.

Hydroplaning doesn't happen often. But it can if your tires haven't much tread or if the pressure in one or more is low. It can happen if a lot of water is standing on the road. If you can see reflections from trees, telephone poles, or other vehicles, and raindrops "dimple" the water's surface, there could be hydroplaning.

Hydroplaning usually happens at higher speeds. There just isn't a hard and fast rule about hydroplaning. The best advice is to slow down when it is raining, and be careful.

### ***Some Other Rainy Weather Tips***

- Turn on your headlights -- not just your parking lights -- to help make you more visible to others.
- Look for hard-to-see vehicles coming from behind. You may want to use your headlights even in daytime if it's raining hard.
- Besides slowing down, allow some extra following distance. And be especially careful when you pass another vehicle. Allow yourself more clear room ahead, and be prepared to have your view restricted by road spray. If the road spray is so heavy you are actually blinded, drop back. Don't pass until conditions improve. Going more slowly is better than having an accident.
- Use your defogger if it helps.
- Have good tires with proper tread depth. (See "Tires" in the Index.)

## ***DRIVING IN FOG, MIST AND HAZE***

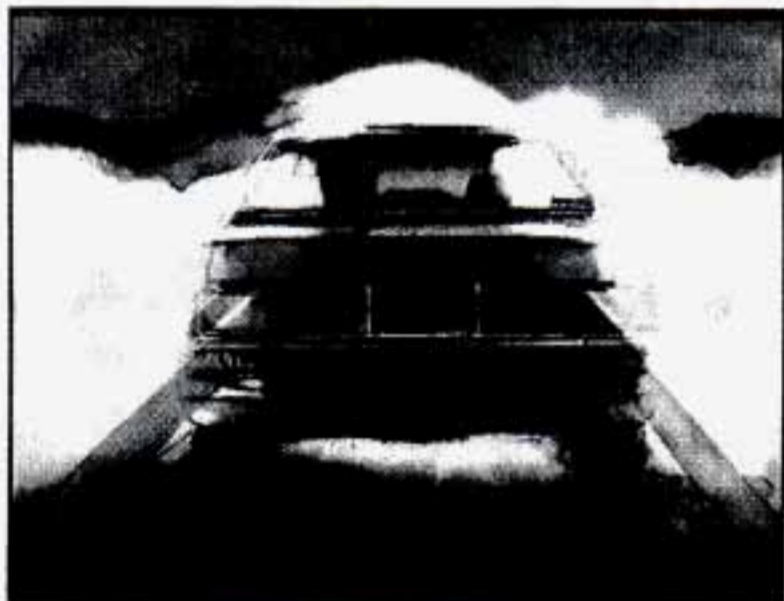

Fog can occur with high humidity or heavy frost. It can be so mild that you can see through it for several hundred feet (meters). Or it might be so thick that you can see only a few feet (meters) ahead. It may come suddenly to an otherwise clear road. And it can be a major hazard.

When you drive into a fog patch, your visibility will be reduced quickly. The biggest dangers are striking the vehicle ahead or being struck by the one behind. Try to "read" the fog density down the road. If the vehicle ahead starts to become less clear or, at night, if the taillights are harder to see, the fog is probably thickening. Slow down to give traffic behind you a chance to slow down. Everybody then has a better chance to avoid hitting the vehicle ahead.

A patch of dense fog may extend only for a few feet (meters) or for miles (kilometers); you can't really tell while you're in it. You can only treat the situation with extreme care.

One common fog condition -- sometimes called mist or ground fog -- can happen in weather that seems perfect, especially at night or in the early morning in valley and low, marshy areas. You can be suddenly enveloped in thick, wet haze that may even coat your windshield. You can often spot these fog patches or mist layers with your headlights. But sometimes they can be waiting for you as you come over a hill or dip into a shallow valley.

Start your windshield wipers and washer, to help clear accumulated road dirt. Slow down carefully.

### ***Tips on Driving in Fog***

If you get caught in fog, turn your headlights on low beam, even in daytime. You'll see -- and be seen -- better. Use your fog lights if your vehicle has them.

Don't use your high beams. The light will bounce off the water droplets that make up fog and reflect back at you.

Use your defogger. In high humidity, even a light buildup of moisture on the inside of the glass will cut down on your already limited visibility. Run your windshield wipers and washer occasionally. Moisture can build up on the outside glass, and what seems to be fog may actually be moisture on the outside of your windshield.

Treat dense fog as an emergency. Try to find a place to pull off the road. Of course you want to respect another's property, but you might need to put something between you and moving vehicles -- space, trees, telephone poles, a private driveway, anything that removes you from other traffic.

If visibility is near zero and you must stop but are unsure whether you are away from the road, turn your lights on, start your hazard warning flasher, and sound your horn at intervals or when you hear approaching traffic.

Pass other vehicles in fog only if you can see far enough ahead to pass safely. Even then, be prepared to delay your pass if you suspect the fog is worse up ahead. If other vehicles try to pass you, make it easy for them.

## *CITY DRIVING*



One of the biggest problems with city streets is the amount of traffic on them. You'll want to watch out for what the other drivers are doing and pay attention to traffic signals.

Here are ways to increase your safety in city driving:

- Know the best way to get to where you are going. Try not to drive around trying to pick out a familiar street or landmark. Get a city map and plan your trip into an unknown part of the city just as you would for a cross-country trip.
- Try to use the freeways that rim and crisscross most large cities. You'll save time and energy. (See the next section, "Freeway Driving.")
- Treat a green light as a warning signal. A traffic light is there because the corner is busy enough to need it. When a light turns green, and just before you start to move, check both ways for vehicles that have not cleared the intersection or may be running the red light.

- Obey all posted speed limits. But remember that they are for ideal road, weather and visibility conditions. You may need to drive below the posted limit in bad weather or when visibility is especially poor.
- Pull to the right (with care) and stop clear of intersections when you see or hear emergency vehicles.

## ***FREEWAY DRIVING***

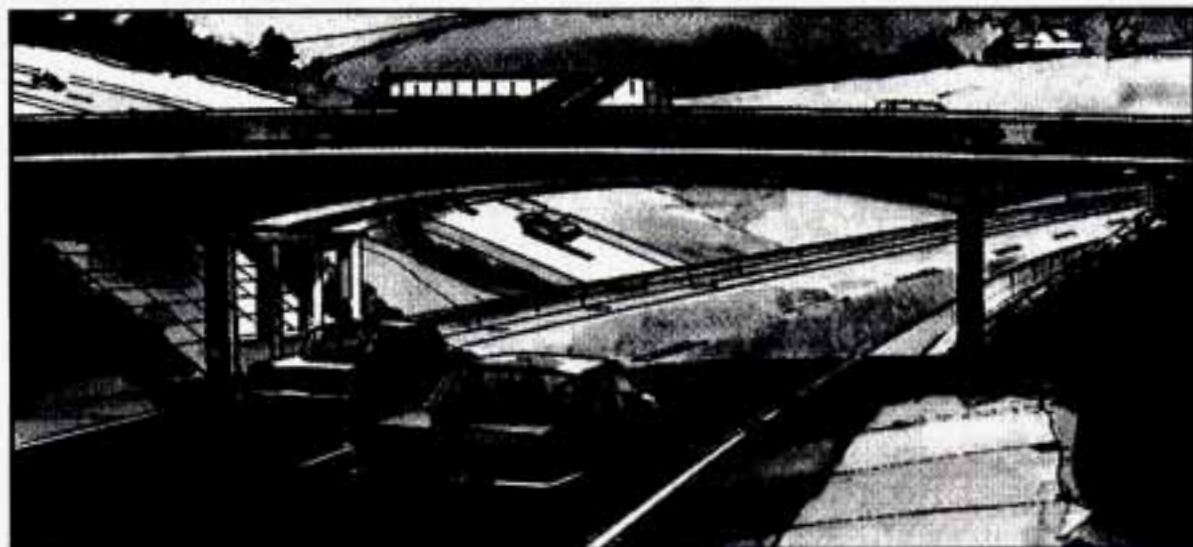

Mile for mile, freeways (also called thruways, parkways, expressways, turnpikes, or superhighways) are the safest of all roads. But they have their own special rules.

The most important advice on freeway driving is: Keep up with traffic and keep to the right. Drive at the same speed most of the other drivers are driving. Too-fast or too-slow driving breaks a smooth traffic flow. Treat the left lane on a freeway as a passing lane.

### ***Entering the Freeway***

At the entrance there is usually a ramp that leads to the freeway. If you have a clear view of the freeway as you drive along the entrance ramp, you should begin to check traffic. Try to determine where you expect to blend with the flow. If traffic is light, you may have no problem. But if it is heavy, find a gap as you move along the entering lane and time your approach. Try to merge into the gap at close to the prevailing speed. Switch on your turn signal, check your rearview mirrors as you move

along, and glance over your shoulder as often as necessary. Try to blend smoothly with the traffic flow.

## ***Driving on the Freeway***

Once you are on the freeway, adjust your speed to the posted limit or to the prevailing rate if it's slower. Stay in the right lane unless you want to pass. If you are on a two-lane freeway, treat the right lane as the slow lane and the left lane as the passing lane.

If you are on a three-lane freeway, treat the right lane as the slower-speed through lane, the middle lane as the higher-speed through lane, and the left lane as the passing lane.

Before changing lanes, check your rearview mirrors. Then use your turn signal.

Just before you leave the lane, glance quickly over your shoulder to make sure there isn't another vehicle in your "blind" spot.

If you are moving from an outside to a center lane on a freeway having more than two lanes, make sure another vehicle isn't about to move into the same spot. Look at the vehicles two lanes over and watch for telltale signs: turn signals flashing, an increase in speed, or moving toward the edge of the lane. Be prepared to delay your move.

Once you are moving on the freeway, make certain you allow a reasonable following distance. Expect to move slightly slower at night.

## ***Leaving the Freeway***

When you want to leave the freeway, move to the proper lane well in advance. Dashing across lanes at the last minute is dangerous. If you miss your exit do not, under any circumstances, stop and back up. Drive on to the next exit.

At each exit point is a deceleration lane. Ideally it should be long enough for you to enter it at freeway speed (after signaling, of course) and then do your braking before moving onto the exit ramp. Unfortunately, not all deceleration lanes are long enough -- some are too short for all the braking. Decide when to start braking. If you must brake on the through lane, and if there is traffic close behind you, you can allow a little extra

time and flash your brake lights (in addition to your turn signal) as extra warning that you are about to slow down and exit.

The exit ramp can be curved, sometimes quite sharply.

The exit speed is usually posted. Reduce your speed according to your speedometer, not to your sense of motion. After driving for any distance at higher speeds, you may tend to think you are going slower than you actually are. For example, 40 mph (65 km/h) might seem like only 20 mph (30 km/h). Obviously, this could lead to serious trouble on a ramp designed for 20 mph (30 km/h)!

## ***DRIVING A LONG DISTANCE***

Although most long trips today are made on freeways, there are still many made on regular highways.

Long-distance driving on freeways and regular highways is the same in some ways. The trip has to be planned and the vehicle prepared, you drive at higher-than-city speeds, and there are longer turns behind the wheel. You'll enjoy your trip more if you and your vehicle are in good shape. Here are some tips for a successful long trip.

## ***BEFORE LEAVING ON A LONG TRIP***

Make sure you're ready. Try to be well rested. If you must start when you're not fresh -- such as after a day's work -- don't plan to make too many miles that first part of the journey. Wear comfortable clothing and shoes you can easily drive in.

Is your vehicle ready for a long trip? If you keep it serviced and maintained, it's ready to go. If it needs service, have it done before starting out. Of course, you'll find experienced and able service experts in Cadillac dealerships all across North America. They'll be ready and willing to help if you need it.

Here are some things you can check before a trip:

- **Windshield Washer Fluid:** Is the reservoir full? Are all windows clean inside and outside?
- **Wiper Blades:** Are they in good shape?
- **Fuel, Engine Oil, Other Fluids:** Have you checked all levels?

- **Lights:** Are they all working? Are the lenses clean?
- **Tires:** They are vitally important to a safe, trouble-free trip. Is the tread good enough for long-distance driving? Are the tires all inflated to the recommended pressure?
- **Weather Forecasts:** What's the weather outlook along your route? Should you delay your trip a short time to avoid a major storm system?
- **Maps:** Do you have up-to-date maps?

## ***ON THE ROAD***

Unless you are the only driver, it is good to share the driving task with others. Limit turns behind the wheel to about 100 miles (160 km) or two hours at a sitting. Then, either change drivers or stop for some refreshment like coffee, tea or soft drinks and some limbering up. But do stop and move around. Eat lightly along the way. Heavier meals tend to make some people sleepy.

On two-lane highways or undivided multilane highways that do not have controlled access, you'll want to watch for some situations not usually found on freeways. Examples are: stop signs and signals, shopping centers with direct access to the highway, no passing zones and school zones, vehicles turning left and right off the road, pedestrians, cyclists, parked vehicles, and even animals.

## ***HIGHWAY HYPNOSIS***

Is there actually such a condition as "highway hypnosis"? Or is it just plain falling asleep at the wheel? Call it highway hypnosis, lack of awareness, or whatever.

There is something about an easy stretch of road with the same scenery, along with the hum of the tires on the road, the drone of the engine, and the rush of the wind against the vehicle that can make you sleepy. Don't let it happen to you! If it does, your vehicle can leave the road in less than a second, and you could crash and be injured.

What can you do about highway hypnosis? First, be aware that it can happen.



Then here are some tips:

- Make sure your vehicle is well ventilated, with a comfortably cool interior.
- Keep your eyes moving. Scan the road ahead and to the sides. Check your rearview mirrors frequently and your instruments from time to time. This can help you avoid a fixed stare.
- Wear good sunglasses in bright light. Glare can cause drowsiness. But don't wear sunglasses at night. They will drastically reduce your overall vision at the very time you need all the seeing power you have.
- If you get sleepy, pull off the road into a rest, service, or parking area and take a nap, get some exercise, or both. For safety, treat drowsiness on the highway as an emergency.

As in any driving situation, keep pace with traffic and allow adequate following distances.

## ***HILL AND MOUNTAIN ROADS***



Driving on steep hills or mountains is different from driving in flat or rolling terrain.

If you drive regularly in steep country, or if you're planning to visit there, here are some tips that can make your trips safer and more enjoyable.

- Keep your vehicle in good shape. Check all fluid levels and also the brakes, tires, cooling system and transaxle. These parts can work hard on mountain roads.
- Know how to go down hills. The most important thing to know is this: let your engine do some of the slowing down. Don't make your brakes do it all. Shift to a lower gear when you go down a steep or long hill. That way, you will slow down without excessive use of your brakes.

 **CAUTION:**

**If you don't shift down, your brakes could get so hot that they wouldn't work well. You would then have poor braking or even none going down a hill. You could crash. Shift down to let your engine assist your brakes on a steep downhill slope.**

 **CAUTION:**

**Coasting downhill in "N" (Neutral) or with the ignition off is dangerous. Your brakes will have to do all the work of slowing down. They could get so hot that they wouldn't work well. You could crash. Always have your engine running and your vehicle in gear when you go downhill.**

- Know how to go uphill. You may want to shift down to a lower gear. The lower gears help cool your engine and transaxle, and you can climb the hill better.
- Stay in your own lane when driving on two-lane roads in hills or mountains. Don't swing wide or cut across the center of the road. Drive at speeds that let you stay in your own lane. That way, you won't be surprised by a vehicle coming toward you in the same lane.

- It takes longer to pass another vehicle when you're going uphill. You'll want to leave extra room to pass. If a vehicle is passing you and doesn't have enough room, slow down to make it easier for the other vehicle to get by.
- As you go over the top of a hill, be alert. There could be something in your lane, like a stalled car or an accident.
- You may see highway signs on mountains that warn of special problems. Examples are long grades, passing or no-passing zones, a falling rocks area, or winding roads. Be alert to these and take appropriate action.
- Winter driving can present special problems. See "Winter Driving" in the Index.

### *Parking on Hills*



Hills and mountains mean spectacular scenery. But please be careful where you stop if you decide to look at the view or take pictures. Look for pull-offs or parking areas provided for scenic viewing.

Another part of this manual tells how to use your parking brake (see “Parking Brake” in the Index). But on a mountain or steep hill, you can do one more thing. You can turn your front wheels to keep your vehicle from rolling downhill or out into traffic.

Here’s how:

### *Parking Downhill*

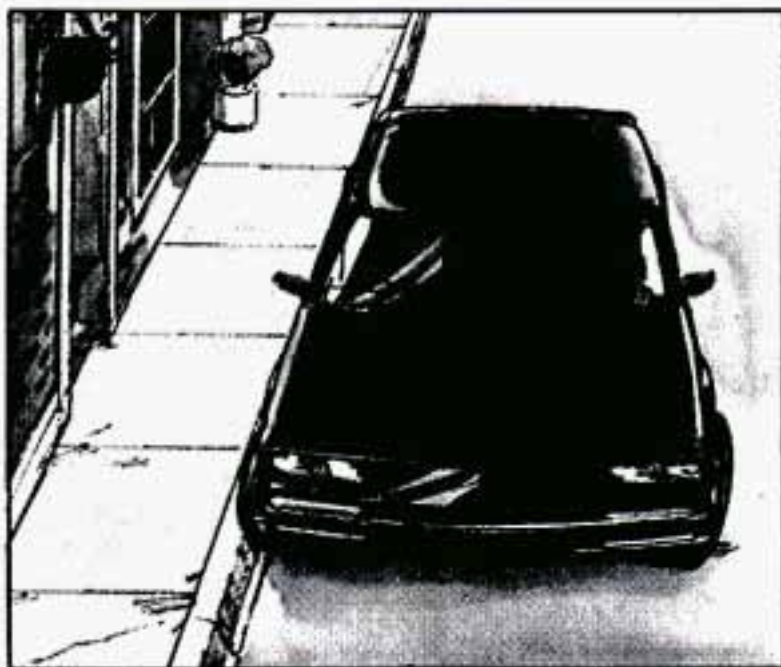

Turn your wheels to the right.

You don’t have to jam your tires against the curb, if there is a curb. A gentle contact is all you need.

### *Parking Uphill*



If there is a curb, turn your wheels to the left if the curb is at the right side of your vehicle.



If you're going uphill on a one-way street and you're parking on the left side, your wheels should point to the right.

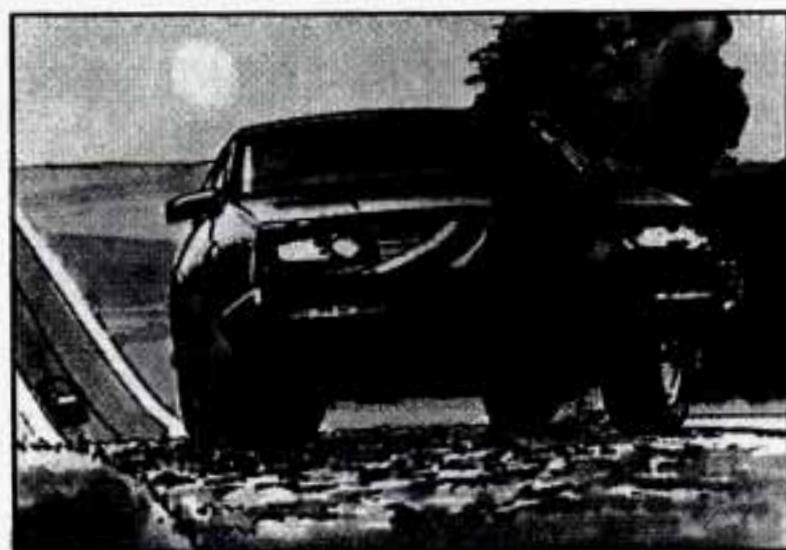

If there is no curb when you're parking uphill, turn the wheels to the right.

If there is no curb when you're parking uphill on the left side of a one-way street, your wheels should be turned to the left.

### ***Torque Lock (Automatic Transaxle)***

If you are parking on a hill and you don't shift your transaxle into "P" (Park) properly, the weight of the vehicle may put too much force on the parking pawl in the transaxle. You may find it difficult to pull the shift lever out of "P" (Park). This is called "torque lock." To prevent torque lock, always be sure to shift into "P" (Park) properly before you leave the driver's seat. To find out how, see "Shifting Into 'P' (Park)" in the Index.

If "torque lock" does occur, you may need to have another vehicle push yours a little uphill to take some of the pressure from the transaxle, so you can pull the shift lever out of "P" (Park).

## ***WINTER DRIVING***



Here are some tips for winter driving:

- Have your Cadillac in good shape for winter. Be sure your engine coolant mix is correct.
- Snow tires can help in loose snow, but they may give you less traction on ice than regular tires. If you do not expect to be driving in deep snow, but may have to travel over ice, you may not want to switch to snow tires at all.
- You may want to put winter emergency supplies in your trunk.

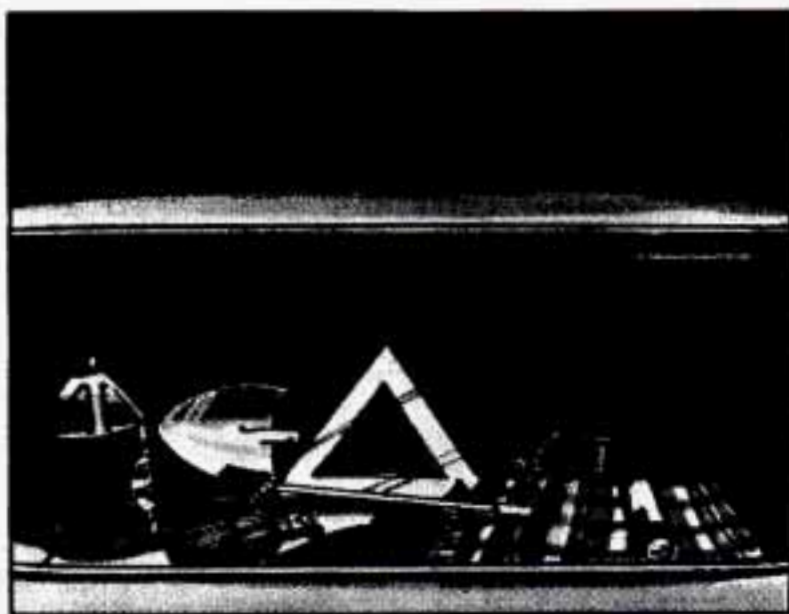

Include an ice scraper, a small brush or broom, a supply of windshield washer fluid, a rag, some winter outer clothing, a small shovel, a flashlight, a red cloth, and a couple of reflective warning triangles. And, if you will be driving under severe conditions, include a small bag of sand, a piece of old carpet or a couple of burlap bags to help provide traction. Be sure you properly secure these items in your vehicle.

### ***Driving on Snow or Ice***

Most of the time, those places where your tires meet the road probably have good traction.

However, if there is snow or ice between your tires and the road, you can have a very slippery situation. You'll have a lot less traction or "grip" and will need to be very careful.



What's the worst time for this? "Wet ice." Very cold snow or ice can be slick and hard to drive on. But wet ice can be even more trouble because it may offer the least traction of all. You can get "wet ice" when it's about freezing (32°F; 0°C) and freezing rain begins to fall. Try to avoid driving on wet ice until salt and sand crews can get there.

Whatever the condition -- smooth ice, packed, blowing or loose snow -- drive with caution. Accelerate gently. Try not to break the fragile traction. If you accelerate too fast, the drive wheels will spin and polish the surface under the tires even more.

Your anti-lock brakes improve your ability to make a hard stop on a slippery road. Even though you have the anti-lock braking system, you'll want to begin stopping sooner than you would on dry pavement. See "Anti-lock" in the Index.

- Allow greater following distance on any slippery road.
- Watch for slippery spots. The road might be fine until you hit a spot that's covered with ice. On an otherwise clear road, ice patches may appear in shaded areas where the sun can't reach: around clumps of trees, behind buildings, or under bridges. Sometimes the surface of a curve or an overpass may remain icy when the surrounding roads are clear. If you see a patch of ice ahead of you, brake before you are on it. Try not to brake while you're actually on the ice, and avoid sudden steering maneuvers.



## *If You're Caught in a Blizzard*



If you are stopped by heavy snow, you could be in a serious situation. You should probably stay with your vehicle unless you know for sure that you are near help and you can hike through the snow. Here are some things to do to summon help and keep yourself and your passengers safe: Turn on your hazard flashers. Tie a red cloth to your vehicle to alert police that you've been stopped by the snow. Put on extra clothing or wrap a blanket around you. If you have no blankets or extra clothing, make body insulators from newspapers, burlap bags, rags, floor mats -- anything you can wrap around yourself or tuck under your clothing to keep warm.

You can run the engine to keep warm, but be careful.



### **CAUTION:**

**Snow can trap exhaust gases under your vehicle. This can cause deadly CO (carbon monoxide) gas to get inside. CO could overcome you and kill you. You can't see it or smell it, so you might not know it was in your vehicle. Clear away snow from around the base of your vehicle, especially any that is blocking your exhaust pipe. And check around again from time to time to be sure snow doesn't collect there.**

CAUTION: (Continued)

**CAUTION:** (Continued)

**Open a window just a little on the side of the vehicle that's away from the wind. This will help keep CO out.**



Run your engine only as long as you must. This saves fuel. When you run the engine, make it go a little faster than just idle. That is, push the accelerator slightly. This uses less fuel for the heat that you get and it keeps the battery charged. You will need a well-charged battery to restart the vehicle, and possibly for signaling later on with your headlights. Let the heater run for awhile.

Then, shut the engine off and close the window almost all the way to preserve the heat. Start the engine again and repeat this only when you feel really uncomfortable from the cold. But do it as little as possible. Preserve the fuel as long as you can. To help keep warm, you can get out of the vehicle and do some fairly vigorous exercises every half hour or so until help comes.

### ***If You're Stuck in Deep Snow***

This manual explains how to get the vehicle out of deep snow without damaging it. See "Rocking Your Vehicle" in the Index.

## ***TOWING A TRAILER***

### **CAUTION:**

**If you don't use the correct equipment and drive properly, you can lose control when you pull a trailer. For example, if the trailer is too heavy, the brakes may not work well -- or even at all. You and your passengers could be seriously injured. Pull a trailer only if you have followed all the steps in this section.**

### **NOTICE:**

**Pulling a trailer improperly can damage your vehicle and result in costly repairs not covered by your warranty. To pull a trailer correctly, follow the advice in this section.**

Load-pulling components such as the engine, transaxle, wheel assemblies, and tires are forced to work harder against the drag of the added weight. The engine is required to operate at relatively higher speeds and under greater loads, generating extra heat. What's more, the trailer adds considerably to wind resistance, increasing the pulling requirements.

All of that means changes in:

- Handling
- Durability
- Fuel economy

### ***If You Do Decide To Pull A Trailer***

If you do, here are some important points.

- There are many different laws having to do with trailering. Make sure your rig will be legal, not only where you live but also where you'll be driving. A good source for this information can be state or provincial police.

- Consider using a sway control.
- You can ask a hitch dealer about sway controls.
- Don't tow a trailer at all during the first 500 miles (800 km) your new vehicle is driven. Your engine, axle or other parts could be damaged.
- Then, during the first 500 miles (800 km) that you tow a trailer, don't drive over 50 mph (80 km/h) and don't make starts at full throttle. This helps your engine and other parts of your vehicle wear in at the heavier loads.
- When towing a trailer, close all windows and set the Electronic Climate Control System to "ECON", "AUTO", "DEFOG" or Defroster to assure that the fan is running.
- Three important considerations have to do with weight:

### 1. **Weight of the Trailer**

How heavy can a trailer safely be?

It should never weigh more than 1,000 pounds (450 kg). But even that can be too heavy.

It depends on how you plan to use your rig. For example, speed, altitude, road grades, outside temperature and how much your vehicle is used to pull a trailer are all important. And, it can also depend on any special equipment that you have on your vehicle.

You can ask your dealer for our trailering information or advice, or you can write us at Cadillac.

In Canada, write to General Motors of Canada Limited, Customer Assistance Center, 1908 Colonel Sam Drive, Oshawa, Ontario L1H 8P7.

### 2. **Weight of the Trailer Tongue**

When a trailer is connected to your vehicle, the trailer tongue adds to the weight your vehicle is carrying. So, remember to subtract the weight of the trailer tongue from your vehicle's capacity weight.

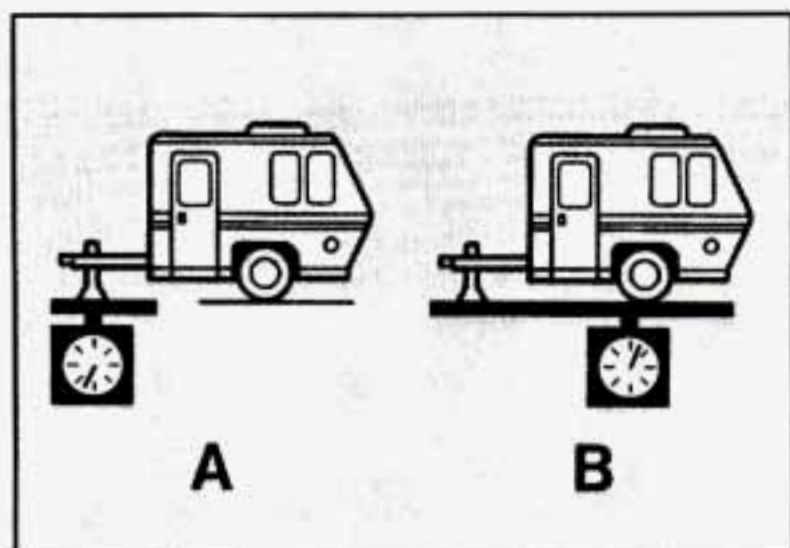

The trailer tongue (A) should weigh 10% of the total loaded trailer weight (B). After you've loaded your trailer, weigh the trailer and then the tongue, separately, to see if the weights are proper. If they aren't, you may be able to get them right simply by moving some items around in the trailer.

### 3. Total Weight on Your Vehicle's Tires

Be sure your vehicle's tires are inflated to the limit for cold tires. You'll find these numbers on the Certification label at the rear edge of the driver's door (or see Index under "Tire Loading"). Then be sure you don't go over the GVW limit for your vehicle.

## *Hitches*

It's important to have the correct hitch equipment. Crosswinds, large trucks going by, and rough roads are a few reasons why you'll need the right hitch. Here are some rules to follow:

- Will you have to make any holes in the body of your vehicle when you install a trailer hitch? If you do, then be sure to seal the holes later when you remove the hitch. If you don't seal them, deadly carbon monoxide (CO) from your exhaust can get into your vehicle (see Index under "Carbon Monoxide"). Dirt and water can, too.
- The bumpers on your vehicle are not intended for hitches. Do not attach rental hitches or other bumper-type hitches to them.

## ***Safety Chains***

You should always attach chains between your vehicle and your trailer. Cross the safety chains under the tongue of the trailer so that the tongue will not drop to the road if it becomes separated from the hitch. Follow the manufacturer's recommendation for attaching safety chains. Always leave just enough slack so you can turn with your rig. And, never allow safety chains to drag on the ground.

## ***Trailer Brakes***

Does your trailer have its own brakes? Be sure to read and follow the instructions for the trailer brakes so you'll be able to install, adjust and maintain them properly.

- Because you have anti-lock brakes, do not try to tap into your vehicle's brake system. If you do, both brake systems won't work well, or at all.

## ***Driving with a Trailer***

Towing a trailer requires a certain amount of experience. Before setting out for the open road, you'll want to get to know your rig. Acquaint yourself with the feel of handling and braking with the added weight of the trailer. And always keep in mind that the vehicle you are driving is now a good deal longer and not nearly so responsive as your vehicle is by itself.

Before you start, check the trailer hitch and platform, safety chains, electrical connector, lights, tires and mirror adjustment. If the trailer has electric brakes, start your vehicle and trailer moving and then apply the trailer brake controller by hand to be sure the brakes are working. This lets you check your electrical connection at the same time.

During your trip, check occasionally to be sure that the load is secure, and that the lights and any trailer brakes are still working.

## ***Following Distance***

Stay at least twice as far behind the vehicle ahead as you would when driving your vehicle without a trailer. This can help you avoid situations that require heavy braking and sudden turns.

## ***Passing***

You'll need more passing distance up ahead when you're towing a trailer. And, because you're a good deal longer, you'll need to go much farther beyond the passed vehicle before you can return to your lane.

## ***Backing Up***

Hold the bottom of the steering wheel with one hand. Then, to move the trailer to the left, just move that hand to the left. To move the trailer to the right, move your hand to the right. Always back up slowly and, if possible, have someone guide you.

## ***Making Turns***

When you're turning with a trailer, make wider turns than normal. Do this so your trailer won't strike soft shoulders, curbs, road signs, trees, or other objects. Avoid jerky or sudden maneuvers. Signal well in advance.

## ***Turn Signals When Towing a Trailer***

When you tow a trailer, your vehicle has to have a different turn signal flasher and extra wiring. The green arrows on your instrument panel will flash whenever you signal a turn or lane change. Properly hooked up, the trailer lights will also flash, telling other drivers you're about to turn, change lanes or stop.

When towing a trailer, the green arrows on your instrument panel will flash for turns even if the bulbs on the trailer are burned out. Thus, you may think drivers behind you are seeing your signal when they are not. It's important to check occasionally to be sure the trailer bulbs are still working.

## ***Driving On Grades***

Reduce speed and shift to a lower gear **before** you start down a long or steep downgrade. If you don't shift down, you might have to use your brakes so much that they would get hot and no longer work well.

On a long uphill grade, shift down and reduce your speed to around 45 mph (70 km/h) or less to reduce the possibility of engine and transaxle overheating.

If your trailer weighs more than 1,000 pounds (450 Kg) and you have an automatic transaxle with Overdrive, you may want to drive in "3" instead of Overdrive

## ***Parking on Hills***

You really should not park your vehicle, with a trailer attached, on a hill. If something goes wrong, your rig could start to move. People can be injured, and both your vehicle and the trailer can be damaged.

But if you ever have to park your rig on a hill, here's how to do it:

1. Apply your regular brakes, but don't shift into "P" (Park) yet.
2. Have someone place chocks under the trailer wheels.
3. When the wheel chocks are in place, release the regular brakes until the chocks absorb the load.
4. Reapply the regular brakes. Then shift into "P" (Park) firmly and apply your parking brake.
5. Release the regular brakes.

## ***When You Are Ready to Leave After Parking on a Hill***

1. Apply your regular brakes and hold the pedal down while you:
  - Start your engine;
  - Shift into a gear; and
  - Be sure the parking brake has released.
2. Let up on the brake pedal.
3. Drive slowly until the trailer is clear of the chocks.
4. Stop and have someone pick up and store the chocks.



## ***Maintenance When Trailer Towing***

Your vehicle will need service more often when you're pulling a trailer. See the Maintenance Schedule for more on this. Things that are especially important in trailer operation are automatic transaxle fluid (don't overfill), engine oil, axle lubricant, belts, cooling system, and brake adjustment. Each of these is covered in this manual, and the Index will help you find them quickly. If you're trailering, it's a good idea to review these sections before you start your trip.

Check periodically to see that all hitch nuts and bolts are tight.



## SECTION 5

### PROBLEMS ON THE ROAD



Here you'll find what to do about some problems that can occur on the road.

## ***HAZARD WARNING FLASHERS***



Your hazard warning flashers let you warn others. They also let police know you have a problem. Your front and rear turn signal lights will flash on and off.



Press the button in to make your front and rear turn signal lights flash on and off.



The light on your instrument panel will flash indicating that the hazard warning flashers are on.

Your hazard warning flashers work no matter what position your key is in, and even if the key isn't in.



To turn off the flashers, pull out on the collar.

When the hazard warning flashers are on, your turn signals won't work.

## ***OTHER WARNING DEVICES***

If you carry reflective triangles, you can set one up at the side of the road about 300 feet (100 m) behind your vehicle.

## ***JUMP STARTING***

If your battery has run down, you may want to use another vehicle and some jumper cables to start your Cadillac. But please follow the steps below to do it safely.

### **CAUTION:**

**Batteries can hurt you. They can be dangerous because:**

- They contain acid that can burn you.
- They contain gas that can explode or ignite.
- They contain enough electricity to burn you.

**If you don't follow these steps exactly, some or all of these things can hurt you.**

### **NOTICE:**

**Ignoring these steps could result in costly damage to your vehicle that wouldn't be covered by your warranty.**

**Trying to start your Cadillac by pushing or pulling it won't work, and it could damage your vehicle.**

## ***TO JUMP START YOUR CADILLAC:***

1. Check the other vehicle. It must have a 12-volt battery with a negative ground system.

### **NOTICE:**

**If the other system isn't a 12-volt system with a negative ground, both vehicles can be damaged.**

2. Get the vehicles close enough so the jumper cables can reach, but be sure the vehicles aren't touching each other. If they are, it could cause a ground connection you don't want. You wouldn't be able to start your Cadillac, and the bad grounding could damage the electrical systems.



### **CAUTION:**

**You could be injured if the vehicles roll. Set the parking brake firmly on each vehicle. Put an automatic transaxle in "P" (Park).**

3. Turn off the ignition on both vehicles. Turn off all lights that aren't needed, and radios. This will avoid sparks and help save both batteries. And it could save your radio!

### **NOTICE:**

**If you leave your radio on, it could be badly damaged. The repairs wouldn't be covered by your warranty.**

4. Open the hoods and locate the batteries.



### **CAUTION:**

**An electric fan can start up even when the engine is not running and can injure you. Keep hands, clothing and tools away from any underhood electric fan.**

Find the positive (+) and negative (-) terminals on each battery.



4.9 Liter



4.6 Liter  
(Northstar)

5. Start by removing the red positive (+) terminal cover.

**⚠ CAUTION:**

Using a match near a battery can cause battery gas to explode. People have been hurt doing this, and some have been blinded. Use a flashlight if you need more light.

CAUTION: (Continued)

**CAUTION:** (Continued)

**Be sure the batteries have enough water. You don't need to add water to the Delco Freedom® battery installed in every new GM vehicle. But if a battery has filler caps, be sure the right amount of fluid is there. If it is low, add water to take care of that first. If you don't, explosive gas could be present.**

**Battery fluid contains acid that can burn you. Don't get it on you. If you accidentally get it in your eyes or on your skin, flush the place with water and get medical help immediately.**

6. Check that the jumper cables don't have loose or missing insulation. If they do, you could get a shock. The vehicles could be damaged, too.

Before you connect the cables, here are some things you should know. Positive (+) will go to positive (+) and negative (-) will go to negative (-) or a metal engine part. Don't connect (+) to (-) or you'll get a short that would damage the battery and maybe other parts, too.



**CAUTION:**

**Fans or other moving engine parts can injure you badly. Keep your hands away from moving parts once the engines are running.**



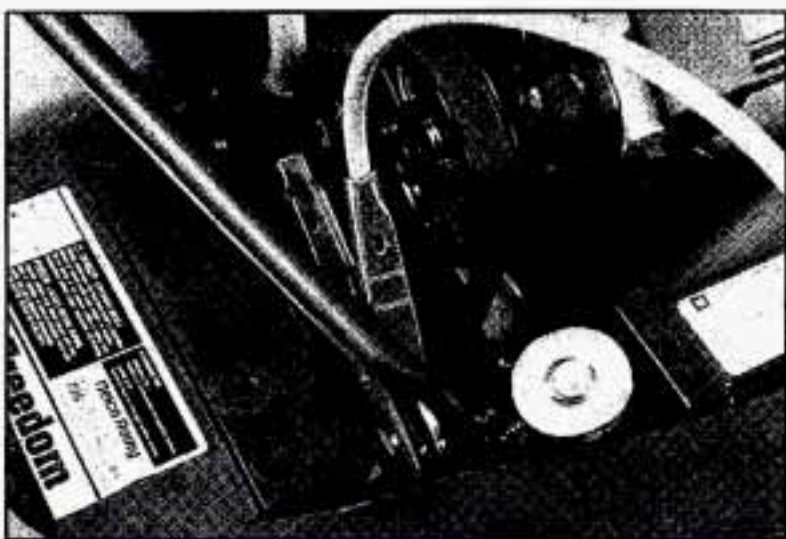

4.9 Liter



4.6 Liter  
(Northstar)

7. Connect the red positive (+) cable to the positive (+) terminal of the vehicle with the dead battery.
8. Don't let the other end touch metal. Connect it to the positive (+) terminal of the good battery.
9. Now connect the black negative (-) cable to the good battery's negative (-) terminal.
10. Don't let the other end touch anything until the next step. The other end of the negative cable doesn't go to the dead battery. It goes to a

heavy unpainted metal part on the engine of the vehicle with the dead battery.

Attach the cable at least 18 inches (45 cm) away from the dead battery, but not near engine parts that move. The electrical connection is just as good there, but the chance of sparks getting back to the battery is much less.

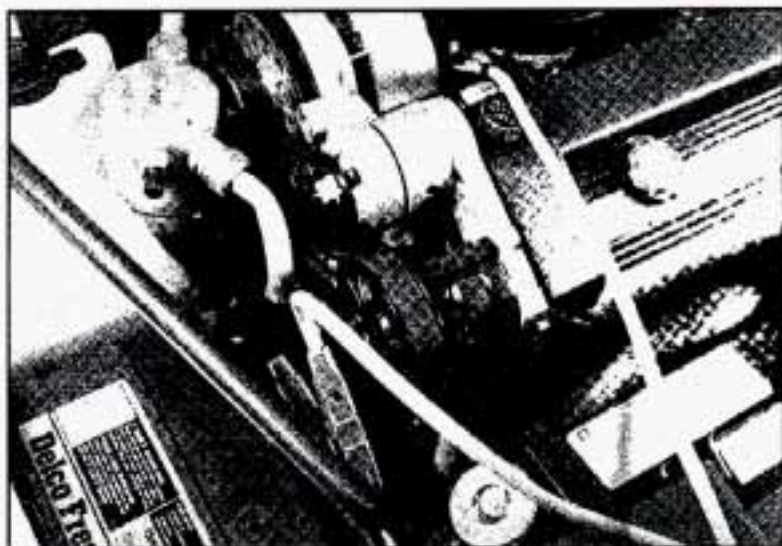

4.9 Liter

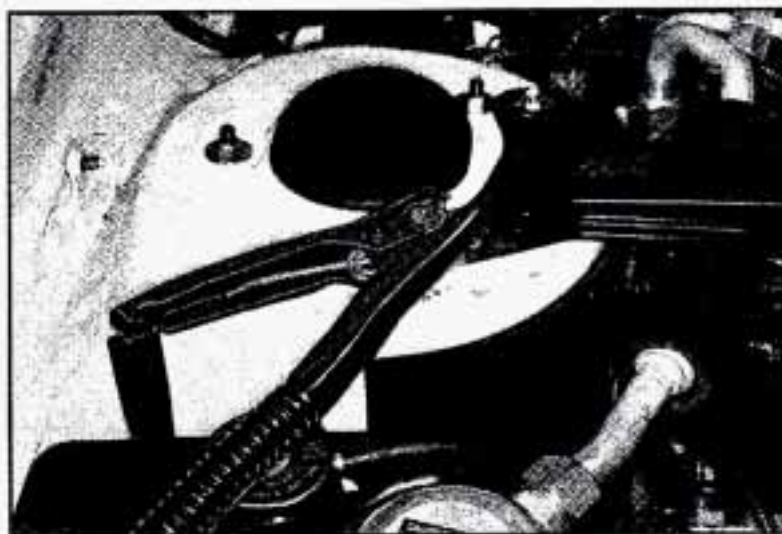

4.6 Liter  
(Northstar)

11. Now start the vehicle with the good battery and run the engine for awhile.

12. Try to start the vehicle with the dead battery.

If it won't start after a few tries, it probably needs service.

13. Remove the cables in reverse order to prevent electrical shorting.

Take care that they don't touch each other or any other metal.

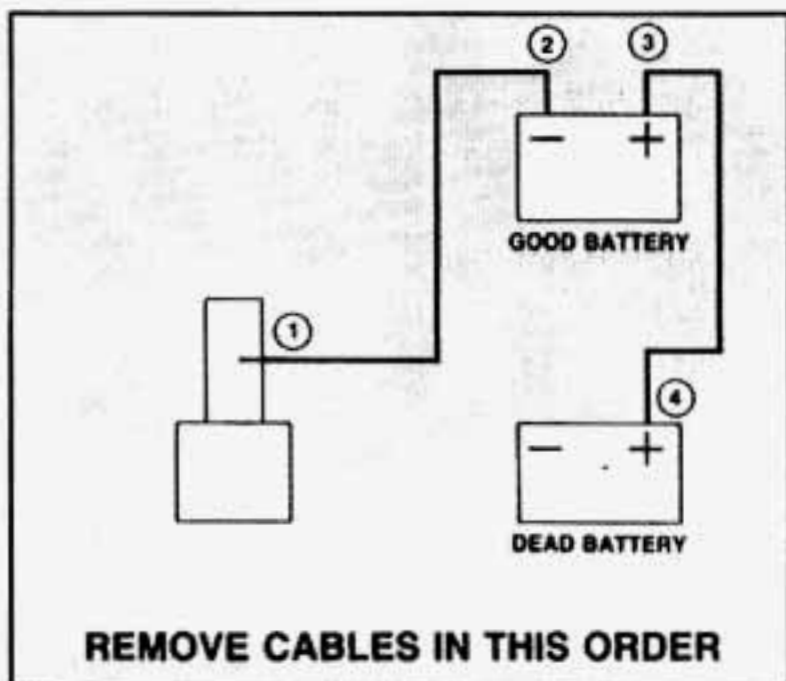

## ***TOWING YOUR VEHICLE***

Try to have a GM dealer or a professional towing service tow your Cadillac. The usual towing equipment is a sling-type, or a wheel-lift, or car carrier tow truck.

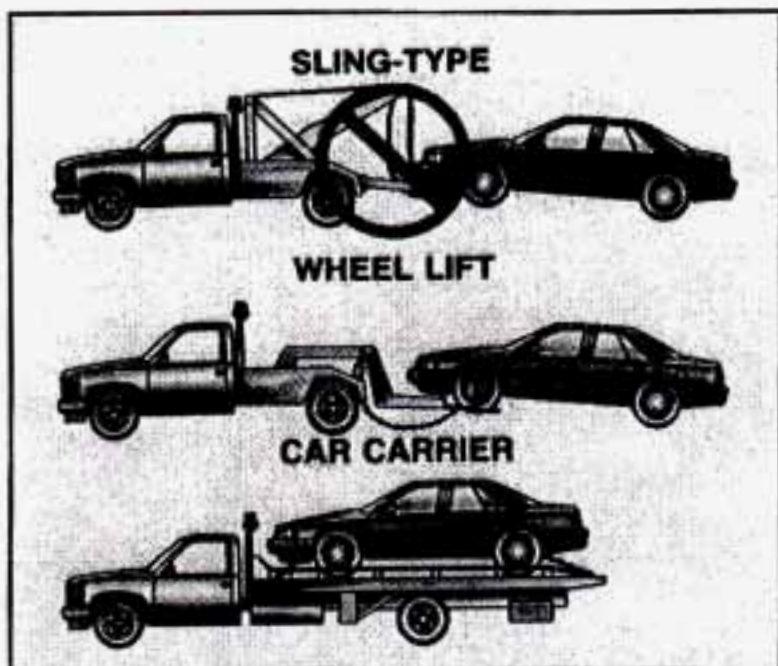

If your vehicle has been changed or modified since it was factory-new by adding aftermarket items like fog lamps, aero skirting, or special tires and wheels, these instructions and illustrations may not be correct.

Before you do anything, turn on the hazard warning flashers.

When you call, tell the towing service:

- That your vehicle cannot be towed from the front or rear with sling-type equipment.
- That your vehicle has front-wheel drive.
- The make, model, and year of your vehicle.
- Whether you can still move the shift lever.
- If there was an accident, what was damaged.

When the towing service arrives, let the tow operator know that this manual contains detailed towing instructions and illustrations. The operator may want to see them.

**⚠ CAUTION:**

**To help avoid injury to you or others:**

- **Never let passengers ride in a vehicle that is being towed.**
- **Never tow faster than safe or posted speeds.**
- **Never tow with damaged parts not fully secured.**
- **Never get under your vehicle after it has been lifted by the tow truck.**
- **Always use separate safety chains on each side when towing a vehicle.**
- **Never use “J” hooks. Use T-hooks instead.**



When your vehicle is being towed, have the ignition key off. The steering wheel should be clamped in a straight-ahead position, with a clamping device designed for towing service. Do not use the vehicle's steering column lock for this. The transaxle should be in Neutral and the parking brake released.

Don't have your vehicle towed on the front wheels, unless you must. If the vehicle must be towed on the front wheels, don't go more than 55 mph (88 km/h) or farther than 500 miles (804 km) or your transaxle will be damaged. If these limits must be exceeded, then the front wheels have to be supported on a dolly.

 **CAUTION:**

**A vehicle can fall from a car carrier if it isn't properly secured. This can cause a collision, serious personal injury and vehicle damage. The vehicle should be tightly secured with chains or steel cables before it is transported.**

**Don't use substitutes (ropes, leather straps, canvas webbing, etc.) that can be cut by sharp edges underneath the towed vehicle.**

## ***ENGINE OVERHEATING***

You will find the warning light about a hot engine on your Cadillac instrument panel (Export Only).

The driver information will display either "ENGINE COOLANT HOT IDLE ENGINE" or "STOP ENGINE ENGINE OVERHEATING."

### ***If Steam Is Coming From Your Engine:***



#### **⚠ CAUTION:**

**Steam from an overheated engine can burn you badly, even if you just open the hood. Stay away from the engine if you see or hear steam coming from it. Just turn it off and get everyone away from the vehicle until it cools down. Wait until there is no sign of steam or coolant before opening the hood.**

**If you keep driving when your engine is overheated, the liquids in it can catch fire. You or others could be badly burned. Stop your engine if it overheats, and get out of the vehicle until the engine is cool.**

## **NOTICE:**

**If your engine catches fire because you keep driving with no coolant, your vehicle can be badly damaged. The costly repairs would not be covered by your warranty.**

### ***If No Steam Is Coming From Your Engine:***

If you get the overheat warning but see or hear no steam, the problem may not be too serious. Sometimes the engine can get a little too hot when you:

- Climb a long hill on a hot day.
- Stop after high speed driving.
- Idle for long periods in traffic.
- Tow a trailer.

If you get the overheat warning with no sign of steam, try this for a minute or so:

1. Turn off your air conditioner.
2. Turn on your heater to full hot at the highest fan speed and open the window as necessary.
3. Try to keep your engine under load (in a drive gear where the engine runs slower).

If you no longer have the overheat warning, you can drive. Just to be safe, drive slower for about ten minutes. If the warning doesn't come back on, you can drive normally.

If the warning continues, pull over, stop, and park your vehicle right away.

If there's still no sign of steam, you can idle the engine for two or three minutes while you're parked, to see if the warning stops. But then, if you still have the warning, **TURN OFF THE ENGINE AND GET EVERYONE OUT OF THE VEHICLE** until it cools down.

You may decide not to lift the hood but to get service help right away.



## COOLING SYSTEM - 4.9 LITER

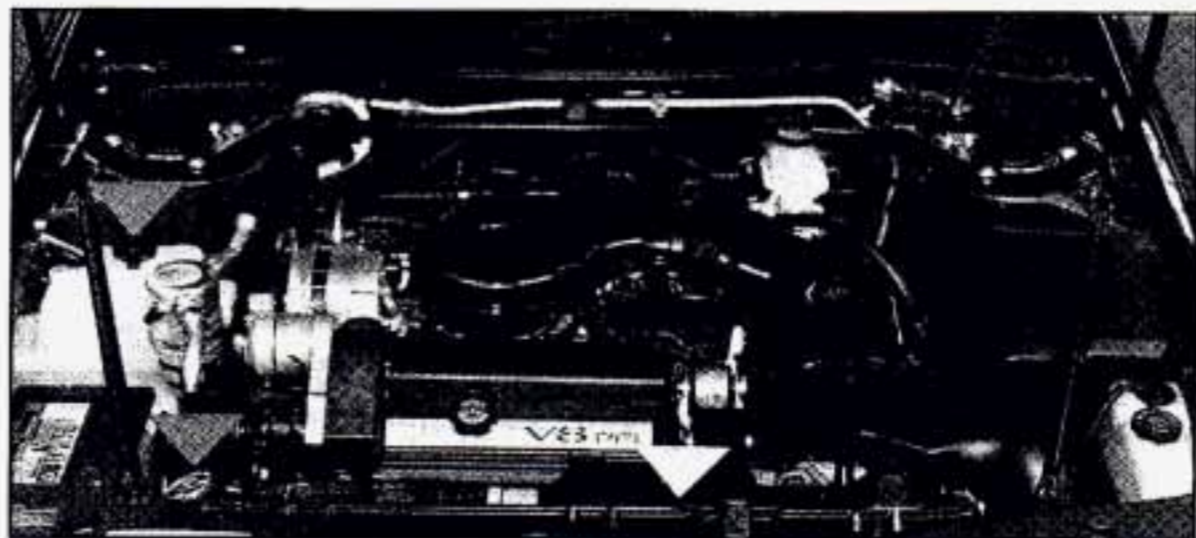

When you decide it's safe to lift the hood, here's what you'll see:

- ▼ Coolant recovery tank
- ▼ Radiator pressure cap
- Electric engine fans

### CAUTION:

**An electric fan under the hood can start up even when the engine is not running and can injure you. Keep hands, clothing and tools away from any underhood electric fan.**

If the coolant inside the coolant recovery tank is boiling, don't do anything else until it cools down.



The coolant level should be at or above "FULL COLD." If it isn't, you may have a leak in the radiator hoses, heater hoses, radiator, water pump or somewhere else in the cooling system.

**⚠ CAUTION:**

**Heater and radiator hoses, and other engine parts, can be very hot. Don't touch them. If you do, you can be burned.**

**Don't run the engine if there is a leak. If you run the engine, it could lose all coolant. That could cause an engine fire, and you could be burned. Get any leak fixed before you drive the vehicle.**

**NOTICE:**

**Engine damage from running your engine without coolant isn't covered by your warranty.**

If there seems to be no leak, check to see if the electric engine fans are running. If the engine is overheating, both fans should be running. If they aren't, your vehicle needs service.

## *How to Add Coolant to the Coolant Recovery Tank*

If you haven't found a problem yet, but the coolant level isn't at or above "FULL COLD," add a 50/50 mixture of clean water (preferably distilled) and a proper antifreeze at the coolant recovery tank. (See "Engine Coolant" in the Index for more information about the proper coolant mix.)



### **CAUTION:**

**Adding only plain water to your cooling system can be dangerous. Plain water, or some other liquid like alcohol, can boil before the proper coolant mix will. Your vehicle's coolant warning system is set for the proper coolant mix. With plain water or the wrong mix, your engine could get too hot but you wouldn't get the overheat warning. Your engine could catch fire and you or others could be burned. Use a 50/50 mix of clean water and a proper antifreeze.**

### **NOTICE:**

**In cold weather, water can freeze and crack the engine, radiator, heater core and other parts. Use the recommended coolant.**



**⚠ CAUTION:**

**You can be burned if you spill coolant on hot engine parts. Coolant contains ethylene glycol and it will burn if the engine parts are hot enough. Don't spill coolant on a hot engine.**

When the coolant in the coolant recovery tank is at or above "FULL COLD," start your vehicle.

If the overheat warning continues, there's one more thing you can try. You can add the proper coolant mix directly to the radiator, but be sure the cooling system is cool before you do it.

 **CAUTION:**

**Steam and scalding liquids from a hot cooling system can blow out and burn you badly. They are under pressure, and if you turn the radiator pressure cap -- even a little -- they can come out at high speed. Never turn the cap when the cooling system, including the radiator pressure cap, is hot. Wait for the cooling system and radiator pressure cap to cool if you ever have to turn the pressure cap.**

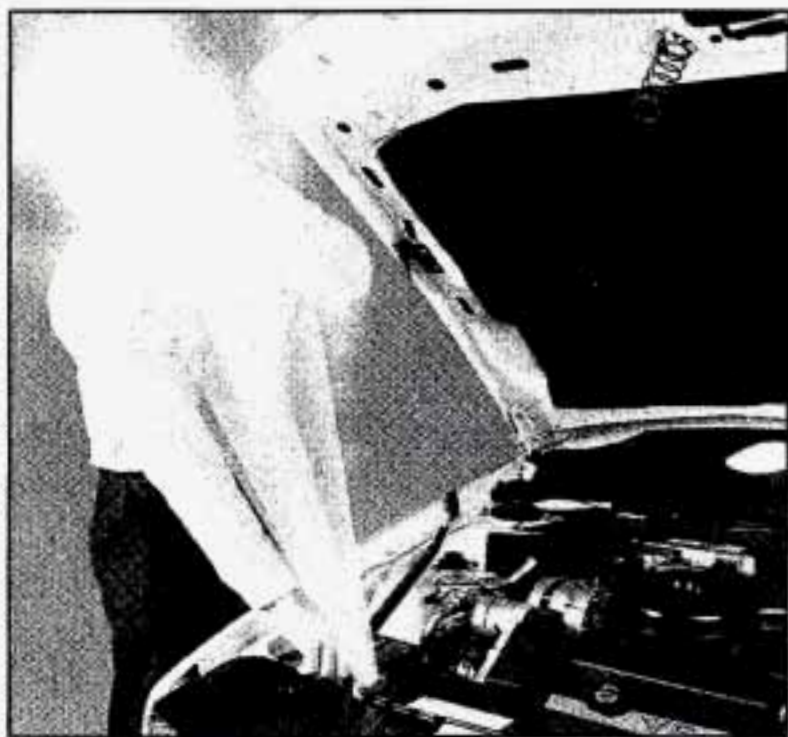

## *How to Add Coolant to the Radiator*



1. You can remove the radiator pressure cap when the cooling system, including the radiator pressure cap and upper radiator hose, is no longer hot. Turn the pressure cap slowly to the left until it first stops.

(Don't press down while turning the pressure cap.)

If you hear a hiss, wait for that to stop. A hiss means there is still some pressure left.



2. Then keep turning the pressure cap, but now push down as you turn it. Remove the pressure cap.



3. Fill the radiator with the proper mix, up to the base of the filler neck.



4. Then fill the coolant recovery tank to "FULL COLD."



5. Put the cap back on the coolant recovery tank, but leave the radiator pressure cap off.



6. Start the engine and let it run until you can feel the upper radiator hose getting hot. Watch out for the engine fans.

7. By this time the coolant level inside the radiator filler neck may be lower. If the level is lower, add more of the proper mix through the filler neck until the level reaches the base of the filler neck.



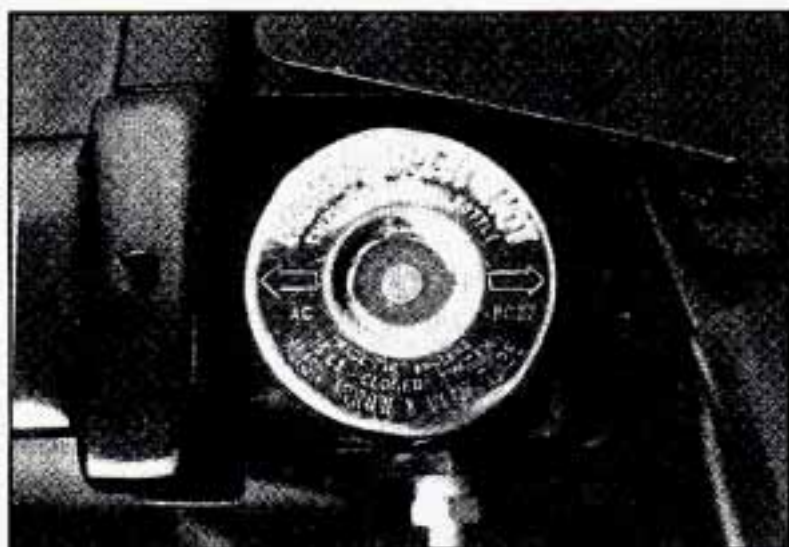

8. Replace the pressure cap. Be sure the arrows on the pressure cap line up like this.

## ***COOLING SYSTEM - 4.6 LITER (NORTHSTAR)***

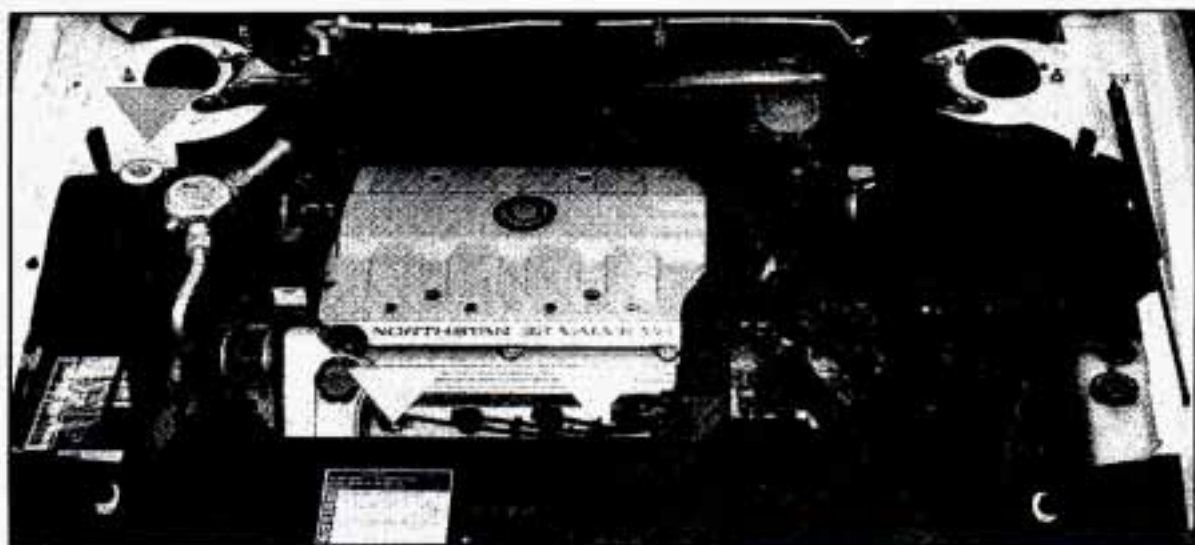

When you decide it's safe to lift the hood, here's what you'll see:

- ▼ Coolant surge tank with pressure cap
- Electric engine fans

**⚠ CAUTION:**

**An electric fan under the hood can start up even when the engine is not running and can injure you. Keep hands, clothing and tools away from any underhood electric fan.**

If the coolant inside the coolant surge tank is boiling, don't do anything else until it cools down.



The coolant level should be at or above "FULL COLD." If it isn't, you may have a leak in the radiator hoses, heater hoses, radiator, water pump or somewhere else in the cooling system.

**⚠ CAUTION:**

**Heater and radiator hoses, and other engine parts, can be very hot. Don't touch them. If you do, you can be burned.**

**Don't run the engine if there is a leak. If you run the engine, it could lose all coolant. That could cause an engine fire, and you could be burned. Get any leak fixed before you drive the vehicle.**

## **NOTICE:**

**Engine damage from running your engine without coolant isn't covered by your warranty.**

If there seems to be no leak, check to see if the electric engine fans are running. If the engine is overheating, both fans should be running. If they aren't, your vehicle needs service.

### ***How to Add Coolant to the Coolant Surge Tank***

If you haven't found a problem yet, but the coolant level isn't at or above "FULL COLD," add a 50/50 mixture of clean water (preferably distilled) and a proper antifreeze at the coolant recovery tank. (See "Engine Coolant" in the Index for more information about the proper coolant mix.)

## **CAUTION:**

**Adding only plain water to your cooling system can be dangerous. Plain water, or some other liquid like alcohol, can boil before the proper coolant mix will. Your vehicle's coolant warning system is set for the proper coolant mix. With plain water or the wrong mix, your engine could get too hot but you wouldn't get the overheat warning. Your engine could catch fire and you or others could be burned. Use a 50/50 mix of clean water and a proper antifreeze.**

## **NOTICE:**

**In cold weather, water can freeze and crack the engine, radiator, heater core and other parts. Use the recommended coolant.**



### **CAUTION:**

**You can be burned if you spill coolant on hot engine parts. Coolant contains ethylene glycol and it will burn if the engine parts are hot enough. Don't spill coolant on a hot engine.**

Should a low coolant condition exist, an overheat protection "Limp Home" feature of the 4.6 L Northstar allows alternate firing groups of four cylinders for a predetermined number of cycles to prevent engine damage, enabling your vehicle to be driven to the nearest service center.



### **CAUTION:**

**Steam and scalding liquids from a hot cooling system can blow out and burn you badly. They are under pressure, and if you turn the coolant surge tank pressure cap -- even a little -- they can come out at high speed. Never turn the cap when the cooling system, including the coolant surge tank pressure cap, is hot. Wait for the cooling system and coolant surge tank pressure cap to cool if you ever have to turn the pressure cap.**

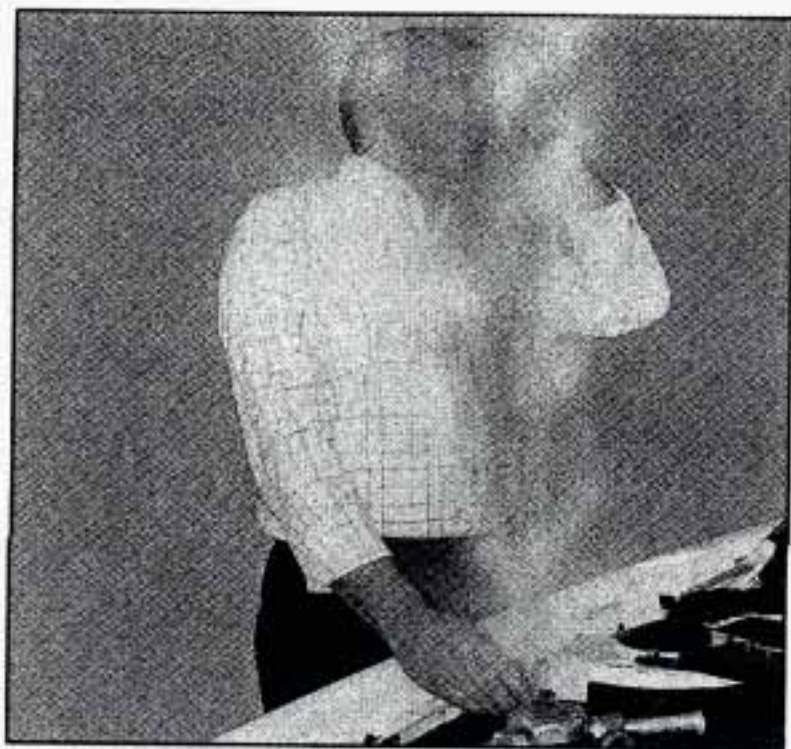

1. You can remove the coolant surge tank pressure cap when the cooling system, including the coolant surge tank pressure cap and upper radiator hose, is no longer hot. Turn the pressure cap slowly to the left until it first stops.

(Don't press down while turning the pressure cap.)

If you hear a hiss, wait for that to stop. A hiss means there is still some pressure left.



2. Then keep turning the pressure cap, but now push down as you turn it. Remove the pressure cap.



3. Fill the coolant surge tank with the proper mix, up to the base of the filler neck.



4. Put the cap back on the coolant surge tank.

5. Start the engine and as the engine runs the coolant will circulate through the cooling system. Any air that was introduced while adding coolant will purge itself and rise to the top of the surge tank. If the "ENGINE COOLANT LOW" message does not appear on the Driver Information Center, coolant is at the proper fill level. If an "ENGINE COOLANT LOW" message does appear, repeat steps 1 through 4 or see your dealer.

## ***IF A TIRE GOES FLAT***

It's unusual for a tire to "blow out" while you're driving, especially if you maintain your tires properly. If air goes out of a tire, it's much more likely to leak out slowly. But if you should ever have a "blowout," here are a few tips about what to expect and what to do:

If a front tire fails, the flat tire will create a drag that pulls the vehicle toward that side. Take your foot off the accelerator pedal and grip the steering wheel firmly. Steer to maintain lane position, then gently brake to a stop well out of the traffic lane.

A rear blowout, particularly on a curve, acts much like a skid and may require the same correction you'd use in a skid. In any rear blowout, remove your foot from the accelerator pedal. Get the vehicle under control by steering the way you want the vehicle to go. It may be very bumpy and noisy, but you can still steer. Gently brake to a stop, well off the road if possible.

If your tire goes flat, the next section shows how to use your jacking equipment to change a flat tire safely.

## ***CHANGING A FLAT TIRE***

If a tire goes flat, avoid further tire and wheel damage by driving slowly to a level place. Turn on your hazard warning flashers.

### **⚠ CAUTION:**

**Changing a tire can cause an injury. The vehicle can slip off the jack and roll over you or other people. You and they could be badly injured. Find a level place to change your tire. To help prevent the vehicle from moving:**

- 1. Put the shift lever in "P" (Park).**
- 2. Set the parking brake firmly.**
- 3. Turn off the engine.**

**To be even more certain the vehicle won't move, you can put chocks at the front and rear of the tire farthest away from the one being changed. That would be the tire on the other side of the vehicle, at the opposite end.**





The following steps will tell you how to use the jack and change a tire.



The equipment you'll need is in the trunk under the spare tire cover.

Rotate the plastic wing nut and remove that cover to access the spare tire.

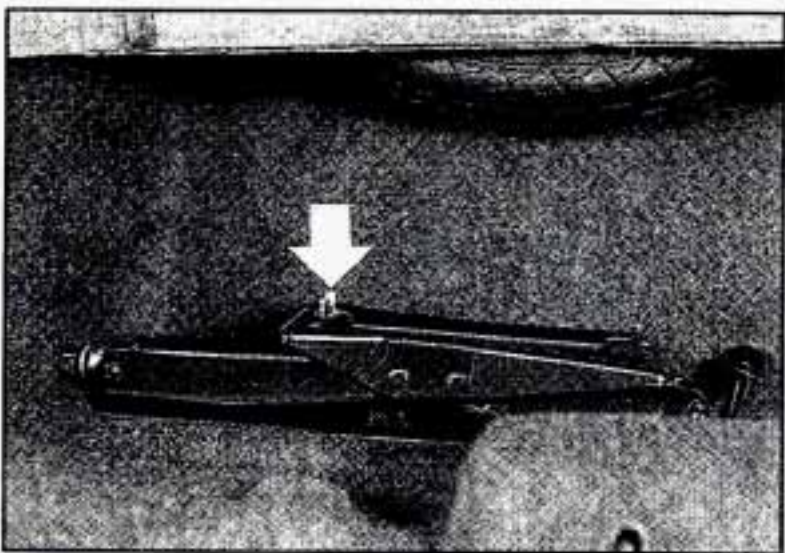

Then remove the wing nut that secures the jack and wrench and remove them from the trunk.



Attach the wheel wrench to the jack bolt and rotate it clockwise (to the right). That will raise the lift head a little.



There is a center wheel cover on your aluminum wheel. Use the flat end of the wheel wrench, prying along the edge of the cover until it comes off. Be careful not to scratch the aluminum wheel edge. Don't try to remove it with your bare hands.



Using the wheel wrench, loosen all the wheel nuts. Don't remove them yet.

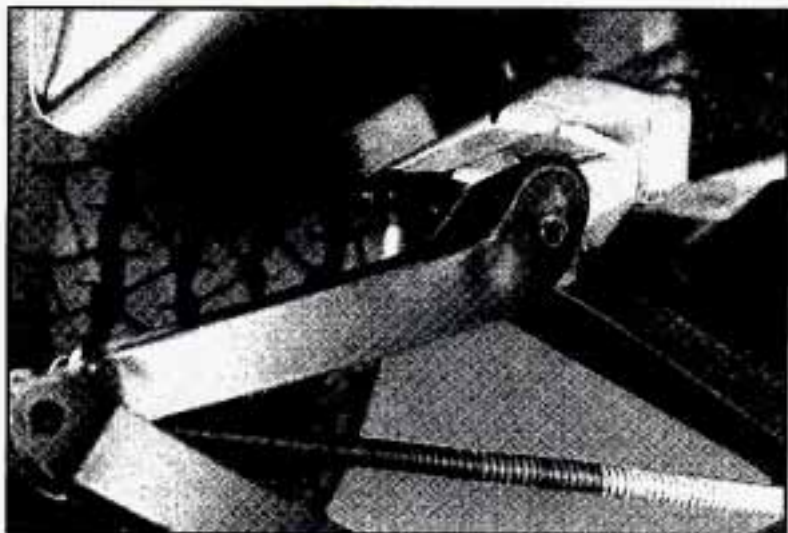

Position the jack under the vehicle. Your vehicle has a notch on the frame near each of the wheels. Fit the lift head into the notch nearest the wheel with the flat tire.

**⚠ CAUTION:**

**Getting under a vehicle when it is jacked up is dangerous. If the vehicle slips off the jack, you could be badly injured or killed. Never get under a vehicle when it is supported only by a jack.**

**NOTICE:**

**Raising your vehicle with the jack improperly positioned will damage the vehicle or may allow the vehicle to fall off the jack. Be sure to fit the jack lift head into the proper location before raising your vehicle.**

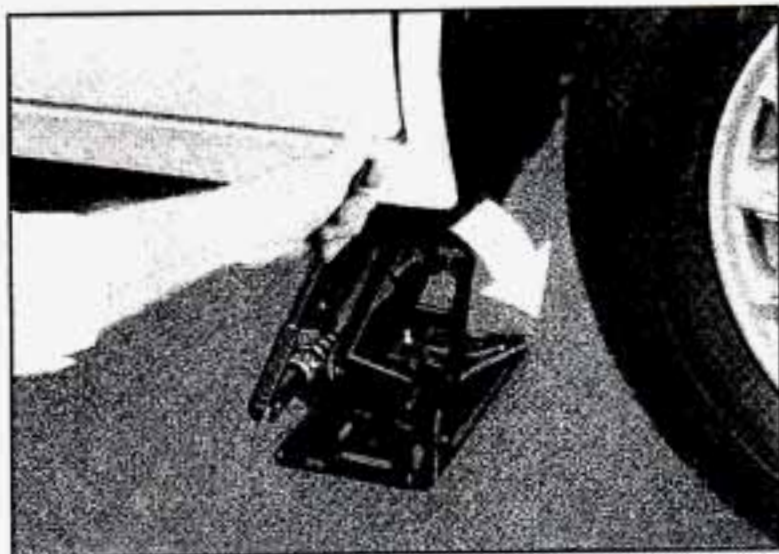

Raise the vehicle by rotating the wheel wrench clockwise. Raise the vehicle far enough off the ground so there is enough room for the spare tire to fit.

Remove all the wheel nuts and take off the flat tire.

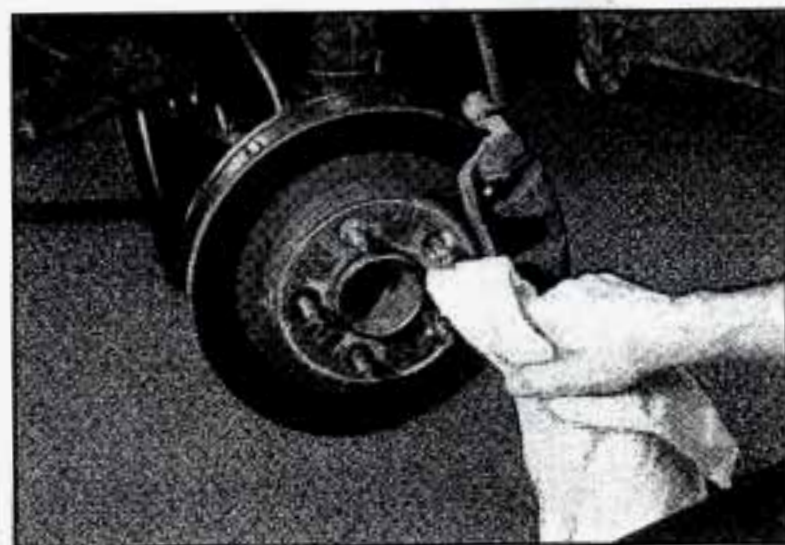
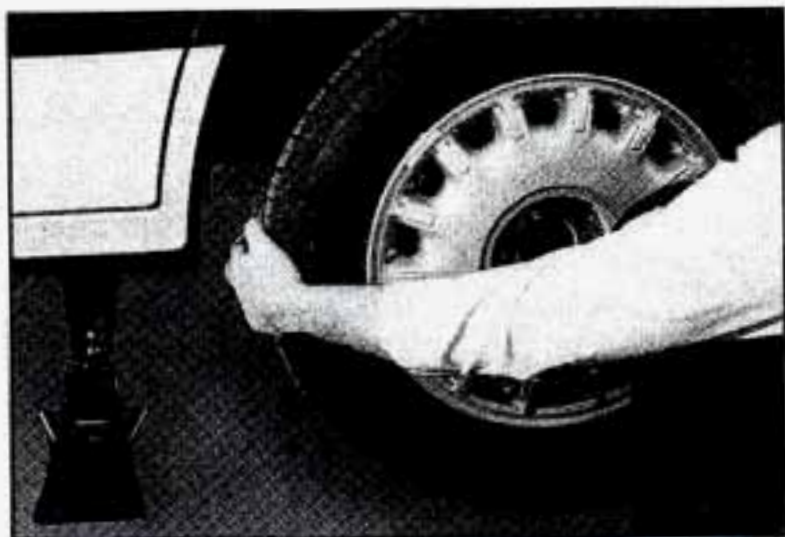

**⚠ CAUTION:**

Rust or dirt on the wheel, or on the parts to which it is fastened, can make the wheel nuts become loose after a time. The wheel could come off and cause an accident. When you change a wheel, remove any rust or dirt from the places where the wheel attaches to the vehicle. In an emergency, you can use a cloth or a paper towel to do this; but be sure to use a scraper or wire brush later, if you need to, to get all the rust or dirt off.

Remove any rust or dirt from the wheel bolts, mounting surfaces or spare wheel. Place the spare on the wheel mounting surface.

**⚠ CAUTION:**

**Never use oil or grease on studs or nuts. If you do, the nuts might come loose. Your wheel could fall off, causing a serious accident.**

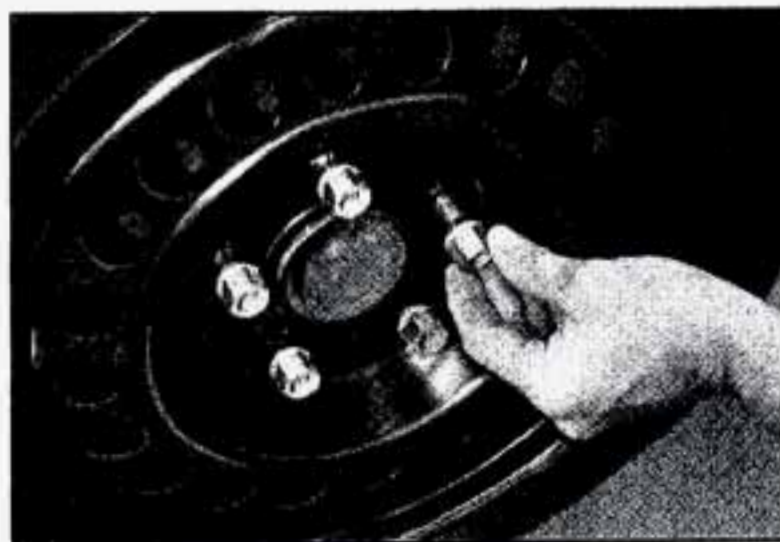

Replace the wheel nuts with the rounded end of the nuts toward the wheel. Tighten each nut by hand until the wheel is held against the hub.

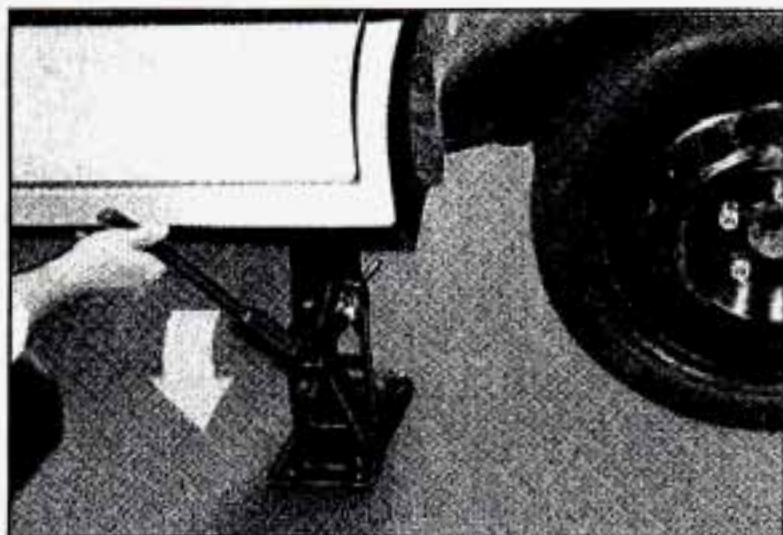

Lower the vehicle by rotating the wheel wrench counterclockwise. Lower the jack completely.

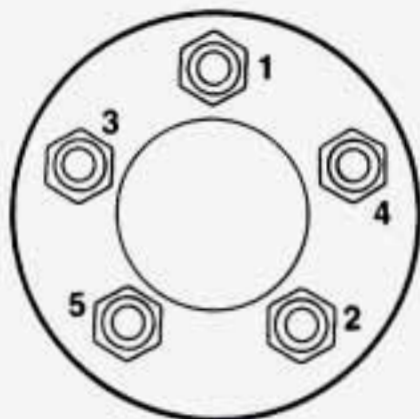

Tighten the wheel nuts firmly in a criss-cross sequence as shown.



### **CAUTION:**

**Incorrect wheel nuts or improperly tightened wheel nuts can cause the wheel to become loose and even come off. This could lead to an accident. Be sure to use the correct wheel nuts. If you have to replace them, be sure to get the right kind.**

**Stop somewhere as soon as you can and have the nuts tightened with a torque wrench to 140 N·m (100 ft.lbs.).**

Don't try to put a wheel cover on your compact spare tire. It won't fit. Store the wheel cover in the trunk until you have the flat tire repaired or replaced.

### **NOTICE:**

**Wheel covers won't fit on your compact spare. If you try to put a wheel cover on your compact spare, you could damage the cover or the spare.**



### **CAUTION:**

**Storing a jack, a tire or other equipment in the passenger compartment of the vehicle could cause injury. In a sudden stop or collision, loose equipment could strike someone. Store all these in the proper place.**

## ***COMPACT SPARE TIRE***

Although the compact spare was fully inflated when your vehicle was new, it can lose air after a time. Check the inflation pressure regularly. It should be 60 psi (420 kPa). The compact spare is made to go up to 3,000 miles (5000 km), so you can finish your trip and have your full-size tire repaired or replaced where you want. Of course, it's best to replace your spare with a full-size tire as soon as you can. Your spare will last longer and be in good shape in case you need it again.

Your anti-lock brake system warning light may come on when you are driving with a compact spare. See "Anti-Lock Brake System Warning Light" in the Index.



## **NOTICE:**

**Don't take your compact spare through an automatic car wash with guide rails. The compact spare can get caught on the rails. That can damage the tire and wheel, and maybe other parts of your vehicle.**

Don't use your compact spare on some other vehicle.

And don't mix your compact spare or wheel with other wheels or tires. They won't fit. Keep your spare and its wheel together.

## **NOTICE:**

**Tire chains won't fit your compact spare. Using them will damage your vehicle and destroy the chains too. Don't use tire chains on your compact spare.**



## **CAUTION:**

**Storing a jack, a tire, or other equipment in the passenger compartment of the vehicle could cause injury. In a sudden stop or collision, loose equipment could strike someone. Store all these in the proper place.**

The flat tire should be placed in the spare tire well.

## ***IF YOU'RE STUCK: IN SAND, MUD, ICE OR SNOW***

What you don't want to do when your vehicle is stuck is to spin your wheels. The method known as "rocking" can help you get out when you're stuck, but you must use caution.

### **CAUTION:**

**If you let your tires spin at high speed, they can explode and you or others could be injured. And, the transaxle or other parts of the vehicle can overheat. That could cause an engine compartment fire or other damage. When you're stuck, spin the wheels as little as possible. Don't spin the wheels above 35 mph (55 km/h) as shown on the speedometer.**

### **NOTICE:**

**Spinning your wheels can destroy parts of your vehicle as well as the tires. If you spin the wheels too fast while shifting your transaxle back and forth, you can destroy your transaxle.**

### **Rocking your vehicle to get it out:**

First, turn your steering wheel left and right. That will clear the area around your front wheels. Then shift back and forth between "R" (Reverse) and a forward gear, spinning the wheels as little as possible. Release the accelerator pedal while you shift, and press lightly on the accelerator pedal when the transaxle is in gear. If that doesn't get you out after a few tries, you may need to be towed out. If you do need to be towed out, see "Towing Your Vehicle" in the Index.



## SECTION 6

### SERVICE AND APPEARANCE CARE

Here you will find information about the care of your Cadillac. This section begins with service and fuel information, and then it shows how to check important fluid and lubricant levels. There is also technical information about your vehicle, and a section devoted to its appearance care.

#### *SERVICE*

Your Cadillac dealer knows your vehicle best and wants you to be happy with it. We hope you'll go to your dealer for all your service needs. You'll get genuine GM parts and GM-trained and supported service people.

We hope you'll want to keep your GM vehicle all GM. Genuine GM parts have one of these marks:



#### *Doing Your Own Service Work*

If you want to do some of your own service work, you'll want to get the proper Cadillac Service Manual. It tells you much more about how to service your Cadillac than this manual can. To order the proper service manual, see "Service Publications" in the Index.

You should keep a record with all parts receipts and list the mileage and the date of any service work you perform. See "Maintenance Record" in the Index.

## **CAUTION:**

**You can be injured if you try to do service work on a vehicle without knowing enough about it.**

- **Be sure you have sufficient knowledge, experience, and the proper replacement parts and tools before you attempt any vehicle maintenance task.**
- **Be sure to use the proper nuts, bolts and other fasteners. “English” and “metric” fasteners can be easily confused. If you use the wrong fasteners, parts can later break or fall off. You could be hurt.**

## **NOTICE:**

**If you try to do your own service work without knowing enough about it, your vehicle could be damaged.**

## ***FUEL***

Use premium unleaded gasoline rated at 91 octane or higher. It should meet specifications ASTM D4814 in the U.S. and CGSB 3.5-92 in Canada. These fuels should have the proper additives, so you should not have to add anything to the fuel.

In the U.S. and Canada, it's easy to be sure you get the right kind of gasoline (unleaded). You'll see “UNLEADED” right on the pump. And only unleaded nozzles will fit into your vehicle's filler neck.

Be sure the posted octane is at least 91. If the octane is less than 91, you may get a heavy knocking noise when you drive. (In an emergency, you may be able to use lower octane -- as low as 87 -- if heavy knocking does not occur.) If you're using 91 or higher octane unleaded gas and you still get heavy knocking, your engine needs service.

What about gasoline with blending materials that contain oxygen, such as MTBE or alcohol?

MTBE is “methyl tertiary-butyl ether.” Fuel that is no more than 15% MTBE is fine for your car.

Ethanol is ethyl or grain alcohol. Properly-blended fuel that is no more than 10% ethanol is fine for your car.

Methanol is methyl or wood alcohol.

## **NOTICE:**

**Fuel that is more than 5% methanol is bad for your vehicle. Don't use it. It can corrode metal parts in your fuel system and also damage plastic and rubber parts. That damage wouldn't be covered under your warranty. And even at 5% or less, there must be “cosolvents” and corrosion preventers in this fuel to help avoid these problems.**

### Gasolines for Cleaner Air

Your use of gasoline with detergent additives will help prevent deposits from forming in your engine and fuel system. That helps keep your engine in tune and your emission control system working properly. It's good for your vehicle, and you'll be doing your part for cleaner air.

Many gasolines are now blended with materials called oxygenates. General Motors recommends that you use gasolines with these blending materials, such as MTBE and ethanol. By doing so, you can help clean the air, especially in those parts of the country that have high carbon monoxide levels.

In addition, some gasoline suppliers are now producing reformulated gasolines. These gasolines are specially designed to reduce vehicle emissions. General Motors recommends that you use reformulated gasoline. By doing so, you can help clean the air, especially in those parts of the country that have high ozone levels.

You should ask your service station operators if their gasolines contain detergents and oxygenates, and if they have been reformulated to reduce vehicle emissions.

## ***FUELS IN FOREIGN COUNTRIES***

If you plan on driving in another country outside the U.S. or Canada, unleaded fuel may be hard to find. Do not use leaded gasoline. If you use even one tankful, your emission controls won't work well or at all. With continuous use, spark plugs can get fouled, the exhaust system can corrode, and your engine oil can deteriorate quickly. Your vehicle's oxygen sensor will be damaged. All of that means costly repairs that wouldn't be covered by your warranty.

To check on fuel availability, ask an auto club, or contact a major oil company that does business in the country where you'll be driving.

You can also write us at the following address for advice. Just tell us where you're going and give your Vehicle Identification Number (VIN).

General Motors of Canada Ltd.  
International Export Sales  
P.O. Box 828  
Oshawa, Ontario L1H 7N1, Canada

## ***FILLING YOUR TANK***

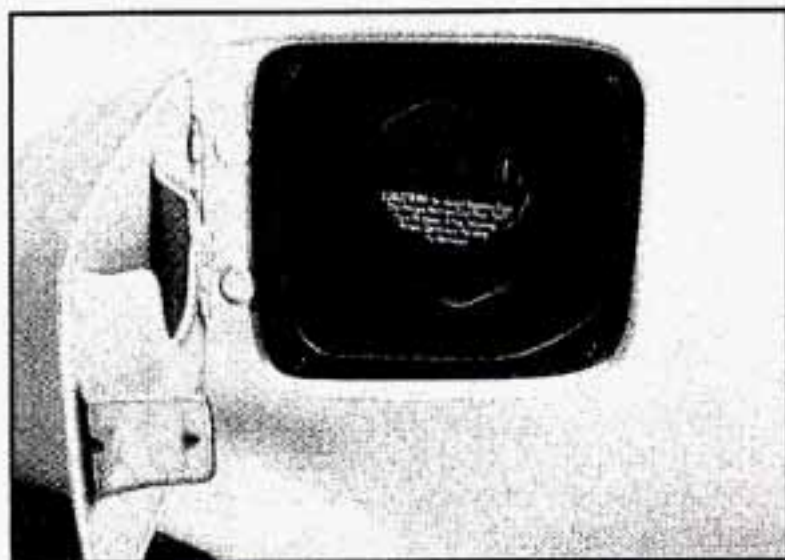

**⚠ CAUTION:**

**Gasoline vapor is highly flammable. It burns violently, and that can cause very bad injuries. Don't smoke if you're near gasoline or refueling your vehicle. Keep sparks, flames, and smoking materials away from gasoline.**

The cap is behind a hinged door on the left side of your vehicle.



The release button is in the glove box.

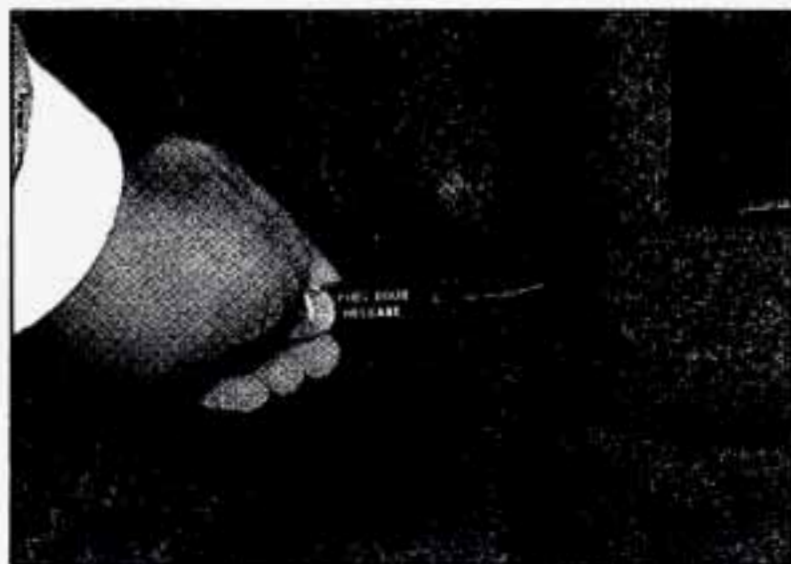

Or you can use the manual door release override in the trunk.

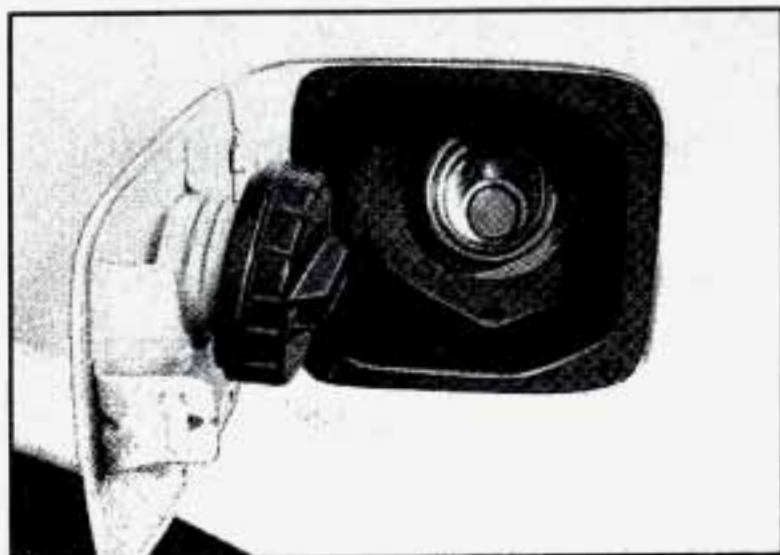

While refueling, hang the cap inside the fuel door.

To take off the cap, turn it slowly to the left (counterclockwise).

**⚠ CAUTION:**

If you get gasoline on you and then something ignites it, you could be badly burned. Gasoline can spray out on you if you open the fuel filler cap too quickly. This spray can happen if your tank is nearly full, and is more likely in hot weather. Open the fuel filler cap slowly and wait for any “hiss” noise to stop. Then unscrew the cap all the way.

When you put the cap back on, turn it to the right until you hear a clicking noise.

**NOTICE:**

If you need a new cap, be sure to get the right type. Your dealer can get one for you. If you get the wrong type, it may not fit and your fuel tank and emissions system might be damaged.



## ***CHECKING THINGS UNDER THE HOOD***

### ***HOOD RELEASE***

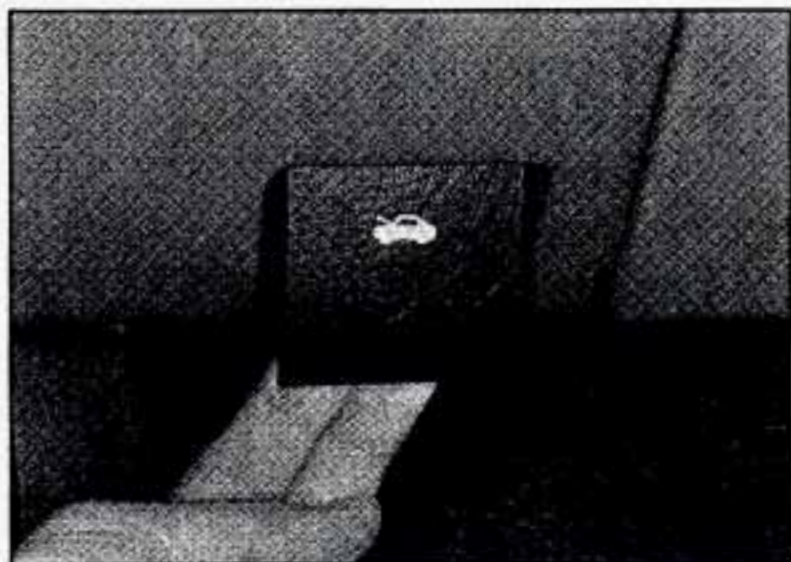

To open the hood, first pull the lever inside the vehicle located at the lower left side of the instrument panel.

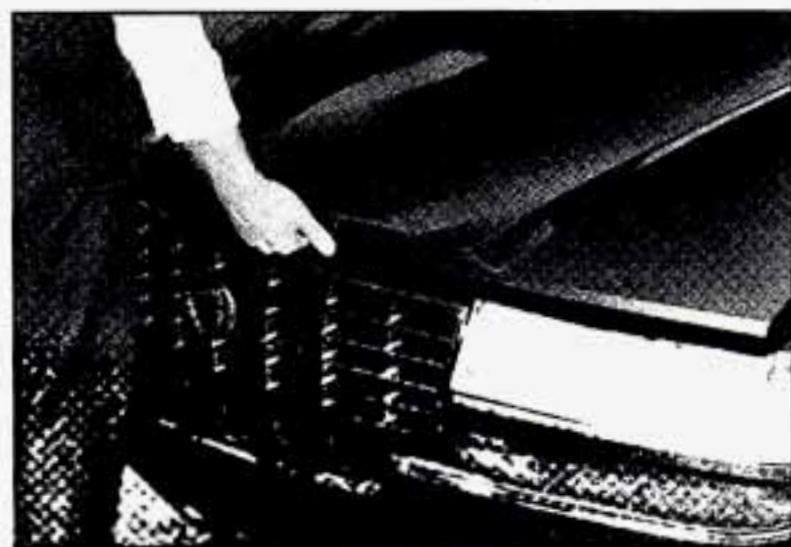

Then go to the front of the vehicle and release the secondary hood release and lift the hood.

 **CAUTION:**

An electric fan under the hood can start up and injure you even when the engine is not running. Keep hands, clothing and tools away from any underhood electric fan.

 **CAUTION:**

Before closing the hood, be sure all filler caps are on properly. Then just pull the hood down and close it firmly.

### *Fluid Usage Label*

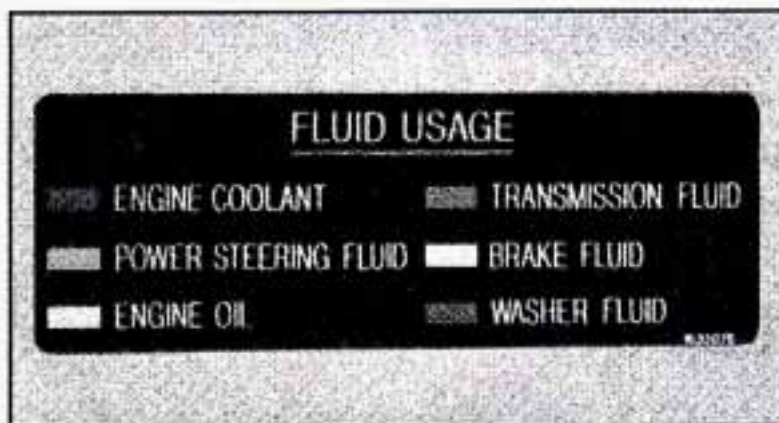

4.9 Liter



4.6 Liter (Northstar)

Use the fluid usage label to identify the correct fluid you want to check.

## ***ENGINE OIL***

It's a good idea to check your engine oil every time you get fuel. In order to get an accurate reading, the oil must be warm and the vehicle must be on level ground.



4.9 Liter

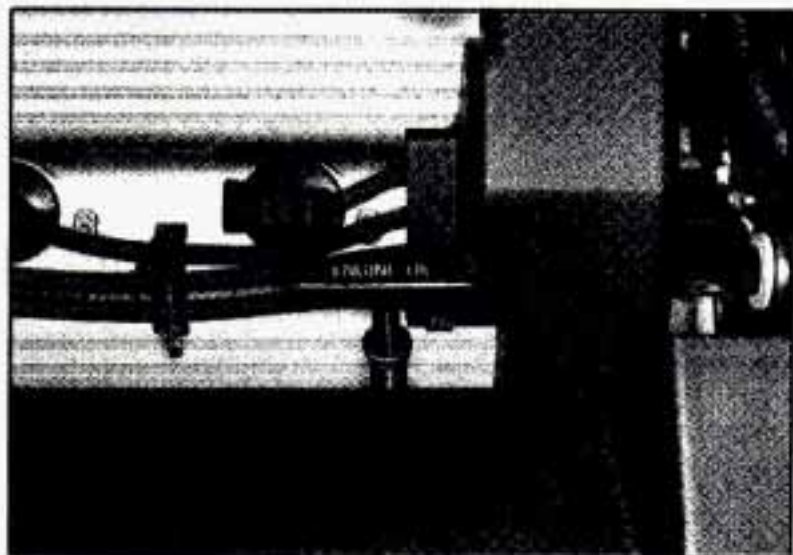

4.6 Liter (Northstar)

Turn off the engine and give the oil a few minutes to drain back into the oil pan. If you don't, the oil dipstick might not show the actual level.

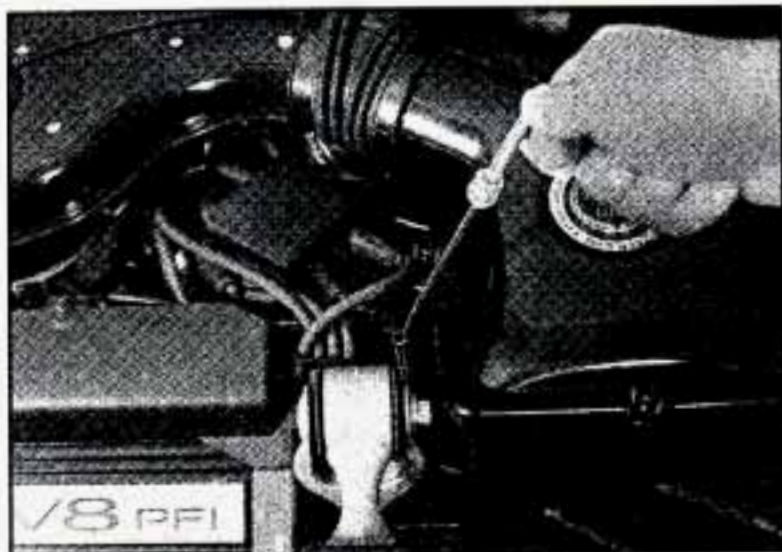

4.9 Liter

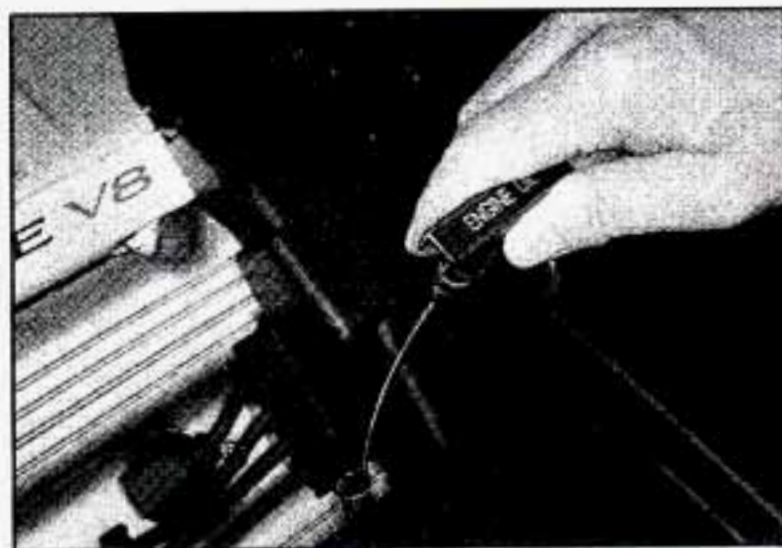

4.6 Liter (Northstar)

**To Check Engine Oil:** Pull out the dipstick and clean it with a paper towel or cloth, then push it back in all the way. Remove it again, keeping the tip lower.

4.9 Liter

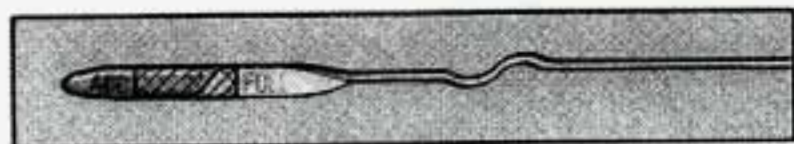
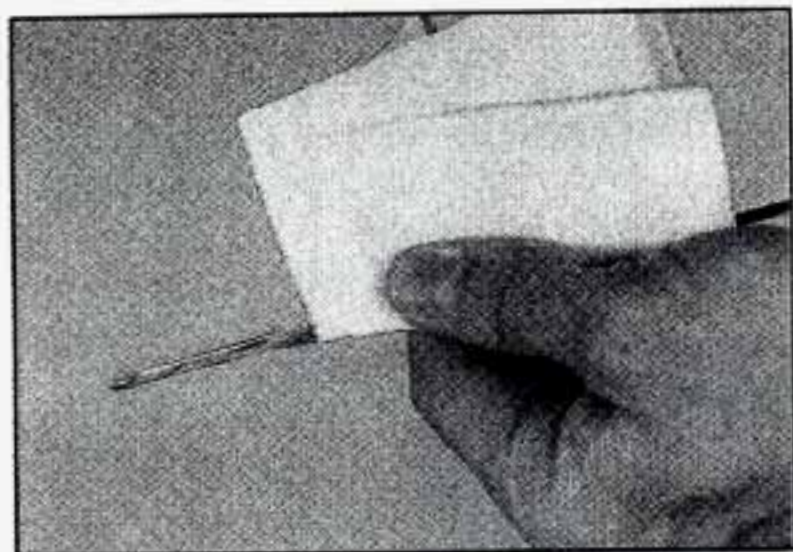

4.6 Liter (Northstar)

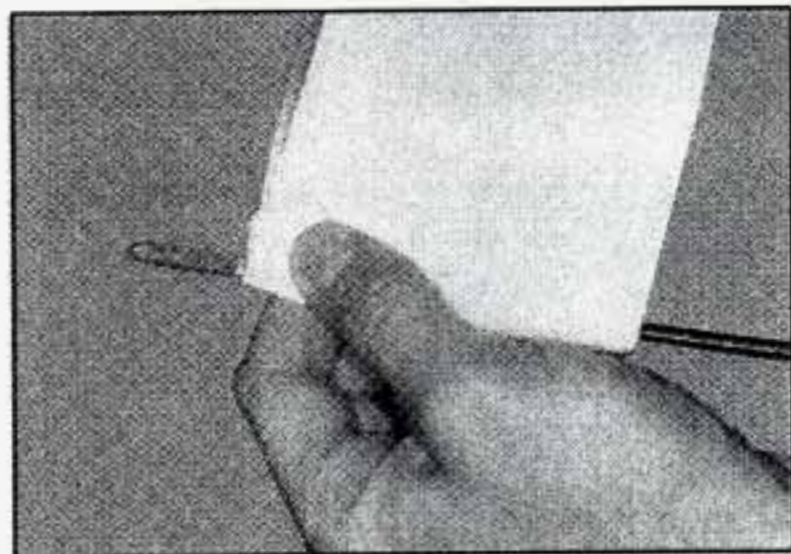

**When to Add Oil:** If the oil is at or below the ADD line, then you'll need to add some oil. But you must use the right kind. This section explains what kind of oil to use. For crankcase capacity, see "Capacities and Specifications" in the Index.

## **NOTICE:**

**Don't add too much oil. If your engine has so much oil that the oil level gets above the cross-hatched area that shows the proper operating range, your engine could be damaged.**



4.9 Liter

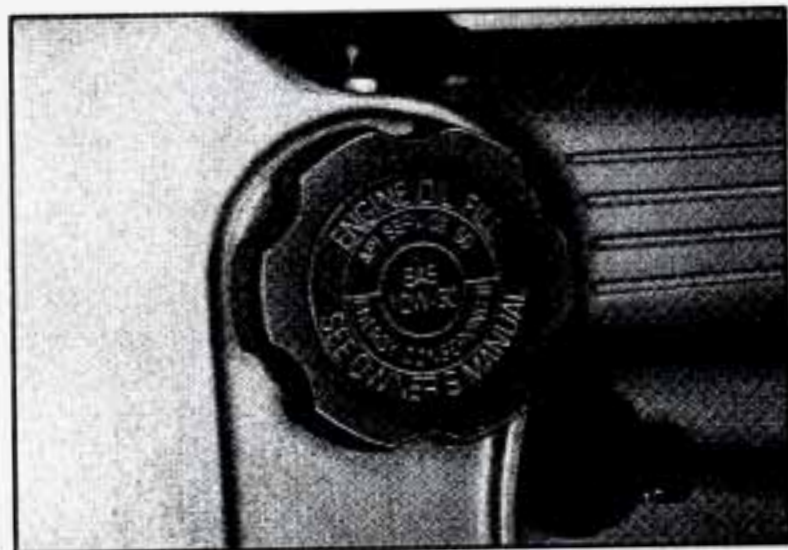

4.6 Liter (Northstar)

To remove, turn the oil fill cap counterclockwise.

Just fill it enough to put the level somewhere in the proper operating range. Push the dipstick all the way back in when you're through.



#### What Kind of Oil to Use:

Look for three things:

- SG

"SG" must be on the oil container, either by itself or combined with other quality designations, such as "SG/CC," "SG/CD," "SF,SG,CC," etc. These letters show American Petroleum Institute (API) levels of quality.

#### **NOTICE:**

**If you use oils that don't have the "SG" designation, you can cause engine damage not covered by your warranty.**

## RECOMMENDED SAE VISCOSITY GRADE ENGINE OILS

FOR BEST FUEL ECONOMY AND COLD STARTING, SELECT THE LOWEST SAE VISCOSITY GRADE OIL FOR THE EXPECTED TEMPERATURE RANGE.

**HOT  
WEATHER**

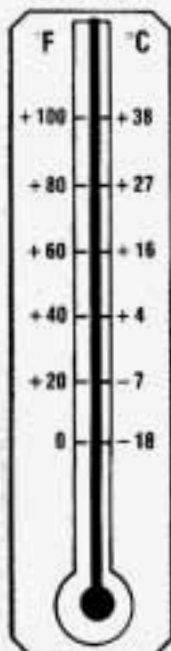

**COLD  
WEATHER**

**LOOK  
FOR THIS  
LABEL**



**SAE 5W-30**

**SAE 10W-30  
PREFERRED**

**SAE 30**

**DO NOT USE SAE 10W-40 GRADE OIL OR  
ANY OTHER GRADE NOT RECOMMENDED**

- **SAE 10W-30**

As shown in the viscosity chart, SAE 10W-30 is best for your vehicle. However, you can use SAE 5W-30 if it's going to be colder than 60°F (16°C) before your next oil change. When it's very cold, below 0°F (-18°C), you should use SAE 5W-30.

These numbers on an oil container show its viscosity, or thickness. Do not use other viscosity oils such as SAE 10W-40 or SAE 20W-50.

- **Energy Conserving II**

Oils with these words on the container will help you save fuel.



This doughnut-shaped logo (symbol) is used on most oil containers to help you select the correct oil.

You should look for this on the oil container, and use **only** those oils that display the logo.

GM Goodwrench® oil (in Canada, GM Engine Oil) meets all the requirements for your vehicle.

**Engine Oil Additives:** Don't add anything to your oil. Your Cadillac dealer is ready to advise if you think something should be added.

**When to Change Engine Oil:** Your vehicle is equipped with an engine oil life index (EOLI) feature as part of the Driver Information Center display (DIC). Oil change intervals are determined by the EOLI and will usually fall at, or between, the two recommended alternative intervals of 3,000 miles (5,000 kilometers) and 7,500 miles (12,500 kilometers), but could be shorter than 3,000 miles (5,000 kilometers) under some very severe driving conditions shown in Schedule I. The system will also indicate the need for an oil change if 7,500 miles (12,500 kilometers) or one year has passed.

Engine oil life remaining is displayed through engine data as the 'OIL LIFE INDEX' and as a 'CHANGE ENGINE OIL' message. The 'OIL LIFE INDEX' display includes a number between 0 and 100. This is the percentage of oil life **REMAINING** based on driving conditions and mileage driven since the last time of the oil life indicator was reset. When the remaining oil life is less than 10%, a 'CHANGE OIL SOON' message will appear. This is a reminder to schedule an engine oil change. When the oil life index reaches 0, the 'CHANGE ENGINE OIL' message will appear. This indicates that no oil life remains and the oil should be changed as soon as possible, but certainly within the next 200 miles (320 km).

The EOLI will not detect excessively dusty conditions or engine malfunctions which may effect the oil. If you drive in dusty areas, change the engine oil after every 3,000 miles (5,000 kilometers) or 3 months (whichever comes first), unless instructed to do so sooner by the DIC.

On Northstar 4.6 Liter engine equipped vehicles a 'CHECK OIL LEVEL' message will appear whenever the oil level's approximately one quart low.

**How To Reset the Oil Life Indicator:** After the oil has been changed, display the 'OIL LIFE INDEX' message by pressing the 'INFORMATION' button. Then press and hold the 'STORE/RECALL' button until the display shows '100'. This will reset the oil life index. The message will remain OFF until the next oil change is needed. The percentage of oil life remaining may be check at any item by pressing the INFORMATION button several times until the 'OIL LIFE INDEX' message appears.

**Engine Block Heater:** An engine block heater can be a big help if you have to park outside in very cold weather, -20° F (-29° C) or colder. If your vehicle has this option, see "Engine Block Heater" in the Index.

#### **What to Do with Used Oil:**



#### **CAUTION:**

**Used engine oil contains things that have caused skin cancer in laboratory animals. Don't let used oil stay on your skin for very long. Clean your skin and nails with soap and water, or a good hand cleaner. Wash or properly throw away clothing or rags containing used engine oil.**

Used oil can be a real threat to the environment. If you change your own oil, be sure to drain all free-flowing oil from the filter before disposal. Don't ever dispose of oil by pouring it on the ground, into sewers, or into streams or bodies of water. Instead, recycle it by taking it to a place that collects used oil. If you have a problem properly disposing of your used oil, ask your dealer, a service station or a local recycling center for help.

## ***AIR CLEANER***

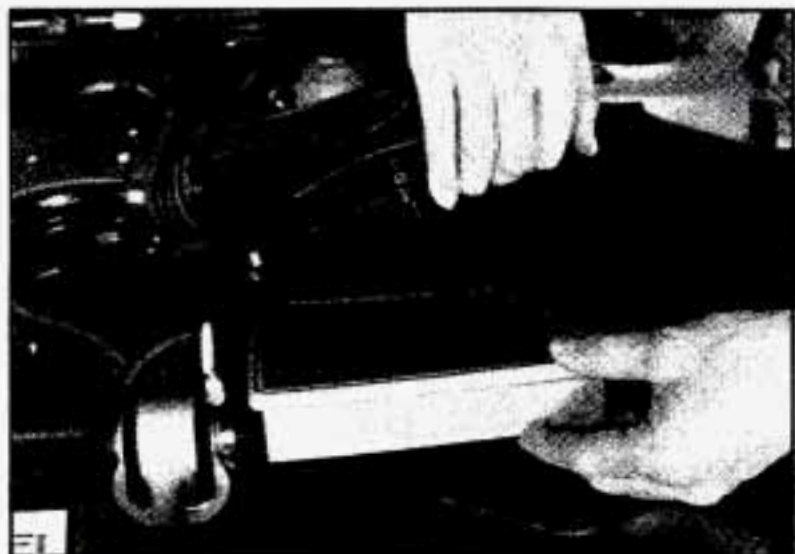

4.9 Liter



4.6 Liter (Northstar)

To gain access to the air cleaner element, loosen the four screws and lift the top half of the air cleaner assembly.

Refer to the Maintenance Schedule to determine when to replace the air filter.

See "Scheduled Maintenance Services" in the Index.

 **CAUTION:**

**Operating the engine with the air cleaner off can cause you or others to be burned. The air cleaner not only cleans the air, it stops flame if the engine backfires. If it isn't there, and the engine backfires, you could be burned. Don't drive with it off, and be careful working on the engine with the air cleaner off.**

**NOTICE:**

**If the air cleaner is off, a backfire can cause a damaging engine fire. And, dirt can easily get into your engine, which will damage it. Always have the air cleaner in place when you're driving.**

## ***AUTOMATIC TRANSAXLE FLUID***

### **When to Check and Change:**

A good time to check your automatic transaxle fluid level is when the engine oil is changed. Refer to the Maintenance Schedule to determine when to change your fluid. See "Scheduled Maintenance Services" in the Index.

### **How to Check:**

Because this operation can be a little difficult, you may choose to have this done at a Cadillac dealership Service Department.

If you do it yourself, be sure to follow all the instructions here, or you could get a false reading on the dipstick.

## **NOTICE:**

**Too much or too little fluid can damage your transaxle. Too much can mean that some of the fluid could come out and fall on hot engine parts, starting a fire. Be sure to get an accurate reading if you check your transaxle fluid.**

Wait at least 30 minutes before checking the transaxle fluid level if you have been driving:

- When outside temperatures are above 90° F (32° C).
- At high speed for quite a while.
- In heavy traffic -- especially in hot weather.
- While pulling a trailer.

To get the right reading, the fluid should be at normal operating temperature, which is 180° F to 200° F (82° C to 93° C).

Get the vehicle warmed up by driving about 15 miles (24 km) when outside temperatures are above 50° F (10° C). If it's colder than 50° F (10° C), you may have to drive longer.

### To check the fluid level:

- Park your vehicle on a level place.
- Place the shift lever in "P" (Park) with the parking brake applied.
- With your foot on the brake pedal, move the shift lever through each gear range, pausing for about three seconds in each range. Then, position the shift lever in "P" (Park).
- Let the engine run at idle for three to five minutes.

Then, without shutting off the engine, follow these steps:

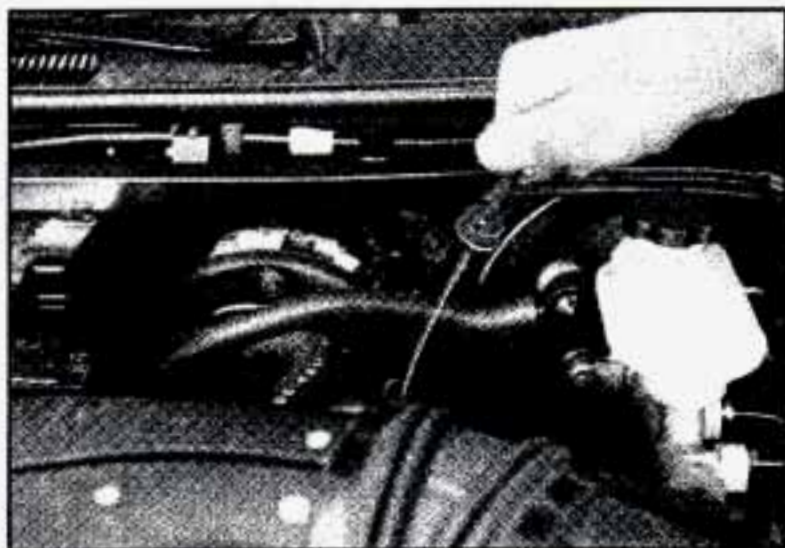

4.9 Liter



4.6 Liter (Northstar)

Turn cap  
counterclockwise to  
unlock cap.

1. Pull out the dipstick and wipe it with a clean rag or paper towel.
2. Push it back in all the way, wait three seconds and then pull it back out again.

4.9 Liter

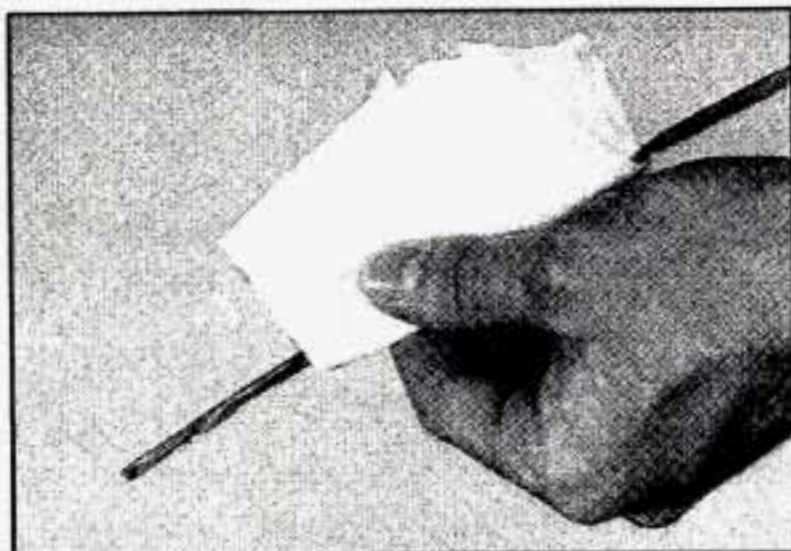

4.6 Liter (Northstar)

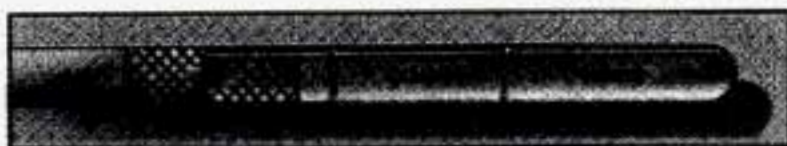

3. Check both sides of the dipstick, and read the lower level. The fluid level must be in the cross-hatched area.
4. If the fluid level is where it should be, push the dipstick back in all the way.

#### **How to Add Fluid:**

Refer to the Maintenance Schedule to determine what kind of transaxle fluid to use. See "Recommended Fluids and Lubricants" in the Index.

If the fluid level is low, add only enough of the proper fluid to bring the level into the cross-hatched area on the dipstick. It doesn't take much fluid, generally less than a pint. Don't overfill. We recommend you use only fluid labeled DEXRON®-IIE, because fluids with that label are made especially for your automatic transaxle. Damage caused by fluid other than DEXRON®-IIE is not covered by your new vehicle warranty.

- After adding fluid, recheck the fluid level as described under "How to Check."

- When the correct fluid level is obtained, push the dipstick back in all the way.

### How To Reset Transaxle Fluid Change Indicator: 4.6L (Northstar)

Your vehicle is equipped with a transaxle fluid change indicator. A “CHANGE TRANS FLUID” message will display on the Information Center when the power train computer determines that the transaxle fluid needs to be changed or at each 100,000 miles (160,000 km) interval, whichever occurs first. When this message appears, change the transaxle fluid and reset the transaxle fluid life indicator as follows:

- Turn the key “ON” with the engine stopped.
- Press and hold the “OFF” and “REAR DEFOG” buttons on the climate control simultaneously until the “TRANS FLUID RESET” message appears in the Information Center (between 5 and 20 seconds).

## ***ENGINE COOLANT***

The following explains your cooling system and how to add coolant when it is low. If you have a problem with engine overheating, see “Engine Overheating” in the Index.

The proper coolant for your Cadillac will:

- Give freezing protection down to  $-34^{\circ}\text{F}$  ( $-37^{\circ}\text{C}$ ).
- Give boiling protection up to  $262^{\circ}\text{F}$  ( $128^{\circ}\text{C}$ ).
- Protect against rust and corrosion.
- Help keep the proper engine temperature.
- Let the warning lights work as they should.

### **What to Use:**

Use a mixture of one-half clean water (preferably distilled) and one-half antifreeze that meets “GM Specification 1825-M,” which won’t damage aluminum parts. You can also use a recycled coolant conforming to GM Specification 1825-M with a complete coolant flush and refill. Use GM Engine Coolant Supplement (sealer) with any complete coolant change. If you use these, you don’t need to add anything else.



## CAUTION:

Adding only plain water to your cooling system can be dangerous. Plain water, or some other liquid like alcohol, can boil before the proper coolant mix will. Your vehicle's coolant warning system is set for the proper coolant mix. With plain water or the wrong mix, your engine could get too hot but you wouldn't get the overheat warning. Your engine could catch fire and you or others could be burned. Use a 50/50 mix of clean water and a proper antifreeze.

## NOTICE:

If you use an improper coolant mix, your engine could overheat and be badly damaged. The repair cost wouldn't be covered by your warranty. Too much water in the mix can freeze and crack the engine, radiator, heater core and other parts.

### *Adding Coolant*



4.6 Liter (Northstar)

#### To Check Coolant

When your engine is cold, the coolant level should be at "FULL COLD", or a little higher.

When your engine is warm and the “ENGINE COOLANT LOW” message does not appear on the Driver Information Center, coolant is at the proper fill level.



4.9 Liter

**To Check Coolant:** When your engine is cold, the coolant level should be at “FULL COLD,” or a little higher. When your engine is warm, the level should be up to “FULL HOT,” or a little higher.

**To Add Coolant 4.9L:** If you need more coolant, add the proper mix at the coolant recovery tank.

 **CAUTION:**

**Turning the radiator pressure cap when the engine and radiator are hot can allow steam and scalding liquids to blow out and burn you badly. With the coolant recovery tank, you will almost never have to add coolant at the radiator. Never turn the radiator pressure cap -- even a little -- when the engine and radiator are hot.**

Add coolant mix at the recovery tank, but be careful not to spill it.



### **CAUTION:**

**You can be burned if you spill coolant on hot engine parts. Coolant contains ethylene glycol, and it will burn if the engine parts are hot enough. Don't spill coolant on a hot engine.**

**To Add Coolant 4.6L (Northstar):** If you need more coolant, add the proper mix at the coolant surge tank.



### **CAUTION:**

**Turning the surge tank pressure cap when the engine and radiator are hot can allow steam and scalding liquids to blow out and burn you badly. Never turn the surge tank pressure cap -- even a little -- when the engine and radiator are hot.**

**You can be burned if you spill coolant on hot engine parts. Coolant contains ethylene glycol, and it will burn if the engine parts are hot enough. Don't spill coolant on a hot engine.**

**To Check or Add Coolant:** When the engine is cold, the coolant level should be at "FULL COLD," or a little higher. Remove the pressure cap from the surge tank; use a flashlight as necessary to see into the tank. The coolant level should be at or above the seam inside the tank.

If you need more coolant, add the proper mix.

## ***RADIATOR OR SURGE TANK PRESSURE CAP***

### **NOTICE:**

**Your radiator or surge tank cap is a 15 psi (105 kPa) pressure-type cap and must be tightly installed to prevent coolant loss and possible engine damage from overheating. Be sure the arrows on the cap line up with the overflow tube on the filler neck.**

When you replace your radiator or surge tank pressure cap, an AC® cap is recommended.

## ***THERMOSTAT***

Engine coolant temperature is controlled by a thermostat in the engine coolant system. The thermostat stops the flow of coolant through the radiator until the coolant reaches a preset temperature.

When you replace your thermostat, an AC® thermostat is recommended.

## ***POWER STEERING FLUID***

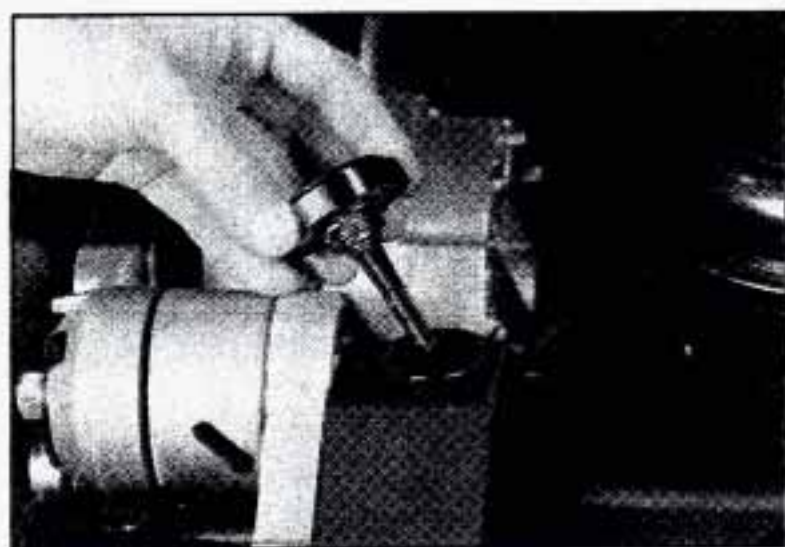

4.9 Liter



4.6 Liter (Northstar)

### How To Check Power Steering Fluid:

Unscrew the cap and wipe the dipstick with a clean rag. Replace the cap and completely tighten it. Then remove the cap again and look at the fluid level on the dipstick.

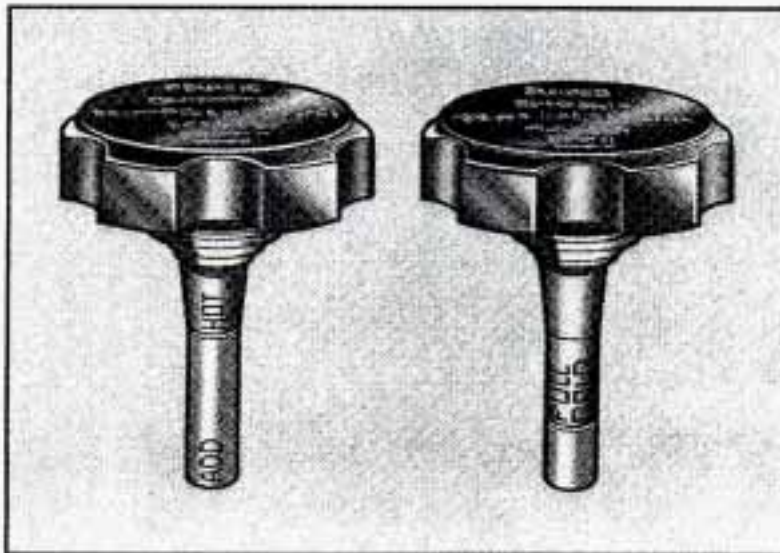

- When the engine compartment is hot, the level should be at the "HOT" mark.
- When the engine compartment is cool, the level should be at the "FULL COLD" mark.

**What to Add:**

Refer to the Maintenance Schedule to determine what kind of fluid to use. See "Recommended Fluids and Lubricants" in the Index.

**NOTICE:**

**When adding power steering fluid or making a complete fluid change, always use the proper fluid. Failure to use the proper fluid can cause leaks and damage hoses and seals.**

***WINDSHIELD WASHER FLUID*****To Add:**

Open the cap labeled "WASHER FLUID ONLY." Add washer fluid until the bottle is full.

## **NOTICE:**

- **When using concentrated washer fluid, follow the manufacturer's instructions for adding water.**
- **Don't mix water with ready-to-use washer fluid. Water can cause the solution to freeze and damage your washer fluid tank and other parts of the washer system. Also, water doesn't clean as well as washer fluid.**
- **Fill your washer fluid tank only 3/4 full when it's very cold. This allows for expansion, which could damage the tank if it is completely full.**
- **Don't use radiator antifreeze in your windshield washer. It can damage your paint.**

## ***HEADLIGHT WASHER FLUID (EXPORT ONLY)***

**To Add:**



Open the cap labeled "WASHER FLUID ONLY." Add windshield washer fluid until the bottle is full.

## **NOTICE:**

- **When using concentrated washer fluid, follow the manufacturer instructions for adding water.**
- **Don't mix water with ready to use washer fluid. Water can cause the solution to freeze and damage your washer fluid tank and other parts of the washer system. Also, water doesn't clean as well as washer fluid.**
- **Fill your washer fluid tank only 3/4 full when it's very cold. This allows for expansion, which could damage the tank if it is completely full.**
- **Don't use radiator antifreeze in your windshield washer. It can damage your paint.**

## ***BRAKE MASTER CYLINDER***

Your brake master cylinder is here. It is filled with DOT-3 brake fluid.



4.9 Liter





4.6 Liter (Northstar)

There are only two reasons why the brake fluid level in your master cylinder might go down. The first is that the brake fluid goes down to an acceptable level during normal brake lining wear. When new linings are put in, the fluid level goes back up. The other reason is that fluid is leaking out of the brake system. If it is, you should have your brake system fixed, since a leak means that sooner or later your brakes won't work well, or won't work at all. So, it isn't a good idea to "top off" your brake fluid. Adding brake fluid won't correct a leak. If you add fluid when your linings are worn, then you'll have too much fluid when you get new brake linings. You should add (or remove) brake fluid, as necessary, only when work is done on the brake hydraulic system.

**⚠ CAUTION:**

**If you have too much brake fluid, it can spill on the engine. The fluid will burn if the engine is hot enough. You or others could be burned, and your vehicle could be damaged. Add brake fluid only when work is done on the brake hydraulic system.**

When your brake fluid falls to a low level, the "CHECK BRAKE FLUID" message will display on the Driver Information center and your brake warning light will come on. See "Brake System Warning Light" in the Index.

## ***To Check Brake Fluid: 4.9 Liter***

Remove the cap.

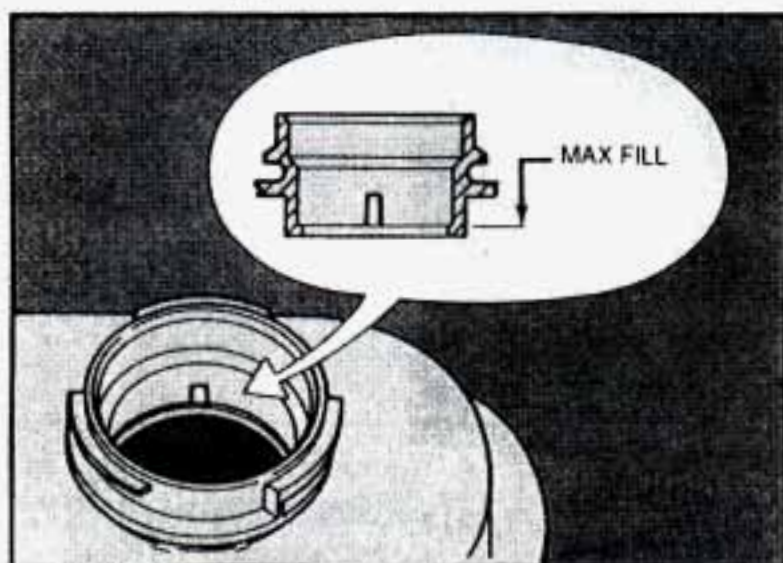

The fluid level must be to the "MAX FILL" line at the base of the neck as shown.

## ***To Check Brake Fluid: 4.6 Liter (Northstar)***

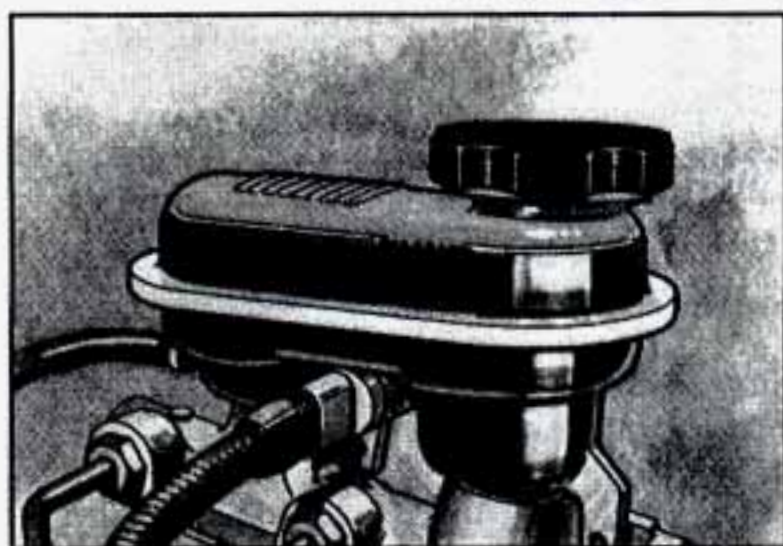

You can check the brake fluid without taking off the cap. Just look at the indicators on the brake fluid reservoir. The fluid levels should be above "MIN." If they aren't, have your brake system checked to see if there is a leak.

After work is done on the brake hydraulic system, make sure the level is above "MIN" and or slightly below or at the "MAX" indicator.

## ***What to Add:***

When you do need brake fluid, use only DOT-3 brake fluid -- such as Delco Supreme 11® (GM Part No.1052535). Use new brake fluid from a sealed container only.

### **NOTICE:**

- **DOT-5 silicone brake fluid can damage your vehicle. Don't use it.**
- **Don't let someone put in the wrong kind of fluid. For example, just a few drops of mineral-based oil, such as engine oil, in your brake system can damage brake system parts so badly that they'll have to be replaced.**
- **Brake fluid can damage paint, so be careful not to spill brake fluid on your vehicle.**

## ***REPLACING BRAKE SYSTEM PARTS***

The braking system on a modern vehicle is complex. Its many parts have to be of top quality and work well together if the vehicle is to have really good braking. Vehicles we design and test have top-quality GM brake parts in them, as your Cadillac does when it is new. When you replace parts of your braking system -- for example, when your brake linings wear down and you have to have new ones put in -- be sure you get new genuine GM replacement parts. If you don't, your brakes may no longer work properly. For example, if someone puts in brake linings that are wrong for your vehicle, the balance between your front and rear brakes can change, for the worse. The braking performance you've come to expect can change in many other ways if someone puts in the wrong replacement brake parts.

## ***BATTERY***

Every new Cadillac has a Delco Freedom® battery. You never have to add water to one of these. When it's time for a new battery, we recommend a Delco Freedom® battery. Get one that has the catalog number shown on the original battery's label.

## *Vehicle Storage*

If you're not going to drive your vehicle for 25 days or more, take off the black, negative (-) cable from the battery. This will help keep your battery from running down.



### **CAUTION:**

**Batteries have acid that can burn you and gas that can explode. You can be badly hurt if you aren't careful. See "Jump Starting" in the Index for tips on working around a battery without getting hurt.**

Contact your dealer to learn how to prepare your vehicle for longer storage periods.

## *Battery Power Loss*

If you lose battery power or the battery is disconnected, your car's computer must be programmed. It takes just over 20 minutes to do it. If you want to do it yourself, here's how:

- Apply the parking brake.
- Make sure the front wheels are straight.
- Turn off the Electronic Climate Control.
- Start the engine in "P" (Park) and let it idle for 15 minutes. Then:
- Put your foot on the brake pedal, shift the transaxle to Ⓓ and let it idle for 3 minutes or more. Do not accelerate the engine. Then:
- With the car in Ⓓ (Drive), turn the Electronic Climate Control to "Auto" and let the engine idle for 3 minutes or more.
- Turn your engine off.

Now your computer is programmed.

## ***HALOGEN BULBS***

### **⚠ CAUTION:**

Halogen bulbs have pressurized gas inside and can burst if you drop or scratch the bulb. You or others could be injured. Take special care when handling and disposing of halogen bulbs.

## ***LAMP HOUSINGS***

Your Cadillac's lamp housings are designed with small vents so moisture will be removed when the lights are on, or after driving for a short time.

## ***HEADLIGHT BULB REMOVAL***

The following procedure tells you how to remove the halogen headlight bulb. Follow either the EXPORT or DOMESTIC illustration that best describes your vehicle.

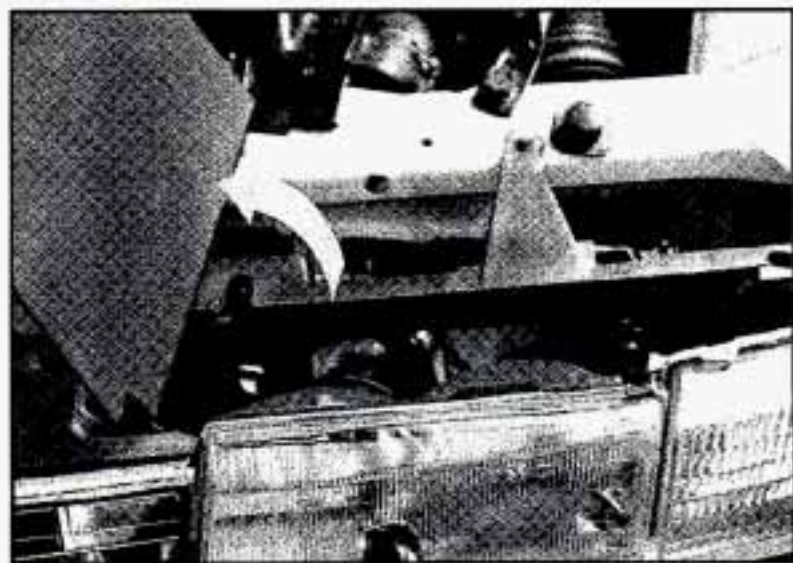

Lift the cover up to gain access.

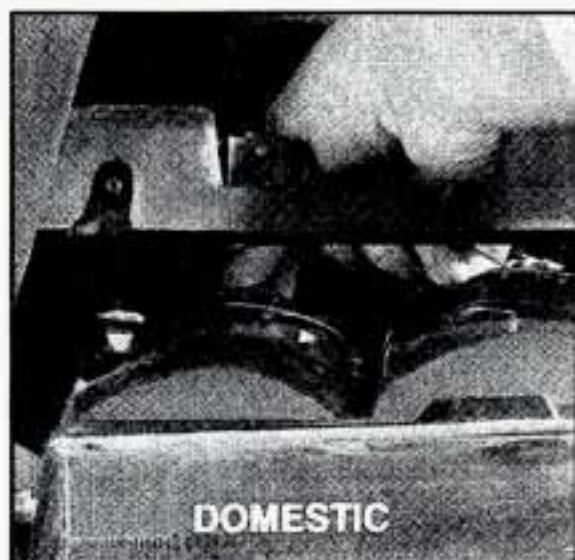

**DOMESTIC** - Turn the headlight housing socket counterclockwise to unlock socket from lamphousing.

**EXPORT** - Remove the rubber plug cover and remove plug.

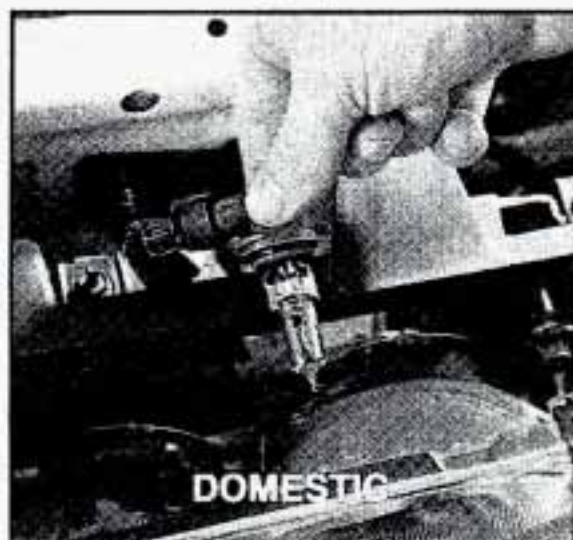

**DOMESTIC** - Remove headlight housing socket.

**EXPORT** - Remove both retaining lock clips securing bulb assembly in headlamp housing.



**DOMESTIC** - Remove the wiring harness from the headlight housing socket

**EXPORT** - Remove the headlight bulb and socket from the headlamp assembly.

**DOMESTIC** - Replace the bulb and socket and connect the wiring harness. Reinstall the headlight housing socket into the headlamp assembly.

**EXPORT** - Install new headlight bulb and socket into headlamp assembly.

### **NOTICE:**

**Do not touch glass portion of the new halogen bulb! The oil from your fingers will shorten the life of your new halogen bulb.**

## ***TAILLIGHT BULB REPLACEMENT***

Taillight bulb replacement is the same for either STS or Seville .

1. Open the trunk to gain access to the taillight housing.



2. Remove the plastic trim retainer screws and pull back the trim material.

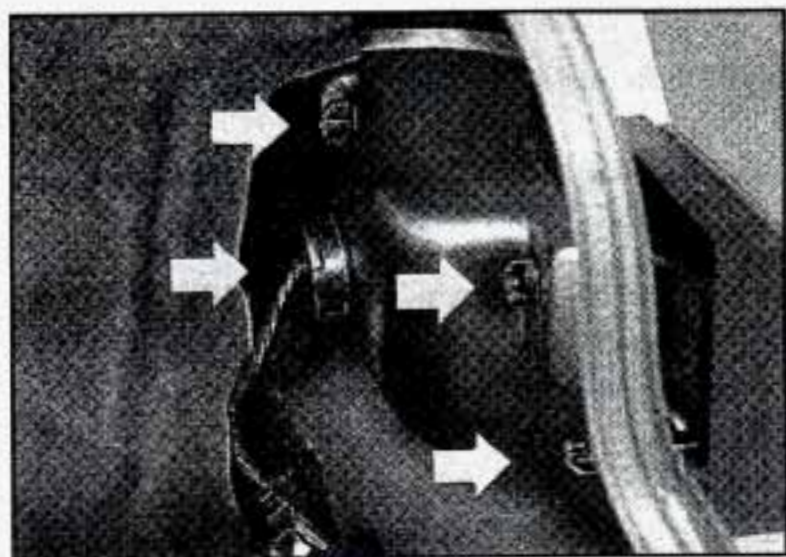

3. Remove the four wing nuts.
4. Gently remove the taillight housing.



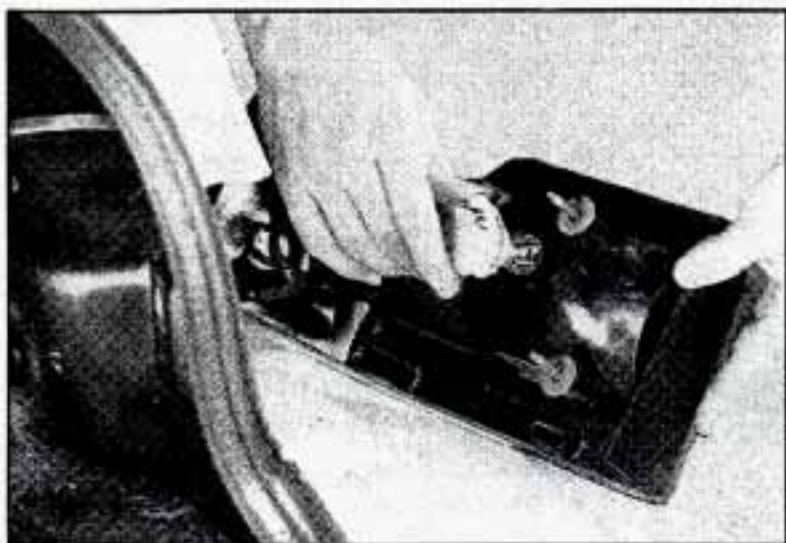

5. Press the bulb housing lever, rotate the housing counterclockwise and remove it. Push and rotate the bulb counterclockwise to remove bulb.

Once you have replaced the burned out bulb, just reverse the steps to reassemble the taillight.

## ***WIPER BLADE REPLACEMENT***

Position the windshield wipers on the windshield in the “mid” wiper position. To do this, turn the ignition key to Accessory and turn the wipers on. Then with the door open, turn the ignition key to off.

Start with the driver side wiper blade assembly.

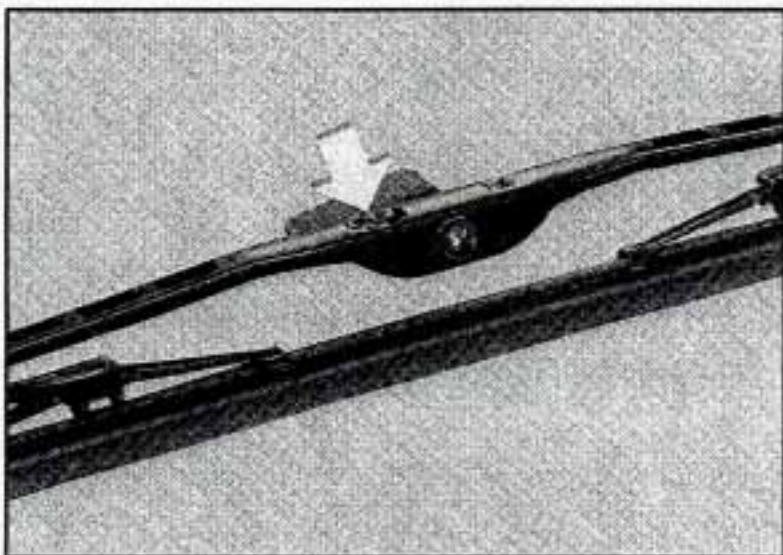

Using a small screwdriver or your finger, gently lift the release lever up while at the same time pulling the blade assembly from the wiper arm.

Do the same with the passenger side wiper blade assembly.

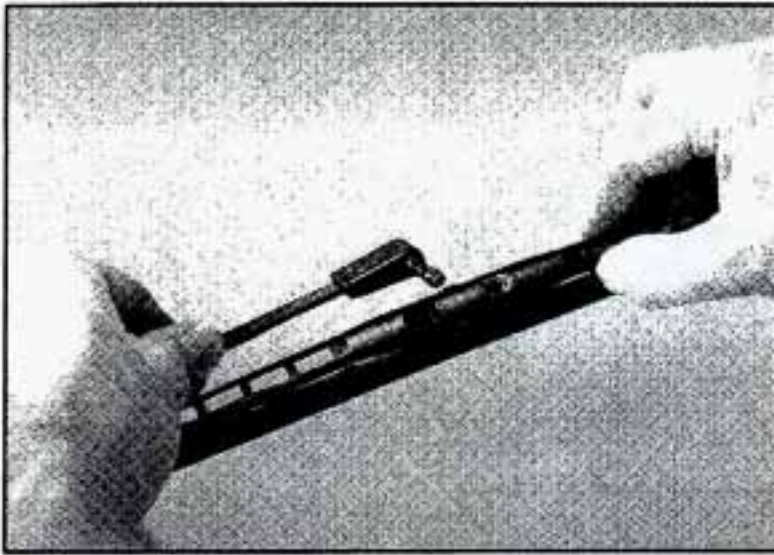

To install the wiper blade, align the wiper arm pin with the hole on the wiper blade assembly and snap it into place.

The arrow on the wiper blade are to point towards the wiper arm.

If you only want to replace the wiper inserts follow these steps:



1. Disconnect the wiper insert by bending the end of the insert gently using pliers. Then pull it from the blade housing retaining tab.
2. Now pull the insert from the blade housing.

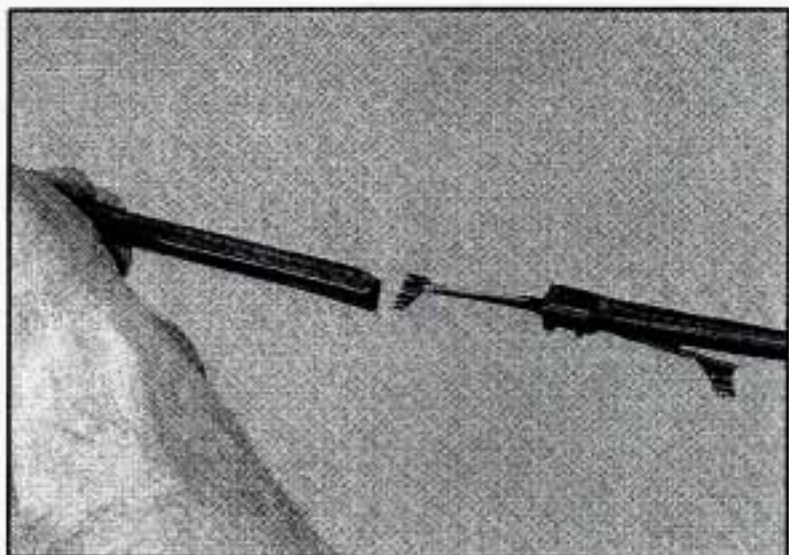

3. Reinstall the new insert by aligning the blade housing tabs and the edge of the insert. Make sure that the insert is connected to all the housing tabs.
4. Install the wiper blade assembly to the wiper arm.

## ***AIR CLEANER FILTER REPLACEMENT (4.6 LITER NORTHSTAR)***

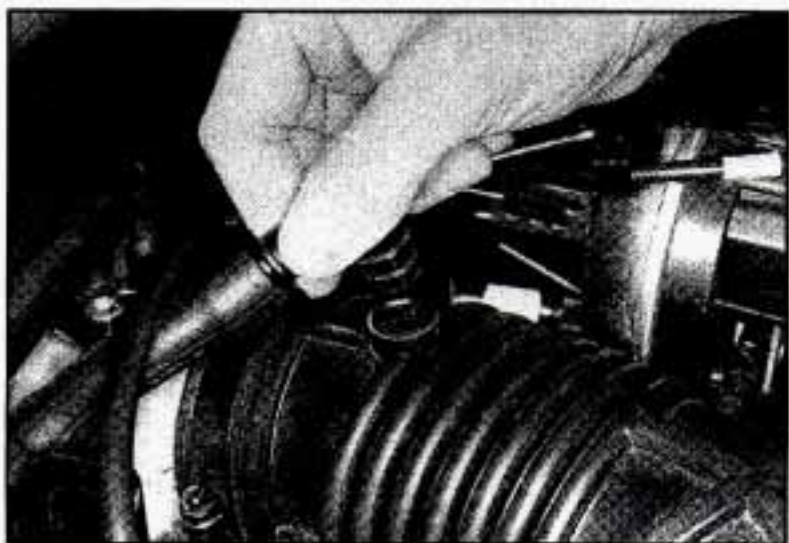

Remove the crankcase vent tube from top of the air duct.

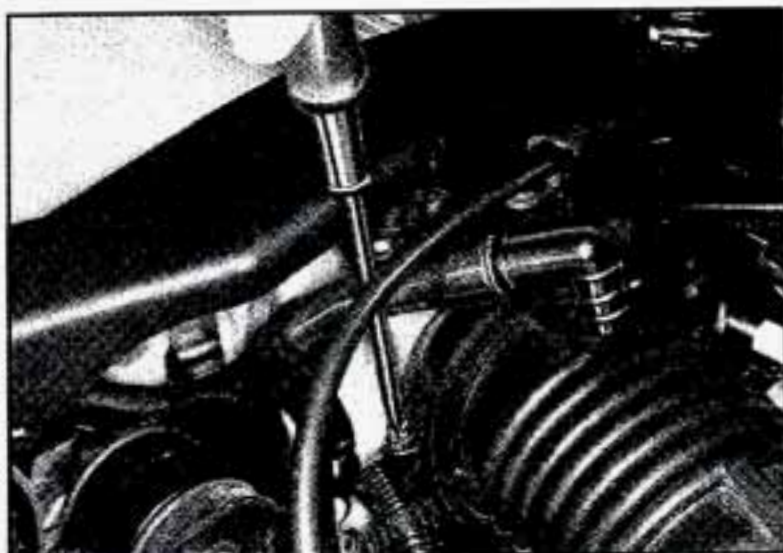

Loosen clamp at the throttle body and disconnect air duct from the throttle body.

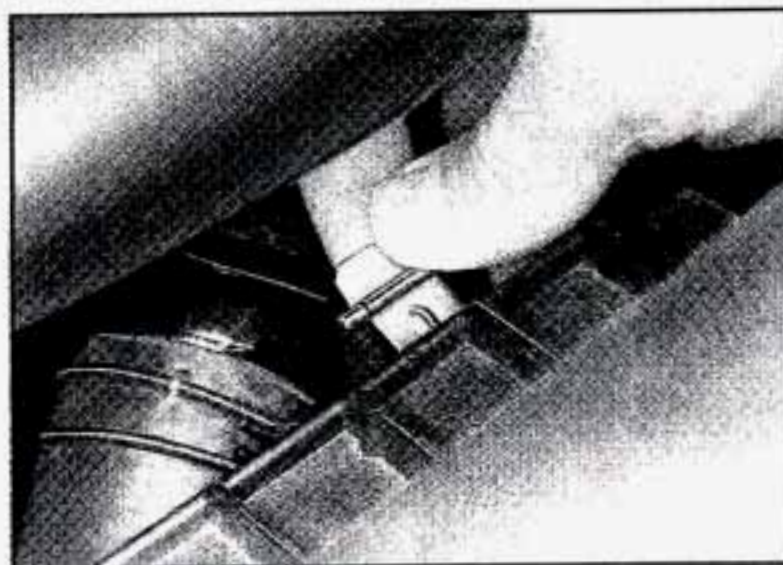

Unlatch clamp and gently remove air cleaner from the vehicle.

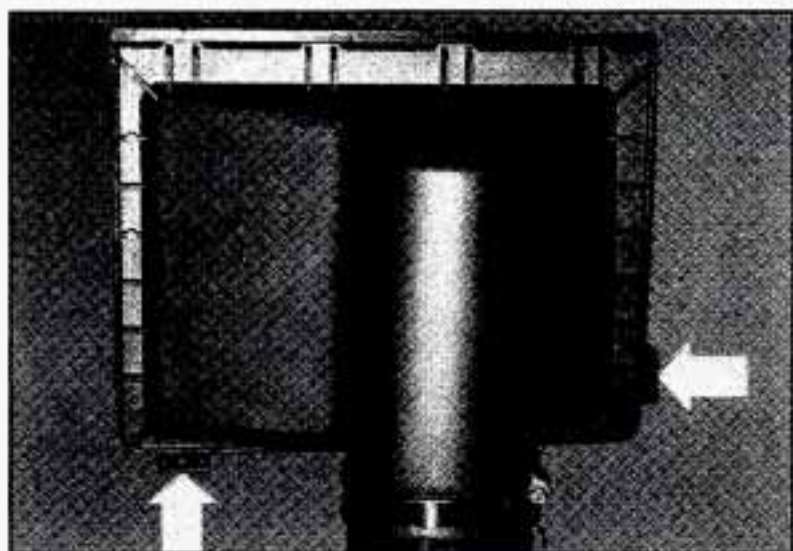

Push the two tabs and pivot the top half to separate the air cleaner.

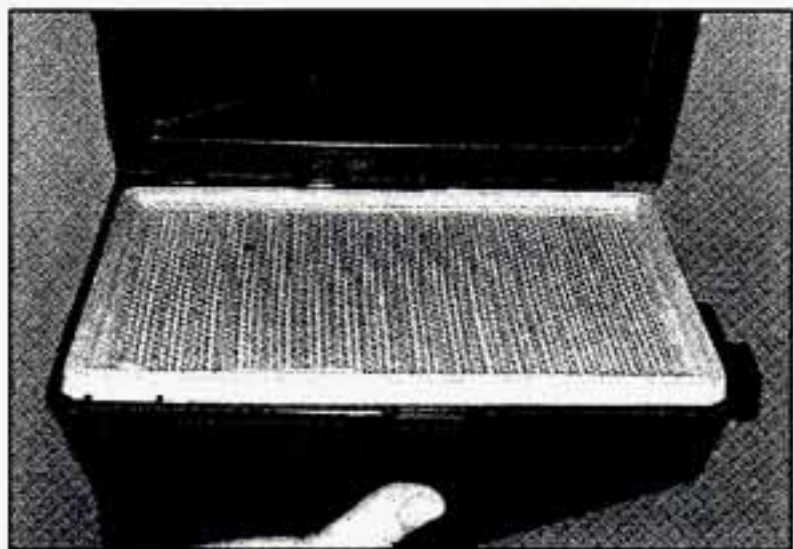

Once you have replaced the air cleaner filter, reverse the steps to reassemble and install back into your vehicle.

## ***LOADING YOUR VEHICLE***



### **TIRE-LOADING INFORMATION**

**OCCUPANTS      VEHICLE CAP. WT.**

**FRT.    CTR.    RR.    TOTAL    LBS.    KG**

**MAX. LOADING & GVWR SAME AS VEHICLE**

**CAPACITY WEIGHT      XXX      COLD TIRE**

**TIRE SIZE              SPEED      PRESSURE**

**RTG      PSI/KPa**

**FRT.**

**RR.**

**SPA.**

**IF TIRES ARE HOT. ADD 4PSI/28KPa SEE**

**OWNER'S MANUAL FOR ADDITIONAL**

**INFORMATION**

**GEN GME**

Two labels on your vehicle show how much weight it may properly carry. The Tire-Loading Information label found on the driver's door tells you the proper size, speed rating and recommended inflation pressures for the tires on your vehicle. It also gives you important information about the number of people that can be in your vehicle and the total weight that you can carry. This weight is called the Vehicle Capacity Weight and includes the weight of all occupants, cargo, and all nonfactory-installed options.



MFD BY GENERAL MOTORS CORP  
DATE GVWR GAWR FRT GAWR RR

THIS VEHICLE CONFORMS TO ALL APPLICABLE U.S. FEDERAL MOTOR VEHICLE SAFETY, BUMPER, AND THEFT PREVENTION STANDARDS IN EFFECT ON THE DATE OF MANUFACTURE SHOWN ABOVE.

**GEN GME**

The other label is the Certification label, found on the rear edge of the driver's door. It tells you the gross weight capacity of your vehicle, called the GVWR (Gross Vehicle Weight Rating). The GVWR includes the weight of the vehicle, all occupants, fuel and cargo. Never exceed the GVWR for your vehicle, or the Gross Axle Weight Rating (GAWR) for either the front or rear axle.

And, if you do have a heavy load, you should spread it out. Don't carry more than 176 lbs. (80 kg) in your trunk .



### **CAUTION:**

**Do not load your vehicle any heavier than the GVWR or the maximum front and rear GAWRs. If you do, parts on your vehicle can break, or it can change the way your vehicle handles. These could cause you to lose control. Also, overloading can shorten the life of your vehicle.**

### **NOTICE:**

**Your warranty does not cover parts or components that fail because of overloading.**

If you put things inside your vehicle -- like suitcases, tools, packages, or anything else -- they will go as fast as the vehicle goes. If you have to stop or turn quickly, or if there is a crash, they'll keep going.



### **CAUTION:**

**Things you put inside your vehicle can strike and injure people in a sudden stop or turn, or in a crash.**

- **Put things in the trunk of your vehicle.**

**In a trunk, put them as far forward as you can. Try to spread the weight evenly.**

- **Never stack heavier things, like suitcases, inside the vehicle so that some of them are above the tops of the seats.**
- **When you carry something inside the vehicle, secure it whenever you can.**
- **Don't leave a seat folded down unless you need to.**

## ***TIRES***

We don't make tires. Your new vehicle comes with high quality tires made by a leading tire manufacturer. These tires are warranted by the tire manufacturers and their warranties are delivered with every new Cadillac. If your spare tire is a different brand than your road tires, you will have a tire warranty folder from each of these manufacturers.





## **CAUTION:**

**Poorly maintained and improperly used tires are dangerous.**

- **Overloading your tires can cause overheating as a result of too much friction. You could have an air-out and a serious accident. See “Loading Your Vehicle” in the Index.**
- **Underinflated tires pose the same danger as overloaded tires. The resulting accident could cause serious injury. Check all tires frequently to maintain the recommended pressure. Tire pressure should be checked when your tires are cold.**
- **Overinflated tires are more likely to be cut, punctured, or broken by a sudden impact, such as when you hit a pothole. Keep tires at the recommended pressure.**
- **Worn, old tires can cause accidents. If your tread is badly worn, or if your tires have been damaged, replace them.**

**See “Inflation - Tire Pressure” in this section for inflation pressure adjustment for higher speed driving.**

### ***Inflation - Tire Pressure***

The Tire-Loading Information label which is located on the driver's door shows the correct inflation pressures for your tires, when they're cold. “Cold” means your vehicle has been sitting for at least three hours or driven no more than a mile.

If you'll be driving at speeds higher than 100 mph (160 km/h) where it is legal, raise the “cold” inflation pressure of each tire to 35 psi (240 kPa). When you end this very high speed driving, reduce the “cold” inflation pressures to those listed on the Tire-Loading Information label. Never inflate the tires higher than the maximum “cold” inflation pressures stated on the sidewall of the tires.

## **NOTICE:**

**Don't let anyone tell you that underinflation or overinflation is all right. It's not. If your tires don't have enough air (underinflation) you can get:**

- **Too much flexing**
- **Too much heat**
- **Tire overloading**
- **Bad wear**
- **Bad handling**
- **Bad fuel economy.**

**If your tires have too much air (overinflation), you can get:**

- **Unusual wear**
- **Bad handling**
- **Rough ride**
- **Needless damage from road hazards.**

**When to Check:** Check your tires once a month or more.

The Seville tire pressures are:

- Front - 28 psi (200 kPa)
- Rear - 26 psi (179 kPa)

Seville recommended tire size is:

- XGT4 Touring Design Blackwall (P225/60R16)

The STS tire pressures are:

- Front - 29 psi (200 kPa)
- Rear - 29 psi (200 kPa)

STS recommended tire size is:

- GA Performance Blackwall (P225/60ZR16)

Don't forget your compact spare tire. It should be at 60 psi (420 kPa).

**How to Check:** Use a good quality pocket-type gage to check tire pressure. Simply looking at the tires will not tell you the pressure, especially if you have radial tires -- which may look properly inflated even if they're underinflated.

If your tires have valve caps, be sure to put them back on. They help prevent leaks by keeping out dirt and moisture.

### *Tire Inspection and Rotation*

To make your tires last longer, have them inspected and rotated at the mileages recommended in the Maintenance Schedule. See "Scheduled Maintenance Services" in the Index.

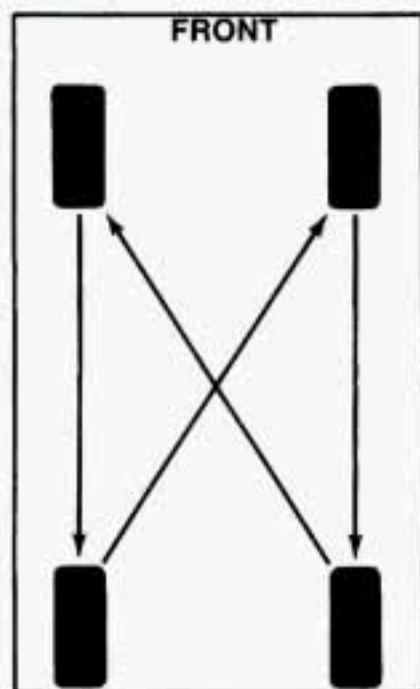

Use this rotation pattern.

After the tires have been rotated, adjust the front and rear inflation pressure as shown on the Tire-Loading Information label. Make certain that all wheel nuts are properly tightened. See "Wheel Nut Torque" in the Index.

## CAUTION:

Rust or dirt on a wheel, or on the parts to which it is fastened, can make wheel nuts become loose after a time. The wheel could come off and cause an accident. When you change a wheel, remove any rust or dirt from places where the wheel attaches to the vehicle. In an emergency, you can use a cloth or a paper towel to do this; but be sure to use a scraper or wire brush later, if you need to, to get all the rust or dirt off. (See “Changing a Flat Tire” in the Index.)

### *When It's Time for New Tires*

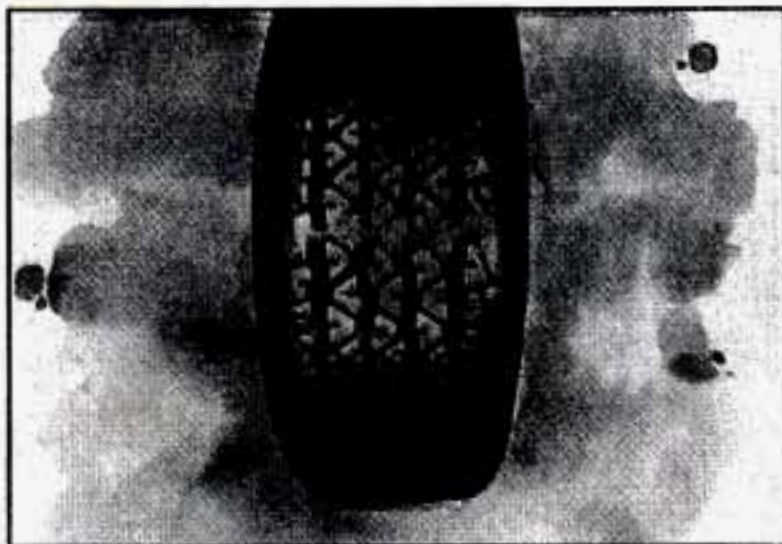

One way to tell when it's time for new tires is to check the treadwear indicators, which will appear when your tires have only  $\frac{2}{32}$  inch (1.6 mm) or less of tread remaining.

You need a new tire if:

- You can see the indicators at three places around the tire.
- You can see cord or fabric showing through the tire's rubber.
- The tread or sidewall is cracked, cut or snagged deep enough to show cord or fabric.
- The tire has a bump, bulge or split.
- The tire has a puncture, cut, or other damage that can't be repaired well because of the size or location of the damage.

## ***Buying New Tires***

To find out what kind and size of tires you need, look at the Tire-Loading Information label.

The tires installed on your vehicle when it was new had a Tire Performance Criteria Specification (TPC Spec) number on each tire's sidewall. When you get new tires, get ones with that same TPC Spec number. That way, your vehicle will continue to have tires that are designed to give proper endurance, handling, speed rating, traction, ride and other things during normal service on your vehicle. If your tires have an all-season tread design, the TPC number will be followed by a "MS" (for mud and snow).

If you ever replace your tires with those not having a TPC Spec number, make sure they are the same size, load range, speed rating and construction type (bias, bias-belted or radial) as your original tires.



### **CAUTION:**

**Mixing tires could cause you to lose control while driving. If you mix tires of different sizes or types (radial and bias-belted tires), the vehicle may not handle properly, and you could have a crash. Be sure to use the same size and type tires on all four wheels.**

**It's all right to drive with your compact spare, though. It was developed for use on your vehicle.**

## ***Uniform Tire Quality Grading***

The following information relates to the system developed by the United States National Highway Traffic Safety Administration which grades tires by treadwear, traction and temperature performance. (This applies only to vehicles sold in the United States.)

## ***Treadwear***

The treadwear grade is a comparative rating based on the wear rate of the tire when tested under controlled conditions on a specified government test course. For example, a tire graded 150 would wear one and a half (1 1/2) times as well on the government course as a tire graded 100. The relative performance of tires depends upon the actual conditions of their use, however, and may depart significantly from the norm due to variations in driving habits, service practices and differences in road characteristics and climate.

## ***Traction - A, B, C***

The traction grades, from highest to lowest are: A, B, and C. They represent the tire's ability to stop on wet pavement as measured under controlled conditions on specified government test surfaces of asphalt and concrete. A tire marked C may have poor traction performance.

**Warning:** The traction grade assigned to this tire is based on braking (straight-ahead) traction tests and does not include cornering (turning) traction.

## ***Temperature - A, B, C***

The temperature grades are A (the highest), B, and C, representing the tire's resistance to the generation of heat and its ability to dissipate heat when tested under controlled conditions on a specified indoor laboratory test wheel. Sustained high temperature can cause the material of the tire to degenerate and reduce tire life, and excessive temperature can lead to sudden tire failure. The grade C corresponds to a level of performance which all passenger car tires must meet under the Federal Motor Vehicle Safety Standard No. 109. Grades B and A represent higher levels of performance on the laboratory test wheel than the minimum required by law.

**Warning:** The temperature grade for this tire is established for a tire that is properly inflated and not overloaded. Excessive speed, underinflation, or excessive loading, either separately or in combination, can cause heat buildup and possible tire failure.

Those grades are molded on the sidewalls of passenger car tires.

While the tires available as standard or optional equipment on General Motors vehicles may vary with respect to these grades, all such tires meet General Motors performance standards and have been approved for use on General Motors vehicles. All passenger type (P Metric) tires must conform to Federal safety requirements in addition to these grades.

### ***Wheel Alignment and Tire Balance***

The wheels on your vehicle were aligned and balanced carefully at the factory to give you the longest tire life and best overall performance.

In most cases, you will not need to have your wheels aligned again. However, if you notice unusual tire wear or your vehicle pulling one way or the other, the alignment may need to be reset. If you notice your vehicle vibrating when driving on a smooth road, your wheels may need to be rebalanced.

### ***Wheel Replacement***

Replace any wheel that is bent, cracked or badly rusted. If wheel nuts keep coming loose, the wheel, wheel bolts, and wheel nuts should be replaced. If the wheel leaks air out, replace it (except some aluminum wheels, which can sometimes be repaired). See your Cadillac dealer if any of these conditions exist.

Your dealer will know the kind of wheel you need.

Each new wheel should have the same load carrying capacity, diameter, width, offset, and be mounted the same way as the one it replaces.

If you need to replace any of your wheels, wheel bolts, or wheel nuts, replace them only with new GM original equipment parts. This way, you will be sure to have the right wheel, wheel bolts, and wheel nuts for your Cadillac model.

#### **CAUTION:**

**Using the wrong replacement wheels, wheel bolts, or wheel nuts on your vehicle can be dangerous. It could affect the braking and handling of your vehicle, make your tires lose air and make you lose control. You could have a collision in which you or others could be injured. Always use the correct wheel, wheel bolts, and wheel nuts for replacement.**

## **NOTICE:**

The wrong wheel can also cause problems with bearing life, brake cooling, speedometer/odometer calibration, headlight aim, bumper height, vehicle ground clearance, and tire or tire chain clearance to the body and chassis.

### Used Replacement Wheels



## **CAUTION:**

Putting a used wheel on your vehicle is dangerous. You can't know how it's been used or how many miles it's been driven. It could fail suddenly and cause an accident. If you have to replace a wheel use a new GM original equipment wheel.

### *Tire Chains*

## **NOTICE:**

Use tire chains only when you must. Use only SAE Class "S" type chains that are the proper size for your tires. Install them on the front tires and tighten them as tightly as possible with the ends securely fastened. Drive slowly and follow the chain manufacturer's instructions. If you can hear the chains contacting your vehicle, stop and retighten them. If the contact continues, slow down until it stops. Driving too fast with chains on will damage your vehicle.



## *APPEARANCE CARE*



### **CAUTION:**

Cleaning products can be hazardous. Some are toxic. Others can burst into flame if you strike a match or get them on a hot part of the vehicle. Some are dangerous if you breathe their fumes in a closed space. When you use anything in a container to clean your Cadillac, be sure to follow the instructions. And always open your doors or windows when you're cleaning the inside.

Never use these to clean your vehicle:

- Gasoline
- Benzene
- Naphtha
- Carbon Tetrachloride
- Acetone
- Paint Thinner
- Turpentine
- Lacquer Thinner
- Nail Polish Remover

They can all be hazardous -- some more than others -- and they can all damage your vehicle, too.

## **NOTICE:**

**Don't use any of these unless this manual says you can. In many uses, they will damage your vehicle:**

- **Laundry Soap**
- **Bleach**
- **Reducing Agents**

## ***CLEANING THE INSIDE OF YOUR CADILLAC***

Use a vacuum cleaner often to get rid of dust and loose dirt. Wipe vinyl with a clean, damp cloth.

Your Cadillac dealer has two GM cleaners -- a solvent-type spot lifter and a foam-type powdered cleaner. They will clean normal spots and stains very well.

Here are some cleaning tips:

- Always read the instructions on the cleaner label.
- Clean up stains as soon as you can -- before they set.
- Use a clean cloth or sponge, and change to a clean area often. A soft brush may be used if stains are stubborn.
- Use solvent-type cleaners in a well-ventilated area only. If you use them, don't saturate the stained area.
- If a ring forms after spot cleaning, clean the entire area immediately or it will set.

## ***USING FOAM-TYPE CLEANER ON FABRIC***

- Vacuum and brush the area to remove any loose dirt.
- Always clean a whole trim panel or section. Mask surrounding trim along stitch or welt lines.
- Mix Multi-Purpose Powdered Cleaner following the directions on the container label.
- Use suds only and apply with a clean sponge.
- Don't saturate the material.
- Don't rub it roughly.
- As soon as you've cleaned the section, use a sponge to remove the suds.
- Rinse the section with a clean, wet sponge.
- Wipe off what's left with a slightly damp paper towel or cloth.
- Then dry it immediately with an air hose, a hair dryer or a heat lamp.

### **NOTICE:**

**Be careful with a hair dryer or heat lamp. You could scorch the fabric.**

- Wipe with a clean cloth.

## ***USING SOLVENT-TYPE CLEANER ON FABRIC***

First, see if you have to use solvent-type cleaner at all. Some spots and stains will clean off better with just water and mild soap.

If you need to use it, then

- Gently scrape excess soil from the trim material with a clean, dull knife or scraper. Use very little cleaner, light pressure and clean cloths (preferably cheesecloth). Cleaning should start at the outside of the

stain, “feathering” toward the center. Keep changing to a clean section of the cloth.

- When you clean a stain from fabric, immediately dry the area with an air hose, hair dryer, or heat lamp to help prevent a cleaning ring. (See the previous NOTICE.)

## ***SPECIAL CLEANING PROBLEMS***

**Greasy or Oily Stains:** Like grease, oil, butter, margarine, shoe polish, coffee with cream, chewing gum, cosmetic creams, vegetable oils, wax crayon, tar and asphalt.

- Carefully scrape off excess stain.
- Then follow the solvent-type instructions above.
- Shoe polish, wax crayon, tar and asphalt will stain if left on a vehicle seat fabric. They should be removed as soon as possible. Be careful, because the cleaner will dissolve them and may cause them to bleed.

**Non-Greasy Stains:** Like catsup, coffee (black), egg, fruit, fruit juice, milk, soft drinks, wine, vomit, urine and blood.

- Carefully scrape off excess stain, then sponge the soiled area with cool water.
- If a stain remains, follow the foam-type instructions above.
- If an odor lingers after cleaning vomit or urine, treat the area with a water/baking soda solution: 1 teaspoon (5 ml) of baking soda to 1 cup (250 ml) of lukewarm water.
- Finally, if needed, clean lightly with solvent-type cleaner.

**Combination Stains:** Like candy, ice cream, mayonnaise, chili sauce and unknown stains.

- Carefully scrape off excess stain, then clean with cool water and allow to dry.
- If a stain remains, clean it with solvent-type cleaner.

## ***CLEANING VINYL OR LEATHER***

Just use warm water and a clean cloth.

- Rub with a clean, damp cloth to remove dirt. You may have to do it more than once.
- Things like tar, asphalt and shoe polish will stain if you don't get them off quickly. Use a clean cloth and solvent-type vinyl/leather cleaner.

## ***CLEANING THE TOP OF THE INSTRUMENT PANEL***

Use only mild soap and water to clean the top surfaces of the instrument panel. Sprays containing silicones or waxes may cause annoying reflections in the windshield and even make it difficult to see through the windshield under certain conditions.

### ***Care of Wood Panels***

- Use a clean cloth moistened in warm soapy water (use mild dish washing soap). Dry the wood immediately with a clean cloth.
- Wood surfaces can be polished using ordinary household furniture polishes. Apply the polish to a clean cloth, then rub the cloth on the wood panel.

## ***CARE OF SAFETY BELTS***

Keep belts clean and dry.



### **CAUTION:**

**Do not bleach or dye safety belts. If you do, it may severely weaken them. In a crash they might not be able to provide adequate protection. Clean safety belts only with mild soap and lukewarm water.**

## ***GLASS***

Glass should be cleaned often. GM Glass Cleaner (GM Part No. 1050427) or a liquid household glass cleaner will remove normal tobacco smoke and dust films.

Don't use abrasive cleaners on glass, because they may cause scratches. Avoid placing decals on the inside rear window, since they may have to be scraped off later. If abrasive cleaners are used on the inside of the rear window, an electric defogger element may be damaged. Any temporary license should not be attached across the defogger grid.

## ***CLEANING THE OUTSIDE OF THE WINDSHIELD AND WIPER BLADES***

If the windshield is not clear after using the windshield washer, or if the wiper blade chatters when running, wax or other material may be on the blade or windshield.

Clean the outside of the windshield with GM Windshield Cleaner, Bon-Ami Powder® (GM Part No. 1050011). The windshield is clean if beads do not form when you rinse it with water.

Clean the blade by wiping vigorously with a cloth soaked in full strength windshield washer solvent. Then rinse the blade with water.

Wiper blades should be checked on a regular basis and replaced when worn.

## ***CLEANING THE OUTSIDE OF YOUR CADILLAC***

The paint finish on your vehicle provides beauty, depth of color, gloss retention and durability.

### ***Washing Your Vehicle***

The best way to preserve your vehicle's finish is to keep it clean by washing it often with lukewarm or cold water.

Don't wash your vehicle in the direct rays of the sun. Don't use strong soaps or chemical detergents. Use liquid hand, dish or car washing (non-detergent) soaps. Don't use cleaning agents that contain acid or abrasives. All cleaning agents should be flushed promptly and not allowed to dry on the surface, or they could stain. Dry the finish with a soft, clean chamois or a 100% cotton towel to avoid surface scratches and water spotting.

High pressure car washes may cause water to enter your vehicle.

### ***Finish Care***

Occasional waxing or mild polishing of your Cadillac may be necessary to remove residue from the paint finish. You can get GM approved cleaning products from your dealer. (See "Appearance Care and Materials" in the Index.)

Your Cadillac has a "basecoat/clearcoat" paint finish. The clearcoat gives more depth and gloss to the colored basecoat.

#### **NOTICE:**

**Machine compounding or aggressive polishing on a basecoat/clearcoat paint finish may dull the finish or leave swirl marks.**

## ***ALUMINUM WHEELS***

Don't use chrome polish on your aluminum wheels. Use wax after you clean them. Also, don't use abrasive cleaners or cleaning brushes on them -- you could damage the protective coating.

### **NOTICE:**

**Don't use an automatic vehicle wash that has hard silicon carbide cleaning brushes. These brushes can take off the protective coating.**

## ***WEATHERSTRIPS***

These are places where glass or metal meets rubber. Silicone grease there will make them last longer, seal better, and not squeak. Apply silicone grease with a clean cloth at least every six months.

## ***SHEET METAL DAMAGE***

If your vehicle is damaged and requires sheet metal repair or replacement, make sure the body repair shop applies anti-corrosion material to the parts repaired or replaced to restore corrosion protection.

## ***FOREIGN MATERIAL***

Calcium chloride and other salts, ice melting agents, road oil and tar, tree sap, bird droppings, chemicals from industrial chimneys, and other foreign matter can damage your vehicle's finish if they remain on painted surfaces. Use cleaners that are marked safe for painted surfaces for these stains.



## ***FINISH DAMAGE***

Any stone chips, fractures or deep scratches in the finish should be repaired right away. Bare metal will corrode quickly and may develop into a major repair expense.

Minor chips and scratches can be repaired with touch-up materials available from your dealer or other service outlets. Larger areas of finish damage can be corrected in your dealer's body and paint shop.

## ***UNDERBODY MAINTENANCE***

Chemicals used for ice and snow removal and dust control can collect on the underbody. If these are not removed, accelerated corrosion (rust) can occur on the underbody parts such as fuel lines, frame, floor pan, and exhaust system even though they have corrosion protection.

At least every spring, flush these materials from the underbody with plain water. Clean any areas where mud and other debris can collect. Dirt packed in closed areas of the frame should be loosened before being flushed. Your dealer or an underbody vehicle washing system can do this for you.

## ***CHEMICAL PAINT SPOTTING***

Some weather and atmospheric conditions can create a chemical fallout. Airborne pollutants can fall upon and attack painted surfaces on your vehicle. This damage can take two forms: blotchy, ringlet-shaped discolorations, and small irregular dark spots etched into the paint surface.

Although no defect in the paint job causes this, Cadillac will repair, at no charge to the owner, the surfaces of new vehicles damaged by this fallout condition within 12 months or 12,000 miles (20 000 km) of purchase, whichever comes first.

## *APPEARANCE CARE MATERIALS CHART*

<b>GM PART NUMBER</b>	<b>SIZE</b>	<b>DESCRIPTION</b>	<b>USAGE</b>
1051516	32 OZ. (0.946 L)	WASHER SOLVENT AND GAS-LINE DE-ICER	WINDSHIELD WASHING SYSTEM AND GAS LINE
1050017	32 OZ. (0.946 L)	POWER STEERING FLUID	POWER STEERING
1052277	12 OZ. (0.354 L)	SPRAY-A-SQUEAK	WEATHER STRIPS- STOPS SQUEAKS ON METAL-TO-METAL AND METAL-TO-RUBBER CONTACT
1050172	16 OZ. (0.473 L)	TAR AND ROAD OIL REMOVER	REMOVES OLD WAXES, POLISHES, TAR AND ROAD OIL
1050173	16 OZ. (0.473 L)	CHROME CLEANER AND POLISH	REMOVES RUST AND CORROSION ON CHROME AND STAINLESS STEEL
1050174	16 OZ. (0.473 L)	WHITE SIDEWALL TIRE CLEANER	CLEANS WHITE AND BLACK TIRES
1050214	32 OZ. (0.946 L)	VINYL/LEATHER CLEANER	SPOT AND STAIN REMOVAL ON LEATHER OR VINYL
1050244	16 OZ. (0.473 L)	FABRIC CLEANER	SPOT AND STAIN REMOVAL ON CLOTH AND FABRIC
1050427	23 OZ. (0.680 L)	GLASS CLEANER	GLASS CLEANING AND SPOT CLEANING ON VINYL
1050429	6 LB. (2.72 KG)	MULTI-PURPOSE POWDERED CLEANER	CLEANS VINYL AND CLOTH ON DOOR TRIM, SEATS, AND CARPET-ALSO, TIRES AND MATS
1052349	12 OZ. (0.354 L)	LUBRIPLATE (WHITE GREASE)	GREASE FOR HOOD, TRUNK AND DOOR HINGES AND LATCHES
1050729	8 OZ. (0.237 L)	VINYL TOP CLEANER	CLEANING OF VINYL TOPS
1052870	16 OZ. (0.473 L)	WASH-WAX (CONC.)	EXTERIOR WASH
1051398	8 OZ. (0.237 L)	SPOT LIFTER	SPOT AND STAIN REMOVAL ON CLOTH AND FABRIC
1051515	32 OZ. (0.946 L)	GM OPTIKLEEN	WINDSHIELD WASHER SOLVENT AND ANTI-FREEZE
1050201	16 OZ. (0.473 L)	MAGIC MIRROR CLEANER POLISH	EXTERIOR CLEANER AND POLISH
9985286	32 OZ. (0.946 L)	DEXRON® III E	AUTOMATIC TRANSMISSION
1052367	16 OZ. (0.473 L)	GM ENGINE OIL SUPPLEMENT (E.O.S.)	SEE YOUR DEALER FOR SPECIFIC USAGE
1052753	1 GAL. (3.785 L)	PERMANENT TYPE ANTI-FREEZE COOLANT (ETHYLENE GLYCOL BASE)	YEAR ROUND COOLANT AND ANTI-FREEZE
1052271	23 OZ. (0.680 L)	GM GEAR LUBRICANT	REAR AXLE
1052358	12 OZ. (0.354 L)	LIMITED-SLIP ADDITIVE	REAR AXLE
1052535	16 OZ. (0.473 L)	DELCO-SUPREME II BRAKE FLUID	BRAKE FLUID

# VEHICLE IDENTIFICATION NUMBER (VIN)



**1 G 6 K S 5 2 B X P U 8 0 0 0 0 1**

**NATION OF ORIGIN**

1 = USA

**MANUFACTURER**

G = GENERAL MOTORS

**MAKE**

6 = CADILLAC

**CARLINE/SERIES**

KS = SEVILLE

KY = STS

**VIN BODY CODE = BODY TYPE**

5 = 89 SEDAN 4 DOOR

**PRODUCTION SEQUENCE NUMBER**

**ASSEMBLY PLANT**

U = HAMTRAMCK, MICH.

**MODEL YEAR**

P = 1993

**CHECK DIGIT**

**ENGINE CODE**

B = 4.9 LITER (200 HP)

9 = 4.6 LITER (295 HP)

**RESTRAINT SYSTEM:**

2 - ACTIVE (MANUAL) BELTS WITH DRIVER AND PASSENGERS INFLATABLE RESTRAINT SYSTEM

This is the legal identifier for your Cadillac. It appears on a plate in the front corner of the instrument panel, on the driver's side. You can see it if you look through the windshield from outside your vehicle. The VIN also appears on the Vehicle Certification and Service Parts labels and the certificates of title and registration.

### ***Engine Identification***

The eighth character in your VIN is the engine code for your GM engine. This code will help you identify your engine, specifications, and replacement parts in this section.

### ***SERVICE PARTS IDENTIFICATION LABEL***

You'll find this label on the spare tire cover. It's very helpful if you ever need to order parts. On this label is:

- Your VIN.
- Its model designation.
- A list of all production options and special equipment.

Be sure that this label is not removed from the vehicle.

### ***ADD-ON ELECTRICAL EQUIPMENT***

#### **NOTICE:**

**Don't add anything electrical to your Cadillac unless you check with your dealer first. Some electrical equipment can damage your vehicle and the damage wouldn't be covered by your warranty. Some of it can just keep other things from working as they should.**

## ***Retained Accessory Power***

When you stop your Cadillac and turn the key to Off, you can use these accessories for 10 more minutes:

- Radio
- Power Windows
- Astrorooftop
- Windshield Wipers

If you open a door, everything will go off. And, after 10 minutes everything will go off, also.

If you want power for another 10 minutes, just turn the key to Run and then back to Off.

## ***FUSES AND CIRCUIT BREAKERS***

The wiring circuits in your vehicle are protected from short circuits by a combination of Mini Fuses, Circuit Breakers, and Maxi Fuses. This greatly reduces the chance of fires caused by electrical problems.

If you have a problem on the road and don't have a spare fuse, you can "borrow" one of the same value. Select a feature that you can get along without that is the same value you need -- like the radio or cigarette lighter -- and use its fuse. Be sure to use a fuse with the same amperage rating number on it (ie. 10A, 20A, etc.) Replace it as soon as you can.

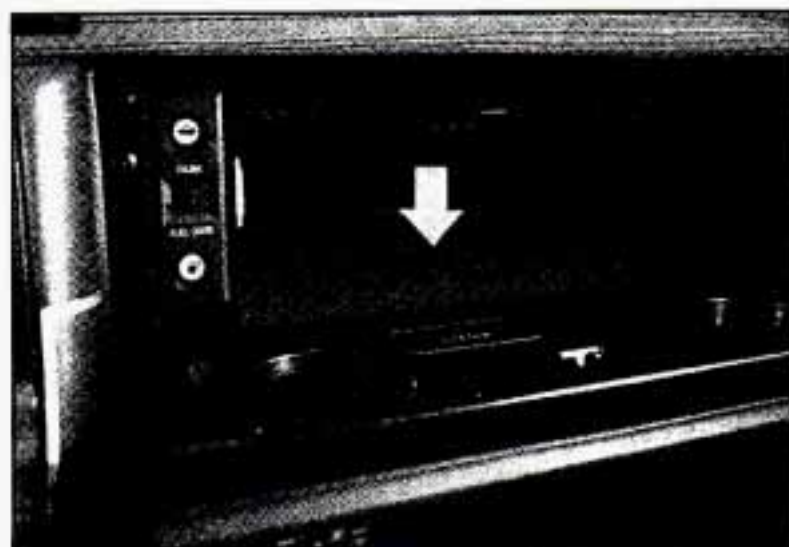

There is a fuse removal tool and some spare mini fuses in the glove box door, just lift the cover up.

## *Engine Compartment Fuse Block*



To gain access, lift the cover.

## *Maxi Fuses/Relay Center*

The maxi fuse and relays are located next to the engine compartment fuse block. If a maxi fuse should blow, have your vehicle serviced by your Cadillac dealer immediately.

COIL 20A	SIR 20A	PCM (IGN) 10A	INJ 10A	INJ 10A	IGN 10A	FUEL 20A
PCM (BAT) 10A			A/C 10A	SENSE 10A	STOP 20A	TURN/HAZ 20A
DRL 10A	DRL 10A		SUSPENSION 10A	RTD (BAT) 20A		
L HDLP LO 10A	R HDLP LO 10A	L HDLP HI 10A	R HDLP HI 10A	IGN 3 10A	COOL FAN 10A	TRANS/ECS 10A

### FUSE CENTER IDENTIFICATION

### ENGINE COMPARTMENT FUSE BLOCK

#### COIL 20A

- 4.9L DISTRIBUTOR
- 4.6L IGNITION CONTROL MODULE

#### SIR 20A

- DIAGNOSTIC ENERGY RESERVE MODULE (DERM) SIR (AIR BAG)
- ARMING SENSOR

#### PCM (IGN) 10A

- POWERTRAIN CONTROL MODULE (PCM)
- PASSKey® DECODER MODULE

#### INJ 10A

- FUEL INJECTORS 1, 4, 6, 7

#### INJ 10A

- FUEL INJECTORS 2, 3, 5, 8

#### IGN 10A

- A/C COMPRESSOR
- ELECTROCHROMIC MIRROR
- INSTRUMENT PANEL CLUSTER
- DIAGNOSTIC ENERGY RESERVE MODULE (DERM) SIR (AIR BAG)
- KEYLESS ENTRY MODULE
- CORNERING LIGHTS
- CHIME MODULE
- TWILIGHT SENTINEL/DRL MODULE
- BACKUP LIGHTS
- BRAKE TRANSMISSION SHIFT INTERLOCK

#### FUEL 20A

- FUEL PUMP
- POWERTRAIN CONTROL MODULE

#### PCM (BAT) 10A

- POWERTRAIN CONTROL MODULE (PCM)

#### A/C 10A

- A/C COMPRESSOR

#### HTD W S 10A

- HEATED WINDSHIELD

#### STOP LP 20A

- STOP LIGHTS

#### TURN HAZ 20A

- HAZARD LIGHTS
- TURN SIGNAL LIGHTS

#### DRL 10A (CANADA)

- DAYTIME RUNNING LIGHTS

#### DRL 10A (CANADA)

- DAYTIME RUNNING LIGHTS

#### SUSPENSION 10A

- ROAD SENSING SUSPENSION (NORTHSTAR)

- SPEED SENSITIVE SUSPENSION (4.9L)

#### RTD (BAT) 20A

- ROAD SENSING SUSPENSION

#### L HDLP LO 10A (EXPORT)

- LEFT HEADLAMP LOW BEAM

#### R HDLP LO 10A (EXPORT)

- RT HEADLAMP LOW BEAM

#### L HDLP HI 10A (EXPORT)

- LEFT HEADLAMP HIGH BEAM

#### R HDLP HI (EXPORT)

- RIGHT HEADLAMP HIGH BEAM

#### IGN 3 10A

- HEATED WINDSHIELD
- HEATER AND A/C PROGRAMMER
- ELECT. LEVEL CONTROL (ELC)
- DEFOGGER RELAY "D"
- CRUISE CONTROL
- POWERTRAIN CONTROL MODULE

#### COOLING FAN 10A

- COOLING FANS
- POWERTRAIN CONTROL MODULE (4.6L)
- FRONT AND REAR HEATED OXYGEN SENSOR (4.6L)

#### TRANS/ECS 10A

- EXHAUST GAS RECIRCULATION (EGR) SOLENOID
- POWERTRAIN CONTROL MODULE (PCM)
- AUTOMATIC TRANSAXLE
- EVAPORATIVE EMISSION CONTROL SOLENOID
- OVERSPEED ALERT MODULE (EXPORT)
- POWER STEERING PRESSURE SWITCH

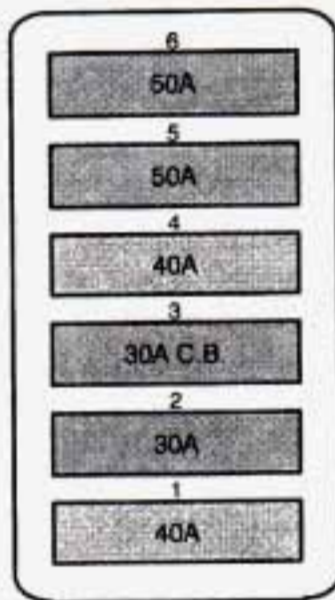
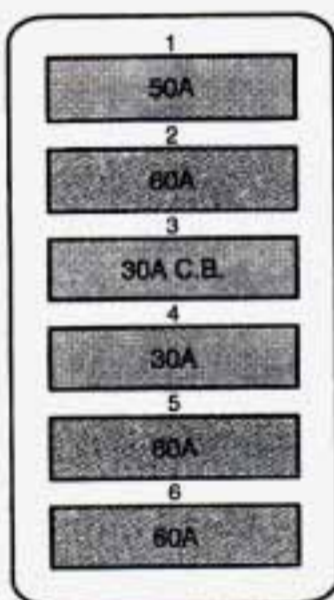
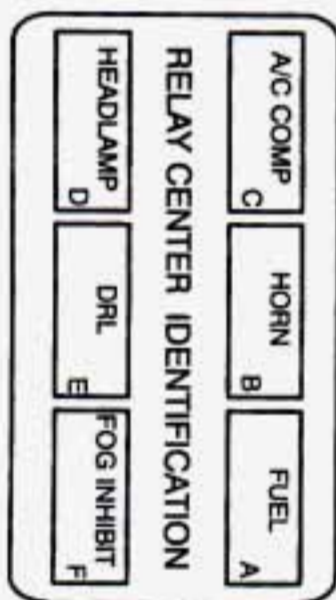

## LH MAXI® FUSE BLOCK

### FUSE 1 (50 AMP)

- RETAINED ACCESSORY POWER (RADIO/WIPERS)
- STARTER
- TRUNK COMP. FUSE A11
- ENGINE COMP. FUSES A1, A3, A5, A7, A9, A11, A13

### FUSE 2 (60 AMP)

#### U.S.A./CANADA Z49/SAUDI

- TRUNK COMP FUSES C1, C3, C5, C7, C9, C11
- ROAD SENSING SUSPENSION

### FUSE 2 EXPORT EXCEPT SAUDI (60 AMP)

- ROAD SENSING SUSPENSION
- REAR FOG LIGHT (EXPORT)
- TRUNK COMP. FUSES C1, C3, C5, C7, C9, C11, C13

### CIRCUIT BREAKER 3 (30 AMP)

- FUEL DOOR RELEASE
- TRUNK RELEASE
- LEFT AND RIGHT POWER SEAT
- LEFT AND RIGHT LUMBAR CONTROL
- KEYLESS ENTRY MODULE
- POWER DOOR LOCKS
- HORNS

### FUSE 4 (30 AMP)

- POWERTRAIN CONTROL MODULE (PCM)
- ELECTRONIC CLIMATE CONTROL
- RAP/ILLUMINATED ENTRY MODULE
- INSTRUMENT PANEL CLUSTER
- PASSKey® DECODER MODULE
- THEFT DETERRENT

### FUSE 5 (60 AMP)

- LEFT AND RIGHT HEATED SEATS
- ELECTRONIC LEVEL CONTROL (ELC)
- TRUNK LID PULL DOWN
- POWER ANTENNA
- REAR DEFOGGER
- LEFT AND RIGHT MIRROR DEFOGGERS

### FUSE 6 (60 AMP)

- RETAINED ACCESSORY POWER (SUNROOF/POWER WINDOWS)
- ENGINE COMP FUSES C7, D1, D3, D5
- TRUNK COMP FUSES A1, A3, A5, A7

## RH MAXI® FUSE BLOCK

### FUSE 1 (40 AMP)

- TURN/HAZ STOP LP
- PARK LIGHTS

### FUSE 2 (30 AMP)

- DELCO-BOSE® SPEAKERS
- RADIO CONTROL HEAD
- REMOTE RADIO RECEIVER

### CIRCUIT BREAKER 3 (30 AMP)

- FLASH TO PASS FEATURE
- DAYTIME RUNNING LIGHT (DRL)
- HEADLIGHTS

### FUSE 4 (40 AMP) HAVAC BLOWER

- HVAC POWER MODULE
- A/C COMPRESSOR

### FUSE 5 (50 AMP) ABS

- ANTILOCK BRAKE PRESSURE VALVE

### FUSE 6 (50 AMP) COOLING FANS

- COOLING FANS



## *Rear Compartment Fuse Block*

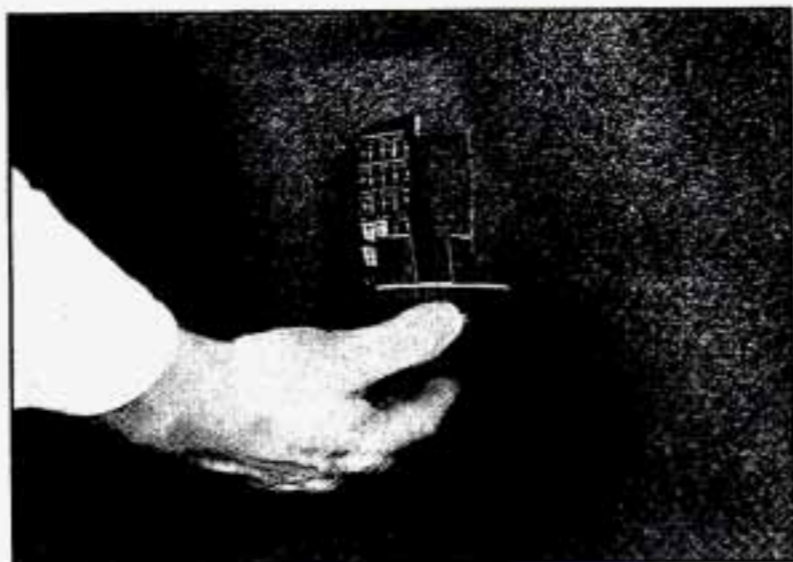

Pull the cover off to gain access.

CRANK 10A	IGN 1 10A		HDLP WASH 30A	IPC (IGN) 10A	CNSL SW 10A	ABS 10A
WIPER 30A	RAD (IGN) 10A	R DEFOG 30A	HTD MIRR 10A	IPC (BATT) 10A	THEFT 10A	HVAC/DABIE 10A
REAR FOG 10A	FOG LP 10A	CNSL FAN 10A	CIGAR 20A	BODY 2 10A	BODY 1 10A	READ LP 10A
L PRK LP 10A	R PRK LP 10A	RAD (BAT) 10A	ANT/TRUNK 20A	ELC 20A	R HTD SEAT 10A	L HTD SEAT 10A

### TRUNK COMPARTMENT FUSE BLOCK

#### CRANK 10A

- RAP/ILLUMINATED ENTRY MODULE
- DIAGNOSTIC ENERGY RESERVE MODULE (DERM)
- STARTER

#### IGN 1 10A

- CATALYTIC CONVERTER ALARM MODULE (EXPORT)
- FUEL LEVEL SENSOR
- ELECTROCHROMIC MIRROR
- THEFT DETERRENT MODULE
- KEYLESS ENTRY MODULE
- TURN SIGNAL LIGHTS
- RAP/ILLUMINATED ENTRY MODULE

#### HDLP WASH 30A (EXPORT)

- HEADLIGHT WASHER MODULE

#### IPC (IGN) 10A

- INSTRUMENT PANEL CLUSTER

#### CNSL SW 10A

- REAR BLOWER MOTOR
- CONSOLE SWITCH

#### ABS 10A

- ELECTRONIC BRAKE CONTROL MODULE (4.9L)
- ELECTRONIC BRAKE AND TRACTION CONTROL MODULE (NORTHSTAR)

#### WIPER 30A

- WIPER/WASHER SWITCH

#### RAD (IGN) 10A

- REMOTE RADIO RECEIVER

#### R DEFOG 30A

- REAR DEFOGGER

#### HTD MIRR 10A

- RIGHT AND LEFT POWER MIRROR-DEFOGGER

#### IPC (BATT) 10A

- INSTRUMENT PANEL CLUSTER

#### THEFT 10A

- PASS-Key<sup>®</sup> DECODER MODULE
- THEFT DETERRENT RELAY
- THEFT DETERRENT MODULE

#### HVAC/DABIE 10A

- HEATER AND A/C PROGRAMMER
- RAP/ILLUMINATED ENTRY MODULE

#### REAR FOG 10A (EXPORT)

- REAR FOG LIGHTS

#### FOG LP 10A (4.6L)

- FOG LIGHTS

#### CNSL FAN 10A

- REAR BLOWER MOTOR

#### CIGAR 20A

- REAR CIGAR LIGHTERS—SEVILLE ONLY
- FRONT CIGAR LIGHTER
- CHIME MODULE

#### BODY 2 10A

- POWER MIRROR SWITCH
- RETAINED ACCESSORY POWER
- TRUNK LIGHT
- CONSOLE SWITCH
- PANEL LIGHTS INHIBIT (EXPORT)
- COURTESY LIGHTS
- KEYLESS ENTRY MODULE

#### BODY 1 10A

- POWER DOOR LOCKS
- DOOR LOCK CYLINDER ILLUMINATION
- GLOVE BOX LIGHT
- FOOTWELL LIGHTS
- TWILIGHT SENTINEL/DRL MODULE
- HEADLIGHT SWITCH

#### READ LP 10A

- LEFT AND RIGHT VANITY MIRRORS
- GARAGE DOOR OPENER
- FRONT AND REAR HEADER LIGHTS

#### L PRK LP 10A

- RADIO DIMMING
- HEADLIGHT SWITCH
- INSTRUMENT PANEL CLUSTER
- LEFT TAIL/STOP/TURN LIGHTS
- LEFT MARKER LIGHT
- LEFT PARK/TURN LIGHT

#### R PRK LP 10A

- RIGHT MARKER LIGHTS - LICENSE LIGHTS
- RIGHT PARK/TURN LIGHT
- ENGINE COMPARTMENT LIGHT
- RIGHT TAIL/STOP/TURN LIGHTS

#### RAD (BAT) 10A

- REMOTE RADIO RECEIVER
- RADIO CONTROL HEAD

#### ANT/TRUNK 20A

- TRUNK PULL DOWN
- POWER ANTENNA

#### ELC 20A

- ELECTRONIC LEVEL CONTROL

#### R HTD SEAT 10A

- PASSENGERS HEATED SEAT

#### L HTD SEAT 10A

- DRIVERS HEATED SEAT

## ***Headlights***

The headlight wiring is protected by a circuit breaker in the light switch. An electrical overload will cause the lights to go on and off, or in some cases to remain off. If this happens, have your headlight wiring checked right away.

## ***Windshield Wipers***

The windshield wiper motor is protected by a circuit breaker and a fuse. If the motor overheats due to heavy snow, etc., the wiper will stop until the motor cools. If the overload is caused by some electrical problem and not snow, etc., be sure to get it fixed.

## ***Power Windows and Other Power Options***

Circuit breakers in the fuse panel protect the power windows and other power accessories. When the current load is too heavy, the circuit breaker opens and closes, protecting the circuit until the problem is fixed or goes away.

## ***BULB CHART***

<b>DESCRIPTION</b>	<b>BULB NO.</b>
Ash Tray Illumination .....	1445
Backup Lights .....	2057
Cornering Light .....	1156 DC7
Courtesy Reading Light .....	168
Fog Light .....	886
Glove Compartment Light .....	194
Headlights Composite	
-Inner High Beam .....	9005 HB3
-Outer Low Beam .....	9006 HB4
-Export Bulb .....	H4
Illumination Entry Lock Lamp .....	192
Instrument Panel Illumination .....	194
Instrument Panel Telltales .....	194

License Plate Light .....	194
Park and Turn Signal .....	2357 NA
Rear Fog/Back-Up Light (Export) .....	P21/5W
Side Marker Lights .....	194
Stop/Tail/Turn Signal .....	2057 NA
Stop/Tail/Turn Signal (Export) .....	P21/5W
Trunk Light .....	1003
Underhood Light .....	561
Vanity Mirror Illumination .....	124

## ***NORMAL MAINTENANCE REPLACEMENT PARTS (4.9 LITER ENGINE)***

Air Cleaner Element .....	AC Type A1096C2 5096932
Battery .....	78A-72
Fuel Filter Element .....	AC Type GF-581 25121468
Engine Oil Filter .....	AC Type PF-45 25010324
PCV Valve .....	AC Type CV-774C 6487779
Spark Plugs .....	AC Type 41-902 5614235
Serpentine Drive Belt .....	3528110
Radiator Cap .....	AC Type RC 27 6410427
Thermostat .....	3528974
Upper Radiator Hose .....	3521235
Lower Radiator Hose .....	3521237
Trans Filter .....	8651909
Trans Pan Gasket .....	8668028

## ***NORMAL MAINTENANCE REPLACEMENT PARTS (4.6 LITER NORTHSTAR)***

Air Cleaner Element .....	AC Type S1096C
.....	25096932
Battery .....	78A-72
.....	1981590
Fuel Filter Element .....	AC Type GF-580
.....	25121468
Engine Oil Filter .....	AC Type PF-58
.....	25014377
PCV Valve .....	AC Type CV-774C
.....	06487779
Spark Plugs .....	AC Type 41-900
.....	5614236
Serpentine Drive Belt .....	3530814
Surge Tank Cap .....	AC Type RC 33
.....	6410665
Thermostat .....	AC Type 131-66
.....	3531407
Upper Radiator Hose .....	3521504
Lower Radiator Hose .....	3521505
Trans Screen Rt. Scavenger .....	8679416
Trans Screen Lt. Scavenger .....	8680700
Trans Pan Screws (16) .....	8682650
Trans Pan Gasket .....	8681197

## ***SPECIFICATIONS***

### ***4.6L 32 Valve (DOHC) Northstar Engine***

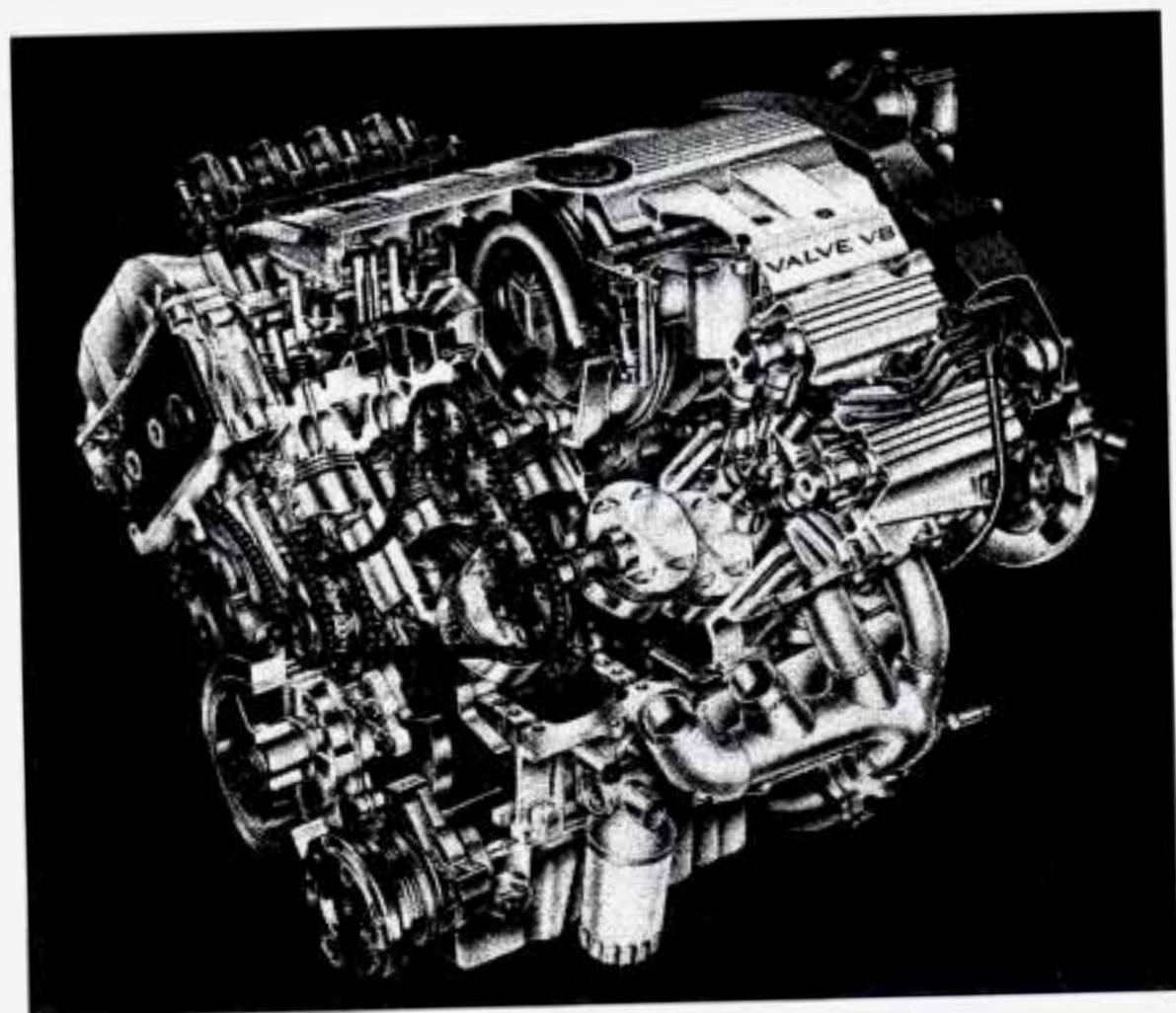

The engine is a 4.6 liter (279 cu.in.) 90° V-8 featuring Dual Overhead Cam (DOHC), 32 valve, and sequential port fuel injection. This design results in a powerful, refined engine which is well suited to even the most demanding driving conditions.

Engine weight is minimized by the use of low mass alloy materials. The crankcase, cylinder heads and oil pan are made from cast aluminum. The induction system housing, cam covers and oil filter adapter are cast magnesium. The reduced engine mass enhances vehicle handling and responsiveness.

The Northstar engine is designed to require less maintenance than many other DOHC V-8 engines. Engine systems are designed to remind the driver when service is required. An oil life index indicator monitors ongoing operating conditions and reminds the driver when an oil change is needed. A low coolant warning message keeps track of the level of this vital fluid. Direct acting hydraulic tappets provide maintenance free zero lash operation of the 32 valves from idle to the 6500 rpm redline. The camshafts are driven by a two stage roller chain assembly which is designed to provide quiet maintenance free operation. Platinum tipped spark plugs increase the replacement interval to 100,00 miles.

The four valve per cylinder design provides more efficient engine breathing which results in higher power than comparable two valve engines. The central location of each spark plug ensures a fast and complete burning of the fuel/air mixture. The induction system uses smooth thermoplastic tubes to channel air into the cylinders. The smoothness of the tubes is equivalent to the elaborate port polishing methods used for race car engines. Careful design using the shape and length of the tubes boosts horsepower by using sonic pressure waves created by the motion of the inlet valves to increase the amount of air entering each cylinder.

The Northstar engine is also designed to be very durable. The aluminum block has cast-in-place iron cylinder liners for greater wear resistance. High strength forged steel connecting rods support the free floating piston pins in bronze bushings for superior high speed performance. The fillets of the nodular iron crankshaft undergo a high pressure compression rolling operation to improve their resistance to fatigue.

Quiet operation is enhanced by the use of special materials and designs. The front cover of the engine is stamped from laminated steel which damps out noise. Special cam cover gasket seals isolate valve train operation. The fuel injectors are placed inside the induction system housing to eliminate the clicking noise which is common to other fuel injected engines.

The Northstar engine is designed to provide years of efficient, reliable, satisfying operation. We think it is also just plain fun to drive.

## **4.9 LITER ENGINE**

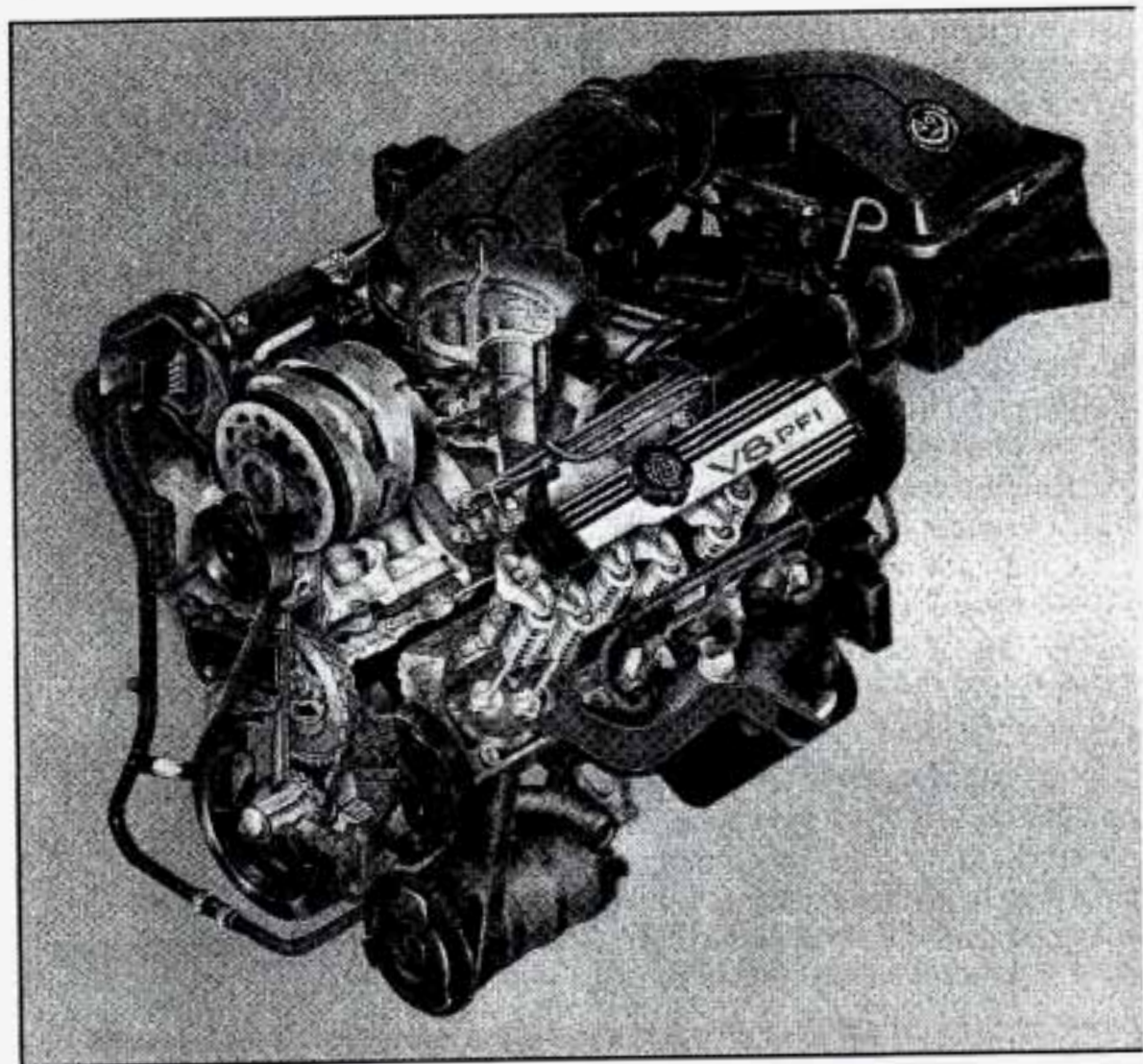

The 4.9 Liter transverse engine is an overhead valve, 90 degree V-8 design. The cylinder bore diameter and the piston stroke provide a piston displacement of 4.9 liters (300 cubic inches).

This engine utilizes an aluminum crankcase with a separate aluminum lifter carrier and removable cast iron cylinder liners. The cylinder heads are made of cast iron and feature integral valve seats and guides. The cast nodular iron crankshaft is supported at five main bearing journals by cast iron main bearing caps and shell type steel-backed aluminum inserts. The center main bearing is the thrust bearing.



The cast aluminum pistons use two compression rings and one oil control ring. The pistons are tin plated to provide a non-scuffing surface when the engine is new.

A steel camshaft is supported by five steel backed babbitt bearings. It is driven by the crankshaft through a chain at the front of the engine. The drive gear is keyed to the crankshaft and the driven sprocket is bolted to the camshaft. Both the crankshaft gear and camshaft sprocket have locating marks to provide the correct valve timing and timing chain installation. The valve lifters are roller hydraulic type and are positioned in the aluminum lifter carrier.

### ***4T80-E Transaxle (STS)***

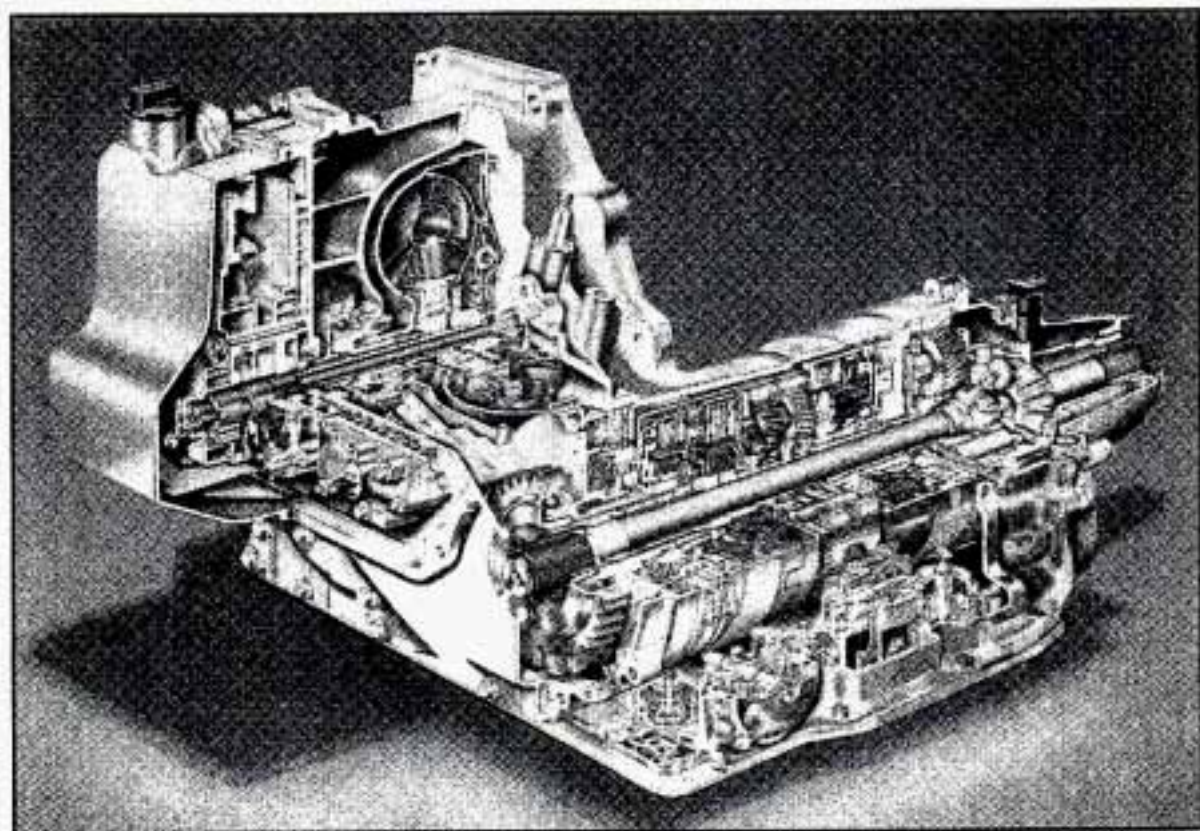

The 4T80-E transaxle has been designed to complement the output characteristics of the Northstar engine. The innovative design incorporates several features which enhance its overall operation.

This transaxle is the first of a new generation of "SMART" transmissions. The computer which controls the electronic shift solenoids adapts to changing environments while you drive. This provides consistent high quality shifts under all conditions. Communication between the engine and transaxle through this computer controls engine output during activation of torque management or traction control. Smooth shifting is ensured by design. Hydraulic accumulators control shift pressures and all shifts are made to free wheeling elements.

The 4T80E uses a dry sump lubrication system with a scavenger pump. This unique feature enables the transaxle to maintain adequate pressurized oil supply during all maneuvers.

Spirited performance with very efficient cruising operation are provided by the combination of 4 speed overdrive gearing, a torque converter clutch, and a 3.71:1 final drive ratio.

### ***4T60-E Transaxle (Seville)***

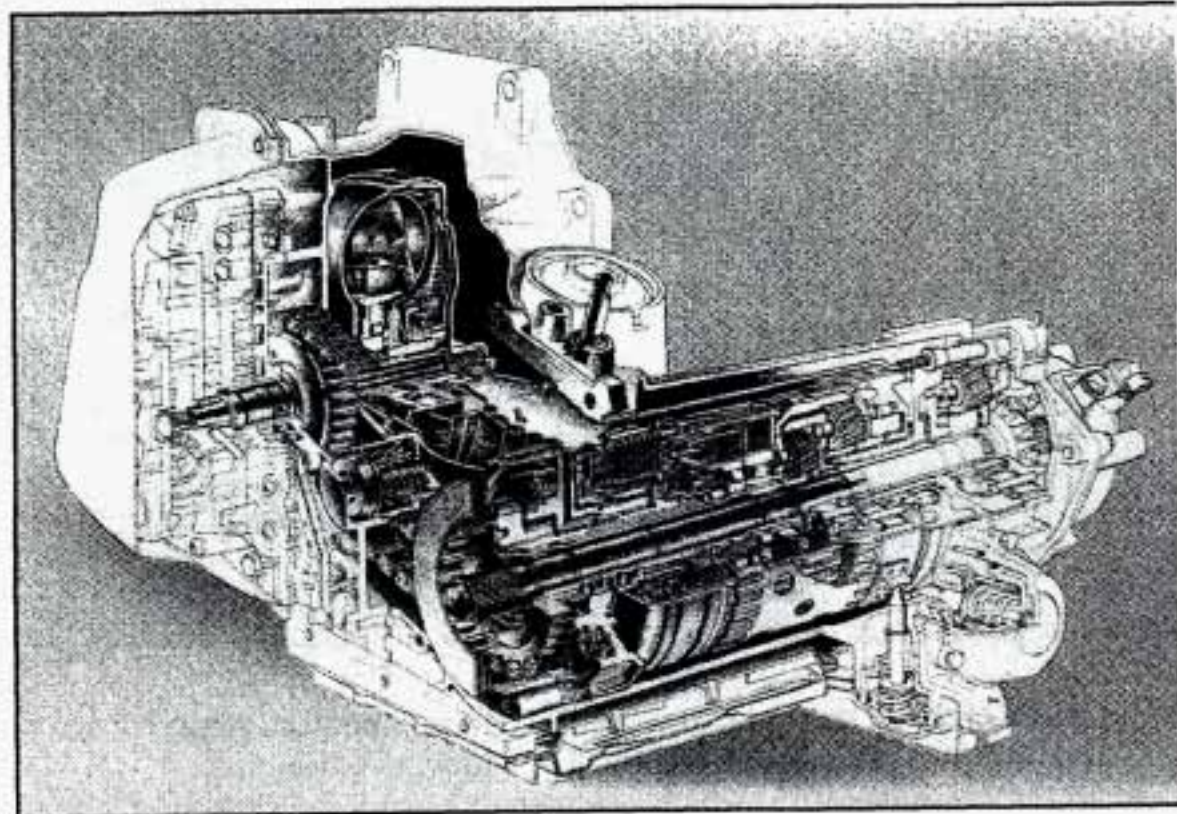

The Hydra-matic 4T60-E 4-speed overdrive, electronic transaxle consists primarily of a five element torque converter; two planetary gear sets, various clutches, final drive assembly, differential assembly, and a control valve body.

The torque converter houses a pump, turbine, pressure plate which is splined to the turbine, and a stator assembly, serving as a fluid coupling, it smoothly transmits power from the engine to the transaxle. It also hydraulically provides additional torque when required. When applied, the pressure plate provides a mechanical direct drive coupling of the engine to the transaxle.

The two planetary gear sets provide the four forward gear ratios and reverse. Changing of the gear ratios is fully automatic and is accomplished through the use of various electronic and mechanical requirements. Four multiple disc clutches, two roller clutches, a sprag clutch, and three bands provide the friction elements required to obtain the various ratios with the planetary gear sets.

A hydraulic system (the control valve body), pressurized by a vane type pump provides the working pressure needed to operate the friction elements and automatic controls.

## *Front Suspension*

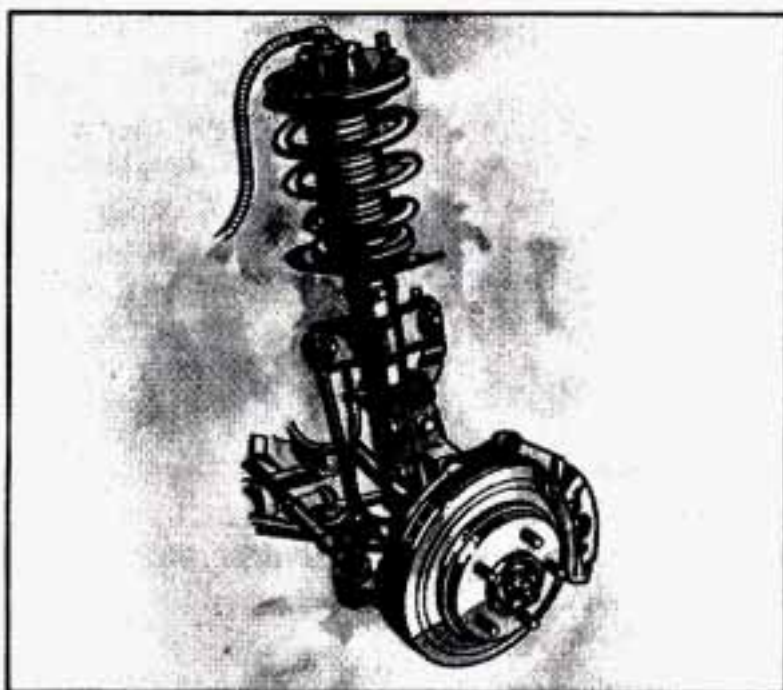

Your fully independent front suspension is a combination strut and spring design. The frame is isolated from the body with six rubber mounts. Rubber bushings are used at the lower control arm pivots. The upper end of the strut is isolated by a rubber mount which contains a bearing to allow for wheel turning. The Road Sensing Suspension on the STS and the Speed Sensing Suspension on Seville will automatically controls the damping rate of the struts.

The lower end of the steering knuckle pivots on a ball joint riveted to the control arm. The ball joint is connected to the steering knuckle with a castellated nut and cotter pin.

## *Short/Long Arm Suspension (SLA)*

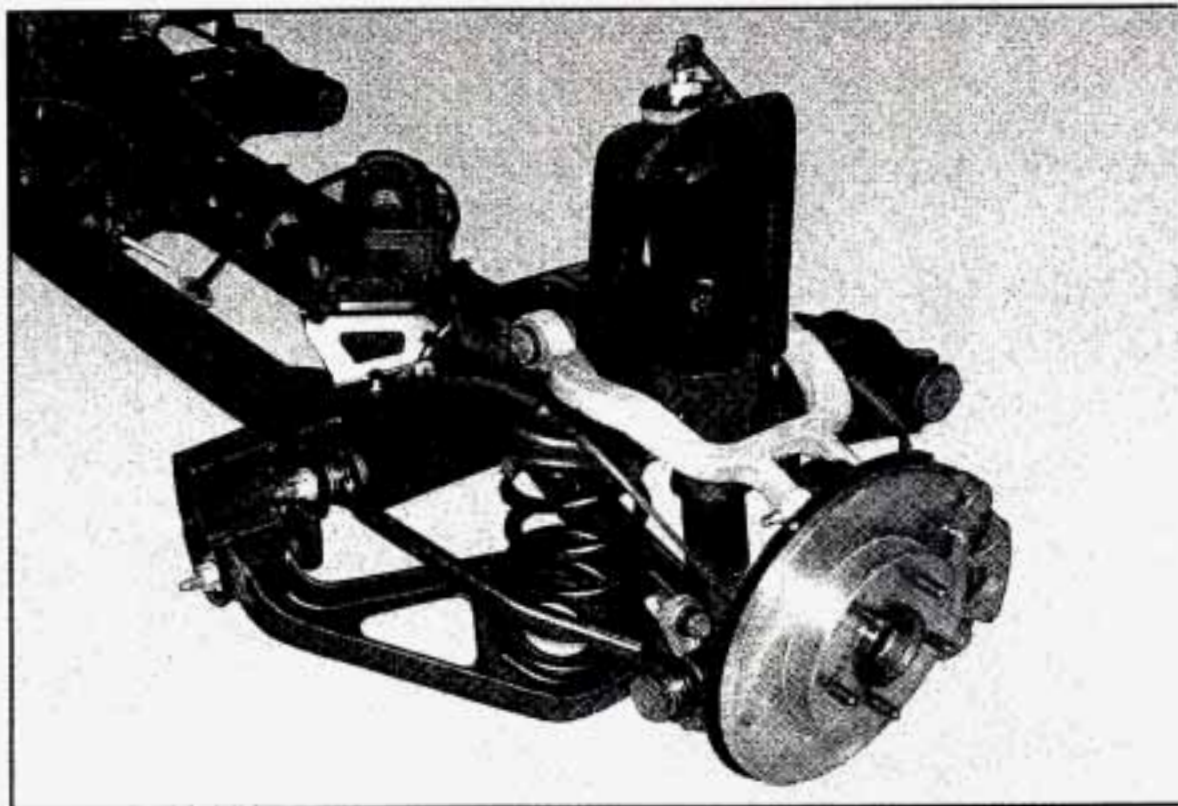

Your vehicle uses an independent short/long arm rear suspension. All the rear suspension components are mounted on a suspension support which is attached to the body at four points and is fully isolated with bushings and insulators to minimize road noise. Each rear wheel is connected to the suspension support through the suspension knuckle using an upper and lower control arm and toe link.

The control arms and toe link are attached to the suspension support on the inboard side, and to a suspension knuckle on the outboard side. The hub and bearing assembly is mounted to the knuckle and is a single, non-serviceable unit which eliminates the need for wheel bearing adjustment. The load leveling (ELC) shock absorbers are attached to the lower control arm, with the upper end of the shock attached to the suspension support. The springs are held in position between the lower control arms and a pocket in the suspension support.

The suspension system also incorporates a new damping system now as Road Sensing Suspension on the STS and Speed Sensing suspension on

the Seville. These systems control the damping forces in the shock absorbers and struts, in response to various road and driving conditions. The systems are capable of making these damping changes extremely fast.

A computer receives inputs from vertical acceleration sensors, wheel to body position sensors, vehicle speed sensor, lift and dive signals. This computer evaluates the inputs from these sensors, to control the damping of each of the struts and shocks independently to provide varied levels of suspension control.

The system also has the capability of providing Speed Sensitive Steering control. This system changes your steering effort based on your vehicle speed.

### *Speed Sensitive Steering*

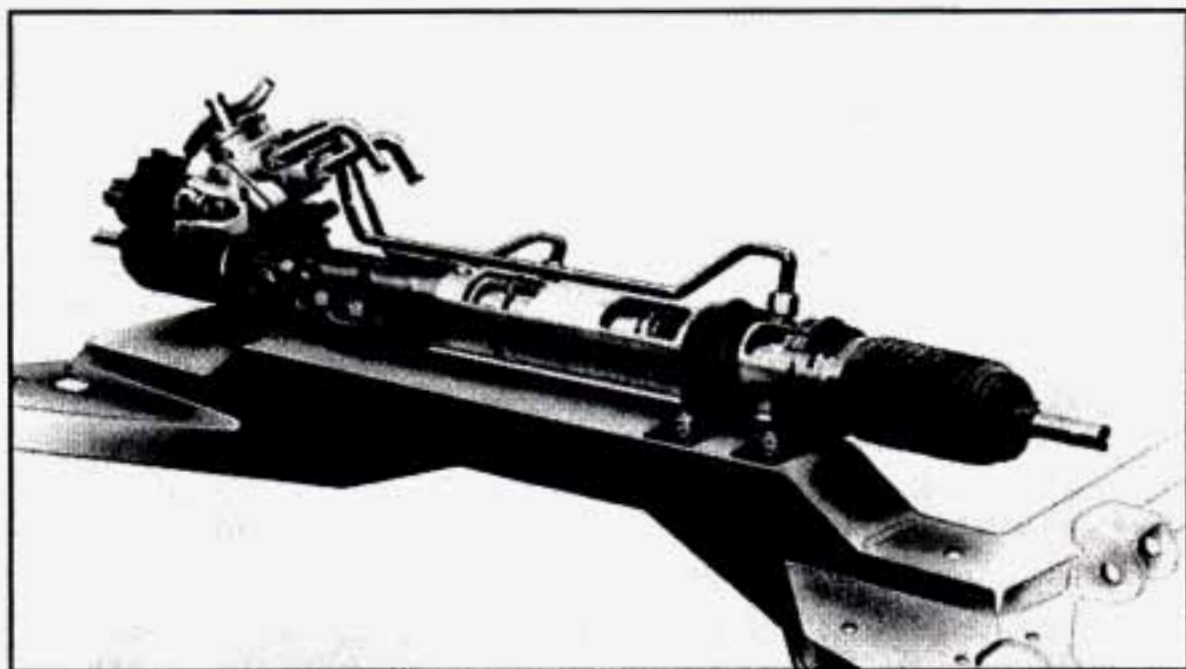

This system varies the amount of steering effort proportionate to your vehicle speed. Steering is easier at a lower speed for increased maneuverability and parking ease. As your vehicle speed increases, the steering effort is also increased to provide a manual like steering feel for maximum control and enhanced vehicle stability.

The power rack and pinion steering system has a rotary spool valve which directs hydraulic fluid coming from the power steering pump to one side or the other side of the rack piston. The integral rack piston is attached to the rack. The rack piston converts hydraulic pressure to a linear force which moves the rack left or right. The force is then transmitted through the inner and outer tie rods to the steering knuckles, which turn the wheels

If hydraulic assist is not available, manual control is maintained. However under these conditions more steering effort is required.

#### 4.6 LITER NORTHSTAR ENGINE

Displacement	4.6L (279 cu.in.)
No. of Cylinders	32-valve DOHC 8 - 90 Degree V
Power (Acc. to SAE J1349)	295 (bhp) @ 6000 rpm 220 (kW) @ 6000 rpm
Torque (Acc. to SAE J1349)	290 (lbs. ft.) @ 4400 rpm 393 (N•m) @ 4400 rpm
Bore	93mm (3.66 in.)
Stroke	84mm (3.31in.)
Compression Ratio	10.3:1
Cylinder Block	Die Cast Aluminum with Iron Cylinder Bores
Cylinder Heads	Cast Aluminum
Intake Manifold	Die Cast Magnesium / Thermoplastic Air Induction Tubes
Valve System	Direct Acting Hydraulic Tappets
Intake Valve	33mm (1.29 in.)
Exhaust Valve	29mm (1.14 in.)
Pistons	Cast Aluminum
Firing Order	1-2-7-3-4-5-6-8
Left Bank	2-4-6-8
Right Bank	1-3-5-7
Camshaft	Induction Hardened Cast Grey Iron
Drive Type	Single Row / Staged Drive 8 mm Roller Chain
Main Bearings	Five

## **4.9 LITER ENGINE**

Displacement	4.9L (300 cu.in.)
No. of Cylinders	8 - 90 Degree V
Power (Acc. to SAE J1349)	200 (bhp) @ 4100 rpm 150 (kW) @ 4100 rpm
Torque (Acc. to SAE J1349)	275 (lbs. ft.) @ 3000 rpm 375 (N•m) @ 3000 rpm
Bore	92mm (3.623 in.)
Stroke	92mm (3.623 in.)
Compression Ratio	9.5:1
Cylinder Block	Die Cast Aluminum
Cylinder Block Bore Liners	Cast Iron
Cylinder Head	Cast Iron
Intake Manifold	Cast Aluminum
Valve System	Roller Hydraulic Lifters
Intake Valve	45mm (1.772 in.)
Exhaust Valve	38mm (1.496 in.)
Pistons	Cast Aluminum
Firing Order	1-8-4-3-6-5-7-2
Left Bank	1-3-5-7
Right Bank	2-4-6-8
Camshaft	Steel
Width	16.2mm (0.64 in.)
Pitch	12.7mm (0.50 in.)
Drive Type	Chain
Crankshaft	Pearlitic Nodular Iron
Main Bearings	5



## ***ENGINE LUBRICATION SYSTEM***

Type of Intake .....	Stationary
Filter System .....	Full-Flow

## ***ENGINE COOLING SYSTEM***

Surge Tank / Radiator Cap Relief Pressure .....	15.0 psi (103 kPa)
Thermostat Starts To Open .....	192-199° F (89-93° C)
Water Pump Type .....	Centrifugal
Drive Belt .....	Serpentine
Radiator Core .....	Aluminum
Radiator Cooling Fans (2) .....	Electric

## ***FUEL SYSTEM***

Induction Type .....	Sequential Port Fuel Injection (SPFI)
System Pressure .....	33.4-43.5 psi (230-300 kPa)
Idle Speed .....	ECM Controlled
Filter Type .....	Paper Type Element
Fuel Pump .....	Electric (In Tank)
Fuel Required .....	Premium Unleaded (91 Octane)

## ***AUTOMATIC TRANSAXLE***

Trade Name (Seville) .....	Turbohydramatic (THM) 4T60E
Type .....	4-Speed Automatic
.....	Viscous Converter Clutch
Trade Name (STS) .....	Turbohydramatic (THM) 4T80E
Type .....	4-Speed Automatic
.....	Torque Converter Clutch
Fluid Required .....	DEXRON IIE®
Axle Ratio .....	2.97:1
Axle Ratio (STS) .....	3.71:1

## ***EMISSION CONTROL SYSTEMS***

Exhaust Gas Recirculation .....	Controlled Flow
Catalytic Converter .....	Ceramic Monolith
Evaporative Emission Control .....	Charcoal Canister
Crankcase Emission Control .....	PCV Valve
Electronic System .....	Open and Closed Loop

## ***EXHAUST SYSTEM***

Type .....	Single with Crossover Pipe
Muffler .....	One-Reverse Flow
Resonator .....	None
Exhaust Pipe .....	Stainless Steel
Intermediate Pipe .....	Stainless Steel
Tail Pipe .....	Stainless Steel

## ***ELECTRICAL SYSTEM***

Voltage .....	12
Ground .....	Negative
Generator (4.9 L) .....	140 Amp
Generator (4.6 L) .....	144 Amp

## ***AIR CONDITIONING SYSTEM***

Refrigerant-12 (R-12) .....	2.375 lbs. (1.08 kg)
-----------------------------	----------------------

Not all air conditioning refrigerants are the same. If the air conditioning system in your vehicle needs refrigerant, be sure the proper refrigerant is used. If you're not sure ask your Cadillac Dealership.

## ***FLUID CAPACITIES***

Transaxle (4T60E) .....	20 pts. (9.5 L)
Transaxle (4T80E) .....	30 pts. (14 L)
Engine Oil (4.9 L) .....	5 quarts (4.7 L)
With Filter Change .....	5.5 qts (5.2 L)
Engine Oil (4.6 L) .....	6.5 qts (6.2 L)
With Filter Change .....	7 qts (6.6 L)
Engine Cooling System .....	12.3 qts (11.7 L)
Fuel Tank .....	20 gallons (76 L)
Power Steering .....	1.3 quarts (1.2 L)
Windshield Washer Reservoir .....	4.2 quarts (4.1 L)

## ***TIGHTEN TORQUE***

Spark Plugs (4.9 L) .....	20 N·m (15 lbs. ft.)
Spark Plugs (4.6 L) .....	15 N·m (11 lbs. ft.)
Oil Pan Drain Plug (4.9 L) .....	30N·m (22 lbs. ft.)
Oil Pan Drain Plug (4.6 L) .....	20N·m (15 lbs. ft.)

## ***VEHICLE DIMENSIONS***

### **Seville/STS**

Shipping Weight .....	3595 lbs. (1630.5 kg)
Shipping Weight (STS) .....	3807 lbs. (1726.8 kg)
Wheel Base .....	111 in. (2819 mm)
Length .....	203.9 in. (5179 mm)
Height .....	54.0 in. (1371 mm)
Width .....	74.3 in. (1887 mm)
Front Tread .....	60.9 in. (1547 mm)
Rear Tread .....	60.9 in. (1547 mm)



We employ technicians certified by the  
National Institute for

**AUTOMOTIVE  
SERVICE  
EXCELLENCE**

Let us show you their credentials



Catalog Number H-3026

Part Number 3532636

---

1973 FLEETWOOD ELDORADO PACE CAR



ROADSIDE SERVICE

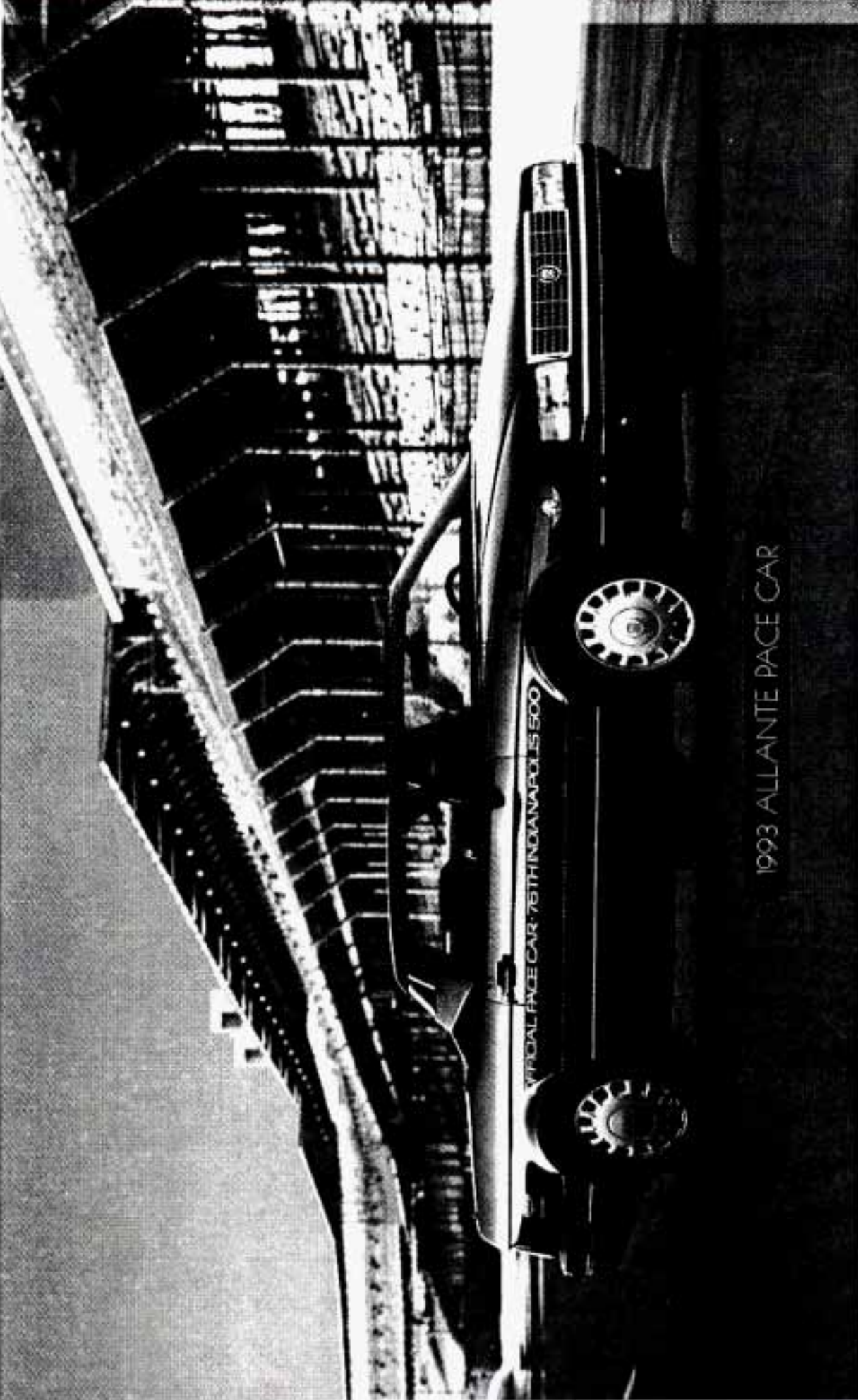

OFFICIAL PACE CAR - 75TH INDIANAPOLIS 500

1993 ALLANTE PACE CAR



## ***OUR COMMITMENT TO YOUR SATISFACTION***

We are committed to providing you the finest ownership experience in the world, starting the moment you take delivery of your new Cadillac.

Cadillac offers another major step toward your continued satisfaction...with Cadillac Roadside Service. Roadside Service is your key to peace of mind ownership—one that covers you on the road, far from home, all day and night, and during the weekend. Roadside Service represents the spirit of luxury leadership at Cadillac Motor Car Division. We hope the need never arises, but if it does, Roadside Service can help.

### ***How Can Roadside Service Help You?***

Cadillac Roadside Service with a staff of phone advisors trained in Cadillac service excellence offers assistance exclusively to Cadillac owners. In many cases, the advisor can quickly help resolve your car problem over the phone.

If the phone advisor determines that it may be possible to repair your car at roadside and a technician is available, the advisor will arrange for an experienced Cadillac dealership technician to contact you, and if appropriate, travel to your location in a specially equipped vehicle and attempt to repair your car on-site. The Roadside Service vehicle contains the necessary tools and parts to complete most minor repairs to get you back on the road.

Roadside Service phone advisors and technicians are trained by Cadillac and are familiar with your car, which provides a level of service knowledge usually found only at your Cadillac Dealership. **Because Roadside Service assists Cadillac owners exclusively,** your call always receives top priority and immediate action. Should you require a tow truck, locksmith, hotel accommodations, or other vital services on a moments notice, Roadside Service will locate and make the arrangements for you promptly.

### ***When Is Roadside Service Available?***

Cadillac owners have the peace of mind knowing that Roadside Service is available 24 hours a day, 365 days a year, as follows:

<b>TYPE OF ASSISTANCE</b>	<b>MONDAY-FRIDAY</b>	<b>WEEKENDS AND HOLIDAYS</b>
Phone Advisor	24 Hours	24 Hours
Dealer Technician	5:00 p.m.-12:00 midnight	8:00 a.m.-12:00 midnight
Outside Service	24 Hours	24 Hours

### ***Where Is It Available To You?***

**Wherever you drive in the United States or Canada** an advisor is available to assist you over the phone and a dealer technician will travel to your location within a **30 mile radius**, of a participating Cadillac dealership. If you are not within a 30 mile radius, we will arrange to have your car towed to the nearest Cadillac dealership or service facility of your choice, after which you may recontact us for further assistance.





### ***How Do You Obtain Roadside Service?***

Just dial the special toll-free number and an experienced advisor at the Cadillac Roadside Operations Center will assist you. The advisor will ask your name, home address, location and the telephone number you're calling from (avoid using credit card phones, since return calls cannot be placed to you through them), along with the location of your Cadillac, the model year, Vehicle Identification Number, and a description of the problem. Remember, Roadside Service is available to drivers of any model year Cadillac.

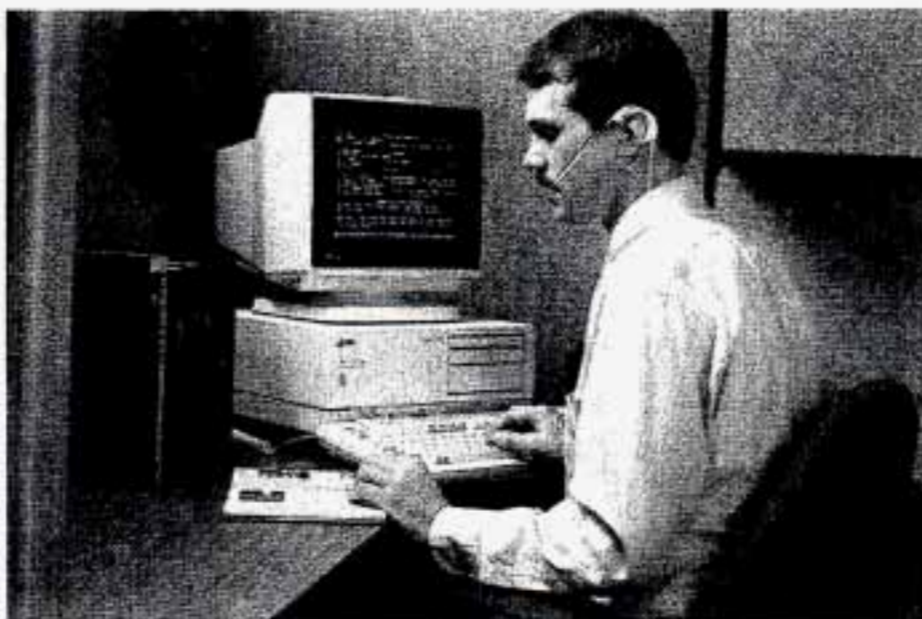

### ***Who Will Repair Your Cadillac At Roadside?***

In many cases, the advisor at the Roadside Service Operations Center can provide instructions to get you back on the road. For more complex problems, the advisor will have an experienced Cadillac Dealership Service Technician, when available, call you. The technician will evaluate the possible cause of the problem and, if you choose, come to your assistance to attempt a roadside repair.



### ***What If Your Cadillac Cannot Be Repaired at Roadside?***

When you call the Roadside Operation Center, the advisor will determine if your car can be repaired at roadside within a reasonable period of time (approximately 45 minutes). If your car can't be repaired within that time or requires the resources of a Cadillac dealership service facility, the advisor will arrange tow service for you. Towing may also be necessary after the technician has attempted a repair, but determines that your car cannot be repaired at roadside.

If arrangements for towing are made by an advisor from the Cadillac Roadside Operations Center, it is for the convenience of the owner and Cadillac is not responsible for the tow company. During the first 12 month/12,000 mile period towing services are covered for any disablement. Beyond this period, if the repair is covered under the applicable General Motors New Car Limited Warranty, the towing expense will be eligible for reimbursement by the servicing Cadillac dealership.



### ***Is There Any Membership Or Enrollment Fee?***

There is no membership or enrollment fee for Roadside Service— any Cadillac is eligible under this program.

While Cadillac Roadside Service is not an auto club, the services and repairs provided often go beyond those offered by some auto clubs . Our objective is to provide immediate assistance to ensure that all Cadillac drivers are assisted in a professional and timely manner with the help of experienced Cadillac advisors and dealership technicians.

### ***What Will Roadside Service Cost You***

There is no cost to call the toll-free Roadside Service number.

If a dealership Service Technician travels to your location, there is a nominal service fee to cover the technician's travel to and from your location. Labor is charged at one and a half times the Cadillac dealership retail labor rate, with a 30-minute minimum. There is also a charge for any parts used and a mileage fee if the technician travels beyond 30 miles.

If the repair to your car is determined to be eligible for coverage under the General Motors New Car Limited Warranty, the participating Cadillac Roadside Service dealership will arrange for a reimbursement for the total cost of the repair on the next business day.

## ***Additional No Charge Roadside Service Special Features For Cadillac Owners:***

- **Emergency Road Service Performed at the Scene for the Following Disablements** – during the first 12 month/12,000 mile period.
  - Lock Out Assistance
  - Gas Delivery
  - Towing Service
  - Battery Jump Starts
  - Flat Tire Change  
(Covers Change Only\*)

\*Determination of replacement tire under Warranty Coverage must be made by a Cadillac dealership or appropriate tire manufacturer.



- **Trip Interruption** – If your trip is interrupted due to a warranty failure, incidental expenses may be reimbursed during the 12 months/12,000 mile period. Items covered are hotel, meals and rental car.
- **Trip Routing** – Free trip routing assistance is available during the first four years. Within a week of contacting Roadside Service with your travel plans, Cadillac will provide a detailed trip routing and personalized North American Road Atlas.

### ***How Do You Pay For Roadside Service?***

Payment is due at the time the repair is performed. Payment may be made by cash, personal check or any major credit card honored by the participating Cadillac dealership.

### ***What If You've Locked Your Keys In The Car?***

If your keys are locked in the car, the technician or locksmith must be given proof of ownership (original vehicle registration and your driver's license) before attempting to enter the vehicle. This precaution is for your protection. For this reason we suggest you carry your vehicle registration and Gold Key Card which includes a convenient credit card type key. This special key can be used to unlock either front door or the trunk compartment.



### ***What If Your Car Is In An Unsafe Location Or On A Limited Access Highway?***

If your car is located in an area that is determined to be unsafe (by you, the advisor or the technician), or if the vehicle is on a limited access freeway or regulated highway, the advisor will arrange to tow your Cadillac to a safe location, where service can be performed. Additional assistance will be provided if necessary.

## *Other Roadside Services*

Cadillac Roadside Service is committed to your total peace of mind and is staffed by Cadillac-trained phone advisors and technicians to provide phone or on-site repair assistance. Beyond the coverage period Roadside Service can also arrange a wide variety of other services to assist you, such as:

- Tow Service
- Battery Jump Start
- Flat Tire Change
- Locksmith
- Fuel Delivery
- Trip Routing
- Taxi
- Lost Keys
- Hotel Information

While there is no charge for some of these items during the specified period, the owner is responsible for any expenses beyond the covered period.

We hope you never need any of the emergency services, but if you do, Roadside Service can promptly locate and arrange them for you wherever you travel in the United States or Canada. It's part of how Cadillac Roadside Service is dedicated to your continued satisfaction.

### *Glove Compartment Decal And Wallet Card*

The Roadside Service toll-free number is located on a decal in the glove compartment, on the wallet card in the back of the Gold Key Owner's Literature portfolio and on the Gold Key Card you received shortly after taking delivery of your new Cadillac.



### *Information To Provide When Calling Cadillac Roadside Service*

When you call Cadillac Roadside Service, the advisor will ask your name and home address, the telephone number and location you are calling from, the location of your Cadillac and a description of the problem. The advisor will ask the following information about your Cadillac:

- Vehicle Identification Number (VIN)

This 17 character code is located on the driver's side top surface of the instrument panel and may be seen through the windshield.

- Model and Year
- Delivery Date
- Mileage

1953 COUPE DE VILLE

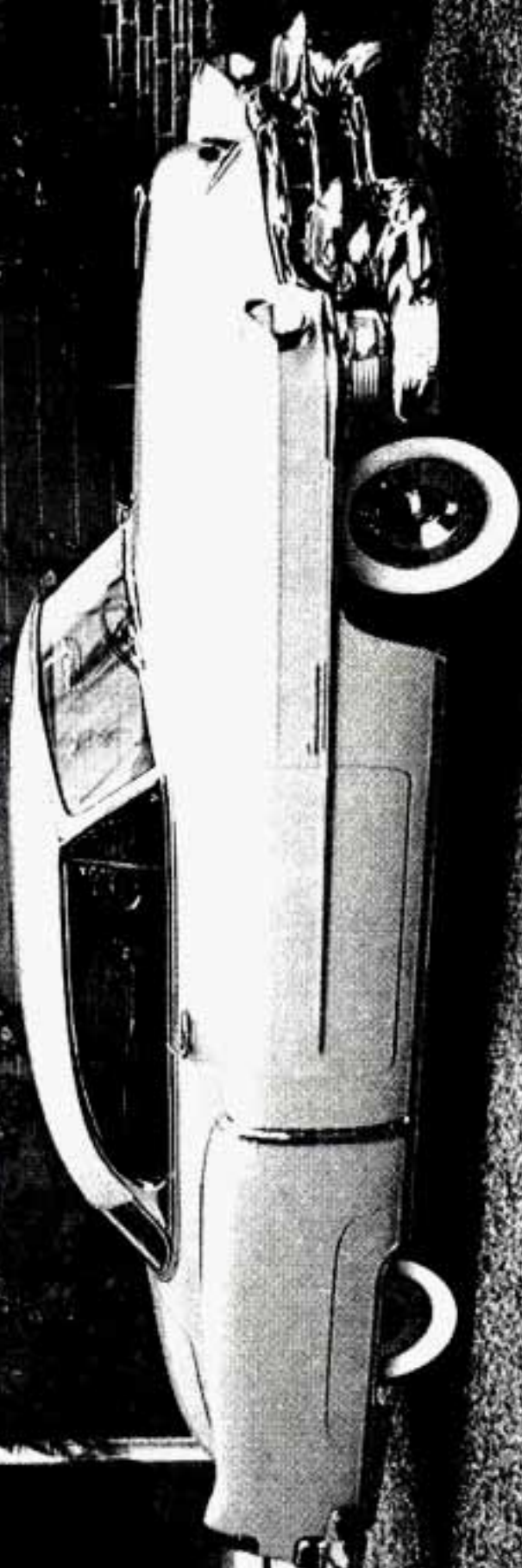

1957 ELDORADO BIARRITZ CONVERTIBLE







## OWNER ASSISTANCE

This section will explain how to contact Cadillac if you need assistance. It also tells you how to obtain service publications and how to report any safety defects.

This section includes the following:

- Customer Satisfaction Procedure
- Zone and Central Office Addresses
- Customer Assistance for Hearing/Speech Impaired
- Mediation/Arbitration Program
- Reporting Safety Defects
- Product Service Publications (PSPs)
- Owner's Manuals and Service Manuals

### CUSTOMER SATISFACTION PROCEDURE

Your satisfaction and goodwill are important to your dealer and to Cadillac. Normally, any problems with the sales transaction or the operation of your vehicle will be resolved by your dealer's Sales or Service Departments. Sometimes, however, despite the best intentions of all concerned, misunderstandings can occur. If your concern has not been resolved to your satisfaction, the following steps should be taken:

**STEP ONE — Discuss your problem with a member of dealership management.** Satisfaction can often be quickly obtained at that level. If the matter has already been reviewed with the Sales, Service or Parts Manager, contact the General Manager or owner of the dealership.

**STEP TWO —** If after contacting a member of Dealership Management, it appears your problem cannot be resolved by the dealership without further help, **contact the Cadillac Consumer Relations Center** 24 hours per day by calling 1-800-458-8006 or if you have an Allanté call 1-800-ALLANTÉ.

In Canada, contact GM of Canada Customer Assistance Center in Oshawa by calling 1-800-263-3777 (ENGLISH). In Quebec, the French language number is 1-800-263-7854.

In Mexico, call 1-900-254-17-86. In Puerto Rico, U.S. Virgin Islands, call 1-809-763-1315. In all other overseas locations, contact GM International Export Sales in Canada by calling 1-416-644-4112.

For prompt assistance, please have the following information available to give the Consumer Relations Representative:

- Your name, address and telephone number
- Vehicle Identification Number (This is available from the vehicle registration or title, or the plate attached to the left top of the instrument panel and visible through the windshield.)
- Dealership name and location
- Vehicle delivery date and present mileage
- Nature of problem

In order to give your inquiry prompt attention, please call the appropriate toll free number listed. However, if you wish to write Cadillac, please send all correspondence to the respective United States, Canada or GM Overseas Central Office address listed on the following page.

When contacting Cadillac, please remember that your problem will likely be resolved in the dealership, using dealership facilities, equipment and personnel. That is why we suggest you follow Step One first.

## **CUSTOMER ASSISTANCE FOR THE HEARING OR SPEECH IMPAIRED**

To assist owners who have hearing difficulties, Cadillac has installed special TDD (Telecommunication Devices for the Deaf) equipment in its Consumer Relations Center. Any hearing or speech impaired customer who has access to a TDD or a conventional teletypewriter (TTY) can communicate with Cadillac by dialing: 1-800-TDD-CMCC. (TDD users in Canada can dial 1-800-263-3830).

# **ZONE AND CENTRAL OFFICE ADDRESSES**

## **CENTRAL OFFICES**

### **UNITED STATES**

Consumer Relations Center  
Cadillac Motor Car Division  
2860 Clark  
Detroit, Michigan 48232  
1-800-458-8006 (24 Hours)  
1-800-ALLANTÉ (Allantés only)

### **CANADA**

Consumer Relations Department  
General Motors of Canada Limited  
Oshawa, Ontario L1J 5Z6  
1-800-263-3777 (ENGLISH)  
1-800-263-7854 (FRENCH)

## **INTERNATIONAL EXPORT SALES**

P.O. Box 828  
Oshawa, Ontario L1H 7N1  
Fax: 416-644-4866  
Telex: 821-06981215

## **CADILLAC ZONE OFFICES**

### **CENTRAL ZONE**

Post Office Box 33109  
Detroit, Michigan 48232

### **FLORIDA ZONE**

Barrette Bank Centre  
Fifth Floor  
625 North Flagler  
West Palm Beach,  
Florida 33401

### **MID-ATLANTIC ZONE**

Post Office Box 9010  
Wayne, Pennsylvania 19087

### **EASTERN ZONE**

Post Office Box 3003  
Parsippany, New Jersey 07054

### **SOUTHEAST ZONE**

Post Office Box 50256  
Atlanta, Georgia 30302

### **LOS ANGELES ZONE**

Post Office Box 5018  
Thousand Oaks, California  
91359-5018

### **MIDWEST ZONE**

Post Office Box 3002  
Naperville, Illinois 60566

### **NORTHWEST ZONE**

Post Office Box 23850  
Oakland, California 94623

### **SOUTHWEST ZONE**

Post Office Box 660118  
Dallas, Texas 75266-0118

**\*NOTE:** The state of  
Alaska is serviced by  
the Northwest Zone.  
The state of Hawaii is serviced  
by the Los Angeles Zone.

## GENERAL MOTORS OF CANADA REGIONAL OFFICES

### CALGARY, AB T2P 3W7

4220 Blackfoot Trail  
P.O. Box 2510  
1-800-263-3777

### TORONTO, ONTARIO M3C 1J1

1200 Eglinton Ave. E.  
416-359-0588  
1-800-263-3777

### MONTREAL, QUEBEC

H9R 4R2  
5000 Trans-Canada Hwy.  
Pointe Claire, Quebec  
1-800-263-7854

## GENERAL MOTORS OFFICES OVERSEAS

### FAR EAST

GM Overseas  
Distribution Corp.  
Roppongi Fuji Building  
2-6 Nishiazabu 3-Chome  
Minato-Ku  
Tokyo, Japan 106  
Telephone: 03-470-3461  
Telex: JAPAUTO J22776

### EUROPE

GM OI X/IES Europe RMO  
C/O GM Service GmbH  
Postfach 1710  
D-6090 Ruesselsheim  
Federal Republic of Germany  
Telephone: 6142-602319 or 312  
Telex: 4182841 GMO D  
Fax: 6142-82632 or Code (02)

### DUBAI

GM ODC/IES Middle East  
Regional Marketing Office  
Dubai International Trade Centre  
Level 30  
P.O. Box 9233  
Dubai, United Arab Emirates  
Telex: 46542 GM ODC EM

### PUERTO RICO

U.S. VIRGIN ISLANDS  
GM Overseas Distribution Corp.  
Centro Commercial  
San Francisco  
Rio Piedras, Puerto Rico  
Mail: G.P.O. Box G-4382  
San Juan, Puerto Rico 00936  
Telephone: 809-763-1315  
Telex: 3450394

### SAUDI ARABIA

GM Overseas  
Distribution Corp.  
P.O. Box 5784  
Jeddah, 21432 Saudi Arabia  
Telephone: 02-665-3380  
Telex: 401748 GMOT SJ

### MEXICO

General Motors de Mexico  
Consumer Relations Supervisor  
Service Department  
Apartado Postal 107-BIS  
Mexico 1, D.F.  
Telephone: 905-245-17-86  
Telex: 1763185

## **GM PARTICIPATION IN BETTER BUSINESS BUREAU MEDIATION/ARBITRATION PROGRAM\***

Our experience has shown that the Customer Satisfaction Procedure described earlier in this section has been very successful in achieving customer satisfaction. If you have discussed a concern with your Dealership management and have not been able to resolve it, let us know. Questions and concerns are resolved most efficiently if you telephone or write directly to our offices as described. However, if you have not been substantially satisfied, Cadillac wants you to be aware of GM's voluntary participation in a no-charge mediation/arbitration program called BBB AUTO LINE. This program is administered by the Council of Better Business Bureaus through local Better Business Bureaus. It can resolve individual disputes involving vehicle repairs and the interpretation of your New Vehicle Limited Warranty.

We prefer that you not resort to BBB AUTO LINE until after a final decision is made under the Customer Satisfaction Procedure. However, you may file a claim at any time by contacting your local Better Business Bureau (BBB) or calling the following 24 hour toll-free number to obtain the telephone number of your nearest BBB office: 1-800-955-5100. For further information about filing a claim, you may also write to:

**BBB AUTO LINE**  
Council of Better Business Bureaus  
4200 Wilson Boulevard  
Suite 800  
Arlington, Virginia 22203

In order to file a claim, you will have to provide your name and address, the vehicle identification number (VIN) of your vehicle, and a statement of the nature of your complaint. BBB staff may try to help resolve your dispute through mediation. If mediation is not successful, or if you do not wish to participate in mediation, eligible customers may present their case to an impartial third party arbitrator at an informal hearing. The arbitrator will render a decision in your case, which you may accept or reject. If you accept a valid arbitrator decision, Cadillac will be bound by that decision. The entire dispute settlement process should ordinarily take about 40 days from the time you file your complaint to the time a decision is rendered (or 47 days if you did not first contact your dealership or Cadillac).

We encourage you to use this program before or instead of resorting to the courts. We believe it offers advantages over courts in most jurisdictions because it is fast, free of charge, and informal (lawyers are not usually present, although you may retain one at your expense if you choose). Arbitrators make decisions based on the principles of fairness and equity. They are not required to duplicate the functions of courts by strictly applying state or federal law. If you wish to go to court however, we do not require that you first file a claim with BBB AUTO LINE \*\* unless state law provides otherwise. Whatever your preference may be, remember that if you are unhappy with the results of BBB AUTO LINE, you can still go to court because an arbitrator's decision is binding on Cadillac but not on you unless you accept it.

Eligibility is limited by vehicle age/mileage, on the component involved and other factors. For further information concerning the program, call your local BBB or call 1-800-955-5100 for the toll-free number of your nearest BBB. You may also call the Cadillac Consumer Assistance Center.

*\*This program may not be available in all states, depending on state law. (Canadian owners should refer to the Canadian Warranty Booklet). General Motors reserves the right to change eligibility limitations and/or to discontinue its participation in this program.*

*\*\* Some states may require that you first file a claim with BBB AUTO LINE before resorting to state operated procedures (including court).*

## **REPORTING SAFETY DEFECTS TO THE UNITED STATES GOVERNMENT**

If you believe that your vehicle has a defect which could cause a crash or could cause injury or death, you should immediately inform the National Highway Traffic Safety Administration (NHTSA), in addition to notifying General Motors.

If NHTSA receives similar complaints, it may open an investigation, and if it finds that a safety defect exists in a group of vehicles, it may order a recall and remedy campaign. However, NHTSA cannot become involved in individual problems between you, your dealer, or General Motors.

To contact NHTSA, you may either call the Auto Safety Hotline toll-Free at 1-800-424-9393 (or 366-0123 in the Washington, D.C. area) or write to NHTSA, U.S. Department of Transportation, Washington, D.C. 20590. You can also obtain other information about motor vehicle safety from the Hotline.

## **REPORTING SAFETY DEFECTS TO THE CANADIAN GOVERNMENT**

If you live in Canada, and you believe that your vehicle has a safety defect, you should immediately notify Transport Canada, in addition to notifying General Motors of Canada Ltd. You may write to Transport Canada at Box 8880, Ottawa, Ontario K1G 3J2.

## **REPORTING SAFETY DEFECTS TO GENERAL MOTORS**

In addition to notifying NHTSA (or Transport Canada) in a situation like this, we certainly hope you'll notify us. Please call us at our Consumer Relations Center, 1-800-458-8006, or in Canada call, 1-800-263-3777, (English) or 1-800-263-7854 (French), or write: Cadillac Motor Car Division, Consumer Relations Center, 2860 Clark Avenue Detroit, MI 48232.

## **SERVICE PUBLICATIONS**

Information on how to obtain Product Service Publications, subscriptions, Indexes and summaries as described below is applicable only in the fifty U.S. states (and the District of Columbia) and only for cars and light trucks with GVWR less than 10,000 pounds (4 536 kg).

In Canada, information pertaining to Product Service Bulletins and Indexes can be obtained by writing to: General Motors of Canada Limited, Service Publications Department, 1908 Colonel Sam Drive Oshawa, Ontario L1H 8P7.

Cadillac regularly sends its dealers useful service bulletins about Cadillac products. Cadillac monitors product performance in the field. We then prepare bulletins for servicing our products better. Now, you can get these bulletins too.

Bulletins cover various subjects. Some pertain to the proper use and care of your vehicle. Some describe costly repairs. Others describe inexpensive repairs which, if done on time with the latest parts, may avoid future costly repairs. Some bulletins tell a technician how to repair a new or unexpected condition. Others describe a quicker way to fix your vehicle. They can help a technician service your vehicle better.

Most bulletins apply to conditions affecting a small number of vehicles. Your Cadillac dealership or a qualified technician may have to determine if a specific bulletin applies to your vehicle.

You can subscribe to all Cadillac bulletins. This way you'll get them as they come out. You can wait a while and get an index to the bulletins. You can also get individual bulletins. However, you'll need the index to identify them.

### **Subscriptions**

You can subscribe to all Cadillac Product Service Publications (PSPs). This will include bulletins for all cars sold by Cadillac and will not be limited to PSPs applicable to any particular model. When you buy a subscription, you will receive the PSPs in periodic mailings shortly after they come out. A subscription costs \$100.00 U.S. (\$110.00 including a special binder) and it entitles you to all PSPs published by Cadillac during that model year. You can purchase a subscription by sending a check or money order to Cadillac Service Publications, Post Office Box 07130, Detroit, Michigan 48027, along with the order form located on page 15. You may get additional subscription ordering forms by calling the toll-free number shown in this section or you can find them at participating dealerships.

### **Individual PSPs**

If you don't want to buy all the PSPs issued by Cadillac for all models in the model year, you can buy individual PSPs such as those which may pertain to a particular model. To do this, you will first need to see our index of PSPs. It provides a variety of information. Here's what you'll find in the index and how you can get one.

## **What You'll find in the Index:**

- ◆ A list of all PSPs published by Cadillac in a model year (1990 or later). PSPs covering all models of Cadillac cars are listed in the same index.
- ◆ Ordering information so you can buy the specific PSPs you may want.
- ◆ Price information for PSPs you may want to buy.

## **How You Can Get an Index:**

Indexes are published periodically. Most of the PSPs which could potentially apply to the most recent Cadillac models will be listed in the last quarterly publication for that model year. This means you may want to wait until the end of the model year before ordering an index, if you are interested in buying PSPs pertaining to a current model year vehicle.

Some PSPs pertaining to a particular model year vehicle may be published on later years, and these would be listed in the later year's index. When you order an index for a model year that is not over yet, we'll send you the most recently published quarterly issue. You can specify an index for an earlier model year, but not before 1990.

Cut out the order form, fill it out, and mail it. We will see to it that an index is mailed to you. There is no charge for indexes for the 1990–1993 model years.

## **Toll-Free Telephone Number**

If you want an additional ordering form for an index or a subscription, just call toll-free and we'll be happy to send you one. Automated recording equipment will take your name and mailing address. The number to call is 1-800-551-4123.

## **Copies at Participating Dealers**

Copies of Indexes and individual PSPs are at your Cadillac dealership. You can ask to see them.

**A VERY IMPORTANT REMINDER:** These PSPs are meant for technicians. They are not meant for the 'do-it-yourselfer'. Technicians have the equipment, tools, safety instructions, and training to do a job quickly and safely.

Cadillac reserves the right to change these procedures without notice after November, 1991.

## **Cadillac Owner's Manuals and Service Publications**

You can get these by using the order form. Additionally, past model Owner's Manuals and Service Information Manuals are available for a minimum of ten model years and frequently much longer. Credit card orders may be placed using the toll-free number 1-800-782-4356. High quality copies of out of print older model manuals are available, also. You may receive a free listing of either by using the order form.



**SERVICE MANUALS  
(AVAILABLE AFTER SEPTEMBER, 1992))**

<b>MODEL YEAR</b>	<b>FORM NO.</b>	<b>DESCRIPTION</b>	<b>PRICE EACH</b>
1993	H-3012	Brougham Service Information Manual	\$50.00
1993	H-3014	DeVille/Fleetwood Service Information Manual	45.00
1993	H-3016	Eldorado, Seville Service Information Manual	45.00
1993	H-3008	Allanté Service Information Manual	55.00
1993	H-3046	Quick Reference Specifications Guide (All Models)	7.00
1992 and Prior	CPCH-092	Order Form for Past Model service Manuals	FREE

**OWNER'S LITERATURE**

<b>MODEL YEAR</b>	<b>FORM NO.</b>	<b>DESCRIPTION</b>	<b>PRICE EACH</b>
1993	H-3024	DeVille Owner Information	15.00
1993	H-3025	Fleetwood Owner Information	15.00
1993	H-3026	Seville Owner Information	15.00
1993	H-3028	Eldorado Owner Information	15.00
1993	H-3022	Brougham Owner Information	15.00
1993	H-3020	Allanté Owner Information	25.00
1993	3532657	Maintenance Coupon Booklet	4.00
1993	3532627	Warranty Booklet (All Models except Allanté)	2.00
1993	3532628	Allanté Assurance Plan (Warranty)	2.00
1992 and Prior	CPCH-092	Order Form for Past Model Owner's Literature	FREE

**NOTE:** Owner Literature Portfolios, Vehicle and Owner Information labels and Gold Keys are available by contacting your Cadillac dealership

**PRODUCT SERVICE PUBLICATIONS INDEXES**

<b>MODEL YEAR</b>	<b>FORM NO.</b>	<b>DESCRIPTION</b>	<b>PRICE EACH</b>
1990	H-2655	Index (Includes applicable bulletin summaries) To review all product service publications (PSPs) for a specific model year vehicle, it is necessary to order the index for that model year and all subsequent model year indexes.	FREE
1991	H-2755		FREE
1992	H-2855		FREE
1993	H-2955		FREE
1990	H-2652B	Bound PSP Edition – includes index plus complete PSPs	20.00
1991	H-2752B	Bound PSP Edition – includes index plus complete PSPs	20.00
1992	H-2852B	Bound PSP Edition – includes index plus complete PSPs (available 10-91)	20.00
1993	H-2952B	Bound PSP Edition – includes index plus complete PSPs (available 10-92)	20.00

**INDIVIDUAL PRODUCT SERVICE PUBLICATIONS  
(Refer to PSP Index for Form Number)**

<b>MODEL YEAR</b>	<b>FORM NO.</b>	<b>DESCRIPTION</b>	<b>PRICE EACH</b>
1990 thru 1993	See details on PSP Index	First Individual PSP Per Order	\$4.00
		Each Additional PSP In Same Order	2.00

**ANNUAL PRODUCT SERVICE PUBLICATION SUBSCRIPTION**

<b>MODEL YEAR</b>	<b>FORM NO.</b>	<b>DESCRIPTION</b>	<b>PRICE EACH</b>
1993	H-3058	Subscription to all Product Service Publications released by Cadillac throughout the Model Year (September 1 through August 31). PSPs mailed quarterly.	\$100.00
	H-2134	3-Ring Binder for Product Service Publications. Includes set of Index Tabs.	\$10.00



1959 FLEETWOOD 60 SPECIAL SEDAN

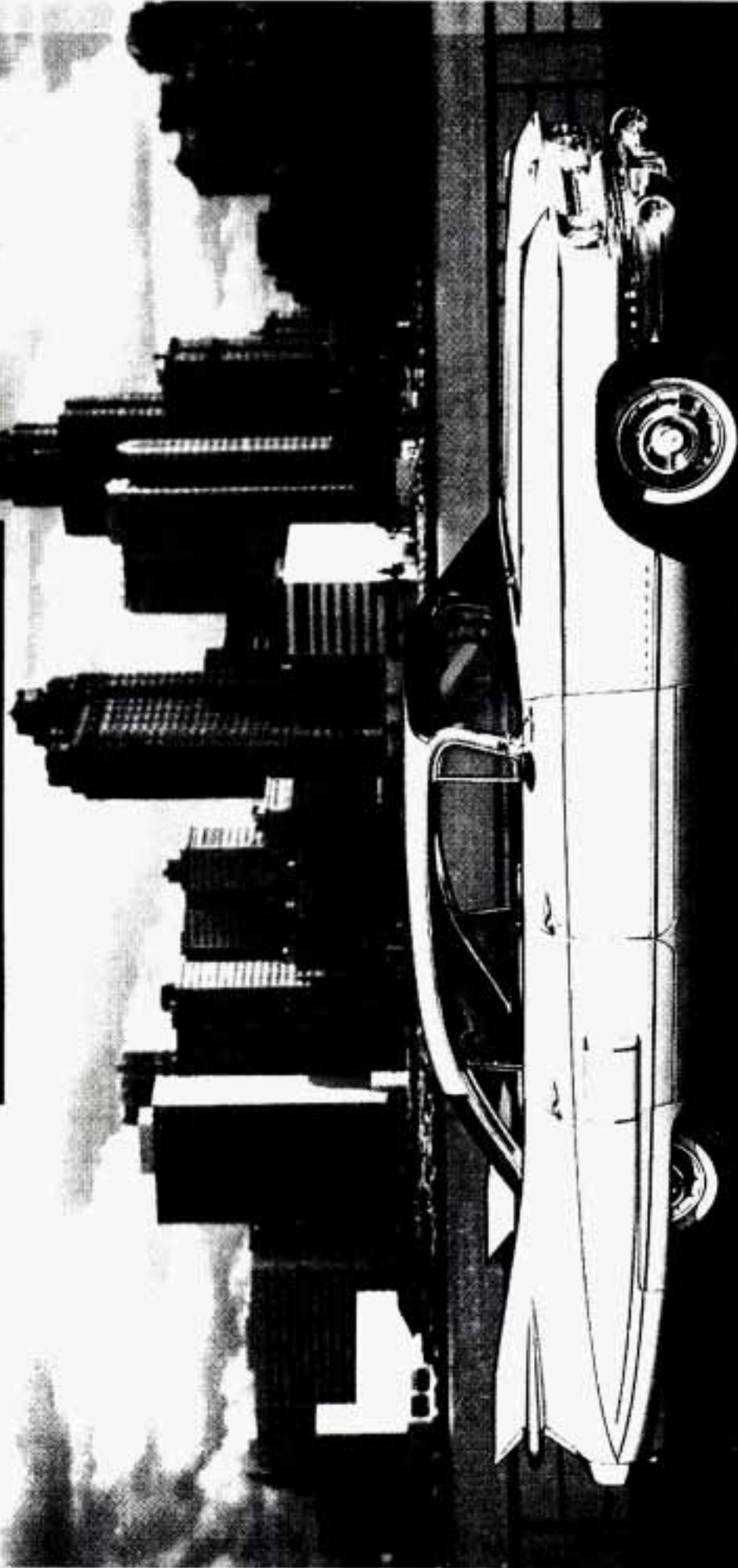

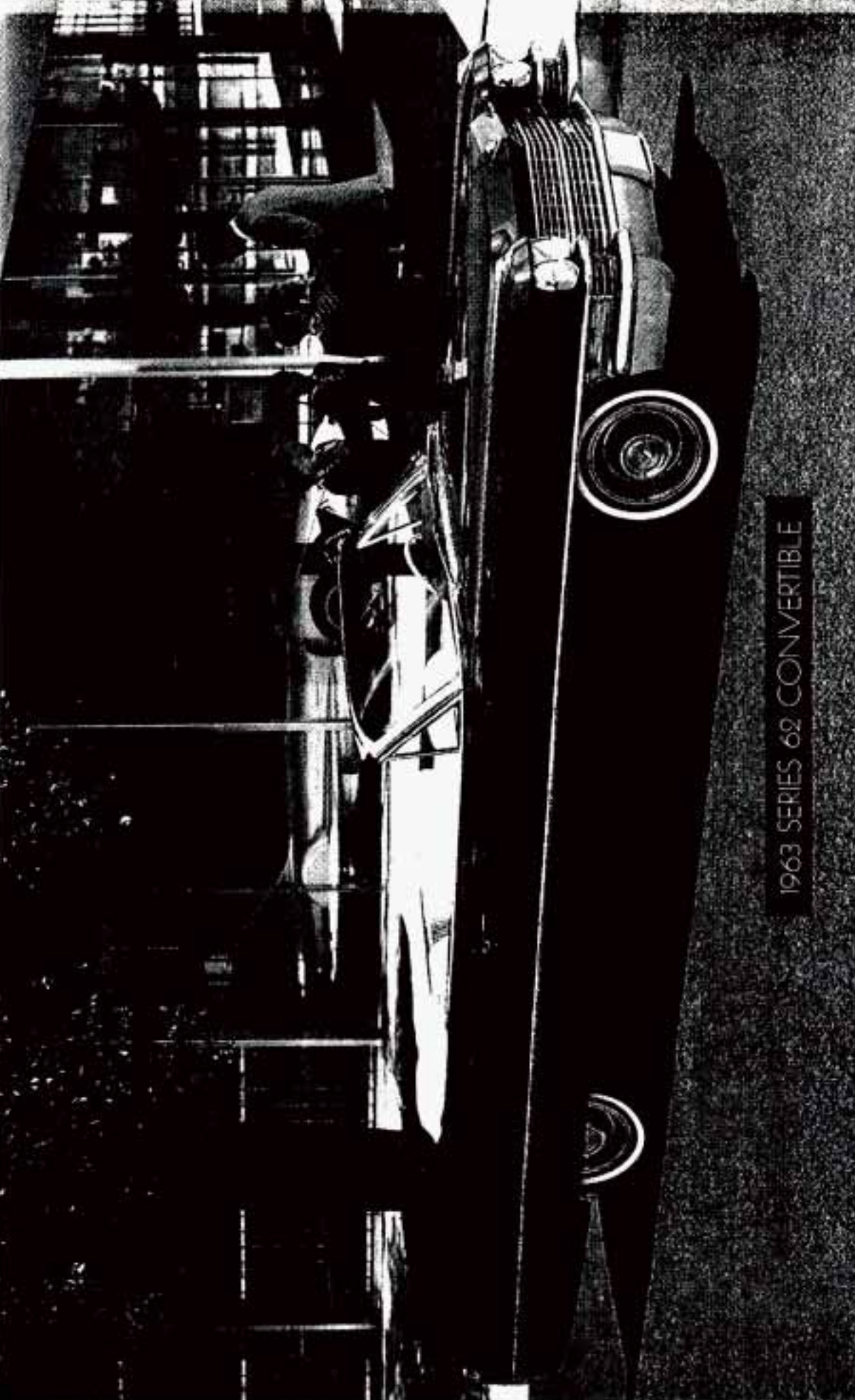

1963 SERIES 62 CONVERTIBLE



## SUBJECT INDEX

### A

Acc (Ignition Key Position) .....	80
Accessory Power, Retained .....	327
Adding	
Brake Fluid .....	293
Electrical Equipment .....	326
Engine Coolant .....	240,245,283,285
Engine Oil .....	271
Power Steering Fluid .....	288
Transaxle Fluid .....	281
Additives, Engine Oil .....	275
Adjustment, Brake .....	184
Adult Safety Belt Usage .....	18
Air Bag .....	30
Air Cleaner .....	277
Air Cleaner Replace .....	See Maint. Book, p.22
Air Cleaner Filter Replacement .....	301
Air Conditioner .....	147
Air Outlets .....	146
Air System .....	146
Alarm, How To Turn Off Theft .....	77
Alcohol, Driving Under The Influence Of .....	175
Alcohol in Gasoline .....	263
Aluminum Wheels, Cleaning .....	322
AMAX® .....	154
AM Radio Reception .....	153
AM Stereo Radio Reception .....	154
Antenna, Cleaning Radio .....	164
Antifreeze .....	237,245
Anti-Lock Brakes .....	181
Anti-Lock Brake System Warning Light .....	129,181
Anti-Theft Tips .....	75
Appearance Care .....	315
Arm, Wearing A Safety Belt Under Your .....	28
Ashtrays .....	121
Astrorooft .....	119
Automatic Air Conditioning System .....	147
Automatic Door Lock .....	68
Automatic Overdrive .....	86

Automatic Transaxle .....	83
Automatic Transaxle Fluid .....	278

## B

Baby Restraint .....	46
Battery .....	293
Battery Cables, Starting With .....	223
Battery Charge Light .....	131
Battery Power Loss .....	294
Beam, Headlight, High-Low Switch .....	101
Belt	
Lap .....	41
Lap-Shoulder .....	19
Rear Seat .....	38
Blizzard, If You're Caught In A .....	211
Block Heater, Engine .....	82
Blood Alcohol Level .....	176
"Blowout," Tire .....	249
Boat, Towing A .....	213
Bose Sound Systems .....	160
Brake	
Adjustment .....	184
Fluid .....	292
Master Cylinder .....	290
Parking .....	88
Pedal Travel .....	184
Brake System, Anti-Lock, Warning Light .....	129
Brake System Warning Light .....	128
Brake Wear Indicators, Disc .....	183
Brakes, Anti-Lock .....	181
Brakes, Trailer .....	216
Braking .....	179
Braking in Emergencies .....	184
Braking If Your Engine Stops .....	181
"Break-In", New Vehicle .....	79
Break-In Schedule, When Towing A Trailer .....	214
Buckling Up .....	18
Bulb Chart .....	333
Bulbs, Halogen, Removal .....	295
Bulbs, Taillight Replacement .....	298
Bulbs, Turn Signal .....	334

## C

Cables, Battery, Starting With .....	223
Camper, Towing A .....	213
Capacities, Fluid .....	349

Carbon Monoxide In Exhaust .....	211
Cassette Tape Player, Care Of Your .....	163
Cassette Tape Systems .....	158
Cautions, Safety .....	1
CB Radio, Adding A .....	155,326
Cellular Telephone, Adding A .....	155,326
Center Console .....	73
Central Door Unlocking System .....	68
Chains, Tire .....	314
Change The Oil, When To .....	275
Changing A Flat Tire .....	250
Charge, Battery, No Warning Light .....	131
Chassis Lubrication .....	See Maint. Book, p.18
Checking	
The Brake Fluid .....	292
The Engine Oil Level .....	270
The Power Steering Fluid .....	287
The Transaxle Fluid .....	278
Things Under The Hood .....	267
Your Restraint Systems .....	61
Your Safety Belt Systems .....	61
Checks, Service Station .....	See Maint. Book, p.8
Chemical Paint Spotting .....	323
Child Restraint, Securing .....	47
Child Restraints .....	46
Children And Safety Belts .....	43
Cigarette Lighter .....	122
Circuit Breakers .....	327
City Driving .....	198
Cleaner, Air .....	277
Cleaning	
Aluminum Wheels .....	322
Fabric .....	317
Glass .....	320
Vinyl or Leather .....	319
Safety Belts .....	319
The Inside Of Your Cadillac .....	316
The Outside Of Your Cadillac .....	321
The Power Antenna .....	164
The Top of the Instrument Panel .....	319
The Underbody Of Your Car .....	323
The Windshield and Wiper Blades .....	320
Weatherstrips .....	322
Clock, Setting The .....	162
Climate Control, Electronic .....	147
Closed-In Places, Don't Idle In .....	96
CO In Your Exhaust .....	95,211



Comfort Controls and Audio Systems .....	146
Compact Disc Player, Care Of Your .....	163
Compact Disc Sound Systems .....	161
Compact Spare Tire .....	258
Computer That Shows Fuel Economy .....	135
Console, Center .....	73
Contents, Table Of .....	See Front of Owner Info. Manual
Control Of A Vehicle .....	178
Control, Loss Of .....	189
Controls, Features And .....	63
Convex Outside Mirror .....	118
Coolant, Engine: Proper Solution To Use .....	237,245
Coolant, Safety Warnings About .....	233,245
Cooling System .....	235,243
Cooling System Service .....	See Maint. Book, p.20
Cruise Control .....	104
Cruise Control, Change Speed With .....	107
Cruise Control, Get Out Of .....	109
Cruise Control On Hills .....	108
Cruise Control, Turning Off .....	109
Curves, Driving On .....	184

## D

Damage To Finish .....	323
Damage To Sheet Metal .....	323
Damage Warnings .....	2
Daytime Running Lights (Canada Only) .....	113
Dead Battery, What To Do If You Have A .....	223
Defensive Driving .....	174
Defogger, Rear Window .....	151
Defrost .....	150
Delco-Bose Gold Series Compact Disc Music Sys .....	160
Delco Sound Systems .....	155
DEXRON IIE® .....	281
Dimensions, Vehicle .....	349
Disc Brake Wear Indicators .....	183
Disposal, Used Oil .....	276
Door Locks .....	65
Door, Security Lock, Rear .....	67
Downhill, Parking .....	206
Downshifting .....	87
Driver Information Center .....	136
Driver Information Center Messages .....	137
Driver's Side S.I.R. ("Air Bag") .....	30

Driving	
And the Road, Your	165
At Night	190
Defensive	174
Hill and Mountain	203
In A Foreign Country	264
In Cities	198
In Fog, Mist And Haze	196
On Snow Or Ice	209
In The Rain	193
In Winter	208
On A Long Trip	201
On The Freeway	199
On The Road	202
On Curves	184
Through Deep Standing Water	83
Winter	208
Drunken Driving	175
Dual Braking System	128

## E

Electric Outside Mirror Control	118
Electrical Equipment, Adding	155,326
Electronic Climate Control	147
Electronic Level Control	145
Electronic Solar Sensor	151
Emergencies, Braking In	184
Emergencies, Steering In	185
Emergency Starting, Discharged Battery	223
Emergency Towing	229
Engine	
Block Heater	82
Change Oil Indicator	143
Coolant	282
Coolant Temperature Warning Lights	130
Exhaust	95
Oil	269
Oil Additives	275
Oil Light	132
Oil, When To Change	275
Overheating	233
Speed Limiter (Northstar)	133
Warning Light About Need For Service	127
Ethanol In Gasoline	263
Exhaust, Caution	95,211
Exhaust, Dangerous Gas In	95,211

Expectant Mothers, Use Of Safety Belts By .....	36
Explanation of Maint. Service .....	See Maint. Book, p.18
Express Down Window (Driver's Side) .....	97
Expressway Driving .....	199
Extender, Safety Belt .....	61
Exterior Appearance .....	315

## F

Fabric, Foam-Type Cleaner On .....	317
Fabric, Solvent-Type Cleaner On .....	317
Fasteners, Replacement .....	262
Features And Controls .....	63
Fetus, Risk To -- From Safety Belt Use .....	36
Filling Your Fuel Tank .....	264
Filter, Oil .....	323
Finish Damage .....	323
First Gear, When To Use .....	88
Flash-To-Pass Feature .....	101
Flat Tire .....	249
Flat Tire, Changing A .....	250
Flooded Engine, Starting A .....	81
Floor Mats .....	123
Fluid	
Brake .....	290
Headlight Washer .....	289
Power Steering .....	286,349
Transaxle .....	278
Windshield Washer .....	288
Fluid Capacities .....	349
Fluids & Lubricants, Recommended ...	See Maint. Book, p.38
Fluid Usage Label .....	268
FM Stereo Radio Reception .....	154
Foam-Type Cleaner On Fabric .....	317
Fog Lights (STS) .....	112
Fog, Driving In .....	196
Fog: Getting It Off the Windshield .....	150
Francais, Guide En .....	See Introduction
Freeing Car From Sand, Mud, Ice or Snow .....	260
Freeway Driving .....	199
French Language Manual .....	See Introduction
Front Seatbacks, Reclining .....	7,8
Fuel .....	262
Fuel Data Panel .....	135
Fuel Gage .....	134
Fuel Door, Remote .....	265
Fuel Tank, Filling Your .....	264
Fuels in Foreign Countries .....	264

Fuse Replacement .....	327
Fuses And Circuit Breakers .....	327

## G

Garage Door Opener .....	123
Gear Positions .....	83
Gearshift Lever, Positions Of .....	83
Gasoline .....	262
Gasoline Tank, Filling Your .....	264
Glass Cleaning .....	320
Glove Box .....	73
Graphic Symbols .....	3
Guard Against Theft .....	75
Guide En Francais .....	See Introduction

## H

Halogen Bulbs .....	295
Halogen Headlight Bulb Removal .....	295
Hazard Warning Flashers .....	221
Haze, Driving In .....	196
Headlight Bulb Removal .....	295
Headlight High-Low Beam .....	101
Headlight On Warning .....	110
Headlight Washers .....	104
Headlight Washer Fluid .....	289
Head Restraints .....	10
Heated Windshield .....	152
Heater .....	146
Heater, Engine Block .....	82
Height Adjuster, Shoulder Belt .....	22
High-Low Headlight Beam Switch .....	101
High Speed, Shifting When Engine Is Running At .....	86
Highway Hypnosis .....	202
Hill and Mountain Roads .....	203
Hills, Parking On .....	205
Holding A Baby In Your Car .....	44
Hood, Don't Open If You See Steam .....	239,246
Hood, Opening The .....	267
Horn .....	97
Hot Coolant, Warning Light For .....	130
Hot Engine, Safety Warnings About .....	233
How The Air Bag System Works .....	32
How To Obtain Roadside Service .....	See Roadside Serv.
How To Operate Your Sound System .....	155
How To Use This Manual .....	1
How To Wear Safety Belts Properly .....	18

Hydroplaning .....	194
--------------------	-----

## I

Ice, If You're Stuck In .....	260
Identification Label, Service Parts .....	326
Identification Number, Vehicle .....	325
Idling Your Engine .....	92
If A Tire Goes Flat .....	249
Ignition Key Positions .....	79
Illuminated Entry System .....	68
Indicator, Bulbs For Turn Signal .....	334
Indicators, Warning, On Instrument Panel .....	127
Infant Restraint .....	46
Inflatable Restraint Light .....	31
Inflation, Tire Pressure .....	307
Information Center, Driver .....	136
Information System On Instrument Panel .....	124
Inside Mirrors (Manual) .....	115
Inspection, Tire .....	309
Instrument Panel .....	124
Instrument Panel Warning Lights .....	127
Interior Cleaning .....	316
Interior Lights .....	112
Introduction .....	See Front of Owner Info. Manual

## J

Jacking And Removing Flat Tire .....	251
Jump Starting .....	223

## K

Keys .....	63
Keys, Ignition .....	79
Keyless Entry, Remote .....	68
Kilometer Indicator .....	126

## L

Label, Fluid Usage .....	268
Lamp Housings .....	295
Lane Change Indicator .....	100
Lap Belt .....	41
Lap-Shoulder Belt .....	19
Larger Children and Safety Belts .....	57
Leaking, Of Exhaust Into Your Car .....	95,211
Leather, Cleaning .....	319
Leaving Your Vehicle .....	68

Light, Air Bag System .....	131
Light, Battery Charge .....	131
Light, Safety Belt Reminder .....	11,17
Light, Service Engine Soon .....	130
Light, Engine Oil .....	132
Light, Engine Temp .....	130
Light, Turn Signal Indicator .....	100
Light, Underhood .....	113
Lighter, Cigarette .....	122
Lights .....	110
Lights, Battery Charge .....	131
Lights, Fog (STS) .....	112
Lights, Interior .....	112
Lights, Operation of .....	111
Lights, Reading .....	114
Lights, Traffic .....	172
Lights, Warning, On Instrument Panel .....	127
Loading -- Tires .....	304
Loading Your Vehicle .....	304
Lock, Rear Door Security .....	67
Log, Operating Record .....	See Maint. Book, p.44
Long Distance Driving .....	201
Loss Of Control .....	189
Low Battery, What To Do About A .....	223
Low Oil Pressure, Warning Light For .....	132
Lubricants, Recommended .....	See Maint. Book, p.38
Lumbar Control Switch .....	9

## M

Maintenance .....	See Maintenance Book
A Word About .....	See Maint. Book, p.2
Coupons .....	See Maint. Book, All
Explanation of Services .....	See Maint. Book, p.18,20,22,24
Oil Change .....	See Maint. Book, p.2
Owner Checks .....	See Maint. Book, p.26,28,30
Operating Record Log .....	See Maint. Book, p.44-80
Recommended Fluids .....	See Maint. Book, p.38,40,42
Schedules .....	See Maint. Book, p.10,12,14,16
Service Ctr. Inspec. & Serv. ..	See Maint. Book, p.32,34,36
Service Station Owner Checks .....	See Maint. Book, p.8
Maintenance Record .....	See Maint. Book, p.44
Markings, Pavement .....	173
Master Cylinder, Brake .....	290
Methanol In Gasoline .....	263
Mileage Indicator .....	125

Mirrors, Front Seat Vanity .....	117
Mirrors, Inside Day/Night Rearview .....	115
Mirrors, Outside .....	118
Mist, Driving In .....	196
Mobile Telephone, Adding A .....	155,326
Mountain Driving .....	203
MTBE In Gasoline .....	263
Mud, If You're Stuck In .....	260

## N

"N" (Neutral) Gear Position .....	86
New Vehicle "Break-In" .....	79
Night, Driving At .....	190
Night Vision .....	191
Notices About Damage .....	2

## O

Occupant Restraint .....	10
Octane Required For Your Car .....	262
Odometer .....	127
Odometer And Speedometer .....	125
Odometer, Trip .....	126
Off (Ignition Key Position) .....	80
Off Road Recovery .....	186
Oil, Engine .....	269
Oil, When To Change Your Engine .....	275
Oil Life Indicator .....	143
Oil Quality .....	273
Oil Thickness (Viscosity) .....	274
Operating Record .....	See Maint. Book, p. 44
Operation in Foreign Countries .....	264
Outside Air .....	146
Outside Mirrors .....	118
Overdrive, Automatic .....	86
Overheated Engine, Warning Light For .....	130
Owner Checks & Services .....	See Maint. Book, p.26

## P

"P" (Park) Position .....	84
Paint Spotting, Chemical .....	323
Park Position .....	84
Park, Shifting Into .....	90

Park, Shifting Out Of .....	93
Parking Brake .....	88
Parking Downhill .....	206
Parking On Hills .....	205
Parking Over Things That Burn .....	94
Parking Uphill .....	206
PASS Key™ (Personalized Automotive Security Sys) .....	77
Passing Another Vehicle .....	187
Pavement Markings .....	173
Pedal Travel, Brake .....	184
Perception Time, In Braking .....	179
Polishing and Waxing .....	321
Possible Damage to Your Cadillac, Notices About .....	2
Possible Injury To People, Cautions About .....	1
Power	
Antenna, Cleaning The .....	164
Door Locks .....	66
Seat Controls .....	6
Steering .....	184
Steering Fluid .....	286
Windows .....	97
Pregnancy, Use Of Safety Belts During .....	36
Problems On The Road .....	220
Product Serv. Publications .....	See Owner Assistance
Proper Safety Belt Usage, For Adults .....	18
Pull Down System, Trunk .....	74

## R

"R" (Reverse) Gear Position .....	85
Racing, Shifting When Your Engine Is .....	86
Radiator Overheating .....	233
Radiator Pressure Cap .....	286
Radio, Two-Way, Adding A .....	155,326
Radio Systems .....	153
Rain, Driving In .....	193
Reaction Time, In Braking .....	179
Reading Lights .....	114
Rear Ashtray .....	122
Rear Door Security Lock .....	67
Rear Window Defogger .....	151
Reclining Seat .....	7
Recommended Fluids & Lubricants ...	See Maint. Book, p.38
Recovery, Off Road .....	186
Recreational Vehicle, Towing A .....	213
Remote Fuel Door .....	265



Remote Trunk Release .....	74
Remote Keyless Entry .....	68
Replacement Fasteners .....	262
Replacing Brake System Parts .....	293
Replacing Safety Belts .....	61
Replacing Tires .....	310
Replacing Wheels .....	313
Reporting Safety Defects	
to Canadian Gov't. ....	See Owner Assistance
to General Motors .....	See Owner Assistance
to U.S. Gov't .....	See Owner Assistance
Restarting Your Car When It's Moving .....	86
Restraint, Infant .....	46
Restraint, Occupant .....	10
Restraint Systems, Checking Your .....	61
Restraints, Child .....	46
Restraints, Head .....	10
Restraints, Larger Children .....	57
Retained Accessory Power .....	327
Reverse Gear Position .....	85
“Riding” The Brakes .....	180
Road Sensing Suspension .....	143
Road, Your Driving And The .....	165
Road Signs .....	165
Roads, Hill and Mountain .....	203
Rocking Your Car Out Of Snow, Ice, Sand Or Mud .....	260
Rotation, Tire .....	309
Rotate, If You're Stuck And Your Front Wheels Can't .....	88
Run (Ignition Key Position) .....	80
Running Your Engine While You're Parked .....	96

## S

Safety Belt Extender .....	61
Safety Belt Reminder Light .....	11,17
Safety Belt Replacement, Need For .....	61
Safety Belt Use During Pregnancy .....	36
Safety Belt Usage By Adults .....	18
Safety Belt Usage By Children .....	43
Safety Belts .....	10
Safety Belts, Center Rear Passenger's Position .....	41
Safety Belts, Cleaning .....	319
Safety Belts, How To Wear Properly .....	18
Safety Belts, Torn .....	62
Safety Belts, Rear Seat .....	38
Safety Belts, Replacing After A Crash .....	61

Safety Belts, Right Front, Adult Passenger .....	37
Safety Belts: They're For Everyone .....	10
Safety Belts, Twisted .....	29
Safety Belts, Why To Wear .....	12
Safety Cautions .....	1
Safety Defects	
Reporting to Canadian Gov't .....	See Owner Assistance
Reporting to General Motors .....	See Owner Assistance
Reporting to U.S. Gov't .....	See Owner Assistance
Safety Warnings .....	1
Sand, If You're Stuck In .....	260
Schedule I Maint. Serv. ....	See Maint. Book, p.14
Schedule II Maint. Serv. ....	See Maint. Book, p.16
Scheduled Maint. Serv.,	
Explanation of .....	See Maint. Book, p.18
Seat, Lumbar and Heated .....	9
Seat Belt (Any Subject) .....	10
Seats and Safety Belts .....	6
Seat Controls .....	6
Second Gear, When To Use .....	87
Securing A Child Restraint .....	46
Selecting the Right Schedule .....	See Maint. Book, p. 12
Service and Appearance Care .....	261
Service Center Inspec. & Serv. ....	See Maint. Book, p.32
Service Engine Soon Warning Light .....	130
Service Information .....	See Owner Assistance
Service Parts Identification Label .....	326
Service Station Checks .....	See Maint. Book, p.8
Servicing Cadillac with the Air Bag System .....	35
Setting The Clock .....	162
Setting The Trip Odometer .....	126
Sheet Metal Damage .....	322
Shift Lever, Console .....	91
Shift Lever, Positions Of .....	84
Shift Lever, Steering Column .....	90
Shifting Into Park .....	90
Shifting Out Of Park .....	93
Shoulder Belt Height Adjuster .....	22
Shoulder Belt Tightness Adjustment .....	24
Signaling Turns .....	100
Signs, Road .....	165
S.I.R. ....	30
Skidding .....	189
Slippery Surfaces, Driving On .....	209
Smaller Children, Use Of Lap-Shoulder Belt .....	43
Snow, If You're Stuck In Deep .....	212

Snow Or Ice, Driving On .....	209
Snowstorm, If You're Caught In A Bad .....	211
Solvent-Type Cleaner On Fabric .....	317
Sound Equipment, Adding .....	155,326
Sound System, How to Operate Your .....	155
Spare Tire, Compact .....	258
Spark Plug Replacement .....	See Maint. Book, p.22
Specifications .....	336
Speedometer And Odometer .....	125
Speed Sensitive Steering .....	142
Speed Sensitive Suspension .....	145
Stains, Removing .....	318
Start (Ignition Key Position) .....	80
Starting Your Engine .....	80
Starting Your Car If The Battery Is "Dead" .....	221
Steam From Hot (Overheated) Engine .....	211
Steep Hill, Parking On A .....	205
Steering .....	184
Steering Column Shift Lever .....	98
Steering In Emergencies .....	185
Steering Tips .....	184
Steering Wheel, Tilt .....	98
Steering Without Power Assist .....	184
Stereo Sound Systems .....	155
Storage, Center Console .....	73
Storing Your Vehicle .....	294
Stuck, If Your Ignition Key Is .....	80
Stuck, If Car Is - In Sand, Mud, Ice Or Snow .....	212
Subscribing to Cadillac Prod. Serv. Pub. ....	See Own. Assist.
Sunglass Compartment .....	120
Sunglasses, Wearing At Night .....	191
Supplemental Inflatable Restraint (S.I.R.) .....	30
Surge Tank Pressure Cap .....	286
Symbols Used On Your Vehicle .....	3

## T

Table Of Contents .....	See Front of Owner Info. Manual
Tachometer .....	133
Taillight Bulb Replacement .....	298
Tamper-Resistance Of Odometer .....	127
Tape Player Care .....	163
Temperature, Engine, Warning Light .....	130
Theft .....	75
Theft Deterrent System .....	76
Thermostat .....	286

Third Gear, When To Use .....	87
Tilt Steering Wheel .....	98
Time, Setting The .....	162
Tire Chains .....	314
Tire, Flat .....	249
Tire Pressure Inflation .....	307
Tire Inspection and Rotation .....	309
Tires -- Loading .....	306
Tire Quality Grading .....	311
Tires .....	306
Tires, When It's Time For New Tires .....	310
Torn Safety Belts .....	62
Torque Lock (Auto Transaxle) .....	207
Towing A Trailer .....	213
Towing Your Vehicle .....	229
Traction Control System (STS) .....	123
Trademarks, GM .....	261
Traffic Lights .....	172
Traffic Officer .....	174
Trailer Towing .....	213
Transaxle, Automatic .....	83
Transaxle Fluid .....	278
Transaxle Gear Positions .....	83
Transaxle Service .....	See Maint. Book, p.22
Travel, Brake Pedal .....	184
Trip Odometer .....	126
Trunk Release, Remote .....	74
Turn Signal and Lane Change Indicator .....	100
Turn Signal/Headlight Beam .....	101
Twilight Sentinel .....	111
Twisted Safety Belts .....	29
Two Children Wearing The Same Safety Belt .....	59

## U

Underbody Maintenance .....	323
Underhood Light .....	113
Uniform Tire Quality Grading .....	311
Unleaded Gasoline .....	262
Uphill Parking .....	206
Upholstery Care .....	317
Urban Driving .....	198
Used Oil, How To Dispose Of .....	276

## V

Vanity Mirrors, Front Seat .....	117
Vehicle Damage Warnings .....	2
Vehicle Identification Number (VIN) .....	325
Vehicle Storage .....	294
Vehicle Symbols .....	3
Vents .....	146
Vinyl, Cleaning .....	319

## W

Warning Lights .....	127
Flashers, Warning Hazard .....	221
Light, Anti-Lock Brake System .....	129,181
Light, Brake System .....	128
Light, Engine Oil Pressure .....	132
Lights, On Instrument Panel .....	127
Lights, Service Engine Soon .....	130
Lights: What To Do If One Goes On .....	127
Warnings, Safety .....	1
Warnings, Vehicle Damage .....	2
Washer, Headlight .....	104
Washer, Windshield .....	103
Water, Don't Use -- For Windshield Washer .....	104
Wear Indicators, Disc Brake .....	183
Weatherstrips, Cleaning .....	322
Wet Road Driving .....	193
Wheel Alignment And Tire Balance .....	313
Wheel Nut Torque .....	257
Wheel Replacement .....	313
Why Safety Belts Work .....	12
Why Wear Safety Belts? .....	10
Window Express Down, Driver's Side .....	97
Windows, Power .....	97
Windshield	
Cleaning The .....	320
Washer .....	103
Washer Fluid .....	288
Wipers .....	102
Wiper Blade Replacement .....	299
Wipers: If They Stop .....	333
Winter Driving .....	208
Working On Your Vehicle .....	261
Worn Tires .....	310
Wrecker Towing .....	229

1964 SERIES 62 CONVERTIBLE

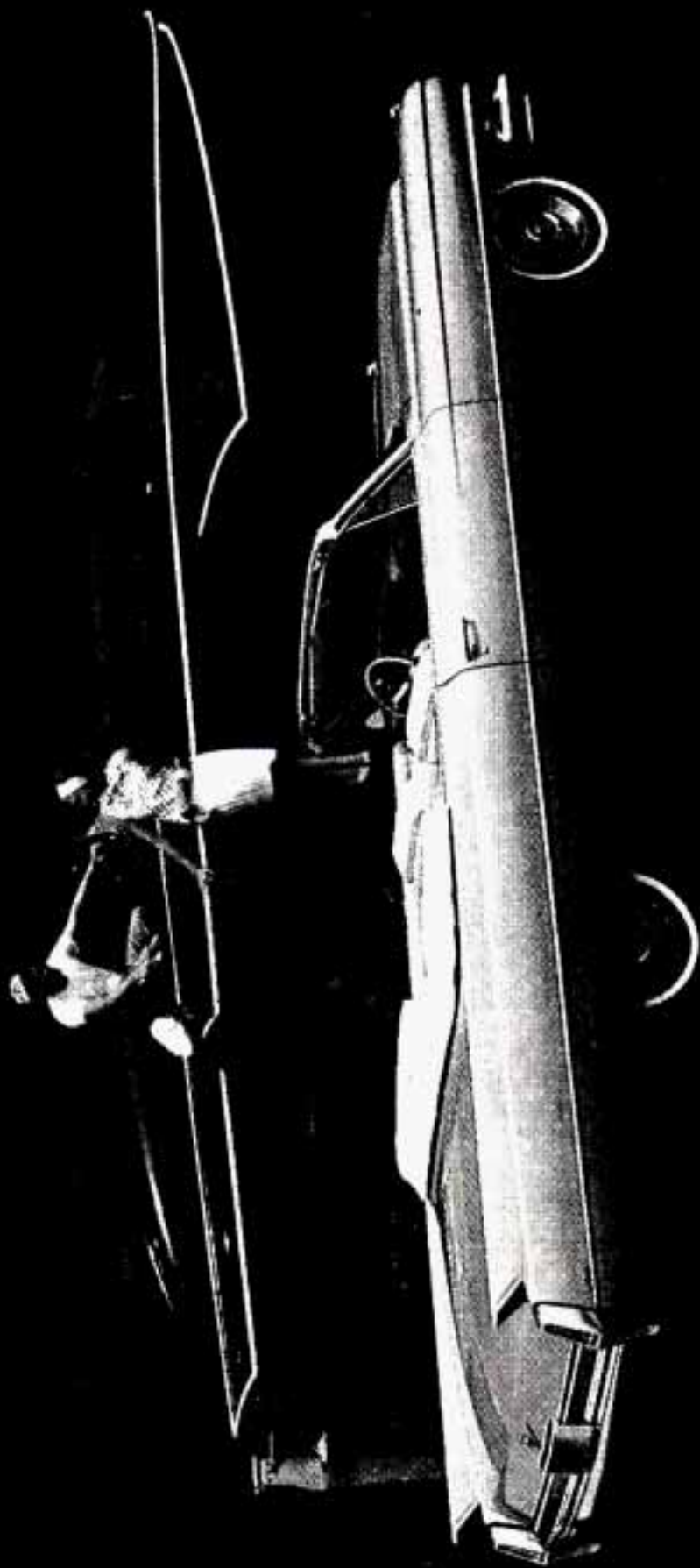



1970 FLEETWOOD ELDORADO